

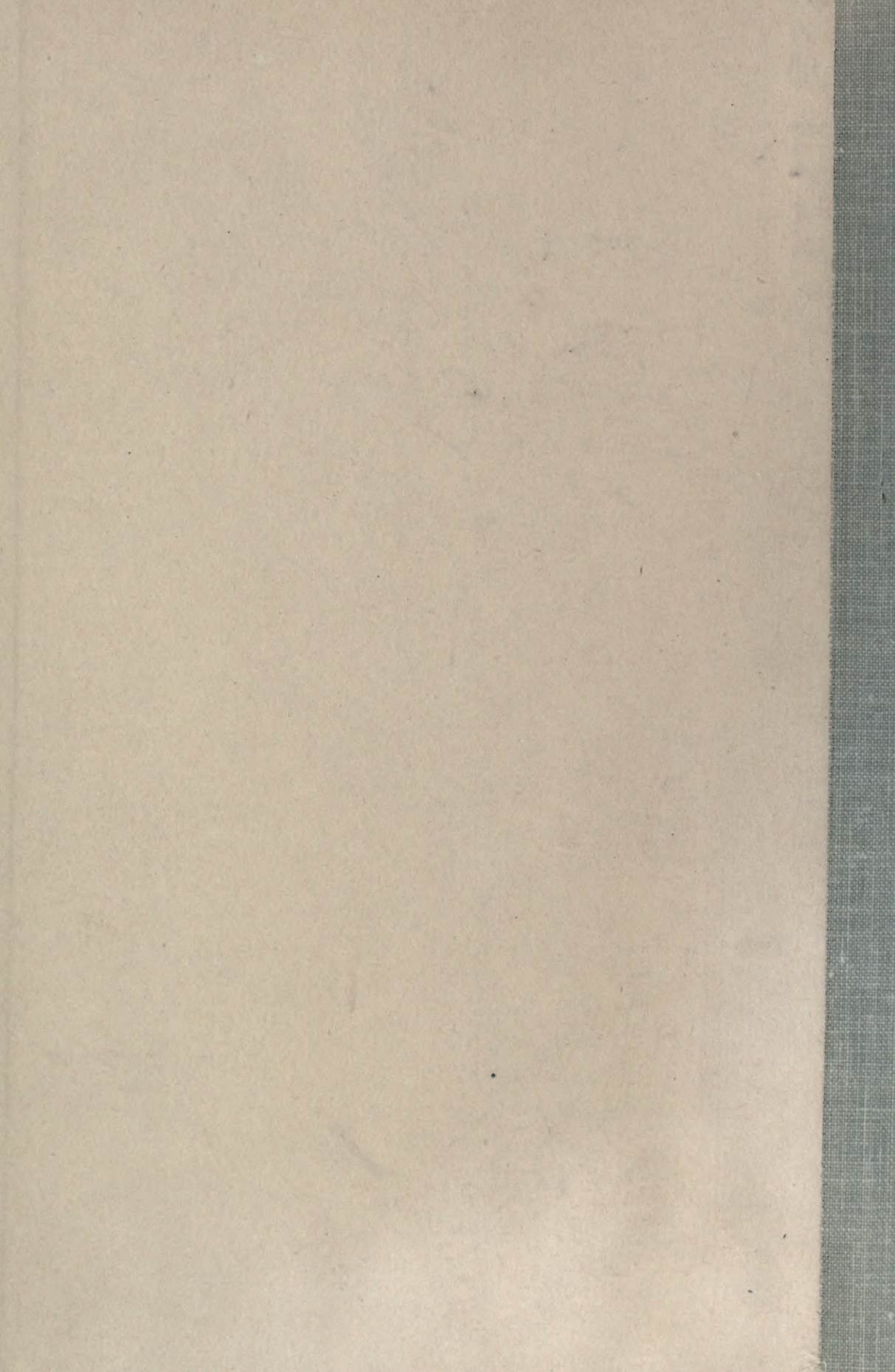

UNIVERSITY OF TORONTO



3 1761 01291561 7





Digitized by the Internet Archive
in 2007 with funding from
Microsoft Corporation



EXPERIMENTAL MORPHOLOGY



THE MACMILLAN COMPANY

NEW YORK · BOSTON · CHICAGO
ATLANTA · SAN FRANCISCO

MACMILLAN & CO., LIMITED

LONDON · BOMBAY · CALCUTTA
MELBOURNE

THE MACMILLAN CO. OF CANADA, LTD.

TORONTO

Morpho.

EXPERIMENTAL MORPHOLOGY

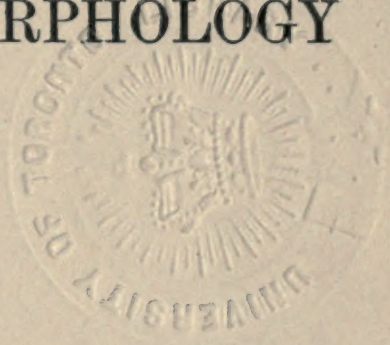

BY

CHARLES BENEDICT DAVENPORT, PH.D.

INSTRUCTOR IN ZOÖLOGY IN HARVARD UNIVERSITY

108730
27 | 3 | 11

New York

THE MACMILLAN COMPANY

LONDON: MACMILLAN & CO., LTD.

1908

All rights reserved



COPYRIGHT, 1896, 1899,

By THE MACMILLAN COMPANY.

New edition, two parts in one volume, April, 1908.

Norwood Press
J. S. Cushing Co. — Berwick & Smith Co.
Norwood, Mass., U.S.A.

Dedicated

**TO THE MEMORY OF THE FIRST AND MOST IMPORTANT
OF MY TEACHERS IN NATURAL HISTORY**

MY MOTHER

Die morphologische Betrachtung setzt also eine genaue chemisch physikalische Kenntniss, 1. des betreffenden Körpers selbst, und 2. aller der bei seiner Entstehung auf ihn einwirkenden Stoffe und Körper voraus. — JAEGER, *Zoologische Briefe*, p. 9.

La vie ne se conçoit que par le conflit des propriétés physico-chimiques du milieu extérieur et des propriétés vitales de l'organisme réagissant les unes sur les autres. — BERNARD, *Rapport sur les progrès de la physiologie générale en France*, 1867, p. 5.

There can be little doubt, indeed, that every science as it progresses will become gradually more and more quantitative. Numerical precision is doubtless the very soul of science, as Herschel says. — JEVONS, *Principles of Science*, chap. xiii.

PREFACE

THE problem which, since the time of Aristotle, has stood first in interest and importance among the great questions of Biology is that of the causes which direct the development of the individual—that marvellous process by which the germ is built up into the complex organism, by which the embryo clothes itself with the characters peculiar to its species, by which even minute individual traits of form and action are exactly reproduced in the offspring from its parents.

The burden of clearing up this problem has fallen, naturally enough, upon the shoulders of students of morphology. For since morphologists deal with form, they are properly especially concerned with the interpretation of form—they may well be asked to account for it. Thus the problem of development is an acknowledged morphological problem.

Several distinct steps can be recognized in the progress which has been made in the interpretation of form. The earlier studies were concerned chiefly with answering the question, *What* are the differences between the various adult forms? The results of observations and reflections relating to this question constitute the sciences of descriptive and comparative anatomy. Next, a more fundamental inquiry was entered upon: *How* are these forms produced or developed? The results of observations and reflections upon this subject constitute the science of comparative embryology. Finally, in these later days a still more fundamental question has come to the front: *Why* does an organism develop as it does? What is that which directs the path of its differentiation? This is the problem which the new school of "Entwicklungsmechanik" has set for itself—it is likewise the problem with which this book is concerned.

The causes which determine the course of an organism's development are numerous, but fall into two general categories; namely, internal causes, which include the qualities of the developing protoplasm; and external causes, which include the chemical and physical properties of the environment in which the protoplasm is developing. The internal and external causes may be studied separately, and in order to disentangle their effects they must needs be studied separately. It is the purpose of the present work to consider the effects resulting from external causes.

When we wish to isolate the separate effects in any complex of causes, we must resort to the well-known procedure of experimentation,—and we find, indeed, that these external causes lend themselves readily to this method of treatment. Accordingly we call in experiment to get an insight into the causes of organic form, and thus justify the name which we have applied to our study,—*Experimental Morphology*.

The primary subdivision of the subject is based upon the morphogenic processes to be treated of; and of these, four principal classes may be recognized. The first includes those processes which are characteristic of all living *protoplasm*; the second, those connected with *growth*; the third, those involved in *cell-division*; and the fourth, those producing *differentiation*. It is proposed to devote one part of the work to each of these four classes of processes.

The secondary subdivision may be based upon the chemical and physical agents whose effects we wish to isolate. These may be grouped into eight categories, determined largely by convenience; namely, 1, chemical substances; 2, water; 3, density of the medium; 4, molar agents; 5, gravity; 6, electricity; 7, light; and 8, heat. It is proposed to devote one chapter to a consideration of the effects of each of these agents upon protoplasm, upon growth, upon cell-division, and upon differentiation.

Two words should be said about the point of view from which this book has been written. In the first place, the developing organism is regarded as a *living* organism, and as such endowed with irritability and capacity of response; consequently, at the outset, we must especially consider the phe-

nomenon of response to external stimuli. Again it is with living *organisms* that we have to deal, and, accordingly, no distinction should be made between animals and plants. I have, indeed, made no such distinction; nevertheless, tastes and training have led me to lay especial stress upon animals. Even this is unfortunate, for the problem with which we are concerned is precisely the same problem in all *living organisms*.

In the second place, much stress is laid upon the quantitative measurement of agents and effects. The lack of precision in many investigations can hardly be too strongly decried; for it often results in confusion and useless disputes. On the other hand, there is good reason for believing that exact measurement is the key to many of the most puzzling of our problems, and important results are to be expected from its use.

As for the aim of the book, it is twofold. I have hoped on the one hand that it might be readable to those who are interested in the general matters of which it treats — matters of importance for philosophy, for psychology, and for pedagogy. For man is an organism, and the development of his qualities is modified by just those agents which guide the development of other organisms. My primary aim, however, has been a different one. It is this aim to which other purposes have been made subservient, which justifies the historical treatment that has been often adopted, and justifies also the detailed descriptions of methods which the lay reader will, naturally, omit. This aim is so to exhibit our present knowledge in the field of experimental morphology as to indicate the directions for further research.

A few words of explanation and acknowledgment are necessary: It was planned at the first to issue all four parts of the work at once; but the task grew in the doing, while the need of its publication became more pressing. So it was decided to issue the work in parts as soon as each should be done. Even under this arrangement it has not been possible to include some of the papers of the last six months; especially I regret the omission of important papers by VERWORN and LOEB upon Galvanotaxis. In writing a book of this sort, which draws upon several sciences, I have had recourse to the kind assistance of several of my colleagues in the physical and

chemical departments of the University. I must especially thank for favors Professor W. C. SABINE, Dr. G. W. COGGESHALL, and Dr. H. E. SAWYER. Of my zoological associates, I am greatly indebted to Dr. G. H. PARKER, who has read nearly the entire manuscript and has offered valuable criticisms on it, and to Professor E. L. MARK, who has read parts of the manuscript and proof and has made important suggestions and emendations. I am also greatly indebted to Mr. CHARLES BULLARD for his kindness in making photographs of figures from which most of the illustrations of the First Part were reproduced. Finally, I cannot forbear to mention the painstaking work of my wife, GERTRUDE CROTTY DAVENPORT, in preparing the manuscript for the press and revising the proofs.

As I send out this work I do so with the hope that it may stimulate to even greater activity in the field of experimental morphology. The subject is new, its importance hardly yet generally recognized, its needs incompletely appreciated. In its scope it embraces much of physics and chemistry, for life and development are to be studied as the physicist studies light and heat, or as the chemist studies solutions and combustion. They are phenomena which must be analyzed by the use of instruments of precision to determine the quality and quantity of the acting agents, and to measure the change in the phenomena resulting from a change in these agents. No other field offers a better opportunity for the utilization of a broad scientific training. The times, too, are auspicious. Biology has never before attracted so many enthusiastic workers as it does to-day. As DRIESCH has said, "Die Lust an thatsächlicher exacter biologischer Forschung ist erwacht"; and the greatest problem of morphology is ever more and more the object of this biological experimentation.

CHARLES BENEDICT DAVENPORT.

CAMBRIDGE, MASS., Dec. 1, 1896.

PREFACE TO PART II

DEVELOPMENT consists of growth and differentiation, accompanied in the larger organisms by nuclear- and cell-division. The present Part deals with growth.

The importance of the study of growth cannot be overestimated, and it is a cause for wonder that the treatment of the subject has been so much neglected by text-books. Indeed, it is a surprising fact that it has not been thoroughly and systematically investigated. For, in last analysis, the maintenance of the human race depends upon that property which protoplasm among all substances alone displays of increasing itself for an indefinite time and to an indefinite amount. And the possibility of increasing the human race beyond limits that are not far off depends upon a better knowledge of the conditions of growth. The reader has only to consider that the world's supply of 2500 million bushels of wheat, 2000 million bushels of maize, 90 million tons of potatoes, and its untold millions of tons of beef, pork, and fish are reproduced each year by growth. The mineral matters of the soil are being washed out into the sea and are largely lost, but the capacity of growth under appropriate conditions is never lost; it redoubles as the amount of the growing substance is increased. The only thing, then, which limits growth is the limitations in the conditions of growth. What are these conditions? This is the important question to which attention has been directed in this Part.

Aside from this practical interest, the study of growth is important as bearing on the question of the dependence of vital activities, and especially development, upon external conditions,

and the possibility of the control of development by appropriately altering those conditions. Growth phenomena show themselves, indeed, particularly susceptible to this control, and are consequently especially valuable for experimental study.

In the preparation of the Second Part, I have been put again under heavy obligations to my friend and colleague, Dr. G. H. PARKER, who has read most of the manuscript and made important suggestions. I am also indebted to Dr. H. E. SAWYER for reading Chapter XI in the manuscript, and to my wife for much painstaking work on the manuscript and proofs and for compiling the index.

C. B. D.

CAMBRIDGE, MASS., Dec. 11, 1893.

CONTENTS

PREFACE	PAGE vii
-------------------	-------------

CHAPTER I

ACTION OF CHEMICAL AGENTS UPON PROTOPLASM

§ 1. Modification of Vital Actions	1
1. Oxygen	2
2. Hydrogen	5
3. Oxides of Carbon	6
4. Ammonia	6
5. Catalytic Poisons	7
6. Poisons which form Salts	12
a. Acids	12
b. Soluble Mineral Bases	13
c. Salts of Heavy Metals	13
7. Substitution Poisons	15
8. Sodid Fluoride	21
9. Special Poisons	22
§ 2. Acclimatization to Chemical Agents	27
§ 3. Chemotaxis	32
Summary of the Chapter	45
Appendix to Chapter I	52
Literature	54

CHAPTER II

EFFECT OF VARYING MOISTURE UPON PROTOPLASM

§ 1. On the Amount of Water in Organisms	58
§ 2. On the Effect of Desiccation upon the Functions of Protoplasm	59
1. Effect of Dryness on Metabolism	59
2. Effect of Dryness upon the Motion of Protoplasm	60
3. Desiccation-rigor and Death	60
§ 3. On the Acclimatization of Organisms to Desiccation	65
§ 4. The Determination of the Direction of Movement by Moisture — Hydrotaxis	66
Literature	67

CHAPTER III

ACTION OF THE DENSITY OF THE MEDIUM UPON PROTOPLASM

	PAGE
§ 1. Introductory Remarks upon the Structure of Protoplasm and the Physical Action of Solutions	70
§ 2. Effect of Varying Density upon the Structure and General Functions of Protoplasm	74
§ 3. Acclimatization to Solutions of Greater or Less Density than the Normal	85
§ 4. Control of the Direction of Locomotion by Density—Tonotaxis .	89
Literature	93

CHAPTER IV

ACTION OF MOLAR AGENTS UPON PROTOPLASM

§ 1. Effect of Molar Agents upon Lifeless Matter	97
§ 2. Effect of Molar Agents upon the Metabolism and Movement of Protoplasm	98
§ 3. Effect of Molar Agents in Determining the Direction of Locomotion—Thigmotaxis (Stereotaxis) and Rheotaxis	105
Literature	110

CHAPTER V

EFFECT OF GRAVITY UPON PROTOPLASM

§ 1. Methods of Study	112
§ 2. Effect of Gravity upon the Structure of Protoplasm	113
§ 3. Control of the Direction of Locomotion by Gravity—Geotaxis .	114
Literature	124

CHAPTER VI

EFFECT OF ELECTRICITY UPON PROTOPLASM

§ 1. Concerning Methods	126
§ 2. The Effect of Electricity upon the Structure and General Functions of Protoplasm	129
§ 3. Electrotaxis	140
Summary of the Chapter	151
Literature	152

CHAPTER VII

ACTION OF LIGHT UPON PROTOPLASM

	PAGE
§ 1. The Application and Measurement of Light	154
§ 2. The Chemical Action of Light upon Non-living Substances	161
1. The Synthetic Effects of Light	162
2. Analytic Effect of Light	163
3. Substitution Effects of Light	164
4. The Isomerismic and Polymerismic Changes produced by Light	164
§ 3. The Effect of Light upon the General Functions of Organisms	166
1. Effect of Light upon Metabolism	166
<i>a.</i> The Thermic Effect of Light on Metabolism	166
<i>b.</i> The Chemical Effect of Light on Metabolism	170
2. Vital Limits of Light Action on Protoplasm	171
3. Effect of Light upon the Movement of Protoplasm	175
<i>a.</i> Effect of Low Intensity of Light on Movement — Dark-rigor	175
<i>b.</i> Effect of High Intensity of Light on Movement — Light-rigor	178
§ 4. Control of the Direction of Locomotion by Light — Phototaxis and Photopathy	180
1. False and True Phototaxis	181
2. Distribution of Phototaxis and Photopathy	182
<i>a.</i> Protista	182
<i>b.</i> Cells and Cell-organs	189
<i>a.</i> Chlorophyll Bodies	189
<i>β.</i> The Rearrangement of Pigment in Animal Cells in Response to Light	192
<i>γ.</i> The Migration of Pigment Cells in the Metazoan Body	193
<i>c.</i> Metazoa	194
3. The General Laws of Phototaxis and Photopathy	196
<i>a.</i> The Sense of the Response	196
<i>b.</i> The Effective Rays	201
<i>c.</i> Phototaxis <i>vs.</i> Photopathy	203
<i>d.</i> The Mechanics of Response to Light	207
Summary of the Chapter	210
Literature	212

CHAPTER VIII

ACTION OF HEAT UPON PROTOPLASM

	PAGE
§ 1. Nature of Heat and the General Methods of its Application	219
§ 2. The Effect of Heat upon the General Functions of Organisms	222
1. Effect of Heat upon Metabolism	222
2. Effect of Heat upon the Movement of Protoplasm and its Irritability	225
§ 3. Temperature-Limits of Life	231
1. Temporary Rigor and Death at the Higher Limit of Tem- perature, Maximum and Ultramaximum	231
2. Temporary Rigor and Death at the Lower Limit of Tempera- ture, Minimum and Ultraminimum	239
§ 4. Acclimatization of Organisms to Extreme Temperatures	249
1. Acclimatization to Heat	249
2. Acclimatization to Cold	257
§ 5. Determination of the Direction of Locomotion by Heat — Ther- motaxis	258
Notes to Table XXI	263
Literature	267

CHAPTER IX

GENERAL CONSIDERATIONS ON THE EFFECTS OF CHEMICAL
AND PHYSICAL AGENTS UPON PROTOPLASM

§ 1. Conclusions on the Structure and Composition of Protoplasm	274
§ 2. The Limiting Conditions of Metabolism	275
§ 3. The Dependence of Protoplasmic Movement upon Metabolism and upon External Stimuli	277
§ 4. The Determination of the Direction of Locomotion	278

CONTENTS

CHAPTER X

	PAGE
INTRODUCTION: ON NORMAL GROWTH	281

CHAPTER XI

EFFECT OF CHEMICAL AGENTS UPON GROWTH

§ 1. Effect of Chemical Agents upon the Rate of Growth	293
1. The Materials of which Organisms are composed	294
<i>a.</i> Analysis of the Entire Organism	296
<i>b.</i> Detailed Account of the Various Elements used as Food	304
Oxygen, 304; Hydrogen, 306; Carbon, 306; Nitro-	
gen, 307; Phosphorus, 313; Arsenic, Antimony,	
and Bismuth, 314; Sulphur, 314; Chlorine, 316;	
Bromine, 316; Iodine, 317; Fluorine, 317; Lith-	
ium, 318; Sodium, 318; Potassium, 318; Rubidium	
and Cæsium, 320; Strontium, 321; Manganese, 321;	
Iron, 321; Magnesium, 323; Silicon, 324; Copper,	
324.	
2. The Organic Food used by Organisms in Growth	324
<i>a.</i> Fungi	324
<i>b.</i> Green Plants	326
<i>c.</i> Animals	327
Amœba, 328; Amphibia, 329; Mammals, 330.	
3. Growth as a Response to Stimuli	331
<i>a.</i> Acceleration of Growth by Chemical Stimulants	331
<i>b.</i> The Election of Organic Food	333
§ 2. Effect of Chemical Agents upon the Direction of Growth — Chemo-	
tropism	335
1. Chemotropism in the Tentacles of Insectivorous Plants	335
2. Chemotropism of Roots	336
3. Chemotropism of Pollen-tubes	337
4. Chemotropism of Hyphæ	340
5. Chemotropism of Conjugation Tubes in Spirogyra	342
Literature	343

CHAPTER XII

THE EFFECT OF WATER UPON GROWTH

	PAGE
§ 1. Effect of Water upon the Rate and Quantity of Growth	350
§ 2. Effect of Water on the Direction of Growth—Hydrotropism	355
1. Roots	356
2. Rhizoids of Higher Cryptogams	357
3. Stems	358
4. Pollen-tubes	358
5. Hyphæ of Fungi	358
Literature	360

CHAPTER XIII

EFFECT OF THE DENSITY OF THE MEDIUM UPON GROWTH

§ 1. Effect of Density upon the Rate of Growth	362
Literature	369

CHAPTER XIV

EFFECT OF MOLAR AGENTS UPON GROWTH

§ 1. Effect of Molar Agents upon the Rate of Growth	370
1. Contact	370
2. Rough Movements	370
3. Deformation	372
4. Local Removal of Tissue	375
§ 2. Effect of Contact upon the Direction of Growth—Thigmotropism	376
1. Twining Stems	376
2. Tendrils	377
3. Roots	380
4. Cryptogams	381
5. Animals	382
6. The Accumulation of Contact-stimulus and Acclimatization to it	382
7. Explanation of Thigmotropism	383
§ 3. Effect of Wounding upon the Direction of Growth—Trauma- trophism	384
1. False Traumatropism	384
2. True Traumatropism	384
§ 4. Effect of Flowing Water upon the Direction of Growth—Rheo- tropism	387
Summary of the Chapter	388
Literature	389

CHAPTER XV

EFFECT OF GRAVITY UPON GROWTH

	PAGE
§ 1. Effect of Gravity upon the Rate of Growth	391
§ 2. The Effect of Gravity upon the Direction of Growth—Geotropism	391
1. False Geotropism	392
2. True Geotropism	392
<i>a.</i> Roots	392
<i>b.</i> Stems	397
<i>c.</i> Rhizoma	398
<i>d.</i> Cryptogams	398
<i>e.</i> Animals	398
<i>f.</i> After-effect in Geotropism	401
Summary	402
Literature	403

CHAPTER XVI

EFFECT OF ELECTRICITY UPON GROWTH

§ 1. Effect of Electricity upon the Rate of Growth	405
§ 2. Effect of Electricity upon the Direction of Growth—Electro-	409
tropism	409
1. False and True Electrotropism	409
2. Electrotropism in Phanerogams	411
3. Electrotropism in Other Organisms	412
4. Magnetropism	413
5. Explanation of Electrotropism and Summary	413
Literature	414

CHAPTER XVII

EFFECT OF LIGHT UPON GROWTH

§ 1. Effect of Light on the Rate of Growth	416
1. Retarding Effect of Light	416
2. Accelerating Effect of Light	423
3. The Effective Rays	427
<i>a.</i> The Effective Rays in the Retardation of Growth by Light	427
<i>b.</i> The Effective Rays in the Acceleration of Growth by Light	432
4. The Cause of the Effect of Light on the Rate of Growth	436
§ 2. Effect of Light upon the Direction of Growth—Phototropism	437
1. Plants	437
2. Animals	442
<i>a.</i> Serpulidæ	442
<i>b.</i> Hydroids	443

	PAGE
3. General Considerations	444
<i>a.</i> Persistence of Stimulation	444
<i>b.</i> Acclimatization to Light	444
<i>c.</i> Mechanics of Phototropism	444
Literature	445

CHAPTER XVIII

EFFECT OF HEAT ON GROWTH

§ 1. Effect of Heat on the Rate of Growth	450
1. Plants	450
2. Animals	457
3. Some General Phenomena accompanying Heat Effects	460
<i>a.</i> Latent Period	460
<i>b.</i> Sudden Change of Temperature	460
<i>c.</i> Cause of Acceleration of Growth by Heat	461
§ 2. Effect of Heat on the Direction of Growth—Thermotropism	463
1. Effect of Radiant Heat	463
2. Conducted Heat	464
3. Causes of Thermotropism	466
Summary of the Chapter	467
Literature	467

CHAPTER XIX

EFFECT OF COMPLEX AGENTS UPON GROWTH, AND GENERAL CONCLUSIONS

§ 1. The Coöperation of Geotropism and Phototropism	470
§ 2. Effect of Extent of Medium on Size	473
§ 3. General Considerations relating to the Action upon Growth of External Agents	478
1. Modification of Rate of Growth	478
2. Modification of Direction of Growth—Tropism	480
3. Adaptation in Tropisms	484
4. Critical Points in Tropism	484
Literature	486

LIST OF TABLES IN PARTS I AND II	489
--	-----

INDEX TO PARTS I AND II	493
-----------------------------------	-----

EXPERIMENTAL MORPHOLOGY

EXPERIMENTAL MORPHOLOGY



CHAPTER I

ACTION OF CHEMICAL AGENTS UPON PROTOPLASM

IN this chapter it is proposed to consider (I) the effect of the various chemical agents upon the chemical constitution of protoplasm, as revealed by the results of their application,— death, modification of the metabolic processes, and of rate of movement; (II) the phenomena of acclimatization to chemical agents; and (III) the effect of such agents in determining the direction of locomotion, — chemotaxis.

§ 1. MODIFICATION OF VITAL ACTIONS*

The vital processes are chemical processes, taking place in a highly complex, very unstable, constantly changing substance, whose activities we call life. It is not easy to study this living substance chemically by the ordinary methods; for these usually, first of all, kill the substance. That the living substance and the dead are quite different is illustrated, for example, in the action of diamid (N_2H_2) and hydroxylamine ($NH_2 - O - H$), which show no action upon dead protoplasm, but are powerful poisons for all living plasm. The instability of protoplasm enables us, on the other hand, to make use of

* In the preparation of this section, much use has been made of the admirable work of LOEW ('93). Not only is the adopted classification of poisons for the most part his, but also, in a few cases, passages from his book have been translated *in toto* here. Most of the determinations of killing strengths of the various reagents for which no other authority is given have been taken from LOEW's book.

certain indirect means for determining its constitution. Since death is due to chemical change, we ought to determine what substances are fatal poisons to protoplasm; and since every activity of protoplasm is a chemical process, we ought to study the modifications of these processes by the action of various chemical reagents.

In studying the behavior of protoplasm in the presence of various reagents, we shall make use especially of observations upon Protista, sexual cells, and tissue cells. In cases where sufficient observations on isolated plant or animal cells are wanting, use will be made of observations upon Metazoa.

At the outset, attention should be called to the necessity of a more quantitative study of the subject. A quantitative study demands, especially, a careful noting of the conditions of the experiment; for the various physical conditions under which the reagent is applied modify the result. Thus, it has been shown, for example, by RICHET ('89, p. 212) that with various poisons the toxic dose diminishes in amount with the elevation of the temperature of the body.

1. **Oxygen.**—It is almost certain that no protoplasm can long survive in the absence of oxygen. Apparent exceptions are found in the case of the anærobic bacteria, some of which are killed in the presence of free oxygen, but multiply rapidly when the oxygen supply is cut off. It has been suggested that, in the case of these and some other parasitic organisms, oxygen is derived from the breaking down of O-containing compounds in the nutritive medium. (Cf. LOEW, '91, p. 760.)

The effect of *diminished oxygen* upon protoplasm is described by CLARK ('89, pp. 370, 371) and by DEMOOR ('94, p. 191). CLARK determined the minimum oxygen pressure necessary for the vital movements of the plasmodia of Myxomycetes and the protoplasm of plant hairs and tissue cells. This he found to range from 1 mm. (plasmodia of Myxomycetes) to 3 mm. (leaf hairs of *Urtica*) of mercury.

DEMOOR* subjected *Tradescantia* stamen hairs, in water, to a

* In studying the effect of a vacuum, DEMOOR employed a piece of apparatus constructed essentially on the plan of an ENGELMANN'S chamber. This consists of a box whose top is a centrally perforated metallic diaphragm and whose bottom is a circular glass. The vertical walls consist of an outer cylinder, at

pressure of 6 to 8 cm. of Hg, or 0.08 to 0.1 of an atmosphere (p. 71). In one hour, on the average, the protoplasmic movements were affected, and in most cells ceased in 2 to 3 hours, slight oscillations only of granules occurring. Thus, not death, but arrest of activity, occurred during this period as a result of reduction of atmospheric pressure — upon which the amount of oxygen held in the water depends. That death did not occur is shown by the fact that when air was readmitted at the normal pressure the protoplasm promptly regained its normal activity. Cells immobilized during 24 hours regain their movements in less than 5 minutes, and these become normal in from 10 to 20 minutes.

Pure oxygen acts in an opposite fashion from diminished oxygen tension, exaggerating the activity of protoplasm. Under its action the protoplasmic movements are much accelerated, but preserve, meantime, their normal character. (*Tradescantia* hairs, leucocytes; DEMOOR, '94, pp. 192, 218.) In Ciliata the rate of the contractile vesicle does not, however, seem to be altered. (ROSSBACH, '72, p. 40.)

Ozone and *hydrogen peroxide* produce atomistic "active" oxygen by becoming split up in the plasma. Ozone (O_3) is said to kill quickly bacteria in water, if the latter does not contain too much organic substance; in the dry state, however, bacteria are injured only slowly by it. (OHLMÜLLER, '92, p. 861.)

Other substances which, with a greater or less degree of probability, may be said to act through oxidation of the protoplasm, may be treated of here.

Hydrogen peroxide (H_2O_2). — PANETH ('89) added one part of neutralized H_2O_2 to 10,000 (0.01%) of hay infusion, and found that all Ciliata were dead within 15 to 30 minutes. Stronger solutions act more rapidly; and even in a 0.005% solution, only part of the animals survived. Algæ survived only 10 to 12 hours in a completely neutral 0.1% solution. A 10% solution is fatal in a few minutes. (Cf. BOKORNY, '86, p. 355.)

Salts of chromic, manganic, permanganic, and hypochlorous

the periphery of the diaphragm, and an inner cylinder at the inner margin of the diaphragm. An inlet and an outlet tube communicate with each of the spaces, — the central space and that between the two cylinders.

acids act as intense poisons, apparently by directly yielding oxygen atoms to the plasma proteins.

Sodic chromate (Na_2CrO_4). — Many anærobic Schizophytes are killed even by a 0.05% solution of this salt. Splenic fever bacteria do not develop in a 0.05% solution in bouillon; in an agar-agar solution, they do not cease to develop until a concentration of 0.5% is reached, although they no longer produce spores in a 0.05% solution. Sodic chromate also acts strongly on algæ. (LOEW, '93, p. 16.)

Potassic dichromate ($\text{K}_2\text{Cr}_2\text{O}_7$). — A 0.1% solution kills algæ (*Spirogyra*) in a few hours.

Potassic permanganate (KMnO_4) is an energetic poison for algæ and Infusoria. A 0.2% solution kills Infusoria (*Paramecium*) in one minute.

Chlorine, bromine, and iodine, as well as hypochlorous acid salts, act, even in very considerable dilution, fatally upon all organisms, by splitting water, forming hydro-halogen compounds, and leaving the oxygen to unite with the living protoplasm. The action of bromine upon glucose may be written —

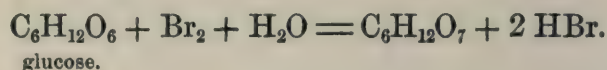

(LOEW, '93, p. 15.)

BINZ has pointed out that (on Infusoria) the poisonous action of these three halogens, like their other chemical properties, diminishes with increase of atomic weight, in the series Cl, Br, I. (Compare the *osmotic* effects of the halogens, p. 72.)

Potassic chlorate (KClO_3) — also similar salts of I and Br — oxidizes in an essentially different fashion from the permanganates. For the latter oxidize even dead organic matter, but the former does not. This reagent may be considered a passively oxidizing one. Concerning its visible effects, we find that bacteria in general are injured by a 2% solution; with weaker solutions in nutrient media the bacteria reduce it to KCl. The anaërobic forms are affected by a 0.5% solution; the aërobic withstand up to 3%. Algæ (*Spirogyra*) die after a few days in a 0.01% solution of the salt. (LOEW, '93, p. 17.)

Arsenious acid (H_3AsO_3) and to a less degree arsenic acid (H_3AsO_4) are poisons which BINZ and SCHULZ ('79) believe

to act by oxidizing the protoplasm. Thus H_3AsO_3 can take up free oxygen as it would be found in water, and it can part with it readily to the protoplasm, thus oxidizing and eventually wholly consuming it. Such is one theory of its action. A few words as to effects upon Protista: Infusoria survive in 0.1% potassic arsenite in spring water only a short time, but live for weeks in a 0.1% solution of the potassic arsenate. (LOEW, '83, p. 112.) Algæ (*Spirogyra*) are killed by a 0.1% solution of potassic arsenite in six days, — the protoplasm contracts and shows formation of granules, the death of the chlorophyll bands preceding that of the cytoplasm. The same solution of potassic arsenate, meantime, shows no injurious action, (LOEW, '87, p. 445.) Still other arsenious acid salts tried upon other algæ (*Zygnema*, *Diatomacea*), upon Infusoria, and upon tadpoles showed themselves, uniformly, more powerful agents than the corresponding arsenic salts. The lower fungi are only slightly affected by arsenious salts; not at all by those of arsenic acid.

2. **Hydrogen.** — KÜHNE ('64, p. 52) subjected *Amœba* to H for 24 minutes. At the end of that time, some individuals had assumed a spherical shape, others appeared unchanged in form, but were motionless. Similar results were obtained with *Actinophrys*, the plasmodium stage of *Myxomycetes*, and with the stamen hairs of *Tradescantia*.

DEMOOR ('94, p. 190) also experimented upon the latter object, and his results are worth giving in detail.* During the first moments of the passage of the gas, the protoplasmic movements are slightly accelerated. Soon the protoplasm becomes very granular, and, after a variable time, 15 to 40 minutes, is quiet. The aspect of the protoplasm at this time varies with the character of the cell. If it is young, having a large nucleus and without a primordial utricle, the protoplasm appears uniformly granular. If, on the contrary, the cell possesses a great reserve of water, with long, protoplasmic filaments, the protoplasmic granules become more refringent, increase in volume, and accumulate around the nucleus, — the peripheral

* Method: The hydrogen gas may be generated in a KIPP's apparatus, and should pass through a series of washing flasks containing, *e.g.*, solutions of potash and acetate of lead. See VERWORN: *Allgemeine Physiol.*, p. 285. DEMOOR kept his stamen hairs in sugared water in an ENGELMANN's chamber.

protoplasm appearing hyaline. The living substance is in repose. The hydrogen may be passed through the apparatus containing the stamen hairs for from 1 to 5 hours without any movement or other change appearing in the protoplasm. Air is now admitted. The protoplasmic movements rapidly return; the granules at first oscillate in their places, then gradually extend the range of their movement. In 5 to 6 minutes the cell has regained all of its anatomical and physiological characters. A similar immobility affects also leucocytes subjected to hydrogen. This occurs in about an hour; but there is great individual variation in this respect. Upon substituting air, the activity of the protoplasm is resumed in from 10 to 20 minutes. Protoplasm which has been subjected to the action of hydrogen thus appears not to be permanently modified, since normal movements recur rapidly upon readmitting air. It seems probable, therefore, that the temporary cessation in movements in the presence of hydrogen is due to the exclusion of oxygen from the protoplasm.

3. The two **Oxides of Carbon**, CO_2 and CO , have very different effects upon protoplasm. Thus DEMOOR ('94, pp. 191, 202, 219) found that whereas the former immobilizes quickly, but kills very slowly, perhaps chiefly by asphyxia, the latter seems in some cases actively to attack the protoplasm. In leucocytes, the ectosarc is separated from the endosarc in a number of completely hyaline fragments; the endosarc becomes vacuolated, and death ensues in from 20 to 60 minutes. Many bacteria are only slightly affected by CO .

4. **Ammonia** (NH_3). — A 10% solution provokes vacuolization, partial coagulation, and irregular movements in the protoplasm of the *Tradescantia* hair. The cell finally enters into repose, all the granules accumulating around the nucleus. Washing the preparation with water restores the original characters of the protoplasm. Thus, ammonia at first energetically excites protoplasm, later producing anæsthesia. (DEMOOR, '94, p. 193.) Even with very weak aqueous solutions (0.005%), which do not kill the protoplasm, BOKORNY ('88) has observed the production in *Spirogyra* cells of granules, which process does not, however, seem to modify the normal activities of the cell. These granules, "proteosomes," are intensely blackened

by alkaline (0.001%) silver solutions. Other basic substances, like potash and organic amine bases, and various alkaloids, produce the same effect. (Cf. LOEW and BOKORNY, '89.)

Azoimid. — LOEW ('91) has studied the effect upon protoplasm of this somewhat close ally of ammonia, $\begin{array}{c} \text{N} \\ \parallel \\ \text{N} \end{array} \rangle \text{NH}$. The

poisonous action of this substance seems to depend upon its excessively unstable structure, for it easily disintegrates with violent explosion and production of ammonia. This latter then produces the characteristic granulations. Infusoria are killed in 2 to $2\frac{1}{2}$ hours by a 0.1% solution of N_3Na , and the water-living Nematodes, Planaria, Ostracoda, Copepoda, and young Planorbis and Lymnæa are killed by a 0.05% solution in 30 to 40 minutes. Algæ are more resistant.

5. **Catalytic Poisons.** — There is a large number of unstable C-compounds which are neither acid nor basic nor characterized by chemical energy, which are, nevertheless, intense poisons for all living cells. Here belong the anæsthetics — ethylether, chloroform, chloral, carbontetrachlorid, methylal, alcohols, carbon disulphide, etc.*

NÄGELI believes these to act as poisons by virtue of an inherent lively condition of molecular movement, which disturbs the normal condition of movement in the living plasma body, and, on that account, produces death. LOEW believes, more precisely, that the transmitted condition of violent movement leads to chemical transformations in the unstable albumen of the protoplasm.

As examples of the effect of the mere presence of many unstable carbohydrates upon chemical processes, it has been found that HCl and prussic acid, which unite alone only at a high temperature, unite in the presence of various ethers at -15° . Again, the mere presence of some CH compounds transforms a substance into its isomeric condition. Thus, thiourea is transformed by an alcoholic solution of amylnitrite into its isomer rhodanammonium. Such poisons, which change the protoplasm by transmission of molecular movements, may be called cata-

* This paragraph and the two following are largely translated from LOEW ('93).

lytic poisons; the process which they inaugurate being known as catalysis (apparently produced by mere contact).

First will be considered the laws of *relation between molecular composition and strength of action*. We may begin with the methan series. This series, which has CH_3 — as its base, runs as follows: —

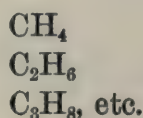

In the members of this series, *the poisonous action increases up to a certain limit, with the number of C atoms*; above that limit the compounds are more stable and are more indifferent; *e.g.* paraffine ($\text{C}_{21}\text{H}_{44}$ to $\text{C}_{27}\text{H}_{56}$).

Beginning with methan, CH_4 , we find this substance — marsh gas — innocuous when mingled with air. *As the H atoms become replaced by one or more chlorine atoms, the poisonous qualities increase,* —

CH_3Cl is slightly anæsthetic,

CHCl_3 = chloroform,

CCl_4 is very dangerous, stupefying involuntary muscles.

If the H atoms are replaced by any other halogen, — *e.g.* I, — anæsthesia is produced among some Vertebrates. Thus, 0.5 to 1 grain of CH_2I_2 kills a rabbit.

In ethan (C_2H_6) also, when Cl replaces H, the substance becomes a more active poison; *e.g.* $\text{C}_2\text{H}_3\text{Cl}_3$, methal chloroform, acts like chloroform.

Also, among the sulphur hydrocarbons we observe the same fact of increase of poisonous action with increase in the number of Cl atoms to the molecule; thus, —

sulphur ethyl, $\text{C}_2\text{H}_5\text{—S—C}_2\text{H}_5$ is a weak poison.

monochlorsulphurethyl, $\text{C}_2\text{H}_5\text{—S—C}_2\text{H}_4\text{Cl}$ is a stronger poison.

dichlorsulphurethyl, $\text{C}_2\text{H}_4\text{Cl—S—C}_2\text{H}_4\text{Cl}$ is a very powerful poison.

In the more complex sulphonic hydrocarbons of the methan series, where the alkyls CH_3 —, C_2H_5 —, etc., are introduced, the rule holds that *the more atoms in the alkyl the more active the substance as a poison*; thus, —

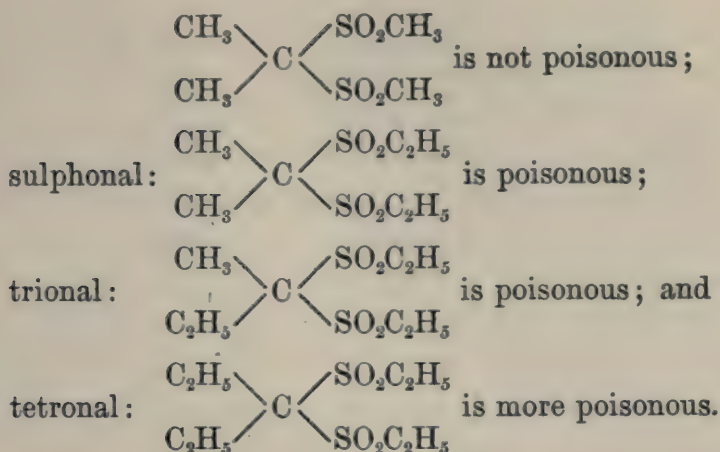

The same holds for the acetals; thus, —

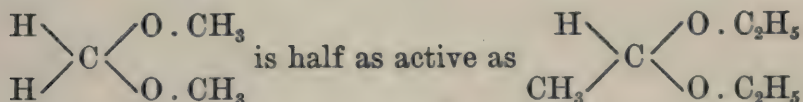

We find the same thing in the ethyl group, —

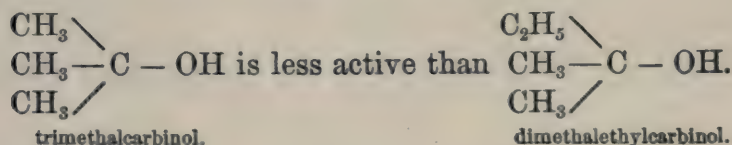

And also in the alcohols, —

methyl alcohol, CH_3OH , weak action;
 ethyl alcohol, $\text{C}_2\text{H}_5\text{OH}$, weak action;
 isopropyl alcohol, $\text{C}_3\text{H}_7\text{OH}$, stupefying.

A few words now concerning the *morphological changes* observed in protoplasm subjected to the action of poisons belonging to this group. Here belong especially the various anæsthetics.

Chloroform and *ether* seem to affect all protoplasm anæsthetically, that of the higher plants as well as that of the higher animals. (BERNARD, C., '78, and ELFING, F., '86.) KÜHNE ('64, p. 100) first studied the effect of chloroform vapor upon *Tradescantia* hairs, but DEMOOR ('94, p. 193) has since described the action of this reagent in much more detail. $\frac{1}{4}$ chloroform water at first (2 to 5 minutes) produces a very intense excitement in the movements of the protoplasm, a strong vacuolization occurs, and then the cytoplasm gradually

becomes immobile and dies in from 15 to 30 minutes. The nucleoplasm is less energetically acted upon than the cytoplasm. Upon swarm-spores, which are highly responsive to light (p. 182), weak solutions of ether and chloroform have such an effect that without preventing locomotion they destroy the power of responding to the stimulus of the external agent. So, too, the migrations of the chlorophyll in *Metaphyta** under the influence of light (see p. 189) is prevented. Ciliata are slightly paralyzed, for the period of the contractile vacuole is diminished. The whole cell body becomes distended with water, and the trichocysts are exploded. (SCHÜRMEYER, '90, p. 453.)

When chloroform water is slowly applied to leucocytes they acquire a spherical form; when quickly applied they become immobile without change of form. The first effect is a very intense increase in movements, especially of the ectosarc. Ultimate washing in serum suffices to restore the leucocyte to its wonted activity; so that it has not been killed, but only anaesthetized. (DEMOOR, '94, p. 217.)

Chloral hydrate, $\text{CCl}_3 - \text{C} \begin{array}{l} / \text{OH} \\ - \text{OH} \\ \backslash \text{H} \end{array}$, which is closely related to

chloroform, $\text{Cl} - \text{C} \begin{array}{l} / \text{Cl} \\ - \text{Cl} \\ \backslash \text{H} \end{array}$, acts similarly as a protoplasmic anaes-

thetic. A 0.1% solution kills Infusoria, Rotifera, and diatoms in 24 hours, but filamentous algæ and Nematoda withstand it.

Sulphonal in 0.1% solution is less injurious than the preceding, since during 24 hours the above-mentioned organisms are uninjured. (LOEW, '93, p. 25.)

Upon the effect of *alcohols* on protoplasm, extended experiments have recently been made by TSUKAMOTO ('95). These reveal in much detail the peculiarities of action of the different kinds. I give three tables showing the time of resistance in hours of various organisms to the various alcohols, constructed from data furnished by his paper.

* ELFING, F. ('86, pp. 47-51). The swarm-spores employed belonged to the species *Chlamydomonas pulvisculus*. The strengths of the solutions which inhibit their response without stopping locomotion are: of ether, 1% to 5%; of chloroform, 12% to 25%. The migration of chlorophyll in *Mesocarpus* is inhibited by a 1% to 2% ether solution.

TABLE I

TIME (IN HOURS) OF RESISTANCE OF TADPOLES OF BUFO VULGARIS, LAUR.
(HIND LEGS HAD JUST APPEARED) TO VARIOUS ALCOHOLS

STRENGTHS.	0.01%	0.1%	0.3%	0.5%	0.7%	1.0%	1.5%	2.0%	2.5%
methylic*								0.3-0.8	0.07-0.3
ethylic							stupor	0.16	
propylic, norm.				0.6	0.3	0.15			
propylic, iso.				0.5	0.2-0.3	0.15			
butylic, norm.		1.0	0.08						
butylic, iso.			0.15-0.25	0.05-0.15					
butylic, tertiary.				0.15-0.33	0.05-0.25				
amylic, norm.		0.2-0.5							
allylic	4-5	1.5-2.0							

TABLE II

TIME (IN HOURS) OF RESISTANCE OF INFUSORIA AND OSTRACODA TO VARIOUS ALCOHOLS

STRENGTHS.	0.005%	0.1%	0.5%	1.0%	3.0%
methylic					20
ethylic					4
propylic, norm.				72 †	
propylic, iso				18	
butylic, norm.			48	18	
butylic, iso			72	48 †	
butylic, tertiary.				48 + †	
amylic, norm.		24 +	24		
allylic	24				

* The structural formulas of these alcohols are given here for reference:—

- methylic H - CH₂OH
- ethylic CH₃ - CH₂OH
- propylic, norm. CH₃ . CH₂ - CH₂OH
- propylic, iso. (CH₃)₂ - CHO
- butylic, norm. CH₃ . CH₂ . CH₂ - CH₂OH
- butylic, iso. $\begin{matrix} \text{CH}_3 \\ \text{CH}_3 \end{matrix} > \text{CH} - \text{CH}_2\text{OH}$
- butylic, tertiary $\begin{matrix} \text{CH}_3 \\ \text{CH}_3 \end{matrix} > \text{COH} - \text{CH}_3$
- amylic, norm. CH₃ . CH₂ . CH₂ . CH₂ - CH₂OH
- allylic CH₂ . CH - CH₂OH

† Ostracoda only ; the Infusoria died after 18 hours.

TABLE III

TIME (IN HOURS) OF RESISTANCE PERIOD OF SPIROGYRA COMMUNIS TO VARIOUS ALCOHOLS

STRENGTHS.	0.005%	0.01%	0.05%	0.1%	0.5%	1.0%	2.0%	3.0%	4.0%
methylic							120	96	48
ethylic							72	72	48
propylic, norm. . .						72			
propylic, iso. . . .						48			
butylic, norm. . . .					72	48			
butylic, iso.					96	48			
butylic, tertiary.						48			
amylic, norm. . . .					24				
allylic	66	72	24	24					

From these experiments it appears that allylic alcohol is more injurious than the others, so that TSUKAMOTO ('95, p. 281) believes it to attack the protoplasm directly rather than to act merely catalytically. We see also that the rule enunciated above about the greater activity of substances with more complex alkyls holds true in general. Of the butylic alcohols the normal is the most poisonous; the tertiary, least.

Carbonic disulphide (CS_2) is one of the more powerful catalytic poisons. A saturated aqueous solution, which contains only a trace of CS_2 , nevertheless kills quickly algæ, bacteria, and the lower water animals. (LOEW, '93, p. 29.)

6. **Poisons which form Salts.**—This is the third group recognized by LOEW. In this case we have to do with acids and bases which unite with the protein substances of the protoplasm-producing salts. Thus disturbances leading to death are produced. In addition this group comprises the poisonous metallic salts. So we may recognize three groups: *a.* acids; *b.* the soluble mineral bases; *c.* salts of heavy metals.

a. Acids.—The strong *inorganic* acids act, in general, more powerfully than the organic. Most bacteria, algæ, and Infusoria are very sensitive to inorganic acids (see MIGULA, '90), but splenic fever bacteria resist 1% HCl for 24 hours, and their spores 2% HCl for 48 hours. Mold withstands 1% phosphoric acid. Certain tissues have gained a high resistance capacity to inorganic acids. Thus, the gland cells of marine

Gastropoda (Dolium, Cassis, Tritonium, Natica heros) secrete 2% to 3% H_2SO_4 . (LOEW.)

To *organic acids* many algæ are little resistant. Thus Spirogyra and Sphæroplea die in 0.1% malic or tartaric acid after 30 minutes; in 0.05% malic or tartaric acid after 24 hours; in 0.01% of these same acids in a few days. Formic acid prevents development of bacteria even in small percents — 0.05% to 0.006%. On the other hand, some protoplasm has acquired a resistance to organic acids. The vinegar eel — Rhabditis aceti — lives in 4% acetic acid. The protoplasm of the Drosera tentacle resists 0.23% tartaric, citric, and other organic acids.

b. Soluble mineral bases, including those of corrosive alkalies and the alkaline earths: Ca, Ba, and Sr. The corrosive alkalies cause a swelling of the protoplasm, but the primary effect is rather a chemical one. (Cf. FROMANN, '84, p. 90.)

The lower water animals and plants are quickly killed by 0.1% potassic or sodic hydrate. Thus, the movements of Chara cease in 0.05% KOH in 35 minutes. Bacteria are more resistant; the limit for the typhus bacilli being between 0.10% and 0.14%, and for the cholera bacillus, between 0.14% and 0.18%. Ascaris is still more resistant, living for 20 minutes in a 2% solution of NaOH.

CaO is still more powerful. A 0.007% to 0.025% solution in bouillon kills bacilli. A 0.013% solution is fatal to algæ like Spirogyra.

K_2CO_3 kills bacteria in 0.8% to 1.0% solutions.

Na_2CO_3 kills Ascaris in a 5.8% solution after 5 to 6 hours. (LOEW, '93, pp. 33, 34.) FROMANN has discussed the histological changes in protoplasm after treatment in Na_2CO_3 .

It is difficult to say whether the action of some of these reagents may not be an osmotic, rather than a chemical one. The action of Na_2CO_3 , for example, as described by FROMANN, is very similar to that of NaCl, whose action is probably solely osmotic.

c. Salts of Heavy Metals. — The method of action of these poisons has been accounted for upon the following grounds: When amido-acids (which are found as disintegration products of all animal tissues) are treated with salts of the heavy metals,

the hydrogen in either the carboxyl-group or the amido-group can be replaced by the metal. Likewise the hydrogen of the amido-group in urea derivatives and many bases are replaceable by metals. In the still more complicated protein stuffs the H bound to the N or O can be replaced. Many metals, indeed, like silver or mercury replace *preferably* the H of the amido-groups, and on this account, perhaps, their salts are especially poisonous. (LOEW, '93, p. 34.)

Salts of Hg, Ag, and Cu cause death to Spirogyra even in a dilution of 1 : 1,000,000 ; the chlorophyll bodies being first affected.* Upon the bacteria of splenic fever the double cyanides of Ag, Hg, and Au are the most injurious, next those of Cu, Pb, and Zn, and, finally, those of Pt, Ir, and Os. Tadpoles and Tubifex are killed in 24 hours by solutions of CuSO_4 weaker than 0.00005%. (LOCKE, '95, p. 327.) Among mercuric salts, splenic fever bacteria do not develop in 0.0003% HgCl_2 in nutritive bouillon, nor 0.0125% in blood. Lactic acid bacteria do not reproduce in 0.0007%. Mold spores are killed in

* In this connection reference must be made to the posthumous paper of NÄGELI ('93), "Ueber oligodynamische Erscheinungen in lebenden Zellen." This author found that water distilled in copper vessels or 1 litre of water in which 12 clean copper coins had stood for four days acted fatally upon Spirogyra. The water was found in one such case to contain 1 part Cu in 77,000,000 of water. It was believed to be in solution in the form of the hydroxyd (CuH_2O_2). Similarly produced solutions of other metals, Ag, Zn, Fe, Pb, Hg, had a similarly fatal effect upon Spirogyra. NÄGELI believed that the effect of the metals was not a chemical one, but was due to a new force — "oligodynamic." Besides the fact of the action of very dilute solutions, the only evidence he adduced for the new force was based on the difference of action on the chlorophyll bands of solutions of 1 : 1000 or 1 : 10,000 and 1 : 10,000,000. In the weaker solutions ("oligodynamic" action) the bands alone were drawn away from the cell-wall, in the stronger solution (chemical action) the whole peripheral protoplasm was shrunk away. It does not seem necessary to invoke a new force to explain the action of weak solutions: first, because the two actions are not sharply separated, according to NÄGELI's own data; secondly, because the chlorophyll bands are in general more sensitive than the rest of the protoplasm (p. 5); and, thirdly, because the action of so weak a solution is not surprising in view of the fact that Spirogyra is one of the least resistant of organisms. Even in a comparatively resistant organism, like Stentor, a solution of 1 : 80,000,000 HgCl_2 produces acclimatization to the poison and 1 : 10,000,000 has an injurious effect. Yet between the action of such solutions and those of 1 : 1000 there is a complete graduation in increasing effect. (See p. 30.) Even in NÄGELI's experiments solutions of less than 1 : 100,000,000 had little action.

0.1%. NEAL and I have found that *Stentor coerulesus* is killed by a 0.001% solution HgCl_2 in a few seconds. (Cf. p. 30.) *Ascarids* die in a 0.1% solution in an hour. (SCHRÖDER, '85.)

Silver salts occasionally act upon bacteria more energetically than those of Hg. Cadmium and zinc salts are poisonous — the former more so than the latter. Thus, whereas 0.015% of cadmium sulphate inhibits reproduction of lactic acid bacteria, 0.1% of zinc sulphate is not injurious. Many salts of thallium are likewise active. Thus LOEW ('93, p. 37) found that in 0.1% thallium sulphate *Spirogyra* died in 4 to 6 hours.

7. **Substitution Poisons.** — In this group LOEW places certain nitrogenous substances which attack the amido and aldehyde groups of living protoplasm. These are extremely unstable substances and may therefore be transformed by agents which have no effect upon dead protoplasm. The supposed method of action of a poison upon an aldehyde may be illustrated in the case of the poison hydroxylamine ($\text{H}_2\text{N} - \text{OH}$); which justifies at the same time the term "substitution poisons."

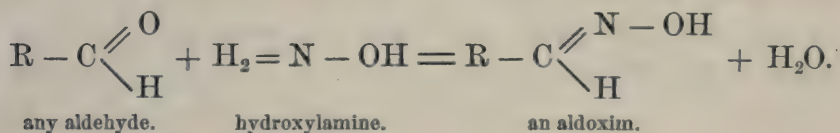

Hydroxylamine. — This is a general and powerful poison. Thus, among the lower organisms, a solution of neutral hydroxylamine of —

- 0.001% kills diatoms within 24 hours. (LOEW, '85^a, p. 523.)
- 0.005% kills in 36 hours *Infusoria* which withstand a similar concentration of strychnine. (LOEW.)
- 0.01% kills diatoms in something less than 15 hours; *Planaria* and leeches in 12 to 16 hours. (LOEW.)
- 0.1% paralyzes the muscles of *Rotifera* in 10 to 15 minutes; those of *Nais* in 20 to 30 minutes. (HOFER, '90, pp. 324, 325.)
- 0.2% kills *Rotifers*, *Copepoda*, and *Isopods* in 1 hour (LOEW); stupefies *Vorticella* in from 2 to 10 minutes. (HOFER, '90, p. 325.)
- 0.25% stupefies *Stentor* in 10 to 20 minutes. (HOFER.)

Benzenylamidoxim and *acetoxim*, more complex derivatives of hydroxylamine, are somewhat less poisonous.

Diamid, or *hydrazin* ($H_2N - NH_2$) in the form of neutral solutions of the sulphate is a rapid poison. A solution of —

0.01% kills various alga species in 1 to 2 days.

0.02% is injurious to bacteria.

0.05% kills various water animals within 12 hours. (LOEW, '93.)

Phenylhydrazin $\left[\begin{array}{l} C_6H_5 \\ H \end{array} \right] N - NH_2$ is more powerful. A solution of —

0.0067% kills Infusoria and algæ within 18 hours.

0.05% prevents the development of bacteria and mucors.

As free ammonia (NH_3) is a far weaker poison than diamid ($H_2N - NH_2$), so *anilin* ($C_6H_5NH_2$) is far weaker than phenylhydrazin ($C_6H_5 \cdot NH \cdot NH_2$).

Passing now to the more complex nitrogenous compounds, we find, first, that bodies which possess slight or no poisonous power, and contain tertiary N, can become strong poisons by addition of H and formation of imido-groups (*i.e.* groups which can be derived from ammonia by the substitution for two H atoms of bivalent acid radicals); thus, —

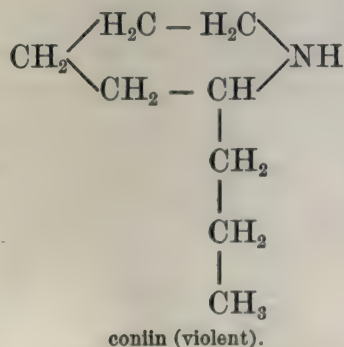
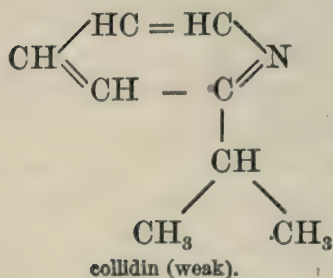
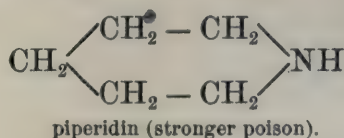
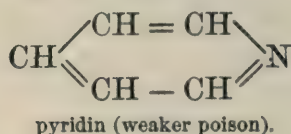

In the preceding and the two following cases it is seen that, in general, when there is a hydrogen atom of the amid radical (NH_2) unreplaced by an alkyl, the substance is poisonous.

ONLY SLIGHTLY POISONOUS.

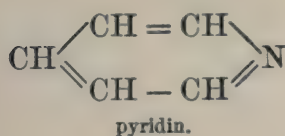
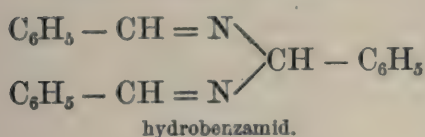

VIOLENT POISONS.

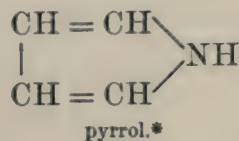
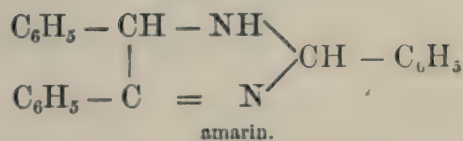

This increased poisonousness, correlated with the presence of H joined to N, may be accounted for by the union of this H with the O of the ketons or aldehydes of the living substance.

Likewise when one or more H atoms of the amido-group are replaced by an acid radical (*e.g.* that of acetic acid, $\text{CO} \cdot \text{CH}_3$), the poisonous qualities of the substance are considerably diminished; thus, —

MORE POISONOUS.

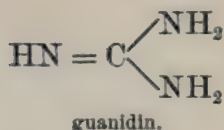
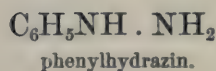
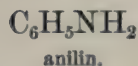

LESS POISONOUS.

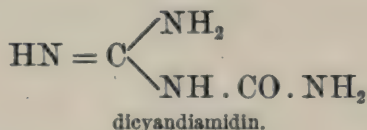
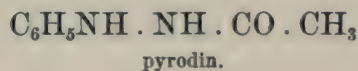

In like manner when, in an imido-group, the H (of the NH radical) is replaced by alkyls (*e.g.* CH_3), the substances become less poisonous; thus, —

* While a 0.07 % solution of pyrrol kills Isopods, Rotifers, Planaria, etc., in about 1 hour, these organisms withstand a solution of pyridin of the same strength. (LOEW, '87, p. 444.)

† SCHÜRMEYER ('90, p. 445) finds that upon Ciliata (Carchesium) a 0.1 % solution slightly accelerates at first the action of the cilia, diminishes the rate of succession of the phases of the contractile vacuole, and leaves the protoplasm permanently more or less paralyzed.

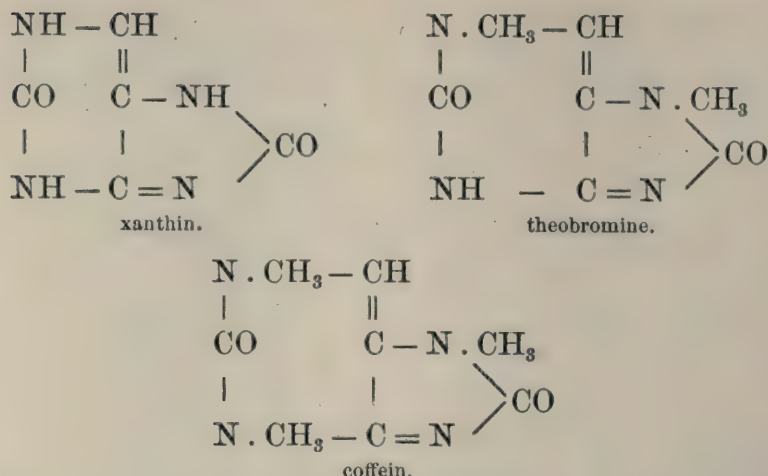

are successively less poisonous. (LOEW, '93, p. 46.)

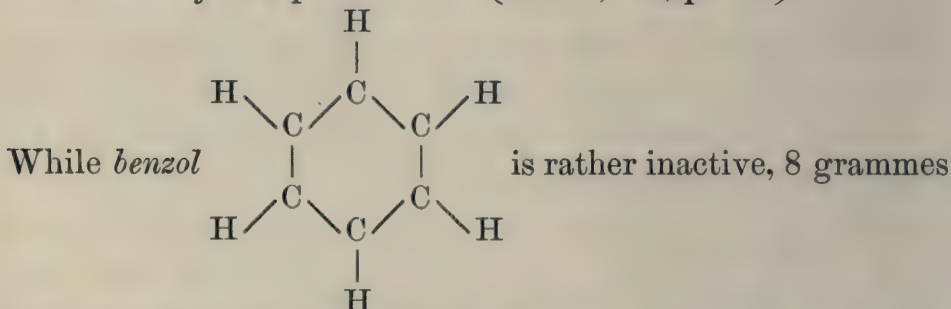

per day being withstood by the human organism, with the replacement of the H atoms by OH the substance becomes more poisonous in direct proportion to the number of H atoms thus replaced. (LOEW, '87, p. 440.) Thus there follow in order of poisonousness:—

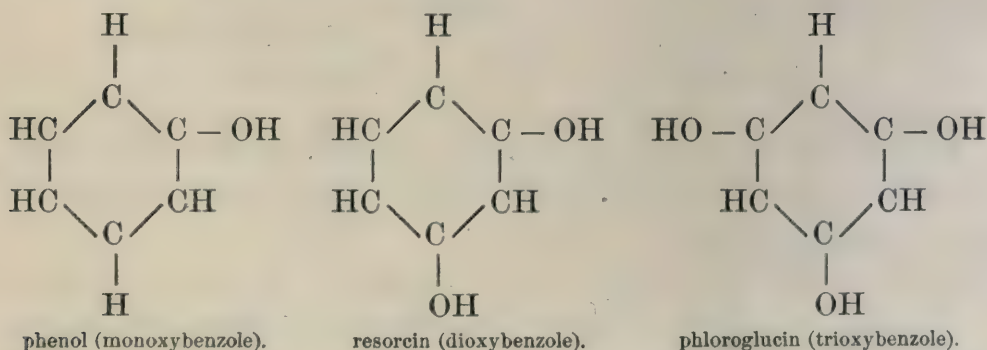

Phenol (or carbohic acid) and its derivatives attack unstable substances, especially aldehydes, forming insoluble products.

Phenol itself produces in the higher animals a paralysis of the nerve centres. Algæ die in a 1% solution after 20 to 30

minutes; in a 0.1% solution after 3 days. Infusoria die quickly in a 1% solution. *Ascaris* lives only 3 hours in a 0.5% solution.

Resorcin (0.5 g.) is hypnotic to man; 0.085 g. per kg. is fatal to dogs. Its isomer — pyrocatechin — is more active. 0.1% of it in spring water kills diatoms and Infusoria after a few minutes, and filamentous algæ in a few hours; while, with resorcin, Infusoria, diatoms, and green algæ live several hours — even as long as 18 hours.

By replacing one of the H atoms of phenol by COOH (or carboxyl), thus producing salicylic acid, the poisonous qualities are reduced.

Hydrocyanic Acid, CNH. — The action of this substance is peculiar in that, acting on the central nervous system, it is in small quantities a more violent poison for Vertebrates than for Invertebrates. Hydrocyanic acid acts upon aldehydes — in dilute solutions upon the most unstable compounds only; in stronger concentration upon all aldehydes. Its peculiar working may be hypothetically explained by assuming the aldehydes of the ganglion cells to be more unstable than those of other cells, so that traces of CNH which do not injure other cells destroy quickly the nerve cells. (LOEW.)

The action may be shown by the equation, —

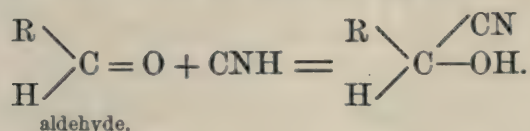

The degree and variety of its action may be inferred from the following data, taken from LOEW ('93): Infusoria die quickly in a 0.1% solution, but *Ascaris* resists a 3% solution for 75 minutes. The resistance of the hedgehog to CNH is remarkable; five times the dose which killed, in 4 minutes, a cat weighing 2 kg. produced in the hedgehog only a slight sickness. A myriapod (*Fontaria*) excretes CNH when irritated. Certain salts of CNH act as poisons; e.g. (CN)₂Hg, Na₂Fe(CN)₅NO.

Hydric sulphide acts as a poison either by deoxidizing the plasma,



or by acting on the aldehydes,

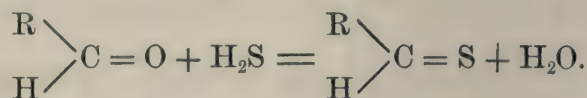

It acts rather energetically upon algæ and Infusoria. In Vertebrates, the central nervous system is attacked and the oxy-hæmoglobin of the blood is altered.

Sulphurous oxide (SO_2) attacks members of the aldehyde group, —

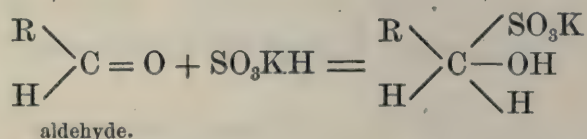

0.1% kills lower fungi in a few minutes, 0.01% in a few hours.

Selenous oxide (SeO_2), which acts chemically much like SO_2 and has a much greater molecular weight (64 : 111), acts less energetically as a poison. A 0.1% solution kills *Spirogyra* and *Zygnema* in 3 hours, while 0.01% is scarcely injurious. Tellurous oxide (TeO_2 , mol. wt. = 157) is non-poisonous, although chemically closely allied to the two preceding. (BOKORNY, '93.)

Aldehydes. — The poisonous action of these substances derived from oxidation of alcohol is dependent upon their instability. So we find that an aldehyde, which, like grape sugar, is fairly stable, is likewise non-poisonous; while formaldehyde, which is very unstable and active, is correspondingly poisonous. Aldehydes attack especially the unstable amides, affording nitrogenous compounds; *e.g.* —

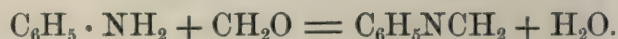

Now, even in passive albumens, part of the N is in the form of amido-groups; for, in treating with nitric acid, much nitrogen is set free, which would not occur were all of the N secondarily or tertiarily bound up. (LOEW, '93, p. 58.) Hence the poisonousness of aldehydes for living albumens.

Formaldehyde. — This substance ($\text{H} - \text{CH} : \text{O}$) acts upon propeptones and upon albumen, affording compounds which are not readily soluble. An aqueous solution of —

0.01% is fatal to bacteria.

0.05% kills worms, molluscs, and isopods in 2 hours. (LOEW, '88, p. 40.)

1.00% kills Spirogyra very quickly. (COHN, '94, p. 5.)

A weak solution seems to act anæsthetically upon Noctiluca. (MASSART, '93, p. 65.)

When various radicals are substituted in $H - CH : O$, the substance acts more like a catalytic poison. Thus, ethylaldehyde ($CH_3 - CHO$) is anæsthetic; and paraldehyde ($(CH_3 - CHO)_3$) kills algæ in a solution of 0.002% in 24 hours and causes protoplasm to become immobile either (leucocytes) after momentary stimulation (DEMOOR, '94, p. 218) or (Noctiluca) at once (MASSART, '93, p. 66).

Several derivatives of ethylaldehyde are poisonous. LOEW ('93, p. 60) has shown that in a 0.1% solution of the neutral sulphate of $NH_2 - CH_2 - CH : (OC_2H_5)_2$, amidoacetal, Infusoria, and diatoms die within 15 hours, and, somewhat later, filamentous algæ.

Nitrous acid, as is well known, produces, even in great dilution, OH-compounds from amido-compounds ($R - NH_2$); or else, under certain conditions, especially with aromatic amido-compounds, diazo-compounds result; *e.g.* —

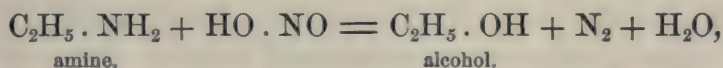

and

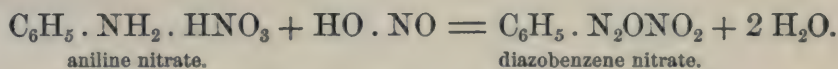

Thus a solution of 0.001% of free nitrous acid is poisonous to algæ, and more so than nitric acid. The lower fungi are also very sensitive to nitrous acid. Its action as an *acid* is weak, so that its salts are set free in the presence of even the weaker organic acids. On this account, even neutral nitrates kill such plants (some algæ, *e.g.* Spirogyra) as have an acid cell-sap.

8. **Sodic Fluoride.** — The poisonous action of the fluorides of the light metals, and especially sodium, has not hitherto been explained. A 0.2% solution of NaF kills various algæ (Oscillaria, Cladophora, CEdogonium, diatoms) within 24 hours,

producing a change in size of the nucleus. (LOEW, '92.) A 1% solution kills the nerves of a frog in 2 hours.

9. **Special Poisons.** — *Toxic Protein Compounds.* Little need be said here concerning the recent discoveries of poisonous albuminoids excreted by disease-producing bacteria, or of those secreted by the parasitized body (alexines). Similar compounds, highly poisonous to Vertebrates, have been extracted from the seeds of some Phanerogams, *e.g.* ricin, from the seeds of *Ricinus communis* (castor-oil bean); abrin, from the seeds of the leguminous *Abrus precatorius*, L.; and phallin, from the toadstool *Agaricus phalloides*, Fr. Finally, in this group may be placed a large number of protein substances derived from animals, which are more or less poisonous to a greater or smaller number of kinds of protoplasm. The poison of the rattlesnake (*Crotalus*) and of the cobra (*Naja*) is fatal to Vertebrates in small, hypodermically injected, doses. Hydra, Turbellaria, Rotifera, and Crustacea are also affected by it; but Infusoria and Flagellata are apparently unaffected. (HEIDENSCHILD, '86, p. 330.)

It is important that, according to the experiments of several investigators, among the earlier of whom may be mentioned DAREMBERG ('91) and BUCHNER ('92), the various species of Vertebrates possess protein substances in their blood serum which are to a certain extent injurious to other species, since the blood serum of any one species will destroy the red and white blood corpuscles of another. The poisonous action of these animal protein substances seems to be due to their unstable character, whereby they easily form unions with the unstable groups of the protoplasm, frequently producing thereby violent poisons which work as substitution poisons. (LOEW, '93, pp. 81-84.)

Alkaloids. — These basic, nitrogenous compounds have, for the most part, very complex molecules, so that their structure has, in many cases, not been determined. Consequently the nature of their chemical action upon protoplasm is, in general, unknown.

LOEW suggests ('93, p. 85) the following theory of action of alkaloids. The bases unite with the active protein substances of the cell, and thereby introduce a disturbance of equilibrium

in the plasma body — a disturbance which is especially manifest in their action upon the protoplasm of ganglion cells. The capacity of this union is influenced by various factors: by the configuration and degree of dilution of the poison; by the degree of instability of the kind of protoplasm acted upon; by the configuration of the molecule of the active protein substance in the cells; and by the specific (micellar) structure of the plasma body. That organic bases can unite with active albumen is known from observations upon plant cells containing stored-up active protein substances. If the configuration of the albumen molecule and the general texture of the protoplasm favor the attack by the base, a disturbance of the equilibrium of the protoplasm will result, even in considerable dilution of the poison.

The alkaloids affect chiefly the nervous tissue in the higher animals, producing, in some cases, paralysis; in others, increased activity. Thus, curarin is paralytic in its action, while the closely allied strychnin is (in dilute solutions) stimulating upon nerve cells. Since action is almost confined to nerve tissue, additional evidence is afforded of the extraordinary instability of the nervous protoplasm.

The dissimilar effect of an alkaloid upon the different substances constituting nerve protoplasm gives an idea of the complexity of the latter. Thus, an alkaloid may stimulate nerves with certain functions to increased activity, and may reduce nerves in the same body, having other functions, to depression and paralysis; *e.g.* nicotin excites sensory nerves, and depresses the activity of the cardio-motor nerves.

It is important that many of these alkaloids act also upon Protozoa and the lowest plants, in which nervous substance is still undifferentiated. Other of these alkaloids, however, do not act upon Protista.

We will now proceed to an examination of the action of the principal vegetable alkaloids, arranged according to the systematic position of the plants from which they are obtained.

Nicotin. — The effect produced by nicotin is directly proportional to the differentiation of nervous substance; thus, it is almost inoperative on Protozoa and Actinia. Hydra is not very sensitive, 0.5% being a fatal dose. A solution of 0.05%

causes *Medusæ* to become quiet in 30 minutes, and is fatal to the earthworm in a few hours; Echinoderms are paralyzed by a 0.05% solution in 30 minutes; *Palæmon* (after temporary stimulation) is paralyzed by a 0.01% solution in 30 minutes; *Sepiola* is killed by 0.005% in less than a minute. (GREENWOOD, '90.)

Veratrin, *Atropin*, and *Cocaine* act upon Vertebrates so as to excite the central nervous system at first, and then to paralyze it. All act, however, as poisons upon undifferentiated protoplasm (Protozoa). Thus, ROSSBACH ('72) found that when Ciliata were subjected to veratrin chloride and to atropin sulphate, a peculiar rotary movement took place about one end as a fixed axis. Then imbibition of water with great vacuolation of the protoplasm occurred. Later, the contractile vacuole fails to contract, and protoplasmic movements cease a few seconds after. (Cf. KÜHNE, '64, pp. 47, 65, 100.)

Cocaine is apparently a benzol derivative, closely related, chemically, to atropin. Its formula is thus given:—

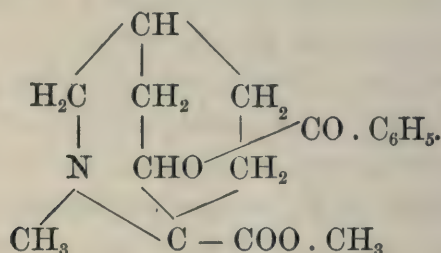

Its action upon Protista has been studied by CHARPENTIER ('85), ADDUCO ('90), SCHÜRMEYER ('90, pp. 438-448), ALBERTONI ('91, p. 318), DANILEWSKI ('92), and MASSART ('93, p. 66); upon sexual cells, by O. and R. HERTWIG ('87, p. 159) and ALBERTONI ('91, p. 309); and upon tissue cells by ALBERTONI. The result has been to show that cocaine first stimulates for a very short time to excessive activity, and then stupefies and paralyzes. With the paralysis, a strong vacuolation of the protoplasm occurs, since the excretory function of the contractile vacuole is inhibited (SCHÜRMEYER, '90, p. 439). Cocaine acts similarly upon the nerve centres and muscles of the more differentiated animals.

Morphin acts less violently upon the nervous tissue of Vertebrates. It has a very weak action upon Protista.

Strychnin, chemically considered, is an alkaloid with the formula: $C_{21}H_{22}N_2O_2$; specific gravity, 1.359 at 18°; soluble to about 0.025% in water at 14.5°; has a very bitter taste. The nitrate is generally employed. The action of strychnin upon Protista is known through the studies of MAX SCHULTZE ('63, p. 32), BINZ ('67, pp. 384-389), ROSSBACH ('72, pp. 52-54), and SCHÜRMEYER ('90, pp. 423-433). KRUKENBERG ('80) has studied its effects upon higher Invertebrates. Its action upon sexual cells has been studied by the brothers HERTWIG ('87, pp. 153-156, 164).

Although not fatal to bacteria and only in strong solutions fatal to the large fungi, strychnin is a nearly universal protoplasmic poison. It kills the protoplasm of the *Drosera* tentacles and hinders the development of peas, corn, and lupines. The amount of strychnin that Protozoa can withstand has been variously stated, while all authors admit considerable individual variation in this respect. Probably Protozoa cannot ordinarily resist a saturated solution for one minute. ROSSBACH ('72, p. 52) found that no infusorian of his cultures survived a "0.1% solution" long enough to be placed under the microscope. A 0.02% or 0.01% solution can be withstood for a few minutes (0.01% solution was withstood for 5 minutes, SCHÜRMEYER). As for the weakest solution that will kill, SCHÜRMEYER found that a *Paramecium* resisted for only 15 to 20 minutes so weak a solution as 0.0005%, while ROSSBACH found *Stylonychia* little affected by a 0.0055% solution. The spermatozoa of Echinoids, according to the HERTWIGS ('87, p. 164), so resist a 0.01% solution that after 180 minutes the movement is only somewhat retarded. Echinoid eggs are injured in a few minutes by 0.005%.

The injurious action of strychnin on Protozoa varies in the different groups, the resistance capacity increasing, in general, with the height of systematic position of the group. The first effect in Ciliata is an increased activity of the cilia; if cirri are present, these strike more powerfully; locomotion is abnormally rapid; but the movements lack coördination, and a rotation takes place about the axis of progression. Next,

the movements become so disorganized that locomotion is impossible, despite accelerated cilia-motion. Finally, the movements suddenly cease, death intervening. (SCHÜRMEYER, '90, pp. 423-426.) The process of excretion seems to be especially affected. Immediately after the addition of a 0.02% solution, the contractile vesicle increases to from 4 to 10 times its normal diameter, and loses its spheroidal form. In a slightly greater dilution, 0.014%, the contractile vesicle momentarily constricts, but in diastole gains twice its normal diameter, and the time between phases of contraction is greatly increased. Thus, the normal rate of contraction for *Euplotes* at 15° C. is between 30 and 35 seconds; but in a 0.014% solution of strychnin this is diminished to 1 in 500 seconds. Frequently, several vacuoles are formed, and, eventually, the whole body becomes greatly vacuolated, and death intervenes. (ROSSBACH, '72, pp. 52, 53.) Many higher organisms are not very sensitive to strychnin. Thus, *Ascaridæ* have a considerable resistance, which SCHRÖDER ('85, p. 307) ascribes to their not opening their mouths in the solution, the poison being thus obliged to pass through the skin. So, too, snails were found by KRUKENBERG ('80, p. 100) to be very resistant to strychnin.

Curare, or *urare*, is an alkaloid, derived from *Strichnos* species. The commercial substance is very variable in composition. NIKOLSKI and DOGIEL ('90) have studied the effects of this drug upon various organisms. Upon adding a few drops of a 0.8% solution of curare to water containing an *amœba*, the first effect is a shrinking towards a spherical form and a cessation of all movements. Subsequent washing in water ultimately restores the normal movements. As is well known, it paralyzes also the protoplasm of the nerve endings.

Quinine, or chinin ($C_{20}H_{24}N_2O_2$). — The "sulphate," which is first produced in the process of extraction, is commonly employed. This is, moreover, more soluble than the pure alkaloid, 1 part dissolving at 9.5° in 788 parts of water. Investigations on the action of this poison upon protoplasm have been made especially by BINZ in a series of papers beginning with '67; by ROSSBACH ('72) on Protozoa; by TEN BOSCH ('80) on leucocytes; by O. and R. HERTWIG ('87) on sexual cells; and by KRUKENBERG ('80) on higher Invertebrata.

Amœba, Actinophrys, and various Infusoria are killed by a 0.1% solution in a few minutes, and leucocytes and eggs of Echinoids are paralyzed even by a 0.005% solution. Its action is thus more powerful than that of strychnin. The protoplasm at first contracts, then gradually dissolves and streams away. Upon the higher animals, quinine so acts as to paralyze the central nervous tissue (in Mollusca, KRUKENBERG, '80, p. 10), and it affects the cerebrum and heart ganglia of mammals.

Antipyrin, or phenyldimethylpyrazolon, is an alkaloid derived from and belonging clearly to the benzol type, in which one atom of H is replaced by a complex atom-group, as may be seen from the formula —

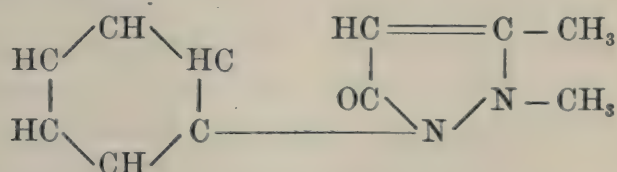

The effect of this agent upon Protozoa has been studied by SCHÜRMEYER ('90, pp. 434-437) and MASSART ('93, p. 64). A solution of 0.1% acting for 80 minutes, caused *Oxytricha* at first to move more rapidly, but eventually to become transformed into a shapeless mass, whose protoplasm disintegrates. Acting upon *Noctiluca*, a 0.25% solution causes a bright glimmer immediately after applying, followed by darkness again. Thus there is here a momentary hyperesthesia.

§ 2. ACCLIMATIZATION TO CHEMICAL AGENTS

It is clear that the protoplasm of different organisms is dissimilar. We see this in the different reactions to the same chemical agent. Not only is the reaction of the various species unlike, but individuals of the same species from different localities differ widely. (Cf. LOEW, '85.)

We are, naturally, most familiar with this phenomenon in the case of man. Thus, the common North American poison ivy (*Rhus toxicodendron*) produces, in some persons, extensive inflammation in parts which have come even indirectly in con-

tact with it; while, by other persons, it may be taken into the mouth with impunity.

The phenomenon shown by man is found in other animals also. Thus, among Invertebrates, although few bacteria can resist 1% Na_2CO_3 , and even the extremely resistant *Ascaris* lives only 5 to 6 hours in a 5.8% solution of this salt, LOEW ('77, p. 137) has found in Owen's Lake, California (an alkaline water containing among other things 2.5% Na_2CO_3), numerous living Infusoria, Copepoda, larvæ of *Ephydra*, and molds. Again, the vinegar eel, *Rhabditis aceti*, lives in a 4% solution of acetic acid, although this strength is usually fatal; *e.g.* a 0.23% solution of acetic acid kills the tentacles of *Drosera*. (DARWIN, '75, p. 191.)

What is true of the whole organism is true also of its parts. The gland cells of some marine Gasteropoda (*Dolium*, *Cassis*, *Tritonium*, *Natica heros*) secrete H_2SO_4 of a strength (2% to 3%) which is fatal to most protoplasm; the myriapod *Fontaria* excretes, when irritated, the extremely poisonous CHN; and, according to LOEW ('87, p. 438), the plant *Oxalis* produces potassic oxalate, which is a violent poison to most protoplasm.

One general law of high resistance is worthy of notice: an organism which produces an albuminoid poison is strongly resistant to that poison. Thus, FAYRER ('74) has shown that venomous serpents are not destroyed by the secretion of their poison glands when it is injected into them; and BOURNE ('87) has shown that scorpions are not injured by their own venom.

An explanation of the facts of varied resistance capacity is first gained through experiment. We all know that, among men, a high resistance capacity to a poison may be acquired by taking a small quantity of it at frequent intervals. Thus, users of tobacco, alcohol, and various alkaloids become, in time, capable of taking, without apparent injury, quantities which would at first have proved fatal. Arsenic eaters may eventually swallow without injury four times the ordinarily lethal dose, *i.e.* as much as 0.4 gramme. (BINZ and SCHULZ, '79.)

Results similar to those observed in man have been obtained by experiment upon other animals. Thus, SEWALL ('87) inoculated a pigeon hypodermically with sub-lethal doses of

rattlesnake poison (*Crotalophorus tergeminus*). While no unacclimatized pigeon could resist 1 drop of a 6.8% solution of venom in glycerine, pigeons inoculated with at first weak, then gradually increasing solutions, came at last (after 178 days) to resist 4 drops of the glycerine venom mixture. Likewise KANTHACK ('92) succeeded in acclimatizing two rabbits and a hen to serpent's venom.

Very similar are the experiments of EHRlich ('91). This investigator fed white mice (which are killed by $\frac{1}{20}$ of their weight of a 0.0005% solution of ricin, hypodermically injected) upon food cakes soaked in a weak solution of the poison. After feeding them for a varying length of time upon constantly increasing solutions, he determined the maximum solution which, hypodermically injected, they would withstand. If we call the maximum solution which the unacclimatized organism will withstand our unit of immunity, we can express the degree of immunity of the acclimatized organisms by the strength of solution (expressed in terms of that unit) which they can resist.

The following table, taken from EHRlich's paper, shows the gradual increase of immunity as a result of feeding on the poison : —

TABLE IV

NO. OF EXPERIMENT DAY.	STRENGTH OF LAST DOSE GIVEN, IN MG.	NUMBER OF INDIVIDUALS EXPERIMENTED ON.	MAXIMUM INJECTED SOLUTION BORNE, %'s.	DEGREE OF IMMUNITY.
IV	4	8	{ Die in 0.0005	1
V	5	16	0.0007	1.3
VI	6	23	0.0066	13.3
VII	7	5	0.005	10
VIII	8	18	0.01	20
X	12	9	0.02	40
XII	20	3	0.033	66.6
XV	50	1	0.05	100
XVIII	80	4	0.1	200
XXI	80	1	0.2	400

Thus after the first 4 or 5 days the immunity rapidly increased; so that, while the solution of $\frac{1}{200000}$ kills normal

mice, those acclimatized during 21 days resist $\frac{1}{1000}$ to $\frac{1}{500}$, occasionally $\frac{1}{250}$, corresponding to a grade of immunity of 200 to 800.

By fundamentally similar procedures CALMETTE ('94) has rendered rabbits immune to the action of strong doses of the venom of *Naja tripudians* (cobra) and of *Pelias berus*.

Still more recently MARMIER ('95) has isolated a toxin produced by anthrax bacteria reared in a peptone-glycerine solution. Inoculated into an animal sensitive to anthrax, this toxin produces, in certain doses, death by cachexy. By employing suitably *graduated* doses, however, one can obtain immunity of the organism to anthrax, as one does to the venom of serpents.

Some attempts to produce acclimatization in lower organisms have been made by Dr. H. V. NEAL and myself. Stentor was employed as the object of experimentation. We reared two lots of Stentors under similar conditions except that Lot 1 was cultivated in water and Lot 2 in 0.00005% HgCl_2 . After the lapse of two days both were put into a killing solution of 0.001% HgCl_2 , and the second lot was found to survive longer than the first. The mean resistance period to the killing solution of the lot reared in water was 83 seconds; of that reared in 0.00005% corrosive sublimate, 304 seconds. Similar results were obtained in other experiments. In Fig. 1 a curve is given showing the relation between strength of culture solution and period of resistance. From this curve, based upon 132 determinations, it appears that *the resistance period varies directly with the strength of the solution in which the protoplasm has been cultivated.*

This law holds good, however, only within certain limits. If the culture solution is too strong, above 0.0001%, the organism will be weakened by it so that it cannot resist the killing solution so long as those reared in water can.

A similar effect of heightened resistance to quinine is obtained by cultivating organisms in quinine.

Experiment shows that a slight increase of the resistance period follows subjection to the culture for one hour only; and that the degree of acclimatization varies directly as the time of subjection.

The facts obtained by us clearly indicated, then, that, without selection, — for no deaths occurred in our culture solutions, — the protoplasm may become modified merely by subjection to the poison, so as to gain an increased resistance to it. Hence the acclimatizations that we find in nature need not have been brought about by natural selection — *must* have occurred, indeed, even without selection, if the organisms had been gradually subjected to their environment.

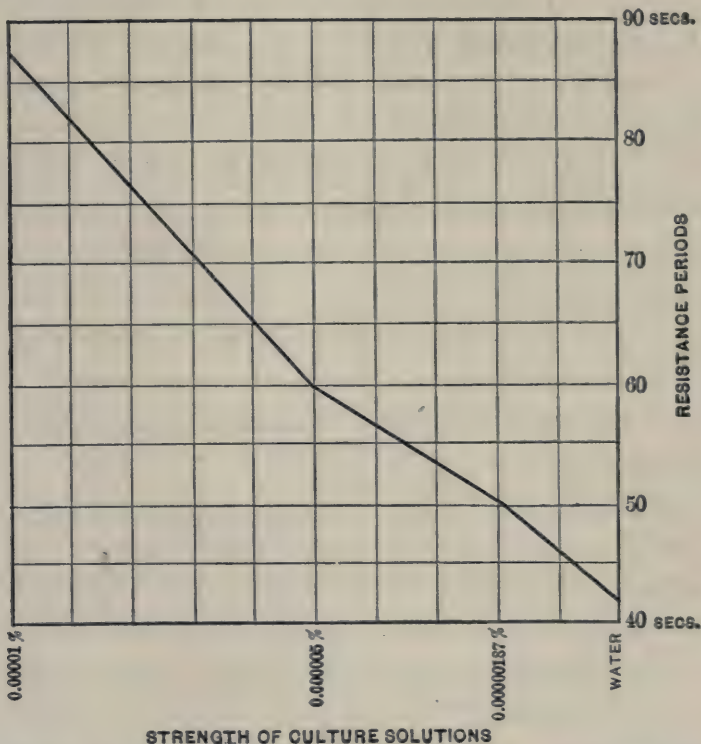

FIG. 1. — Curve of resistance periods to a 0.00125% solution of HgCl_2 of Stentors reared in various solutions of HgCl_2 during 20 to 96 hours.

We did not determine for how long a time the acclimatized Protozoa retained their heightened resistance capacity. The only data we have upon the subject of persistence of acclimatization is derived from studies on Vertebrates.

Thus it is the familiar experience of arsenic eaters that, after they have broken off their habit, the body does not quickly return to a normal condition. Even after a considerable period of self-denial the taking of large doses may be recommenced — must be recommenced, indeed, or illness sets in.

EHRlich ('91) has studied experimentally the phenomenon

of acclimatization to ricin. Mice which had gained an immunity of over 200, and were then kept for 6.5 months on normal food, had still a resistance, although not precisely determined, certainly far above 50.

It is an important question: Is an organism acclimated to one poison thereby rendered more resistant to poisons in general, or only to the specific poison to which it has been acclimated? EHRlich found that mice acclimated to ricin were just as sensitive to abrin as the normal animals, and the same is true, *mutatis mutandis*, for mice which resist abrin.

Concerning the changes in the protoplasm brought about by acclimatization little is known.

EHRlich ('91) and CALMETTE ('94) have shown that in the blood of the immunized animal a substance, antitoxic to the specific substance employed, is produced, and this apparently prevents the action of the strong poison by transforming its molecules. The antitoxic substance is of such a nature that when blood containing it (from an acclimatized animal) is injected into an unacclimatized one, the latter becomes immune to the poison.

For Protista another hypothesis is admissible; namely, that the weak solution of the poison, which is used in acclimatization, *gradually* destroys those compounds upon which the strong solution would have acted suddenly and, therefore, fatally. The gradual destruction is not fatal because of its slowness. At the same time it prevents the violent action of the strong poison, since it leaves it nothing to be acted upon.

The parallelism between the results of experiments upon acclimatization to poisons and those upon immunization through vaccination, leads to the suspicion that, at bottom, the two processes are closely akin.

§ 3. CHEMOTAXIS

ENGELMANN ('81) seems to have been the first to show that the direction of locomotion of simple protoplasmic masses is determinable by chemical agents in the environment. He found that *Bacterium termo* is thus acted upon by oxygen which is not uniformly distributed. Like many Infusoria, these bacteria

gather at the margin of the cover-glass, where oxygen is more abundant than elsewhere. If oxidized blood is introduced under the cover-glass, they move toward it, but not toward blood containing much CO_2 in place of oxygen. If green algæ are introduced, the bacteria move towards them so long as they, under the influence of sunlight, are producing oxygen. In the dark the algæ have no effect.

During the decade and a half which have elapsed since ENGELMANN'S first paper appeared, chemotactic phenomena have been observed among nearly all kinds of motile organisms and with reference to the most diverse kinds of chemical substances. ENGELMANN ('82) has studied the chemotactic movements of diatoms; STAHL ('84), of Myxomycetes; PFEFFER ('84, '88), of plant spermatozoids, zoöspores, Flagellata, Infusoria, and bacteria; ADERHOLD ('88), of *Euglena viridis*; VERWORN ('89, p. 107), of *Cryptomonas*; STANGE ('90), of zoöspores and Myxomycetes; and MASSART ('91), of *Spirillum*, *Heteromita*, and Ciliata.

Within the last five years a voluminous literature has grown up on the medical side relating to chemotaxis in leucocytes and pathogenic bacteria. Into this literature we cannot penetrate deeply, but refer to some of the principal papers: LEBER, '88; BUCHNER, '91; ROEMER, '92; METSCHNIKOFF, '92.

It thus appears that chemotactic phenomena show themselves among all the groups of lower motile organisms: Rhizopoda (Myxomycetes), Flagellata, Ciliata, bacteria, diatoms, zoöspores, and spermatozoöids. It can hardly be questioned that the phenomena shown by these organisms are of the same order as those seen in Metazoa — in those ants which LUBBOCK ('84, p. 233) has shown to move from chemical agents (essence of cloves, lavender water, and other scented stuffs), saturating a camel's-hair brush placed about $\frac{1}{4}$ inch above their path; and in the larvæ of flies with which LOEB ('90, p. 79) has experimented. LOEB found that these crept towards a piece of flesh brought nearer to them than the distance of 1.5 cm. Even just hatched larvæ (which had therefore never been stimulated by meat) reacted in this way. Not meat only, but a trace of meat juice on glass attracted the larvæ strongly. While decaying flesh and cheese allure, neither fat, asafœtida, nor ammonia do so.

Returning now to the simple organisms, let us consider the kinds of chemical substances which incite to a response.

Oxygen is for almost all organisms a means of attraction. Various methods of demonstrating this have been used. Thus STANGE ('90, p. 139) filled capillary tubes with pure oxygen, under an air-pump, and brought them to the water containing zoöspores, which then penetrated into them.

The aggregation of zoöspores and bacteria to the edges of the cover-glass, to the open end of a capillary tube (ADERHOLD,

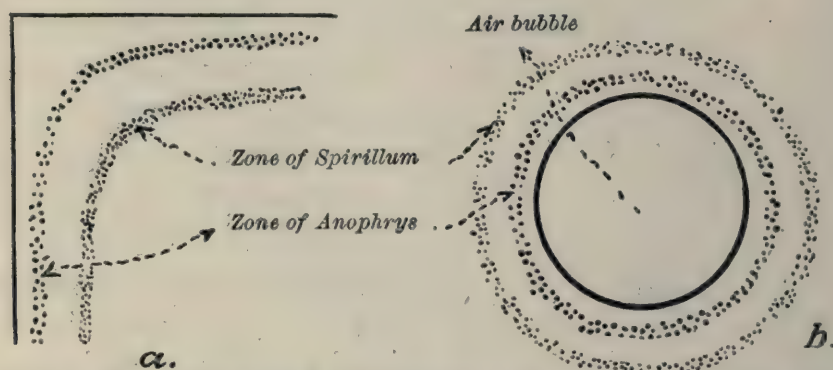

FIG. 2. — *a.* Corner of the glass slip covering a drop of liquid containing *Spirillum* and *Anophrys*, showing their aggregation with reference to the aerated bounding film of the drop. *b.* An air-bubble in the drop, showing aggregation of the organisms about it. (From MASSART, '91.)

'88, p. 314), or to an enclosed air-bubble, are well-known phenomena. (Cf. MASSART, '91, p. 159; VERWORN, '89, p. 107; and see Fig. 2.)

ENGELMANN ('94) has employed a still more refined method of studying attraction towards oxygen. A drop of foul water is put on a glass slide with an alga cell in the centre, and is covered by a cover-glass whose edges are hermetically sealed by vaseline. The bacteria are uniformly distributed in the water, moving in a lively manner, since they gain oxygen everywhere. If the slide thus prepared is kept in the dark, the oxygen is gradually consumed and the bacteria become quiescent, showing no distribution with reference to the central chlorophyllaceous body (Fig. 3).

If the slide is now exposed to the light, oxygen is produced by the alga and a regular distribution of the bacteria in two distinct regions — in a mass around the central alga, and in a

peripheral zone — is apparent (Fig. 4). The peripheral zone contains bacteria which are beyond the tactic action of the oxygen. The central mass of bacteria have emigrated from what is now a clear ring between the centre and the peripheral zone. If the light be temporarily cut off, the central bacteria

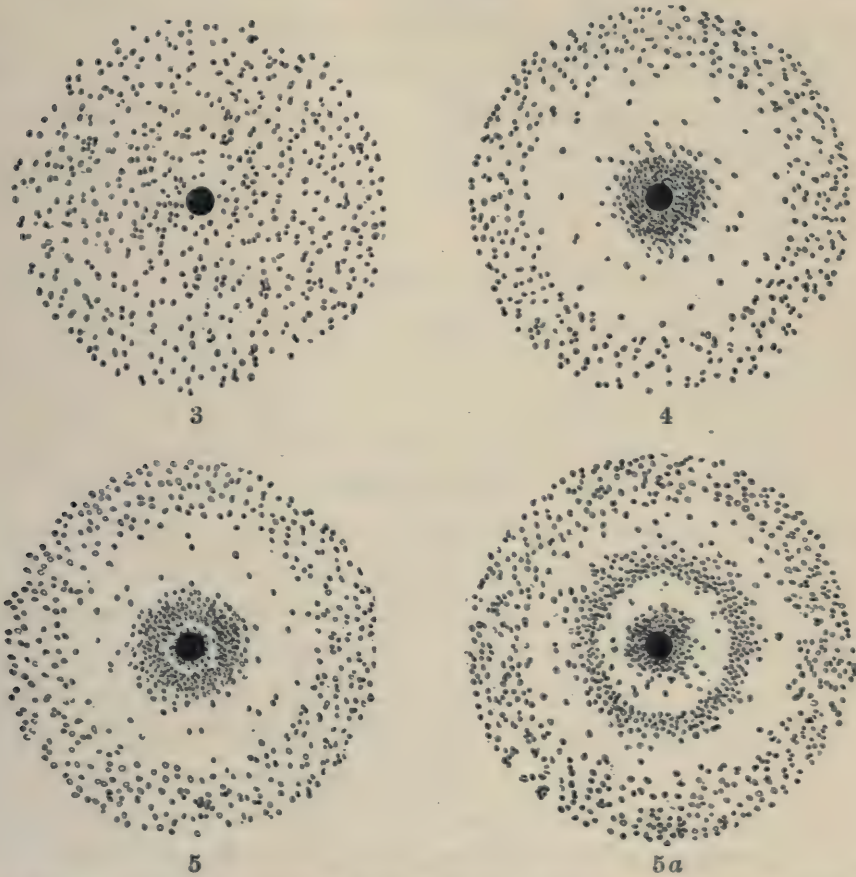

FIGS. 3-5 a. — Bacteria surrounding an algal cell. Fig. 2 shows the uniform distribution of the bacteria when the drop of water is kept in the dark. Fig. 3 shows the aggregation of the bacteria towards the algal cell when this has emitted oxygen rapidly in the strong light for two minutes. Fig. 4 shows the same preparation shortly after the light has been cut off. Fig. 5 shows the same preparation when a fainter light is now permitted to fall upon the green cell. Magnified about 170 diameters. (From ENGELMANN, '94.)

begin to disperse (Fig. 5). If, a minute after, a *dim* light be let through, the radius of its activity will be relatively small, so that a central aggregation will be found and also an inner peripheral zone, comprising those dispersing central bacteria which are not affected by the small oxygen tension resulting from the dim light (Fig. 5 a).

Inorganic Salts.—PFEFFER* ('88, p. 601) tried various salts of potassium; viz. chloride, phosphates, nitrate, sulphate, carbonates, chlorate, ferrocyanide, and tartrate, and found that all attracted various bacteria (*B. termo*, *Spirillum undula*), and the flagellate *Bodo saltans* with greater or less strength, when the solution in the capillary tube contained 0.1% K. So, likewise, various salts of sodium, rubidium, cæsium, lithium, ammonium, calcium, strontium, barium, magnesium, especially the chlorides, were employed. All of these solutions at a concentration of 0.5% exhibited a marked attractive influence upon *Bacterium termo*; a weaker one, upon the two other species.

STANGE ('90) experimented with the action of various phosphates upon zoöspores of a *Saprolegnia* belonging to the *ferax* group of DE BARY.† Sodid, ammonic, lithic phosphate, calcic phosphate held in solution by CO₂, as well as phosphoric acid were employed and found to act attractively. Other salts, KNO₃, K₂SO₄, KCl, HKCO₃, BaClO₃, SrCO₃, MgSO₄, had either a negative or indifferent action upon the zoöspores.

The attractive action of the phosphates is correlated with the fact that phosphates are abundant in the muscles of insects. The following table shows the effect of the different strengths of solutions of four phosphates upon zoöspores of *Saprolegnia*. In this table, constructed from STANGE, the symbol *r* indicates repulsion; 0, no action; *a*, attraction; *a*₁ indicates a slight attraction; *a*₂, a strong attraction; *a*₂*r*₁, an attraction which is partly balanced by a repulsion due to density, so that the

* The method employed by PFEFFER in his experiments was as follows: Glass capillary tubes with a lumen of from 0.03 to 0.14 mm. diameter and a length of 7 to 12 mm., and sealed by fusion at one end were employed. To fill the capillary tube, it was placed in a watch-glass containing the experiment solution, and the whole was placed in a vessel from which air was pumped. Under the diminished atmospheric pressure, 2 to 4 mm. of fluid entered the capillary tube; the rest of the tube contained air, which kept the fluid oxidized. After rinsing, the free end of the tube was plunged into the drop culture, whence the solution diffused out.

† The species were cultivated upon carcasses of flies thrown into glasses filled with bog water. After good colonies were obtained, the carcasses were washed, to rid of Infusoria. Such colonies may be employed to infect sterilized flies' legs placed in sterilized bog water, or they may be transferred directly to wounds in flies' legs.

organisms pass only into the first part of the tube ; a_3r_3 , such a balancing of the opposing forces that the organisms stand before the mouth of the capillary tube.

STRENGTH OF SOLUTION, % 's.	SODIC DIPHOS- PHATE (HNa_2PO_4).	POTASSIC MONO- PHOSPHATE (H_2KPO_4).	AMMONIUM PHOS- PHATE ($\text{H}_2\text{NH}_4\text{PO}_4$?).	PHOSPHORIC ACID (H_3PO_4).
0.8 to 0.4	a_3r_2	a_3r_2	a_3r_3	r
0.4 to 0.08 . . .	a_2r_1	a_2r_1		
0.08 to 0.04 . . .	a_2	a_2	a_2	a_1r_2
0.01 to 0.02 . . .	0	a_1	a_1	a_1r_1
0.02 to 0.008 . . .		0	0	a_2
0.008 to 0.004 . . .				a_1
0.004 to 0.002 . . .				0

It will be noticed that the various substances produce different effects in the same strength of solution ; and it is interesting to observe (a point to which further reference will be made) that the strength of solution required to produce a given response is roughly proportional to the molecular weight of the substance employed.

Inorganic acids and hydrides seem, in general, to act repulsively, but phosphoric acid is an important exception to this rule. DEWITZ ('85, pp. 222, 223) states that mammalian spermatozoa are attracted by KHO.

Organic Compounds.—*Alcohol*, in grades between 10% and 1%, acts repulsively towards bacteria. *Glycerine* is neutral to the same organisms and to zoöspores of Saprolegnia. (STANGE, '90.) The *sugars*, etc., dextrose, milk sugar, dextrin, act attractively upon *Bacterium termo* in 10% or weaker solutions. Many *organic acids* are among the most attractive reagents. It was with malic acid that PFEFFER ('84) tried his earlier fundamental experiments upon the spermatozoids of ferns. The attraction exerted is very great, so that a capillary tube of 0.1 to 0.14 mm. calibre, containing a 0.05% solution of malic acid, attracts from a drop of water full of spermatozoids at the rate of 100 individuals in one hour. Even a 0.001% solution acts chemotactically. Now, malic acid is of very wide distribution among plants, and it occurs in the fern prothalli upon which the sexual

organs arise, so that it seems probable that it occurs in the mouth of the archigonium, and that by its presence spermatozoids are attracted towards the egg cell.

STANGE ('90, p. 155) has experimented much more fully with the action of organic acids upon zoöspores of *Saprolegnia* and upon myxamœbæ. To the former, acetic acid (0.01%) and tartaric acid (0.0125%) act attractively. Upon the latter, still other acids were tried; butyric, lactic, and valeric acids cause response in concentrations between 0.2% and 4%; malic acid, between 0.5% and 4%. Other attracting acids are: propionic, citric, tartaric, and tannic. Acetic acid repels the amœbæ of *Æthaliu*m, its repellent action being about equal to the attractive action of an equal amount of butyric acid.

Nitrogenous Compounds.—*Urea*, *asparagin*, *kreatin*, *taurin*, *hypoanthin*, *carnin*, and *peptone* have been found by PFEFFER ('88) to exert an attractive influence, especially in the case of the reagents *italicized*.

Benzol Derivatives.—PFEFFER found that sodium salicylate and (commercial) sulphate of morphine are clearly attractive to *Bacterium termo* in 1% solutions.

From the foregoing list of organic compounds whose effect upon Protista has been tested by PFEFFER and STANGE, it appears that except alcohol and sometimes acetic acid, none acts repulsively, and that glycerine alone is neutral to all protoplasm. It is further true that we do not find here any strict relation between the chemotactic action of a substance and its advantage to the organism. Substances which have a nutritive value for the organism, such as glycerine has for bacteria, may be wholly neutral, while solutions which act fatally, like 1% sodic salicylate and 1% morphine, attract. In the same way, many of the organic salts which act attractively cannot be considered as of importance to the organism. On the other hand, as already pointed out, the attraction of most Protista to oxygen, of *Saprolegnia* zoöspores to phosphates, as well as the cases of attraction of bacteria (PFEFFER, '88, p. 605) and of fly larvæ (LOEB, '90, p. 79) to meat extract, and of *Myxomycetes* to bark extract (STAHL, '84; STANGE, '90), is advantageous. Chemotaxis is, therefore, in some cases, a response to the stimulus afforded by substances which can be employed by

the organism as food; under which circumstances it can be called "Trophotaxis."* In other cases it is a response to chemical substances which have no significance as food, and have no other importance for the organism.

It is clear that we cannot assume that response to injurious substances is an adaptation which has been brought about by natural selection. If a response occurs in one case independent of the action of selection, we should hesitate to ascribe to this cause the origin of other, even favorable, responses.

General Remarks on the Relation between Molecular Composition and Response. — PFEFFER ('88, pp. 608–612) has pointed out that the capacity of any substance to stimulate cannot be inferred from its chemical constitution and relationships. Thus, the minimum concentration of milk sugar which will produce a response is 1%, while in the case of the closely allied grape sugar it is 10%; but in the very different kreatin it is also 1%. Also, the action of any chemical compound is determined not by the elements, such as C, H, O, which it contains, but by the entire molecule; in other words, the atomic composition is less important than the structure of the molecule or the arrangement of its atoms. Thus, malic acid and its compounds with neutral ammonium, sodium, barium, and calcium containing 0.001% parts of the acid, have an equal action upon the spermatozoids of ferns, which do not react to the diethylester of malic acid, even in strong solutions. (PFEFFER, '88, p. 655.) Again, nitrogenous organic compounds are, in general, more active than the non-nitrogenous ones; but this cannot be held to be due alone to the presence of N; for dextrin ($C_6H_{10}O_5$) is nearly as active as the nitrogenous peptone, and, on the other hand, the nitrates of metals are not more active than their chlorides, while the ammonia salts are relatively weak.

Relation between the Strength of the Stimulus and that of the Response. — When we say that malic acid attracts spermatozoids we mean that under certain physical conditions of the water which we may call normal it does so. And under normal conditions of the water, it is only within certain limits

* STAHL ('84, p. 164) called the attraction of plasmodium of myxomycetes to bark extract "Trophotropism."

that malic acid attracts. The strengths of solutions which attract under such conditions lie between 0.001% and 10%. The weaker solution may be designated the minimum; the stronger, the maximum concentration which provokes a response. The minimum solution provoking response is also often called by the Germans the "Reizschwelle," or "stimulation threshold";* the optimum, the "Reizhohe," or "stimulation acme"; the range, the "Reizumfang."

The character of the responses observable at the two limits is very different; at the minimum, attraction is very feeble; thus, while a capillary tube containing 0.01% neutral sodic malate, plunged into water at 14°–20° C., swarming with spermatozoids, attracts 400 of them in 10 minutes, a 0.001% solution attracts only 10–25 individuals during the same time, and a 0.0008% exerts little attractive effect, the spermatozoids remaining undirected in their movements. At the maximum, on the contrary, repulsion is observed. The spermatozoids move from the mouth of the capillary tube. Between the two extremes lies the concentration of greatest attraction — the acme. As we pass from the acme towards the minimum, the attraction becomes less and less. As we pass towards the maximum, the attraction remains the same, or increases; but repelling influences are now at work, which eventually entirely counteract the attractive influences.

A satisfactory method of expressing quantitatively the facts just mentioned has not been invented. PFEFFER ('88, p. 599) has employed the nomenclature which we have used above (p. 36) — a_1 to a_3 being combined with r_1 to r_3 to indicate the coworking in varying proportions of attraction and repulsion. Using this nomenclature, we may illustrate the statements made in the last paragraph with examples taken from PFEFFER'S work: —

* The following substances at the solutions named produce the threshold attraction (a_1) in Bodo saltans: KCl, 0.02%; K_3PO_4 , 0.002%; KH_2PO_4 , 0.0035%; KNO_3 , 0.26%; K_2SO_4 , 0.22%; $KClO_3$, 0.3%; $K_4(CN)_6Fe$, 0.235%; $K_2 \cdot C_4H_4O_6$, 0.02%; RbCl, 0.14%; LiCl, 0.6%; $LiNO_3$, 3%; NH_4Cl , 0.3%; neutral ammonium phosphate, 0.08%; $SrCl_2$, 0.2%; $Sr(NO_3)_2$, 0.4%; $BaCl_2$, 0.17%; dextrin, 0.1%; urea, 1%; asparagin, 0.1%; taurin, 1%; sarkin, 0.33%; pepton, 0.01%; meat extract, 0.01%.

GRADE OF SOLUTION.	RESPONSE OF	
	BACTERIUM TERMO.	SPIRILLUM.
9.53 % KCl = 5 % K	a_3	a_3r_3
1.906 % KCl = 1 % K	a_3	a_3r_1
0.191 % KCl = 0.1 % K	a_3	a_3
0.019 % KCl = 0.01 % K	a_2	a_1
0.0019 % KCl = 0.001 % K	a_1	0
	BODO SALTANS.	
3.48 % KH_2PO_4 = 1.0 % K	a_3r_3	
0.348 % KH_2PO_4 = 0.1 % K	a_3r_2	
0.035 % KH_2PO_4 = 0.01 % K	a_2	
0.0035 % KH_2PO_4 = 0.001 % K	a_1	
0.00067 % KH_2PO_4 = 0.0002 % K	0	

Compare also the table on p. 37.

For all reagents which exert an attractive influence there exists the maximum (repelling) and minimum (indifferent) limits referred to. In the case of reagents, which, like alcohol, repel bacteria at between 1% and 10%, there is doubtless an indifferent limit, but it is not necessary that there should be a degree of concentration at which attraction takes place. In the one case, then, the phenomena of indifference, attraction, repulsion, follow each other with increasing concentration; in the other case, only indifference and repulsion. The difference in action of the two cases is due, in part at least, to the fact that all solutions, independently of their chemical constitution, become repellent when they become concentrated enough. The repulsion, then, of high grades of chemical solutions is purely an osmotic phenomenon, and, as such, will come under discussion in the third chapter. It follows, also, from what has been said, that, in the case of those reagents which exert no attraction at any concentration, the acme and maximum coincide and lie at the saturation point of the solution.

Finally, we may discuss the third case in which the reagent acts indifferently, as glycerine does upon bacteria between 17% and 0.86%. It is clear, that if the density of the solution can

be rendered great enough, a repulsion due to osmosis must occur. If the substance is, however, only soluble slightly or miscible, it may be that repulsion will never occur. Whether or not attraction will occur before the repulsion point is reached will have to be determined experimentally for each reagent.

Thus the action of an untried substance upon any organism may be any one of three kinds: (1) It may be indifferent at all grades; (2) it may be indifferent at lower and repellent at higher grades; (3) it may be indifferent, attractive, and repellent at successive grades. Of two substances belonging to the second or third class, one may act upon an organism at a certain concentration with indifference, the other at the same concentration with repulsion. Likewise the same solution of a substance may attract one kind of protoplasm and repel another, under otherwise similar conditions.

We have seen above that the same reagent acts upon the same kind of protoplasm similarly only when the other conditions of the experiment are also the same. Among the varying conditions which have been especially investigated is that of the chemical constitution of the medium. The experiment has generally been made as follows: A particular species, let us say *Bacterium termo*, is to be subjected to the action of a particular reagent, *e.g.* meat extract. The bacteria are reared in cultures containing a varying quantity of the meat extract, and the concentration of the capillary fluid producing the threshold stimulation is measured in each case. We may compare not only the threshold stimulations but also the concentrations necessary to produce the response indicated by a_1 , a_2 , etc. The following table, from PFEFFER ('88, p. 634), gives some of such determinations:—

CULTURE FLUID— MEAT EXTRACT.	CAPILLARY FLUID—MEAT EXTRACT.			
	3 × cult. conc.	5 × cult. conc.	8 × cult. conc.	10 × cult. conc.
0.01 %	0.03 % (?)	0.05 % (a_1)	0.08 % (a_2)	0.1 % (a_2)
0.1 %	0.3 % (?)	0.5 % (a_1)	0.8 % (a_2)	1 % (a_2)
1 %	3 % (?)	5 % (a_1)	8 % (a_2)	10 % (a_2)

From this table it appears that the strength of solution necessary to provoke a certain response depends upon the strength of solution to which the protoplasm has been previously subjected and increases proportionately with it. It is clear that the capillary solution of 0.1%, which produces a marked chemotaxis in bacteria reared in a culture solution of 0.01%, would awaken no response in bacteria reared in 0.1%.

We are now in a position to appreciate the importance of still another addition to our terminology of stimuli — the differential threshold stimulation (*Reizunterscheidsschwelle*) — which may be defined as the minimum increase of a preëxisting stimulus which is capable of calling forth a just noticeable reaction. In the case just cited, the differential threshold stimulation lies just above 3 times the preëxisting (culture) stimulus, and this is true whatever the degree of the preëxisting stimulus; and it is shown by experiment that, in general, as the preëxisting stimulus increases, the differential threshold stimulation increases in the same proportion. This observation is in perfect accord with the law formulated long ago by WEBER with especial reference to sight. This law runs: The smallest change in the magnitude of a stimulus which will call forth a response (differential threshold stimulation) always bears the same proportion to the whole stimulus. We may express this law mathematically, as FECHNER has done, by the following considerations: Let us take the case of a protoplasmic body, as, for example, that of a spermatozoid, living in a stimulating medium (s) of a certain concentration and experiencing a certain reaction r' ; then s corresponds to r' . In order just to get a chemotactic response (threshold stimulation), a solution of say 30 times the concentration must be brought to the solution affording the stimulation s . This will give a reaction which is greater than r' by a quantity which we may designate r , so that the quantity of the whole reaction may be designated as $r' + r$. If the organisms are now placed in this stronger solution ($31s$), the solution in the capillary tube must be 30 times stronger ($30 \times 31s$) in order to give the differential threshold stimulation. The reaction following this stimulation may be designated, according to FECHNER'S conception, as $r' + r + r$. The relation of the successive stimuli and the reac-

tions may be shown by the following table, following one given by PFEFFER ('84, p. 401) :—

	s corresponds to r' .	
$s +$	$30s =$	$31s$ corresponds to $r' + r$.
$31s +$	$30 \times 31s =$	$31 \times 31s$ corresponds to $r' + r + r$.
$31 \times 31s +$	$30 \times 31 \times 31s =$	$31 \times 31 \times 31s$ corresponds to $r' + r + r + r$.

That is to say, while the stimulation increases geometrically, the reaction increases arithmetically. In the preceding table the second term of the left-hand member of the equation is always the differential threshold stimulation.

The most important objection that can be urged against this formula of FECHNER is that there is not sufficient reason for believing that the various reactions (r) to the differential threshold stimulations of various strengths are equal, nor that the stronger reaction to the strong stimulus is composed of many weak reactions. If these assumptions were true, it would follow that when the successively higher stimuli increase as a series of numbers the reactions increase as the logarithms of these numbers. If now we adopt as a unit in this phenomenon the quantity of the threshold stimulation (estimated in units of concentration of solution, of mass, light intensity, heat intensity, etc.), which we may call s , the strength of any stimulus (S) may be estimated in those units, and the strength of the corresponding reaction (R) will be indicated by the equation $R = c \cdot \log S$, in which c is a constant to be determined empirically, and S the strength of the stimulus expressed in units of the threshold stimulation.*

While we are not yet in a position to understand the significance of WEBER'S law, we cannot fail to be struck with the resemblance of the phenomena with which it concerns itself to those of acclimatization referred to in the second section of this chapter. We there showed that organisms subjected for a while to a chemical agent no longer reacted as at first to that reagent. We have here shown that organisms subjected for

* Since the German word for stimulus is *Reiz* (initial R), and since the reaction is usually indicated by the initial letter in *Empfindung*, in German textbooks this formula usually runs $E = c \cdot \log R$, which differs from the above equation only in the symbols employed.

a while to the action of a certain stimulating agent respond no longer to a concentration which would at first have provoked a reaction. In both cases it is the action of the chemical agent which modifies the subsequent action of the protoplasm, without doubt by changing the chemical constitution of the protoplasm.

Mechanics of Response.—Having considered the general relation between strength of stimulus and of reaction, it now becomes necessary to examine more in detail into the way in which the reaction takes place.

A variety of kinds of locomotion exists among chemotactic organisms — that of the Myxomycetes is amœboid, that of Infusoria is by flagella or cilia. In all cases the first and perhaps the only effect of the acting reagent is to determine the position of the axis of the body, in the case of bodies with fixed form; or to determine the pole of outflow in the case of amœboid organisms. The axis lies in the line of flow of the diffusing solution or perpendicular to the isotonic lines, or lines of equal concentration. Whatever movement now occurs must be either towards or from the source of stimulus.

I have said above that the axis orientation is perhaps the only effect of the acting reagent. PFEFFER ('84, p. 463; '88, p. 631), indeed, maintains that the stimulus does not directly cause a markedly more rapid locomotion in the case of bacteria and Flagellata; but in the case of plasmodia it seems possible that such a hastening of movements occurs. (STAHL, '84.) However, it is necessary that *measurements* should be made in this matter. Further observations on the mechanics of taxis must be deferred to the general treatment of the subject in Chapter IX.

SUMMARY OF THE CHAPTER

We attempted in the first section to bring together observations relating to the action of various chemical substances upon protoplasm with the aims of discovering the general laws of poison-action on protoplasm and of gaining an insight into the chemical structure of protoplasm and the chemical operations involved in the elementary vital processes. We ought now, therefore, to attempt to draw such conclusions as the imperfect and often confusing data we have collected will permit.

All the reagents with which we have dealt have been substances capable of absorption by, mixture with, or solution in, water; and the reason for this is that almost all protoplasm is itself enveloped by water and largely composed of water.

For the most part we have dealt with mixtures or solutions. Now the action of these is a double one. They exhibit, first, an osmotic action, and, secondly, they may attack the molecules of the protoplasm, transforming them. The osmotic action we will consider in the third chapter; the transforming one alone concerns us now. It is not easy, without experiment, to say to which of these two categories of action the change wrought by any substance is due. To determine between the two possible causes it would be desirable in each case to treat the protoplasm to a control solution having the same osmotic action as the first, but no transforming effect. If such a solution produces no modification of the protoplasm, then the effect wrought by the first reagent is due purely to molecular transformations. It is not easy to find a reagent of which we may be certain that it acts only osmotically. NaCl is probably more generally useful in this way than any other substance. In the experiments which have hitherto been made, this double action of solutions has not been sufficiently considered. Hence, a doubt concerning the immediate cause hangs about many of the phenomena described in the first section.

The first principle which the data collected establish is that the protoplasm of different organisms is dissimilar. This is shown by the diversity in their chemical reactions; by the fact that whereas, in one case, a certain percent solution causes so extensive a molecular transformation as to result in death, in another, no injurious effect is produced.

Thus, according to BOER ('90, p. 479), it takes of gold chloride to kill —

TABLE V

Anthrax bacillus	0.0125%
Cholera spirillum	0.1%
Diphtheria bacillus	0.1%
Typhoid bacillus	0.2%
Glanders bacillus	0.25%

Thus the weak solution, 0.0125%, of AuCl_3 , which is fatal to anthrax, does not injure the glanders bacillus, which requires a solution 20 times as strong; and we conclude that the chemical constitution of the glanders bacillus must be different from that of anthrax.

The dissimilarity of the different protoplasts may be either a qualitative or a quantitative one. That is to say, the *kinds* of molecules, or the *proportions* of the different molecules, may differ in the two cases. If we assume that gold chloride acts upon protoplasm by the Au replacing some of the H in an amido-acid, then the diversity in action of AuCl_3 upon anthrax and typhoid may be accounted for by assuming that the amido-acids are dissimilar in anthrax and typhoid or that the proportion of the kinds especially affected is different in the two cases. To which of these two causes the diverse reactions to AuCl_3 are due cannot yet, in any given case, be determined.

A second principle which we may draw from our data is this: Some kinds of protoplasm have a *general* high resistance to all chemical agents, while other kinds have a high or low resistance to particular agents only (*specific* high or low resistance). Thus, in the case of pathogenic bacteria, the experiments of BOER ('90) show that, in general, the anthrax bacillus has a low resistance, and glanders a high one. His experiments were made with 10 reagents upon five kinds of bacteria. Table VII gives in modified form the results obtained by BOER. His results are given in the form of Table V; the present table is constructed from the original by making the mean of the five observations in each column unity and reducing the separate observations proportionately. Thus Table V becomes —

TABLE VI

Anthrax bacillus	0.09
Cholera spirillum	0.75
Diphtheria bacillus	0.75
Typhoid bacillus	1.51
Glanders bacillus	1.88

All the other determinations have been treated in like manner. Throughout the table the numbers in each column stand for

relative resistance capacity. The reagents are placed with the weakest-acting first.

TABLE VII

SUBSTANCES.	CAUSTIC SODA (NaHO).	CARBOLIC ACID (C ₆ H ₆ O).	MURIATIC ACID (HCl).	SULPHURIC ACID (H ₂ SO ₄).	METHYL VIOLET.
MOLECULAR WEIGHTS.	40	94	37	98	
Anthrax bacillus	0.46	0.95	0.40	0.37	0.07
Cholera spirillum . . .	1.38	0.71	0.32	0.37	0.33
Diphtheria bacillus . .	0.69	0.95	0.63	0.94	0.17
Typhoid bacillus	1.09	1.43	1.46	0.94	2.22
Glanders bacillus	1.38	0.95	2.19	2.36	2.22

SUBSTANCES.	SILVER NITRATE (AgNO ₃).	GOLD CHLORIDE (AuCl ₃).	MALACHITE GREEN.	OXYCYANIDE OF Hg.	AVERAGE.
MOLECULAR WEIGHTS.	170	304			
Anthrax bacillus	0.20	0.09	0.02	0.93	0.388
Cholera spirillum . . .	1.04	0.75	0.17	0.62	0.632
Diphtheria bacillus . .	1.67	0.75	0.11	0.93	0.760
Typhoid bacillus	1.04	1.51	1.75	1.25	1.415
Glanders bacillus	1.04	1.88	2.92	1.25	1.802

From this table we see that the bacillus of glanders is more resistant than that of anthrax (except in one instance, in which the resistance is equal in the two cases) whatsoever be the poison employed. The bacillus of glanders affords, thus, a good illustration of an organism with a general high resistance capacity.

The diversity in general resistance capacity which is found among bacteria exists also among other organisms. Thus, the parasitic *Ascaris* has shown itself highly resistant in all cases in which the action of a poison on it has been compared with that on another species; for instance (p. 10) 0.1% chloral hydrate kills Infusoria, Rotifera, and diatoms in 24 hours, but *Ascaris* withstands this solution. Again, while 0.1% HCN kills Infusoria quickly, *Ascaris* resists 3% for 75 minutes. The general higher resistance may be due to one of three causes:

either to the fact that the protoplasm is protected from attack, as is the case with the encysted forms of Protozoa, which are very resistant; or to the fact that the protoplasm is not so readily acted upon by reagents brought actually in contact with it, due to diminished amount of water or other structural modifications; or, finally, that the protoplasm has a different composition, certain unstable molecules found in other kinds of protoplasm being absent.

We will now consider the phenomena of diversity in *specific* resistance of protoplasm. A case of specific *low* resistance is found in the nervous tissue. Thus many of the alkaloids, *e.g.* nicotine and cocaine, are almost indifferent to the protoplasm of Protista, but act towards the nervous system as powerful poisons. Hence we are led to conclude that nervous protoplasm contains especially unstable compounds, upon which its action depends. When they are subjected to the action of very weak —towards most substances, indifferent—reagents, extensive and fatal transformations occur.

Cases of specific *high* resistance are apparently found in some glands which secrete intense poisons, or in some organisms which live in solutions of some usually poisonous agent. Examples of this class are the HCl-secreting glands of the Vertebrate alimentary tract, the poison-glands of venomous serpents, and the H₂SO₄-secreting glands of Gasteropoda; also the vinegar eel, which lives in 4% acetic acid. It ought to be said that it is largely an inference based upon experiments on acclimatization, that these glands or organisms will not show a *general* high resistance. Experiments are needed to determine this point. As to the cause of specific high resistance, I believe that much light is gained from the facts of acclimatization, and that any sufficient theory of the latter would serve also to explain the former (see p. 30).

Under the general poisons we have distinguished four main groups: *a.* oxidizing poisons; *b.* salt-forming poisons; *c.* substitution poisons; *d.* catalytic poisons. I will comment briefly upon the action of the poisons of each of these groups.

a. Oxidizing Poisons.—The ordinary oxidation processes in living protoplasm involve the consumption not of the proto-

plasm itself, but of the thermogenic substances stored therein (sugar, yolk). After these have been consumed in starvation, or when the organism is subjected to the action of oxidizing poisons, the molecules of the protoplasm become oxidized. All protoplasm which is readily accessible must be injured by the direct attacks of "active" oxygen.

b. Salt-forming Poisons. — The facility with which an acid or a base forms salts with the protein substances of the protoplasm must depend, in large part, upon the quality of the protein molecules. It is well known that certain protein substances, such as keratin, chitin, and fibrin, are not readily acted on by acids or bases, and it seems necessary to suppose that some such resistant proteids are the essential parts of glands which secrete these reagents. Into this group fall the salts of heavy metals characterized by their extraordinary fatality.

c. Substitution Poisons. — This group comprises, besides a few sulphur compounds, almost exclusively nitrogenous substances, and among these a large proportion of compounds with closed chains. As many of these are indifferent to dead albumen, but violent poisons to living protoplasm, it is clear that the latter must contain certain extremely unstable groups (amido-, aldehyde-, and keton-groups, LOEW, '80). Among these poisons the relation between molecular structure and poisonous action is very marked, especially in the nitro-compounds. Thus, bodies containing H united with N are poisonous in direct proportion to the number of H atoms so combined. It seems probable that H so combined is very easily given up to the molecules of the living substance, destroying them. H in the hydroxyl radical seems also more easily parted with than H joined to C.

d. Catalytic Poisons. — Chiefly organic compounds of the fat series, which have little chemical energy and produce, for the most part, anæsthesia. The poisonous action seems here proportional to the complexity and instability of the compound. Thus, in many groups, when the alkyls CH_3- , C_2H_5- , etc., are successively introduced, the substance grows more poisonous as the number of atoms in the alkyl increases. In the methan series and among sulphureted compounds the substitution of Cl for H increases the poisonous action.

The study of the action of poisons upon protoplasm gives us an insight into the extreme complexity of the living substance — its composition out of numerous kinds of compounds, many of which are extremely unstable. Not all protoplasm contains the same compounds, hence it must be a very dissimilar thing in different organisms. Not all of the compounds in any protoplasmic body are essential to life, for we may act upon a protoplasmic body by a weak reagent, and gradually change its composition so that it will no longer be killed by the strong solution, and all of this without perceptible injury — at least, this is the conclusion to which the study of acclimatization of Protista leads us. The altered chemical constitution will be transmitted in the division of the individual, and thus the composition of the protoplasm of a race will have been determined by the medium in which it and its ancestors have been living.

Finally, we may consider what light the action of reagents throws upon the processes involved in the elementary vital functions. The normal *movement* of protoplasm is profoundly modified by interfering with the oxygen supply. Thus, when the oxygen pressure is diminished, movements are retarded; in the presence of pure oxygen they are accelerated. Some anæsthetic or paralyzing agents — *e.g.* chloroform and some alkaloïds, veratrin, atropin, cocaine, strychnin, and antipyrin — give rise first to acceleration, then to disappearance of movements in the protoplasm. Protoplasmic movement is, consequently, closely associated with oxidation, and it does not occur in the absence of irritability.

Normal *locomotion* is interfered with by strychnin and cocaine. Their stimulating action produces accelerated movements, and these are accompanied by loss of coördination.

Since many catalytic poisons (anæsthetics) destroy *irritability*, one may conclude from the action of these chemical agents that (p. 7) stability of molecular movement is essential to the performance of this function.

Disturbance of the *excretory* function results from the action of CO, NH₃, chloroform, cocaine, strychnin; at least, an excessive vacuolation of the protoplasmic body occurs under the action of these agents.

Experiments on chemotaxis show that many substances brought near to protoplasmic bodies control their locomotion. The effect upon locomotion depends both upon the kind of protoplasm and the strength of the reagent. In many cases, a certain strength of reagent attracts an organism, while a stronger solution repels, and a weaker solution is indifferent. In such a case we may speak of the protoplasm as being attuned to the attracting strength of the reagent. We find great diversity in the strength of solution of a reagent to which different protoplasms are attuned. This difference of attunement to chemotactic reagents is parallel to the difference in strength of the killing solution of various protoplasms. As the latter is probably due to the past action of chemical agents upon the protoplasm, so is also the former.

APPENDIX TO CHAPTER I

Cytotaxis (= *Cytotropism*)

ROUX ('94) has given the latter name to a phenomenon which is probably only a special case of chemotaxis, but which may be better considered apart. He isolated, in an indifferent medium, two or three cells from the egg of a frog (*Rana fusca*) at the morula or blastula stage of development. These he placed near each other upon a glass slide, and found that they moved slowly, and that the direction of the movement of any one cell was, under certain conditions, determined by the position of the other cell or cells.

In order to perform the experiment a proper medium in which to study the movement of the cells must be prepared as follows: a small quantity—5 to 10 ccm.—of fresh egg albumen (not cut up, but with the albumen threads intact) is filtered through clean wadding, and the completely clear filtrate is used. In other cases a more or less strong salt solution is employed. The cleavage cells are isolated in the filtrated albumen, on a glass plate, by means of needles. To diminish evaporation the glass plate is put into a shallow glass vessel containing several drops of water.

When two cells were placed near each other (about one-fourth of their diameter apart), the distance between them diminished. The approach took place along a line joining the two cells;

and when several pairs of cells were in the field, this movement took place in various directions, indicating that their movement was not determined by conditions outside the approaching cells. To get further light on the migration of the cells, their distance apart was measured at short intervals of time. The results of two series of such measurements are represented graphically in Figs. 6 and 7. In both of these diagrams the heavy lines indicate the successive positions assumed by four points; namely, the points of the two cells which are nearest each other and those which are most distant. In the first case the cells traverse the distance of their diameters ($58\ \mu$) in about 10.5 minutes. The rate of migration is, however, extremely variable. In some cases the cells seem even to move apart (negative cytotaxis?).

Certain special cases are worthy of consideration. When a third cell lies near an approaching pair, the path of migration of the pair may become convex towards the third cell.

Two cell-complexes, each composed of three or four cells, may approach and connect. But masses composed of a larger number of cells form "closed complexes" which show no cytotactic activity. The isolated cells of differ-

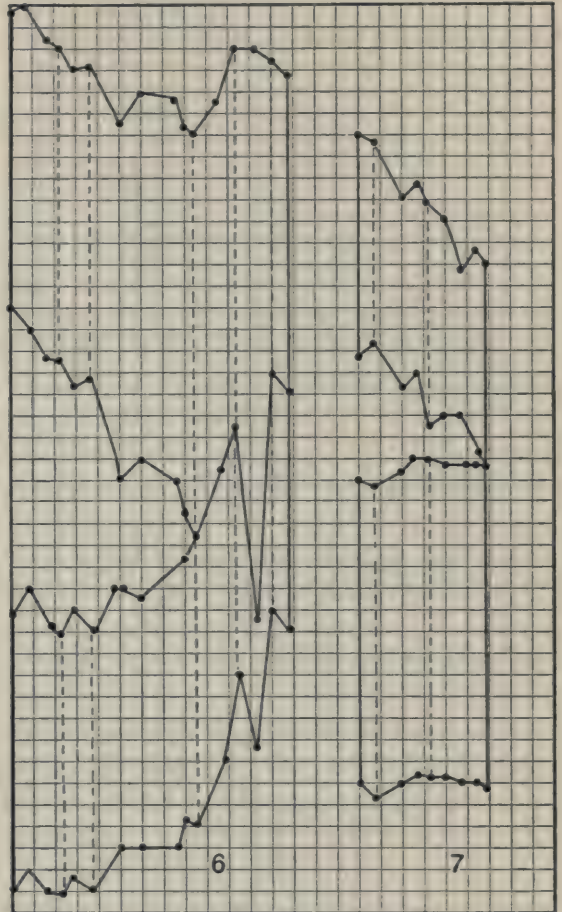

FIGS. 6, 7.—Two sets of curves, showing the course of "cytotactic" movements of the cleavage cells of the frog. In each figure the dotted line represents a diameter of the cell. The full line represents the successive positions of the extremities of the diameters as the cells approach. The distances between horizontal lines = $4\ \mu$; between vertical lines, 75 seconds. (From Roux, '94.)

ent eggs of the same species behave like cells from the same egg.

By these important experiments it is established that, inside of the body, parts may act upon parts, determining the direction of motion. The importance of this fact will be discussed in a later Part of this book.

LITERATURE

- ADDUCO, V. '90. Sur l'existence et sur la nature du centre respiratoire bulbaire. *Arch. Ital. de Biol.* XIII, 89-123. 21 March, 1890.
- ADERHOLD, R. '88. Beitrag zur Kenntnis richtender Kräfte bei der Bewegung niederer Organismen. *Jena. Zeitschr.* XXII, 310-342.
- ALBERTONI, P. '91. Wirkung des Cocains auf die Contractilität des Protoplasma. *Arch. f. d. ges. Physiol.* XLVIII, 307-319. 28 Jan. 1891.
- BERNARD, C. '78. Leçons sur les phénomènes de la vie communs aux animaux et aux végétaux. Tome I, 404 pp. Paris.
- BOER, O. '90. Ueber die Leistungsfähigkeit mehrerer chemischer Desinfektionsmittel bei einiger für den Menschen pathogenen Bacterien. *Zeitschr. f. Hygiene.* IX, 479-491.
- BOSCH, C. TEN '80. De physiologische werking van chinamine. *Onderzoek. Physiol. Lab. Utrecht.* V, 248-292.
- BINZ, C. '67. Ueber die Einwirkung des Chinin auf Protoplasma-Bewegungen. *Arch. f. mik. Anat.* III, 383-389.
- BINZ, C. and SCHULZ, H. '79. Die Arsengiftwirkungen vom chemischen Standpunkt betrachtet. *Arch. f. exper. Path. u. Pharm.* XI, 200-230.
- BOKORNY, T. '86. Das Wasserstoffsperoxyd und die Silberabscheidung durch actives Albumin. *Jahrb. f. wiss. Bot.* XVII, 347-358.
- '88. Ueber die Einwirkung basischer Stoffe auf das lebende Protoplasma. *Jahrb. f. wiss. Bot.* XIX, 206-220.
- '93. Ueber die physiologische Wirkung der tellurigen Säure. [Abstr. in] *Bot. Centralbl.* LVII, 16.
- BOURNE, A. G. '87. The Reputed Suicide of Scorpions. *Proc. Roy. Soc. London.* XLII, 17-22.
- BUCHNER, H. '91. Die chemische Reizbarkeit der Leukocyten und deren Beziehung zur Entzündung und Eiterung. *Sb. Ges. Morph. u. Physiol. München.* VI, 148-152.
- '92. Die keimtodtende, die globulicide und die antitoxische Wirkung des Blutserums. *Münchener Med. Wochenschr.* XXXIX, 119-123.
- CALMETTE, A. '94. L'immunisation artificielle des animaux contre le venom des serpentes et la thérapeutique expérimentale des morsures venimeuses. *C. R. Soc. de Biol.* (10) I, 120-124.

- CHARPENTIER, A. '85. Action de la cocaine et d'autres alcaloïdes sur certains infusoires à chlorophylle. *C. R. Soc. de Biol.* XXXVII, 183, 184.
- CLARK, J. '89. Protoplasmic Movements and their Relation to Oxygen Pressure. *Proc. Roy. Soc. Lond.* XLVI, 370, 371. June 20, 1889.
- COHN, F. '94. Formaldehyd und seine Wirkung auf Bacterien. *Bot. Centralbl.* LVII, 3-6.
- DANILEWSKI, B. '92. Ueber die physiologische Wirkung des Cocains auf wirbellose Thiere. *Arch. f. d. ges. Physiol.* LI, 446-454.
- DAREMBERG, G. '91. Sur le pouvoir destructeur du serum sanguin pour les globules rouges. *C. R. Soc. Biol.* XLIII, 719-721.
- DARWIN, C. '75. *Insectivorous Plants.* 462 pp. New York: Appleton & Co.
- DAVENPORT, C. B. and NEAL, H. V., '96. On the Acclimatization of Organisms to Poisonous Chemical Substances. *Arch. f. Entwickl. d. Organismen.* II, 564-583. 28 Jan. 1896.
- DEMOOR, J. '94. Contribution à l'étude de la physiologie de la cellule (independance fonctionnelle du protoplasma et du noyau). *Arch. de Biol.* XIII, 163-244, Pls. IX, X. 28 Feb. 1894.
- DEWITZ, J. '85. Ueber die Vereinigung der Spermatozoen mit dem Ei. *Arch. f. d. ges. Physiol.* XXXVII, 219-223. 29 Oct. 1885.
- EHRlich, P. '91. Experimentelle Untersuchungen über Immunität. I Ueber Ricin. II Ueber Abrin. *Deutsche med. Wochenschr.* 976-979; 1218, 1219.
- ELFVING, F. '86. Ueber die Einwirkung von Äther und Chloroform auf die Pflanzen. *Öfversigt af Finska Vetensk. Soc. Förh.* XXVIII, 36-53.
- ENGELMANN, T. W. '81. Neue Methode zur Untersuchung der Sauerstoffausscheidung pflanzlicher und thierischer Organismen. *Arch. f. d. ges. Physiol.* XXV, 285-292. 20 June, 1881.
- '82. Ueber Licht- und Farbenperception niederster Organismen. *Arch. f. d. ges. Physiol.* XXIX, 387-400. 3 Nov. 1882.
- '94. L'émission d'oxygène sous l'influence de la lumière, par les cellules à chromophylle, démontrée au moyen de la méthode bactérienne. *Arch. Néerland.* XXVIII, 358-371.
- FAYRER, J. '74. *The Thanatophidia.* 2d ed., 178 pp., 31 pls. London: Churchill.
- FROMANN, C. '84. Untersuchungen über Struktur, Lebenserscheinungen und Reaktionen thierischer und pflanzlicher Zellen. *Jena. Zeitschr.* XVII, 1-349. Taf. I-III. 19 Jan. 1884.
- GREENWOOD, M. '90. On the Action of Nicotin upon Certain Invertebrates. *Jour. of Physiol.* XI, 573-605. Dec. 1890.
- HEIDENSCHILD, W. '86. Untersuchungen über die Wirkung des Giftes der Brillen- und der Klapperschlange. *Jahresber. d. Thier-Chem.* XVII, 330. [From Inaug. Diss. Dorpat. Lookmann, 1886.]
- HERTWIG, O. and R. '87. Ueber den Befruchtungs- und Teilungsvorgang des tierischen Eies unter dem Einfluss äusserer Agentien. *Jena. Zeitschr.* XX, 120-241. 8 Jan. 1887.

- HOFER, B. '90. Ueber die lähmende Wirkung des Hydroxylamins auf die contractilen Elemente. *Zeitschr. f. wiss. Mikr.* VII, 318-326. 18 Dec. 1890.
- KANTHACK, A. A. '92. The Nature of Cobra Poison. *Jour. of Physiol.* XIII, 272-299. May, 1892.
- KRUKENBERG, C. F. W. '80. Vergleichend-physiologische Studien. 1 Reihe, 1 Abth., 77-155.
- KÜHNE, W. '64. Untersuchungen über das Protoplasma und die Contractilität. 158 pp., 8 Taf. Leipzig: Engelmann.
- LEBER, T. '88. Ueber die Entstehung der Entzündung und die Wirkung der entzündungserregenden Schädlichkeiten. *Fortschritte d. Medicin.* VI, 460-464.
- LOCKE, F. S. '95. On a Supposed Action of Distilled Water as such on Certain Animal Organisms. *Jour. of Physiol.* XVIII, 319-331. 5 Sept. 1895.
- LOEB, J. '90. Der Heliotropismus der Thiere und seine Uebereinstimmung mit dem Heliotropismus der Pflanzen. 118 pp. Würzburg: Hertz.
- LOEW, O. '77. Lieutenant Wheeler's Expedition durch das südliche Californien im Jahre 1875. *Petermann's Geogr. Mitth.* XXIII, 134-140.
- '83. Sind Arsenverbindungen Gift für pflanzliches Protoplasma? *Arch. f. d. ges. Physiol.* XXXII, 111-113. 12 Sept. 1883.
- '85. Ueber den verschiedenen Resistenzgrad im Protoplasma. *Arch. f. d. ges. Physiol.* XXXV, 509-516. 30 Jan. 1885.
- 85^a. Ueber die Giftwirkung des Hydroxylamins verglichen mit der von anderen Substanzen. *Arch. f. d. ges. Physiol.* XXXV, 516-527. 30 Jan. 1885.
- '87. Ueber Giftwirkung. *Arch. f. d. ges. Physiol.* XL, 437-447. 18 May, 1887.
- '88. Physiologische Notizen über Formaldehyd. *Sb. Ges. f. Morpol. u. Physiol. München.* IV, 39-41.
- '91. Die chemischen Verhältnisse des Bakterienlebens. *Centralbl. f. Bakteriol. u. Parasitenk.* IX, 659-663; 690-697; 722-726; 757-760; 789-790. May-June, 1891.
- '92. Ueber die Giftwirkung des Fluornatriums auf Pflanzenzellen. *Münchener Med. Wochenschr.* XXXIX, 587.
- '93. Ein natürliches System der Gift-Wirkungen. 136 pp. München, Wolff u. Lüneburg, 1893.
- LOEW, O. and BOKORNY, T. '89. Ueber das Verhalten von Pflanzenzellen zu stark verdünnter alkalischer Silberlösung. *Bot. Centralbl.* XXXIX, 369-373; XL, 161-164, 193-197.
- LUBBOCK, J. '84. Ants, Bees, and Wasps. *Internat. Sci. Ser.* XLII, 448 pp. 5 pls. New York: Appleton.
- MARMIER, L. '95. Sur la toxine charbonneuse. *Ann. de l'Inst. Pasteur.* IX, 533-574.
- MASSART, J. '91. La sensibilité à la concentration chez les êtres unicellulaires marins. *Bull. l'acad. roy. Belg.* (3) XXII, 148-167.

- MASSART, J. '93. Sur l'irritabilité des Noctiluques. Bull. Sci. France et Belg. XXV, 59-76. 23 Oct. 1893.
- MIGULA, W. '90. Ueber den Einfluss stark verdünnter Säurelösungen auf Algenzellen. Inaug. Diss., Breslau, 1889. Abstract in Bot. Centralbl. XLI, 207. 12 Feb. 1890.
- METSCHNIKOFF, E. '92. Leçons sur la pathologie comparée de l'inflammation. Paris. 1892.
- NÄGELI, C. v. '93. Ueber oligodynamische Erscheinungen in lebenden Zellen. Neue Denkschr. all. schweiz. Ges. XXXIII, Abth. 1, 52 pp.
- NIKOLSKI, W. and DOGIEL, J. '90. Zur Lehre über die physiologische Wirkung des Curare. Arch. f. d. ges. Physiol. XLVII, 68-115. 28 Feb. 1890.
- OHLMULLER, '92. Ueber die Einwirkung des Ozons auf Bacterien. Chem. Centralbl. 1892, I, 860. [Abstr.]
- PANETH, J. '89. Ueber das Verhalten von Infusorien gegen Wasserstoff-superoxyd. Centralbl. f. Physiol. III, 377-380. 9 Nov. 1889.
- PFEFFER, W. '84. Locomotorische Richtungsbewegungen durch chemische Reize. Unters. a. d. bot. Inst. Tübingen. I, 363-482.
- '88. Ueber chemotaktische Bewegungen von Bacterien, Flagellaten und Volvocineen. Untersuch. bot. Inst. Tübingen. II, 582-662.
- RICHET, C. '89. La chaleur animale. 307 pp. Paris: Alcan.
- ROEMER, F. '92. Die chemische Reizbarkeit thierischer Zellen. Arch. f. path. Anat. u. Physiol. CXXVIII, 98-131. 1 April, 1892.
- ROSSBACH, M. J. '72. Die rythmischen Bewegungserscheinungen der einfachsten Organismen und ihr Verhalten gegen physikalische Agentien und Arzneimittel. Verh. phys.-med. Ges. Würzburg. I, 179-242; also in Arbeiten a. d. zool.-zoot. Inst. Würzburg. I, 9-72.
- ROUX, W. '94. Ueber den Cytotropismus der Furchungszellen des Grasfrosches (*Rana fusca*). Arch. f. Entwickl. d. Organismen I, 43-202. Taf. I-III.
- SCHRÖDER, W. v. '85. Ueber die Wirkung einiger Gifte auf Askariden. Arch. f. exp. Path. XIX, 290-309.
- SCHÜRMYER, C. B. '90. Ueber den Einfluss äusserer Agenten auf einzellige Wesen. Jena. Zeitschr. XXIV, 402-470. 26 March, 1890.
- SCHULTZE, M. '63. Das Protoplasma der Rhizopoden und der Pflanzenzellen. 68 pp. Leipzig: Engelmann.
- SEWALL, A. '87. Experiments on the Preventive Inoculation of Rattlesnake Venom. Jour. of Physiol. VIII, 203-210. August, 1887.
- STAHL, E. '84. Zur Biologie der Myxomyceten. Bot. Ztg. XLII, 145-156; 161-176; 187-191. 7-21 March, 1884.
- STANGE, B. '90. Ueber chemotactische Reizbewegungen. Bot. Ztg. XLVIII, 107-111; 124-127; 138-142; 155-159; 161-166. Feb., March, 1890.
- TSUKAMOTO, M. '95. On the Poisonous Action of Alcohols upon Different Organisms. Jour. Coll. Sci. Japan. VII, 269-281.
- VERWORN, M. '89. Psycho-physiologische Protisten-studien. 218 pp. 6 pls. Jena: Fischer.

CHAPTER II

EFFECT OF VARYING MOISTURE UPON PROTOPLASM

IN this chapter it is proposed to speak (I) of the amount of water in organisms; (II) of the effect of desiccation upon the functions of protoplasm; (III) of the acclimatization of organisms to desiccation, and (IV) of the control of the direction of locomotion by moisture — hydrotaxis.

§ 1. ON THE AMOUNT OF WATER IN ORGANISMS

Any theory of the structure of protoplasm must recognize that water forms the greater part of the whole mass; between 60% and 90%. In the case of dry seeds and grains, however, it may fall below 15%. Many determinations have been made of the proportion of water in the body of entire organisms and in their organs. I give in tabular form some of these determinations, which were made by BEZOLD ('57), designated by (B); KRUKENBERG ('80), designated by (K); and LIEBERMANN ('88), designated by (L).

TABLE VIII

SPECIES.	CONDITIONS OF WEIGHING.	% WATER.
Various sponges (K)	In most cases, kept a short time in fresh sea water; dried on surface and weighed.	84.0 to 74.5
Medusa: Rhizostoma Cuvieri (K).	Whole animal, directly from water	95.4
	Piece of disc.	95.0
Various Actinia (K)	A few minutes after removal from sea.	87.7 to
	A little water lost from central cavity	83.2
Acyonium palmatum (K)	Weighed when fresh, 73.5 g.	84.3
Asteracanthion glacialis (K).	Weighed 850 g.	82.3
Lumbricus complanatus (K).	2 large specimens	87.8

SPECIES.	CONDITIONS OF WEIGHING.	% WATER.
<i>Oniscus murarius</i> (B)	200 young individuals	68.1
<i>Squilla mantis</i> (K)	1 individual	81.9
<i>Astacus fluviatilis</i> (B)	3 individuals weighing from 16.6 to 27.4 g.	71.1
<i>Doris tuberculata</i> (K)		88.4
<i>Doriopsis limbata</i> (K)	3 individuals	86.5
<i>Arion empiricorum</i> (B)	6 individuals weighing from 4.3 to 27.1 g.	86.8
<i>Limax maximus</i> (B)	4 individuals weighing from 0.1 to 17.1 g.	82.1
<i>Botryllus</i> (K)	4 individuals weighing from 111.2 to 35.2 g.	93.6
Various Vertebrates (B)		58.4 to 80.1
Chick (L)		
7 days old	Embryo only, yolk removed	92.8
21 days old	Embryo only, ready to hatch	80.4
Turnip (root)	From Goodale's <i>Physiolog. Bot.</i> , p. 236	91.0

These determinations suffice to show that water immensely predominates over any other substance in active organisms, and indicate that it plays an important role.

The role played by water is, in fact, extremely varied. It serves to maintain that unstable, foam-like structure of the protoplasm upon which its capacity for movement depends; it acts as a solvent for matter taken into the protoplasmic body; and it serves to transport dissolved substances from place to place in the organism. In a word, it is essential to movement and to those chemical processes which constitute metabolism.

§ 2. ON THE EFFECT OF DESICCATION UPON THE FUNCTIONS OF PROTOPLASM

We may consider this topic under the following heads: (1) effect upon metabolism; (2) effect upon the motion of protoplasm; and (3) the production of desiccation-rigor and death.

1. **Effect of Dryness on Metabolism.** — Since water is so essential to metabolism, we should expect that a diminution of metabolism would accompany dryness. And this is clearly the case. Thus dry seeds, in which the water is reduced to only 10

to 15%, when placed under conditions of temperature favorable to metabolism, show almost no change in the course of days. This has been indicated also by an experiment of KOCHS' ('90, p. 685), who placed seeds, which had been dried in a vacuum, in a receptacle connected with a GEISSLER'S tube, such as is used in the spectroscopic study of gases. The air was completely pumped out of both vessels, and after some months a spectroscopic study of the gases in the GEISSLER'S tube showed no trace of nitrogen or carbon, yet the seeds later germinated. This experiment can hardly be considered to demonstrate KOCHS' point, however, since the seeds were deprived of oxygen, as well as moisture.

The act of drying may, on the contrary, induce the manufacture and elimination of certain secretions. This occurs apparently in many Protista, which form cysts in the drying pools. This phenomenon is seen again in some of the higher animals, — such as our garden slugs, — which secrete slime in large amount when kept for a short time in a dry place. In both cases the result is of immense importance for the continued life of the organism, — in both cases it is to be considered a response to the stimulus afforded by evaporation of water.

2. Effect of Dryness upon the Motion of Protoplasm. — We have seen that water plays an important role in the movement of protoplasm. When by any means the water is partly withdrawn, the protoplasmic currents will be slowed. When, on the contrary, protoplasm, which is lying in an "indifferent" medium, such as blood serum, is placed in distilled water, unusually active movements occur. This has been shown by ENGELMANN ('68, p. 446) in the case of the spermatozoa of the frog, and the ciliated epithelium of the frog's œsophagus just removed from its body. Similarly, DEHNECKE ('81) found that protoplasm of the tissue cells of the higher plants exhibited abnormally rapid movements upon adding water. These observations indicate that water may act as a stimulus to the movement of protoplasm.

3. Desiccation-rigor and Death. — It is a familiar fact which has been established by over a hundred and fifty years of experimentation, that some organisms, when gradually dried, may cease from movements. This immotile condition has

sometimes been regarded as death. By PREYER ('91) it has been called "anabiosis." I shall call it desiccation-rigor, and correlate it with phenomena, produced by various other agents, which cause the cessation of a movement that is restored again when the action of the untoward agent is withdrawn.

And these are just the conditions we meet with here, — cessation of activity without loss of power of revival. This was very evident from the work of SPALLANZANI (1787, Tom. II, pp. 212, 213). This author showed clearly that one and the same adult rotifer can be observed in the evaporating drop, until all the water is gone, and it has lost all movement and its normal form. If, after an hour, the slide is moistened again, the rotifer reassumes, by degrees, its natural form and activities. SPALLANZANI noticed, what has been the nearly unanimous testimony of subsequent observers, that a rotifer dried for hours on clean glass does not revive; revivification occurs only when the rotifers have crawled into sand. As for the length of time during which desiccation-rigor may persist in rotifers without death occurring, we know only that it may be considerable, extending through months, and even years.

Similar phenomena to those observed in rotifers have been described for tardigrades and certain nematodes, although these organisms have not been studied in so much detail. Among the tardigrades only those species which live in moss, and are thus especially liable to desiccation, withstand drying. (LANCE, '94.) Among nematodes, *Tylenchus devastatrix*, KÜHN, which lives in grains of wheat, is a classic object of study. *Strongylus rufescens* is, according to RAILLIET ('92), capable of resisting dryness for 68 days or more. We may thus conclude that adult organisms of certain species may be subjected to desiccating influences, and that those same individuals may resist them so as to reëxhibit activities after the return of favorable conditions.*

While the results of these drying experiments are scarcely doubted, much difference of opinion has arisen concerning the interpretation of the results. The first moot point is the degree of desiccation which the protoplasm of the organisms

* See in connection with this the valuable report of BROCA ('61).

experiences. Many writers have assumed that this has been rendered in their experiments very great or nearly perfect. Thus DOYÈRE ('42, p. 28) says: "What is the condition of the animalcules in the dried sand of the gutters? I have never seen them, at such times, in any other condition than reduced to spangles as fragile and more deformed than when dried free on the glass. I have never discovered a single one which manifested any traces whatever of life, or which did not present all the appearances of a *complete* desiccation. Nevertheless, I do not pretend by this to invalidate all contrary assertions; the principal fact, that of the return to life after an *absolute* desiccation, is not affected thereby." The physicist GAVARRET ('59, p. 317) subjected, for 34 days, moss containing rotifers to a vacuum having a pressure of only 4 mm. of mercury, and other experimenters have likewise employed a similar "chemically drying" device, which they believed capable of extracting all water from the protoplasm.

The evidence that all water is withdrawn from the body of the organism is often very slight. The fact that the seeds or plant tissues in which nematodes or tardigrades are living, have been dried until they lose no appreciable weight, is not sufficient evidence that their inhabitants are completely dried.

On the other hand, there is positive evidence that one, at least, of the organisms which has been considered as having been absolutely dried, can protect itself from this condition. It is especially DAVIS ('73) who has shown this. This author has experimented with the rotifer *Philodina roseata*. When dried on a glass plate with sand, it assumes a spherical form. At the same time, however, it secretes a gelatinous envelope. Thus encapsuled it may rest for days until upon the addition of water it reassumes its active, adult form. That a layer of such gelatinous substance is sufficient to resist the drying action of a vacuum-chamber with sulphuric acid, was illustrated by putting grapes varnished with gelatine in such a dry chamber for one week. They emerged in a fresh, juicy condition. One of the encapsuled rotifers was crushed after "desiccation" and yielded under the cover-glass a drop of fluid. In this case then the rotifer was not fully dried. DAVIS accounts for the fact that isolated rotifers dried on a clean

slide will not survive desiccation, on the ground that the sand forms a necessary retreat in which the organism can quietly encapsule itself. Of the fact of such encapsuling there can be no doubt; it is abundantly substantiated by the testimony of HUDSON ('73 and '86). There is a doubt, however, whether this encapsuling is a phenomenon common to all organisms which can resist desiccating influences, and, therefore, whether DAVIS's explanation is generally applicable. To sum up: I believe there is no sufficient evidence that an adult organism or active protoplasm of any sort can rapidly lose all of its "free water" without such a destruction of its finer structure as would make it incapable of exhibiting vital activities upon moistening again.

A much greater capacity undoubtedly inheres in spores and seeds. Thus KOCHS ('90) subjected perforated seeds of *Zea* mais, *Phaseolus*, and *Triticum vulgare* to an almost perfect vacuum (made by a mercury pump) for 8 days, and they nearly all germinated. Even the small radish seed, with part of the cuticula removed, subjected to a vacuum for three weeks germinated perfectly. Probably there is no limit to the amount of desiccation which seeds and other masses of protoplasm especially adapted to resist desiccation can withstand.

The second moot point is this: Is the protoplasm, rendered immotile by drying, living or not? SPALLANZANI prejudiced the question by the title of his chapter on this matter,—"Observations and experiments on some marvellous animals which the observer can at his will make pass from death to life"; and he and many of his successors argue that death has truly occurred. PREYER ('91), however, prefers to reserve the term "dead" for protoplasm which is at the same time lifeless and incapable of life; while to protoplasm which is lifeless but capable of revivification he applies the term "anabiotic." The question then is this, is life truly suspended during the immotile state? If we think of life as the sum of the chemical changes occurring in the protoplasm, we shall realize that all degrees of vitality, even to complete cessation of activity, may occur without our being able anywhere to say at this point life becomes extinct. We can hardly hope ever to deny that minimum vital changes are occurring; since the minimum changes

must be beyond our ken. That these vital changes are sometimes exceedingly slight, is sufficiently indicated by the experiments upon seeds performed by KOCHS ('90), and referred to on p. 60. That, however, slight changes are occurring even in seeds is indicated by the fact that dessication-rigor cannot continue indefinitely without loss of the power of revivification.

In the case of the rotifers, tardigrades, and nematodes, months, and even years, may elapse without complete loss of capacity for revivification. It is generally admitted, however, that in cases of long-continued drought, the chances of revitalizing upon moistening are much diminished.* In the case of seeds it has been maintained that under certain conditions, such as are realized in the mummy-graves of Egypt, life may persist for more than a thousand years. However, the experiments of MÜNTER ('47), and more especially of KOCHS ('90, p. 683), throw doubt upon this assertion, since they found that the ancient, charred seeds fell to pieces in water like lime. As for seeds preserved above ground in the ordinary way, KOCHS was assured by seedmen that they could not remain capable of germination over 10 years. These facts go to show that gradual changes occur in the dry protoplasm which are probably metabolic changes, *i.e.* vital changes; and that therefore life is hardly extinct in the very driest protoplasm.

The whole matter of desiccation-rigor is, after all, one with which we are familiar in nature's larger laboratory. Many Protista, when the ponds in which they live dry out, encyst themselves and enter into a motionless condition in which they resist the hot and dry summer winds. Thus, they may lie for weeks, and, as experimentation has shown, they may be dried for several years (see BÜTSCHLI, '89, p. 1663, for references) without loss of capacity for revivification. The same device

* Thus RAILLIET ('92) says of *Strongylus rufescens*: "I have seen them regain their activity after 42 and even 68 days of desiccation. However, this activity is much slower in manifesting itself. After the course of a month a contact of 8 to 10 minutes is sufficient to bring them back to movement. . . . After 68 days at least 50 minutes are required, and certain individuals have shown activity only after 1 hour and 20 minutes. Moreover, the movements were limited, and only a small number of cases contorted themselves like ordinary *Anguillulidæ*."

for resisting desiccation is seen in the gemmules of sponges, and Bryozoa, the eggs of many animals, and the spores of many plants. Thus some protoplasm normally responds to the stimulus of drought by going into desiccation-rigor.

While, as we have seen, some protoplasmic bodies may be dried as far as possible by the ordinary methods used in chemistry without death ensuing, other bodies, especially the adult forms of higher organisms, whose cellular respiration is dependent upon a circulating fluid, are killed by desiccation. For loss of this fluid or desiccation-rigor in the pumping muscles will produce asphyxia. But these conditions do not militate against the belief that there is no necessary lower limit to the amount of water which must occur in quiescent protoplasm in order that it may retain vitality during a limited period.

§ 3. ON THE ACCLIMATIZATION OF ORGANISMS TO DESICCATION

We have seen in the last section that certain organisms are more capable of resisting desiccation without fatal effect than others; *e.g.* rotifers, tardigrades, and *Tylenchus*. Now it is clear that these organisms are especially apt to become dried, so that it is possible that their high capacity for resistance has been produced by acclimatization without selection. I shall here add certain other cases of resistance to dryness which I believe, but cannot prove, to have been thus produced. LANCE ('94) has mentioned, as already stated, that only those tardigrades which live in the moss of gutters (where they are alternately wet and dried), and not those living in water, show the phenomenon of revivification. CERTES ('92) has found that, although marine Ciliata cannot, in general, withstand desiccation, those from the chotts and saline lakes of Algeria may be dried like those from fresh-water ponds and swamps. The difference in resistance between the forms dwelling in the sea and in inland salt-water ponds is doubtless due to the fact that the former are not regularly desiccated, while the latter are; consequently the latter alone have had a chance to become acclimated to desiccation.

§ 4. THE DETERMINATION OF THE DIRECTION OF MOVEMENT BY MOISTURE, — HYDROTAXIS

This phenomenon has been described by STAHL ('84) in *Æthaliium*. When this Myxomycete is placed in the dark upon a glass plate covered with several layers of moistened filter paper, it expands uniformly over the homogeneously moistened substratum. If, now, the plate be placed in a drying chamber, the paper dries slowly, and one can see that the mass of the plasmodium draws towards those places which remain longest damp. If a dilute gelatine jelly is smeared upon a glass slide supported in a horizontal position about 2 mm. above the plasmodium, still in the dark chamber, the plasmodium sends up branches, some of which may touch the gelatine and spread out over it. If the water dries still further, the entire Myxomycete may become transferred to the slide above. If, now, the paper be moistened again, the plasmodium sends branches down to it. STAHL'S explanation is that of the old mechanical school. He says, the peripheral protoplasmic layer lying next the dryer region is poorer in water; while that next the damper part of the substratum contains much water. If it be assumed that the internal streaming tends to occur uniformly towards all points of the periphery, it is clear that the dryer, more consistent part will offer greater resistance than the more fluid part, and in this part, therefore, branches will tend to arise. In correspondence with the interpretations which we have hitherto placed upon similar phenomena I prefer to call this a case of response to the stimulus of excessive moisture — in any case it may be designated positive hydrotaxis.

When, however, the plasmodium of *Æthaliium* is in the fruiting stage, it retreats from the moister part of the substratum, and other Myxomycetes in the fruiting stage show the same negatively hydrotactic tendency. Thus the same agent, water, stimulates the same organism, at different stages, to reverse movements.

I will now summarize the conclusions concerning the effect of water upon protoplasm. Water constitutes by far the larger part of protoplasm and of all active organisms. Metabolism is

directly dependent upon it, and certain excretory processes are stimulated by it. The motion of protoplasm is likewise dependent upon water, which determines the unstable condition of that substance. Desiccation, therefore, produces a rigor, and this may continue, in the absence of water, for months, and even years, the organism being, meanwhile, ready to awake to activity upon the return of moisture. The degree of desiccation which organisms can resist varies. In the case of the higher organisms, it is slight; in the case of bodies especially adapted to resist dryness (spores, seeds, statoblasts), there is, perhaps, no practicably attainable limit to the dryness which their protoplasm may undergo without loss of power of revivification. The condition of desiccation-rigor is not known to be one of death which is replaced by life upon return of moisture. It is probably rather a condition of minimum metabolism. The great resistance capacity exhibited by certain organisms is correlated with their liability to desiccation in their natural surroundings. Finally, Myxomycetes (and probably other organisms) respond to inequalities in the amount of moisture in their environment, moving either towards or from greater moisture. We recognize thus that the activities of protoplasm are to a large extent dependent upon the existence of water in it; and that protoplasm reveals itself as sensitive to differences in the amount of moisture, responding by secretions, by the assumption of a quiescent condition, and by locomotion with reference to water.

LITERATURE

- BLAINVILLE, H. DE '26. Sur quelques petits Animaux qui, après avoir perdu le mouvement par la dessiccation, le reprennent comme auparavant quand on vient à les mettre dans l'eau. *Ann. des Sci. Nat.* IX, 104-110.
- BEZOLD, A. VON '57. Untersuchungen über die Vertheilung von Wasser. organischer Materie und anorganischen Verbindungen im Thierreiche, *Zeitsch. f. wiss. Zoöl.* VIII, 487-524. 26 Feb. 1857.
- BOS, R. '88. Untersuchung über *Tylenchus devastatrix*, KÜHN. *Biol. Centralb.* VII, 646-659. 1 Jan. 1888.
- BROCA, P. '61. Rapport sur la question soumise à la Société de Biologie par MM. POUCHET, PENNETIER, TINEL et DOYÈRE au sujet de la réviviscence des animaux desséchés, lu par M. PAUL BROCA au nom d'une

- commission comp. de MM. BALBIANI, BERTHELOT, BROWN-SÉQUARD, DARESTE, GUILLEMIN, CH. ROBIN et BROCA. *Mém. Soc. de Biol.* (3), 1-139.
- BÜTSCHLI, O. '89. Protozoa (part). *BRONN's Klass. u. Ord. d. Thier-reichs.* I Bd. 1585-2035. 1889.
- CERTES, A. '92. Sur la vitalité des germes des organismes microscopique des eaux douces et salées. *Bull. Soc. Zool. France.* XVII, 59-62.
- DAVIS, H. '73. A New Callidina: with the Result of Experiments on the Desiccation of Rotifers. *Monthly Micr. Jour.* IX, 201-209. 1 May, 1873.
- DEHNECKE, C. '81. Einige Beobachtungen über den Einfluss der Präparationsmethode auf die Bewegungen des Protoplasma der Pflanzenzellen. *Flora.* LXIV, 8-14, 24-30. 1, 11 Jan. 1881.
- DOYÈRE, M. P. L. N. '42. Mémoire sur les Tardigrades. *Ann. des. Sci. Nat.* (2) XVIII, 5-35.
- ENGELMANN, T. W. '68. Ueber die Flimmerbewegung. *Jena. Zeitschr.* IV, 321-479.
- FAGGIOLI, F. '92. De la prétendu reviviscence des Rotifères. *Arch. Ital. de Biol.* XVI, 360-374. 31 Jan. 1892.
- FROMENTEL, E. DE '77. Recherches sur la revivification des rotifères, des anguillules et des tardigrades. *C. R. Assoc. franç. l'avanc. des sci.* VI (Le Havre), 641-657.
- GAVARRET, J. '59. Quelques expériences sur les rotifères, les tardigrades et les anguillules des mousses des toits. *Ann. Sci. Nat. (Zoöl.).* (4), XI, 315-330.
- HUDSON, C. T. '73. Remarks on Mr. Henry DAVIS' Paper "On the Desiccation of Rotifers." *Monthly Micr. Jour.* IX, 274-276. 1 June, 1873.
- '86. [Desiccation of Rotifers.] *Jour. Roy. Micr. Soc.* (2) VI, 79.
- KOCHS, W. '90. Kann die Kontinuität der Lebensvorgänge zeitweilig völlig unterbrochen werden? *Biol. Centralbl.* X, 673-686. 15 Dec. 1890.
- KRUKENBERG, C. F. W. '80. Ueber die Vertheilung des Wassers, der organischen und anorganischen Verbindungen im Körper wirbelloser Thiere. *Vergl.-Physiol. Stud.* I, 2 Abth. 78-106.
- LANCE, D. '94. Sur la reviviscence des Tardigrades. *Comp. Rend.* CXVIII, 817, 818. 9 Apr. 1894.
- LIEBERMANN, L. '88. Embryochemische Untersuchungen. *Arch. f. d. ges. Physiol.* XLIII, 71-157. 7 Apr. 1888.
- MUNTER, J. '47. *Flora.* XXX, 478.
- POUCHET, F. A. '59. Recherches et expériences sur les animaux ressuscitants. Paris: J. B. Ballière et fils. 92 pp. 1859.
- PREYER, W. '91. Ueber die Anabiose. *Biol. Centralbl.* XI, 1-5. 1 Feb. 1891.
- RAILLIET, A. '92. Observations sur la resistance vitale des embryons de quelques Nématodes. *C. R. Soc. de Biol.* XLIV, 703, 704.

- RYWOSCH, D. '89. Einige Beobachtungen an Tardigraden. Sb. Naturf. Ges. Dorpat. IX, 89-92.
- SPALLANZANI, L. 1787. Oeuvres: Opuscules de physique, animale et végétale, etc. Trans. Jean SENEBIER. 3 tomes. Pavia and Paris.
- STAHL, E. '84. (See Chapter I, Literature.)
- ZACHARIAS, O. '86. Kommen die Rotatorien und Tardigraden nach vollständiger Austrocknung wieder aufleben oder nicht? Biol. Centralb. VI, 230-235. 15 June, 1886.

CHAPTER III

' ACTION OF THE DENSITY OF THE MEDIUM UPON PROTOPLASM

IN this chapter we shall consider (I) the structure of protoplasm and the physiological action of solutions; (II) the effect of density upon the structure and general functions of protoplasm; (III) acclimatization to solutions of greater or less density than the normal; and (IV) control of the direction of locomotion by density — tonotaxis.

§ 1. INTRODUCTORY REMARKS UPON THE STRUCTURE OF PROTOPLASM AND THE PHYSICAL ACTION OF SOLUTIONS

It is now generally recognized that protoplasm consists of two substances closely interwoven: the living plasma and a watery chylema. The relation of the plasma and the chylema is still a debated matter. Since the only theory of the structure of protoplasm which has been experimentally tested is that of BÜTSCHLI, his theory is especially worthy of recognition. According to this theory, the relation of plasma and chylema is that of water and air in a foam-work. The whole protoplasmic mass is bounded and penetrated through and through by plasma films which envelop watery globules. It is with membranes constructed of such protoplasm that the physical phenomena of osmosis are exhibited.*

Osmosis occurs when two aqueous solutions of different density are separated by an animal membrane.† Such a mem-

* Excellent treatises on the physical and chemical nature of solutions, including a discussion of osmosis, are: OSTWALD, '91, and WHETHAM, '95.

† Osmosis occurs likewise when such solutions are separated by inorganic walls containing pores of extreme fineness; *e.g.* a wall of porous clay in which copper ferrocyanide has been precipitated.

brane permits the free passage of water, but not of the dissolved substance, or rather, of the dissolved substance but slowly. Under these conditions, the water flows more rapidly towards the solution containing the greater number of molecules (per cc.). The theory of this movement is that upon the side containing the greater number of molecules of salt fewer water molecules will in a given time strike the membrane than upon the other side; and since the number passing through is proportional to the number striking, relatively fewer molecules of water will consequently pass out, and so there will be a resultant flow of water to that side; and if the mass of water is confined, it will exert great pressure.

This phenomenon of osmosis plays an important part in organic life. Thus, under certain conditions, cells take in the surrounding water, so that their walls are put under tension (turgescence). The tension thus gained may be considerable, amounting to 6 or 7 atmospheres. Under other conditions the cells give up their water to the surrounding medium, thus losing their turgescence. This occurs when they are put into certain solutions of KNO_3 or NaCl . The relation between the density of the internal and external fluids thus determines the internal pressure experienced by the cell.

A quantitative method of determining this pressure in the presence of various solutions has been employed by PFEFFER ('77). Solutions of different *dry* salts in different proportions, enveloped by a semi-permeable membrane, were placed in pure water, and the pressure upon a column of mercury determined. It was found, for example, that with a 1% solution of cane sugar a pressure of 47.1 cm. of mercury* was produced; with a 1% solution of K_2SO_4 , a pressure of 193 cm. of Hg. He concluded, as a result of his various experiments, (1) that the pressure is proportional to the concentration of the solution, and (2) that as the temperature rises the pressure increases.

DE VRIES ('84) made a noteworthy advance, using plant cells as objects of experimentation and subjecting them to various solutions of substances freed of water. He determined the degree of concentration which a solution of KCl must have

* The pressure of 76 cm. of mercury equals that of 1 atmosphere.

in order that no endosmosis or exosmosis should occur through the cell wall.* He next determined the same thing for some other substances, *e.g.* KI, and found that the degree of concentration which produces no osmosis is, for two different solutions, proportional to the molecular weights of the salts dissolved in them. Solutions which produce the same osmotic effect DE VRIES called isotonic. A solution of 0.746% KCl is isotonic with a solution of 1.661% of KI, for the molecular weight of KCl is 74.6, and that of KI is 166.1. Thus the first result which DE VRIES gained was that the osmotic effect of solutions of salts of similar structure depends upon the number of their molecules in the solution.

The second conclusion of DE VRIES was that salts of *dis-similar structure* have different osmotic properties, even when the number of molecules in the two solutions is the same. Thus, he found that with an equal number of molecules to the solution (molecular-weight solutions †) :—

- (1) All salts of alkalis with one atom of metal to the molecule are isotonic (formula, $R'A'$ [composed of a monad metallic radicle, R , and a monad acidic radicle, A]);
- (2) All organic compounds with no metal radicle have two-thirds the osmotic action of the first group; *e.g.* cane sugar, $C_{12}H_{22}O_{11}$. ‡

* As is well known, when a fully developed plant cell is put into a strong saline solution the living plasma sac separates from the cell wall and contracts, eventually, into a ball, — the result of the chylema flowing out of the protoplasm (plasmolysis). The weaker the concentration, the less marked the plasmolytic phenomena. Finally, a concentration is reached so weak that the separation of the plasma sac hardly occurs or is limited to a single corner. This concentration may be regarded as equal to that of the cell-sap — as that at which no osmosis occurs. (See Fig. 8.)

† I shall use the phrase “molecular-weight solution” to indicate solutions in the making up of which the molecular weight of the substance in grammes, dissolved in 100 g. of water, is used as the unit of concentration. It will often be convenient to abbreviate it as MW % sol. Chemists frequently use as a unit solution, called “normal” solution, the molecular weight in grammes dissolved in 1000 g. of water. Our MW % sol. is therefore equal to one-tenth of a “normal” solution.

‡ The fact that glycerine can be absorbed by some plants has introduced a complexity into the determination of its isotonic coefficient. This determination has been made the subject of a special investigation by DE VRIES ('88), who, by the use of slowly absorbing plants, has found the isotonic coefficient to be 1.78, which agrees approximately with the number given above for organic compounds.

- (3) All salts of alkalis with two atoms of metal to the molecule have four-thirds the osmotic action of (1) (formula, $R_2'A''$); e.g. K_2SO_4 .
- (4) Salts of alkalis with three atoms of the metal to the molecule have five-thirds the osmotic action of (1) (formula, $R_3'A'''$); e.g. $K_3(C_6H_5O_7)$.

In other words, the osmotic action of groups (2), (1), (3), and (4) are in the proportions of 2, 3, 4, 5. These last numbers are the *Isotonic Coefficients* of DE VRIES. In addition to these substances, DE VRIES determined that the isotonic coefficient is, in the case of —

salts of earthy alkalis with 1 acid radicle; e.g. $MgSO_4$. . . 2
 salts of earthy alkalis with 2 acid radicles; e.g. $CaCl_2$. . . 4

In the third place DE VRIES established the law that each acid group and each metal has, in all compounds, the same partial isotonic coefficients; the coefficient of any salt is the sum of these partial coefficients of the constituent components. These partial coefficients are: —

for each atom-group of an acid 2
 for each atom of an alkaline metal (Li, Na, K, Rb, Cs) . . . 1
 for each atom of an earthy metal (Ca, Sr, Ba, Mg) 0

while of the compounds the isotonic coefficients are —

$KCl = 1 + 2 = 3,$ $MgSO_4 = 0 + 2 = 2,$
 $K_2SO_4 = 2 \times 1 + 2 = 4,$ $MgCl_2 = 0 + 2 \times 2 = 4,$
 $K_3(C_6H_5O_7) = 3 \times 1 + 2 = 5,$ etc.

The determination of isotonic coefficients has subsequently been extended by several authors, especially by HAMBURGER ('86 and '87) and by MASSART ('89).

The work of HAMBURGER was done upon blood corpuscles. The method employed by him was as follows: In certain weak solutions the hæmoglobin passes out of the red blood corpuscles of ox blood. The concentration at which it just began to extrude was determined for various salts, and it was found that these concentrations were usually proportional to the molecular weights of the substances divided by certain whole numbers, which are the same as the isotonic coefficients of DE VRIES.

The work of MASSART was done chiefly upon bacteria. He made use of the fact demonstrated by PFEFFER (see p. 41) that substances, which at a low concentration attract bacteria chemotactically, at a higher concentration repel them. He found that, in general, the repulsions exercised by the various dissolved substances are proportional to their isotonic coefficients, when the solutions are made up as MW solutions. Thus, when a 10 MW % concentration of a substance with isotonic coefficient 2 just begins to repel bacteria, a substance which just begins to repel in a 5 MW % concentration has an isotonic coefficient of 4.*

§ 2. EFFECT OF VARYING DENSITY UPON THE STRUCTURE AND GENERAL FUNCTIONS OF PROTOPLASM

Under this head we may consider, (*a*) the effect upon the general structure of protoplasm; (*b*) the modification of general functions, and (*c*) the production of death.

* Starting from the observations of PFEFFER and DE VRIES the modern school of physico-chemists has greatly extended our knowledge of solutions. As a result of their work it appears that the validity of DE VRIES' law will not hold strictly for all solutions at all concentrations. For the number of effective particles in every solution of electrolytes, namely, of salts, bases, and acids, is greater than the number of molecules put into the solution; because a certain proportion of the dissolved molecules break up or *dissociate* into their constituent *ions*, and the osmotic pressure is determined by the number of both molecules and free ions in the solution. In the case of sugar, the alcohols and non-electrolytes in general, no dissociation occurs. In a normal solution of potassic chloride, on the other hand, 75.5% of the molecules dissociate, each forming two free ions. Since 24.5% of the molecules are intact and there are 151 free ions percent of the molecules introduced, the total number of molecules and free ions in the solution is 175.5% of the molecules introduced and the osmotic effect of a normal solution of KCl is 1.755 times that of a normal solution of sugar. The percentage of molecules of any electrolyte, as for instance KCl, which dissociate in solution increases as the strength of the solution diminishes, eventually becoming 100. Thus, in one-half the normal solution, 78% of the molecules of KCl dissociate; at 0.1 times the normal solution, 86%; at 0.01, 94%; at 0.001, 98%. Also, the percentage of molecules dissociated in normal solutions of different electrolytes varies. Thus, in such a solution of NaCl, 67.5% of the molecules are dissociated; of LiCl, 61%; of CaCl₂, 53% (each into 3 ions); of MgCl₂, 40%; of KI, 79%; of MgSO₄, 19%; of Na₂SO₄, 35.6% (each into 3 ions); and so on. Valuable and extensive tables for the determination of the percentage of dissociation at different concentrations will be found in WHETHAM, '95.

a. Since a protoplasmic mass is bounded by a film, permitting osmosis, it is clear that its characters may be greatly altered by varying the degree of concentration of the solution in which it lives; and we have already seen that they are so altered.

When plant cells, with a rigid cell-wall, are put into dense solutions, the water is drawn from the protoplasmic sac which, contracting, is torn from the cell-wall. The salt solution penetrates through the latter, but cannot enter the bounding plasma-film, which continues to contract around the diminishing globule of water until only a small ball remains.

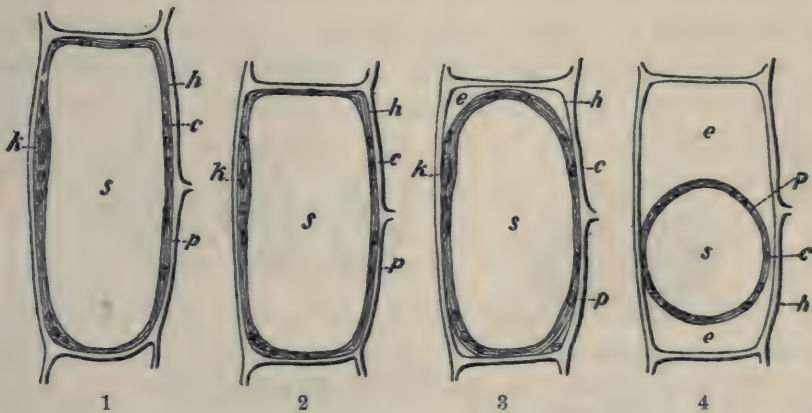

FIG. 8.—1. Young, not more than half-grown, cells from the cortical parenchyma of *Cephalaria leucantha*. 2. The same cell in a 4% solution of potassium nitrate. 3. The same cell in a 6% solution. 4. The same cell in a 10% solution. 1 and 4 from nature, 2 and 3 diagrammatic, all in optical longitudinal section. *h*, cell membrane; *p*, lining layer of protoplasm; *k*, cell nucleus; *c*, chlorophyll bodies; *s*, cell-sap; *e*, salt solution which has penetrated within the cell-membrane. (From SACHS: *Pflanzenphysiologie*, after DE VRIES.)

Put into pure water, on the contrary, the protoplasmic sac becomes distended, provided the cell sap contains an appropriate solution, generally a plant-acid. Thus turgescence is brought about.

The same effect of varied density upon the structure of protoplasm is observable among animals also. Thus, KÜHNE ('64, p. 48) and CZERNY ('69, pp. 158, 161) found that *Amœba* shrinks into a spherical mass when put into a 1% to 2% NaCl solution, and, when returned to fresh water, swells. Also, the character of the pseudopodia of *Amœba* and *Myxomycetes* changes. They become more numerous and attenuated, so that

the whole form of the organism has been likened to a horse-chestnut with its shell on. (KÜHNE, '64, pp. 48, 83; CZERNY, '69, p. 159.) ZACHARIAS ('84, p. 254, and '88) has described a similar phenomenon in the spermatozoön of *Polyphemus pediculus*. When put into a 3% NaCl solution the spermatozoa lost their cylindrical form and protruded long pseudopodia. A remarkable fact about the pseudopodia, moreover, was that in locomotion they were used like flagella. Likewise, FABRE-DOMERGUE ('88, p. 102) and MASSART ('89) have observed that the protoplasm of encysted Ciliata swells or contracts according as it is placed in a less or more dense medium; the cyst thus being perfectly permeable by water. MASSART has, indeed, obtained a rough quantitative expression of this statement, which is given in Tables X and XI, p. 87. HAMBUR-

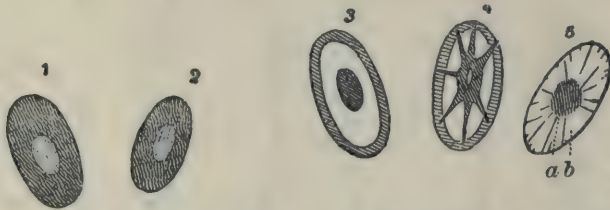

FIG. 9.—Blood corpuscles of the frog. 1, 2, normal; 3, 4, 5, various degrees of plasmolysis by solutions. *a*, nucleus and shrunken plasma; *b*, water-filled spaces. (From HAMBURGER, '87.)

GER ('87) has found that dense solutions produce the same modifications upon blood-corpuscles (see Fig. 9).

Again, GRUBER ('89) has found those individuals of the heliozoön *Actinophrys sol* which live in fresh water different from those which live in the sea, and he has produced that difference artificially. In the marine variety the plasma is dense, granular, free from vacuoles; while that of the fresh-water kind is extraordinarily rich in vacuoles, and has even a foamy appearance. If a marine form is gradually accustomed to fresh water its protoplasm soon acquires a vacuolated structure which renders it indistinguishable from the fresh-water one. GRUBER also accustomed fresh-water *Actinophrys* to sea water, when it acquired the structure of the normal marine form. Likewise the marine *Amœba crystalligera*, which has a dense protoplasm, becomes vacuolated after being accustomed to fresh water. Also, SCHMANKEWITSCH ('79) has found that when the fresh-

water flagellate *Anisonema acinus*, BÜTSCHLI, is cultivated for many generations in water to which sea salt is gradually added, its structure is modified with the increasing density. The individuals become smaller and their feeding canal is not well-formed. Another change, which has been studied only in Vertebrates, is loss of weight. BERT ('71) found that a gold-fish plunged into sea water loses 67% of its weight, and that young eels lose 10% to 17%. This fact also is clearly what we should expect from the theory of action of solutions, according to which the weak solutions of the body cavity should lose water. Thus, the changes produced in the structure of protoplasm by more or less dense solutions are chiefly the results of osmosis.

b. Among the functions of protoplasm, general movements (with locomotion) and excretion seem to be most markedly affected by density. Thus, KÜHNE ('64, p. 48) found that, when first subjected to a 1% NaCl solution, the movements of *Amœba* became more lively for a moment. ENGELMANN ('68, p. 343) noticed the same acceleration in movement in the cilia of the epithelium lining the frog's œsophagus when subjected to pure water—hence, to a weaker solution than the normal cell fluid. Even after death, fresh water causes a transitory activity in the cilia. In all cases, after a minute or two (1% solution) the movements begin to diminish, until at last they cease. This cessation of movement, whether due to loss or imbibition of water, is not necessarily death. For, if the abnormal concentration has not acted for too long a time, the movements return when the protoplasm is placed again in its normal fluid. (KÜHNE, '64, p. 48; ENGELMANN, '68, p. 343.)* At a certain

* A similar cessation of movement occurs when the lower organisms are subjected in water to very great pressures. Experiments upon this phenomenon have been made chiefly by REGNARD ('84, '84^a-'84^d, and '86), CERTES ('84, '84^a), and ROGER ('95). REGNARD was able, by the use of a special apparatus, to subject beer yeast, in water, during 1 hour, to a pressure of 1000 atmospheres (about 1000 kilograms per sq. cm.). When yeast so subjected was then placed in sugared water, it showed at first no activity. It was not dead, however, but had fallen into a latent life; for 1 hour after it had been relieved from pressure it revived and fermentation set in. Some algæ, Infusoria, and actinians, subjected to 600 atmospheres during 10 to 60 minutes, or to 300 atmospheres for 24 hours (CERTES, '84), exhibited a similar temporary rigor. Likewise muscle at 200 to

strength, however, varying for different individuals (ENGELMANN, CZERNY), death rapidly ensues. Thus *Amœba* quickly breaks up in a 10% solution, and the ciliated epithelium of a frog's throat in a 2.5% solution. Four phases in the action of concentrations may thus be observed: stimulation, retardation, density-rigor, and death. Even in concentrations at which motion is not entirely inhibited, locomotion may be interfered with. Thus, RICHTER ('92, pp. 37-40) found that while normal *Tetraspora* swarm-spores move at the rate of about 60μ per second, or else rotate about 100 times per minute, those in an 11% solution hardly move from their place, or sometimes move one-eleventh as fast as the normal swarm-spores. While it is possible that the dense water affords a mechanical obstacle to locomotion, it seems more probable that it is the general diminution of activities which causes the slow migration.

The modification of excretion by abnormal concentrations has been studied especially by ROSSBACH ('72). This experimenter worked upon fresh-water Ciliata (which alone possess a contractile vacuole) by subjecting them to a 0.5% solution of NaCl. The contractile vacuole became diminished almost to invisibility, and the interval between contractions was increased. In a 1% solution of sugar a reduction in size of the contractile vacuole occurred, but this was not so marked as in the case of the 1% NaCl solution. This is what we should expect according to theory, for the number of molecules in a 1% solution of sugar (mol. wt., 342) is much less than in a 1% solution of NaCl (mol. wt., 58.5), and their relative osmotic action is as $\frac{2}{3 \times 342} : \frac{3}{3 \times 58.5}$, or as 0.002 : 0.017, or as 2 : 17.

The phenomenon of contracting vacuoles seems not to be confined to Protozoa. It occurs in the embryos of some Mollusca, especially the stages of fresh-water Pulmonates, upon which my friend, Dr. KOFOID, performed some density experiments. The early cleavage and blastula stages of many fresh-water Pulmonates contain a central fluid-filled vacuole, which

300 atmospheres loses its contractility, and at 400 atmospheres becomes rigid and hard. It also increases immensely in weight by the addition of water. ROGER pointed out that, subjected for 2 minutes to a pressure of 3000 kilograms per sq. cm., certain bacteria (*Streptococcus*) are even killed.

undergoes periodic enlargement and discharge as in the case of the contractile vacuole. KOFOID ('95, p. 104) found that when eggs of *Physa* and *Amnicola* were placed in a 0.19% or 0.10% NaCl solution, the contents of the central cavity, once extruded, were not so quickly restored as in the control eggs, and that the maximum volume attained by the vacuole in the salt solution was less than that attained in fresh water. For example, "the cavity of the control eggs attained a diameter of 5 to 7 units, while that of the eggs in the salt solution was only 3 to 4 at the time of elimination. There were, however, a very few cases in which the cavity reached a diameter of 5 units." Of interest is the additional fact that marine *Gastropoda* do not seem to have a "cleavage" cavity, but that this is confined to eggs developing in fresh water or moist situations.

The effect of density upon the higher animals is very complex, according to the observations of BERT ('71) upon the gold-fish. Plunged into sea water it shows violent, uncoordinated movements; then it becomes immobile, and rises to the surface by virtue of its relatively lower specific gravity.

The effect of fresh water upon marine organisms is equally striking, as GOGORZA* ('91) has shown. They go immediately to the bottom and move with difficulty. Swimming animals swim badly if at all, and small fishes have to make much exertion to rise to the surface. The sensibility also undergoes great changes. Many animals soon become lethargic. Echinoderms and molluscs act as if anæsthetized, since they do not respond as quickly as usual to external stimuli, and, finally, pass into complete paralysis. The action is slower upon Crustacea and fish; but here, too, fresh water acts as an anæsthetic. The respiratory movements become deep and rapid, bivalves extend their branchiæ, and Crustacea beat the water rapidly with their appendages in order to renew the supply. Animals ordinarily transparent, like medusæ, become opaque; first externally, then internally. The cornea of fish becomes opaque and the external slime coagulates. The tissues become swollen, so that soft-bodied animals are visibly deformed — in

* For an abstract of the work of GOGORZA, I am indebted to the kindness of Mr. F. C. WAITE.

fishes the eyes are forced out, the foot of gastropods swells, the blood corpuscles swell up and burst, and muscular tissue may increase as much as 6 times in volume. The enlargement of the different tissues is exhibited in the following table, which shows the percentage increase in weight and volume of organs of *Scyllium canicula*, placed in fresh water.

	AFTER 2 HOURS.		AFTER 24 HOURS.	
	% Increase in Weight.	% Increase in Volume.	% Increase in Weight.	% Increase in Volume.
Muscular tissue	15	50	20	200
Glandular tissue	12	0	19	100
Nervous tissue	20	50	60	250

All of these phenomena are clearly explicable upon the assumption of their production by endosmosis.

c. The pressure due to dense solutions may become very great, amounting, as I have said, to many atmospheres. So it is not surprising that a change of medium may rend cells or at any rate kill organisms. This result may be brought about either when the denser solution is inside of the body or outside; the former case is realized when marine animals are plunged into fresh water, the latter when fresh-water animals are plunged into solutions of salts. Studies upon the fatal effects of varying the concentration of solutions have been made by BERT ('66), PLATEAU ('71), COUTANCE ('83), RINGER and BUXTON ('85), DE VARIGNY ('88), MASSART ('89), GOGORZA ('91), and RICHTER ('92).

BERT'S ('66) studies were made upon marine fish which he plunged into fresh water. In a vessel holding 4.8 litres of fresh water, a mullet died in 44 minutes, and a *Sparus* in 86 minutes. Since the fishes lived longer in a sugar solution, BERT concluded that death was due to diminished density of the medium. In this conclusion he was nearer the truth than his immediate followers in this work.

PLATEAU'S ('71) observations were made upon all classes of Invertebrates, but especially upon Arthropods. He subjected

them to solutions both more and less dense than the normal, and determined their resistance periods. As a result of subjecting fresh-water animals to salt solutions, he found that their *resistance period diminished approximately as the thickness of the skin (and cuticula) diminished*. Thus, when plunged into sea water (3.046% salts) adult water insects resisted indefinitely; insect larvæ 6 to 4 hours; Entomostraca less than an hour; Nephelis, 5 to 7 minutes; Planaria, 4 minutes; and Hydra only 1 minute. GOGORZA ('91) got similar results, finding the resistance capacity of the different groups to diminish in this order: molluscs, crustaceans, fish, worms, tunicates, echinoderms, cœlenterates. So we may consider this relation between resistance period and thickness of covering a general law of resistance; and it is what we should expect upon the theory that the solutions act osmotically.

By subjecting organisms to separate solutions, each containing 3% of the various salts found in sea water, PLATEAU was able to show that NaCl produced the most important effect, MgCl₂ the next most important effect, and MgSO₄ still less. This is shown by the following —

TABLE IX

RESISTANCE PERIODS OF FRESH-WATER CRUSTACEA TO VARIOUS CONSTITUENTS OF SEA SALT. TEMPERATURE NOT GIVEN

(Numbers indicate minutes elapsing before death occurred)

SPECIES.	3% NaCl.	3% MgCl ₂ .	3% MgSO ₄ .	SEA WATER.
	MOL. WT., 58.5; I.C., 3; OSMOTIC INDEX, $\frac{3}{58.5}$	MOL. WT., 95; I.C., 4; OSMOTIC INDEX, $\frac{4}{95}$	MOL. WT., 120; I.C., 2; OSMOTIC INDEX, $\frac{2}{120}$	
Gammarus roeselii. .	105	131	520	230
Asellus aquaticus . .	155	1162	2000	160
Daphnia sima	7.8	19.5	87	22
Cyclops quadricornis	12.1	37	690	257
Cypris fusca	26.7	223	460	36

Although from this table it seems clear that there is an inverse relation between resistance period and osmotic index, PLATEAU did not believe that the death of the animals experi-

mented upon was due alone to the osmotic action of the salts. To this conclusion he was led by an unfortunately devised experiment. He compared the action of several pairs of solutions, one of the members of the pair being a salt, and the other member sugar, the dissolved substance of each having the same gross weight. In all cases the action of the salt was the more powerful. But this is what we should expect upon the theory that death is caused by osmosis, since the osmotic index of sugar is far lower than that of any of the salts with which comparison was made.

Let us now ascertain the relation between the resistance period and the "osmotic index." To determine the *relative* resistance periods for any species in the different salts, we may take as our unit the average resistance period to all the salts, and express the separate resistance periods in terms of that unit. To determine the osmotic index, we divide the isotonic coefficient by the molecular weight. The resistance periods will vary inversely as the osmotic indices. For the salts, NaCl, MgCl₂, MgSO₄, the reciprocals of the osmotic indices are: 19.6, 23.8, 58.8; and the mean relative resistances are: 19, 63, 217. From this comparison it is seen that while the reciprocals of the osmotic indices increase roughly from 1 to 3, the relative resistance period increases from 1 to 11; or the resistance period increases more rapidly than the reciprocals of the osmotic indices, and roughly as the squares of those reciprocals.

At about the same time with PLATEAU'S work was published that of BERT ('71). The work of the latter was done chiefly upon fresh-water fishes; incidentally, upon frogs and some fresh-water Arthropoda. These were plunged directly into sea water, and their resistance periods determined. Some species showed an extraordinary variability in their resistance period; sticklebacks (*Gasterosteus leiurus*) from the same locality (about Paris) resisting for from 2 hours to 1 month or more.

A decided advance was made by BERT in observing that the resistance period varies with the temperature; thus, the European minnow (*Phoxinus lævis*) died in sea water—

at 9° C. in 30 minutes,	at 22° C. in 14 minutes,
at 14° C. in 25 minutes,	at 28° C. in 9 minutes.

Thus, in this case there is a diminution in the resistance period of approximately 1 minute for every degree of increase in the temperature.

Similar observations have been made by others. GOGORZA ('91, p. 242) finds that in all animals, at a low temperature, the resistance period is 2 to 3 times as long as at a high temperature.

In connection with these facts, it is to be noted that osmotic pressure increases with temperature, indeed, is proportional to the absolute temperature. (OSTWALD, '91, p. 114.) But as we are not able to say what relation exists between osmotic pressure and resistance period, we cannot say whether the above table agrees with the physical law.

Finally, we may discuss the question of the relation between the strength of the solution and the length of the resistance period. Data for this discussion are afforded by the extensive observations of GOGORZA. This author disclaims having found any mathematical relation, but his tables, properly treated, do show such a relation. The resistance periods depend upon so many factors that the times obtained by subjecting one animal to different concentrations of a salt cannot be directly compared with those obtained from another animal. It is the *relative* resistance periods only that can be thus compared.* GOGORZA's concentrations were obtained by subjecting marine animals to mixtures of marine and fresh water. No. 1 contained 100% sea water; No. 2, 75%; No. 3, 66%; No. 4, 50%; No. 5, 33%; No. 6, 25%; No. 7, 0%. Averaging the relative lengths of life of 22 species which died in 75%, or weaker percents of sea water, and comparing with the percentage of salts in various concentrations (the density of Mediterranean sea water being taken as 1.037), we get—

NO. OF SOLUTION :	1	2	3	4	5	6	7
% of salt in solution	3.7	2.8	2.5	1.9	1.2	0.9	0.00
Rel. resist. per.	Indef.	50.0	28.3	10.83	5.44	3.46	1.84
Log. of rel. res. per.		1.7	1.45	1.04	0.73	0.54	
Log. rel. res. per. × 1.7 . .		2.9	2.5	1.7	1.2	0.9	

* The relative resistance periods are calculated by the method described on p. 82.

The curve shown in Fig. 10 is constructed from the second and third lines of this table. The table shows that, within the limits of 2.8% and 0.9% concentration, the curve is a logarithmic one, *i.e.* as the ordinates increase the abscissæ increase as the logarithms of the ordinates. In line 4 are given the (BRIGGS') logarithms of the numbers in line 3, and in line 5 these logarithms are each multiplied by a constant, 1.7, which gives a series of numbers closely similar to that of line 2. The relation between density and resistance period can thus be expressed by the equation

$$D = k. \log. R,$$

in which *D* stands for density; *R*, for resistance period; and *k* is a constant whose value depends upon the system of logarithms employed. This formula may be

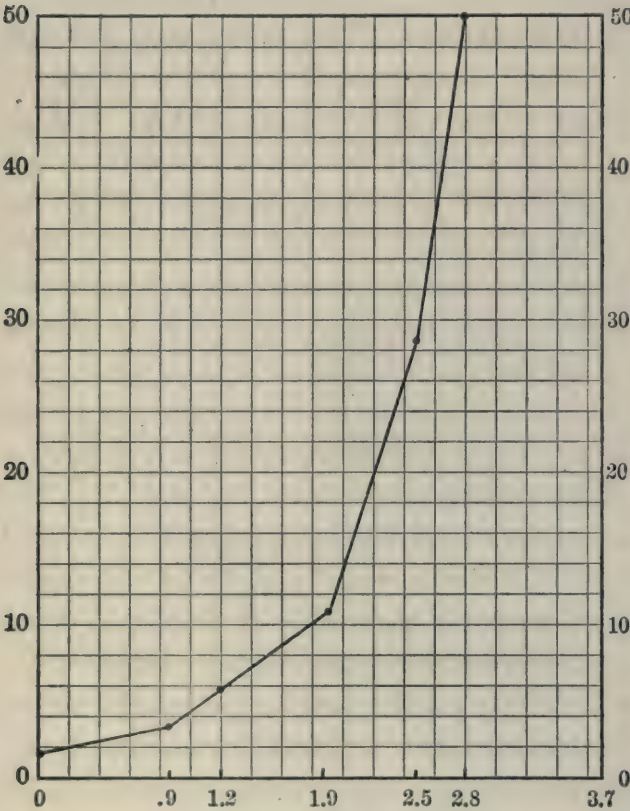

FIG. 10.— Curve showing relation between the percentage of salt in mixtures of fresh and salt water (abscissæ) and the mean resistance periods in hours of various organisms plunged therein (ordinates). Constructed from the table. (After data of GOGORZA, '91.)

transformed into the equivalent: $R = e^{\frac{D}{k}}$, in which *e* is the base of the NAPERIAN system of logarithms. Since the osmotic pressure is proportional to the concentration (p. 71), it follows also that $R = e^{\frac{O}{k'}}$ where *O* stands for the osmotic pressure and *k'* for a new constant. The same relation holds when we compare the reciprocals of the relative resistance periods—or the relative rapidity of killing—and the absolute diminution of concentration.

§ 3. ACCLIMATIZATION TO SOLUTIONS OF GREATER OR LESS DENSITY THAN THE NORMAL

In the preceding section we saw that different organisms had a diverse resistance period to the same density of solution. In part, this may be accounted for, as we have seen, on the ground of a difference in the rapidity of osmotic action — thick-skinned animals resisting longer than thin-skinned ones. All diversity in the effect of solutions, cannot, however, be accounted for on this ground. Thus, the molluscs of the sea and those of fresh water appear to have an equally pervious epidermis, yet the former will, of course, withstand a much stronger solution of salt than the latter. This difference in resistance capacity seems closely correlated with the conditions of the medium in which the organism has been reared. Thus, BEUDANT ('16) found that littoral species (living, therefore, in a part of the sea where the water is much diluted by rivers), *e.g.* *Ostrea*, *Mytilus*, *Patella vulgata*, resist fresh water better than deep-sea species; and this discovery has been abundantly confirmed by DE VARIGNY ('88).*

That the conditions of density of the culture medium determine the resistance capacity is proven by experiment, for, by varying the density of the culture solution, we may vary the resistance period of the individuals experimented on. BEUDANT ✓ ('16) was the first to show this. He used *Lymnea*, *Physa*, *Planorbis*, *Ancylus*, *Paludina*, and some other fresh-water Mollusca. He began in April by putting these organisms into a 1% NaCl solution, and, continuing to add salt slowly, by September many of these withstood a 4% solution — a solution which kills animals suddenly subjected to it. He performed likewise the reverse experiment upon marine Mollusca (*Patella*,

* The extremes of density in which organisms are capable of living are often considerable. On the one hand, the individuals of some species, especially fish, are able to migrate from fresh to salt water and back, with impunity. On the other hand, many species of a family, the other members of which are marine, have become accustomed to fresh water. Examples of this last case are the hydroid *Cordylophora lacustris*, the mollusc *Dreissena*, and the endoproctan bryozoan *Urnatella*. Likewise, some marine species have come to live in excessively salt water. Such, for example, is the case with *Artemia salina* which lives in Salt Lake, Utah, containing over 22% of salts. (LEIDY, '72, p. 165.)

Turbo, Arca, Cardium edule, Mytilus edulus, etc.) bringing them to live in fresh water by gradually diluting the medium.

PLATEAU ('71) gradually accustomed the fresh-water *Asellus aquaticus* to pure sea water, so that even in mixtures containing between 20% and 80% of sea water they laid eggs and produced a second generation. The second generation lived 108 hours in pure sea water, while *Asellus* freshly taken and plunged into sea water live only about 5 hours.

Not only the larger organisms, but also tissues and Protozoa may become acclimated. ROTH observed in '66 (p. 190) that cilia become "accommodated" to gradually increasing densities; ENGELMANN ('68, p. 343), however, denied, though without critical experiments, the validity of this conclusion for the case of the ciliated epithelium of the frog's throat. Later, CZERNY ('69, p. 161) succeeded in acclimating *Amœba* to a 4% solution of NaCl, although *Amœba* rarely resists 1% when suddenly subjected to it.

These early experiments have since been greatly extended, observations having been made upon nearly all groups of organisms — upon algæ, by RICHTER ('92); upon Myxomycetes, by STAHL ('84); upon *Actinospherium*, by VERWORN ('89, p. 10); upon bacteria, Flagellata, Ciliata, and Hydra, by MASSART ('89); upon Ciliata, by FABRE-DOMERGUE ('88); upon Crustacea, by PLATEAU ('71), SCHMANKEWITSCH ('75 and '77), and BERT ('83); upon the tadpoles of frogs, by YUNG ('85, p. 520); and upon representatives of almost all of the principal groups, by DE VARIGNY ('88) and GOGORZA ('91).

The aims and methods of these experimenters have been very diverse. Some have sought merely to illustrate how marine organisms may have come to live in fresh water, or the reverse. Such have usually made mixtures of fresh and salt water, the proportions of the one gradually increasing (DE VARIGNY, SCHMANKEWITSCH, GOGORZA), or they have added sea salt, dry or in solution, to the normal fresh-water medium of the organism (YUNG). MASSART, on the other hand, having in mind the more fundamental problem of the action of density upon protoplasm, has employed solutions of a single salt at a time — solutions, moreover, based usually upon the osmotic index of the salt as a unit of concentration.

Although there has been a gradual improvement in methods, the conditions other than that of concentration have too often been omitted from consideration. The omission of the temperature of the experiment solutions is especially unfortunate, for according to GOGORZA ('91, p. 270), acclimatization is more easily effected at a low temperature than at a high one.

Of the papers mentioned above, that of MASSART is especially worthy of extended notice from its quantitative nature. He subjected cysts of Ciliata to various concentrations of KNO_3 and noted the effect upon the protoplasm. In the following tables, the first line of numbers names the solution in parts of the molecular weight expressed in grammes. The symbols in the columns headed by these numbers have the following significations: 0, no effect; *v*, the cysts possess a large vacuole whose pulsations are infrequent; *vp*, the vacuole is still prominent but plasmolysis is occurring; *p*, the plasmolysis is more marked and the vacuole is gone; *P*, the plasmolysis is so marked that the form of the infusorian is lost. The results given in the third and fourth lines were obtained from individuals acclimated for 22 hours to a 1.8 MW % and to a 3 MW % solution of KNO_3 respectively. The observations were made immediately after immersion of the cysts. No mention is made of the temperature.

TABLE X—VORTICELLA

HUNDREDTHS OF MOLECULAR WEIGHT.	0.5	1.0	1.5	2.0	2.5	3.0	3.5	4.0	5.0
Unacclimated	<i>v</i>	<i>v</i>	<i>vp</i>	<i>vp</i>	<i>p</i>	<i>P</i>		<i>P</i>	
Acclimated to 1.8%				<i>v</i>	<i>vp</i>	<i>vp</i>	<i>p</i>	<i>P</i>	<i>P</i>
Acclimated to 3.0%						<i>vp</i>	<i>p</i>	<i>P</i>	<i>P</i>

TABLE XI—COLPODA

HUNDREDTHS OF MOLECULAR WEIGHT.	0.5	1.0	1.5	2.0	2.5	3.0	3.5	4.0	5.0
Unacclimated	0	<i>v</i>	<i>v</i>	<i>v</i>	<i>v</i>	<i>v</i>		<i>v</i>	
Acclimated to 1.8 MW %				0	<i>v</i>	<i>v</i>	<i>vp</i>	<i>p</i>	<i>P</i>
Acclimated to 3.0 MW %						<i>v</i>	<i>p</i>	<i>P</i>	<i>P</i>

If we take as our unit in Table X the concentration represented by vp , and in Table XI the concentration represented by v , we may conclude that the subjection for 22 hours to a 1.8 MW % or to a 3 MW % solution of the salt has given a resistance capacity of between 2 and 3 times the normal.*

The question now arises, what is the cause of this increased resistance capacity? It is not merely apparent, resulting from the selection of the more resistant individuals, thus elevating the mean. It is clearly due to a diminution in the intensity of osmosis; and this must be due to the establishment of an equilibrium between internal and external osmotic pressures.

Now, this equilibrium can only be brought about by the density of the internal fluids becoming equal to that of the external medium; and this requires that the salt held in solution shall traverse the bounding protoplasmic films, gaining the interior. That such a traversing occurs has been argued by MASSART ('89), who has himself produced new evidence for this conclusion. As is well known numerous pigments in solution penetrate to the nucleus of the living protist. Potassic nitrate (JANSE, '87, p. 22), glycerine, and urea (DE VRIES, '88 and '89) have been observed to penetrate protoplasm.† That NaCl does the same thing has been shown by many observers. Thus, EMERY ('69) found that when a frog is placed in a salt solution and is left there for some time, then rinsed in water until no salt appears in the washings, and, finally, put into pure water, salt is given forth from the epidermis (precipitation on adding silver nitrate). Likewise PLATEAU ('71, p. 20) found that various fresh-water Arthropods reared in a salt solution excreted an unusual amount of salt; and FREDERIC ('85) has determined that the quantity of salt in the blood of *Carcinus* varies from 3.1% to 1.5%, according to the

* A few data concerning proper acclimatization cultures to NaCl may be found useful. To acclimate bacteria 0.003 to 0.009 MW % may be added daily; *Oscillaria*, 0.01 MW %, added monthly; *Anabæna* and *Tetraspora*, 0.018 MW %, added monthly; *Ciliata*, 0.003 MW %, daily; *Hydra viridis*, 0.001 MW %, daily for 6 days; *Tubifex*, 0.02 MW %, daily; tadpoles, 0.004 to 0.014 MW %, daily.

† A fact observed by BERT ('71) suggests that some solids are taken into the body in acclimatization; for, he says, fresh-water fishes acclimatized to sea water gain in weight, and when placed in fresh water fall to the bottom. The fact that they fall to the bottom indicates that their specific gravity is increased.

density of the salt solution in which it has been reared. Finally, MASSART has shown, by a new method, that several soluble organic compounds can permeate the bounding cell-film of Flagellata. Thus, if after permanently plasmolyzing *Polytoma uvella* by a 0.02 MW % solution of KNO_3 , a 0.01 MW % solution of saccharose be added to the solution, the protoplasm soon regains its normal form, apparently by absorption of saccharose, since the cell-wall is impermeable to KNO_3 . By the same method, potassium acetate, calcium butyrate, calcium phosphate, glycerine, ammonium tartrate, asparagine, glyucose, sodium benzoate, salicin, and phloridzin can be shown to permeate the protoplasm of this flagellate. All these facts point to the conclusion to which physicists had arrived concerning dead animal membranes, that protoplasm admits the slow penetration of the dissolved salts, and thus effects the eventual equilibration of internal and external densities.

In conclusion, a word may be said concerning variability in capacity of acclimatization. The data afforded upon this subject by RICHTER ('92) are the most valuable. He was able to acclimatize *Tetraspora* to 16% (0.27 MW %) NaCl, while *Spirogyra* would not withstand, under like treatment, 0.5% (0.0085 MW %). It is clear then that, just as the resistance capacity varies, so also does the acclimatization capacity.

§ 4. CONTROL OF THE DIRECTION OF LOCOMOTION BY DENSITY: TONOTAXIS

Three authors only, so far as I know, have concerned themselves with this phenomenon,—STAHL ('84), PFEFFER ('84, '88), and MASSART ('89, '91). STAHL ('84) observed that plasmodia of *Myxomycetes* withdrew from solutions either denser or less dense than the normal, and concludes that the action is not a simple, directly explicable one, but is rather a highly complicated irritability phenomenon. The observations of PFEFFER were incidental to his study of chemotaxis. He found that high concentrations of many substances acted repulsively, and he was at first ('84, p. 455) inclined to attribute this repulsion to osmotic action, but later ('88, p. 624) he believed this view disproved. The disproof he considered to lie in this, that

the repulsive quality varies with the quality of the substance — may occur even in substances which are not attractive at any concentration. PFEFFER is, therefore, inclined to regard strong, repelling solutions as acting in a different fashion from attractive ones. Just as strong sunlight may repel organisms attracted by weak light, — both phenomena being light phenomena, — so the repulsion and attraction of solutions may both be regarded as chemical phenomena.

The work of MASSART brought evidence against PFEFFER'S conclusions, and added many important data. His studies were made chiefly upon bacteria, to a less degree upon Flagellata, Hydra, the frog, and the human conjunctiva. The results of the studies showed that neutral solutions of a certain concentration repel, and that the repulsion is proportional to their isotonic coefficients and inversely proportional to their molecular weights, and, therefore, that the repulsions are purely osmotic phenomena.

The conclusions of MASSART thus summarized were obtained by the use of special methods, which gave quantitative results. So they are worth detailed consideration. A drop of liquid containing bacteria is suspended from the under side of a cover-glass in a moist chamber whose side walls are formed of cardboard, and whose top is the cover-glass. Into the drop, glass capillary tubes similar to those used by PFEFFER are introduced, filled with the solution whose action is to be studied. In addition to this solution all the tubes should contain $\frac{5}{100000}$ MW % (0.00691 gr. %) K_2CO_3 for the purpose of attracting the bacteria. When a tube containing only this dilute solution of K_2CO_3 is put into the drop, bacteria crowd into it and literally fill it in from 20 to 30 minutes. But when a series of increasing solutions of a neutral salt like NaCl is added to the K_2CO_3 , the organisms at first do not crowd in so rapidly, then remain at the mouth, and, finally, are repelled from the tube opening. MASSART has tabulated the results obtained with Spirillum upon using tubes containing different chemical substances in different degrees of concentration. One of these tables, in slightly modified form, is reproduced here. In this table, *A* indicates that the bacteria entered the tube readily; *a*, that they merely gathered about its mouth; *o*, that they

were repelled. The numbers at the heads of the columns are the different values of n in the formula, $\frac{n}{1000}$ MW %. Since the different solutions were made up on the basis of molecular weights, all solutions of a given concentration contained the same number of molecules.

TABLE XII

ISOTON. COEF. 3.	1	2	3	4	5	6	7	8	9	10
NH ₄ Cl	A	A	A	a	a	o	o	o	o	o
NaCl	A	A	A	A	a	a	o	o	o	o
KCN	o	o	o	o	o	o	o	o	o	o
KCl	A	A	A	A	a	a	o	o	o	o
NH ₄ NO ₃	A	A	A	A	a	a	o	o	o	o
NaNO ₃	A	A	A	A	a	a	a	o	o	o
KNO ₃	A	A	A	A	a	a	o	o	o	o
KBr	A	A	A	A	a	o	o	o	o	o
KClO ₃	A	A	A	A	a	o	o	o	o	o
KI	A	A	A	A	a	a	o	o	o	o

From this table it appears that, as a rule, solutions of $\frac{7}{1000}$ MW % and over are repelled, while those of $\frac{4}{1000}$ or under, except in the case of KCN, permit the free migration of the bacteria into the tube.

In the case of those substances whose isotonic coefficient is 4, solutions of $\frac{6}{1000}$ MW % and over always repel, and those of $\frac{3}{1000}$ in the majority of cases permit free migration. In the case of those substances whose isotonic coefficient is 2, solutions of over $\frac{10}{1000}$ MW % repel, and those of under $\frac{8}{1000}$ usually permit free migration. The solutions at which repulsion just occurs in the three cases are in the ratio 10 : 7 : 6; which is nearly the same ratio as the reciprocals of the isotonic coefficients, which, multiplied by 2 run, 10 : 6.6 : 5. Thus the conclusion seems justified that the repelling action of these substances is proportional to their isotonic coefficients, and is, therefore, probably osmotic in its nature.

In a second work, MASSART ('91) has studied this matter with the aid of new methods. A drop of sea water containing bacteria is prepared as before, on a cardboard ring, but, in place

of a capillary tube containing a dense solution, grains of NaCl are placed at one point of the margin of the drop. These grains gradually dissolve, their molecules gradually diffuse through the drop, and as they do so the bacteria retreat before them, remaining in the zone of least concentration. Again, a drop of distilled water was placed alongside of the drop of sea water containing *Spirillum*, and the two drops were connected by a communicating canal of water (Fig. 11). As the dis-

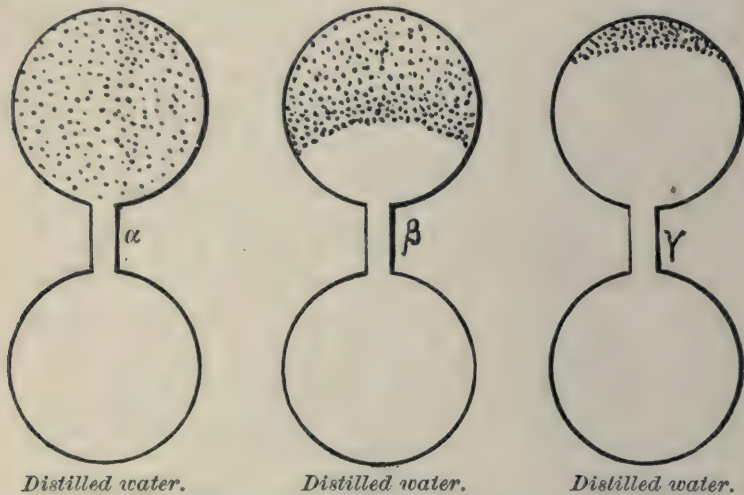

FIG. 11. — A drop of sea water connected with a drop of distilled water (in lower part of diagrams). The marine bacteria of the former retreat before the encroachment of the latter. (From MASSART, '91.)

tilled water mingles with the sea water at one mouth of the communicating canal, the bacteria retreat further and further from that mouth, keeping in the most concentrated part of the drop. Finally, when a drop of sea water is connected with one of distilled water, and granules of NaCl are placed in the drop of sea water, the bacteria, retreating from the zone of too great concentration penetrate into the drop of distilled water (Fig. 12), where they now find the proper concentration. Thus, *Spirillum* is sensitive both to solutions denser and to those weaker than the normal (hyperisotonic solutions and hypisotonic solutions, MASSART).

In summing up the observations of this section, we notice that some organisms (for MASSART found some non-sensitive bacteria) are sensitive to concentration. This sensitiveness is

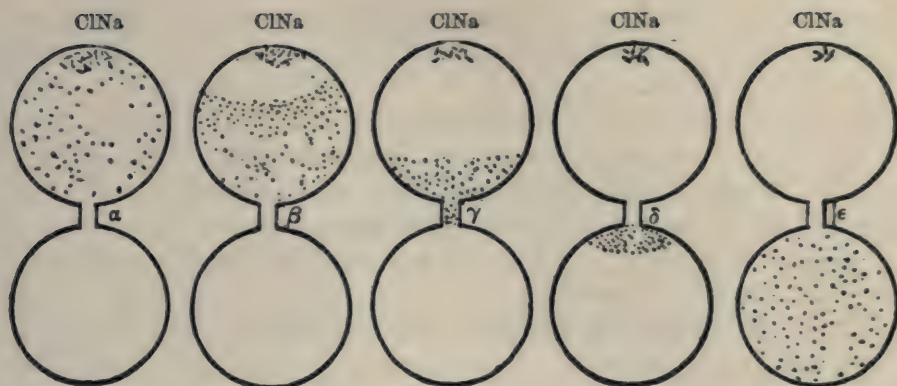

FIG. 12. — A drop of sea water joined by a canal with a drop of distilled water. The density of the sea water is being gradually increased in the successive figures by the dissolution of grains of salt placed at one edge. As the solution thickens, the organisms (marine Anophrys, represented by dots) retreat towards the distilled water. (From MASSART, '91.)

such that they are repelled by either hyperisotonic or hypiso-
 tonic solutions; only in a certain concentration do they come
 to rest. We may speak of these organisms as attuned to
 this concentration. Different organisms are attuned to dif-
 ferent concentrations, and there can be no doubt that the
 degree of concentration to which they are attuned is deter-
 mined by the past experience of the organisms, as the facts
 of acclimatization indicate.

LITERATURE

- BERT, P. '66. Note sur la mort des poissons de mer dans l'eau douce. *Mém. Soc. Sci. phys. et nat. Bordeaux.* IV, 47-49.
- '71. Sur les phénomènes et les causes de la mort des animaux d'eau douce que l'on plonge dans l'eau de mer. *Comp. Rend.* LXXIII, 382-385; 464-467. Aug. 1871.
- '73. La mort des animaux d'eau douce que l'on immerge dans l'eau de mer. *C. R. Soc. de Biol., Paris.* XXIII, 59-61.
- '83. Sur la cause de la mort des animaux d'eau douce qu'on plonge dans l'eau de mer et réciproquement. *Comp. Rend.* XCVII, 133-136. 16 July, 1883.
- BEUDANT, F. S. '16. Mémoire sur la possibilité de faire vivre des Mollusques fluviatiles dans les eaux salines, etc. *Jour. de Phys.* LXXXIII, 268-284. 1816.
- BÜTSCHLI, O. '92. Untersuchungen über mikroskopische Schäume und das Protoplasma. Leipzig. 232 pp. 1892.

- CERTES, A. '84. Note relative à l'action des hautes pressions sur la vitalité des micro-organismes d'eau douce et d'eau de mer. C. R. Soc. de Biol. XXXVI, 220-222.
- '84a. De l'action des hautes pressions sur les phénomènes de la putrefaction et sur la vitalité des micro-organismes d'eau douce et d'eau de mer. Comp. Rend. XCIX, 385-388. 25 Aug. 1884.
- COUTANCE, H. A. '83. Action biologique des sels de l'eau de mer au point de vue de l'entretien des animaux marins. Bull. de la Soc. d'Acclimat. (3) X, 98-106. Feb. 1883.
- CZERNY, V. '69. Einige Beobachtungen über Amöben. Arch. f. mik. Anat. V, 158-163.
- EMERY, H. '69. Notes physiologiques. Ann. des Sci. Nat. (Zool.). (5) XII, 305-325.
- ENGELMANN, T. W. '68. (See Chapter II, Literature.)
- FABRE-DOMERGUE '88. Recherches anatomique et physiologiques sur les infusoires ciliés. Ann. des Sci. Nat. (7) V, 1-140.
- FREDERICQ, L. '85. Influence du milieu ambiant sur la composition du sang des animaux aquatiques. Arch. de Zool. (2) III, xxxiv-xxxviii.
- GOGORZA Y GONZÁLEZ, D. J. '91. Influencia del agua dulce en los Animales Marinos. Annales de la Soc. Esp. Hist. Nat. XX, 220-271. 1891.
- GRUBER, A. '89. Biologische Studien an Protozoen. Biol. Centralbl. IX, 14-23. 1 March, 1889.
- HAMBURGER, H. J. '86. Ueber den Einfluss chemischer Verbindungen auf Blutkörperchen im Zusammenhang mit ihren Molecular-Gewichten. Arch. f. Anat. u. Physiol., Physiol. Abth. Jahrg. 1886. 476-487.
- '87. Ueber die durch Salz- und Rohrzucker-Lösungen bewirkten Veränderungen der Blutkörperchen. Arch. f. Anat. u. Physiol., Physiol. Abth. Jahrg. 1887. 31-50.
- JANSE, J. M. '87. Plasmolytische Versuche an Algen. Bot. Centralbl. XXXII, 21-26.
- KOFOID, C. A. '95. On the Early Development of Limax. Bull. Mus. Comp. Zoöl. XXVII, 35-118.
- KÜHNE, W. '64. (See Chapter I, Literature.)
- LEIDY, J. '72. On Artemia from Salt Lake, Utah. Proc. Acad. Nat. Sci. Philad. 1872. 164-166.
- MASSART, J. '89. Sensibilité et adaption des organismes à la concentration des solutions salines. Arch. de Biol. IX, 515-570.
- '91. (See Chapter I, Literature.)
- OSTWALD, W. '91. Solutions. Translated by MUIR. 316 pp. London: Macmillan. 1891.
- PLATEAU, F. '71. Recherches physico-chemiques sur les articulés aquatiques. Mém. cour. l'Acad. Roy. Belgique. XXXVI, 68 pp.
- PFEFFER, W. '77. Osmotische Untersuchungen. Leipzig. 1877.
- '84. (See Chapter I, Literature.)
- '88. (See Chapter I, Literature.)

- REGNARD, P. '84. Recherches expérimentales sur l'influence des très hautes pressions sur les organismes vivants. *Comp. Rend.* XCVIII, 745-747. 21 March, 1884.
- '84^a. Note sur les conditions de la vie dans les profondeurs de la mer. *C. R. Soc. de Biol.* XXXVI, 164-168.
- '84^b. Note relative à l'action des hautes pressions sur quelques phénomènes vitaux (mouvement des cils vibratiles, fermentation). *C. R. Soc. de Biol.* XXXVI, 187-188.
- '84^c. Sur la cause de la rigidité des muscles soumis aux très hautes pressions. *C. R. Soc. de Biol.* XXXVI, 310-311.
- '84^d. Effect des hautes pressions sur les animaux marins. *C. R. Soc. de Biol.* XXXVI, 394-395.
- '86. Action des hautes pressions sur les tissus animaux. *Comp. Rend.* CII, 173-176.
- RICHTER, A. '92. Ueber die Anpassung der Süßwasseralgen an Kochsalzlösungen. *Flora.* L, 4-56.
- RINGER, S. and BUXTON, D. W. '85. Concerning the Action of Small Quantities of Calcium, Sodium, and Potassium Salts upon the Vitality and Function of Contractile Tissue and the Cuticular Cells of Fishes. *Jour. of Physiol.* VI, 154-161. July, 1885.
- ROGER, H. '95. Action des hautes pressions sur quelques bacteries. *Arch. de Physiol.* (5) VII, 12-17. Jan. 1895.
- ROSSBACH, M. J. '72. (See Chapter I, Literature.)
- ROTH, M. '66. Ueber einige Beziehungen des Flimmerepithels zum contractilen Protoplasma. *Arch. f. path. Anat. u. Physiol.* XXXVII, 184-194. Oct. 1866.
- SCHMANKEWITSCH, V. '75. Ueber des Verhältniss der *Artemia salina* Miln. Edw. zur *Artemia Mühlhausenii* Miln. Edw. und dem Genus *Branchipus* Schaeff. *Zeitschr. f. wiss. Zool.* XXV, Suppl., 103-116.
- '77. Zur Kenntniss des Einflusses der äusseren Lebensbedingungen auf die Organisation der Thiere. *Zeitsch. f. wiss. Zool.* XXIX, 429-494. 6 Sept. 1877.
- '79. [Abstr. in *Nature.* XXIX, 274. 1884.]
- STAHL, E. '84. (See Chapter I, Literature.)
- VARIGNY, H. DE '88. Beitrag zum Studium des Einflusses des süßen Wassers auf die Seethiere. *Centralbl. f. Physiol.* I, 566-568. 21 Jan. 1888.
- VERWORN, M. '89. (See Chapter I, Literature.)
- VRIES, H. DE '84. Eine Methode zur Analyse der Turgorkraft. *Jahrb. f. wiss. Bot.* XIV, 427-601.
- '88. Le Coefficient Isotonique de la Glycerine. *Arch. Néerland.* XXII, 384-391.
- '89. Ueber die Permeabilität der Protoplaste für Harnstoff. *Bot. Ztg.* XLVII, 309.
- WHETHAM, W. C. D. '95. *Solutions and Electrolysis.* Cambridge Nat. Sci. Man. Cambridge, Eng. 296 pp. 1895.

- YUNG, E. '85. De l'influence des variations du milieu physico-chimique sur le développement des animaux. Arch. Sci. phys. et nat. (3) XIV, 502-522. 15 Dec. 1885.
- ZACHARIAS, O. '84. Ueber die amœboiden Bewegungen der Spermatozoen von *Polyphemus pediculus* de Geer. Zeitschr. f. wiss. Zool. XLI, 252-258.
- '88. Ueber Pseudopodien und Geisseln. Biol. Centralbl. VIII, 548, 549. 15 Nov. 1888.

CHAPTER IV

ACTION OF MOLAR AGENTS UPON PROTOPLASM

THIS subject is so ill-defined that it is impossible to draw any line of distinction between contact on the one hand and a crushing pressure, or wounding, on the other. The molar agents may be solid or fluid. The methods of application may vary from a blunt contact or a sharp cut or puncture to the impact of flowing liquid. All these agents have this in common, however, that they act in a gross, mechanical way. The subject will be discussed under the following heads: (I) The effect of molar agents upon lifeless matter; (II) effect upon the metabolism and movement of protoplasm; and (III) effect in determining the direction of locomotion, — thigmotaxis (stereotaxis) and rheotaxis.

§ 1. EFFECT OF MOLAR AGENTS UPON LIFELESS MATTER

Mechanical disturbance can induce in certain lifeless compounds violent chemical changes. Compounds which are so affected are preëminently unstable. This instability, however, varies greatly in degree. In some cases, the blow of a hammer is required to upset the molecules; the result being often a violent explosion. In other cases (*e.g.* chloride or iodide of nitrogen), the slightest touch of a feather suffices to produce an explosion. Now, most of the substances which explode upon impact, and which are used in the arts, are organic compounds, — fulminate, nitro-glycerine, gun-cotton, and picric-acid derivatives, — and therefore it is not surprising that we find the notoriously unstable protoplasm violently affected by contact.

Especially important for biology is the fact that undulatory motions and other *periodic* disturbances produce very important

molecular changes in chemical compounds. Certain substances have a specific rate of vibration, so that when this is reproduced by a vibrating cord or plate, explosion of the substance may occur. Iodide of nitrogen is one of these substances which is exploded by a high note. (CHAMPION and PELLET, '72, p. 212.) Upon this property of explosive compounds depends, apparently, the efficacy of "detonators," the explosion of a small quantity of which is capable of producing the explosion of a great mass of a second compound. Living protoplasm is, likewise, especially affected by periodic disturbances, and it is doubtless due to the peculiarities of its chemical structure that the auditory epithelium is so affected by sound waves in all their modifications of pitch, volume, and timbre.

§ 2. EFFECT OF MOLAR AGENTS UPON THE METABOLISM AND MOVEMENT OF PROTOPLASM

We shall first consider the effect on metabolism, and then on movement. The principal metabolic effects that will be considered are phosphorescence and secretion.

The *phosphorescence* of organisms is usually regarded as a slow combustion (oxidation) of organic substances. This chemical process is apparently accelerated by mechanical irritation, as every one must have noticed who has rowed a boat on a quiet summer's evening upon the sea. At every stroke of the oar, a gleam is sent along its length. An analytical study of this phenomenon has been made by MASSART ('93, p. 62). When a drop of water containing *Noctiluca* is put on filter paper, and the liquid is absorbed, there comes a moment when the surface film of the water flattens the spherical body of *Noctiluca*. At that moment of pressure light is emitted. If, however, the water is put into a slight vibration by a needle attached to a tuning-fork, and if the agitation is insufficient to deform the body, no light will be given forth. Deformation of the body, but not slight agitation, is, consequently, accompanied by those metabolic processes which result in the production of light.

Secondly, contact may induce the production and discharge of secretions. VERWORN ('89, p. 81) has called attention to this phenomenon in the cases of *Actinosphærium* and *Thalassi-*

cola. When *Actinosphærium* is subjected to a slight stimulation, such as would be produced by other Protozoa wandering among its pseudopodia, it shows no response. But when an infusorian or a rotifer swims against the pseudopodia with force, they discharge a sticky substance which holds the disturbing organism fast. The same result follows the irritation of one of the pseudopodia by touching it with a fibre of cloth or filter paper. Like effects follow the irritation of *Thalassicola*. Thus, some Protista respond to particular kinds of contact by the excretion of a sticky substance.

In the higher animals, also, contact may call forth secretions; thus, the stolons of many hydroids secrete a cement from the surface applied to the substratum.

Among the higher plants, also, contact has sometimes a similar effect. Examples appear in DARWIN'S ('75, p. 393) work on the gland cells of insectivorous plants. In many species, to be sure, *e.g.* *Drosera*, *Dionæa*, *Drosophyllum*, mere contact of inorganic bodies has no effect upon the secretions of the glands of the leaves. In the case of *Pinguicula lusitanica*, however, fragments of glass, as well as seeds and albumen, caused the glands with which they came in contact to secrete more freely than before.

This response to contact by secretion is, for the most part, an *advantageous* one. It enables the Protista and the insectivorous plants to hold their prey or their enemy, as the case may be; and it enables the stolon to hold fast to the substratum.

The change in metabolism may be so profound as to lead to death. HORVARTH ('78) and MELTZER ('94) have shown that when bacteria are violently shaken, not only is growth interfered with, as we shall see in the second part of this book, but death may ensue, so that cultures of bacteria may be sterilized.

We now turn to consider the *modification of movement* by molar agents. The general phenomena are familiar. An amœba, any other rhizopod, or a white blood corpuscle contracts when the cover-glass over it is disturbed. The streaming in the plasmodia of *Myxomycetes* is retarded or inhibited

upon shaking. When alga cells, such as those of *Chara* or *Vallisneria*, are freshly transferred to the slide, the disturbance causes cessation of movements (HOFMEISTER, '67, p. 50). When the stamen hairs of *Tradescantia* are crushed, the streaming of the plasma ceases. When *Chara* is cut across or punctured, rotation stops for a longer or shorter time (DUTROCHET, '37, p. 780). Even when a stem of *Chara* is pricked at the node by a needle, without penetrating into the cavity, move-

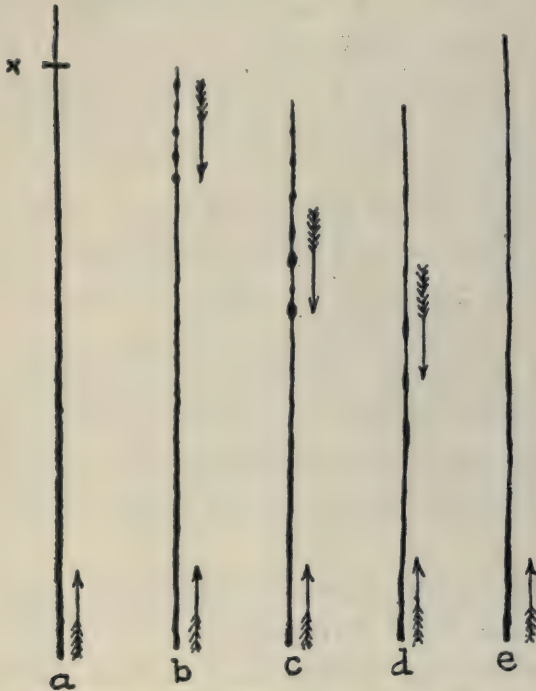

FIG. 13. — Pseudopodium of *Orbitolites*, retracting as a result of local stimulation. The arrows give the direction of the streaming of protoplasm. At the left is shown the beginning of the excitation; at the right, its end. (From VERWORN, '92).

tally (Fig. 13, *b*). This movement meets with the normal centrifugally migrating plasm and turns the latter towards the centre again (Fig. 13, *c*). Gradually the thickenings elongate until, before they have reached the central body, they are no longer visible (Fig. 13, *d*). In about 2 minutes normal movements are completely restored (Fig. 13, *e*). Slightly different results are gained from *Cyphoderia* (Fig. 14). When the large pseudopodium of this organism is touched with a needle near its distal end, it thickens (as in the case of *Orbitolites*) and

movement ceases for a minute or two. Thus, mechanical disturbance profoundly affects protoplasm.

Let us now consider more in detail the changes which take place in the protoplasm. VERWORN ('92, p. 24) has given us data on this matter. *Orbitolites* is a rhizopod having extremely delicate, filamentous pseudopodia. If one of these pseudopodia be cut across as at *x*, Fig. 13, *a*, the following changes occur: the protoplasm lying next the cut directly collects into small spherical or fusiform masses which begin to migrate centri-

the thick region, together with all the proximal lying protoplasm, begins to flow towards the centre. The whole plasma thread retracts.

Again, if an individual of *Diffugia* (Fig. 15) be slightly shaken, the pseudopodium contracts into the shell; if it be

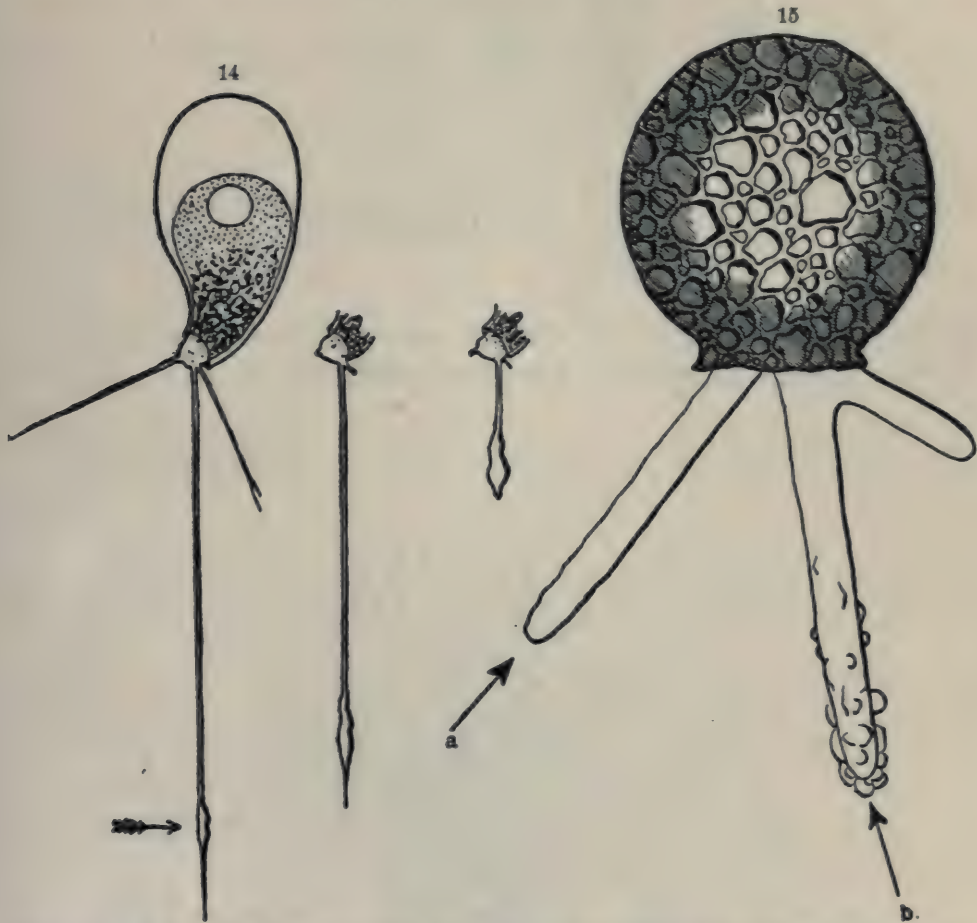

FIG. 14. — *Cyphoderia margaritacea*, showing the retraction of its pseudopodium as a result of irritation at the point indicated by the arrow. (From VERWORN, '92.)

FIG. 15. — *Diffugia urceolata*; at *a*, stimulated by a weak local irritation; at *b*, by a somewhat stronger one. (From VERWORN, '89.)

violently shaken, the following changes occur: drops of a less highly refractive substance seem to gather on the surface of the filamentous pseudopodium and unite to form a sheath surrounding a more highly refractive axis. At the same time, axis and sheath retreat into the central mass. In this case, then, we have a segregation of dissimilar protoplasmic substances, and a tendency to collect about centres along the

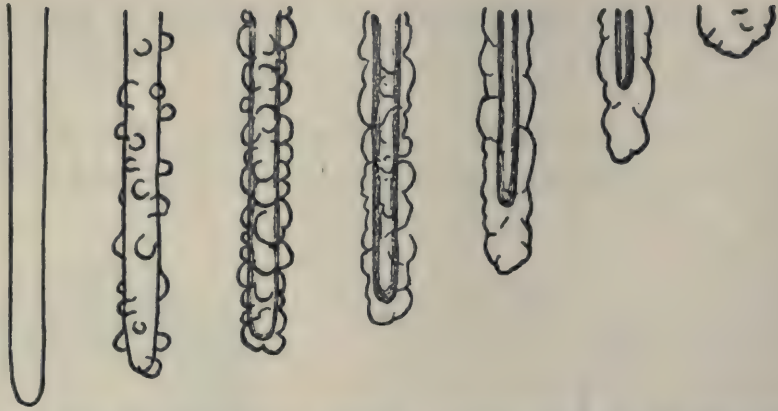

FIG. 16.—A series showing seven phases in the contraction of a pseudopodium of *Diffugia lobostoma*, following total stimulation. The series passes from left to right. (From VERWORN, '92.)

pseudopodium and in the whole mass. The same thing is seen in the widely dissimilar *Actinosphaerium* (Fig. 17). Here is

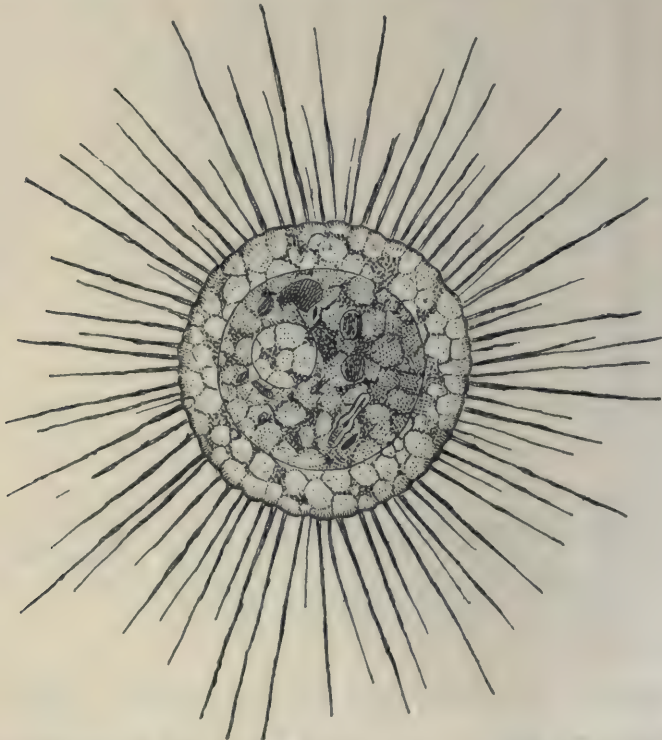

FIG. 17.—*Actinosphaerium Eichhornii*, unirritated. Natural size about 0.5 mm. (From VERWORN, '89.)

especially noticeable (Figs. 18, 19) the tendency to produce fusiform or spherical aggregations, and to retract the pseudopodia. So, too, in the irritated stamen hairs of *Tradescantia*;

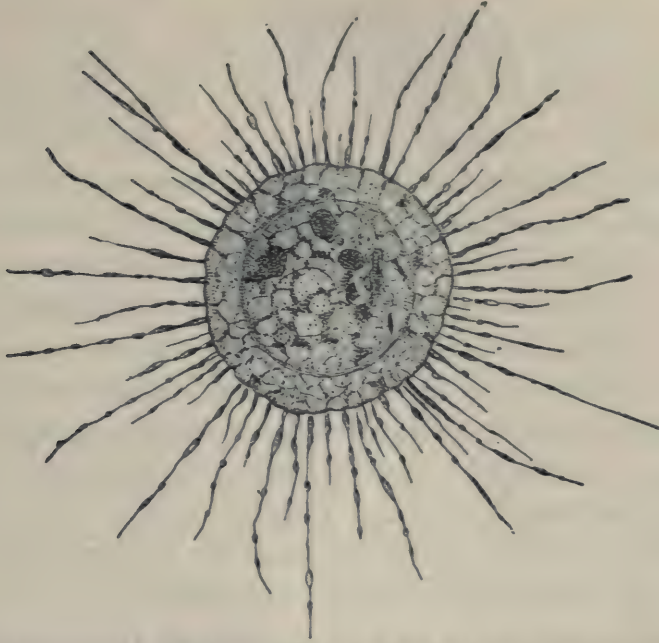

FIG. 18. — *Actinosphaerium Eichhornii*, at the beginning of irritation. The protoplasm is accumulated along the pseudopodia in drops and spindles. (From VERWORN, '89.)

says HOFMEISTER ('67, p. 50), "The threads become knotty, tear apart, draw together into short clubs or balls, and fuse

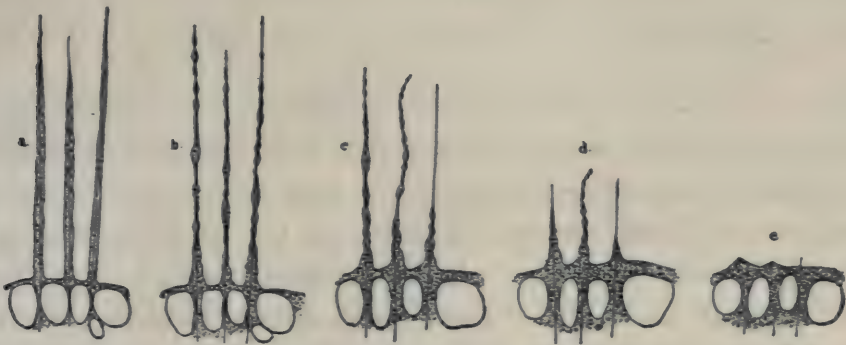

FIG. 19. — Three pseudopodia of the same individual, much enlarged. *a*, normal condition; the axial thread is seen, surrounded by protoplasm. *b*, the pseudopodia at the beginning of stimulation. *c*, *d*, the stimulation is continuing, and the axial thread is shortening. *e*, the three pseudopodia are almost completely retracted. (From VERWORN, '89.)

partly with the collection of protoplasm lying about the cell-nucleus and partly with the peripheral protoplasmic layer."

These similar phenomena from various organisms are fundamental; how are they to be interpreted? It is well known

that non-vital semi-fluid substances tend to assume a spherical form by virtue of the property of surface tensions. That protoplasm does not always assume this form is due to special causes. When a Protist or one of its pseudopodia is irritated by contact, it tends to assume a spherical form or a thread tends to aggregate into spherical drops. It seems probable, we cannot say more than that, that this aggregation is due to a diminution in the activity of those causes which oppose the action of surface tension; and so the latter reasserts itself. It is likewise possible that new attractive centres arise. That a thread should break up into drops indicates, moreover, a loss in cohesion. Loss of cohesion, formation of new centres of attraction, and diminution of the form-maintaining forces,—these seem to be the effects of contact. They must be due to the chemical changes wrought by contact.

The changes just referred to constitute the essence of contraction, a phenomenon of widespread occurrence not only among Protista, but among the higher plants and animals; for example, in the sensitive plant and in Vertebrate muscle. Into these contraction phenomena which follow contact in the higher organisms we cannot go; their study belongs to the field of plant and animal physiology. At bottom, however, we must believe many of these phenomena in the higher organisms to be due to the same causes as contraction in Protista.

A few words concerning rhythmically repeated disturbances. A single disturbance gives rise, as we have seen, to a series of phenomena producing contraction; but in a few seconds the effects of the disturbances are past and the protoplasm returns to its uncontracted form. If, however, the shock is repeated before relaxation has fully occurred a new contraction is superimposed on the first, and the resulting contraction is more violent than a single one. If now shock follow shock in quick succession, a violently contracted condition, known as tetanus, results. Under the condition of tetanus the amœba becomes a spherical mass, *Actinosphærium* retracts all of its pseudopodia, a branching *Carchesium* stock forms a little ball, and muscle fibres are greatly shortened. In a word, rhythmically repeated shocks are accompanied by an exaggeration of those changes which result from a single shock.

§ 3. EFFECT OF MOLAR AGENTS IN DETERMINING THE DIRECTION OF LOCOMOTION — THIGMOTAXIS (STEREOTAXIS) AND RHEOTAXIS *

We have already seen that when a pseudopodium of an amœba is touched by a solid body it retracts. In this retraction the centre of mass is transferred to a new point. If the stimulation is often repeated upon the same side, contraction continues on that side, until eventually the amœba will have migrated a considerable distance. In this case the determination of the direction of locomotion is closely allied to the phenomena of contraction as a result of stimulation, considered in section 2. The retraction of the protoplasm which follows its irritation is the cause of the migration of the amœba in a definite direction. This direction is away from the touching body. The response may consequently be called negative thigmotaxis.

The phenomenon of negative thigmotaxis is widespread. There are almost no free-moving organisms which do not move away from contact or molar disturbance of an unusual or violent sort. Thus you may very definitely control the direction of movement of a planarian or a slug by touching the body upon the side opposite the direction in which you wish it to move. In such cases, also, there is first a contraction of the body upon the irritated side.

The opposite phenomenon of movement towards, or clinging to, the irritating body — positive thigmotaxis — is less common and therefore more striking. It has long been known, I imagine, — it certainly is an observation easily made, — that an amœba which has come in contact with a solid body clings close to it and moves over its surface. LE DANTEC ('95, p. 211) has described the action in much detail. An amœba descending in the drop touches the glass slide first by a single protruding pseudopodium. Next, the pseudopod elongates horizontally, and at the same time affixation takes place, so that the organism does not roll about when the water is agitated. The

* Thigmotaxis, under the different form "thigmotropism" (from *θιγμα*, "contact") was first applied to these phenomena by VERWORN ('89, p. 90); stereotaxis, under the form "stereotropism" (from *στερεός*, "solid"), was introduced by LOEB ('90, p. 28), and is practically synonymous with thigmotaxis.

pseudopod gradually extends itself, and new ones are formed, until at last the whole substance of the amœba is spread out parallel to the glass, over whose surface it moves. That there is a considerable adherence is shown by the fact that the amœba is not disturbed by an appreciable current. If, however, it is made to contract, it loses its hold at once.

Very similar phenomena occur, according to VERWORN ('95, p. 429), in Orbitolites also. Such an organism lying in a watch glass begins to send out pseudopodia which, so long as they move free in the water, are simple straight threads; but when they touch the glass they adhere to it, stream out along it, and send out branches. In these Rhizopoda, consequently, the presence of a solid body is a stimulus to the spreading out of the pseudopodia and to those changes by which close adhesion is effected.

We now pass to the other simple organisms. Among Infusoria, PFEFFER ('88, pp. 618-621) has found that *Glaucoma scintillans* and, to a less degree, *Colpidium colpoda*, *Paramecium aurelia*, and *Stylonychia mytilus* aggregate about solid bodies in the water, such as fragments of soaked filter paper or particles of barium sulphate. Since these cannot supply oxygen or soluble substances, the effect produced is doubtless due to contact.

The aggregated organisms tend, in moving, to keep upon the surface of the solid. Thus PFEFFER ('88, p. 619) found that *Urostyla weissii*, coming in contact with glass threads, moved along them on their ventral surfaces; and MASSART ('91) observed some *Chlamydomonades* remain hanging to objects with which they came in contact. VERWORN ('95, p. 431), likewise, finds that *Oxytricha* travels over the surface of *Anodonta* eggs or particles of detritus which it happens upon in the water. In one instance, the organism ran for some time over the surface of an egg of *Anodonta* without being able to leave it. After four hours, it was able, by the aid of a piece of slime which came in contact with the egg, to free itself from that body.

Phenomena similar to the above-described for bacteria and Infusoria are found in spermatozoa also. DEWITZ ('85 and '86) first noticed this in the case of the cockroach, *Periplaneta*

orientalis. When an 0.8% or 0.9% NaCl solution containing spermatozoa was put under a cover-glass, the spermatozoa arranged themselves in two layers, one in contact with the cover-glass, the other in contact with the slide. By isolating some of the spermatozoa at the upper surface and putting them under a cover-glass, he found that they likewise distributed themselves at both upper and lower surfaces. Hence the segregation into two layers was not due to a difference in kind between the spermatozoa occupying the two positions, but to the fact that there were here two surfaces of contact, separated

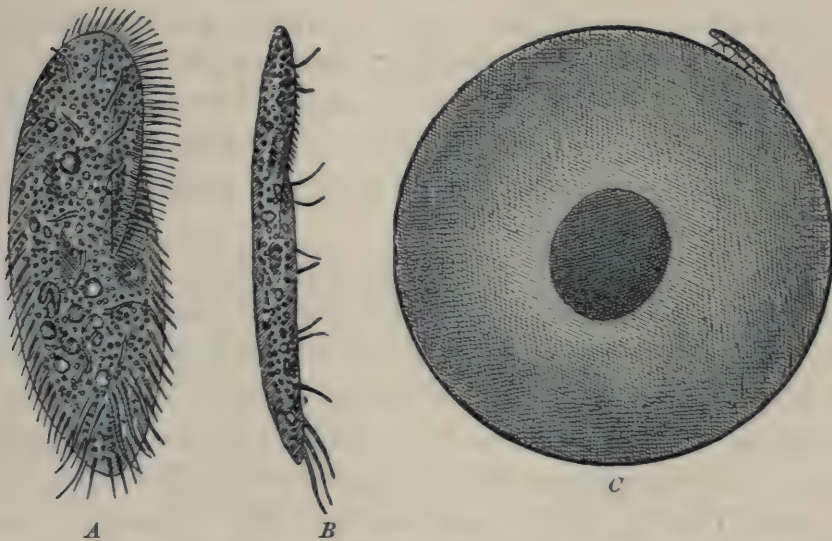

FIG. 20.—*A*, *Oxytricha* seen from below; *B*, from the side; *C*, crawling over the egg of *Anodonta*. (FROM VERWORN, '95.)

by a water-film. If a spherical grain be placed in the drop of water, aggregation takes place about that also. A similar experiment, with similar results, was made by MASSART ('88) with frog spermatozoa. Here, too, the active spermatozoa kept in contact with the upper and lower glass surfaces, whilst the weak forms lay midway between. The fact that only active spermatozoa show this tendency to keep in contact with solids, indicates that we are here dealing with irritability to contact.

The quality of the surface influences its capacity for stimulating to positive thigmotaxis. Thus, while mere roughness has no effect, if the surface of glass be smeared with a slimy mass, so thick that the spermatozoa can hardly penetrate it,

they may no longer cling to the glass, but wander, undirected, through the water. Again, while the surface film of water often acts thigmotactically, if the surface tension is reduced by a thin covering of oil, it no longer holds the organisms. It would seem that a certain minimum difference in rigidity, between any surface and the medium, is necessary in order that the surface should act thigmotactically.

Once in contact with a sufficiently attracting surface, the organism may move to and fro over it, but it can hardly leave it. It is, as DEWITZ ('86, p. 366) says, as though the spermatozoa were attracted by a magnet. This close adhesion of the organism to the irritating surface is a remarkable phenomenon. LE DANTEC ('95) suggests that the amœba adheres to the glass by *molecular attraction*. On the other hand, it may be doubted whether the close adhesion signifies anything else than the absence of a sufficient stimulus to leave the surface of contact.

When an organism has been stimulated by contact for some time, it at last becomes changed so that it no longer responds as it did at first. Thus Dr. W. E. CASTLE has informed me that he has seen a colony of Stentors, in an aquarium, being constantly struck by Tubifex waving back and forth, yet the Stentors did not contract as they usually do when struck. PFEFFER ('88, p. 619) has observed that Urostyla retreats, after a time, from the surface with which it was in contact. These facts indicate that protoplasm can become acclimatized to contact so as to be no longer stimulated by it.

We now turn to the consideration of *Rheotaxis*, which may be regarded provisionally as a form of thigmotaxis, although the possibility of its being rather a case of chemotaxis is not excluded.

ROSANOFF ('68) was the first to notice the rheotaxis of the large plasmodium of *Æthaliium septicum*, but he ascribed it to geotaxis. The correct interpretation was first given by STRASBURGER ('78, p. 62), and has been confirmed by JÖNNSSON ('83), and STAHL ('84). When *Æthaliium* is placed on a strip of saturated filter paper, the upper end of which is dipped in a beaker of water, it is subjected to a current of water in the substratum. At the same time it moves

against the current. The current controls the direction of locomotion.

The evidence that it is indeed the current is partly gained by exclusion. It cannot be geotaxis, for if the current is flowing upwards on any arm of the strip, the plasmodium flows down. It can hardly be hydrotaxis, for the strip is uniformly saturated throughout. The action of light may be excluded by shutting the whole apparatus in the dark, when the same response occurs. When the direction of the current in the strip is reversed, the movement of the plasmodium is reversed also. Thus no other cause will explain the result but that of the moving water.

Satisfactory evidence that it is the current as such which acts will not be forthcoming until it has been shown that other fluids than water, *e.g.* oil, provoke a similar response. Until such an explanation has been tried, it must remain uncertain whether the phenomenon is not perhaps due to a difference in the quality of the afferent and the efferent water.

Finally, it must be mentioned that higher organisms, especially fish, are rheotactic. Whoever has seen fish ascending streams from the sea in the spring has had this vividly impressed upon him. Before some dam thousands of fish will be seen, all facing the torrent of water against which they can hardly hold their own. It is the current which determines their position. They are responding to the direction of flow of the waters.

To recapitulate: In many non-living substances, especially organic compounds, violent chemical changes (explosions) are brought about by contact and especially by repeated vibrations. So, too, in protoplasm, chemical change, exhibiting itself in modified metabolism, frequently follows contact. The explanation adapted to the non-living series of phenomena is adapted to the living series also, — the molecules of the substance are complex, loosely associated, very unstable, so that even a slight mechanical disturbance will serve to dissociate their atoms. Protoplasm is a mixture of so many substances that the whole mass does not become changed at once; but continued stimulation may eventually produce such widespread changes as to lead to death. One of the most evident

results of contact upon protoplasm is modification of movement, — momentary quiet, followed by contraction. Rapidly repeated shocks lead to a summation of responses called tetanus. Slowly repeated shocks may lead to acclimatization to contact. Finally, the direction of locomotion is in some cases controlled by contact; many organisms move from the touching body — negative thigmotaxis; others may face the impact of flowing water or keep close, as though attached, to the rigid surface — positive thigmotaxis. If the changed chemical condition following contact be called the “response,” then all changes wrought by contact on protoplasm may be considered as responses.

LITERATURE

- CHAMPION, P. and PELLET, H. '72. Sur la théorie de l'explosion des composés détonants. *Compt. Rend.* LXXV, 210–214.
- DANTEC, F. LE '95. Sur l'adhérence des amibes aux corps solides. *Compt. Rend.* CXX, 210–213. 28 Jan. 1895.
- DARWIN, C. '75. (See Chapter I, Literature.)
- DEWITZ, J. '85. Ueber die Vereinigung der Spermatozoen mit dem Ei. *Arch. f. d. ges. Physiol.* XXXVII, 219–223. 29 Oct. 1885.
- '86. Ueber Gesetzmässigkeit in der Ortsveränderung der Spermatozoen und in der Vereinigung derselben mit dem Ei. *Arch. f. d. ges. Physiol.* XXXVIII, 358–385. 31 March, 1886.
- DUTROCHET '37. (See Chapter VIII, Literature.)
- HOFMEISTER, W. '67. Die Lehre von der Pflanzenzelle. Leipzig: Engelmann. 664 pp. 1867.
- HORVATH, A. '78. Ueber den Einfluss der Ruhe und der Bewegung auf das Leben. *Arch. f. d. ges. Physiol.* XVII, 125–134. 21 May, 1878.
- JÖNSSON, B. '83. Der richtende Einfluss strömenden Wassers auf wachsende Pflanzen und Pflanzentheile (Rheotropismus). *Ber. D. bot. Ges.* I, 512–521.
- LOEB, J. '90. (See Chapter VII, Literature.)
- MASSART, J. '88. Sur l'irritabilité des spermatozoïdes de la grenouille. *Bull. l'Acad. roy. Belg.* (3) XV, 750–754.
- '91. La sensibilité tactile chez les organismes inférieurs. *Jour. de Médecine de Bruxelles.* 5 Jan. 1891. [Abstract only seen in *Centralb. f. Bacteriol.* XI, 566.]
- '93. (See Chapter I, Literature.)
- MELTZER, S. J. '94. Ueber die fundamentale Bedeutung der Erschütterung für die lebende Materie. *Ztschr. f. Biol.* XXX, 464–509.
- PFEFFER, W. '88. (See Chapter I, Literature.)

- ROSANOFF, S. '68. De l'influence de l'attraction terrestre sur la direction des plasmodia des myxomycètes. *Mém. Soc. Sci. nat. Cherbourg*, XIV, 149-172, Tab. I.
- STAHL, E. '84. (See Chapter I, Literature.)
- STRASBURGER, E. '78. (See Chapter VII, Literature.)
- VERWORN, M. '89. (See Chapter I, Literature.)
- '92. *Die Bewegung der lebendigen Substanz*. 103 pp. Jena: Fischer. 1892.
- '95. *Allgemeine Physiologie*. 584 pp. Jena: Fischer. 1895.

CHAPTER V

EFFECT OF GRAVITY UPON PROTOPLASM

WE shall consider this subject under three heads: (I) Methods of Study; (II) Effect of Gravity upon the Structure of Protoplasm; (III) Control of Locomotion by Gravity — Geotaxis.

§ 1. METHODS OF STUDY

Under normal circumstances gravity acts upon organisms continuously, uniformly, and in one direction only at a time. In this respect it is widely different from most of the agents

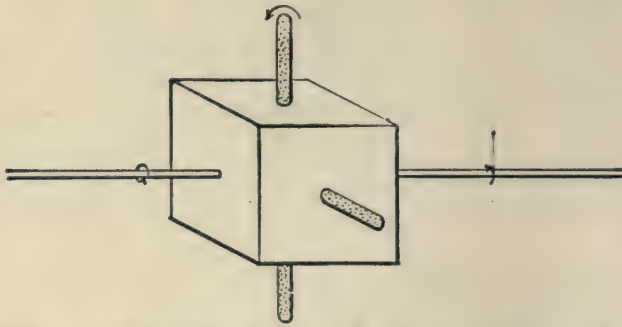

FIG. 21. — Diagram of the essential part of a klinostat. A rotating block or drum, to which tubes containing the geotactic organisms may be attached in the position indicated.

which we have to consider. Since its action is uniform it can be varied only in an indirect way; *i.e.* by turning the organism or by replacing gravity in part by a force working in another direction. One of the simplest ways of turning the organism so as to eliminate gravity is by means of the klinostat (Fig. 21). This is made in various forms, and consists essentially of a horizontal rod supported near the ends and made to revolve about its long axis by clockwork. Towards the middle of the rod, or at one end, is rigidly affixed a block to which may be

fastened, radially, the vessels containing the objects of experimentation. When the rod revolves, all sides of the object are brought successively and equally under the influence of gravity's pull. By this means the *directive* action of gravity is eliminated.

In the case of organisms living in water, the effect of gravity may be overcome by the buoyancy of the medium. It is clear that an organism floating in a medium of its own weight cannot be affected by gravity. This condition can be brought about by increasing the specific gravity of water by adding soluble substances such as gelatine and gum arabic. Since the specific gravity of the organism tends gradually to change with that of the medium, this method does for rapid experiments only.

In dealing with larger organisms, which, like slugs, can keep affixed to glass or other smooth surfaces, the inclination of the surface may be varied from a vertical position to a horizontal one, thus varying the active component of gravity. Finally, gravity may be replaced by centrifugal force by rapidly rotating either about a horizontal or a vertical axis. By varying the rate of rotation the centrifugal force will vary, in accordance with the formula, $f = \frac{2\pi^2r}{t^2}$, in which r is the rotating radius (in meters) and t^2 the square of the time of a rotation (in seconds). This varying centrifugal force will act exactly in the same way as gravity, only *from* the centre of rotation.

§ 2. EFFECT OF GRAVITY UPON THE STRUCTURE OF PROTOPLASM

Very few observations have been made upon this subject, and yet indications are not wanting that the field would well repay working. Thus, where the cell contains specifically heavier and lighter substances the two will be separated by the action of gravity. This occurs in plant cells in which, according to DEHNECKE ('80), various contained bodies, *e.g.* chlorophyll granules and starch grains, tend to sink to the lower side of the cell. This result is produced in from a few minutes to several hours. This effect is likewise seen in many

ova in which the yolk sinks to the lower pole and the protoplasm floats on top, in whatever position the egg may be held. This fact undoubtedly has an important effect upon development, as we shall see later.

Of the specifically heavier bodies above referred to, the nucleolus is a striking example, as HERRICK ('95) has recently shown. Thus, when the ovary of a lobster is killed, the nucleoli of all the nuclei are found in contact with that part of the nuclear membrane which was the lowest at

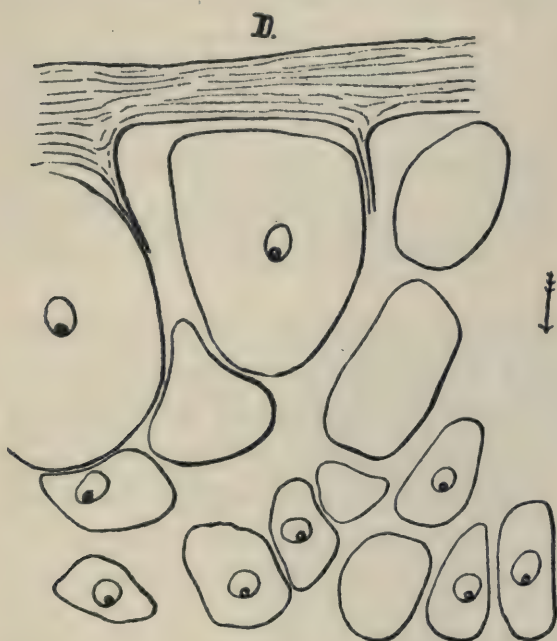

FIG. 22. — Section through the ovary of a lobster hardened with its dorsal surface (*D*) uppermost. The nucleoli lie against the ventral surface of the nucleus. Magnified 50 diameters. (From HERRICK, '95.)

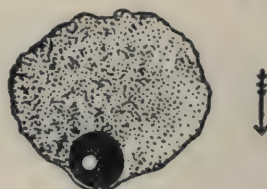

FIG. 23. — Section through the nucleus of a young ovum ($\frac{1}{4}$ mm. in diameter) showing the nucleolus, which has, apparently, caused a distention of the nuclear membrane by the pressure of its own weight. Arrow shows the direction of the earth's centre. Magnified 248 diameters. (From HERRICK, '95.)

the moment of killing (Fig. 22). The weight of the nucleolus is relatively so great as sometimes to cause a depression in the part of the nuclear membrane upon which it rests (Fig. 23).

§ 3. CONTROL OF THE DIRECTION OF LOCOMOTION BY GRAVITY — GEOTAXIS*

The control of the movements of Protista has been investigated chiefly by four naturalists: SCHWARZ ('84), who studied *Euglena* and *Chlamidomonas*; ADERHOLD ('88), who studied

* So called by SCHWARZ ('84, p. 71).

Euglena and desmids; MASSART ('91), who worked upon bacteria, and ciliate and flagellate Infusoria; and JENSEN ('93), who experimented with Euglena, Chlamydomonas, and eight species of Ciliata.

The observation that led SCHWARZ to his study was that Euglena and Chlamydomonas, shaken up with sand and covered by it, constantly, even in the dark, rose to the surface. The experiments now made by SCHWARZ to determine the true cause of the phenomenon were a model of experimental investigation. In the first place only fresh and actively moving individuals were used, and light was carefully excluded, either by enveloping the culture vessel in black paper, or by working in a dark chamber. I shall now give in detail the experiments and their results.

When the Flagellata were placed in water they responded like those in sand — they soon came to the upper surface. But may not this upward movement be purely passive due to the small specific gravity of the algæ or to currents in the water? To get an answer to this question SCHWARZ heated the sand to 70° C — a fatal temperature — and no aggregation occurred. Again, the algæ were subjected to vapor of chloroform; no aggregation. Again, to a low temperature (5° to 6°); no aggregation. An aggregation occurred, however, when the temperature of the same culture was raised to 22°. Finally, Lycopodium spores and Euglena in the resting stage do not move upwards; hence no currents are passing in this direction. On the contrary, these experiments show that the upward movements of the algæ are the results of its own active locomotion.

Nor can it be that anything else than gravity determines the direction of the locomotion. That the greater amount of oxygen at the upper level is not the controlling agent was shown by smearing the sides of a glass cylinder with a thin layer of sand containing the algæ. In this thin layer, permeated by oxygen, they still accumulated at the upper margin. That the locomotion was not directed by currents in the water (Rheotaxis, p. 108) was indicated by the fact that whether the free end of the tube, at which evaporation is occurring, be up or down, migration is always upwards. Thus, since the stimulus

of chemical agents and currents was eliminated, gravity seemed to remain as the only directing force.

It only remained to show that the attractive force of the earth can be replaced by centrifugal force, and this SCHWARZ was able to do by means of the klinostat. By varying the rate of rotation of this machine he varied the centrifugal force and was able to determine the limits within which the Infusoria move against an opposing force. The acceleration of the rotation-force may be expressed in terms of the attraction of gravity as a unit by the formula $c = \frac{f}{g}$, when c equals the acceleration of centrifugal force in the required units; f , the centrifugal force found, as on p. 113; and g the acceleration due to gravity. It appeared from the experiments that, in both living *Euglena* and *Chlamidomonas* migration took place towards the central end, thus against the centrifugal force, when the latter was over 0.5 g., and under 8.5 g. Under the lower limit no migration occurred; near the upper limit aggregation occurred at both ends; above the upper limit aggregation took place at the peripheral end—that is to say, *with* the centrifugal force. Clearly, then, geotaxis is in these cases a movement against an opposing force, provided that force is considerable (over 0.5 g.) but not too great (over 8.5 g.).

The workers in this field who followed SCHWARZ advanced our knowledge of geotaxis in two principal ways: first, by increasing the number of organisms known to be geotactic, and, secondly, by revealing the fact that closely allied species may have geotaxis of opposite sense.

MASSART ('91, pp. 161–167) employed a simple but satisfactory method. He placed Protista in a capillary tube which was open, hence equally oxygenated at the two ends. By inverting the tube the ends were brought into different relative positions with respect to the earth, causing the geotactic organisms to migrate throughout its length. As a result of his experiments it appeared that *Spirillum*; the flagellata, *Polytoma*, *Chlamydomonas*, and *Chromulina*; and the ciliata, *Anophrys* and *Euplotes*, are geotactic. The sense of geotaxis may be different between individuals of the same genus; thus, under similar conditions *Spirillum* separated into a lot lying at the

upper part of the tube and a lot at the lower part; and the individuals of both the upper and lower lot were active. The sense of response depends upon temperature also. Thus *Chromulina woroniniana* is negatively geotactic at 15° to 20° C., and positively geotactic at 5° to 7° C. The other species mentioned above are negatively geotactic — *i.e.* move in the direction opposite to that in which the force tends to carry them.

JENSEN* ('93) finally has greatly extended our knowledge of the species responsive to gravity, has shown the necessity for regarding carefully the other agents acting during the experiment, and has entered more carefully into the cause of the phenomenon than previous authors. The new forms which JENSEN worked with were these Ciliata: *Paramecium*, *Urostyla*, *Spirostomum*, *Colpoda*, *Colpidium*, *Ophryoglena*, and *Coleps*; also the more commonly used species, *Euglena* and *Chlamydomonas*. The other agents whose action may modify that of gravity are chemical stuffs, density, warmth, light, etc. Light may be easily excluded. On warm days the typical geotactic phenomena are often absent, the *Paramecia* sinking to the deeper, cooler layers. The Infusoria aggregate around bacteria in the water, — chemotaxis (Fig. 24,

b), — and they shun the uppermost layer, apparently because, owing to evaporation, this layer is denser — tonotaxis (Fig. 24, *c*). Whether light inhibits the geotactic response was one of the questions asked and answered by JENSEN. When

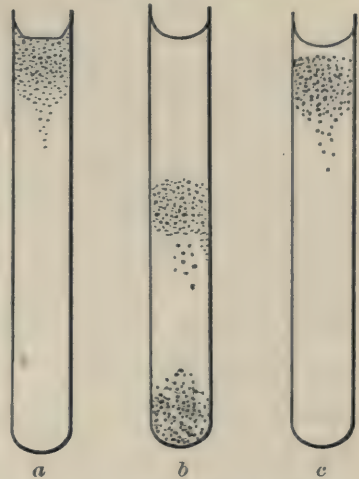

FIG. 24. — Glass tubes, about 0.5 cm. in diameter and 20 cm. long, fused at one end, and filled with water containing *Paramecium* (represented by points). *a* shows aggregation of the *Paramecium* at upper end of tube; *b*, aggregation of *Paramecium* around bacteria suspended in the water — chemotaxis veiling geotaxis; *c* shows that occasionally the *Paramecia* avoid the uppermost layer of the water. (From JENSEN, '93.)

* JENSEN used glass tubes of 0.5 to 1 cm. diameter, and 5 to 100 cm. length, fused at one end. To prevent the free end becoming richer in oxygen, a layer of oil 2 to 3 cm. high was poured over that end, or, air being carefully excluded, it was sealed by an impermeable plug of wax.

the centrifugal machine was used in the sunlight, movements towards the centre clearly appeared. It was thus proved that negative geotaxis (which is the same as centrotaxis) may occur in the sunlight.

The data of geotaxis are incomplete without a consideration of this phenomenon in the higher animals. LOEB is one of the first investigators in this field. In 1888, he found that flies, deprived on both sides of the free ends of the balancers or the wings, and placed upon a board, move always upwards upon it. If the plane of the board is held oblique to the horizontal, the fly always moves along that line which makes the smallest angle with the vertical. Likewise cockroaches seem to be stimulated by gravity when this acts perpendicularly to their ventral surface, so that they tend to move off from a horizontal surface and do not come to rest until they are on a more or less nearly vertical one. Thus, LOEB put twenty-one cockroaches into a truncated, pyramidal box, one of whose sides made an angle of 80° with the horizontal; another 60° , the third 45° , and the fourth 25° . After an hour, the number of individuals on each face of the box was counted at intervals of 10 minutes. Adding together the results of 10 such counts he found on the steepest wall 94 cases; on the wall inclined at 60° , 61 cases; on that inclined at 45° , 28 cases; on that at 25° , 25 cases; and on the horizontal surfaces, 2. After several hours 75 to 80% of the animals were found on the steepest side, although it had the smallest area. Later, LOEB ('90 and '91) showed that the holothurian *Cucumaria cucumis*, the starfish *Asterina gibbosa*, and the lady-bird beetles (*Coccinellidæ*) are likewise geotactic. Finally, it may be mentioned that several species of the slug, *Limax*, are geotactic.

There is in Protista, as already mentioned, a limit to the intensity of the attractive force below which no response will occur. Is there such a limit in Metazoa likewise? Experiments upon this point have been made by Miss HELEN PERKINS and myself in connection with my experimental course at Radcliffe College. We have also been able to answer the question, what difference in effect is produced by different intensities of gravity's action. We experimented with the great slug, *Limax maximus*, which crawls readily upon a glass plate placed

at any angle. As explained on p. 113, the intensity of gravity's action will diminish as the sine of the angle of inclination of the plate is diminished from 90° to 0°. We determined the deviation of the slug from a vertical position upon plates at various inclinations, and after the lapse of a constant time (45 seconds). The experiments were performed in a dark box. The number of tests made at each inclination was sixty. The time required to respond fully to gravity did not vary appreciably with the angle of inclination. The results obtained indicated that the deviation of the slug from verticality diminished with the cosine of the angle made by the plate. The relation between the angular deviation from verticality and the sine of inclination of the glass plate is graphically represented in Fig. 25. The conclusion from the experiments is that the lower limit of the sensitiveness of *Limax* to gravity is extremely small, below 0.13 g., and that as the angle of inclination of the plate diminishes the deviation from 45° towards verticality diminishes in accordance with the relation: $\delta = a \cdot \sin \theta$, in which

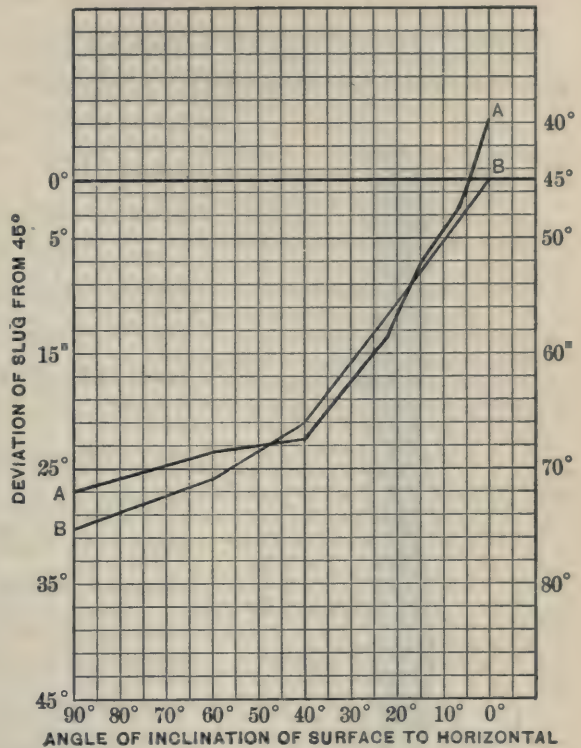

FIG. 25. — Curves showing relation between the sine of the angle of inclination of a glass plate and the angular position of a slug which was first placed on it in a horizontal position and then left for 40 seconds in the dark. Curve A is constructed by drawing ordinates from the heavy horizontal line, 0°-45°, corresponding to each angle of inclination of the surface (laid off as abscissæ). The lengths of the ordinates are determined by the number of degrees of deviation of the axis of the slug from 45° towards 90°. 45° is taken as a base, since it would be the mean angular deviation from the initial position of a slug crawling undirected upon a horizontal plate. Curve B is constructed by drawing down from the base ordinates proportional to the natural sines of the different angles of inclination of the glass plate.

of *Limax* to gravity is extremely small, below 0.13 g., and that as the angle of inclination of the plate diminishes the deviation from 45° towards verticality diminishes in accordance with the relation: $\delta = a \cdot \sin \theta$, in which

δ is the angular deviation of the slug from 45° towards 90° , expressed in degrees; θ is the angle of inclination of the plate to the horizontal, and a is a constant.

In inquiring into the cause of geotaxis in animals it seems best to consider chiefly the phenomenon as exhibited in Protista,

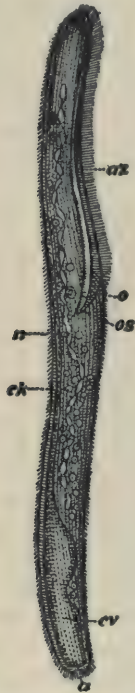

FIG. 26. — *Spirostomum ambiguum*, side view. *az*, adoral zone of cilia; *o*, mouth; *os*, gullet; *n*, nucleus; *ck*, contractile canal; *cv*, contractile vacuole; *a*, anus. Magnified about 120 diameters. (From BÜTSCHLI [BRONN'S *Thier-reich*: Protozoa], after STEIN.)

for in the higher animals this capacity seems bound up with the possession of special organs of orientation. In this group the first and apparently most important part played by gravity is the determination of the axis of the individual, which comes to lie vertical and with the head end up or down according to the conditions of the protoplasm. After the positions of the axis and poles are determined, ordinary locomotion produces the geotactic phenomena. That gravity may determine a vertical position without locomotion occurring is shown in the ciliate infusorian *Spirostomum* (Fig. 26), which at times occurs in large numbers in ordinary aquaria, suspended almost motionless in mid-water, having a distinctly vertical position and with the head end directed upward. They cannot be said to be strictly motionless, since by carefully attending to them one can see them slowly rising or falling

or alternately, perhaps, rising and falling in their almost imperceptible movements. Miss JULIA B. PLATT, who has studied carefully the movements of *Spirostomum*, found that of 78 individuals observed all but 7 had the anterior extremity directed upwards and the 7 exceptional individuals were all moving downwards. It therefore seems quite certain that *Spirostomum* tends in water to orient itself with reference to gravity, although without aggregating at the upper surface.

To explain the phenomenon of axis-orientation, two principal theories have been advanced. The first may be called the *mechanical* theory; the second the *response-to-stimulus* theory. The first theory is that once suggested by VERWORN ('89, p. 122). It appeared to him that it was self-evident from purely physical grounds that, in complete quiescence of the flagellum, the hinder end of the protist should be directed downwards, and not the anterior flagellum-bearing end. If one conceives such an individual to move its flagellum, which precedes in locomotion, it must move towards the surface of the water; thus against gravity. VERWORN finds the stimulation theory inconceivable, since gravity cannot even be compared with stimuli. In falling, the body of the protist might rub against the water particles, which would offer a stimulus, but this would be more allied to rheotaxis.

It might seem an easy thing to determine whether geotactic Protista artificially rendered quiescent (*e.g.* killed or stupefied) would stand with their anterior ends uppermost; but the killing is apt to distort the form, and the organisms being heavier than water* fall to the bottom. Something might be gained from an observation of how they fall, but there is very great discordance among authors upon this point, probably in part due to difficulties of observation. Thus SCHWARZ ('84, p. 68) says that both *Euglena* and *Chlamidomonas* assume all positions in falling; MASSART ('91, p. 164) finds that *Chlamidomonas* falls with flagellum directed upwards and JENSEN ('93, p. 451) declares that *Euglena viridis* killed by iodine falls

* Few determinations seem to have been made of the specific gravity of living Protista. JENSEN ('93^a) attempted to do this for *Paramecia*, but his method was bad and his results bad likewise. He made solutions of potassium carbonate, of varying specific gravity, and found that *Paramecium* just floats in a solution whose sp. gr. is 1.25. The difficulty of the method is that solutions of salt having a relatively small molecular weight act so powerfully in withdrawing water from the organism as to cause it to shrink and increase in relative weight. Miss PLATT has used solutions of gum arabic whose osmotic action is so slight that organisms live in it for hours. In such solutions, paralyzed but living *Spirostoma* and *Paramecia* neither sank nor rose when the specific gravity was between 1.016 and 1.019; so that it seems probable that the specific gravity of Infusoria lies near 1.017. Tadpoles recently hatched and having a length of 9.5 mm. had a sp. gr. of 1.044, while those 12 mm. long had a sp. gr. of 1.017.

almost without exception with the broader flagellate pole downwards. Both from the fact that it can be easily demonstrated that when a body heavier than water falls in that medium its larger end will precede, and from the fact that JENSEN was especially careful that the killed organism should not be deformed, his results must be considered the best established. Now, since the dead *Euglena* tends to sink with flagellum downwards whereas the active *Euglena* stands flagellum upwards, we must conclude that the orientation of *Euglena* and probably other Protista is not passive but due to their activity and must be regarded as a response more or less directly due to gravity.

But just how does gravity act as a stimulus to determine the direction of orientation of the body? We have two principal theories to examine. First, that of JENSEN, that gravity acts indirectly on the organism by directly causing a difference in pressure in the water at different levels. This difference in water pressure, at various levels, affects directly the two poles of the organisms, which stand at different levels, and the organism responds to this difference in pressure. The second theory, which I adopt, is that the organism, owing to its specific gravity being greater than the medium, experiences greater resistance (friction + weight) in going upwards even to the slightest extent than in going downwards (friction - weight). Another stimulus, which is probably associated with this, depends upon the fact that an unsymmetrical body, heavier than water, tends to fall with its larger end down. Those negatively geotactic organisms, which stand with their larger end up, will be consequently in a condition of unstable equilibrium; those organisms which stand with their larger end down will be in stable equilibrium. In the first case a deviation from verticality would be accompanied by relatively diminished resistance on one side; in the second by relatively increased resistance on one side. In either case, the distribution of the mass of the animal may give the organism the means of determining, but not in a mechanical way, the position of its axis.

The evidence for the first theory JENSEN finds especially in a fact which he believes opposes the second. Negatively geotactic organisms, placed in an inclined tube, move towards

the upper side and then travel obliquely, not vertically, along it toward the upper part of the tube, thus into strata of constantly diminishing pressure. If weight controlled in any way their movements, they should move vertically as from 1 to 2 (Fig. 27) until they meet the side of the glass. Then they should move off, as to 3, then vertically to 5, and so on. Since they do not so move, gravity, JENSEN thinks, cannot be said to act directly. In criticism of this conclusion it may be urged that it is without proper foundation, for if an organism whose irritability (instincts) would lead it to move vertically is mechanically unable to do so exactly, it will do so as far as practicable. This observation cannot, therefore, be said to militate against the second theory. Finally, there is this positive objection to JENSEN'S theory that it is applicable only to geotaxis in water animals, and can therefore be only a special explanation of geotaxis.

On the other hand, there is evidence which is opposed to the first theory and favors directly the second. And JENSEN has himself contributed some of this evidence. He put *Urostylela* into a glass tube containing a 0.5% aqueous gelatine solution. They showed no tendency to go upwards. At the expiration of 20 hours many deaths had occurred, but some normally active individuals were still at the lower end of the tube. Why this loss of geotaxis? JENSEN believes it due to the fact that the difference in pressure of the successive layers did not increase proportionally to the increase in resistance of the solution. I would suggest that it may be due to the fact that the weight of the body of the Protista is now relatively less than that of the solution, so that the organism, tending to move against resistance, comes to lie at the bottom of the buoyant fluid, hence appears positively geotactic.

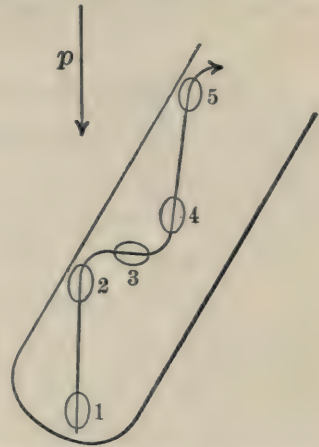

FIG. 27.—Hypothetical line of migration of *Paramecium* in an inclined tube, upon the assumption that gravity acts directly to determine direction of locomotion, according to the conception of JENSEN. The arrow at *p* indicates the direction of the pull of gravity; 1, 2, 3, 4, 5, successive positions occupied by the *Paramecium*. (From JENSEN, '93.)

Geotaxis in the higher organisms, especially Vertebrates, cannot here be discussed at length. It is sufficient to state that as LOEB ('91, p. 189) concludes, it is probably dependent upon the internal ear. Miss PLATT has, at my suggestion, subjected young negatively geotactic tadpoles to solutions of gum arabic of the same specific gravity as themselves, and has found that they still migrate upwards. This result makes it probable that here also orientation is effected by the internal ear, and hence is independent of the action of gravity upon the entire body.

Finally must be mentioned the phenomenon of *acclimatization to a central pressure*. This has been observed by JENSEN ('93, p. 470), who says, when *Paramecium* or *Urostyle* has been strongly "centrifugated" towards the peripheral end of the tube, where it is subjected to a high pressure, it shows, when the tube is then placed vertically, a much livelier geotaxis than it would have done without "centrifugating." Clearly the temporary action of the high pressure has increased the irritability to gravity.

To recapitulate: Gravity affects the structure of protoplasm by separating the lighter and heavier substances. It may determine the direction of locomotion by determining the verticality of the axis of the body. Varying the intensity of gravity's attraction diminishes the *precision* with which this determination takes place. The determination of the vertical position is, in the lower organisms, probably due to difference in ease of movement when going up and going down.

LITERATURE

ADERHOLD, R. '88. (See Chapter I, Literature.)

DEHNECKE, C. '80. Ueber nicht assimilirende Chlorophyllkörper. Inaug. Diss. Köln. Abstr. in Bot. Ztg. XXXVIII, 795-798. Also in Bot. Centralbl. I, 1537.

HERRICK, F. H. '95. Movements of the Nucleolus through the Action of Gravity. Anat. Anz. X, 337-340. 8 Jan. 1895.

JENSEN, P. '93. Ueber den Geotropismus niederer Organismen. Arch. f. d. ges. Physiol. LIII, 428-480. 5 Jan. 1893.

'93*. Die absolute Kraft einer Flimmerzelle. Arch. f. d. ges. Physiol. LIV, 537-551. 24 June, 1893.

- LOEB, J. '88. Die Orientirung der Thiere gegen die Schwerkraft der Erde. (Thierischer Geotropismus.) Sb. Würzb. Phys.-med. Ges.
'90. (See Chapter VII, Literature.)
'91. Ueber Geotropismus bei Thieren. Arch. f. d. ges. Physiol. XLIX, 175-189. 1891.
- MASSART, J. '91. Recherches sur les organismes inférieurs. III. La sensibilité à la gravitation. Bull. l'Acad. roy. Belg. (3) XXII, 158-167. 1891.
- SCHWARZ, F. '84. Der Einfluss der Schwerkraft auf die Bewegungsrichtung von Chlamidomonas und Euglena. Ber. bot. Ges. II, 51-72.
- VERWORN, M. '89. (See Chapter I, Literature.)

CHAPTER VI

EFFECT OF ELECTRICITY UPON PROTOPLASM

IN this chapter we shall consider (I) some methods employed in the investigation of this subject; (II) the effect of electricity upon the structure and general functions of protoplasm; and (III) the effect of electricity in determining direction of locomotion — electrotaxis.

§ 1. CONCERNING METHODS

While the phenomena of magnetism and electricity are closely allied, their effects upon protoplasm seem to be widely dissimilar. Thus no certain action of magnetism has hitherto been observed, but electricity, however produced, causes nearly uniformly an effect.

Any experimental work with the electric current involves apparatus for its production, application, and measurement; namely, batteries or other sources of electricity; electrodes for applying the current to the organism; troughs to contain the free swimming animals used for experimentation; a galvanometer for measuring the current; a rheochord for varying the intensity of the current; a reversing key; and, for interrupted currents, an induction machine with interrupter, and an electrometer for measuring such currents. A description of the principal forms of these instruments and the methods of constructing some of them will be found in VERWORN, '95, Chapter V, and in OSTWALD, '94, Chapter XV.

Since the works just named are easily accessible, it will be unnecessary here to describe these instruments in detail. A few *additional* suggestions, the result of my experience, may, however, be found helpful. Concerning *batteries*, first; accumulators are without doubt to be preferred, where practicable, on

account of the strength and continuance of their currents. In other cases, CLARK or DANIELL elements, if enough of them are united in series, will meet the requirements. The character of the *electrodes*, next, will depend upon the nature of the investigation. Nonpolarizable ones of hair (camel's-hair brush), clay, or paper (plug of filter paper in glass tubing drawn out to a cone) are usually employed, but all of these offer considerable resistance. The *troughs* will vary in form and size with the organisms to be contained in them; some of them will be described in connection with the experiments in which they have been employed. They are all rectangular enclosures having clay ends when it is desirable that these should be nonpolarizable. For large troughs, sheet-zinc electrodes are used, covering the smaller sides of the trough. Although some of the reflecting *galvanometers* are more sensitive, a "millammeter" such as that made by the WESTON Electrical Works is a much more convenient instrument and sensitive enough for most work of this sort. The *rheochord* is practically a low-resistance box, capable of indefinitely fine gradations. This is introduced into the short branch of a divided circuit, so that by varying its resistance a varying share of the current shall be forced into the longer circuit. A very simple and excellent device for altering the strength of current is the "Compression-rheostat" of BLASIUS and SCHWEIZER ('93). This consists of a piece of rubber tubing filled with zinc sulphate, stopped at the ends and introduced into the circuit. By means of a thumbscrew the walls of the middle of the tube may be pressed together, the lumen correspondingly reduced, and the resistance increased. The *induction apparatus* usually employed is one invented by DU BOIS-REYMOND. In this the secondary coil may be withdrawn from the primary coil to any desired distance, thereby diminishing the intensity of the induced current. Through the action of such an instrument the current is alternately made and broken, and each electrode becomes in quick succession anode and kathode. Since alternating currents cannot be measured by an ordinary galvanometer, an electrometer must be employed. So much concerning apparatus.

A word should be said about the method of stating the current employed. Very many authors have been satisfied with

saying that the current was strong or weak, others have given the kind and number of elements employed. Such statements are wholly inadequate to give an accurate idea of the strength of current to which the organisms under experimentation were subjected. Even merely to state the galvanometer reading in milliamperes is insufficient. We must know as nearly as possible what strength of current is passing through the organism, and this involves knowing the density of the current passing through the water in the trough. Now it is obvious that a current passing through a mass of water of small cross-section is stronger per square millimeter than an equal current distributed over a large cross-section. It is necessary, consequently, to know the cross-section of the mass of water through which the stimulating current is passing, in order to determine the "density" or strength at any point. For technical purposes the unit of current-density is taken at 1 ampere to the square millimeter. HERMANN and MATTHIAS ('94, p. 394) propose for physiological purposes a unit one-millionth as great, to be designated as δ . δ then indicates a current of $\frac{1}{1000}$ milliampere per square millimeter of cross-section. It is very desirable that, when practicable, currents should hereafter be expressed in δ 's. More than one useless discussion has been precipitated by not giving a sufficiently accurate quantitative expression to the current employed. (See, for illustration, below, p. 149.)

Finally, the strength of current necessary to produce a certain result depends upon the relative conductivity of the organism and the surrounding water. If, through the presence of substances in solution, the conductivity of the water is abnormally great, one must use a greater current (as read off from the galvanometer) than otherwise to produce a certain effect. (WALLER, '95, p. 97.) It would probably be best, when possible, to use in the trough the water in which the organism has been living, since the quantity of salts in the organism has been shown to vary with that of its medium. (See p. 88.)*

* See KAISER, Wien Akad. CIV, p. 17, 1895, for a new trough adapted to the stage of the microscope.

§ 2. THE EFFECT OF ELECTRICITY UPON THE STRUCTURE AND GENERAL FUNCTIONS OF PROTOPLASM

The fundamental phenomenon of the action of an electric current upon protoplasm may be seen while watching a heliozoan (*Actinosphærium*), lying in a drop of water, through which a weak, constant current is "made." We find that the filamentous pseudopodia begin quickly to retract at the two poles lying in the axis of the current; and as the current continues, this contraction continues likewise. The primary effect of a weak constant current is thus a centripetal flowing of the protoplasm. The current stimulates to contraction.

If, now, the current be increased, or be longer continued, further changes occur. The pseudopodia lying in the current become varicose, and break up into a chain of drops; the vacuoles on the periphery begin to burst, emptying out their fluids; and in these regions the protoplasm collapses. Thus, the stronger current produces continued contraction, accompanied by collapse of the protoplasmic foam-work.

Finally, the plasma itself begins, upon the anode side, to disintegrate, and the loose particles to move towards the positive electrode. As the plasma of this side is gradually eaten away, the outline of the *Actinosphærium* passes through phases like those of the waning moon, until, finally, the last thin crescent fades away. The particles of the mass have wholly lost their cohesion (Fig. 28).

The facts just given concerning the behavior of *Actinosphærium* to the constant current are gathered from the observations of KÜHNE ('64, p. 59) and VERWORN ('89^a, pp. 8, 9). Fundamentally similar observations have been made by KÜHNE ('64, p. 79) and VERWORN ('89^b, p. 274) on *Myxomycetes*, and by VERWORN ('89^a, pp. 13, 17) on the rhizopods, *Polystomella* and *Pelomyxa*. So these data may be considered as of general worth for naked protoplasm.

Also upon ciliated epithelium, the constant current acts as a very strong excitant, producing an active movement in cilia which had previously nearly ceased to beat. This excitation occurs, especially about the two poles, immediately upon "making" the current. (KRAFT, '90, pp. 234, 235.)

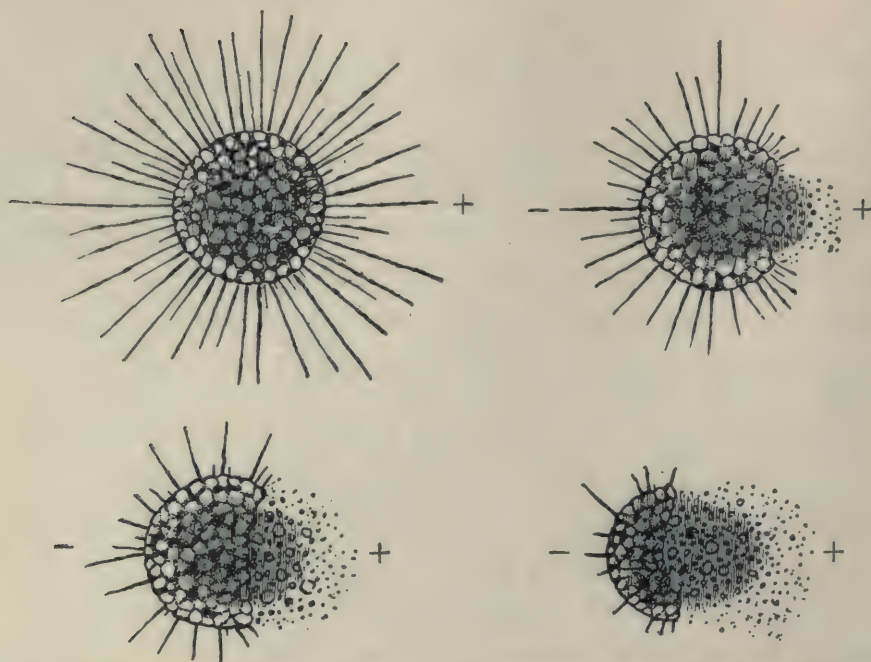

FIG. 28. — *Actinosphaerium eichhornii* in four successive stages of polar excitation by means of the constant electric current. Disintegration begins at the anode (+) pole. (From VERWORN, '95.)

Allied, apparently, to the foregoing phenomena are the protoplasmic changes which follow the sudden *breaking* of the current. Unless the current has been very feeble, the pseudopodia of *Actinosphaerium* begin, at the moment of breaking, to contract and become varicose upon the kathode side, while the formerly irritated anode side is quiet. Thus, the breaking of the current also acts as a stimulus, but this is, in general, weaker than that caused by making.

If, now, a current which endures for only an instant — if a single induction shock — is sent through, the making and breaking stimuli are practically coincident, and a violent response may be called forth. Thus, ENGELMANN ('69, p. 317) found that *Amœba*, subjected to a strong shock, retracted its pseudopodia, and assumed a spherical form within two seconds; and GOLUBEW ('68, p. 557) has described a similar response in leucocytes. Under similar circumstances, the flagellum of the flagellate *Peranema* (Fig. 29) made an energetic stroke. (VERWORN, '95, p. 414.) I have spoken above as though there were both a making and a breaking stimulus; but this is not known to be the case. It is generally recognized from experiments

on muscle, that it is the "making" only of a single induction shock which produces the response; but VERWORN ('89^a, pp. 19-22) has found that in the rhizopod *Pelomyxa* it is, on the contrary, the breaking excitation which causes the response. The subject deserves further study.

Finally, the effect of an alternating current must be considered. This current is characterized by the fact that it is composed of a series of rapidly repeated instantaneous shocks

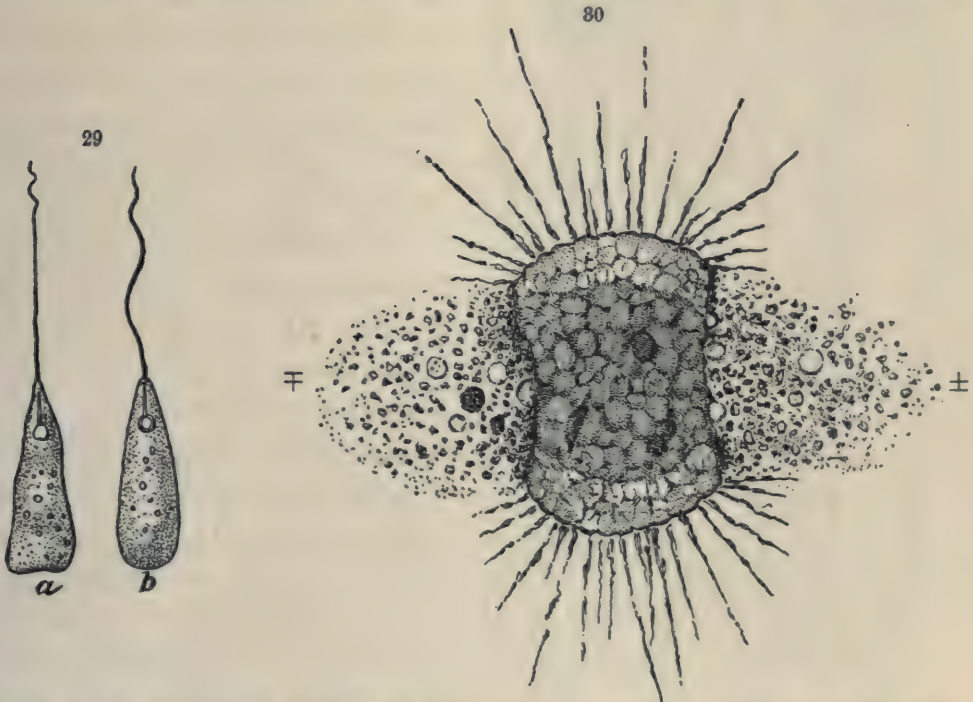

FIG. 29. — *Peranema*. *a*, quietly swimming; *b*, irritated by an induction stroke. (FROM VERWORN, '95.)

FIG. 30. — *Actinosphaerium eichhornii*, STEIN. Showing effect of the alternating current. At both poles the pseudopodia are undergoing a disintegration, which proceeds equally at the two poles. (FROM VERWORN, '89.)

which alternately reverse their direction. Thus, each pole of the organism subjected to such a current receives alternately the making (or breaking) effects at anode and kathode. The maximum action is thus obtained. When an *Actinosphaerium* is stimulated by such a current, the pseudopodia at both poles contract and become varicose; and, finally, the protoplasmic substance begins to disintegrate and to flow out from the cell towards the two electrodes, until the body acquires a biconcave form. (VERWORN, '89^a, p. 11.) In this case the disintegra-

tion takes place at both poles, since both are, alternately, anodes (Fig. 30).

Similar effects have been observed in other cases. Thus, when an amœba is subjected to an alternating current, it becomes spherical; the protoplasmic streaming of the plasmodia



FIG. 31.—One of the cells of a stamen hair of *Tradescantia virginica*. *A*, unstimulated; *B*, stimulated by an induction current. At *a*, *b*, *c*, *d*, the protoplasm has aggregated into drops and clumps. (From VERWORN, '89, after KÜHNE, '64.)

of a myxomycete ceases, and, with stronger currents, the whole mass contracts, water being forced out. Finally, an attempt at a similar result is seen in the stamen-hair cells of *Tradescantia*, in which, under stimulation, the protoplasmic threads segregate into irregular or spheroidal clumps. (KÜHNE, '64, pp. 30, 31, 75, 99.) In all these cases we see that the action of a violent current, like repeated contact, leads (as ENGELMANN, '69, p. 321, has suggested) to results which can be accounted for on the ground of reduced cohesion,—first, tendency to spherical aggregation, and, finally, disintegration (Fig. 31).

After having studied the effect of the electric current upon Protista and simple cells, it remains to consider, very briefly, its effect upon muscle and upon nerve. Since CALDANI discovered, in 1756, that frogs, shortly after death, could be stimulated to movement by frictional electricity, and GALVANI and VOLTA, towards the end of the last century, discovered, by the same response, the phenomenon of galvanism, these tissues have frequently been made the subject of careful experimentation. It has been shown, not merely that

the nerve can be stimulated to its functions, but that muscle from which the activity of the nerve has been excluded by the use of curare (which inhibits the action of the nerve, but not of the muscle), will contract upon the passage of a current.

Upon the character of the current, however, depends that of the response; thus, although, as we have seen, a closed constant current continues to stimulate *Protista*, it has been said not to stimulate nerve or muscle. A contraction follows, it has been maintained, only upon considerable variations in the electrical condition, such as result from making or breaking the current. It is probable, however, that there is not so great a difference in responsiveness of muscle and *Protista* as would seem to be implied, for BIEDERMANN ('83) has shown that the constant current produces a whole series of slight contractions in muscle which cannot be regarded merely as a secondary result of the making shock; and FICK ('63) has observed contraction due to the constant current in muscles of *Lamelibranchia*. So that even in muscles, there is an actual, though weak, response to a steady, constant current.

There are two phenomena following momentary shocks applied to muscles which deserve notice in passing. First, when a single induction shock is passed directly through a muscle, we notice that the contraction is not simultaneous with the shock, but follows only after the lapse of a certain "latent period." This latent period represents, it is believed, time spent in transformations going on in the plasma preparatory to contraction. Secondly, when we pass (especially in a muscle-nerve preparation) a series of induction shocks, closely following one another, as in the alternating current, a very violent contraction is produced, since the new shock comes to the muscle before it has had time fully to relax, and causes a contraction of the already contracted tissue. Thus stimulus is superimposed upon stimulus, and a summated response (tetanus) takes place.

We must now consider more carefully a subject to which we have hitherto merely alluded, namely, the relation to the electrodes of the point of the organism at which the response first appears. Thus, when the amœboid *Pelomyxa* is subjected to the constant current, a contraction appears, at the time of

making the current, at that pole only which is turned towards the anode. When the current is broken, on the contrary, a contraction occurs at the kathode, the pseudopodia next the anode becoming quiet. (VERWORN, '89^a, p. 19.) This relation may be expressed in tabular form as follows : —

	AT ANODE.	AT KATHODE.
Upon making	excitation	rest
Upon breaking	rest	excitation

All Protista do not, however, according to VERWORN, respond in the same way as *Pelomyxa* ; thus, with the constant current of a certain intensity, he got in both *Polystomella crispa*, and *Actinosphærium*, the following reaction : —

	AT ANODE.	AT KATHODE.
Upon making	excitation	rest
Upon breaking	rest	rest

It must be said, however, that the reactions obtained in any case are dependent upon the strength of current employed ; thus, with a stronger current, the following result was obtained with *Actinosphærium* : —

	AT ANODE.	AT KATHODE.
Upon making	excitation	excitation
Upon breaking	rest	excitation

A comparison of the last two tables seems to indicate that, very probably, with a current intermediate between the weak and the strong current employed, we should get a result like that obtained with *Pelomyxa*. At any rate, we may say that all these cases tend to group themselves about the *Pelomyxa* formula ; — making : anode, excitation ; kathode, rest ; breaking : anode, rest ; kathode, excitation. A brief designation of this type is desirable. Since the condition at the anode upon

making is distinctive, we may call this the anode-excitation type, or, briefer still, *anex* type.

Turning, now, to nerve and muscle tissue, we meet with a type of response, on making and breaking the current, altogether irreconcilable with this. As is well known, when a constant current is made or broken, all the tissue lying between the electrodes is not stimulated at one time, but the excitation makes its appearance at the anode or kathode, and thence is transmitted to the other pole. One can demonstrate this on slow-moving (*e.g.* extremely tired or dying) muscle at the extremities of which the electrodes are placed. The contraction begins at one electrode, and travels towards the other. By using more refined methods, this relation, which holds for nerves, striated and smooth muscle (*cf.* ENGELMANN, '70, p. 302) has been formulated as follows:—

	AT ANODE.	AT KATHODE.
Upon making	rest	excitation
Upon breaking	excitation	rest

This is seen to be the very opposite of the response given by *Pelomyxa*. It may be called the kathode-excitation type, or, in brief, the *katex* type.

Having now seen that two fundamentally different types exist in the response of the two extreme groups of the animal kingdom, the question arises, what is the distribution of these types amongst the intermediate forms—the Invertebrate Metazoa? Fortunately, through the investigations of NAGEL ('92 and '92*), we have data upon this subject. In NAGEL'S experiments, the whole animal was employed, the two electrodes were placed at the opposite ends of its long axis, the metallic circuit was then made or broken as required, and the pole (anode or kathode) at which contraction first occurred was noted. Thus, NAGEL found that when the current was made through the sea-hare, *Aplysia*, there was strong excitation and momentary retraction of the parts next to the anode, while next to the kathode the body showed a considerably weaker contraction. Upon breaking the current, there was some excitation of the parts of the

body next to the kathode, but none at the anode end. The result that one obtains depends, however, to a certain extent, upon the strength of the current that one employs. But NAGEL did not, apparently, measure his currents, so there is no certainty that his results can be at once duplicated. Taking the results for various Invertebrates as they are given, however they are instructive.

TABLE XIII

	UPON MAKING.		UPON BREAKING.	
	AT ANODE.	AT KATHODE.	AT ANODE.	AT KATHODE.
<i>Limnæus</i>	excitation	rest	rest	excitation
<i>Planorbis</i>	excitation	rest	rest	excitation
<i>Aplysia punctata</i> . .	excitation >	excitation	rest	excitation
<i>Schæurgus</i> (octopod)	excitation >	excitation	rest	excitation
<i>Helix hortensis</i> . . .	excitation >	excitation	rest	slight excitation
<i>Ciona intestinalis</i> . .	excitation >	excitation	rest	rest
<i>Janus cristatus</i> . . .	excitation =	excitation	rest	slight excitation
<i>Pleurobranchia</i> . . .	excitation =	excitation*	rest	slight excitation
<i>Nassa reticulata</i> . . .	weak excit.	rest	rest	rest

All the species in this table (all of which, except *Ciona*, are Mollusca) show in their response a more or less close approach to the type of *Pelomyxa* (excitation, rest; rest, excitation); and we may believe that with appropriate stimulus they would respond in precisely that way.

In a second class of cases the response of the whole animal belongs to the katex type; thus two species examined by NAGEL showed the following responses:—

TABLE XIV

	UPON MAKING.		UPON BREAKING.	
	AT ANODE.	AT KATHODE.	AT ANODE.	AT KATHODE.
<i>Pagurus striatus</i> . . .	rest	excitation	excitation	rest
<i>Triton cristatus</i> . . .	excitation <	excitation		

* Inconstant in occurrence.

These are representatives of the groups Crustacea and Vertebrata.

Among all the species studied by NAGEL there was only one which gave results not easily assignable to either of the two types. This organism is the larva of a dragon-fly, *Æschurea*. Its formula is excitation = excitation; rest, rest. NAGEL says, however, that these results were uncertain and variable.

In some other groups studied — Cœlenterata and Echinodermata — the current used provoked no response at either pole; while with *Amphioxus* the current employed produced excitation at both poles on both making and breaking the circuit. Such variations as these, are, however, easily accounted for on the ground that different species require currents of different strengths to call forth what may be termed the typical response.

Not merely between different groups do we find a difference in the type of response, but even inside the group of Protozoa dissimilarity has been shown to occur. Thus VERWORN ('89^b, p. 301) has given reasons for believing that three flagellate species, the ciliate *Opalina*, and some bacteria belong to the katex type, although as just stated (p. 133) other Protozoa exhibit the anex type of response.

Finally it appears that individuals of one and the same species subjected to different intensities of current may give rise to responses belonging to the opposite types. Thus when a medium current is "made" through *Triton cristatus* the excitation is greater at the kathode than at the anode; but when the weakest current is employed a making response occurs at the anode only, and when a slightly greater intensity is used the continuance of the current provokes a continuance of the excitation at the anode. (NAGEL, '92^a, p. 341.) Likewise the reaction of Vertebrate muscle varies with its internal condition. Thus degenerated or over-stimulated muscle shows predominating anode stimulation on making the current; and transverse stimulation of the muscle fibre gives the same result.*

To sum up, two principal types of response to the electric current may be distinguished: the first or anex type characterizing most Protozoa, Mollusca, Vertebrates (slightly stimulated),

* For a discussion of these cases see VERWORN ('89^a, p. 24).

and weak muscle fibres; the second or katex type found especially among some Flagellata, Arthropoda, and Vertebrata. A third possible type (katanex type) is certainly of very limited distribution. Between the two types we notice this connecting link, that in some Vertebrates a weak current produces one type of response; a strong current the other. The reason for the existence of these two distinct types—one of which characterizes animals with less differentiated, the other those with more differentiated, muscular and nervous systems—is still greatly in need of investigation.

The nature of the protoplasmic change wrought by the current is an important matter. We have already accounted for the effect that we see in the Protista, on the ground of reduced cohesion. It is probable also that the current gives rise in the cytoplasm to chemical changes which are different at the two poles. It is well known that when a current is passed through a neutral solution of a salt there is produced an acid at the anode, and an alkali at the kathode. Since in the higher animals, at least, the body contains such solutions, it seems probable that acid and alkaline substances are here likewise produced by the passing current. This probability is supported by an observation of KÜHNE ('64, p. 100), who found that the violet coloring matter of the stamen hairs of *Tradescantia* become changed by the action of a very strong induction shock. He says that a change in the violet fluid, like that which occurs at the anode, can be brought about by dilute hydrochloric acid; while a change like that appearing at the kathode can be produced by potassic hydrate. An observation of NAGEL ('92^a, p. 346) suggests also that the current acts by producing a chemical change. He finds that that part of the body of the snail and the leech which shows most markedly the anode-making excitation is coincident with that which is most sensitive to chemical substances. So that the reaction to a galvanic, still more to a faradic, stimulation resembles that to a strong, disagreeable taste (quinine). In this case the response may result either from the chemical substance acting directly on the muscles or attacking first the sense organs. In the latter case the response would occur through the mediation of the nervous system.

So far then we have distinguished two chief effects of the current on protoplasm—a dissociation effect and a chemical effect. It may now be worth while to mention that there is good reason for believing that in the more highly differentiated animals, like Vertebrates, not all protoplasm is affected to the same degree nor in the same way. Thus a nervous and a muscular effect can be clearly distinguished in frogs, for example. The principal effect is exerted upon the central nervous system, for HERMANN ('86, p. 415) found that the tail of tadpoles is responsive only so long as it contains a piece of spinal nerve; and upon frogs subjected to curare, which inhibits the action of the nerve alone, the current produces a much-diminished effect, giving rise merely to muscular twitchings. (BLASIUS and SCHWEIZER, '93, p. 528.) Very little progress has been made, however, upon the determination of the action of different intensities upon the different tissues of which the Vertebrate body is composed.

We have seen that the electric current provokes a response, and we have seen also that organisms vary in their responsiveness so that a current strong enough to call forth a response in one species is not sufficient to excite another species. We may say that the one species is *attuned* to a different strength of current from the other. This difference in responsiveness indicates, of course, a corresponding difference in composition of the protoplasm. Such a difference may, moreover, be produced in a single individual by artificial means. These means are the subjection for a considerable period to the electric current. Suppose we subject an organism to a current of a strength only slightly greater than that just necessary to provoke a response. After the current has acted for some time we find that it no longer excites. This phenomenon of acclimatization to the galvanic current was first observed among the Protista, so far as I know, by KÜHNE ('64, pp. 76, 78), who found that in Myxomycetes, after a few induction shocks had been sent through the plasmodium, additional shocks of the same intensity were without effect, and stronger shocks had to be sent through to cause contraction. Similar results were obtained by VERWORN ('89^a, p. 10; '89^b, p. 272) in subjecting *Actinosphærium*

and *Amœba* to a weak constant current. At first the pseudopodia on the anode side plainly retracted, but later ceased to do so, and, finally, the current still passing, the retracted pseudopodia began to extend again. The action of the current so modified the protoplasm as to change the attunement of the organism.

§ 3. ELECTROTAXIS

In studying the subject of aggregation with reference to the electric current, we shall consider first the simplest case of this phenomenon as it is exhibited in *Amœba*; then pass to the more complex forms of Protista, especially the Ciliata, and after

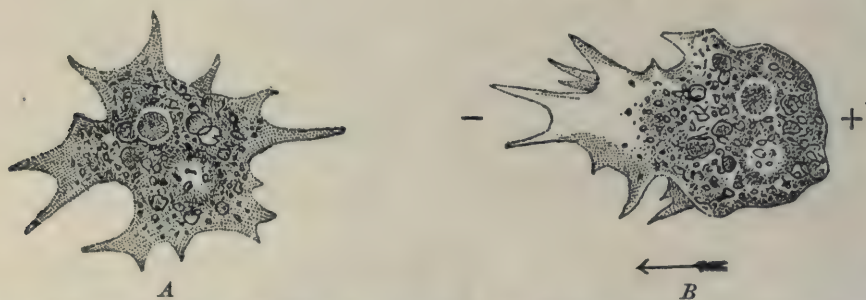

FIG. 32.—Galvanotaxis of *Amœba diffluens*. *A*, *Amœba* creeping, unstimulated; *B*, after closing of the constant current. The arrow indicates the direction of locomotion. (From VERWORN, '95.)

that to the Metazoa. After dealing with the phenomena we must attempt to explain them.

When such an amoeba as that shown in Fig. 32, *A*, is subjected in a drop of water to the action of a weak constant current, as already indicated (p. 129), it contracts, especially upon the face turned towards the anode. If the current is not strong enough to produce disintegration at that pole, but only repeated contraction, and if meanwhile the kathode pole retains its power of throwing out pseudopodia, the amoeba must gradually move from the anode (Fig. 32, *B*), and if several *Amœbæ* are under the cover-glass, they will eventually aggregate about the kathode. Here we have, then, in its simplest form, a case of electrotaxis, and, since the organism moves toward the negative electrode, we may call it negative electrotaxis.

If now, instead of an amoeba, we watch a free swimming flagellate Infusorian, — *Trachelomonas hispida* (Fig. 33), — we

see the long flagellum which precedes in locomotion coming to lie in the current and directed towards the kathode, so that the animal migrates in that direction. The following explanation of the observed fact that the flagellum becomes directed towards the kathode has been offered by VERWORN ('89^b, p. 298). The flagellum and the pole from which it arises constitute the most sensitive end of the body. When the flagellum is stimulated it beats violently, and since it is stimulated most when turned towards the anode, it beats most violently when in this attitude. A position 180° from this is one of comparative rest. In intermediate positions the degree of stimulation is intermediate. After a few strokes the body will "naturally" come to assume and to retain that position in which the flagellum is least stimulated.

More detailed still is our knowledge of electrotaxis among

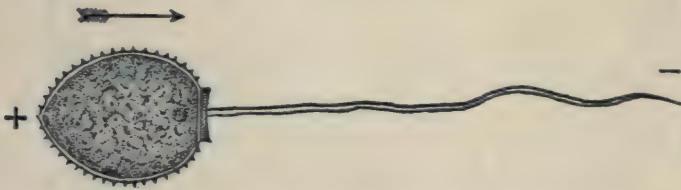

FIG. 33.—*Trachelomonas hispida*, swimming towards the kathode (—) upon closure of the current. The arrow shows the direction of locomotion. (From VERWORN, '89.)

the ciliate Infusoria. The authors who have worked upon this group are chiefly VERWORN ('89^a and '89^b) and LUDLOFF ('95). The work of the former shows that the phenomenon of electrotaxis is exhibited by many species, especially *Paramecium aurelia* and *P. bursaria*, *Stentor cœrulens* and *S. polymorpha*, *Pleuronema chrysalis*, *Opalina ranarum*, *Bursaria truncatella*, *Halteria grandinella* and *Stylonichia mytilus*. LUDLOFF employed only *Paramecium*, but studied it much more completely, especially using various currents of known relative intensity.* He found that the precision with which

* LUDLOFF employed a trough with wax walls, clay ends, and glass bottom, and used brush electrodes. The intensities of current given by him are the readings of the galvanometer. The cross-section of the water mass in which the *Paramecia* were, and over which the current spread itself, is not exactly given, but was probably about 20 sq. mm. If we employ the unit of strength recommended by HERMANN and MATTHIAS (p. 128), namely, 1 one-millionth of

the Paramecia aggregated at one pole was determined by the strength of the current, as follows: A current of 3δ caused in general a movement towards the kathode, although many individuals appeared not to be affected by it. In 20 seconds the anode end of the fluid was almost free from Infusoria. With currents of 6δ and 15δ the aggregation at one pole became more complete and took place in a short time. Indeed, there was a relation found between the time required for

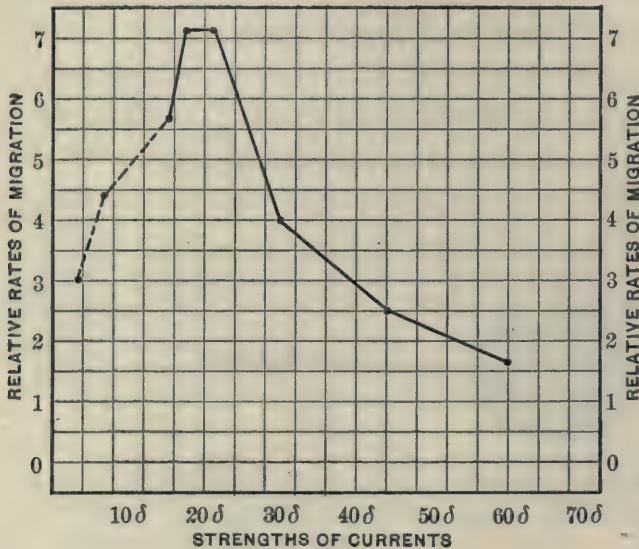

FIG. 34.—Curve showing relation between strength of currents and relative time elapsing before Paramecia have aggregated at the kathode. The ordinates are measured by the reciprocals of the number of seconds elapsing; the abscissæ, by the strength of current in δ 's.

aggregation at the kathode and the strength of current employed, which is instructive, and is given above in graphic form (Fig. 34).

This curve shows that as the current increased from 3δ to 21δ the rapidity of aggregation increased, but as the current increased still further this rate diminished until locomotion nearly ceased at above 60δ . The intensity, therefore, of 21δ produced the most rapid movements.

Upon opening the current, the Infusoria in all cases swim,

1 ampere per sq. mm. (designated δ), then we must divide LUDLOFF'S galvanometer readings (given in milliamperes) by $\frac{20}{1000}$, or (which is the same thing) multiply them by 50. That will give us the current in δ 's per sq. mm. All of the numerical data given in the text have undergone this operation.

rapidly for a moment, towards the opposite pole (anode), but then quickly begin to redistribute themselves throughout the water. This redistribution has occurred in about 20 seconds

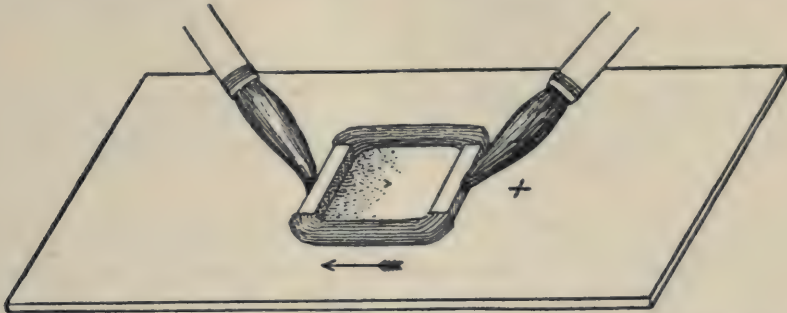

FIG. 35. — Apparatus for studying electrotaxis of *Paramecium*. A rectangular trough, whose ends are of clay and sides of wax, is built upon a glass plate. The current is applied by means of brush electrodes. The direction of the migration of the paramecia is indicated by the arrow. They move towards the kathode. (From VERWORN, '95.)

after the current is broken, and the time is independent of the strength of the preëxisting current.

The movement of the Infusorian from one pole to the other takes place along the lines of flow of the current. If the terminals are two parallel plates, these lines are about parallel (Fig. 35); if they are two points near the opposite sides of

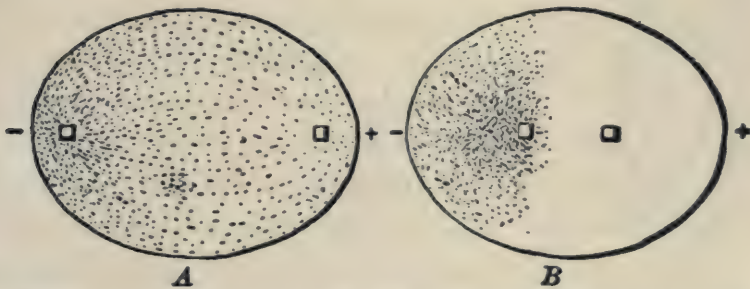

FIG. 36. — Curves made by *Paramecia* in its galvanotactic response when pointed electrodes are used in the drop of water. *A*, beginning of migration; *B*, complete aggregation. (From VERWORN, '95.)

a water drop, the lines have the direction of the lines made by iron filings scattered on a plate over the two poles of a magnet (Fig. 36).

Besides this path of general migration, the form of the path followed by individuals varies with the current. Normally *Paramecium* moves in a long spiral. As the current is in-

creased, however, this spiral becomes shorter, *i.e.* has more turns per centimeter of progression from one pole to the other

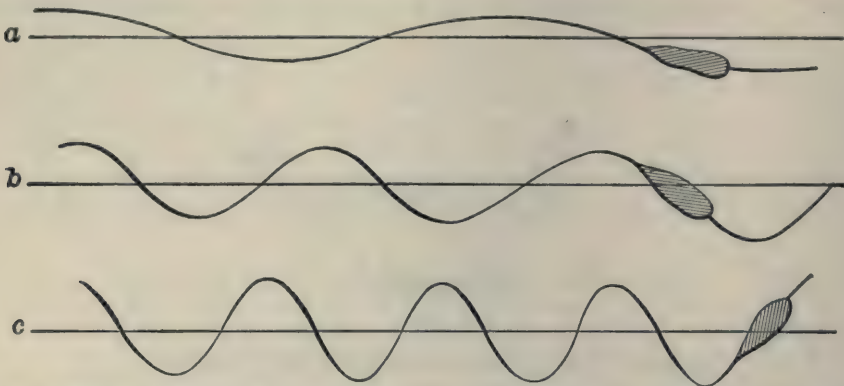

FIG. 37. — Form of the path of *Paramecium* under different conditions. *a*, when not subjected to the constant current; *b*, when subjected to a slight current; *c*, when subjected to a still stronger one. (From LUDLOFF, '95.)

(Fig. 37), until at 60δ , in making one turn of the spiral, the organism progresses hardly more than its own length.

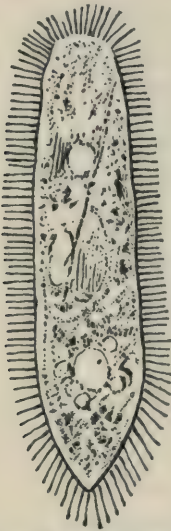

FIG. 38. — *Paramecium*, showing position of cilia when unstimulated. The blunt end is anterior. (From LUDLOFF, '95.)

ment (the "recovery"). With an intensity of 24δ , vibration of cilia occurs at both kathode and anode. It is, however, more

Finally, the effect of the current upon the movement of the cilia must be considered.* In the resting *Paramecium* the cilia rise perpendicularly from the surface of the body (Fig. 38). If an individual stands with its anterior (blunt) end towards the anode, and a current of 8δ passes through, the cilia at the posterior (kathode) end begin to vibrate. If the individual lies transverse to the current and the current is closed, the cilia on the kathode side vibrate, those on the anode side being quiet. With a current of 16δ one can see that the kathode stimulation increases the *forward* (anteriad) phase of the cilium move-

* LUDLOFF was enabled to make a careful study of the effect of the current on the cilia by making use of gelatine solutions such as have been recommended by JENSEN ('93, p. 556).

intense at the kathode and is also in opposite directions at the two poles. This law is important, and may be thus formulated: *The current intensifies at the anode the backward movements and at the kathode the forward movements of the cilia, and the latter are more intensified than the former*; or, in other words, the anode stimulation increases the effectiveness of the normal stroke, the kathode stimulation diminishes the effectiveness of the normal stroke, and the diminishing effect is the greater of the two.

On the basis of these observed facts, LUDLOFF has proposed a theory which accounts for several of the electrotactic phenomena in the Ciliata, especially the fact that with strong currents there is a diminution in the rate of locomotion, and that at a lower intensity the axis of the organism is placed in the axis of the current, with its anterior end towards the kathode. This theory may be stated as follows: In every complete swing of a cilium two phases may be distinguished—the backward “stroke” and the forward “recovery.” Normally the stroke is the more effective, otherwise forward locomotion would not occur. The excess in effectiveness of the stroke may be designated by the quantity x . Let us assume a Paramecium lying in the axis of the current with its anterior end towards the kathode. Then the stimulus received at the anode or hinder end increases the effectiveness of the stroke by a quantity which we may designate m . Thus the excess energy of the stroke over recovery is for these hinder cilia $x + m$. The stimulus received at the kathode or anterior end diminishes the effectiveness of the stroke by a quantity which we may call n , which is larger than m . Here the excess energy of stroke over recovery is $x - n$. If at any intensity of current n exceeds x , the anterior cilia will work to oppose the forward motion of the individual, and when $n - x = x + m$ locomotion will not occur. Such a strength of current probably occurred in the experiment given on p. 142, where locomotion ceased at above 60δ .

To account for orientation of the axis and its anterior end, we have merely to apply the general law given above. Let us suppose that we are observing a Paramecium lying in the axis of a current of medium intensity, with its anterior

end towards the anode. Since n is here supposed to be less than x , the resultant effect is to move the animal forward. In moving forward in its spiral course, one side becomes presented to the anode. On this side the excess of energy of the stroke is $x + m$, while on the kathode side it is $x - n$. The resultant effect of the cilia on the two sides forms a couple which revolves the organism about one of its short axes until it comes again into the axis of the current, but with its anterior end towards the kathode. The beating of its cilia must now carry it towards the kathode (Fig. 39).

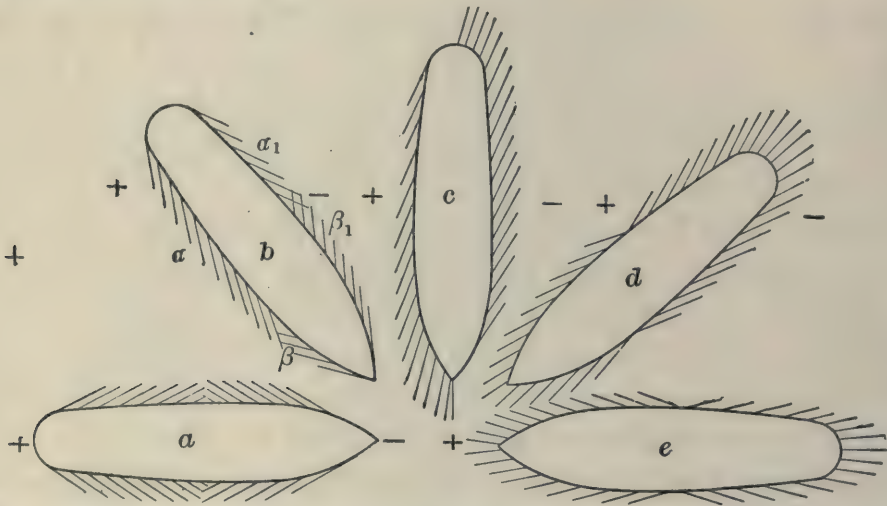

FIG. 39.—Diagram showing the successive attitudes (*a*, *b*, *c*, *d*, and *e*) assumed by *Paramecium* when its head is turned towards the anode at the beginning (*a*). It rotates till its head is next the kathode (*e*). (From LUDLOFF, '95.)

Before leaving the Protozoa, we ought to look over the whole field. We have hitherto considered only cases of migration towards the kathode — negative galvanotaxis. VERWORN ('89^b), however, has found that some Protista are positively electrotactic; namely, the flagellata, *Polytoma uvella*, *Cryptomonas ovata*, and *Chilomonas paramecium*; the ciliate, *Opalina*; and some bacteria. Finally, VERWORN ('95, p. 446) describes one of the elongated Ciliata — *Spirostomum ambiguum* — which places its long axis across that of the current and migrates towards neither pole, a condition which may be called (after VERWORN) transverse electrotaxis.

Passing now to the Metazoa, we find investigations concerning electrotaxis among Invertebrates by NAGEL ('92 and '92^a

and '95), and BLASIUS and SCHWEIZER ('93); and among Vertebrates by these authors and also HERMANN ('85 and '86), EWALD ('94, '94^a, and '94^b), HERMANN and MATTHIAS ('94), and WALLER ('95). The number of species investigated has been considerable. I give below a table of the Invertebrate genera studied and the sense (+ or -) of their response at the given intensity of currents. Barely rough quantitative expression of strength of current can be deduced from NAGEL's paper. Where no data are given the currents are supposed to be of intermediate strength. N. stands for NAGEL, B.S. for BLASIUS and SCHWEIZER. The numbers which follow give the year of publication and the page.

TABLE XV

SPECIFIC NAME.	STRENGTH OF CURRENT.	SENSE OF RESPONSE.	AUTHORITY.
Mollusca :			
<i>Limnæa stagnalis</i>	weak	-	N. '95
Var. other Gastropoda (probably) .		-	N. '92 ^a ; '95
Annelida :			
<i>Lumbricus</i>		-	N. '95, 626
<i>Tubifex rivulorum</i>		-	N. '95, 631
<i>Hirudo medicinalis</i>	0.8 δ	-	B.S. '92, 516
<i>Branchiobdella parasitica</i>		-	B.S. '92, 516
Crustacea :			
<i>Cyclops</i>	strong	+	N. '92, 629
<i>Asellus aquaticus</i>	strong	+	N. '95, 633
<i>Astacus fluviatilis</i>	0.4 δ	+	B.S. '92, 518
Insecta :			
<i>Notonecta</i>		+?	N. '95, 636
<i>Corixa striata</i>		+	N. '95, 636
<i>Dytiscus marginalis</i>	1.9 δ	+	B.S. '92, 519
<i>Hydrophilus piceus</i>	1.9 δ	-	B.S. '92, 519

From this table it appears that Mollusca and Annelida are usually negatively electrotactic to a current of medium intensity, while Arthropoda are mostly positively electrotactic to such a current. It is noteworthy, however, that two quite

closely allied beetles like *Dytiscus* and *Hydrophilus* should by the same observers be found to react in different ways.

In addition to the species named, some have been studied which have given no results. Thus NAGEL ('95, p. 639) obtained no response from the larva of *Libellula depressa*, even with a wide range of current-intensities.

Passing now to the Vertebrata, we enter a region in which, as a result of more numerous studies, the data are more voluminous, but at the same time less in accord. Since many matters are here still in dispute, we may best consider historically, *i.e.* in chronological sequence, what has hitherto been done in this field.

The first person to describe the phenomenon of electrotaxis in Vertebrates — as, indeed, in any organism — was HERMANN ('85, '86). He used frog larvæ 14 days old, held in a shallow rectangular porcelain trough, along the two small sides of which thick zinc wires were placed, connected with a chain of 20 small zinc-carbon elements. No mention of the strength of the current except such as can be gained from these facts was made. This omission of quantitative details is to be regretted, since had the strength of current to which the organisms were subjected been given, much subsequent confusion might have been avoided. With this current, then, of unknown intensity, flowing through the water containing the larvæ, all of the latter were seen to place themselves in the axis of the current with their heads directed toward the anode. This orientation was the consequence of the fact that a current passing cephalad through the larva acted as a violent stimulus; but while passing caudad it brought stupefaction or even (temporary) paralysis.

The results obtained by HERMANN were now confirmed and extended by BLASIUS and SCHWEIZER ('93). They employed a wooden trough with sheet zinc electrodes of nearly the cross-section of the smaller ends of the trough, and experimented upon fishes, *Salamandra*, and the frog. The weakest current employed was 0.35 δ to 0.47 δ , which merely affected the character of the swimming of the fish subjected to it, without determining its direction. The next stronger current mentioned was 1.58 δ . With this current a marked orientation of

the fish with their heads to the anode was noticed. With *Salamandra* larvæ currents of 2.3δ to 4.7δ were chiefly employed. In the experiments of BLASIUS and SCHWEIZER the organisms sometimes migrated toward the anode, if the current was not so strong as to stupefy, but they lay stress upon the point that the migration is a secondary phenomenon — that the orientation is the primary effect of the current.

Next came the observations of EWALD ('94), who used very young tadpoles (5 days) and non-polarizable *points* as electrodes. Thus he was not able to give the strength of current to which the individuals were subjected. His results seemed directly to oppose those of the two preceding authors, for with his (unknown) current, the tadpoles were stimulated when the current passed caudad and stupefied by one passing cephalad; also they placed themselves in the axis of the current with their heads towards the kathode. The larvæ did not seem to find this position as a direct response to stimulus, but whenever an individual, in its turnings to the right and left, fell into this — electrotactic — position it was no longer stimulated, but stupefied, and so came to rest.

These discordant results of EWALD led HERMANN, with his student MATTHIAS, again into the discussion. By careful measurements of the strength of current, they found that between 0.3δ and 1.5δ frog tadpoles of from 1 to 3 weeks old did face the kathode, as EWALD found, and did move towards it. But HERMANN and MATTHIAS ('94) believed this result to be due to the fact that only cephalad-flowing currents of this intensity excite, and thus only such currents are able to produce locomotion.

EWALD ('94^b), however, cannot accept their idea that a caudad-passing current of small intensity produces no excitation, for, he says, he has seen small fish, lying with face to the anode, made to move towards the kathode by the action of the weak current. Since HERMANN and others have shown that very strong currents cause paralysis even when flowing cephalad, EWALD concludes that we must recognize the existence of three different effects at three intensities; weakest, medium, and strongest. The medium current (which has the broadest range) is that by which the organisms are irritated as it flows

cephalad, so that they come to lie with head towards anode; the weakest current is that by which (following EWALD) the organisms are irritated as it flows caudad, so that they come to lie facing the kathode; finally, the strongest current is that at which a violent stimulation leading to paralysis is produced by the cephalad-flowing current (as well as the caudad?).

In seeking for an explanation of electrotaxis in Metazoa, it is necessary, first of all, to notice that there is a close relation between response to the make-shock (as described on pp. 136, 137) and the direction of orientation of the body in electrotaxis. Thus all gastropods studied are, upon making, excited chiefly at the anode, and, correspondingly, all gastropods hitherto studied when subjected to the current face the kathode; so on the other hand, such Crustacea as have been studied are stimulated at the kathode, and they accordingly come to face the anode. In regard to Vertebrates, we have apparently a double electrotactic orientation varying with the current, and correspondingly we have, as NAGEL has shown (p. 137), a double irritability depending on the current. A medium current produces a kathode excitation and an anode orientation; while the weakest current produces an anode excitation and a kathode orientation. So we may lay it down as a general law: *Positively electrotactic organisms exhibit the katex type of irritability; and negatively electrotactic organisms exhibit the anex type or, in general, the electrotactic organism turns tail to the exciting pole.*

EWALD ('94, pp. 611-615) accounts for this difference of response of Vertebrates to weak and strong currents, by the aid of certain observations that he made upon the excitation of the nerve cord. We have already seen that the making of the medium constant current stimulates at the kathode, so that an animal turns tail to the kathode. EWALD found that the two parts of the dorsal nerve were differently stimulated by the current; the brain was stimulated chiefly by a caudad-passing current; the spinal cord chiefly by a cephalad-passing current. This conclusion was established by two experiments. First, the two electrodes, placed a few millimeters apart, are brought into contact with different parts of the body of a fish.

Let the current be passing through the fish from the anterior to the posterior electrode. At the tail end we get no excitation; and, as we pass forward, the body remains quiet until, passing the region of the medulla oblongata, an excitation appears. If the operation is repeated with a reverse current, we get excitation behind the head and quiet on the head. Secondly, if a frog larva be cut in two transversely at the root of the tail, the head end is irritated only by a caudad-flowing current; the tail end only by a cephalad-flowing current; while in both cases the opposite current quiets. (Cf. also EWALD, '94^b, p. 162.) These observations were now made use of to explain the opposite orientation of the tadpole in the presence of weak and strong currents. NAGEL assumed that the weakest currents can affect the brain only. Now if that current runs caudad, it will strongly stimulate the body so that it turns tail to the anode. The medium currents, however, stimulate the whole dorsal nerve, but the spinal cord to a preponderating degree, so that a cephalad-passing current irritates more than a caudad current, and the animal will turn tail to the kathode. Thus weaker or stronger current will determine — or + electroaxis.

SUMMARY OF THE CHAPTER

Electricity affects protoplasm in two principal ways: first, by causing contraction; second, by determining orientation. We can distinguish two principal types of contraction phenomena and, corresponding to and dependent upon these, two types of orientation phenomena. The first type of contraction is that which is produced, upon making the constant current, chiefly at the anode; the second is produced chiefly at the kathode. The corresponding orientation or migration types are, facing the kathode and facing the anode. Since the orientation phenomena are dependent upon the contraction phenomena, the most important causes to be investigated are, first, that of contraction, and second, that of the difference in type of contraction exhibited by different organisms. The fundamental teaching of this chapter is that the electric current acts as a stimulus upon protoplasm, and may determine the character of its activities.

LITERATURE

- BIEDERMANN, W. '83. Ueber rythmische Contraction quergestreifter Muskeln unter dem Einflusse des constanten Stromes. Sitzb. Wien. Akad., Math.-Nat. Cl. LXXXVII, Abth. 3, pp. 115-136. Taf. I-II, 1883.
- BLASIUS, E. and SCHWEIZER, F. '93. Electrotropismus und verwandte Erscheinungen. Arch. f. d. ges. Physiol. LIII, 493-543. 10 Feb. 1893.
- ENGELMANN, T. W. '69. Beiträge zur Physiologie des Protoplasma. Arch. f. d. ges. Physiol. II, 307-322.
- '70. Beiträge zur allgemeinen Muskel- und Nervenphysiologie. Arch. f. d. ges. Physiol. III, 247-326.
- EWALD, J. R. '94. Ueber die Wirkung des galvanischen Stroms bei der Längsdurchströmung ganzer Wirbelthiere. Arch. f. d. ges. Physiol. LV, 606-621. 10 Feb. 1894.
- '94^a. Berichtigung. Arch. f. d. ges. Physiol. LVI, 354. 11 Apr. 1894.
- '94^b. Ueber die Wirkung des galvanischen Stroms bei der Längsdurchströmung ganzer Wirbelthiere. II Mitth. Arch. f. d. ges. Physiol. LIX, 153-164. 30 Nov. 1894.
- FICK, A. '63. Beiträge zur vergleichenden Physiologie der irritablen Substanzen. Braunschweig. 1863. (Not seen.)
- GOLUBEW, A. '68. Ueber die Erscheinungen, welche elektrische Schläge an den sogenannten farblosen Formbestandtheilen des Blutes hervorbringen. Sitzb. Wien. Akad., Math.-Nat. Cl. LVII, Abth. 2, 555-572.
- HERMANN, L. '85. Eine Wirkung galvanischer Ströme auf Organismen. Arch. f. d. ges. Physiol. XXXVII, 457-460. 2 Dec. 1885.
- '86. Weitere Untersuchungen über das Verhalten der Frochlarven im galvanischen Strome. Arch. f. d. ges. Physiol. XXXIX, 414-419. 21 Oct. 1886.
- HERMANN, L. and MATTHIAS, F. '94. Der Galvanotropismus der Larven von *Rana temporaria* und der Fische. Arch. f. d. ges. Physiol. LVII, 391-405. 20 July, 1894.
- JENSEN, P. '93. Methode der Beobachtung und Vivisektion von Infusorien in Gelatinelösung. Biol. Centralbl. XII, 556-560. 1 Oct. 1892.
- KRAFT, H. '90. Zur Physiologie des Flimmerepithels bei Wirbelthieren. Arch. f. d. ges. Physiol. XLVII, 196-235. 9 May, 1890.
- KÜHNE, W. '64. Untersuchungen über das Protoplasma und die Contractilität. Leipzig: Engelmann. 1864.
- LUDLOFF, K. '95. Untersuchungen über den Galvanotropismus. Arch. f. d. ges. Physiol. LIX, 525-554. 5 Feb. 1895.
- NAGEL, W. A. '92. Beobachtungen über das Verhalten einiger wirbelloser Thiere gegen galvanische und faradische Reizung. Arch. f. d. ges. Physiol. LI, 624-631. 26 March, 1892.
- '92^a. Fortgesetzte Beobachtungen über polare galvanische Reizung bei Wasserthieren. Arch. f. d. ges. Physiol. LIII, 332-347. 24 Nov. 1892.

- NAGEL, W. A. '95. Ueber Galvanotaxis. Arch. f. d. ges. Physiol. LIX, 603-642. 5 Feb. 1895.
- OSTWALD, W. '94. Manual of Physico-chemical Measurements. Translated by J. Walker. 255 pp. London: Macmillan. 1894.
- VERWORN, M. '89^a. Die polare Erregung der Protisten durch den galvanischen Strom. Arch. f. d. ges. Physiol. XLV, pp. 1-36. 23 March, 1889.
- '89^b. The same (*continued*). Arch. f. d. ges. Physiol. XLVI, pp. 267-303. 18 Nov. 1889.
- '95. (See Chapter IV.)
- WALLER, A. D. '95. Galvanotropism of Tadpoles. Science Progress. IV, 96-103. Oct. 1895.

CHAPTER VII

ACTION OF LIGHT UPON PROTOPLASM

IN this chapter it is proposed to discuss (I) the application and measurement of light; (II) its chemical action; (III) the effect of light upon the general functions of organisms; and (IV) the control of locomotion by light — phototaxis and photopathy.

§ 1. THE APPLICATION AND MEASUREMENT OF LIGHT

Light, which as a form of radiant energy is closely related to radiant heat, is always accompanied by a certain quantity of heat, whose action (in at least one control experiment in every set) should be eliminated. To cut out heat without great loss of light, we must employ transparent adiathermal media. Of these, a plate of ice is the most effective, but alum, on account of its higher melting point, is more convenient. A parallel-sided vessel full of distilled water, or, still better, a saturated aqueous solution of alum, forms an inexpensive, highly adiathermal screen.

The quality of the light used in any experiment should be carefully determined. If any other light than that of the sun or incandescent solids is employed, it should be subjected to spectroscopic analysis. For biological purposes a direct-vision hand spectroscope, such as BROWNING'S, is convenient and adequate.

Often *monochromatic light* or a definite range of the spectrum is desired. This may be obtained in various ways. The purest monochromatic light can be got by making a long spectrum and using the desired part of it. To make such a spectrum one may employ, in a dark room, a lamp, followed in succession by a slit and a lens to form an image of the slit

on a prism of bisulphide of carbon,* which gives very great dispersion of the rays.

In defining the regions of the solar spectrum which are employed in any study, it is usual to make reference to the dark absorption bands (FRAUENHOFER'S lines) which cross the solar spectrum. The largest of these are lettered, beginning with *A* in the visible red and ending with *H* in the visible violet. At other times it may be more convenient to define any part of the spectrum by means of the extreme wave lengths between which it lies. Lithographs showing the spectral colors and the wave lengths corresponding thereto are given in encyclopædias and most of the text-books on physics. A crude attempt is made to show the relation between color and wave length in Fig. 40. The wave lengths at

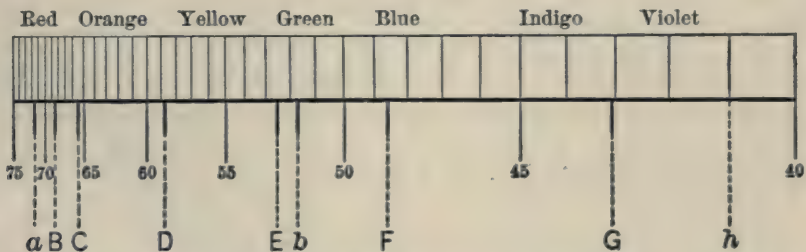

FIG. 40. — Diagram of the solar spectrum showing the main absorption bands and the range of the various spectral colors. The numbers are wave lengths in hundred-thousandths of a millimeter. (From REINKE, '84.)

the different absorption bands are given more exactly (in thousandths of a millimeter, = μ) in the following table, and also the number of waves per second in 10^{12} ths.

TABLE XVI

ABSORPTION BAND.	WAVE LENGTH, λ .	VIBRATIONS PER SECOND $n \times 10^{12}$.	ABSORPTION BAND.	WAVE LENGTH, λ .	VIBRATIONS PER SECOND $n \times 10^{12}$.
<i>A</i>	0.760 μ	392	<i>E</i>	0.527 μ	566
<i>B</i>	0.687 μ	433	<i>F</i>	0.486 μ	613
<i>C</i>	0.656 μ	454	<i>G</i>	0.431 μ	692
<i>D</i>	0.589 μ	506	<i>H</i>	0.397 μ	751

* The bisulphide prism may be made as follows: Upon a thick glass plate three rectangular pieces of glass of equal size are placed perpendicularly, so as

Extreme ultra-violet $\lambda = 0.295 \mu$; 1010×10^{12} vibrations per second.

To obtain monochromatic light from the spectrum, REINKE'S ('84) spectrophor will be found useful (Fig. 41). In this instrument a beam of sunlight cast by a heliostat through a slit at H is converged by means of an interpolated lens, O , upon a prism, P , set at the angle of minimum deviation. Passing through this prism the rays are dispersed and a spectrum is formed upon a diaphragm D . D_1 composed of halves bounding a second slit whose position and width may be varied at will so as to include any desired part of the spectrum. A large lens C known as the collector brings the rays which have passed through the second slit to a focus at E . Just in

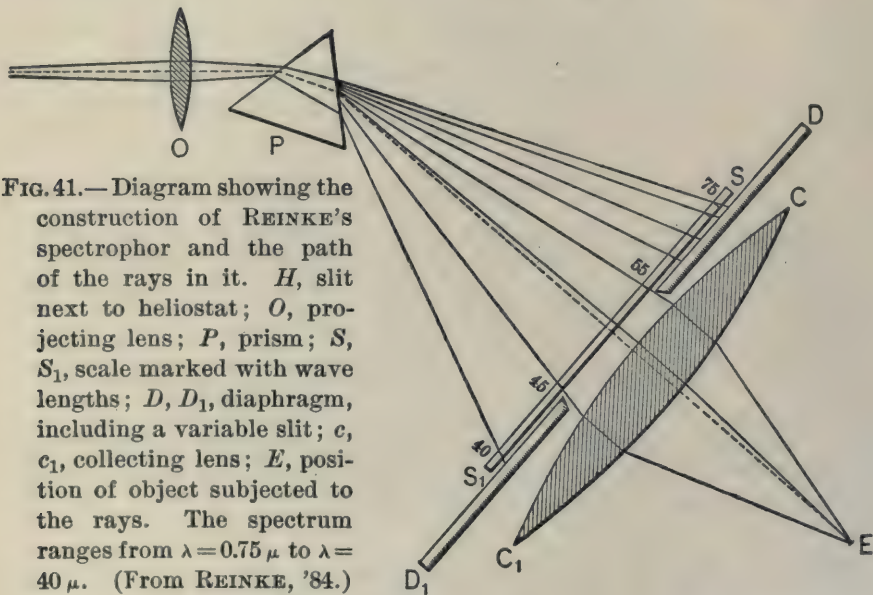

FIG. 41.—Diagram showing the construction of REINKE'S spectrophor and the path of the rays in it. H , slit next to heliostat; O , projecting lens; P , prism; S , S_1 , scale marked with wave lengths; D , D_1 , diaphragm, including a variable slit; c , c_1 , collecting lens; E , position of object subjected to the rays. The spectrum ranges from $\lambda = 0.75 \mu$ to $\lambda = 40 \mu$. (From REINKE, '84.)

front of the diaphragm is placed a scale S , S_1 of wave lengths fitted to the spectrum obtained. Such a scale may be constructed with reference to the position of FRAUENHOFER'S lines by interpolation from Fig. 40.* To include rays whose wave lengths differ by exactly 0.05μ the slit must be wider when at the blue end than when at the red end of the spectrum (Fig. 40).

to form a hollow, triangular (60°) prism. The plates are fixed to each other and to the glass base by a pasty cement made by mixing plaster of paris and liquid glue. This cement soon hardens, and is not attacked by the carbon disulphide. The hollow prism is now filled with fluid, and a triangular glass plate is cemented on as a cover.

* If artificial light is used, two points on the scale can be obtained as follows: Volatilize in a Bunsen flame, temporarily replacing the lamp, a salt of barium and one of calcium, and note the position of the extreme blue band on the former (line F) and the yellow band of the latter (line D). After determining these two points the remaining lines can be plotted upon the scale.

A second method of getting monochromatic light is by the use of flames tinged with various volatilized metals. Of these, lithium salts give reds at $\lambda=0.67 \mu$ and $\lambda=0.61 \mu$, sodium salts give a pure yellow light of $\lambda=0.59 \mu$, thallium salts (poisonous vapor) a green at about $\lambda=0.54 \mu$, and indium salts a blue and a violet, both beyond $\lambda=0.46 \mu$. The number of metallic vapors which give even nearly monochromatic light is, however, not large.

A third method for producing monochromatic light is found in the use of solutions of pigments. Such solutions may be held in deep glass vessels whose back and front glass surfaces are parallel and near together. In the following table are given in the first column the names which may be applied to different parts of the spectrum, following HELMHOLTZ (Handbuch, p. 251); in the second column the pigments which while dry give corresponding spectral colors in diffuse daylight and which may also be used in making solutions; and in the third column certain pigments which in solution YUNG ('78, p. 251) found to transmit almost exclusively the part of the spectrum named in the first column.

TABLE XVII

From outer limit to line <i>C</i> , red . . .	Cinnibar, HgS (vermilion)	Alcoholic solution fuchsin *
<i>C</i> to <i>D</i> , { orange	Minium	.
{ golden yellow . . .	Litharge, PbO	
<i>D</i> to <i>E</i> , { yellow	Chrome yellow,	Concen. Sol. potassic chromate
{ yellow-green . . .	PbO ₂ CrO ₃	(a little red and green)
<i>E</i> to <i>b</i> , green	cupric arsenite, SCHEEL'S green	Nickel nitrate, NiO ₂ (NO ₂) ₂
<i>b</i> to <i>F</i> , transition from blue-green to blue		
<i>F</i> to <i>F</i> ½ <i>G</i> , cyanite blue	Berlin blue	Bleu de Lyon (a little V) †
<i>F</i> ½ <i>G</i> to <i>G</i> , indigo blue	Ultramarine	
<i>G</i> to <i>H</i> , violet		Violet de Parme

Solutions made up from these pigments should, however, be examined spectroscopically before using to make sure of the purity of the color.

* Also a solution of iodine in carbon disulphide. (PRINGSHEIM, '80, p. 409.)

† *F* to *H* is given by ammoniated copper sulphate, CuSO₄·4NH₃ + H₂O (PRINGSHEIM).

Finally, a fourth and decidedly practical way of obtaining pure colors is by the use of transparent plates of colored glass or other transparent solids. It is very difficult to get monochromatic glasses of certain colors in the market. A pure red is easily obtainable; the blue is apt to contain some red also; and the green, both blue and yellow. Lord RAYLEIGH ('81, p. 64) has used "films of gelatine or of collodion, spread upon glass and impregnated with various dyes, gelatine being chosen when the dye is soluble in water and collodion when the dye is soluble in alcohol." This method seems to me to be of wide applicability in our light experiments. For solid media are, after all, far less troublesome than fluids, vapors, or spectra; and convenience is one of the most valuable qualities of a method.

A brief statement must be made concerning the physical properties of the different light waves. An inspection of any prismatic solar spectrum shows that certain parts are brighter to our eyes than others, and a thermometer placed in different parts of the spectrum indicates a higher temperature towards the red end. Curves are given in Fig. 42 which show the *relative* warmth of different parts of the visible spectrum both when the spectrum is a normal one (*i.e.* such as is given by a diffraction grating, where all rays differing in wave length by 0.1μ are equally distant) and when it is prismatic (in which there is a crowding of rays at the red end). Curves of relative brightness and of relative chemical (actinic) activity, so far as can be judged from the union of chlorine and hydrogen, are also given, for the *prismatic* spectrum. Being laid off on the "normal" scale the curves last mentioned are somewhat distorted. From these curves it appears that the brightest part of the spectrum lies between lines *D* and *E*, at $\lambda = 0.59\mu$;* the warmest part is, in the normal spectrum, near $\lambda = 0.60\mu$, but in the prismatic spectrum, beyond the visible red, at about $\lambda = 1.00\mu$. Finally, the chemical activity of the rays increases towards the blue end of the spectrum, but the relative activity is different for the different substances acted upon. Measured by their ability to unite chlorine and hydrogen, the rays having

* MENGARINI ('89, p. 135) finds the point of maximum brightness to lie at about 0.57μ .

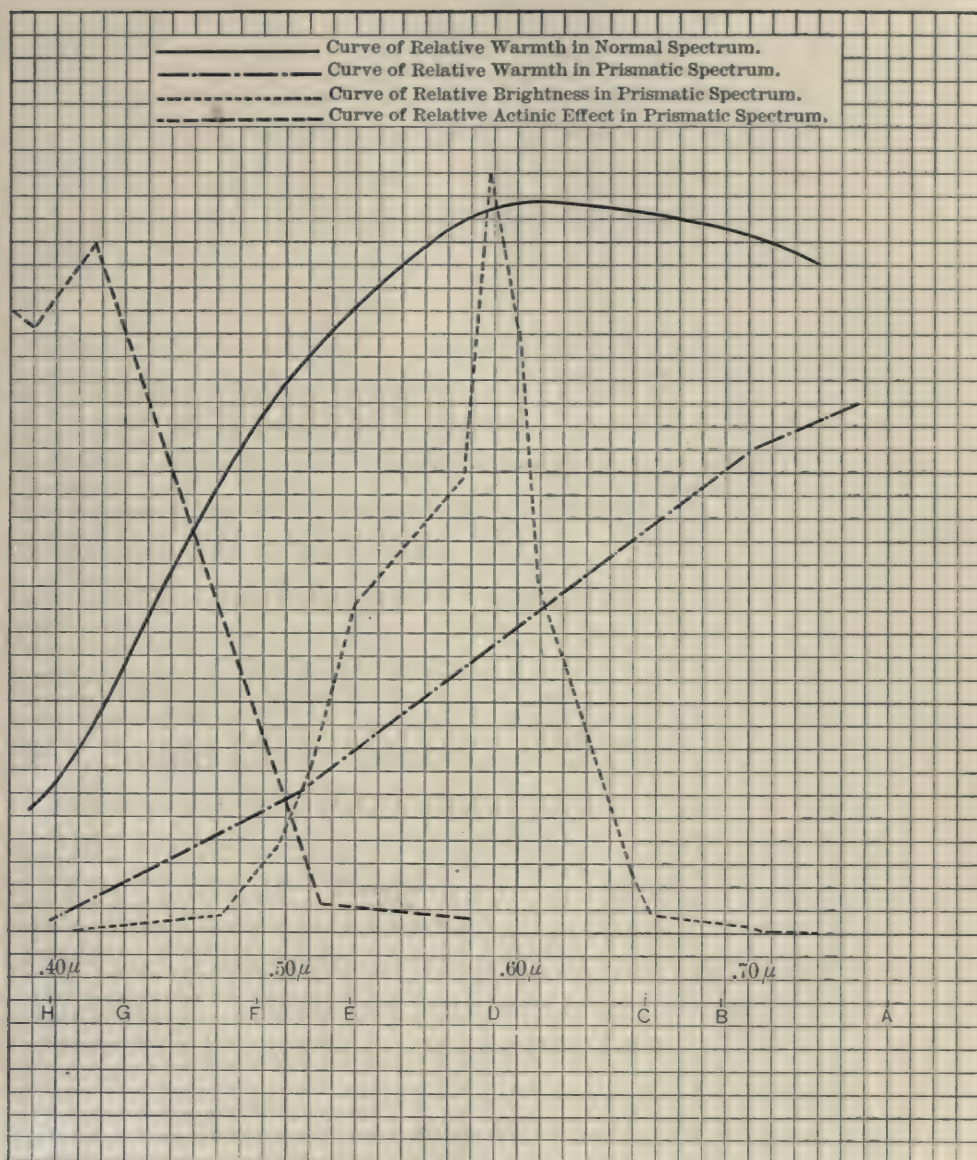

FIG. 42. — Scale of *normal* solar spectrum, above which is drawn the normal curve of relative warmth; also the curves of relative warmth, brightness, and actinism of the *prismatic* solar spectrum. The curves of warmth are taken from LANGLEY ('84, p. 233); the curve of brightness is constructed from the data of VIERORDT ('73, p. 17); that of actinism is taken from BUNSEN and ROSCOE ('59, p. 268) and indicates the relative efficiency of the different rays of the midday sun in causing the union of chlorine and hydrogen. The absolute value of the ordinates is entirely arbitrary.

a longer wave length than $0.51\ \mu$ have feeble chemical action; at about $\lambda = 0.42\ \mu$ this action reaches a maximum.

Not only the quality but also the intensity of the light with which we experiment must be known. It is, fortunately, quite

easy to determine the intensity of white light in terms of a recognized unit; namely, a paraffine candle burning at the rate of 7.78 grammes per hour. A paraffine candle burning at this rate has one candle power (C. P.); burning at twice this rate, 2 candle power, and so on. A comparison of any other light with this standard may be made by means of any of the well-known photometers, of which text-books of physics give a description.

The determination of the intensity of a *colored* light requires an additional piece of apparatus; namely, a spectrophotometer. The two principal types of spectrophotometer are that of VIERORDT ('73) and that of GLAN ('77), both of which have undergone important improvements. The principle in both types is the same. A spectrum of both the unmodified (standard) light and that which has passed through the colored screen are made side by side, so that their corresponding colors can be compared. Since the source of light is the same, every part of the spectrum of the unmodified light will be brighter than the corresponding part of the spectrum of the colored light. To bring the corresponding colors in the two spectra to the same intensity, the unmodified light must be made less intense to a measurable extent. In VIERORDT'S spectrophotometer this result is brought about by narrowing that half of the slit through which the unmodified light passes to get to the prism. In GLAN'S apparatus the diminution in intensity is gained by the polarization of both lights and the obscuring of the brighter by the rotation of its analyzing NICHOL prism, until equality of brightness is obtained. A modified form of VIERORDT'S convenient instrument is made by H. KRÜSS of Hamburg, Germany. A modified form of GLAN'S photometer is described by VOGEL ('77).

VOGEL'S apparatus (Fig. 43) consists essentially of a collimator containing (1) a slit of changeable width, separated by a band q into an upper and a lower part to receive respectively the modified and the normal light; (2) a lens to render the rays parallel before they impinge upon (3) a doubly refracting quartz prism, by which both upper and lower rays are broken into two polarized rays. Of these four rays the uppermost and the lowest are cut off by a diaphragm near F , so that only the middle two, which lie near together, pass eventually to the eye. These two rays are oppositely polarized and come, one from the upper, the other from the lower slit. The two

rays now pass through (4) a NICHOL prism (capable of being rotated alongside a graduated arc) set at 45° , in which position both rays pass through without changed relative intensity. The rays emerging from the collecting telescope are now dispersed by passing through the vertically placed prism, and the adjacent parallel spectra are observed through a telescope. By a rotation of the

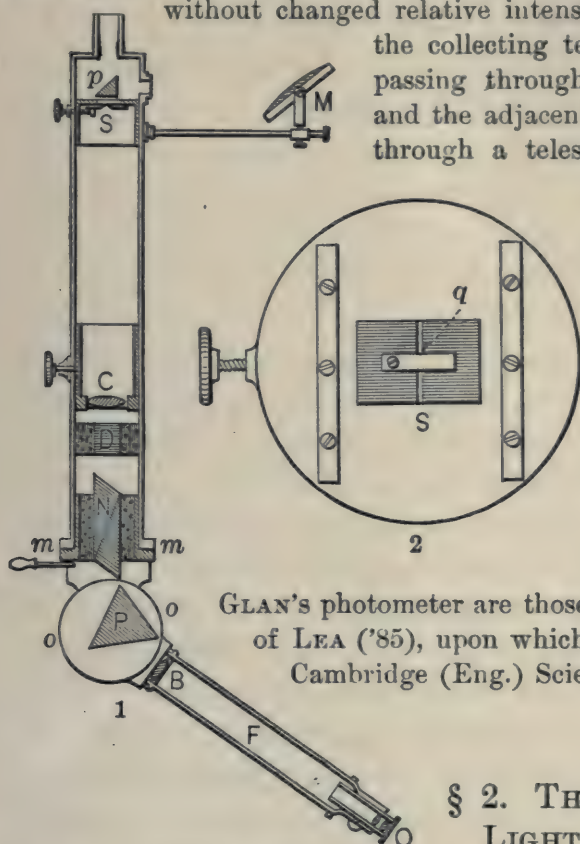

FIG. 43. — Diagrams showing construction of VOGEL'S spectrophotometer. 1. Horizontal section through the optical axis. *M*, mirror to reflect standard light, by aid of a totally reflecting prism *p*, into the optical axis. *S*, shutter with slit divided into an upper and a lower half by means of a band *q*; *C*, collimating lens. *D*, doubly refracting quartz prism; *m, m*, the holder of the NICHOL prism *N*, which can be rotated through an arc that can be read off from a graduation on *m, m*; *P*, a flint glass prism; *B, F, O*, observing telescope, in which, at the focal point, near *F*, is a diaphragm cutting out the two outermost of the four spectra coming through *B*. 2. Front view of the shutter. (From VOGEL, '77.)

NICHOL prism through an observed number of degrees the stronger light may be brought to the intensity of the weaker. The relative intensity of two lights with reference to a third (constant) is as the squares of the tangent of the angle through which the NICHOL prism has been rotated. Other modifications of

GLAN'S photometer are those of Lord RAYLEIGH ('81) and of LEA ('85), upon which the spectrophotometer of the Cambridge (Eng.) Scientific Instrument Co. is based.

§ 2. THE CHEMICAL ACTION OF LIGHT UPON NON-LIVING SUBSTANCES

The process of photography has made us familiar with the fact that daylight acts upon the halogen salts of silver, gold, platinum, and other metals, although the nature of the chemical change wrought by the light is uncertain. It is not, perhaps, generally appreciated, but it is well known to chemists, that light can produce or further very many chemical changes, particularly among organic compounds. The effects are mainly due to the blue and violet rays, hence are

not the results of the heat of sunlight. Most of these chemical effects may be grouped under four heads. 1. Synthetic; 2. Analytic; 3. Substitutional; and 4. Isomerismic and Polymerismic. A few others may be classed (5) as fermentative. Let us now consider each of these five classes.*

1. **The Synthetic Effects of Light** will be considered chiefly with reference to organic compounds. All the cases I have gathered fall into three groups: addition to the organic compound either (α) of oxygen, (β) of chlorine or bromine, or (γ) of another organic compound.

Among the compounds which take up oxygen is bilirubin, $C_{32}H_{36}N_4O_6$, a solution of which, in sunlight, even when air is excluded, oxidizes to biliverdin, $C_{32}H_{36}N_4O_8$. In the absence of sunlight this change requires air (B. III, 418). DUCLAUX ('87, p. 353) finds that vegetable oils, such as olive or palm oils, are rapidly oxidized if exposed to light. CHASTAIGN ('77, p. 198) believes this oxidizing action of light upon organic compounds to be of very wide-spread occurrence; the blue-violet part of the spectrum being, in this respect, the most active.

The direct combination by means of light of a halogen and another substance is also not rare. Thus, in daylight, hydrogen unites with chlorine explosively. It unites with bromine also, although with difficulty. Similarly, equal volumes of chlorine and carbon monoxide unite quickly in the sunlight or magnesium light to form carbon monoxid chloride, $COCl_2$ (B. I, 546). Again, when chlorine is passed through alcohol under the influence of strong sunlight or magnesium light the two substances unite and produce chloral hydrate (STREET and FRANZ, '70). Likewise, when chlorine is passed, in sunlight, through a solution of $C_3H_2Cl_2O_2$ in CS_2 , there is formed $C_3H_2Cl_4O_2$, two atoms of Cl having been added. Finally, C_2Cl_6 may be made by uniting C_2Cl_4 and Cl_2 in sunlight (B. I, 158); and the compound $C_2H_4 \cdot FeBr_2 \cdot 2H_2O$ may be made by passing, in sunlight, C_2H_4 through a concentrated aqueous solution of $FeBr_2$ (B. I, 113).

* Most of these cases were obtained by searching through BEILSTEIN ('86-'93). References to this book will be made throughout this section by the letter B, followed by the number of the volume and page upon which the statement may be found.

Important cases of the direct synthesis of organic compounds are given by KLINGER and STANDKE ('91). These authors have shown that in sunlight (and not in the dark) phenanthrenchinon unites directly with benzaldehyd to form a third compound phenanthrenhydrochinonmonobenzoat, in accordance with the formula: $C_{14}H_8O_2 + C_6H_5CHO = C_{14}H_8(OH)(O \cdot CO C_6H_5)$. Again, chinon (benzochinon) and benzaldehyd may unite in the sunlight to form benzohydrochinon, according to the formula: $C_6H_4O_2 + C_6H_5CHO = C_6H_5CO C_6H_3(OH)_2$. Finally, benzochinon and isovaleraldehyd may similarly unite to form isovalerochinhydron, thus: $C_6H_4O_2 + C_4H_9CHO = C_4H_9CO C_6H_3(OH)_2$. These cases, then, are examples of organic compounds which are wholly indifferent in the dark, but which, subjected to strong sunlight, lose their identity by uniting directly; they may suffice to illustrate the important synthetic effect of sunlight on non-living, organic compounds.

2. **Analytic Effect of Light.** — Cases of this effect are numerous, varied, and striking. I will cite a few. The organic dibasic acids $C_nH_{2n-2}O_4$ break up in the sunlight and in the presence of a small quantity of uranium oxide, into CO_2 and an acid $C_nH_{2n}O_2$ (B. I, 63). For example, oxalic acid, $C_2H_2O_4$, breaks up thus into formic acid, CH_2O_2 and CO_2 . Also an aqueous solution of butyric acid, $C_4H_8O_2$, in the presence of uranyl nitrate, breaks up, in the sunlight, into CO_2 and C_3H_8 (B. I, 422). We have seen that chlorine will unite directly with organic compounds under the influence of light; on the other hand, compounds containing chlorine may lose it in the sunlight. Thus under these conditions the ketone $(C_8H_{17}NO \cdot HCl)_2PtCl_4$, an ammoniacal derivative of acetone, becomes $(C_8H_{17}NO \cdot HCl)_2PtCl_2$; and $(C_9H_{17}NO \cdot HCl)_2PtCl_4$ becomes $(C_9H_{17}NO \cdot HCl)_2PtCl_2$ (B. I, 982, 983). Again, chlorine acetate, $Cl \cdot O \cdot C_2H_3O$, undergoes slow decomposition in the light (B. I, 462); $C_5H_6Cl_2$, a derivative of pentine, C_5H_8 , does the same; and ethylester, $ClO \cdot C_2H_5$, explodes in sunlight. Similarly explosive in sunlight is the greenish oil distilled when absolute alcohol is poured over dry calcium chloride (B. I, 223). Finally, sugar (DUCLAUX, '86, p. 881) and oxalic acid (DOWNES and BLUNT, '79, p. 209) are oxidized and break up into water, carbon dioxide, and other compounds. These cases may serve

to show the important chemical effects of sunlight in the disintegration of organic compounds.

3. **Substitution Effects of Light.** — The principal substitution effect of light is the replacement of hydrogen in an organic compound by either chlorine or bromine. This occurs so frequently that examples are superfluous. The substitution takes place most rapidly and completely in direct *sunlight*, and it has been shown that the rays at the blue end of the spectrum are the most active in this process. The compounds affected belong to the most varied groups of both the fatty and aromatic series — carbohydrates, acids, aldehydes, ketones, and sulphides.

4. **The Isomerismic and Polymerismic Changes produced by Light** are among the most interesting. I will cite some examples. In the first place, it may be said that the changes in the elements phosphorus and sulphur by which they assume their red form have been ascribed to sunlight. Elæomargin acid, $C_{17}H_{30}O_2$, is a compound found in connection with glycerine in the oil of the seeds of *Elæococca* (*Aleurites*) *vernica* — Chinese oil tree — one of the *Euphorbiaceæ*. This acid crystallizes in rhombic plates which melt at 48° . When an alcoholic solution of this acid is placed in a bright light, leaf-like crystals of its isomere, elæostearin acid, which melt at 71° , are produced (B. I, 535). Again, thymochinon forms yellow crystals, which are soluble in alcohol. Subjected to a strong light, opaque, whitish-yellow crystals are produced, which are insoluble in alcohol. This substance, which does not arise in the dark, and is hence not merely the result of oxidation, is called polythymochinon (B. III, 180). Again, among the derivatives of ethylene, C_2H_4 , is chlorethylene, C_2H_3Cl , a gas. When placed in the sunlight this passes into a polymere, which forms a viscous, amorphous, insoluble mass (B. I, 158). In like fashion, bromethylene, C_2H_3Br , a fluid, is rapidly transformed in the sunlight into a polymere, which is solid, amorphous, and insoluble in water, alcohol, or ether (B. I, 181), and bromacetylen, C_2HBr , a gas, is gradually transformed, in the light, into a solid polymere. Finally, very many substances undergo a gradual change of color in the sunlight, but the nature of the accompanying molecular change is unknown.

5. Changes resembling those brought about by *fermentation* are produced by light. Thus NIEPCE DE SAINT VICTOR and CORVISART ('59) have found that a 0.1% solution of starch, exposed during 6 to 18 hours to the summer sun, becomes transformed into sugar, while in the dark no such change occurs. The change is favored by a small quantity of uranium nitrate. In a similar fashion glycogen is transformed into sugar more rapidly in the light than in the dark. On the other hand, GREEN ('94) finds that the ferment which normally transforms starch into sugar is destroyed by subjection to a strong light, the violet rays being especially active in this process. Likewise, ptyalin, the ferment of saliva, is destroyed by light.

To sum up, light affects organic compounds in very varied and important ways. We are, accordingly, prepared to find that light exerts a very important influence on the activities of protoplasm. Nor is the influence necessarily confined to the surface, for most protoplasmic bodies are more or less translucent. Thus SACHS ('60) found by looking through a tube with one end fitted to the eye and the other directed towards the sunlight, that considerable layers of plant tissue, for example over 32 mm. of the tissue of the potato tuber, did not cut out all the light, and that red had the greatest penetrating power, violet the least. Even the epidermis of man permits light to pass, and ONIMUS ('95) asserts that light can pass through the hand to such an extent as to affect during 26 to 30 minutes an orthochromatic plate kept in a tight wooden box perforated only by the opening which is covered by the hand. Whether the "RÖNTGEN rays," which have so striking a power of penetrating organic matters, are more of the nature of light than of other physical agents, is still a subject of debate. Whether they produce any important chemical changes in protoplasm has not yet been fully determined.*

* During the six months which have elapsed since the above was written, accounts of marked physiological effects of the RÖNTGEN rays have been published. Thus, exposure of the skin to them for an hour frequently causes loss of hair and finger nails, and produces symptoms resembling those of sunburn. AXENFELD (Centralbl. f. Physiol. X, 147) finds that many insects and a crustacean, Porcellius, kept in a box only one-half of which is penetrated by the rays, aggregated in this part. Several experiments upon the tropic influences of the rays have resulted negatively.

§ 3. THE EFFECT OF LIGHT UPON THE GENERAL FUNCTIONS OF ORGANISMS

In this section we shall consider in succession (1) the effect of light upon metabolism; (2) the vital limits of light action on protoplasm; and (3) the effect of light upon the movement of protoplasm.

1. **Effect of Light upon Metabolism** (including Assimilation). —Metabolism is a complex of chemical processes. Since, as we have already seen, light has important chemical effects, we are not surprised to find that it plays an important role in metabolism. The effects of light are, however, of two distinct kinds. One is a thermic effect, due to the heat rays of white light; the other is a chemical effect due to the “actinic rays” of the spectrum.

a. The Thermic Effect of Light on Metabolism is shown chiefly in the assimilative processes of chlorophyllaceous plants. The facts of this assimilation are chiefly these: various simple compounds, water, carbon dioxide, salts of ammonia and nitrates, are used as food by plants. For every volume of the gas—carbon dioxide—taken in, one volume (nearly) of oxygen is excreted. Starch ($C_6H_{10}O_5$) is the first visible product of the water and carbon dioxide taken in. Chlorophyll is essential to the absorption of carbon dioxide, to the giving forth of oxygen, and to the formation of starch. Finally, chlorophyll can assimilate only in the presence of sunlight and at a proper temperature.

Now, not all the rays of sunlight with their varied wave lengths are essential to this process. Just what rays are the essential ones has been a point of some dispute. The earlier studies on the subject, made chiefly by DRAPER ('44), SACHS ('64), and PFEFFER ('71), were unanimous in declaring that the most active rays in assimilation were those occupying the yellow part of the spectrum at about line *D*—the region of maximum brightness to our eyes (Fig. 42). But these observers were at fault in that, while they carefully determined the *quality* of light and the corresponding quantity of assimilation, none of them gave, in the experiments with color screens, any adequate data upon the *intensity* of the diversely colored

lights employed; and this is a fundamental matter, for it has been shown, for instance by REINKE ('83 and '84), that, within certain limits, the rate of assimilation increases with the intensity of the light (Fig. 44). Even in experiments with the colors of prismatic spectra one must remember that the rays are crowded together at the red end, so that a given length of the spectrum contains more rays at that end than at the other (cf. Fig. 40).

Later investigations with improved methods have shown quite conclusively that it is especially the rays with $\lambda = 0.68 \mu$, or those very close to the absorption band *B*, which are most

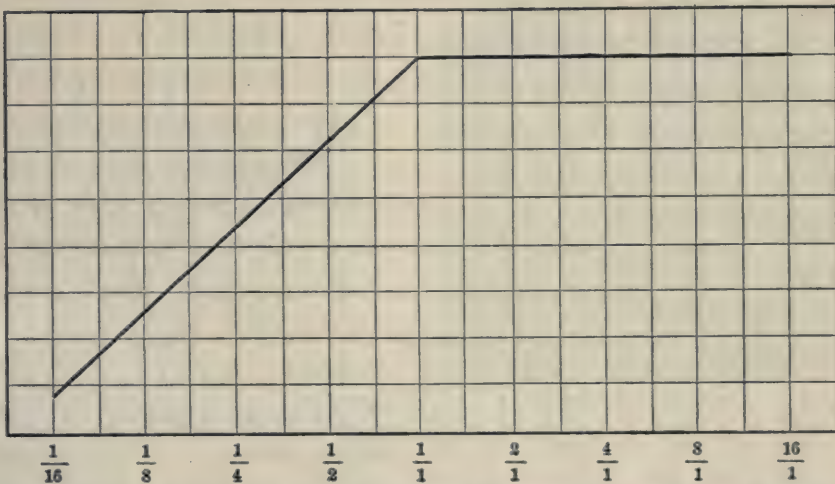

FIG. 44. — Curve showing the relation between intensity of light (abscissæ) and quantity of oxygen set free by *Elodea canadensis*. † indicates the unit intensity of the light from the heliostat. (From REINKE, '84.)

active in assimilation. The methods employed have been most diverse, but they have yielded the same result. TIMIRIAZEFF ('77) studied the assimilative power of the different parts of the solar prismatic spectrum, determining by gasometric methods the quantity of gases decomposed in a given time. REINKE ('84) also used the spectrum, but by means of his spectrophor was able to get more strictly monochromatic light, to use more nearly comparable extents of the spectrum, and, especially, to get a more exactly comparable (in this case, optimum) assimilative intensity for each part of the spectrum than his predecessors. (See p. 156.) As the measure of assimilation, REINKE used the number of gas bubbles set free

per minute by the submerged, illuminated plant. As is shown in Fig. 45, the maximum of gas production occurred at about

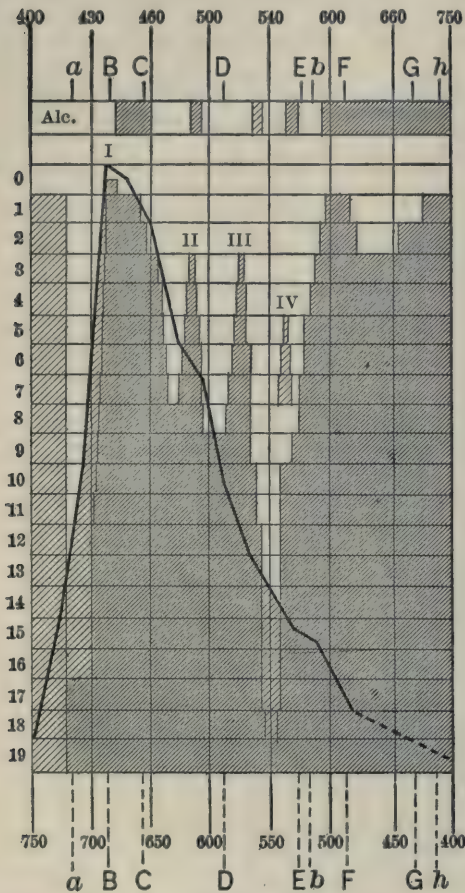

FIG. 45.—Curve whose ordinates are proportional to the number of gas bubbles eliminated per minute by leaves illuminated by the various rays whose wave lengths are given at the bottom of the diagram, and whose number of vibrations per second are given at the top. The background of the figure is composed of the absorption spectra of the chlorophyll in living leaves. 1, 2, etc., at the left, indicate the number of leaves of *Impatiens parviflora*, which, when superimposed, give the corresponding spectrum at the right of these numbers. The absorption at 0 is from a fern prothallus, that at *Alc.* is derived from an alcoholic solution of chlorophyll. I to IV indicate absorption bands. Beyond *F* there is very general absorption of the highly refractive rays. (After REINKE, '84.)

absorption line *B*—and this is the more marked of the absorption bands of chlorophyll.

A similar result was reached by ENGELMANN and set forth in a long series of papers ('81, '82, '82^a, '83, '83^a, '84, '86, and '87). He found that certain bacteria are extremely sensitive to oxygen, moving in the direction of small increments of the oxygen density. Now, by putting a thread of alga in the same water with bacteria and subjecting the thread to a "microspectrum," that part in which assimilation is proceeding most rapidly, and in which, therefore, oxygen is being most rapidly excreted, will be indicated by the greatest aggregation of bacteria. The microspectrum was produced by means of an apparatus especially designed by ENGELMANN for his work and now manufactured by the ZEISS firm in Jena. The appearances seen under the microscope when the spectrum falls upon the alga in the bacterium-water are shown in Fig. 46. The maximum aggregation (hence, maximum assimilative activity) at the red end occurs

close to the absorption band of chlorophyll. Observations upon the chlorophylls of brown, blue-green, and red cells, which, as ENGELMANN'S microspectro-photometer indicated, have a maximum absorption at other points, showed a maximum of assimilative activity at these other absorption points. In bacterio-purpurin also, in which some of the most active assimilative rays are those of the invisible red at about $\lambda = 0.85 \mu$, most oxygen is produced at this point. (ENGELMANN, '83, p. 709.)

Finally, by an ingeniously devised experiment, TIMIRIAZEFF ('90) has settled this matter in the most direct and indubitable



FIG. 46. — Piece of *Cladophora* with swarming bacteria in the microspectrum (gas-light). The chlorophyll grains which fill the cells very uniformly are omitted; and, instead, the absorption band between *B* and *C*, and the tolerably pronounced band at the violet end between *E* and *F*, are indicated by shading. (From ENGELMANN, '82.)

fashion. He kept a plant for two or three days in the dark, until the starch in its leaves had gone; then, in a dark room, a prismatic spectrum was thrown upon the leaf and the position of FRAUENHOFER'S lines indicated on the leaf. After from three to six hours, starch had formed, under the influence of the light, only in the region of the absorption bands of chlorophyll lying between *B* and *D*. This was determined by plunging the leaf into boiling alcohol, thus decolorizing it, and then staining in tincture of iodine, which combines especially with the starch. The deeply dyed places, where starch had been formed, reproduced the absorption spectra of chlorophyll.

The concurrent testimony of these and other observers working upon so diverse material and with such excellent methods

justifies the conclusion that it is the rays absorbed by the plant pigments which enable them to do their work in the decomposition of carbon dioxide. The effective absorbed rays are, moreover, chiefly those towards the red end of the spectrum, those having over 525×10^{12} vibrations per second (*i.e.* below the *D* line).*

In conclusion it may be said that the greater proportion of the radiant energy entering the plant tissue is absorbed. Thus MAYER ('93) has shown that of dark radiant heat at 100° about 80% is absorbed by a leaf through which it passes, and this proportion is about the same whether the leaf is thick or thin. Of this absorbed heat perhaps less than 10% is absorbed by the chlorophyll. The rest must be used up in the vital processes other than assimilation.

b. The Chemical Effect of Light on Metabolism must now be considered; and of this we must notice at the outset two degrees. The greater effect, which is a fatal one and the better known, will be treated of further on. The lesser effect is less striking, yet it must be included in the greater. It shows itself in a disturbance of metabolism.

This disturbance of metabolism is evinced in some green plants by heightened production of carbon dioxide and the formation of chlorophyll; and it is noteworthy that a similar result occurs among Infusoria, according to the observations of FATIGATI ('79), who finds the violet rays more active than the green in this process. Among the Metazoa light produces important chemical changes in the retina of the eye, and especially in the skin, facilitating the production of pigment. That important chemical changes take place in the illuminated retina follows from the experiment of placing the electrodes at opposite surfaces of the frog's retina. The galvanometer shows in the darkened eye a slight "current of rest" flowing from the front face to the deeper-lying part, containing the cones. If now the retina be suddenly illuminated by blue, green, yellow, red, or white light, a current, the result of chemical action, appears flowing in the opposite direction; this continues for

* Other, less important, thermal effects of light on plants are found in the formation of chlorophyll and in the quickening of transpiration, which seem chiefly due to the red and ultra-red rays.

some time, slowly diminishing, however, in intensity. Certain chemical changes in the living retina may, indeed, be studied optically. These especially concern the visual purple. This is a substance lying in the outer ends of the rods of the retina, which, under the action of light, becomes bleached, but regains its color in the dark (HELMHOLTZ, *Handb.*, pp. 265–273). These facts serve to indicate that light may influence metabolism even in organisms destitute of chlorophyll.

2. **Vital Limits of Light Action on Protoplasm.** — We have seen above (p. 167) that the rate of assimilation diminishes in chlorophyllaceous plants with a diminution in the intensity of the light. At last a point is reached where the intensity is so low that no further assimilation can occur, and after the consumption of the stored-up food-stuffs, starvation and death must eventually ensue. For non-chlorophyllaceous organisms, however, no such lower limit exists. Many, as parasites or cave dwellers, live in complete darkness, even through many generations. A lower vital limit to the action of light exists only in the case of chlorophyllaceous plants.

With the *upper vital limit*, it is, however, quite different. This is found in the most diverse groups. Its occurrence in *bacteria* being of especial hygienic importance, these organisms have been made the object of exhaustive studies. MONTEGAZZA (see NICKLÈS, '65) was perhaps the first to discover that strong light kills bacteria, but DOWNES and BLUNT ('78 and '79) were the first to study the matter thoroughly. Since their time, numerous experiments have been made upon bacteria, as well as the higher fungi. For literature, see FRANKLAND and WARD ('92), and WARD ('93, p. 309). Even the earliest observers found that, while cultures of bacteria reared in the dark rapidly flourished, they not merely did not thrive when subjected to sunlight, but actually became sterilized. That the sterilization was complete was shown by the fact that when the culture was placed again in the dark, no bacteria developed in it. This result is most striking when certain bacteria, say of the species *Bacillus anthracis*, are mixed with gelatine or agar-agar, poured uniformly over a glass plate. If the glass plate is then covered by a black paper stencil containing some character, *e.g.* the letter *E*, and exposed to a November sun-

light for 6 hours, and if then the whole plate is placed in a dark incubator at 20° C. for 48 hours, the bacteria will be found to have developed in all parts of the plate except in the *E*-shaped area sterilized by the light (Fig. 47). Compare the earlier results of BUCHNER ('92). That in these cases it is the light and not a high temperature which induces the sterilization in the illuminated region is shown by the fact that BUCHNER ('92) obtained even more striking results when parts of the culture plate were exposed under 50 cm. of water, which cuts off the heat.

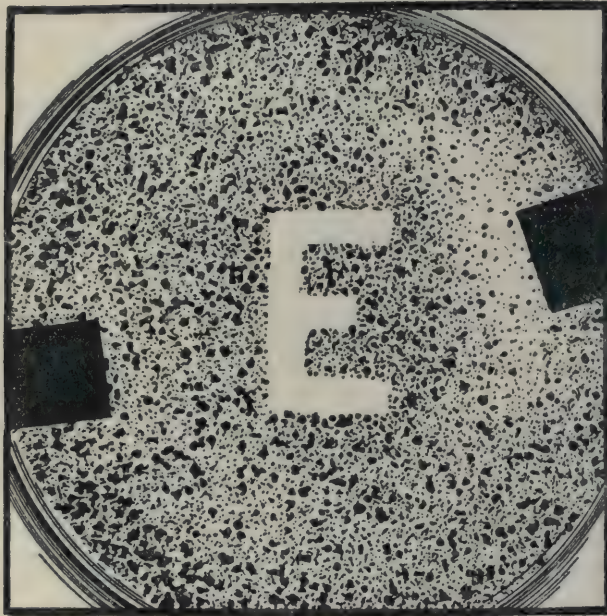

FIG. 47. — Appearance of a gelatine culture of *Bacillus anthracis*, exposed to the light over only the area *E*, and then incubated for 48 hours. In the area *E* no colonies have developed. (From WARD, '93.)

Not all rays have this bactericidal property. DOWNES and BLUNT ('78) found that only the blue rays were thus active, for behind red or yellow glass the bacteria readily developed. WARD ('94) threw a solar spectrum upon an agar film in which bacteria were developing in a dark chamber. He found that the bactericidal effect was greatest in the region of the blue-violet rays (about $\lambda = 0.43 \mu$) and diminished towards the extreme violet and the yellow, where it had almost disappeared. These facts were ascertained by incubating the bacteria for 48 hours after insolation, when certain parts affected by the spectrum were found to remain clear (Fig. 48). When an electric

spectrum (obtained by the use of a quartz prism) was employed, a bactericidal effect was obtained (provided no glass intervened) in the ultra-violet. That the action of the light was not in these cases primarily upon the food-film was shown by the fact that a plate of sterile agar, exposed behind a stencil plate, and then laid flat on a film of dried unexposed spores, permitted the uniform growth of the spores, in the illumined as

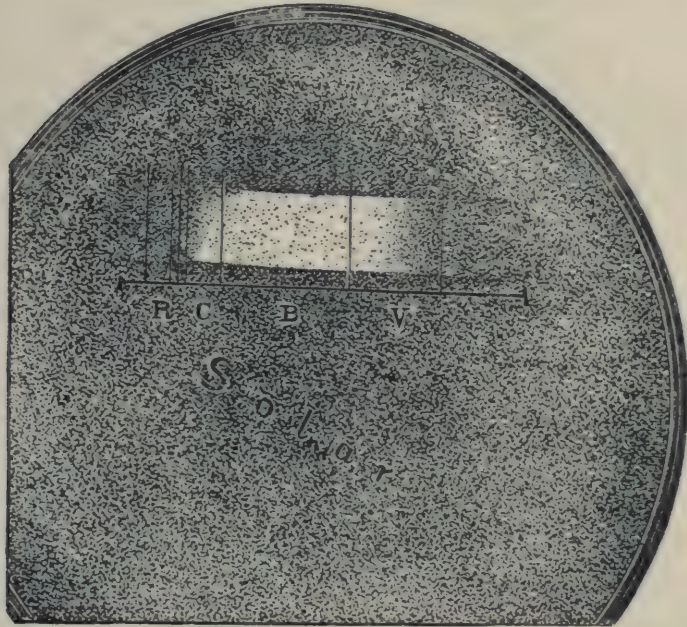

FIG. 48.—Plate of anthrax spores, exposed for 5 hours to the solar spectrum in August, and incubated for 48 hours. The horizontal line shows the length of the spectrum. The vertical lines are not FRAUENHOFER'S lines, but serve to show the limits of the principal regions of the spectrum. The clearest area is that where fewest spores have developed in the incubation—where, consequently, the bactericidal effect was greatest. (From WARD, '94.)

well as in the unillumined region. All these observations show that the bactericidal action of light is due to the action of the chemical rays on the protoplasm.

Another fact of importance, first discovered by DOWNES and BLUNT, is that light has no effect upon bacteria when they are in a vacuum. This abundantly confirmed observation indicates that death only secondarily results from light. The primary cause of death is an oxidation process,—a process rendered possible by the mediation of light. As we have seen (p. 162), many organic compounds undergo oxidation in the highly refracted light rays. Probably there are in bacteria such com-

pounds, the rapid oxidation of which is incompatible with life. In any case it is clear that the bactericidal effect of light is a chemical one.

Concerning the range of organisms which are thus affected, it must be said that chiefly pathogenic species, such as the bacteria of anthrax, of typhus fever, and of cholera have been experimented with and have shown themselves most susceptible. Other bacteria are, however, likewise affected. Among the other fungi, WETTSTEIN ('85) found that the conidia of *Rhodomycetes Kochii*, a human intestinal parasite, did not develop in the light. KLEIN ('85) found the same thing to be true for the conidia of *Botrytis cinerea*, and showed that the blue-violet rays were the most effective ones. ELVING ('90, p. 105) gained similar results with *Aspergillus*, although several days or weeks of insolation did not *kill* the fully ripe spores. WARD ('93) determined that insolated spores, cultivated on agar or gelatine plates, of *Oidium lactis* (5 cases), *Saccharomyces pyriformis* (4 cases), and "a 'Stysanus' conidial form" found as a saprophyte on the screw-pine, *Pandanus*, (2 cases) became injured. These are all hyaline and colorless except *Stysanus*, which is nearly so. Certain *colored* spores which WARD experimented with gave negative results, and WARD concluded that this is because the blue end of the spectrum is cut off before reaching the deeper protoplasm. However this may be, we actually find that in many, but not all, fungi the metabolic processes of the spores are disturbed and even death is provoked by intense light.

Why the spores should be especially susceptible to the action of light is an important inquiry. WARD believes the answer to be that the spores contain oily substances, which are especially liable to oxidation in light, as we have already seen.

Finally, we have to consider the experiments which demonstrate that a strong sunlight may be injurious even to green plants. This result follows clearly from the work of PRINGSHEIM ('81). When strong sunlight is focussed for a short time upon cells of *Spirogyra*, *Nitella*, *Mesocarpus*, or *Tradescantia* stamen hairs in atmospheric air (5 to 15 minutes), they are killed. No result occurs, however, when the same light falls upon green cells in which the atmosphere has been replaced by

hydrogen (Fig. 49). That it is here also the oxygen (and not the carbon dioxide) of the air which is the destructive agent is shown by subjecting the plants to air freed of carbon dioxide, when they are killed by light as before.

The most important results following from the conclusions of this sub-section are: a minimum vital limit of light action exists only in the case of those organisms (chlorophyllaceous plants) which depend upon light for assimilation; a maximum limit is found among the most diverse organisms, those with chlorophyll and those without. The rays which have the more rapid vibrations are the more active. They produce chemical changes to which death is primarily due.

3. **Effect of Light upon the Movement of Protoplasm.**—Under this head we shall consider only those protoplasmic movements which may not be grouped under Locomotion, and shall discuss three classes of cases:

(a) effect of low intensity of light upon movement; (b) effect of high intensity of light upon movement; and (c) effect of change of intensity on contraction.

a. *Effect of Low Intensity of Light on Movement — Dark-rigor.*—We have already seen that chlorophyllaceous plants must eventually die if kept in the dark. Some time before death occurs the plants go into a condition of immobility, which may be called dark-rigor, since return of light brings a return of movements. Dark-rigor is very marked in the sensitive plant.

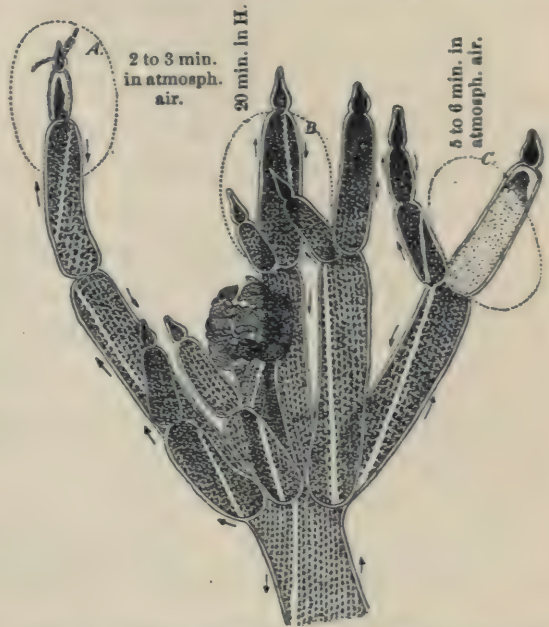

FIG. 49. — Piece of a sprout of *Nitella mucronata* which was subjected in a gas chamber to a green light in three successive experiments *A, B, C*. In experiment *A* the insolation lasted 2 to 3 minutes, the gas chamber being filled with atmospheric air. In experiment *B* the insolation lasted 20 minutes in the presence of hydrogen. In experiment *C* the insolation occurred again in the presence of atmospheric air and lasted 5 to 6 minutes. (FROM PRINGSHEIM, '81.)

If this plant is kept for several days in darkness, the usual response to touch does not occur. From some observations of BERT ('70, p. 338), it appears that it is the absence of the blue-violet and orange-red rays which brings about this dark-rigor; for it occurs nearly as rapidly in green light as in the dark. In these cases the absence of movement in the dark might seem to be the result of diminished assimilation.

But dark-rigor occurs under conditions which destroy the general validity of this conclusion; for example, in the reddish-purple bacteria* whose reactions have been studied chiefly by ENGELMANN ('83 and '88). It appears that in these organisms light is essential to movement; for, after having been kept over night in the dark, they are found in the morning at first motionless; only later, after 5 to 10 minutes of illumination, do they awaken to activity. If now, after keeping for a time in the light, the organisms are brought again into the dark, their movements gradually diminish until, in a few hours, they have ceased. We have seen above (p. 51) that oxygen is necessary to movement, and we know that many plants excrete oxygen in the light. We might expect that the quiescence of these organisms in the dark is a consequence of their failure to produce the oxygen necessary to locomotion, and indeed they do produce in the light a slight quantity of oxygen, by virtue of their chromophyll (bacterio-purpurin, LANKESTER). But that it is not merely oxygen which induces movement is shown by the fact that when an abundant oxygen supply is artificially furnished, no movement occurs in the dark. Thus light, in the presence of oxygen, is essential to movement; it seems to be necessary to the irritable condition upon which locomotion depends. This irritable state of the protoplasm conditioned upon a certain intensity of light ENGELMANN calls *phototonus*.†

The analysis of this matter has been carried further. It has been found that a perceptible time (latent period) elapses

* This term includes bacteria known as *Bacterium photometricum*, *Bacterium roseopersicinum*, *rubescens*, etc., *Monas okeni*, *Spirillum violaceum*, and by other names.

† The term was applied to this phenomenon by ENGELMANN on account of its resemblance to that already described for the higher plants, and to which SACHS had previously given this name.

between the illumination of the organism and the occurrence of movement. Also, the ultra-red rays produce most rapid locomotion, next the orange-yellow, and weakest the violet-blue and violet-red. Spectrum analysis shows that the most active rays are the ones absorbed by the chromophyll (Fig. 50).

This phenomenon of phototonus is not confined to the purple bacteria. Thus, FAMINTZIN ('67, pp. 29-31) has shown that the movements of the closely related *Oscillaria* are diminished in the dark. SOROKIN ('78) found that protoplasmic streaming in the plasmodium of *Dictyidium* ceases at night, being awakened to movement by the light. Finally, VER-

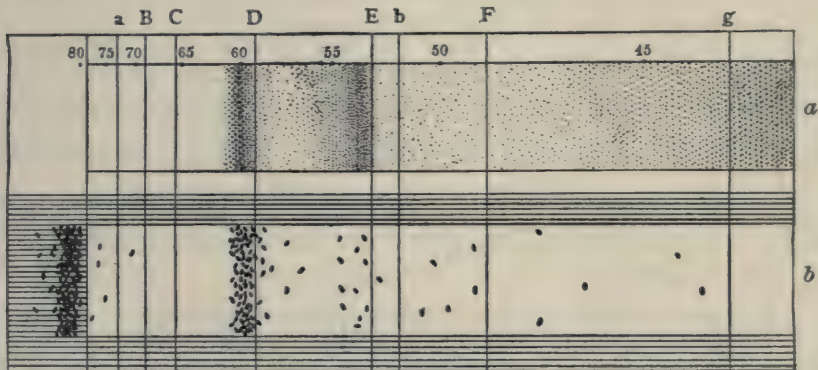

FIG. 50. — *a*. Spectrum of the chromophyll of bacterio-purpurin, showing absorption bands at $\lambda = 0.59\mu$ and $\lambda = 0.53\mu$. An (invisible) absorption band has been determined by means of the bolometer at $\lambda = 0.85\mu$. *b*. The bacteria are seen aggregated chiefly in the regions of the absorption bands. The accumulation of bacteria in these regions of absorbed energy seems due to the fact that the moving bacteria cannot pass from a region of high energy to one of low without a violent stimulus which impels them back again. (From ENGELMANN, '83a.)

WORN ('89, *Nachschrift*, and '95, p. 393) finds that, in the dark, the ciliate *Pleuronema chrysalis* rests quietly in the water, only occasionally making its peculiar spring. But when diffuse daylight is focussed upon it, for instance by the mirror of a microscope, it springs rapidly by the movement of its long cilia; and this movement is often repeated, so long as light continues to fall. The movement is produced by blue or violet rays; red rays have little or no effect. A latent period of from 1 to 3 seconds elapses before the response occurs.

These cases serve to show that light, in the presence of other suitable conditions, is, both for some chlorophyllaceous organisms and plant tissues and for some organisms destitute of

chlorophyll, nearly or quite essential to movement. Phototonus is a convenient name for the condition induced by light.

b. Effect of High Intensity of Light on Movement — Light-rigor. — We have just seen that in some organisms the most vigorous movements occur at an optimum intensity of light, which produces phototonus. At a lower intensity there is no movement. It appears, furthermore, that there is for many organisms a maximum intensity of light, below that which produces death (ultramaximum), which causes a cessation of movement that may be called *light-rigor*. This condition is distinguished from that of death by the fact that diminished light brings return of activity. ENGELMANN ('82, p. 109) observed this condition in his *Bacterium photometricum*, and remarks that it is common to all bacteria. Similar light-rigor has been observed in green plants also. PRINGSHEIM ('81, p. 516) found that when, in the presence of oxygen, strong sunlight was let fall upon *Nitella*, the movements ceased after $1\frac{1}{2}$ minutes. If the insolation was now interrupted, normal movements were resumed.

Summing up the effects of varied intensities of light, it appears that for many organisms there is an optimum, which produces a condition of phototonus, in which the organism moves and responds regularly to stimuli. As the light intensity falls below, or rises above this optimum, the activity of movement diminishes, ceasing at certain points in the conditions of dark-rigor and light-rigor. Beyond each of these points, again, is the point of death.

c. Contraction produced by Change in Intensity of Illumination. — We here consider a number of cases not closely related except in this, that quick movements are produced after stimulation by change in the intensity of the light. The cases are found both among Protista and Metazoa.

Among the sulphur-bacteria ENGELMANN ('88, p. 665; 88^a) has noticed that a sudden diminution in the intensity of the light, produced by shading the mirror of the microscope, is followed by a spring backwards, often to the distance of 10 to 20 times the organism's length. This reaction ENGELMANN has called "Schreckbewegung." When the light is suddenly increased, a forward movement takes place, but this is

less marked. Among the Myxomycetes, ENGELMANN ('79) has found that the amœboid *Pelomyxa*, when suddenly subjected to a strong light, contracts into a spherical mass. Sudden darkening or gradual illumination produces no such contraction. Among swarm-spores, STRASBURGER ('78, pp. 575, 576) has noticed that a sudden diminution of the light puts the quiet *Hæmatococcus* spores again in motion, and makes the *Botrydium* spores start as though disturbed. Such violent movements of the protoplasm indicate that a very considerable chemical change has taken place in it.

Passing, next, to the Metazoa, we find that certain smooth muscle fibres are made to contract by the direct action of light; thus, STEINACH ('92) has offered most convincing evidence that the contraction of the iris, in the lower vertebrates at least, may occur as a direct reaction to illumination, even when the eyeball is cut out, and the iris, indeed, separated from connection with the ciliary part of the eye.

Some of the higher animals react strikingly like ENGELMANN'S bacteria. Thus, LOEB ('93, p. 103) found that *Serpula uncinata* retracts into its tube when the hand is passed between it and the light; but sudden increase of illumination has no effect. NAGEL ('96, p. 76) finds the same thing in *Spirographis*, and ANDREWS ('91, pp. 285, 296) has observed the same phenomenon in the eyeless *Hydroides dianthus*. In these cases the branchiæ seem to be the sensitive organs. Adult barnacles show a similar sensitiveness to light; for POUCHET ('72, p. 111) found that momentary cutting off of the light, as by the shadow of the hand, caused arrest, for several seconds, of the rhythmic movements of protrusion of the appendages from the shell. In this case, the sensitive region has not been located. Some lamellibranchs (NAGEL, '96, p. 50) react similarly to increased light. These are examples of a phenomenon which we shall meet with again in considering growth. They serve to show that there is a wide-spread irritability of protoplasm to changes in intensity of light.

Let us now review the conclusions of this section. Light—especially the thermic rays—is essential to the decomposition of carbon dioxide by chlorophyllaceous plants. The only effective rays are those absorbed by the chlorophyll. The rate

of assimilation is increased by increased intensity of light. The chemical rays act to increase metabolic changes, and the output of carbon dioxide. As these rays become more intense, the metabolic changes go on with abnormal rapidity, until, finally, death ensues; thus, intense light is fatal to many, perhaps to all, organisms. Absence of light, however, is injurious only as preventing assimilation in chlorophyllaceous organisms; but these supply the food for other organisms, so that continued darkness in any environment must likewise be eventually fatal to all life. All organisms, before succumbing to darkness or to light, enter into a condition of rigor, from which they may return to activity if favorable conditions are restored. Sudden change of intensity often produces violent protoplasmic changes, awakening quiescent organisms to activity, or causing, in the higher organisms, violent contractions.

All of these effects of light, whether produced by the thermic or chemic rays, probably give rise to great chemical changes by which disturbances of metabolism, and eventually death, may be produced. Not all organisms find light immediately necessary to their existence; but very powerful light, long continued, proves fatal to most protoplasm.

§ 4. CONTROL OF THE DIRECTION OF LOCOMOTION BY LIGHT — PHOTOTAXIS AND PHOTOPATHY *

In this section we shall (1) distinguish between false and true phototaxis; (2) consider the observed cases of phototaxis among Protista, the parts of higher organisms, and the Metazoa as entire organisms; and (3) discuss the general laws of phototaxis and photopathy.

* In this section we shall deal with two sets of phenomena which very likely are different, but which, in our ignorance, we cannot always distinguish. The first includes that active migration of organisms whose direction is determined by that of the rays of light. This is phototaxis. The second includes the wandering of organisms into a more or less intensely illuminated region, the direction of locomotion being determined by a difference in intensity of illumination of the two poles of the organism. This is photopathy. According as the migration is towards or from the source of light, we can distinguish positive (+) and negative (−) phototaxis. According as the migration is towards or from the more intensely illuminated area, we can distinguish positive (+) and negative

1. **False and True Phototaxis.** — It must certainly be a very old observation that when small organisms are placed in a vessel in front of a window, they are soon found arranged with reference to the window; some lying on the nearer side, some on the further side, and others swimming indifferently back and forth through the vessel. The conclusion is near at hand that this arrangement of the organisms is determined by the light. This conclusion is, however, not necessarily correct. Thus, SACHS ('76) showed that, under certain conditions, wholly passive substances — oil drops, in a mixture of water and alcohol — might exhibit a similar aggregation towards the window or away from it. These conditions are that the vessel should be cooler next the window. Then, on the cooler side, there will be a descending current; on the warmer side, an ascending current; on the surface, a current towards the win-



FIG. 51. — Vertical section through a dish showing distribution in water of passively suspended bodies, as a result of difference of temperature at the two sides of the vessel. *A*, warmer side; *B*, cooler side. Arrows show the direction of movement of currents in the water. The objects lighter than water are grouped at *b*; those heavier than water, at *a*.

dow; and on the bottom, a current from the window. If the passive bodies are such as float, they will thus be carried towards the window, and will exhibit a false phototaxis (in the positive sense); if, on the contrary, they tend to sink, they will be carried from the window, and show false negative phototaxis. Now this appearance, due to passive transportation by currents, may likewise, under the given conditions, be exhibited by *organisms* — but the phenomenon is not due to light (Fig. 51).

There is at least one other kind of pseudophototaxis. This

(-) photopathy; and correspondingly we can in this second case speak of the organisms themselves as photophil or photophob. In this nomenclature I follow GRABER. STRASBURGER used *photometry* for what I here call *photopathy*, but OLTMANN'S ('92, p. 206) has employed photometry to indicate the capacity of organisms to perceive different degrees of intensity of light. So, perhaps, the terminology here employed may lead to the least confusion.

may occur when there are in the vessel chlorophyllaceous organisms producing oxygen in the sunlight. The oxygen, more abundantly formed on the sunny side of the vessel, becomes, then, a means of attraction to other (chemotactic) organisms, whose position seems thus to be determined directly by relative brightness.

A good example of this kind of pseudophototaxis is described by ENGELMANN ('81^a). He found that the Schizomycetes in a certain drop of water, partially illuminated, were aggregated toward the illuminated side. Examination revealed the presence of a chlorophyllaceous schizomycete — *Bacterium chlorinum* — in the drop, and the apparent phototactic appearances were easily accounted for as follows: Under the influence of light the *Bacterium chlorinum* secreted oxygen, and this acted chemotactically to attract the bacteria, which thus moved, at the same time, towards the illuminated area. That it was the oxygen produced in the sunlight rather than the light itself which attracted, was evinced by the fact that, when the supply of oxygen is abundant in all parts of the drop, or if the *Bacterium chlorinum* is removed, no aggregation takes place at the bright point.

2. Distribution of Phototaxis and Photopathy. — *a. Protista.*

— We now come to the consideration of the cases of true phototaxis and photopathy, and shall first discuss the distribution of the phenomenon in the different groups of Protista. Of the Protista we may take up first the chlorophyllaceous forms.

Flagellata and Swarm-Spores. — In no other group does phototaxis show itself more clearly than in this. The earliest studies were made here, but despite the ease of gaining results they were mostly fragmentary and uncritical. A simple experiment of NÄGELI ('60) had, indeed, showed conclusively that swarm-spores are responsive to light. A glass tube three feet long and held vertically was filled with alga-water. When the upper end of the tube was enveloped by black paper the organisms moved to the lower end, and conversely. A difficulty was encountered, however, in the fact that when zoöspores were placed in a plate by a window, the organisms gathered at the edge next the window, which, since the edge of the plate threw a shadow there, was the darkest part of the surface. In consequence some authors had concluded that swarm-spores shun the light; whereas COHN asserted, all too briefly, that they move in the direction of the rays and toward the source of light. Finally, FAMINTZIN ('67) had discovered that swarm-

spores which moved towards a light of a certain intensity would move from light of a certain greater intensity. That was the condition of knowledge on this subject when STRASBURGER'S ('78) epoch-making paper appeared.

STRASBURGER worked with swarm-spores of various species of algæ, and with the flagellate *Chilomonas* and *Euglena*. He observed again the phenomenon that the sense (+ or -) of response depends upon the intensity of the light. He also showed that the rate of movement is quicker in stronger light on account of the fact that the path taken by the organism is straighter; and (p. 586) that phototaxis is the result of the organism putting its long axis in the axis of the infalling rays. STRASBURGER found also that, in general, the smaller species of swarm-spores and the smaller individuals are more responsive than the larger ones.

Later studies have extended our knowledge of the distribution of phototaxis in this group. Swarm-spores have been studied by STAHL ('78, '80); *Euglena*, by ENGELMANN ('82, p. 396); and *Volvox*, by CIENKOWSKI ('56), VERWORN ('89, p. 45), and OLTMANN'S ('92). Especially interesting is the fact that colorless swarm-spores, like those of *Chytridium*, which are parasitic upon chlorophyllaceous forms, respond like the green organisms. (STRASBURGER, '78, p. 568.)

Desmids, especially *Closterium*, have been experimented with by STAHL ('78 and '79), KLEBS ('85), and ADERHOLD ('88). All are markedly phototactic in moderate, diffuse daylight. This phototaxis is the more striking since the method of locomotion of these forms is peculiar. The crescentic *Closterium moniliferum*, for example, stands inclined and glides along, one extremity touching the substratum, the free extremity in advance. The gliding seems to result from the secretion of a stream of mucus along the substratum. Now STAHL believed that the angle of inclination of the *Closterium* is dependent upon the direction of the infalling rays of light, being parallel thereto. This relation has been denied by KLEBS, but ADERHOLD, by varying the direction of the infalling rays, has shown that the azimuthal position is determined by light. Under certain conditions *Closterium moniliferum* moves by a sort of head-over-heels motion, since the free end bends down to the

substratum and becomes attached, and the former attached end becomes free. STAHL explains this on the ground that the ends of *Closterium* periodically exchange their tendency to point towards the light. The appearances just described are found in diffuse daylight. In stronger light the azimuthal position is 90° from the infalling light. If direct sunlight falls upon desmids, they move from the light (negative phototaxis).

Diatoms have been studied by STAHL ('80) and VERWORN ('89, p. 47). Locomotion is effected in these organisms as in desmids by the secretion of mucous threads. The movement towards diffuse daylight (*Navicula*, *Stauroneis*) takes place slowly, but it often affects nearly all the individuals. The long axis does not seem to be clearly oriented in the direction of the infalling rays, which may be partly accounted for by the normal zigzag method of locomotion. Under strong sunlight diatoms appear negatively phototactic. Occasionally a culture will be found whose individuals are separated into two groups — one next the positive side, the other next the negative side of the vessel.

Oscillaria. — VERWORN ('89, p. 50) has made experiments on the reaction of these organisms, whose method of locomotion is probably similar to that of desmids. They are markedly positively phototactic from half darkness to direct sunlight; only in intense sunlight do they fail to accumulate at the positive end of the vessel. The aggregation at the positive pole takes place by the threads assuming a direction parallel to the rays of light and creeping forward thus, side by side. VERWORN states that after all have attained the + edge, rotation of the slide or vessel through 180° does not cause a prompt transfer of all individuals towards the light side — at least during the time of his observation only a few had crawled towards the light in its new position. According to WINOGRADSKY ('87), *Beggiatoa* is generally negatively phototactic.

Myxomycetes. — In its amœboid form and when subjected to strong sunlight *Æthelium septicum* retreats into the substratum, but while in the dark it comes to the surface (HOFMEISTER, '67, p. 625; STRASBURGER, '78, p. 620). Also, when the plasmodium is partially illuminated, the protoplasm tends to flow from

the illuminated region. (BARANETZKI, '76, p. 328, and STAHL, '84, p. 167.)

BARANETZKI proceeded as follows: a glass plate was placed in a saucer so that its surface was 2 or 3 mm. below the rim. The plate was covered by filter paper which extended over the rim and here dipped into water, by which means it was kept moist. Over the saucer was laid an opaque cover, blackened below and provided with a narrow slit. The plasmodium was placed on the filter paper and diffuse daylight was thrown upon the slit by means of a plane mirror. In less than half an hour the illuminated threads of the plasmodium had become very thin, owing to the retreat of the protoplasm from under the slit to the darker region (Fig. 52).



FIG. 52.—Plasmodium of *Æthalium septicum*, after having been kept in the dark for some time and then illuminated, for half an hour, over a cross-shaped area, only. The illuminated area is on the upper part of the figure. The protoplasm has retracted from it, leaving a partially clear region in the form of a cross. (From BARANETZKI, '75.)

Rhizopoda.—Although, as we have seen, *Pelomyxa* is irritated by a sudden illumination, a phototactic or photopathic response has not hitherto been certainly observed in this group. VERWORN ('89, pp. 40, 41), indeed, experimented, but with negative results, upon *Amœba limax*, *Amœba princeps*, *Actinosphærium*, and *Actinophrys*. Only in *Polystomella crispa* did he notice a slow wandering towards the source of light; but he was uncertain whether this was due to light.

VERWORN'S method was not well devised, however, for bringing out phototactic response. The Protista were placed on the slide, and, after cutting out heat rays by means of a plate of ice, were subjected to the light or to the ENGELMANN microspectrum, and illuminated at different intensities either over the whole body or over only a part. All disturbing influences, he says, were as far as possible eliminated: gravity, by an exact horizontal position of the microscope on a table with three screw-feet; the action of the edge of the drop, by using a very broad drop; and, finally, *the laterally*

impinging rays of light, by means of a black cardboard box placed over the slide. Thus it is clear that all of his light fell upon the organism in perpendicular rays from below. This method of experimentation would clearly not show whether *Amœba* is phototactic or not.

I have experimented with *Amœba proteus*, using methods resembling VERWORN'S, and likewise dissimilar ones, and have reached new results. In the first place, I have proceeded somewhat after the fashion of VERWORN to determine whether the amœba in a field illuminated from below, and separated by a sharp line into a light and dark half, showed any change of movement in passing from dark to light or from light to dark; also, whether an amœba moving in a uniformly illuminated field changed its direction when half of its body was darkened. Nearly all such experiments were negative. No effect resulting from the change from light to dark or the reverse could be detected. Thus far my results agreed with VERWORN'S.

In a second set of experiments, I proceeded differently. Usually one amœba was isolated by means of a capillary tube. It was then introduced, with a drop of clear water, between two slips of glass, each about 25 by 50 mm., which were kept 2 mm. apart, and at the same time cemented together, by glass strips of equal thickness placed near the ends. By this means a broad field for movement with uniformity of conditions of contact was ensured. The whole space between the two glass plates being now filled with clear water, the entire apparatus was submerged in a vessel which contained water about 2 cm. deep, and which was slightly smaller than the stage of the microscope. Finally, the entire stage, but not the substage optical apparatus, was kept in the dark by means of a cone made of several thicknesses of dense black cloth fastened by a slip-noose to the objective, and folded below the stage so as completely to exclude all extraneous lateral light. Light from the mirror was cut off by an interposed card. Through a slit in the cloth on the side next the window,—a west window,—a beam of direct sunlight, or of reflected light from the morning sky, was admitted to the amœba. The plates of glass being as nearly as possible horizontal and occasionally rotated, the directive action of gravity was eliminated. Since, so far as could be seen with

the microscope, no local sources of food or oxygen occurred in the water between the plates of glass, chemotactic influences were uniformly distributed. From the conditions of the experiment already described, a difference in temperature or of illumination at the two poles of the amœba is scarcely conceivable. The rays of radiant energy were the only directing agent. Under these conditions the amœba nearly uniformly showed itself negatively phototactic to light of an intensity varying from strong diffuse light to direct sunlight. The absence of uniformity is to be ascribed to the accidental presence of some disturbing agent. The movements made by the amœba were represented graphically by making at intervals a camera drawing of its outline. Two such graphic representations are reproduced in Figs. 53 and 54. It must be said that it is difficult to get so extended a series of changes in light as is shown in Fig. 54, for the phenomenon of acclimatization comes in and the responses become irregular. But, despite such irregularities, my studies lead me unhesitatingly to conclude that Amœba, although not at all photopathic, is strongly phototactic. This result is important, for, since Amœba is responsive to light, it may very well be that such responsiveness is a general property of protoplasm.

Ciliata. — A double action of light must be here taken into account. ENGELMANN ('82^a, pp. 391–395) states that those Ciliata which contain chlorophyll (algæ) — *e.g.* Paramecium bursaria, Stentor viridis, Bursaria — move towards the light, but only when the oxygen tension in the water is low. Also when the water drop is illuminated by a microspectrum, instead of white light the organisms aggregate towards the red end. Here are the rays by which most oxygen is produced from the chlorophyll, since assimilation takes place fastest here. When the organisms are placed in excessively oxidized water they move from the light. The conclusions to which ENGELMANN arrived from these and other facts were that these species have a very delicate sensitiveness to variations in oxygen tension, and that it is through this sensitiveness that light influences movement. Accordingly, it would seem that the apparent phototaxis is truly a case of chemotaxis; but this conclusion requires better evidence.

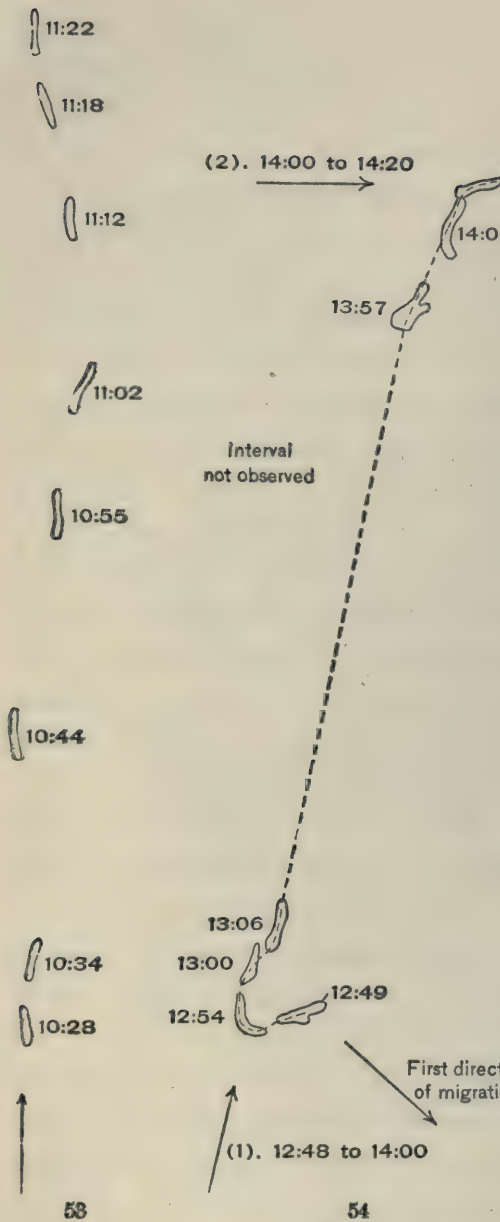

FIG. 53. — Camera drawing, showing the successive positions assumed by an amoeba subjected to light falling upon it from one side. The arrow lies in a horizontal projection of the sun's rays. The amoeba retreats from the source of light. The numbers to the right of the outlines of the amoeba give the observed times between 10:28 and 11:22 A.M. Magnified 16 diameters.

FIG. 54. — Camera drawing, showing the successive positions assumed by an amoeba retreating from the light. The position of the infalling ray was successively changed from (1) to (2), (3), and (4). The arrow labelled "First direction of migration" shows the direction of locomotion of the amoeba before the light fell upon it at the beginning of the experiment. The numbers indicate hours and minutes. During the interval from 13:06 (=1:06) P.M. to 13:57, the amoeba was not under direct observation, since I was called away. Magnified 16 diameters.

Cases that can be explained only on the ground of the immediate effect of light upon the direction of movement are certainly rare. ENTZ ('88), indeed, has intimated that *Opalina* flees from light, but VERWORN ('89, pp. 53-57) was not able to confirm him in this point. VERWORN'S method was here, as in the case of *Amoeba*, not satisfactory. Instead of having the light fall from one side only upon the drop containing the *Opalinas*, he let the light pass vertically from below through a small hole, and could observe no tendency to avoid the illu-

minated spot. The light in this case clearly did not act from one side, and the test of phototaxis can therefore hardly be said to have been critically made. Likewise, even with unilateral illumination, VERWORN was unable to gain a phototactic response with *Stentor rœselii*, *St. cœruleus*, *Carchesium polypinum*, and *Uroleptus musculus*. On the other hand, we have often noticed here in Cambridge that our *Stentor cœruleus* is (rather indefinitely) negatively phototactic to diffuse daylight. Thus, an individual swimming free in a bit of glass tubing pointing horizontally towards the window only very slowly wanders away from the light. In conclusion, then, we must admit that Ciliata are not markedly phototactic, but more refined methods must be used before we can say of any of them that they exhibit no trace of this response.

Let us summarize briefly the results obtained from Protista. Phototaxis is most marked among actively motile, chlorophyllaceous forms. Many colorless forms are, however, also phototactic — *Beggiatoa*, *Amœba*, plasmodia of *Myxomycetes*, and swarm-spores of *Chytridium*. The phenomenon is thus widespread, if it is not universal.

b. Cells and Cell-organs. — Under this head will be considered, (α) the rearrangement of chlorophyll corpuscles, (β) the rearrangement of pigment in animal cells, and (γ) the migration of pigment cells in the metazoan body.

a. That the *chlorophyll bodies* of the higher plants change their position in the cell according to the intensity of the light to which they are subjected has been made known chiefly through the labors of FAMINTZIN ('67), BORODIN ('69), FRANK ('72), STAHL ('80), and MOORE ('87). If one fastens a strip of black paper upon a leaf on which the sun's rays are falling, one will find, upon removing the paper after a time, that the darkened part is dark green whilst the brightly illuminated part is considerably lighter, so that an image of the form of the dark paper is produced upon the leaf. This image is, however, only temporary. A few hours after the removal of the paper the leaf is of a uniform green again. Sections through a leaf thus affected show that in the dark green (shaded) part of the leaf the chlorophyll lies on those walls of the cells which are perpendicular to the incoming rays,

whilst in the light green (illuminated) part of the leaf the chlorophyll lies upon the walls parallel to the rays. When

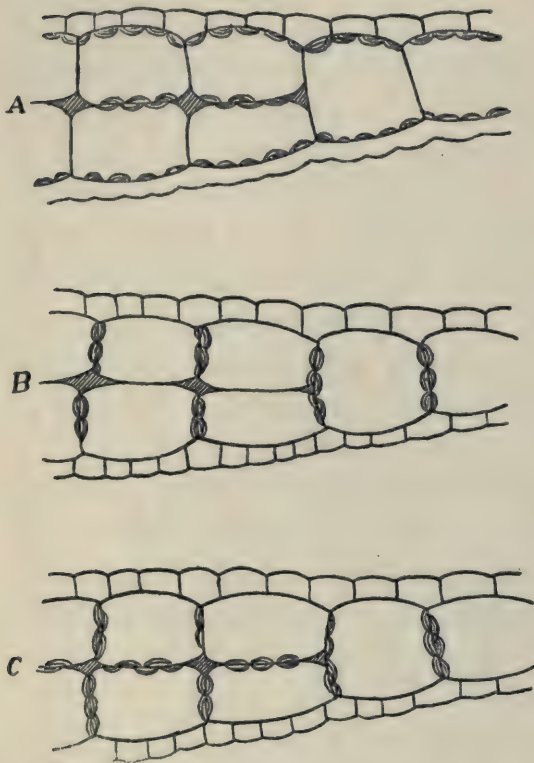

FIG. 55. — Cross-section through the leaf of *Lemna trisulca*. A. Position of the chlorophyll grains in diffuse daylight — epistrophe. B. Position of the chlorophyll grains in intense light — positive apostrophe. C. Position of the chlorophyll grains in darkness — negative apostrophe. (After STAHL.)

the grains are upon the superficial face of the cells they are said to be in *epistrophe*; when they have turned away from this face they are in *apostrophe*. This apostrophic position is found under two opposite conditions of illumination: under intense light, as we have just seen (positive apostrophe, MOORE), and upon prolonged standing in the dark (negative apostrophe). (Fig. 55.)

It appears, then, that epistrophe occurs only within certain limits of light intensity. The intensities included between these limits constitute what MOORE calls the epistrophic interval. The epistrophic interval varies in position and in extent

in different species.* It has been found that in the case of plants which normally live in the bright sun the epistrophic

* The limits were determined by MOORE, in a roughly quantitative way, by means of his *photrum*, constructed as follows. A room with a single window illuminated by the sun was chosen and 12 feet spaced off from the window back into the darkness. The intensity of the light diminished of course as one retreated from the window. Plants of various species were allowed to stand, simultaneously, at varying distances from the window, and the distance back at which epistrophe began to appear, and, finally, at which negative apostrophe came in, were noted. Then a diagram $\frac{1}{48}$ the actual scale was made (Fig. 56), showing the position of the points of beginning and ending of epistrophe (so-called positive and negative critical points).

interval is a region of relatively high intensity (Fig. 56, 6); in aquatic plants the epistrophic interval occurs in a region of low intensity (Fig. 56, 1 and 2); and in shade-loving aërophytes in an intermediate position (Fig. 56, 4 and 5). One may say that every species is attuned to a certain intensity and range of light, in which epistrophe occurs, just as in swarm-spores there is a certain intensity and range of light in which positive phototaxis occurs, and that attunement depends upon the conditions to which the organism has adjusted itself through living in them.

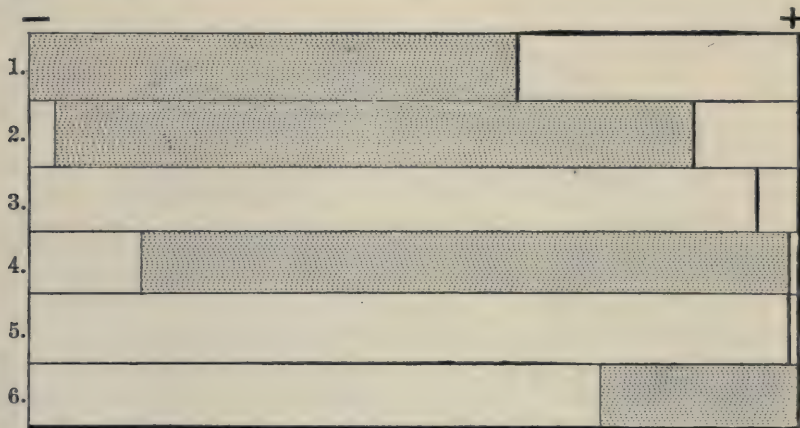

FIG. 56. — A diagram of MOORE'S photrum, showing for six spaces the epistrophic interval (shaded region). 1. *Anacharis (Elodea) canadensis*, "water-weed." 2. *Lemna trisulca*. 3. *Saxifraga granulata* (position of positive critical point). 4. *Oxalis acetosella* (position of negative critical point only approximate). 5. *Pteris critica* (positive critical point). 6. *Pyrethrum sinense* (garden Chrysanthemum). + indicates the brighter end of the photrum.

Concerning the question of the mechanism of the movement of the chlorophyll grains, there is much difference of opinion. It is urged on the one hand that the chlorophyll grains move actively to attain their new positions, and, on the other, that they are passively carried by the cell currents. Of these two views analogical reasons are perhaps the strongest for preferring the second.

As to the question in how far these movements can be regarded as adaptive, we may say that STAHL believed that they regulate the relation between intensity of sunlight and assimilating area, so that the quantity of assimilation shall not become too great. HIERONYMUS ('92, p. 466) considers them to be for the purpose of screening the nucleus. MOORE (p. 222).

however, chiefly from a consideration of vegetative apostrophe, has been led to the conclusion "that the movements of chlorophyll have no relation whatever to benefit or injury experienced by the grains, nor necessarily to the well-being of the protoplasm."

β. The Rearrangement of Pigment in Animal Cells in Response to Light.—One of the striking cases of this effect of light is seen in the pigment cells of the skin of the chameleon, as described by KELLER ('95, pp. 144, 162). He has found that the dark color of the (illuminated) skin is due to the rich

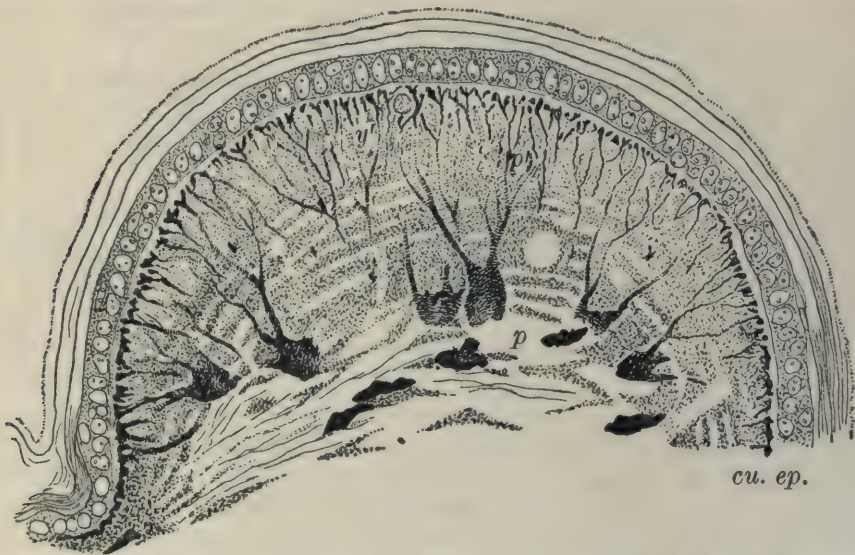

FIG. 57.—Vertical section through a black dermal papilla of *Chamæleo vulgaris*. *ep*, epidermis; *cu*, cutis; *p*, black pigment cells; *p'*, processes of the cells containing pigment; *y'*, yellow pigment cells. (After KELLER, '95.)

branching at the base of the epidermis of black pigment cells lying deep in the cutis (Fig. 57). In the dark, the pigment granules stream out of the branches into the cell body, but the branches themselves are undisturbed (Fig. 58). So long as the black pigment has this central position, the skin appears whitish. The light, on the contrary, causes the pigment, which is probably carried passively in the plasma, to move centrifugally. Whether the direct response to light of the pigment cells of the frog, as described by STEINACH ('91), is of the same nature, or due to contractions of the pigment cells, remains to be determined.

Again, in the retina of the compound eyes of Arthropoda,

we find this capacity for rearrangement of pigment granules, as EXNER ('89 and '91, p. 104), STEFANOWSKA ('90), SZCZAWINSKA ('91), PARKER ('95), and others have shown. In the higher Crustacea, for example, the pigment granules of the pigment cells surrounding the rhabdome (or "spindle") are, in the dark, below the level of the spindle. Upon illumination, however, these granules migrate (or are carried) upwards, and partly envelop the rhabdomes. I believe it has not been determined what rays are involved in producing this result. This response to light is considered to be an advantageous one, since

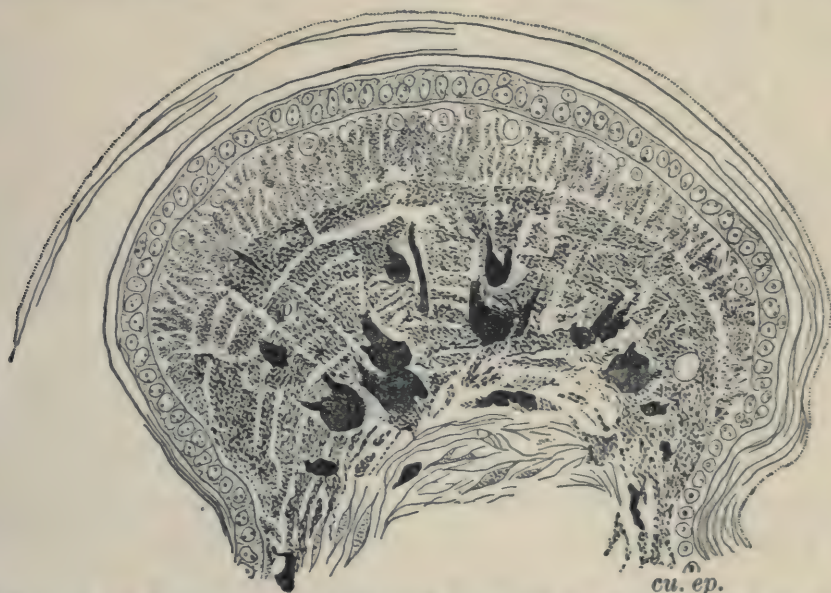

FIG. 58. — Vertical section of a whitish-yellow dermal papilla; lettering as in Fig. 57. *p'*, processes of black pigment cells containing no pigment. (After KELLER, '95.)

the pigment thus cuts off side rays from the perceptive organ — the rhabdome.

It is interesting that we should find cells containing two so diverse kinds of pigment as chlorophyll and the retinal pigment responding to light in so similar a fashion. In most of the cases, if not all, this response is an adaptive one.

γ. The Migration of Pigment Cells in the Metazoan Body. — It has been shown, apparently first by ENGELMANN ('85), that the pigment cells of the retina vary their movements with the light. Thus, when a strong light is thrown upon the retina of the frog, the pigment cells send out pseudopodium-like processes between the rods and cones, whereas in the dark the

pigment lies behind all these elements. Also, among the Crustacea, the protoplasm of the outer pigment cells, surrounding the cones of the compound eye, migrates centripetally in a strong light, to return again to its peripheral position in darkness. These movements may also be considered adaptive. They are, in addition, movements which are discharged only by light.

c. *Metazoa*. — We may treat of the control by light of the movements of the higher animals somewhat more summarily than we have the preceding classes. The facts will be arranged by groups in systematic order.

Among *radial* animals, *Hydra* has perhaps been for the longest time an object for photopathic study. TREMBLEY (1744, p. 66) had noticed that *Hydra viridis*, and even mutilated pieces of it, came to the light side of the vessel. When the light was admitted only through a chevron-shaped slit, the Hydroids were later found aggregated opposite the slit in the form of a chevron. That it was not the warmth of the sunlight that attracted was shown by turning the slit towards the cooler air, whereupon the same response occurred. The observations of TREMBLEY showed that the Hydroids did not move in as straight a line as possible towards the light (they must, of course, follow a firm substratum), but gradually wandered towards it. The response of *Hydra* must therefore be considered as photopathy. More extensive studies were made upon *Hydra* by WILSON ('91), who found that *Hydra fusca* is likewise responsive to light, and, indeed, photophil with reference to diffuse daylight, and photophobic to direct sunlight. And it can be shown that it is an advantage to *Hydra* to be photophil, since many of the Entomostraca upon which it feeds are phototactic.

Besides *Hydra*, I know of only one case of response by Cœlenterata to light. The larvæ of the *sponge* *Reniera* are said (MARSHALL, '82, p. 225) to flee from the light, — probably negative phototaxis.

Among *Echinodermata*, *Asteracanthion rubens* (GRABER, '85, p. 155) appears to be photophil, and *Asterina gibbosa* (DRIESCH, '90, p. 155) to be photophobic.

Although, as we have seen, some radial animals may respond to light, the phenomenon is more wide-spread in the bilateral groups, — flatworms, annelids, crustaceans, insects, molluscs,

and Vertebrates. The results of experiments may here be given in tabular form. Unless otherwise stated, the light is supposed to be diffuse daylight, and the response to be phototactic.

TABLE XVIII

ORGANISM.	SENSE OF RESPONSE.	AUTHORITY	REMARKS.
Fresh-water planaria	—	LOEB, '90, p. 95	
Polynoë sp.	—	DRIESCH, '90, p. 155	
Polygordius, larva	—	LOEB, '93, p. 90	see p. 200
Earthworm	—	{ DARWIN, '81, p. 21 GRABER, '83, p. 210 HESSE, '96	} photophob
Leech	—	LOEB, '90, p. 96	
Daphnia	{ + +	{ TREMBLEY, 1744, p. 96 BERT, '78, p. 989 LUBBOCK, '82, '83	} photophil (?)
Many marine copepoda	—(or +)	DAVENPORT and CANNON	
Balanus, larva	—(or +)	LOEB, '93, p. 96	phototactic see p. 200
		GROOM and LOEB, '90, p. 160	see p. 200
Limulus, larva	—	LOEB, '93, p. 83	
Idotea tricuspidata	+	GRABER, '85, p. 141	photophil
Diastylis (Cuma) rathkii	+	LOEB, '90, p. 91	mud-inhabiting
Carcinus mænas	—	DRIESCH, '90, p. 156	photophob
Homarus americanus, larva	+	HERRICK, '96, p. 189	
Plant lice	+	LOEB, '90, p. 55	
Blatta germanica (blinded)	—	GRABER, '83, p. 235	photophob
Musca dom. (?), larva	—	LOEB, '90, p. 69	
Musca, adult	+	LOEB, '90, p. 81	
Musca vomitoria, larva	—	DAVIDSON, '85, p. 160	
Musca cæsar, larva	—	POUCHET, '72, p. 113	
Eristalis tenax, larva	—	POUCHET, '72, p. 129	
Lepidoptera, adult	+	{ SEITZ, '90, p. 337 LOEB, '90, p. 46	} see p. 197
Lepidoptera, larva	+	{ LOEB, '90, p. 51 POULTON, '87, p. 315	
Ants, after gaining wings	+	LOEB, '90, p. 63	
Melolontha vulgaris. (May beetle)	—	LOEB, '90, p. 86	
Tenebrio molitor, larva	—	LOEB, '90, p. 84	
Dentalium	—	LACAZE-DUTHIERS, '57, p. 25	photophob
Rissoa octona	+	GRABER, '85, p. 144	photophil
Littorina rudis	—	DRIESCH, '90, p. 155	photophob
Gasterosteus spinachia	—	GRABER, '85, p. 148	
Triton	—	GRABER, '83, p. 221	photophob
Frog	—	LOEB, '90, p. 90	

A study of this table reveals the fact that, in general, organisms which live in shady places or in the dark are negatively phototactic or photopathic, while those living in the light are positively phototactic or photopathic. Thus most fresh-water planarians and leeches are inhabitants of shady pools. Polynoë is generally found in dark retreats, the earthworm and fly larvæ are lovers of the dark, and shell-molluscs are for the most part enclosed in cases impervious to light. On the other hand, *Daphnia* is found largely in open pools, larvæ of Lepidoptera and many adult insects live in the sun. Into this general rule there are some cases which do not so obviously fall. But we have little data concerning the habits of the races employed and the absolute intensity of light used, so that these cases may perhaps be only apparent exceptions. One clear exception is that of the mud-inhabiting *Diastylus*, which is + phototactic.

3. **The General Laws of Phototaxis and Photopathy.** — Under this head we shall consider: (*a*) the sense of the response; (*b*) the effective rays; (*c*) prototaxis *vs.* photopathy; (*d*) the mechanics of response to light.

a. The Sense of the Response. — In considering, now, more generally, the effect of daylight upon the direction of locomotion of organisms, we must recognize that the sense of response (whether + or -) depends upon internal conditions and external conditions — upon the quality of the protoplasm and the nature of the environment. Let us consider, first, the dependence upon *internal conditions*.

We find that, under similar external conditions, different organisms respond differently. For example, many *Oscillariæ* (p. 184) are positively phototactic even in direct sunlight; whilst even moderately strong light will repel many diatoms. In fact, we find that a positively phototactic or photopathic organism is such only in the presence of a certain intensity of light. When the intensity is diminished below a certain point, no response will occur. When, on the other hand, the intensity is increased above a certain point, the organism moves away from the source of light. There is a certain range of intensity in which alone the positive responses occur. The position and the extent of this positively phototactic range vary for the

different species, — they are closely correlated with the conditions of light in which the organism has been reared. As a result of these conditions, we may say that each organism is attuned to its peculiar range and intensity of light.

Upon the ground of this difference in attunement may be explained the remarkable difference in behavior of butterflies and moths to light. It is well known that butterflies fly towards even the strongest sunlight, whilst moths are secluded during the daytime, but at night fly towards the candle-light. LOEB ('90, p. 46) has performed some experiments with these insects, which I will cite in detail.

EXPERIMENT 1. — (a) Sphinx, Bombyx, and other moths were kept in a large glass cage in a room illuminated only by daylight. As darkness came on, the moths began to fly towards that side of the cage which was next the window. Again (b), pupæ of nocturnal moths, left in a room, emerged during the night, and were always found in the morning at the closed window of the room. Finally (c), a nocturnal moth, made to fly in the daytime, directed its way to the window. Thus, nocturnal moths are positively phototactic to diffuse daylight as well as candle-light.

EXPERIMENT 2. — Hawk-moths were brought into a room with the single window at one end, and a petroleum lamp at the opposite end. It was found that, as twilight came on, the moth flew to the window, or to the light, according to the relative intensity of the one or the other at the point where the moth was liberated. Thus, there is no preference for artificial light.

The conclusion at which LOEB arrived was that these moths undergo a diurnal variation in responsiveness to light, which corresponds to the change from day to night. But the fact that, in experiment 1 c, nocturnal moths flew, in the daytime, towards the diffusely lighted window, throws a doubt upon this interpretation. All the facts are equally well explained upon the following ground: Butterflies are attuned to a high intensity of light, moths to a low intensity; so that bright sunlight, which calls forth the one, causes the other to retreat. On the other hand, a light like that of a candle, so weak as not to stimulate a butterfly, produces a marked response in the moth. We shall consider, in a moment, the cause of these differences in light attunement.

We have seen that one internal condition modifying response is the racial quality of attunement. A second is that of *period of life*. Thus, LOEB ('90, p. 56) has found that, at the intensities

employed, the wingless plant lice were hardly responsive to light. The winged form was markedly positively phototactic. So, likewise, in the case of ants (LOEB, '90, p. 63), during the period of the marriage flight the males and females (but not the workers) are strongly positively phototactic, but after that period they show themselves neutral. The case of the house-fly, *Musca*, is interesting, since the larva and adult are phototactic in opposite senses (see table). In most of these cases, the difference in responsiveness is associated with a difference in habit.

The sense of response depends, also, as we have seen, upon *external conditions*. In this regard, the immediately preceding conditions of light, the temperature, the concentration, and the supply of oxygen have important effects. We shall consider, in order, the action of these conditions.

Light can modify the response to light; thus, GROOM and LOEB ('90) have shown that the nauplii of *Balanus*, as well as other pelagic animals, come to the surface of the sea during the night, but descend before the strong sunlight. This does not indicate merely a low light-attunement of the race; for nauplii exposed to sunlight in the early afternoon are all positively phototactic, and only gradually, as the day progresses, move from the sunny window, until, finally, even as dusk approaches, all are found on the side away from the window. Nor have we here to do with a diurnal change in the sense of the response. For if a culture is kept in the dark, it is found to be at first positively phototactic at whatever time of day it is exposed; only later acquiring the negative phototaxis. In the same way, when the young *Balanus* larvæ leave the interior of the shell of the parent, they are at first positively phototactic; but after being in the light for from $\frac{1}{4}$ to 2 hours, they become negatively phototactic. The more intense the light, the quicker its effect.

Another observation upon the nauplii is representative of a new class of light effects. When nauplii which have become negatively phototactic through exposure are covered for a few minutes, and then suddenly again exposed to light, they move momentarily towards the light, and then begin their negative movement again. Somewhat similar are the results obtained

by STRASBURGER ('78, p. 574) on *Ulothrix* spores, which are positively phototactic in a weak light. While responding to such a light, they do not, however, turn at once when a light of repelling intensity is thrown upon them. So, also (p. 600), when *Hæmatococcus* is responding to indigo light, the interposition of red glass does not at once cause it to turn from its path. In all these cases, the immediately preceding condition of light continues to exert an action which modifies the response.

Closely allied are the results obtained by VERWORN ('89, p. 50) upon the diatom, *Navicula brevis*, which is attuned to only the faintest light. When, however, a culture had been reared by a window for two weeks, the attunement to light had been so raised that now a slight degree of positive phototaxis took place in diffuse light. We have in these facts examples of a phenomenon which we have observed in the action of other agents. It is one expression of the acclimatization of organisms to the peculiar conditions of their environment. We have just seen that every organism has its optimum intensity of light for metabolism and response, and that this optimum is very varied; but, throughout, one law holds. Organisms which are accustomed to live in strong light have a high optimum intensity; and those accustomed to live in a weak light have a low optimum intensity. This relation is, indeed, so close as to raise the suspicion that the normal intensity of the light has determined the optimum. And this suspicion is confirmed by the experimental evidence just cited. Now, since the position of the optimum is usually advantageous, we may conclude that light can so modify protoplasm as to adapt it for the conditions in which it is living.

We now pass to the consideration of the effect of *temperature* upon response. This effect was noticed by STRASBURGER ('78, p. 605) in the swarm-spores of *Hæmatococcus*, *Ulothrix*, etc., which, at a temperature of 16° C. to 18° C., gather at the side of the drop next to the window. If, now, they are subjected to a temperature of 40° C., the intensity of the light being constant, they migrate to the opposite side. On the other hand, at a temperature of 35°, the + aggregation is more complete than at 16° to 18°. Control experiments with emulsions satisfied STRASBURGER that this change is not due to

currents in the water, but is a truly vital phenomenon. That it is such is indicated also by the following curious behavior. If swarm-spores which normally aggregate at 18° towards the positive side of the drop, are suddenly brought to 18° from 30° , they appear, for a moment, negative. Conversely, if swarm-spores which normally aggregate at 30° towards the negative side of the drop are suddenly brought from 8° to 30° , they appear, for a moment, positive. Thus, the immediately preceding culture-temperature affects the sense of the response.

The results obtained by STRASBURGER have been in part confirmed by other authors in other species.

GROOM and LOEB ('90, pp. 166, 172) state that in the case of the nauplii of *Balanus* — “at a higher temperature, for instance 25° C., the phenomena [of phototaxis] are run through more sharply and quickly than at a temperature of about 15° ”; and again, “we often succeeded in suddenly changing the sense of the heliotropism of the larva by a sudden change, of only a few degrees, in the temperature of the water.” This statement is unfortunately so vague as to say little more than this, that temperature influences the response. MASSART ('91, p. 164) remarks, incidentally, that the flagellate *Chromulina* is + phototactic at 20° C., but — phototactic at 5° C. LOEB ('93, pp. 90, 96) obtained a result with *Polygordius* larvæ and Copepoda which seems, at first sight, the opposite of STRASBURGER'S. *Polygordius* larvæ, negatively phototactic at 16° , were gradually cooled to 6° , at which temperature they began to move rapidly towards the + side of the vessel. As the temperature gradually rose they became — phototactic again. Individuals which were (abnormally) + phototactic at 17° to 24° , when raised gradually to 29° became — phototactic. Sudden diminution of temperature within the limits at which response occurs did not change the sense of their response. Thus, negative individuals brought suddenly from 23° to 13° remained negative. Exactly parallel results concerning the relation of temperature and response were obtained by LOEB from Copepoda.

All results may be harmonized in the expression: Diminution of temperature below the normal causes reversal of the normal response; elevation of the temperature to near the maximum accelerates the normal response. The point of light attunement varies with the temperature.*

Not only light and heat, but also the *concentration of the medium* affects light attunement. We are indebted to LOEB

* It follows from these experiments that it is necessary in any phototactic investigation to regard not only the intensity of the light, but also the temperature.

('93, pp. 94, 96) for information on this subject. Negatively phototactic *Polygordius* larvæ were placed in sea water to which 1% to 1.3% NaCl had been added. They now appeared positively phototactic. Positively phototactic individuals, on the other hand, placed in sea water diluted with 40% to 60% fresh water became negatively phototactic. Similar results were obtained with Copepoda. Thus increased concentration rendered + phototactic (raised light attunement), while diminished concentration rendered - phototactic (lowered light attunement). Increased concentration works, therefore, upon *Polygordius* and Copepoda, according to LOEB, like diminished temperature.

Finally, the *chemical condition* of the medium has an important effect on photopathy, as can be judged from certain observations of ENGELMANN ('82^a, p. 391). Various chlorophyllaceous Ciliata, *e.g.* *Stentor viridis* and *Paramecium bursaria*, are photopathic only when the oxygen supply in the medium is below the normal. In such media they are strongly photophil. This case is clearly not a case of phototaxis, as we have just seen (p. 187). The response is advantageōus since it brings these organisms into the sunlight, where chlorophyll can produce oxygen.

To recapitulate: the sense of response in phototaxis is modified by previous subjection to light, by temperature, and by concentration. These agents modify the attunement of the organism. Any quantitative experiments upon phototaxis must therefore take all of them into account. Certain chlorophyllaceous organisms exhibit + photopathy, but only in an insufficiently oxygenated medium.

From the foregoing considerations we conclude that for every phototactic organism there are three ranges of intensity to be distinguished: the positively phototactic range in which the organism moves towards the light; below this, the indifferent range extending to darkness; above it, the negatively phototactic range extending up nearly or quite to the point of light-rigor. The limits of these ranges vary with both external and internal conditions.

b. The Effective Rays.— We have hitherto considered chiefly the action of white light, merely referring casually to the

action of the different rays of which it is composed. We must now answer the question: What different effects do the different rays have?

The effect of the different rays in phototaxis is very clearly seen in the various groups of Protista and among the Flagellata and the swarm-spores, there is entire uniformity of response according to the testimony of COHN ('65, p. 36), STRASBURGER ('78, pp. 593-599), ENGELMANN ('82^a, p. 398, in *Euglena*), and VERWORN ('89^a, p. 49, in *Navicula*). Here the more actinic rays with shorter and more rapidly vibrating wave, act exactly like white light, whilst the rays from the opposite end of the spectrum have no more effect than darkness. More precise determinations were made by STRASBURGER ('78, p. 597), who found that the swarm-spores of the alga *Botridium* responded to the blue and violet, but especially to the indigo, whilst the green and ultra-violet were alike without effect. And ENGELMANN, by means of his microspectral apparatus, was able to determine that *Euglena* responded chiefly to the rays $\lambda = 0.47\mu$ to $\lambda = 0.49\mu$; that is, rays very near FRAUENHOFER'S line *F*. The colorless Myxomycetes agree with the chlorophyllaceous forms, according to BARANETZKI ('76, p. 332), in responding to blue rays only.

Among the higher organisms, *Hydra*, according to WILSON, accumulates especially behind blue glass, to a small extent behind green glass, and is entirely indifferent both to the upper violet rays and those below the green. The photophil starfish *Astracanthion rubens*, even when deprived of its eyes, was found by GRABER to be "cyanophil"; even, though in slight degree, to a low intensity of light. Among Mollusca, GRABER found that the photophil *Rissoa* moved towards the blue even when the intensity of the blue light was less than that of the red, and DRIESCH asserts that the photophob *Littorina rudis* shuns only blue rays. Thus, without multiplying cases, the results of experiments may be summed up as follows: positively phototactic or positively photopathic organisms are such only in the presence of the blue rays.

There are some few observations which are in apparent discord with this conclusion. Whether the ultra-violet rays are ever active is a fairly debatable question. LUBBOCK ('82,

p. 127; '84, p. 137) showed that *Daphnia*, and some ants are very sensitive to the violet rays, and GRABER ('83, p. 214) found that the photophobic earthworm withdraws from ultra-violet rays. This result is unusual, however, for most experimenters have agreed with this much of BERT'S ('78, p. 989) conclusions, that "the animals see . . . only those rays which we ourselves see," or, better, that the range of irritability of the protoplasm of our retina is as great as that of any other protoplasm.

Below the blue, some authors have believed the yellow rays, the brightest of the spectrum, to be prevalingly photopathic. Thus both BERT ('68, p. 381) and LUBBOCK ('83, p. 214) find that *Daphnia* accumulates especially in the yellow and green parts of the spectrum. Regarding these results I have only the comment that they need further confirmation.

c. Phototaxis vs. Photopathy. — We have hitherto assumed the existence of two dissimilar sorts of locomotor response to light — phototaxis and photopathy. Phototaxis we defined as migration in the direction of the light rays, and photopathy as migration towards a region of greater or less intensity of light. Are we justified in making this distinction?

The chief ground for this distinction is the existence of two sorts of phenomena which, not having been generally recognized as different, have led to extensive discussion. The best-established of these phenomena is phototaxis, which was proved to exist by certain crucial experiments of STRASBURGER on Protista, and of LOEB on Metazoa. Mr. W. B. CANNON and I have used STRASBURGER'S methods on *Daphnia*, and confirmed his results. Figure 59 gives a view of our apparatus, which was essentially the same as STRASBURGER'S. It consisted of a hollow prism *P*, containing a dark solution and placed over the trough *T*, with its organisms. STRASBURGER ('78, p. 585) put swarm-spores of *Botrydium* and *Bryopsis* into the trough, and reflected the light perpendicularly through the prism upon the trough. There was now a perfect gradation in intensity from the thick end to the thin edge of the prism. Yet the organisms showed no tendency to aggregate at the clearer end. The light was now permitted to enter the trough obliquely, the thicker end of the prism being next the source

of light, as in the figure. The spores now moved towards the source of light, *i.e.* in the direction of the infalling rays but constantly into a region of less intensity of light.

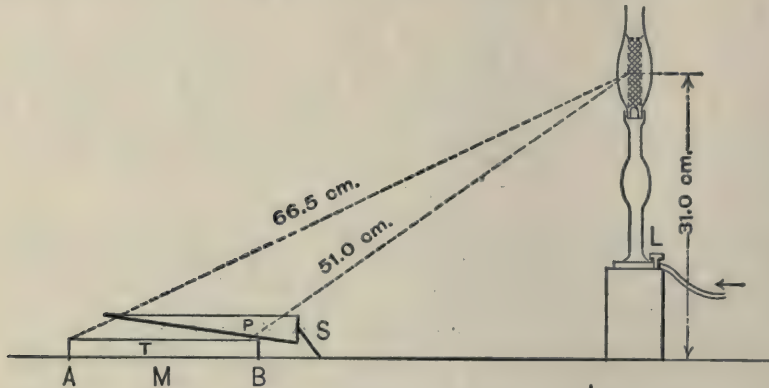

FIG. 59.—Diagram showing the position of apparatus and the direction of the rays in an experiment in phototaxis. *T*, trough of water containing organisms, *A* and *B* its two ends, *M* its middle. *P*, a prismatic box containing a solution of India ink. *S*, screen to cut off extraneous light. *L*, gas-lamp having a WELSBACH burner. Drawn to scale.

LOEB'S ('90, p. 32) results were obtained by the use of quite different methods. In one case he employed a chamber made of two test tubes placed with their mouths together. One of the tubes was darkened except for a clear streak at one end, *c*; and this darkened tube was pointed towards the light, so that the rays fell through its axis. Although the clear chamber was evidently the brighter, the *Porthesia* larvæ with which he experimented moved into the darkened chamber and thus towards the source of light (Fig. 60). Again, a clear test tube containing larvæ (Fig. 61) was placed so that its closed end *b* was directed towards the window *FF*. A bundle of sun's rays *SS* struck nearly perpendicularly the mouth of the tube *a*, when the larvæ were aggregated at the beginning. Nevertheless the larvæ, since their progress in the direction of the perpendicular rays was soon interrupted by the walls of the tube, moved towards the window, from the region of greater intensity of light in the direction of rays which passed more nearly in the axis of the tube. That this is not negative photopathy to strong light is indicated by the fact that the *Porthesia* larva is attuned to a high intensity of light. The evidence would thus seem satisfactory that the direction of migration of certain

organisms is determined by the direction of the light rays. There is, then, such a thing as phototaxis.

But is the direction of locomotion ever determined by a difference of intensity of light in adjacent regions, without reference to the direction of the light rays? Whole series of observations make this probable; for a migration to a definite part of the trough has followed unequal illumination by rays perpendicular to the trough. Thus LUBBOCK found that

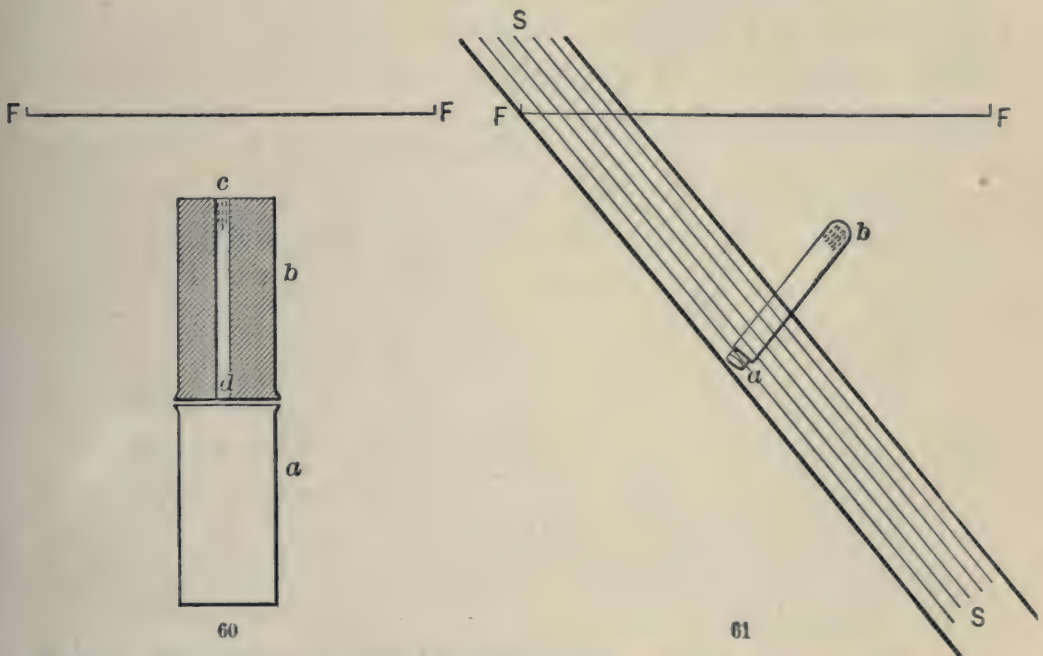

FIG. 60.—Two test tubes *a* and *b*, containing *Porthesia* larvæ *c*, which move towards the window *FF*, although in doing so they pass from a brighter to a darker region. (LOEB, '90.)

FIG. 61.—Diagram to show how *Porthesia* larvæ move in the test tube *ab* towards the window *FF*, although in doing so they leave the part of the tube more brightly illuminated by the sun's rays *SS*. (LOEB, '90.)

Daphnias, placed in a trough nearly perpendicular to the rays dispersed by a prism, moved towards the brighter part of the spectrum. GRABER employed screens of diverse translucency and color, which were placed adjacent to one another, and found that the organisms tended to aggregate opposite the one or the other. OLTMANN'S ('92, p. 195) has offered certain new experiments pointing in the same direction. These experiments were made upon *Volvox minor* and *Volvox globator*, which were placed in a trough between which and the source

of light a vertical screen was interposed. This screen formed one side of a wooden box and consisted of two glass plates making an angle of 2° with each other, the interspace being filled with a solution of India ink in gelatine. When the sunlight was let through this screen, the individuals in the trough behind it sorted themselves into two groups; the parthenogenetic individuals, which collected opposite the clearer part of the screen, and the female individuals, with fertilized eggs, which collected behind the darker part of the screen, each suiting itself to the intensity of light to which it was attuned. When the intensity of the light was changed, the organisms also changed their positions.

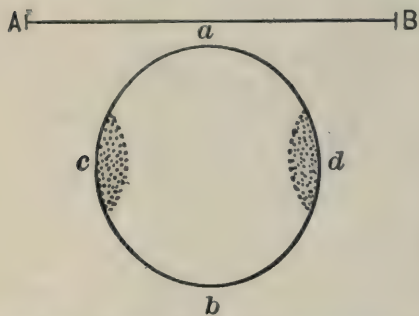

FIG. 62.—Diagram showing position taken by *Planaria torva* in a shallow cylindrical glass vessel *a, b, c, d*, placed opposite a window *AB*. (LOEB, '93.)

Finally, LOEB ('93, pp. 100–103) has found that fresh-water planarians (*Planaria torva*) gradually accumulate in the darker parts of the vessel, since the light constantly stimulates them to movement, and in their wanderings they gain the dark places by accident and there are at rest. So it comes about that when these *Planaria* are in a shallow cylindrical vessel (Fig. 62, *a, b, c, d*) in front of a window *AB*, they accumulate neither at the

side towards the window nor that away from it, but at *c* and *d*, where the side walls of the vessel cut off much of the light. All these cases, then, lead to one conclusion, that organisms may move with reference to more or less intense light—that there is such a thing as photopathy.

Indeed, a phototactic and a photopathic response may be exhibited by the same organism. Thus in CANNON'S and my experiments *Daphnia* was found to be phototactic, although other observers have clearly shown it to be photopathic, a result which we have not been able to disprove. We conclude, then, that some organisms have this double response to light that they may move in the direction of its rays, and that they may keep in a certain intensity of light to which they are attuned.

d. *The Mechanics of Response to Light.*—Under this head I shall speak of the part of the protoplasmic body most sensitive to light, of the immediate effect of the light, and of the cause of this immediate effect.

There can be no question that radiant energy with rapidly vibrating waves produces upon all protoplasm a profound effect. The question arises, however, to what extent in organisms a special kind of protoplasm is differentiated for the reception of rays which result in a discharge of the locomotor response. Certainly such a differentiated protoplasm can hardly be considered necessary to the discharge of such a response, since there is no morphological evidence of its existence in the responsive amoeba. However, even in the swarm-spores and Flagellata such a specialized protoplasm is clearly indicated. Thus ENGELMANN ('82*, p. 396) found that when a dark band fell across the body of a swimming Euglena, no reaction occurred so long as the hinder chlorophyllaceous part alone was shaded. When, however, the clear area at the base of the flagellum was shaded, a marked reaction occurred. Here, near the pigment spot, if not at it, is the specialized light-perceiving protoplasm.

Similarly specialized protoplasm occurs extensively in the higher groups in the form of retinas; but there is much evidence that in many eyeless Metazoa the whole surface contains such light-perceiving substances. This is well known to be the case in the earthworm (cf. HESSE, '96). According to DUBOIS, ('89, p. 233), the siphon of the boring mussel *Pholas dactylus* contracts at the least variation of light intensity upon the skin. Similarly, other Lamellibranchia (*Ostrea*, *Unio*, *Venus*) close their valves (NAGEL, '96, p. 58). Blinded *Helix* are said by WILLEM, ('91, p. 248) and NAGEL ('96, p. 19) to be similarly sensitive. The lamellibranch *Psammobia*, the blind *Proteus anguinus*, and the blinded *Triton cristatus* are irritated by rays of light, especially the blue rays, falling upon the skin (NAGEL, '96, p. 22; GRABER, '83, p. 233; DUBOIS, '90, p. 358). Thus, in many Metazoa, protoplasm sensitive to light is of widespread occurrence, outside of the retina.*

The *immediate visible effect of light* upon the organism differs

* For an extended list of cases of such dermatoptic reaction, see NAGEL, '96.

according to the form of the organism. In elongate, antero-posteriorly differentiated animals the first visible phototactic response is the orientation of the organism's axis in the direction of the impinging ray, and with the head end directed towards the source of light, or from that source, according as the organism is positively or negatively phototactic. The orientation is the more precise and the retention of the position the more sure the nearer the light approaches the optimum (attractive) or maximum (repellent) intensity, as the case may be. If two rays of different intensities making an angle with each other fall upon the organism, it apparently moves in the direction of the intenser ray, if free to do so.*

In *Amoeba*, without differentiated axes, the effect of the ray of light is to determine the position of the centrifugal streaming by which a pseudopod is thrown out away from the light; and the streaming continues in this single direction so long as conditions do not change. Thus the locomotion is in a straight line, lying in the ray of light.

Light not merely determines the direction of the axis but the position of the head end. As we have seen (p. 196) this determination of the position of the head depends upon the attunement of the organism, a quality which in turn varies with certain internal and external conditions. Acting upon a "highly attuned" protoplasmic mass, light will cause orientation in one sense; upon "lowly-attuned" protoplasm, an orientation in the opposite sense.

Whether light has any other effect than that of orientation of the body is a mooted question. STRASBURGER ('78, p. 577) and LOEB ('90, p. 109) recognize that migration from one point to another is more rapid in strong light than in weak, but believe this difference in rate of migration is wholly explicable upon the ground that the orientation is more precise in the stronger light, that there is less wandering from side to side. Some experiments made by Mr. CANNON and me upon *Daphnia* seem to confirm this view and at the same time afford quantitative data upon the degree of hastening. Thus in 18 trials *Daphnia*

* This statement is provisional only. It seems to follow from the experiments of LOEB made upon moths and described on page 197. The point is worthy of detailed comparative study.

required, to travel 18 cm. in full light, 15% longer time than the same individual required in light $\frac{1}{4}$ as strong. Since the increased time was only 15% instead of 300%, as it should be were rate proportional to intensity, it seems probable—a conclusion confirmed by the direct observation of the organisms in the trough—that the slower rate in the weaker light is due to less precise orientation. How would the rate be influenced by two lights of different intensities acting from opposite directions? Upon this matter we have no experimental data.

Light, then, serves to orient the organism; but how? This again leads us to the general question of the cause of the tactic response,—a question which must be referred to a later chapter. Certain special considerations may, however, be introduced here. Let us first think of the way in which light acts on the negatively phototactic (and photopathic?) earthworm. Repre-

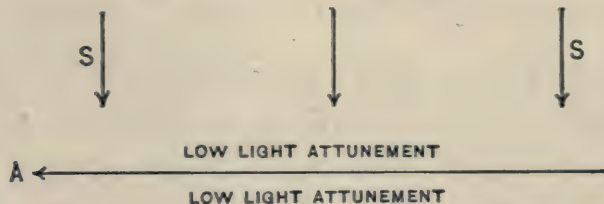

FIG. 63.—Diagram, representing sunlight (*SS*) falling upon an elongated, bilateral organism (represented by the arrow) whose head is at *A*. (Original.)

sent the worm by an arrow whose head indicates the head end (Fig. 63, *A*). Let solar rays *SS* fall upon it horizontally and perpendicularly to its axis. Then the impinging ray strikes it laterally, or, in other words, it is illuminated on one side and not on the other. Since, now, the protoplasm of both sides is attuned to an equal intensity of light, that which is the less illuminated is nearer its optimum intensity. Its protoplasm is in a phototonic condition. That which is strongly illuminated has lost its phototonic condition. Only the darkened muscles, then, are capable of normal contraction; the brightly illuminated ones are relaxed. Under these conditions the organism curves towards the darker side; and since its head region is the most sensitive, response begins there. Owing to a continuance of the causes, the organism will continue to turn from the light until both sides are equally illuminated; *i.e.* until it is in the light ray. Subsequent locomotion will carry the organism in a

straight line, since the muscles of the two sides now act similarly. Thus orientation of the organism is effected. The same explanation, which is modified from one of LOEB ('93, p. 86), will account, *mutatis mutandis*, for positive phototaxis.

Such an explanation can serve only for elongated organisms. The case of the amœba is quite different. Here we must think of the protoplasm as being modified by a light ray so as to flow centrifugally especially in that ray, perhaps through peculiar molecular disturbance wrought by the ray.

As for photopathic response, that is probably to be accounted for on the ground upon which ENGELMANN has explained the arrangement of *Bacterium photometricum* in the microspectrum; on the ground, namely, that increased brightness causes a movement forwards, that a diminution in brightness causes a movement backwards, or *vice versa*, thus resulting in the accumulation of the organisms in the darker or lighter parts of the field.

To summarize, then, light acts directly either through difference in intensity on the two sides of the organism, or by the course the rays take through the organism. Difference in intensity of light may also determine the position of organisms with reference to light by virtue of the irritation produced by rapid change of intensity.

SUMMARY OF THE CHAPTER

The study of the effect of light on protoplasm must be made quantitative as well as qualitative, and demands the use of apparatus for determining the quality and intensity of the light employed. The reactions produced by light upon protoplasm are undoubtedly of a chemical character, and, indeed, experiments with non-living organic compounds show that it has an important effect in synthesis, in analysis, in substitution, in the production of isomeric or polymeric conditions, and in fermentation. Since protoplasm consists of a large number of kinds of organic substances, we should expect light to produce far-reaching results, the more so as it can penetrate deep into the tissues of the organism.

The effect of light upon the general functions of organisms is

revealed in modifications of metabolism and of movement, and in the production of death. Upon metabolism we can distinguish an effect of the red rays, which are greatly absorbed by chlorophyll and are chiefly active in assimilation, and an effect of the blue rays, which seem to produce important chemical changes, increasing the production of carbon dioxide in plants, creating an electric current in the retina as it falls thereon, and bleaching visual purple. These chemical changes become more vigorous with increased intensity of light and may lead to death; while, at the opposite extreme, complete absence of light may prove fatal by withdrawing the necessary thermic and chemical energy. Again we find light sometimes necessary to movement in protoplasm, at other times by its absence or too great intensity inhibiting movement, or, again, by sudden change in intensity, creating abrupt changes in movement. Thus light undeniably has a great effect upon the processes of metabolism and movement.

Finally, in those complex processes involved in locomotion, light produces very widespread effects; for the direction (and, though only indirectly, perhaps, the rate) of locomotion is influenced in so important a way that when light is withdrawn the organism wanders aimlessly about. Of the various rays, those with wave length = 40μ to 49μ are the most active in controlling locomotion. Movement towards the light takes place at intensities of light varying greatly with the species and also with the conditions other than light in which the individual finds itself, — two factors upon which depends the degree of attunement. Light having an intensity above that to which the organism is attuned repels the organism. Two kinds of effects are produced by light: one by the direction of its ray — phototactic; the other by the difference in illumination of parts of the organism — photopathic.

We thus see that organisms respond to light, and that this response, exhibited in movements, is not of a widely different order from the disturbances produced in metabolism, which in turn are of the same order as the chemical changes produced by light in our laboratories upon non-living substances. In a word, response to light is the result of chemical changes in the protoplasm wrought by light.

LITERATURE

- ADERHOLD, R. '88. (See Chapter I, Literature.)
- ANDREWS, E. A. '91. Compound Eyes of Annelids. *Jour. of Morph.* V, 271-299. Sept. 1891.
- BARANETZKI, J. '76. Influence de la lumière sur les plasmodia des myxomycètes. *Mém. Soc. Sci. nat. Cherbourg.* XIX, 321-360.
- BEILSTEIN, F. '86-'93. *Handbuch der organischen Chemie.* Hamburg u. Leipzig. Voss. 2^{te} Au., Bd. II, III, 1886-1888; 3^{te} Auf., Bd. I, 1892, 1893.
- BERT, P. '68. Les animaux voient-ils les mêmes rayons lumineux que nous? *Mém. Soc. Sci. Bordeaux.* VI, 375-383.
- '70. Influence de la lumière verte sur la sensitive. *Comp. Rend.* LXX, 338-340. 14 Feb. 1870.
- '78. Influence de la lumière sur les êtres vivants. *Revue Scient.* XXI, 981-990. 20 Apr. 1878.
- BORODIN, '69. Ueber die Wirkung des Lichtes auf die Vertheilung der Chlorophyllkörner in den grünen Theilen der Phanerogamen. *Bull. de l'Acad. imp. St. Petersb.* XIII, 571 et seqq.
- BUCHNER, H. '92. Ueber den Einfluss des Lichtes auf Bakterien. *Centralbl. f. Bakteriol. u. Parasitenk.* XII, 217-219. 18 Aug. 1892.
- BUNSEN, R. and ROSCOE, H. E. '59. Photochemischer Untersuchungen. V. Die Sonne. *POGGENDORFF'S Annalen.* CVIII, 193-273.
- CHASTAING, P. '77. Étude sur la part de la lumière dans les actions chimiques et en particulier dans les oxydations. *Ann. de Chim. et Phys.* (5) XI, 145-223.
- CIENKOWSKI, L. '56. Zur Genesis eines einzelligen Organismus. *Bull. phys. math. Acad. St. Petersburg.* XIV, 261-267.
- COHN, F. '65. Ueber die Gesetze der Bewegung mikroskopischer Thiere und Pflanzen unter Einfluss des Lichtes. *Jahresber. d. Schles. Ges. f. väterl. Cult.* XLII, 35, 36.
- DARWIN, C. '81. *The Formation of Vegetable Mould through the Action of Worms, with Observations on their Habits.* New York: Appleton, 326 pp.
- DAVIDSON, J. '85. On the Influences of Some Conditions on the Metamorphosis of the Blowfly (*Musca vomitoria*). *Jour. Anat. and Phys.* XIX, 150-165. Jan. 1885.
- DOWNES, A. and BLUNT, T. P. '78. On the Effect of Light upon Bacteria and Other Organisms. *Proc. Roy. Soc. London.* XXVI, 488-500.
- '79. On the Influence of Light upon Protoplasm. *Proc. Roy. Soc.* XXVIII, 199-212.
- DRAPER, J. W. '44. On the Decomposition of Carbonic-acid Gas by Plants in the Prismatic Spectrum. *Am. Jour. Sci.* XLVI, 398-400. Also in his *Scientific Memoirs*, 1878, pp. 167-176.
- DRIESCH, H. '90. Heliotropismus bei Hydroidpolypen. *Zool. Jahrb., Abth. f. Syst.* V, 147. 3 May, 1890.

- DUBOIS, R. '89. Sur le mécanisme des fonctions photodermatique et photogénique, dans le siphon du *Pholas dactylus*. *Comp. Rend.* CIX, 233-235. 5 Aug. 1889.
- '90. Sur la perception des radiations lumineuses par le peau, chez les Protées aveugles des grottes de la Carniole. *Comp. Rend.* CX, 358-361. 17 Feb. 1890.
- DUCLAUX, E. '86. Sur les transformations chimiques provoquées par la lumière solaire. *Comp. Rend.* CIII, 881, 882. 8 Nov. 1886.
- '87. Sur la migration des matières grasses. *Ann. de l'Inst. PASTEUR.* I, 347-355.
- ELVING, F. '90. Studien über die Einwirkung des Lichtes auf die Pilze. Helsingfors. [From abstract in *Centralbl. f. Physiol.* V, 8, 9.]
- ENGELMANN, T. W. '79. Ueber Reizung contractilen Protoplasmas durch plötzliche Beleuchtung. *Arch. f. d. ges. Physiol.* XIX, 1-7.
- '81. Neue Methode zur Untersuchung der Sauerstoffausscheidung pflanzlicher und thierischer Organismen. *Arch. f. d. ges. Physiol.* XXV, 285-292. 20 June, 1881.
- '81^a. Zur Biologie der Schizomyceten. *Arch. f. d. ges. Physiol.* XXVI, 537-545. 23 Dec. 1881.
- '82. Ueber Sauerstoffausscheidung von Pflanzenzellen in Microspectrum. *Arch. f. d. ges. Physiol.* XXVII, 485-489. 7 June, 1882.
- '82^a. Ueber Licht- und Farbenperception niederster Organismen. *Arch. f. d. ges. Physiol.* XXIX, 387-400. 3 Nov. 1882.
- '83. Farbe und Assimilation. *Bot. Ztg.* XLI, 1-13, 17-29. Jan. 1883.
- '83^a. *Bacterium photometricum*. *Arch. f. d. ges. Physiol.* XXX, 95-124. Taf. I. 10 Jan. 1883.
- '84. Untersuchungen über die quantitativen Beziehungen zwischen Absorption des Lichtes und Assimilation in Pflanzenzellen. *Bot. Ztg.* XLII, 81.
- '85. Ueber Bewegungen der Zapfen und Pigmentzellen der Netzhaut unter dem Einfluss des Lichtes und des Nervensystems. *Arch. f. d. ges. Physiol.* XXXV, 498-508. 30 Jan. 1885.
- '86. Zum Technik und Kritik der Bakterienmethode. *Arch. f. d. ges. Physiol.* XXVIII, 386-400. 31 Nov. 1886.
- '87. Note sur l'assimilation chlorophyllienne. *Bull. Soc. Belg. de Micros.* XIII, 127-133.
- '88. Ueber Bacteriopurpurin und seine physiologische Bedeutung. *Arch. f. d. ges. Physiol.* XLII, 183-186. 3 Feb. 1888.
- '88^a. Die Purpurbakterien und ihre Beziehungen zum Lichte. *Bot. Ztg.* XLVI, 661-669, 667-689, 693-701, 709-720. Oct., Nov. 1888.
- ENTZ, '88. Studien über Protisten, I. Budapest: K. Ungar. Nat. Ges. 464 pp. [Quoted from VERWORN '89.]
- EXNER, S. '89. Durch Licht bedingte Verschiebungen des Pigmentes im Insectenaugen und deren physiologische Bedeutung. *Sb. K. Akad. Wiss., Wien.* XCVIII, Abth. 3, 143-151, 1 Taf. 1889.

- EXNER, S. '91. Die Physiologie der facettirten Augen von Krebsen und Insecten; Eine Studie. Leipzig. 206 pp., 7 Taf. 1891.
- FAMINTZIN, A. '67. Die Wirkung des Lichtes und der Dunkelheit auf die Vertheilung der Chlorophyllkörner in den Blättern von *Mium* sp.? *Jahrb. f. wiss. Bot.* VI, 49-54.
- FATIGATI, E. S. '79. Influence des divers couleurs sur le développement et la respiration des infusoires. *Comp. Rend.* LXXXIX, 959, 960. 1 Dec. 1879.
- FRANK, B. '72. Ueber die Veränderung der Lage der Chlorophyllkörner und des Protoplasmas in der Zelle, und deren innere und äussere Ursachen. *Jahrb. f. wiss. Bot.* VIII, 216-303.
- FRANKLAND, P. F. and WARD, H. M. '92. First report to the Water Research Committee of the Royal Society, etc. *Proc. Roy. Soc.* LI, 183-279. [Bibliography on effect of light on bacteria, 237-239.]
- GLAN, P. '77. Ueber ein neues Photometer. *Ann. de Phys. et Chim.* (2) I, 351-601, Taf. III.
- GRABER, V. '83. Fundamentalversuche über die Helligkeits- und Farbenempfindlichkeit augenloser und geblendeter Thiere. *Sb. K. Akad. Wiss., Wien.* LXXXVII, Abth. 1, 201-236.
- '85. Ueber die Helligkeits- und Farbenempfindlichkeit einiger Meerthiere, *Sb. K. Akad. Wiss., Wien.* XCI, Abth. 1, 129-150.
- GRANT, R. E. '29. On the Influence of Light on the Motions of Infusoria. *Edinb. Jour. of Sci.* X, 346-349.
- GREEN, R. '94. The Influence of Light on Diastase. *Ann. of Bot.* VIII, 370-373.
- GROOM, T. T. and LOEB, J. '90. Der Heliotropismus der Nauplien von *Balanus perforatus* und die periodischen Tiefenwanderungen pelagischer Tiere. *Biol. Centralbl.* X, 160-177.
- HELMHOLTZ, H. v. *Handbuch der Physiologische Optik.* 2te Aufl. Hamburg and Leipzig: Voss.
- HERRICK, F. H. '96. The American Lobster: A Study of its Habits and Development. *Bull. U. S. Fish Commission for 1895.* pp. 1-252, Pls. A-J and 1-54.
- HESSE, R. '96. Untersuchungen über die Organe der Lichtempfindung bei niederen Thieren. I. Die Organe der Lichtempfindung bei den Lumbriciden. *Zeitschr. f. wiss. Zool.* LXI, 393-419. 23 June, 1896.
- HIERONYMUS, G. '92. Beiträge zur Morphologie und Biologie der Algen. *Beitr. z. Biol. d. Pflanz.* V, 461-495, Taf. 17-18.
- HOFMEISTER, W. '67. (See Chapter IV, Literature.)
- KELLER, R. '95. Ueber den Farbenwechsel des Chameleons und einiger anderer Reptilien. *Arch. f. d. ges. Physiol.* LXI, 123-168. 24 June, 1895.
- KLEBS, G. '85. Ueber Bewegung und Schleimbildung der Desmidiaceen. *Biol. Centralbl.* V, 353-367. 15 Aug. 1885.
- KLEIN, L. '85. Ueber die Ursachen der ausschliesslich nächtlichen Sporenbildung von *Botrytis cinerea*. *Bot. Ztg.* XLIII, 6-15. 2 Jan. 1885.

- KLINGER, H. and STANDKE, O. '91. Ueber die Einwirkung des Sonnenlichtes auf organische Verbindungen. Ber. Chem. Ges. Berlin. XXIV, 1340-1346. 11 May, 1891.
- LACAZE-DUTHIERS '57. Histoire de l'organisation et du développement du Dentale. III Partie. Mœurs du Dentale. Ann. des Sci. Nat. (Zool.), (4) VIII, 18-28.
- LANGLEY, S. P. '84. Researches on Solar Heat and its Absorption by the Earth's Atmosphere. Profess. Papers Sig. Serv. XV, 242 pp. Washington, Gov't Print. Office. 1884.
- LEA, S. '85. On the Comparison of the Concentrations of Solutions of Different Strength of the Same Absorbing Substance. Jour. of Physiol. V, 239-246. Feb. 1885.
- LOEB, J. '88. Die Orientirung der Thiere gegen das Licht (Thierischer Heliotropismus). Sb. d. phys.-med. Ges., Würzburg, Jg. 1888, pp. 1-5.
- '90. Der Heliotropismus der Thiere und seine Uebereinstimmung mit dem Heliotropismus der Pflanzen. Würzburg: G. Hertz. 118 pp.
- '93. Ueber künstliche Umwandlung positiv heliotropischer Thiere in negativ heliotropische und umgekehrt. Arch. f. d. ges. Phys. LIV, 81-107.
- LUBBOCK, J. '82. On the Sense of Color among Some of the Lower Animals. Part I. Jour. Linn. Soc. (Zool.). XVI, 121-127. Jan. 26, 1882.
- '83. The same, Part II. Jour. Linn. Soc. XVII, 205-214. Aug. 14, 1883.
- '84. (See Chapter I, Literature.)
- MARSHALL, W. '82. Die Ontogenie von Reniera filigrana O. Schm. Zeitsch. f. wiss. Zool. XXXVII, 221-246. 27 Sept. 1882.
- MASSART, J. '91. (See Chapter I, Literature.)
- MAYER, A. G. '93. The Radiation and Absorption of Heat by Leaves. Am. Jour. Sci. XLV, 340-346. April, 1893.
- MENGARINI, G. '89. Ueber das Maximum der Lichtstärke im Sonnenspectrum. Unters. z. Naturlehre. XIV, 119-137.
- MOORE, S. LEM. '87. Studies in Vegetable Biology. III. The Influence of Light upon Protoplasmic Movement, Part I. Jour. of Linn. Soc. (Bot.). XXIV, 200-251, Pl. V. 30 Nov. 1887.
- '88. The same, Part II. Jour. of Linn. Soc. (Bot.). XXIV, 351-389, Pls. XIII-XV. 8 Aug. 1888.
- NAGEL, W. A. '96. Der Lichtsinn augenloser Thiere. Jena: FISCHER.
- NÄGELI, C. '60. (See Chapter VIII, Literature.)
- NICKLES, J. '65. Influence of Light on the Production of Proto-organisms. Am. Jour. Sci. (2) XXXIX, 81-83. Jan. 1865.
- NIEPCE DE SAINT VICTOR and CORVISART, L. '59. De la fécule végétale et animale sous la rapport de l'influence transformatrice qu'exerce sur elle la lumière solaire, etc. Comp. Rend. XLIX, 368-371. 5 Sept. 1859.
- OLTMANN, F. '92. Ueber die photometrischen Bewegungen der Pflanzen. Flora. LXXV, 183-266. Taf. IV.

- ONIMUS, E. '95. Pénétration de la lumière dans les tissus vivants. C. R. Soc. de Biol. Paris. XLVII, 678, 679. 26 Oct. 1895.
- PARKER, G. H. '95. The Retina and Optic Ganglia in Decapods, especially in *Astacus*. Mitth. Zool. Stat. Neapel. XII, 1-73, Pls. I-III.
- PFEFFER, W. '71. Die Wirkung farbigen Lichtes auf die Zersetzung der Kohlensäure in Pflanzen. Arb. bot. Inst. Würzburg. I, 1-76.
- POUCHET, G. '72. De l'influence de la lumière sur les larves de diptères privées d'organes extérieurs de la vision. Rev. et Mag. de Zool. (2) XXIII, 110-117; 129-138; 183-186; 225-231; 261-264; 312-316. March-August, 1872.
- POULTON, E. B. '87. Notes in 1886 upon Lepidopterous Larvæ, etc. Trans. Ent. Soc. Lond. for 1887. pp. 281-321, Pl. X. Sept. 1887.
- PRINGSHEIM, N. '80. Ueber Lichtwirkung und Chlorophyllfunction in der Pflanze. Jahrb. f. wiss. Bot. XII, 288-437. Taf. XI-XXVI.
- '81. Ueber die primären Wirkung des Lichtes auf die Vegetation. Monatsber. Akad. Wiss., Berlin, Jahre 1881. pp. 504-534.
- RAUM, J. '89. Die gegenwärtige Stand unserer Kenntnisse über den Einflusse des Lichtes auf Bacterien und auf den thierischen Organismen. Zeitschr. f. Hygiene. VI, 312-368.
- RAYLEIGH, LORD, '81. Experiments on Color. Nature. XXV, 64-66. 17 Nov. 1881.
- REINKE, J. '83. Untersuchungen über die Einwirkung des Lichtes auf die Sauerstoffausscheidung der Pflanzen. I. Mitt. Bot. Ztg. XVI, 697-707; 713-723; 732-738.
- '84. The same. II. Mitt. Bot. Ztg. XLII, 1-10; 17-29; 33-46; 49-59. Jan. 1884.
- SACHS, J. '76. Ueber Emulsionsfiguren und Gruppierung der Schwärmsporen im Wasser. Flora. LIX, 241-248; 257-264; 273-281.
- '60. Ueber die Durchleuchtung der Pflanzentheile. Sb. K. Akad. Wiss., Wien. XLIII, Abth. 1. 6 Dec. 1860. [Also in his Gesammelte Abh. über Pflanzen-physiol. I, 167.]
- '64. Wirkungen farbigen Lichts auf Pflanzen. Bot. Ztg. XXII, 353-358, 361-367, 369-372. Nov., Dec. 1864. [Also in his Ges. Abh. I, 261-292.]
- '92. Gesammelte Abhandlungen über Pflanzenphysiologie. I Bd. Leipzig, Engelmann.
- SEITZ, A. '90. Allgemeine Biologie der Schmetterlinge. Zool. Jahrb. Abth. f. Syst. V, 281-343. 19 July, 1890.
- SOROKIN, N. '78. Grundzüge der Mykologie mit Uebersicht der Lehre über die Infectionskrankheiten. Bd. I, Hft. 1, 511 pp. Kasan [Russian. Only the Abstract in Botan. Jahresber. VI (1878), 1 Abth., p. 471, has been seen.]
- STAHL, E. '78. Ueber den Einfluss des Lichtes auf die Bewegungserscheinungen der Schwärmsporen. Verh. phys.-med. Ges. Würzburg. XII, 269, 270.

- STAHL, E. '79. Ueber den Einfluss des Lichtes auf die Bewegungen der Desmidien nebst einigen Bemerkungen über den richtenden Einfluss des Lichtes auf Schwärmosporen. Verh. phys.-med. Ges. Würzburg. XIV, 24-34.
- '80. Ueber den Einfluss von Richtung und Stärke der Beleuchtung auf einige Bewegungserscheinungen im Pflanzenreiche. Bot. Ztg. XXXVIII, 297 et folg. April-June, 1880.
- '84. Zur Biologie der Myxomyceten. Bot. Ztg. XLII, 145-155, 161-175, 187-191. March, 1884.
- STEFANOWSKA, M. '90. La disposition histologique du pigment dans les yeux des Arthropodes sous l'influence de la lumière directe et de l'obscurité complète. Recueil Zool. Suisse. V, 151-200. Pls. VIII, IX. 15 July, 1890.
- STEINACH, E. '91. Ueber Farbenwechsel bei niederen Wirbelthieren bedingt durch directe Wirkung des Lichtes auf die Pigmentzellen. Centralbl. f. Physiol. V, 326-330. 12 Sept. 1891.
- '92. Untersuchungen zur vergleichenden Physiologie der Iris. Arch. f. d. ges. Physiol. LII, 495-525. 28 July, 1892.
- STRASBURGER, E. '78. Wirkung des Lichtes und der Wärme auf Schwärmosporen. Jena. Zeitschr. XII, 551-625.
- STREIT, G. and FRANZ, B. '70. Einwirkung von Chlor auf absoluten Alkohol bei Sonnenlicht. Jour. prakt. Chem. CVIII, 61, 62. 13 Jan. 1870.
- SZCZAWINSKA, V. '91. Contribution à l'étude des yeux de quelques Crustacés et recherches sur les mouvements du pigment granuleux et des cellules pigmentaires sous l'influence de la lumière et de l'obscurité dans les yeux des Crustacés et des Arachnides. Arch. de Biol. X, 523-566. 31 March, 1891.
- TIMIRIAZEFF '77. Recherches sur la decomposition de l'acid carbonique dans le spectre solaire par les parties vertes des végétaux. Ann. de Chim. et de Physiq. (5) XII, 335-396.
- '90. Enregistrement photographique de la fonction chlorophyllienne par la plante vivante. Comp. Rend. CX, 1346-1347. 23 June, 1890.
- TREMBLEY, A. 1744. Mémoires pour servir à l'histoire d'un genre de polypes d'eau douce, à bras en forme de cornes. Leyden. 324 pp., 13 pls. 1744. [The reference is to the end of the first memoir.]
- VERWORN, M. '89. (See Chapter I, Literature.)
- '95. (See Chapter IV, Literature.)
- VIERORDT, K. '73. Die Anwendung des Spectralapparates zur Photometrie der Absorptionsspectren und zur quantitativen chemischen Analyse. 169 pp., 6 Taf. Tübingen: Laupp.
- VOGEL, H. C. '77. Spectral-photometrische Untersuchungen insbesondere zur Bestimmung der Absorption der die Sonne umgebenden Gashülle. Monatsber. Akad. Wiss., Berlin. Jg. 1877, pp. 104-142, Taf. I.
- WARD, H. M. '93. Experiments on the Action of Light on Bacillus anthracis. Proc. Roy. Soc., London. LII, 393-400. 10 Feb. 1893.

- WARD, H. M. '93^a. Further Experiments on the Action of Light on *Bacillus anthracis*. Proc. Roy. Soc. LIII, 23-44.
- '94. The Action of Light on Bacteria. III. Proc. Roy. Soc. LIV, 472-475.
- '94^a. Further Experiments on the Action of Light on *Bacillus anthracis* and on the Bacteria of the Thames. Proc. Roy. Soc. LVI, 315-394.
- WETTSTEIN, R. v. '85. Untersuchungen über einen neuen pflanzlichen Parasiten des menschlichen Körpers. Sb. K. Akad. wiss. Wien. XCI, 1 Abth., 33-58.
- WILLEM, V. '91. La vision chez les Gastropodes pulmonés. Comp. Rend. CXII, 247, 248. 26 Jan. 1891.
- WILSON, E. B. '91. The Heliotropism of Hydra. Am. Nat. XXV, 413-433.
- WINOGRADSKY, S. '87. Ueber Schwefelbakterien. Bot. Ztg. XLV, 489 et folg. Aug.-Sept. 1887.
- YUNG, É. '78. Contributions à l'histoire de l'influence des milieux physiques sur les êtres vivants. Arch. de Zool. VII, 251-282.

CHAPTER VIII

ACTION OF HEAT UPON PROTOPLASM

IN this chapter it is proposed to consider (I) briefly, the nature of heat and the general methods of its application; (II) the action of heat upon the general functions of organisms; (III) the temperature-limits of life; (IV) the acclimatization of organisms to extreme temperature, and (V) the determination of the direction of locomotion by heat — thermotaxis.

§ 1. NATURE OF HEAT AND THE GENERAL METHODS OF ITS APPLICATION

Heat is believed to be due to the vibrations of the molecules of bodies. In any heated solid, fluid, or gaseous mass the molecules are in constant motion. When the temperature is increased, the motion is increased, and the impacts of the flying molecules become more frequent. If a vessel containing water is brought into contact with warmer air or warmer fluid, its molecules fly faster, its temperature is raised. As the motion of the molecules in the walls of the vessel increases, the increased motion is transmitted to the contained water, and finally to the objects in the water. Thus the motion of the molecules of an organism in the water is increased with the increase of the temperature of the water. Heat, as so-called radiant heat, is transmitted through space in straight lines, and follows all the laws of light, into which it passes when the rate of wave vibrations becomes rapid enough to affect the retina. The chief effects of radiant heat were considered in the last chapter.

Heat is an important element in all chemical processes. The state of cohesion — solid, liquid, gaseous — and the ease with

which molecular decomposition and synthesis occur, vary directly with it. This is an important consideration in our study of protoplasm, for most of its changes are chemical changes.

A word should be said concerning general methods of applying heat to protoplasm. In the case of the higher plants and

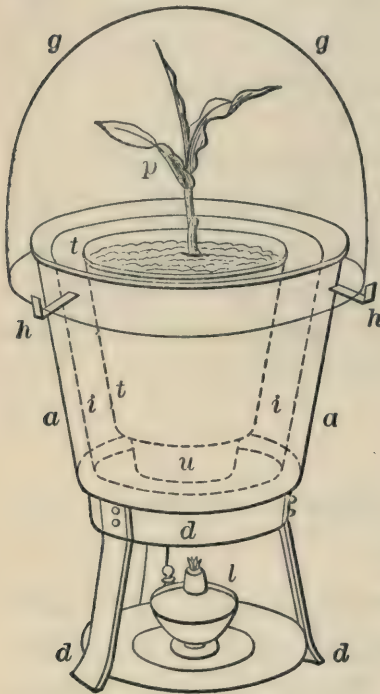

FIG. 64. — Apparatus for studying the effect of heat upon germination in phanerogams. *a*, the external; *i*, the internal vessel, between which is a water space; *t*, flower-pot filled with earth and containing a seedling of maize *p*; *h*, three supports for the glass bell *g*; *u*, support for the flower-pot; *d*, tripodal iron stand carrying the spirit-lamp *l*. (From SACHS, '92.)

seedlings, the device of SACHS ('92, p. 117) may be employed. This consists of two metallic vessels, *a* and *i* (Fig. 64), of similar form, one placed inside of the other, the interspace being filled with water. Within the inner vessel is placed the pot (*t*) with the object of experimentation. The whole is covered over by a half globe of glass (*g*), extending down to below the level of the top of the pot. The water is heated by a lamp (*l*) below, by which means moisture and warmth are carried to the plant.

In the case of the lower organisms, brief experiments may be conducted in shallow aquaria for the horizontal microscope (Fig. 65), like those devised by CORI ('93). It is preferable to put inside of the outer vessel a smaller glass vessel, which shall contain the organisms and the thermometer marking the temperature of the water. For long-continued experiments where constant high temperature is required,

a warm oven, such as is used in bacteriological work, is essential.

The production of extremely low temperatures offers special difficulties. For temperatures to -40° or so, various freezing mixtures can be employed. Of these chopped ice and common salt in equal parts give a temperature of -18° ; calcium chloride and snow, in proportions of 3 to 2, give -33° ; and calcium chloride and snow, in the proportion of 2 to 1, give -42° ,

the initial temperature being always supposed to be 0° . Far lower temperatures than these have been obtained by physicists, notably PICTET, to whose work we shall refer again

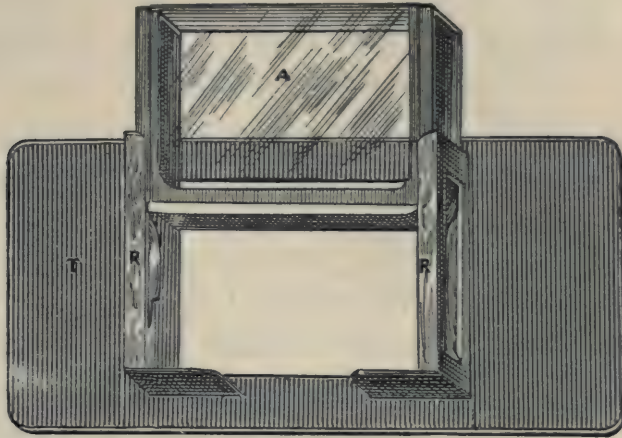

FIG. 65. — CORI'S stage aquarium. *A*, the aquarium proper; *T*, holder for the aquarium; *R, R*, slides, with springs. (From CORI, '93.)

(p. 240). The organisms to be acted upon may be kept in an apparatus (Fig. 66) like that employed by POUCHET ('66).

Throughout this chapter, as indeed throughout the whole book, thermometric readings are given in Centigrade scale,

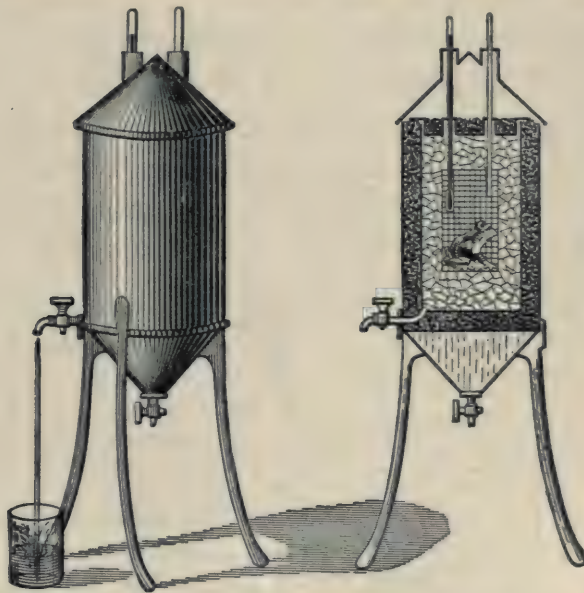

FIG. 66. — Cold chamber seen in external view and in section. The wall is composed of an inner cylinder containing the freezing mixture and the receptacle for the object of experimentation, and an outer cylinder separated from the inner by a packing of fragments of charcoal. The receptacle containing the organism is provided with a thermometer and an air tube. (From POUCHET, '66.)

unless otherwise stated. All readings not designated by the — sign are above the Centigrade 0 point. The point of absolute 0, to which we may have occasion to refer, is -273° C.

§ 2. THE EFFECT OF HEAT UPON THE GENERAL FUNCTIONS OF ORGANISMS

Under this topic will be considered (1) the effect upon metabolism, and (2) the effect upon movement and irritability.

1. **Effect of Heat upon Metabolism.** — Within certain limits the relative increase of temperature leads to a relative increase in the activity of the various metabolic processes. This is well seen in those chemical changes which produce so-called *phosphorescence*. Many years ago MACAIRE ('21, p. 157) showed for fireflies, and ARTAUD ('25, p. 372) for the organisms of the sea, that light begins to appear shortly above 20° , reaches its maximum intensity at 40° in the fireflies and 35° in the water organisms, and entirely disappears at 59° to 62° in the first case, and 43° in the second. The temperature of these three points — lowest temperature of metabolic activity, temperature of greatest activity, and highest temperature permitting of activity — may be called, respectively, the minimum, optimum, and maximum temperatures for phosphorescence.

The effect of temperature on metabolism is seen in the *absorption of oxygen* by organisms. Thus VON WOLKOFF and MAYER ('74) found that more oxygen is absorbed by seedlings, as the temperature is increased, from 0° to about 35° C. This is shown in the following table. (From VINES, '86, p. 198.)

FIVE NASTURTIUM SEEDLINGS.		FOUR WHEAT SEEDLINGS.	
TOTAL AMOUNT OF O ABSORBED PER C.C.	TEMPERATURE C.	TOTAL AMOUNT OF O ABSORBED.	TEMPERATURE C.
0.60	22.4°	0.10	15.6°
0.77	27.0°	0.038	4.4°
0.76	30.5°	0.067	9.8°
0.77	30.0°	0.088	15.4°
1.04	35.0°	0.022	0.3°
0.91	38.2°	0.010	0.1°

Likewise MOISSAN ('79, p. 296) found that, in the dark, the amount of oxygen absorbed by a branch of certain plants varied with the temperature. Thus there was absorbed per hour by

Pinus pinaster (30 grammes) . . .	{ at 0° C.,	0.32 c.c.
	{ at 13°,	1.30 c.c.
	{ at 15°,	1.90 c.c.
Agave americana (70 grammes) . . .	{ at 11° C.,	0.54 c.c.
	{ at 40°,	5.56 c.c.

These experiments serve to show clearly that in plants more oxygen is absorbed as the temperature is raised to the optimum.

The same result is obtained from animals also. Thus TRE-VIRANUS ('31, p. 23) found that the honey bee *Apis mellifica* absorbed at 14° C. 1.35 Paris cubic inches, and at 27.5°, 2.77 cubic inches of oxygen. At the higher temperatures the bee was very active, so that the result seems here somewhat complicated by the increased muscular activity accompanying a higher temperature, which invokes a more rapid respiration. Nevertheless, the phenomena of increased oxygen absorption with higher temperature are fundamentally the same in plants and animals.

Turning now to the process of *excretion*, it appears that the amount of CO₂ evolved by seedlings varies with the temperature. On this point we have data by DEHERAIN and MOISSAN ('74, p. 327), RISCHAWI ('77), and others. DEHERAIN and MOISSAN experimented with leaves of tobacco kept in the dark. The same plant was used throughout the experiment, and it remained throughout in good condition. In the following table the temperatures are given in the first column, and, in the second, the number of grammes of CO₂ produced per 100 grammes of leaves: —

TEMP.	Gms. CO ₂ .	TEMP.	Gms. CO ₂ .	TEMP.	Gms. CO ₂ .	TEMP.	Gms. CO ₂ .
7	0.031	15	0.165	20	0.263	40	0.961
13	0.139	18	0.178	21	0.289	41	1.132
14	0.157	19	0.193	32	0.514	42	1.325

When plotted (with the temperatures as abscissæ) the relation between temperature and weight of CO₂ produced is expressed

by a line which is slightly steeper at the higher temperatures than at the lower. This change of steepness is, however, much less striking in the case of the etiolated wheat seedlings studied by RISCHAWI, where the following series was obtained: —

TEMPERATURE.	WEIGHT CO ₂ IN MG.	TEMPERATURE.	WEIGHT CO ₂ IN MG.
5°	3.30	25°	17.82
10°	5.28	30°	22.04
15°	9.90	35°	28.38
20°	12.54	40°	37.60

The evidence from excretion thus also confirms the conclusion that the metabolic processes are accelerated by raising the temperature to a certain limit.

The effect of heat in the metabolic process of chlorophyll formation is shown in some plants upon which SACHS ('64) experimented. He prepared three culture chambers, all illuminated by a north light. *A* was kept at a high temperature, namely, 30° to 34° C.; *B* was kept at a temperature of 16° to 20° C., and *C* at 8° to 14° C. Into these chambers were put etiolated seedlings of *Phaseolus multiflorus* (bean) and *Zea mais* (maize) which had been reared in the dark. The first traces of turning green appeared in *A* after 1½ hours; in *B* after 2 to 5 hours; whilst in *C* no trace of greening appeared until several days had passed. Thus it appeared that at the temperature of 8° to 14° C. chlorophyll is hardly produced.

We now pass to the consideration of some Protista. An indication, at least, that the rate of metabolism is increased with temperature is gained from the increased rapidity of formation of the contractile (excreting) vacuoles of Ciliata under these conditions. Thus, ROSSBACH ('72, p. 33) found that the rapidity of the rhythmic movements of the contractile vacuole is most intimately related with the temperature of the body, so that one and the same species of animal under normal conditions always has, at a given temperature, the same number of contractions. From the number of the rhythmic contractions one can therefore draw a certain conclusion concerning the existing degree of temperature. This relation between

temperature and interval between contractions is given in Fig. 67. We cannot say that the increment of excretion is exactly equal to that of contraction, but there is doubtless a correlation between the two activities.

From all these facts we may conclude that, within certain limits, an increase of temperature increases metabolism, and a diminution of temperature diminishes it. But the increment in metabolic processes soon finds a limit at a temperature above which the metabolic processes begin to diminish.

2. Effect of Heat upon the Movement of Protoplasm and its Irritability.—All observers (DUTROCHET, '37, pp. 777, 778; NÄGELI, '60, p. 77; SACHS, '64; HOFMEISTER, '67, pp. 53, 54; and COHN, '71, for plant cells; and KÜHNE, '59, p. 821; and SCHULTZE, '63, p. 46, for Protozoa) agree that a gradual increase in temperature above that of the ordinary living room results, within certain limits, in an increase in the rate of movement of the protoplasm. A diminution in temperature, on the contrary, causes a decrease in the movement.

For this acceleration with increased temperature, NÄGELI sought to obtain a quantitative expression. He measured the time consumed at different temperatures in the migration through 0.1 mm. of the granules floating in the stream of protoplasm seen in the end cells of *Nitella syncarpa*. Some

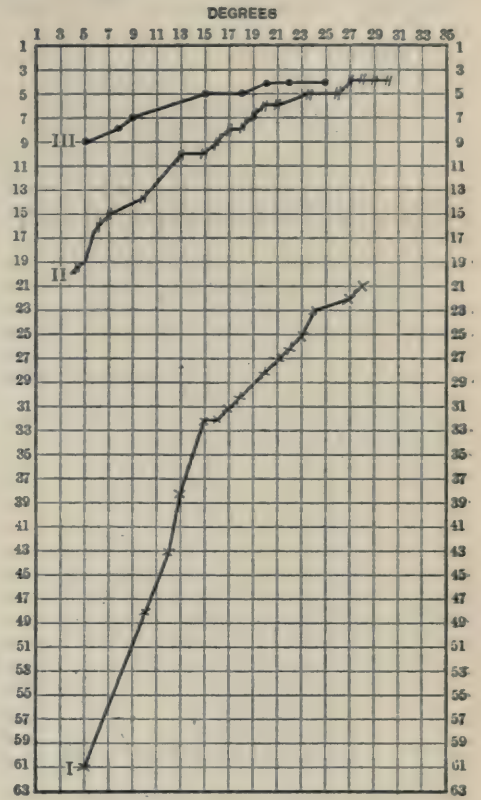

FIG. 67.—The mean thermal curves determined by ROSSBACH for the contractile vesicle of Infusoria. I, for *Euplotes charon*; II, for *Stylonychia pustulata*; III, for *Chilodon cucullulus*. The abscissæ indicate degrees of temperature, Centigrade, in two-degree intervals; the ordinates give the number of seconds elapsing between successive contractions of the vesicle, in two-second intervals. (From SEMPER, "Animal Life.")

measurements were made, also, by SCHULTZE, on *Tradescantia* hairs. But the work of neither of these equals in importance the determinations of VELTEN ('76), which I propose to give in some detail. He determined the time consumed by the

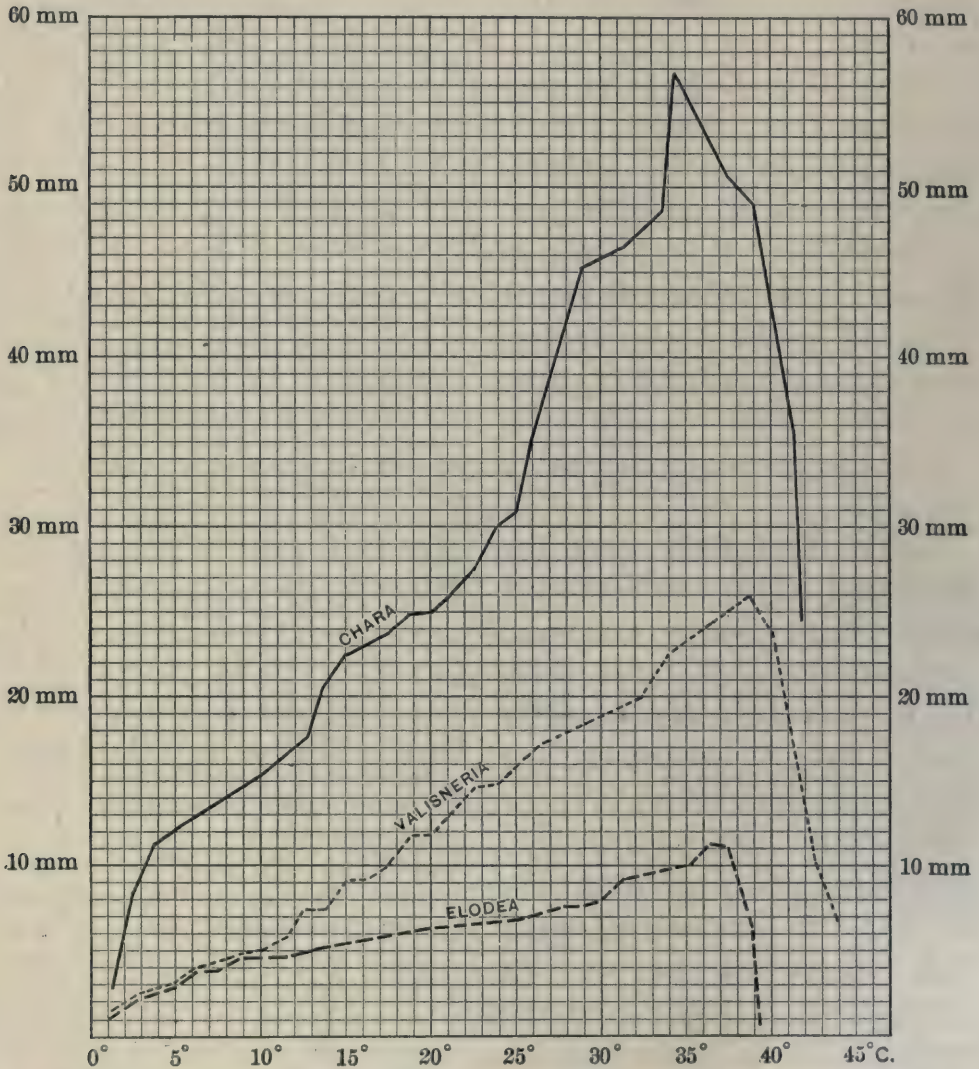

FIG. 68. — Curves showing the relation between temperature (abscissæ) and rate of movement per minute of the chlorophyll grains floating in the protoplasm of the cells of three species of green plants. (Data from VELTEN, '76.)

floating chlorophyll grains in cells of *Elodea canadensis* and *Vallisneria spiralis*, or the small granules near the wall of cells of *Chara* in traversing 0.1 mm., at various temperatures. The results in modified form are given graphically for these three species in Fig. 68. In this figure, the ordinates represent distance (in millimetres) traversed in 1 minute. The abscissæ

represent temperatures (Centigrade) from 0° on the left to 44° on the right. The rate of movement increases regularly up to a maximum (the optimum), a rise of 1°C. being associated with an increased rate of movement in *Chara* of 1.4 mm.; in *Vallisneria* of 0.62 mm.; in *Elodea* of 0.26 mm. The rate of increase is, in general, slightly greater near the optimum. The optimum varies, in the three species, from 34° to 39° . Beyond the optimum the rate rapidly decreases, cessation of movement being reached, in the case of *Elodea*, in 3.7° , in *Vallisneria* in 6.2° , in *Chara* in 8.4° beyond the optimum. The curves exhibited in Fig. 68 are characteristic of other vital functions besides motion, and illustrate this general law, that the optimum temperature for the vital activities lies much nearer to the maximum vital temperature than to the minimum.

After having seen that the rate of flow of protoplasm is dependent upon temperature, we should expect to find, as we do, that that other form of protoplasmic motion, cilia vibration, would be likewise dependent. Some quantitative data concerning relation of temperature and rate of vibration were gained as early as 1858 by CALLIBURCÈS. He placed a bit of ciliated membrane from the frog's œsophagus in a moist chamber, and in contact with the cilia he laid a small glass cylinder, horizontally supported, and provided with a dial by which its revolutions could be counted. He found that the mean time for a revolution was,—

at 12° to 19°C.	22 minutes, 3 seconds;
at 28°C.	3 minutes, 7 seconds;

thus, in increasing the temperature from 15° to 28°C. , the rate of vibration is increased sevenfold.

Essentially similar results were obtained, through the use of new methods, by ROTH ('66, pp. 185–189), upon the ciliated epithelium of the frog's uterus, rabbit's trachea, and gill of *Anodonta*, and by ENGELMANN ('68, pp. 381–384; 443, 444; 454, 455; and '77), upon the frog's œsophagus. The simplest of these methods was to determine the rate of the transportation of fine particles over the surface of the tissue. The result of these studies showed that the optimum temperature for the

movements of Vertebrate cilia lies between 35° and 40° C., and that a gradual elevation of temperature to this point is accompanied by gradual increase in the rapidity of the stroke, the law of which is exhibited in the curves shown in Figs. 69 and 70.

This variation in rate and regularity of cilia movement with change in heat is marked in Infusoria, as ROSSBACH ('72, p. 312)

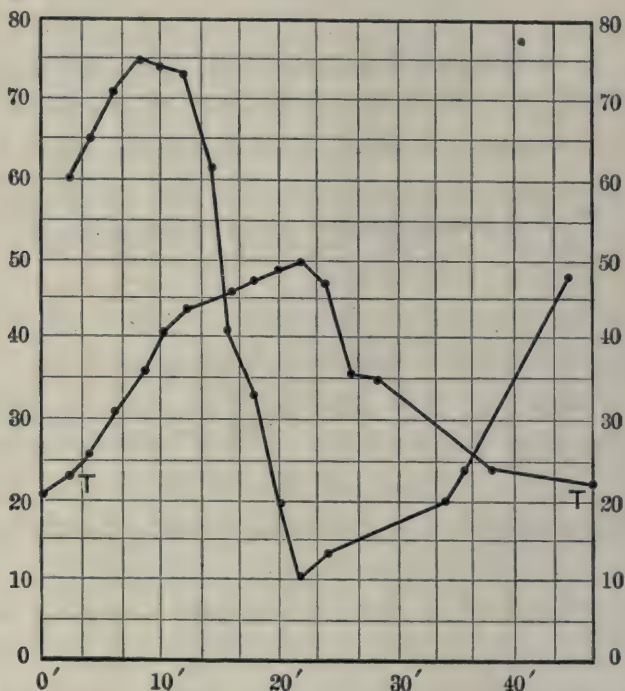

FIG. 69.—Curves showing relation between temperature (curve *TT*) and rapidity of movement of the cilia of the mouth and œsophagus of the frog. The abscissæ give, in minutes, the lapse of time from the beginning of the experiment. The ordinates give, for the temperature curve, the degrees Centigrade, and, for the other curve, the corresponding number of units of motor activity for the immediately preceding 2 minutes as registered by ENGELMANN'S apparatus. (From ENGELMANN, '77.)

and SCHURMAYER ('90, pp. 411, 412) have shown. The lower the temperature falls below 15° C., the slower the locomotion, almost ceasing at $+4^{\circ}$. Upon raising the temperature above 15° , motion quickens, until, between 25° and 30° , motion reaches a maximum, the Ciliata shooting back and forth with the quickness of an arrow. Between 30° and 35° , the movements become still more violent, and take on a new character. They are no longer coördinated. Towards 40° , the progres-

sive movement becomes slower, and finally ceases, while the rotation continues, but in ever diminishing rapidity. A new axis of rotation is assumed, running lengthwise and obliquely, or running transversely, in the short axis of the body. Finally, somewhere between 38° and 40° , motion ceases. Thus, the optimum temperature for the activities of the protoplasm lies at about 30° C., and the maximum temperature is perhaps 10° higher.

The experiments upon plant protoplasm, amœboid organisms, and ciliated cells thus agree in demonstrating a close relation be-

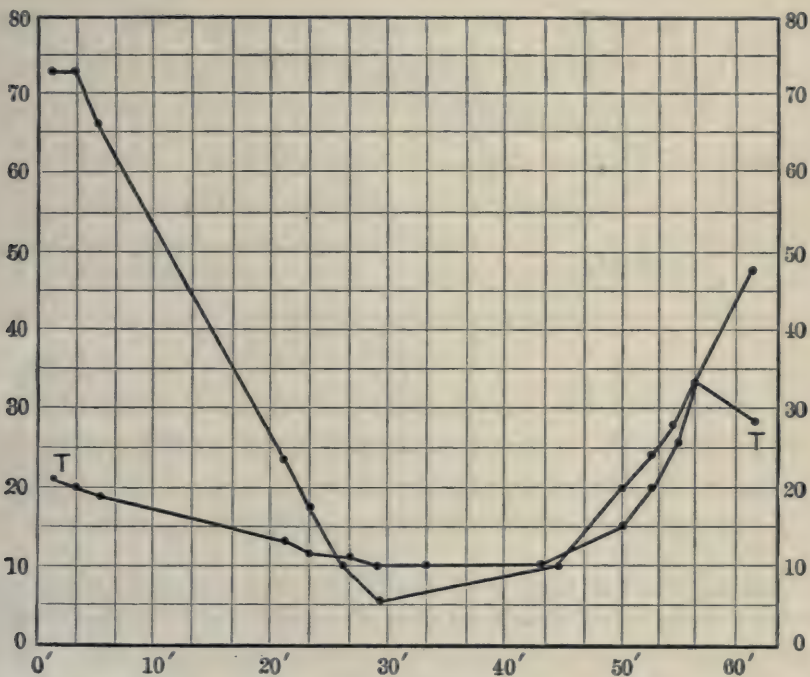

FIG. 70. — A set of curves having the same meaning as those of Fig. 69. In this case, however, the temperature first falls and then rises, instead of rising first and then falling. (From ENGELMANN, '77.)

tween temperature and protoplasmic movement. This relation is such that, as the temperature is elevated above the freezing point of water, the movements regularly increase, and reach their greatest activity at about the temperature of slow-running waters in the midst of summer, namely, about 25° to 30° C.*

* The maximum temperature attained by bodies of ordinary water inhabited by organisms seems to be close to the position of the optimum temperature of organisms. Yet, temperature data concerning the waters from which the organ-

Above this temperature, the rate of protoplasmic movement rapidly decreases.

That temperature influences the *irritability* of protoplasm is demonstrated by many facts. Thus, STRASBURGER ('78, p. 611) found that, at a high temperature, the light attunement of swarm-spores changes. For example, swarms of *Hæmatococcus* and *Ulothrix*, which are — phototactic, move at 30° C. from the — to the + side of the drop. LOEB ('90, p. 43) has found that *Prothesia* larvæ do not respond to light at a temperature below +13° C. Similarly, in respect to geotaxis, SCHWARZ ('84, p. 69) found that *Euglena* did not respond at below 5° to 6° C. So, too, CAMPBELL ('88, p. 130) has shown that the response of muscles to electric stimulus varies with the temperature. Thus, with the neck muscles of the tortoise at —

TEMPERATURE.	NUMBER OF SHOCKS PER SECOND REQUIRED TO TETANIZE.
4° C.	1
9° C.	5
21° C.	25
28° C.	34

isms of the experiment have been taken are, unfortunately, rarely given in experiments on heat. From observations made by the Massachusetts State Board of Health (Report on Water Supply and Sewage, 1890, Part I, p. 660), it appears that the various ponds and reservoirs in the state, having a depth varying from 19 to 5 metres, had a mean August (maximum) temperature ranging (in the different ponds) from 24° to 21° C. Various rivers, mostly not of mountain origin, had, in 1887, a mean July (maximum) temperature, varying (in different cases) from 26.5° to 24° C. Even in those ponds and streams in which the surface temperature is over 25°, a lower temperature can be found below the surface. Thus, from the report referred to, it appears that, while at 3.3 metres below the surface we have nearly the surface temperature, at 6.6 metres below the surface, we find a decrease of 3° to 10°, and at 10 metres a decrease of from 9° to 17° below the surface temperature in different ponds. As for the sea, the highest recorded surface temperature is about 32° C. (Red Sea, Gulf of Mexico.) See A. AGASSIZ, "Three Cruises of the Blake," Bull. Mus. Comp. Zoöl., XIV, p. 301. It would be a valuable piece of work to determine the maximum summer temperature attained by the waters of shallow ponds, pools, and marshes inhabited by organisms.

This shows that the muscle responds, and tends to return to its uncontracted condition less quickly at a low than at a higher temperature. In general, then, protoplasm is more responsive, the closer we approach its optimum temperature.

§ 3. TEMPERATURE-LIMITS OF LIFE

In the preceding sections we have seen that, as the temperature is raised above the optimum, or as it approaches 0° C., the vital activities begin to diminish. Finally, we meet with a higher or a lower limit, at which all movement and the processes of metabolism cease. This point may be called, in the case of the higher limit, the maximum, and in the case of the lower limit, the minimum. The maximum and the minimum are not points of death, but merely of cessation of activity, lasting while the temperature endures, but being replaced by renewed activity when the temperature is shifted towards the optimum. This quiescent, or latent, condition of the protoplasm near the vital limits of temperature may be called temporary rigor (German "Starre") to distinguish it from death. Death occurs at a very few degrees beyond temporary rigor.

1. **Temporary Rigor and Death at the Higher Limit of Temperature, Maximum and Ultramaximum.** (ENGELMANN, '79, p. 358.) — The occurrence, at a high temperature, of a condition resembling death, except that the organism may revive from it, seems first to have been noticed by P. DE CANDOLLE ('06, p. 346). He found that a Sensitive plant, kept 11 hours at 37° C., lost all sensibility to touch, and did not close with the coming on of night. Maintained, during the following day and night, at a temperature of about 20° , it remained insensitive during that period; but on the succeeding night it closed its leaves, and on the following day had regained its sensitiveness to touch. Thus, the high temperature of 37° had produced an immobile state which was not death, since it was only temporary. It may be called the state of temporary heat-rigor.

The earliest record which I have found of a similar observation among animals is that of PICKFORD ('51). He states that, at a high temperature, muscle went into a rigid con-

dition ("Scheintodtenstarre") from which it might return to a normal condition of sensitiveness. Such a rigid state was brought about by subjecting a decapitated frog in water to 35° R. (43.8° C.) for 1 minute. I will now add some additional cases of production of temporary heat-rigor in protoplasm which I have found in the literature.

In 1863, MAX SCHULTZE (pp. 33, 34) found temporary heat-rigor in *Actinophrys*, which retracts its pseudopodia and appears as a lifeless mass at 35° to 38°, but is not killed until 43° is reached. In the same year SACHS ('63, p. 453) repeated more fully the experiments of P. DE CANDOLLE on *Mimosa pudica*. He found that a temperature of 30° C. for 3 hours did not produce rigor. A temperature of 40° for 1 hour produced loss of sensibility during 20 minutes. Raised slowly even to 50°, sensibility was only temporarily lost, but 52° proved fatal. Immersed in water, heat-rigor occurred at a temperature 5° to 10° lower. SACHS clearly distinguishes a "vorübergehende Wärmestarre" from death.

KÜHNE ('64, pp. 45, 67, 87, 103) drew a sharp contrast between the rigidity of death, which he calls "Wärmestarre," and the transitory immobile condition or "Wärmetetanus." He found this latter condition to occur in *Amoeba* subjected to 35° for 1 minute, in *Actinophrys* subjected to 35°-40° for several minutes, in motile *Myxomycetes* (*Didymium serpula*) subjected to 30° for 5 minutes, in *Tradescantia* stamen hairs at over 45°, when gradually brought to that temperature. In all cases there is such a relation between temperature and time of subjection that the greater the one is the less need be the other in order to produce heat-rigor.

Very instructive also are the observations of HOFMEISTER ('67, pp. 54, 55) which I briefly summarize: Hairs from the stem and leaf of *Ecbalium ageste* showing lively movement were gradually raised from 16°-17° C. to 40° C. They became motionless at 40° C. After 1 to 2 hours, movement returned, and was very violent. Cooled and raised again to 45° C., the protoplasm was motionless at first, but after 17 minutes movements recurred but were not rapid. Put again into 47.5° (after first cooling) heat-rigor occurred in 5 minutes, but upon cooling, movements return.

Very similar experiences have befallen subsequent investigations which unite in supporting the conclusion that at a certain temperature, slightly below the death point, protoplasm becomes immobile, but retains the capacity for subsequent reacquisition of movement upon lowering the temperature.

Finally, studies upon muscle, especially those of CHMULEVITCH ('69), SAMKOWY ('74), MORIGGIA ('91), GOTSCHLICH ('93), and others, have shown that as the temperature is elevated up to about 30° C., the muscle contracts more and more,

lengthening again as the temperature falls. If, however (GOTSCHLICH), the temperature is raised in about 60 seconds to 38° and then lowered, the elongation of the muscle takes place only very slowly. This is the condition of "thermische Dauerverkürzung," and is probably the same as the condition of temporary heat-rigor of SACHS. When, however, the temperature is raised rapidly to 45° to 50° (or slowly to 35°), death-rigor appears, accompanied by a coagulation of the protoplasm which renders the whole mass opaque and permanently contracted. The rapidly replaced contraction accompanying elevation to about 30°, the slowly obliterated contraction of 38°, and the permanent contraction of 45° are then three stages in a series of effects of heat on muscle.

If now, contraction, heat-rigor, and death-rigor are merely three stages in a series of effects of increasing temperature, they probably have related immediate causes. Heat-rigor is certainly a condition of tetanus, but the fact that the protoplasm in this condition is not sensitive and cannot quickly return to the relaxed condition indicates that some of those changes that produce death-rigor have already occurred, but not to such an extent that the organism cannot recover from them. As GOTSCHLICH says ('93, p. 154), "Die thermische Dauerverkürzung ist also eine qualitative unvollendete Starre" (*i.e.* death-rigor). From this point of view there is no exact point at which heat-rigor occurs, since the period of persisting rigidity varies in extent from 0 to many hours, and thus passes by almost imperceptible gradations from a contraction in response to heat on the one hand to death-rigor on the other. The muscle increases in sensitiveness as the temperature rises to the optimum, just as the movements of plasma in Chara do. Beyond the optimum, sensitiveness diminishes, and this leads to a condition of heat-rigor which becomes the more pronounced the higher the temperature, until, through completed coagulation, death occurs.

We must now consider this point at which death occurs from heat; and, as an introduction to this discussion, we may tabulate the results of experiments by numerous observers who have attempted to determine the ultramaximum temperature.

TABLE XIX

RESULTS OF EXPERIMENTS TO DETERMINE THE ULTRAMAXIMUM TEMPERATURE OF ORGANISMS IN WATER, OR THE TEMPERATURE AT JUST ABOVE WHICH ORGANISMS REARED UNDER NORMAL CONDITIONS WILL DIE

SPECIES.	MAXIMUM TEMPERATURE.	CONDITIONS OF EXPERIMENT.	AUTHORITY.
<i>Cryptogams.</i>			
Bacteria	45° C.	Maximum temperature of growth in liquid	COHN, '77, p. 253;
Yeast	53°	Moist; average max.	'94, p. 150
Oscillatoriae	45°	Death point	SCHÜTZENBERGER, '79, p. 162
Nostoc	42°		
Spirogyra }	44°		
Edogonium }	46°		
Hydrodictyon	45° to 60°		
Cladophora	45°	Gradually raised	SACHS, '64, p. 5
Nitella flexilis	45°		DUTROCHET, '37, p. 777
Funaria hygrometrica . .	43°		DE VRIES, '70, p. 388
Marchantia polymorpha } Lunularia vulgaris }	46°		" "
<i>Phanerogams.</i>			
Vallisneria spiralis	45° to 50°	Gradually raised	SACHS, '64, p. 5
Ceratophyllum demersum	45° to 50°	Suddenly immersed for 10 minutes	
Various plant cells	47° to 48°	Died (suddenly subjected)	SCHULTZE, '63, p. 48
<i>Protozoa.</i>			
Æthalion sept.	40°	Plasmodium died after 2 minutes	KÜHNE, '64, p. 87
Amœba	40° to 45°	Death point	" "
Actinophrys	42°	Death point. Activity lost at 38°	SCHULTZE, '63, p. 34
Miliolidæ	43°	Death point	SCHULTZE, '63, p. 38
Various Flagellata and swarm-spores	40° to 60°	45° to 60° most usual. Heat-rigor usually occurs between 40° to 50° and is lower for marine than for f. w. species. These temperatures for the motile stage	BÜTSCHLI, '84, p. 860; STRASBURGER, '78, p. 611; DALLINGER, '80, p. 10
Various Infusoria	45°	Can withstand only a short time	SCHÜRMEYER, '90, p. 412

SPECIES.	MAXIMUM TEMPERATURE.	CONDITIONS OF EXPERIMENTS.	AUTHORITY.
Paramecium	42° to 46° C.	Gradually subjected	MENDELSSOHN, '95, p. 19
Stentor	44° to 50°	Heat-rigor point, temperature raised gradually. From a pool kept warm by boiler waste	DAVENPORT and CASTLE, '95, p. 229
Vorticellidæ	41° to 42°		SCHULTZE, '63, p. 49
<i>Cœlenterata.</i>			
Actinia	38°	Gradually raised (1 hour)	FRENZEL, '85, p. 464
Beroë ovatus	40°	Death point, suddenly subjected	DE VARIGNY, '87, p. 63
<i>Mollusca.</i>			
Various Mollusca	30° to 40°	Suddenly immersed	FRENZEL, '85, p. 461-466
Pleurobranchæa	33°	Temp. gradually raised	" "
Aplysia	33°	Died in 3 hours	" "
Eledone	35°	Died	" "
Young squids	37°	Heat-rigor; died at 41°	BERT, '67, p. 135
<i>Vermes.</i>			
Turbellaria	44.5°	Death point	SCHULTZE, '63, p. 49
Anguillulidæ	44.5°	" "	SPALLANZANI, 1787, Tom. I., p. 56 SCHULTZE, '63, p. 49
Rotifera }	45° to 48°	Moist	DOYÈRE, '42, p. 29
Tardigrada }	98°	Dried	BROCA, '61, p. 44-46
Diopatra	40°	Suddenly immersed, died quickly; at 30° lived indefinitely	FRENZEL, '85, pp. 461-465
Terebella	27° to 30°	Suddenly heated; slowly warmed, resisted 30°	" "
Naididæ	44.5°		SCHULTZE, '63, p. 49
"Bloodsucker"	44°	Death point	SPALLANZANI, 1777, Tom. I., p. 56
<i>Crustacea.</i>			
Daphnia sima	33.5°	Suddenly subjected	PLATEAU, '72, p. 316
Cyclops quadricornis }	36°	" "	" " 317
Cypris fusca }			
Gammarus rösellii	36°	" "	" " 316
Asellus aquaticus	43.5°	" "	" " 316

SPECIES.	MAXIMUM TEMPERATURE.	CONDITIONS OF EXPERIMENT.	AUTHORITY.
Palæmon	26° C.	Died in 2 hours (suddenly subjected)	FRENZEL, '85, p. 463
Scyllaris	30°	Died in 1 hour (suddenly subjected)	" "
Pagurus prideauxii	36°	Death point	DE VARIGNY, '87 ^a , p. 173
Dromia vulgaris	38°		
Pisa gibbosa	36°		
Portunus puber.	34°		
Carcinus sp.	38°		
Grapsus sp.	38°		
<i>Arachnida.</i>			
Argyroneta aquatica	38.5°	Suddenly subjected	PLATEAU, '72, p. 316
Hydrachna cruenta	46.2°	Submerged (?)	" "
<i>Insecta.</i>			
Podura	27°	Suddenly subjected; died slowly. At 36° died at once	NICOLET, '42, p. 11
Agabus bipustulatus	38°	Death point	PLATEAU, '72, p. 316
Hydaticus transversalis	39°		
Culex pipiens, larva	40°		
Hydrophilus caraboides	42°		
Hydroporus dorsalis	42°		
Nepa cinerea } Notonecta glauca }	44° to 45°		
Cloë diptera, larva }			
Musca vom. (?)	37.5°	Death point	SPALLANZANI, 1787, Tom. I, pp. 56-58
Musca vom., larva	42.5°		
Musca vom., pupa	43.7°		
Silk worm larva	42.5°		
"Butterfly" larva	42.5°		
Culex larva	43.7°		
<i>Echinodermata.</i>			
Antedon	30°	Died rapidly (suddenly subjected)	FRENZEL, '85, pp. 460-463
Holothuria	30° to 40°	Died in several hours (suddenly subjected)	" "
<i>Vertebrata.</i>			
Many fresh-water fishes	40°	Survived only a few seconds	EDWARDS, '24, p. 114
	36°	In pond out of doors.	KNAUTHE, '95, p. 752
Fish	33°	Temperature elevated gradually	BERT, '76, p. 169
	27° to 38°		DAVY, '63, p. 125

SPECIES.	MAXIMUM TEMPERATURE.	CONDITIONS OF EXPERIMENT. *	AUTHORITY.
Hippocampus	30° C.	Lived half an hour	FRENZEL, '85, p. 462
Salamander	44°	Death point	SPALLANZANI, 1787, Tom. I, p. 56
Frog	40° to 42°	Suddenly subjected in water; death at once	EDWARDS, '24, p. 374
Frog, adult (summer) . .	42° to 43°	Death-rigor in 7 to 14 minutes	MORIGGIA, '91, p. 385
Frog, adult	43.8°		SPALLANZANI, 1787, p. 55
Frog, tadpoles	41°	Raised in from 5 to 10 minutes	See p. 253
Rabbit }	44° to 45°	Death point when raised gradually; convulsions at 42°	OBERNIER, '66, p. 22
Dog }			
Man	45°	In water; giddiness in a few seconds	EDWARDS, '24, p. 374
Human spermatozoa . . .	50°	Died in 10 minutes	MANTEGAZZA, '66, p. 186
Vertebrate muscle	40° to 50°		KÜHNE, '59, pp. 784-804
Vertebrate muscle (frog)	{ 45° to 50° 35°	Raised in 30 seconds Raised in 18 minutes	GOTSCHLICH, '93, p. 123

The determinations given in the above table may be compared only with caution, for diverse conditions give results which cannot be directly correlated. Thus individuals of the same species, but reared under diverse environment, have a different resistance period to heat. The lethal temperature varies according as the organisms are suddenly or gradually subjected to the high temperature. Also, the individuals of the same species will die at different temperatures according as they are rapidly subjected to the high temperature or gradually accustomed to it, and, as we have seen, a lower temperature, long continued, often produces the same result as a higher temperature during a brief period. Finally, too little care has been exercised in most cases to determine the temperature of the water immediately upon, and a few minutes after, placing the animals in it, — an operation which lowers the temperature of the water. In the experiments cited, unless otherwise stated, the conditions were gradual subjection continued for a short time only. The quality of the water in which the

experiments were carried on is supposed to be, except for its temperature, normal for the species. Summarizing the table, we find that the Protista have the highest maximum temperature of any group, it being in extreme cases about 60° for active organisms, but generally between 40° and 45° . Among the Metazoa, the highest maxima recorded (excepting Rotifera and Tardigrada) are 44° to 45° for Turbellaria, *Anguillula*, *Naïdidæ*, *Nepa* (water-scorpion), *Notonecta* (water-boatman), *Cloë* larva, Salamander, and mammals. A water-mite (*Hydrachna*) is said to have withstood up to 46.2° , and some vertebrate tissues resist up to 50° . For the great majority of Metazoa, the maximum temperature lies below 45° and, in the case of marine species, below 40° . The low maximum temperature of marine species is probably due to the low maximum temperature of the sea as compared with ponds. We may consequently conclude from the foregoing that the maximum temperature for protoplasm lies generally between 35° and 50° , the lower limit being characteristic of organisms living in a medium of low temperature (the sea), the latter, of organisms reared in warm pools or of organs (vertebrate muscle) in a body kept at a high temperature.

The question now arises, what is the cause of the death of protoplasm at high temperatures? To get some insight into this matter, let us examine the phenomena accompanying death of protoplasm from overheating. KÜHNE ('64, p. 44) thus describes the appearance of an *Amœba* subjected for a moment to a fatal temperature (45°). The structure is entirely altered since it has become transformed into a mass of knobbed, opalescent, solid lumps, which, even in transferring to the slide, become easily broken apart. This appearance is clearly due to a coagulation of the protoplasm. A similar coagulation takes place in *Actinophrys eichhornii* (KÜHNE, '64, p. 67) at 45° . "The sphere shrinks into a flat, hardly transparent, cake, no longer reacts to the strongest induction shocks, and breaks up after 24 hours into a heap of small granules and irregular pieces." Likewise, in muscles a change is produced by heat which is evidently a kind of coagulation. A coagulation then seems to be the immediate cause of death at high temperatures.

But just what is the component of protoplasm which co-

agulates at the death point of organisms? As KÜHNE ('64, p. 1) pointed out, it cannot be ordinary egg albumen; for, excepting the contractile substance, we know of no native albumen which coagulates between 35° and 50° C. It was KÜHNE'S great service to show that there is a substance which can be pressed out of frozen, triturated, and then thawed muscle, which becomes quickly opalescent at 40°, through the separation of the muscle plasma into myosin and a serum. This serum, in turn, contains an albuminoid which coagulates at 47° (DEMANT, '79 and '80). Now, since there are proteids in muscle which coagulate at about the point at which muscle goes into permanent heat-rigor, and since these proteids can no longer be squeezed out of rigid muscles, the conclusion seems justified that permanent heat-rigor in muscle is due to the coagulation of these proteids.

Related, easily coagulable proteids occur in widely dissimilar organisms. For example, myosin has been found in vegetable protoplasm (WEYL, '77, p. 96), and HALLIBURTON ('88) has described a globulin from blood corpuscles which coagulates at 48° to 50°. Their distribution in protoplasm is, therefore, probably general, and so we are justified in concluding that the death of protoplasm by heat is, in general, the result of the coagulation of a proteid (globulin). Death occurs because the vital machinery has been broken down.*

2. Temporary Rigor and Death at the Lower Limit of Temperature, Minimum and Ultraminimum.— Whilst towards the upper limit of ordinary terrestrial temperatures (35° to 40° C.) molecular changes in organic compounds are hastened, towards the lower limits (— 40° to — 50°) molecular changes are slow, being principally confined to the transformation from the liquid or gaseous to the solid or liquid condition. This transformation does occur in the water of protoplasm, but the colloids,

* At this place reference may be made to the fact that protoplasm subjected to a high temperature sometimes breaks to pieces with the suddenness and completeness of an explosion. Thus STRASBURGER ('78, p. 611) found that *Chilomonas curvata* was uniformly killed at 45° C. by the explosion of the body, and Dr. W. E. CASTLE tells me that he has observed the same phenomenon under like conditions in *Stentor*. An investigation of this profound change in protoplasm would be sure to throw valuable light upon the nature of the living substance.

which constitute the living part, are not modified by even the lowest of the terrestrial temperatures, except that the molecular changes which they undergo are very slow. This being true, protoplasm which contains no water, or very little, ought not to be changed by low temperatures, — that is to say, the *machine* will not be injured.

With the activities of the machine — with the vital processes — it is, however, quite different. They are essentially chemical processes, and hence we should expect them to be diminished at a low temperature. If, as PICTET ('93) maintains from an extensive and highly important series of experiments, no chemical processes take place at temperatures below -100°C ., then protoplasm ought to exhibit no vital processes at this temperature, and, indeed, experience shows that, as we have already seen, as the temperature is lowered below the optimum, all manifestations of activity diminish. It is clear that at a certain point they must entirely cease. And at that point death, following the usual definition of the word, would ensue.

But does the cessation of the vital processes, without injury to the mechanism, necessarily preclude the possibility of a return to activity? Let us examine the experimental evidence on this point. SCHUMACHER ('74, p. 179) subjected yeast to cold and found that, at the lowest temperature produced (-113.7°), the yeast cells were not completely killed. More recently, PICTET ('93*, cf. also C. DE CANDOLLE, '84) has submitted various dry seeds and spores of bacteria to a temperature of nearly -200° , at which temperature the atmosphere becomes liquefied, but without fatal effects. Other results were still more remarkable: vibratile cilia from the mouth of the frog were cooled to -90° , and recovered their movement upon raising the temperature. Some Rotifera and Infusoria were frozen in their native water at -60° , and kept at that temperature, apparently, for nearly 24 hours. Most have subsequently regained their activity. Eggs of the frog, lowered slowly to -60° , can revive. Eggs of the silk-worm can resist to -40° . Other experiments of PICTET* will be referred to

* This general criticism of PICTET's paper is, I believe, valid. He does not give us data enough upon time of subjection to the low temperature, time employed in reducing the temperature, and other details. Thus, concerning his

later. As a result of these and others' investigations we may conclude: Protoplasm may under certain circumstances, of which one of the most important is the absence of water, resist, uninjured, the lowest temperatures. *There is no fatal minimum temperature for dry protoplasm.*

We must now turn our attention to those cases in which the phenomena of cessation of activity or death appear, and seek to determine their causes; and first concerning temporary cold-rigor. We have already seen that as the temperature is lowered, the rate of metabolic processes and protoplasmic movements is lowered. What happens at the lower limit of activity, and where does this lie? The chlorophyll granules of *Vallesneria* move (according to VELTEN) only about 1 mm. per minute at 1° C. and not at all at 0°; the rotation of *Nitella* ceases (NÄGELI, '60, p. 77) at 0° C.; in *Tradescantia* hairs, movement is wholly arrested on freezing the cell sap (KÜHNE, '64, p. 100, and DEMOOR, '94, p. 194). Even in seeds and bacteria, which are not killed by the lowest temperatures, all vital activities have probably ceased at 0°, for DE CANDOLLE ('65) found that in only one species out of ten could he get a seed kept at 0° to germinate, and even then germination was so retarded that it took from 11 to 17 days as opposed to 4 days at 5.7°. Likewise, bacteria do not multiply below +5° to +10° (BONARDI and GEROSA, '89). Among animals, KÜHNE ('64, p. 46) found *Amœba* cooled to near 0° almost motionless. PURKINJE and VALENTIN ('35) first noticed that the ciliated

experiments on *Scolopendra*, he merely says: "I have frozen to -40° three *Scolopendras* which perfectly resisted the treatment and lived after thawing out. Submitted to -50°, they have also resisted. Frozen a third time to -90°, they are all three dead." Now, in the absence of further data, it is quite possible that the heat of metabolism kept the internal body temperature considerably above that of the chamber, the thick cuticula preventing rapid loss of heat, very much as a man's clothing enables him to withstand the -40° of an arctic winter. Another experiment of PICTET's lends greater probability to this explanation of some cases of great resistance. Three snails were subjected to a temperature of from -110° to -120° during several days. The operculum of two of these was not intact, so that it did not close the orifice. These two individuals died; but the third, which was completely sealed up, survived. Those which were not sufficiently clad, so to speak, lost so much internal heat that their internal fluids were frozen. Of course this criticism cannot apply in the case of those organisms mentioned in the text which are without a thick cuticula.

epithelium of the frog ceased its movements at 0° . Muscles of the frog were found by KÜHNE ('64, p. 3) to become at -3° to -7° a solid lump which did not, however, wholly lack irritability. The evidence of all these cases shows that activity nearly ceases in protoplasm at or near 0° C.

Another effect produced on protoplasm by cold — an effect which often immediately precedes quiescence — is violent contraction. This has been repeatedly observed. The protoplasm of *Tradescantia* hairs, which has been in cold-rigor, was found by KÜHNE ('64, p. 101) to lie in separated rounded drops and lumps, — an appearance like that resulting from excessive stimulation. The rapid freezing of muscle gives rise, according to HERMANN ('71, p. 189), to violent contractions. The sciatic nerve of the frog's leg when cooled to -4° to -8° causes clonic contractions of the muscle, lasting two minutes. (AFFANASIEFF, '65, p. 678, and others.) It is clear, then, that cold acts as a violent stimulus to protoplasm.

The final result of temporary rigor is thus clearly brought about by the coöperation of two causes: (1) the diminution in the chemical processes upon which metabolism and movement depend, and (2) the directly stimulating effect of the cold, which acts like contact or excessive heat. Both causes work to produce a quiescence which may be replaced by activity when the causes are withdrawn.

The fact that cold-rigor usually occurs close to the zero-point indicates that the activities of protoplasm are closely determined by the fluid state of water. This fact is not to be explained on the ground that freezing prohibits all chemical change — many chemical changes take place below the freezing point of water, but, apparently, few of those which are involved in metabolism. Nor is the rigor due to the change which the freezing of the protoplasmic fluids brings, because as the temperature approaches the zero-point, but while the water is still perfectly fluid, metabolism diminishes; and it diminishes at such a rate as to cease just where water begins to freeze. The critical point for vital activity has been adjusted to this critical point of water.

So, too, the composition of protoplasm is such that at a temperature, lying below the normal and above the freezing point

of water, those chemical changes rapidly occur which we designate response to the stimulus of cold. This composition of protoplasm, upon which cold can work such important modifications, is a quality of immense importance in the economy of the organism, as the changes of each autumn testify.

Below the point of temporary cold-rigor lies that of death, if death point there be. The position of the death point is, however, very diverse in different organisms. Part of the diversity in the death points assigned by different authors is, however, due to the fact that in the methods of determining the death points there has been a lack of uniformity.

Five elements ought always to be regarded in experiments on the ultraminimum temperature. (1) History of the temperature conditions in which the individual or its race had lived before experimentation; (2) rate at which the organism has been cooled, — if possible, the temperature of the organism itself rather than that of the medium; (3) intensity of cold just sufficient to kill; (4) duration of application of the cold and the kind of medium in which the organism is subjected to the cold;* and (5) the rate of thawing out.† These elements have been too much neglected in the past.

I shall now present in tabular form some of the more reliable determinations of the death point of organisms, pre-acing with the caution that the results are not closely comparable.

* The duration of application and intensity of the fatal cold stand in an inverse relation, so that organisms which resist a temperature $-A^{\circ}$ for X minutes will resist a lower temperature, $-(A+a)^{\circ}$, for a shorter time, $X-x$. Thus, *Clepsine complana* resists -8° C. for 15 minutes; -5° C. for 90 minutes. So *Planorbis corneus* resists -7° for 5 hours, but -5° for 48 hours. Again, *Musca domestica* can resist -12° for 5 minutes; -8° for 20 minutes; and -5° C. for 40 minutes. (ROEDEL, '86.) Since many authors have little regarded the duration of action of the cold, their determinations have little scientific value.

† The importance of this is illustrated by some experiments of SACHS ('60, p. 177), who found that the leaves of the beet or cabbage frozen at from -4° to -6° died if they were thawed in air at 2° or 3° , or in water at 6° to 10° ; but lived when slowly thawed in water at 0° . In general, the more gradual the thawing, the lower the fatal temperature.

TABLE XX*

DETERMINATIONS OF THE ULTRAMINIMUM OF ORGANISMS REARED UNDER
NORMAL CONDITIONS

SPECIES.	MINIMUM TEMPERATURE.	CONDITIONS OF EXPERIMENT.	AUTHORITY.
<i>Plant cells.</i>			
Tradescantia	-14° +	In water, rapidly frozen	KUHNE, '64, p. 100
Hair cells	-14° -	In air, rapidly frozen	
Swarm-spores	- 1°	Fully frozen, cautiously thawed	STRASBURGER, '78, p. 612
Swarm-spores (Proto-coccus)	0° to -1°		COHN, '50, p. 720
<i>Protozoa.</i>			
Amœba	0° -	Rapidly frozen on slide over ice and salt	KÜHNE, '64, pp. 46-47
<i>Animal tissues.</i>			
White blood corpuscles:			
of Amphibia	{ -2° to -3° - 7°	During 8 hours; warmed rapidly	SCHENK, '69, p. 26
of rabbit	- 3°	For a short time; warmed rapidly	" " 26
Saliva corpuscle	-6° to -8°	During 15 minutes	" " 26
Red blood corpuscle	-15° +	Over 60 minutes	" " 27
			POUCHET, '66, p. 18
Spermatozoa:			
of Amphibia	-4° to -7°		SCHENK, '69, p. 29
of Mammalia	- 6° -	Returned to activity on thawing	" " 30
of frog	- 8° to -10° -	Frozen in testis	PREVOST, '40.
of frog	-10° to -12°		QUATREFAGES, '53, p. 353
of man	-17°	Gradually thawed	MANTEGAZZA, '66, p. 183
Eggs of Amphibia	- 7°	During 1 hour	SCHENK, '69, p. 28
	- 6°	Subjected a very short time	ROTH, '66, p. 189
Ciliated epithelium of Anodonta	{ - 3°	Subjected during 6 minutes	" " 189

* Temperatures all in degrees Centigrade. - before a number indicates below zero, - or + after a number indicates that the true lethal temperature lay slightly below or above that number. (A) indicates that the organism was in air; (W), in water.

SPECIES.	MINIMUM TEMPERATURE.	CONDITIONS OF EXPERIMENT.	AUTHORITY.
<i>Platyhelminths.</i>			
<i>Dendrocoelum lacteum</i>	0° to -1°	Suddenly or gradually subjected, till ice forms	ROEDEL, '86, p. 207
<i>Mollusca.</i>			
<i>Helix hispida</i>	- 8°	During 30 minutes	" " 191
<i>Helix pomatia</i>	- 10°	During 600 minutes	" " 192
<i>Helix pomatia</i>	(-14° to -18°)+	Gradually frozen for 180 minutes, and then thawed	POUCHET, '66, p. 28
<i>Helix hortensis</i>	(-14° to -18°)+	During 180 minutes	" "
<i>Helix aspera</i>	(-14° to -18°)+	" 180 "	" "
<i>Planorbis</i>	- 7°	" 300 " (A)	ROEDEL, '86, p. 212
<i>Limnæa</i>	- 7°	" 180 " (A?)	" " 212
<i>Pulmonate embryos</i>	0° to -1°	"Died upon freezing" (W and A)	" " 212
<i>Limax</i>	- 17°+	During 2 hours (A)	POUCHET, '66, p. 26
<i>Annelida.</i>			
<i>Aulostomum gulo</i>	- 2°	During 12 to 15 hours (W)	ROEDEL, '86, p. 206
<i>Clepsine complanata</i>	- 5°	During 90 minutes (W)	" " 213
"Leech"	- 6°	" "some minutes" (W)	DOENHOFF, '72, p. 725
<i>Insecta.</i>			
<i>Apis mellifica</i>	- 1.5°	During 210 minutes	ROEDEL, '86, p. 212
<i>Apis mellifica</i>	- 1.5°	" a few minutes	DOENHOFF, '72, p. 724
<i>Formica rufa</i>	- 1.5°	" 180 minutes	ROEDEL, '86, p. 196
<i>Pelopæus (chrysalis)</i>	- 28° -	Out-of-doors, withstood this temperature	WYMAN, '56, p. 157
<i>Lema sp.</i>	- 6°	During 30 minutes	ROEDEL, '86, p. 197
<i>Pæderus riparius</i>	- 4°	" 45 "	" " 197
<i>Phytonomus sp.</i>	- 12°	" 90 "	" " 197
<i>Melolontha</i>	- 18° +	" 120 " (A)	POUCHET, '66, p. 26
<i>Melolontha (larva)</i>	- 15° +	" 180 " (A)	" " 26
<i>Cetonia</i> }	- 17° +	" 120 " (A)	" " 26
<i>Hydrophilus</i> }			
<i>Dytiscus</i>	- 4°	" 60 " (A)	KOCHS, '90, p. 682
<i>Vanessa cardui, larva</i>	- 15°	" 600 "	ROEDEL, '86, p. 212
<i>Vanessa io, larva</i>	- 17° +	" 120 "	POUCHET, '66, p. 27
<i>Smerinthus populi</i>	- 10°	" 150 "	ROEDEL, '86, p. 212
<i>Ocneria dispar</i>	- 4°	" 30 "	" " 212
<i>Culex pipiens, larva</i>	- 4°	" 60 "	" " 212
<i>Musca</i>	- 6° to - 10°	" 180 "	DOENHOFF, '72, p. 725
<i>Musca dom.</i>	- 5°	" 20 "	ROEDEL, '86, p. 201
<i>Various insects</i>	0°	" 2 to 30 minutes (on ice)	PLATEAU, '72, p. 98

SPECIES.	MINIMUM TEMPERATURE.	CONDITIONS OF EXPERIMENT.	AUTHORITY.
<i>Arachnida.</i>			
Phalangium opilio . . .	— 9°	During 60 minutes	ROEDEL, '86, p. 201
Tegenaria domestica . . .	— 6°	“ 60 “	“ “ 201
Argyroneta aquatica . . .	— 4°	“ 180 “	“ “ 201
Hydrachna cruenta . . .	— 4°	“ 30 “	“ “ 201
“ Spider ”	— 2° to — 3°	“ 480 “	DOENHOFF, '72, p. 724
<i>Crustacea.</i>			
Cyclops quadricornus.	0°	“ 1 “ (W)	PLATEAU, '72, p. 300
Cyclops spirillum . . .	— 6°	“ 120 “ (W)	ROEDEL, '86, p. 201
Daphnia pulex	0°	“ “ (W)	“ “ 201
Gammarus pulex	0°	“ 30 “ (W)	PLATEAU, '72, p. 300
Asellus aquaticus	0°	“ “ (W)	ROEDEL, '86, p. 205
Astacus fluviatilis	— 11.5°	“ a day (A)	PLATEAU, '72, p. 299 ROEDEL, '86, p. 205 POUCHET, '66, p. 32
<i>Vertebrata.</i>			
Rana esculata	— 4° to — 10°	“ 180 minutes (A)	“ “ 19

Summarizing these conditions, we find that the following organisms, even when thawed out carefully, are killed by subjecting to a temperature of between 0° and — 5° for 60 minutes: Amœba, swarm-spores, white blood corpuscles of Amphibia, planarians, pulmonate embryos, small leeches, certain entomostacans, and some insects and spiders. These organisms are all either soft bodied or of small size, and, excepting animals which, like the bees, live in protected situations, they do not winter over in our northern temperate countries. The following species, on the other hand, resist — 10° for at least 60 minutes: some snails (possibly), the beetles *Melolontha* (perhaps) and *Phytonomus*, the *Vanessa* larva, *Pelopæus chrysalis*, and the crayfish, — all protected by a thick covering, or of rather large size. The reason why large size and thick covering should increase resistance is not far to seek, — both conditions tend to prevent the rapid loss of heat, — to defend the body from freezing through and through.

Another cause of variation in resistance to cold is, doubtless, the amount of water in the protoplasm. I have already referred to this cause as explaining the fact that dry seeds and spores

can withstand almost any temperature.* MÜLLER-THURGAU ('80) found that the "succulent labellum of *Phajus* freezes at -0.56° C.; the succulent leaf of *Sempervivum*, at -0.7° ; the potato tuber, at -1° ; the leaf of *Tradescantia mexicana*, at -1.16° ; the ivy leaf, at -1.5° ; the leaves of *Pinus austriaca*, at -3.5° ; young shoots of *Thujopsis*, at -4° ." (VINES.) In this series of plant tissues, we see that the more succulent the tissue, the higher its ultraminimum. Possibly the reason why spermatozoa have so low an ultramaximum, despite their small size, is on account of the denseness of their protoplasm.

Not all variations in ultraminimum temperature are, however, explicable upon the ground of difference in size, body-covering, or density of plasm. The interpretation of the difference in sensitiveness to cold of the honey bee (*Apis mellifica*) and the red ant (*Formica rufa*), between *Bombyx* on the one hand and *Smerinthus* and *Vanessa* on the other, must wait for further knowledge.

The question now arises, what is the cause of death in organisms and protoplasm which succumb to low temperatures? With the higher animals the immediate cause is doubtless in part asphyxia resulting from a stoppage in the flowing of the frozen blood plasma, and in part the destruction of the red blood corpuscles, as well as the white.† With the simpler organisms, like planarians, Protozoa, or *Tradescantia* hair-cells the case is different. An insight into the changes which produce death in such organisms may be gained from KÜHNE'S ('64, p. 101) description of the effect of a temperature of -14° on *Tradescantia* hair-cells. The frozen hairs were placed in water and observed under the microscope. "The appearance,"

* Striking cases are on record of the resistance of gemmules, or "animal spores," to cold. Thus, WELTNER ('93, p. 276) saw gemmules of *Spongilla fragilis* frozen in an aquarium from December 26 to January 24, from the end of January to February 5, from February 20 to March 6, and from March 12 to 24; the intervals being occupied by thawings. Yet these gemmules produced young sponges. In other cases, a certain amount of freezing favors the subsequent development of gemmules, e.g. those of fresh-water Bryozoa (BRAEM, '90, p. 83) and the eggs of the silk-worm (DUCLAUX, '71).

† POUCHET ('66, p. 18) found that when blood of the frog was let fall into a capsule at a temperature of -15° few of the red corpuscles were uninjured. In most the nuclei had been cast out into the plasma.

says KÜHNE, "was very remarkable, for there was no trace of the protoplasmic network; but the violet cavity of the cell contained, in addition to the naked nucleus, a large number of separate round drops and lumps." In this case, the separate pieces eventually became active again, so that the protoplasm, though nearly killed, was not quite so.

The phenomena seen by KÜHNE so closely resemble those produced in the same kind of cells by the galvanic current and other strong irritants as to indicate that cold acts as an intense irritant. We cannot, however, conclude that cold acts in no other way. It is clear that the expansion of forming ice in the vacuoles of the protoplasm must seriously disturb the structure, and, since the whole matter has received little attention, it is possible that a molecular change of some sort takes place when there is much water in the freezing protoplasm. To summarize: Death by freezing results in the higher animals largely from asphyxia, and in the simpler organisms from excessive irritation, mechanical rupture, and, perhaps, other causes.

I shall now sum up this section on the effect of extremes of heat and cold. As the temperature is elevated above the optimum, molecular changes occur in the protoplasm leading to its contraction. The contraction becomes more violent as the temperature is still raised, until, finally, a new series of molecular changes occur by which the protoplasm begins to coagulate. At this point the protoplasm begins to lose its irritability. If this process has not proceeded far, the vital activities may, under favorable conditions, return (temporary heat-rigor). Beyond a certain point (death point) recovery is impossible. The death point varies with the species, but lies not far from the maximum natural temperature attained by the medium in which they live. On the other hand, as the temperature is diminished from the optimum, the chemical processes of metabolism decrease in vigor and come to a standstill at about the freezing point of water. Violent contractions accompany the cooling process, concomitantly with which the protoplasm breaks down. From this condition of temporary cold-rigor recovery is still possible; but a little below, at a point dependent upon the size of the body and the diathermous qualities of its

covering, the water of the body begins to freeze, and in that process, or the subsequent thawings, the protoplasm undergoes a (partly mechanical) change resulting in death. If the body, however, contains no water, freezing cannot kill it.

Thus the effect of high temperatures is principally chemical, involving the living plasma; that of low temperatures is principally mechanical, involving the water of the body. Both raising and lowering the temperature act also as irritants.* Finally, the positions of the maximum and minimum stand in most intimate relation to the inorganic environment of the organism and have been molded to that environment.

§ 4. ACCLIMATIZATION OF ORGANISMS TO EXTREME TEMPERATURES

The phenomena to be discussed in this section fall naturally into two subsections: (1) acclimatization to heat and (2) acclimatization to cold. They will be considered in that order.

1. **Acclimatization to Heat.** — Our study of the maximum temperature which organisms reared under ordinary circumstances can withstand, led us to the conclusion that few active organisms can resist a temperature of over 45°, and for whole groups like Cœlenterata, marine Mollusca, and Crustacea, and the fishes, 40° is a point of death. Yet, on the other hand, it has long been known that there are organisms living in certain hot springs in waters of considerably higher temperature. I shall now give in tabular form some cases which I have collected of organisms living at or above the normally lethal temperature of the species.†

* Whether *sudden* change of temperature has an especial effect upon the movement of protoplasm is a disputed question, which has been answered positively by DUTROCHET ('37, p. 777) and HOFMEISTER ('67, p. 53) for *Nitella*, and DE VRIES ('70, p. 394) for root hairs of *Hydrocharis*, but has since, as a result of careful experiments, been denied by VELTNER ('76, p. 214) for *Nitella* and other plant cells.

† It is desirable that accurate data concerning the temperature of organisms in hot springs should be made, and we have, in this country, unusually favorable conditions offered for this study, especially in Arkansas, California, and the Yellowstone National Park. It is to be hoped that persons who have had the proper training should, when contemplating a visit to hot springs, provide them-

TABLE XXI

LIST OF SPECIES FOUND IN HOT SPRINGS, WITH THE CONDITIONS UNDER WHICH THEY OCCUR

No.*	SPECIES.	TEMP. C.	LOCALITY AND CONDITION OF LIFE.	AUTHORITY.
1	Chroöcoccus	51° to 57°	Benton's Hot Springs, Cal.	WOOD, '74, p. 34
2	Nostocs or Protococcus	93°	Geysers, Lake Co., Cal.; not abundant at this temperature	BREWER, '66, p. 391, also WYMAN, '67, p. 155
3	Nostocs	51° to 57°	Benton's Hot Springs, Cal.	WOOD, '74, p. 34
4	Anabæna thermalis	57°	Dax, warm springs	SERRES, '80, pp. 13-23
5	Leptothrix	44° to 54°	Carlsbad Springs	COHN, '62, p. 539
6	Oscillaria or "Confervæ"	54° to 68°	Yellowstone Nat. Park, U.S.A.	WEED, '89, p. 399
7	"	54.4°	Springs, Bernardino Sierra, Cal.	BLAKE, '53, p. 83
8	"	57°	Algeria, Constantine province, waters of Hammam-Meskhoutin	GERVAIS, '49, p. 12
9	"	57°	Hot Springs, Taupo, New Zealand	SPENCER, '83, p. 303
10	"	60° to 65°	Geysers, Lake Co., Cal., U.S.A.	BREWER, '66, p. 392
11	"	60° to 65°	Hot Springs, Ark., U.S.A. (Long)	JAMES, '23, II, p. 291
12	"	71°	Hot Springs at Baños Luzon, Philippines	DANA, '38-'42, p. 543
13	"	75.5°	Soorujkoona Hot Springs	HOOKE, J. D. '55, I, p. 24
14	"	81° to 85°	Ischia	EHRENBERG, '59, p. 493.
15	"	98°	Iceland	FLOURENS, '46, p. 934
16	"	?	Outlet of Lake Furnas, Azores.	DYER, '74, p. 324

selves with a hand lens, bottles of alcohol for preserving organisms for further study, and an accurately calibrated thermometer. A source of error to be guarded against lies in the precise determination of the temperature of the water immediately surrounding the organism observed; for in some warm springs or their outlets the surface water is said to be much warmer than the deeper layers in which the organisms are found. Finally, if possible, it would be desirable to determine on the spot, experimentally, the maximum temperature which these organisms can withstand. For this determination some of the methods referred to on p. 220 should be used.

* Notes on each of these cases will be found at the end of this chapter, pp. 263-267.

No.	SPECIES.	TEMP. C.	LOCALITY AND CONDITION OF LIFE.	AUTHORITY.
	Diatoms		Frequently associated with other algæ in hot springs	
17	<i>Physa acuta</i>	33° to 35°	Sources of Dax, St. Pierre, France	DUBALEN, '73, p. iv
18	<i>Paludina</i> sp.	50°	Thermal waters, Abano, Padua	DE BLAINVILLE, '24, p. 141
19	"Bivalve testaceous animal"	?	Hot Springs, Ark.	MITCHILL, '06, p. 306
20	Rotifera and Anguillulidæ	44° to 54°	Carlsbad Springs, Bohemia	COHN, '62, p. 539
21	Anguillulidæ	45°	Aix, springs	DE SAUSSURE, 1796, V, p. 13, § 1168
22	"	81°	Ischia, in hot springs	EHRENBERG, '59, p. 494
23	<i>Cypris balnearia</i>	45° to 50.5°	Hammam-Meskhoutin	MONIEZ, '93, p. 140
24	<i>Stratiomys</i> larva	69°	In hot spring, Gunnison Co., Col.	GRIFFITH, '82, p. 599
25	"	?	In hot spring, Uinta Co., Wyo.	BRUNER, '95
26	"Water beetle"	44.4°	In warm spring, India; abundant	HOOKEER, J. D. '55, p. 24
27	"	?	Hot spring, Port Moller, Alaska	DALL, W. H. (personal letter)
28	Barbels	34°	?	BERT, '77, p. 169
29	Frogs	38°	"Baths of the Pise"	SPALLANZANI, 1787, Tom. I, p. 55

To summarize: Protista are stated to have been found in nature in water at temperatures far above 60° C. The most striking cases are of *Oscillaria* and "Conferva" from several localities, which resist nearly up to the boiling point of water. The closely allied *Nostocs* are, perhaps, next most abundant and resistant, reaching 93° (possibly *Protococcus*) in the California geysers. Metazoa are stated to live at temperatures far above 45°. Although some doubt has been cast on No. 22 by HOPPE-SEYLER'S inability to confirm EHRENBERG'S observations, the case seems established of *Cypris* thriving at 45° to 50.5°. Very extraordinary are the observations Nos. 24 and 25 on *Stratiomys* larvæ, which, however, are sadly in need of confirmation by competent observers. Leaving out of account, for the moment, the less well established cases, there still remains abundant evidence that organisms can live and thrive

in hot springs at a temperature near or above that which proves fatal to their close allies.

No one doubts that in all the cases cited above the individuals living in hot springs have been derived from ancestors which lived in water whose temperature rarely exceeded 40° C. The race has therefore become acclimatized, and the question arises: How has that acclimatization been effected?

Now experiments have shown that organisms, when gradually accustomed thereto, may resist a temperature which would have killed them if they had been suddenly subjected to it. Therefore it seems probable that the acclimatization of organisms to hot springs has been a slow, long-continued process, during which they have become gradually accustomed to higher and higher temperatures, probably attaining the hot springs by slowly advancing up their effluent streams.

This adaptation may have taken place without selection, purely by the capacity of individual adaptation which organisms possess. That individual adaptation is sufficient to account for the vitality of organisms in hot springs has been shown by experiment. DUTROCHET ('37, p. 777) observed, long ago, that an organism which at first seemed injured by a high temperature gradually regained activity while still subjected thereto.

Thus, he found that the current of *Nitella* was at first diminished by raising it to 27° C., but it soon became rapid again; raised, now, to 34°, the circulation began to fall off again, but in a quarter of an hour, the same temperature continuing, the circulation became very rapid. This phenomenon was repeated, also, at 40°. Similarly, HOFMEISTER ('67, p. 53) brought *Nitella flexilis* suddenly from + 18.5° to + 5° C. The streaming movements ceased. After staying 15 minutes in the cooler room, however, the rotation of protoplasm recovered.

Much more important, however, are the remarkable experiments of DALLINGER ('80). He kept *Flagellata* in a warm oven for many months. Beginning with a temperature of 15.6° C., he employed the first four months in raising the temperature 5.5°; this, however, was not necessary, since the rise to 21° can be made rapidly, but for success in higher temperatures it is best to proceed slowly from the beginning. When the temperature had been raised to 23°, the organisms began

dying, but soon ceased, and after two months, the temperature was raised half a degree more, and eventually to 25.5°. Here the organisms began to succumb again, and it was necessary repeatedly to lower the temperature slightly, and then to advance it to 25.5°, until, after several weeks, unfavorable appearances ceased. For eight months, the temperature could not be raised from this *stationary point* a quarter of a degree without unfavorable appearances. During several years, proceeding by slow stages, DALLINGER succeeded in rearing the organisms up to a temperature of 70° C., at which the experiment was ended by an accident.

In this case it is plain that the high temperature acted upon the same protoplasm at the end of the experiment as it did at the beginning. But while the protoplasm at the beginning of the experiment was killed at 23° C., at the end it withstood 70°. It will be seen that, by gradual elevation of the temperature, Flagellata may become acclimated to a temperature of water far above that which they can withstand when taken directly from out of doors, and approaching that of the hottest springs containing life.

A series of experiments, less extensive than that of DALLINGER, was carried on by Dr. CASTLE and myself ('95, pp. 236-240) upon the tadpoles of our common toad, *Bufo lentiginosus*. Recently laid eggs were divided into two lots: one lot was kept in a warm oven at a constant temperature of 24° to 25°, others at about 15° C. Both lots developed normally, but the former much the more rapidly. At the end of 4 weeks the point of heat-rigor was ascertained for each lot, by gradually heating (in from 5 to 10 minutes) the water containing them, until the tadpoles showed no response to stimulus, but, upon cooling, regained activity. The result was that the toad tadpoles had gained an increased capacity to heat. For when they were reared at a temperature of about 15° C., every tadpole went into heat-rigor at 41° C., or below; whereas, when they were reared at 24° to 25°, a temperature 10° higher, no tadpole died under 43°, the average increase of resistance being 3.2°. This increased capacity of resistance was not produced by the dying off of the less resistant individuals, for no deaths occurred in these experiments during

the gradual elevation of the temperatures in the cultures. The increased resistance was due, therefore, to a change in the protoplasm of the individuals.

The question now arose: In how far is this change in the protoplasm permanent? Will a return of the individuals to cool water cause a return to the old point of heat-rigor? We made a few experiments on this subject which showed that tadpoles which during 33 days in warm water have acquired an increased resistance of 3.2° lose part of that acquired resistance during 17 days' sojourn in cooler water. But the loss is a very slow one. The effect of the high temperature on the tadpoles is not, therefore, transitory, but persists — we have not been able to determine how long — after the cause has been removed.

So we may conclude: Individual organisms have the capacity of becoming adapted to a high degree of temperature, so that a temperature which normally is fatal may be withstood. This adaptation of the individual accompanies the subjection of organisms to temperatures higher than those to which they have already become accustomed. This capacity exists among both Protozoa and Metazoa. The effect of the elevated temperature persists (though in diminished degree) a considerable time after the individual has been restored to a lower temperature.

Acclimatization may show itself not only in the change of the maximum temperature, but also in the elevation of the optimum. This is shown by the following experiments of MENDELSSOHN ('95, p. 19). When *Paramecia* are placed in a trough whose temperature is 24° to 28° at one end and 36° to 38° at the other, they are found to collect at the cooler end, which indicates that the temperature of that end lies nearer their optimum. If, however, the *Paramecia*, while uniformly distributed in the trough, are subjected to a uniform temperature of 36° to 38° for from 4 to 6 hours, and then, in the same trough, to a temperature varying from 24° at one end to 36° at the other, they no longer collect at the usual optimum of 24° to 28° , but at 30° to 36° . Thus in 4 to 6 hours, by the action of a temperature of 36° to 38° , the optimum has been raised 6° to 8° .

Since experiments have proved the fact of acclimatization, it now remains to determine, if possible, its cause; to answer the question, by virtue of what property can organisms which, like Flagellata, normally perish at 45° C. come to live at 70° or even higher temperatures? We have seen that death at high temperatures is apparently due to coagulation of certain proteids in the protoplasm which undergo a chemical change at between 45° and 50° C. Now, although the matter has not yet been studied in these proteids, it has been shown for egg albumen that in proportion as it is dried its coagulation point rises, as the following table from LEWIS ('90) shows:—

EGG ALBUMEN.	COAGULATION TEMPERATURE.
In aqueous solution	56° C.
With 25 % water	74° to 80° C.
With 18 % water	80° to 90° C.
With 6 % water	145° C.
Without water	160° to 170° C.

Since the coagulation point of egg albumen is raised by dryness, it is very probable that a similar cause may act to raise the coagulation point of protoplasm in organisms of hot springs. Experimental studies are much needed upon this point. Meanwhile it can be said that *one* of the qualities which gives capacity of resistance to high temperatures is dryness. I shall now cite some cases that I have collected, which prove this point. It has been found that while moist yeast is killed at a temperature below 60°, dry yeast may be heated to 100° C. without losing its vitality (SCHÜTZENBERGER, '79, p. 162). Damp uredo-spores are killed at 58.5° to 60° C., but dry ones withstand up to 128° (HOFFMAN, '63); and dry spores of some molds up to 120° (PASTEUR, '61, p. 81). According to DALLINGER ('80, pp. 11-14), the dry spores of various Flagellata are capable of withstanding a temperature from 10° to 27° C. higher than that which these spores can resist in fluid. According to DOYÈRE ('42, p. 29), various animalcules (Rotifers, Tardigrades) which cannot in water withstand a temperature of 50° C. may, after long drying, be heated in air to 120° C.

(rarely to 125°) without all dying. The foregoing cases show clearly that increased resistance capacity is frequently gained by subjecting the protoplasm of the organism to dryness.

But there are other conditions under which the living substance shows extraordinary resistance capacity. In general, as is well known, the spores of organisms withstand higher temperatures than the motile stage, when both are in water. This rule holds for many cases: The spores of some bacteria may be heated for a time above 100° C. without killing them, although their motile stage is killed by 50° to 52° (LEWITH, '90). DALLINGER and DRYSDALE ('74, p. 101) and DALLINGER ('80, pp. 13, 14) have determined maximum temperatures for several Flagellata and their spores in water. While none in the motile stage could withstand a temperature higher than 61°, the spores in water withstood maximum temperatures varying between 65.5° and 131° for the different species.

Have the high resistance capacity of dry protoplasm and that of spores a common cause? Or, in other words, is the protoplasm of spores especially free from water? Many observations make it appear probable that this is so.

Thus in the case of bacteria, the protoplasm of the spore stage is optically denser and occupies less space than in the motile stage. (Cf. LEWITH, '90.)

In the case of the ciliate Infusoria, the larger size of the protoplasmic mass makes the comparison of the condition of the protoplasm in the two stages easier. We glean the facts from BÜTSCHLI ('89, pp. 1652-1654). As the process of encystment proceeds, the contractile vacuole continues to function, the intervals between its contractions gradually increase, and finally it disappears some time after the encystment is completed. Hand in hand with these changes goes a gradual condensation of the protoplasm. This condensation BÜTSCHLI believes to be due to an excretion of water from the protoplasm.

In *Actinosphærium* the change from the richly vacuolated motile form to the encysted condition is even more marked. As BRAUER ('94, p. 193) has shown, the protoplasmic mass becomes, during the process of encystment, smaller and denser. The loss of water from the protoplasm is without doubt due to

the continued activity of the contractile vacuole at a time when no fluids are being taken into the protoplasmic body.

From the foregoing considerations it appears probable that one of the important characters of "spores" is the diminished amount of free water held in the protoplasm; or, in other words, its dryness. This dryness of the coagulable substance would seem to be cause of its higher resistance.

So far the evidence seems complete. Whether, however, loss of water is the ultimate cause of the high resistance capacity of hot-spring organisms or of those gradually acclimatized is still uncertain. Analogy renders it highly probable that such is the case.

2. **Acclimatization to Cold.**—Just as organisms may become acclimatized to high temperatures, so also may they live in very cold regions. I cite a few examples: Several species of Protista are said to live in the Alps above the snow line, coloring the snow red. (SHUTTLEWORTH, '40.) A tardigrade is found in the same locality. Certain insects live on or in the snow or ice. Thus *Desoria glacialis* (or glacier flea) lives on the Swiss glaciers, and on the snow live *Podura hiemalis*, *Trichocera brumalis* (when the temperature is "below the freezing point," FITCH, '46, p. 10), and other species of *Trichocera* and *Podura*. Cf. also *Boreus hiemalis* and *B. brumalis* (FITCH). Although swarm-spores are usually extremely sensitive to cold, STRASBURGER ('78, p. 613) cites a case of a marine alga in which they were being formed and thrown out when the temperature of the water was between -1.5° and -1.8° C.

Increased resistance to cold seems often the result of the action of cold on the organism. Thus, while SCHWARZ ('84, p. 69) found that *Euglenæ* gathered in the *summer* time were not responsive below $+5^{\circ}$ to $+6^{\circ}$ C., ADERHOLD ('88, p. 320) found that *Euglenæ* gathered in the *winter* would respond even at 0° . We may say, the winter cold had in some way lowered the heat attunement of these Protista.

In seeking for an explanation of acclimatization to cold we should recall that the cause of death from cold is chiefly the freezing of water in the protoplasm, and the irritation of excessive cold. Accustomed to great cold, protoplasm would doubtless be no longer irritated by it; whether under these circumstances

it would contain less water is a question which lacks an experimental answer.

The conclusion from the results offered in this section is this: protoplasm may become so modified through the action of excessive heat or cold that it is no longer killed at the ordinary fatal temperatures. This result is partly due to the fact that it is then not so strongly irritated by these extreme temperatures, and partly owing to the fact that the coagulation and freezing points have been shifted, possibly through loss of water.

§ 5. DETERMINATION OF THE DIRECTION OF LOCOMOTION BY HEAT — THERMOTAXIS

Our knowledge of this subject is still in its infancy and depends chiefly upon the observations of STAHL ('84), VERWORN ('89, pp. 67-68), GRABER ('83 and '87), LOEB ('90, p. 43), DE WILDEMANN ('94), and MENDELSSOHN ('95). The first two and the last two mentioned have employed Protista, and we may consider their work first.

STAHL'S studies were made upon Myxomycetes. He used two beakers, of which one was filled with water at 7°; the other with water at 30°. These were placed near each other, and a strip of filter-paper, on which lay the plasmodium of *Æthelium septicum*, was stretched between them. The two ends of the strip with the corresponding ends of the plasmodium hung into the two glasses. The result was that the plasmodium moved from the colder water toward the warmer, although before the experiment it was moving in the opposite direction. WORTMANN ('85) added the observation that when the warmer temperature rose above 36° a repellent action of the warmer water was discernible.

VERWORN experimented chiefly with *Amœba*. The difficulty in this operation depended upon the necessity of warming only a part of the body of so small an animal. He used a glass plate of 5 sq. cm. area, to the upper surface of which was glued a piece of black paper, in which had been cut a rectangular opening, 3 sq. mm. large, and with very sharp edges. This plate was placed on the stage of the microscope so that the hole lay

in the rays of the infalling, concentrated light of midsummer, reflected from the mirror. Upon the black paper was placed the cover-glass with the amœba in a drop of water. The light from the mirror was cut off until the amœba, in its migrations, lay half-way over the edge of the orifice. Then concentrated light was let through the slit. A small part of the body was still moved across the line of demarcation; then for a moment movement ceased and a few seconds after the protoplasm of the amœba began to flow backwards. In from 10 to 30 seconds the amœba was wholly in the dark again. Similarly, when the cover-glass was moved so that the amœba was brought half-way over the open orifice it retreated into the dark. Direct measurement showed that the temperature at the illuminated part was 40° to 50° C., whilst over the black paper it was 15° to 20° less. That the movement was not due to the light was shown first by cutting out, by means of ice, the heat rays only. No reaction occurred. Secondly, by cutting out the light but not the heat, by passing the light through a solution of iodine in CS_2 so that only the ultra-red rays (which act like darkness to all organisms) went through; the typical reaction occurred when the temperature over the slit was 35° . From all of these experiments the conclusion seems justified — Amœba is positively thermotactic towards that temperature.

Similar results were obtained by VERWORN with the shelled Rhizopod *Echinopyxis aculeata*, and later (see JENSEN, '93, p. 440) with *Paramecium*. More complete studies on the latter were, however, made by MENDELSSOHN, who worked in VERWORN'S laboratory. MENDELSSOHN devised an excellent method of study. A brass plate 20 cm. \times 6 cm. and 4 mm. thick is properly supported in a horizontal position, and to its under face are affixed, transversely, tubes through which hot or cold water may be run from a reservoir placed at a high level. In the middle of the plate a space 10 cm. \times 2 cm. and 2 mm. deep is cut out and into it is fitted a glass or ebonite trough. Special thermometers whose bulbs are coiled in the plane of the trough, and hence perpendicularly to the stem, serve to measure the temperature of the water in the trough at any point. By means of water running through the transverse tubes either end of the trough may be heated or cooled as

desired. Starting now with the trough filled with infusion water, the *Paramecia* are seen to be uniformly distributed (Fig. 71, *a*). Hot water is run through tubes under the right end of the trough. After 10 minutes the thermometers show the temperature of the water at the right end to be 38° , at the left end 26° . At this moment, all *Paramecia* are in the left third of the trough (Fig. 72, *b*). If now the hot water be passed through the left tube only, the temperature rises at that end to 36° or 38° , falling to 27° or 28° at the other, and

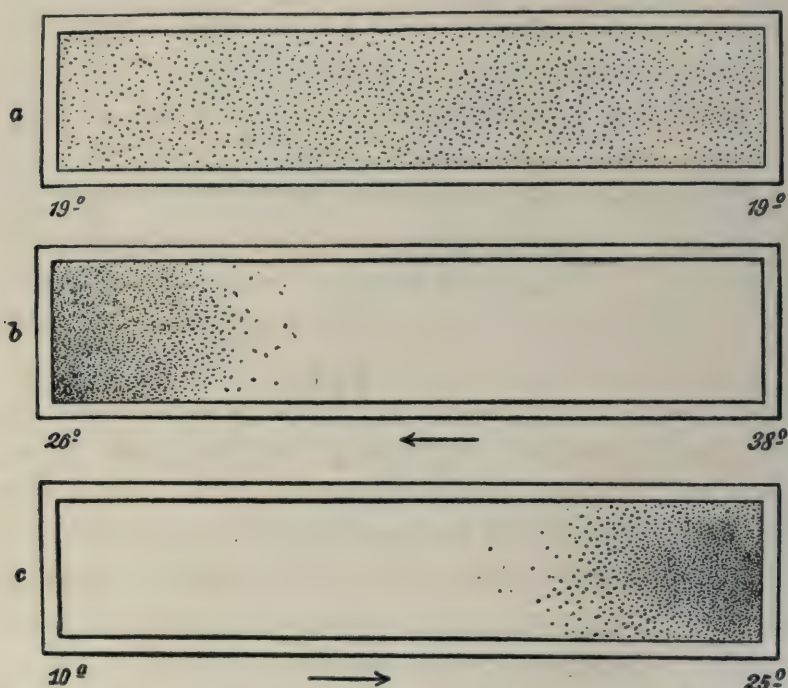

FIG. 71.—Distribution of *Paramecium* in a trough of water with variable temperature at the ends. (From MENDELSSOHN, '95.)

the *Paramecia* swim to the right end. Thus, with reference to a temperature of 38° , *Paramecia* are negatively thermotactic.

If, now, cold water be passed through the left tube so that the temperature of the left end of the trough falls to 10° , while the right end is at 25° , the *Paramecia* migrate to the right end. Towards a temperature of 25° *Paramecium* is thus positively thermotactic (Fig. 72, *c*).

Finally, if cold water be passed through the tube at one end of the trough and hot water at the other, the organisms will be found accumulated in the middle of the trough where the tem-

perature ranges from 24° to 28° C. This temperature is thus the optimum temperature for *Paramecium*, the temperature towards which it tends to move when the extremes are offered to it. Using another nomenclature, we may say, *Paramecium* is *attuned* to a temperature of 24° to 28° C.,* and tends to keep in the temperature to which it is attuned.

Similar results have been obtained by DE WILDEMANN ('94) from *Euglenæ* which were kept in damp sand and in the dark, in a horizontal test-tube warmed at one end. Under these conditions they migrated towards the temperature of 30° rather than that of 15 to 22°.

Finally, we may consider thermotaxis as it is revealed in the higher animals. LOEB ('90, p. 43) enclosed the larvæ of the bombycid moth *Porthesia* in an opaque box, one end of which was next the stove. The animals moved to the warmer end of the box. The migration differed, however, from migrations with reference to light in that the body was not definitely oriented with reference to the source of heat, but the larvæ *wandered* thither. Similarly some ants (*Formica sanguinea*) are thermotactic according to WASMANN ('91, p. 22); and the cockroach (GRABER, '87, p. 254) moves towards that temperature which is more nearly normal for it. GRABER ('83, p. 230) has likewise shown that the salamander *Triton* is similarly responsive. Thus some Metazoa as well as Protista are clearly thermotactic.

Looking now for the cause of thermotaxis, we see at the outset that it is necessary to distinguish between two possibilities: a movement towards a greater or less intensity of heat, and a movement with reference to the direction of the heat rays in radiant heat. Now we have seen in earlier chapters, in considering the action of gravity, the electric current, and light, that these agents determine the direction of locomotion by determining the orientation of the axis of the body; and since radiant heat passes in lines, it might be possible to have a similar effect here. But there is no evidence that radiant heat acts here. In the case of the *Myxomycete*, it is clear that

* Adequate control experiments with dead *Paramecia* and fine suspended particles demonstrated that the movement was not purely passive; *i.e.* due to currents in the water.

a difference in the temperature of the two ends is sufficient to determine direction of locomotion. In the case of *Paramecium*, it is improbable that radiant heat acted, since this passes with difficulty through water. Finally, in the case of the insects enclosed in a box there is evidence of no axis orientation, and in the case of VERWORN'S experiments with the *Amœba* the action of direction is clearly shut out. We must therefore conclude that direction of locomotion in thermotaxis is not usually, if ever, determined by direction of heat rays.

Since it is not direction of heat rays, it is probably difference of intensity of the agent at the two poles of the organism which is the determining factor. This is clearly so in the case of the *Myxomycete* and *Amœba*. In the case of insects also, it is clear that one part of the body being appreciably nearer the source of heat would be appreciably warmer than the other, and this difference in temperature might serve as an indication to the organism of the direction of the source of heat. But when we come to consider MENDELSSOHN'S experiments on *Paramecium*, we pause to think of the organism being so sensitive as to be affected differently at the two poles by so slight a difference of intensity as these poles must experience. MENDELSSOHN has found that the least difference of intensity at the ends of his 10 cm. long trough which will call forth a thermotactic response is 3° C. The length of a *Paramecium* is about 0.2 to 0.25 mm., which corresponds to a difference of 0.01° C. of temperature at its two poles. This is the minimal temperature-difference which acts as a stimulus to *Paramecium* and calls forth a thermotactic response. Although this difference is small, we must, with MENDELSSOHN, in the absence of opposing data, consider it the determining factor in thermotaxis, and conclude that, in general, the thermotactic response is a response to differences in the intensity of heat to which the two poles of the body are subjected.

Let us now sum up the results of our study of the effect of heat on protoplasm. The rates of the metabolic processes and of protoplasmic movements are controlled by temperature, since they diminish from the optimum slowly towards the minimum and rapidly towards the maximum. At these points movement and irritability cease as a result of excessive stimulation, and

either the beginning of coagulation (maximum) or the cessation of chemical change (minimum) appears. Finally, death takes place at the ultramaximum through coagulation of the proteids, while it may occur beyond the minimum also, if the protoplasm contains much water. The optimum temperature is unlike in the different species, and certain individuals even may gain a very high or low optimum (lying even beyond the normal extremes) through the process of gradual acclimatization. The acclimatization seems to be due to the direct action of the varying environment upon the constitution of protoplasm. Finally, many simple organisms (probably all protoplasm) respond to heat by a locomotion which is adapted to keep them at the temperature to which they are attuned. The movement seems to be determined by the difference in intensity of heat at the different parts of the body. This whole chapter reveals protoplasm as a substance whose integrity is limited by chemico-physical conditions. Within those limits, however, it is highly sensitive to changes in temperature, becoming so altered by an untoward temperature as not to be injured by it, or migrating, if possible, so as to keep in the temperature to which it is already attuned. In a word, protoplasm shows itself to be a highly irritable, automatically adjustable substance.

NOTES TO TABLE XXI (p. 250)

1. The *Chroococcus* was found in some of the fronds of *Nostoc*s from Owen's Valley (see No. 3); but it is not stated whether they were in those *Nostoc*s which were derived from the hottest springs.

2. No details are given by BREWER concerning the method of determining temperature. "In these warm mineral waters low forms of vegetation occur. The temperatures were carefully observed in many cases. The highest temperature noted, in which the plants were growing, was 93° C. (about 200° F.). But they were most abundant in waters of the temperature 52° to 60° (125° to 140° F.). In the hotter springs the plants appeared to be of the simplest kind, apparently, simple cells of a bright green color; but they were examined only with a pocket lens. In the water below, about 60° to 65° C., filamentous *Confervæ* formed considerable masses of a very bright green color." In a letter to WYMAN, however, BREWER says, concerning the same locality and determinations: "The temperatures given here were carefully observed with a standard Centigrade thermometer, with a naked elongated bulb," and "at the higher temperature [93° C.] they [the vegetable forms] were not abundant and existed as grains like *Nostoc* or *Protococcus*, intensely green and rather dark."

3. The temperature determinations, like the organisms, came from a Mrs. PARTZ, who is vouched for as reliable. No details concerning the method of obtaining temperatures are, however, given. The springs form a basin from which flows a creek. "In the basin," says Mrs. PARTZ, "are produced the first forms [Nostoc] partly at a temperature of 124° to 135° Fahr. Gradually in the creek, and to a distance of 100 yards from the spring, are developed, at a temperature of 110°-120° Fahr., the algæ," etc.

4. Not seen by me.

5. COHN states: "Thermometerbeobachtungen zeigten in verschiedener Temperatur des Wassers verschiedene, schon durch die Farbe erkennbare Arten; zwischen 43° und 35° R., die hellgrüne Leptothrix, zwischen 35° und 25° die Oscillarien, Mastichocladen, etc., gesellt mit Räderthieren, Infusorien und Wasserälchen; in noch abkühlterem Wasser die farblose *Hygrocrocis nivea*; Wasser über 44° enthält keine lebenden Organismen. Ganz dasselbe fand AGARDH 1827."

6. No statement as to the method of determining temperature. The measurements were made in the outlet to a hot spring. In this outlet *Hypeothyx laminosa* flourished at 68° and occurred at even a higher temperature.

7. This account also leaves something to be desired as to definiteness: "Small springs rise at intervals of 10 to 20 feet along a distance of 30 to 40 rods. Their waters unite and form a little stream that empties into a brook a short distance below. . . . A dense mass of beautiful green confervæ grew about the bottom and sides of the channel, and floated in rich waving masses in the hot water. In the immediate vicinity of the springs, however, no vegetable growth appears. . . . The temperature of the hot stream, below all the springs, was found to be 130°."

8. GERVAIS' account is detailed, but the method employed in determining temperature is not given. The principal sections of interest are as follows: "Nous avons dit que l'eau au moment où elle s'échappe des sources avait donné à notre thermomètre + 95° cent." [It cooks eggs, meat, beans, etc.] "Il est inutile de dire qu'on ne trouve en cet endroit aucun animal ne aucun végétal aquatique vivant. Cependant on voit courir sur les cônes d'où jaillit l'eau bouillante, et en des points où le pied éprouve, même à travers la chaussure, un sentiment de vive chaleur, de petites Araignées qui m'ont paru être du genre *Lycose*. Quelques-unes s'aventurent même et cela sans inconvénient à travers la surface des petits cratères remplis d'eau chaude que présentent les cônes dont il s'agit. Dans la substance calcaire également fort chaude d'un de ces cônes que nous percions à coups de pioche pour en faire sortir l'eau bouillante par le flanc, nous avons trouvé plusieurs exemplaires vivants d'un petit Coléoptère de la famille des Hydrophiles, l'*Hydrobius orbicularis*, qui y avaient fixé leur demeure.

"L'eau à + 95° qui sort de différents points d'Hammam-Meskhoutin perd assez rapidement cette température élevée. Elle n'a déjà plus que 57° dans les vases du second tiers de la cascade, dans lesquelles on commence à trouver des productions cryptogamiques. Celles-ci sont en partie couvertes d'un enduit ferrugineux assez épais."

9. Plants found in samples of water from Taupo, "growing in water the temperature of which varied from 105° F. to 131°." Two individuals are given as occurring at "temp. 136°"; two at "temp. 116°."

10. See note 2.

11. The reference reads: "Not only confervas and other vegetables grow in and about the hottest springs, but great numbers of little insects are constantly sporting about the bottom and sides." The temperature of the various springs runs from 92° to 151° F.

12. DANA SAYS: "A species of feathery vegetation occurs also upon them [the stones of the brook], bordering the streamlets where the temperature is 160° F., and presenting various shades of green and white."

13. Data concerning temperature incomplete. "Confervæ abound in the warm stream from the springs, and two species, one ochreous brown, and the other green, occur on the margins of the tanks themselves, and in the hottest water; the brown is the best salamander, and forms a belt in deeper water than the green; both appear in luxuriant strata, wherever the temperature is cooled down to 168°, and as low as 90°."

14. This seems a carefully observed case. Hot water flowed from the clefts of the rock. "Die flache und schroffe Felswand worauf das heisse Wasser rieselnd und tropfend herabfloss war mit 2 fingerdicken hell und dunkelgrünen oder auch gelben, röhlichen und braunen Filzen überdeckt. In diese Filze an den Spalten eingesenkt zeigte das Thermometer 65 bis 68° R., entfernter von der Spalte schnell abnehmend weniger. Die organischen Filze waren so heiss, dass sie mit den Fingern nicht fassbar waren." Examined microscopically, the mass was found to consist partly of dead, partly of living "Eunotia forms" overgrown with *Oscillaria*. A similar condition was found also "in der Schlecht der Acqua della Rita bei eine Temperatur von 59° R. . . . Ich untersuchte in Serravalle aufgefangenes Wasser von 65° R. Wärme, welches ich in ein Glas laufen liess, während ich die felzige Masse drückte. Es war sehr voll von vielartigen lebenden kleinen Thieren. Darunter war 4 Arten munter bewegter Räderthiere, nämlich *Diglena Catellus*, *Conurus uncinatus*, die Abänderung des *Brachionus Pola* mit kleinen Stirnzähnen am Schilde, auch *Philodina erythro-phthalma*, ausgebildete Eier im Innern führend. Von Polygastern fanden sich in frischer Lebensthätigkeit eine noch unbekannte eigenthümliche, kleine Nussula, Formen von *Enchelys* und *Amphileptus* von weniger sich auszeichnender Gestaltung. Besonders auffallend war die lebende *Eunotia Sancta Antonii* der Capverdischer Inseln, deren Lebenszustand und Lebensbedingungen hierdurch zum erstenmale bekannt werden." Despite the evident care taken to obtain accurate results, EHRENBURG'S observations have not been confirmed by HOPPE-SEYLER ('75, pp. 119, 120), who examined Ischia, but found no algæ living at a temperature much above 60°.

15. The entire reference is this: "M. FLOURENS met sous les yeux de l'Académie des *conferves* recueillies en Islande par M. DESCLOIZEAUX, qui les a trouvées végétant dans la source thermale de Gröf, à une température de 98 degrés" [of course, C.]. HOOKER ('13, p. 160) is often quoted as having obtained vegetation in Icelandic hot springs. Unfortunately, he gives no temperature determinations. He says: "Close to the edge of many of the hot springs [vicinity of the Great Geyser], and within a few inches of the boiling water, in places that are, consequently, always exposed to a considerable degree of heat, arising both from the water itself and the steam, I found *Conferva limosa* Dillw. in abundance." Again, "In water, also, of a very great degree of heat, were, both abundant and luxurious, *Conferva flavescens* of Roth and a new species allied to *C. rivularis*."

16. The temperatures were not taken on the spot. MOSELEY says: "The water from which the Algæ were gathered was in the pools from which the *Chroöcoccus* was collected as far as I can now [*i.e.* many months after (?)] judge after testing water of successive temperatures with my finger, about 149°–158° F. The water of the sulphur-springs, in the area splashed by which the *Oscillatoria* are found, is quite scalding to the hand, and probably between 176° to 194° F."

17. The reference reads: "Dans celle [source chaude] de Saint Pierre, dont la temperature varie de 33 à 35 degrés, les *Physa acuta*, Drap. sont en nombre si considérable qu'elles forment un véritable fond mouvant dans les canaux." These hot water molluscs, as experiment showed, were killed at about 43°, while *Physa* from ordinary sources die at once at 35°. They perished after a few hours at 5° or 6°.

18. Merely the note: "On en [living mollusca] trouve aussi dans des eaux thermales: par exemple le *turbo thermalis*, espèce de paludine sans doute, vit dans celles d'Abano, dont la température est de 40° R."

19. The statement is not critical: "Their heat [hot springs] is too great for the hand to bear; the highest temperature is about 150°." "In the hot water of these springs a green plant vegetated, which seemed to be a species of *conferva* growing in such situations: probably the *fontenalis*. But what is more remarkable, a bivalve testaceous animal adhered to the plant, and lived in such a high temperature too."

20. See note 5.

21. "J'ai mesuré plusieurs fois & en diverses saisons, la chaleur de ces eaux, & je l'ai toujours trouvée à très-peu près la même; savoir, de 35 degrés dans celle du soufre, & de 36½ ou 36.7 [R. from context] dans celle de St. Paul. Malgré la chaleur de ces eaux, on trouve des animaux vivans dans les bassins qui les reçoivent; j'y ai reconnu des rotifères, des anguilles & d'autre animaux des infusions. J'y ai même découvert en 1790, deux nouvelles especes de tremelles douées d'un mouvement spontané."

22. See note No. 14.

23. Many individuals collected by R. BLANCHARD "dans les eaux de thermes du Hamman-Meskhoutine, près Guelma, dans les premiers jours d'avril; l'eau des thermes, au point de la récolte, a une température de 45° et de 50.5° C. Les Cypris formaient une sorte de zone continue, de couleur chocolat, sur le bord de l'eau."

24. Found "in a hot spring, temperature 157° F., attached to the rock by the long end at about an angle of 45° and continually moving. . . . The rocks were covered with them."

25. The note in "Insect Life" is abstracted from a longer article by BRUNER in the newspaper called the Lincoln (Nebraska) "Evening Call," for April 6, 1895. The article, through the kindness of Professor H. B. WARD of the University of Nebraska, I have now before me. The larvæ were sent to Professor BRUNER by JOHN C. HAMM, of Evanston, Wyoming, upon whom this statement of the conditions of life of the organisms depends. The larvæ were found in a cup-shaped depression in the top of a small isolated cone about 20 inches high, situated about a few feet from a large sulphur mound or "dune," under which one could hear the rumbling of boiling water. Through apertures in the bottom the almost boiling water came up into the cup and ran over the edge of the pot.

The larvæ were actively moving. Mr. HAMM writes to Mr. BRUNER: "I did not have a thermometer with which to take the temperature, but . . . the water was so hot when I saw them that I could not hold my hand in it. My best judgment is and was at the time that the water was not more than twenty or thirty degrees [Fahr., of course] below the boiling point."

26. "A water beetle abounded in water at 112°" [F.].

27. Too hot for the hand to bear more than a moment or two.

28. The reference is to a discussion of a paper by BERT. "M. PAUL BERT a vu des barbellons dans de l'eau à 34° C."

29. "Mon ami Mr. COCCHI," says SPALLANZANI, "raconte que les Grenouilles ne souffrent point dans les bains de Pise, quoiqu'elles soient exposées à une chaleur indiquée par le 111° du Thermometre de FAHRENHEIT qui correspond au 37° du Thermometre de RÉAUMUR [! sic]."

LITERATURE

ADERHOLD, R. '88. (See Chapter I, Literature.)

AFFANASIEFF, N. '65. Untersuchungen über den Einfluss der Wärme und der Kälte auf die Reizbarkeit der motorischen Froschnerven. Arch. f. Anat. u. Physiol. 1865. pp. 691-702.

ARTAUD, J. B. L. '25. Essai sur la phosphorescence de l'eau de la mer. Bull. sci. nat. (FERUSSAC). VI, 130, 131.

BERT, P. '67. Mémoire sur la physiologie de la Seiche (*Sepia officinalis* Linn.). Mém. Soc. Sci. Bordeaux. V, 115-138.

'67^a. Sur la mort des animaux à sang froid par l'action de la chaleur. Mém. Soc. sc. phys. et nat. Bordeaux. V, xxii.

'76. Sur l'influence de la chaleur sur les animaux inférieurs. C. R. Soc. de Biol. Paris. XXVIII, 168.

BLAINVILLE, DE '24. Article *Mollusques* in Dict. des Sci. Nat. T. XXXII, 141.

BLAKE, W. P. '53. Geological Report, in Explorations and Surveys for a Railroad Route to the Pacific Ocean. Vol. V. War Dept. U.S.A.

BONARDI, E. and GEROSA, G. G. '89. Nouvelles recherches par rapport à l'influence de certaines conditions physiques sur la vie des microorganismes. Arch. Ital. de Biol. XII, 89-93. 28 July, 1889.

BRAEM, F. '90. Untersuchungen über die Bryozoen des süßen Wassers. Biblioth. Zool. II. 134 pp.

BRAUER, A. '94. Ueber die Encystirung von *Actinosphaerium Eichhornii* Ehrbg. Zeitschr. f. wiss. Zool. LVIII, 189-221, Taf. x, xi.

BREWER, W. H. '66. Observations on the Presence of Living Species in Hot and Saline Waters in California. Am. Jour. Sci. XLI, 391-394.

BROCA, P. '61. (See Chapter II, Literature.)

BRUNER, L. '95. Animal Life in Thermal Springs. Insect Life. VII, 413-414.

- BÜTSCHLI, O. '84. Protozoa. BRONN'S Klassen u. Ord. d. Thierreichs. I Bd., II Abth. 785-864.
- '89. The same. III Abth., Infusoria. pp. 1585-2035.
- CALLIBURCÈS, P. '58. Recherches expérimentales sur l'influence exercée par la chaleur sur les manifestations de la contractilité des organes. *Comp. Rend.* XLVII, 638-641.
- CAMPBELL, J. P. '88. Experiments on Tetanus and the Velocity of the Contraction Wave in Striated Muscle. *Stud. Biol. Lab. Johns Hopkins Univ.* IV, 123-145. Apr. 1888.
- CANDOLLE, A. DE '65. De la germination sous des degrés divers de température constante. *Arch. des sci. nat. et phys.* XXIV, 243-282.
- CANDOLLE, A. P. DE '06. Expériences relatives à l'influence de la lumière sur quelques végétaux. *Mém. présent. à l'institut des sci. lett. et arts par divers savants.* Sci. math. et phys. I, 329-350.
- CANDOLLE, C. DE '80. De l'effet des températures très-basses sur la faculté germinative des graines. (*Verh. Schweizer naturf. Ges. Jahresber.* 1877-1878). *Bot. Ztg.* XXXVIII, 64. 23 Jan. 1880.
- '84. *Arch. d. sci. phys. et nat.* (3) XI, 325-326. 15 March, 1884. [No title.]
- CHMULEWITCH, J. '69. De certaines propriétés physiques et physiologiques des muscles. *Comp. Rend.* LXVIII, 936-938. 19 Apr. 1869.
- COHN, F. '50. Nachträge zur Naturgeschichte des *Protococcus pluvialis* Kützing. *Verh. d. Kais. Leop.-Car. Akad.* XXII², 607-764.
- '62. Ueber die Algen des Karlsbader Sprudels und deren Antheil an der Bildung des Sprudelsinters. *Flora.* XLV, 538-540.
- '71. [Das Gefrieren der Zellen von *Nitella syncarpa.*] *Bot. Ztg.* XXIX, 723.
- '77. Beiträge zur Biologie der Bacillen. *Beiträge z. Biol. d. Pflanzen.* II, 249-276.
- COHN, J. '94. Ueber thermogene Bakterien. *Verh. Ges. deutsch. Naturf. u. Ärzte.* 65. Vers. Nürnberg, 1893. pp. 148-150.
- CORI, C. I. '93. Das Objectischaquarium. *Zeitschr. f. wiss. Mikr.* X, 148-151.
- DALLINGER, W. H. '80. On a Series of Experiments made to Determine the Thermal Death-point of Known Monad Germs when the Heat is Endured in a Fluid. *Jour. Roy. Mic. Soc.* III, 1-16. 1880.
- '87. The President's Address. *Jour. Roy. Mic. Soc.* 185-189. 1887.
- DALLINGER and DRYSDALE, J. '74. Further Researches into the Life History of Monads. *Monthly Micros. Jour.* XI, 97-103. 1874.
- DANA, J. D. '38-'42. Geology. U. S. Explor. Exped. 1838-1842. Vol. X. 756 pp.
- DAVY, J. '63. Some Observations on the Vitality of Fishes as tested by Increase of Temperature. *Rept. 32d Meet. Brit. Assoc. Adv. Sci.* 1862. Notices, 125.
- DEHÉRAIN, P. P. and MOISSAN, H. '74. Recherches sur l'absorption d'oxygène et l'émission d'acide carbonique par les plantes maintenues dans l'obscurité. *Ann. Sci. Nat. (Bot.)* (5). XIX, p. 321-357.

- DEMANT, B. '79. Beiträge zur Chemie der Muskeln. *Zeitschr. f. physiol. Chem.* III, 241-249.
- '80. Ueber das Serumalbumin in den Muskeln. *Zeitschr. f. physiol. Chem.* IV, 384-386. 18 Aug. 1880.
- DEMOOR, J. '94. (See Chapter I, Literature.)
- DOENHOFF '72. Ueber das Verhalten kaltblütiger Thiere gegen Frosttemperatur. *Arch. f. Anat. u. Phys.* Jg. 1872, pp. 724-727.
- DOYÈRE, M. P. L. N. '42. (See Chapter II, Literature.)
- DUBALEN '73. Note sur les Mollusques qui vivent dans les sources chaudes de Dax. *Actes Soc. Linn. Bordeaux.* XXIX, C. R., p. iv.
- DUCLAUX, E. '71. Études physiologiques sur la graine de vers à soie. *Ann. de chim. et de physique.* (4) XXIV, 290-306.
- DUTROCHET '37. Observation sur le Chara flexilis: Modifications dans la circulation de cette plante sous l'influence d'un changement de température, d'une irritation mécanique, de l'action des sels, etc. *Comp. Rend.* V, 775-784. 4 Dec. 1837.
- DYER, W. T. T. '74. Note on the Foregoing Communication [of Moseley, '74]. *Jour. Linn. Soc. (Bot.)* XIV, 326-327. 17 Oct. 1874.
- EDWARDS, W. F. '24. De l'influence des agens physique sur la vie. Paris: Crochard. 654 pp. 1824.
- EHRENBERG '59. Ueber eine auf der Insel Ischia jüngst beobachtete, zur Erläuterung einer ungarischen aus Kieselorganismene bestehenden Felsart dienende Wirkung heisser Quellen. *Monatsber. Akad. Wiss. Berlin*, aus d. Jahre 1858, pp. 488-495.
- ENGELMANN, T. W. '68. Ueber die Flimmerbewegung. *Jen. Zeitschr.* IV, 321-479.
- '77. Flimmeruhr und Flimmermühle. Zwei Apparate zum Registriren der Flimmerbewegung. *Arch. f. d. ges. Physiol.* XV, 493-510. 23 Oct. 1877.
- '79. Physiologie der Protoplasma- und Flimmerbewegung. *Handb. d. Physiol. (Hermann).* I, 343-408. 1879.
- FITCH, A. '46. Winter Insects of Eastern New York. *Amer. Quart. Jour. of Sci. and Agric.* V, 274-284. Extr. by WESTWOOD, *Trans. Ent. Soc. Lond.* (2) I, Proc. 95-98. 1851.
- FLOURENS '46. (Note on conferva of Icelandic hot springs.) *Comp. Rend.* XXIII, 934.
- FRENZEL, J. '85. Temperaturmaxima für Seethiere. *Arch. f. d. ges. Physiol.* XXXVI, 458-466.
- GERVAIS, P. '49. Observations sur les eaux d'Hamman-Meskhoutin. *L'Institut.* XVII, 11-121.
- GOTSCHLICH, E. '93. Ueber den Einfluss der Wärme auf Länge und Dehnbarkeit des elastischen Gewebes und des quergestreiften Muskels. *Arch. f. d. ges. Physiol.* LIV, 109-164. 21 Apr. 1893.
- GRABER, V. '83. (See Chapter VII, Literature.)
- '87. Thermische Experimente an der Küchenschabe. *Arch. f. d. ges. Physiol.* XLI, p. 240-256. 17 Oct. 1887.

- GRIFFITH, H. G. '82. Larvæ of a Fly in a Hot Spring in Colorado. *Am. Nat.* XVI, 599.
- HALLIBURTON, W. D. '88. On the Nature of Fibrin Ferment. *Jour. of Physiol.* IX, 229-286. Nov. 1888.
- HEINRICH, R. '71. Beiträge zur Kenntniss des Temperatur- und Lichteinflusses auf die Sauerstoff abscheidung bei Wasserpflanzen. *Landwirthsch. Versuch-Stat.* XIII, 136-154.
- HERMANN, L. '71. Die Erstarrung in Folge starker Kältegrade. *Arch. f. d. ges. Phys.* IV, 189-192.
- HOFFMAN, H. '63. Neue Beobachtungen über Bacterien mit Rücksicht auf *Generatio spontanea.* *Bot. Ztg.* XXI, 304-307, 315-319.
- HOFMEISTER, W. '67. (See Chapter IV, Literature.)
- HOPPE-SEYLER, F. '75. Ueber die obere Temperaturgrenze des Lebens. *Arch. f. d. ges. Physiol.* XI, 113-121. 26 July, 1875.
- HOOKE, J. D. '55. *Himalayan Journals.* 2 vols. John Murray. London, 1855.
- HOOKE, W. J. '13. *Journal of a Tour in Iceland in the Summer of 1809.* 2d ed. 2 vols. London, 1813.
- JAMES, E. '23. *Account of an Expedition from Pittsburgh to the Rocky Mountains under Command of Major Stephen H. Long,* Philadelphia. 2 vols. 1823.
- JENSEN, P. '93. (See Chapter V, Literature.)
- KNAUTHE, K. '95. Maximaltemperaturen, bei denen Fische am Leben bleiben. *Biol. Centrallb.* XV, 752.
- KOCHS, W. '90. Kann die Kontinuität der Lebensvorgänge zeitweilig völlig unterbrochen werden? *Biol. Centralbl.* X, 673-686. 15 Dec. 1890.
- KÜHNE, W. '59. Untersuchungen über Bewegungen und Veränderungen der kontraktilen Substanzen. *Arch. f. Anat. u. Phys.* 1859. pp. 564-642, 748-835.
- '64. (See Chapter I, Literature.)
- LEWIS, S. '90. Ueber die Ursache der Widerstandsfähigkeit der Sporen gegen hohe Temperaturen. Ein Beitrag zur Theorie der Desinfektion. *Arch. f. exper. Pathol.* XXVI, 341.
- LOEB, J. '90. (See Chapter VII, Literature.)
- MACAIRE-PRINSEP, J. '21. Mémoire sur la phosphorescence des lampyres. *Ann. de Chimie.* XVII, 151-167.
- MANTEGAZZA, P. '66. Sullo sperma umano. *Rendic. reale Instit. Lomb.* III, 183-196.
- MENDELSSOHN, M. '95. Ueber den Thermotropismus einzellige Organismen. *Arch. f. d. ges. Phys.* IX. 20 Feb. 1895.
- MITCHILL, S. L. '06. *Account of a Journey up the Washita (or Ouachita) River, in Louisiana, performed by WILLIAM DUNBAR, Esq., and Dr. HUNTER.* *Med. Repository.* New York. (2) III, 305-308.
- MOISSAN, H. '79. Sur les volumes d'oxygène absorbé et d'acide carbonique émis dans la respiration végétale. *Ann. des. Sci. Nat.* (6) Bot. VII, 292-339. July, 1879.

- MONIEZ, R. '93. Description d'une nouvelle espèce de Cypris vivant dans les eaux thermales du Hammam-Meskhoutine. Bull. Soc. Zool. France. XVIII, 140-142.
- MORIGGIA, A. '91. Die Ueberhitzung von Muskel- und Nervenfasern. Untersuch. z. Naturl. d. Mensch. u. d. Th. (MOLESCHOTT). XIV, 332-395.
- MOSELY, M. N. '74. Notes on Fresh Water Algæ obtained at the Boiling Springs at Furnas, St. Michael's, Azores, and their Neighborhood. Jour. Linn. Soc. (Bot.). XIV, 321-325. 17 Oct. 1874.
- MÜLLER-THURGAU '80. Landwirthsch. Jahrb. IX. [Quoted by VINES, '86.]
- NÄGELI, C. '60. Ortsbewegungen der Pflanzenzellen und ihre Theile. (Strömungen) Beitr. z. wiss. Bot. II, 59-108. 1860.
- NICHOLET, H. '42. Recherches pour servir à l'histoire des Podurelles. Schweizer Gesell. N. Denksch. VI. 88 pp.
- OBERNIER '66. Versuch über den Einfluss hoher Wärmegrade an Thieren. Verh. d. naturhist. Vereines d. preuss. Reinl. u. Westphal. XXIII, Sitzbr. 22, 23.
- PASTEUR, L. '61. Mémoire sur les corpuscles organisés qui existent dans l'atmosphère, examen de la doctrine des générations spontanées. Ann. Sci. Nat. (4) Zool. XVI, 5-98.
- PEALE, A. C. '83. The Thermal Springs of Yellowstone National Park. 12 Ann. Rept. U. S. Geol. and Geog. Surv. of Territories. Pt. II, 63-454.
- PICKFORD, P. '51. Untersuchungen über die Lebensreize. Zeitschr. f. rat. Med. (2) I, 335-383.
- PICTET, R. '93. Essai d'une méthode générale de synthèse chimique. Arch. des sci. phys. et nat. (3) XXIX, 5-27. 15 Jan. 1893.
- 93*. De l'emploi méthodique des basses températures en biologie. Arch. des sci. phys. et nat. (3) XXX, 293-314. 15 Oct. 1893.
- PLATEAU, F. '72. Recherches physico-chimiques sur les articulés aquatiques. II Part. Resistance à l'asphyxie par submersion, action du froid, action de la chaleur, température maximum. Bull. l' Acad. roy. Belg. XXXIV, 274-321.
- POUCHET, F. A. '66. Recherches expérimentales sur la congélation des animaux. Jour. de l'Anat. III, 1-36.
- PREVOST '40. Recherches sur les animalcules spermatiques. Compt. Rend. XI, 907, 908.
- PURKINJE and VALENTIN '35. De phænomeno generali et fundamentali motus vibratorii continui in membranis cum internis animalium plurimorum et superiorum et inferiorum ordinum obvii. Wratislariæ. 96 pp. 1835.
- QUATREFAGES, A. DE '53. Recherches sur la vitalité de quelques poissons d'eau douce. Ann. des Sci. Nat. (3) XIX, 341-369.
- RICHTER, C. '85. De quelques températures élevées auxquelles peuvent vivre des animaux marins. Arch. de Zool. (2) III, VI-VIII.

- RISCHAWI, L. '77. Zur Frage über die Athmung der Pflanzen. Schrift. d. neuruss. Ges. d. Naturf. Bd. V. 1887. [Russian. Abstract only seen in Botanischer Jahresbericht. V, 721, 722. 1879.]
- ROEDEL, H. '86. Ueber das vitale Temperaturminimum wirbelloser Thiere. Zeitschr. f. Naturw. LIX, 183-213. 1886.
- ROSSBACH, M. J. '72. (See Chapter I, Literature.)
- ROTH, M. '66. Ueber einige Beziehungen des Flimmerepithels zum contractilen Protoplasma. Arch. f. path. Anat. u. Phys. XXXVII, 184-194.
- SACHS, J. '60. Untersuchungen über das Erfrieren der Pflanzen. Landwirthsch. Versuchs. Stat. II, 167-201.
- '63. Die vorübergehende Starre-Zustände periodisch beweglicher und reizbarer Pflanzenorgane. Flora, XLVI, 449-459, 465-472, 481-489, 497-506. Nov. 1863.
- '64. Ueber die obere Temperatur-Gränze der Vegetation. Flora, XLVII, 5-12, 24-29, 33-39, 65-75. Jan.-Feb. 1864.
- '92. Gesammelte Abhandlungen über Pflanzenphysiologie. Bd. I, Leipzig, Engelmann. 1892.
- SAMKOWY '74. Ueber den Einfluss der Temperatur auf den Dehnungszustand quergestreifter und glatter muskulatur verschiedener Thierklassen. Arch. f. d. ges. Physiol. IX, 399-402. Oct. 1874.
- SAUSSURE, H. B. DE 1796. Voyages dans les Alpes. Tom. I-III. Neuchâtel. 1796.
- SCHENK, S. L. '69. Ueber den Einfluss niederer Temperaturgrade auf einige Elementarorganismen. Sb. K. Akad. Wien. LX, 2, 25-30.
- SCHULTZE, M. '63. (See Chapter I, Literature.)
- SCHUMACHER, E. '74. Beiträge zur Morphologie und Biologie der Hefe. Sb. Wien. Akad. LXX, 1, 157-188. June, 1874.
- SCHURMAYER, C. B. '90. Ueber den Einfluss äusserer Agentien auf einzelne Wesen. Jena. Zeitschr. XXIV, 402-470. 26 March, 1890.
- SCHÜTZENBERGER, P. '79. On Fermentation. Internat. Sci. Ser. XX. New York: Appleton and Co. 351 pp.
- SCHWARZ, F. '84. (See Chapter V, Literature.)
- SEMPER, C. '81. The Natural Conditions of Existence as they affect Animal Life. New York: Appleton and Co. 427 pp.
- SERRES, H. '80. Bull. Soc. Borda à Dax. V, 13-23.
- SHUTTLEWORTH, R. J. '40. Nouvelles observations sur la matière colorante de la neige rouge. Biblioth. univer. de Genève. XXV, 383-405.
- SPALLANZANI, L. 1787. (See Chapter II, Literature.)
- SPENCER, W. J. '83. Notes on Fresh-water Algæ. Trans. and Proc. New Zealand Inst. XV, 302-304. 1883.
- STAHL, E. '84. (See Chapter I, Literature.)
- STRASBURGER, E. '78. (See Chapter VII, Literature.)
- TREVIRANUS, G. R. '31. Versuche über das Athemholen der niedern Thiere. Unters. über d. Natur. d. Menschen, d. Thiere u. d. Pfl. (TIEDEMANN and TREVIRANUS.) IV, 1-39.

- VARIGNY, H. DE '87. Note sur l'action de l'eau douce, de la chaleur et de quelques poisons sur le *Beroe ovatus*. C. R. Soc. Biol. Paris. XXXIX. C. R. pp. 61-63.
- '87^a. Ueber die Wirkung der Temperaturerhöhungen auf einige Crustaceen. Centralbl. f. Physiol. I, 173-175.
- VELTEN, W. '76. Die Einwirkung der Temperatur auf die Protoplasmabewegung. Flora, LIX, 177-182, 193-199, 209-217. April-May, 1876.
- VERWORN, M. '89. (See Chapter I, Literature.)
- VINES, S. H. '86. Lectures on the Physiology of Plants. Cambridge [Eng.] Univ. Press. 710 pp. 1886.
- VRIES, H. DE '70. Matériaux pour la connaissance de l'influence de la température sur les plantes. Arch. Néerl. V, 385-401.
- WASMANN, E. '91. Parthenogenesis bei Ameisen durch künstliche Temperaturverhältnisse. Biol. Centralbl. XI, 21-23. 1 Feb. 1891.
- WEED, W. H. '89. The Vegetation of Hot Springs. Am. Nat. XXIII, 394-400.
- WELTNER, W. '93. Spongillidenstudien, II, Arch. f. Naturg. pp. 245-284.
- WEYL, T. '77. Beiträge zur Kenntniss thierischer und pflanzlicher Eiweisskörper. Zeitsch. f. Physiol. Chem. I, 72-110.
- WILDEMANN, É. DE '94. Sur le thermotaxisme des Euglènes. Bull. Soc. Belg. Micros. XX, 245-258. 6 Aug. 1894.
- WOLKOFF, VON and MAYER '74. Landwirthsch. Jahrb. III. 1874.
- WOOD, H. C. '74. A Contribution to the History of the Fresh-water Algæ of North America. Smithsonian Contributions to Knowledge. XIX, Art. III. 1874.
- WORTMANN, J. '85. Der Thermotropismus der Plasmodien von *Fuligo varians* (*Aethalium septicum* d. Aut.). Ber. D. Bot. Ges. III, 117-120.
- WYMAN, J. '56. [Observations on the Cold endured by Hibernating Insects.] Proc. Bost. Soc. Nat. Hist. V, 157.
- '67. Observations and Experiments on Living Organisms in Heated Water. Am. Jour. Sci. XLIV, 152-169.
- YUNG, É. '85. (See Chapter III, Literature.)

CHAPTER IX

GENERAL CONSIDERATIONS ON THE EFFECTS OF CHEMICAL AND PHYSICAL AGENTS UPON PROTOPLASM

IN the present chapter it is proposed to consider certain general matters upon which the facts given in this First Part throw light: namely, (I) the structure and composition of protoplasm; (II) the limiting conditions of metabolism; (III) the dependence of protoplasmic movement upon metabolism and external stimuli; and (IV) the determination of the direction of locomotion.

§ 1. CONCLUSIONS ON THE STRUCTURE AND COMPOSITION OF PROTOPLASM

The question of the *structure* of protoplasm is preëminently a histological one. Microscopical study must eventually be relied upon to settle it. However, the results of experimental work seem to favor, as we have already pointed out (p. 70), BÜTSCHLI'S view of a honeycomb, or foam structure, of protoplasm.

The problem of the *constitution* of protoplasm is, on the other hand, preëminently a chemical one, and it must be solved by experimental methods. Our results can lead us to certain *qualitative* statements on this matter.

The chemical composition of protoplasm is immensely complex. Just as the geologist is forced by the facts to assume a vast, but not infinite, time for earth building, so the biologist has to recognize an almost unlimited complexity in the constitution of protoplasm.

The evidence that protoplasm is so complex is gained partly from the results of micro-chemistry. Many staining fluids act upon only a small part of the protoplasm of a single cell, so that a mixture of stains may be used, each component of which

attacks a different constituent of the protoplasm. In this way the dissimilar substances in protoplasm are made strikingly apparent. Not only does the protoplasm of one cell show this differentiation, but that of different cells of the body stains very diversely. Another line of evidence for the complexity of protoplasm is gained from the study of the effect of poisons. We have seen that the same poisonous substance acts very differently upon allied species of organisms (*e.g.* of bacteria) and upon the various organs of the body, — a fact which in many cases can only be accounted for on the ground of dissimilar composition. Again, most protoplasm must contain substances which are acted upon specifically by the different agents; for instance, certain highly explosive compounds which are set off by contact, certain others which are disturbed by light, and still others which are especially changed by heat. Each compound, again, must form an inconsiderable part of the whole, for (if the action be not too intense or prolonged) the “stimulus” of the agent results in no disturbance of the activities in general. Likewise, the facts of acclimatization, according to which, apparently, certain substances in the protoplasm may be destroyed without other important change in activities, give additional insight into protoplasmic complexity. Finally, the same agent acts in varying degree on closely related protoplasm, and this indicates that, even when the general composition is the same, the proportions of the different substances vary. From the facts of protoplasmic staining and of the varied effects of poisons, from the diverse effects of other stimulating agents, and from the facts of acclimatization of organisms, we conclude that in dealing with protoplasm we are not always dealing with the same thing, but, on the contrary, with very diverse combinations, which have this in common, that they exhibit life.

§ 2. THE LIMITING CONDITIONS OF METABOLISM

Metabolism is life. To know the limits within which it can occur is to know the vital limits. It is impossible to define these limits closely, however, for, at either extreme, metabolism graduates insensibly into inaction. It will be necessary, consequently, to place our limits very far out.

The limiting conditions at which inaction occurs are of two sorts. These may be termed respectively structural and dynamical. These two sorts of limiting conditions may be illustrated by comparing the protoplasmic mass to a factory, with many boilers and engines, much shafting and belting, and countless machines doing the most varied work. The amount of energy developed in the boilers and the efficiency of the engines and machines varies with certain conditions, such as the amount of heat applied to the former, and the friction and waste in the latter. The limiting mechanical conditions are reached when the boiler is rent by the steam pressure, a break-down is caused by friction, or a part rusts through and crumbles away. The limiting dynamical conditions are reached when the heat no longer suffices to form steam in the boiler, or the power is insufficient to run the machines. In either case, at the structural, or at the dynamical limit, work ceases. It may be the work of a small part of the factory, so that the cessation is hardly noticed; or it may involve all the machines, producing complete cessation of activity.

To return to the protoplasm: the *structural* limiting conditions are of two main sorts, — mechanical and chemical. The mechanical limiting conditions are those in which the gross structure becomes broken down, while the chemical limiting conditions are those in which the composition becomes changed. To the mechanical group belongs the breaking down of the plasma films, either by drawing out the water of the protoplasm (by osmosis or by drying) or by the expansion due to the freezing of the chylema. To the chemical group belong, for example, the reactions upon protoplasm of the halogen salts of the heavy metals, and of complex nitrogenous organic compounds in whose molecules hydrogen is unstably joined to nitrogen, also the coagulation of the plasma by high temperatures and the destruction of molecules by contact, by the electric current, or by light. The *dynamical* limiting conditions, on the other hand, are the absence of oxygen or other food-stuffs, the absence of the water necessary to the solution and circulation of the food, absence of light, in the case of chlorophyllaceous organisms, and a temperature much below 0° C. Thus, the conditions essential to metabolism are the

absence of causes mechanically rupturing the machine, the absence of agents of such intense activity as to change profoundly its molecular constitution, and the presence of those agents—food, heat, light, and water—which supply or distribute the energy of metabolism.

Given protoplasm under these conditions, and normal metabolism must occur; without them, there is no metabolism. Vary the dynamical conditions quantitatively, and a quantitative variation in metabolism will ensue. Approach a structural limiting condition, and metabolism begins to cease. This conclusion, important for experimental morphology, is now reached: *A vital phenomenon occurring in a given protoplasmic mass can be reproduced only when the dynamical conditions are reproduced, and the structural limiting conditions are in no wise closely approached.*

§ 3. THE DEPENDENCE OF PROTOPLASMIC MOVEMENT UPON METABOLISM AND UPON EXTERNAL STIMULI

I do not propose to enter the debated ground of the cause of protoplasmic motion; but shall merely summarize the results of our studies on this subject. First, protoplasmic movement is closely related to metabolism and is probably dependent upon it. This is indicated by the fact that cessation of movement always occurs before the vital limit is reached. Rigor always precedes death. A second series of facts indicating the same thing is found in the closeness with which the optimum for metabolism agrees with the optimum for movement. Thus at about 35° C. both the metabolic processes and the movements of protoplasm find their optimum. These two results, then, that movement is impossible in dead protoplasm even when its structure is seemingly unaltered, and the close approximation of the optimum points for metabolism and for movement, are the best justification for the belief that movement is dependent upon metabolism.

But are the conditions essential to metabolism the only conditions necessary for movement? In other words, will movement always accompany metabolism, or are external stimuli

essential to its production? There is in biology no question more important than this, and the answer is not so certain as it ought to be. The fact that rigor occurs at a point at which recovery of movement is still possible is not sufficient evidence that metabolism has not ceased with the motion; for I think it has not been shown that with rigor "latent life" does not come in. On the other hand, the fact that some bacteria are motionless in the absence of light (which can hardly be essential to metabolism) would seem to indicate that conditions other than those of metabolism are necessary to movement. This single fact cannot, however, lead us to a definite answer, and our inquiry, whether or not "stimuli" are essential to protoplasmic movement, must still be regarded as unanswered.

§ 4. THE DETERMINATION OF THE DIRECTION OF LOCOMOTION

As we watch an animalcule swimming across the field of view, or as we see a larger organism moving, perhaps in a broken line, towards any point, we think of its movements as controlled from inside. Yet it is clear that if an organism is moving definitely towards a point, it must be on account of some influence emanating from that point and falling upon the organism. Without external directive influences of some sort there can be no directed movements.

This conclusion is confirmed by experiment. I have put an amœba into the apparatus already described (p. 186), so that the chemical conditions of its environment were uniform; contact and temperature were also similar on all sides; the directive action of gravity was annulled and all light was cut off. At intervals the position of the amœba was platted by the aid of light reflected momentarily from below the stage of the microscope and by means of a camera. Thus the path of the amœba was traced. A typical tracing made in this way is reproduced in Fig. 72. Compare the devious path made under these conditions with the straight path taken in response to light (Fig. 53). The curious spiral twists and the turning of the line upon itself are characteristic of all the tracings which I have made under these conditions. Important also is the

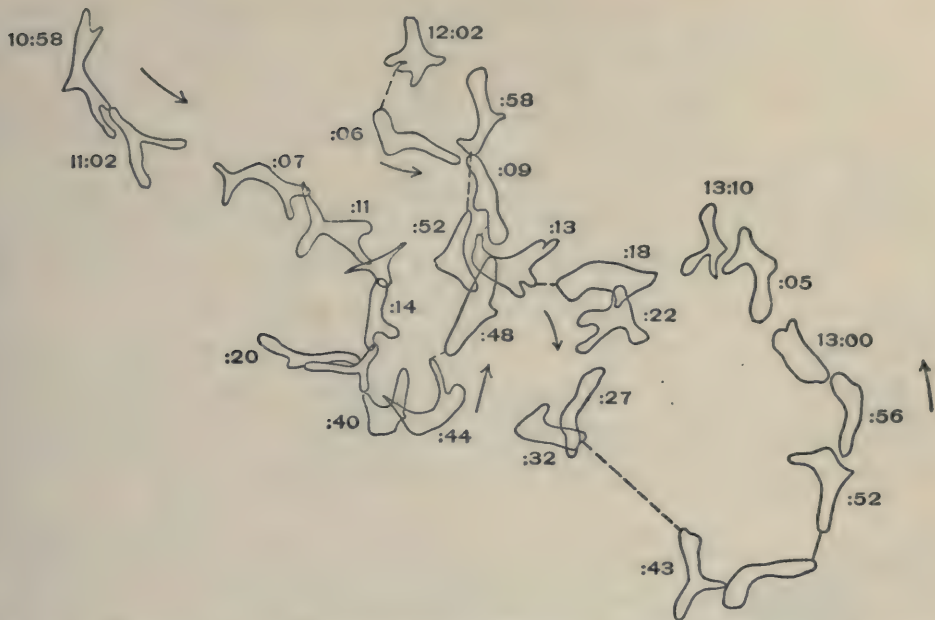

FIG. 72.—Camera drawing, showing the successive positions assumed by *Amœba proteus* when acted upon by external agents uniformly in all directions. Magnified 16 diams.



FIG. 73.—Tracks made on paper by larvæ of *Musca cæsar* moving in the dark from a central spot of colored fluid. (From POUCHET, '72. *Revue et Mag. de Zool.* (2) XXIII.)

fact that whereas the amœba responding to light is constantly elongated in the direction of the infalling ray, the amœba which is not stimulated from one direction exhibits, most of the time, a stellate appearance. The wandering of the undirected organism is illustrated again in the experiment of Pouchet on the larvæ of *Musca* (*Lucilia*) *cæsar*, kept in the dark (Fig. 73; compare Fig. 74, where the same larvæ are migrating under the directive influence of light).

From these experiments we make the deduction that external agents play a role of the utmost importance for morphology, — of the utmost importance because by them alone is determined the *direction* of migration of the motile cells or the migrating

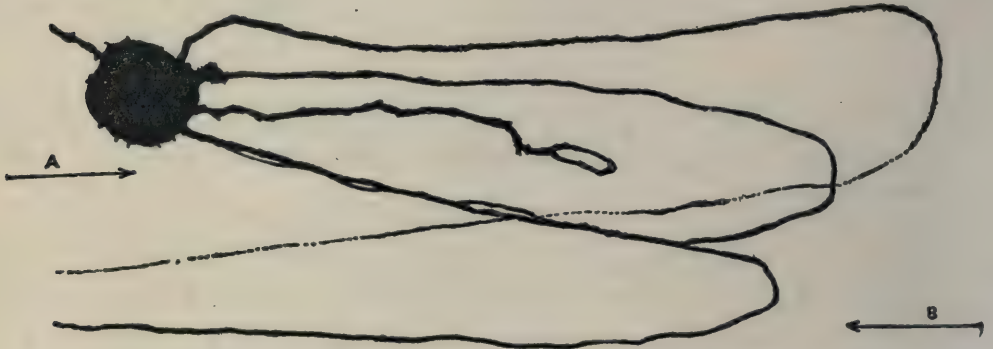

FIG. 74. — Tracing made like that of Fig. 73 by fly larvæ, when the light falls upon them in the direction of the arrow. *A*, the first direction of the light; *B*, the second direction. To be compared with the undirected movements of Fig. 73. (From POUCHET, '72.)

protoplasm of whatever sort in the organism. The *sense* of that migration depends in part upon the internal condition of the protoplasm. The *mechanism* by which locomotion is effected — that is wholly internal. The mechanism and the energy necessary to make it go are alone impotent to determine any adaptive movement or any other predictable result. To mechanism and energy must be added a stimulus external to the responding protoplasm in order that an adaptive or orderly result should occur.*

* There are several other important matters upon which the results of this First Part throw light, such as the Mechanics of Response and the Origin of Adaptation in Response. Since additional facts for the discussion of these topics will be gained from the succeeding Parts, that discussion will be deferred.

PART II

THE EFFECT OF CHEMICAL AND PHYSICAL AGENTS UPON GROWTH



CHAPTER X

INTRODUCTION: ON NORMAL GROWTH

ORGANIC growth is increase in volume.* It is not development; it is not differentiation; it is not increase in mass, although the latter may often serve as a convenient measure of growth.

In analyzing the processes of growth in organisms we must recognize at the outset that organisms are composed of living matter and formed substance, and that growth may therefore result from the increase in volume of either of these. The living matter, in turn, is composed of two principal substances: the plasma and the enchylema or cell sap; so growth may be due to the increase of either of these substances, — may result either from assimilation, or more strictly from the excess of

* Growth has been variously defined. Thus HUXLEY has called growth "increase in size," which is essentially the same as my definition. SACHS ('87, p. 404) defines growth as an increase in volume intimately bound up with change of form ("eine mit Gestaltveränderung innig verknüpfte Volumenzunahme"); and he illustrates the definition by the example of the growth of a sprout from its beginning to its full development. In this case two phenomena are distinguishable: first, increase in volume, and, second, the filling out of the details of form. As SACHS says, these phenomena taken together are generally denominated "development"; and it seems decidedly advantageous to retain this word with its usual signification, and to distinguish the two component processes by the terms growth and differentiation.

PFEFFER'S ('81, p. 46) definition differs still more widely from the one proposed above. He defines growth as change in form in the protoplasmic body ("die gestaltliche Aenderung im Protoplasmakörper"); and he goes on to say that increments of volume and mass are not proper criteria of growth. PFEFFER illustrates this statement by the following example: A plant stem or a cell mem-

the constructive over the excretory processes of the plasma, or from the taking in of water.*

Of the three factors involved in growth— increase of formed substance, of plasma, and of enchylema — the part played by the last seems to me to have been underestimated. Plant physiologists have been in the best position to acquire the facts.

brane can be permanently elongated by extension beyond the limits of elasticity without the volume necessarily increasing;—and he apparently means to include such an artificial deformation in his definition of growth. “And,” he continues, “under certain circumstances a diminution of volume of a plant segment can indeed occur as a result of growth, when, for example, the elasticity of the wall is increased by growth and water is pressed from the cell until equilibrium is restored.” It may be doubted, however, if PFEFFER would say that in this case the cell, as a whole, had grown; but if he would, then his definition is a wide departure from ordinary usage.

Also, VINES ('86, p. 291) offers a definition, which is intermediate between that of SACHS and that of PFEFFER. “By growth,” he says, “we mean permanent change of form, accompanied usually by increase in bulk.” But then he goes on to say, “Nor does this increase even of the organized structures of an organ, that is of the protoplasm and the cell wall, necessarily imply that it is growing. Thus, an increase of the cell wall may take place without any appreciable enlargement of the cell, as, for instance, when a cell wall thickens.” But since the thickening is a “permanent change of form,” it should be considered by the author a growth process were not increase in size of the cell after all, in the author’s mind, the most important criterion of its growth. Finally, FRANK ('92, p. 355) finds no other criterion for growth than an increase in volume (dependent, however, upon the increase of a particular substance). Thus, with these different plant physiologists, we see the word growth bearing the ideas of increase of volume and differentiation, then of differentiation alone, and, finally, of increase of volume alone.

* Various analyses of the process of growth have been made by different authors. Let us look at a few of these opinions. Says HUXLEY ('77, p. 2), “growth is the result of a process of molecular intussusception.” According to N. J. C. MÜLLER ('80, p. 100), “all phenomena of growth depend, in last analysis, upon this, that the molecule of the solid substance is introduced into the region of growth.” FRANK ('92, p. 355) understands by growth that increase of volume which consists of the apposition or intussusception of new solid molecules of similar matter (“welche auf der An- oder Einlagerung neuer fester Moleküle gleichartigen Stoffes beruhen”). According to VERWORN ('95, p. 475), growth is due to the excess of assimilation over disassimilation. These definitions include what I regard as only half the process of growth.

On the other hand, DRIESCH ('94, p. 37) distinguishes two kinds of cell growth: (1) passive growth, due to imbibition of water, and (2) active growth, resulting from assimilation. This classification agrees with the one I have proposed, but I think the term passive growth very inapt, since the imbibition of water is as truly an active process as any other vital activity.

They have recognized in the tip of the plant three growth regions. At the extreme tip of the stem (or radicle) is the region of rapid cell division but comparatively slow growth ;

next below is the zone exhibiting the Grand Period of growth ; and still below is the zone of histological differentiation (Fig. 75).

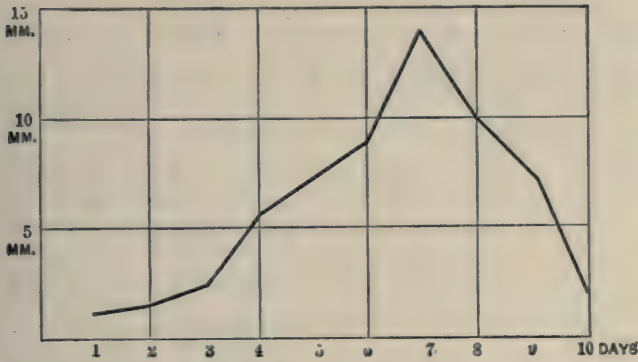

FIG. 75. — Curve of daily growth in length of a disc, originally 1 mm. long, and taken immediately behind the vegetation point of a radicle of *Phaseolus*. It comes to occupy in successive days the three zones referred to in the text. From SACHS, Lectures on Plant Physiology.

In the first zone growth of plasma is occurring ; in the second zone growth of the enchylema is chiefly taking place ; in the third zone there is growth of

formed substance. The immense preponderance of the growth of the second period (at 7 days) is an index to the preponderating influence in growth of the imbibition of water.

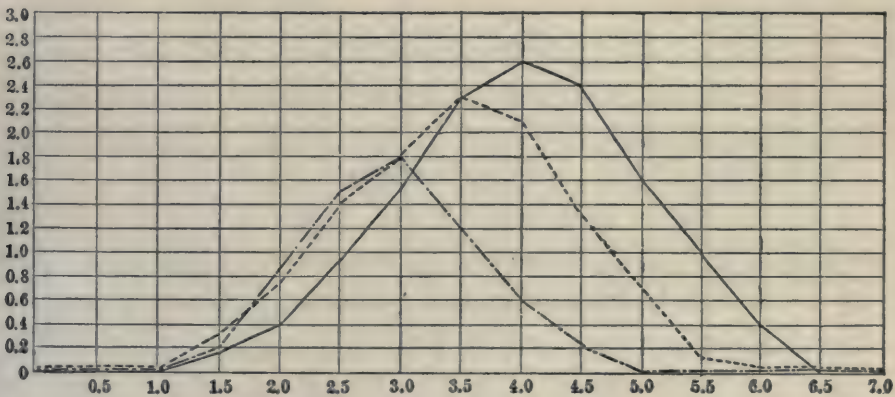

FIG. 76. — Curve representing the intensity of growth of roots of *Pisum sativum*, ———; *Vicia sativa*, - - - - -; and *Lens esculenta*, - · - · - ·, the time being assumed to be constant. The length of the abscissæ in the direction from left to right corresponds to the distance, in millimeters, of the marked spaces on the root from the root apex. The ordinates correspond to the amount of growth, in millimeters, of the corresponding piece of the root after 20 hours. From CIESIELSKI ('72.)

That which occurs with one and the same piece of the stem on successive days takes place simultaneously at the different zones of the growing organ. Thus in the radicle (Fig. 76)

we find during a period of 20 hours little growth occurring at the root tip, a maximum of growth at 3 or 4 millimeters from the tip, and further up less growth, until a zone of almost no growth is reached.

An analysis of the substance of the stem at different levels below the tip reveals the same thing—a sudden increase in the

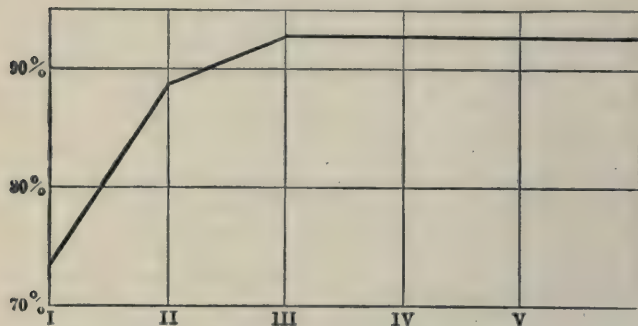

FIG. 77. — Curve showing the percentage of water in successive internodes of hothouse plants of *Heterocentron roseum* Hook. et Arm., about 4 decimeters high. The ordinates indicate the percentage of water at each internode from the terminal bud (I) to the fifth (VI). (From KRAUS, '79.)

amount of water from 73% at the tip to 88% at the first internode (II), reaching a maximum at 93% in the second internode (III), then falling slightly (92.7) to the fifth internode (VI, Fig. 77). The experiments and observations upon which these conclusions

rest thus agree in assigning the chief rôle to water in the growth of plants.

While the fact that water constitutes a large proportion of the growing animal was made known by the classical researches of BAUDRIMONT and MARTIN SAINT-ANGE ('51), the importance of the part which it plays in the growth of animals seems first to have been appreciated by LOEB ('92, p. 42), who showed how in the withdrawal of water by plasmolytic methods growth was interfered with. Later I made a series of determinations of the relative part played by water and dry substance in the growth of an animal (tadpole). Eggs and embryos at various ages were weighed after removal of superficial water. Then they were kept in a desiccator from which air had been pumped and which contained a layer of sulphuric acid to absorb moisture. After repeated weighings a condition was found in which the drying mass lost no more water (constant weight). The total diminution in weight indicated the mass or volume of free water contained in the organism at the beginning of the experiment. Numerous weighings were

made during two seasons upon *Amblystoma*, toads, and frogs. All series showed the same thing; the most complete series is that given in the following table:—

TABLE XXII
EMBRYOS OF FROGS. 1895*

DATE.	DAYS AFTER HATCHING.	AVERAGE WEIGHT, IN MG.	WEIGHT OF DRY SUBSTANCE, IN MG.	WEIGHT OF WATER IN MG.	% OF WATER.
May 2	1	1.83	.80	1.03	56
" 3	2	2.00	.83	1.17	59
" 6	5	3.43	.80	2.63	77
" 8	7	5.05	.54	4.51	89
" 10	9	10.40	.72	9.68	93
" 15	14	23.52	1.16	22.36	96
June 10	41	101.0	9.9	91.1	90
July 23	84	1989.9	247.9	1742.0	88

These results are graphically represented in Fig. 78. The curve and table show that, exactly as in plants, there is a

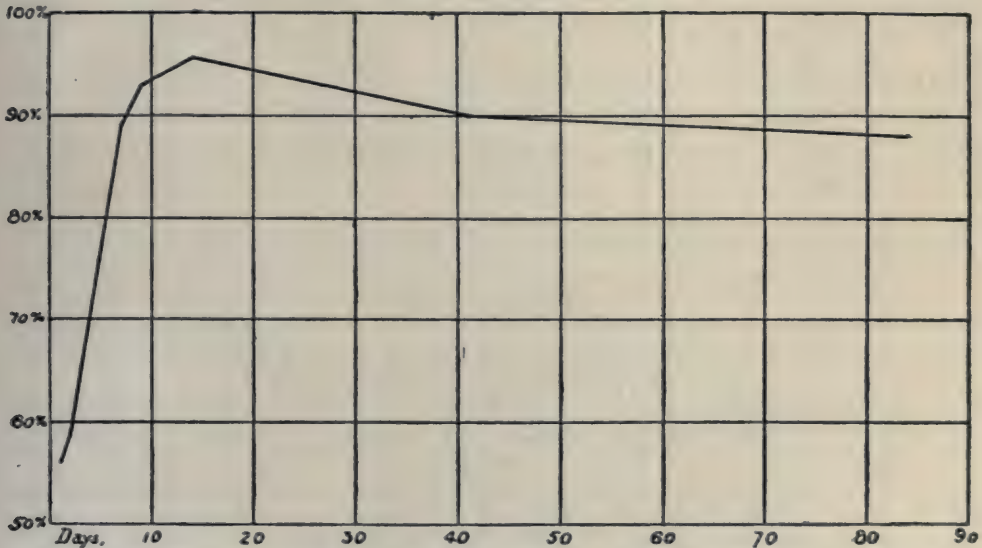

FIG. 78.—Graphic representation of last column of Table, showing percentage of water in frog embryos from 1 to 84 days after hatching. Compare with Fig. 77.

period of slow growth accompanied by abundant cell division—the earliest stages of the egg. Then follows, after the first

* Compare with the less complete table of BAUDRIMONT and MARTIN SAINT-ANGE, '51, p. 532.

few hours, a period of rapid growth due almost exclusively to imbibed water, during which the percentage of water rises from 56 to 96 ; lastly comes the period of histological differentiation and deposition of formed substance, during which the amount of dry substance increases enormously, so that the percentage of water falls to 88 and below. But the *growth* is due chiefly to imbibed water.

The foregoing facts thus unite in sustaining the conclusion that at the period of most rapid growth of organisms growth is effected by water more than by assimilation.

In later development the proportion of water slowly falls. This fact is well brought out in the following tables :—

TABLE XXIII

SHOWING THE PERCENTAGE OF WATER IN CHICK EMBRYOS AT VARIOUS STAGES UP TO HATCHING, FROM POTTS, '79

HOURS OF BROODING.	ABSOLUTE WEIGHT IN GRAM.	% WATER.
48	0.06	83
54	0.20	90
58	0.33	88
91	1.20	83
96	1.30	68
124	2.03	69
264	6.72	59

TABLE XXIV

SHOWING THE PERCENTAGE OF WATER IN THE HUMAN EMBRYO AT VARIOUS STAGES UP TO BIRTH, FROM FEHLING, '77

AGE IN WEEKS.	ABSOLUTE WEIGHT IN GRAM.	% WATER.
6	0.975	97.5
17	36.5	91.8
22	100.0	92.0
24	242.0	89.9
26	569.0	86.4
30	924.0	83.7
35	928.0	82.9
39	1640.0	74.2

These results indicate that during later development growth is largely effected by excessive assimilation or by storing up formed substance.

From another standpoint we can recognize two kinds of growth: one a *transitory* growth, after which the enlarged organ may return again to its former size, and the other a *permanent* or *developmental* growth, which is a persisting enlargement, and plays an important part in development. As an example of transitory growth may be cited the case of the Sensitive Plant, whose leaflets when touched turn upwards as a result of the growth of cells on the convex side; but this enlargement is only temporary—it is transitory growth. This phenomenon is indeed usually not included in the idea of growth; yet it is well-nigh impossible to draw a sharp line of distinction between it and permanent growth. For example, when a tendril of the Passion Flower is touched it may curve as a result of growth of the cells on the convex side, and this curvature may later become obliterated, as in the case of the Sensitive Plant; but the longer the contact is continued the more the cells enlarge, and the more their walls become permanently modified. Thus the condition of temporary growth shades insensibly into that of permanent growth. So far as possible we shall consider in this book only developmental growth.

Still another classification may be made of the phenomena of growth. We may distinguish between diffused and localized growth. In diffused growth the entire individual or many of its parts are involved. In localized growth the process is confined to a limited region. Thus in the early development of the frog diffused growth occurs, while in the formation of the appendages we have an example of localized growth. Since localized growth is an important factor in differentiation, many of the data concerning this phenomenon will be first considered in the Part dealing with Differentiation.

Normal growth may or may not be accompanied by cell-division. But usually cell-division occurs sooner or later in the growing mass. The act of cell-division seems to retard the process of growth. This conclusion follows from some experiments of WARD ('95, p. 300) on the growth of bacteria, which

are summarized in the curve, Fig. 79. This shows how the growth in length of the bacterial rods is delayed at intervals

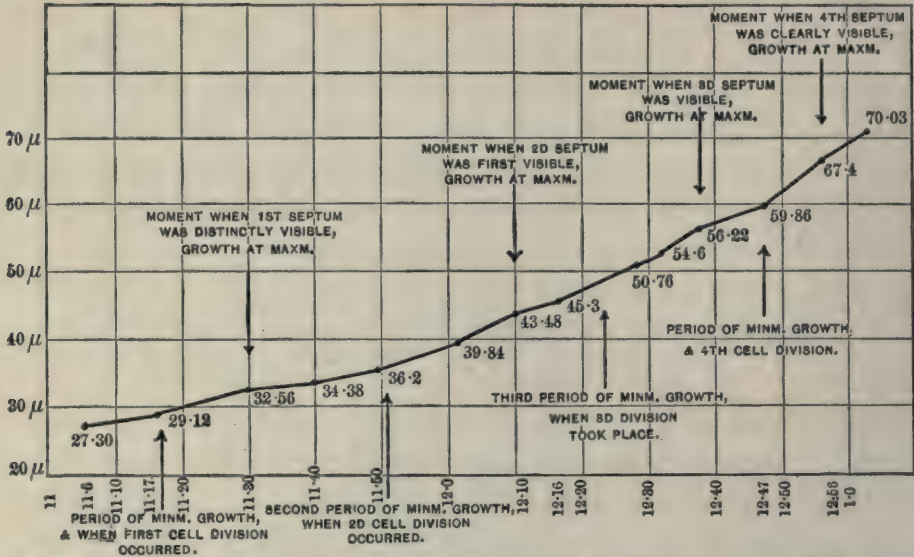

FIG. 79. — Curve of growth of a bit of a filament of *Bacillus ramosus*, 27.30 μ long at the beginning and 70.88 μ at the end of the period of observation. The curve shows certain periods of diminished growth (indicated by the arrows below the curve), which correspond to cell-division. From WARD ('95, p. 300).

by the nuclear divisions and the accompanying formation of transverse septa.*

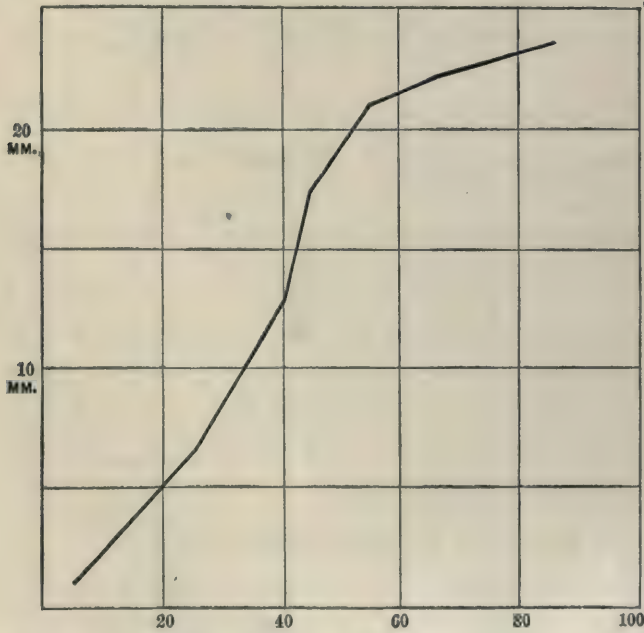

FIG. 80. — Curve of length of shell of *Lymnaea stagnalis* at intervals from hatching up to 85 days. From SEMPER, *Animal Life*, p. 163.

The course of normal growth may now be studied in

* Attention may here be called to a phenomenon which has repeatedly been observed when a single growing mammal has been weighed at regular intervals. This is a sort of alternation of periods of unusually rapid growth with periods of diminished growth, the interval being a day or two. There is an irregularity in the length of these periods. See SAINT-LOUP, '93; compare also MINOT, '91, Table XIV.

the case of certain selected, typical organisms. This may be most quickly done by the use of curves whose abscissæ represent time intervals and whose ordinates represent size or weight. Figures 80, 81, and 82 are such curves. In all cases excepting that of guinea pig (in which the curve represents the growth of only a comparatively late developmental period, namely, from birth onward) the curves exhibit one characteristic shape.

The absolute increments are not, however, shown directly by these curves. To obtain them one must transform the curves into others in which the successive ordinates shall represent the absolute increment of weight over the last preceding. Under these circumstances the absolute increments rapidly reach a maximum from which they decline to zero.*

Why does the growth decline to zero? The theory has been suggested † that there is a "certain impulse given at the time of impregnation which gradually fades out, so that from the beginning of the new growth there occurs a diminution in the rate of growth." The facts of

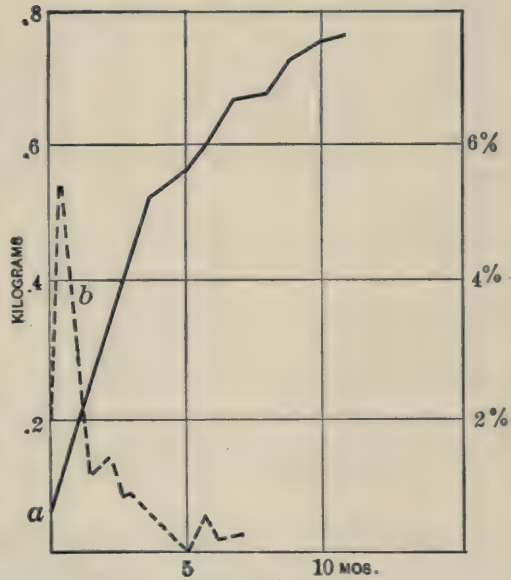

FIG. 81. — The continuous line (a) represents the weights in fractions of a kilogramme attained by guinea pigs from birth until 12 months old. The broken line (b) represents the daily percentage increments (%'s at the right) of the same guinea pigs up to 7 months. After MINOT ('91).

* Another method of representing curves of growth has been proposed by Professor MINOT ('91, p. 148), who argues that for a given period the rate of growth should be expressed as the fraction of weight added during that period; for, he says, "the increase in weight depends on two factors: first, upon the amount of body substance, or, in other words, of growing material present at a given time; second, upon the rapidity with which that amount increases itself." Such a curve of percentage daily increments is given for the guinea pig in Fig. 81. Since, however, the greater part of the "body substance" at its period of greatest growth is not "growing material," as assumed, but water, the peculiar value of the curve of percentage increments is doubtful.

† By MINOT, '91, p. 151.

growth in the tip of the plant do not, however, support this theory, for the protoplasm at this point may go on growing

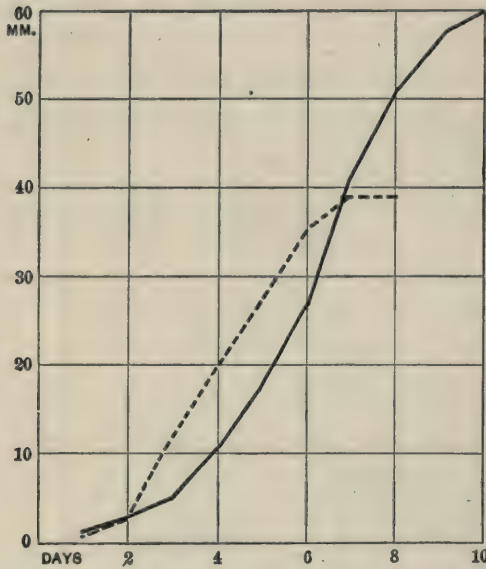

FIG. 82. — Curves of growth of *Phaseolus multiflorus* (continuous line) and *Vicia faba* (broken line). The ordinates represent actual lengths attained on the respective days by a bit of stem originally 1 mm. long. After SACHS, Lectures on Plant Physiology.

for centuries, as we see in the case of trees. Some of the protoplasm at the tip is, however, constantly falling back to form part of the stalk: this part soon ceases to grow, undergoing histological differentiation. The reason why the animal ceases at length to grow is the same as the reason why the differentiated tissue below the tip of the epicotyl ceases to grow — not because there is a necessary limit to growth force at a certain distance from impregnation, but because it is in the nature of the species that the individual should cease to grow at this point.

The indefinite growth of this part, the limited growth of that, are as much group characters as any structural quality.

To recapitulate briefly: Growth is increase in size, and may result from increment of either the formed substance through secretion, the plasma through assimilation, or the enchylema through imbibition. This increment may be either transitory or permanent; the latter class chiefly concerns us here. Growth may be either diffused throughout the entire organism, or local, forming a factor of differentiation. In normal growth the increase is at first slow, then rapidly increases to a maximum, and, finally, in most animals, diminishes to zero. This final cessation is a special quality of certain organisms, to be explained like structural qualities, on special grounds.

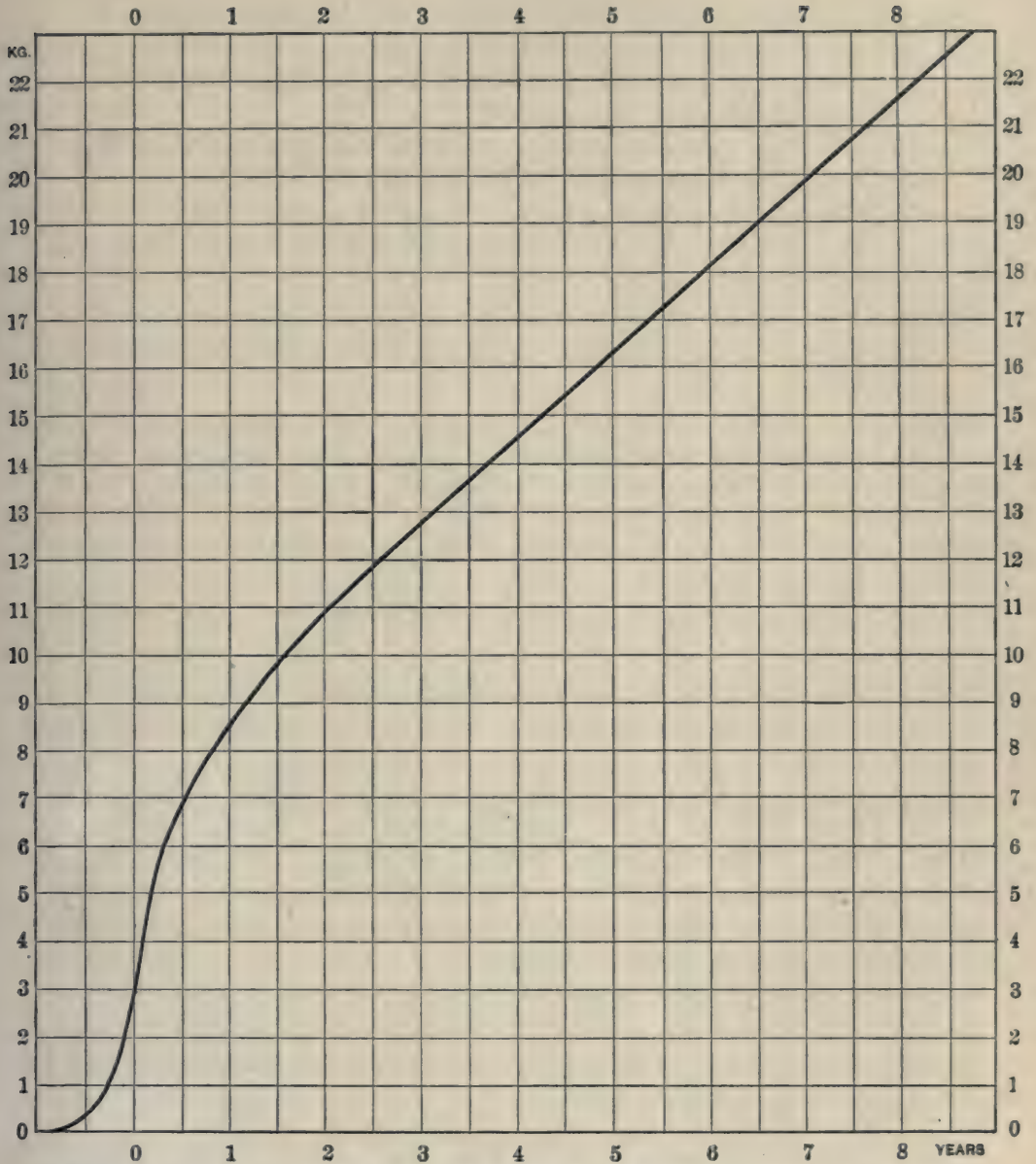

FIG. 83. — Curve of growth of man. The ordinates represent weight in kilogrammes. The prenatal part of the curve is constructed from the data of FEHLING ('77); the postnatal part from QUETELET ('71) for the male. The curve of the first twelve months of postnatal life is adapted from GALTON ('84).

LITERATURE

BAUDRIMONT, A., and G. T. MARTIN SAINT-ANGE, '51. Recherches anatomiques et physiologiques sur le développement du fœtus et en particulier sur l'évolution embryonnaire des oiseaux et des batraciens. Mém. présentés par divers savants à l'Acad. des Sci. de l'Inst. Nat. de France. XI, 469-692. 18 pls.

- DRIESCH, H. '94. Analytische Theorie der organischen Entwicklung. Leipzig. Engelmann, 185 pp. 1894.
- FEHLING, H. '77. Beiträge zur Physiologie der placentaren Stoffverkehrs. Arch. f. Gynäkologie. XI, 523-557.
- FRANK, A. B. '92. Lehrbuch der Botanik nach dem gegenwärtigen Stand der Wissenschaft bearbeitet. I. Band. Leipzig. 1892.
- GALTON, F. '84. Life History Album. 172 pp. London. 1884.
- HUXLEY, T. H. '77. A Manual of the Anatomy of Invertebrated Animals. 698 pp. London. 1877.
- KRAUS, G. '79. Ueber die Wasservertheilung in der Pflanze. Festschr. z. Feier des Hundertjährigen Bestehens d. Naturf. Ges. in Halle. pp. 187-257.
- LOEB, J. '92. Untersuchungen zur physiologischen Morphologie der Thiere. II. Organbildung und Wachsthum. 82 pp. 2 Taf. Würzburg. 1892.
- MINOT, C. S. '91. Senescence and Rejuvenation. Jour. of Physiol. XII, 97-153. Plates 2-4.
- MÜLLER, N. J. C. '80. Handbuch der allgemeinen Botanik. I. Theil. Heidelberg. 1880.
- PFEFFER, W. '81. Pflanzenphysiologie. Engelmann. Leipzig. 2 Bde. 383 + 474 pp.
- POLL, R. '79. Untersuchungen über die chemischen Veränderungen im Hühnerei während der Bebrütung. Landwirth. Versuchs-Stat. XXIII, 203-247.
- QUETELET, A. '71. Anthropométrie ou mesure des différentes facultés de l'homme. 479 pp. 2 pls. Bruxelles and Paris. 1871.
- SACHS, J. '87. Vorlesungen über Pflanzenphysiologie. Leipzig. Engelmann. 884 pp. 1887.
- SAINT-LOUP, R. '93. Sur la vitesse de croissance chez les Souris. Bull. Soc. Zool. de France. XVIII, 242-245.
- VERWORN, M. '95. Allgemeine Physiologie. 584 pp. Jena: Fischer. 1895.
- VINES, S. H. '86. Lectures on the Physiology of Plants. Cambridge [Eng.] Univ. Press. 710 pp. 1886.
- WARD, H. M. '95. (See Chapter XVII, Literature.)

CHAPTER XI

EFFECT OF CHEMICAL AGENTS UPON GROWTH

WE shall consider this subject under two heads : (1) Effect upon the rate of growth, and (2) Effect upon the direction of growth.

§ 1. EFFECT OF CHEMICAL AGENTS UPON THE RATE OF GROWTH

Organic growth, occurring in a material composed of water, plasma, and formed substance, consists in the increment of each of these components. The means and results of varying the quantity of water in the organism will be discussed in the next chapter ; here we are to consider the results of assimilation, including the production of formed substance. The scope of our work may be more precisely defined as the answer to the question, What rôle do the various chemical substances (excluding water) play in the metabolic changes involved in growth ?

There are two rôles played by chemical substances in the body ; and, accordingly, we may distinguish two kinds of chemical agents having diverse effects upon growth. These agents — foods, in the widest sense of the word — must supply the material — the atoms — from which the molecules of the plasma, or of its formed substance, are made up ; and, secondly, they must supply energy for metabolism. Foods, then, yield to the organisms matter and motion ; they are hylogenic (plastic) and thermogenic (respiratory).

These two offices of chemical agents in growth are only in certain cases exerted by distinct kinds of food. In the case of animals, sodium chloride and iron compounds are examples of wholly plastic foods, while the free oxygen taken into the body is chiefly thermogenic. In the case of the free oxygen, however, it is quite probable that it is sometimes used in the construction of the molecule of active albumen which, according

to LOEW, constitutes the essential living substance. For example, oxygen performs this office in LOEW'S ('96, p. 39) hypothesis of the formation of albumen in plants from the nitrogenous products which result from the action of an enzyme upon the reserve proteids, *i.e.* leucine. Thus

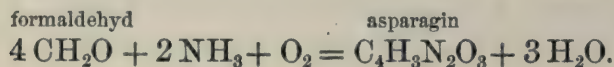
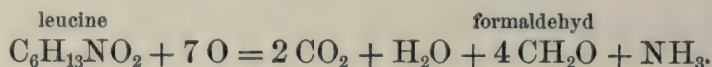

Now since, as LOEW makes probable, asparagin is a stage in the production of albumen, the free oxygen molecule may be essential to the synthesis of the living substance.

The facts indicate that the plastic and thermogenic functions of foods are inextricably intermingled—that both are exhibited in the mutations of the living substance as well as in the respiratory processes. Thus, on the one hand, assimilation is accompanied not only by endothermic (energy-storing) but also by exothermic (energy-releasing) processes; while, on the other hand, the partial oxidation of the food proteids may be a necessary step towards assimilation. It is because the net result is the storing or the release of energy that we may speak of any complex of processes as enthodermic or exothermic, and certain foods as plastic or thermogenic.

The source of energy in organisms is not, however, solely food. Energy may likewise be derived directly from energy in the environment. This source is of greatest importance in the case of chlorophyllaceous organisms, but it is probably not of importance for them alone. For the heat and light of the environment aid, as we have seen (pp. 166–171, 222–225), various metabolic processes in all kinds of protoplasm.

1. The Materials of which Organisms are Composed.—To determine the sorts of materials which plastic food must supply to the body, it will be instructive to consider the proportional composition of the body out of water and dry substance, both organic and inorganic. Such data, gathered from various animals and plants, are given in the following table:—

TABLE XXV

ANIMALS

SPECIES.	% WATER.	% ORGANIC MATTER TO WHOLE WEIGHT.	% ASH TO WHOLE WEIGHT.	% ORGANIC MATTER TO DRY SUBSTANCE.	% ASH TO DRY SUBSTANCE.	AUTHORITY.
Sponges, average	79.4	11.0	9.7	54.1	45.9	KRUKENBERG, '80
<i>Medusæ :</i>						
Rhizostoma cuvieri . . .	95.4	1.6	3.0	34.8	65.2	"
<i>Actiniaria :</i>						
Anthea cereus	87.6	10.7	1.6	87.0	13.0	"
Actinia mesembryanth.	83.0	15.4	1.7	90.0	10.0	"
Sagartia troglodytes . .	76.8	20.9	2.3	81.1	18.9	"
Cerianthus membran. .	87.7	11.6	1.7	87.2	12.8	"
Alcyonium palmatum .	84.3	10.8	4.9	68.8	31.2	"
<i>Asteroidea :</i>						
Astercanthion glacialis.	82.3	14.1	3.6	79.6	20.4	"
<i>Annelida :</i>						
Lumbricus complanatus	87.8	9.7	2.4	80.2	19.8	"
<i>Crustacea :</i>						
Oniscus murarius	68.1	21.2	10.6	66.6	33.4	BEZOLD, '57
Squilla mantis	72.0	22.1	5.9	78.9	21.1	KRUKENBERG, '80
Astacus fluviatilis . . .	74.1	16.8	9.1	64.9	35.1	BEZOLD, '57
<i>Mollusca :</i>						
Doris tuberculata	88.4	9.0	2.6	77.6	22.4	KRUKENBERG, '80
Doriopsis limbata	86.5	12.4	1.1	91.9	8.1	"
Arion empiricorum	86.8	10.1	3.1	76.5	23.5	BEZOLD, '57
Limax maximus	82.1	16.4	1.5	91.6	8.4	"
Ostrea virginiana	88.3	10.8	0.9	92.3	7.7	"
(without shell)						
<i>Tunicata :</i>						
Botryllus	93.6	3.1	3.3	48.4	51.6	KRUKENBERG, '80
<i>Vertebrata :</i>						
Cyprinus auratus	77.8	17.6	4.6	79.1	20.9	BEZOLD, '57
Triton igneus	80.2	16.1	3.7	81.1	18.9	"
Triton cristatus	79.6	17.0	3.4	82.9	17.1	"
Bombinator igneus	77.3	19.4	3.3	85.2	14.8	"
Bufo cinereus	79.2	14.8	6.0	71.1	28.9	"
Rana esculenta	82.7	14.2	3.0	82.2	17.8	"
Anguis fragilis	55.0	32.1	12.9	71.5	28.5	"
Lacerta viridis	71.4	23.2	5.4	81.3	18.7	"
Sparrow	67.0	27.8	5.2	84.3	15.7	"
Bat	67.5	27.4	5.0	85.2	14.8	"
Mouse	70.8	25.7	3.5	88.0	12.0	"
Man	65.7	29.6	4.7	86.3	13.7	VOLEMMANN, '74

PLANTS

Oats, in blossom	77.0	6.4	16.6	27.8	72.2	WOLFF, '65
Wheat, in blossom . . .	69.0	9.3	21.7	30.0	70.0	"
Pea vines, green	81.5	4.8	13.7	26.0	74.0	"

a. Analysis of the Entire Organism.—We are now ready to consider the atomic composition of the dry substance of organisms. VOLKMANN ('74) has contributed data on this subject in the case of man. Thus the dry substance gives:—

C	O	H	N	ASH
52.9%	18.5%	7.7%	7.4%	13.4%

In the case of a plant (stems and leaves of dry clover) we have, according to JOHNSON:—

C	O	H	N	S	P	REMAINING ASH
47.4%	37.8%	5.0%	2.1%	0.12%	0.30%	2.0%

These two determinations, fairly typical of the higher plants and the higher animals respectively, run nearly parallel. The greatest difference is shown by the nitrogen, which is more than three times as abundant in animals as in plants. Oxygen, on the other hand, is more abundant in plants.

The ash, in turn, must be further analyzed. The following table gives the percentage composition of the ash of various organisms:—

TABLE XXVI

ANIMAL.	NEW-BOEN DOG.	MENHADEN (FISH).	OAT PLANT.
AUTHORITY.	BUNGE, '89.	COOK, '68, p. 498.	AVENDT (VINES, '86, p. 129).
CaO	29.5	40.0	12.1
P ₂ O ₅	39.4	35.8	8.8
K ₂ O	11.4	7.1	45.9
Cl	8.4	3.1	6.1
Na ₂ O	10.6	4.7	2.32
MgO	1.82	3.1	4.12
Fe ₂ O ₃	0.72	—	0.54
SiO ₂	—	6.1	17.2
SO ₃	—	—	2.86

It would be valuable to know the relative number of atoms of each of the metalloids and metals named in the preceding table. This may be determined in the following way: Find the proportion by weight of each metallic radical (excluding the oxygen) in the entire ash and divide this percentage by the molecular weight of the metal. The varying weights of the elements are thus eliminated, and a set of numbers which indicate relative abundance of atoms is obtained. We multiply these small fractions by 1000 for convenience. The results are as follows:—

TABLE XXVII

	NEW-BORN DOG.	MENHADEN (FISH).	OAT PLANT.
Ca	528	715	216
P	555	506	124
K	243	151	974
Cl	24	174	173
Na	343	150	60
Mg	45	77	114
Fe	9	—	6
Si	—	101	287
S	—	—	36

These examples may suffice to show how diverse is the composition of different organisms and how diverse therefore must be their requirements in the way of food to build up the adult body. The examples serve also to indicate what are the important elements for organisms. They appear to be the same for animals and plants, and are:—

*Carbon	*Calcium	Sodium	*Sulphur
*Oxygen	*Potassium	Chlorine	Silicon
*Hydrogen	*Phosphorus	*Magnesium	*Iron
*Nitrogen			

While this list does not pretend to exhaust the elements found in organisms, it contains those which are usually present.

In the organism the atoms just named are, of course, found in combination. The carbon, oxygen, hydrogen, and nitrogen are contained in the organic matter of the organism — the

* Those elements which are starred (*) are essential to all organisms.

greater part of the entire dry matter. The relations of the remaining elements are largely obscure. Some of them form inorganic acids in the body, such as hydrochloric and sulphuric acids. Others form inorganic compounds deposited in the body as supporting or protective substances, such as the calcic phosphate and calcic carbonate of bone and spicules and the silicic oxide of plants. But there can be little doubt that a large and highly important part of these elements is built up into organic molecules and in this position plays a weighty and varied part in metabolism and growth. As examples of the way in which the metals and metalloids occur in the organic molecule I may cite a few cases in which the molecular structure has been determined more or less satisfactorily. Thus we have sulphur in albumen, $C_{72}H_{112}N_{18}SO_{22}$; iron in hematin, $C_{34}H_{35}N_4FeO_5$; phosphorus in lecithin, $C_{42}H_{84}NPO_9$, and nuclein, $C_{29}H_{49}N_9P_3O_{22}$, magnesium in chlorophyllan, and various halogens in the urates of sodium, calcium, and lithium. In discussing as we shall immediately the importance of each of these elements for the formation of the body we shall find additional facts concerning the importance of the metallic atoms in the organic molecules. There is good reason for believing that the peculiar properties of hæmoglobin depend upon its iron and that the characteristic properties of nuclein depend largely upon its phosphorus and (as the later investigations indicate) its iron also. As our knowledge develops, the importance to many organic molecules in the living body of metallic or metalloid elements becomes clearer; the "ash" of the body is not something accidental, secondary, or superfluous, but is an essential part of the organism.

We must now consider the source of the various elements necessary to nutrition. Botanists early determined that C, H, and O enter the organism through the carbonic acid and water which green plants absorb. Concerning the source of nitrogen there has been less certainty; it is generally believed to come from nitrates in the soil, but that matter will be considered later in more detail. Another source of the more characteristically organic elements, C, H, N, and O, is, without doubt, organic compounds of various sorts. Although it has long been known that insectivorous plants absorb the organic mat-

ters they digest, still it is only recently that the fact that green plants in general can make use of organic compounds has been recognized. BOKORNY ('97) has lately brought together the evidence which makes this conclusion certain. It appears that in the presence of organic solutions some algæ may grow for half a year in the absence of carbon dioxide; and the potato plant may, *even in the dark*, store up starch in its tubers in the presence of rich organic food. Nitrogen may also be gained from amido-bodies; thus, BÄSSLER ('87) found that his maize cultures grew better in asparagin,

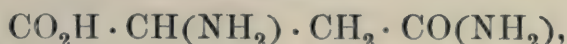

than in potassium nitrate. Thus plants may gain their C, H, O, and N from either organic or inorganic sources.

Non-chlorophyllaceous organisms, on the other hand, have long been known to gain their C, H, N, and O from organic compounds; indeed, it has generally been believed that they can gain those elements from organic compounds only. Certain observations, however, throw doubt upon the entire correctness of this belief; these are especially the remarkable results gained by WINOGRADSKY ('90) from nitrifying bacteria (Fig. 84). This author found that the bacteria could grow in a mixture of inorganic salts free of organic matters.

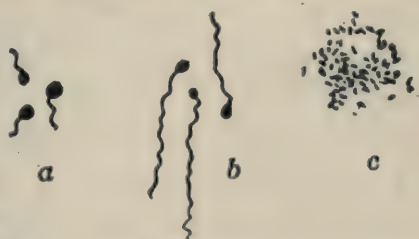

FIG. 84. — *a*, *Nitrosomonas europæa* (nitrite bacteria from Zürich); *b*, *Nitrosomonas javensis* (nitrite bacteria from Java); *c*, *Nitrobacter* (nitrate bacteria from Quito). Magnified 1050. After WINOGRADSKY, from FISCHER, Vorlesungen über Bakterien, 1897.

Solutions free from organic matter were prepared by the following means: The culture vessels were cleaned by boiling in them sulphuric acid and potassium permanganate. The water used in the cultures and in washing the vessels was twice distilled in vessels without joints of organic material — the second time with the addition of sulphuric acid and potassium permanganate. The magnesium sulphate and potassium phosphate, used as food, were calcined; the calcium carbonate, used in excess, was likewise calcined and saturated with carbon dioxide; finally, the ammonium sulphate was especially prepared to avoid organic impurities. The culture flasks were plugged with calcined amianthus, not with cotton. The solutions were inoculated with a mere trace of the culture containing nitrifying

organisms. The cultures were then reared either in complete darkness or in dim light. The precautions taken to eliminate organic matters would seem to be complete; but those who know the difficulties of such experiments seem willing to admit the possibility "that exceedingly minute quantities of organic nitrogen and carbon are actually present" (JORDAN and RICHARDS, '91, p. 880). On the other hand, "exceedingly minute quantities" of organic matter could hardly account for the vigorous growth of bacteria; and, in general, *a priori* objections cannot be permitted to overthrow results gained by the use of methods which are beyond reproach.

The organisms placed in this water, deprived of the last traces of organic matter, developed rapidly, but not quite so rapidly as organisms placed in natural water to which the necessary salts had been added. Analysis showed that not only nitrates but also organic carbon compounds had been formed. Thus the careful experiments of WINOGRADSKY demonstrate what the less critical experiments of HERÆUS ('86) had already rendered probable, that a complete synthesis of organic matter may take place through the action of living beings and independently of the solar rays. These noteworthy observations, then, obliterate the last sharp line of distinction between the nutritive processes of chlorophyllaceous and non-chlorophyllaceous organisms. We may now state that the elements C, H, N, and O may be gained from complex organic food materials by all organisms, and from simple compounds, such as carbonic acids, ammonia, and water, by all chlorophyllaceous organisms, and, very probably, by certain non-chlorophyllaceous ones also.

The elements other than C, H, N, and O are probably gained by chlorophyllaceous and non-chlorophyllaceous organisms alike, from either inorganic or organic compounds containing the necessary elements; although, possibly, animals make use of the metals more readily when they are in organic compounds. Suitable proportions of the different metals in a nutritive solution for green plants are given in the following tables, showing various standard solutions employed by different experimenters:—

TABLE XXVIII
NUTRITIVE SOLUTIONS FOR PHANEROGAMS

<i>SACHS' Solution</i>		GRAMMES.
Distilled water		1,000.0
Potassium nitrate, KNO_3		1.0
Calcium sulphate, CaSO_4		0.5
Magnesium sulphate, MgSO_4		0.5
Calcium phosphate, CaHPO_4		0.5
Ferrous sulphate, FeSO_4		trace
<i>SCHIMPER'S Solution ('90)</i>		
Distilled water		600.0
Calcium nitrate, $\text{Ca}(\text{NO}_3)_2$		6.0
Potassium nitrate, KNO_3		1.5
Magnesium sulphate, MgSO_4		1.5
Neutral potassium phosphate, K_3PO_4		1.5
Sodium chloride, NaCl		1.5
<i>FRANK'S Solution</i>		
Water, $\frac{1}{21}$ distilled; $\frac{20}{21}$ Berlin reservoir water		1,000,000.0
Calcium nitrate, $\text{Ca}(\text{NO}_3)_2$		267.4
Potassium chloride, KCl		121.5
Potassium phosphate, K_3PO_4		101.9
Magnesium sulphate, $\text{MgSO}_4 \cdot 7 \text{H}_2\text{O}$		100.2
Ferric chloride, Fe_2Cl_6		trace

The first differs from the others chiefly in the absence of chlorine.

How fit ordinary waters may be to provide all these salts is shown by this analysis of the ordinary drinking water of Boston (JORDAN and RICHARDS, '91) :—

TABLE XXIX
PARTS BY WEIGHT OF INORGANIC MATTERS IN 1,000,000 PARTS OF
POTABLE WATER

Sulphuric acid	4.58
Chlorine	4.00
Alumina and oxide of iron	0.75
Calcium oxide	6.45
Magnesia	1.60
Potash	0.92
Soda	5.00
Silica	3.04
Nitrates	0.25

All of the elements mentioned above, except phosphorus, appear in this list. Thus, ordinary drinking water is clearly well adapted to the nutrition of plants.

For *algæ*, MOLISCH ('95) used the solution given in the following table :—

TABLE XXX
NUTRITIVE SOLUTION FOR ALGÆ

	GRAMMES.
Water	1,000.0
(NH ₄) ₂ HPO ₄	0.8
(KH ₂)PO ₄	0.4
MgSO ₄	0.4
FeSO ₄	trace
	(2 drops of a 1% sol.)

Here we note an absence of the calcium used in the solutions for phanerogams.

Fungi likewise require a mixture of salts, according to NÄGELI ('80, p. 354) and BENECKE ('95), in the following proportions :—

TABLE XXXI
NUTRITIVE SOLUTIONS FOR FUNGI

NÄGELI'S Solution		BENECKE'S Solution	
	GRAMMES.		GRAMMES.
Water	1,000.0	Water	1,000.0
(NH ₄)H ₂ PO ₄	0.5	KH ₂ PO ₄	5.0
MgSO ₄ + 7 H ₂ O	0.5	MgSO ₄ + 7 H ₂ O	0.01
KCl ₂	0.5	K ₂ SO ₄	0.5
FeSO ₄	0.05	NH ₄ Cl	10.0
Organic Compounds		FeSO ₄	trace
		Glycerine	50.0

The solutions differ principally in the proportion of the salts.

Finally, all *animals* likewise require a certain quantity of salts. What the proportions are can be shown in the case of young mammals, which live during part of their growing period exclusively upon milk. A wonderfully close relation exists, indeed, between the proportions of the mineral constituents of milk and of the young mammal before it has begun to suck. This is shown in the analyses made by BUNGE ('89) upon the milk of a dog and the body of its newly-born pup.

TABLE XXXII

COMPARISON OF ASH IN NEW-BORN DOG AND IN THE MILK OF ITS MOTHER

ASH.	IN MILK: % OF ASH.	IN NEW-BORN DOG: % OF ASH.
P ₂ O ₅	34.2	39.4
CaO	27.2	29.5
Cl	16.9	8.4
K ₂ O	15.0	11.4
Na ₂ O	8.8	10.6
MgO	1.5	1.8
Fe ₂ O ₃	0.12	0.72

The quantities in the two columns are fairly similar. The greatest proportional difference occurs in the case of *iron*, and this fact requires a special explanation, which is briefly this, that iron is more important for the rapidly growing embryonic stages than for later life.

So likewise in the eggs of birds we find stored up all the mineral matters which are necessary for their development. Thus the yoke of the hen's egg contains phosphoric acid, lime, chlorine, potassa, soda, magnesia, iron oxide, and silica in the relative abundance indicated in this descending series. This series closely agrees with that given for milk.

In the case of marine animals, also, certain inorganic elements are a necessary food. The following list of such elements is based upon the results of thorough experiments by HERBST ('97) upon developing eggs of sea-urchins, starfishes, hydroids, ctenophores, and tunicates; the most favorable proportions of the elements were not, however, determined: calcium (in the form of carbonate, sulphate, or chloride), chlorine, iron (trace), magnesium, phosphorus (as Ca₃P₂O₈ or CaHPO₄), potassium, sodium, and sulphur. Now all these elements are found in sea water, which in the Mediterranean Sea near Naples contains in 1000 parts of water *

* After FORCHHAMMER ('61), p. 383.

	30.292	parts	NaCl
	3.240	"	MgCl ₂
	2.638	"	MgSO ₄
	1.605	"	CaSO ₄
	0.779	"	KCl
	0.080	"	silicic acid, calcium phosphate, and insoluble residue, including CaCO ₃ and Fe ₂ O ₃ .
Total .	38.634		

From the foregoing tables it appears that mineral substances, and essentially the same mineral substances, are required by all organisms. The differences in this respect between the different organisms are slight. Thus while sodium is not included among the necessary elements of either chlorophyllaceous plants or fungi, its occurrence in considerable quantity in milk, probably associated with chlorine as common salt, indicates that it is important for some animals.

The important conclusion seems warranted that all organisms may use as hylogenic food any sort of compound which will furnish the appropriate elements, but that among animals, and to a less degree among fungi, organic combinations have the preference because they fulfil at the same time the thermogenic function.

b. Detailed Account of the Various Elements used as Food.— We may now consider the part which each element plays in the growth of the body as a whole, reserving for the Fourth Part a consideration of the specific rôle which the element plays in organs of the body. We may, in general, consider first the share taken by the element in the constitution of the body, then the form in which the element gains access to the body, and finally what general effect it has upon the growth of the organism.

Oxygen.— Excepting carbon, oxygen constitutes a greater part of the body, by weight, than any other element. Between 20% and 25% of the dry substance of the human body and between 35% and 45% of that of green plants is oxygen. The oxygen used as hylogenic food comes to land-animals from the organic compounds and the air consumed by the developing young; the oxygen of water-animals may come from their food or from the oxygen dissolved in water; finally,

that of phanerogams is believed to be gained chiefly from the air at all parts of the body, roots as well as stems and leaves.

Since oxygen is of great importance for metabolism (p. 2), it is naturally essential to growth. It is well known that the lower the oxygen tension is, the more slowly do seeds germinate and pass through their early stages of growth. Thus in an experiment performed by BERT ('78, pp. 848-853) barley grains which germinated and were reared at various pressures had in six days the following dry weights: —

ATMOSPHERIC PRESSURE.	RESULTING WEIGHT.
76 cm. mercury (normal atmosphere)	8.8 mg.
50 " (0.66 ")	7.1
25 " (0.33 ")	6.2
7 " (0.1 ")	No growth

On the contrary, as the oxygen pressure increases up to about twice the normal, growth is accelerated, but beyond that point growth is retarded until at about 7 atmospheres growth hardly occurs.

In older seedlings, observations upon which have been made by WIELER ('83), JENTYS ('88), and JACCARD ('93), atmospheric pressure below the normal, even down to one-fourth or one-eighth of the normal, appears to induce accelerated growth; likewise in pure oxygen at the atmospheric pressure growth is as rapid as or somewhat more rapid than in the ordinary atmosphere. When, however, the oxygen tension is above the atmospheric pressure or below one-eighth of the normal, growth is retarded. It thus appears that an abnormal oxygen pressure may accelerate growth, and as we shall see later, the same effect is produced by other abnormal conditions.

Among animals, also, the oxygen tension exerts an important effect upon growth. This is shown by the experiments of RAUBER ('84, pp. 57-65) upon the eggs of the frog.

To get a variable atmospheric pressure RAUBER used champagne flasks in which were put the eggs and a little water. Through the air-tight cork of the inverted flask one end of a U-shaped glass tube of proper length and strength was passed. To the other end was fixed a funnel through which

mercury could be poured into the tube. The column of mercury produced the increased pressure in the flask, and the difference in height of the mercury in the two arms of the tube was a measure of this pressure. To get a pressure below the normal a partial vacuum was produced by a water-pump and the flask was then sealed. We assume (with BERT, '78, p. 1153) that the chief effect of the variation in the atmospheric pressure was the variation in the amount of oxygen absorbed by the water. Pure oxygen was also used in the flask.

At a pressure of three atmospheres no growth occurred. At a pressure of two atmospheres growth was slower than at the normal pressure. At three-fourths of an atmosphere also growth was retarded and at one-half an atmosphere death generally occurred. Thus the optimum condition of oxygen tension is near the normal for the atmosphere.

The same thing is indicated in a qualitative way by the experiments of LOEB ('92). The stems of the hydroid Tubularia possess in ordinary water a high regenerative capacity, but in water deprived of oxygen by boiling no regeneration takes place, although, after the water has been aerated again by shaking, rapid growth occurs.

Hydrogen.—This element forms, in its various compounds, between 5% and 10%, by weight, of the dry substance of organisms. How is it acquired? In the case of plants it is believed that it is taken into the organism as a constituent of water, which combines with carbon or carbonic acid in the plant, forming either starch directly or some other compound from which starch is later derived. Other possible sources of hydrogen are ammonia and its compounds, also the organic compounds absorbed. The hydrogen of fungi and animals has clearly been derived from the latter compounds alone. The effect of hydrogen gas upon growth seems to be merely that due to the replacement of oxygen; it has no active effect.

Carbon is the largest constituent of dry organic matter, of which it forms between about 44% and 60%. In green plants it is obtained for the most part from the carbon dioxide or carbonic acid of the air which is absorbed by the leaves. Other sources of carbon for green plants are found in many organic compounds, such as urea, uric acid, hippuric acid, glycocoll, kreatin, guanin, asparagin, lucin, tyrosin, and acetamid. These afford nitrogen also. Certain green plants make use of animal

matter, *e.g.* insects, as food. Fungi and animals obtain their carbon from carbon compounds elaborated by plants. The indispensableness of carbon for the life of all organisms as well as for their growth requires no illustration.

Nitrogen. — Of the importance of nitrogen as a hylogenic food nothing more need be said than that it is essential to the formation of albumen. The ordinary form in which nitrogen is



FIG. 85. — Cultures of *Sinapis alba* in pure quartz sand, to which have been added equal amounts of a nutritive solution, but unequal quantities of nitrogen in the form of calcic nitrate, as follows: *A*, without nitrogen; *B*, 0.1 gramme calcic nitrate in each vessel; *C*, 0.6 gramme calcic nitrate in each vessel. After a photograph. From FRANK ('92).

obtained by the seedling is, as already stated (p. 298), that of the nitrates or ammonia in the soil (Fig. 85). Growing fungi gain it chiefly from nitrogenous organic compounds, but many fungi can make use of ammonium nitrate for this purpose. Growing animals gain nitrogen chiefly, if not exclusively, from organic compounds, especially albumen and allied substances.

Free nitrogen is found wide-spread in nature. It forms about 79% of the volume of the air; penetrates into water, though in a smaller proportion than in the air, and even into the soil. Thus for organisms living in any of these media free

nitrogen is a possible food. Is it actually made use of? This question has until recently usually been answered in the negative, and this conclusion was the more readily accepted since nitrogen is a notoriously inert gas.

Another view, however, has within recent years come to obtain. It developed in this wise. It had long been known that land which has lain fallow or on which clover or other leguminous crops have been reared is in a way strengthened as if fertilized, and it was also known that this strengthening is due to the fact that the soil acquires nitrogen from the air and "fixes" it in the form of nitrates. While the studies of PASTEUR on fermentation, since 1862, had paved the way for the interpretation of the process, the fact that it is due to organisms was first proved by SCHLÖSING and MÜNTZ ('77, '79). This proof they made by chloroforming a certain mass of nitrifying earth and finding that the nitrifying process thereupon ceased. Later, they isolated a form of bacteria which had the nitrifying property. Their results were quickly confirmed and extended by others, notably BERTHELOT ('85, '92, etc.), in a long series of investigations, so that there is now no question that the nitrification of the earth is brought about by the activity of bacteria, perhaps of several species.

The results thus gained were extended to some of the higher fungi by FRANK ('92, p. 596).

Spores of *Penicillium cladosporioides* were sown in a nutritive solution of pure grape sugar and mineral salts, completely free of nitrogen, and in the presence of air which had been freed from ammonia by passing through sulphuric acid. The fungi grew, but not so rapidly as those in a solution containing nitrogenous compounds, and produced a mass of hyphæ. These hyphæ, when tested, yielded ammonia. One such culture solution of 65 cc. volume became filled with the fungus mass in ten months and yielded 0.0035 gramme of nitrogen, which must have been derived from the air.

As similar results have been gained for other molds by BERTHELOT ('93) and for *Aspergillus* and *Penicillium glaucum* by PURIEWITSCH ('95), we seem almost justified in predicting that the capacity for assimilating free, atmospheric nitrogen will prove to be a characteristic of all fungi.

Now if it is conceded that some organisms can make use of the nitrogen of the air, it is clear that the *a priori* objection to

all organisms doing so, the objection, that is, on the ground of the inertness of nitrogen, is disposed of. The question is now merely one of fact. Do the algæ, the higher plants, and the animals make nitrogenous compounds out of free atmospheric nitrogen?

Of these groups, the algæ first claim our attention because of the inherent probability that they will act more like bacteria than any other group, since they pass over into the bacteria through such connecting forms as the Oscillariæ and Nostocs. SCHLÖSING and LAURENT ('92), FRANK ('93), KOCH and KOSSOWITSCH ('93), experimented with various species of Nostoc, Oscillaria, Lyngbya, Tetraspora, Protococcus, Pleurococcus, Cystococcus, Ulothrix, etc., and found that, when supplied with a non-nitrogenous food, these plants produced nitrogenous compounds in the substratum, evidently gaining their nitrogen from the previously purified air.

Doubt exists, however, as to whether the free nitrogen is taken in *directly* by the algæ or only after having been assimilated by bacteria associated with the algæ and by them made into nitrogenous compounds. For the latter alternative speak the experiments of KOSSOWITSCH ('94) and MOLISCH ('95). KOSSOWITSCH, who with KOCH had previously found that algæ gain nitrogen from the air when reared in impure cultures, now took special pains to get algal cultures free from bacteria. To this end he reared algæ on potassium silicate permeated by a nutritive solution. The pure cultures thus gained were then grown in a sterilized flask to which air, freed from ammonia, was admitted. The nutritive solution was made of salts free from nitrogen but containing the other essential elements. The results of this experiment were striking. The pure cultures of algæ grew for a time, but then ceased. New non-nitrogenous food did not revive them, but the addition of nitrates caused rapid growth.

Other evidence was gained from analyses. When the cultures of algæ were pure there was no increase in the amount of nitrogen in the dry matter of the algæ. But when bacteria were mingled with the algæ, the quantity of nitrogen was increased. This is shown in the following typical analysis:—

CONTENTS OF CULTURE.	MILLIGRAMMES OF N IN CULTURE.	
	AT THE BEGINNING.	AT THE END.
Cystococcus, pure culture	2.6	2.7
Cystococcus, with bacteria {	no sugar	3.1
	with sugar	8.1

These results, abundantly confirmed by MOLISCH ('95), seem to show that unless bacteria are present algæ can build up free N into nitrogenous compounds only slowly, if at all.*

While SCHLÖSING and MÜNTZ, BERTHELOT, and others were gaining an explanation of the enrichment of fallow ground, HELLRIEGEL ('86) and WILFARTH were making their investigations upon the cause of the enriching action of leguminous crops, which led them to the conclusion that it was due to the fixation of nitrogen in plants with root-nodosities containing bacteria, the compounds thus formed by the symbiotic bacteria being directly assimilated by the plant. This conclusion has been repeatedly sustained for leguminous plants (Fig. 86).

The question whether green phanerogamous plants other than legumes can make use of free atmospheric nitrogen is one which is still in hot debate, and it is not an easy one to answer. The calm conviction, based chiefly upon the excellent work of BOUSSINGAULT ('60), and LAWES, GILBERT, and PUGH ('61), that nitrogen is not thus obtained was rudely shaken by the paper of FRANK ('93) in which that author stated that he finds that nitrogen is removed from the air by non-leguminous plants—plants, moreover, which are not known to have bacteria living in their roots. Consequently he is of opinion that perhaps the fixation of free nitrogen may be carried on by any living plant cell.

The difficulties in the solution of the problem may thus be set forth. It is recognized that all growing plants make use

* One "crucial test" of FRANK still requires an explanation. If the free nitrogen is "fixed" by the aid of bacteria, the process should go on in the dark. Experiment shows that it does not do so. This difficulty Kossowitsch overcomes by the assumption that the activities of the bacteria are dependent upon certain carbohydrates which the plant can afford them only in the light.

of nitrogen, but the nitrogen is usually obtained from the soil in the form of nitrates. It is feasible to determine by analysis the amount of nitrogen in the soil at the beginning of the experiment and the amount in the seed planted, and then after the experiment to determine the quantity in the soil and in the plant. But the difficulty comes in interpreting the results



FIG. 86. — Parallel cultures of peas in the symbiotic and the non-symbiotic conditions. Each series comprises three culture vessels: *B*, the symbiotic plants in soil without nitrogen; *C*, the non-symbiotic plants in like soil; *A*, for comparison, non-symbiotic plants after addition of nitrate to the soil. After a photograph. (From FRANK, '92.)

of the analyses. Thus the fact that the sum of nitrogen in the plant and the soil is greater at the end than at the beginning of the experiment does not prove that the plant has taken in free nitrogen; for, as we have seen, the soil contains nitrifying bacteria, which intermediate between the free nitrogen of the air and the nitrates absorbed by the green plants. This diffi-

culty may be partly met by sterilizing the soil, but this probably produces also other changes than the death of the bacteria.

The most careful observations of the last five years have not supported FRANK'S generalization. Here and there there have been observers who, like LIEBSCHER ('92) and STOKLASA ('96), believe they have evidence for the direct assimilation of free nitrogen by the cells of phanerogams. But the evidence for the contrary opinion is predominant.

The experiments which speak for the theory that green plants cannot directly make use of free nitrogen are not in unison. Thus, some indicate that in non-leguminous as well as leguminous plants nitrogen of the air is indirectly made use of through the action of the bacteria of the soil, while according to others it would seem not to be made use of at all. To the first class belong the experiments of PETERMANN ('91, '92, and '93) with barley, of NOBBE and HILTNER ('95) with mustard, oats, and buckwheat, and of PFEIFFER and FRANKE ('96) with mustard. To the second class belong the experiments of SCHLÖSING and LAURENT ('92 and '92^a) with various plants, DAY ('94) with barley, and AEBY ('96) with mustard. In the second class, however, the experimental conditions did not favor the development of the bacteria of the soil. The experiments of PETERMANN were, however, carried out upon a very large scale and under practically normal conditions and showed a marked difference between the acquisition of nitrogen by barley growing in an unsterilized soil and in a sterilized one. Likewise NOBBE and HILTNER, and PFEIFFER and FRANKE, were careful to rear plants under normal conditions, so that their results are worthy of especial consideration. They agree that there is an acquisition of nitrogen by the plant growing in normal soil and that this occurs only when the soil is unsterilized. We conclude then that probably phanerogams, like algæ, can use the free nitrogen of the air as food only after it has been converted into nitrates by the action of the nitrifying organisms—the bacteria of the soil.

Turning now to animals, whose nutrition is often compared with that of fungi, we find an absence of knowledge on the subject of the nutritiveness of free nitrogen. It is clear that

land animals are in a favorable position for making use of it, since it penetrates with the oxygen to all parts of the body. It is found in the blood of mammals, but still as free nitrogen. Whether it eventually becomes fixed in the body is entirely unknown. The *a priori* argument against such fixation — the argument of inertness — has lost much of its force since the discovery of the nitrifying organisms.

Phosphorus. — This element is of constant occurrence in organisms. It has been found in yeast, mucors of the most diverse kinds, seeds, plant tissues, and animal tissues of all kinds. It is indeed one of the first among the mineral elements of most organisms, as shown on pages 296 and 297. Of the dry substance of a fish, about 7% is phosphoric acid, and the dry substance of many seeds yields 15%. Phosphorus occurs in organisms as phosphoric acid compounds. Of these the most important organic compounds are *nuclein*, which has albuminoid properties, and occurs chiefly in all nuclei and in deutoplasm; *lecithin*, of a fatty nature, occurring in yeast, plasmodium of *Æthaliium*, seeds, milk, yolk of eggs, and nervous tissue; and *glycerin-phosphoric acid*, a product of decomposition of lecithin and found wherever the latter occurs. As examples of inorganic salts we have the sodium and potassium phosphates of the blood and tissues and the calcium phosphate deposited in bone.

So important an element as phosphorus would naturally form an essential part of the food of all growing organisms. It is supplied at first in the germ, — seed or egg, — but later must come from without. Plants gain phosphorus from the disintegrating rocks. Animals derive it chiefly from plants, directly or indirectly, or from the calcic phosphate of the sea; in mammals it is supplied to the developing young through the milk, which, as we have seen on page 303, is rich in phosphates.

The abundance of phosphorus in the body indicates that its office in the organism is an important one, and its peculiar abundance in seeds, yolk, and milk indicates that it is especially important in growth. Experiments have been directed towards this point. The fact has long been established that plant growth cannot occur in the absence of phosphates, and this is true not only for green plants, but also for molds and yeast

(RAULIN, '69). Embryos of various marine animals also will not develop in the absence of phosphorus (HERBST, '97). The peculiar importance of phosphorus for growth is also indicated by the fact that HARTIG and WEBER ('88) found more phosphoric acid in the ash of the growing ends of the plant than in its fully differentiated parts. Again, LOEW ('91^a) found that *Spirogyra* kept in a nutritive solution of salts in which phosphorus alone was lacking, continued to live and, indeed, to form starch and albumen, but its cells did not grow or divide; so that LOEW concludes that an important use of phosphorus is to nourish the cell-nucleus, and this fact is easily understood from the known importance of the phosphorus-containing nuclein of chromatin in cell-division. All these facts go to show that phosphorus is of prime importance in the growth of organisms.

Arsenic, Antimony, Boron, and Bismuth, and their compounds, are apparently all injurious to organisms, so that sublethal solutions strong enough to be active, interfere with or even inhibit growth.

Sulphur. — This element is, without doubt, of constant occurrence in organisms of all sorts, for it constitutes between 0.3% and 2% of all proteids, out of which organic bodies are largely composed. Sulphur forms between 0.6% and 1% of various (dry) organs of man, and nearly 1% of the dry substance of a month-old seedling of *Sinapis alba*.

In the growth of a plant (*Sinapis alba*) the amount of its sulphur increases from 0.02 mg. in the seed to 84.4 mg. in the adult plant, and, indeed, it has been shown in one case (ARENDE, '59, for the oat plant) that the percentage of sulphuric acid in the ash increases from 2.9 to 4.2 as the plant develops from a seedling to maturity. Since the sulphur goes chiefly into the composition of the living substance, its hygienic importance for growth is evident.

The form in which sulphur may be taken into the body is very varied. It is well known that green plants usually absorb it in the form of sulphates, especially sulphates of potassium, calcium, and magnesium; marine animals take it chiefly from the calcic sulphate of sea water, and land animals gain it largely from organic sulphur compounds produced in

plants. Whether non-chlorophyllaceous plants can make use of it has been much discussed, and is worthy of further investigation. WINOGRADSKY ('88, '89) has, indeed, shown that the sulpho-bacteria store up pure sulphur from sulphuretted hydrogen (H_2S), and PRESCH ('90) has concluded, as a result of feeding himself with pure sulphur and analyzing the sulphur of the urine, that about one-fourth of the sulphur taken into the body in an elementary form becomes built up into organic molecules. Recently HERBST ('97) has shown that embryos

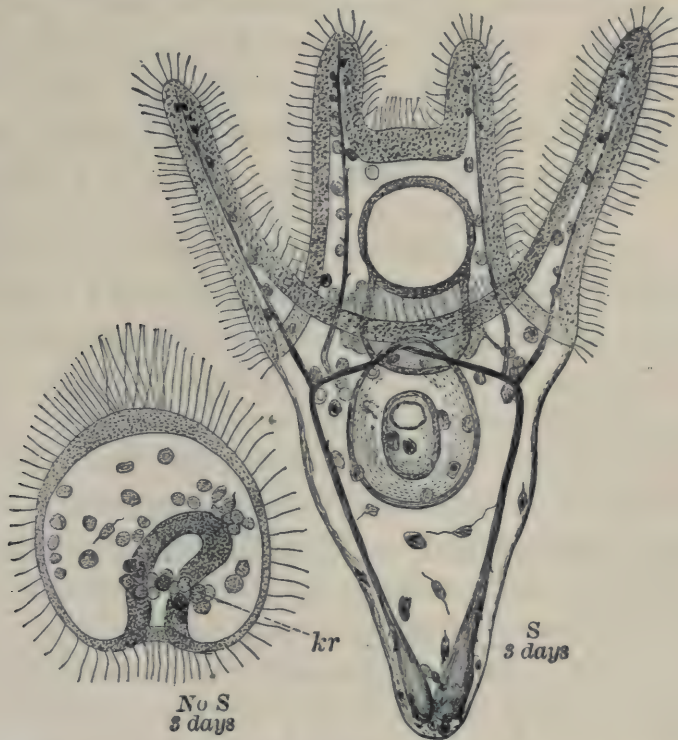

FIG. 87. — *Right*, Larva of *Echinus* reared for 72 hours in water containing all the necessary salts; the sulphur being in the form of 0.26% magnesium sulphate and 0.1% calcic sulphate, and the phosphate in the form of $CaHPO_4$. The larva is normal. *Left*, Larva reared for 68 hours in a solution containing no sulphur nor $CaCl_2$. The typical larva without sulphur, but with $CaCl_2$, differs from this chiefly in the presence of rudimentary spicules; *kr*, spicule-forming cells. (From HERBST, '97.)

of sea-urchins and other marine animals do not develop in the absence of sulphur (Fig. 87). These facts indicate that not green plants merely, but all organisms, can use elementary sulphur as a hylogenetic food.

The Halogens, chlorine, bromine, iodine, and fluorine, are elements which are closely similar in their chemical reactions

outside of organisms, and carry a part of that peculiarity with them into organisms. All of them are of physiological interest; but so far as we know chlorine and iodine are most important.

Chlorine. — This element is probably of constant occurrence in organisms, and indeed in rather large quantities, as Table XXVII, p. 297, shows. It is not strange that it should be so, since this element is very widely distributed in all waters. This very fact, however, renders it possible that chlorine is merely an accidental constituent of organisms, being unessential to growth, and precisely this conclusion has been maintained.

Of green plants it was early asserted that growth occurs as readily in solutions containing no chlorine as in ordinary potable water, but of late years evidence opposed to this view has been accumulating. Thus, while it appears that growth may occur in the absence of chlorine, ASCHOFF ('90) and others have found that growth is not so vigorous as in solutions containing this element. It has been thought that chlorine makes an advantageous combination with the potassium necessary for the plant, but the true significance of the favorable properties of chlorine remains undetermined.

Turning to animals, we find that chlorine occurs in the milk of mammals, and is therefore probably necessary to them. According to HERBST ('97, p. 709) it is a necessary food for young echinoids. Certainly in the form of sodium chloride it is an essential food of the higher animals, and some of them, especially the herbivora, require large quantities of it, as "salt-licks" testify. The function of chlorine is not altogether plain. It must be used in the production of the hydrochloric acid of the digestive juices. In addition, sodium chloride is found widely distributed in the tissues. It has often been asserted that it goes through the tissues unchanged; but NENCKI and SCHOUMOW-SIMANOWSKY ('94) believe that it is probably disintegrated and the chlorine built up into organic molecules.

Bromine. — The normal occurrence of traces of this element has lately been demonstrated by HOTTER ('90) for a great variety of plants. It occurs most abundantly in various fruits, apple, pear, peach, and also in the leaves and twigs of many plants, as well as in various berries. Its normal occur-

rence permits us to believe that it has an importance, if not for growth, at least for development; there is, however, no direct evidence that it is generally necessary to organisms. Since it is closely allied to chlorine, the question whether it may replace chlorine in growth has been tested. NENCKI and SCHOUWOW-SIMANOWSKY ('94) have found that in the higher animals the bromides can replace the chlorides to a limited extent, but are clearly less advantageous. Altogether the importance of bromine for growth is slight.

Iodine. — This element is of wide-spread occurrence in organisms, probably as a constituent of organic molecules, for it is found in plants, especially in some species of *Fucus* and *Laminaria* (cf. ESCHLE, '97); in invertebrates, especially in sponges and the stem of *Gorgonia*; and in vertebrates, especially in mammals, where it has recently been shown to be most important for growth. It has long been known that mammals which have been deprived of the thyroid gland acquire a weak condition of body known as myxœdema. This effect has been accounted for by the loss, to the organism, of a substance elaborated in the thyroid gland; for when the thyroid gland, or a decoction of it, is fed to the animal it recovers to a certain extent its normal condition. The nature of this substance has been investigated by BAUMANN and ROOS ('96), who find that it is a compound of iodine — thyriodine; for when thyriodine is fed to the myxœdema patient, the same favorable result ensues as follows feeding upon the gland.

Fluorine is found rather widely distributed among vertebrates in very minute quantities. It forms about 1.3% of the total ash of bone. It is present also in the hen's egg, being more abundant in the yolk than in the albumen (TAMMANN, '88). Since it is chiefly found in the body as a constituent of bone, possibly in the form of the mineral apatite, $\text{Ca}_{10}\text{F}_2(\text{PO}_4)_6$, it may very well be that its chief importance is in the constitution of this formed substance. According to BRANDL and TAPPEINER ('92) the normal amount in the body may be greatly increased by feeding small quantities of sodium fluoride during a long period. Altogether, we have no reason for thinking that fluorine is essential to the growth of organisms in general.

Salts of Alkalis.— This group contains one or two of the most important elements of which organisms are composed. The elements are only slightly replaceable by one another.

Lithium seems normally to have little importance for growth, although slight traces of it have been found spectroscopically in the blood (HOPPE-SEYLER, '81, p. 453).

Sodium is probably of constant occurrence in organisms. The quantity of it in the body is widely different in different species; and as our table on page 297 shows, it may vary in its position from one of the most abundant of the elements to one of the least. Whereas sodium is not essential to the nutrition of plants, it is necessary in the form of sodium chloride to certain higher animals. Sodium is also found in all the tissues of the body, and perhaps enters into the albuminoid molecule (NENCKI, '94). The fact that, as we have seen on page 303, soda is a prominent constituent of milk, indicates its importance in the growth of mammals. Finally, HERBST ('97) has been able to demonstrate its indispensability for the growth of marine animals.

Potassium constitutes an important part of all organisms. It forms the largest part of the ash of nearly all phanerogams (see page 297) and is markedly abundant in yeast and in many invertebrates. It occurs in the body as chloride and as sulphate, and probably also in combination with albumen and various organic acids (VINES, p. 134).

That it is an essential and unreplaceable food for all organisms is indicated by trustworthy experiments upon fungi, algæ, phanerogams, invertebrates, and vertebrates. RAULIN ('69) first showed that only culture-solutions containing this metal permit the growth of fungi.

The experiments of BENECKE ('96) upon the growth of certain molds, *e.g.* *Aspergillus*, are worth citing in detail as an illustration of the method.

He sowed spores in culture-vessels made of a glass which analysis had shown to be free from potassium. Two of these vessels contained a nutritive aqueous solution consisting of 3% cane sugar and 0.25% magnesium sulphate. To the one of these solutions was added 1.2% potassium nitrate, and 0.26% potassium phosphate; and to the other 1% sodium nitrate and 0.5% sodium phosphate. After four days the first culture was covered by a sheet of fungi and in five weeks the whole surface was black with spores; in

the second culture, on the other hand, little growth had occurred even at the end of five weeks. The crop from each of the cultures was then harvested and its dry weight determined. That of the first culture was 0.3 gramme, that of the second 0.03 gramme.

By a somewhat similar procedure MOLISCH ('95) has been able to show that potassium is essential to the growth of algæ; and NOBBE and others ('71) that it is necessary for the growth of phanerogams.

The experiments upon animals have been rather less satisfactory on account of the greater difficulties in experimentation.

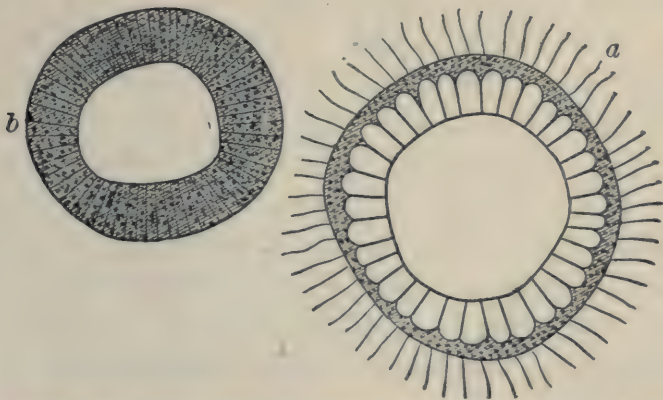

FIG. 88. — Two embryos of *Sphærechinus* from parallel cultures. *a*, reared in a solution containing all the necessary salts; embryo normal. *b*, reared in the same solution, but without potassium; blastula wall abnormally dense, and embryo of small size. (From HERBST, '97.)

Nevertheless we have some trustworthy data upon this matter. On the side of the invertebrates we have the experiments of LOEB ('92), who placed a hydroid, *Tubularia*, in fresh water to which solutions of various combinations of the salts found in sea water were added so as to give approximately the normal osmotic effect. Under these circumstances regeneration of the hydroids occurred only in the solutions containing potassium. Again, HERBST ('97) finds potassium essential to the growth of embryos of echinoids (Fig. 88). Thus the potassium compounds seem necessary to the processes upon which growth depends. On the side of vertebrates we have the somewhat inconclusive results of KEMMERICH ('69), who fed two young dogs of the same age and of nearly the same size upon meat boiled until a large portion of its salts was extracted. To the food of one dog he added only sodium chlo-

ride; to that of the other, both sodium chloride and potassium salts. After 26 days the dog fed on the potassium salts as well as the sodium chloride was about 30% heavier than the other, and this difference was reasonably ascribed to the beneficial effects of the potassium.

The particular part which potassium takes in growth is still somewhat doubtful. The recent observations of COPELAND ('97) with seedlings reared in water cultures in which sodium replaces potassium, lead him to the conclusion that potassium is necessary to turgescence. The potassium salts become lodged in the cell-sap, as analysis shows, and are therefore, perhaps, one of the principal causes of imbibition.

Rubidium and *Cæsium*. — These rather rare metals are important only because of the fact that they may replace potassium in the growth of some fungi. WINOGRADSKY ('84) recognized this to be the case with rubidium in yeast cultures. NÄGELI ('80) found that in molds rubidium and cæsium gave even greater growth of dry substance than potassium cultures, a conclusion abundantly confirmed by the studies of BENECKE ('95). Whatever, therefore, is the significance of potassium for growth, rubidium and cæsium seem to have the same significance.

Earthy Metals. — Under this head are included the elements calcium, strontium, and barium, which form compounds having closely similar molecular structure and properties. We might therefore expect them to be in some degree mutually replaceable.

Calcium shares with potassium and phosphorus the position of one of the most abundant elements of organisms. It is found in every tissue and seems to be a constant accompaniment of protoplasm.

Its constant occurrence is indicative of its importance as food for both plants and animals. It is apparently indispensable and unreplaceable by any other element in phanerogams; but MOLISCH ('94) finds that growth can take place in certain molds (*Penicillium*, *Aspergillus*) as well in its absence as in its presence, and in some algæ, but not in all (MOLISCH, '95), calcium is apparently of little importance. In animals, calcium can be replaced by other elements only to a very slight extent.

Its absence from the water in which echinoid larvæ are developing produces dwarfs. In vertebrates, owing to the need of this metal for the skeleton, large quantities of calcium are taken in by the growing organism. In normal growth, then, the food of animals and phanerogams must contain calcium.

Strontium, although closely allied to calcium, is rather rarely found in considerable amount in organisms. In certain plants, as *e.g.* *Fucus*, it is constantly present. It can be stored up in the animal organism when supplied abundantly in the food, but in general is believed to be of little importance for growth.

Manganese, likewise, is not of general importance, although it is found abundantly in certain plants, *e.g.* *Trapa natans*, *Quercus robur*, and *Castanea vesca*, and in the excretory organ of the mollusc *Pinna squamosa* (KRUKENBERG, '78).

Iron.—This most abundant of the heavy metals occurs so frequently in organic substances, especially those related to the compounds found in protoplasm, that it is little wonder that iron has been found to be an essential ingredient of all protoplasm, hardly less important than oxygen itself. Although its occurrence has been demonstrated, especially by SCHNEIDER ('89), in all the large groups of animals, its amount in any individual or organ is always very small. Iron oxide (Fe_2O_3) forms between 1% and 2% of the ash of muscle, about 5% of the ash of blood, and rarely rises to 5% in plants.

It is found in the body, for the most part, as in yolk (BUNGE, '85), in organic union. It occurs thus in the chromatin of the nucleus of all cells (MACALLUM, '92, '94; SCHNEIDER, '95).

That chromatin contains iron has been demonstrated by MACALLUM ('91) by means of a microchemical method whose general validity has never, so far as I know, been questioned. It was shown by BUNGE, in 1885, that when tissue is put into ammonium sulphide the iron, even in an organic molecule, is separated from its compound, and uniting with the sulphur forms ferrous sulphide (FeS). This ferrous sulphide appears in the protoplasm as green granules (black in large quantity); and the fact that these granules appear abundantly in the nucleus shows that iron is especially abundant there. Additional evidence is given if after several weeks the chromatin loses its stained appearance and becomes rusty. This result is interpreted as due to the formation of ferric oxide, Fe_2O_3 ; for when the

nuclei are subjected to hydrochloric acid and potassium ferricyanide they immediately assume a deep azure-blue color, clearly due to the formation of "Prussian blue" or $\text{Fe}_4(\text{FeC}_6\text{N}_6)_3$. This series of reactions can only be explained on the ground that there is iron in the nucleus.

Iron has shown itself to be essential to the growth of all organisms. Its importance for growth is indicated by its relative abundance in the yolk of birds' eggs, and by the fact of its occurrence in larger proportion in a mammal just born than

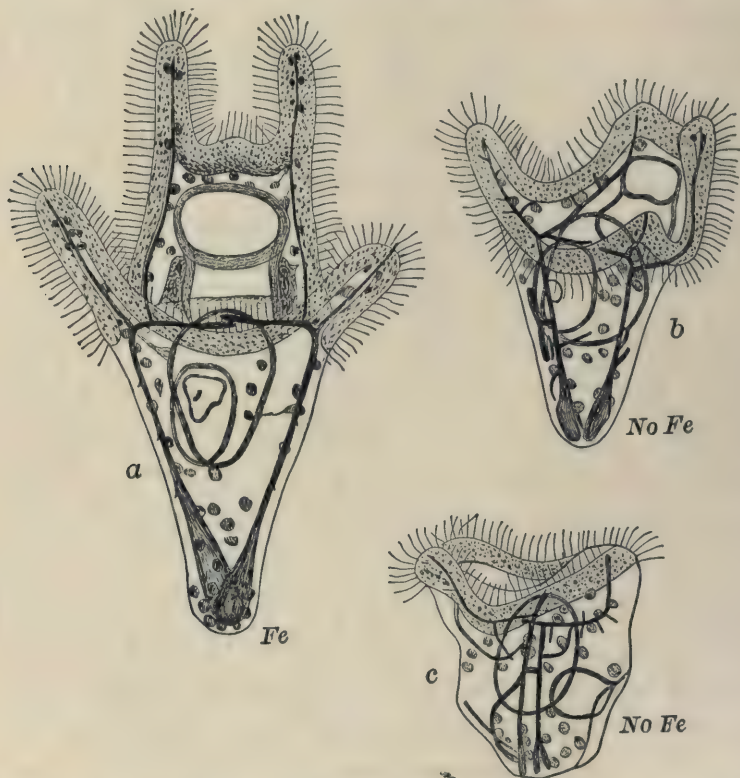

FIG. 89. — Echinus larvæ from parallel cultures, all $5\frac{1}{2}$ days old. *a*, reared in a solution containing all salts, including iron as FeCl_3 ; *b* and *c*, from solutions containing all salts excepting iron. (From HERBST, '97.)

in later stages. When excluded from a nutritive solution which is otherwise complete, growth is imperfect (Fig. 89). This may be associated with the facts that in plants the chlorophyll granules are not developed in its absence, that in the higher animals hæmoglobin cannot be formed, and that the chromatic substance of all cells requires it.

The question in what form iron is absorbed by the organism has been the subject of an extensive discussion. Although doses of metallic iron have long been used with favorable

results in medical practice, BUNGE ('85) concluded that only organic iron compounds are assimilable. The studies of KUNKEL ('91 and '95) and WOLTERING ('95) have, however, shown in the clearest manner that inorganic iron is assimilated, stored in the liver, and made use of in the construction of such organic compounds as the hæmoglobin of the blood. At the same time, as SOCIN ('91) and others have shown, iron may be gained from organic compounds. Apparently, iron compounds of any sort may be made use of by the organism.

Magnesium.—This metal is closely associated with calcium, the two usually occurring together in organisms just as they do in the inorganic world. As the table on page 297 shows, magnesium is of constant occurrence among organisms, although never present in great quantity. The magnesium is gained by green plants at the same time with the calcium from mineral salts (chiefly magnesium carbonate and sulphate) derived from disintegrating rocks. Fungi can also make direct use of the salts of magnesium (excepting always the chloride); and animals, although no doubt chiefly gaining their magnesium from plants or the waters in which they live, may make use of mineral salts, especially in the construction of the mineral parts of various formed substances, such as those of bone.

So constant an element is presumably necessary to the organism, and numerous observations make it quite certain that this is true for green plants in general. Indeed, the fact that magnesium occurs in chlorophyllan of chlorophyll makes it probable that it functions in assimilation. Concerning its indispensableness for fungi there can likewise be no doubt, since BENECKE'S ('95, p. 519) experiments show it to be replaceable neither by calcium, barium, or strontium. While some investigators, like HOPPE-SEYLER, believed it to have little significance for the animal body,—to be an accidental accompaniment of calcium,—later study has shown that it is of importance for regeneration of hydroids (LOEB, '92), and, according to HERBST ('97), a constituent of the sea water which is necessary to the normal growth of various marine larvæ. Also its occurrence, although slight, in milk, as well as its very abundant occurrence in seeds, indicate that it plays an important, if an unknown, part in growth.

Silicon. — This element is of wide occurrence among organisms. In many plants, especially the grains and grasses, it is exceeded in abundance only by potassium. Among the lower organisms whole groups, *e.g.* diatoms, Radiolaria, and glass sponges, are characterized by the great amount of silica made use of. Even in vertebrates it is found wide-spread in the blood, gall, bones, feathers, and hair. The silicon required for the body is gained by plants and lower organisms from the soluble silicates or silicic acid of the soil and waters; by vertebrates, probably from plants.

Although SACHS ('87, p. 271) was able in 1862 to show that growth even of maize (about one-third of whose ash is silica) continues in the absence of silicon, yet some grains do better, according to WOLFF ('81), when that element is abundant. It is significant, likewise, that, as POLECK ('50) found, 7% of the ash in the albumen of the hen's egg is silicon.

Copper. — Brief mention may be made of the fact that this metal occurs in a great variety of organisms, but usually in minute quantity. It occurs as a physiologically important constituent of the hæmocyanine of the blood of the squid (FREDERICQ, '78, p. 721), of crabs and lobsters, and of certain gastropods and lamellibranchs (FREDERICQ, '79).

2. **The Organic Food used by Organisms in Growth.** — All organisms may use organic compounds as food; all organisms which contain no chlorophyll, certain bacteria excepted, must do so. This organic food may consist of solutions of definite composition or it may consist of solid masses of plant and animal tissue composed of varied and indeterminate kinds of organic molecules. The former are made use of chiefly by plants; the latter, by the higher animals. This distinction is, however, not a necessary and constant one, for on the one hand insectivorous plants and many fungi live upon solid masses which they digest, and on the other hand some of the Protozoa can be fed upon known solutions, and doubtless some of the higher animals could be likewise fed, although few experiments seem to have been made in this direction. Even in methods of nutrition there is no sharp line to be drawn between the different groups of organisms.

a. Fungi. — Our knowledge of the effect of known chemi-

cal compounds used as food has been much more advanced by studies upon this group than upon any other. Yeast and bacteria have been especially investigated, but valuable results have been obtained upon the higher fungi also. Considering all these results together, it appears that the nutritive value of an organic compound is perhaps chiefly determined by its assimilability; that is, the less the energy required to attack and transform the compound by the various chemical means at hand, the more favorable it is as a food. This assimilability depends in turn upon the molecular structure—upon a certain molecular instability or lability—upon the possession of that quality which is found in its extreme expression in many organic poisons. As LOEW ('91, p. 761) has expressed it: Poison action, like nutritive action, is a relative conception. An indifferent body can become, by entrance of one atom-group, a nutritive substance; by entrance of an additional atom group, a poison. While a certain lability—that is, a certain degree of ease of decomposition—is a condition of the nutritive quality of a substance, a slight increase of this lability can give it a poisonous character, especially when the loosely arranged atoms can link into that atom-grouping upon which the vital movement in the protoplasm depends. Thus methan is indifferent for bacteria, methylalcohol is a nutritive substance, formaldehyd is a poison, and its combination with sodic sulphate again a nutritive material.*

Additional laws of nutritive value which hold true in many cases are as follows: The assimilable carbon compounds contain the group CH_2 or at least CH . Under otherwise similar conditions, compounds with one carbon atom are assimilated with great difficulty (methylamin) or not at all (formic acid, chloral); and, in general, but with important exceptions in the case of certain classes of substances, the assimilability increases as the number of carbon atoms in the molecule increases. The

* The graphic formulas of these substances are:—

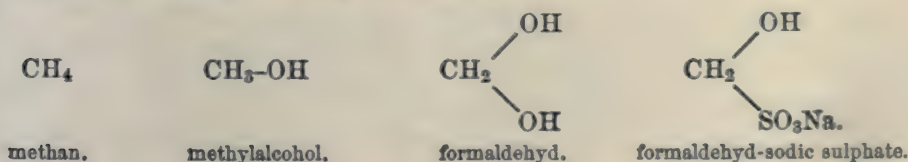

radical HO- is usually easily released, consequently we find compounds containing this radical in general more assimilable than allied compounds in which the HO- is replaced by H. Especially is this true when the HO- is joined with radicals containing carbon and hydrogen atoms. For example, foods with the radical $-\text{CH}_2 \cdot \text{OH}$ are more nutritive than those with $-\text{CH}_3$. Hydroxylized acids are better food for bacteria than non-hydroxylized — lactic acid, $\text{C}_3\text{H}_6\text{O}_3$, is better than propionic acid, $\text{C}_3\text{H}_6\text{O}_2$. It is, perhaps, a special case under this rule that multivalent alcohols — *i.e.* those containing several HO groups — are better foods than the univalent ones; for instance, glycerine, $\text{CH}_2\text{OH}-\text{CHOH}-\text{CH}_2\text{OH}$, is better than propylalcohol, $\text{CH}_3 \cdot \text{CH}_2 \cdot \text{CH}_2\text{OH}$. Finally, the entrance of the extremely unstable aldehyd ($-\text{CH}:\text{O}$) and keton ($-\text{CO}-$) groups increases the nutritive capacity of the food; for example, glucose, $\text{CH}_2\text{OH} \cdot (\text{CH} \cdot \text{OH})_4\text{CHO}$, or fructose, $\text{CH}_2\text{OH} \cdot (\text{CH} \cdot \text{OH})_3 \cdot \text{CO} \cdot \text{CH}_2\text{OH}$, is better than mannit, $\text{CH}_2\text{OH} \cdot (\text{CH} \cdot \text{OH})_4 \cdot \text{CH}_2\text{OH}$. But all substances containing the group CHOH are good foods, since this compound can be used directly in the construction of carbohydrates, and eventually of albumen.

As an example of the application of these general principles may be given this series of substances arranged in the order of their decreasing nutritive value for yeast and molds (NÄGELI and LOEW, '80): 1, sugars; 2, mannit, glycerine, the carbon groups in leucin; 3, tartaric acid, citric acid, succinic acid, the carbon groups in asparagin; 4, acetic acid, ethylalcohol, kinic acid; 5, benzoic acid, salicylic acid, the carbon groups in propylamine; 6, the carbon groups in methylamin, phenol.

In conclusion may be mentioned a food for bacteria which, although inorganic, resembles organic compounds in that it may serve as a source of energy. This is the hydrogen disulphide employed by the sulphur bacteria and allied forms (WINOGRADSKY, '87, '89).

b. Green Plants. — It has already been shown that organic compounds can be assimilated by green plants. The experiments which have shown this have been made upon both algæ and phanerogams, especially by BOKORNY, LOEW, A. MEYER, and LAURENT. It appears that, in the absence of carbon

dioxide, Spirogyra may form starch from methylalcohol, formaldehyd, glycol, methylal, acetylethylesteracetat, acetic acid, lactic acid, butyric acid, succinic acid, phenol, asparaginic acid, citric acid, acid calcium tartrate, ammonium tartrate, calcium bimalate, glycocoll, tyrosin, leucin, urea, hydantoin, kreatin, and peptones.* Phanerogams form starch from glycerine, cane sugar, levulose, dextrose, lactose, maltose, mannit, dulcit, and lecithin. While daylight favors assimilation it can be in some cases dispensed with. Thus the potato plant can accumulate starch in the dark when glycerine is used as food.

An attempt to gain a deeper insight into the conditions of formation of albumen from organic matter has been made by HANSTEEN ('96), who reared Lemna in solutions of grape sugar or cane sugar, on the one hand, and amids, like asparagin, urea, glycocoll, leucin, alanin, or kreatin, on the other; also on grape sugar and inorganic nitrogenous bodies such as potassium nitrate, sodium nitrate, ammonium sulphide, and ammonium sulphate. As a result of feeding on grape sugar alone at 20° C. during 24 hours, much starch was stored in the cells; when grape sugar and inorganic nitrogenous bodies were combined little starch and much albumen were produced. Much albumen was also gained when the nutritive solution contained cane sugar and urea, or asparagin and ammonium chloride, or asparagin and ammonium sulphate. The production of albumen in green plants is favored by nitrogenous organic compounds.

c. Animals. — These organisms are distinguished from the foregoing by an immense requirement of energy for their muscular processes, much of which is continually lost to the organism in the form of motion communicated to the environment. On the other hand, growth is generally slower than in plants. Consequently in animal nutrition thermogenic foods are the more important and the nutritive processes are prevailingly exothermic. The plastic processes are the less striking; nevertheless, it is they which chiefly concern us in our study of growth.

Among the organic compounds ingested, carbohydrates are

* The reagents were employed in about 0.1% solution, and whenever acid were neutralized with lime-water.

believed to have little importance as plastic foods—we have chiefly to consider the use of the complex fats, albuminoids, and other organic compounds. We can make little use of the extensive tables of calorific properties of foods which, however important for determining capacity for supplying energy, afford little insight into the plastic properties of the food—its importance for the growth of dry substance or the imbibition of water.

The difficulties in the way of feeding animals upon known nutritive solutions are great, both because solutions are not their normal food, and because, in the case of water organisms, the bacteria introduced with the animals thrive better than they. Consequently the observations on nutritive compounds for animals are meagre. It will be best to consider them under the types upon which they have been made.

Amœba.—We owe important studies on the foods of *Amœba* to the fact that some species have a pathogenic importance. Cultures of them have therefore been made by bacteriological methods. It is found that various, even innocuous kinds, will grow upon egg albumen in distilled or phenylated water kept at about 15° C. (CRIVELLI et MAGGI, '70, '71; MONTI, '95), upon agar-agar sheets from which the soluble substances have been removed by repeated washing in distilled water (BEYERINCK, '96), upon "*Fucus* [*Chondrus?*] *crispus*" (CELLI, '96), or upon slices of potato (GORINI, '96). It is thus clear that, in addition to salts, *Amœba* needs only a very simple nitrogenous diet. It is, however, uncertain whether the *amœba* feeds directly from the organic food stuff, or indirectly upon the bacteria which grow upon the food supplied.



FIG. 90. — *Polytoma uvella*,
a flagellate infusorian.
(FROM VERWORN, 95.)

Infusoria.—A beginning has been made in the study of this group by OGATA ('93), who reared pure cultures of the flagellate *Polytoma uvella* (Fig. 90) on plates of nutrient gelatine (which is extremely rich in protein) and also upon a medium composed of 500 ccm. meat bouillon, 12.5 grammes grape sugar, and 250 grammes of a Japanese mixture of algæ called "*nori*," derived mostly from the species *Porphyra vulgaris*.

The mixture was cooked, neutralized, filtered, sterilized, and infected with the flagellates, which had been isolated by means of capillary tubes. Here again growth was supported by simple, definite foods.

Amphibia. — It is a great leap from Protozoa to vertebrates, but precise feeding experiments are almost lacking in the invertebrate Metazoa. In the present group come the pioneer experiments of YUNG ('83). This author fed a number of tadpoles derived from the same batch of eggs upon foods of various kinds in unlimited quantity and under otherwise similar conditions. After forty-two days the size of the tadpoles in each lot was measured and the following results were obtained: —

TABLE XXXIII
RESULTS OF FEEDING TADPOLES ON VARIOUS SUBSTANCES

NO. OF VESSEL.	1	2	3	4	5	6
KINDS OF FOOD.	AQUATIC PLANTS: ANACHARIS AND SPIROGYEA.	ALBUMINOUS EGG ENVELOPE OF FROG.	PIECES OF YOLK OF HEN'S EGG.	ALBUMEN OF HEN'S EGG.	PIECES OF FISH FLESH.	PIECES OF BEEF FLESH.
Length of tadpole	18.3	23.2	26.0	33.0	38.0	43.5
Breadth of tadpole	4.2	5.0	5.8	6.6	8.8	9.2

It will be observed that the importance for growth was not proportional to the calorific properties of the respective foods, for the yolk of the hen's egg has about 40% higher fuel value than dry egg albumen or dry flesh. The least growth occurred with a plant food which is relatively rich in carbohydrates, and has some protein and little fat; the third greatest growth occurred with the yolk, which has more fat than protein; next comes egg albumen, with more protein than fat; and, finally, fish and beef flesh, characterized by their high percentage of nitrogenous matter. The tadpole grows fastest on a highly nitrogenous diet.

Additional experiments upon the frog's egg have been made by DANILEWSKY ('95), who found that such eggs placed in water containing $\frac{1}{15000}$ of lecithin gained in 54 days 300% greater weight than those reared in pure water. The author believes, however, that this small quantity cannot act in a directly nutritive manner but, rather, that it favors in some way the assimilation of food.

Mammals. — The requirements of agriculture have led to numberless experiments upon the feeding of domesticated mammals. Yet they are for the most part of little value for our purpose. A few of the better class of experiments from our point of view may be given, together with such conclusions as they permit.

Years ago, LAWES and GILBERT ('53), from extensive feedings of sheep and pigs, upon diverse foods, reached the conclusion that those "apparently *grew* more where, with no deficiency of other matters, the nitrogenous constituents were very liberally supplied. Hence, the gross increase obtained might be somewhat more nitrogenous with the large supply of nitrogenous food; but it would in that case, according to some experiments of our own, contain a larger proportion of water, and less of solid matter, than where more fat had been produced." More recent studies made on various domesticated animals tend to confirm these results. A mixed diet with an abundance of nitrogenous food permits of greater growth than an equal quantity of food of one kind, or mixed food in which the nitrogenous constituent is scant. Growth tends to increase with the quantity of nitrogenous food rather more closely than with that of the non-nitrogenous food devoured.

This conclusion is sustained by the striking results gained by PRÖSHER ('97) in investigating the cause of the varying percentage rate of growth of different mammals. The relation between growth and the percentage of the different organic and certain mineral constituents of milk is given in the following table: —

TABLE XXXIV

SHOWING FOR VARIOUS MAMMALS THE TIME REQUIRED TO DOUBLE THE BIRTH-WEIGHT, THE PERCENTAGE OF DIFFERENT ORGANIC CONSTITUENTS IN THE MILK, AND THE RELATIVE QUANTITY OF ALBUMEN, CALCIUM OXIDE, AND PHOSPHORIC ACID IN THE MILK OF THE DIFFERENT SPECIES—THE QUANTITY IN MAN BEING TAKEN AS THE STANDARD

1	2	3	4	5	6	7	8
SPECIES.	RELATIVE TIME TO DOUBLE WEIGHT.	% FAT.	% SUGAR.	% ALBUMEN.	RELATIVE QUANTITY ALBUMEN.	RELATIVE QUANTITY CaO.	RELATIVE QUANTITY P ₂ O ₅ .
Man	1	3.5	6.6	1.9	1.0	1	1
Horse	$\frac{1}{3}$	1.1	6.1	2.3	1.2	4	3
Ox	$\frac{1}{4}$	4.5	4.5	4.0	2.2	5	4
Pig	$\frac{1}{10}$	6.9	2.0	6.9	3.7	—	—
Sheep	$\frac{1}{18}$	10.4	4.2	7.0	3.8	8	9
Dog	$\frac{1}{22}$	10.6	3.1	8.3	4.45	14	10
Cat	$\frac{1}{38}$	3.3	4.9	9.5	5.1	—	—

From this table it is clear that there is a close relation between rate of growth and the percentage of albumen only among the organic substances of milk. This relation is best brought out by comparing columns 2 and 5. The last two columns show a close relation between growth and the quantity of calcium and phosphorus in the milk. But of the organic substances the quantity of the nitrogenous compound determines the rate of growth.

3. **Growth as a Response to Stimuli.**—Hitherto we have regarded the process of growth in too mechanical a way, as though certain nutritive compounds, passing into a chemical mill, were inevitably transformed, at a certain rate, into protoplasm or formed substance. We have now to recognize that the growth processes are essentially vital processes, and, as such, characterized by all that complexity which we find in such a vital process as response to stimuli.

a. Acceleration of Growth by Chemical Stimulants.—Many chemical agents which are not themselves food may stimulate the growth processes. We have already seen (p. 51) how certain poisons cause, in dilute solutions, accelerated move-

ments and heightened metabolism. To the cases previously given may be added the experiments of SCHULZ ('88), who found that various poisons, such as corrosive sublimate, iodine, bromine, and arsenious acid, increase the activities of yeast in fermentation. It is not strange, therefore, to find that poisons may, at a certain concentration, accelerate growth. That they do so follows from the experiments of RICHARDS ('97), who reared the molds *Aspergillus*, *Penicillium*, and *Botrytis* in nutritive solutions to which had been added small quantities of zinc sulphate, other metallic salts, cocaine, morphine, and other alkaloids. After five to seven days *Aspergillus*, reared in nutritive solutions in which sugar was the organic compound, had gained the following dry weights (in milligrammes). In all the experiments, except those in the column headed "Control," the solution contained certain non-nutritious substances in from 0.002% to 0.033% concentration.

TABLE XXXV

SHOWING THE TOTAL DRY WEIGHT IN MILLIGRAMMES OF A CROP OF ASPERGILLUS REARED IN THE ABSENCE AND IN THE PRESENCE OF VARYING QUANTITIES OF IRRITATING SUBSTANCES

SUBSTANCE.	CONTROL.	0.002%	0.004%	0.008%	0.016%	0.033%
ZnSO ₄	335	730	760	765	770	715
NaFl	250	565	405	340	270	245
Na ₂ SiO ₃	350	520	575	450	435	380
CoSO ₄	245	405	350	235	170	75
Cocaine	280	410	320	350	390	540
Morphine	160	155	170	140	210	215

It is clear from this table that the addition of even small quantities of innutritious and poisonous substances may so excite the hygienic processes as to cause twice or even far more than twice the normal formation of dry substance in a given time, and that this excessive growth increases with the concentration of the salt up to a certain optimum, beyond which growth declines again to below the normal. Similarly TOWNSEND ('97) has observed that a seedling living under a bell jar whose atmosphere contains a small quantity of ether grows

faster than one under similar conditions but without ether. If the plant is subjected to an increased quantity of ether, growth is retarded. The effect of these poisons is thus very different from that of nutritive substances; it is due to the irritating properties of the poison.

b. *The Election of Organic Food.*—Not all of the food-stuff presented to the organism is utilized by it—neither, on the one hand, all of the kinds of food, nor, on the other, all of the food of the most acceptable kind if offered beyond a certain amount. There is an election of kind and of amount. A study of an election of kind has been made by DUCLAUX ('89), and, especially, PFEFFER ('95). The method employed was this: To the organisms (various molds, *Aspergillus*, *Penicillium*, etc.) were offered two compounds; one more nutritious, the other less so. Under these circumstances, the more nutritious compound was usually taken by the organism, while the less nutritious was often left entirely alone; thus, dextrose was preferred to glycerine, peptone to glycerine, and dextrose to lactic acid, even when, in each case, the quantity of the latter substance was in excess of the former. The election was not, however, always of the more nutritious material, so far as we can judge of relative nutritiveness. Thus, when *Aspergillus* was sown on a nutritive fluid, containing 8% dextrose and 1% acetic acid, proportionally far more of the latter was assimilated than of the former, although the latter is of less value as food, as was shown by the fact that the plant had also to devour a considerable quantity of the dextrose. This extensive assimilation of a slightly nutritive substance is not, so far as we can see, an adaptive process.

The character of the election may change with age, so that what is favorable for growth at one time is not at another. Thus DUCLAUX ('89) found that alcohol restrains or arrests the germination of the spores of molds, whereas it is made use of almost as abundantly as sugar by the adult plant; so, likewise, lactose and mannit cannot nourish young plants when they replace sugar in the nutritive solution, whereas they are a good food for the older plants.

So, also, among vertebrates, the food of the young, supplied in the egg or in the milk of the parent, is very unlike that

which is most favorable for growth in later stages. So important is this difference of food at different ages that agriculturists persistently change the ratio of the different foods supplied as their animals increase in age. The reason for this change in food required lies doubtless in this, that the chemical processes of growth change with the age of the animal; at first imbibition of water predominates, then comes the secretion of the various formed substances of the organism and the constant maintenance and increase of the plasma. The most favorable food of an organism at any time is dependent upon the metabolic processes going on at that time.

The election of quantity is not less striking. It is well known that an increase above a certain limit in the amount of food presented to an organism or even actually taken into its body does not result in any increase in growth. There is a certain amount, fixed within broad limits, which corresponds to a maximum of nutritiveness. This amount, this feeding capacity, is not, however, necessarily constant at all stages of the adult growth of the organism. For it has been observed in certain animals, *e.g.* pigs, that as they grow older there is a steady increase in the amount of food required to produce a pound of gain in weight. Such facts serve to indicate that the rate of growth is largely determined by internal factors.

Let us now summarize the results of this study of the effect of chemical agents upon the rate of growth. Of foods, those used in the plastic processes are chiefly to be considered. The substances serving as plastic food must contain all the elements normally occurring in the organism. These are found in diverse proportions in different organisms, and hence the necessity of dissimilar foods. Not only carbon, oxygen, hydrogen, and nitrogen are necessary, but a whole series of other elements, such as phosphorus, sulphur, chlorine, iodine, sodium, potassium, calcium, iron, and magnesium are more or less essential. The organic plastic food varies with the group of organisms. Of relatively little importance for green plants, it becomes essential to fungi. In this group we find the most important character of a nutritive substance to be a certain degree of lability. Among animals a mixed diet is especially beneficial, but nitrogenous food favors growth more than non-nitrogenous

food. Finally, growth must be studied as a response to chemical agents which may stimulate the protoplasm to absorb and assimilate them to the degree required by the organism, or which may stimulate the protoplasm to absorb some other substances, as we have seen in the case of zinc sulphate. The quantity and quality of food needed will, moreover, vary with the age and other qualities of the organism. The consumption of food both in quantity and in quality will be closely determined by the demand. All these complexities in the process of nutrition indicate that it, like other processes in organisms, can only be explained on the assumption of a vastly complex molecular organization of the protoplasm.

§ 2. EFFECT OF CHEMICAL AGENTS UPON THE DIRECTION OF GROWTH — CHEMOTROPISM

One of the most common processes in the early development of organisms is the turning or bending of a filament, tubule, or lamella. The cause of this turning is clearly an unequal growth of the two sides of the organ. When the bending organs are internal, their movements are largely removed from experimental study; when external, as in plants, they more easily lend themselves to our investigation. The object of this investigation is always to find in how far the direction of these tropic movements is determined or is determinable by external agents.

In the present section it is proposed to consider in how far tropic movements are determined by chemical agents. At the outset it must be said that the growth which gives rise to these bendings is frequently due to imbibition of water; and in such cases it may be only temporary. Yet these temporary bendings pass by such insensible gradations into permanent ones that a sharp distinction between the two is impracticable and unimportant. Rejecting such a classification of the subject, we may adopt one based on the tropic organ.

1. **Chemotropism in the Tentacles of Insectivorous Plants.** — This case of chemotropism was the earliest to be observed; it was DARWIN ('75, p. 76) who first called attention to it. He found that when drops of water or solutions of non-nitrogenous

compounds are placed upon the leaves of the sundew, *Drosera*, the tentacles remain uninflected; but when a drop of a nitrogenous fluid, such as milk, urine, albumen, infusion of raw meat, saliva, or isinglass, is placed on the leaf, the tentacles quickly bend inwards over the drop. DARWIN now set to work systematically to determine which salts and acids cause and which do not cause inflection. Of nine salts of ammonia tried, all caused inflection of the tentacles, and of these the phosphate of ammonia was the most powerful. Sodium salts in general cause inflection while potassium salts do not. The earthy salts are in general inoperative, as are likewise those of lead, manganese, and cobalt. The more or less poisonous salts of silver, mercury, gold, copper, nickel, platinum, and chromic and arsenious acids produce great inflection with extreme quickness. Other substances which caused inflection were nitric, hydrochloric, iodic, sulphuric, phosphoric, boracic, and many organic acids; gallic, tannic, tartaric, citric, and uric acids alone being inoperative. In all these cases, where a bending of the tentacles over the drop occurs, the turning must be regarded as a response to the stimulus of the chemical substance. An excitation proceeds from the irritated region to the protoplasm upon whose imbibitory activity the turning of the tentacles depends.

2. **Chemotropism of Roots.** — Attention was directed to the fact that roots turn towards or from chemical substances by MOLISCH ('84), who experimented with gases. When grains of maize or peas are sprouted in water, their roots will turn

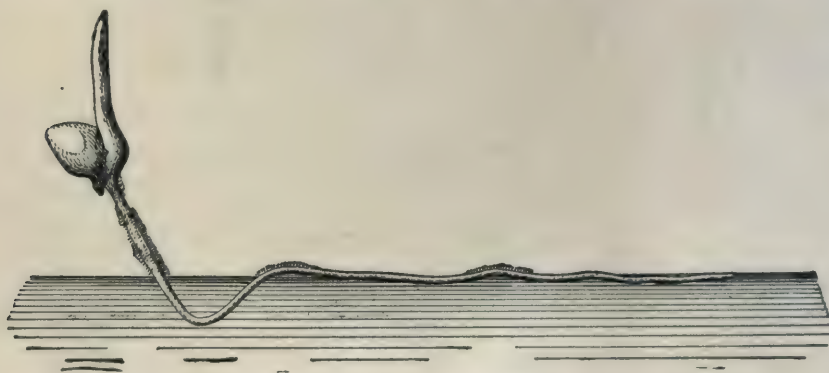

FIG. 91. — Seedling of *Zea*, whose radicle originally was just touching the water obliquely with its apex and thereafter nutated in characteristic fashion, keeping close to the air. (From MOLISCH, '84.)

upwards towards the surface of the water — in response to the more abundant oxygen supply there (Fig. 91), and will grow along the surface of the water. MOLISCH undertook a systematic investigation of the action of various gases in controlling this growth.

The method employed was as follows: The gases were enclosed in glass vessels whose mouth was closed by a plate of hard rubber perforated by slits, 2 cm. long by 2 mm. broad. The vessel being laid on its side so that the slits were vertical, the rootlet of a germinating grain was placed in front of it. As the gas diffused from the vessel, it was for some time in excess upon one side of the rootlet. The gases experimented with were pure oxygen, pyrogallic acid, nitrogen, carbon dioxide, chlorine, hydrochloric acid gas, illuminating gas, ammonia, nitrous oxide, ether, chloroform, and oil of turpentine.

In all cases there occurred, generally after about an hour, a turning of the root towards the gas (positive aërotropism, MOLISCH), followed by a marked curvature from the slit (negative aërotropism). Since decapitated roots respond in the same way as intact ones, but in less degree, MOLISCH concluded that the gases affect the growing region directly and do not require the intervention of the root-tip.

3. **Chemotropism of Pollen-tubes.**—The suggestion was early made by PFEFFER ('83), as a consequence of his discovery of chemotaxis in swarm-spores, that perhaps the bending of the antheridium-tube of *Saprolegnia* towards the oögonium was a case of response to a chemical agent. STRASBURGER ('86) offered a similar suggestion for phanerogams. PFEFFER ('88) then made experiments, but was unable to control the direction of growth of pollen-tubes. MOLISCH ('89 and '93) was next led to undertake further study in this direction by the observation that, when various pollen-grains are germinating in a nutritive drop and a cover-glass is placed over them, the pollen-tubes, after approaching near to the edge of the cover-glass, turn away towards the centre again (Fig. 92, *a, b*). The movement from the margin of the cover-glass cannot be ascribed to a difference of density produced by evaporation at the margin, for it occurred in a saturated atmosphere; nor can it be due to surface tension of the bounding film of water, for the turning occurred before the surface film was reached. These results

were abundantly confirmed by MIYOSHI ('94^a), so we must conclude that the pollen tube is negatively aerotropic to oxygen. However, this negative aërotropism does not occur in all pollen, for that of *Orobus vernus* and various other legumes, of *Primula acaulis*, *Viola odorata*, *V. hirta*, etc., were indifferent.

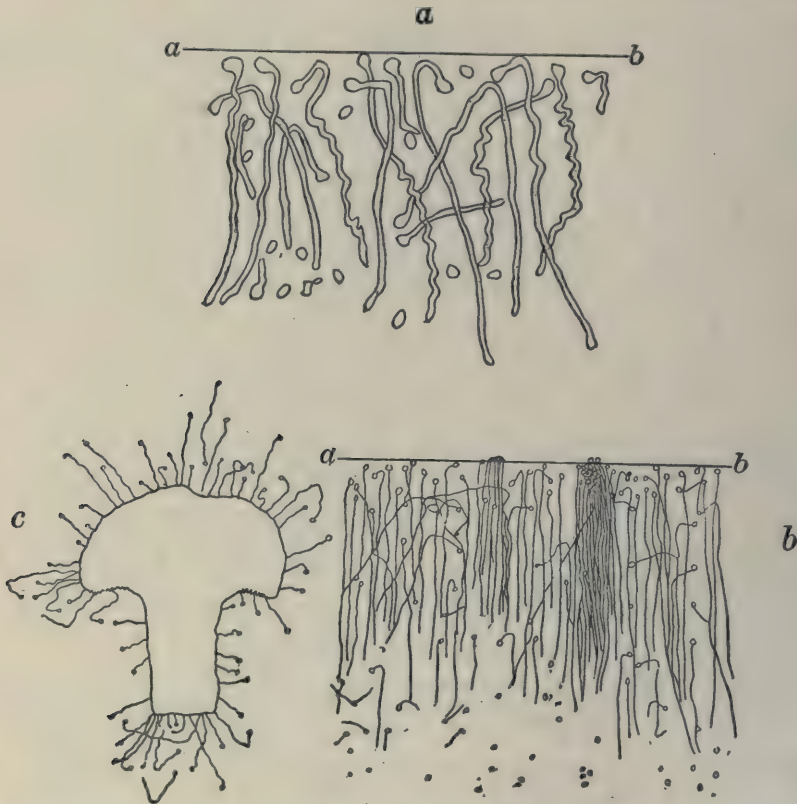

FIG. 92. — Illustrates chemotropism of pollen-tubes. *a*. Negative chemotropism with reference to the air (aërotropism) of pollen-tubes of *Narcissus tazetta*; the tubes are growing under a cover-glass in a 7% sugar solution and turn at the edge, *a*, *b*, from the air; magnified about 20. *b*. Negative aërotropism of pollen-tubes of *Cephalanthera pallens*, after 20 hours; *a*, *b*, edge of cover-glass. *c*. Stigma of *Narcissus tazetta* in 7% sugar solution; pollen-tubes grow towards the stigma; magnified about 10. (From MOLISCH, '93).

A second class of chemotropisms is seen in the turning of pollen-tubes towards the stigma of a flower.* When pollen is sown upon a plate of agar-agar or gelatine on which the upper end of a ripe pistil has been placed, the tubes are sent out in

* MOLISCH accounts for the failure of some of the earlier experiments with pollen-tubes on the ground that certain pollen-tubes do not exhibit this class of chemotropism. Among these are *Viola odorata*, *V. hirta*, *Orobus vernus*, etc. — species which are likewise not aërotropic.

all directions at first, but quickly grow towards the pistil (Fig. 92, *e*).—MIYOSHI ('94^a) found that the top of the pistil was most attractive and that lower sections were less so until the ovary is nearly reached, when the attraction is high again. If the ovules of *Scilla* are placed on the plate of agar with its own pollen, the pollen-tube will even grow into the micropyle of the ovule. Pollen-tubes of a different species or even genus, *e.g.* *Diervilla rosea*, *Ranunculus acer*, etc., may likewise enter the *Scilla* ovule, and even hyphæ of *Mucor stolonifer* will turn towards the ovules and penetrate into them. Thus the attracting stuff is not a specific stimulant confined in its activity to one kind of pollen-tube nor even to pollen-tubes in general.

The nature of the attracting substance has been studied by MIYOSHI. Glucose is certainly present in the fluid excreted by the ripe stigma of many phanerogams; and, if the agar-agar substratum contain a 2% solution of cane sugar, there is no longer chemotropism with reference to the ovule, since now the attraction is not confined to a particular point. So it may be concluded that it is the sugar of the ovule or stigma which attracts the pollen-tube and that the excreted fluid contains about a 2% solution. Consequently, the chemotropism of pollen-tubes may be only a special case of chemotropism to sugar.

Further experimentation confirmed MIYOSHI ('94) in this conclusion. Using the method employed by him in the case of hyphæ (p. 340), he injected *Tradescantia* leaves with various solutions and sowed pollen of *Digitalis purpurea* upon the leaves. When pure water was injected there was no effect, but the substances named in the following list attracted the pollen-tubes so that they grew down through the stomata into the leaf:—

cane sugar	2-8%	levulose	1% (slight action)
grape sugar,	4-8%	lactose	1-2% ("slight")
dextrin	1-2%		

The following solutions were neutral:—

maltose	1%	asparagin	2%
meat extract		glycerine	2-5%
peptone		gum arabic	2%

The following were repellent:—

alcohol	0.1%	potassium sulphate .	1%
ammonium sulphate,	1%	sodium malate .	0.5–2%

It will be observed that all the attracting substances are sugars.

4. **Chemotropism of Hyphæ.**—While various authors had noticed an apparent movement of hyphæ towards certain chemical agents or towards their hosts, the earliest systematic observations upon this subject are those of WORTMANN ('87). He placed fly-legs and other nutritive substances in *Saprolegnia* cultures and noticed that the hyphæ left their original direc-

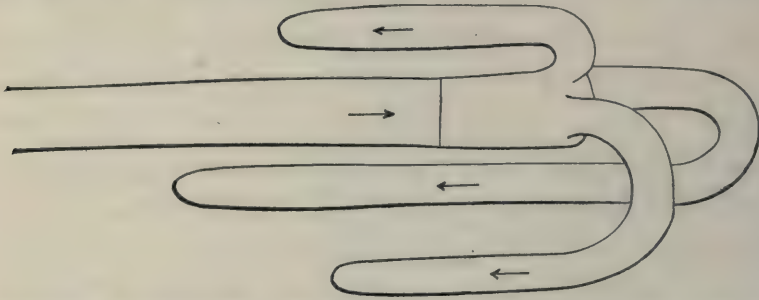

FIG. 93.—Negative chemotropism of a hypha of *Peziza trifoliorum* from the secretions of a mycelium of *Aspergillus niger*. (From REINHARDT, '92.)

tions to grow straight towards the food substance. Later REINHARDT ('92) showed that hyphæ of *Peziza* may be lured out of their straight direction by spores of *Mucor* placed near them; or, again, if a plate of gelatine rich in sugar be placed above a plate of pure gelatine upon which hyphæ of *Peziza* are growing, all hyphæ will send up branches to meet the more nutritive surface; or, again, if *Aspergillus niger*, whose secretions are fatal to *Peziza*, is placed near the latter, the hyphæ cease to grow at a distance of about 2 mm. from the *Aspergillus* and then send out shoots which grow away from the injurious substance (Fig. 93).

The most exhaustive studies on this subject are, however, those of MIYOSHI ('94), who worked with germinating spores of *Mucor mucedo* and *M. stolonifer*, *Phycomyces nitens*, *Penicillium glaucum*, *Aspergillus niger*, and *Saprolegnia ferox*. Perforated membranes were employed, either in the form of plant epidermis with stomata or of collodion films perforated

by a fine needle point. The solutions were injected into the leaf of *Tradescantia*, spores were sown upon its stoma-bearing surface, and the whole was kept in a moist chamber. If the solution was attractive, the growing hyphæ penetrated into the stomata, whereas in the absence of the solution they showed no tendency to do so. Similarly, spores sown on the perforated plate sent hyphæ downwards through the holes when the plate was floating on attractive solutions, but not otherwise. Mole-

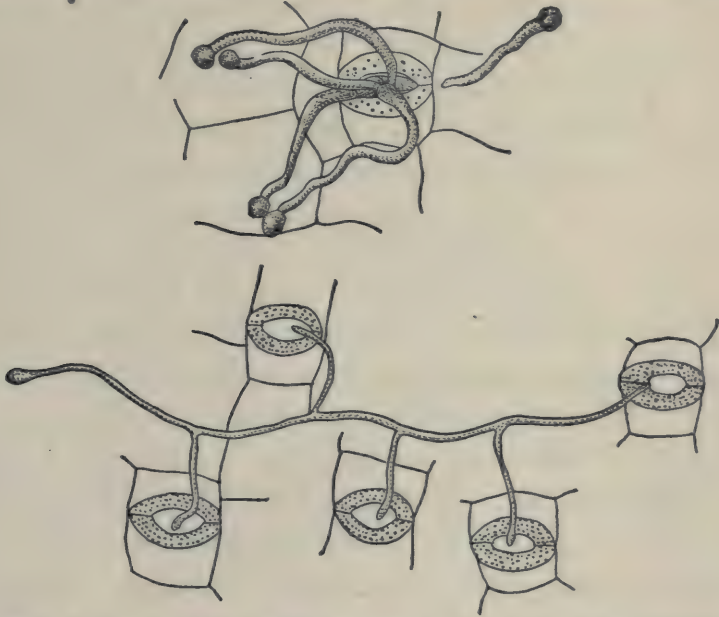

FIG. 94. — *Upper figure*: Piece of the under side of a leaf of *Tradescantia discolor* injected with 2% ammonium chloride, and sown with spores of *Mucor stolonifer*. The young hyphæ show chemotropic turnings, and have eventually penetrated into the stomata. Drawn 27 hours after sowing the spores; magnified 100. *Lower figure*: *Penicillium glaucum* growing on a leaf of *Tradescantia*, which has been injected with a 2% solution of cane sugar. The hyphæ have branched, and the branches have penetrated into the stomata. Drawn 25 hours after sowing the spores; magnified 70. (From MIYOSHI, '94.)

cules diffusing out from the solution through the openings determine the direction of the growing hyphæ, so that from all directions hyphæ grew radially towards the openings in the membranes (Fig. 94).

To prove that the result gained was truly chemotropism, and not something else, a series of experiments was made. That it was not a response to gravity was shown by sowing the spores below as well as on top of a leaf; that it was not a response to light or moisture was shown by keeping the cult-

ures in a dark, moist chamber ; in both cases, the chemotropic responses occurred. That contact was not the determining factor was shown by placing above and below sheets of perforated collodion a layer of 5% gelatine, deprived of calcium salts, which are attractive. One of these layers was fertilized with grape sugar, the other remained sterile. The spores were sown sometimes in the sterile, sometimes in the fertile layer of gelatine ; in the former case, the hyphæ always grew (up or down) into the sterile layer ; in the other case, they remained in the fertile layer. If both gelatine layers were sterile, or if both were equally fertile, the hyphæ did not grow through the holes in the membranes. Not the holes, but the stuff diffusing from them, determined the direction of growth of the hyphæ.

There is a close relation between the chemical constitution of the agents and their effects. The following substances are attractive: compounds of ammonium (ammonium nitrate, chloride, malate, tartrate), phosphates (of potassium, sodium, ammonium), meat extract, peptone, sugar, asparagin, lecithin, etc. The following are neutral: glycerine and gum arabic (1 to 2%). The following are repellent: all free inorganic as well as organic acids, alkalis, alcohol, and certain salts, *e.g.* potassium-sodium tartrate, potassium nitrate, calcium nitrate, potassium chloride (2%), potassium chlorate (8%), magnesium sulphate, sodium chloride (2%), ferric chloride (0.1%), phosphoric acid, etc. Comparing this list with that which PFEFFER and STANGE tried on swarm-spores (Pt. I, pp. 36-38), we find that there is a rather close correlation. In both cases, glycerine (a good food) is neutral, alcohol repellent, phosphates attractive. As in the reaction of swarm-spores, so in those of hyphæ, WEBER'S law is followed.

5. Chemotropism of Conjugation Tubes in Spirogyra. — This case is closely allied to chemotropism of pollen-tubes. Attention was first called to it by OVERTON ('88), who observed that at the point where the tubes were about to arise bacteria accumulated from the surrounding water. From this phenomenon, and on other grounds, he was led to conclude that a substance is excreted at this point which exercises a directive influence upon the conjugation tubes, insuring their meeting. This conclusion has been confirmed by HABERLAND

('90), who finds additional evidence for it in the character of the turnings which the two tubes from the opposite cells undergo in order successfully to impinge upon each other.

The results of experimentation upon chemotropism show that various substances may direct the growth of such elongated organs as the tendrils, roots, and hyphæ of plants; so that greater growth takes place on the side turned from the region of greatest concentration or towards it, as the case may be. In many instances it can be shown that the direction of growth is on the whole an advantageous one for the organism — so that the directed growth may be considered an adaptive one. In other cases, however, the response seems to have no relation to adaptation.

If that which controls direction is the unequal concentration of chemical agents in the medium, the immediate cause is excessive growth on one side, due to excessive imbibition or to excessive assimilative activity. The relation between these causes is doubtless complicated. The chemical agent acts upon the protoplasm, changing its molecular structure; the changed protoplasm exhibits changed growth activities. Thus we say the chemical agents act as stimuli.

LITERATURE

- AEBY, J. H. '96. Beitrag zur Frage der Stickstoffernährung der Pflanzen. Landwirthsch. Versuchs-Stat. XLVI, 409-439.
- ASCHOFF, C. '90. Ueber die Bedeutung des Chlors in der Pflanze. Landw. Jahrbücher. XVIII, 113-141.
- BÄSSLER, P. '87. Die Assimilation des Asparagins durch die Pflanze. Landwirthsch. Versuchs-Stat. XXXIII, 231-240.
- BAUMANN, E. '95. Ueber das normale Vorkommen von Jod im Thierkörper. (I. Mitth.) Zeitschr. f. physiol. Chemie. XXI, 319-330. 28 Dec. 1895.
- BAUMANN, E. and ROOS, E. '96. Idem (II. Mitth.), ibidem. XXI, 481-493. 2 Apr. 1896.
- BAUMANN, E. '96. Idem (III. Mitth.), ibidem. XXII, 1-15. 16 May, 1896.
- BENECKE, W. '95. Die zur Ernährung der Schimmelpilze nothwendigen Metalle. Jahrb. f. wiss. Bot. XXVIII, 487-530.
- '96. Die Bedeutung des Kaliums und des Magnesiums für Entwicklung und Wachsthum des *Aspergillus niger* v. Th., sowie Einiger anderer Pilzformen. Bot. Ztg. LIV.

- BERTHELOT, '85. Fixation directe de l'azote atmosphérique libre par certains terrains argileux. *Comp. Rend.* CI, 775-784. 26 Oct. 1885.
- '92. Nouvelles recherches sur la fixation de l'azote atmosphérique par les microbes. *Comp. Rend.* CXV, 569-574. 24 Oct. 1892.
- '93. Recherches nouvelles sur les microorganismes fixateurs de l'azote. *Comp. Rend.* CXVI, 842-849. 24 Apr. 1893.
- BERT, P. '78. La pression barométrique. *Recherches de physiologie expérimentale.* 1168 pp. Paris, 1878.
- BEYERINCK, M. W. '93. Bericht über meine Kulturen niederer Algen auf Nährgelatine. *Centralbl. f. Bakteriologie u. Parasitenkunde.* XIII, 368-373. 23 Mar. 1893.
- '96. Kulturversuche mit Amöben auf festem Substrate. *Centralbl. f. Bakteriologie u. Parasitenkunde.* XIX, 257-267. 28 Feb. 1896.
- BEZOLD, A. VON '57. (See Chapter I, Literature.)
- BOKORNY, T. '97. Ueber die organische Ernährung grüner Pflanzen und ihre Bedeutung in der Natur. *Biol. Centralbl.* XVII, 1-20; 33-48. Jan. 1897.
- BOUSSINGAULT, J. B. J. D. '60. *Agronomie, chimie agricole et physiologie.* 2 tomes. Paris, Mallet-Machelie, 1860.
- BRANDL, J., and TAPPEIMER, H. '92. Ueber die Ablagerung von Fluorverbindungen im Organismus nach Fütterung mit Fluornatrium. *Ztschr. f. Biol.* XXVIII, 518-539.
- BUNGE, G. '73. Ueber die Bedeutung des Kochsalzes und des Verhalten der Kalisalze im menschlichen Organismus. *Ztschr. f. Biol.* IX, 104-143.
- '74. Der Kali-, Natron-, und Chlorgehalt der Milch, verglichen mit dem anderer Nahrungsmittel und das Gesamt-Organismus der Säugethiere. *Ztschr. f. Biol.* X, 295-335.
- '85. Ueber die Assimilation des Eisens. *Ztschr. f. physiol. Chem.* IX, 49-59.
- '89. Ueber die Aufnahme des Eisens in den Organismus des Sauglings. *Ztschr. f. physiol. Chem.* XIII, 399-406.
- CELLI, A. '96. Die Kultur der Amöben auf festem Substrate. *Centralbl. f. Bakteriologie.* XIX, 536-538. 25 Apr. 1896.
- COPELAND, E. B. '97. The Relation of Nutrient Salts to Turgor. *Bot. Gazette.* XXIV, 399-416. Dec. 1897.
- COOK, G. H. '68. *Geology of New Jersey.* Newark, 1868.
- CRIVELLI, G. B. and MAGGI, L. '70. Sulla produzione delle Amibe. *Rend. R. Inst. Lombardo.* (2), III, 367-375. Plate.
- '91. Ancora sulla produzione delle Amibe. *Ibidem.* (2), IV, 198-203.
- DANILEWSKY, B. '95. De l'influence de la lécithine sur la croissance et la multiplication des organismes. *Comp. Rend.* CXXI, 1167-1170. 30 Dec. 1895.
- '96. De l'influence de la lécithine sur la croissance des animaux à sang chaud. *Comp. Rend.* CXXIII, 195-198. 20 July, 1896.
- DARWIN, C. '75. *Insectivorous Plants.* London: Murray. 462 pp. 1875.
- DAY, T. C. '94. The Non-Assimilation of Atmospheric Nitrogen by Germinating Barley. *Trans. and Proc. Bot. Soc. Edinburgh.* XX, 29-34.

- DUCLAUX, E. '89. Sur la nutrition intracellulaire. Ann. de l'Inst. Pasteur. III, 97-112. March, 1889.
- ESCHLE '97. Ueber den Jodgehalt einiger Algenarten. Zeitschr. f. physiol. Chemie. XXIII, 30-37. 27 Mar. 1897.
- FORCHHAMMER, G. '61. Resultater af sine Undersogelser, saavel over Saltmængden i Middelhavets Vand. Overs. K. danske Vidensk Selskabs Forhandl. Aaret. 1861. 379-391.
- FRANK, A. B. '88. Die Ernährung der Pflanzen mit Stickstoff. Berlin, 1888.
- '92. Lehrbuch der Botanik, I. 669 pp. Leipzig: ENGELMANN.
- '93. Die Assimilation des freien Stickstoffs durch die Pflanzenwelt. Bot. Ztg. LI, 139-156.
- FREDERICQ, L. '78. Sur l'organisation et la physiologie du Poulpe. Bull. de l'Acad. roy. de Belg. XLVI, 710-765.
- '79. Note sur le sang du Homard. Ibid. XLVII, 409-413.
- GORINI, C. '96. Die Kultur der Amöben auf festem Substrate. Centralbl. f. Bakteriöl. XIX, 785.
- HABERLAND, G. '90. Zur Kenntniss der Conjugation bei *Spirogyra*. Sitzungsber. d. Akad. d. wiss. Wien. Math.-Nat. Cl. XCIX¹, 390-400. 1 Tafel.
- HANSTEEN, B. '96. Beiträge zur Kenntniss der Eiweissbildung und der Bedingungen der Realisirung dieses Processes im phanerogamen Pflanzenkörper. Ber. deutsch bot. Ges. XIV, 362-371. 28 Dec. 1896.
- HARTIG, R. and WEBER, R. '88. Das Holz der Rotbuche. Berlin, 1888. [Quoted from LOEW, '91, p. 270.]
- HELLRIEGEL, H. '86. Welche Stickstoffquellen stehen der Pflanze zu Gebote? Tageblatt des 59. Versammlung, Deutscher Naturforscher und Aerzte. Berlin, 1886. p. 290.
- HENSEN, V. and APSTEEN, C. '97. Die Nordsee-Expedition, 1895, des Deutschen Seefischerei-Vereins. Ueber die Eimenge der im Winter laichenden Fische. Wiss. Meeresuntersuchungen, herausgegeben von der Kommission zur wiss. Unters. d. deutschen Meere in Keil, N. F. Band II, Heft. 2, pp. 1-98.
- HERBST, C. '97. Ueber die zur Entwicklung der Seeigellarven nothwendigen anorganischen Stoffe, ihre Rolle und ihre Vertretbarkeit, I. Theil. Die zur Entwicklung nothwendigen anorganischen Stoffe. Arch. f. Entwicklungsmechanik d. Organismen. V. 649-793. Taf. XII-XIV. 9 Nov. 1897.
- HERAEUS '86. Zeitschr. f. Hygiene. I.
- HOPPE-SEYLER, F. '81. Physiologische Chemie. Berlin, 1881.
- HOTTER, E. '90. Ueber das Vorkommen des Bor im Pflanzenreich und dessen physiologische Bedeutung. Landw. Versuchs-Station. XXXVII, 437-458. 1890.
- JACCARD, P. '93. Influence de la pression des gaz sur le développement des vegetaux. Comp. Rend. CXVI, 830-833. 17 April, 1893.
- JENTYS, S. '88. Ueber den Einfluss hoher Sauerstoffpressungen auf das Wachsthum der Pflanzen. Unters. a. d. bot. Inst. Tübingen. II. 419-464.

- JOHNSON, S. W. '68. How Crops grow. 394 pp. New York.
- JORDAN, E. O. and RICHARDS, E. '91. Investigations upon Nitrification and the Nitrifying Organism. From Report, Mass. State Board of Health, Water Supply, and Sewage. Part II. pp. 865-881. [Dated 1890.]
- KEMMERICH, E. '69. Untersuchungen über die physiologische Wirkung der Fleischbrühe, des Fleischextracts und der Kalisalze des Fleisches. Arch. f. d. ges. Physiol. II, 49-93.
- KOCH, A. and KOSSOWITSCH, P. '93. Ueber die Assimilation von freiem Stickstoff durch Algen. Bot. Ztg. LI, 321-325. Nov. 1, 1893.
- KOSSOWITSCH, P. '94. Untersuchungen über die Frage, ob die Algen freien Stickstoff fixiren. Bot. Ztg. LII, 97-116. 16 May, 1894.
- KRUKENBERG, C. F. W. '80. (See Chapter II, Literature.)
- '78. Mangan ohne nachweisbare Mengen von Eisen in der concretionen aus dem Bojanus'schen Organe im Pinna squamosa Gm. Unters. Physiol. Inst. Univ. Heidelberg. II, 287-289.
- KUNKEL, A. J. '91. Zur Frage der Eisenresorption. Arch. f. d. ges. Physiol. L, 1-24. 25 June, 1891.
- '95. Blutbildung aus anorganischen Eisen. Arch. f. d. ges. Physiol. LXI, 595-606. 25 Sept. 1895.
- LAURENT, E. '88. Sur la formation d'amidon dans les plantes. Bruxelles, 1885.
- LAWES, J. B. and GILBERT, J. H. '53. On the Composition of Foods, in Relation to Respiration and the Feeding of Animals. Rept. 22d Meet. British Ass. Adv. Sci. for 1852, 323-353.
- LAWES, J. B., GILBERT, J. H. and PUGH, E. '61. On the Sources of the Nitrogen of Vegetation, with Special Reference to the Question whether Plants assimilate Free or Uncombined Nitrogen. Philos. Trans. Roy. Soc. London. CLI, 431-577.
- LIESCHER '93. Beitrag zur Stickstofffrage. Jour. f. Landwirtschaft. XLI. [not seen.]
- LOEB, J. '92. (See Chapter X, Literature.)
- LOEW, O. '91. Die chemische Verhältnisse des Bakterienlebens. Centralbl. f. Bakteriol. IX, 659-663.
- '91^a. Ueber die physiologischen Functionen der Phosphorsäure. Biol. Centralbl. XI, 269-281. 1 June, 1891.
- '96. The Energy of the Living Substance. 116 pp. London. 1896.
- LOEW, O. and BOKORNY, T. '87. Chemisch-physiologische Studien über Algen. Jour. f. prakt. Chem. XXXVI, 272-291.
- LÜPKE, R. '89. Ueber die Bedeutung des Kaliums in der Pflanze. Landw. Jahrb. XVII, 887-913.
- MACALLUM, A. B. '91. On the Demonstration of the Presence of Iron in Chromatin by Micro-chemical Methods (Abstract). Proc. Roy. Soc. XLIX, 488-489. July 10, 1891.
- '92. Idem. Proc. Roy. Soc. XL, 277-286. Jan. 20, 1892.
- '94. On the Absorption of Iron in the Animal Body. Jour. of Physiol. XVI, 268-297. 17 April, 1894.

- MEYER, A. '85. Ueber die Assimilations-producte der Laubblätter angiospermer Pflanzen. Bot. Ztg. XLIII, 417 et seq.
- MIYOSHI, C. '94. Ueber Chemotropismus der Pilze. Bot. Ztg. LII, 1-27. 1 Taf.
- '94^a. Ueber Reizbewegungen der Pollenschläuche. Flora. LXXVIII, 76-93. 24 Jan. 1894.
- MOLISCH, H. '84. Ueber die Ablenkung der Wurzeln von ihrer normalen Wachstumsrichtung durch Gase (Aërotropismus). Sb. k. Akad. d. Wiss. Wien. XC¹, 111-191.
- '89. Ueber die Ursachen der Wachstumsrichtungen bei Pollenschläuchen. Sitzungsanzeiger k. Akad. Wiss. Wien. 1889, No. II.
- '92. Die Pflanze in ihren Beziehungen zum Eisen. Jena, 1892.
- '93. Zur Physiologie des Pollens, mit besonderer Rücksicht auf die chemotropischen Bewegungen der Pollenschläuche. Sb. k. Akad. d. Wiss. Wien. CII¹, 423-448.
- '94^a. Ueber Chemotropismus der Pilze. Bot. Ztg. LII¹, 1-27.
- '94^b. Ueber Reizbewegung der Pollenschläuche. Flora. LXXVIII, 76-93. 24 Feb. 1894.
- '94^c. Die mineralische Nahrung der niederen Pilze. Sb. Wien. Akad. CIII¹, 554-574.
- '95. Die Ernährung der Algen. Süßwasser Algen. I. Abhandl. Sb. Akad. Wiss. Wien. CIV¹, 783-800.
- '96. The same. II. Abhandlung. Sb. Akad. Wiss. Wien. CV¹, pp. 633-648.
- MONTI, R. '95. Sur les cultures des amibes. Arch. Ital. de Biol. XXIV, 174-176.
- NÄGELI, K. v. [with Loew, O.]. '80. Ernährung der niederen Pilze durch Kohlenstoff- und Stickstoffverbindungen. Sb. München Akad. X, 277-367.
- NENCKI, M. '94. Note sur les prétendues cendres des corps albuminoïdes. Arch. des sci. biol. St. Petersburg. III, 212-215.
- NENCKI, M. and SCHOUKOW-SIMANOWSKY, E. O. '94. Études sur le chlore et les halogènes dans l'organisme animale. Arch. des sci. biol. St. Petersburg. III, 191-211.
- NOBBE, F., SCHRODER, J. and ERDMANN, R. '71. Ueber die organische Leistung der Kaliums in der Pflanze. Landw. Versuchs-Stat. XIII, 321-399; 401-423.
- NOBBE, F. and HILTNER, L. '95. Vermögen auch Nichtleguminosen freier Stickstoff aufzunehmen? Landw. Versuchs-Stat. XLV. 155-159.
- OGATA, M. '93. Ueber die Reinkultur gewisser Protozoen (Infusorien). Centralbl. f. Bakteriologie. XIV, 165-169. 7 Aug. 1893.
- OVERTON, C. E. '88. Ueber den Conjugationsvorgang bei Spirogyra. Ber. D. bot. Ges. VI, 68-72.
- PETERMANN, A. '91. Contribution à la question de l'azote. Première note. Mém. cour. et autres mém. de l'acad. Roy. de Belg. Collection in 8vo. XLIV. 23 pp. 1 pl. Jan. 1891.
- '92. Seconde note. Same Mémoires. XLVII, 1-37, 1 pl.

PFEFFER, W. '83. (See Chapter I, Literature.)

'88. Ueber chemotactische Bewegungen von Bakterien, Flagellaten und Volvocineen. *Unters. a. d. bot. Inst. Tübingen*, II. 582-661.

'95. Ueber Election organischer Nährstoffe. *Jahrb. f. wiss. Bot.* XXVIII, 205-268.

PFEIFFER, T. and FRANKE, E. '96. Beitrag zur Frage der Verwertung elementaren Stickstoffs durch den Senf. *Landw. Versuchs-Stat.* XLVI, 117-151. Taf. I.

POLECK, T. '50. Analyse der Asche von Eiweiss und Eigelb der Hühnereier. *Ann. de Physik und Chemie.* LXXVI, 155-161. 7 Feb. 1850.

PRESCH, W. '90. Ueber das Verhalten des Schwefels im Organismus und den Nachweis der unterschweifigen Säure im Menschenharn. *Arch. f. path. Anat. u. Physiol.* CXIX, 148-167. 2 Jan. 1890.

PRÖSCHER '97. Die Beziehungen der Wachsthumsgeschwindigkeit des Säuglings zur Zusammensetzung der Milch bei verschiedenen Säugethieren. *Zeitschr. f. physiol. Chem.* XXIV, 285-302. 22 Dec. 1897.

PURIEWITSCH, K. '95. Ueber die Stickstoffassimilation bei den Schimmelpilzen. *Ber. D. bot. Ges.* XIII, 342-345. 27 Nov. 1895.

RAUBER, A. '84. Ueber den Einfluss der Temperatur, des atmosphärischen Druckes und verschiedener Stoffe auf die Entwicklung thierischer Eier. *Sitzungsber. d. naturf. Gesell. Leipzig.* X, 55-70.

RAULIN, J. '69. Études chimiques sur la végétation. *Ann. des Sci. Nat. (Bot.).* (5), XI, 93-299.

REINHARDT, M. O. '92. Das Wachsthum der Pilzhyphen. *Jahrb. f. wiss. Bot.* XXIII, 479-599.

RICHARDS, H. M. '97. Die Beeinflussung des Wachsthums einiger Pilze durch chemische Reize. *Jahrb. f. wiss. Bot.* XXX, 665-688.

ROOS, E. '96. Ueber die Wirkung der Thyrojodins. *Zeitschr. f. physiol. Chem.* XXII, 16-61. 16 May, 1896.

SACHS, J. v. '87. Vorlesungen über Pflanzenphysiologie. Leipzig, Engelmann.

SCHIMPER, A. F. W. '90. Zur Frage der Assimilation der Mineralsalze durch die grüne Pflanze. *Flora.* LXXIII, 207-261.

SCHLÖSING, T. fils et LAURENT, E. '92. Recherches sur la fixation de l'azote libre par les plantes. *Ann. de l'Inst. Pasteur.* VI, 65-115. Feb. 1892.

'92. Sur la fixation de l'azote libre par les plantes. *Ann. de l'Inst. Pasteur.* VI, 824-840. Dec. 1892.

SCHLÖSING, T., and MÜNTZ, A. '77. Sur la nitrification par les ferments organisés. *Comp. Rend.* LXXXIV, 301-303. 12 Feb. 1877.

'79. Recherches sur la nitrification. *Comp. Rend.* LXXXIX, 891-894. 24 Nov. 1879.

SCHNEIDER, R. '89. Verbreitung und Bedeutung des Eisens im animalischen Organismus. *Humbolt.* VIII, 337-345. Sept. 1889.

'95. Die neuesten Beobachtungen über natürliche Eisenresorption in thierischen Zellkernen und einige charakteristische Fälle der Eisenverwerthung im Körper von Gephyreen. *Mitth. a. d. Zool. Stat. zu Neapel.* XII, 208-215. 6 July, 1895.

- SCHULZ, H. '88. Ueber Hefegifte. Arch. f. ges. Physiol. XLII, 517-541. 20 March, 1888.
- '93. Ueber den Schwefelgehalt menschlicher und thierischer Gewebe. Arch. f. d. ges. Physiol. LIV, 555-573. 7 July, 1893.
- SOCIN, C. A. '91. In welcher Form wird das Eisen resorbirt? Zeitschr. f. physiol. Chem. XV, 93-193. 10 Jan. 1891.
- STOKLASA, J. '96. Studien über die Assimilation elementaren Stickstoffs durch die Pflanze. Landw. Jahrb. XXIV, 827-863.
- STRASBURGER, E. '86. Ueber fremdartige Bestäubung. Jahrb. f. wiss. Bot. XVII, 50-98.
- TAMMANN, G. '88. Ueber das Vorkommen des Fluors in Organismen. Zeitschr. f. physiol. Chem. XII, 322-326.
- TAPPEINER, H. '93. Ueber Ablagerung von Fluorsalzen im Organismus nach Fütterung mit Fluornatrium. Sb. Ges. Morph. u. Physiol. München. VIII, 22-26.
- TOWNSEND, C. O. '97. The Correlation of Growth under the Influence of Injuries. Ann. of Bot. XI, 509-532.
- VINES, S. H. '86. (See Chapter VIII, Literature.)
- VOLKMANN, A. W. '74. Untersuchungen über das Mengenverhältniss des Wassers und der Grundstoffe des menschlichen Körpers. Ber. d. Sächs. Ges. d. Wiss., Leipzig. XXVI, 202-247.
- WIELER, A. '83. Die Beeinflussung des Wachsens durch verminderte Partiärpressung des Sauerstoffs. Unters. a. d. bot. Inst. Tübingen. I, 189-232.
- WINOGRADSKY, S. '84. Ueber die Wirkung äusserer Einflüsse auf die Entwicklung von Mycoderma vini. Arb. St. Petersburger Naturf. Ges. XIV, 132-135 [Russian]. Abstr. in Bot. Centralbl. XX, 165-167.
- '87. Ueber Schwefelbakterien. Bot. Ztg. XLV, 493 et seq.
- '89. Recherches physiologiques sur les sulphobactéries. Ann. l'Inst. Pasteur. III, 49-60. Feb. 1887.
- '90. Recherches sur les organismes de la nitrification. Ann. l'Inst. Pasteur. IV, 257-275. May, 1890.
- '95. Recherches sur l'assimilation de l'azote libre de l'atmosphère par les microbes. Arch. des sci. biol. de St. Petersb. III, 297-352.
- WOLFF, E. v. '81. Ueber die Bedeutung der Kieselsäure für die Haferpflanze. Landw. Versuchs-Stat. XXVI, 415-417.
- '65. Mittlere Zusammensetzung der Asche, aller land- und forstwirtschaftlichen wichtigen Stoffe. Stuttgart, 1865.
- WOLTERING, H. W. F. C. '95. Ueber die Resorbbarkeit der Eisensalze. Zeitschr. f. physiol. Chem. XXI, 186-233. 26 Nov. 1895.
- WORTMANN, J. '87. Zur Kenntniss der Reizbewegung. Bot. Ztg. 812.
- YUNG, É. '83. Contributions à l'histoire de l'influence des milieux physico-chimiques sur les êtres vivants. Arch. de Zool. (2). I, 31-52.

CHAPTER XII

THE EFFECT OF WATER UPON GROWTH

WE have already, in Chapter X, laid stress upon the importance of the imbibition of water for the growth of both plants and animals. Here we may consider more in detail the relation between growth and water, both as concerns the rate or quantity of growth and the direction of growth, or hydro-tropism.

§ 1. EFFECT OF WATER UPON THE RATE AND QUANTITY OF GROWTH

It naturally follows from what we know of the importance of water for growth, that the rate of growth will be closely dependent upon water supply. And as all growth-phenomena have been better studied in plants than in animals, our further illustration of this fact will be drawn chiefly from the former.

First, *plant germination* demands a certain minimal quantity of water. What this quantity is may be determined either by finding the least amount which will permit of normal germination, or by measuring the amount absorbed by different seeds before protruding their radicles. This latter quantity has been shown by the careful determinations of HOFFMANN ('65, p. 52) to vary from between 40% and 60% of the original dry weight, in the case of various cultivated grains, to over 100% in the case of various Leguminosæ.

In fungi, likewise, LESAGE ('95, p. 311) has found that there is a hygrometric limit below which *Penicillium* spores will not germinate; and that the interval elapsing before germination begins is the shorter the moister the atmosphere.

The method employed by LESAGE is of wide applicability. The tension of the water-vapor formed above a saline solution is less than that formed above distilled water; and it diminishes in proportion to the concentration

of the solution. Indeed, to a given solution of a particular salt, *e.g.* sodium chloride, there corresponds a constant hygrometric state, however much the temperature may vary. This hygrometric condition may be calculated by the formula: $1 - na$, where saturation is taken as unity, n equals the number of grammes of sodium chloride dissolved in 100 grammes of water, and a is a constant factor, varying with the salt, and equal to 0.00601 in the case of sodium chloride. The spores were reared in a moist chamber, whose bottom was made by a plate full of the solution.

The results of LESAGE'S experiments are given in the following table:—

TABLE XXXVI

SHOWING INTERVAL IN DAYS ELAPSING BEFORE GERMINATION WHEN SPORES OF PENICILLIUM ARE KEPT IN MOIST CHAMBERS OVER VARIOUS SOLUTIONS OF SODIUM CHLORIDE

n	0	21.5	23.5	26.5	30-33.5
Interval . . .	1	6	9	11	No germination after 171 days

From these results it follows by calculation that the spores germinate at the hygroscopic state of 0.82-0.84 or over, but not below this limit.

The foregoing cases, taken from the two principal groups of plants, agree in showing that a certain amount of water is essential to the revival of the metabolic activities which are preliminary to germination. The large quantity of water absorbed by the seed or spore affords the mechanism or the stimulus to growth.

Also, in the *later stages* of plant growth, the water both of the atmosphere and of the soil is essential. The importance of atmospheric moisture was shown by REINKE ('76), who compared the size of the leaf-stem in different hygrometric conditions.

The method of measuring was as follows: a young potted *Datura* (one of the Solanaceæ) was placed so that the lower half of one of its stems was horizontal. A fine platinum wire, suspended from a standard above, hung vertically near the stem, and made one turn around it. The lower end of the wire carried a 2-gramme weight. That part of the wire which surrounded the stem was protected by a layer of tinfoil. As the stem swelled or grew thinner, the weight rose or fell. The vertical oscillation of the weight measured the variation in circumference of the stem.

It appeared that as the atmospheric moisture increased, a considerable increase in the cross-section of the stem followed ; and as it diminished, the size of the stem diminished likewise. The results are graphically given in Fig. 95.

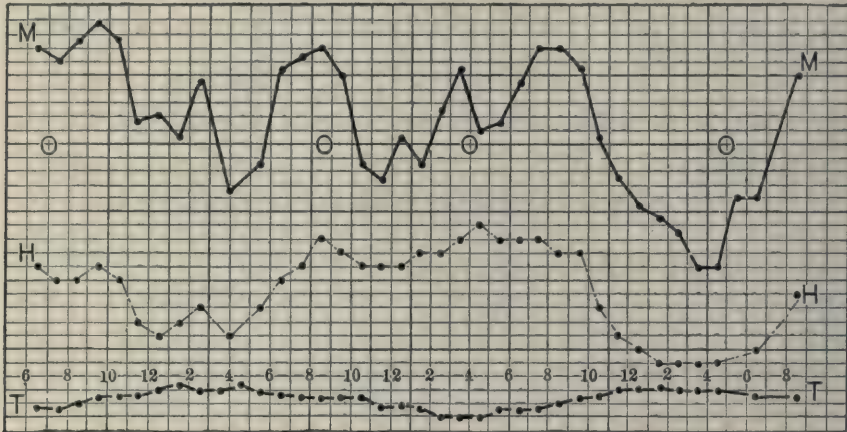

FIG. 95.— Curve of growth in thickness of a *Datura* stem, *M-M*, correlated with variations in relative humidity, *H-H*, the temperature *T-T* remaining nearly uniform. The part of the curve falling below *O-O* indicates loss of thickness below the normal. The abscissæ represent hours. (From REINKE, '76.)

These experiments have been repeated by FRANCIS DARWIN ('93) upon the fruit of a gourd, *Cucurbita*, whose growth is little influenced by variations in temperature. He determined, by means of a delicate micrometer apparatus, the average increment in microns per minute ; and, at the same time, by means of a dewpoint thermometer, the moisture of the air. The relation between rate of growth and psychometric readings is best shown graphically, as in the curves of Fig. 96. The

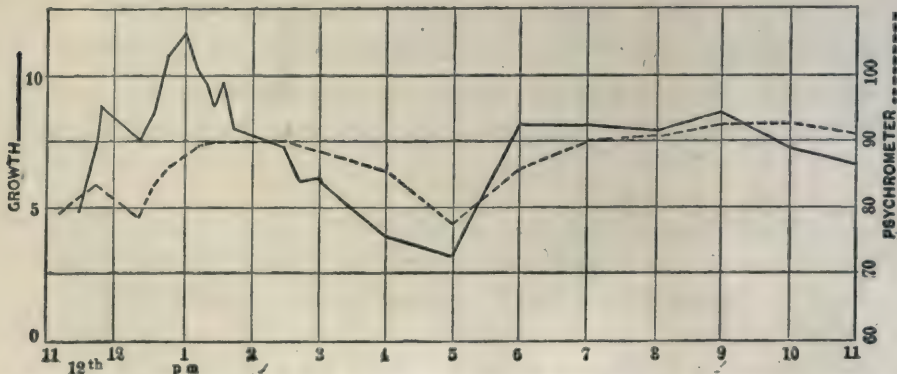

FIG. 96.— Curve of diameter of fruit of *Cucurbita* (full line) correlated with variation in humidity (broken line). The abscissæ represent hours; the ordinates represent growth in μ per minute (numbers on the left) and per cents of humidity (numbers on the right). (From DARWIN, '93.)

figure shows plainly how, in general, an increment or a decrement in one of these quantities is accompanied by a corresponding change in the other.

The cause of this relation between changes in volume and in moisture is partially explained by considering the quickness with which increased growth follows increased moisture. It is undoubtedly due, as TSCHAPLOWITZ ('86) has suggested, to the diminution in the transpiration of the plant in moist air as compared with dry air. The change in the rate of transpiration is, however, not to be conceived as an immediate physical result of the change in moisture, but as a response to the stimulus of greater or less water in the atmosphere.

The amount of water in the soil also has an important influence on the rate of growth. Quantitative studies on this well-known fact were afforded by HELLRIEGEL, who reared barley in soils which contained various fractional parts of the saturation quantity. Giving his results in the form of a table, we have the following relation between the humidity of the soil and the amount of dry matter produced, after a certain number of days, in the grain and in the chaff: —

TABLE XXXVII

HUMIDITY OF SOIL.	PRODUCTION, IN DRY MATTER.	
	Grains.	Chaff.
80%	8.77	9.47
60	9.96	11.00 (Max.)
40	10.51 (Max.)	9.64
30	9.73	8.20
20	7.75	5.50
10	0.72	1.80
5	—	0.12

The principal conclusion that one can draw from this table is that there is an optimum humidity of the soil for growth, which is not, however, the same for all organs.

More extensive researches upon this subject have been made by JUMELLE ('89), who studied chiefly the effect of water upon the growth of the various organs of the plant, and by

GAIN ('92, '95), who studied the effect upon the entire plant, so that his results are of especial interest here.

GAIN planted seeds of various species in sand to which a little garden loam had been added. He was careful either to select seeds of equal size or, after sprouting had occurred, to weed out all but the normal, medium-sized ones. In one set of experiments, the soil contained from 3% to 6% of water; in the other, from 12% to 16%.

GAIN found that the entire plant grew faster in the humid than in the dry soil, as the accompanying diagram, Fig. 97,

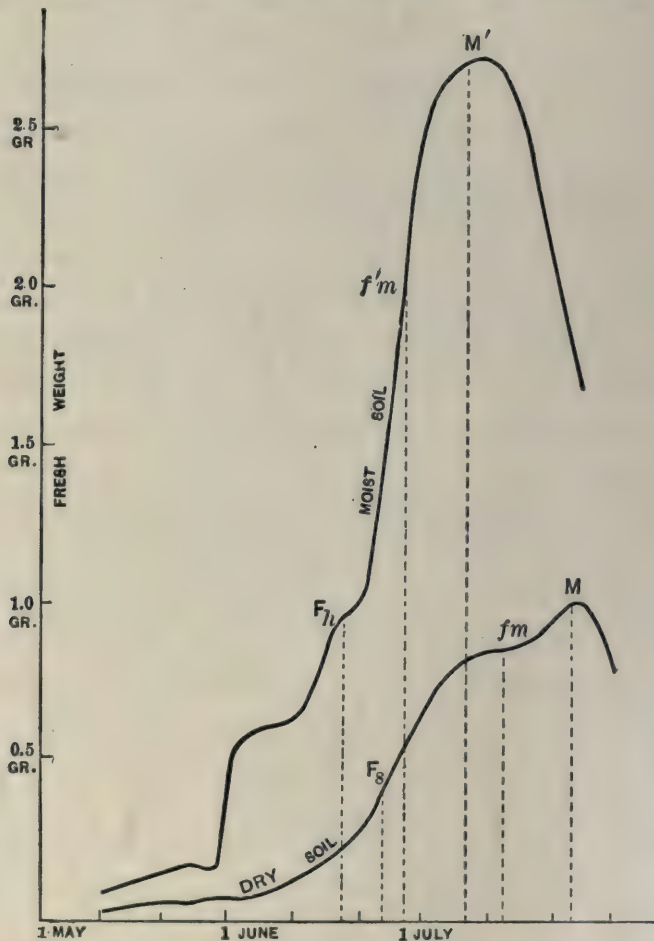

• FIG. 97. — Curves of fresh weight of two similar seedlings of flax, one growing in moist, the other in dry, soil. The maximum weight (M) gained by the plant differs in the two cases, and also the time of gaining that weight. F , time of flowering; fm , time of fructification. (From GAIN, '95.)

indicates. The aërial parts of the plant are more affected than the subterranean. The ratio of growth of plants in moist soil to those in dry varied from 1.12 (radish) to 2.33 (bean).

Among animals the importance of moisture for the growing young is indicated by the fact that even in species living on the land or in the air the eggs and larvæ are frequently confined to moist situations, as in pulmonate gasteropods, in many insects, and in reptiles. When this is not the case, the eggs are provided with thick, water-containing envelopes, as in birds, or are placed on succulent leaves, or in special fluid-filled receptacles, as in many insects. Only rarely, as for example in the case of the meal worm, *Tenebrio*, and the *Der-mestidæ*, are the young found growing in a very dry medium. Doubtless in such cases the amount of water required for growth is less than in the cases where the larvæ develop in moist situations.

To summarize, a minimal quantity of water is essential to germination and growth; and above this limit growth proceeds more rapidly with the increase in water up to a maximum which varies with the species.

§ 2. EFFECT OF WATER ON THE DIRECTION OF GROWTH — HYDROTROPISM

A growing organ, such as a leaf, root, or stolon, is normally in a condition of turgescence, as a consequence of the imbibition of water. So long as the turgidity is equal on the two sides of the organ the latter retains its normal position. If the turgidity is diminished on one side, the organ bends towards that side; if it is increased on one side, the organ bends from that side. Thus, variations in cell turgidity cause changes in the position of organs.

This inequality of turgescence on the two sides of an organ may arise in a homogeneous atmosphere; for certain organs have the capacity in a dry atmosphere of losing water on one side faster than on the other, and in a moist atmosphere of becoming more turgescient on one side than on the other. Consequently, the organ assumes a characteristic position according as the hygroscopic condition of the atmosphere is high or low. Such hygroscopic movements are of wide occurrence among plants, and are often highly adaptive. We see them, for example, in the folding of vegetative parts of the so-called Resurrection Plant of California (*Selaginella lepidophylla*), by

which the whole plant is rolled into a ball capable of being transported by the wind, perchance to a moister region. These hygroscopic movements occurring in a homogeneous medium are to be distinguished from true hydrotropism, for they are not properly growth phenomena.

True hydrotropism occurs in growing elongated organs, such as roots or stolons, which grow from or toward a region of greater or less moisture. The observations on this phenomenon have not been numerous, and are difficult to bring under one point of view; consequently, we shall do best to classify the cases studied on the basis of the organs considered.

1. **Roots.**—The first studies upon hydrotropism in roots were made in the middle of the eighteenth century; but they were crude and uncritical. The first adequate experiments were made by KNIGHT ('11). He half-buried some beans in a flower-pot filled with earth, inverted the pot (in which the earth and seeds were retained by a grating), and kept the earth moist by adding water through the hole in the bottom of the pot. The radicles, instead of growing vertically downwards as radicles normally do, ran horizontally along the surface of the moist earth. The same results were got by JOHNSON ('29), who found in addition that if the mouth of the inverted flower-pot, or other seed receptacle, be placed in a moist atmosphere, the roots grow vertically downwards; they are no longer turned aside by dry air. Then DUCHARTRE ('56) discovered that when a seedling was grown in relatively dry earth, with its aërial part in a close, moist chamber, the roots did not penetrate vertically into the soil, but grew out horizontally, and even upwards. SACHS ('72) varied this experiment by planting his seeds in a basket made of netting, fixed to a metallic frame, and hung with its sides inclined at an angle of 45° with the horizontal plane. When the apparatus was placed in a damp chamber the radicles grew vertically downwards; but in dry air they turned back towards the bottom of the sieve containing the damp earth, and ran along its under surface. SACHS called especial attention to the fact that it is the damper side which becomes concave; and this shows that the turning is not due to direct physical causes.

The second epoch in the study of hydrotropism now began.

The fact of its existence being granted, the conditions of its occurrence were carefully studied. Thus DARWIN ('80, Chapter III) investigated the locus of the irritable protoplasm. Some of the young bean-radicles were coated for the distance of a millimetre or two from the apex with a mixture of olive oil and lamp black in order to exclude the moist air. Such showed almost no hydrotropic movements. Killing the tip by caustic produced the same result. Thus the terminal two millimetres or so include the irritable protoplasm.

This conclusion was disputed by WIESNER ('81, p. 133) and DETLEFSEN ('82) on the grounds that on the one hand coating or killing the tip introduced abnormal conditions to which the failure of hydrotropism might be ascribed, and, on the other hand, after the tip of the root was cut off a curving might still occur. However, a very careful review of the subject with new experiments by MOLISCH ('84), a pupil of WIESNER, confirmed DARWIN'S conclusion. Thus MOLISCH covered all of the radicle excepting the terminal 1 to 1.5 mm. with wet paper. This upper part could then hardly be irritated by an unequal distribution of moisture in the environment. Nevertheless, when a strip of moist filter-paper was placed opposite the tip the hydrotropic response occurred. The response must then have been due to a stimulus received exclusively at the tip, and it may be concluded that the tip alone is stimulated by moisture.

Now, although only a millimetre or two of the tip is irritable, the response of bending takes place some distance, 7 to 28 mm., behind the tip, nearly in the region of maximum growth. Thus sensitive and responsive regions do not coincide — there is a transmission of stimuli. The facts that the hydrotropic response occurs in the region of rapid growth and that at the minimum temperature of growth response no longer occurs, indicate clearly that the hydrotropism of roots is not the result of mechanical loss of turgescence on one side, but that it is on the contrary a growth phenomenon — a localized growth which is a response to a stimulus.

2. **Rhizoides of Higher Cryptogams.** — While it is *a priori* probable that the rhizoids of hepatics should react like the roots of phanerogams, MOLISCH desired to demonstrate the fact

by experiment. Upon a glass disc was placed a piece of moist filter-paper so large that its edges hung vertically downwards as a flap beyond the margin of the disc. Thalli of various Marchantiaceæ were placed in sand at the margin of the disc in such a way that the young growing edge projected half a centimetre beyond. The disc and the object on it were exposed to daylight, but slowly rotated in a horizontal plane in order to eliminate phototropic action. The young, positively geotropic, rhizoids which developed beyond the margin of the disc did not grow vertically downwards, but turned towards the flap of moist filter-paper, thus proving that they are positively hydrotropic. The same is doubtless true of the rhizoids of ferns.

3. **Stems.** — Very few studies seem to have been made upon the hydrotropism of the stems of seedlings; the most important are those of MOLISCH. Several sets of experiments were carried out upon seedlings of flax, pepper-grass (*Lepidium sativum*), bean, *Nicotiana camelina*, etc. The method employed was nearly that of WORTMANN (see below). Of these plants the hypocotyls of the flax alone showed any hydrotropism; it may accordingly be concluded that stems are markedly hydrotropic in but few seedlings.

4. **Pollen-Tubes.** — The reactions to moisture of these organs have been studied by MIYOSHI ('94). He placed pollen-grains on the stigma of the same species and found that whereas in a dark, *moist* chamber the pollen-tubes grew in all directions, when dry air was admitted the pollen-tubes turned towards the centre of the stigma. This turning is best explained as a response to the greater moisture surrounding the mouth of the stigma. It is clearly also an advantageous result, since it tends to direct the pollen-tube to the ovary.

5. **Hyphæ of Fungi.** — While SACHS ('79) early suggested that the sporangium bearer of *Phycomyces nitens* is negatively hydrotropic, the first experimental evidence on this point was offered by WORTMANN ('81).

Spores of *Phycomyces* were sown on bread kept in a moist chamber whose walls were made opaque to prevent phototropism. When, after three or four days, some of the sporangium-bearers had gained a height of one or two centimetres all were bent to one side excepting one which protruded

through a small hole in the glass disc. Parallel to this hypha and close to it was placed a piece of soaked card. After 4 to 6 hours the hypha turned from the damp card; but when the card was dry no such turning occurred.

The extraordinary sensitiveness of the sporangium bearing filaments of *Phycomyces* has been shown by the experiments of ERRARA ('93). He found that these organs turned toward rusting iron, china-clay, agate (but not rock crystal), and sulphuric acid. He explained this result on the ground that these substances absorb the moisture in their vicinity. Consequently the hydrotropic filaments turn towards this relatively dryer region. So sensitive, indeed, is this plant that it may be used to detect a very slight difference in the hygroscopic properties of chemically related substances.

Not only do the hyphæ of *Phycomyces* turn from moisture, but, as MOLISCH ('83) showed, those of *Mucor stolonifer* and the relatively great trunk of the toadstool *Coprinus velaris* respond in the same way. The spores are thereby carried away from the moist situation.

In conclusion a word may be said concerning the cause of hydrotropism. It is probable that two diverse phenomena are confused under the term. One of these is seen when a multicellular organ like the root of phanerogams is unequally moistened on opposite sides; the moister side will lose water less quickly than the other, or it may actually imbibe some. Its cells will accordingly become more turgescient and the whole moister side more convex. This result is due to a relatively direct, almost mechanical, cause; it simulates negative hydrotropism, but it is so different in kind from the true phenomenon that it may be called false hydrotropism.

In the second class of cases we see multicellular organs, such as roots, becoming concave towards the slightly moister region, or unicellular organs, such as rhizoids, pollen-tubes and hyphæ — organs which cannot be supposed to become unequally turgescient on the two sides — exhibiting a + or - turning. These cases cannot be explained on direct mechanical grounds; they are responses to stimuli, and, as such, examples of true hydrotropism.

These two kinds of hydrotropism may occur in the same organ under different conditions and thus cause turnings in

opposite directions. Thus WORTMANN ('81, p. 374) finds that a mycelium growing downwards towards water turns horizontally before touching it and branches profusely. Similarly a root growing towards water will not penetrate into it, but will turn to one side. The greatly increased moisture causes the reversal of the tropism, but this is probably due to the fact that a false hydrotropism replaces the true response; however, as true hydrotaxis may take place in both directions, so there may be a true negative as well as positive hydrotropism.

I now summarize our conclusions concerning the effect of water upon growth. Water plays a part in growth second in importance to no other agent, so that in its absence growth cannot occur. As the quantity is increased, growth is increased until an optimum is reached. The amount imbibed does not, however, depend directly upon the amount available, but rather upon the needs or the habits of the species. Growth of elongated organs may take place from or towards moisture, and the turning may be a true response to the stimulus of higher or lower aqueous tension, — a response which may show itself in a bending at some distance behind the irritable tip. This response is, moreover, often of an advantageous kind, directing the rootlets towards water and the pollen-tube towards the moist stigma or keeping the sporangium in the dry atmosphere necessary for the production of dry spores. In a word, imbibition of water and growth with reference to the source of moisture are regulated to the advantage of the species.

LITERATURE

- DARWIN, C. '80. *The Power of Movement in Plants*. London, 1880.
- DARWIN, F. '93. On the Growth of the Fruit of *Cucurbita*. *Ann. of Bot.* VII, 459-487. Pls. XXII, XXIII. Dec. 1893.
- DETLEFSEN, E. '82. Ueber die von Ch. Darwin behauptete Gehirnfunktion der Wurzelspitze. *Arb. a. d. bot. Inst. Würzburg*. II, 627-647.
- DUCHARTRE, P. '56. Influence de l'humidité sur la direction des racines. *Bull. Soc. bot. France*. III, 583-691.
- ERRARA, L. '93. On the Cause of Physiological Action at a Distance. *Rept. Brit. Ass. Adv. Sci. for 1892*, 746, 747.

- GAIN, E. '92. Influence de l'humidité sur la végétation. *Compt. Rend.* CXV, 890-892. 21 Nov. 1892.
- '95. Recherches sur la rôle physiologique de l'eau dans la végétation. *Ann. Sci. Nat., Bot.* (7), XX, 63-215. Pls. I-IV.
- HOFFMANN, '65. Beiträge zum Keimungsprocess. *Landwirthsch. Versuchs-Stat.* VII, 47-54.
- JOHNSON, H. '29. The Unsatisfactory Nature of the Theories proposed to account for the Descent of the Radicles in the Germination of Seeds, shewn by Experiments. *Edinb. New Philos. Mag.* VI, 312-317.
- JUMELLE, H. '89. Recherches physiologiques sur le développement des plantes annuelles. *Revue Générale de Bot.* I, 101 et seq.
- KNIGHT, F. A. '11. On the Causes which influence the Direction of the Growth of Roots. *Phil. Trans. Roy. Soc. London.* Pt. I; 209-219.
- LESAGE, P. '95. Recherches expérimentales sur la germination des spores de *Penicillium glaucum*. *Ann. Sci. Nat., Bot.* (8), I, 309-322. Nov. 1895.
- MIYOSHI, M. '94. Ueber Reizbewegungen der Pollenschläuche. *Flora.* LXXVIII, 76-93.
- MOLISCH, H. '84. Untersuchungen über den Hydrotropismus. *Sb. Wien. Akad.* LXXXVIII¹, 897-942. Taf. I.
- REINKE, J. '76. Untersuchungen über Wachsthum. *Bot. Ztg.* XXXIV, 65-69, 91-95, 106-111, 113-134, 136-160, 169-171. Pls. II, III. Feb., Mar. 1876.
- SACHS, J. '72. Ablenkung der Wurzel von ihrer normalen Wachstumsrichtung durch feuchte Körper. *Arb. bot. Inst. Würzburg.* I, 209-222.
- '79. Ueber Ausschliessung der geotropischen und heliotropischen Krümmungen während des Wachsens. *Arb. bot. Inst. zu Würzburg.* II, 209-225.
- TSCHAPLOWITZ, F. C. '86. Untersuchungen über die Wirkung der klimatischen Factoren auf das Wachsthum der Culturpflanzen. *Forsch. Agr.* IX, 117-145. [Abstr. in *Bot. Jahresber.*] XIV, 57, 58.
- WIESNER, J. '81. Das Bewegungsvermögen der Pflaunen. 212 pp. Wien, 1881.
- WORTMANN, J. '81. Ein Beitrag zur Biologie der Mucorineen. *Bot. Ztg.* XXXIX, 368-374, 383-387. June, 1881.

CHAPTER XIII

EFFECT OF THE DENSITY OF THE MEDIUM UPON GROWTH

IN this chapter we cannot, as hitherto, consider the effect of density upon both the rate or quantity and the direction of growth, for no studies seem to have been made upon the latter subject.

§ 1. EFFECT OF DENSITY UPON THE RATE OF GROWTH

We have seen in Chapter III (p. 77) that the increase or decrease in the concentration of a solution produces, by osmosis, changes in the structure of protoplasm, in its locomotion, and in its excretory activity. It remains to be seen to what extent change in density can affect the metabolic activities concerned in growth.

The relation between the rate of growth of plants and concentration has been the subject of much study, *e.g.* by WIELER ('83), DEVRIES ('77), JARIUS ('86), JENTYS ('88), ESCHENHAGEN ('89), and STANGE ('92). It is agreed that, in general, as the solution containing the plant becomes more concentrated the seedling or the fungus (JENTYS, p. 455) grows more slowly.

The question now arises whether there is any maximum concentration at which growth is completely inhibited. Data on this subject are given by ESCHENHAGEN, who finds that various fungi will not grow at a concentration above the following limits:—

	STARCH. $C_6H_{12}O_6$.	GLYCERINE. $C_3H_8O_3$.	SODIUM NITRATE. $NaNO_3$.	COMMON SALT. $NaCl$.
Aspergillus . . .	53%	43%	21%	17%
Penicillium . . .	55	43	21	18
Botrytis	51	37	16	12

Also RACIBORSKI ('96) found that *Basidiobolus* cultivated in a nutritive solution containing 10% peptone, 1% glucose, and the necessary salts, ceased to grow when the concentration of the salts reached the following percents:—

sodium chloride, NaCl, 6%. glycerine, C₃H₈O₃, 20%.
 potassium chloride, KNO₃, 11%. glucose, C₆H₁₂O₆, 25%.

The foregoing maximum concentrations vary with the molecular weights of the dissolved substances, indicating that their effect is purely an osmotic one.

Germination is likewise affected by concentration, as a valuable series of experiments by VANDEVELDE ('97) clearly shows.

Seeds of the pea, *Pisum sativum*, were soaked for 24 hours in solutions of common salt varying from 1% to 35%, then removed, planted, and the percentage of seeds which germinated (G%) and the mean interval elapsing before germination (I) determined. (I) was, more precisely, the time elapsing (in days) before one half of the seeds had germinated. The results are given as follows:—

TABLE XXXVIII

SHOWING THE RELATION BETWEEN THE CONCENTRATION OF THE SOLUTION IN WHICH PEAS HAVE BEEN SOAKED AND THEIR GERMINATION

%	G %	I	%	G %	I	%	G %	I	%	G %	I
1	98.00	2.1	10	12.46	5.9	19	4.00	5.7	28	6.83	5.7
2	97.17	3.7	11	7.00	6.6	20	5.67	5.7	29	3.83	6.7
3	85.17	4.0	12	10.00	6.3	21	3.33	7.0	30	10.33	6.5
4	34.50	4.6	13	8.50	6.8	22	1.50	5.6	31	8.83	6.8
5	32.66	4.8	14	7.19	6.3	23	1.83	6.2	32	10.67	7.2
6	16.83	5.0	15	4.50	6.7	24	4.00	5.8	33	23.00	6.2
7	15.33	5.2	16	6.83	7.1	25	0.83	5.8	34	31.33	6.5
8	14.83	5.3	17	4.76	6.6	26	4.50	6.3	35	56.83	7.0
9	12.66	5.4	18	3.33	6.2	27	8.17	6.8			

This table yields some remarkable results. As the concentration increases from 1% to 15%, the percentage of germinations diminishes from 98 to 4.5, and the mean germination interval increases from 2.1 days to nearly 7, near which point it remains at all higher concentrations. From 15% to 29% the percentage of germinations fluctuates so irregularly between 6.8 and 0.83 that within these limits it may be considered con-

stant. As the concentration increases from 29%, instead of the grains all being killed or failing to germinate, we have the interesting result that the percentage of germinating individuals rises rapidly from 4 to 56. VANDEVELDE hazards the following explanation of this result: "Dilute solutions are easily absorbed; the more concentrated the solution, the smaller the power of diffusion; in a saturated solution the seeds do not swell and the action of the surrounding solution is less injurious." But we need to know more of the conditions under which this result occurs before we can accept any interpretation.

With animals we find growth similarly affected as with plants. LOEB ('92) first showed this in his experiments upon the regenerative growth of decapitated tubularian hydroids. The regenerating hydroids were kept in water more and less dense than, and equally dense with, sea water. At the end of eight days the length of the regenerated piece was measured in seven to nine individuals at each concentration. The results may be given in the form of a curve (Fig. 98) by laying off as abscissæ the percents of sodium chloride in the water and as ordinates the corresponding average growth in millimetres:—

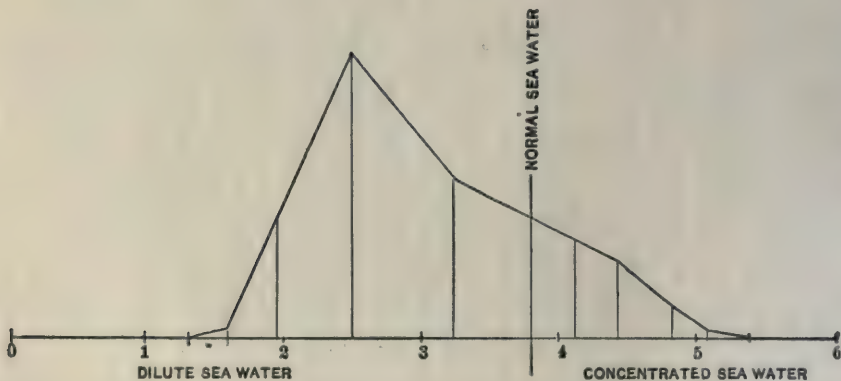

FIG. 98.—Curve showing the relation between the density of the medium and the proportional rate of growth of regenerating Tubularia. The maximum ordinate indicates 10.5 mm. growth in 8 days. The numbers at the base of the curve are per cents of density in excess of distilled water; thus "3" signifies a specific gravity of 1.03. (From LOEB, '92.)

This curve shows that the optimum concentration for growth is not, as might have been expected, the normal concentration, but one considerably below the normal, namely 2.5% instead

of 3.8%. Anything which favors endosmosis seems, within certain limits, to favor growth.

Regenerating annelids have also been studied at my laboratory by Mr. J. L. FRAZEUR. A large number of worms of a species of *Nais*, all of approximately the same size, were cut into two parts. Of these the anterior, consisting of twelve segments, was alone preserved for experimentation, and was placed in water either pure or containing a variable amount of common salt in solution. At the end of ten days the anterior piece had regenerated at its tail end a certain number of segments varying with the strength of the solution as shown in the following:—

TABLE XXXIX

SHOWING THE AVERAGE NUMBER OF SEGMENTS OF *NAIS* REGENERATED PER DAY IN VARIOUS SOLUTIONS OF SODIUM CHLORIDE

SOLUTION.	NO. OF INDIVIDUALS.	AVG. NO. OF SEGMENTS REGENERATED PER DAY.	SOLUTION.	NO. OF INDIVIDUALS.	AVG. NO. OF SEGMENTS REGENERATED PER DAY.
Water	15	2.13	0.250%	7	1.19
0.125%	5	1.72	0.375	5	1.18
0.188	16	1.42	0.500	5	1.14

The decrease in the number of regenerated segments was thus, with increasing concentration, at first rapid, then slow.

Fission, which is so closely bound up with growth that we may treat it as an index of growth, is also controlled by the concentration of the medium. Mr. P. E. SARGENT has, at my suggestion, studied this subject in the naid *Dero vaga*. This species divides so rapidly that ordinarily it doubles its numbers every ten days. The worms were kept in solutions of varying concentration of various salts. They were reared in similar jars, supplied with similar food,* and kept under otherwise similar conditions. A definite number of worms having been put in each jar, the increment at the end of ten days was deter-

* 1 to 2 cc. of corn meal extract was added every day to the 200 cc. of water in which the worms were living.

mined by counting. The results of some of these countings are given below for a number of salts :—

TABLE XL

AVERAGE INCREASE *Per Cent* OF INDIVIDUALS OF *DERO VAGA* REPRODUCING, DURING TEN DAYS, IN SOLUTIONS OF DIFFERENT SALTS AT VARYING CONCENTRATIONS. MINUS QUANTITIES INDICATE DIMINUTION IN NUMBER OF INDIVIDUALS

STRENGTH OF SOLUTION.	NO. OF INDIV.	NaCl.	NO. OF INDIV.	MgSO ₄ .	NO. OF INDIV.	CaCl ₂ .	NO. OF INDIV.	MgCl ₂ .	NO. OF INDIV.	KCl.
MOLEC. WEIGHTS,		58.5		120		111		95		74.6
Control: water	787	113.0%	75	134.0%						
0.05 %	100	85.2	50	22.0	50	40 %	25	12 %	50	12 %
0.10	350	77.0	75	-10.6	50	-12			50	-64
0.15	100	58.0	75	-2.6	25	-36	25	-28	25	-92
0.20	350	40.8	75	-35.3	50	-58	25	-68		
0.25	100	21.5	75	-65.3	25	-72				
0.30	350	3.2	75	-84.0	25	-84				
0.35	25	-24.0			25	-92				
0.40	375	-18.1			25	-100				
0.50	150	-35.0								

These columns, and especially the first one, show a close relation between concentration and growth (as tested by multiplication of individuals). They show also that the diminished growth falls off rapidly at first with slight increments of concentration, then less slowly at the higher grades (Fig. 99). Finally they show that different salts have diverse osmotic effects, for sodium chloride is less retarding than any other salt at the same percentage of concentration. The effect of the remaining salts is seen to increase as the molecular weight diminishes, and therefore the osmotic effect increases (Fig. 99). The fact that magnesium sulphate dissociates at these weak concentrations only about two-thirds as much as calcium chloride does, would lead us to expect even a relatively smaller effect as compared with calcium chloride than we find (see p. 74, note); perhaps further experimentation would give facts

agreeing closer with theory. On the whole, Table XL indicates that it is the osmotic effect which retards growth.

In tadpoles a similar retarding effect of solutions has been observed by YUNG ('85), who made solutions of 0, 2, 4, 6, and 8 grammes of sea salt in 1000 grammes of water, and reared frog's embryos in them. Other conditions excepting concentration were believed to be alike in all experiments. In the 0.2% solution the tadpoles developed at nearly the same rate as in pure water. In the denser solutions there was a retardation in development, which increased with the density of the solution, so that in the 0.8% solution the larvæ hatched out seventeen days behind the normal time.

The effect of a sudden change in the density of the solution has been especially studied by TRUE ('95). Beans, *Vicia faba*, which had radicles from 17 to 35 mm. long, were placed directly in the solutions and held there so that the cotyledons alone were free. The cultures were kept in the dark. When the transfer was made suddenly to a 1% solution of potassium nitrate, it was observed that a mechanical contraction occurred, followed by a more or less prolonged period of retar-

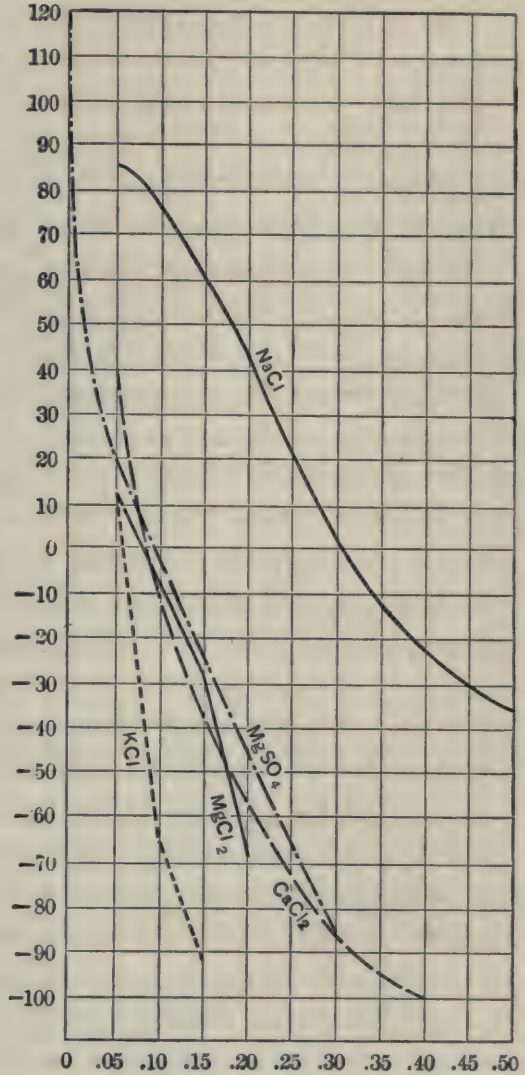

FIG. 99. — Curves of average increase per cent of individuals (ordinates) of *Dero vaga* reproducing, during 10 days, in solutions of different salts, whose strengths are laid off as abscissæ. The data are taken from Table XL.

dation in the rate of growth. When, on the other hand, the plant was transferred from a salt solution to which it had become accustomed to pure water, a mechanical elongation quickly occurred, but this too was followed by a retardation in the rate of growth. Thus the reduction in the rate of growth is not a mechanical result of change of medium, but is a response to the stimulus of changed environment.

We have hitherto considered almost exclusively the effect of aqueous solutions. We must now consider how a variation in the pressure of the atmosphere affects the growth of plants. Upon this subject experiments have been made by JACCARD ('93), who found that when the pressure of the air was reduced from 78 cm. to between 10 cm. and 40 cm. of mercury, growth is two or three or even six times as rapid as in ordinary air. Likewise when the air is compressed to between three and six atmospheres acceleration in growth occurs, although not to the same extent as in the depressed air. If, however, the rarefaction is very great (below 10 cm.) or the pressure excessive (over 8 atmospheres), growth is retarded. Experiments indicate that this result is not wholly due to the concentration of the oxygen in the air. We may therefore conclude that a change in pressure from the normal accelerates growth by irritating the growing plasma up to a certain limit, beyond which its injurious effects counterbalance its favorable ones.

Summing up this account of the effect of concentrated solutions upon the growth of organisms, we find that in general as the density increases beyond the normal the rate of growth diminishes until, at a certain concentration, it ceases. In the particular case of marine organisms a reduction in concentration to a certain point causes excess of growth; below that point, diminution. It is probable that the diminution in growth is proportional to the osmotic action of the medium (Chapter III).

An explanation of the foregoing phenomena may be attained by reference to the principles laid down in preceding chapters. In Chapter X it has been shown that growth depends very largely upon the specific imbibition of water. We do not know the cause of the difference in imbibitory properties at different times; but if, as has been suggested, it is purely an endosmotic phenomenon resulting from the secretion of plant

acids or salts in the cell sap, then we can understand how a denser medium should diminish or destroy the imbibitory tendency. On the other hand, a change in concentration may act in a more indirect fashion to cause increased growth; namely, by calling forth a response to the irritation of changed conditions of pressure.

LITERATURE

- ESCHENHAGEN, F. '89. Ueber den Einfluss von Lösungen verschiedener Concentration auf das Wachsthum von Schimmelpilze. Stolp, 1889.
- JACCARD, P. '93. Influence de la pression des gaz sur le développement des végétaux. Comp. Rend. CXVI, 830-833. 17 April, 1893.
- JARIUS, M. '86. Ueber die Einwirkung an Salzlösungen auf den Keimungsprocess der Samen einiger einheimischer Culturgewächse. Landwirthschaft. Versuchs-Stat. XXXII, 149-178. Taf. II.
- JENTYS, S. '88. Ueber den Einfluss hoher Sauerstoffpressungen auf das Wachsthum der Pflanzen. Unters. a. d. bot. Inst. Tübingen. II, 419-464.
- LOEB, J. '92. (See Chapter X, Literature.)
- RACIBORSKI, M. '96. Ueber den Einfluss äusserer Bedingungen auf die Wachstumsweise des Basidiobolus ranarum. Flora. LXXXIII, 110-115.
- STANGE, B. '92. Beziehungen zwischen Substratconcentration, Turgor und Wachsthum bei einigen phanerogamen Pflanzen. Bot. Ztg. L, 253 et seq.
- TRUE, R. H. '95. On the Influence of Sudden Changes of Turgor and of Temperature on Growth. Ann. of Bot. IX, 365-402. Sept. 1895.
- VANDEVELDE, A. J. J. '97. Ueber den Einfluss des chemischen Reagentien und des Lichtes auf die Keimung der Samen. Bot. Centralbl. LXIX, 337-342. 11 March, 1897.
- DE VRIES, H. '77. Ueber die Ausdehnung wachsenden Pflanzenzellen durch ihren Turgor. Bot. Ztg. XXXV, 1-10.
- WIELER, A. '83. Die Beeinflussung des Wachsens durch verminderte Partialdruck des Sauerstoffs. Unters. a. d. Bot. Inst. Tübingen. I, 189-232.
- YUNG, É. '85. De l'influence des variations du milieu physico-chimique sur le développement des animaux. Arch. des Sci. Phys. et Nat. XIV, 502-522. 15 Dec. 1885.

CHAPTER XIV

EFFECT OF MOLAR AGENTS UPON GROWTH

It is proposed in this chapter to consider, first, the effect of contact, rough movements, deformations, and associated molar agents upon the rate of growth, and, secondly, the effect of such agents upon the direction of growth.

§ 1. EFFECT OF MOLAR AGENTS UPON THE RATE OF GROWTH

We have already (Chapter IV) seen that profound changes in metabolism and the motion of protoplasm are induced by various sorts of contact. We shall here consider how those changes result in modifications of growth.

1. **Contact.**—In the case of organs which normally grow upon a solid substratum the growth may take place more rapidly after coming in contact than before. Thus LOEB ('91, p. 29) says of the stolons of the hydroid *Aglaophenia pluma*, that when they reach a solid surface they begin to grow more rapidly than stolons which develop free in the water. Evidently the stimulus of contact excites to extraordinary growth.

2. **Rough Movements.**—Experiments with this agent have been almost confined to bacteria, and have been made by shaking. The first experimenter in this direction was HORVATH ('78), whose method of work is worth giving in some detail.

Glass tubes about 20 cm. long and 2 cm. wide were half filled by a nutritive fluid, inoculated with an infusion full of various bacteria, and sealed. The tubes were then fixed on a board which was made to swing horizontally to and fro by means of a motor through an arc of about 25 cm. length at the rate of 100 to 110 times per minute. At the end of each excursion the board received, by means of a special device, an extra blow. The resulting agitation was like that made in shaking a test-tube.

The results of HORVATH'S experiments were these. Tubes which were shaken for 24 hours were clear at the end of that period, while similar tubes kept at rest had become muddy with bacteria in the same time. If, now, the shaken tubes were kept at rest during a day in a warm oven, they, too, produced a rich growth of bacteria. When, however, the tubes had been shaken for 48 hours they not only were found clear, but they did not become cloudy upon subsequent warming (I, p. 99). The shaking during the briefer period had thus merely interfered with the normal growth processes, but the more prolonged shaking had resulted in the death of the bacteria.

Subsequent attempts by other workers to reproduce these results, by the use, however, of other methods, partially or completely failed. REINKE ('80), indeed, found that in water agitated for 24 hours bacteria had ceased to grow, but had not been killed; in so far a confirmation of HORVATH. Other investigators, however (BUCHNER, '80; TUMAS, '81; LEONE, '85; SCHMIDT, '91; RUSSELL, '92; and others), have either obtained no effect upon the growth of bacteria, or have found it increased by motion. The results seemed hopelessly discordant.

The more recent work of MELTZER ('94) has, however, brought these conflicting observations under one general law, and has thus offered an interpretation of the varied results. He pointed out first that the diverse results of previous investigators were due to the use of different species of bacteria and of different kinds and degrees of shaking; in a word, to dissimilar methods. MELTZER employed pure cultures of bacteria of ascertained species, and counted the colonies by the well-known bacteriological methods. Shaking was either violent, being done in a machine somewhat like HORVATH'S; or slight, being done by hand. The media used were neutral salt solutions, KOCH'S bouillon, or pure water. The results showed that a slight shaking is advantageous to the metabolism of *Bacterium ruber* in water. Thus, while a culture containing 950 colonies, left quiet, was reduced after 8 days to 259 colonies; shaken, it had at the end of the same period 1366 colonies; and shaken with glass drops rolling loose in the tube,

it had attained 16,200 colonies. When, however, the shaking was longer continued the number of colonies began to fall off, so that after 21 days the medium shaken with glass drops exhibited only 5 colonies. These facts enable us to distinguish a minimum degree of movement which will permit of growth (shaking for 6 days without glass drops); an optimum (shaking for 8 days with glass drops); and a maximum (shaking for 21 days with glass drops). The optimum is very diverse in different species. Thus in *Bacterium megaterium* it is so low that shaking for a little over 1.5 days results fatally. It is probable that the growth of every race of bacteria is attuned to a particular optimum of movement.*

3. **Deformation.** — Under this head we may consider the effects of pulling and bending upon the growth of an elongated body. Data upon this subject have been obtained only from plants.

The effect of pulling upon the growth in length of a plant stem has been studied by BARANETZKY ('79), SCHOLTZ ('87), and HEGLER ('93). The results obtained are concordant and important. It appears that when a weight is attached, by means of a cord running over a pulley, to the epicotyl of various seedlings — such as *Helianthus*, *Tropæolum*, *Cannabis*, *Linum*, etc., — the growth in length of the stem is, under appropriate conditions, not accelerated but retarded. When, for example, a pull of 13 grammes is exerted upon the epicotyl

* Concerning the cause of the increase of growth accompanying a slight molar disturbance and the diminished growth and death accompanying a violent one, MELTZER has something to say. He finds in those cultures in which no growth of bacteria occurs, no fragment of cells but on the contrary nothing except a fine "dust" — the bacteria have experienced a molecular disintegration. In order to explain this disintegration, MELTZER accepts NÄGELI'S conception of the structure of protoplasm, — micellæ enveloped by water, — and supposes that a molar disturbance modifies the normal movements of these micellæ. A very violent movement causes the micellæ to separate completely; a much less turbulent movement causes an increase in the vibrations of the micellæ by which they are brought into more intimate contact with food material including oxygen, and more easily get rid of the metabolic products. Without accepting NÄGELI'S micellar hypothesis, we may account for the beneficial effects of slight movement upon the ground of an increased supply of oxygen afforded by it; and we may regard the fatal effect as the result of disturbed metabolism or of protoplasmic disintegration.

of a Cannabis seedling there is a momentary elongation followed for six hours by no growth whatever; then periods of growth alternating with periods of retardation occur until, after perhaps 24 hours, the hourly growth is nearly equal to that of the unweighted plant. The least weight which will cause a retardation is different for different plants. In the case of Cannabis and Linum it is below 1.3 grammes, a result which indicates that the weight of the index used in self-recording auxanometers is sufficient to retard the growth of the plant and thus to give an abnormal growth curve.

The diminution of growth is not the same at all periods of the plant's development. Thus the retarding effect is greatest at the commencement of the grand period of growth, but begins quickly to diminish until at the maximum of growth there is no retarding effect. Then, as the rate of growth decreases, the retardation becomes more evident. The effect of the pull is best seen in comparing the curves of daily fluctuation of growth of the weighted and unweighted plants. The early morning is the period of rapid growth, and at this time the growth of the stretched plant is quite equal to or exceeds that of the un-

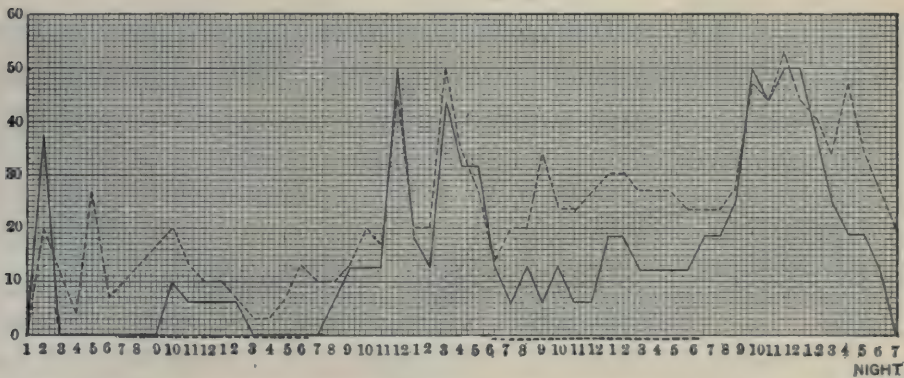

FIG. 100. — Curves of hourly growth, measured in hundredths of a millimetre, — vertical scale at the left. The full line gives the course of growth of a Cannabis seedling subjected to a pull of 13 grammes. The dotted line gives, for comparison, the course of nearly normal growth, the plant being subjected to a pull of only 3 grammes. The numbers at the bottom indicate hours of the day; the broken line at the bottom indicates night-time. (From HEGLER, '93.)

weighted one. During the early night, on the contrary, when growth is feeble, the stretched stem grows slowly (Fig. 100). If an etiolated plant is used, the daily growth fluctuations are eliminated and the effect of the larger growth cycle becomes

evident. Thus, in general, the more rapid the growth, the less is the retardation provoked by pulling.

The direction in which we must look for an explanation of these facts is indicated by the circumstance that, in the most rapid period, growth is chiefly due to imbibition of water, while in the preceding and succeeding periods it is due more to an increase in the plasma. Thus not all kinds of growth are equally affected by the irritation of pulling, but principally that growth which is due to assimilation. Further insight into this matter is gained from the circumstance that despite the fact that growth is slower in the plant under tension the turgescence in the stretching zone is greater in such a plant than in a normal one. This indicates again that it is not the imbibitory process which is interfered with but rather the assimilative one. All these facts thus lead to one conclusion, that, under tension, the plasma, especially that of the cell-wall, grows in length less rapidly than under normal circumstances. This diminution of growth can hardly be explained in a direct mechanical way; we must consider it a response to the stimulus of pulling.

A confirmation of this conclusion is found in the fact that the effect of the pulling gradually wears off. Thus when one of a pair of seedlings of *Cannabis sativa* is subjected to a pull of 20 grammes, there is a retardation during the first day of 61% in the stretched plant as compared with the control plant; during the second day of 51%; during the third day of only 9%. (HEGLER, '93, p. 389.) In order that the retardation should continue, additional weight must be imposed; then an increased retardation occurs. Thus in one case HEGLER subjected one of two *Helianthus* seedlings to a pull of 50 grammes. During the first day the retardation of the pulled plant was 20%; during the second there was an excess of growth over the control of 17%; then 150 grammes were added; on the third day the retardation was 18%; on the fourth there was an acceleration of 2%. This series of phenomena is clearly like that which we have observed in locomotion — there is an accommodation of the growing protoplasm to the stimulus.

There can be little doubt that in the cases of diminished growth in length there is a thickening of the cell-walls and

probably an increase in cross-section of the whole stem. There is indeed considerable experimental evidence for this conclusion. Thus SCHENCK ('93) found that when stems are irritated by twisting or bending, an excessive growth both of cell-walls and of the wood as a whole follows. So, too, NEWCOMBE ('95) finds that roots become strengthened by attaching weights to them. In fact, if stems are deprived of their normal swaying movements, for instance by enclosing internodes in plaster casts which inhibit lateral movements and partly support the weight of the superior part of the plant, their walls remain abnormally thin.

These effects of deformation are of especial importance because they are so clearly not at all directly mechanical but adaptive; they are, indeed, rather opposed to the direct mechanical effects which would tend to stretch the cells, and thus to diminish the thickness of their walls. Here again the organism shows itself a highly irritable thing, capable of responding in an adaptive fashion.

4. **Local Removal of Tissue.** — When a protist, for instance a Stentor, is transected, certain changes take place along the cut surface. First, there is a warping of the edges towards each other; secondly, rapid growth (differential growth, page 287) occurs. Similarly, if a Hydra be cut lengthwise, the free edges may fold towards each other so as to form a smaller cylinder, and the seam, by growth, will be healed over. So, too, in the higher animals, the removal of a bit of tissue results usually in the closure of the wound and growth to fill the gap. We may call these two processes warping and regenerative growth.

The causes of these two processes are probably different. The warping seems to result from the presence of tensions and pressures in the tissues whose equilibrium is disturbed by the cut. This process is probably grossly mechanical. The regenerative growth, however, must have a less direct explanation. It is apparently a typical response to the stimulus of cutting, or of the new environment presented at the cut edge.

Here, too, may be mentioned an experiment by LOEB ('92, p. 51), which throws light upon the cause of these internal tensions. Below the crown of tentacles of a *Cerianthus* a

horizontal slit was made in the side of the body-wall. The tentacles over the slit contracted — there was a sort of negative growth. The shortening was doubtless due, as LOEB says, to the loss of water and consequently of turgescence in this part of the body-wall (Fig. 101). I have cut the body-wall of a hydroid immediately below an incipient bud, whereupon the bud at once flattened out. These experiments show how important water pressure is for the maintenance of the size of the body and for growth, and in so far explain the mechanical effect of a cut or other similar wound.

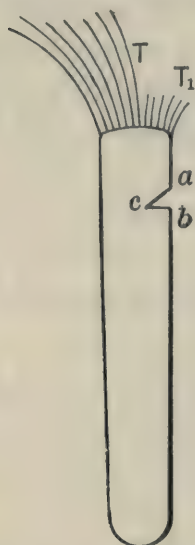

FIG. 101. — *Cerianthus*, from which a piece, *a, b, c*, has been cut, causing a loss of turgescence and consequent shrinking of tentacles on the cut side. (From LOEB, '92.)

§ 2. EFFECT OF CONTACT UPON THE DIRECTION OF GROWTH — THIGMOTROPISM

Having seen that molar agents can affect the rate of growth, we are in a position to understand how a molar agent, acting upon one side only of an elongated organ or plate of tissue, may induce a less or greater growth upon that side, and, consequently, a bending towards or from it. This turning phenomenon may now be considered. Before taking up the permanent growth turnings, however, we may consider a case of transitory growth, which throws valuable light upon the true nature of thigmotropism, and serves to connect it with thigmotaxis. This is the case of the pseudopodia of *Orbitolites*, which, according to VERWORN ('95, p. 429), float at first free in the water after being protruded through holes in the shell; but as soon as they grow longer and heavier they sink in the water, until their distal ends touch the substratum. To this they become attached by a delicate secretion, and grow out along it by the streaming of the protoplasm. The persistent clinging to the substratum is a thigmotropic reaction, and one which belongs clearly to the category of response.

1. **Twining Stems.** — The characteristic form of twining plants, like the bean, has long excited the interest of natural-

ists. A study of the cause of this form was made by PALM ('27), by MOHL ('27), and by DUTROCHET ('43, '44); and from this early period to the present there have existed on this matter great differences of opinion. On the one hand, there has been maintained a view that had great inherent probability, the view, namely, that the twining of plants is a response to the contact-stimulus of the object about which they are coiled. Against the general validity of this view certain experiments of DARWIN ('82, p. 16) seem conclusive. For he found that even the hard rubbing of the stalk caused no modification of the normal spiral growth. Accordingly, the conclusion seems generally accepted to-day that the peculiar form of growth of most twining plants is the combined result of geotropism, by which the stem grows upwards, and a special form of nutation, by which it impinges against the supporting stick and bends round it. The twining is thus mechanical,—depending upon the structure of the stem,—rather than responsive.

An exception among twining plants is found in the dodder, *Cuscuta*. This plant is a parasite, belonging to the *Convolvulus* family, and lives upon the flax and other plants. It is leafless, and twines closely about its host, into which it sends the feeding organs—the haustoria. According to the careful studies of PEIRCE ('94), the stem, when not in contact with any solid body, makes long, steep turns about the axis of the spiral, as is the case with other twiners. If now the free stem, during a period of slow growth, be brought into contact with a wooden or glass rod or a thread at about 3 cm. from the tip, the stem bends sharply, and in the course of 15 hours makes two or three close turns around the vertical support. If the contact be made at a distance of only about 1 cm. below the tip, there will be little or no change in the character of the twining. If the point of contact be too far below the tip,—6 to 7 cm.,—there will also be no effect. The result is thus clearly dependent upon a stimulus applied at a definite sensitive point; it is a typical response.

2. **Tendrils.**—Very similar to the phenomena of close twining in *Cuscuta* is that of coiling in the tendrils of phanerogams—those most marvellously sensitive of all plant structures. DARWIN ('82) and PFEFFER ('85), particularly, have

studied by experimental methods the movements of these organs. The conditions which induce the twining of tendrils are peculiar. It appears that tendrils are not irritated by mechanical shaking, such as is produced by a powerful current of air issuing from a narrow tube; nor by a drop or strong current of water, provided it contains no hard particles; nor even by a stream of mercury, or the surface of pure mercury or oil. All solid bodies, however, with the exception of moist gelatine, when rubbed against the stem stimulate it so as to produce a bending at the irritated point.

The behavior of moist gelatine is instructive. PFEFFER first observed that it was exceptional, and PEIRCE has found the same exception to hold for *Cuscuta*. PFEFFER'S experiments showed that, no matter how great the pressure or strokes made by drops of 5 to 14% gelatine, or by glass rods covered by a layer of moist gelatine, no response occurred; and PEIRCE ('94, p. 66) found that when the *Cuscuta* stem came in contact with a rod covered with wet gelatine it made only the long, steep turns characteristic of the free-growing stem. Later, when it reached the part of the rod not covered with gelatine, it formed at once a close, tight coil. That it is not the chemical composition of gelatine which prevents the twining is shown by the fact that dry gelatine, even to 25%, irritates; also, if some sand is mingled with the moist gelatine, tropism occurs. The fact that wet gelatine does not irritate is explained by PFEFFER upon the ground that the stimulus is not given by mere contact, for a blow does not produce it. A certain degree of adhesion between the tendrils and the irritating substance is necessary. The moist surface of the gelatine prevents such adhesion taking place. The effective irritation is a sort of tickling.

The degree of this tickling may, however, be extremely slight. Thus PFEFFER ('85, p. 506) placed a rider of cotton thread, weighing 0.00025 milligramme, on a tendril, and found that no effect was produced so long as it was quiet; whereas, when the rider was put in motion by a current of air, a considerable bending occurred. Under similar conditions, a thread weighing 0.00012 milligramme produced no reaction. MACDOUGAL ('96, p. 376) finds that a spider's web, 43 cm.

long, suspended above a tendril of *Echinocystis*, caused such a reaction that the tendril coiled around and fastened to it.

Concerning the *irritable region*, it appears that in most tendrils there is an especially sensitive side and an especially sensitive zone. The presence of a more irritable side is not a constant character of all tendrils, however. Thus, *Cobæa scandens*, *Cissus discolor*, and others, are irritable on all sides. When a differentiation in this respect occurs, however, a bending takes place towards the more irritable side. The sensitive zone lies either at the tip or immediately below.*

The *period of development* at which the tendril is most irritable must also be considered. Thus, DARWIN ('82, p. 174) says: "Tendrils which are only three-fourths grown, and, perhaps, even at an earlier age, but not whilst extremely young, have the power of revolving and grasping any object which they may touch. These two capacities . . . both fail when the tendril is full grown." PFEFFER ('85, p. 485) and MÜLLER ('86, p. 104) likewise find tendrils irritable only in the latter part of their growth-period.†

There are four periods in the response to a momentary stimulus: (1) a latent period elapsing before the curvature begins to take place; (2) a period of bending; (3) a period of quiescence in the bent condition; and, finally, (4) a period of

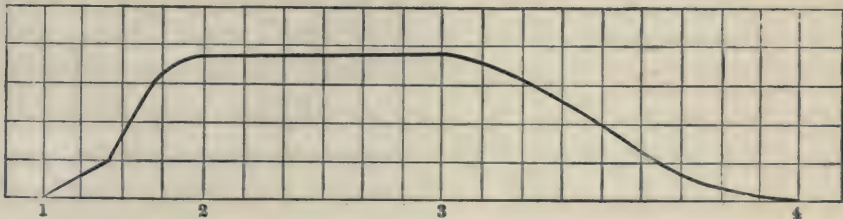

FIG. 102. — Curve of contraction of a tendril. The distance of the curve from the base represents the amount of displacement of the tip; one unit on the base-line represents five minutes of time; 1 to 2, latent period and period of contraction; 2 to 3, period of maintenance; 3 to 4, period of relaxation. (From MACDOUGAL, '95.)

* In *Cuscuta*, according to PEIRCE ('94, p. 64), the tip is non-irritable; the most sensitive zone is 3 cm. below the tip.

† In *Cuscuta*, PEIRCE ('94, pp. 63, 64) found that neither the stalk of seedlings nor of older plants, during the period of rapid growth which follows the formation of haustoria, are sensitive. Irritability shows itself only when growth becomes less rapid, as it does some time after forming haustoria.

straightening again. These periods are represented graphically in Fig. 102. The latent period is of variable length in different species. Perhaps the shortest period is that of *Cyclanthera*, which MÜLLER ('86, p. 103) found to vary in the most sensitive condition of the plant from 5 to 9 seconds. DARWIN ('82, p. 172) found a latent period in *Passiflora* tendrils of 25 to 30 seconds, while in other cases (*Dicentra smilax*, *Ampelopsis*) this period may be 30 to 90 minutes or more in length. The entire time required for the plant to straighten completely again is, according to MÜLLER ('86, p. 104), for *Cyclanthera* about 20 minutes. These times depend, however, to a large extent upon various external agents. Thus a quick response is favored by a temperature between 17° and 33° C., sunlight rather than shade, considerable humidity, and small size of tendril. Thus this growth response resembles, in its dependence upon various conditions, other responses, *e.g.* those of muscle, to stimuli.

3. **Roots.** — Thigmotropism in roots was apparently first investigated by SACHS ('73, pp. 437-439). He fastened germinating seeds of various species in a moist chamber so that their radicles, of about 10 to 30 mm. length, were horizontal. A pin was now placed against the root near its tip so as to exert considerable pressure. Usually within eight or ten hours a turning of the root in the growing region occurred so that it became concave towards the pin and finally made a complete loop about it, or, if the needle was vertical, descended along it in a spiral — a result of the double action of thigmotropism and geotropism. This response was, however, rather inconstant and appeared not to be very powerful.

The sense of the thigmotropic response was, in the foregoing example, positive; that is, the turning was towards the solid body. DARWIN ('81, p. 131) believed that he had evidence that the response is sometimes negative. Thus he says that the radicle of a germinating bean, coming in contact with a sheet of extremely thin tinfoil (0.003 to 0.02 mm. in thickness), was in one experiment deflected without making a groove upon it; also, when a piece of paper was gummed to the root near the tip, the root usually turned so that it became convex to the gummed paper. But DARWIN'S conclusion has not been

sustained by later work. Thus DETLEFSEN ('82) found that bean radicles plunged right through tinfoil 0.0074 mm. in thickness, and WIESNER ('84) and SPAULDING ('94) have shown that the turning from the gummed paper is the result of the injurious action of the gum. Indeed, it is difficult to see how a root, which must force its way through the earth, should turn from a solid surface. Experience shows rather that it turns towards it and tends to grow along it or through it.

4. **Cryptogams.** — Among Fungi a thigmotropic response has been observed and studied in the mold *Phycomyces nitens* by ERRARA ('84) and WORTMANN ('87). They find that rubbing the sporangiferous hypha lightly with a bristle or glass thread for from three to six minutes will produce a response more powerful even than that to light. As with tendrils, 7% to 14% gelatine, almond oil, and water drops provoke no bending; but, on the other hand, even the mutual rubbing of two adjacent sporangiferous hyphæ may incite a response. The response will, however, appear only when the growing region of the hypha is irritated; if the hypha is fully grown, no thigmotropism will take place. The sharpest part of the bend will occur at the region of greatest growth, not necessarily at the point of contact. However, WORTMANN finds that the turning commences at the point of contact, but becomes more and more pronounced as the bend approaches the most rapidly growing part of the hypha. The response to a brief contact is only temporary. Thus when a sporangiferous hypha 2.3 cm. long was touched for one minute with a glass thread a bending began to appear after 15 minutes and disappeared 10 minutes later. Thus *Phycomyces* follows closely the laws of response of tendrils.

The rhizoids of the hepatic *Marchantia* and its allies have been found by MOLISCH ('84, p. 933) to behave in a similar way to the foregoing. When the hepatics are placed on damp filter-paper, over a watch-glass, in a moist chamber and in the light, one finds after 48 hours that rhizoids have penetrated through the filter-paper. Since the paper reveals, even to the microscope, no pores, and since grains of corn starch, of from 2 to 24 microns diameter, will not pass through it, we must conclude that the root hairs of 10 to 25 microns diameter, although

consisting of only a single cell, have the power of forcibly boring their way between the fibres of the paper. This phenomenon is most easily accounted for on the ground of response to contact.

5. **Animals.** — The phenomenon of thigmotropism is exhibited among animals in the power of growing along an irregular substratum. Thus the stolons of hydroids, Bryozoa, and some compound ascidians, upon once gaining the surface of an appropriate substratum, cling closely to it without reference to the direction, up or down, which the substratum may take. It is not necessary that the surface should be a rough one; the surface film of water may incite the response. More striking is the direction of growth of regenerating hydroid stems, according to the observations of LOEB ('91, p. 18). This experimenter found that when pieces are cut from a stem of *Tubularia* and are so placed in a cylindrical glass vessel that the lower end lies buried in the sand while the upper end is in contact with the side of the vessel, then, regeneration of the hydranth occurring, the new growth is perpendicular to the surface of the vessel, *i.e.* horizontal. This direction is independent of the direction of light rays, since it occurs at all parts of the circumference of the vessel; nor is it a response to gravity, since the stems normally assume a vertical position. The phenomena are, in so far, exactly like those in plants.

The experiments made upon plants suggest a series which might be made upon animals. Do stolons exhibit nutations to aid in the finding of the solid substratum? What substances call forth the thigmotactic response? Will a momentary irritation cause turning? The field of thigmotropism, like that of the other tropic phenomena of sessile animals, is an imperfectly worked one.

6. **The Accumulation of Contact-Stimulus and Acclimatization to it.** — These two phenomena accompanying contact-stimulation must be alluded to. PFEFFER ('85, p. 506) pointed out that a soft blow which calls forth no response when given once, will produce bending when given repeatedly for several minutes. The basis for an explanation of this phenomenon is given by an observation of DE VRIES ('73, p. 307), who withdrew the support from a tendril which had already turned

through 45° as a result of contact irritation. The tendril continued to bend at the previously irritated point even after the irritant had been removed. Thus a stimulated condition persists after the removal of its inciting cause, and this gives a chance for the building up of a powerfully stimulated condition by the accumulation of slight stimuli.

The persistence of the stimulated condition is revealed by another set of changes. PFEFFER found that the tendrils of *Sicyos* when repeatedly rubbed at short and regular intervals first coil and then gradually straighten out. DARWIN ('82, p. 155), who had previously shown this same thing, found also that after a tendril of *Passiflora gracilis* had been stimulated 21 times in 54 hours it finally hardly responded at all. Similar results have been obtained with *Drosera* hairs (PFEFFER, '85, p. 514). Thus the constantly repeated stimulation produces such a modification of the protoplasm that it eventually fails to respond. On the one hand, this phenomenon is the same as that of fatigue; on the other, it resembles closely the condition seen in stimulated *Protista* referred to in Chapter IV, § 3, and there designated as acclimatization.

7. **Explanation of Thigmotropism.** — Concerning the cause of the bending of plants as a result of contact, I know of no better explanation than that offered by SACHS ('87, pp. 697–699). He ascribes the bending to a difference in the rate of growth on the two sides of the bending cylindrical organ. This is indicated by the fact that it is chiefly in the region of “stretching” that the response occurs; *i.e.* shortly behind the apex. At the very tip, growth by assimilation is chiefly occurring; below the region of stretching, growth is occurring only slowly. The measurements of DE VRIES ('73) have, however, shown directly that the convex side of the tendril grows faster than the straight tendril and the concave side less rapidly. The convex side thus pushes still farther over the concave, producing the coiling. As the region of stretching is one of imbibition of water, we conclude that more water is taken in on the convex side than on the concave, where even a loss of water may occur; or perhaps there is a movement of water from the irritated towards the opposite side. The irritant then produces a chemical change on one side of the organism such as to cause

a movement towards that side or from that side according as the organ is positively or negatively thigmotropic.

§ 3. EFFECT OF WOUNDING UPON THE DIRECTION OF GROWTH — TRAUMATROPISM *

Under this head may be considered the effect of a special class of molar agents, namely, those which produce a wound, upon the direction of growth of roots. We may consider first false and then true traumatropism.

1. **False Traumatropism.** — When the growing tissue of the radicle of a seedling is destroyed on one side by caustic or heat,

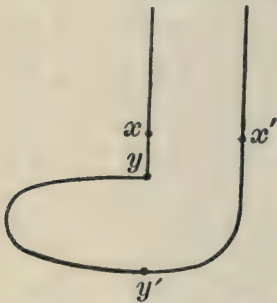

FIG. 103. — Diagram of a root tip, illustrating false traumatropism: xy , region of wounding. The line $y-y'$ ran originally parallel to the line $x-x'$, but by growth has been brought to make an angle of 90° with it.

the radicle turns towards that side (CIESIELSKI, '72; DARWIN, '81; SPAULDING, '94). This result is satisfactorily explained on the ground that the killing of the growing tissue on one side causes a retardation or cessation of growth on that side; so that, while the points x, y (Fig. 103), remain nearly stationary, the points x^1, y^1 , opposite to them, grow widely apart. It will be seen at once that this bending belongs to a wholly different category from the thigmotropic curvatures described in the last section. It is, as DARWIN called it, a mechanical bending; it is a false traumatropism.†

2. **True Traumatropism.** — Of widely different cause from the foregoing is the turning due to slight wounding which has been investigated by CIESIELSKI ('72), DARWIN ('81), DETLEFSEN ('82), WIESNER ('84), and SPAULDING ('94). DARWIN irritated the radicle of a bean by touching it near the apex with dry caustic (nitrate of silver). The point of wound-

* From Greek, *τραῦμα*, a wound.

† A phenomenon allied to this is seen when at an early stage one half of a frog embryo is killed and, consequently, remains of small size; the larger, growing, side soon comes to bend around the smaller, dead, side. A fuller account of these experiments, made by Roux and others, upon the frog's egg, must be postponed to the next Part of this work, since it is complicated by the phenomenon of regeneration.

ing appeared as a small, dark spot on one side of the radicle. The seedlings were then suspended in a moist chamber, over water, and at a temperature of 14.4° C. After 24 hours almost all of the radicles showed a marked curvature from the wounded side. Other means can be used to produce this result: a thin slice cut off obliquely from the tip of the radicle, a drop of shellac, of copper sulphate, of potassium hydrate, or steam at about 95° C. (SPAULDING) — in general, any agent which irritates strongly without killing.

Concerning the place on the root where the injury must be made in order that a response should appear, SPAULDING finds that if the branding is made further from the apex than 1.5 mm. no traumatic curvature will occur; or if an oblique cut at the apex should not involve the growing root tip, as at *ab*, Fig. 104, it is without effect. So

it seems that the proliferating root tip is the sensitive part.

The point of maximum curvature is, however, not at the root tip, but lies in the region of most rapid growth. The length of time

elapsing between injury and response varies with the species and with the temperature. Thus, at a temperature of 18° C. the curvature begins in from 45 to 55 minutes, and reaches a maximum within 24 hours (WIESNER).

The long, latent period and the slowness of complete response give an insight into the reason for this separation of the perceiving and responding zones. During the latent period the irritated tissue is becoming stretching tissue through the imbibition of water, while the root tip is becoming generated in advance, leaving

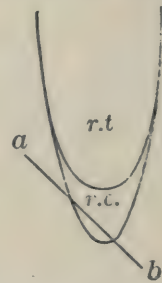

FIG. 104. — Diagram showing the relations of the root tip, *r.t.*, and the root cap, *r.c.*; *a, b*, line of a cut which involves only the root cap.

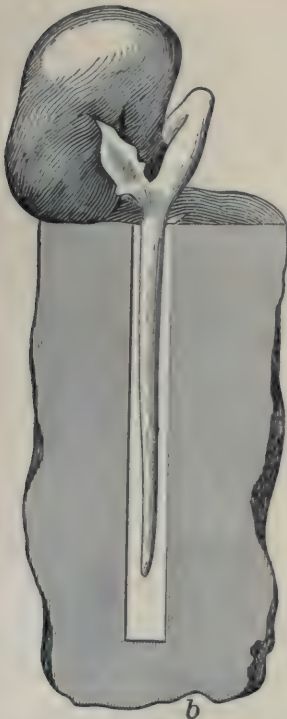

FIG. 105. — Median longitudinal section through a gypsum cast, *b*, surrounding and repressing a root of *Vicia faba*. Natural size. (From PFEFFER, '93.)

the irritated protoplasm behind. This can be demonstrated if (following PFEFFER, '93) the freshly irritated radicle is confined in a plaster cast (Fig. 105). The growth of the tip is slackened so that it does not leave the irritated tissue far behind; at the same time, the zone of stretching encroaches upon the root tip, so that, if the radicle is released after several days, the curvature, although taking place, occurs abnormally near the tip. If the response were transmitted a fixed distance backward from the tip, we should expect that in the confined plant either the turning would take place at the normal position or would altogether fail to occur. Since neither of these effects follows, the conclusion is strengthened that the identical plasm which is irritated responds, producing the traumatic curvature.

Temperature, controlling as it does the rate of growth, controls the length of the latent period. According to the observations of WIESNER, this is at —

TEMPERATURE.	IN DAMP CHAMBER.	IN WATER.
8.0° C.	438 min.	393 min.
17.5° C.	87	52
25.0° C.	37	28
33.0° C.	58	70

Thus, 25° C. seems to be about the optimum temperature for the traumatropic response; and this is a temperature 10° to 12° below the optimum for protoplasmic movements (Chap. VIII, § 2).

The true explanation of traumatropism remains, after prolonged discussion, uncertain. DARWIN regarded it as a response to stimulation, but DETLEFSEN and WIESNER sought to show that it is the immediate mechanical result of the injury. Thus, DETLEFSEN assumed tensions in the root cap, which caused the root when cut on one side to shorten on the other; but this conclusion was disproved by SPAULDING, who found that the usual results do not follow when the root cap is injured without injuring the root tip. WIESNER'S explanation was based on the observation that decapitated roots grow more

rapidly in water than normal ones. In like manner, if the root is, as it were, half decapitated, by cutting the tissue on one side, an abnormally rapid growth will take place on that side, proximal to the injury. The reason for this more rapid growth, continues WIESNER, is that the nutritive fluids intended for the tip are prevented by the injury from attaining the tip, and, consequently, go to build up the cell-walls above the wound. While the possibility of this explanation cannot be denied, the facts are not opposed to another interpretation, such as is offered by SPAULDING, and which is more in accord with the explanations of other tropic phenomena. This explanation is that the wounding produces a chemical change in the protoplasm of one side of the root, such that growth occurs more rapidly upon that side, either as a result of increased upbuilding of cell-walls or of increased imbibition of water, or of both.

§ 4. EFFECT OF FLOWING WATER UPON THE DIRECTION OF GROWTH — RHEOTROPISM

When the radicle of a bean is suspended by the cotyledons above a stream of flowing water, so that it lies in the axis of the current and points down stream, the free end, as it grows, gradually turns, and becomes directed up stream. It turns against the current.

This remarkable phenomenon, named rheotropism by its discoverer, JÖNSSON ('83, p. 518), has been carefully studied by him by the following method: The stream, whose rate could be controlled at will, flowed in a trough. Over the current, seedlings of maize and other grains, with well-developed radicles, were suspended so that the radicles lay in the axis of the current, and were directed either up stream or down as desired. When the rootlets were directed down stream, a turning began, after a latent period of several hours, and reached its final position in the current in about twenty hours. If the rootlet was originally directed up stream, it simply grew straight ahead until mechanically bent out of position by the impact of the water. By directing a rootlet alternately down stream and up stream after each rheotropism has occurred, the whole root may become very zigzag. These facts show clearly that cer-

tain radicles are sensitive to the impact of water, so that they turn in such a way that the irritant shall affect their two sides equally, and shall be directed against the tip. While the precise part of the radicle which is sensitive to the current has not been determined, the responding part is in the region of greatest growth, and the response is such that the root becomes concave towards the irritant.

Among animals, a response which probably belongs to this category has been observed by LOEB ('91, p. 36) in the growing stem of the hydroid *Eudendrium*. In a vessel of water in which all other hydranths turned towards the light, there was one which rose near the cloacal opening of an ascidian, from which strong currents of water passed. This individual was turned with its concave side towards the impinging current. It is probable that the current had induced a rheotropic response.

SUMMARY OF THE CHAPTER

The rate of growth of the entire organism or of its organs is accelerated by contact, as in the stolons of hydroids; by rough movement, as in bacteria; by cutting—when accelerated growth occurs along the cut surface. Growth in length may be retarded by pulling, as in stems and roots. Many organisms show themselves very sensitive in their growth to mechanical irritation.

The direction of growth is determined by external agents, acting as irritants, in the cases of the twining dodder, tendrils in general, roots, the hyphæ of *Phycomyces*, the rhizoids of hepatics, and the hydranths of various hydroids. Wounding may cause a turning from the wounded side in the radicle of a seedling, and radicles and hydroids may even grow so as to face the current.

The sensitiveness to contact may be excessively great, a swinging cotton rider weighing 0.00025 mg. causing a tendril to bend. This sensitive region varies from near the tip in roots to some distance behind the tip in the case of tendrils. The response may occur after seconds, as in *Cuscuta*, or after hours, as in traumatropism of radicles. The bending usually reaches a maximum at the region of greatest growth. The

stimulated condition persists for some time after irritation, so that a summation of effects may occur. An acclimatization to contact may appear, when no response is invoked by the irritation. The thigmotropic response may be explained, in general, as due to a chemical change, wrought by the one-sided impact, such as to cause a disturbance in the equality of the growth processes — assimilation, secretion, or imbibition — on the two sides of the organ.

 LITERATURE

- BARANETZKY, J. '79. Die tägliche Periodizität im Längenwachsthum der Stengel. *Mém. de l'Acad. de St. Petersb.* XXVII. 91 pp.
- BUCHNER, H. '80. Ueber die experimentelle Erzeugung des Milzbrandcontagiums aus den Heupilzen. *Sb. k. bayer. Akad. München.* X, 368-413.
- CIESIELSKI, T. '72. Untersuchungen über die Abwärtskrümmung der Wurzel. *Beiträge zur Biologie der Pflanzen.* Band I, Heft II. pp. 1-30. Taf. I.
- DARWIN, C. '65. On the Movements and Habits of Climbing Plants. *Jour. Linn. Soc. (Bot.).* IX, 1-118.
- '82. *The Movements and Habits of Climbing Plants.* 208 pp. 3d thousand. London, 1882. [Date of first edition, 1875.]
- DARWIN, C. and F. '81. *The Power of Movement in Plants.* 592 pp. New York, 1881.
- DETLEFSEN, E. '82. (See Chapter XII, Literature.)
- DUTROCHET, H. '43. Des mouvements révolutifs spontanés qui s'observent chez les végétaux. *Ann. Sci. Nat.* XX (Bot.), 306-329.
- '44. Recherches sur la volubilité des tiges de certains végétaux et sur la cause de ce phénomène. *Ann. Sci. Nat.* II (Bot.), 156-167.
- ERRARA, L. '84. Die grosse Wachstumsperiode bei den Fruchtragern von *Phycomyces*. *Bot. Ztg.* XLII, Nos. 32 to 36. Aug., Sept. 1884.
- HEGLER, R. '93. Ueber den Einfluss des mechanischen Zugs auf das Wachsthum der Pflanze. *Beiträge z. Biol. d. Pflanzen.* VI, 383-432.
- HORVATH, A. '78. (See Chapter IV, Literature.)
- JÖNSSON, B. '83. (See Chapter IV, Literature.)
- LEONE, T. '85. Sui microorganismi delle acque potabili. *Atti della R. Accad. Lincei* (4) *Rencond.* I.
- LOEB, J. '91. Untersuchungen zur physiologischen Morphologie der Thiere. I. Ueber Heteromorphose. Würzburg, 1891.
- '92. (See Chapter X, Literature.)
- MACDOUGAL, D. T. '96. The Mechanism of Curvature of Tendrils. *Ann. of Bot.* X, 373-402. April, 1896.
- MELTZER, S. J. '94. (See Chapter IV, Literature.)

- MOHL, H. v. '27. Ueber den Bau und das Winden der Ranken und Schlingpflanzen. Tübingen, 1827.
- MOLISCH, H. '84. (See Chapter XII, Literature.)
- MÜLLER, O. '86. Untersuchungen über die Ranken der Cucurbitaceen. Beiträge z. Biol. d. Pflanzen. IV, 97-144.
- NEWCOMBE, F. C. '95. The Regulatory Formation of Mechanical Tissue. Bot. Gazette. XX, 441-448. Oct. 1895.
- PALM, L. H. '27. Ueber das Winden der Pflanzen. 101 pp. 3 Tab. Stuttgart, 1827.
- PEIRCE, G. J. '94. A Contribution to the Physiology of the Genus *Cuscuta*. Ann. of Bot. VIII, 53-117. Pl. VIII. March, 1894.
- PFEFFER, W. '85. Zur Kenntniss der Kontaktreize. Unters. a. d. bot. Inst. Tübingen. I, 483-535.
- '93. Druck und Arbeitsleistung durch wachsende Pflanzen. Abh. sächs. Ges. d. Wiss., Leipzig. XX, 235-474.
- REINKE, J. '80. Ueber den Einfluss mechanischer Erschütterung auf die Entwicklung der Spaltpilze. Arch. f. d. ges. Physiol. XXIII, 434-446.
- RUSSELL, H. S. '92. The Effect of Mechanical Movement upon the Growth of Certain Lower Organisms. Bot. Gazette. XVII, 8-15. Jan. 1892.
- SACHS, J. '73. Ueber das Wachsthum der Haupt- und Nebenwurzeln. Arb. Bot. Inst. Würzburg. I, 385-474.
- '87. (See Chapter X, Literature.)
- SCHENCK, H. '93. Ueber den Einfluss von Torsionen und Biegungen auf das Dickenwachsthum einiger Lianen-Stämme. Flora. LXXVII, 313-326.
- SCHMIDT, B. '91. Ueber den Einfluss der Bewegung auf das Wachsthum und die Virulenz der Mikroben. Arch. f. Hygiene. XIII, 247.
- SCHOLTZ, M. '87. Ueber den Einfluss von Dehnung auf das Längenwachsthum der Pflanzen. Beitr. z. Biol. d. Pflanzen. IV, 365-408.
- SPAULDING, V. M. '94. The Traumatropic Curvature of Roots. Ann. of Bot. 423-452. Pl. XXII. Dec. 1894.
- TUMAS, L. '82. Ueber die Bedeutung der Bewegung für das Leben der niederen Organismen. Medic. Wochenschr. 1882. No. 18. St. Petersburg.
- VERWORN, M. '95. Allgemeine Physiologie [1st Aufl.]. 584 pp. Jena, 1895.
- DE VRIES, H. '73. Längenwachsthum der Ober- und Unterseite sich krümmender Ranken. Arb. Bot. Inst. Würzburg. I, 302-316.
- WIESNER, J. '84. Untersuchungen über die Wachsthumsbewegungen der Wurzeln. Sb. k. Akad. Wiss. Wien. LXXXIX¹, 223-302.
- WORTMANN, J. '87. Zur Kenntniss der Reizbewegungen. Bot. Ztg. XLV, 785 et seq. Dec. 1887.

CHAPTER XV

EFFECT OF GRAVITY UPON GROWTH

§ 1. EFFECT OF GRAVITY UPON THE RATE OF GROWTH

IT is a result of the sessility of the higher plants that they and their parts are acted upon continuously in one direction by gravity. It might consequently be suspected that the rate of their growth would be affected if they were placed in an abnormal position with respect to this agent. In the experiments which have been made to test the correctness of this suspicion various methods have been employed. When the growth of *Penicillium* which is removed from gravity's action by being slowly revolved on a klinostat is compared with that of a plant under normal conditions, the former is found to be more rapid. The plant seems to reap an advantage from not having to sustain its own weight (RAY, '97). When *Phycomyces* is inverted, its growth is slower than in the normal position (ELFVING, '80). These two experiments upon fungi indicate a considerable sensitiveness on their part to gravity. Experiments made by ELFVING ('80) and SCHWARZ ('81), upon the growth of inverted phanerogams and those from which the action of gravity had been eliminated by the slowly rotating klinostat, as well as those which had been subjected to excessive pressure by the centrifugal machine, yielded for the most part only negative results. Upon the rate of growth of seedlings gravity has little effect.

§ 2. THE EFFECT OF GRAVITY UPON THE DIRECTION OF GROWTH — GEOTROPISM

As with contact so with gravity two classes of effects may be distinguished, which, while often producing similar results, bring them about through very dissimilar processes. The first of these is a mechanical effect due to gravity acting upon the

growing organ as it might upon any other heavy body. The second is a vital effect, having no immediate, direct, physical relation to the cause. The first may be called false geotropism; the second, true geotropism.

1. **False geotropism** may be treated very briefly, since it is not a true growth phenomenon. As an example of such geotropism may be cited the downward bending of the top of a stem heavily laden with a head of seed or with fruit, or the upward growth of the long fronds of kelp in the sea on account of the buoyant effect of the dense sea water. In such cases the direction of the growth can be accounted for upon well-known principles of hydrostatics.

2. **True Geotropism.**—The biological effect, on the other hand, which is seen in true geotropism is often opposed to the gross physical one. It shows itself especially in various groups of sessile plants and animals. Since, unfortunately, comparatively few experiments have been made upon geotropism in animals, the great mass of our knowledge on this subject is derived from studies on plants.

The general fact of geotropism strongly impresses one who stands on the shore of a lake in our northern country and looks across to the dense pine forest on the opposite side. The landscape is composed of vertical and horizontal lines—vertical lines below formed of close-set trunks of trees, horizontal lines above formed of the great branches. If at one side a steep slope ascends, its outline is obscured by the grill-work of perpendicular lines formed by the vegetation which clothes it. Here the effect—the dissimilar effect—of gravity in determining the direction of growth of two organs, trunk and branch, is seen. There are, however, still other organs which may respond to the same stimulus. Among these are the roots, flower stalks, and leaves of phanerogams; the vertical parts of many vascular cryptogams; the sporiferous hyphæ of fungi and some vertical algæ, *e.g.* Chara. There is no need to examine all these cases of geotropism, but only such of them as will help us to get at the principles of the action of gravity in determining the direction of growth.

a. Roots.—When a seedling is so placed that its radicle is horizontal, the radicle does not continue to grow out in the

same direction; but all additional growth is vertical so that the radicle bends sharply downwards—it is positively geotropic. The curvature does not take place at the very tip of the root,—in the region of growth by assimilation,—but immediately behind in the region of stretching or of growth by imbibition. The precise region at which the curvature occurs was determined by CIESIELSKI ('72), by means of a method illustrated in Fig. 106. It is here seen that the maximum bending occurs in this radicle at between 3 and 4 mm. from the tip. It is also plain that the geotropic curvature is in some way connected with growth—could not occur without growth.

To show that the normal vertical growth of a root is due to the pressure of gravity, KNIGHT, in 1806, determined experimentally that the direction of its growth can be determined by other pressures replacing gravity, such as centrifugal force. Thus when seedlings were attached to the rim of a wheel and this was made to rotate rapidly about a horizontal axis the radicles grew straight outward from the axis; thus in the sense in which the centrifugal pressure acted, as before they had grown in the sense of the pull of gravity.

A second method of proof, employed by SACHS ('79), consisted in eliminating the effect of gravity by means of the klinostat (Chapter V, § 1), under which circumstances the root grew irregularly. Such results leave no room for doubt that it is gravity which determines the verticality of the root.

The question now arises, in what way does gravity control the direction of growth of this organ? An early suggestion was that the action was direct, due to the relatively great specific gravity of the root tip; but this idea was easily refuted by a mass of evidence. Thus it is not, *a priori*, easy to see

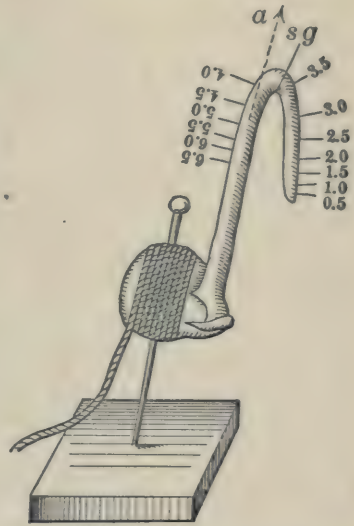

FIG. 106.—An originally straight radicle of the pea, graduated in 0.5 mm. spaces and placed nearly vertically with its apex directed upwards in the direction of *a*, has turned downwards in the zone of greatest growth at between 3.5 and 4 mm. from the tip. (From CIESIELSKI, '72.)

how the mere weight of the tip of the plant, supported as it is by the firm soil, should enable it to find its way down. Experiments, also, have shown that the radicle will curve downwards against considerable resistance such as is afforded by the surface of a cup of mercury, by a weight which is lifted by means of a thread passing over a pulley (JOHNSON, '29), or by a delicate spring which is compressed by the down-curving radicle (WACHTEL, '95). By these various methods it has been demonstrated that the down-curving of the geotropic radicle is an active process capable of overcoming resistance amounting, in one case, to 150 milligrammes. Consequently gravity does not act in a grossly mechanical way, but as a stimulus inciting a growth response.

If now the down-curving of the root is a response the question arises, where is the stimulus received; at the region of curvature or at some other point? This is a question which has excited much discussion, owing to apparent contradictions in the experimental evidence. The first attempt to answer this question was made by CIESIELSKI * ('72), who cut off the terminal one-half millimeter of the radicle, placed the rootlet in a horizontal position, and found that, although growth continued, no down-curving occurred until, after several days, the root tip had regenerated. He concluded that the root tip is useful or necessary in geotropism. SACHS ('73, p. 433) repeated CIESIELSKI'S experiments and likewise found an incomplete exhibition of geotropism. But this he attributed to the excessive irritation of the cutting, which led to exaggerated movements of nutation, tending to obscure geotropism. DARWIN ('80) confirmed CIESIELSKI'S results after both cutting off the root apex and cauterizing it, and explained SACHS' partial failure to get like results on the ground that he did not amputate the radicles in a strictly transverse direction. DARWIN concluded that the "tip of the radicle is alone sensitive to geotropism, and that when thus excited it causes the adjoining parts to bend." The exact length of the sensitive part seems to vary with certain conditions, but it is generally less

* HARTIG ('66, p. 53) had already stated that the decapitated root was not geotropic.

than 1 to 1.5 mm. This terminal millimeter or so, then, acts like a sense organ in a vertebrate, which receives the sensation at some distance, it may be, from the responding organ.

From this time on, two schools may be distinguished, of which the first, following DARWIN, regarded the stimulus as received at the root tip and transmitted to the region of growth; while the second conceived the stimulus to act directly upon the root in the bending region and to arise from the difference in the pressures on the upper and lower surfaces of the radicle. The second school persistently denied the validity of the decapitation experiments, WIESNER ('81) in particular maintaining that decapitation inhibited growth and consequently growth curvatures, but did not necessarily remove the sensitive organ. The first school was forced to new experiments. FRANCIS DARWIN ('82) maintained on the basis of such experiments that it is not the cutting *per se* which inhibits geotropism; for the cutting of the root tip, as for example, lengthwise, without its removal, permits the normal response. But it was easy to reply to this that a transverse cut might well affect growth more seriously than a longitudinal one.

The satisfactory solution of this difficulty required a method by which, without mutilating the root, gravity should act horizontally upon the chief growing part of the root without so acting upon the root tip. A method for accomplishing this was invented by PFEFFER ('94). A radicle of a bean or other species, fixed to a klinostat, was made to grow into a small glass tube, closed at its further end and bent so as to form two arms, at right angles to each other, and each about 1.5 to 2.0 mm. long. The preparation was now turned until the root tip was directed vertically downwards, while the rest of the root, and especially its chief growing region, was horizontal (Fig. 107). This region was then subjected to the full transverse action of gravity, while the tip was not so acted upon. Meanwhile the normal growth processes were not interfered with, for as the root lengthened it backed out, so to speak, from the bent tube, the apex remain-



FIG. 107. — Diagram illustrating the method employed in PFEFFER's experiment.

ing at the blind end. Under these conditions no geotropic curvature occurred; but such curvature always took place when the root tip was placed horizontally or at any acute angle with the horizon. This experiment seems, then, better fitted than any previous one to prove that the geotropic sensitiveness of the root resides in the apex.* Consequently, since, as an inspection of Fig. 106 will show, the curving part of the root can contain none of the originally irritated cells, there must be a transmission of stimuli from the root tip to the curving region.

Two associated phenomena remain to be considered. First, geotropic response is more powerful, the bending becomes stronger, as the angle made by the root with the vertical increases, reaching a maximum when the root is horizontal (SACHS, '73, p. 454). Secondly, as already indicated, response does not take place immediately after the root is placed horizontally. In one experiment of SACHS' ('73, p. 440) a bean radicle placed horizontally and growing in loose earth at 20° C. began to turn downwards in the second hour. There is thus a considerable latent period.

The cause of geotropism in roots is indicated by the conditions of its occurrence already mentioned. It is intimately associated with growth, yet, as KIRCHNER ('82) has shown, it may occur at a temperature (2° to 3.5° C.) at which growth is extremely slow. The turning is clearly due to unequal growth upon the convex and concave sides of the root. But is it due to acceleration on the convex side over the normal, to retardation on the concave side, or to both? Measurements have been made upon plants to decide this question. In one set of such measurements made upon the bean radicle by SACHS ('73, p. 463) the growth was hastened about 3% on the convex side and retarded 42% on the concave side, so that both acceleration and retardation occur.

Finally, lateral roots which run more or less obliquely downwards have been shown by SACHS ('74) and others to be influenced by gravity; for, if the plant be inverted, the roots will turn until they assume their normal inclination to the horizontal plane.

* But species may differ in this respect as in phototropism (see page 441).

b. Stems. — The central fact that the upward growth of stems is determined by gravity is established by the observations that on the klinostat no definitely directed growth occurs, and that on the centrifugal machine the stem turns in the opposite sense to that of the centrifugal pressure. The stem is negatively geotropic. As with roots, so with stems, a number of questions now arise: Where is the sensitive region and where the response? At what inclination of the stem is the strongest geotropic curvature called forth? What is the immediate cause of the curvature?

As Fig. 108 shows, the response of the stem of a seedling is fundamentally different from that of the radicle. Instead of the tropism beginning at one point, and continuing there as in the root (Fig. 106), it begins close below the cotyledons of the seedling and passes downwards towards the base as far as growth is still occurring. Response, consequently, takes place along the whole "stretching" region. The sensitive region also, unlike that of the root, is not confined to the tip, but extends along the entire bending stem.

The position in which the strongest response is incited was believed by SACHS ('79^a, p. 240) to be the horizontal one, and BATESON and DARWIN ('88) have confirmed this conclusion. Their method depends upon the fact that a stem placed horizontally and restrained for several hours from taking the vertical position will, upon being released, suddenly spring upwards. In using this method it was found that the stem springs through a greater arc after having been

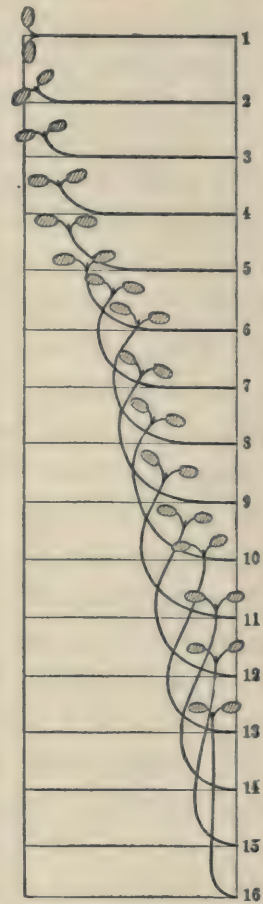

FIG. 108. — Course of geotropism in a plumule. The successive figures 1 to 16 indicate successive stages in the geotropic turning of a seedling growing in half darkness. Placed at first horizontal as at 1, the plant has become completely erect at 16. The most rapid growth is just behind the cotyledons and diminishes toward the base. The temporary bending beyond the vertical is to be noted. (From STRASBURGER, NOLL, SCHENCK, and SCHIMPER, *Textbook of Botany*, Macmillan.)

restrained for two hours in a horizontal position than if restrained in any oblique position, whether the tip be directed up or down.

Concerning the cause of the curvature there is little to add to what was said under "Roots." The remote cause is apparently the dissimilar action of gravity on the upper and the under sides of the stem; the immediate cause is the difference in growth on the two sides of the stem. In the special case of stems with knots, the knots show themselves especially responsive to the geotropic stimulus.

c. Rhizoma. — These horizontally running, root-like, subterranean stems are strikingly responsive to gravity, as ELFVING ('80), especially, has shown. He has reared various rushes in a glass box with their axes making various angles with the vertical. In their subsequent growth all the rhizomes of the plants extended in a strictly horizontal direction. In this case any component of gravity, however small, running in the direction of the axis of the rhizome seems to irritate. The curving into a horizontal plane may be called transverse geotropism (diageotropism, FRANK).

d. Cryptogams. — We have already seen (p. 391) that the sporangiferous hyphæ of *Phycomyces nitens* are negatively geotropic. The same is true of certain algæ. Thus RICHTER ('94) has found that when the stem of *Chara* is inverted the youngest two or three internodes curve upwards in their further growth so that the apex of the stem is now directed zenithwards. On the other hand the rhizoids of this species are positively geotropic. Rotation experiments show that in the absence of the directive pressure of gravity there is no definite orientation. Finally, some mosses are slightly geotropic. Thus, BASTIT ('91) reared *Polytrichum juniperinum* in the dark in both air and water, some plants being placed right side up, others inverted. In both cases new branches budded from the roots and, although etiolated, grew irregularly upwards — there was a feeble negative geotropism.

e. Animals. — Since only sessile organisms can be expected to show marked geotropism, this phenomenon among animals must be confined to rather few groups. It has been studied hitherto exclusively in the group of hydroids. Many repre-

sentatives of this group show themselves, however, markedly responsive.

The first observations upon geotropism in hydroids seem to have been made by LOEB ('91^a, pp. 27, 28). He says: "When a stolon was formed at the cut end of a vertical stem (of *Aglaophenia*) it grew (in case it did not come in contact with a solid body) first a short distance horizontally, and then downwards. In horizontal stems the stolon grew directly down-

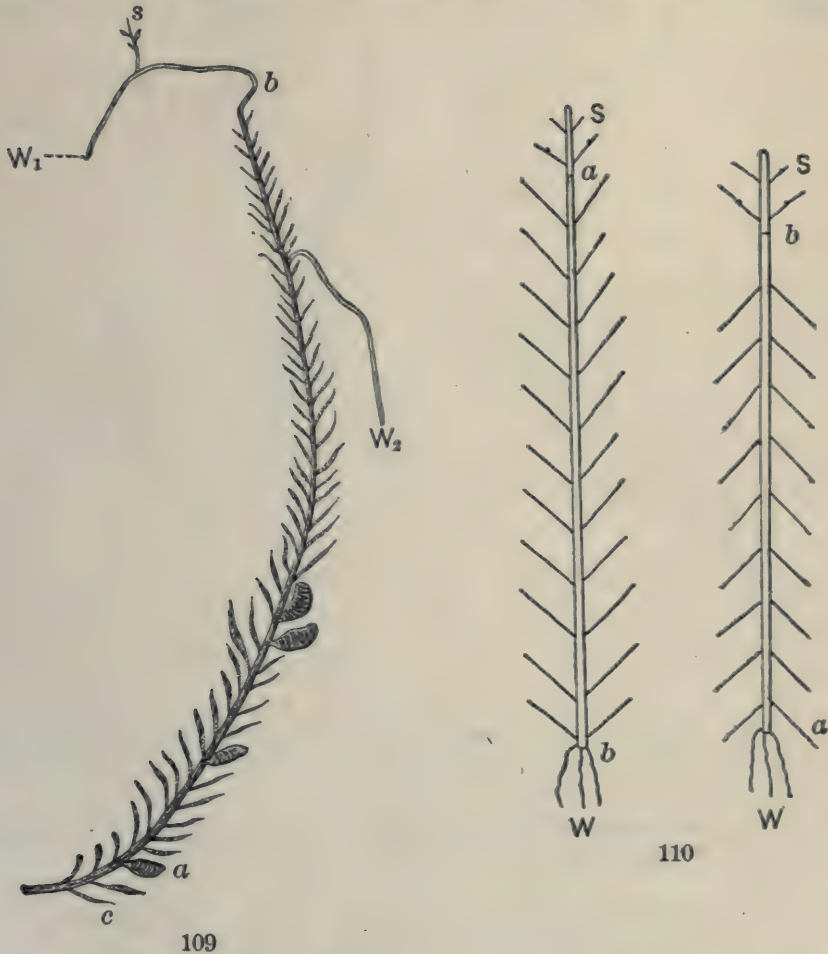

FIG. 109. — Positive geotropism of regenerated stolons (*W*₁, *W*₂) and negative geotropism of regenerated hydranths of *Aglaophenia pluma*. The original piece of the stem is included between *b* and *c*. This piece was placed vertically, right end up, in the aquarium. At the cut end, *b*, the stolon (*W*₁) has arisen, but has soon begun to grow downwards. It has produced a vertical hydranth at *s*. *W*₂, an adventitious stolon. (From LOEB, '91^a.)

FIG. 110. — Two bits of regenerating stems of *Antennularia antennina*. The one at the left is in the normal position; that at the right is inverted. From both, new hydranths (*S*) have developed at the upper end, and new stolons (*W*) at the lower end. (From LOEB, '92.)

wards." "Adventitious stolons grew directly downwards towards the earth. This was most noteworthy when such adventitious stolons arose from a reversed stem (with the apex down) sticking in the sand; under these circumstances the stolon grew towards the apex. These descending stolons showed occasionally twistings and curlings, such as are found in tendrils. The newly arising sprouts [hydranths] behaved in the reverse fashion from the stolons: they grew vertically upwards" (Fig. 109). Subsequently, LOEB ('92, p. 8, '94)

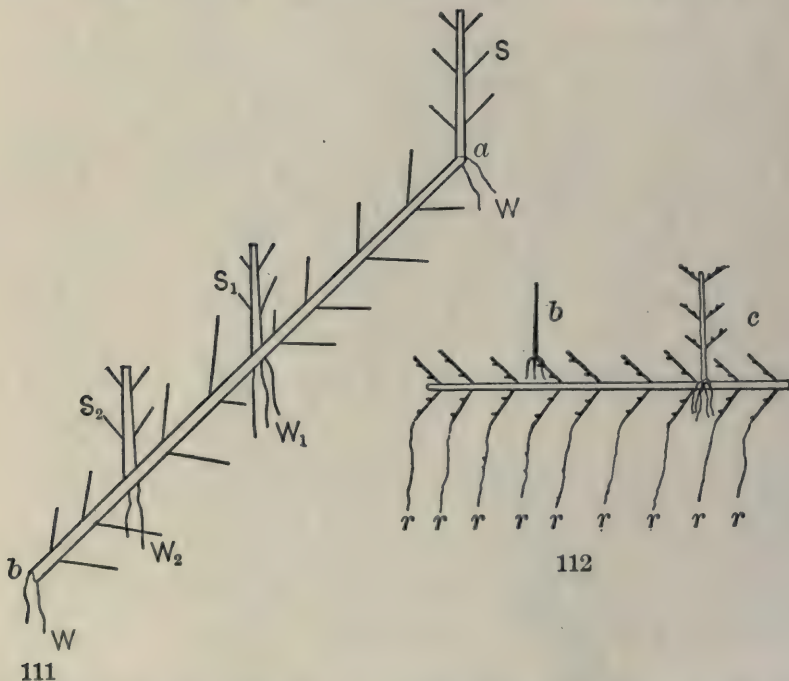

FIG. 111. — A bit of regenerating stem of *Antennularia antennina* placed in the water obliquely, with the basal end downwards. The new hydranths (*S*) and stolons (*W*) arise vertically. (From LOEB, '92.)

FIG. 112. — A piece of the stem of *Antennularia* placed horizontally, and regenerating stolons (*r, r*) downwards, and hydranths (*b, c*) upwards. (From LOEB, '94.)

found another hydroid, *Antennularia*, which, whether the stem was held inverted, oblique, or horizontal, sent out new stems, which grew vertically upwards, and stolons, which grew vertically downwards (Figs. 110, 111, 112). The growing stolon, if moved out of its first position, will curve until it acquires again its vertical direction. The geotropism of stolons has been likewise carefully studied by DRIESCH ('92). This author found in a species of *Sertularella* that, although the main stolons are not geotropic, the daughter (secondary) sto-

lons are markedly negatively geotropic. As the following figure shows (Fig. 113), it is only the newly growing part which exhibits this geotropism. These geotropic movements

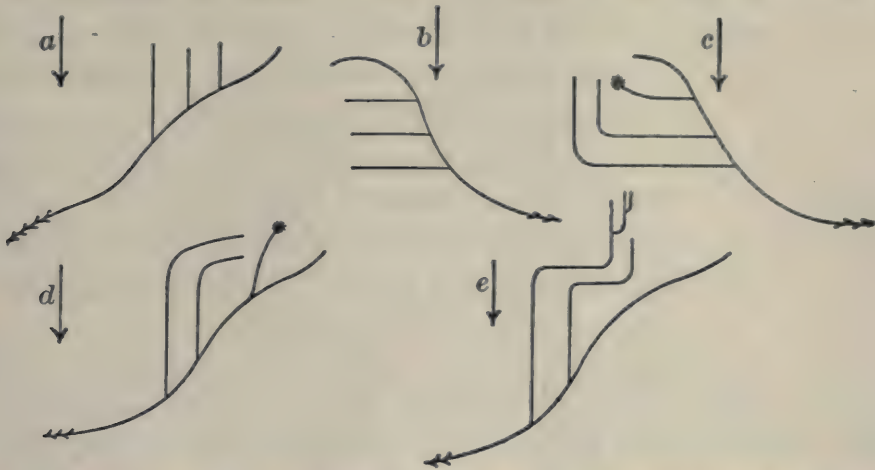

FIG. 113.—Diagrams of a *Sertularella* stock, showing how the direction of growth is determined by gravity. The arrow points towards the earth's centre. The stock originally placed in the position *a* is subsequently reversed as at *b*, and again as at *d*. The asterisk indicates a hydranth. (From DRIESCH, '92.)

in animals, which occur near the growing apex, are clearly due to unequal growth on the two sides of the inclined stem or stolon.

Many untouched questions on geotropism in animals arise for solution—questions about the location of the perceiving and the responding portions of the stem, latent period and after effect, and others. Especially is it desirable to find how wide-spread the geotropic phenomena are in sessile animals.

f. After-effect in Geotropism.—When a root or stem is placed horizontally, and retained in that position for a part of its latent period, and then, before the curving has appeared, is rotated on its long axis through 180° , the turning takes place at about the time and towards the same side as it would had the organ been left undisturbed; in its new position the root turns up, and the stem, for the moment, down. The response, once set in motion, works itself out, until finally annihilated by an opposing response (HOFMEISTER, '63; CIESIELSKI, '72).

This experiment has been variously modified in ways which throw light on the meaning of the after-effect. It has repeatedly been observed that if the root tip be decapitated before

the end of the latent period the geotropism will occur in the normal manner. The impulse once transmitted, the geotropic function of the root tip is finished. Again, SACHS ('74^a) laid a stem in a horizontal position for an hour or two, until up-curving had commenced near the tip. The tip was now held horizontal, and for from one to three hours, during which stretching took place, the horizontal part grew horizontally, while the new tip turned zenithwards. The tip in turning determines the direction of the incipient stretching zone, and the stretching continues in this direction without regard to subsequent changes in position of the stem. The stretching is independent of any control on the part of the tip.

Other conditions of geotropic after-effect have been determined by WORTMANN ('84). He treated a stem according to SACHS' method, and placed it in a chamber filled with hydrogen. Growth ceased. After oxygen was readmitted the tip turned up at once, but no after-effect appeared. This had been annihilated by the absence of oxygen. If, however, the stimulated sprout was placed vertically in de-aërated water, there was an after-effect, but no geotropic response. So we may conclude that, in the absence of oxygen, the geotropic response will not occur; and that an after-effect may occur if the stretching tissue is bathed with water for imbibition, but not under other conditions.

SUMMARY

The rate of growth seems to be little affected by the absence of gravity or the abnormal condition of its action, except in some of the higher fungi, where the removal of gravity hastens growth, and its abnormal direction retards. Geotropism is found only in sessile organisms. In roots the turning occurs in the region of greatest growth, and the tip alone is sensitive to gravity's action. The response is preceded by a latent period, and is strongest after the root has been placed horizontal; it is due, in the case of both roots and stems, to an acceleration of growth on one side and its retardation on the other. In plumules the turning begins near the tip and proceeds towards its base; the whole bending region is responsive

as well as sensitive. Many cryptogams show negative geotropism. Many branches and rhizomes show transverse geotropism. Among animals, hydroids show negative geotropism. A marked after-effect follows negative stimulation, by means of it we can show that stretching or the geotropic curvature are independent of any control from the tip after once the stimulus has been transmitted to the stretching region. Like other responses to stimuli, geotropism does not occur in the absence of oxygen.

 LITERATURE

- BASTIT, E. '91. Recherches anatomiques et physiologiques sur la tige et la feuille des mousses. *Rev. Gén. de Bot.* III, 255 et seq.
- BATESON, ANNA, and DARWIN, F. '88. On a Method of Studying Geotropism. *Ann. of Bot.* II, 65-68. June, 1888.
- CIESIELSKI, T. '72. (See Chapter XIV, Literature.)
- DARWIN, C. '80. (See Chapter XII, Literature.)
- DARWIN, F. '82. On the Connection between Geotropism and Growth. *Jour. Linn. Soc.* XIX, 218-230.
- DRIESCH, H. '92. Kritische Erörterungen neuerer Beiträge zur theoretischen Morphologie. II. Zur Heteromorphose der Hydroidpolypen. *Biol. Centralb.* XII, 545-556. 1 Oct. 1892.
- ELFVING, F. '80. Beitrag zur Kenntniss der physiologischen Einwirkung der Schwerkraft auf die Pflanzen. *Acta Soc. Scient. Fennicæ, Helsingfors.* XII, 25-58.
- '80^a. Ueber einige horizontal wachsende Rhizome. *Arb. Bot. Inst. Würzburg.* II, 489-494.
- HARTIG, T. '66. Ueber das Eindringung der Wurzeln in den Boden. *Bot. Ztg.* XXIV, 49-54. 16 Feb. 1866.
- HOFMEISTER, W. '63. Ueber die durch die Schwerkraft bestimmten Richtungen von Pflanzentheilen. *Jahrb. f. wiss. Bot.* III, 77-114.
- JOHNSON, H. '29. The Unsatisfactory Nature of the Theories proposed to account for the Descent of the Radicles in the Germination of Seeds shewn by Experiments. *Edinb. New Philos. Jour.* April, 1829. 312-317.
- KIRCHNER, O. '82. Ueber die Empfindlichkeit der Wurzelspitze für die Einwirkung der Schwerkraft. *Prog. zur 64. Jahresfeier d. k. Württemb. Landwirths. Akad., Hohenheim.* 53 pp. *Abstr. Bot. Centralb.* XIII, 180-183.
- KNIGHT, T. A. '06. On the Direction of the Radicle and Germen during the Vegetation of Seeds. *Phil. Trans. London for 1806.* pp. 99-108.
- LOEB, J. '91. Ueber Geotropismus bei Thieren. *Arch. f. d. ges. Physiol.* XLIX, 175-189.

- '91^a. Untersuchungen zur physiologischen Morphologie der Thiere. I. Ueber Heteromorphose. 80 pp. Taf. Würzburg, 1891.
- '92. Untersuchungen zur physiologischen Morphologie der Thiere. II. Organbildung und Wachstum. Würzburg: G. Hertz. 81 pp.
- '94. On Some Facts and Principles of Physiological Morphology. Biol. Lectures, Wood's Holl Laboratory, 1893. pp. 37-61.
- PFEFFER, W. '94. Geotropic Sensitiveness of the Root-tip. Ann. of Bot. VIII, 317-320. Sept. 1894.
- RAY, J. '97. Variations des champignons inférieurs sous l'influence du milieu. Rev. Gén. de Bot. IX, 193-212, 245-259, 282-304. June-Aug. 1897.
- RICHTER, J. '94. Ueber Reaction der Characeen auf äussere Einflüsse. Flora. LXXVIII, 399-423.
- SACHS, J. '73. Ueber das Wachstum der Haupt- und Nebenwurzel. Arb. Bot. Inst. Würzburg. I, 385-474.
- '74. The same, continued. Arb. Bot. Inst. Würzburg. I, 584-634.
- '74^a. Ueber Wachstum und Geotropismus aufrechter Stengel. Flora. LVI, 320-331.
- '79. Ueber Ausschliessung der geotropischen und heliotropischen Krümmungen während des Wachsens. Arb. Bot. Inst. Würzburg. II, 209-225.
- '79^a. Ueber orthotrope und plagiotrope Pflanzentheile. Ibid. pp. 226-284.
- '87. Vorlesungen über Pflanzen-Physiologie. 2 Aufl. Leipzig: Engelmann. 884 pp. 1887.
- SCHWARZ '81. Der Einfluss der Schwerkraft auf das Längenwachstum der Pflanzen. Unters. Bot. Inst. Tübingen. I, 53-96.
- WACHTEL, M. '95. Einige Versuche betreffend die Frage über die geotropischen Krümmungen der Wurzeln. Abstr. in Bot. Centralb. LXIII, 309, 310.
- WIESNER, J. '81. Bewegungsvermögen der Pflanzen. Wien, 1887.
- WORTMANN, J. '84. Studien über geotropische Nachwirkungserscheinungen. Bot. Ztg. XLII, 705-713. 7 Nov. 1884.

CHAPTER XVI

EFFECT OF ELECTRICITY ON GROWTH

§ 1. EFFECT OF ELECTRICITY UPON THE RATE OF GROWTH

ELECTRICAL changes are so intimately associated with chemical changes that we may reasonably expect not only to find that the metabolic processes of growth are accompanied by the development of electricity, but also to find that an electric current disturbs growth. It is indeed known that electricity is produced in seedlings, for MÜLLER-HETTLINGEN ('83) has obtained from a seedling of *Vicia faba* by connecting the two extremities a maximum electromotive force of about one-tenth of a volt. (Fig. 114.) There is thus in the living plant an electric stress. Will an outside current, which must affect that of the organism, disturb also its growth?

In the case of the growing animal even a slight current of electricity is usually injurious. Thus LOMBARDINI ('68) and WINDLE ('93 and '95) have subjected the egg of the chick to such a current running transversely through the embryo, with the result that the embryo either soon ceased to develop or developed abnormally. RUSCONI ('40), on the other hand, believed that a slight current accelerated the development of the frog's egg. More extended experiments with known strengths of currents are much to be desired.*

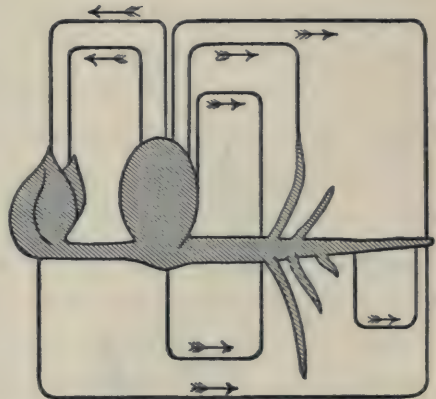

FIG. 114. — *Vicia* seedling. The lines uniting different points of the seedling may represent the wires running to the galvanometer; the points themselves are those from which the current was led off; the arrows go with the currents in the wires. (From MÜLLER-HETTLINGEN, '83.)

* Certain unconfirmed results with a powerful magnet deserve to be noted. MAGGIORINI ('84) found that developing hens' eggs subjected to this agent produced four times the normal number of cases of arrested development.

Upon growing plants, on the other hand, numerous experiments have been made. Nevertheless there is still a difference of opinion even as to the occurrence of any effect. During the middle of the last century much attention was paid to this subject. BERTHELON (1783) and several others concluded from extended researches that electricity favors plant growth; but their results, apparently having no practical value, were largely forgotten. A century later GRANDEAU ('79) revived the idea of the beneficial effect for plants, not merely of currents of electricity, but also of those of the atmosphere. This paper seems to have been the starting-point of the modern discussion.

The methods employed in studying the action of electricity

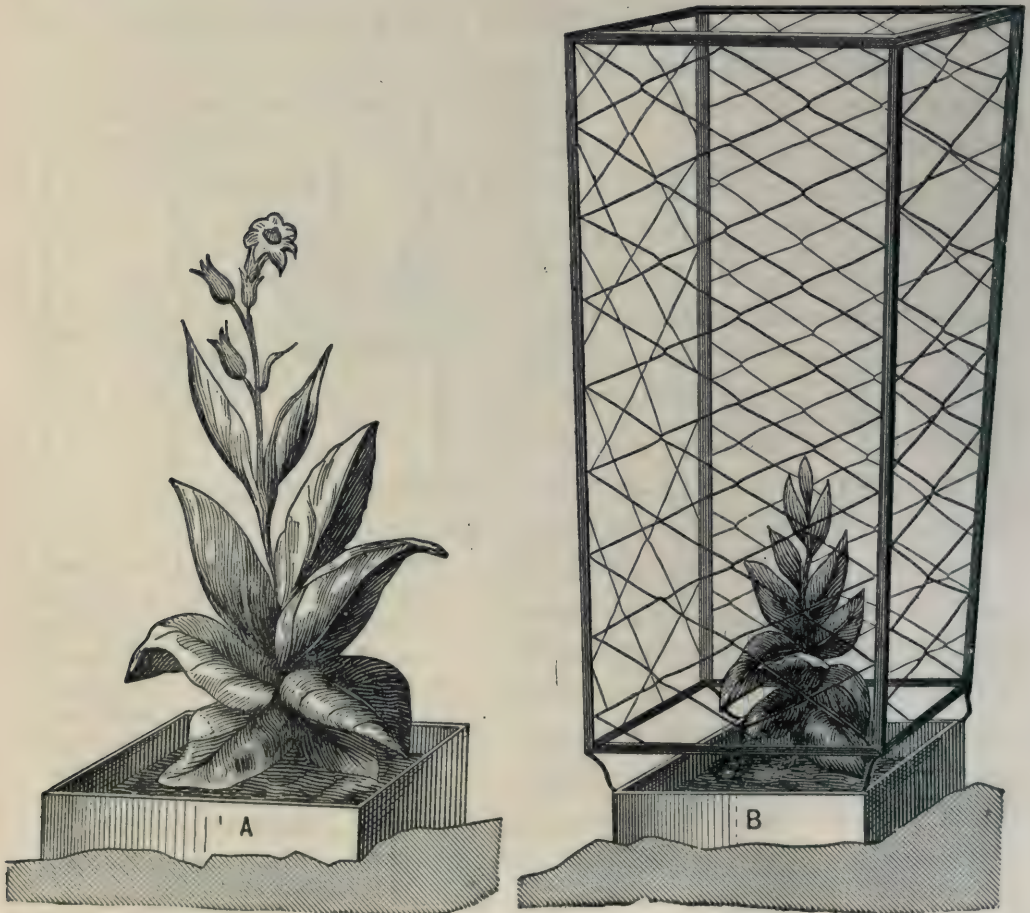

FIG. 115. — The effect of atmospheric electricity upon the growth of plants. *A*, Tobacco plant reared under normal conditions. *B*, Similar plant reared under a wire cage, by means of which it is isolated from the action of atmospheric electricity. (From GRANDEAU, '79.)

have been of two general kinds. On the one hand the seedling is electrified by passing a current through the soil in which it is growing and after several days comparing it with an untreated seedling. On the other hand the tension of the atmospheric electricity is altered either by electrifying the air of the chamber in which a plant is growing, or by isolating a plant from the action of atmospheric electricity by means of a cage made of fine wire and with meshes so wide that a minimum amount of light is cut out (Fig. 115 *A* and *B*).

The method of passing a current through the soil has been employed by WARREN ('89), CHODAT ('92), MCLEOD ('93 and '94), and by other investigators with results favorable to the plants. MCLEOD passed the current transversely. He sunk plates of metal on either side of the pea seeds employed in the experiment and used a current from a single cell. While the control seedlings germinated somewhat earlier than the electrified ones, at the end of 45 days the latter had outstripped the former. Again, a coil of wire, partly stripped of its insulation, was imbedded in the ground, and from a lot of similar mustard seeds some were placed next to the uncovered wire and others about one inch away from the insulated part of the wire. A constant current was sent through, and at the end of seven days the seedlings planted near the uncovered wire were one-third larger than the others. CHODAT used a current passing lengthwise through the plant. Similar beans were divided into two equal lots and each was reared in glass cylinders under similar conditions, except that one was unelectrified while the other was electrified by the following method. The cylinder rested on one armature of tin-foil while the other was suspended 1.8 meters over the first. The armatures were connected with a Holtz machine and a current was passed through the cylinder for about three hours each day. The result was that on the fourth day leaves began to show on the electrified seedlings but not on the control ones, and on the seventh day all the electrified seedlings had attained considerable size, whereas the control ones were just making their appearance. The electrified seedlings were spindling, however, much as if reared in the dark. WARREN'S experiments are noteworthy in that he found the seedlings which

were nearer the positive electrode more advanced than those which were nearer the negative electrode.

The method of electrifying the air over the plants was employed by CELI ('78), FREDÁ ('88, on *Penicillium*), and LEMSTRÖM ('90). Their methods were somewhat dissimilar: CELI discharged static electricity through a wire breaking up into fine points over the growing seedlings and got increased growth; FREDÁ used a similar method with *Penicillium* reared on bread but obtained no favorable effect, LEMSTRÖM conducted his experiments upon a larger scale, since he covered a small part of a field of germinating barley with fine parallel wires about a meter apart, provided with metal points at intervals, and supplied with a current from a Holtz machine during eight hours a day for over two months. In LEMSTRÖM'S experiments the yield of the electrified field was 35% in excess of that of the unelectrified, and the quality of the grain was better. These experiments, which extended through several years, were carried on in various parts of Scandinavia and in France, and generally resulted in a favorable effect upon the growth of malt crops.

The method of eliminating atmospheric electricity was used with success by GRANDEAU ('79), who employed the method of isolating seedlings in a wire cage referred to on p. 407. The plants reared in the wire cage grew uniformly less rapidly than similar plants reared outside. ALOI ('95) has confirmed these results with the same method, using maize and bean seedlings.

On the other hand other investigators, preëminently WOLLNY ('93), who used the methods both of increasing and of eliminating atmospheric electricity, obtain only negative results. Thus the whole matter stands, rejected on *a priori* grounds by many, denied as a result of negative experiments by others, but still apparently demonstrated by three lines of experimentation, none of them, however, free from criticism. There prevails a cautious scepticism concerning the validity of the positive results obtained.

Various explanations have been offered by those who accept the positive results. FREDÁ, who found that *Penicillium* is injured by the increased atmospheric electricity, attributed that

injury to the greatly increased amount of ozone that appeared in his vessels. In the open air, on the other hand, the increase of ozone would be relatively so slight that it might well be advantageous to growth. WARREN'S results would then be accounted for by the fact that the ozone is especially produced at the positive pole, thus favoring for a time the excessive growth at that pole. On this explanation the electricity would act only indirectly. Somewhat similar is the conclusion of THOUVENIN ('96), that the electric current aids the plant in its decomposition of carbon dioxide. On the other hand there is reason for believing that since plants are adjusted to an (internal) electrical condition, a slight external one might be advantageous rather than injurious.

§ 2. EFFECT OF ELECTRICITY UPON THE DIRECTION OF GROWTH — ELECTROTROPISM

In 1882 the Finnish botanist ELFVING announced his discovery that when the radicle of the seedling of a bean or of certain other species was subjected in water to a transverse current of electricity, it grew towards the anode. This was the introduction to a series of interesting studies on what has been called electrotropism. In classifying the data which have been acquired we may make use of the following heads: 1. False and True Electrotropism; 2. Electrotropism in Phanerogams; 3. Electrotropism in Other Organisms; 4. Magnetropism; and 5. Explanation of Electrotropism and Summary.

1. **False and True Electrotropism.** — ELFVING himself observed two opposing phenomena in the seedlings which he subjected to the current. In most cases the radicles grew towards the anode, but in one species, *Brassica oleracea* — the wild cabbage — the radicle grew towards the kathode. ELFVING was inclined, in consequence, to believe that some species respond by growth in one direction and other species by the opposite growth; that these are diverse responses to the same agent, just as negative and positive chemotropism are. Gradually, however, it became evident, chiefly through the work of MÜLLER-HETTLINGEN ('83) and especially BRUNCHORST ('84, '89), that these results are due to dissimilar causes. Thus

BRUNHORST ('84, p. 209) found that the radicles of seedlings of *Brassica* grow, under otherwise similar conditions, at a current intensity* of 0.03δ to 0.05δ , towards the kathode, and at a current intensity of 3.0δ towards the anode (Fig. 116).

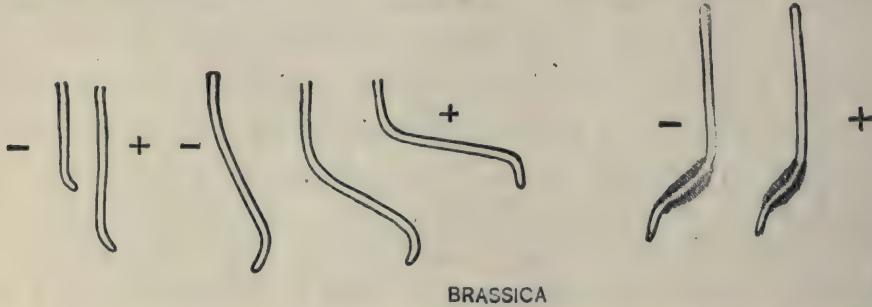

FIG. 116.— Effect of different strengths of electric current on the radicle of *Brassica*.
 At the right: strength of current, 1.1δ ; all strongly negative and growing well.
 At the middle: strength of current, 1.8δ ; after a few hours negative at the apex but positive higher up. At the left: strength of current, 3.1δ ; all positive, weak, and dead. (From BRUNHORST, '84.)

If decapitation has occurred the kathode turning does not follow, whereas the anode turning does occur as in the intact root. A similar result having been obtained with seedlings of various species, the conclusion was drawn that “the positive galvanotropic curving is a simple chemico-pathological phenomenon which has only a superficial analogy with the directive movements of roots, and therefore does not deserve the name galvanotropism” [electrotropism].

The cause of the positive turning effect, it has been suggested, lies in the fact that certain substances, perhaps hydrogen peroxide and ozone, produced in electrolysis act more injuriously upon the positive than upon the negative side. According to another explanation, offered by RISCHAWI ('85), the positive curvature is due to the kathophoric action

* The current density (see Chapter VI, § 1) is calculated from the following data: The amount of copper deposited in a voltameter was 0.14 mg. to 35 mg. per hour during the course of experimentation. A current of one ampere intensity deposits 0.000326 gramme of copper per second or 1.17 mg. per hour per milliampere. Thus the strength of current varied from 0.12 to 30 milliamperes. The determination of the density requires a knowledge of the cross-section over which the current spread itself. For this we may take the given area of the electrodes, 6499 sq. mm., which is not far from the cross-section of the trough.

of the current.* DUBOIS-REYMOND had found that when a current was passed through a cylinder of hard-boiled albumen it became concave towards the anode owing to the passage of water into the plant and its aggregation at the kathode side. RISCHAWI found that a cylinder of plant tissue did the same, and he attributed this result as well as that seen in the living radicle to the accumulation of water at the kathode side. But, as BRUNHORST points out, this is not the whole explanation, for the positive curving is generally accompanied by death of the tissue, and death would not necessarily result from the kathophoric action. By the use of a transverse partition of porous clay BRUNHORST ('89) has been able to show that the radicles in the positive half of the vessel are much more seriously affected than those in the negative half, which fact the kathophoric theory will not explain, but the chemical theory will (Fig. 117). In accordance with the view that the positive reaction is not a reaction to stimulus, but is a false electrotopism, it will be henceforth neglected. The negative reaction, on the contrary, is a response to stimulus — a true electrotopism.

2. Electrotopism in Phanerogams. — We have seen that the transverse electric current, when not too strong, causes a turning of the tip of the seedling from the anode. That this turning is a growth phenomenon is indicated by the fact that it takes place a few millimeters behind the tip in the region of maximum growth. This is then the region of response.

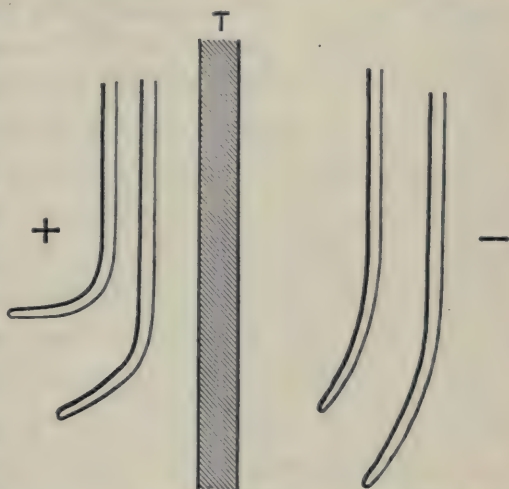

FIG. 117. — Radicles of *Phaseolus* on opposite sides of a partition, *T*, subjected to a transverse electric current, of 6.5 δ intensity, for two hours. On the positive side of the partition all the roots are strongly positive; on the negative side, where the water is being continually renewed, the roots are slightly positive, being bent less than 40°. (From BRUNHORST, '89.)

* The kathophoric action is seen when an electric current passes perpendicularly through a porous partition submerged in water. The liquid moves through the partition towards the kathode (hence called also electrical endosmosis).

The location of the sensitive region has been demonstrated by various methods. MÜLLER-HETTLINGEN placed the tip only of a radicle in contact with moist flannel through which the current was passing; the radicle turned from the anode. Also BRUNHORST ('84) found that when merely the apex was in contact with the electrified water there was a marked turning from the anode, even when the current was so powerful as to cause the submerged root to turn towards the anode. The tip is sensitive. Next BRUNHORST cut off the tip and found that no response occurred when the current traversed the radicle. Hence the tip is necessary to response, and it may be concluded provisionally that as in geotropism so in galvanotropism the root tip is the only sensitive part of the radicle.

The critical point at which the electrotropic effect passes into the mechanical one is indicated by a sigmoid turning of the radicle. According to BRUNHORST'S observations this critical point lies, at a temperature of 20°, for *Phaseolus* seedlings near 1.2 δ; for *Helianthus* near 1.3 δ; for *Lupinus*, 2.5 δ; for *Brassica*, 3 δ; for *Lepidium*, 3.5 δ. These results indicate that the different species have a diverse sensitiveness to the electric current, so that an intensity which causes the radicle of one species to turn from the anode will cause the other to turn towards it (false electrotropism).*

3. **Electrotropism in Other Organisms.**—While the stolons of hydroids, Bryozoa, and tunicates offer an excellent opportunity for experiments on electrotropism in animals, results have been obtained, so far as I know, outside the group of phanerogams only in the mold *Phycomyces*. HEGLER ('92) has subjected this organism not to the ordinary electric current, but to HERTZ' electric waves.† The result was that, after exposing to the radiant electricity for from three to six hours, the sporangiferous hyphæ curved markedly from the source of

* We can now easily understand why ELFVING obtained, with approximately the same current, a positive curvature in many species, but a negative one with *Brassica*. As the list just given shows, the critical point in *Brassica* lies high.

† These were obtained by reflecting, by means of a parabolic tin reflector, the radiant energy upon the stems of the fungi. The latter were covered with a pasteboard box, to keep out light, and the whole experiment was performed in a darkened room. The fungi were experimented with when about 8 to 10 cm. long, a period when they are most sensitive to light.

the rays in the same fashion, but not so powerfully, as they would have curved from light. Thus, electric waves produce in *Phycomyces* a negative electrotropism.

4. **Magnetropism.**—It was stated in an earlier chapter* that magnetism has no clearly established effect upon protoplasm. The alleged effect on growth is, consequently, worthy of attention. TOLOMEI ('93) placed over a glass vessel containing germinating peas a large horseshoe magnet, connected with a battery composed of eight Daniell cells. The germinating organs bent away from the centre of the magnetic field; by an appropriate position of the magnet the roots might be forced to grow upwards. TOLOMEI also asserts that young plants are diamagnetic, *i.e.* tend to place their long axes at right angles to the lines of force of the magnet. These results are interesting enough to deserve confirmation.

5. **Explanation of Electrotropism and Summary.**—Is electrotropism the direct result of the current, or is it, like the effect upon the rate of growth, an indirect result, due, for instance, to chemical agents produced by the current? If the action is indirect, it may be either of a mechanical or of a chemical nature. RISCHAWI, who proposed the very clever explanation of positive curvature on the ground of kataphoric action, offered a similar explanation for negative electrotropism. He finds that a cylinder made of coagulated yolk, and placed in the water transverse to the current, bends at first convex to the anode, owing to the more rapid diffusion at first of water into that side; but, later, when the whole mass becomes permeated, it bends so as to be concave towards the anode. So, in the root, a weak current can induce a weak diffusion of the external water into the cells on the anode side. This theory does not, however, meet the conditions; for, first, a long-continued weak current does not induce the positive curvature, and, secondly, because the decapitated root does not turn from the anode, and the irritation of the tip alone can induce the result. The mechanical theory must be rejected.

There remains only the other theory, that the negative tropism is a response to a stimulus of some sort applied at the tip.

* Chapter VI, § 1.

It is possible that the stimulus is due to a chemical agent produced by the current, or directly to the current itself. The first alternative is opposed by the fact that the reflected HERTZ waves, which have little or no gross chemical effect, still incite a response. There is every reason for concluding that the electric current, like gravity, and, as we shall see, light, acts in determining the direction of growth immediately.

The electric current appears to affect the rate of growth of some plants, so that they grow more rapidly when lying in the magnetic field or in a highly electrified atmosphere than otherwise; but this effect is often slight and uncertain. The directive effect on the growth of elongated organs is more marked. Apart from a false electrotopic effect produced by the injury of the positive side of the root, so that growth ceases on that side, there is a true electrotopic effect, which shows itself in a turning of the root from the anode. This is a true response to stimulus, depending for its consummation upon the presence of the root tip. The HERTZ waves produce this effect in *Phycomyces*. Magnetism has an uncertain effect. The whole phenomenon is closely like that of response to gravity and light.

LITERATURE

- ALOI, A. '91. Dell' influenza dell' elettricità atmosferica. *Malpighia*. V, 116-125.
- '95. Dell' influenza dell' elettricità atmosferica sulla vegetazione delle piante. *Bull. Soc. Bot. Italiana*. Oct. 1895. pp. 188-195.
- BERTHELON DE ST. LAZARE 1783. *De l'électricité des végétaux, ouvrage dans lequel on traite de l'électricité de l'atmosphère sur les plantes, etc.* Paris et Lyon: Didot. 468 pp. 3 Tab.
- BRUNCHORST, J. '84. Die Funktion der Spitze bei den Richtungsbewegungen der Wurzeln. II. Galvanotropismus. *Ber. D. Bot. Ges.* II, 204-219.
- '89. Notizen über den Galvanotropismus. *Bergens Mus. Aarsberetning for 1888*. No. 5. 35 pp.
- CELI '78. Appareil pour expérimenter l'action de l'électricité sur les plantes vivantes. *Comp. Rend.* LXXXVII, 611-612. 22 Oct. 1878.
- CHODAT, R. '92. Quelques effets de l'électricité statique sur la végétation. *Arch. Physiq. et Nat.* (3), XXVIII, 478-481.
- DUBOIS-REYMOND, É. '60. Ueber den secundären Widerstand, ein durch den Strom bewirktes Widerstandsphänomen an feuchten porösen Körpern. *Monatsber. Berlin Ak.* 1860. pp. 846-906.

- ELFVING, F. '82. Ueber eine Wirkung des galvanischen Stroms auf wachsende Keimlinge. *Bot. Ztg.* XL, 257-264, 273-278. Apr. 1882.
- FREDA, P. '88. Sulla influenza del flusso elettrico nello sviluppo dei vegetali acolorofillici. *Le stazioni sperimentali agrarie ital.* Roma. XIV, 39-56. [Abstr. in *Just's Jahresber.* XVI, 93, 94.]
- GAUTIER, A. '95. [Comments on paper of FLAMMARION.] *Comp. Rend.* CXXI, 960, 961. 16 Dec. 1895.
- GRANDEAU, L. '79. De l'influence de l'électricité atmosphérique sur la nutrition des végétaux. *Ann. de Chim. et de Physiq.* (5), XVI, 145-226. Feb. 1879.
- HEGLER, R. '92. Ueber den Einfluss des mechanischen Zugs auf das Wachstum der Pflanze. *Beiträge zur Biologie der Pflanzen.* Band VI. Heft. III, 383-432. Taf. XII-XV.
- LEMSTRÖM, S. '90. Om elektricitetens inflytande på växterna. Helsingfors, 1890. 67 pp. 4°. [Abstr. in BAILEY. *Trans. Mass. Hortic. Soc.* for 1894. 54-79.]
- LOMBARDINI '68. *Forme Organiche Irregolari negli Ucelli e ne' Batrachida.* Pisa, 1868.
- MAGGIORINI, C. '84. Influenza del magnetismo sulla embriogenesi e sterilità degli uovi. *Atti Acad. Lincei.* (3), *Transunti*, VIII, 274-279.
- MCLEOD, H. M. '93. The Effect of Current Electricity upon Plant Growth. *Trans. and Proc. New Zealand Inst.* XXV, 479-482. May, 1893.
- '94. The same. *Ibid.* XXVI, 463, 464.
- MÜLLER-HETTLINGEN, J. '83. Ueber galvanische Erscheinungen an keimenden Samen. *Arch. f. d. ges. Physiol.* XXXI, 193-214. 2 May, 1883.
- RISCHAWI, L. '85. Zur Frage über den sogenannten Galvanotropismus. *Bot. Centralb.* XXII, 121-126.
- RUSCONI, M. '40. Ueber künstliche Befruchtungen von Fische und über einige neue Versuche in Betreff künstlicher Befruchtung an Fröschen. *Arch. f. Anat. Physiol. und wiss. Medicin (Müller).* 1840. 185-193.
- THOUVENIN, M. '96. De l'influence des courants électrique continus sur la décomposition de l'acide carbonique chez les végétaux aquatique. *Rev. Gén. de Bot.* VIII, 433-450.
- TOLOMEI, G. '93. Azione del magnetismo sulla germinazione. *Malpighia.* VII, 470-482. [Abstr. *Just's Jahresber.* XXI, 37.]
- WARREN, H. N. '89. The Effects of Voltaic Electricity toward Germination. *Chem. News.* LIX, 174.
- WINDLE, B. C. A. '93. On Certain Early Transformations of the Embryo. *Jour. of Anat. and Physiol.* XXVII, 436-453. July, 1893.
- '95. On the Effects of Electricity and Magnetism on Development. *Jour. of Anat. and Physiol.* XXIX, 346-351. April, 1895.
- WOLLNY, E. '93. Electriche Culturversuche. *Forsch. Agr.* XVI, 243-267. [Abstr. in *Just's Jahresber.* XXI, 36.]

CHAPTER XVII

EFFECT OF LIGHT UPON GROWTH

WE have seen in Chapter VII that light profoundly affects metabolism, not only by its heat rays, which are essential to the process of starch formation in green plants, but also by its more chemically active rays, which produce chemical changes in organisms of all classes. We have now to see how, as a result of these effects, light has an influence upon growth.

§ 1. EFFECT OF LIGHT ON THE RATE OF GROWTH

Two fundamental principles, established in the First Part of this work, must be recognized at the outset of this discussion, or else the data which have been accumulated will appear confused and meaningless. The first principle is that white light is not a constant, definitely determined thing, but varies in its intensity, and, as we saw in the case of phototaxis (I, p. 201), at the different intensities produces diverse, even opposing, effects. The second principle is that not all organisms are similarly affected by the same intensity of white light. This is because they are attuned to diverse intensities of light, so that the same intensity will call forth a dissimilar response in different organisms (I, p. 196). It is a consequence of these two principles that, when we classify our data on the basis of the intensity of the light, we shall find dissimilar effects in each class; or when, on the other hand, we classify on the basis of results, we shall have to consider in each class apparently diverse causes. Since, however, results are always more certain than causes, we adopt the method of treatment on the basis of results.

1. **Retarding Effect of Light.** — We have already in the First Part of this work seen that Protista are injuriously affected by strong sunlight, cultures of bacteria becoming

sterilized and ordinary aquaria being quickly deprived of living occupants. To the higher organisms, on the other hand, sunlight is generally not fatal, but is usually unfavorable to growth. This result is most clearly seen in seedlings. Thus WIESNER ('79, p. 181) exposed seedlings of the vetch *Vicia sativa* under a clear glass globe to sunlight, after having marked off a centimeter's distance upon its zone of strongest growth, and having placed it in a horizontal position so that it should get the full force of the sun's rays. No growth occurred during seven and a half hours, although the control, in a darkened globe, turned its tip upwards and grew from 2.5 to 3.1 mm. during that period. A vertical seedling of the same age was so protected by its foliage that in the sunlight it grew from 0.5 to 1.2 mm. on the different sides. Thus, when the growing part of a seedling is exposed to sunlight, little or no growth occurs, and accordingly we find, as SACHS ('63) first pointed out, that the growing tissue of vegetative points is usually protected from the sun's rays.

In animals, likewise, it is noteworthy that embryonic tissue, and indeed the entire embryonic individual, is usually sheltered from sunlight. In animals the embryo is sheltered in the darkness of the maternal body; in birds and reptiles the egg shells are not merely mechanically resistant, but more or less opaque, and, moreover, the whole egg is usually hidden from light.* The delicate, often externally pigmented, embryos of Amphibia are often buried by one of the parents or else develop among weeds in the water. More rarely, as sometimes in the case of frogs, they occur in open ponds, but then imbedded in a thick envelope of albumen. Fishes usually bury their eggs † or affix them to the under side of stones or place them in other shady retreats. To the general rule, however, pelagic fish eggs seem to constitute an important exception; but some of these, perhaps all, can change their level in the water (HENSEN and APSTEIN, '97, p. 63). Among molluscs, embryos are often retained in the shell of the parent or laid in capsules and then

* BLANC ('92) has indeed shown that the development of the hen's egg is much retarded when subjected in the incubator to daylight.

† MILLET ('35) has shown that exclusion of light is the chief advantage gained in this habit.

attached to the under side of rocks, hidden in sand or secreted in other shady places. Insects affix their eggs to the under side of leaves, provide nests for them, bury them in the earth, in masses of food, in a hundred places hidden from direct sunlight. Even the larvæ, which swarm on the surface of seas and

lakes, sink before the rising sun and find protection beneath the superincumbent strata of water.* From these facts we may conclude that, in general, growth does not take place in nature in full exposure to sunlight.

Diffuse daylight, even the light which is essential to all healthy green plants, markedly affects their growth. This is a matter of every-day observation. Who has not observed the contrast between the elongated, scraggy form of plants grown in the dark and the repressed, compact form characteristic of the light? (Fig. 118.) Experiments and comparative measurements give us an insight into the degree of this difference. Take, for example, the case of tubers. SACHS ('63) planted similar potato tubers in flower-pots. One pot was covered with a clear bell-jar and placed in the window; the other, which served as a control, was covered by a large flower-pot, thus remaining in the dark. Both pots were kept equally moist. At the end of a period of 53 days, while the control tubers had produced sprouts from 150 to 200 mm. high, those which had been



FIG. 118. — Two seedlings of *Sinapis alba* of equal age. *E*, reared in the dark, etiolated. *N*, reared in ordinary daylight, normal. Root hairs arising from the roots. (From STRASBURGER, NOLL, SCHENCK, and SCHIMPER, Textbook of Botany.)

* The degree of protection from light afforded by layers of water is indicated by certain calculations of WHIPPLE ('96), who finds that in a reservoir whose color is slight (0.33, platinum standard), a layer of water one foot thick absorbs 25% of the light falling upon it, so that only 0.75², or 56%, of the light at the surface gets below two feet; 0.75³, or 42%, below three feet, and so on.

exposed to the spring sunlight were only 10 to 13 mm. high — a reduction to one-fifteenth the height in the dark. Many seedlings show the same thing; thus SACHS found that the hypocotyl of the buckwheat (*Fagopyrum*), which attains a height of 35 to 40 cm. in the dark, reaches only 2 to 3 cm. when freely exposed on a sunny day — here again a reduction in height of about 94%. This diminution in length is accompanied for a while by a diminution in size of the plant as a whole. This is shown by the measurements of KARSTEN ('71), who raised kidney beans in the dark and in the light for a month or two, and found that the entire individual reared during this period in the light weighed less than that reared in the dark.

The proportionate weight in dark and light was as 12 to 10, fresh weight. The only organs which were heavier in the seedlings grown in the light were the roots (slightly) and the leaves (as 5.4 to 1). This excess in the growth of illuminated leaves as compared with those developed in the dark is characteristic only of such as have broadly expanded blades. Such leaves seem to require the light for their full development; they constitute a special case, the peculiarities of whose development will be considered together with that of other special cases in the last Part of this work. The growth of leaves, like that of the rest of the plant, is relatively retarded in the daytime, but this is probably due to the increased transpiration of that period (PRANTL, '73).

The effect of daylight upon the growth of stems is, as SACHS has pointed out, unequal in the different plants. In extreme cases (internodes of *Bryonia*, a wild gourd; of *Dioscorea*, the yam; etc.) daylight has no evident effect, for the stems have the scrawny, "etiolated" habit characteristic of plants grown in the dark. Plants which are little repressed by light are said by SACHS to be chiefly those whose rapidly growing parts are sheltered from the sun's rays by protecting coverings. We may conclude that the growth processes of such plants are little interfered with by strong light, because their protoplasm has through long experience become attuned to it. Except where such attunement has occurred, light tends to retard the growth of phanerogams.

The germination of seeds and spores of fungi is accompanied by processes akin to those of growth, and so may be treated here. The germinating protoplasm of seeds is partly shielded from light by a thick coat; nevertheless a series of careful

observers in the early half of the century, and, more recently, NOBBE ('82), ADRIANOWSKY ('83), and others, have shown that germination of seeds takes place slightly earlier in the dark than in daylight. Among fungi, also, we have the assurances of HOFFMANN ('60, p. 321) that the spores of the mushroom *Agaricus campestris* germinate more slowly in the light; and of DE BARY ('63, p. 40) that the spores of the potato fungus, *Peronospora infestans*, and its allies do germinate with difficulty in the daylight, and not at all in the sunlight. Thus

the germination of spores even more than of seeds is retarded by light (p. 174).

Passing now to the growth of fungi, we find numerous and harmonious observations on the effect of light. FRIES ('21, p. 502) first noticed that the growth of fungi is retarded in the light, and SCHMITZ ('43, p. 512), KRAUS ('76, p. 6), VINES ('78), STAMEROFF ('97), and others have confirmed this result for hymenomycetes, the ergot fungus, and molds.* BREFELD ('77, p. 90; '89, p. 275) found that the toadstool *Coprinus stercorarius* reared in the dark attains a length of two feet or more, while in the daylight it is only an inch long (Fig. 119). Again, the sporangiferous hypha of the dung mold *Pilobolus microsporus*, which is eight or ten inches long in the dark, grows only half

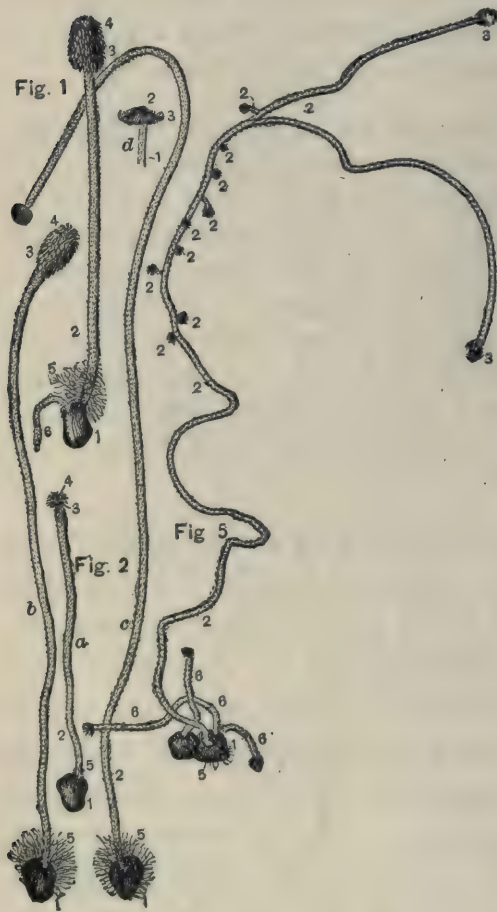

FIG. 119. — *Coprinus stercorarius* in reduced size. Fig. 1, typical young fruiting fungus reared in the light. Fig. 2, a, b, c, d, fungus reared in weak illumination. Fig. 5, *Coprinus* reared in darkness. 1, sclerotium; 2, stalk; 3, 4, fruit; 5, roots; 6, hyphæ. (From BREFELD, '77.)

* But BULLOT ('97) denies it in the case of *Phycomyces nitens*. His experiments are not, however, convincing.

an inch long in the daylight. *Bacillus ramosus*, in one case, grew during five hours, in the dark, 540μ ; in the light, 200μ (WARD, '95). These results demonstrate that the inhibiting or retarding effect of sunlight, and even of diffuse daylight, is probably unconnected with the chlorophyll function, but is due to a more general effect of light upon growing protoplasm.

Even brief illumination has its marked effect. Thus VINES ('78, p. 137), who has made exact measurements of the hourly growth of the sporangiferous hyphæ of the mold *Phycomyces nitens*, found that growth was diminished whenever the plant was subjected for only an hour to sunlight (Fig. 120). The same is true for phanero-gams (GODLEWSKI, '93).

The great diurnal period of darkness and illumination to which plants are subjected in nature likewise has its effect on growth. The first studies made upon this subject were by TREW in 1727. Numerous observers followed, but it was left to SACHS ('72), by the aid of his aux-anometer, to obtain a

continuous curve of growth. This showed at a glance that during the night the rate of growth gradually increases, reaches a maximum at about daybreak, diminishes to a minimum a little before sunset, and then begins to rise again.* This variation in the rate of growth is opposed to the diurnal fluctuation of temperature, since this is low at night and high during the day. It is favored, on the other hand, by the circumstance that heat

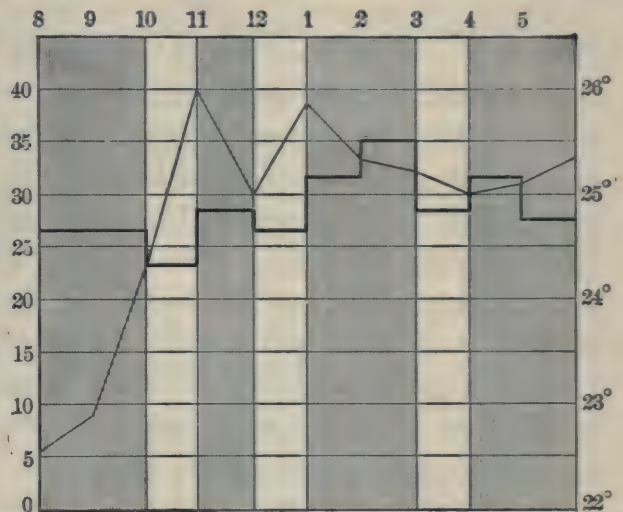

FIG. 120.—Diagram illustrating the retarding influence of light upon the growth of a sub-aërial hypha of *Phycomyces*. The thick line represents the course of growth, the thin line that of temperatures; the unshaded spaces, periods of exposure to light; the shaded spaces, periods of darkness. The figures at the left indicate tenths of millimeters, those at the right, degrees of temperature; those at the top, hours. (After VINES, '78.)

* A similar periodicity has been detected among toadstools and puffballs by KRAUS ('83, p. 97).

and light favor transpiration; and this means loss of water and, consequently, of growth. Just how far these opposing effects neutralize each other cannot be said, but our comparative study gives assurance that the effect may well be produced by light acting alone. While the diurnal periodicity in growth can clearly be ascribed to no other cause than the alternation of day and night, it is an important fact that this periodicity may be exhibited for several days after the plant has been placed in a room kept constantly dark. There is apparently a persistence of an effect impressed by environment.

Among animals the evidence of a retarding effect upon growth is not so clear. MAUPAS ('87, p. 1008), indeed, concludes from actual experiment that various ciliate Infusoria multiply with equal rapidity in the presence or the absence of light. In the higher vertebrates, on the other hand, light, acting through the retina, increases destructive metabolism, as MOLESCHOTT ('55) first pointed out, so that many vertebrates undergo a greater loss of weight in the light than in the dark. Indeed, a diurnal periodicity in the weight of animals was described as long ago as 1852, by BIDDER and SCHMIDT, who found that starving cats lost weight much faster in the day than at night. These facts constitute a not unimportant parallel with the conditions in plant growth.

In summarizing the foregoing facts on the retardation of growth by light, we see that strong sunlight usually completely inhibits growth, so that the growing parts of organisms, or entire organisms during the period of growth, are usually concealed. Even diffuse light retards growth, especially in the following organisms: most seedlings, many of the higher aërial fungi, germinating seeds in general, and spores of fungi. Also, light hastens destructive metabolism in the higher vertebrates so as to diminish weight rapidly. The organisms thus brought together are without exception aërial. This fact suggests that in plants, at least, the restraint of growth by light may be due to the rapid loss of water which accompanies illumination. The illumination of seedlings and fungi for only a brief period—an hour or so—retards their growth. These organisms likewise exhibit a diurnal periodicity in growth corresponding to the alternation of day and

night. Not all seedlings and fungi are equally affected by light; the effect depends upon their normal conditions of illumination — the conditions to which they have become attuned.

2. **Accelerating Effect of Light.** — Although certain species of phanerogams are little affected in their growth by light, actual acceleration probably rarely occurs in this group. The parasitic mistletoe (*Viscum album*) seems to form an important exception, however, since, according to WIESNER ('79, p. 183; '98, p. 506), it neither grows nor germinates in the dark. This fact is correlated with a peculiarity in its phototropic response, as we shall see later (p. 438). Among aquatic algæ several cases of acceleration of growth by light have been

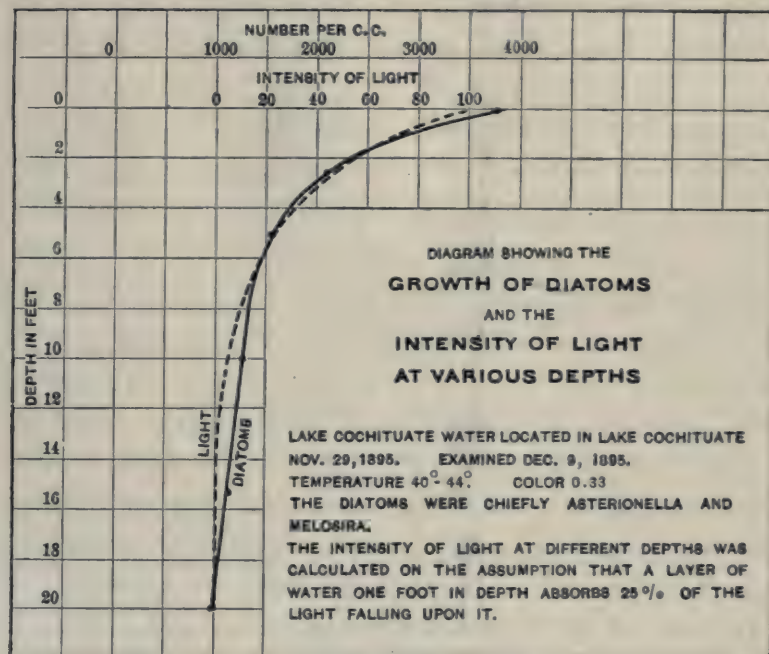

FIG. 121.

recorded. The flat, circular, green thallus of *Coleochæte scutata*, when obliquely illuminated, grows, according to KNY ('84), faster on the side next to the light. Again, *Spirogyra* which has been kept in the dark until all of its starch has been consumed grows when placed in the light, but does not grow in darkness (FAMINTZIN, '67). Lately WHIPPLE ('96) has given quantitative data on the relation between intensity of light and of growth in diatoms. A known quantity of diatoms of one or two species was placed in a bottle of water,

covered with bolting cloth, and suspended in the water of a reservoir, at the surface and at various depths below the surface down to 20 feet. Experiments were made at a time when the temperature of the reservoir water was almost the same at all depths. After several days the bottles were collected and the number of diatoms in each determined. The results of one series of experiments, shown graphically in Fig. 121, demonstrated that the growth of diatoms is directly proportional to the intensity of light received by them.* We may conclude that in general, excepting perhaps the mistletoe, those plants whose growth is accelerated by light normally have their growing parts fully exposed to sunlight. Their protoplasm is attuned to a high intensity of light—is not retarded by it; indeed, demands it for the normal exercise of its functions.

Passing now to the subject of germination, we find that the first development of the spores of the higher cryptogams usually requires or is favored by light (HOFFMANN, '60, p. 321, and others). The spores of many ferns, of the moss *Polytrichum commune* (BORODIN, '68), of the hepatics *Duvalia* and *Preissia* (LEITGEB, '77), and of *Vaucheria* do not germinate at all in the dark. However, this result is not universal among the higher green cryptogams, for MILDE ('52, p. 627) observed that spores of *Equisetum* germinated in the dark as well as in the light; and it is clear that certain fern spores (*Ophioglossum*) can do so, for they germinate when covered by soil to a depth of 3 to 5 cm. It is somewhat unexpected to find the spores of such dark-lovers as ferns and hepatics normally dependent for their germination upon light. One calls to mind, however, the fact that it is the habit of such spores to germinate on the surface, where their prothalli are found—hence at such times always subjected at least to a diffuse light.

Certain seeds, also, are said to germinate more readily in the light than in the dark. We have already cited the case of the mistletoe; the same seems to be true of the meadow grass, *Poa*, as is shown by the following experiments of STEBLER ('81). Two species were experimented with, and two experi-

* However, WHIPPLE found that growth at the surface, where full sunlight fell upon the bottle, was less than at a few inches below the surface.

ments were made upon each species. In each experiment two lots of seeds were placed together in a thermostat; the one being subjected to daylight, the other being kept in darkness. The percentage of germination in the eight lots was as follows:—

	POA NEMORALIS.		POA PRATENSIS.	
	LIGHT.	DARK.	LIGHT.	DARK.
Experiment No. 1.	62	3	59	7
Experiment No. 2.	53	1	61	0

The result seems decisive and has been fully confirmed by LIEBENBERG ('84) and JÖNSSON ('93), not only for *Poa* but certain other *small* seeds.

According to LIEBENBERG the favorable action of daylight is due rather to the alternation of high and low temperature on the seed. Thus, while about 3% of *Poa* seeds germinate in a dark chamber kept constantly either at 20° or 28° C., 91% are germinated after 34 days in a dark chamber kept for 19 hours at 20° C. and for 5 hours at 28° C. In this case we have to do clearly with a response to a particular stimulus of the heat rays reminding us of the stimulus of alternating heat and cold necessary for the germination of certain animal statoblasts or gemmules (BRAEM, '95).

Among growing animals, studies on the effect of light were early made by EDWARDS ('21), who concluded that tadpoles would not develop at all in the dark. In this he went as far from the truth in one direction as HIGGENBOTTOM ('50 and '63) and MACDONNELL ('59), who denied any difference of growth in the light and in the dark, did in the other. The work of YUNG ('78) first revealed the exact truth of the matter. This naturalist placed freshly laid frogs' eggs in vessels, each containing 4 liters of water and 60 eggs. One lot was placed in front of a window, where, however, it never received the direct rays of the sun. The other lot was kept constantly in the dark. Otherwise the conditions of the

two lots were very similar. After 30 days, and again after 60, 3 typical tadpoles of each lot were measured. Their averages, together with those from a second series, are given below :—

TABLE XLI

SHOWING FOR TWO LOTS OF TADPOLES THE RELATIVE SIZES ATTAINED IN THE LIGHT AND IN THE DARK

	REARED IN THE		RELATIVE SIZE OF "LIGHT" TADPOLES COMPARED WITH "DARK."	
	LIGHT.	DARK.		
Lot 1: 30 days	Length	23.10 mm.	19.66 mm.	117 %
	Breadth	5.50	4.66	118
Lot 1: 60 days	Length	32.16	30.30	106
	Breadth	7.66	7.16	107
Lot 2: 25 days	Length	19.83	15.83	125
	Breadth	4.33	3.50	124

This table clearly shows that tadpoles grow faster in the light than in the dark, and that the difference in the rate of growth is more marked during the first than during the second month of development.*

Other animals have been experimented upon by YUNG. He placed recently fecundated eggs of the sea trout, *Salmo trutta*, in 4-liter vessels, each of which contained 200 eggs. Those lots which were reared in the light hatched a day earlier than those reared in the dark. Also, the pond snails, *Lymnæa stagnalis*, reared in the light hatched in 27 days, whereas those reared in the dark required 33 days. Perhaps less weight is to be given to the observation of HAMMOND ('73), who found that 20-day-old cats, reared under similar conditions except as concerns daylight, grew faster in the light than in the dark.

* With these experiments agree certain experiments of LESSONA ('77) and CAMERANO ('93) upon the size of tadpoles taken from ponds so thickly covered with vegetation as to shut out the light, as compared with tadpoles from fully exposed ponds. CAMERANO finds that, at the same stage of development, the sizes are as 9 to 14, or the tadpoles reared in the light are 156% of the size of those reared in the darker ponds. Such observations in which the other conditions are not controlled are not, however, altogether satisfactory.

There is thus a considerable body of evidence that a not too intense light accelerates the growth of animals in general.

To sum up, we find that diffuse light accelerates growth in the following organisms: Mistletoe seedlings, *Coleochæta*, etiolated *Spirogyra*, diatoms, germinating spores of many ferns, mosses, hepatics, and *Vaucheria*, germinating seeds of *Viscum* and small-seeded grasses, tadpoles, embryo snails, trout, and, perhaps, young kittens; in brief, of a parasitic seedling, of algæ, of germinating spores in many higher cryptogams, of a few germinating seeds, and of some animals. The collection seems like a heterogeneous one; yet omitting germination phenomena, the case of the parasitic mistletoe, and the doubtful cat, all the organisms concerned are aquatic. The reason why the growth of aquatic organisms is not restrained by light may be that with them light does not produce increased transpiration.

3. **The Effective Rays.** — As we have seen in the First Part the various rays of which white light is composed affect protoplasm diversely. The question now arises, What part do the separate kinds of rays play in the retarding and accelerating effect of light on growth — what are the rays upon which these effects especially depend?

At the outset it must be stated that a large part of the recorded observations upon this subject is worthless because the methods were not quantitative. Let us suppose we have a white light of known intensity which inhibits growth, and that we desire to know which of the component rays are most effective in imbibition. The different component rays should have the same intensity as they have in the given white light. For a more effective ray of weak intensity will produce a smaller result than a less effective ray of great intensity; because not only quality but intensity of the light determines its effect. Now, insufficient care has been taken to measure, by the methods given in Chapter VII, the intensity of the colored light employed; consequently it is little wonder that most contradictory statements are given as to the effect of red, green, and violet light upon related organisms, and that great caution is demanded in drawing conclusions from the data at hand.

a. *The Effective Rays in the Retardation of Growth by Light.* — We have already seen (p. 166) that experiments upon the effect of the different rays upon metabolism occupied the attention of naturalists in the first half of the century. It was but

a step to the study of the effect of these rays upon growth, and this step was taken by SACHS in 1864.

The method of subjecting the plant to particular rays was as follows: The apparatus consisted of a glass jar, placed inside of a larger glass jar, the interspace being filled with a colored fluid. This apparatus stood behind a southeast window. Orange light was obtained by 12 to 13 mm. of a saturated solution of potassium dichromate, which transmitted red, orange, and yellow, but no blue or violet; and blue light, by the same thickness of ammoniated copper sulphate, which excluded all rays of shorter vibration than the green, but, likewise, reduced the intensity of the violet end of the spectrum. The relative chemical intensity of the light passing through the solutions was determined by noting the time required to blacken photographic paper held in the inner jar.

Under the conditions of the experiment young seedlings of the white mustard, *Brassica alba*, and of flax, *Linum usitatissimum*, grew more rapidly and vigorously in the orange rays, which act thus like darkness, than in the blue, which act thus like daylight. In orange light the leaves, although differentiated, remain small, while the internodes are elongated; in both of which respects the plants show themselves etiolated. In the blue rays the cotyledons, unlike the leaves, remain small; since, in the absence of assimilation, which requires red rays, they are drawn upon for food. Throughout, the less intense blue rays acted more like white light than the more intense orange rays.

Several confirmatory experiments upon other plants may now be briefly considered. BERT ('78, p. 986) cultivated a Sensitive Plant in a lantern made of red glass. It lived for months, elongated considerably, and had small leaves; one might have called it etiolated but for its remaining green, owing to the formation of chlorophyll in the red rays (p. 170, note). Behind blue glass it had the general form characteristic of white light, but it did not grow as large as in daylight — which includes also the warmer rays. The whole habit of the plants in the red rays indicated greater turgescence than in the blue: a result which BERT suggests may be due to the manufacture in the presence of the red-yellow rays of a material (glucose) causing an endosmotic flow. This explanation, however, seems negatived by the fact that plants grown in darkness exhibit this same condition. WEISNER

('93) finds that the stems of seedlings of *Vicia faba* grow behind SACHS' blue solution, which reduces the intensity from one-third to one-half that of daylight, nearly as slowly as in daylight, and much more slowly than in darkness, in the ratio of : daylight, 141 ; blue, 155 ; darkness, 185. Again, FLAMMARION ('95) cultivated the Sensitive Plant in little conservatories behind clear and colored glass.* From a lot of seedlings reared under normal conditions those were selected which were most alike (all 27 mm. high), and placed, July 4th, in the various conservatories. On October 22d the plants had the following average heights : in the red, 420 mm. ; green, 152 mm. ; white, 100 mm. ; blue, 27 mm. (Fig. 122). Thus, under



FIG. 122. — Action of different solar rays upon the growth of the Sensitive Plant. On August 1st, placed as seedlings each 27 mm. high behind diversely colored glass screens. Photographed Oct. 22. (From FLAMMARION, '95.)

* The data concerning methods are as follows : The blue glass used transmitted only the more highly refracting rays ; the red was almost strictly monochromatic ; the green was less satisfactory, but let through no red. The intensity of illumination decreased considerably in the order : white, red, green, blue. The conservatories were placed side by side, under similar conditions, and a current of air was passed through, from one to the other, to maintain a uniform temperature.

red light, as in darkness, the greatest growth occurred ; under the blue light no growth had occurred, *i.e.* less than under the clear glass. The order of height was thus : blue, white, green, red ; that of the vigor of vegetation was : blue, green, white, red. The peculiarly injurious effect of the violet and ultra-violet rays is shown also in the deleterious action of electric light, which is rich in these rays (SIEMENS, '80, '80^a, '82). All the foregoing observations are thus in accord, and indicate that the retarding action of white light upon seedlings is the resultant of the accelerating and the inhibiting actions of the different rays.

Among fungi we have observations by VINES ('78) which show that *Phycomyces nitens*, subjected intermittently to the action of darkness on the one hand, and of white light, blue light, or yellow light, on the other, suffered a similar retardation in white and blue light, while in yellow light no marked retardation occurred.* *Bacillus ramosus* (Fig. 123) grows behind a red screen as in darkness ; behind a blue screen (of CuSO_4) its growth is retarded as in daylight (WARD, '95, p. 381).

Among algæ FAMINTZIN ('67) has found that *Spirogyra* which has been kept in the dark until all of the starch is consumed grows more rapidly in the successive members of this series: darkness (no growth), blue light, full lamplight, yellow light. Here we see that, while a certain amount of light is necessary to the metabolism of the etiolated alga, growth, as a whole, is favored by the absence of blue rays.

Animals which are symbiotic with algæ flourish or decline with the latter. Accordingly, YUNG ('92) has found that *Hydra viridis*,† which has this kind of symbiosis, grows more rapidly in the successive members of the series : darkness (fatal), violet, green, white, and red. This series is essentially that just given for algæ living alone.

* KRAUS ('76) says that *Claviceps* growing in daylight attains a length of only 4 to 6 mm. ; in green rays, 17 mm. ; in yellow and blue, each, 30 mm. ; and, in the dark, 36 mm. Not much weight can be given to this statement, since an account of methods is lacking.

† A similar result was obtained with the green turbellarian *Convoluta Schultzei*.

The foregoing concordant observations may be summed up in the statements that the action of white light upon seedlings is the resultant of the action of the component rays ; that, of these, the red tends to favor growth by rendering possible starch formation ; the blue, on the other hand, tends to

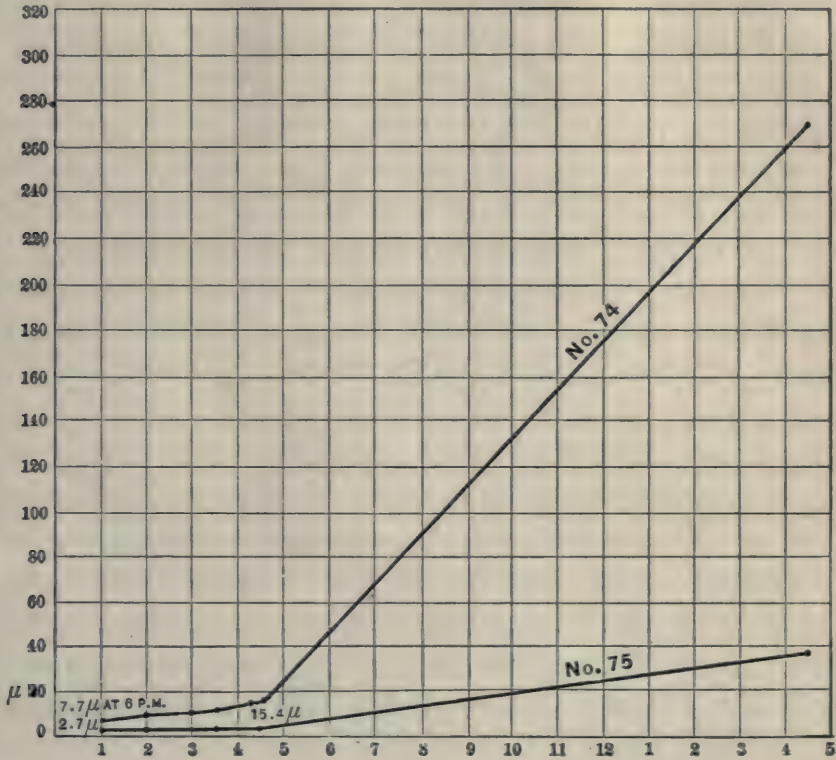

FIG. 123. —Curves of growth of threads of *Bacillus ramosus* in blue light (Experiment No. 75, of WARD) and in red light (Experiment No. 74). The numbers at the left indicate microns ; at the bottom, hours. The retardation due to blue light is evident. (From WARD, '95.)

restrain growth, probably by introducing certain destructive (or controlling) chemical changes ; that, in the dark, seedlings being freed from the restraining action of the chemical rays, grow rapidly so long as the stored food products permit ; that, in daylight, although the means of nutrition is provided, the presence of the inhibiting blue rays tends to cause slow growth. Upon other organisms whose growth is retarded by light, the effect of white and blue light must be quite the same ; and the experiments of VINES and of WARD upon fungi show that this is the case. The effective rays in retardation of growth are clearly those at the blue end of the spectrum.

b. The Effective Rays in the Acceleration of Growth by Light. — We have seen that the effective rays in retardation are the blue; the question now arises: Will the same rays serve, in other cases, for acceleration, or must the latter be due to the red rays?

As concerns the germination of ferns we have the observations of BORODIN ('68, p. 435), in the case of *Aspidium*, that germination did not take place in the blue any more than it did in darkness, while the red rays produced nearly the whole effect of white light. Germination in this case seems to demand the red rays for its processes — processes consisting largely of certain chemical changes favoring imbibition of water. Probably those seeds which germinate more rapidly in the light than in the dark make similar use of the red rays, as JÖNSSON ('93) has, indeed, found they do in the case of *Poa*.

Passing now to animals, we find the first critical work on these organisms is that of BECLARD ('58). This experimenter placed at one and the same time, under diversely colored glass bells, eggs of the flesh-fly, *Musca carnivora*, taken from a single laying. All the eggs produced larvæ; of these, the largest were formed under the violet or blue glass, the smallest under the green. The effect of the other colors was intermediate and fell in the following order: violet, blue, red, yellow, white, green. The larvæ reared under the violet rays were three-fourths greater than those reared under the green.* The apparent acceleration in violet, as compared with white light, indicates that the green rays of white light retard. This was the result actually obtained by SCHNETZLER ('74, p. 251), who found that tadpoles developed more slowly behind green glass (from which red and violet rays chiefly were cut out) than behind clear glass.

YUNG ('78) made more critical experiments upon tadpoles. Screens of nearly monochromatic solutions were used (p. 157). The size of the vessels and the number of tadpoles in each

* Exactly opposite results for blow-flies are given by DAVIDSON ('85), whose work, however, strikes one as crude. Fly larvæ reared in a bottle made of blue glass had at the end of nine days only half the weight, on the average, of larvæ reared either behind clear glass or in the dark. This subject needs careful investigation.

were the same. At the end of one month* three tadpoles were taken at random from each vessel and measured. In the following tables are given the average length and breadth of these tadpoles (from series of 1876 and 1877), and also the lengths compared with that in white light:—

TABLE XLII

AVERAGE DIMENSIONS OF TADPOLES REARED BEHIND CLEAR AND COLORED SCREENS DURING ONE MONTH

COLOR OF LIGHT.	AVERAGE LENGTH.	AVERAGE BREADTH.	LENGTH COMPARED WITH WHITE LIGHT.
White	24.43 mm.	5.37 mm.	100
Violet	28.58	6.75	117
Blue	25.66	5.70	105
Yellow	24.37	5.46	99
Red	20.37	4.66	83
Green	16.99	3.91	70

Similarly, averaging the dimensions of the tadpoles at the expiration of two months, we obtain:—

TABLE XLII_a

AVERAGE DIMENSIONS OF TADPOLES REARED BEHIND CLEAR AND COLORED SCREENS DURING TWO MONTHS

COLOR OF LIGHT.	AVERAGE LENGTH.	AVERAGE BREADTH.	LENGTH COMPARED WITH WHITE LIGHT.
White	31.58 mm.	7.50 mm.	100
Violet	42.32	10.41	134
Blue	33.92	8.00	107
Yellow	32.24	7.50	102
Red	27.17	6.50	86
Green	All	died before	two months

Tadpoles reared in the dark were uniformly slightly larger than those reared in red light, while violet and blue light show themselves especially favorable to the growth of the frog.

* During the first days of development in the cases of the frog, the snail *Planorbis*, and the sea-urchin *Echinus*, there is, according to DRIESCH ('91), no difference in the rate of growth behind various colored glasses. The diverse effects of different rays appear only in later stages.

Upon Echinoderm larvæ VERNON ('95) has made some important experiments. He used YUNG's methods of getting colors; but relative intensity is not indicated. The following table gives his results:—

TABLE XLIII

PERCENTAGE DEVIATIONS IN LENGTH OF LARVÆ OF STRONGYLOCENTROTUS LIVIDUS REARED BEHIND VARIOUS COLORED SCREENS, FROM LENGTH OF LARVÆ REARED IN WHITE LIGHT

COLOR.	NUMBER OF SETS OF EXPERIMENTS.	MEAN CHANGE.
Semi-darkness	3	+ 2.5%
Complete darkness	4	- 1.3
Blue (copper sulphate)	2	- 4.5
Green	4	- 4.8
Red	2	- 6.9
Blue (Lyon's blue)	2	- 7.4
Yellow	2	- 8.9

All larvæ reared in violet light soon died on account of the development of bacteria. In this case the order of growth followed the series: white, blue (of copper sulphate solution), green, red, blue (of Lyon's blue), yellow. This series differs so much from BECLARD'S that the experiment demands confirmation.

Certain experiments of YUNG on the relative time of hatching may be given here, since the time of hatching depends upon rate of growth:—

TABLE XLIV

RELATIVE TIME OF HATCHING OF ORGANISMS REARED BEHIND COLORED SCREENS

LOLIGO VULGARIS.	SALMO TRUTTA.	LYMNEA STAGNALIS.	AVERAGE.
Violet, 50 days	Violet, 32 days	Violet, 17 days	Violet
Blue, 53 "	Yellow, 34 "	Blue, 19 "	Blue
Yellow, } 58 "	Blue, } 35 "	Yellow, 25 "	Yellow
Red, }	White, }	White, 27 "	White
Green, —*	Green, 36 "	Red, 36 "	Red
White, all died	.	Green, all died	Green

* Had not hatched by 62 days.

These series run then in order of effect on growth exactly parallel to the series obtained from the growing tadpole, and are very similar to the series obtained by BECLARD for the blow-fly.

There are certain *a priori* grounds for believing that BECLARD'S series is the more correct, not only for growing flies, but for all animals. We would then get for a curve of relative effect of the different parts of the spectrum upon growth something like Fig. 126, I.* The conclusion to which all these experiments point is this: the accelerating effect of weak white light upon the growth of animals, contrary to the case in plants, is due to the short-waved rays.

The alleged peculiar effects of the green rays cannot go unnoticed. These seem to have been first insisted upon by BERT ('72, '78), who found that in the green lantern the young sensitive plant lost sensibility and died in three or four days, which is about the time in which they would have died in complete darkness. This observation has been confirmed by several experimenters; for example, by KRAUS ('76, p. 8), ADRIANOWSKY ('83), VILLON ('94, p. 461), and GAUTIER ('95) for plants, and by SCHNETZLER and by YUNG for tadpoles. Yet, on the other hand, FLAMMARION ('95) found no peculiar action of green light upon the sensitive plant. In the absence of precision in the opposing statements, we may doubt whether green rays, as such, produce any positive harm. It is probable that they are neutral in growth.

Summing up the results of our study on the effective rays in the modification of growth by light, we find that retardation, as it occurs in most aerial plants, is due to the chemically active rays; that acceleration, as it occurs in animals, is likewise due to the same rays. Both effects must be due to chemical, metabolic changes, induced by light: in the first class,

* The favorable effect of violet or blue rays was noticed also by VILLON ('94, p. 463) upon silkworms. Here may be mentioned the "blue glass" rage of twenty years ago, which was largely due to the writings of General A. J. PLEASANTON ('76), which, while containing a basis of truth experimentally obtained by the author, were of a highly uncritical and even sensational character.

these are of an injurious character; in the second, they favor the metabolic growth processes. Long-waved light, on the other hand, has usually no more effect than darkness, or the absence of light. However, upon germinating ferns and grasses long-waved light has a decided accelerating effect. Since even in daylight growth occurs faster than in the dark we must conclude that upon these organisms the blue rays do not seem to exert an injurious effect; they are, as it were, blind to the blue rays, and hence experience no freedom from restraint in the dark, and, unlike seedlings, no excessive growth there.

4. The Cause of the Effect of Light on the Rate of Growth.

— The action of red rays upon growing phanerogams requires no special explanation here. It is clear, from what we already know, that an etiolated seedling, or alga, can develop only in the presence of the red rays, which are ordinarily essential to its nutrition. Consequently, we find that red rays do not hinder the growth of ordinary seedlings, but cause etiolated green plants as well as seedlings of ferns and grasses to grow faster than they would in the dark.

The action of the blue ray does, on the other hand, demand more detailed consideration, for it seems at first as if its diverse effects upon plants and animals constitute a great difficulty. Why should the same rays retard the growth of aërial organisms and accelerate that of water animals? In inventing an hypothesis to fit the case, we have first to recognize that the action of the blue ray is a chemical one, and is probably of the same kind upon all organisms. It must, consequently, be that the degree of the effect is different. This difference may be due either to a difference in the quality of the different protoplasms or to a dissimilarity of the external conditions under which the effect is produced. We may say that, either on account of the presence of abundant free oxygen in the air, or, perhaps, on account of a greater lability of plant protoplasm, the blue rays effect such extensive transformations (oxidations, QUINCKE, '94) in aërial plants as to interfere with growth, possibly, by promoting loss of water. Upon water organisms, on the other hand, only slight metabolic changes occur, which, on the whole, favor the imbibitory or assimilative processes.

§ 2. EFFECT OF LIGHT UPON THE DIRECTION OF GROWTH —PHOTOTROPISM*

Under this topic will be considered, first, the effect upon plants; secondly, upon animals; and, after that, certain general matters concerning phototropism.

1. **Plants.** — The fact that seedlings reared in a room near a window all have their tops directed towards the source of light instead of vertically can scarcely have escaped any one's notice. References to the phenomenon are found in the literature of the ancients; its scientific study was begun in the early part of the last century by HALES (1727). Not only the stems of seedlings but many other plant-organs show this growth with reference to the direction of the infalling rays of light. Among these are tips of many stems, many leaves, cotyledons, roots (especially aerial ones), tendrils, the fruit-bearing hyphæ of cryptogams, and certain organs of the bryophytes and pteridophytes.

The sense of the turning in ordinary daylight is not always the same. While the stems of most seedlings of phanerogams turn towards the light (positive photo-

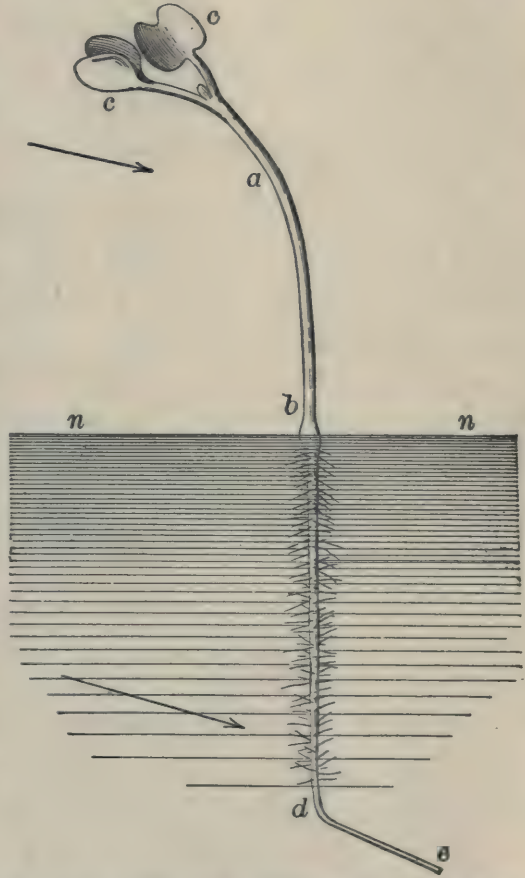

FIG. 124. — Seedling of *Sinapis alba* exhibiting positive phototropism of the stem, *ab*, and negative phototropism of the root, *de*. *nn*, surface of the water in which the plant is germinating. The arrow indicates the direction of the infalling light rays. (From FRANK, '92.)

* On some accounts it is unfortunate to accept this word rather than the older, more familiar term "heliotropism"; but as the latter is obviously unfitted to our broader view of the subject, and encourages the introduction of new special terms, such as selenotropism or turning towards the moon (MUSSET, '90), I think it is desirable to adopt the newer term.

tropism), the following turn from it (negative phototropism): the hypocotyl of the seedling mistletoe; the roots of many plants, *e.g.* *Sinapis* (Fig. 124), *Helianthus*, *Vicia faba*, *Zea mais*, etc.; stems of some recumbent dicotyledons, *e.g.* the moneywort; the root hairs of the prothalli of ferns and hepatics; the tendrils of the vines *Vitis* and *Ampelopsis*. As we shall see later, however, the sense of turning is, within limits, dependent upon the intensity of the light.

Finally, we observe that plants differ greatly in the degree of their phototropism. Thus aquatic plants and non-chlorophyllaceous phanerogams are only very slightly phototropic (compare HOCHREUTNER, '96).

The general phenomena of positive phototropism are seen when a seedling which has been growing in the dark is illuminated upon one side by a horizontal ray. The tip of the seedling, which is normally constantly "nutating" about the vertical line passing through its axis, now begins to move towards the light side of the vertical. The quickness with which it does so seems to vary with the species and with the intensity of illumination of the plant and other conditions of the environment; the turning may be evident in 15 minutes* or it may be delayed for several hours. There is apparently a certain, not precisely determined, latent period elapsing between illumination and response. The curvature first appears just behind the tip of the seedling, but later almost the whole

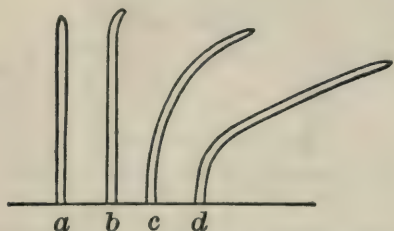

FIG. 125.—Course of phototropic curving of the cotyledon of *Avena sativa*. *a*, before illumination; *b*, after 1½ hours; *c*, after 3½ hours; *d*, after 7½ hours. (From ROTHERT, '94.)

stem above the ground becomes involved, so that after several hours it points straight towards the source of light (Fig. 125).

The *intensity* of light necessary to provoke the maximum response varies with the species. WIESNER ('93) especially has made accurate determinations on this subject.

The unit of measurement is a normal candle (p. 160) burning at a distance

* DARWIN ('81, Chapter IX) found with the aid of a microscope that the tip may begin to turn in from 3 to 10 minutes.

of one meter from the organism (meter-candle). A flame of one candle power at a distance of five meters has, therefore, an effective intensity of $1 \div 5^2 = 0.04$ "meter-candles." An ordinary flame of gas, kept at constant pressure by means of a manometer, was employed in the earlier experiments; a "microburner" in the later ones.

The following table gives the optimum intensity in the case of various seedlings, in units of the meter-candle, at a temperature of 20° to 27° C. and at a humidity of 75 to 77% :—

TABLE XLV

THE OPTIMUM INTENSITY FOR PHOTOTROPISM IN VARIOUS SPECIES OF PLANTS

<i>Lepidium sativum</i> , hypocotyl	0.25–0.11
<i>Pisum sativum</i> , epicotyl	0.11
<i>Phaseolus multiflorus</i> , epicotyl	0.11
<i>Vicia faba</i> , epicotyl	0.16
<i>Helianthus annuus</i> , hypocotyl	0.16
<i>Vicia sativa</i> , epicotyl	0.44
<i>Salix alba</i> , etiolated sprout	6.25

This table shows also the effect of preceding conditions of illumination; the etiolated plant has a very high optimum.

At an intensity of light above the optimum the phototropic response is less pronounced until, finally, at between 100 and 800 meter-candles it disappears. At an intensity below the optimum a similar diminution in response occurs; but the minimum lies often remarkably low. Thus FIGDOR ('93) has found the minimum to lie for the different species at or just below the following intensities (in meter-candles). The temperature was 15° to 24° C., and the humidity between 58 and 80%.

TABLE XLVI

THE MINIMUM INTENSITY FOR PHOTOTROPIC RESPONSE IN VARIOUS SPECIES OF PLANTS

<i>Lepidium sativum</i> , <i>Amaranthus melancholicus</i> ruber, * <i>Papa-</i> ver <i>pæoniflorum</i> , and † <i>Lunularia biennis</i>	limit below 0.00033
* <i>Vicia sativa</i>	0.0026
<i>Salpiglossus sinuata</i> , <i>Reseda odorata</i> , <i>Iberis forestieri</i>	0.004 to 0.16
<i>Mirabilis jalappa</i> , * <i>Helianthus annuus</i> , * <i>Dianthus chinensis</i>	0.016
* <i>Xeranthemum annuum</i> , * <i>Raphanus sativus</i> , * <i>Helichrysum</i> monstrosum, * <i>Capsicum annuum</i> , <i>Cynoglossum officinale</i>	0.016 to 0.06

This list shows that different plants have diverse phototropic sensitiveness. Since in this list species preceded by an asterisk (*) live in the sunlight, that preceded by a dagger (†) is a shade-loving plant, while the others live in an intermediate habitat, we may conclude that, in general, sun-loving plants are less sensitive to light than those not markedly sun loving. The former exhibit a sort of acclimatization to light.*

The *effective rays* have been determined by WIESNER ('79, p. 191) for seedlings of several species as a result of experiments in which colored solutions were employed. His results are summarized in Fig. 126, which shows that the phototropic effect is greatest at the violet end of the spectrum, and that as we pass towards the D line, lying between the yellow and the orange, the effect diminishes, becoming null at D. In the red, again, there is a considerable effect. Beyond the visible red,

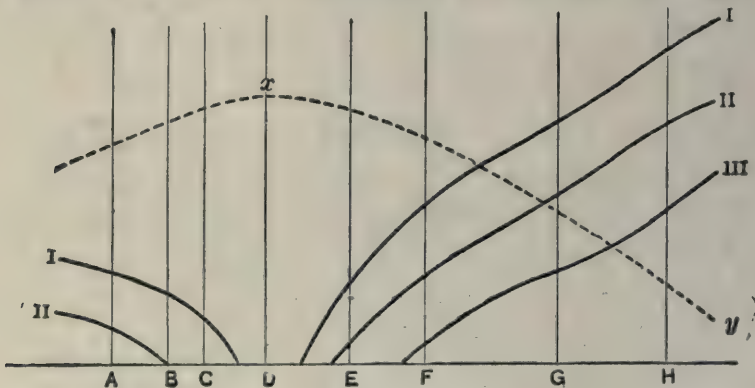

FIG. 126. — A-H, positions of FRAUENHOFER'S lines in the spectrum.

—, curves of phototropic effect of the various rays; the ordinates have only relative values. I, I, curve for the seedling of the vetch, *Vicia*; II, II, for cress seedlings; III, for etiolated willow shoots, upon which latter the more strongly refractive rays only act phototropically.

----, curve of retardation of growth in length of *Helianthus* seedlings reared in the various rays. The ordinates give the increment in length of the seedling subjected to the ray under consideration; thus the retardation is least at *x*, and is greatest at *y*. (FROM WIESNER, '81.)

* Certain plants are so sensitive to differences of illumination on their two sides as to make very delicate photometers. Thus WIESNER determined as nearly as possible by BUNSEN'S photometer the point of equal illumination between two flames, but a seedling still detected a difference between their intensities. MASSART ('88) has made use of this method to demonstrate for phototropism the validity of WEBER'S law. He found that in *Phycomyces* a difference of intensity of 18% between two sources of light could be detected; and this held true for all intensities of light.

in the region of the dark heat rays, we find an effect still produced. This effect of dark heat rays will be referred to again in the next chapter.

The Responding Region. — We have already seen that the curvature begins a short way below the tip of the stem of the seedling. Further study shows that this region of first curvature is also that of maximum growth. The response does not, however, end here, but passes basalwards even after the seedling is transferred to the dark. Also in roots, the region of maximum negative curvature is that of most rapid growth (MÜLLER, '76).

The Perceptive Region. — In most cases the region of response is also that of perception. But DARWIN ('81) found that in some organs this is not the case. When, for example, the phototropic cotyledons of the seedlings of grasses and grains were deprived of their tips for a distance of 2.5 to 4 mm., they exhibited no phototropism; but when only 1.3 mm. of the tip was cut off, the curving occurred, although in diminished degree. Again, when the tips of some of the cotyledons were covered with opaque caps made of glass thickly painted with India ink, while others were covered with transparent glass, the first lot remained straight or nearly so, whereas the second curved normally. From such results DARWIN concluded that the tip of the cotyledon is the chief perceptive region. That it is not the only perceptive part, even in cotyledons, follows from the observations of ROTHERT ('94), who finds that a slight curvature succeeds the illumination of the basal part alone of the cotyledon. In some seedlings of dicotyledons, indeed, the perceptive region exists nearly equally developed along the whole stem.

In those cases where the tip of the plant is alone perceptive there must be the transmission of an impulse from the perceptive to the bending region. The rate of this transmission is variable; in favorable cases it is about 2 cm. per hour (ROTHERT, '94, p. 209). If we define "irritation" or "stimulation" as the condition of the protoplasm immediately antecedent to its response, — as the chemical transformation lying behind the visible result, — then, since in these plants the response occurs some distance from the perceptive region, we

must conclude, with ROTHERT, that here, as in animals, stimulation is a process distinct from perception.

2. **Animals.** — Phototropism among animals will naturally be limited to elongated, sessile forms. It has hitherto been detected only among hydroids and worms of the family Serpulidæ.

a. Serpulidæ. — A type of response to light intermediate between phototaxis and phototropism is described by LOEB ('90) for *Spirographis spallanzanii*. This worm (Fig. 127)

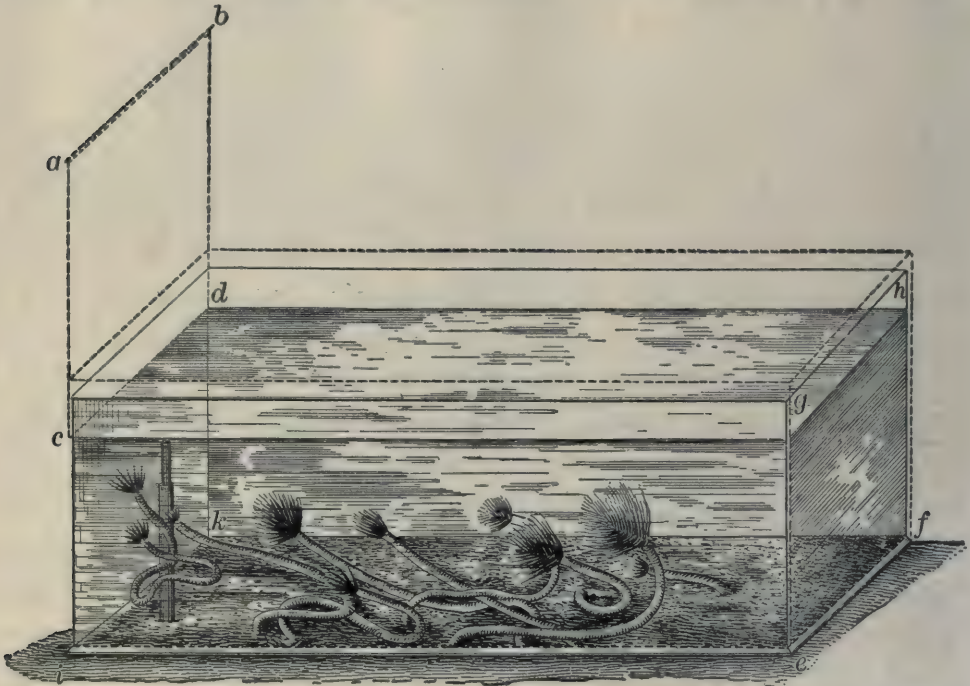

FIG. 127. — Persistent phototropic curvature in *Spirographis spallanzanii*. The animals were originally placed horizontally on the bottom of the aquarium, the majority with their heads towards the side, *efgh*, of the aquarium away from the window. In their further growth the animals curve until their heads are turned towards the light side, *abcd*, of the aquarium, and the axes of their gills stand in the direction of the rays of daylight. (From LOEB, '90.)

builds, from a secretion of the body, cylindrical tubes of somewhat elastic nature which are attached at their base to a solid substratum. When these worms, in their tubes, are illuminated from one side by a pencil of rays, the upper part of the tube comes, within a few hours, to lie in the axis of the pencil, and the gills, which surround the head, are stretched out towards the source of light. This result seems to be due to a sort of phototactic response modified by the sessile habit of

the organism. Since the tube is tough and elastic, its bending towards the light must be due, at first, to muscular action of the animal inhabiting it. Additional secretions are, however, constantly poured forth so that the new position soon becomes in turn the permanent one. *Serpula*, which has a tube containing lime, likewise turns its head end towards the light; but, since its tube is firm and inelastic, the bending which it finally exhibits must be ascribed alone to growth of the shell by additions to its free upper margin.

b. Hydroids. — These have been made the object of study by DRIESCH ('90) and LOEB ('90 and '91, p. 36). In stocks of *Sertularia polyzonias*, reared in an aquarium, one often finds a stolon (primary stolon) growing out from the distal end, at first straight, so as to prolong the axis of the stock, then turning and growing from the source of light. From the convexity of this primary stolon a secondary one buds forth. It grows towards the light for a time, until it in turn buds off a (tertiary) stolon; then it becomes negatively phototropic. Tertiary and succeeding generations of stolons follow the same law. We have here the remarkable phenomenon of change in the sense of response depending upon the condition of development of the stolon (DRIESCH). In *Eudendrium* the hydranths, in contradistinction to the stolons, grow towards the light — they are positively phototropic (Fig. 128).

The effective rays in animal phototropism have not been determined. It is highly probable that, as in plants, they are the more highly refractive ones. The responding region in hydroids is the growing region. The fully formed stolon does not turn in response to light. The perceiving region is still

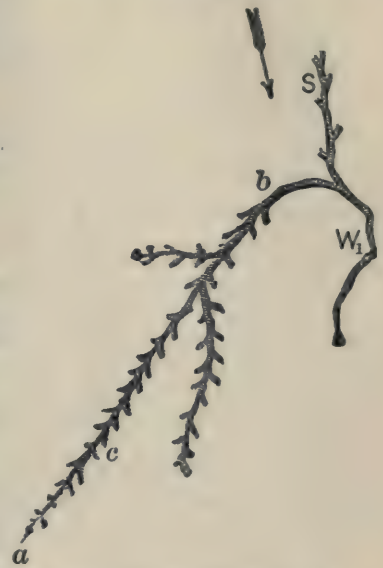

FIG. 128. — Phototropism in regeneration of *Sertularia* (*polyzonias*?). The stock was cut near the stolon at *b* and inserted reversed in the sand, being buried from *a* to *c*. From the upper end *b*, both a stolon, *W₁*, and hydranths, *S*, regenerated, and both grew in the axis of the infalling ray of light, indicated by the arrow. The hydranths are directed toward the source of light; the stolon tip in the opposite direction. Magnified 2 diameters. (From LOEB, '90.)

unknown; the subject has not been investigated. Is it at the tip or at the responding region, or do these regions exactly coincide? The essential identity of phototropism in sessile animals and plants is striking, and indicates how closely similar needs are met by similar capacity for response in the two groups.

3. **General Considerations.** — *a. Persistence of Stimulation.*

If a seedling, after momentary illumination on one side, be placed in the dark before any turning has occurred, phototropism will follow after the same interval as would have elapsed had the plant remained in the light. Even if the irritated seedling be placed in the dark in a horizontal position, no geotropic curvature will interfere with the working out of the stimulus already given. This persistence of an effect wrought by light has been called by WIESNER photomechanical induction: it is, however, only a particular case of persistence of an effect, of which we have seen other examples. As a result of this phenomenon a seedling, intermittently illuminated for one second and kept in the dark for two seconds, will respond phototropically as completely and as quickly as if it had been kept continuously in the light.

b. Acclimatization to light is a process closely related to the foregoing. As early as 1827 MOHL observed that plants reared in a weak light, or in the dark, became, after a time, phototropically more sensitive than plants which had been constantly exposed to full daylight. The observation has been several times confirmed (cf. DARWIN, '81, Chapter IX); so we may conclude that the constant subjection to light diminishes the sensitiveness towards light.

c. Mechanics of Phototropism. — It is clear that phototropic curvature, as seen in the seedling, the mold, or the hydroid, is the result of unequal growth upon the two sides of the cylindrical organ; and, indeed, that the positive phototropism is due to a relative diminution of growth on the side next the source of light, and the negative phototropism to a relative increase of growth on that side. Experiments have shown that in positive phototropism growth is excessively rapid upon the convex side of the organ, and excessively slow upon the concave side. These results are reasonably attributed to an

increased turgescence on the one side and a decreased turgescence on the other.

In unicellular organisms, on the other hand, this mechanism cannot be called upon; and great difficulty has been met with in explaining how an elongated cell, for instance, of a hypha, can curve itself. Some authors have suggested that the cell-wall on the convex side becomes excessively extensible, on the concave side excessively rigid. Again, it has been suggested that this change takes place rather in the protoplasm inside the wall than within the wall itself. If, however, with many plant physiologists we regard the cell-wall as the truly living, only considerably modified, protoplasm, then we may accept both of these views, and, uniting with them the explanation advanced for phototropism in multicellular organs, say: The curving of the unicellular organ is probably due to the increased extensibility, gained through imbibition of water, of the whole protoplasm (including cell-wall) of the convex side, together with a corresponding diminution on the concave side. In a word, then, the mechanism of phototropism may be stated to be the excessively rapid imbibition of water by the protoplasm on the convex side.

But what starts the mechanism? This is the same question that arises with other growth responses. Its answer must be deferred to a later chapter.

LITERATURE

- ADRIANOWSKY, A. '83. Wirkung des Lichtes auf das erste Keimungsstadium der Samen. [Russian.] Abstr. in Bot. Centr. XIX, 73-75.
- ADUCCO, V. '89. Action de la lumière sur la durée de la vie, la perte de poids, la température et la quantité de glycogène hépatique et musculaire chez les pigeons soumis au jeûne. Arch. Ital. de Biol. XII. 208-214. 28 July, 1889.
- BARY, A. DE, '63. Recherches sur le développement de quelques champignons parasites. Ann. d. Sci. Nat. (Bot.). (4), XX, 5-148.
- BECLARD, J. '58. Influence de la lumière sur les animaux. Comp. Rend. XLVI, 441-453.
- BERT, P. '72. Influence des divers rayons colorés sur la végétation. C. R. Soc. Biol. Paris. XXIII, 67-69.
- '78. Influence de la lumière sur les êtres vivants. Revue Sci. (2), VII, 981-990. 20 Apr. 1878.

- BIDDER, F. H., and SCHMIDT, K. '52. Die Verdauungssäfte und der Stoffwechsel. 413 pp. Mitau and Leipzig, 1852.
- BLANC, L. '92. Note sur les effets teratogéniques de la lumière blanche sur l'œuf de poule. C. R. Soc. de Biol. Paris. XLIV, 969-971.
- BORODIN, J. '68. Ueber die Wirkung des Lichtes auf einige höhere Kryptogamen. Bull. Acad. Sci. St. Petersburg. XII, 432-447. 1 Taf. 13 Jan. 1868.
- BRAEM, F. '95. Mittheilung über den Einfluss des Gefrierens auf die Entwicklung thierischer Keime. Jahresber. der Schlesischen Gesellsch. f. Vaterländ. Cultur. LXXII². Zool. Bot. Sect. 2-3.
- BREFELD, O. '77. Botanische Untersuchungen über Schimmelpilze. III. Hft. Leipzig: Arthur Felix. 1877.
- '89. Untersuchungen aus dem Gesamtgebiete der Mykologie. Fortsetzung der Schimmel und Hefenpilze. VIII. Hft. Leipzig: Arthur Felix.
- BULLOT, G. '97. Sur la croissance et les courbures du *Phycomyces nitens*. Ann. Soc. Belg. de Micros. XXI, 69-93. 1897.
- CAMERANO, L. '93. Dell' azione dell' acqua corrente e della luce sullo sviluppo degli Anfibi anuri. Boll. Mus. Zool. ed Anat. Comp. Torino. VIII, 3-12. 20 Jan. 1893.
- DARWIN, C. and F. '81. (See Chapter XIV, Literature.)
- DAVIDSON, J. '85. On the Influences of Some Conditions on the Metamorphosis of the Blow-fly (*Musca vomitoria*). Jour. of Anat. and Physiol. XIX, 150-165. Jan. 1885.
- DRIESCH, H. '90. Heliotropismus bei Hydroïdenpolypen. Zool. Jahrb., System. Abth. V, 147-156. 3 May, 1890.
- '91. Entwicklungsmechanische Studien, II. Über die Beziehungen des Lichtes zur ersten Etappe der thierischen Formbildung. Zeitschr. f. wiss. Zool. LIII, 160-184. 10 Nov. 1891.
- EDWARDS, W. F. '24. De l'influence des agens physiques sur la vie. Paris, 1824. Also, On the Influences of Physical Agents on Life. Translated from the French by Dr. HODGKINS and Dr. FISCHER. London, 1832.
- FAMINTZIN, A. '65. Die Wirkung des Lichtes auf das Wachsen der Keimenden Kresse. Mém. Acad. St. Petersb. (7), VIII. No. 15. 16 pp.
- '67. Die Wirkung des Lichtes auf Algen und einige ihnen nahe verwandte Organismen. Jahrb. f. wiss. Bot. VI, 1-44.
- FIGDOR, W. '93. Versuche über die Heliotropische Empfindlichkeit der Pflanzen. Sitzungsber. Akad. Wiss. Wien. CII¹, 45-59.
- FLAMMARION, C. '95. Étude de l'action des diverses radiations die spectre solaire sur la végétation. Comp. Rend. CXXI, 957-960. 16 Dec. 1895.
- FRIES, E. M. '21. Systema Mycologicum, etc. I. 520 pp.
- GAUTIER, A. '95. Discussion on FLAMMARION, '95. Comp. Rend. CXXI, 960-961.
- GODLEWSKI, E. '90. Die Art und Weise der wachsthumretardirenden Lichtwirkung und die Wachsthumstheorien. Anz. d. Akad. d. Wiss. Krakau, July, 1890, p. 286. [Abstr. Naturw. Rundschau. VI, 150, 151. 21 March, 1891.]

- GODLEWSKI, E. '93. Studien über das Wachsen der Pflanzen. Abh. Krakauer Akad. d. Wiss. XXIII, 1-157. [Polish.] Abstr. in Bot. Centr. LV, 34-40.
- HALES, S. 1727. Statical Essays. Volumen I: Vegetable Staticks, or an Account of Some Statical Experiments on the Sap in Vegetables. 376 pp. 19 Tab. London.
- HAMMOND, '73. Some Points relative to the Sanitary Influence of Light. The Sanitarian, II.
- HENSEN, V. and APSTEIN, C. '97. Ueber die Eimenge der im Winter laichenden Fische. Wiss. Meeresuntersuch. deutsch. Meere. II, Heft 2. pp. 1-98.
- HIGGENBOTTOM, J. '50. Influence of Physical Agents on the Development of the Tadpole, of the Triton, and the Frog. Phil. Trans. Roy. Soc. London for 1850. 431-436. Pl. XXXII.
- '63. Influence des agents physiques sur le développement du têtard de la grenouille. Jour. de la Physiol. VI, 204-210.
- HOCHREUTINER, G. '96. Physiologie des plantes aquatiques du Rhône et du Port de Genève. Rev. Gén. de Bot. VIII, 148-167, 188-200, 249-265. 15 Apr.-15 June, 1896.
- HOFFMANN, H. '60. Untersuchungen über die Keimung der Pilzsporen. Jahrb. f. w. Botanik. II, 267-337.
- JÖNSSON, B. '93. Iakttogelsen öfver ljusets betydelse för fröns groning. Lunds Universitets Års-skrift. XXIX, 47 pp.
- KARSTEN, H. '71. Die Einwirkung des Lichts auf das Wachsthum der Pflanzen, beobachtet bei Keimung der Schminkbohnen. Landw. Versuchs-Stat. XIII, 176-195.
- KNY, L. '84. Das Wachsthum des Thallus von *Coleochæte scutata* in seinen Beziehungen zur Schwerkraft und zum Lichte. Ber. Bot. Ges. II, 93-96.
- KRAUS, G. '76. Versuche mit Pflanzen im farbigen Licht. Ber. Sitzungs d. Naturf. Ges. Halle. Jahre 1876. 4-8.
- '83. Ueber das tägliche Wachsthum der Früchte. Ber. d. Naturf. Ges. zu Halle. 1883. 92-121.
- LEITGEB, H. '77. Die Keimung der Lebermoossporen in ihrer Beziehung zum Lichte. Sb. Wien. Akad. LXXIV, 1 Abth. 425-436. 1 Taf.
- LESSONA, '77. Studê sugli amfibi anuri del Piemonte. R. Accad. dei Lincei Atti. (3) Mem. Sci. I, 1019-1098. 5 Tav.
- LIEBENBERG, A. RITTER VON, '84. Ueber den Einfluss intermittender Erwärmung auf die Keimung der Samen. Bot. Centralb. XVIII, 21-26.
- LOEB, J. '90. Weitere Untersuchungen über den Heliotropismus der Thiere und seine Uebereinstimmung mit dem Heliotropismus der Pflanzen. Arch. f. d. Ges. Physiol. XLVII, 391-416. Taf. IX. 9 May, 1890.
- '91. Untersuchung zur physiologischen Morphologie der Thiere. I. Ueber Heteromorphose. Würzburg: G. Hertz. 1891.
- MCDONNELL, R. '59. Exposé de quelques expériences concernant l'influence des agents physiques sur le développement du têtard de la grenouille commune. Jour. de la Physiol. II, 625-632.

- MASSART, J. '88. Recherches sur les organismes inférieurs. 1. La loi de Weber vérifiée pour l'héliotropisme du champignon. Bull. Belg. Acad. (3), XVI, 590-597.
- MAUPAS, É. '87. Sur la puissance de multiplication des Infusoires ciliés. Comp. Rend. CIV, 1006-1008. 4 Apr. 1887.
- MILDE, J. '52. Zur Entwicklungsgeschichte der Equiseten und Rhizokarpen. Verh. d. Kais. Leop.-Car. Ak. d. Naturf. XV, 2 Abth. 613-646. Taf. 57-59.
- MILLET, C. '55. Influence nuisible de la lumière sur les œufs de certaines espèces de Poissons. L'Institut. XXIII¹, 55. 14 Feb. 1855.
- MOHL, H. v. '27. Ueber den Bau und das Winden der Ranken- und Schlingpflanzen. 152 pp. 13 Tab. Tübingen, 1827.
- MOLESCHOTT, J. '55. Recherches sur l'influence de la lumière sur la production de l'acide carbonique par les animaux. Ann. d. Sci. Nat. (Zool.). (4), IV, 209-224.
- MÜLLER, H. '76. Ueber Heliotropismus. Flora. LIX, 65-70, 88-95.
- MUSSET, C. '90. Sélénétropisme. Comp. Rend. CX, 201-202. 27 Jan. 1890.
- NOBBE, F. '82. Uebt das Licht einen vortheilhaften Einfluss auf die Keimung der Grassamen? Landw. Versuchs-Stat. XXVII, 347-355.
- PLEASANTON, A. J. '76. The Influence of the Blue Ray of the Sunlight and of the Blue Color of the Sky in developing Animal and Vegetable Life, in arresting, and in restoring Health in Acute and Chronic Disorders to Human and Domestic Animals. Philadelphia, 1876.
- PRANTL, K. '73. Ueber den Einfluss des Lichts auf das Wachsthum der Blätter. Arb. a. d. Bot. Inst. Würzburg. I, 371-384.
- QUINCKE, H. '94. Ueber den Einfluss des Lichtes auf den Thierkörper. Arch. f. d. ges. Physiol. LVII, 123-148. 1 June, 1894.
- ROTHERT, W. '94. Ueber Heliotropismus. Beiträge zur Biol. der Pflanzen. VII, 1-212.
- SACHS, J. '63. Ueber den Einfluss des Tageslichts auf Neubildung und Entfaltung verschiedener Pflanzenorgane. Bot. Ztg. XXI, Suppl. 30 pp.
- '64. Wirkungen farbigen Lichts auf Pflanzen. Bot. Ztg. XXII, 353 et seq.
- '72. Ueber den Einfluss der Lufttemperatur und des Tageslichts auf die stundlichen und täglichen Aenderung des Längenwachsthums (Streckung) der Internodien. Arb. a. d. Bot. Inst. Würzburg. I, 99-192.
- SCHMITZ, J. '43. Beiträge zur Anatomie und Physiologie der Schwämme. Linnæa. XVII, 417-548.
- SCHNETZLER, J. B. '74. De l'influence de la lumière sur le développement des larves de grenouilles. Arch. Sci. Phys. et Nat. LI, 247-258.
- SIEMENS, C. W. '80. On the Influence of Electric Light upon Vegetation, and on Certain Physical Principles involved. Proc. Roy. Soc. XXX, 210-219.
- '80^a. Some Further Observations on the Influence of Electric Light upon Vegetation. Proc. Roy. Soc. XXX, 293-295.

- SIEMENS, C. W. '82. On Some Applications of Electric Energy to Horticultural and Agricultural Purposes. Rept. Brit. Assoc. Adv. Sci. LI, 474-480.
- STAMEROFF, K. '97. Zur Frage über den Einfluss des Lichtes auf das Wachstum der Pflanzen. Flora. LXXXIII, 135-150. 22 Feb. 1897.
- STEBLER, '81. Ueber den Einfluss des Lichtes auf die Keimung. Vierteljahrs. Naturf. Ges. Zürich. XXVI, 102-104.
- TREW, C. T. 1727. Beschreibung der grossen Amerikanischen Aloe, wobei das tägliche Wachstum des Stengels der im Jahr 1726, zu Nürnberg verblühten Aloe erläutert wird. 36 pp. 1 Tab. Nürnberg, 1727.
- VERNON, H. M. '95. The Effect of Environment on the Development of Echinoderm Larvæ: An Experimental Inquiry into the Causes of Variation. Phil. Trans. Roy. Soc. London. CLXXXVI^B, 577-632. 14 Oct. 1895.
- VILLON, A. M. '94. La culture sous verres colorés. Rev. Sci. (4), I, 460-463. 14 Apr. 1894.
- VINES, S. H. '78. The Influence of Light upon the Growth of Unicellular Organs. Arb. Bot. Inst. Würzburg. II, 133-147.
- WARD, H. M. '95. On the Biology of *Bacillus ramosus* (Fraenkel), a Schizomycete of the River Thames. Proc. Roy. Soc. LVIII, 265-468.
- WHIPPLE, G. C. '96. Some Experiments on the Growth of Diatoms. Technology Quarterly. IX, 145-168.
- WIESNER, J. '79. Die heliotropischen Erscheinungen im Pflanzenreiche. Eine physiologische Monographie. Theil I. Denkschr. Wien. Akad. XXXIX, 143-209.
- '81. The same. Theil II. Denkschr. Wien. Akad. XLIII, 1-92.
- '93. Photometrische Untersuchungen auf Pflanzenphysiologischen Gebiete. Erste Abhandlung. Orientierende Versuche über den Einfluss der sogenannten chemischen Lichtintensität auf den Gestaltungsprocess der Pflanzenorgane. Sb. Wien. Ak. CII¹, 291-350.
- '98. Ueber die Ruheperiode und über einige Keimungsbedingungen der Samen von *Viscum album*. Ber. Deut. Bot. Ges. XV, 503-516.
- YUNG, É. '78. Contributions à l'histoire de l'influence des milieux physiques sur les êtres vivants. Arch. Zool. Expér. et Gén. VII, 251-282.
- '80. De l'influence des lumières colorées sur le développement des animaux. Mitth. a. d. Zool. Stat. zu Neapel. II, 233-237.
- '92. De l'influence des lumières colorées sur le développement des animaux. Comp. Rend. CXV, 620, 621. 24 Oct. 1892.

CHAPTER XVIII

EFFECT OF HEAT ON GROWTH

As in other cases, so in describing the effect of heat we shall consider separately its effect on the rate and on the direction of growth.*

§ 1. EFFECT OF HEAT ON THE RATE OF GROWTH

The descriptive fact that the rate of growth—of development in general—in both animals and plants is dependent upon temperature, has long been known. The work upon plants was begun earlier than that upon animals, and has been carried further. We may consider, first, the results gained in that group.

1. **Plants.**—As an introduction to the study of the effect of heat upon growing plants, we may consider the results of measurements made upon phanerogams, showing, for various temperatures, the increase in length of the plant after 48 hours :—

* The methods to be employed in subjecting organisms to heat have already been discussed on pp. 219–222. The constant-temperature oven, of the kind employed in bacteriological laboratories, may be used for rearing growing plants or aquatic animals at a high temperature. An ordinary refrigerator will serve for temperatures from near 0° to 8° or 10° C. The methods employed in thermotropic experimentation are referred to on p. 464.

To test the question of the dependence of the optimum for growth upon the temperature to which the organism is normally subjected it would be necessary to rear a species attuned to a warm climate at a constantly low temperature for several generations, or the reverse, and then compare the optimum of the normal race with that subjected to the new conditions. To test the question of the dependence of the range of the growing temperatures upon the range of temperatures in the environment, one lot of individuals of a species should be reared in a constant-temperature room, and another in a very fluctuating temperature.

TABLE XLVII

SHOWING THE AVERAGE TOTAL INCREMENTS IN LENGTH (IN MILLIMETERS) OF THE *Plumules* OF SEEDLINGS SUBJECTED TO DIFFERENT TEMPERATURES (EXPRESSED IN DEGREES CENTIGRADE). THE OBSERVATIONS MARKED S WERE MADE BY SACHS ('60); THOSE MARKED K, BY KÖPPEN ('71); AND THOSE MARKED V, BY DE VRIES ('70). THE TIME INTERVAL IS 48 HOURS

TEMPERATURE.	PHASEOLUS MULTIF. (S).	ZE MAIS (S).	ZE MAIS (K).	PISUM SATIVUM (S).	PISUM SATIVUM (K).	LUPINUS ALBA (K).	SINAPIS ALBA (V).	LEPIDIUM SATIVUM (V).	LINUM USIT. (V).
14-15.9					5.0	9.1	3.8	5.9	1.5
16-17.9	7.4*	4.6*		3.0*					
18-19.9			1.1		8.3	11.6			
20-21.9			9.3		25.5	25.0	24.9	38.0	20.5
22-23.9			10.8		30.0	31.0			
24-25.9			20.1		45.8	33.9			
26-27.9	11.0	5.6	29.6	10.0	53.9	54.1	52.0	71.9	44.8
28-29.9			26.5?		40.4	50.1			
30-31.9			64.6		38.5	43.8	44.1	44.6	39.9
32-33.9	10.5	11.0	69.5	5.7	23.0	14.2			
34-35.9	15.0	13.0		5.0			30.2	26.9	28.1
36-37.9			20.7		8.7	12.6	10.0	0.0	9.2
38-39.9	10.2	9.1		5.5					
42.5	7.5	4.6							

TABLE XLVIII

SHOWING THE AVERAGE INCREMENTS IN LENGTH IN MILLIMETERS OF THE *Radicle* OF VARIOUS SEEDLING PLANTS SUBJECTED TO DIFFERENT TEMPERATURES. TEMPERATURES IN DEGREES CENTIGRADE. ALL FROM SACHS ('60). THE TIME INTERVAL IS 48 HOURS.

° C.	ZE MAIS.	PHASEOLUS MULTIFLORUS.	CUCURBITA PEPO.	PISUM SATIVUM.
17.0	2.5*			4.0*
25.7		39		
26.3	24.5	47		
28.5		34		41.0
33.2	39.0	30		17.0
34.0	55.0	28	30	
38.2	25.2	22	14	12.2
42.5	5.9	7	11	

* Growth during 96 hours.

Data from the higher fungi have been afforded by the studies of WIESNER ('73) upon *Penicillium*. I give all of WIESNER'S data, although not all are strictly concerned with growth. These data show the relation between temperature, on the one hand, and the interval, in days, between sowing and (1) germination, (2) formation of visible mycelium, and (3) spore formation, on the other:—

TABLE XLIX

TIME, IN DAYS, REQUIRED FOR SPORES OF *PENICILLIUM* TO GERMINATE, PRODUCE VISIBLE MYCELIUM, AND TO FORM SPORES, AT VARIOUS TEMPERATURES

TEMPERATURE °C.	TIME TO GERMINATION.	TIME TO PRODUCTION OF VISIBLE MYCELIUM.	TIME TO SPORE FORMATION.
1.5	5.80		
2.0	5.50		
2.5	3.00	6.00	
3.0	2.50	4.00	9.00
3.5	2.25	3.50	8.00
4.0	2.00	3.00	7.75
5.0	1.50	2.90	7.00
7.0	1.20	3.00	6.25
11.0	1.00	2.30	4.00
14.0	0.75	2.00	3.00
17.0	0.75	2.00	3.00
22.0 (Opt.)	0.25	1.00	1.50
26.0	0.50	0.99	2.00
32.0	0.70	1.01	2.10
38.0	0.55	2.25	2.60
40.0	0.70	2.50	3.50

The law of growth of bacteria at various temperatures is illustrated in the observations of WARD ('95, p. 458). His results are epitomized in the curves of Fig. 129.

The curve (Fig. 130) of the phanerogams *Zea mais* and *Pisum sativum*, which is constructed somewhat differently from that of

FIG. 129.— Curve of relation between rate of growth of *Bacillus ramosus* and the temperature. The growth is measured by the period, expressed in minutes (μ), required for the bacillus to double its length. The relative duration of these periods is expressed by the ordinates. The abscissæ are temperatures. (From WARD, '95.)

FIG. 130.— Curves of absolute growth in 48 hours of *Zea mais* and *Pisum sativum* at different temperatures. (Data from Table XLVII.)

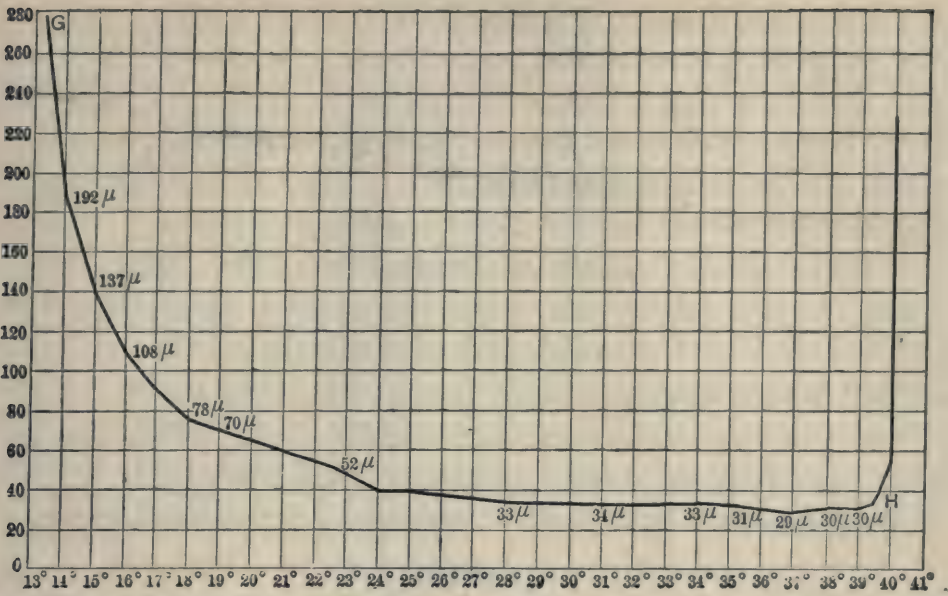

FIG. 129

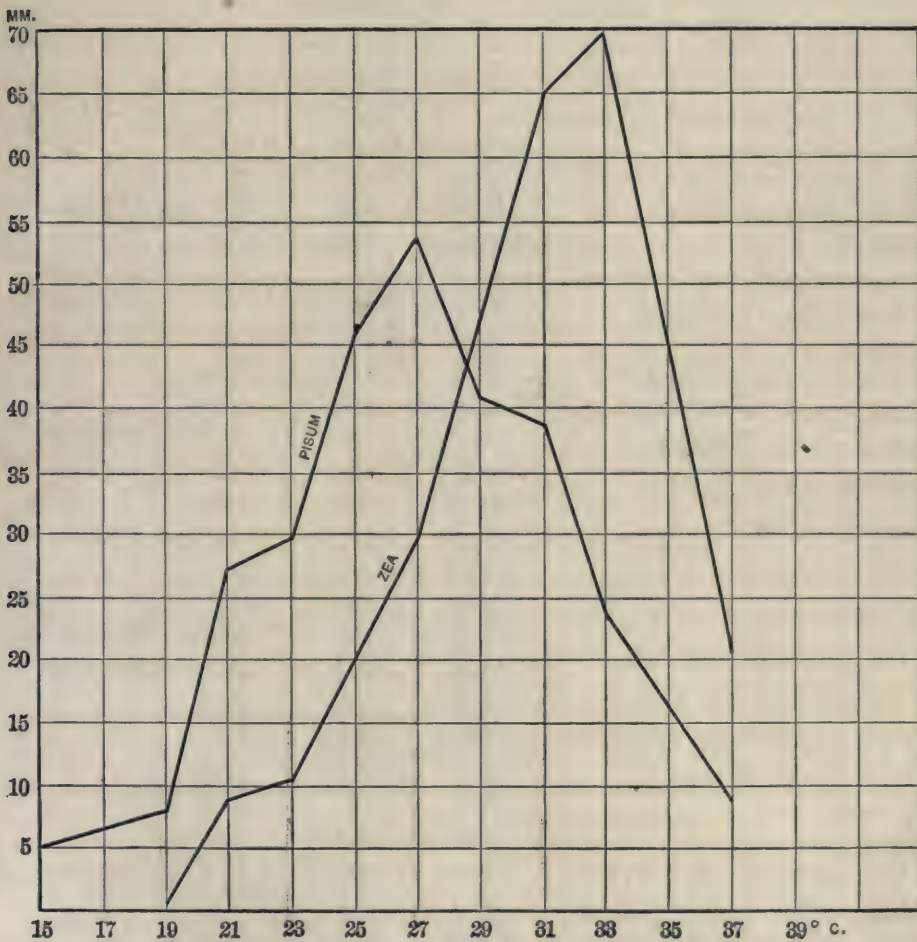

FIG. 130

Fig. 129, shows, more graphically than the tables from which they are drawn, that, as the temperature rises, growth increases up to a certain point, and then diminishes again. The falling off is more rapid than the increase—a condition which we found also in the curves (Fig. 68 ; p. 226) giving the rate of movement of protoplasm at different temperatures. We have thus three critical points to distinguish: the minimum, or lowest temperature at which growth occurs; the optimum, or the temperature of greatest growth; and the maximum, or the highest temperature at which growth can take place. These critical points, then, are to be considered comparatively; and as an introduction to this consideration I present, in a table, the points as they have been determined for various species:—

TABLE L

SHOWING CRITICAL POINTS FOR VARIOUS PLANT ORGANISMS, ARRANGED ACCORDING TO THE OPTIMUM

NAME OF PLANT.	TEMPERATURE FOR GROWTH.			AUTHORITY.
	OPTIMUM.	MINIMUM.	MAXIMUM.	
<i>Bacillus phosphorescens</i>	20.0°	0.0°	37.0°	FORSTER, '87
<i>Penicillium</i>	22.0	1.5	43.0	WIESNER, '73
<i>Phaseolus multiflorus</i> (Radicl.) .	26.3	—	—	SACHS
<i>Pisum sativum</i> (Plumule) . . .	26.6	6.5	—	KÖPPEN
<i>Sinapis alba</i> (Plum.)	27.4	0.0	37.2+	DE VRIES
<i>Lepidium sativum</i> (Plum.) . . .	27.4	1.8	37.2+	"
<i>Linum usitatissimum</i> (Plum.) . .	27.4	1.8	37.2+	"
<i>Lupinus albus</i> (Plum.)	28.0	7.5	—	KÖPPEN
<i>Hordeum vulgare</i> (Plum.) . . .	28.7	5.0	37.7	SACHS
<i>Triticum vulgare</i> (Plum.) . . . {	28.7	5.0	42.5	"
	29.7	7.5	—	KÖPPEN
Yeast	28-34	0.0+	38.0	
<i>Bacillus subtilis</i>	30.0	6.0	50.0	
<i>Bacterium termo</i>	30-35	5.0	40.0+	EIDAM, '75
<i>Zea mais</i> (Plum.) {	32.4	9.6	—	KÖPPEN
	33.7	9.5	46.2	SACHS
<i>Phaseolus multiflorus</i> (Plum.) . .	33.7	9.5	46.2	"
<i>Cucurbita pepo</i> (Plum.)	33.7	13.7	46.2	"
<i>Zea mais</i> (Rad.)	34.0	—	—	"
<i>Bacillus ramosus</i>	37.0	13.0	40.0	WARD, '95
" <i>anthracis</i>	37.0	14.0	45.0	FISCHER, '97
" <i>tuberculosis</i>	38.0	30.0	42.0	"
" <i>thermophilus</i>	63-70	42.0	72.0	"

This table shows, first, that the optimum, minimum, and maximum are correlated; that when one is high or low the others are, in general, high or low also. It shows, moreover, that the position of the optimum varies greatly; so that the minimum of one species, *Bacillus thermophilus*, lies higher than the maximum of another, *Bacillus phosphorescens*. We see, also, that the bacteria have, among all organisms, the greatest variation in the optimum, for this ranges from 20° to 63° – 70° C., or through 43° – 50° C. In the various phanerogams the extreme range of the optimum is from 26.6° to 33.7° C., or through 7° . Again, the range of temperatures at which growth occurs in any one species varies greatly. The most striking feature of this table—the one which most needs accounting for—is its variety.

In respect to the *optimum* we find a certain relation between the degree of temperature of most rapid growth and that to which the organism is normally subjected. Taking the case of an organism with a low optimum, we find *Bacillus phosphorescens* living in the North Sea, and normally subjected to a low temperature; for, even in its southern part, the mean temperature of the North Sea is 17.5° at the surface. Taking the case of organisms with a high optimum, we find *Bacillus anthracis* and *Bacillus tuberculosis* living in the mammalian body at a normal temperature of 35° to 38° C. These numbers lie near the optima of the species. *Bacillus thermophilus* lives in fermenting manure and in other situations attaining a temperature of 60° to 70° . Likewise, among phanerogams, we find a relation between the optimum and the normal temperature—the maize and gourd are of tropical origin, while the white mustard (*Sinapis*) belongs to the temperate zone. That this agreement between optimum and normal temperature is not always close may be partly ascribed to the fact that many species of plants, especially cultivated plants which are usually employed in experimentation, have lived at different times under dissimilar environmental conditions. What, now, is the reason for this general parallelism between the optimum and the normal temperature? As in other cases, it can clearly be ascribed only to an attunement gained by the organism as a result of its subjection to the temperature.

As for the *minimum* we find that, while it varies somewhat with the optimum, it never falls below 0° C. The reason for this is clear; for, as we have already seen (p. 241), 0° C. is the minimum for most vital activities. The fact that the minimum for phanerogams is given some distance above 0° is partly due to the fact that, since growth becomes very slow towards 0°, the absolute minimum for growth is hard to find. KIRCHNER ('83), who paid particular attention to this matter, concluded that the minimum temperature of both radicles and plumules of many seedlings lies between 0° and 1° C. However, we cannot ignore the fact that Cucurbita, for example, has a minimum for growth considerably above the point of cold-rigor, nor that, in pathogenic bacteria, the minimum is near the optimum of some free-living organisms. These facts teach us that the conditions for growth may be surpassed before metabolism has wholly ceased.

The *maximum* temperature tends to be rather constant; inside of the group of phanerogams the range is only from 37° to 46°, or 9°. But 45° to 46° is a fatal temperature for most plant protoplasm (p. 234), and 50° is the outside limit; hence the death-point (ultra-maximum) lies very close to—only slightly beyond—the maximum temperature for growth. It is probable that growth ceases where heat-rigor comes in. The extraordinarily high resistance of Bacillus thermophilus can create no surprise after our study of the capacity of organisms for acclimatization to temperatures near the boiling-point of water (p. 250). It is merely another striking case of the capacity of protoplasm for self-adjustment.

The range of growing temperatures varies, as we have seen, with the species. The greatest range in our table is that of Bacillus subtilis, 44°. It is tolerably uniform for phanerogams (37° to 32°); but in bacteria we have a range of 38° in the case of Bacillus phosphorescens to only 12° in the case of Bacillus tuberculosis. Here, again, we see a relation between the vital peculiarities and the environment of the organism. B. phosphorescens lives on the surface of the sea, whose temperature varies with that of the air; whereas B. tuberculosis lives in the mammalian body, whose temperature is nearly constant. It is interesting that the temperature of 42°, which is

the maximum for *B. tuberculosis* of man, is likewise about the human ultra-maximum; and 30°, the minimum for *B. tuberculosis*, is just below the human ultra-minimum. Thus the range of vital temperatures of this parasite is practically the same as that of its host.

To sum up, the critical temperatures of plants are wonderfully adjusted to their environment, not only in respect to the optimum for growth, but also in respect to the range within which growth is possible. The origin of this adjustment is, as the phenomena of acclimatization show, not to be sought in any process of selection, but in the modification wrought on the protoplasm by the temperature itself.

2. **Animals.**—We may begin our account of the effect of heat on the rate of growth of animals by a table, necessarily drawn from more limited data, but otherwise resembling Table XLVII.

TABLE LI

SHOWING FOR DIFFERENT TEMPERATURES THE ABSOLUTE INCREASE IN LENGTH, MEASURED IN MILLIMETERS, FROM THE 24TH TO THE 48TH HOUR AFTER HATCHING. MEASUREMENTS MADE ON YOUNG TADPOLES OF THE FROG, *RANA VIRESCENS*, AND THE TOAD, *BUFO LENTIGINOSUS*, BY LILLIE AND KNOWLTON, '98

TEMPERATURE.	AVERAGE GROWTH.		TEMPERATURE.	AVERAGE GROWTH.	
	FROG.	TOAD.		FROG.	TOAD.
9-10.9°	4.5	3.0	23-24.9°		41.3
11-12.9	5.3	5.3	25-26.9	31.5	39.0
13-14.9	4.3?	15.5	27-28.9	40.0	
15-16.9		16.3	29-30.9	47.5	56.8
17-18.9	9.5		31-32.9	40.2	55.3
19-20.9	19.8	21.2	33-34.9	43.5	
21-22.9					

OSCAR HERTWIG ('98) has determined the curves of growth for *Rana fusca*, and these are given in Fig. 131. These curves have not been carried beyond the optimum. (Compare Fig. 129.)

This table and the curves show plainly that the growth of organisms so remote as the maize plant and tadpoles are similarly affected by heat. In both cases there is a slow and con-

stantly diminishing increment to the optimum, and then a rapid decline to the maximum.

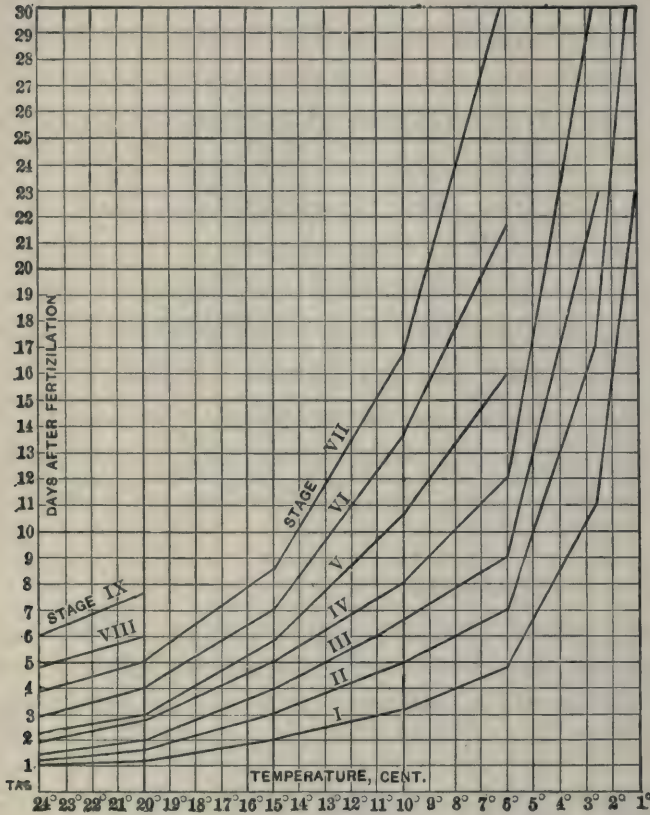

FIG. 131. — Curves showing the relation between the number of days (ordinates, indicated at left) required for the frog tadpole to reach a certain definite stage, and the temperature to which it is subjected during development. Stage I is that of a gastrula whose blastopore is just closing; II, edges of medullary plate rising; III, medullary tube completely closed; IV, tail evident, but gills not formed; V, embryo 5 mm. long; VI, embryo 7.5 mm. long; VII, 9 mm. long; VIII, 11 mm. long; IX, 11.5 mm. long. (From HERTWIG, '98.)

asserted to require at different temperatures the following times for hatching. The figures are suspiciously regular. (From CUENOT, '94, p. 18, after "CLEVELAND.")

Degrees	25	20	15	10
Days	50	55	60	65

Fishes. — Many experiments have been made with these animals for commercial reasons, as it is sometimes desirable to retard growth during transportation or to delay hatching until the season of the natural enemies shall have been passed. Some of the results are summarized in

Although many observations upon the effect of heat on the growth of animals have been made, they have been mostly fragmentary. I have gathered certain cases from the literature which it may not be useless to reproduce here.

Echinodermata. — According to VERNON ('95) the optimum for the development of Echinoid larvæ is 7°–22°.

Crustacea. — Nauplii of Branchipus and Apus hatch out at a temperature of 30° in less than 24 hours, whereas at 16°–20° they require some weeks (SEMPER, '81, p. 129). Lobster larvæ reared at 23° to 27° C. passed the fourth molt in about 10 days, or 3 days earlier than larvæ reared at 19° C. (HERRICK, '96, p. 190).

Insecta. — The migratory locust is as-

TABLE LII

SHOWING FOR THREE SPECIES OF FISH THE INTERVAL, IN DAYS, ELAPSING BETWEEN FERTILIZATION AND HATCHING, AT VARIOUS TEMPERATURES

TEMPERATURE OF WATER.	COD (EARLL, '80).	HERRING (MEYER, '75).	SHAD (RICE, '84).
-2- 0.0	30.0		
0- 1.9	32.5		
2- 3.9	22.0	40	
4- 5.9	16.0		
6- 7.9	13.0	15	
8- 9.9			
10-11.9		11	
13.5			11
20-23.0			3-5

RAUBER ('83) states that eggs of minnows and salmon, which develop during the winter season, will not grow at much above 12°-15°, but will do so at 0°. On the contrary, eggs which normally develop during the summer grow better at the higher temperatures.

Amphibia.— The European *Rana* is said not to develop at 0° (SCHULTZE, '94), and the same is true of the *Amblystoma tigrinum* of the United States. (LILLIE and KNOWLTON, '98). The time required to attain a definite stage, at which the chorda is well developed and head and tail are sharply marked, is for *Rana temporaria*: at 15°, 6 days; at 33°, 1 day (HERTWIG, '96). If brought gradually to it tadpoles may develop at 37°, or even for a few hours at 40°, but they do not thrive long at this temperature. The great effects of temperature on rate of development of the frog are illustrated by Fig. 132.

Birds develop only at a high temperature and within narrow limits. The normal for the chick is 38°, the minimum is 25°, the maximum near 42° (RAUBER, '84). FÉRE ('94) has determined the rate of development of the chick's egg incubated at different temperatures. One lot at an abnormal temperature and a second at 38° were reared synchronously; after a time the eggs were opened and the average stage of development (in hours of a standard series) determined. The following numbers express the ratio of the stage of development at the abnormal temperature to the stage at the normal temperature of 38°:—

Temperature	34°	35°	36°	37°	38°	39°	40°	41°
Index of Development	0.65	0.80	0.72	?*	(1.00)	1.06	1.25	1.51

In summarizing these scattered observations on growing animals we may exhibit in one table their critical temperatures.

*The stage at 37° is taken from too few observations to be trustworthy. The stages at 35° and 36° are irregular, doubtless because of too few observations. As we go beyond 41° the ratio must decline again with great suddenness to 0.

TABLE LIII

CRITICAL POINTS FOR VARIOUS ANIMALS, ARRANGED ACCORDING TO THE OPTIMUM

SPECIES.	OPTIMUM.	MINIMUM.	MAXIMUM.	AUTHORITY.
Minnows } Salmon }	—	0°	12°-15°	RAUBER, '84
Echinus	17°-22°	—	—	VERNON, '95
Rana virescens	30	3	—	LILLIE and K., '98
Bufo lentiginosus	32	6	—	" " "
Gallus domesticus	38	25	42	RAUBER, '84

These critical points for animals show the same variations with reference to optima, minima, maxima, and range that those of plants do, and here also these variations are clearly adjusted to the temperatures normally experienced by the species.

3. Some General Phenomena accompanying Heat Effects. —

a. Latent Period. — We have seen that a change in the rate of growth is produced by a change in temperature. If, however, the times of the two changes be carefully noted, it will be found that a considerable interval elapses between them. This interval, the latent period, varies with the temperature. Thus ASKENASY ('90, p. 75) found that, in the case of maize seedlings cooled to 1°-5°, two or three hours elapsed before decreased growth occurred; whereas, when the seedling was cooled to 0°, five hours elapsed. A similar effect follows a change in the reverse direction.

b. Sudden Change of Temperature. — If the radicle of a seedling is suddenly transferred from water at or near 0° C. to water at between 18° and 21°, two effects follow. The first appears immediately after the transference, and consists in the sudden elongation of the radicle. The second appears later, and consists in a growth which is slower than that of the normal radicle. These facts have been determined by TRUE ('95), who concludes that the first effect is of a physical nature, and is due to the fact that, at the higher temperature, osmotic pressure is greater; hence the tension in the tissues is greater and, consequently, they become stretched. The second effect TRUE regards as a response to the stimulus of the change, since

it is not constant for a given difference between the two temperatures, but is greater in raising the temperature from 5° to 18° than in raising from 17° to 30°. The more abnormal one of the pair of temperatures is, the greater is the response.

c. Cause of Acceleration of Growth by Heat. — The acceleration of growth may be due either to increased assimilation, imbibition, or production of formed substance. Is it principally due to any one of these or are all increased in the same proportion? Data on this subject are afforded by certain measurements made by BIALOLOCKI ('71).

Seeds of rye, barley, and wheat were planted in soil which was fertilized by nutritive solutions and heated by a surrounding bath of water. The average absolute weight of the whole plant of each species was determined after the lapse of twenty days. The proportions of water, organic matter, and ash in the entire plant were likewise determined. Some of the results are given in Table LIV. It is to be noted that the high temperature was applied only to the soil in which the roots of the plant were imbedded.

TABLE LIV

GIVING THE AVERAGE WEIGHT (IN MILLIGRAMMES) AND THE PERCENTAGE OF WATER IN PLANTS WHOSE ROOTS ARE MAINTAINED IN SOIL, AT VARIOUS TEMPERATURES, FOR 20 DAYS (BIALOLOCKI)

TEMPERATURE.	RYE.		BARLEY.		WHEAT.	
	FRESH WEIGHT IN MG.	% WATER.	FRESH WEIGHT IN MG.	% WATER.	FRESH WEIGHT IN MG.	% WATER.
10°	176	87.1	156	88.4	131	84.1
15	269	87.9	383	91.0	241	87.8
20	459	89.1	409	91.0	261	88.2
25	376	88.7	435	90.4	342	87.2
30	408	88.4	365	90.0	402	88.3
40	240	87.0	231	88.6	296	86.4
88	192	87.5	152	88.7	98	83.9

This table shows that the percentage of water increases slightly but constantly as the growth is accelerated by increased temperature, reaching a maximum near the optimum temperature. Other data (not reproduced here) show that the percentage of ash remains about constant, while that of dry organic sub-

stance diminishes slightly towards the optimum temperature for growth. We conclude, consequently, that in the acceleration of growth by heat all three processes are accelerated, but the im-

bibitory process more than the others.

Apparently contradictory are the results gained by COPELAND ('96), who found that the cells in the foliage of a moss which was transferred from a cold room at 2° to a room at 18° to 20° lost, in from one to two weeks, a degree of turgescence measured by a 1 to 3% solution of potassic nitrate (p. 72). When returned to the cold room the cells gained an increased turgescence. The nearer the temperature

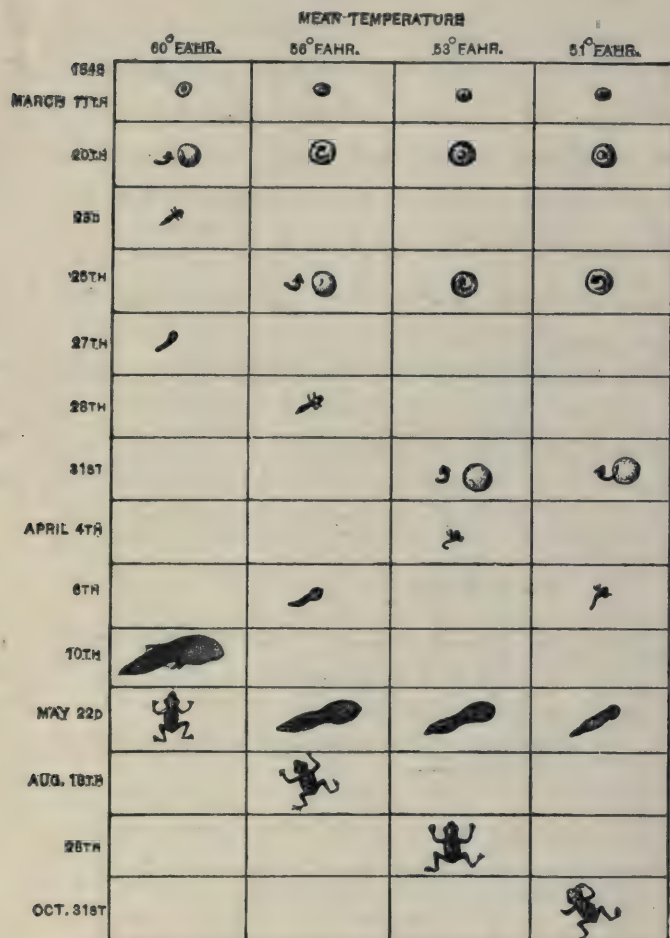

FIG. 132. — A chart showing the correlation between the stage of development of the frog on successive days and the temperature at which it has developed. (From HIGGENBOTTOM, '50.)

lay to the optimum, the more rapid therefore the plant growth, the lower was the turgescence. This seeming paradox can be explained upon the hypothesis that just because the whole tissue is expanding, just because the superficial increase of the organic walls keeps pace, or more than keeps pace, with that of the included water, there is less osmotic pressure in the rapidly growing plants than in the slow-growing ones where the plasma walls are not expanding as fast as the imbibitory process would demand.

We may now gather together the results of our study of the effect of heat on the rate of growth of organisms. The relation between temperature and rate of growth may be expressed by a curve which, starting near 0°, reaches its highest point at a temperature varying with the species, and falls to a maximum temperature generally not far from the lethal temperature for the race. Three critical points are thus distinguishable, — the minimum, the optimum, and the maximum. In both animals and plants these points are correlated. The optimum lies close to the normal temperature for the species, the minimum lies usually only a little above the point of cold-rigor, and the maximum only slightly below the point of heat-rigor. The optimum lies nearer the maximum than the minimum, but the curve is not so unsymmetrical as that of metabolism. Any change in temperature leads to a change in the rate of growth, but this does not take place completely at once: there is a latent period of an hour or so. A sudden rise in temperature, especially from 0° to the ordinary summer temperature, is accompanied not only by a mechanical (elongating) effect, but also by a physiological response, showing itself in accelerated growth. Finally, in the acceleration of growth by heat, the imbibition of water is slightly more accelerated than the other growth processes.

§ 2. EFFECT OF HEAT ON THE DIRECTION OF GROWTH— THERMOTROPISM *

Two sorts of heat are to be here distinguished — radiant and conducted. The former is a form of radiant energy and allied to light, consisting, indeed, of the rays lying beyond the visible red of the spectrum. The latter is due to molecular vibrations of the medium.

1. **Effect of Radiant Heat.** — When *Phycomyces nitens* or seedlings of *Lepidium sativum*, *Zea mais*, etc., are reared on a

* The first suggestion of this phenomenon was based upon an analogy with the action of light and was made by VAN TIEGHEM ('82), who gave it the name Thermotropism. WORTMANN ('83 and '85) first published extensive critical studies on the subject. Others who have contributed data are BARTHELEMY ('84), working on the roots of bulbous plants; VÖCHTING ('88), upon flower buds: and AF KLERCKER ('91) upon radicles.

klinostat whose axis of rotation is parallel to the window, and are subjected to rays of heat from a warmed plate of iron held in the axis of rotation, they turn with reference to the source of heat. Thus WORTMANN found that, at a distance from the iron plate of 10 cm., corresponding to a temperature of 27° C., all the spore-bearing hyphæ of *Phycomyces* turned in seven hours from the source of heat; they were negatively thermotropic. Under the same conditions the plumule of a seedling maize was positively thermotropic. The roots of the hyacinth when growing in water turn towards the adjacent stove-pipe. The flower-buds of *Magnolia* turn, in the field, from the dark heat-rays of the sun (VÖCHTING).

2. **Conducted Heat.**—The methods employed in working with this agent have been as follows: WORTMANN used a box divided into two compartments by a diathermous partition. Through one compartment there passed a constant current of cold water; the second was filled with sawdust in which seeds were imbedded. In front of this second compartment, on the opposite side from the cold-water chamber, was a gas flame, the source of energy. The seeds were scattered through the sawdust, so that some were nearer the flame, others nearer the cold hinder wall. The temperature of the sawdust near each seedling was determined. KLERCKER used essentially the same apparatus, excepting that a box of hot water replaced the flame.

The results of the experiments are summarized in

TABLE LV

SHOWING FOR THE RADICLES OF SEEDLINGS OF VARIOUS SPECIES THE RELATION BETWEEN THE TEMPERATURE AND THE SENSE OF THERMOTROPIC RESPONSE

TEMPERATURE.	ZEA MAIS.	ERYVUM LENS.	PHASEOLUS MULTIFLORUS.
50.0°	—	—	—
40.0	—	—	—
37.5	—, +	—	—
35.0	+	—	—
30.0	+	—	—
27.5	+	—, +	—
25.0	+	+	—
22.5	+	+	—, +
20.0	+	+	+
15.0	+	+	+

This table shows that the sense of thermotropism is not constant for all temperatures, but is positive at the lower temperatures, negative at the higher ones, and neutral at a certain intermediate one. Also, just as different species vary in their optimum so also do they vary in the temperature of neutrality. As the optimum for growth is high in maize radicles (34°), and low in the pea radicle (26°.3), so also is the neutral point. The neutral temperature is thus also probably related to the attunement of the organism and is an advantageous response.

Within the range of positive or of negative turning there is a correlation between the temperature and the angle of inclination of the organ.

KLERCKER has paid particular attention to this fact. His results are summarized in the following table and curves, showing for each species the average inclination at each range of temperature:—

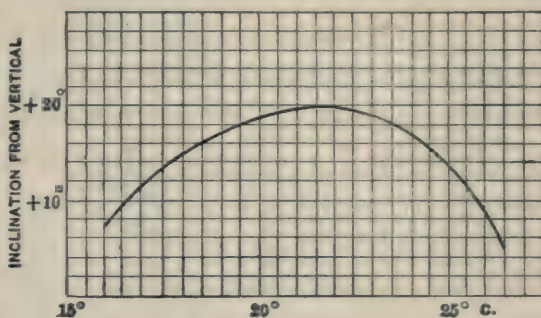

FIG. 133. — Caloritropic curve of *Sinapis alba*, showing the relation between the inclination of the radicle and the surrounding temperature. The numbers on the left give the inclination in degrees; the horizontal series of numbers are the temperatures to which the plant is subjected, the temperature diminishing 4° for every centimeter of departure from the source of heat. (After AF KLERCKER, '91.)

TABLE LVI

THE SENSE (+ or -) AND THE AVERAGE EXTENT (EXPRESSED IN DEGREES OF ANGULAR DEVIATION FROM VERTICALITY) OF THERMOTROPISM AT DIFFERENT TEMPERATURES

<i>Pisum sativum</i>	-8.9 -12.9 -27.2 -38.4 -43.9				
<i>Sinapis alba</i>	+10.5	+19.0	+2.4	(See Fig. 133.)	
<i>Faba vulgaris</i>	-4.3	-6.5	-9.8	-19.1	-28.9
° C.	13, 14, 15, 16, 17, 18, 19, 20, 21, 22, 23, 24, 25, 26, 27, 28, 29, 30, 31, 32, 33, 34, 35, 36, 37, 38, 39, 40, 41				

We see here that the angle of inclination (whether + or -) increases regularly as we depart from the temperature of neutrality or that of 0° curvature.

3. **Causes of Thermotropism.** — VAN TIEGHEM suggested, in his *a priori* account of thermotropism, that it was due to an unequal growth on the two unequally heated sides of the organ, the side whose temperature was nearest the optimum making the greater growth. This explanation is not a direct mechanical one, the turning stem does not act merely like a metallic rod. The curvature is rather the result of unequal growth at unequal temperatures. In accordance with the theory just outlined we should find organs subjected on one side to the optimum temperature growing on that side faster than on the other, and hence turning from the optimum — but they turn towards it. Again, plants subjected on one side to a temperature slightly below the optimum will have a still lower temperature on the opposite side, and should be negatively thermotropic — but they are positive. Finally, plants subjected on one side to a temperature above the optimum will have a lower temperature, one nearer the optimum, on the opposite side, and should be positively thermotropic — but they are negative. In a word, according to the theory, plants should turn from the optimum; they turn, however, towards the optimum, hence VAN TIEGHEM'S theory is exactly opposed to the facts.

WORTMANN, on the other hand, believed that the sense of thermotropism is due to a self-regulation of growth in the organism leading it to make this advantageous turning. The stem tends to place itself in the axis of the heat rays just as in phototropism it places itself in the axis of the rays of light. To this theory we must, however, add that plant organs may respond to conducted heat as well as to radiant heat, since they turn in a direction which, although opposed to the ordinary law of growth, tends to bring the tip into its optimum temperature. Such a result indicates clearly that thermotropism is a response to stimulus.

If thermotropism is a response, where is the perceptive region? Suspecting that it was at the apex, WORTMANN decapitated the root tip, but the response occurred as before. Evidently the whole growing part is sensitive to temperature.

Thermotropism is thus seen to be such a response to the stimulus of either radiant or conducted heat that the organ — plumule,

radicle, flower-bud or sporangiferous hypha—tends to place itself in the axis of the heat rays, if there are any, or to bend towards or from the source of heat. Whether the organ shall bend towards or from the source of heat depends both upon the external temperature and the protoplasm of the plant. The turning is such that it will tend to keep the organ at the optimum temperature for its protoplasm, or bring it into such a temperature. The response is thus, on the whole, an advantageous one.

SUMMARY OF THE CHAPTER

There is in all organisms a close relation between temperature and rate of growth, such that growth is most rapid at that temperature at which the chemical changes of metabolism proceed most quickly. The position of this optimum varies with the normal thermal environment of the race; it is attuned, we may say, to that normal temperature. Certain organisms or their parts grow in a definite direction with reference to the source of heat: away from the source when its temperature is too high; towards the source when the temperature is low. The neutral point varies in the different species in much the same way as the optimum for growth varies. We may say that the different attunements of organisms determine their different neutral points. At the same time these responses are advantageous. In some way the advantageous response of the organism is bound up with its attunement.

LITERATURE

- ASKENASY, E. '90. Ueber einige Beziehungen zwischen Wachstum und Temperatur. *Ber. deut. Bot. Ges.* VIII, 61-94. 23 April, 1890.
- BARTHÉLEMY, A. '84. De l'action de la chaleur sur les phénomènes de végétation. *Comp. Rend.* CXVIII, 1006, 1007. 21 April, 1884.
- BIALOLOCKI, J. '71. Ueber den Einfluss der Bodenwärme auf die Entwicklung einiger Culturpflanzen. *Landw. Versuchs-Stat.* XIII, 424-472.
- COPELAND, E. B. '96. Ueber den Einfluss von Licht und Temperatur auf den Turgor. *Inaug. Diss.*, 59 pp. Halle. *Bot. Centralb.* LXVIII, 177-180. 4 Nov. 1896.
- CUENOT, L. '94. L'influence du milieu sur les animaux. *Encyclopédie scientifique des Aide-Mémoire.* Paris: [1894].

- EARLL, R. E. '80. A Report on the History and Present Condition of the Shore Cod-fisheries of Cape Ann, Mass., etc. Rept. U. S. Fish Com. for 1878. 685-740.
- EIDAM, E. '75. Untersuchungen über Bacterien, III. Beiträge zur Biologie der Bacterien. 1. Die Einwirkung verschiedener Temperaturen und des Eintrocknens auf die Entwicklung von *Bacterium Termo*, Duj. Beiträge z. Biol. d. Pflanzen. I, 208-224.
- FÉRÉ, C. '94. Note sur l'influence de la température sur l'incubation de l'œuf de poule. Jour. de l'Anat. et de la Physiol. XXX, 352-365.
- FISCHER, A. '97. Vorlesungen über Bakterien. Jena: Fischer, 1897.
- FORSTER, J. '87. Ueber einige Eigenschaften leuchtender Bakterien. Centralb. f. Bacteriol. u. Parasitenk. II, 337-340.
- HERRICK, F. H. '96. The American Lobster. Bull. U. S. Fish Com. XV, 1-252. 64 plates.
- HERTWIG, O. '96. Ueber den Einfluss verschiedener Temperaturen auf die Entwicklung der Froscheier. Sitzungsb. Berlin Akad. Jan. 1896. 105-108. 6 Feb. 1896.
- '98. Ueber den Einfluss der Temperatur auf die Entwicklung von *Rana fusca* und *Rana esculenta*. Arch. f. mik. Anat. LI, 319-381. 8 Jan. 1898.
- HIGGENBOTTOM, J. '50. (See Chapter XVII, Literature.)
- KIRCHNER, O. '83. Ueber das Längenwachsthum von Pflanzenorganen bei niederen Temperaturen. Beiträge z. Biol. d. Pflanzen. III, 335-364.
- KLERCKER, JOHN AF, '91. Ueber caloritropische Erscheinungen bei einigen Keimwurzeln. Öfversigt af Kongl. Vetenskaps. Akad. Förh. XLVIII, 765-790.
- KÖPPEN, W. '71. Waerme und Pflanzenwachsthum. Bull. Soc. Impér. des Naturalists, Moscow. XLIII, Part 2, 41-110.
- LILLIE, F. R., and KNOWLTON, F. P. '97. On the Effect of Temperature on the Development of Animals. Zoölogical Bulletin. I, 179-193. Dec. 1897.
- MEYER, H. A. '78. Beobachtungen über das Wachsthum des Herings im westlichen Theile der Ostsee. Jahresber. der Commission zur wiss. Unters. d. Deutschen Meere in Kiel. IV-VI, 227-251.
- RAUBER, A. '84. Ueber den Einfluss der Temperatur, des atmosphärischen Drucks und verschiedener Stoffe auf die Entwicklung thierischer Eier. Sb. Naturf. Ges. Leipzig. X. 55-70.
- RICE, H. J. '84. Experiments upon Retarding the Development of Eggs of the Shad, made during 1879, at the U. S. Shad Hatching Station at Havre de Grace, Md. Report U. S. Fish Com. for 1881. 787-794.
- SACHS, J. '60. Physiologische Untersuchungen über die Abhängigkeit der Keimung von der Temperatur. Jahrb. f. wiss. Bot. II, 338-377.
- SCHULTZE, O. '94. Ueber die Einwirkung niederer Temperatur auf die Entwicklung des Frosches. Anat. Anz. X, 291-294. 19 Dec. 1894.
- SEMPER, C. '81. Animal Life as affected by the Natural Conditions of Existence. 472 pp. New York, 1881.
- TIEGHEM, P. VAN, '82. Traité de Botanique. Paris, 1884. [First part issued in 1882.]

- TRUE, R. H. '95. On the Influence of Sudden Changes of Turgor and of Temperature on Growth. *Ann. of Bot.* IX, 365-402.
- VERNON, H. M. '95. (See Chapter XVII, Literature.)
- VÖCHTING, H. '88. Ueber den Einfluss der strahlenden Wärme auf die Bluthenentfaltung der Magnolia. *Ber. deut. Bot. Ges.* VI, 167-178.
- VRIES, H. DE, '70. Matériaux pour la connaissance de l'influence de la température sur les plantes. *Arch. Néerlandais.* V, 385-401.
- WARD, H. M. '95. (See Chapter XVII, Literature.)
- WIESNER, J. '73. Untersuchungen über den Einfluss der Temperatur auf die Entwicklung des *Penicillium glaucum*. *Sb. Wien. Akad.* LXVIII¹, 5-16.
- WORTMANN, J. '83. Ueber den Einfluss der strahlenden Wärme auf wachsende Pflanzentheile. *XLI*, 457-470, 473-479. July, 1883.
- '85. Ueber den Thermotropismus der Wurzeln. *Bot. Ztg.* XLIII, 193 et seq.

CHAPTER XIX

EFFECT OF COMPLEX AGENTS UPON GROWTH, AND GENERAL CONCLUSIONS

IN the foregoing chapters we have examined the effect upon growth of various agents considered as acting separately. This treatment has been necessary for purposes of analysis, but it has the disadvantage that it does not reveal the normal action of these agents. For, in nature, we find many agents working together upon the growing organism. For example, gravity is constantly acting in one direction, upon sessile organisms at least, and at the same time the chemical character and the density of the surrounding medium, contact and impact, light and heat, are exerting their specific influences. The rate of growth of an organism and the direction of growth of its organs are determined by the resultant of some half dozen controlling factors which, in their totality, constitute environment.

Again, some of the factors influencing growth are so complex that they are not yet amenable to analysis into the chemical, molar, and physical agents whose effects we have considered in foregoing chapters. For instance, the reaction of an organism to its own activity is still too complex an effect for us to be able to resolve it into its elemental reactions to pressure, chemical change, etc. The effect of exercise upon growth may consequently form a subject for special consideration.

§ 1. THE COÖPERATION OF GEOTROPISM AND PHOTOTROPISM

When light falls from one side upon a seedling in the ground, the seedling is influenced by both gravity and light, and tends to respond to both. In responding to both, the apex of the seedling tends to point upwards on account of gravity's action, and laterally towards the source of illumination on account of

the light. As a result of this combined response the plant comes to occupy an oblique position.

The exact angle assumed by the plant is variable. It varies in a given species with the intensity of the light, and, the intensity of the light remaining constant, the angle varies with the species. For example, seedlings of *Lepidium sativum* subjected to a unilateral horizontal illumination for 48 hours showed at different intensities of the light the following inclinations from the vertical (WIESNER, '79, p. 196):—

DISTANCE OF SEEDLING FROM FLAME.	INCLINATION FROM VERTICALITY.
0.25 meter	30°
0.30 “	35
0.75 “	55
1.25 “	70
2.50 “ (optimum)	80
3.00 “	65
3.75 “	35

This table shows that the inclination from verticality increases with the intensity of illumination to a certain maximum degree, beyond which it diminishes again. This maximum inclination is called the phototropic limiting angle.

More extended determinations of the limiting angle have been made by CZAPEK ('95), who finds that it is the same for a given intensity of horizontal light whether the plant is vertical or horizontal, having its apex directed towards the source of light.

TABLE LVII

GIVING THE PHOTOTROPIC LIMITING ANGLE FOR VARIOUS SPECIES OF PLANTS

<i>Phycomyces nitens</i>	90°	<i>Sinapis alba</i> (plumule)	60°
<i>Pilobolus crystallinus</i>	90	<i>Pisum sativum</i>	60
<i>Vicia sativa</i>	70	<i>Vicia faba</i>	60
<i>Avena sativa</i>	70	<i>Phaseolus multiflorus</i>	60
<i>Phalaris canariensis</i>	70	<i>Sinapis alba</i> (radicle)	50
<i>Linum usitatissimum</i>	70	<i>Helianthus annuus</i>	45
<i>Brassica napus</i>	70	<i>Ricinus communis</i>	45
<i>Datura stramonium</i>	70	<i>Cucurbita pepo</i>	40
<i>Lepidium sativum</i>	60		

The phototropic limiting angle is constant for all cases in which gravity and light act at a right angle, whether the plant axis be originally placed vertically upright, inverted, or horizontal. When the direction of the light ray makes some other angle with that of gravity, the resulting position of the plant may be quite different, as CZAPEK ('95) has shown.

If the light falls upon the plant *vertically from below*, in such a way therefore as directly to oppose gravity, the resulting position of the plant varies according to its original position, in a way generally explicable on the ground that one of the two tropic influences has come to prevail, but with diminished power. Thus, when the axis of the seedling is horizontal it will, if like *Avena* it is very sensitive to light, turn its tip slightly upwards for a time, and then definitely down. A slightly phototropic plant, like *Helianthus*, assumes its limiting angle of 45° from the zenith. When the seedling is exactly inverted, plants highly sensitive to light grow down, but *Helianthus* places itself at 135° from the zenith, hence no longer at the limiting angle. When the axis of *Helianthus* is placed obliquely downwards its tip becomes inclined at 45° from the zenith.

If the ray of light falls upon the plant *obliquely from below*, the result on the erect, horizontal, or inverted seedling is a response to the active component of the light ray. The erect seedling is affected in the same way as by the horizontal ray; the horizontal seedling responds as though the light came vertically from below, and all inverted plants place themselves in the axis of the infalling ray.

If the ray of light falls *obliquely from above*, all plants, even *Helianthus*, place themselves in the axis of the ray. This is what might have been anticipated, since gravity affects the inclined plant much less than the horizontal one, and so the active component of the light ray is relatively more effective in this oblique position than in the horizontal one.

The foregoing experiments show that, in general, the geotropic reaction is modified by the simultaneous action of light. I have hitherto assumed that the final position of the plant is the resultant of the action of two tropic agents; that the phototropic and geotropic reactions interlock. Another cause of

the modified position is, however, possible. The stimulating action of light may interfere with the sensibility of the plant to gravity. An early experiment made by CZAPEK seemed to indicate that this is the case. A vertical plant was illumined upon one side and then placed horizontally with the former illumined side facing the nadir. The geotropic curvature was, as might be inferred from the experiment described on p. 444, greatly retarded. The retardation of geotropism by a previous photic stimulation occurs, however, only in species which are much more phototropic than geotropic. That the result just described is not due to a diminution in geotropic sensitiveness follows from two considerations: first, a plant previously geotropically stimulated is not retarded in its subsequent phototropic response, as we should expect if the *irritated state* interfered with the reception of a new stimulus; secondly, the retardation in response to light after geotropic stimulation is most directly explained on the ground that a response which is being actually worked out interferes with an incipient response.

The conclusion may, consequently, be drawn that there is no reason for believing that the modified response resulting either from the simultaneous or successive action of two tropic agents is due to an alteration of geotropic or phototropic sensitiveness, but rather to a modification of the response. The modification of the response is due to the interlocking effect or the mutual interference of the phototropic and geotropic reactions to stimuli.

§ 2. EFFECT OF EXTENT OF MEDIUM ON SIZE

The quantity to which an organism shall grow—the size that it shall attain—is a specific character which is, within limits, independent of the amount of food consumed by the organism. In how far this character is dependent upon other environmental conditions is an interesting question. It is clear that size is relative, and among other things it is related to the extent of the space in which the organism can move. An ant can lose its way in a cage in which an elephant can hardly find room to move. The ant is small, the elephant large, in relation to their common room.

Now it is a common observation of naturalists that there is frequently a relation between the size attained by a developing organism and the extent of the medium in which it is developing. Animals reared in aquaria rarely attain the size of their fellows developing in out-of-door ponds. Even in nature, fishes of a given species living in small or densely inhabited ponds are smaller than fishes of the same species inhabiting large or sparsely populated ponds. According to SEMPER ('74) the experiment was tried of transplanting the very small chars from a small lake in the Maltathal, Carinthia, Austria, where they were very abundant, to another lake where there were few fish. The transplanted chars soon became three times the size of the parent stock.

In other experiments it has often been observed that tadpoles reared in the laboratory, although well fed, never attain the size of those living free. SIEBOLD* found that *Apus* reared in a small vessel grew no longer than 7 or 8 mm. instead of 50 or more. The pond-snail, *Limnæa stagnalis*, has been made the special object of experimental dwarfing. HOGG ('54) found that when confined to a small, narrow cell they acquire, even after six months, only the size of normal animals two or three weeks old. HOGG's conclusions no doubt appeared crude to the physiologist of the last decade. He said that the snail grows "to such a size only as will enable it to move about freely, thus adapting itself to the necessities of its existence."

SEMPER ('74) next undertook a more thorough set of experiments upon these animals. He kept the snails in vessels containing different quantities of water to each individual, and found that as the quantity of water is diminished from 4000 cc. or 2000 cc. to 100 cc., a diminution in the rate of growth occurs. Increasing the number of individuals in a vessel has the same effect as diminishing the volume of water. The relation of volume of water per individual to length of shell at the end of eight or nine weeks is given in Fig. 134. This curve shows that as the volume increases from 100 cc. to 800 cc., the average length of the shell of the snail doubles. The result SEMPER

* Cited from SEMPER ('74).

explains on the hypothesis that water contains some substance necessary to the growth of the snails, which becomes used up before full size is acquired: the more quickly, of course, the smaller the amount of water.

Instigated by SEMPER'S experiments YUNG ('85) now undertook similar ones upon tadpoles. Twenty-five just-hatched tadpoles were put into each of three vessels, A, B, and C, containing about 1200 cc. of water, but of different forms, so that A, which measured 7 cm. diameter, had a depth of 30 cm. of water ;

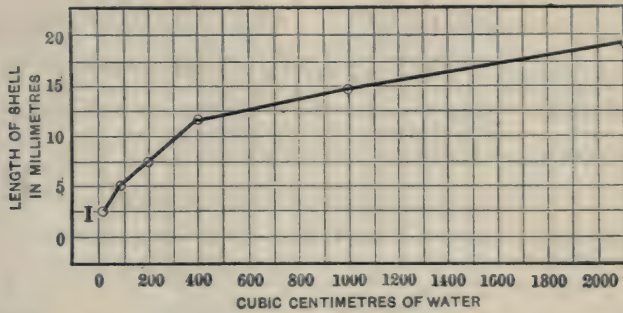

FIG. 134.—Curve of relation between length of shell of *Limnæa stagnalis* and quantity of water in which it is reared. (From SEMPER, '74.)

B, whose diameter was 11 cm., had 13 cm. of water ; and C, whose diameter was 14.5 cm., had 6.5 cm. of water. At the end of one and a half months measurements were made of the length and the breadth of each tadpole with the following average results :—

	VESSEL A.	VESSEL B.	VESSEL C.
Length	26.20	34.2	41.2
Breadth	6.15	7.8	8.8
Date of first metamorphosis	August 4	July 22	June 18

YUNG concluded that the larger size of the animals in the shallower water (C) was due to its absorbing oxygen more thoroughly.

Finally, DE VARIGNY ('94) has attacked even more systematically this problem of effect of extent of medium on size. He has found that *Limnæas* kept for eight months in similar vessels, each containing 550 cc. of water and about 500 cc. of

air, but differing in that one was stoppered and the other not, had attained about the same size (Fig. 135). Since the oxygen supply of the snails in the two vessels was evidently very dissimilar, YUNG'S explanation is shown to be inadequate. Next DE VARIGNY tested the effect of differences in volume. He reared *Limnæas* in different quantities of water, in vessels of dissimilar proportions, such that in all there was the same free surface area of water. The differences in volume had only a slight effect on the size of the snails (Fig. 136). On the other hand differences in surface, with constant volume of water, have an important influence on size. The greatest growth occurs in the broader vessel (Figs. 137, 138). The number of individuals in the vessel influences the average size, as SEMPER found.

To test SEMPER'S theory that the small size of the animals in the small vessel is due to its having exhausted the necessary substance in the water, DE VARIGNY partitioned a vessel of water into two unequal compartments and reared a *Lymnea* in each. One of the compartments was made by partly submerging a test-tube, from which the bottom had been removed, in a beaker of water. A piece of muslin, tied over the bottom of the test-tube, permitted an interchange of water, but not the intermigration of the *Limnæas* between the test-tube and the main vessel of water. The latter constitutes the second compartment in which the snails lived. After several months the individuals kept in the two vessels usually showed a marked difference in size, those reared in the roomier vessel being the larger (Fig. 139). When, however, the two similar snails were kept in similar tubes plunged in beakers of water of unequal volume, they attained about the same size.

A second test of SEMPER'S theory applied by DE VARIGNY consisted in comparing the growth of *Limnæas* in fresh water with their growth in water in which snails had for some time been developing. The snails in the latter showed a slight but nearly constant inferiority in size. It may well be that some of the salts necessary to growth had been extracted from the water by the development of snails therein, making it less fit for growth. Nevertheless, even the most marked differences in the size of the snails in the two kinds of water was not sufficient fully to account for SEMPER'S result by means of SEMPER'S theory.

FIG. 135. — Two individuals of *Limnæa stagnalis*, which have lived from May, 1891, to January, 1892, in two flasks nearly alike in respect to surface and volume of water. In the one case (shell at left) the flask, enclosing 500 cc. of air, was sealed; in the other case (shell at right) the flask remained unsealed throughout the 8 months of experimentation.

(From DE VARIGNY, '94.)

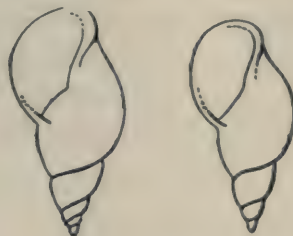

135

FIG. 136. — *Limnæa auricularis*, reared in different masses of water having the same surfaces but different volumes. The specimens, taken in order from left to right, were reared in vessels having surface areas of 100, 200, 400, and 500 cc. respectively. Experiments extended from 15 November to 5 April. (From DE VARIGNY, '94.)



136

FIG. 137. — *Limnæa stagnalis*. The individual at the left lived from 18 November to 20 April in a liter of water having a surface of only 2 cm. diameter; that at the right lived during the same period in an equal volume of water having a surface of 18 cm. diameter. (From DE VARIGNY, '94.)

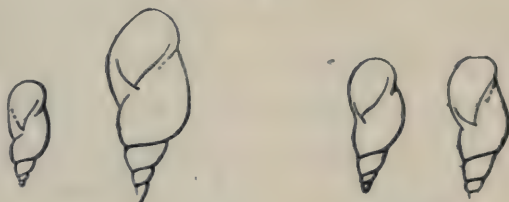

137

138

FIG. 138. — The *Limnæa stagnalis* at the left lived from 21 November to 6 January in 1350 cc. of water having a surface of 3.5 cm. diameter; that at the right, somewhat larger, lived during this period in 600 cc. of water having a surface of 16 cm. diameter. (From DE VARIGNY, '94.)

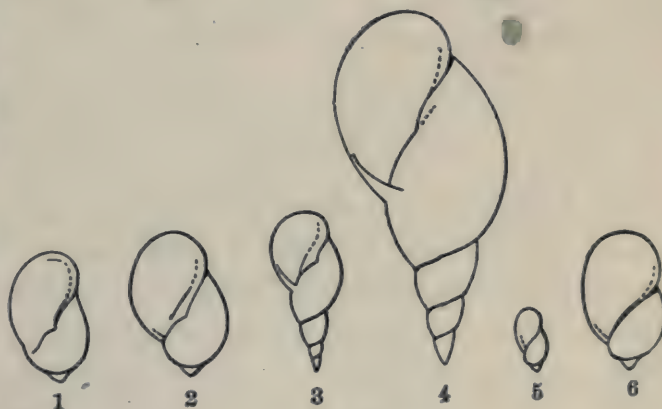

138

FIG. 139. — *Limnæa 1* lived from 18 November to 5 April in a glass without a bottom (capacity 250 cc.), suspended in the beaker (capacity 4200 cc.), in which 2 lived. *Limnæa 3* lived from 20 November to 7 February in a tube, suspended in a vessel in which 4 was reared. *Limnæa 5* lived from 9 April to 24 June in a tube, suspended in the vessel in which 6 lived. (From DE VARIGNY, '94.)

The conclusion to which DE VARIGNY arrived was that the nanism provoked in the small vessels is caused by a diminution of movement and consequently of exercise, for in the restricted medium the movements are fewer and slighter, since the food is near at hand. Also, the snails will exercise more in a body of water with a broad, exposed surface than in a narrower one, because they crawl so much on the surface films.

This interpretation is sustained by all the results excepting those obtained from a varying number of individuals in masses of water of the same volume and form. The fact that the individuals grow larger the fewer they are, may be accounted for, thinks DE VARIGNY, on psychological grounds; for, in the crowded room, movements will be restricted from very much the same cause that makes one move less rapidly in a street containing impediments than in one which is quite clear.

It may well be doubted whether the bottom of this matter has yet been reached. Probably nanism is produced by several causes: such as insufficient supply of mineral constituents in the water, especially of calcium salts, products of excretion in the water, and exercise. There is, however, much reason for believing that HOGG'S conclusion is one which, with our fuller knowledge, we can hardly improve upon — that, in respect to the size attained as in other qualities, the snail has the power of “adapting itself to the necessities of its existence.”

§ 3. GENERAL CONSIDERATIONS RELATING TO THE ACTION UPON GROWTH OF EXTERNAL AGENTS

1. **Modification of Rate of Growth.** — Protoplasm is composed of three kinds of substances: the living plasma, the formed substance, and the watery chylema. Accordingly, growth involves three processes: that of the formation of new plasmas, *assimilation*; that of the manufacture of formed substance, *secretion*; and that of the absorption of water, *imbibition*. Anything which affects these three processes will affect the rate of growth.

The action of external agents upon the rate of growth is of two general kinds. There is, first, the general effect; and, secondly, the specific effect. The *general effect* is more or less similar in all protoplasmic masses (organisms) subjected to the agent; it is the result of some immediate and necessary modifi-

cation of the protoplasm depending upon its very structure. This general effect may be of two sorts: a grosser mechanical one and a more refined. The *grosser general effect* is seen in the osmotic action of dense solutions; in the elongation of an organ consequent upon pulling it with a considerable force; in the interference with vital actions by poisons, by intense light, or by high temperatures. The more *refined general effect* is due to the acceleration of growth by the acceleration of the essential metabolic processes involved in growth; hence come the effects, within limits, of favorable foods, of electricity, of radiant energy, and of warmth. We can explain the effect of such refined agents by known chemical laws.

The grosser and the finer effects pass over into each other at certain intensities. Thus the acceleration of growth produced by summer temperature passes over at a higher temperature into the gross retardation due to coagulation.

The *specific effects*, in contradistinction to the general, appear only in certain organisms or their parts, and have no such evident and explicable relation to the cause as the general effects have to their causes. Such is the increased growth resulting from certain slight poisons, from the deformations of the stems of certain plants, from a wound which leaves a defect to be filled by growth. These effects cannot at present be accounted for satisfactorily by known chemical processes; they result from peculiarities of the specific protoplasms which depend largely upon the past history of each kind of protoplasm.

The same agent may have at different intensities, at one time, the specific; at another, the general effect. Thus the slight pulling of the stem of a seedling may induce the specific shortening effect, whereas a stronger pull will cause a gross elongation.

The gross general effect, the refined general effect, and the specific effect form a series of results brought about by processes which are quite intelligible in the first case, much more complex in the second, and still further removed from our ken in the last; we might speak roughly of these effects as due to physical, chemical, and vital processes respectively, without meaning to imply a qualitative difference between these processes. The most complex of these three processes may also be designated as response to stimulus.

Let us now consider the mechanics of the acceleration of growth by various agents. The mechanics of the effect of food on growth varies of course with the food; some supplying the energy or the material for assimilation, other kinds furthering secretion, and still others going to build up the molecules which do the work of vital imbibition. Whether the poisons which, like zinc sulphate, stimulate growth affect chiefly the assimilatory or the imbibitory process, is unknown; but the slowness of the result suggests a modification of assimilation. The effects of water and of solutions seem to be chiefly upon imbibition; that of deformation and wounding chiefly upon assimilation; that of electricity is uncertain; that of light is probably chiefly upon assimilation; and that of heat upon imbibition. These conclusions are, however, tentative; experiments are needed to test them further: this is one of the next tasks in the investigation of growth.

2. Modification of Direction of Growth — Tropism. — The tropic effect of an external agent occurs only when the agent does not act uniformly from all sides upon the growing organism, but constantly from one side. Hence this effect will be marked only in organisms which for a considerable period present the same surface to the action of the agent. Such an effect is characteristic therefore of sessile plants and animals.

The turning of an organ with reference to an external agent may be either a gross effect or a specific response effect of the agent. As examples of the gross effect may be cited the cases of false traumatropism and false electrotropism, in which the turning is due to the death or injury of the tissue on the concave side of the organ. All cases of true tropism are cases of response to stimuli: such are, chemotropism, hydrotropism, thigmotropism, traumatropism, rheotropism, geotropism, electrotropism, phototropism, and thermotropism.

The mechanics of these tropic responses may now be briefly considered. In general the tropisms are growth phenomena, for they are due to enlargement of the bending organ on one side. The growth seems to be due either to assimilation or imbibition, or both, secretion playing no part. It is not easy to say whether in any case assimilation or imbibition is the more important. An inference can be drawn, however, from

the quickness of response, for growth by imbibition is more rapid than that by assimilation. Also a histological study of the curving region should throw light upon this question. Among the rapid tropisms are chemotropism, especially as seen in the tentacles of *Drosera* and in pollen-tubes, and thigmotropism, as exhibited in tendrils. Such are probably due to differential imbibition. Among slow tropisms are hydrotropism and rheotropism, which are probably due largely to differential assimilation. Traumatropism, geotropism, and the response to radiant energy, namely, electrotropism, thermotropism, and phototropism, are intermediate in their rate, and are probably due to the combined action of assimilation and imbibition.

Sections through the responding region show the importance of imbibition in certain tropisms, as, for example, geotropism. In such sections it is seen that the cells on the convex side are enlarged in all axes and full of water, while those of the concave side are compressed so that the cells are shoved into one another, are diminished in size, and have a dense plasma (Fig. 140). A typical set of measurements

of the dimension of the cells in the curving region, compared with normal cells, is given by CIESIELSKI ('72) as follows :—

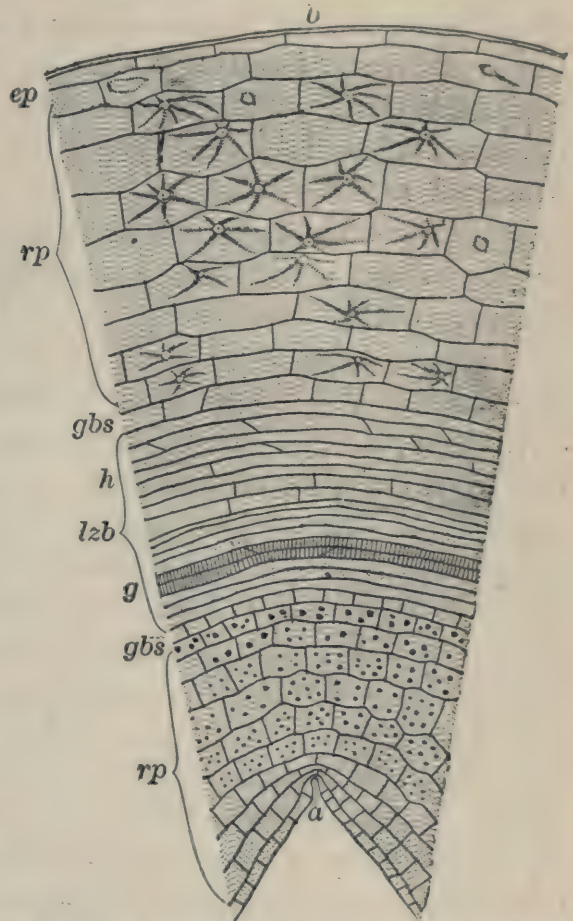

FIG. 140. — A section of a tropic radicle taken in the plane of curvature, at the region *sg*, Fig. 106. *ep*, epidermis; *rp*, parenchyma; *gbs*, sheath of the fibro-vascular bundle; *lzb*, fibro-vascular bundle; *h*, wood-cells; *g*, vessels. Those cells which lie next the nadir (*a*) are smaller than those turned toward the zenith (*b*). The latter appear stretched with water, while the former are dense and of small size. (FROM CIESIELSKI, '72.)

	LENGTH.	BREADTH.	THICKNESS.
Cells of convex side	0.125 mm.	0.045 mm.	0.042 mm.
Cells of concave side	0.020	0.025	0.026
Cells in normal condition	0.099	0.035	0.032

The importance of imbibition for geotropism is also shown by the experiment of cutting a slice off from the upper part of the horizontal root, which then curves only slowly; whereas, if the cut surface is placed down, the curving takes place with abnormal rapidity.

It being admitted that tropisms are, for the most part, largely, if not chiefly, due to differential imbibition, the question arises, How can this produce a turning? It is easy to see how it might be possible in the case of a multicellular plant, but tropism also occurs in animals and unicellular organs, as *e.g.* the hyphæ of *Mucor*. It has been suggested, to meet this difficulty, that the unequal growth affects primarily the cell-walls; but this explanation does not quite meet the case of hydroids. A general statement, applicable to multicellular plants and animals and to unicellular organs, may be made, if the cell-wall be recognized as living, as follows: The imbibition distends the living substance on the convex side, the water probably being in part drawn from the concave side.

Going a step farther, the tropic agent produces such a change in the molecules of the curving region as to cause them to imbibe water with abnormal rapidity. This change may, however, be produced by the agent either directly or indirectly. In all cases in which the sensitive part of the organ becomes the curving part, the action of the agent is direct. Examples are found in the thigmotropism of tendrils, in the phototropism and thigmotropism of stems, and, probably, in traumatropism. In cases in which the curving part is remote from the sensitive part, as in geotropism, the action of the agent is indirect. In these cases there must be a transmission of a stimulus from the sensitive part (the tip) to the responding part, producing the required molecular change there.

Concerning the nature of the changes induced by the tropi-

cally stimulating agent, we have recently gained valuable data from the studies of CZAPEK ('98). He has found that the stimulated protoplasm, for instance, of a geotropic radicle exhibits no visible movements or negative electrical variation, as in the nerve cells of animals, but does exhibit a chemical change. Thus, when the root tip of the seedling of a bean or other species is boiled in a solution of ammoniacal silver nitrate, there is a marked reduction of the silver, especially in the cells of the periblem. This reduction is stronger in the cells of stimulated root tips than in those of unstimulated ones. A second change consists in the diminution in the amount of a substance of the root tip which easily loses oxygen. Such a substance is indicated by such changes as these in the normal root tip: blue coloration (oxidation) of a section of the tip when placed in an emulsion of guaiac gum in water; deep blue coloration of sections by indigo white*; strong violet reaction (indophenal reaction) in sections subjected to an aqueous solution of α -naphthol to which paraphe-nylendiamin has been added. Now all such reactions are less marked in the root after stimulation. We conclude that stimulation results in increased capacity for reduction and diminished capacity for oxidation—an increase in the avidity for oxygen.

These changes occur long before the response of turning shows itself; they occur earlier in the non-sensitive roots, and they are less marked after a slight stimulus, such as results from a slight inclination of the root from the vertical position.

The isolation of the two substances, the reducing and the oxidizing, was now attempted. The former is not changed by boiling or by the action of chloroform, and is soluble in alcohol; the latter is destroyed by heat, is unchanged by chloroform, is insoluble in alcohol, and may be extracted from the triturated cells by water. A large number of root tips of *Vicia faba* were rubbed up with water until no fragments remained. This aqueous extract was filtered, and to the filtrate alcohol was added. A precipitate occurred, which had all the properties of the oxidizing substance. It is highly probable that it belongs to the category of oxidation ferments.

* This is made by the cautious reduction of indigo carmine by dilute hydrochloric acid and zinc.

To get the reducing substance, the preceding solution was filtered to eliminate the alcoholic precipitate. The filtrate had all of the qualities of the reducing substance. A further study of its properties indicated that it belongs to the aromatic organic substances, many of which have an intense reducing action and are hence used in photography.

We may conclude that geotropic stimulation of the root tip induces chemical changes leading to the increase of a reducing substance of aromatic nature, and to the diminution in amount of an oxidizing ferment.

3. **Adaptation in Tropisms.**—The capacity for bending is usually associated with an advantage accruing to the part by that bending. Thus, the upward tropism of the stem and the downward tropism of the root; the positive phototropism of the stem and the positive thigmotropism of the root and of the climbing Dodder; negative traumatropism; and positive and negative thermotropism, depending upon whether the source of heat is of a less or greater temperature than the optimum—all these responses tend to preserve the normal environment for the organism; they are adaptive. At least one tropic response cannot be shown to be advantageous, namely, electrotropism. Electric currents of such intensity as roots respond to certainly do not exist in the soil. The response has no conceivable advantage in the ordinary life of the plant, and yet it occurs with as much precision as does a response to light or heat. If only there were, in the ground, such electric currents as we apply to the plant, we might be able to show an advantage of the response in this case also!

4. **Critical Points in Tropism.**—It has been shown repeatedly in the foregoing chapters that the sense of tropism depends upon the degree of the stimulating agent. Thus *Mucor stolonifer* is strongly positively chemotropic with reference to 2% cane sugar; becomes less so as the concentration approaches 30%; and is negatively chemotropic to a 50% solution. So, likewise, the radicle of *Zea mais* is

- + thermotropic at 12°–36°
- ± thermotropic at 37°–38°
- thermotropic at 40°–49°.

In these cases, as in the tactic phenomena, there is recognizable an optimum intensity of the agent, to which the organism is

attuned, so that, if the intensity rises above that optimum, negative tropism will occur, and, if the intensity falls below that optimum, positive tropism may be expected. This optimum — this intensity to which the organism is attuned — differs, however, in different species. Thus, according to WORTMANN, as we have seen, the turning-point of the radicle is for —

Zea mais, 37°;
Ervum lens, 27°;
Phaseolus multiflorus, below 22°.

But why is the turning-point so different in different species, or why are species attuned to different intensities? This difference is for the most part more or less closely correlated with the usual intensity of the agent to which the growing organism is subjected. To certain minds the phrase "Natural Selection" will be considered sufficient to stifle further inquiry; the known facts of self-adjustment, however, have thrown the burden of proof that Natural Selection has acted in any case upon those who assert it. Meanwhile we may seek for a cause more consistent with sound physiology.

In the first place, the facts of "after-effect" may be considered. It has been shown, with reference to the effect of many of the agents considered, that this effect does not endure only so long as the agent acts, but that it persists for a longer or shorter period after the stimulus has ceased to be applied. Thus, if a stem is placed horizontally, so that gravity stimulates it and causes it to grow up, and it is then placed vertically, the growth continues for a time in the former (now horizontal) direction; or, a horizontally placed root, decapitated after the lapse of one hour, curves geotropically, whereas a root placed horizontally and decapitated at once does not do so. Again, if a tendril is irritated by contact and the irritating body is then removed, a thigmotropic curvature of as much as 45° may occur. Still again, in an experiment of DARWIN ('81, p. 463), a seedling of canary grass was placed before a window for nearly two hours, during which the cotyledon turned towards the glass; the light was now cut off, but the cotyledon continued to bend in the same direction for one-fourth to one-half an hour. It was kept in the dark for an

hour and forty minutes (during which time it acquired an upright position through the action of gravity), and then exposed again to diffuse light from one side for an hour, showing the phototropic curvature. Light was now excluded, but the cotyledon continued to bend for 14 minutes towards the window. In these experiments there was a persistence of the response to light after light had been cut off. Finally, if a plant organ, which has been growing slowly at a low temperature, is quite rapidly subjected to the optimum, the increased growth is slow in making its appearance; it may be delayed for an hour or two.

What is the significance of this after-effect? It seems clearly to show that an agent acting on protoplasm not merely modifies the constitution of the protoplasm, but produces a change which is more or less permanent, and is only slowly obliterated upon removal of the agent, or becomes only slowly overshadowed by a new stimulus. This permanency of the change wrought permits the *accumulation* of extremely slight effects. An instance of such accumulation is seen in tendrils, which exhibit no response to a single soft blow but show evident thigmotropism to a series of such blows.

When, however, the repeated stimuli are each great, it is not an accumulation of effect which is noticed, but rather an absence of any response whatever. Then appears the phenomenon of *acclimatization*, or accustoming to the stimulus. Examples of this have been given in the foregoing chapters. Thus, in the case of thigmotropism, DARWIN found that after repeatedly stimulating the tendril of the passion flower (twenty-one times in 54 hours), it responded only slightly. In the case of traumatropism, DARWIN ('81, p. 193) observed that the radicle, to one side of which a card had been fixed by shellac, eventually became so accustomed to the stimulus that it no longer bent away from it, but grew vertically downwards. In the case of phototropism, WIESNER noticed that after a growing organ had been for some time subjected to daylight, its growth was less markedly controlled by a unilateral illumination.

Any general explanation of acclimatization, whether of metabolic or of growth processes, to repeated irritants must, at the

present time, be hypothetical. The attempt to picture to ourselves the probable processes which bring about this condition should, nevertheless, be undertaken. It is generally accepted that a stimulus of any kind produces a chemical change in the protoplasm, and this leads to a change in the activity of the protoplasm — the response. The different kinds of stimuli usually induce different kinds of responses, and this is probably because each kind of stimulus affects a particular kind of molecule — a kind capable of being transformed by the stimulus in question. If we assume that the reception of any stimulus is due to the transformation of a specific kind of molecule capable of being acted upon by the stimulus in question, then it is not difficult to see how, by repeated, violent stimulations of the same kind, nearly all of the molecules upon which sensation depends should become transformed, so that, thenceforth, the protoplasm should be incapable of receiving that kind of stimulus until such time as the sensitive substance shall have been reproduced. Let us imagine 100 molecules (a_1, a_2, a_3, a_4 — a_{98}, a_{99}, a_{100}) in the root tips which are capable of being decomposed by daylight and as a result setting in motion a series of changes resulting in the phototropic response. Let us imagine that the irritation of light during the first half hour decomposes 50 of them; during the second, 25 of the remainder; during the third, 12 of the remainder, and so on; then, eventually, the sensation will grow weaker if the substance is not renewed, so that the response will diminish in intensity and finally fail altogether. Then we say the organ is acclimated to the reagent, for the application of the agent produces no response.

This explanation of acclimatization to violent agents may now be easily extended to cover the case of attunement. Let us imagine a plant which, living in the dark, is negatively phototropic to ordinary daylight. It is attuned to a low intensity of light. If, however, the plant comes gradually to change its habitat so that it is repeatedly subjected to the sunlight, then, as a result of repeated stimulation, those sensitive molecules which are affected by the light are destroyed, so that the plant no longer turns from the light. It is attuned to it. The same theory, *mutatis mutandis*, will account for attunement to tem-

perature or to chemical agents. It is to be observed that this hypothesis is not an hypothesis to account for response to stimuli or of the usual adaptive nature of that response; but to account only for that phase of "adaptation" which is seen in attunement. The hypothesis is an attempt to explain an adaptive result independently of selection, but rather as a necessary result of the constitution of protoplasm.

The adaptive acclimatized or attuned condition may be inherited. It has been shown that the acclimated condition may long persist, only eventually apparently disappearing. It may well be doubted, however, if the acclimated protoplasm ever returns exactly to its primitive condition. If it does not, progeny developed from the acclimated protoplasm will necessarily be different and respond differently from their parents. Individual attunement will initiate a race attunement.

LITERATURE

CIESIELSKI, '72. (See Chapter XIV, Literature.)

CZAPEK, F. '95. Ueber Zusammenwirkung von Heliotropismus und Geotropismus. *Sb. Wien. Akad. CIV*¹, 337-375.

'98. Ueber einen Befund an geotropisch gereizten Wurzeln. *Ber. deut. Bot. Ges. XV*, 516-520. Jan. 1898.

DARWIN, C. and F. '81. (See Chapter XIV, Literature.)

HOGG, J. '54. Observations on the Development and Growth of the Water-snail (*Limneus stagnalis*). *Trans. Micr. Soc. London. II*, 91-103.

SEMPER, C. '74. Ueber die Wachstums-Bedingungen des *Lymnæus stagnalis*. *Arb. Zool.-Zoot. Inst. Würzburg. I*, 138-167.

VARIGNY, H. DE, '94. Recherches sur le nanisme expérimentale. Contribution à l'étude de l'influence du milieu sur les organismes. *Jour. de l'Anat. et Physiol. XXX*, 147-188.

WIESNER, J. '79. (See Chapter XVII, Literature.)

YUNG, É. '85. (See Chapter XIII, Literature.)

LIST OF TABLES

IN PARTS I AND II

TABLE NO.		PAGE
I.	Time of Resistance of Tadpoles to Various Alcohols	11
II.	Time of Resistance of Infusoria and Ostracoda to Various Alcohols	11
III.	Time of Resistance Period of <i>Spirogyra communis</i> to Various Alcohols	12
IV.	Increase of Immunity resulting from feeding on Ricin	29
V.	Lethal Solutions of Gold Chloride for Various Bacteria	46
VI.	Relative Resistance Periods of Various Bacteria to Gold Chloride	47
VII.	Relative Resistance Period of Various Bacteria to Various Poisons	48
VIII.	Percentage of Water in Organisms	58
IX.	Resistance Periods of Fresh-water Crustacea to Various Constituents of Sea Salt	81
X.	Plasmolysis of <i>Vorticella</i> by Solutions	87
XI.	Plasmolysis of Colpoda by Solutions	87
XII.	Tonotaxis of <i>Spirillum</i> to Various Solutions	91
XIII.	List of Animals showing the <i>Anex</i> Type of Irritability	136
XIV.	List of Animals showing the <i>Katex</i> Type of Irritability	136
XV.	Electrotactic Response of Various Invertebrates	147
XVI.	Wave Lengths and Vibration Times of Different Parts of Spectrum	155
XVII.	List of Solutions giving nearly Monochromatic Colors	157
XVIII.	Phototactic Response of Various Animals	195
XIX.	Results of Experiments to determine the Ultramaximum Temperature of Organisms in Water	234
XX.	Determinations of the Ultraminimum of Organisms reared under Normal Conditions	244
XXI.	List of Species found in Hot Springs, with the Conditions under which they occur	250
XXII.	Percentage of Water and Dry Substance in Frog Embryos at Various Ages	285
XXIII.	The Percentage of Water in Chick Embryos at Various Stages up to Hatching	286
XXIV.	The Percentage of Water in the Human Embryo at Various Stages up to Birth	286
XXV.	Percentage Composition of Animals and Plants	295

TABLE NO.		PAGE
XXVI.	Percentage Composition of the Ash of Various Organisms	296
XXVII.	Relative Abundance of Various Elements in the Ash of Organisms	297
XXVIII.	Nutritive Solutions for Phanerogams	301
XXIX.	Inorganic Matters in Potable Water	301
XXX.	Nutritive Solutions for Algæ	302
XXXI.	Nutritive Solutions for Fungi	302
XXXII.	Comparison of Ash in New-born Dog and in the Milk of its Mother	303
XXXIII.	Results of feeding Tadpoles on Various Substances	329
XXXIV.	Showing for Various Mammals the Time required to double the Birth-weight correlated with the Chemi- cal Composition of the Milk of the Species	331
XXXV.	The Total Dry Weight of a Crop of <i>Aspergillus</i> reared in the Absence and in the Presence of Various Quan- tities of Irritating Substances	332
XXXVI.	Interval elapsing before Germination when Spores of <i>Penicillium</i> are kept in Moist Chambers over Vari- ous Solutions of Sodium Chloride	351
XXXVII.	Relation between the Humidity of the Soil and the Amount of Dry Substance produced	353
XXXVIII.	Relation between Concentration of the Solution and Ger- mination of Peas	363
XXXIX.	Relation of Regeneration of Nais to Strength of Solution	365
XL.	Relation of Reproduction by Fission of <i>Dero</i> to the Strength of the Solution	366
XLI.	Relative Size of Tadpoles reared in the Light and in the Dark	426
XLII.	Average Dimensions of Tadpoles reared behind Clear and Colored Screens	433
XLIII.	Percentage Deviations in Length of Larvæ of <i>Strongylo- centrotus</i> reared behind Various Colored Screens, from Length of Larvæ reared in White Light	434
XLIV.	Relative Time of Hatching of Organisms reared behind Colored Screens	434
XLV.	The Optimum Intensity for Phototropism in Various Species of Plants	439
XLVI.	Minimum Intensity for Phototropic Response in Various Species of Plants	439
XLVII.	Average Total Increments in Length of the <i>Plumules</i> of Seedlings subjected to Different Temperatures	451
XLVIII.	Average Increments in Length of the <i>Radicles</i> of Various Seedlings subjected to Different Temperatures	451
XLIX.	Time required for Spores of <i>Penicillium</i> to germinate, produce Visible Mycelium, and to form Spores, at Various Temperatures	452

LIST OF TABLES

491

TABLE NO.	PAGE
L. Critical Points for Various Plants	454
LI. The Absolute Increase in Length of Tadpoles at Different Temperatures	457
LII. The Time Required for Various Species of Fish to hatch at Various Temperatures	459
LIII. Critical Temperature Points for Various Animals	460
LIV. Average Weight and Percentage of Water in Plants reared at Various Temperatures	461
LV. The Relation between the Temperature and the Sense of Thermotropic Response in Various Seedlings	464
LVI. The Sense and the Average Extent of Thermotropism at Different Temperatures	465
LVII. Phototropic Limiting Angles for Various Plants	471

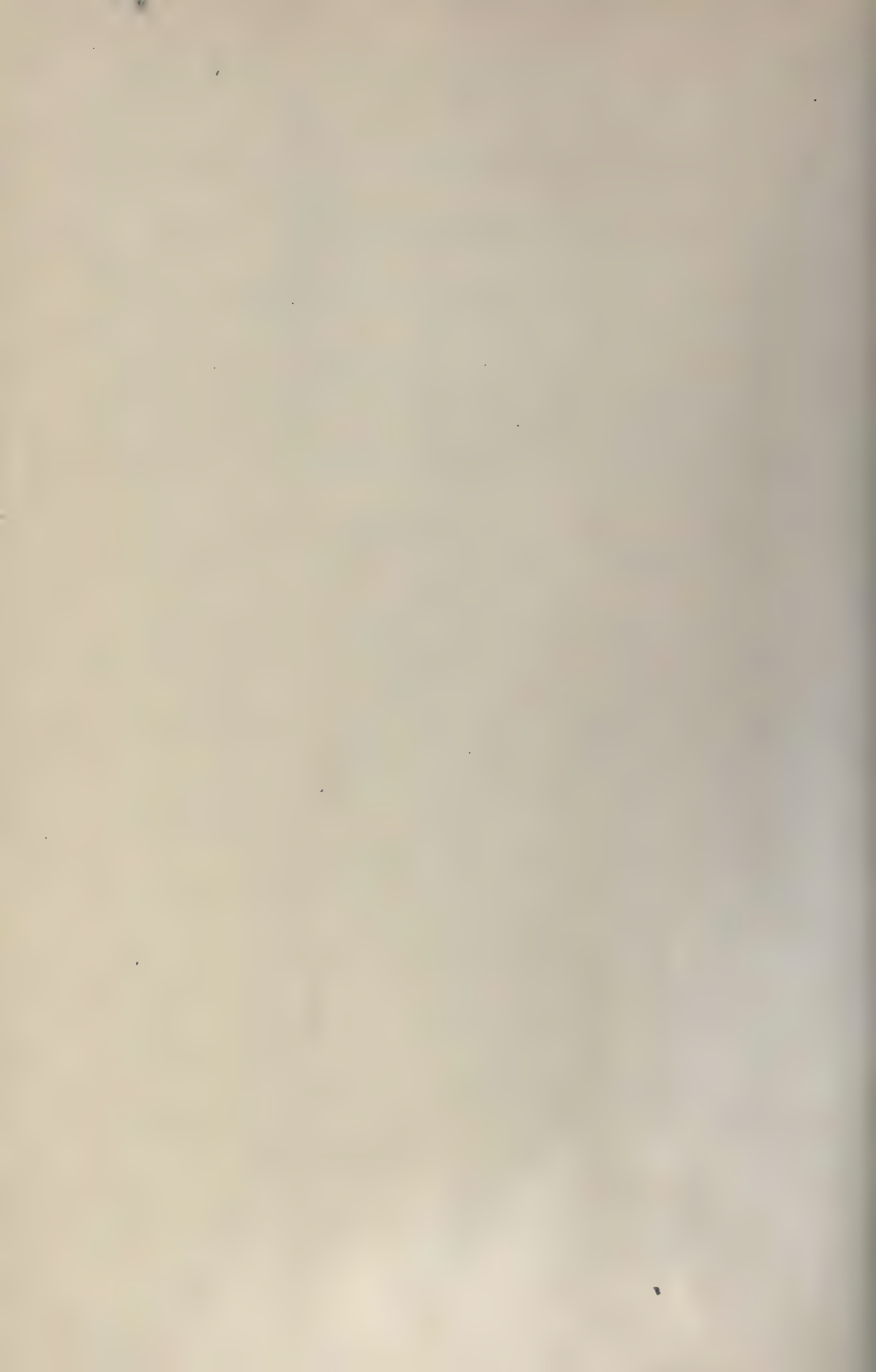

INDEX

- Acclimatization to solutions; 87; to heat and cold, 249, 255, 257; to contact-irritation, 382; to stimuli, 484.
- Acetic acid, attracts zoöspores, 38; repels amœba, 38.
- Acetoxim, 15.
- Acids, inorganic, as poisons, 12; provoking response, 37.
- Acids, organic, as poisons, 13; chemotaxis towards, 37.
- Actinia, action of nicotin on, 23.
- Actinophrys, action of hydrogen on, 5; of quinine, 27; of varying density, 76; heat-rigor of, 232.
- Actinospherium, response to density, 86; contact, 98, 102; alternating current, 131; galvanic current, 139.
- ADDUCO, action of cocaine, 24.
- ADERHOLD, chemotaxis, 33, 34; gravity, 114; phototaxis, 183; acclimatization to cold, 257.
- ADRIANOWSKY, light and seed germination, 420; green rays on plants, 435.
- AEBY, free nitrogen as food, 312.
- Æthaliu, rheotaxis of, 108; phototaxis, 185.
- AFFANASIEFF, cold on muscle, 242.
- Agaricus, light on germination of, 420.
- ALBERTONI, cocaine on protoplasm, 24.
- ALCOHOL, on protoplasm, 10; structural formulas, 11; resistance of organisms to, 11; chemotactic action, 37.
- Aldehydes, 20.
- Algæ, effect on, of hydrogen peroxide, 3; sodic-chromate, 4; potassic permanganate, 4; potassic chlorate, 4; potassic dichromate, 4; potassic arsenite and arsenate, 5; arsenious acid, 5; azoimid, 7; chloral hydrate, 10; carbonic disulphide, 12; organic acids, 13; calcic oxide, 13; diamid, phenylhydrazin, 16; nitrous acid, 21; paraldehyd, 21; sodic fluoride, 21; oxygen, 34; changing density, 86; molar agents, 100; growth of A. and salts, 302; nitrogen, 309; potassium, 318, 319.
- Alkaline salts and growth, 318.
- Alkaloids, as poisons, 22.
- Ammonia, effect on *Tradescantia* and *Spirogyra*, 6.
- Amœba, effect on, of hydrogen, 5; curare, 26; quinine, 27; chemotaxis, 38; varying density, 75, 86; molar agents, 99; thigmotaxis, 105; electric irritation, 130, 132; electric acclimatization, 139; electrotaxis, 148; phototaxis, 186; heat-rigor, 232; coagulation, 238; cold, 241; thermotaxis, 258; foods of A., 328.
- Ampelopsis, phototropism, 438.
- Amphibia, foods of, 329; temperature and growth, 459.
- Amphioxus, electric excitation, 137.
- Ancylus, acclimatization to changed density, 85.
- ANDREWS, photic irritability of Hydroids, 179.
- Anex type of electric response, 137.
- Animals, toxic protein compounds, 22; salts necessary for, 302; organic foods of, 327; thigmotropism, 382; geotropism, 398; phototropism, 442; growth of, at various temperatures, 457.
- Anisonema, change of structure with density of solution, 77.
- Annelida, negatively electrotactic, 147; ultramaximum, 234, 246.
- Antimony, effect on growth, 314.
- Antipyrin, on protoplasm, 27.
- Ants, chemotaxis, 33; phototaxis, 198; thermotaxis, 261.
- Apostrophe, conditions of, 190.

- APSTEIN**, light on pelagic eggs, 417.
Apus, heat on growth of, 458.
Arca, acclimatization to changed density, 86.
ARENDT, sulphur and growth, 314.
Arsenic acid, oxidization by, 5.
Arsenious acid, oxidization by, 5.
ARTAUD, temperature and metabolism, 222.
Arthropoda, effect of varying density, 81, 82; salt absorption by, 88; positively electrostatic, 147.
Ascaridæ, strychnin, 26.
Ascaris, sodic carbonate, 13; sodic hydrate, 13; phenol, 19; hydrocyanic acid, 19.
Ascidia, thigmotropism, 382.
Asellus aquaticus, acclimatization to changing density, 86.
Ash, of organisms, 295, 296; of dog and dog's milk, 303.
ASKENASY, latent period, 460.
Asparagin, chemotaxis towards, 38.
Aspergillus, nitrogen food, 308.
Atmospheric pressure and growth, 368; electricity, 408.
Atropin and protoplasm, 24.
Azoimid, effect on protoplasm, 7.

Bacilli, calcic oxide and caustic potash poisonous to, 13.
Bacillus ramosus, growth in colored light, 430; critical points, 454.
Bacteria, effect on, of oxygen, 2, 168; ozone, 3; potassic chlorate, 4; sodic chromate, 4; carbonic disulphide, 12; organic acids, 13; potassic carbonate, 13; salts of heavy metals, 14; diamid, 16; formaldehyde, 21; chemotactic, 33, 45; towards oxygen, 34; inorganic salts, 36; alcohol and glycerine, 37; to determine isotonic coefficients, 74; acclimatization to density, 86; tonotaxis, 90; effect of violent shaking, 99, 371; of light, 169, 171, 174; dark-rigor, 175; change of light intensity, 178; light-rigor, 178; cold, 241; growth, 288; nitrifying, 299, 308-312; food, 324, 325; growth in light, 430; heat and growth, 452; critical temperatures, 454-457.

Bacterium termo, chemotaxis, 32, 38.
Balanus larvæ, chemotaxis, 198.
BARANETZKI, negative phototaxis, 185; response of Myxomycetes to light, 202; effect of pulling on growth, 372.
Bark extract, attracts Myxomycetes, 38.
Barnacles, respond to shadow, 179.
DE BARY, light and seed germination, 420.
Bases, effect on protoplasm, 13.
BÄSSLER, nutrition of plants, 299.
BASTIT, geotropism, 398.
BATESON, geotropism, 397.
BAUDRIMONT, rôle of water in growth, 284.
BAUMANN, iodine and growth, 367.
Bean, effect of changing density, 367; traumatopism, 384.
BECLARD, colors and growth of fly, 432.
Beetles, geotaxis, 118.
Beggiatoa, negative phototaxis, 184.
BENECKE, solutions for fungi, 302; potassium and growth, 318; rubidium and cesium and growth, 320; magnesium and growth, 323.
Benzenylamidoxim, poison, 15.
Benzol derivatives, chemotaxis towards, 38.
BERNARD, chloroform on protoplasm, 9.
BERT, effect of dense solutions on fish, 79, 80, 82; acclimatization to density, 86; dark-rigor, 176; range of visible spectrum in animals, 203; effective rays in phototaxis, 203; oxygen and plants, 305; effective rays in plant growth, 428; green rays and growth, 435.
BERTHELOU, electricity and plant growth, 406.
BERTHELOT, nitrifying organisms, 308; enrichment of fallow ground, 310.
BEUDANT, acclimatization to density, 85.
BEYERINCK, food of Amœba, 328.
BEZOLD, water in animals, 58, 295.
BIALOBLOCKI, heat and growth, 461.
BIEDERMANN, electric response of muscle, 133.
BINZ, theory of arsenical poisoning, 4, 5; effects on protoplasm of halo-

- gens. 4 ; strychnin, 25 ; quinine, 26 ;
acclimatization to arsenic, 28.
- Birds, effect of temperature on growth,
459.
- Bismuth, effect on growth, 314.
- BLASIUS, compression-rheostat, 127 ;
electric irritation, 139 ; electrotaxis,
147-149.
- Blood-corpuses, to determine isotonic
coefficients, 73 ; effect on, of density,
76 ; and molar agents, 99.
- BLUNT. *See* DOWNES.
- Body, composition, 294.
- BOER, gold chloride, 46.
- BOKORNY, hydrogen peroxide a poison,
3 ; ammonia, 6 ; nutrition of plants,
299.
- BONARDI, minimum temperature for
bacteria, 241.
- BORODIN, light and chlorophyll arrange-
ment, 187 ; light on spores, 424 ;
effective rays in fern growth, 432.
- Boron, and growth, 314.
- TEN BOSCH, quinine and protoplasm,
26.
- BOURNE, scorpions acclimated to own
poison, 28.
- BOUSSINGAULT, free nitrogen as food,
310.
- BRAEM, heat and cold on statoblasts,
425.
- Branchipus, heat and growth, 458.
- BRANDL, fluorine and growth, 317.
- BRASSICA, light on growth, 428.
- BRAUER, encystment, 256.
- BREFELD, light and growth of toad-
stools, 420.
- Bromine, and protoplasm, 4 ; and
growth, 316.
- BRUNCHORST, electrotropism, 409-412.
- Bryonia, light and growth, 419.
- Bryozoa, desiccation of, 65 ; thigmo-
tropism, 382.
- BUCHNER, toxic protein compounds,
22 ; chemotaxis, 33 ; light and bac-
teria, 172 ; movement and growth,
371.
- Bufo lentiginosus, acclimatization to
heat, 253 ; heat and growth, 457-460.
- BUNGE, iron and growth, 321-323.
- BÜTSCHLI, encystment, 256.
- Butyric acid, chemotaxis towards, 38.
- BUXTON. *See* RINGER.
- Cæsium and growth, 320.
- Calcium and growth, 320.
- CALDANI, frictional electricity and
growth, 132.
- CALLIBURCES, heat and protoplasmic
movement, 227.
- CALMETTE, immunization, 30. *See also*
EHRlich.
- CAMPBELL, temperature and proto-
plasmic irritability, 230.
- DE CANDOLLE, heat-rigor, 231 ; cold-
rigor, 240, 241.
- CANNON, phototaxis of Daphnia, 203,
204.
- Carbon, as food, 306 ; oxide of, and
protoplasm, 6.
- Carbonic disulphide, and protoplasm,
12.
- Carcinus, absorption of salt, 88.
- Cardium edule, acclimatization to
density, 86.
- Carnin, chemotaxis towards, 38.
- Cassis, acclimated to sulphuric acid, 28.
- CASTLE, acclimatization to contact,
108 ; to heat, 253.
- Cat, light on growth of, 426.
- Catalytic poison, action of, 7-9.
- CELLI, electrified air and plant growth,
408.
- Cell-division and growth, 287.
- CELLI, food of Amœba, 328.
- CERTES, desiccation of Ciliata, 65.
- Chameleon, pigment response to light,
192.
- Chara, and caustic potash, 13.
- CHARPENTIER, cocaine and protoplasm,
24.
- CHASTAIGN, oxidizing action of light,
162.
- Chemical agents, effect on vital ac-
tions, 1 ; acclimatization to, 27 ; and
growth, 293.
- Chemotaxis, 32-54.
- Chemotropism, 335 ; in insectivorous
plants, 335 ; of roots, 336 ; of pollen-
tubes, 337 ; of hyphæ, 340 ; of con-
jugation tubes of Spirogyra, 342.
- Chick, water in growth of, 286 ; elec-
tricity and growth of, 405 ; heat and
growth, 459.
- Chilomonas, phototaxis and photo-
pathy, 183.
- Chlamydomonas, thigmotaxis of, 106.

- Chloral hydrate, poison, 10.
 Chlorine, poison, 4; effect on growth, 316.
 Chloroform, action on protoplasm, 9, 10.
 Chlorophyll, effect of light on position, 189; temperature and movements, 226.
 CHMULEVITCH, heat-rigor, 232.
 CHODAT, electricity and plants, 407.
 Chromic acid, as poison, 3, 4.
 Chytridium, phototaxis, 183.
 CIENKOWSKI, phototaxis, 183.
 CIESIELSKI, traumatropism, 384; geotropism, 393, 394; after-effect, 401; tropism, 481.
 Cilia, effect of density on movement, 77; electric stimulation, 145; temperature, 227.
 Ciliata, effect on, of oxygen, 3; hydrogen peroxide, 3; chloroform and ether, 10; strychnin, 26; chemotaxis, 33; of saline lakes, 65; density effect, 76, 78, 86; phototaxis, 187.
 CLARK, oxygen, 2.
 Cobra poison, 30.
 Cocaine, effect on protoplasm, 24.
 Cockroach, geotaxis, 118; thermotaxis, 261.
 Cœlenterata, electric response, 137; phototaxis, 194.
 COHN, phototaxis, 202; heat and protoplasm, 225.
 Cold, 242; resistance to, 246; extreme, 248; acclimatization, 257.
 Cold-rigor, 239.
 Colored light, 432-436, 440, 441.
 Crab, copper in blood of, 324.
 Critical temperatures, 460.
 CRIVELLI, food of *Amœba*, 328.
 Crustacea, density, 79, 81; optimum temperature, 458.
 Cryptogams, water and growth, 350; geotropism, 378; thigmotropism, 381.
 Cryptomonas, chemotaxis, 33.
 Ctenophora, inorganic food, 303.
 Cucurbita, moisture, 352.
 CUENOT, temperature and growth, 458.
 Curare, *Amœba*, 26.
 Cyphoderia, molar agents, 100.
 Cytotaxis, 52.
 CZAPEK, phototropism, 471; tropism, 482, 483.
 CZERNY, density, 75, 76, 78, 86.
 DALLINGER, heat and Infusoria, 252-256.
 DANILEWSKY, cocaine, 24; lecithin, 330.
 Daphnia, phototaxis, 203-206.
 DAREMBRAY, blood serum, 22.
 Dark-rigor, 175, 176.
 DARWIN, C., insectivorous plants, 99; chemotropism, 335; hydrotropism, 357; tendrils and twining, 377; thigmotropism, 379, 380, 383; traumatropism, 384-386; geotropism, 394; phototropism, 441, 485.
 DARWIN, F., moisture and growth, 252, geotropism, 397.
 DAVIS, desiccation of rotifers, 62, 63.
 DAY, nitrogen, 312.
 Death, 1; by poisons, 2-24; desiccation, 60-65; density, 80-83; light, 171-175; heat, 231-249; limits, 275-277.
 DEHNECKE, gravity, 113.
 DEHERAIN, temperature and secretion, 223.
 DEMOOR, oxygen, 2, 3; hydrogen, 5, 6; ammonia, 6; oxides of carbon, 6; chloroform, 9; paraldehyde, 21; cold-rigor, 241.
 Density of the medium, effect on protoplasm, 70-93; on growth, 362-369.
 DERMANT, heat-rigor, 239.
 Dero, fission and density, 365, 366.
 Desiccation, protoplasm, 59; rigor and death, 60, 61; acclimatization to, 65.
 Desmids, phototaxis, 183.
 DETLEFSEN, hydrotropism, 257; traumatropism, 384.
 DEWITZ, chemotaxis, 37; thigmotaxis, 106, 107.
 Diamid, poison, 1, 16.
 Diatoms, effect on, of chloral hydrate, 10; hydroxylamine, 15; ethylaldehyde, 21; phototaxis of, 184, 199; silicon food of, 324.
 Differential threshold stimulation, 43.
 Diffugia, molar agents, 101.
 Dionæa, response to contact, 99.
 Dioscorea, light, 419.
 Dodder, twining, 377, 484.
 DOGIEL, curare, 26.

- Dogs, potassium and growth of, 319.
 Dolium, and sulphuric acid, 28.
 DOWNES, analytic effect of light, 163 ;
 bactericidal effect of light, 171-173.
 DOYÈRE, desiccation, 62 ; heat on
 Rotifera, 255.
 Dragon-fly larvæ, electric stimulation,
 137.
 DRAPER, assimilation in plants, 166.
 DRIESCH, phototaxis, 202 ; growth,
 282 ; geotropism, 400 ; phototropism,
 443.
 Drosera, organic acids, 13 ; thigmo-
 taxis, 99 ; thigmotropism, 383, 481.
 Drosophyllum, and contact, 99.
 Dryness and protoplasm, 59, 60.
 DRYSDALE, heat and protoplasm, 256.
 DUBOIS, response to light, 207.
 DUCHARTRE, hydrotropism, 256.
 DUCLAUX, chemical effect of light, 162,
 163 ; election of food, 333.
 DUTROCHET, molar agents, 100 ; tem-
 perature on protoplasm, 225 ; accli-
 matization to heat, 252 ; twining,
 377.
 Duvalia, germination, 424.
 Earthworm, nicotin, 24 ; phototaxis,
 203.
 Echinodermata, nicotin, 24 ; density,
 79 ; electric current, 137 ; phototaxis,
 194 ; light on growth, 434 ; optimum
 temperature for growth, 458.
 Echinoids, strychnin, 26.
 EDWARDS, light on growth, 425.
 Effective rays in growth, 427-436 ; in
 phototropism, 440.
 Egg, food materials in, 303 ; phospho-
 rus, 313 ; iron, 322 ; electricity, 403.
 EHRENBERG, heat, 251.
 EHRlich, ricin, 31 ; acclimatization to
 poison, 32.
 Electricity, 126 ; protoplasm, 129-153 ;
 electro taxis, 140-151 ; growth, 405-
 414 ; electrotropism, 409-414.
 Electrotaxis, 140-151.
 ELFVING, chloroform, 9 ; light, 174 ;
 gravity and growth, 391 ; geotro-
 pism, 398.
 Embryos, phosphorus, 314 ; light, 417,
 418.
 EMERY, salt absorption, 88.
 Encystment, 256.
 ENGELMANN, chemotaxis, 32, 34 ; den-
 sity, 86 ; electricity, 130, 132, 135 ;
 bacteria and spectrum, 163 ; dark-
 and light-rigor, 176, 178 ; changing
 light intensity, 179 ; phototaxis, 182,
 183, 187, 202, 207 ; retinal move-
 ments, 193 ; photopathy and chem-
 ical agents, 201 ; temperature, 227,
 231.
 Entomostraca, density, 81.
 ENTZ, photopathy, 188.
 Ephydra, acclimatization, 28.
 Epistrophe, 190.
 Epithelium, ciliated, 129, 227.
 ERLACH, acclimatization, 29, 30.
 ERRARA, hydrotropism, 359 ; thigmo-
 tropism, 381.
 ESCHENHAGEN, growth and density,
 362.
 ESCHLE, iodine and growth, 317.
 Ether, 9, 10.
 Ethylaldehyde, protoplasm, 21.
 Euglena, chemotaxis, 33 ; phototaxis,
 183 ; acclimatization to cold, 257 ;
 thermotaxis, 261.
 EWALD, electrotaxis, 147-150.
 Excretion and poisons, 51.
 EXNER, pigment and light, 193.
 Extent of medium and size, 473.
 FABRE-DOMERGUE, density, 76, 86.
 Fallow ground, enrichment, 310.
 False, phototaxis, 181 ; traumatro-
 pism, 384 ; geotropism, 392 ; electro-
 tropism, 409.
 FAMINTZIN, phototonus, 177 ; photo-
 taxis, 182 ; chlorophyll position,
 189 ; light and growth, 430.
 FATIGATI, rays which disturb metabo-
 lism, 170.
 FAYRER, serpent poison, 28.
 FECHNER, threshold stimulation, 434.
 FÉRÉ, temperature and chick's growth,
 459.
 FICK, electric stimulation, 133.
 FIGDOR, phototropic limit, 439.
 Fish, density-effects, 79-82 ; rheotaxis,
 109 ; temperature and growth, 458,
 459 ; medium and size, 474. *See also*
 Gold-fish.
 Flagellata, chemotaxis, 33, 36, 45 ;
 salt-absorption, 86, 89 ; phototaxis,
 182 ; acclimatization to heat, 252, 255.

- FLAMMARION, effective rays in growth, 429.
- Fly larvæ, chemotactic, 38; geotactic, 118.
- Fluorine, and growth, 317.
- Food, 309-330; response to, 39; election, 334.
- Formaldehyde, poison, 20, 21.
- FRANK, chlorophyll position, 189; growth definition, 282; nitrogen as food, 308-310.
- FRANKE. *See* PFEIFFER.
- FRANKLAND, light and bacteria, 171.
- FRAZEUR, regeneration and density, 365.
- FREDA, electricity and growth, 408.
- FREDERICQ, salt-absorption, 88; copper and growth, 324.
- Fresh water absorbed by marine organisms, 79, 80.
- FRIES, light and fungi, 420.
- Frog, sodic fluoride, 22; density, 82; salt-absorption, 88; electric stimulus, 132, 139; pigment and light, 192; water in developing, 285; size and medium, 474, 475.
- Frog's egg, cytotaxis, 52; cold-rigor, 240; oxygen and growth, 305; electricity, 405.
- FROMANN, soluble mineral bases as poisons, 13.
- Fungi, salts of arsenic, 5; sulphurous oxide, 20; nitrous acids, 21; nutritive solutions, 302; hydrogen as food, 306; potassium, 318; iron, 323; organic foods, 324-326; water and growth, 350; hydrotropism, 358; light and growth, 420; colored light, 430.
- GAIN, water and growth, 254.
- Galvanic current, acclimatization to, 139.
- Gastropoda, copper in blood, 324.
- GAUTIER, green rays and plants, 435.
- GAVARRET, desiccated rotifers, 62.
- Geotaxis, 114-124.
- Geotropism, 391-403; and phototropism, 470.
- GEROSA, cold, 241.
- Germination, and solutions, 363; and light, 424.
- GILBERT. *See* LAWES.
- GLAN, spectrophotometer, 160.
- Glucose, reaction, 4.
- Glycerine, chemotactic, 37.
- GOGORZA, density, 79-83; acclimatization, 86, 87.
- Gold chloride, poison, 46, 47.
- Gold-fish, density, 77, 79.
- GOLUBEW, electricity stimulus, 130.
- GORINI, Amœba, 328.
- GOTSCHLICH, heat-rigor, 232, 233.
- GRABER, phototaxis, 203, 205, 207; thermotaxis, 258, 261.
- GRANDEAU, electricity, 406, 408.
- Gravity, methods, 112; protoplasm, 113, 114; direction of locomotion, 114-124; growth, 391-403.
- Green plants, light, 174; organic food, 326, 327.
- GREENWOOD, nicotin as poison, 24.
- GROOM, phototaxis and temperature, 200.
- Growth, analysis of processes, 281; three factors, 282; regions in plants, 283; cell-division, 287; kinds of, 287; normal, 288, 289; chemical agents on, 293; as response to stimulus, 331; directed, 335, 355, 376, 384, 387, 391, 409, 437, 460; water, 350; density, 362; molar agents, 370; wounding, 384; gravity, 391; electricity, 405; light, 416; heat, 450; optimum, 454; maximum temperature, 456; range, 456; modification of rate, 478-480; modification of direction, 480-483.
- GRUBER, density, 76.
- HABERLAND, chemotropism, 242.
- Hæmoglobin, properties, 298.
- HALES, phototropism, 437.
- HALLIBURTON, heat-rigor, 239.
- Halogens and growth, 315.
- HAMBURGER, isotonic coefficient, 73; density, 76.
- HAMMOND, light and growth, 426.
- HANSTEEN, organic food of plants, 327.
- HARTIG, phosphorus and growth, 314.
- Heat, absorption by plants, 170; nature of, 219; action on protoplasm, 222-263; chlorophyll formation, 224; irritability, 225; acclimatization to, 249, 251; extremes, 248; direction of locomotion, 258; growth, 450-467; latent period, 460.

- Heat-rigor, 231, 239.
 Hedgehog, hydrocyanic acid, 19.
 HEGLER, pulling and growth, 372, 374;
 electrotopism, 412.
 HEIDENSCHILD, toxic proteids, 22.
 Helianthus, pulling, 374; phototro-
 pism, 438; phototropic angle, 471.
 HELLRIEGEL, nitrogen fixation, 310.
 HELMHOLTZ, light on retina, 171.
 Hen, mineral matter in egg, 303; flu-
 orine, 317.
 HENSEN, light and pelagic eggs, 417.
 Hepatics, thigmotropism, 381.
 HERÆUS, nutrition, 300.
 Herbivora, chlorine, 316.
 HERBST, salts of marine animals, 303;
 phosphorus and growth, 314; sul-
 phur, 315; chlorine, 316; potassium,
 319; magnesium, 323.
 HERMANN, electrical measurements,
 128; electric stimulation, 139; elec-
 trotaxis, 147-149; cold, 242.
 HERRICK, gravity and nucleus, 114;
 temperature and growth, 458.
 HERTWIG, O., growth of frogs, 458, 459.
 HERTWIG, O. and R., cocaine, 24;
 strychnin, 25; quinine, 26; chemo-
 taxis, 33.
 HIERONYMUS, chlorophyll movements,
 191.
 HIGGENBOTTOM, light and growth, 425.
 HILTNER, nitrogen and growth, 312.
 HOFER, hydroxylamine, 15.
 HOFFMANN, water and growth, 250;
 dryness and resistance to heat, 255;
 light and germination, 420, 424.
 HOFMEISTER, molar agents and proto-
 plasm, 100, 102; phototaxis, 184;
 temperature and protoplasm, 225;
 heat-rigor, 232; geotropism, 401.
 Holothuroidea, geotaxis, 118.
 Honey bee, temperature and metab-
 olism, 223.
 HOPPE-SEYLER, acclimatization to heat,
 251; lithium on growth, 318; mag-
 nesium, 323.
 HORVATH, shaking protoplasm, 99; bro-
 mine and growth, 316; rough move-
 ment on growth, 370.
 HUDSON, desiccation, 63.
 Human embryo, water in growth, 286.
 Humidity of soil and growth, 253.
 HUXLEY, definition of growth, 282.
 Hydra, nicotin, 23; density, 81, 86;
 phototaxis, 194, 202; light waves
 and growth, 430.
 Hydrachna, maximum temperature,
 238.
 Hydrazin and protoplasm, 16.
 Hydric sulphide, protoplasm, 19, 20.
 Hydrides, chemotactic, 37.
 Hydrocyanic acid, poison, 19.
 Hydrogen on protoplasm, 5; in organ-
 isms, 306.
 Hydrogen peroxide, poison, 3.
 Hydroidea, inorganic food, 303; iron,
 323; density and regeneration, 364;
 thigmotropism, 382; geotropism, 398,
 399; phototropism, 443.
 Hydroides dianthus, responds to
 shadow, 179.
 Hydrotaxis, 66.
 Hydrotropism, 255.
 Hydroxylamine, poison, 1, 15.
 Hyphæ, chemotropism, 340; hydro-
 tropism, 358.
 Hypochlorous acid, poison, 3, 4.
 Hypozanthin, chemotactic stimulus,
 38.
 Indifferent chemical agents and proto-
 plasm, 41, 42.
 Induction apparatus, 127.
 Infusoria, and potassic permanganate,
 4; halogens, 4; arsenious acid salts,
 5; azoimid, 7; chloral hydrate, 10;
 hydroxylamine, 15; phenylhydrazin,
 16; hydrocyanic acid, 19; ethylalde-
 hyde, 21; quinine, 27; acclimatiza-
 tion, 28; chemotaxis, 33; thigmotaxis,
 106; katex response, 137; electro-
 taxis, 140; wave-lengths which dis-
 turb metabolism, 170; heat and
 movement, 228; cold-rigor, 240; or-
 ganic foods, 328; multiplication and
 light, 422.
 Injurious substances, response to, 39.
 Inorganic salts and protoplasm, 37.
 Insecta, hatching and temperature, 458.
 Insectivorous plants, chemotropism,
 335.
 Invertebrates, quinine, 26; sodic car-
 bonate, 28; water in, 58, 59; elec-
 tric response, 136; electrotopism, 147;
 ultramaximum temperatures, 234-
 237; ultraminimum, 244-246; in hot

- springs, 250, 251; potassium as food, 318.
- Iodine, protoplasm, 4; growth, 317.
- Iron, and growth, 321-323.
- Irritable period in development, 379; region in tendrils, 379.
- Isopoda, hydroxylamine, 15; formaldehyde, 21.
- Isotonic coefficients, 23.
- JACCARD, oxygen on plant growth, 305; pressure and growth, 368.
- JANSE, salt-absorption, 88.
- JARIUS, growth and density, 362.
- JENSEN, geotaxis, 114-118, 121-124.
- JENTYS, oxygen and growth, 305; density and growth, 362.
- JOHNSON, hydrotropism, 256; geotropism, 394.
- JONSSON, rheotaxis, 108; rheotropism, 387; light and germination, 425.
- JORDAN, analysis of water, 301.
- JUMELLE, water and growth, 253.
- KARSTEN, light and plants, 419.
- Katex type of electric response, 138.
- KELLER, retinal pigment and light, 192.
- KLEBS, phototaxis, 183.
- KLEIN, light fatal to fungi, 174.
- KLINGER, synthesis of organic compounds, 163.
- KNIGHT, hydrotropism in roots, 256; geotropism, 393.
- KNOWLTON, temperature and growth, 459.
- KNY, light and growth, 423.
- KOCH, free nitrogen as algæ food, 309.
- KOCHS, desiccation and seed vitality, 63, 64.
- KOFOID, blastula cavity, 78, 79.
- KOSSOWITSCH. *See* KOCH.
- KRAFT, electricity on epithelium, 129.
- KRAUS, light on growth, 420; green rays and growth, 430.
- Kreatin, chemotactic, 38.
- KRUKENBERG, strychnin, 25; quinine, 26; water in organism, 58, 295; iron and growth, 321.
- KÜHN, desiccation of nematodes, 61.
- KÜHNE, effect on protoplasm of hydrogen, 5; chloroform, 9; veratrin, 24; varying density, 75-77; electric current, 129, 132, 138, 139; temperature and movement, 225; heat-rigor, 231, 232; fatal temperature, 238; cold-rigor, 241; cold, 242, 247, 248.
- KUNKEL, iron as food, 323.
- Lactic acid, chemotactic, 38.
- Lamellibranchiata, electric stimulation, 133; light reaction, 179.
- LANCE, desiccation of tardigrades, 61, 65.
- Land animals, acquisition of oxygen, 304; sulphur, 314.
- Larvæ, food, 323; light, 418.
- LAURENT, nitrogen food of plants, 309, 312.
- LAWES, nitrogen as plant food, 310; food of mammals, 330.
- LEBER, chemotaxis, 33.
- LE DANTEC, thigmotaxis, 105, 107.
- Leeches, poison, 15.
- Legumes, enriching action of, 310.
- LEITGEB, light and spores, 424.
- Lemna, organic food of, 327.
- LEMSTRÖM, electricity favors plant growth, 408.
- LEONE, agitation of water and growth, 371.
- LESAGE, moisture and germination, 350, 351.
- Leucocytes, oxygen and protoplasm, 3; chloroform, 10; quinine, 26; chemotaxis, 33; electric stimulation, 130.
- LEWITH, heat and coagulation, 255, 256.
- LIEBENBERG, light and germination, 425.
- LIEBERMANN, water of organism, 58.
- LIEBSCHER, free nitrogen as plant food, 312.
- Life, temperature-limits, 231.
- Light, methods, 154; monochromatic, 156-158; physical properties of different wave-lengths, 158, 159; intensity, 160; chemical action, 161-165; thermic effect on metabolism, 166-170; chemical effect, 170, 171; vital limits, 171; and movement, 175; light-rigor, 178; and carbon dioxide production in plants, 179; phototaxis and photopathy, 180-210; of chlorophyll, 189; of pigment, 192; racial attunement, 197; period of life, 197, 198; mechanics of response

- to, 207-209; retarding effect on growth, 416-423; accelerating effect, 423-427; phototropism, 436-445.
- LILLE, temperature and growth of tadpoles, 459.
- Limax, geotaxis, 118-120.
- Limnæa, poisoned by azoimid, 7; acclimatization to density, 85; light on growth of, 426; extent of medium and size, 474.
- Linum, light and growth, 428.
- Lithium and growth, 318.
- Lobster, copper in blood, 324; heat and growth, 458.
- LOCKE, metallic salts as poisons, 14, 15.
- Locomotion, interference with normal, 51; determination of direction, 32, 66, 89, 105, 114, 140, 180, 258.
- Locust, heat and growth of, 458.
- LOEB, chemotaxis, 33; oxygen attracts fly larvæ, 38; gravity and invertebrates, 118; effect of light intensity, 179, 197; phototaxis, 198; phototaxis and temperature, 200; light attunement, 200; phototaxis, 204, 206, 208; temperature and irritability, 230; thermotaxis, 258-261; rôle of water in growth, 304; oxygen and growth, 306; potassium and regeneration, 319; magnesium and growth, 323; growth and density, 364; contact and growth of stolons, 370; cutting and rate of growth, 376; thigmotropism in hydroids, 382; rheotropism, 388; geotropism in hydroids, 399, 400; phototropism in animals, 442, 443.
- Loew, effect on protoplasm of oxygen, 2; potassic chlorate, halogens and sodic chromate, 4; arsenical salts, 5; catalytic poisons, and azoimid, 7; sulphonal, 10; carbonic disulphide and inorganic acids, 12; soluble mineral bases, 13; salts of heavy metals, 14, 15; hydroxylamine, substitution poisons, 15; complex nitrogenous compounds, 16; hydrocyanic acid, 19; aldehydes, 20; ethylaldehydes, 21; sodic fluoride, 21, 22; alkaloids, 22, 23; acclimatization to poisons, 27; oxygen and growth, 294; phosphorus and growth, 314.
- LOMBARDINI, effect of electricity on development of chick, 405.
- LUBBOCK, chemotaxis, 33; effective wave-lengths in phototaxis, 203, 205.
- LUDLOFF, electrotaxis, 141; theory of electrotaxis in Ciliata, 145.
- MACAIRE, heat and metabolism, 222.
- MACALLUM, iron in growth, 321.
- MACDONNELL, light on frog's growth, 425.
- MACDOUGAL, contact response of tendrils, 378, 379.
- MCLEOD, electricity and plant growth, 407.
- MAGGI, food of *Amœba*, 328.
- Magnesium, and growth, 323.
- Magnetropism, 413.
- Maize, silicon in, 324. *See Zea.*
- Malic acid, chemotactic, 37, 38.
- Mammals, quinine, 27; foods of, 330.
- Man, acclimatization to poisons, 28; sulphur as food, 315.
- Manganese, and growth, 321.
- Manganic acid, poison, 3, 4.
- Marine organisms, effect of fresh water on, 79; foods of, 303.
- MARMIER, immunity, 30.
- MARSHALL, phototaxis, 194.
- MARTIN SAINT-ANGE, rôle of water in growth, 284.
- MASSART, effect on protoplasm of par-aldehyde and formaldehyde, 21; cocaine, 24; antipyrin, 27; chemotaxis, 33, 34; isotonic coefficients, 73, 74; density and protoplasmic structure, 76, 80; acclimatization to density, 86-88; tonotaxis, 89-92; phosphorescence, 98; thigmotaxis, 106, 107; gravity and Protista, 114-116, 121; phototaxis, 200.
- MATTHIAS. *See HERMANN.*
- MAUPAS, light and growth of Infusoria, 422.
- MAYER, absorption of heat by plants, 170; temperature and metabolism, 222.
- Mechanics of response, 45.
- MELTZER, shaking bacteria, 99, 371.
- MENDELSSOHN, change of optimum, 254; thermotaxis, 258, 259.
- Metabolism, modification by poisons, 1-27; by dryness, 59; molar agents,

- 98; by light, 166-175; by heat, 222-225; limiting conditions of, 275.
- METSCHNIKOFF, chemotaxis in bacteria, 33.
- Mice, acclimatized to ricin, 29-32.
- MIGULA, inorganic acids on protoplasm, 12.
- MILDE, light and spores, 424.
- MINOT, growth, 289.
- Mistletoe, light and growth, 423, 438.
- MİYOSHI, chemotropism, 338, 340; hydrotropism, 358.
- MOHL, twining stems, 377; acclimatization to light, 444.
- MOISSAN, temperature and metabolism in plants, 223.
- Moist gelatine, no thigmotropic response to, 278.
- Moisture and protoplasm, 58.
- Molar agents, and lifeless matter, 97; and protoplasm, 97; movement, 98, 99; metabolism, 98; direction of locomotion, 105; and growth, 370.
- Molds, and sodic carbonate, 28; nutritive solutions for, 302; and free nitrogen, 308; potassium and growth, 318; rubidium, 320; election of organic foods, 333; thigmotropism, 381; electrotropism, 412; light, 420.
- Molecular composition and effect on metabolism, 39.
- MOLESCHOTT, effect of light on vertebrates, 422.
- MOLISCH, hydrotropism, 257; potassium and calcium in growth, 319, 320; chemotropism, 336, 337; hydrotropism, 359; thigmotropism, 381.
- Mollusca, formaldehyde, 21; quinine, 27; changed density, 79; electrotaxis, 147; phototaxis, 202, 207; ultramaximum temperature, 235; ultraminimum, 245; species living in hot springs, 251; composition, 295; light and growth, 426.
- MONTGAZZA, effect of strong light on bacteria, 171.
- MONTI, food of *Amœba*, 328.
- MOORE, light and chlorophyll arrangement, 189, 191, 192.
- MORIGGIA, heat-rigor, 232.
- Morphine, and protoplasm, 25.
- Moths, phototaxis, 197.
- Mucor, phenylhydrazin a poison, 16; tropisms in, 482.
- MÜLLER, H., responding region in phototropism, 441.
- MULLER, N. J. C., definition of growth, 282.
- MÜLLER, O., thigmotropism, 379, 380.
- MULLER-HETTLINGEN, electric stress in seedlings, 405; electrotropism, 409.
- MÜLLER-THURGAU, freezing-point in plants, 247.
- MÜNTER, vitality of dried seeds, 64.
- MÜNTZ, nitrifying organisms, 308, 310.
- Musca, light and growth, 432. *See also* Fly.
- Muscle, electric stimulus, 133, 135; cold-effect, 242.
- Myriapoda, hydrocyanic acid secreted, 19.
- Mytilus, acclimatization to density, 85, 86.
- Myxomycetes, hydrogen, 5; chemotaxis, 33, 38, 45; varying density, 75, 86; molar agents, 100; electric stimulation, 129; light stimulus, 179; phototaxis, 184, 202.
- NAGEL, electric stimulus, 135-138; electrotaxis in invertebrates, 146, 150, 151; light stimulus, 179; mechanics of light response, 207.
- NÄGELI, catalytic poisons, 7; salts of metals as poisons, 14; phototaxis, 182; temperature and movement, 225; cold-rigor, 241; nutritive solution for fungi, 302; caesium and growth, 320.
- Nais, regeneration and solutions, 365.
- Naja tripudians, acclimatization to poison of, 30.
- Natica, acclimated to sulphuric acid, 28.
- NEAL, corrosive sublimates as poison, 15; acclimatization to poison, 30, 31.
- Nematoda, azoimid, 7; chloral hydrate, 10; desiccation, 61.
- NENCKI, chlorine and growth, 316; sodium and growth, 318.
- Nepheleis, effect of varying density, 81.
- Nereis, effect of cocaine, 24.
- Nerve, electric stimulation, 133, 135.
- Nicotin, and protoplasm, 23, 24.

- NIEPCE DE SAINT VICTOR, chemical action of light on starch, 165.
- NIKOLSKI, curare and protoplasm, 26.
- Nitella, cold-rigor, 241.
- Nitrogen, source of, in organisms, 307; free N. as food, 308, 313.
- Nitrogenous compounds, as poisons, 16-21; chemotactic, 38.
- Nitrous acids, and protoplasm, 21.
- NOBBE, free nitrogen as plant food, 312; potassium as food, 319.
- Noctiluca, effect of paraldehyde, 21; formaldehyde, 21; antipyrin, 27; deformation, 98.
- Nuclein, composition, 298.
- Nutritive solutions, for algæ, 302; for fungi, 302; light and seed germination, 420.
- Nutritive values, laws of, 325.
- OGATA, food of Infusoria, 328.
- OHLMÜLLER, ozone and bacteria, 3.
- OLTMANN'S, phototaxis, 183, 205, 206.
- ONIMUS, penetrability of tissues by light, 165.
- Optimum, 40; change of, 254; concentration for growth, 364; movement for growth, 372; temperature for growth, 454-456, 460, 461.
- Orbitolites, molar agents, 100; thigmotaxis, 106; thigmotropism, 376.
- Organic, compounds chemotactic, 37; food used in growth, 324; food, election of, 333.
- Organisms, atomic composition of dry substance, 296; elements important for, 297, 298; food of non-chlorophyllaceous O., 299.
- Oscillaria, phototaxis, 184.
- Osmosis, rôle in organic life, 71; quantitative measure of, 71-73.
- Osmotic index, 82.
- Ostracoda, azoimid, 7.
- Ostrea, acclimatization to changed density, 85.
- OSTWALD, temperature and osmosis, 83; electrical methods, 126.
- OVERTON, chemotropism, 242.
- Oxygen, effect on anærobic bacteria, 2; on protoplasm, 2-5; antipyrin, 27; chemotactic, 34; thigmotactic, 106; as food, 304; and growth, 305.
- Ozone, and bacteria, 3.
- Palæmon, nicotin, 24.
- PALM, cause of twining, 377.
- Paludina, changing density, 85.
- PANETH, hydrogen peroxide and Ciliata, 3.
- Paraldehyde, protoplasm, 21.
- Paramecium, strychnin, 26; electro-taxis, 142, 144, 145; change of optimum, 254; thermotaxis, 259, 260.
- Parasites, oxygen, 2.
- PARKER, response of pigment to light, 193.
- PASTEUR, ultramaximum of dry spores, 255.
- Patella, acclimated to diminished temperature, 85.
- Pathogenic bacteria, chemotaxis, 33.
- PEIRCE, twining in dodder, 377.
- Pelias berus, rabbits acclimated to poison of, 30.
- Pelomyxa, electric stimulus, 129, 133, 134.
- Penicillium, fixes free nitrogen, 308.
- Peptone, chemotactic, 38.
- Peranema, electric response, 130.
- Perceptive region, in phototropism, 441.
- PERKINS, gravity and Limax, 118-120.
- Permanganic acid, poison, 3, 4.
- Peronospora, does not germinate in light, 420.
- PETERMANN, free nitrogen as plant food, 312.
- PFEFFER, chemotaxis, 33, 36-45; measure of osmosis, 71; tonotaxis, 89, 90; thigmotaxis, 106, 108; wavelength active in assimilation, 166; growth, 281; election of food, 333; chemotropism, 337; method of isolating the root tip, 395; cause of twining, 377; irritable period in thigmotaxis, 379; contact stimulus, 382, 383, 386.
- PFEIFFER, free nitrogen and plants, 312.
- Phanerogamia, free nitrogen as food, 312; potassium, 318; calcium, 320; electrotropism, 411; red rays and growth, 436.
- Phenol, as poison, 18.
- Phenylhydrazin, poison, 16.
- Phosphorescence, 98.

- Phosphorus, and growth, 313.
- Photopathy, 180; distribution, 182; laws of, 196; and chemical constitution of medium, 201.
- Phototaxis, 180, 195; true and false, 181; distribution, 182; effect on P. of strong light, 196; laws of, 196; effective rays, 201; P. *vs.* photopathy, 203.
- Phototonus, 177.
- Phototropism, 437, 438; optimum intensity in, 439; effective rays, 443; mechanics of, 444; limiting angle, 471, 472; after-effect, 484.
- Phycomyces, water and spores, 358; heat and growth, 464.
- PICKFORD, heat-rigor, 231.
- PICLET, cold-rigor, 240.
- Pigeon, acclimatization to poison, 29.
- Pigs, food of growing, 330.
- Planaria, azoimid, 7; hydroxylamine, 15; density, 81; thigmotaxis, 105; photopathy, 206.
- Planorbis, azoimid, 7; density, 85.
- Plastic foods, 293.
- PLATEAU, density, 80-82, 86; absorption of salt, 88.
- PLATT, geotaxis, 124.
- Poa, light on seeds, 424.
- Poisons, oxidizing, 3, 49; catalytic, 7, 50; salt-forming, 12, 50; substitution, 15, 50; acclimatization to, 29.
- POLECK, silicon in hen's egg, 324.
- Pollen-tubes, chemotropism, 337, 338; hydrotropism, 358.
- Polygordius, phototaxis, 200.
- Polyphemus, density effect, 76.
- Polystoma, salt-absorption in, 89.
- Polystomella, electric stimulus, 129.
- Polytrichum, light and germination, 424.
- Porthesia, thermotaxis, 261.
- Potassium, growth, 318; regeneration, 319.
- Potassium salts, poisons, 4, 5.
- POUCHET, light-stimulus, 179.
- Preissia, light and germination, 424.
- PRESCH, sulphur and growth, 315.
- PREYER, anabiosis, 61, 63.
- PRINGSHEIM, light on green plants, 174; light-rigor, 178.
- Propionic acid, 38.
- PRÖSHER, growth of mammals, 330, 331.
- Protein poison compounds, 22.
- Protista, cocaine, 24; morphine, 25; desiccation, 64; contact response, 99; geotaxis, 114, 115, 118, 121-123; electric stimulus, 134; acclimatization to electricity, 139; electrotaxis, 146; photopathy and phototaxis, 182, 203; heat, 224, 228; thermotaxis, 258, 261; growth of P. and light, 416.
- Protoplasm, hydroxylamine, 1; oxygen, 2, 3; substitution poisons, 15; nicotin, 23; strychnin, 25; quinine, 26; antipyrin, 27; acclimatization to poisons, 32; specific resistance of, 49; structure of, 70; varying density, 74; acclimatization to change of density, 86; contact, 97; periodic disturbances, 98; electric stimulus, 138; temperature, 241; chemical agents and growth, 274; structure and composition, 274, 275; structural limiting conditions, 276.
- Pseudophototaxis, 181, 182.
- PUGH, free nitrogen, 310.
- Pulmonates, fresh-water, varying density, 78.
- PURIEWITSCH, free nitrogen, 308.
- PURKINJE, cold, 241.
- Pyrocatechin, poison, 19.
- QUINCKE, effect of blue rays on growth, 436.
- Quinine on protoplasm, 26, 27.
- Rabbit, acclimatization to snake poisons, 30.
- RACIBORSKI, growth and density, 363.
- Radiant heat and growth, 463.
- Radiolaria and silicon, 324.
- RAILLET, desiccation-rigor, 61.
- Rana, heat and growth, 457-459.
- RAUBER, oxygen on frog's eggs, 305; temperature and growth, 459.
- RAULIN, phosphorus and growth, 314.
- RAY, gravity and growth, 391.
- RAYLEIGH, monochromatic light, 158.
- Regeneration and potassium, 319; density, 364, 365.
- REINHARDT, chemotropism, 340.
- REINKE, light and plant assimilation, 167; moisture and growth, 251; agitation of water and growth, 371.

- Removal of tissue, and growth, 375.
 Repulsion, by chemical agents, 38; by dense solutions, 91.
 Resistance capacity, to poisons, 48; to dense solutions, 83; to heat, 249.
 Resorcin, poison, 19.
 Response to injurious substances, 39; mechanics of R., 45, 277; 480-484.
 Rheostat, 127.
 Rheotaxis, 105-108.
 Rheotropism, 387, 388.
 Rhizoids, hydrotropism of, 257.
 Rhizoma, geotropism, 398.
 Rhizopoda, thigmotaxis, 106; electric stimulus, 129; phototaxis, 185; thermotaxis, 259.
 RICHARDS, E. *See* JORDAN.
 RICHARDS, H. M., growth and chemical irritation, 332.
 RICHET, toxic dose and temperature, 2.
 RICHTER, varying density, 78, 80, 86, 89; geotropism, 398.
 Rigor, cold-R., 242; dark-R., 175; desiccation-R., 61; heat-R., 231; light-R., 178.
 RINGER, density, 80.
 RISCHAWI, temperature and excretion, 223; electrotropism, 410.
 ROEMER, chemotaxis, 33.
 ROOS, iodine and growth, 317.
 Roots, chemotropism, 336; hydrotropism, 256; thigmotropism, 380; geotropism, 393.
 ROSANOFF, chemotaxis, 108.
 ROSSBACH, 24; strychnin, 25, 26; quinine, 26; varying density, 78; heat and excretion, 224; heat and cilia movement, 228.
 ROTH, temperature and cilia movement, 227.
 ROTHERT, transmission of light stimulus, 441.
 Rotifera, chloral hydrate, 10; hydroxylamine, 15; desiccation-rigor, 61, 62; cold-rigor, 240; heat and dryness, 255.
 Rough movements and growth, 370.
 ROUX, cytotropism, 52, 53.
 Rubidium, effect on growth, 320.
 RUSCONI, electricity on frog's egg, 405.
 RUSSELL, movements and growth, 371.
 tissue, 165; active rays in plant assimilation, 166; false phototaxis, 181; temperature and protoplasmic movement, 225; hydrotropism, 256; growth, 281; silicon and growth, 324; hydrotropism, 358; thigmotropism, 380, 383; geotropism, 393-397, 402; light and growth, 417, 418; curve of growth, 421; effective rays in growth, 428.
 Salmo trutta, light on eggs of, 426.
 Salts as poisons, 14, 15; chemotactic, 36.
 SAMKOWY, heat-rigor, 232.
 SARGENT, fission and density, 365, 366.
 Schizomycetes, pseudotaxis, 182.
 SCHENCK, effect of twisting on plant growth, 375.
 SCHLÖSING, nitrifying organism, 308, 310; algæ and nitrogen, 309; free nitrogen and phanerogams, 312.
 SCHMANKEWITSCH, changed density on Flagellata, 76, 77, 86.
 SCHMIDT, movements and growth, 371.
 SCHMITZ, light and growth, 420.
 SCHNEIDER, iron and growth, 321.
 SCHNETZLER, rays affecting growth of tadpoles, 432, 435.
 SCHOLTZ, pulling on plant growth, 372.
 SCHOUMOW-SIMANOWSKY. *See* NENCKI.
 SCHRODER, strychnin, 26.
 SCHULTZE, M., strychnin, 25; temperature and protoplasmic movement, 225; heat-rigor, 232.
 SCHULTZE, O., temperature and growth, 459.
 SCHULZ, salts of arsenic, 4, 5; acclimatization to poison, 28; poisons and cell activity, 332.
 SCHÜRMEYER, chloroform and ether, 10; cocaine, 24; strychnin, 25, 26; antipyrin, 27; heat and cilia movements, 228; cold-rigor, 240.
 SCHÜTZENBERGER, dry protoplasm resists heat, 255.
 SCHWARZ, gravity and Protista, 114-116, 121; temperature and irritability, 230; acclimatization to cold, 257; gravity and growth, 391.
 SCHWEIZER, compression rheostat, 127; electric current, 139; electrotaxis, 147-149.
 Scyllium, effect of changed solution on, 80.
- SACHS, penetration of light into plant

- Sea-urchin, inorganic food, 303.
 Secretion, contact stimulus, 99.
 Seed, vitality, 64; phosphorus in, 303;
 light on germination, 419, 422.
 Seedling, oxygen and growth, 305;
 ether and growth, 333; pulling stim-
 ulus, 372, 373; rheotropism, 387;
 electricity and growth, 405-410.
 Selenous oxide and Spirogyra, 20.
 SEMPER, extent of medium on size of
 snails and fish, 474.
 Sensitive plant, light on growth, 429;
 temperature and growth, 458.
 Sepolia, nicotin, 24.
 Serpula uncinata, sudden change of
 intensity, 179.
 Serpulidæ, phototropism, 442.
 SEWALL, acclimatization to poison, 29.
 Sexual cells, cocaine, 24; quinine, 26.
 Sheep, food of growing, 330.
 SHUTTLEWORTH, acclimatization to
 cold, 257.
 Silkworm, cold-rigor in eggs, 240.
 Silicon and growth, 324.
 Sinapis, phototropic, 438.
 Slug, thigmotaxis, 105.
 Snails, strychnin, 26; extent of me-
 dium on size, 474, 475.
 SOCIN, iron and growth, 323.
 Sodium, salts on protoplasm, 4, 21, 22;
 and growth, 318.
 Solutions, physical action of, 70.
 SOROKIN, phototonus, 177.
 SPALLANZANI, desiccation-rigor in roti-
 fers, 61, 63.
 SPAULDING, false and true thigmo-
 tropism, 384, 385.
 Specific rate of vibration, 98.
 Spectrophor, Reinke's, 156.
 Spectrophotometer, 160.
 Spermatozoa, chemotaxis, 37; thigmo-
 taxis, 106, 107.
 Spermatozoids, chemotaxis, 33.
 Spirillum, chemotaxis, 33.
 Spirographis, sudden change of light,
 179.
 Spirogyra, ammonia, 6; salts of heavy
 metals, 14; selenous oxide, 20;
 formaldehyde, 21; phosphorus on
 growth of, 314; effective rays in
 growth, 430.
 Sponge, silicon and growth, 324.
 Sponge gemmules, 65.
 Spores, desiccation of, 65; heat, 256;
 chemotropism, 341; light and germi-
 nation, 419, 422, 424; heat and ger-
 mination, 452.
 Squid, copper in blood of, 324.
 STAHL, chemotaxis, 33, 38, 45; hydro-
 taxis, 66; acclimatization to changed
 density, 86; tonotaxis, 89; rheotaxis,
 108; light and chlorophyll arrange-
 ment, 181, 191; phototaxis, 183-
 185; theriotaxis, 250.
 STAMEROFF, light and growth, 420.
 STANDKE. *See* KLINGER.
 STANGE, chemotaxis, 33-38; growth
 and density, 362.
 Starfish, geotaxis, 118; phototaxis, 202;
 inorganic food and growth, 303.
 Statoblasts, changing temperature
 necessary to development of, 425.
 STEBLER, light and germination, 424.
 STEFANOWSKA, light response of pig-
 ment, 193.
 STEINACH, direct action of light on iris
 movements, 179; light response of
 pigment, 192.
 Stems, hydrotropism, 358; gravity on
 growth, 397; curvature, 398; day-
 light and growth, 419.
 Stentor, salts as poisons, 15; accli-
 matization, 30, 31; photopathy, 189;
 thigmotropism, 375.
 Stimulus, relation between intensity
 and response, 39, 40.
 STOKLASA, free nitrogen and plants,
 312.
 Stolons, geotropism, 400; phototro-
 pism, 443.
 STRASBURGER, rheotaxis, 108; light-
 response, 179; phototaxis, 183, 184,
 199, 202, 208; light and temperature
 on locomotion, 199; temperature and
 irritability, 230; high temperature,
 239; acclimatization to cold, 257;
 chemotropism, 337.
 Strongylus rufescens, desiccation-rigor,
 61.
 Strontium, growth, 321.
 Structure of protoplasm, 70.
 Strychnin, 25, 26.
 Sugar, attracts *Bacterium termo*, 37.
 Sulphonal, 10.
 Sulphur, on growth, 314; oxide and
 growth, 20.

- Swarm spores, protoplasm, 10; phototaxis, 182, 183.
- SZCZAWINSKA, light response of pigment, 193.
- Tadpoles, salts of arsenic, 5; of heavy metals, 14; varying density, 86; geotaxis, 124; electrotaxis, 149; growth and density, 367; light and growth, 425, 426, 432, 433; extent of medium and size, 475, 478.
- TAMMANN, fluorine and growth, 317.
- Tannic acid, chemotaxis, 38.
- TAPPEINER, fluorine and growth, 317.
- Tardigrades, desiccation, 61, 65; drying and heat resistance, 255.
- Tartaric acid, chemotactic, 38.
- Taurin, chemotactic, 38.
- Temperature, effect on toxic dose, 2; increases osmosis, 83; T. and metabolism, 222, 223; and protoplasmic activity, 229, 230; ultramaximum, 231, 234-237; ultraminimum, 239; sudden change of, 460, 461; thermotropism, 464.
- Temporary rigor, 242.
- Tendrils, twining, 377.
- Tension, effect on plasma, 374.
- Tetraspora, and density, 78, 89.
- Thalassicola, contact-response, 98, 99.
- Thermogenic food, 293.
- Thermotaxis, 105, 258, 261.
- Thigmotropism, 376, 383, 463, 465, 466.
- THOUVENIN, electricity and plants, 409.
- Threshold stimulus to chemical agents, 42.
- TIMIRIAZEFF, plant assimilation and wave-lengths, 167, 169.
- TOLOMEI, magnetropism, 413.
- Tonotaxis, 89-91.
- Tradescantia hairs, oxygen, 2, 3; hydrogen, 5; ammonia, 6; chloroform, 9; molar agents, 102; electric current, 132; cold-rigor, 241, 242; cold, 247.
- Traumatropism, 384, 386.
- TREMBLEY, phototaxis, 194.
- TREVIRANUS, temperature and metabolism, 223.
- TREW, light and growth, 421.
- Triton, electric stimulation, 137; thermotaxis, 261.
- Tritonium and sulphuric acid, 28.
- Trophotaxis, 39.
- Tropism, 484.
- Trout, light and growth, 426.
- TRUE, traumatropism, 384; electrotropism, 410.
- TSCHAPLOWITZ, moisture and growth, 253.
- TSUKAMOTO, alcohols, 10-12.
- Tubers, light and growth, 418.
- Tubifex, poisons, 14.
- Tubularia, oxygen and regeneration, 306; potassium and regeneration, 319.
- TUMAS, molar agents and growth, 371.
- Tunicates, inorganic food of, 303.
- Turbo, acclimatization to changed density, 56.
- Twining stems, 376.
- Ulothrix, prototaxis of spores, 199.
- Ultramaximum temperature, 234.
- Ultraminimum temperature, 244.
- Urea, attractive, 38.
- Urostyla, thigmotaxis, 106.
- VALENTIN, cold, 241.
- Valeric acid, chemical response, 38.
- Vallisneria, cold-rigor, 241.
- VANDEVELDE, germination and concentration, 363.
- DE VARIGNY, varying density, 80; acclimatization to density, 85, 86; extent of medium and size of *Limnæa*, 475-478.
- VELTEN, cold-rigor, 241; temperature and chlorophyll movements, 226, 227.
- Veratrin, poison, 24.
- VERNON, temperature and growth of Echinoidea, 458.
- Vertebrates, chemicals, 25; electrotaxis, 150; potassium on growth, 318; calcium as food, 321; organic foods of, 334.
- VERWORN, chemotaxis, 33, 34; acclimatization to changed density, 86; phosphorescence, 98, 99; molar agents, 100; thigmotaxis, 106; geotaxis, 121-123; electrical apparatus, 126; electric stimulation, 129-131, 134, 137; acclimatization to electric current, 139, 140; electrotaxis, 141,

- 146, 148; phototaxis, 183-185, 188, 199, 202; growth, 282; thermotaxis, 258, 259.
- Vicia, phototropism, 438.
- VIERORDT, spectrophotometer, 160.
- VILLON, green rays and light, 435.
- Vinegar eel, organic acids, 13; acclimated to sodic carbonate, 28.
- VINES, temperature and metabolism, 222; freezing point for plants, 247; growth, 282; potassium and growth, 318; light and growth, 420, 421, 423; effective rays in growth, 430.
- Vitis, phototropism, 438.
- Volvox, phototaxis, 183; light attunement, 206.
- DE VRIES, quantitative studies in osmosis, 71-73; salt-absorption, 88; growth and density, 362; contact stimulus, 382; thigmotropism, 383.
- WACHTEL, geotropism, 394.
- WALLER, electric response, 128; electrotaxis, 147.
- WARD, bactericidal effect of strong light, 171-174; cell division and growth, 287; light and growth, 421.
- WARREN, electric current on plant growth, 407.
- WASMAN, thermotaxis, 261.
- Water, amount in organisms, 58; rôle in organisms, 59; effect on protoplasm, 67; analysis of, 301; effect on growth, 360.
- Water animals, hydrazin a poison, 16; source of oxygen for, 304.
- WEBER, phosphorus and growth, 314.
- WEBER'S law, 43-45, 440.
- WETTSTEIN, light on development, 174.
- WEYL, heat-rigor, 239.
- WHIPPLE, light accelerating growth, 423.
- WIELER, oxygen and plant growth, 305; growth and density, 362.
- WIESNER, hydrotropism, 257; traumatropism, 384, 385; light and seedlings, 417; mistletoe, 423; Vicia faba, 429; intensity of light and response, 438; effective rays for seedlings, 440; heat and spore germination, 452; phototropism and geotropism, 471.
- DE WILDEMANN, thermotaxis, 258, 261.
- WILFARTH, enriching action of legumes, 310.
- WILLEM, light response, 207.
- WILSON, phototropism of Hydra, 202.
- WINDLE, electricity and development of chick, 405.
- WINOGRADSKY, phototaxis, 184; nutrition of bacteria, 299; sulphur and bacteria, 315; rubidium and growth, 320; hydrogen disulphide and bacteria, 326.
- WOLFF, silicon and growth, 324.
- v. WOLKOFF, temperature on metabolism, 222.
- WOLLNY, atmospheric electricity, 408.
- WOLTERING, iron and growth, 323.
- Worms, formaldehyde, 21; electrotaxis, 147; phototaxis, 195; ultramaximum, 235; ultraminimum, 245; acclimatization to high temperatures, 251.
- WORTMANN, chemotropism, 340; hydrotropism, 358, 360; thigmotropism, 381; geotropism, 402.
- Wounding, and traumatropism, 384.
- Yeast, phosphorus and growth, 313; potassium and growth, 318.
- YUNG, acclimatization to changed density, 86; food of Amphibia, 329, 330; density and growth, 367; light and growth, 425, 426; light and growth of hydra, 430; different wave-lengths on growth of tadpoles, 433-435; extent of medium and size of tadpoles, 475.
- ZACHARIAS, varying density on protoplasm, 76.
- Zea, silicon and growth, 324; phototropism, 438; temperature and growth, 451-455; thermotropism, 463-465.
- Zoöspores, chemotaxis, 34, 36, 37.

ERRATA AND ADDENDA

PAGE

- 10, note, ELFING should read ELFVING.
- 21, last sentence in next to last paragraph, should read: "On this account even neutral *nitrites* kill such plants as have an acid cell-sap, *but not such as have a neutral cell-sap* (some algæ, e.g. Spirogyra)."
35. See the valuable paper of H. S. JENNINGS, Jour. of Physiology, XXI, 258-322, 1897, where it is shown that carbon dioxide in weak solutions is attractive; in strong solutions, repellent.
- 59, line 3, 81.9% water should be 71.9%; line 4, 71.1% water should be 74.1%.
64. See WILL, Centralbl. f. Bakteriol. (2), III, 17; latent life of yeast.
- 72, second note, next to last line, *one-tenth of* should read *ten times*.
- 88, second line from bottom, FREDERIC should read FREDERICQ.
- 108, fifth line from bottom, JÖNNSON should read JONSSON.
- 113, line 9, should read, "cannot be affected, as a whole, by gravity."
- 127, fourth line from the bottom, *electrometer* should read *electrodynamometer*.
- 146, line 13, *galvanotaxis* should read *electrotaxis*.
- 157, Table XVII. Other solutions are suggested by WIESNER, '79, Wien. Denkschrift, XXXIX, 187.
160. For measurement of *chemical intensity* see WIESNER, '93. Sitzungsber. Wien. Akad. CII, 298.
- 170, line 5, *over* should read *under*.
- 174, line 13, ELVING should read ELFVING; so, too, on p. 213.
- 191, description of Fig. 56, line 1, *spaces* should be *species*.
- 196, first paragraph. Dr. A. D. MEAD informs me that at Wood's Holl *Diastylus* swims free at night so that it is taken in the tow. Consequently these crustaceans are not exclusively mud-inhabiting, and may constitute no exception to the rule.
- 209, first two lines should read, "*migrated in travelling* 18 cm. in full light, 15% *faster* than the same individual *migrated* in light $\frac{1}{4}$ as strong."
224. A fuller table than that of RISCHAWI is given by CLAUSEN, '89, Landw. Jahrbücher, XIX, 907, 911.
230. Compare with Campbell's table the similar results of EDWARDS, Studies Biol. Lab., Johns Hopkins Univ., July, 1887; and those of HUNT, '97, Science, V, 907.
- 247, line 15, *dele* words "between Bombyx."
251. Trustworthy observations on organisms in hot springs have lately been made by DAVIS, Science, July 30, 1897, and SETCHELL, University (of California) Chronicle, I, 110-119.

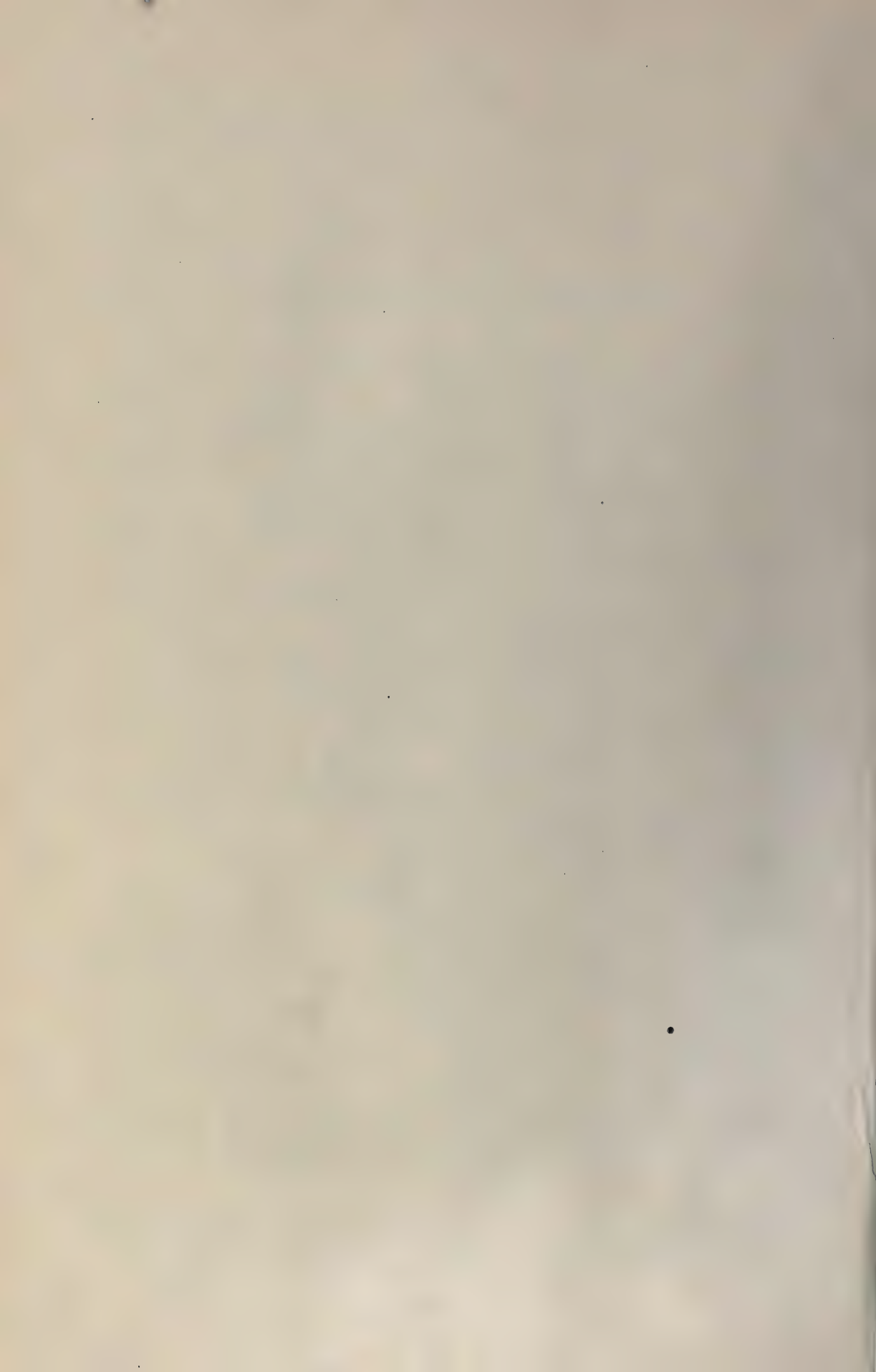

COLUMBIA UNIVERSITY BIOLOGICAL SERIES.

Designed for Independent Reading and as Text-Books for Lecture and Laboratory Courses of Instruction.

Edited by HENRY FAIRFIELD OSBORN,
Da Costa Professor of Zoölogy in Columbia University.

VOL. I. FROM THE GREEKS TO DARWIN. The Development of the Evolution Idea. By HENRY FAIRFIELD OSBORN, Sc.D. 8vo. Cloth. Price \$2.00, *net*.

"This is an attempt to determine the history of Evolution, its development and that of its elements, and the indebtedness of modern to earlier investigators. . . . As a whole the book is admirable. The author has been more impartial than any of those who have in part anticipated him in the same line of work."—*The Nation*.

VOL. II. AMPHIOXUS AND THE ANCESTRY OF THE VERTEBRATES. By ARTHUR WILLEY, Sc.D., Balfour Student of the University of Cambridge. 8vo. Cloth. 135 illustrations. Price \$2.50, *net*.

"The observations on Amphioxus made before the second half of the present century, showed that this remarkable animal bears certain resemblances to Vertebrates; and since then its interest in this respect has gradually become more apparent. . . . A consecutive history of the more recent observations was, therefore, greatly needed by those whose opportunities did not permit them to follow out the matter for themselves, and who will welcome a book written in an extremely lucid style by a naturalist who can speak with authority on the subject."—PROF. W. NEWTON PARKER, in *Nature*.

VOL. III. FISHES, LIVING AND FOSSIL. An Introductory Study. By BASHFORD DEAN, Ph.D., Adjunct Professor of Zoölogy, Columbia University. 8vo. Cloth. 344 illustrations. Price \$2.50.

"For the first time in the history of Ichthyology, students are now provided with an elementary handbook affording a general view of the whole subject. . . . The last sixty pages of the volume are devoted to a list of derivations of proper names, a copious bibliography, and a series of illustrated tabular statements of the anatomical characters of the great groups of fishes. These sections bear signs of having been prepared most carefully and laboriously, and form an admirable appendix for purposes of reference."—ARTHUR SMITH WOODWARD, in *Natural Science*, London.

VOL. IV. THE CELL IN DEVELOPMENT AND INHERITANCE. By EDMUND B. WILSON, Ph.D., Professor of Invertebrate Zoölogy, Columbia University. 8vo. Cloth. 142 illustrations. Price \$3.00.

Extracts from the Preface.—"This volume is the outcome of a course of lectures, delivered at Columbia University in the winter of 1892-93, in which I endeavored to give to an audience of general university students some account of recent advances in cellular biology, and more especially to trace the steps by which the problems of evolution have been reduced to problems of the cell. . . . The rapid advance of discovery has made it seem desirable to amplify the original plan of the work, in order to render it useful to students as well as to more general readers. . . . This book does not, however, aim to be a treatise on general histology."

VOL. V. THE PROTOZOA. (*In preparation.*) By GARY N. CALKINS, M.A.

VOL. VI. AN INTRODUCTION TO COMPARATIVE NEUROLOGY. (*In preparation.*) By OLIVER STRONG, Ph.D.

ATLAS OF NERVE-CELLS. By M. ALLEN STARR, M.D., Ph.D., Professor of Diseases of the Mind and Nervous System, College of Physicians and Surgeons, Medical Department, Columbia University; etc., etc. With the coöperation of OLIVER S. STRONG, A.M., Ph.D., Tutor in Neurology, Columbia University, and EDWARD LEAMING, M.D., F.R.P.S., Instructor in Photography, Columbia University. Illustrated with 53 Artotype Plates and 13 Diagrams. Royal Quarto. Cloth. Price \$10.00.

"Dr. Starr's work will enable the numerous students and practitioners who cannot undertake original research to understand completely the new facts which have been disclosed. The reproductions of micro-photographs leave nothing to be desired, and the details of nerve structure are shown with the minutest accuracy and with the most perfect clearness. The plates are accompanied by an admirably lucid text. . . ."—*The Evening Sun*, New York.

AN ATLAS OF THE FERTILIZATION AND KARYOKINESIS OF THE OVUM. By EDMUND B. WILSON, Ph.D., Professor of Invertebrate Zoölogy in Columbia University, with the coöperation of EDWARD LEAMING, M.D., F.R.P.S., Instructor in Photography, Columbia University. Royal Quarto. Cloth. Price \$4.00.

"This work is of a very high order, and both by its merit and its opportuneness is a noteworthy contribution to science. It takes its place at once as a classic, and is certainly one of the most notable productions of pure science which have appeared in America."—From a Review by CHARLES S. MINOT, in *Science*.

THE MACMILLAN COMPANY,
66 FIFTH AVENUE, NEW YORK.

A TEXT-BOOK OF PHYSIOLOGY.

By MICHAEL FOSTER,

M.A., M.D., LL.D., F.R.S.,

Professor of Physiology in the University of Cambridge, and Fellow
of Trinity College, Cambridge.

8vo. With Illustrations. Sixth Edition. Largely Revised.

-
- PART I. Blood; The Tissues of Movement; The Vascular Mechanism. \$2.60.
- PART II. The Tissues of Chemical Action; Nutrition. \$2.60. *In the press.*
- PART III. The Central Nervous System. \$1.75.
- PART IV. The Central Nervous System (concluded); The Tissues and Mechanisms of Reproduction. \$2.00.
- PART V. (Appendix) The Chemical Basis of the Animal Body. By A. SHERIDAN LEA, M.A., Sc.D., F.R.S. \$1.75.
-

"The present edition is more than largely revised. Much of it is re-written, and it is brought quite abreast with the latest wave of progress of physiological science. A chief merit of this work is its judicious temper, a strict sifting of fact from fiction, the discouragement of conclusions based on inadequate data, and small liking shown toward fanciful though fascinating hypotheses, and the avowal that to many questions, and some of foremost interest and moment, no satisfying answers can yet be given." — *New England Medical Journal*.

"It is in all respects an ideal text-book. It is only the physiologist, who has devoted time to the study of some branch of the great science, who can read between the lines of this wonderfully generalized account, and can see upon what an intimate and extensive knowledge these generalizations are founded. It is only the teacher who can appreciate the judicious balancing of evidence and the power of presenting the conclusions in such clear and lucid forms. But by every one the rare modesty of the author in keeping the element of self so entirely in the background must be appreciated. Reviewing this volume as a whole, we are justified in saying that it is the only thoroughly good text-book of physiology in the English language, and that it is probably the best text-book in any language." — *Edinburgh Medical Journal*.

"From its first issue as a single octavo volume of moderate size, in 1876, it has so grown that each of the five Parts is, in this sixth edition, nearly as large as the entire original work. From the beginning it was regarded as a masterpiece, and at once took a prominent place among text-books of physiology. . . . If one seeks for the reason of the high estimate in which this work is held on both sides of the Atlantic, by the most advanced students as well as by general readers, it may be found in the beauty and simplicity of the style, in the lack of personal prejudice on the part of the author, in his thorough familiarity with the progress of physiological knowledge, and in the rare judgment with which purely hypothetical ideas and those founded on sufficient evidence are discriminated. The work is therefore a most admirable guide to physiological progress as well as general physiological knowledge." — *The Nation*.

FOSTER'S TEXT-BOOK OF PHYSIOLOGY.

IN ONE VOLUME. 8vo. Cloth, \$5.00. Sheep, \$6.00.

Abridged and revised from the Sixth Edition of the Author's
larger Work published in five octavo volumes.

This new Edition contains all the Illustrations included in the larger work, and is published in one octavo volume of about 1400 pages. It contains all of the author's more important additions to the complete work, and is like the sixth edition of that copyrighted in this country.

NOW READY. 16mo. Price, 75 cents.

PHYSIOLOGY FOR BEGINNERS.

New Edition, with an Additional Chapter on Alcohol and Food.

By MICHAEL FOSTER and L. E. SHORE.

THE MACMILLAN COMPANY,

66 FIFTH AVENUE, NEW YORK.

EXPERIMENTAL MORPHOLOGY.

BY

CHARLES BENEDICT DAVENPORT, Ph.D.,

Instructor in Zoology in Harvard University.

PART I.

EFFECT OF CHEMICAL AND PHYSICAL AGENTS UPON PROTOPLASM.

8vo. Cloth. Price \$2.60, net.

It is intended to serve as an introduction and guide to the study and development of the individual regarded as a complex of processes rather than a mere succession of different forms. It brings together under appropriate heads the published observations hitherto made on the subject, laying special stress upon the results and methods of those investigations which have a quantitative value. The central idea of the work is that ontogeny is a series of reactions to chemical and physical agents. This determines the scope of the work, and the division of the effects of agents under the heads: I. Proto-plasmic Movements; II. Growth; III. Cell Division; IV. Differentiation.

"The thoroughness which characterizes this important treatise renders it the most useful annotated bibliography of the subject which has appeared. But it is far more than an expanded bibliography. With a good sense of proportion, Dr. Davenport has placed at the command of biologists, not merely the results which have already been secured in this fascinating field, but he has pointed out certain directions which new investigations ought to pursue if they are to be fruitful. The sequence of subjects does not commend itself to us as in all respects the best, for it appears as if the effect of molar agents and of varying moisture upon protoplasm might well precede instead of follow the action of chemical agents and the molecular forces, but, aside from this, one can go with the author along a straight path, until he comes to the end of this part now before us; namely, the action of light and heat upon protoplasm. The general considerations of the effects of chemical and physical agents upon protoplasm, which constitute the closing chapter of this part, are carefully stated, and kept on relatively safe ground; they are at the same time of a distinctly suggestive character, which must aid in carrying out the chief wish of the author; namely, the stimulation of further inquiries in this attractive and fertile field. Botanists owe to Dr. Davenport very sincere thanks for the exhaustive manner in which he has presented the botanical side of his subject." — *American Journal of Science.*

"The material which is discussed has been well digested and is well arranged, and the style is on the whole clear and concise. The book is a readable one, and the descriptions and criticisms employed in experimentation, and the bibliographical lists at the conclusion of each chapter, contribute materially to the value the book possesses for both the morphologist and the physiologist." — *Science.*

THE MACMILLAN COMPANY,

66 FIFTH AVENUE, NEW YORK.

Zool.
Morphol.

Author Davenport, Charles Benedict

Title Experimental morphology. 108730

UNIVERSITY OF TORONTO
LIBRARY

Do not
remove
the card
from this
Pocket.

Card (grad)

Acme Library Card Pocket
Under Pat. "Ref. Index File."
Made by LIBRARY BUREAU, Boston

