

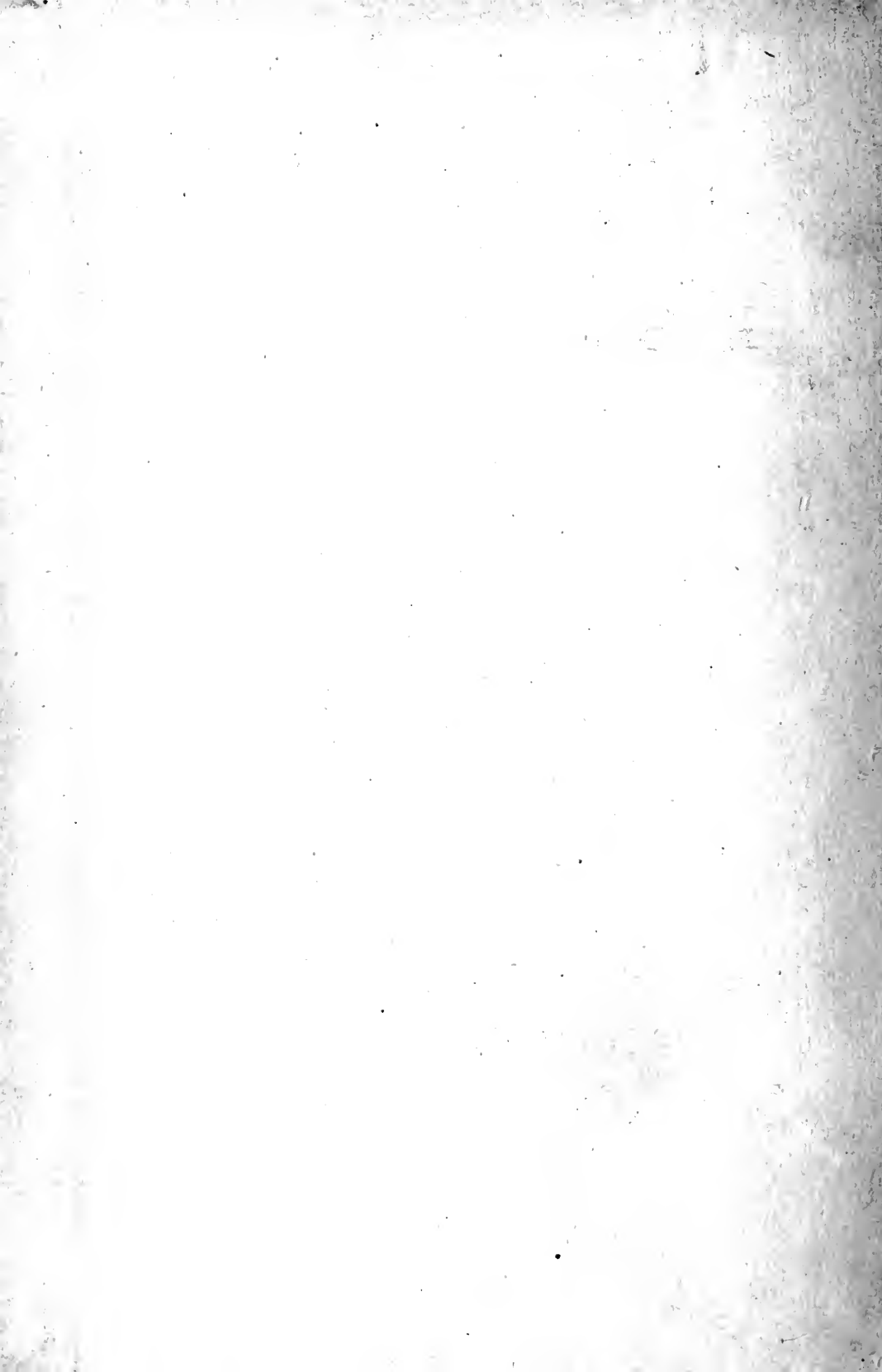

3 1761 06705599 6

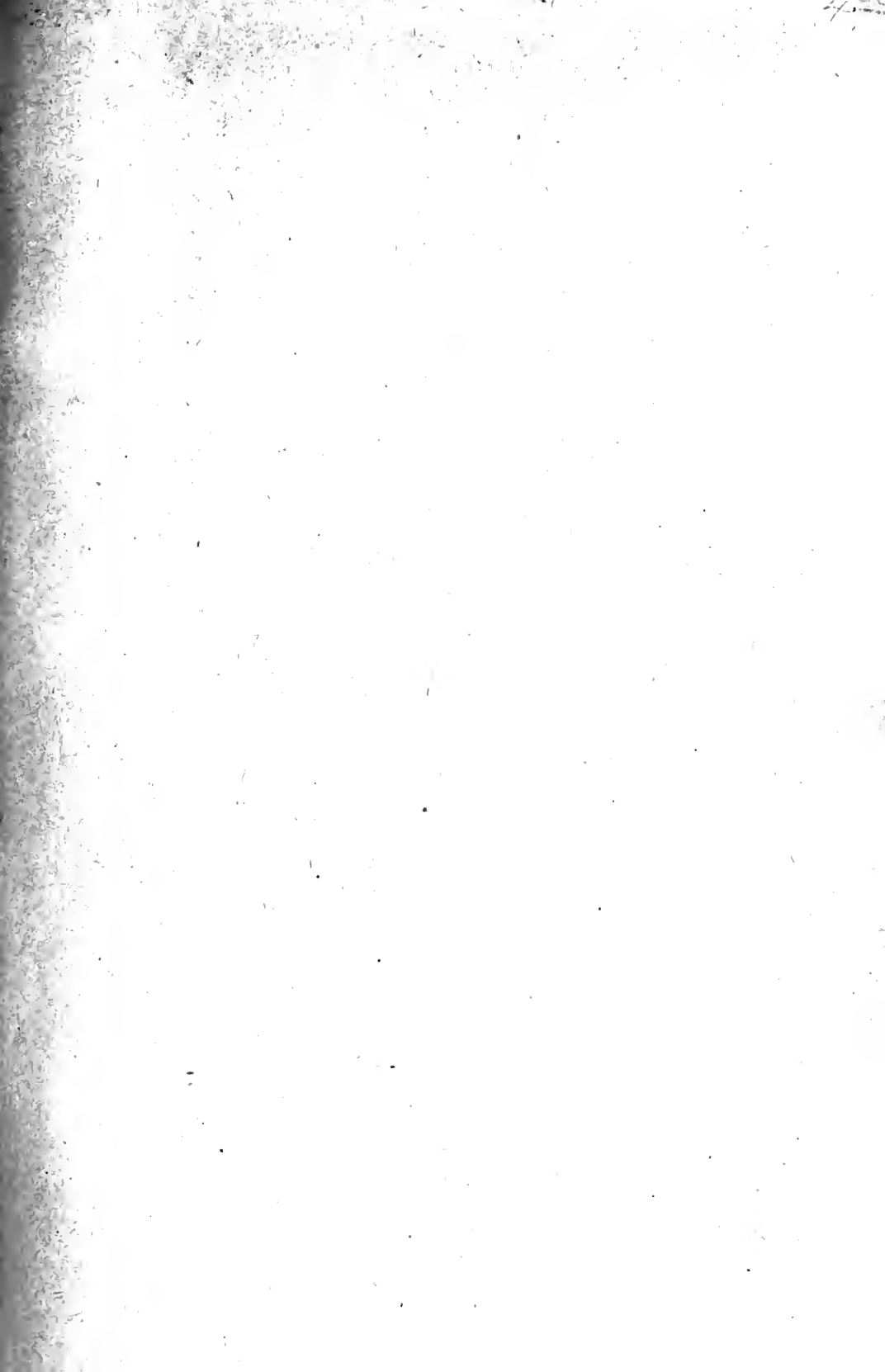



Digitized by the Internet Archive
in 2007 with funding from
Microsoft Corporation

M Therap
J

EXPERIMENTAL PHARMACOLOGY

BY

DENNIS E. JACKSON, P.H.D., M.D.

ASSOCIATE PROFESSOR OF PHARMACOLOGY, WASHINGTON UNIVERSITY
MEDICAL SCHOOL, ST. LOUIS.

*WITH THREE HUNDRED NINETY ORIGINAL ILLUSTRATIONS
INCLUDING TWENTY-FOUR FULL-PAGE
COLOR PLATES*

ST. LOUIS
C. V. MOSBY COMPANY

1917

145790
1914/15

COPYRIGHT, 1917, BY C. V. MOSBY COMPANY

Press of
C. V. Mosby Company
St. Louis

PREFACE.

For several years the writer has had a growing conviction that the teaching of pharmacology might be greatly facilitated, and rendered much more effective and comprehensive, if each student could have in his own hands a laboratory manual giving exact, specific, detailed directions for carrying out most of the experiments which he will be called upon to perform in the study of this most interesting, vital and complex subject. The small number of manuals of this character which heretofore have appeared in this field may be most strikingly compared with the very large number of laboratory manuals which have been published on such subjects as chemistry, botany, physics, zoology, etc. And the thoughtful teacher might be at once inclined to ask himself whether or not the general scope and character of the work done in these various experimental fields may not have been to some extent indicated by the number and character of experimental manuals devoted to these subjects. In consideration of these points the author has therefore ventured to hope that in presenting this manual of experimental pharmacology to teachers and students, some small amount of good may be accomplished.

My especial thanks are due to the publishers, who have rendered every assistance they could in the progress of this work; to Mr. Paul Knabe, who has faithfully devoted much time and labor to the proof reading, the arrangement of the illustrations, and the printing of the book; and to Mr. Paul P. Halleck, who in making the drawings contained herein has given me the advantage both of his extensive experience as an artist, and of his special training as a physician. I am deeply indebted to Mr. John A. Higgins,

who for seven years has faithfully assisted me in performing most of the experiments from which the tracings illustrated in this book have been mainly derived.

D. E. J.

Pharmacological Laboratory,
Washington University Medical School.

CONTENTS.

PART I.

PRELIMINARY EXERCISE.

	PAGE
Assignment of Tables and Permanent Apparatus	33

EXPERIMENTS.

I. Ether. (Action on the Central Nervous System.—Cerebrum.) . . .	53
Chloroform. (Action on the Central Nervous System.—Optic Lobes.)	55
Ether, Ethyl Chloride, Chloroform, Ethyl Bromide. (Irritability and Conductivity of Nerve.)	57
Ethyl Chloride. (Local Anesthesia.)	64
II. Ether. (Action on the Heart.—Dissection for the Vagus Nerve in the Frog.)	65
Chloroform. (Action on the Frog's Heart.)	70
Chloroform. (Action on Lymph Hearts.)	70
III. Turtle: Vagus Dissection. (Action of Ether on the Heart.) . . .	71
Chloroform. (Action on the Turtle's Heart.)	76
IV. Ether, Chloroform, Ethyl Bromide. (Dog: Respiration, Blood-pressure, Cervical Vagi, and Sympathetics.)	77
Anesthetization of the Animal	77
Insertion of Tracheal and Carotid Cannulas; Isolation of Vagi and External Jugular Vein	85
Insertion of Femoral Injecting Cannula; Dissection of Femoral Artery and Vein and Saphenous Nerve	93
Recording Blood-pressure	96
Recording Respiration	97
Adjustment of Writing Points	98
Other Methods of Recording Respiration	98
Beginning of the Records	99
V. Ether, Chloroform, Ethyl Bromide. (Dog: Motor Areas, Blood-pressure, Blood, Heart.)	103
Dissection of Pulmonary Artery and Vein	112
VI. Nitrous Oxide, Carbon Dioxide, Oxygen. (Frog: Central Nervous System.)	113
VII. Nitrous Oxide, Ethyl Chloride, Carbon Dioxide, Increased Atmospheric Pressure, (Decreased Atmospheric Pressure.) (Frog, Guinea Pig, Rat, Kitten, or Pup.)	117
Paul Bert's Experiment	120

	PAGE
VIII. The Closed Method of Anesthesia. For Ether, Chloroform, Ethyl Chloride, Ethyl Bromide, (Nitrous Oxide), "Somnoform," etc., with Oxygen, Student Method. (Dogs or Cats.)	121
IX. Intratracheal Insufflation	129
X. Alcohol. (Frog: Central Nervous System, Heart and Vago-Sympathetic Nerve.)	133
XI. Alcohol. (Turtle: Heart and Vagus Nerve.)	135
XII. Ethyl Alcohol, Brandy, Whiskey, Wine, Methyl Alcohol, Amyl Alcohol. (Dog: Blood-pressure, Respiration, Esophagus.)	136
XIII. Whiskey or Brandy. (Reaction Time.)	144
XIV. Alcohol, Whiskey, Brandy, Wine. (Dog or Cat: Myocardiographic Tracings, Cardiac Sympathetic Nerves.)	147
XV. Antiseptic Action of Alcohol	157
XVI. Alcohol, Brandy, Urethane, Chloral. (Dog: Blood-pressure, Respiration, Cerebrospinal Fluid, Kidney or Spleen.)	158
XVII. Chloral Hydrate, Urethane, Paraldehyde, Chlorotone. (Frogs: Central Nervous System.)	168
XVIII. Chloral Hydrate. (Action on the Frog's Heart.)	169
XIX. Chloral Hydrate. (Frog: Retinal Circulation With the Ophthalmoscope.)	169
XX. Chloral Hydrate, Adrenaline. (Turtle's Heart.)	172
XXI. Chloral Hydrate and Alkalis	172
XXII. Morphine. (Frog: Central Nervous System.)	172
XXIII. Thebaine, Codeine. (Frog: Central Nervous System.)	173
XXIV. Morphine. (Chemical Test for Morphine.)	173
XXV. Morphine. (Dog: Respiration, Excretion, Pupils, Central Nervous System, General Symptoms.)	175
XXVI. Fehling's Test for Reducing Bodies	176
XXVII. Morphine. (Cat: General Symptoms, Central Nervous System.)	177
XXVIII. Morphine, Codeine. (Dog: Respiration, Blood-pressure, Oxygen Consumption, Urine.)	177
XXIX. Morphine, Codeine, Pantopon, Heroine, Peronine, Dionine, Narcotine or Thebaine. (Spinal Dog: Bronchioles.)	194
XXX. Heroine or Codeine. (Spinal Dog: Blood-pressure, Lung Volume and Bladder Contractions.)	206
XXXI. Strychnine. (Frog: Action on the Cord.)	217
XXXII. Strychnine. (Frog: Heart and Vago-sympathetic Nerve.)	220
XXXIII. Strychnine. (Turtle: Heart and Vagus Nerve.)	220
XXXIV. Strychnine. (Dog: Blood-pressure, Respiration, and Kidney, Spleen or Intestinal Loop.)	222
XXXV. Strychnine. (Ether, Morphine, Chloral Hydrate.) (Dog: Blood-pressure, Respiration, Oxygen Consumption, Air Embolism.)	226

	PAGE
XXXVI. Strychnine. (Student: Reaction Time.)	230
XXXVII. Picrotoxine. (Frog: Action on Medulla and Cord.)	231
XXXVIII. Picrotoxine, Chloretone. (Dog: Blood-pressure, Respiration and Kidney, Spleen or Intestinal Loop Volume.)	233
XXXIX. Hydrastine. (Frog: Spinal Cord.)	238
XL. Hydrastine. (Frog: Heart and Vagus Nerve.)	240
XLI. Hydrastine. (Turtle: Heart and Vagus Nerve.)	241
XLII. Caffeine. (Frog: Central Nervous System, Muscles.)	241
XLIII. Caffeine. (Frog: Muscle and Nerve.)	243
XLIV. Caffeine. (Frog: Heart and Vagus Nerve.)	244
XLV. Caffeine. (Turtle: Heart and Vagus Nerve.)	244
XLVI. Caffeine. (Man: Reaction Time.)	244
XLVII. Caffeine. (Frog: Muscular Work.)	245
XLVIII. Caffeine. (Rabbit: Diuresis, Cervical Nerves, Depressor.)	247
XLIX. Caffeine, Sodium Sulphate. (Dog: Blood-pressure, Diuresis, Respiration, Sciatic Nerve.)	249
L. Diuretine, (Sodium-theobromine-salicylate), Agurine, (So- dium-theobromine-acetate). (Rabbit: Diuresis and Res- piration.)	253
LI. Urea, S. A. Matthews' Solution, or Saline Diuretics. (Rab- bit or Cat: Diuresis.)	254
LII. Curara. (Frog: General Action, Claud Bernard's Experi- ment.)	255
LIII. Curara. (Frog: Heart and Vago-sympathetic Nerve.)	257
LIV. Curara. (Turtle: Heart and Vagus Nerve.)	257
LV. Curara, Strychnine. (Dog or Cat: Blood-pressure, Respira- tion, Urine, Sciatic Nerve. Dog: Salivary Ducts and Nerves.)	257
Dog.	259
LVI. Coniine. (Frog: Heart and Vagus Nerve.)	260
LVII. Coniine. (Turtle: Heart and Vagus Nerve, Lungs and Sym- pathetic Nerves.)	260
LVIII. Coniine. (Dog: Blood-pressure, Respiration, Salivary Glands and Kidney, Spleen or Intestinal Loop.)	265
LIX. Atropine. (Frog: Heart and Vagus Nerve.)	268
LX. Atropine. (Frog: Muscle and Nerve).	269
LXI. Atropine. (Turtle: Heart and Vagus Nerve.)	269
LXII. Atropine. (Cat, Guinea Pig, Rat, Dog, Pigeon, or Chicken: Pupil.)	269
LXIII. Atropine. (Dog, Cat or Rabbit: Blood-pressure, Respiration, Heart and Vagus Nerve,—Dog, Salivary Secretion and Chorda Tympani, Sweat Nerves, Pancreatic Secretion.)	270
LXIV. Scopolamine. (Frog: General Symptoms.)	273
LXV. Pilocarpine, Atropine. (Frog: Heart and Vagus Nerve.)	273
LXVI. Pilocarpine or Arecoline and Atropine. (Frog: Retinal Cir- culation.)	274

	PAGE
LXVII. Pilocarpine or Arecoline and Atropine. (Dog, Cat, Rabbit, and Pigeon or Chicken: Pupil.)	275
LXVIII. Pilocarpine, Atropine. (Dog: Blood-pressure, Respiration, Salivary and Pancreatic Secretions.)	275
LXIX. Pilocarpine, Arecoline, Adrenaline, Atropine, and Barium. (Dog: Bladder, Intestine, Respiration, Blood-pressure.)	278
LXX. Pilocarpine, Adrenaline, Arecoline, Atropine, Barium. (Spinal Dog: Blood-pressure and Bronchioles.)	287
LXXI. Nicotine. (Frog: General Symptoms.)	300
LXXII. Nicotine. (Frog: Heart and Vagus Nerve.)	300
LXXIII. Nicotine. (Turtle: Heart and Vagus Nerve.)	301
LXXIV. Nicotine. (Turtle: Lungs.)	302
LXXV. Nicotine, Arecoline, Atropine. (Dog: Blood-pressure, Respiration, Limb Volume, Intestinal Contraction.)	304
LXXVI. Nicotine, Adrenaline, Pilocarpine, Atropine. (Dog: Blood-pressure, Intraocular Pressure, Respiration and Kidney, Spleen or Intestinal Loop Volume.)	307
LXXVII. Nicotine, Adrenaline, Barium. (Dog: Pulmonary Blood-pressure, Carotid Pressure.)	310
LXXVIII. Nicotine, Pilocarpine, Atropine. (Dog: Intraocular Nerves, Salivary Glands, Oxygen Consumption, Blood-pressure and Respiration.)	318
LXXIX. Lobeline. (Frog or Turtle: Heart and Inhibitory Nerves.)	322
LXXX. Lobeline, Pilocarpine. (Turtle: Lung Tracings.)	322
LXXXI. Lobeline, Adrenaline, Pilocarpine, Tetramethylammonium chloride. (Dog: Bladder Contraction, Blood-pressure, Respiration, Pupil.)	325
LXXXII. Lobeline, Nicotine, Pilocarpine. (Guinea Pig, Cat, Dog, or Rabbit; Uterus Strip.)	332
LXXXIII. Adrenaline, Lobeline, Nicotine, Pilocarpine, Atropine. (Guinea Pig, Rabbit, Dog, Cat, Frog: Intestinal Segment.)	334
LXXXIV. Muscarine, Atropine. (Turtle: Lung Tracings.)	336
LXXXV. Physostigmine. (Frog: Heart Tracing.)	337
LXXXVI. Physostigmine, Atropine, (Sodium Nitrite). (Frog: Stomach Ring.)	337
LXXXVII. Physostigmine. (Turtle: Heart Tracing.)	338
LXXXVIII. Physostigmine, (Adrenaline, Atropine). (Turtle: Lung Tracing.)	338
LXXXIX. Physostigmine, Hyosine, Adrenaline, (Trimethylamine) (Dog: Respiration, Blood-pressure, Intestinal Contractions.)	339
XC. Adrenaline, Sodium Nitrite, Barium Chloride. (Dog, Cat or Rabbit: Perfusion of Kidney.)	342

	PAGE
XC. Physostigmine, Atropine, (Heroine), Adrenaline. (Spinal Dog or Cat: Bronchioles, Blood-pressure, and Bladder Contractions.)	346
XCII. Cocaine. (Frog: Central Nervous System.)	350
XCIII. Cocaine, Physostigmine. (Rabbit, Cat, Dog, Pigeon, Sparrow, Chicken, Rat: Action on Pupil.)	350
XCIV. Cocaine, Novocaine. (Local Anesthetic Action.)	351
XC. Cocaine. (Frog or Turtle: Heart Tracings.)	351
XCVI. Cocaine. (Frog: Action on Muscular Work.)	352
XCVII. Cocaine, Novocaine, Barium, Adrenaline. (Dog or Cat: Respiration, Blood-pressure, Intraocular Pressure, Local Vascular Action and Intestinal Contractions.)	353
XCVIII. Novocaine. (Dog: Spinal Anesthesia.)	356
XCIX. Ergot. (Rooster: Action on Comb.)	360
C. Ergot. (Frog: Capillary Circulation.)	361
CI. Tyramine. (Frog: Capillary Circulation.)	363
CII. Ergamine. (Turtle: Lung Tracing.)	363
CIII. Ergotoxine, Ergamine, Adrenaline, Barium. (Dog or Cat: Blood-pressure, Respiration, Uterine Contractions—Barbour's Method.)	363
CIV. Ergamine, Adrenaline, Tyramine, (Codeine or Heroine). (Dog: Blood-pressure, Pulmonary Blood-pressure, Respiration.)	369
CV. Ergamine, Adrenaline (or Hordenine), Atropine. (Spinal Dog, or Cat: Bronchioles.)	373
CVI. Ergotoxine, Ergamine. (Cat, Guinea Pig, Dog, Rabbit: Uterine Strip.)	380
CVII. Ergot. (Cat: Action on Uterus.)	381
CVIII. Pituitrin, Ergamine, Adrenaline. (Dog, Cat, or Rabbit: Uterine Contractions, Blood-pressure.)	382
CIX. Pituitrin, Ergamine, Levulose, Adrenaline. (Dog: Thoracic Duct, Blood-pressure, Bladder Contractions, Respiration.)	384
CX. Pituitrin. (Frog: Capillary Circulation.)	387
CXI. Pituitrin. (Frog or Turtle: Heart Tracing.)	388
CXII. Pituitrin. (Turtle: Lung Tracing.)	388
CXIII. Pituitrin. (Guinea Pig, Cat, Dog, Rabbit: Uterine Strip.)	390
CXIV. Pituitary Extract, Adrenaline, Atropine, Barium (Dog: Bronchial Contraction.)	391
CXV. Pituitrin, Adrenaline, Aconitine. (Dog: Urine Secretion, Intestinal Contractions, Blood-pressure, and Respiration.)	392
CXVI. Pituitrin, Adrenaline, Vanadium. (Dog: Pulmonary Blood-pressure.)	394
CXVII. Dissection of the Eye.—Its Anatomy and Pharmacology	394
CXVIII. Amyl Nitrite. (Student: Plethysmographic Record, General Action.)	397

	PAGE
CXIX. Amyl Nitrite. (Student: Pulse Tracing.)	399
CXX. Amyl Nitrite. (Student: Corpuseles in Retinal Vessels.)	400
CXXI. Amyl Nitrite. (Student: Retinal Blood Vessels.)	401
CXXII. Amyl Nitrite. (Student: Effect on Vision.)	403
CXXXIII. Amyl Nitrite, Nitroglycerine, Sodium Nitrite. (Dog: Blood-pressure, Respiration, Spleen or Intestinal Loop Volume, Blood.)	404
CXXXIV. Nitrites, Pilocarpine, Adrenaline. (Dog: Bronchial Ac- tion.)	406
CXXXV. Digitoxin. (Frog: General Action.)	407
CXXXVI. Digitoxin. (Frog: Heart Tracing.)	408
CXXXVII. Digitoxin. (Turtle: Heart Tracing.)	408
CXXXVIII. Digitoxin. (Dog or Cat: Blood-pressure and Respiration.)	408
CXXXIX. Digitoxin, Strophanthin, Nitroglycerin. (Dog: Pulmonary Blood-pressure, Carotid Pressure.)	415
CXXX. Digitoxin. (Dog: Heart Tracings, Carotid Pressure.)	418
CXXXI. Digitoxin, Strophanthin. (Dog: Diuresis, Spleen Volume, Leg Volume, Blood-pressure and Respiration.)	420
CXXXII. Adrenaline, Potassium Chloride, Digitoxin, Strophanthin. (Cat, Rabbit, Dog: Heart Perfusion—Langendorff Method.)	424
CXXXIII. Aconitine. (Frog: General Action.)	428
CXXXIV. Aconitine. (Frog: Heart Tracing.)	429
CXXXV. Aconitine. (Turtle: Heart Tracing.)	429
CXXXVI. Aconitine. (Dog: Blood-pressure, Respiration, Tempera- ture.)	429
CXXXVII. Aconitine. (Dog: Heart Tracings, Blood-pressure.)	431
CXXXVIII. Aconitine. (Student: Local Action.)	433
CXXXIX. Veratrine. (Frog: General Action.)	433
CXL. Veratrine. (Frog or Turtle: Heart and Inhibitory Ap- paratus.)	434
CXLI. Veratrine. (Frog: Skeletal Muscle.)	434
CXLII. Veratrine. (Turtle: Lung Tracing.)	437
CXLIII. Veratrine, Adrenaline. (Dog: Blood-pressure, Respiration, Intestinal Contraction.)	437
CXLIV. Veratrine. (Dog: Heart Tracings, Blood-pressure.)	440
CXLV. Apomorphine. (Dog: Vomiting Center.)	440
CXLVI. Ipecac. (Dog: Emesis.)	440
CXLVII. Sodium Cyanide, (Hydrocyanic Acid), Sodium Sulphide, Hydrogen Peroxide. (Dog: Respiration, Blood-pres- sure, Oxygen Consumption, Blood Glycosuria.)	441
CXLVIII. Quinine. (Frog: General Symptoms.)	447
CXLIX. Quinine. (Frog or Turtle: Heart Tracing.)	447
CL. Quinine. (Frog: Action on White Corpuscles—Binz's Ex- periment.)	447

CONTENTS

11

	PAGE
CLI. Antipyrine. (Frog: General Action.)	449
CLII. Antipyrine, β -tetrahydronaphthylamine Hydrochloride. (Dog: Respiration, Blood-pressure, Leg Volume.)	449
CLIII. Antipyrine, Peptone. (Two Rabbits: Temperature Regulation.)	451
CLIV. Quinine, Peptone. (Two Rabbits: Temperature Regulation.)	451
CLV. Phenacetine, Acetanilide or Aspirin (Acetylsalicylic Acid). (Fevered Animal: Temperature.)	451
CLVI. Acetylsalicylic Acid (Aspirin). (Student: Headache.)	452
CLVII. Phenylsalicylate (Salol). (Student: Excretion, Absorption.)	452
CLVIII. β -tetrahydronaphthylamine Hydrochloride, Pilocarpine. (Dog: Oxygen Consumption, Blood-pressure, Respiration.)	453
CLIX. Carbolic Acid (Phenol). (Frog: General Action.)	454
CLX. Carbolic Acid, Sodium Sulphate. (Dog: Local Action, Respiration, Blood-pressure, Spleen Volume, Antidote.)	454
CLXI. Phloridzin, Adrenaline. (Rabbit: Glycosuria.)	457
CLXII. Potassium Iodide. (Student: Absorption, Excretion.)	457
CLXIII. Alkalies, Acids, Sodium Nitrite, Adrenaline. (Frog: Perfusion of Vessels.)	458
CLXIV. Magnesium, Calcium. (Rabbit: Anesthesia, Antagonism.—Meltzer and Auer's experiment.)	460
CLXV. Arsenic. (Dog or Rabbit: Respiration, Blood-pressure, Peristalsis, Renal Action, Blood.)	460
CLXVI. Antimony (Tartar Emetic). (Dog: Emesis.)	462
CLXVII. Vanadium, Sodium Hydroxide, Ammonia. (Dog: Blood-pressure, Respiration, Spleen Volume, Reflex and Local Actions, Intestinal or Bladder Contractions.)	462
CLXVIII. Acid, Alkali—Rhubarb, Croton Oil, Magnesium Sulphate. (Dog: Antagonism of Acids and Alkalies, Absorption and Excretion of Rhubarb, Local Action of Croton Oil and Magnesium Sulphate—Moreau's Experiment.)	466

PART II.

SHOP WORK.

I. The Shop	470
Equipment	476
List of Equipment	479
Mechanical Procedures	489
Glass Blowing	493
Frog Clips	495
Brass Arterial Cannulas	496
Stands and Castings	496
Lacquering	498

PHOTOGRAPHY.

	PAGE
II. Photographic equipment	500
Making negatives	502
Lantern slides	505
Making prints	508
Blue prints	510

LIST OF DEALERS.

List of Dealers in Equipment and Supplies	515
---	-----

ILLUSTRATIONS.

FIG.	PAGE
1. Harvard inductorium	35
2. DuBois-Reymond induction coil	36
3. Harvard signal magnet	36
4. Signal magnet	36
5. Hale's signal magnet	36
6. Mercury manometer and signal magnet	37
7. Harvard shielded electrodes	38
8. Woulff ether bottle with regulating clamp	38
9. Large size tracheal cannula	39
10. Medium size tracheal cannula	39
11. Small size tracheal cannula	39
12. Mohr pinch cocks	40
13. Marey tambour	40
14. Adjustable tambour with three interchangeable bowls	40
15. Stethograph drum	41
16. Kidney oneometer	41
17. Roy's kidney oneometer	42
18. Arterial cannula	42
19. Beaker	43
20. Dog board and mouth rod	43
21. Animal board and head holder	43
22. Small, white evaporating dish	43
23. Glass bladder cannula	44
24. Graduated cylinder	44
25. Casserole	44
26. Harvard long paper kymograph	45
27. Hürthle long paper kymograph	45
28. Turtle board	46
29. Specimen jar	46
30. Burette and double clamps	46
31. Battery jar	47
32. Small wood tables	47
33. Serrefine	48
34. Hemostat	48
35. Small sharp-pointed dissecting forceps	48
36. Scalpel	49
37. Small aneurism needle	49
38. Large aneurism needle	49
39. Large blunt-pointed dissecting forceps	49
40. Small blunt-pointed dissecting forceps	49
41. Dissecting scissors	49
42. Dissecting probe (dental)	49
43. Large moderately blunt-pointed dissecting forceps	50
44. Needle holder	50

FIG.	PAGE
45. Large bottle for holding stock salt solution	52
46. Frog board and clip (Harvard)	54
47. Dissection of a frog showing position of the brain, sciatic nerve and arteries and muscles of the hind limb (Color plate)	54
48. Frog's brain	55
49. Method of pithing a frog	56
50. Harvard moist chamber	57
51. Harvard muscle lever	58
52. Harvard gas chamber	58
53. Ether bottles showing method of administering air and ether	59
54. Three forms of containers for ethyl chloride	60
55. Method of smoking drums	61
56. Automatic shellacing pan and drying rack for drum records	62
57. Varnishing pan for varnishing records	63
58. Print and tracing trimmer	63
59. Method of arranging the inductorium	64
60. Dissection of a frog to show the position of the heart, vagus nerve and the muscles of the hind limb (Color plate)	65
61. Diagrammatic dissection to show the innervation of the frog's heart	66
62. Heart lever	66
63. Arrangement of apparatus for recording frog heart tracings	67
64. Medicine dropper	68
65. Anatomy of the frog's heart	69
66. Diagrammatic representation of the lymph spaces of the frog	70
67. Apparatus for recording turtle heart tracings	72
68. Method of sawing out a square in the plastron of a turtle	73
69. Diagrammatic representation of the turtle's heart (Color plate)	74
70. Schematic representation of the vagus and sympathetic nerves in a turtle	75
71. Method of etherizing a dog	77
72. Laboratory table	79
73. Metronome for operating the electric time signal	80
74. Lieb-Becker time marker made from an Ingersoll watch	80
75. Harvard time clock	81
76. Jaquet chronograph	82
77. Two forms of time clocks	82
78. Method of fastening the animal's head to the dog board	83
79. Heavy string with slip noose ready to put around the fore limb	83
80. Method of attaching fore limbs to the dog board	84
81. Method for quickly fastening the string to the board without tying any knots	84
82. Method of fastening the hind limbs	85
83. Method of incising the skin to expose the trachea	86
84. Same as Fig. 83. Separation of borders of sternohyoid muscles	87
85. Same as Fig. 83. Exposing the trachea	87
86. Same as Fig. 83. Lifting up and passing forceps beneath trachea	88
87. Same as Fig. 83. Fifth step in the operation	88
88. Same as Fig. 83. Insertion of the tracheal cannula	89
89. Same as Fig. 83. Lifting up right carotid sheath on an aneurism needle	89

FIG.	PAGE
90. Same as Fig. 83. Ligation of the carotid and vago-sympathetic nerve	90
91. Same as Fig. 83. Opening the carotid artery	90
92. Same as Fig. 83. Insertion of the arterial cannula	91
93. Same as Fig. 83. Final step in operation	91
94. Insertion of femoral injecting cannula	93
95. Dissection to expose the femoral artery and vein and saphenous nerve	95
96. Same as Fig. 95. Position and relations of the vein, artery and nerve	95
97. Exposure of the skull for a trephine opening	103
98. Six inch tinner's snips. For cutting thick skin and fascia, etc.	104
99. Same as Fig. 97. Exposing dura mater	104
100. Trephine	105
101. Upper surface of a dog's brain	106
102. "Straight" glass cannula	107
103. Hand bellows	107
104. Bandage saw	108
105. Method of opening the chest by a median incision	109
106. Method of exposing the left pulmonary artery and vein (Color plate)	110
107. Applying the cardiometer over the ventricles	111
108. Cardiometer	112
109. Administration of nitrous oxide or oxygen to a frog	114
110. Method for making, purifying and administering nitrous oxide to a frog	115
111. Yoke for tanks of oxygen, nitrous oxide or carbon dioxide	115
112. A double yoke for holding gas tanks	116
113. Yoke for holding gas tanks	116
114. Guthrie's carbon dioxide generator	117
115. Method for studying the action of nitrous oxide, ethyl chloride, etc.	118
116. Apparatus used for closed ether anesthesia	122
117. Table arranged for performing an experiment	123
118. Diagrammatic view of the pan as seen from above	124
119. Tracing obtained by the closed method of anesthesia	125
120. Tracing showing the initial action of nitrous oxide	126
121. Tracing showing the action of nitrous oxide and ethyl chloride	127
122. Apparatus for intratracheal insufflation	129
123. Apparatus for administering nitrous oxide to an animal	130
124. Tracing showing action of carbon dioxide	131
125. Injection of drug solutions into anterior lymph sac of frog	134
126. Injection of solutions into anterior lymph sac with a syringe	134
127. Injecting pipette made of glass	135
128. Arrangement of apparatus for recording esophageal contractions	137
129. Tracing showing four esophageal contractions, blood-pressure and respiration	138
130. Harvard membrane manometer	139
131. Arrangement of apparatus which may be used as a membrane manometer	141

FIG.	PAGE
132. Tracing showing action of alcohol on blood-pressure and respiration	142
133. Dissection showing vessels and nerves in the neck and upper part of the chest in a dog (Color plate)	142
134. Arrangement of apparatus for recording reaction time for sight	143
135. Simple key	145
136. Electric tuning fork	145
137. Apparatus for recording reaction time for hearing	146
138. Box for anesthetizing cats	147
139. Bell-jar as used for anesthetizing cats	148
140. Glass or earthen ware jar covered by a glass plate	148
141. Myocardiograph	149
142. Cardiometer arranged for use as a myocardiograph	150
143. Cardiometer made from a large thistle tube	151
144. Arrangement of apparatus for recording heart tracings	152
145. Special heart holder	153
146. Heart levers for dogs	154
147. Schematic representation of the innervation of the heart (Color plate)	154
148. Innervation of heart in the cat	155
149. Myocardiographic and blood-pressure tracings from a dog	156
150. Fermentation tube	157
151. Apparatus for recording the pressure of the cerebrospinal fluid	159
152. Spleen oncometer for dogs	160
153. Spleen oncometer for dogs	161
154. Kidney oncometer	162
155. Rear view of same oncometer shown in Fig. 154	162
156. Kidney oncometer made of a metal pill or ointment box	163
157. View showing the oncometer partly open	163
158. Dissection exposing the kidney from a median incision	164
159. Arrangement of apparatus for making several records simultaneously	165
160. Appearance of the blood-vessels in the ears of a white rabbit (Color plate)	166
161. Dissection showing position of left pulmonary vessels and sympathetic trunk in chest above diaphragm (Color plate)	166
162. Dissection to show the abdominal viscera (dog)	167
163. Electric ophthalmoscope	170
164. Method used for observing the retinal circulation in a frog	171
165. Ventral and dorsal views of a pigeon's brain	173
166. Posterior view of the brain and semicircular canals of a pigeon	174
167. Lateral view of head of pigeon showing brain, etc.	174
168. Base of the brain of a dog	175
169. Upper surface of the skull of a cat	178
170. Mesial section showing the left half of the interior of a cat's skull	179
171. Dorsal surface of the brain of a cat	180
172. Apparatus for recording and measuring the rate of oxygen consumption	181
173. Inner construction of the pans shown in Fig. 172	182
174. Lateral view of a cross-section of the apparatus shown in Fig. 172	182

FIG.	PAGE
175. Arrangement for recording oxygen consumption by an animal	183
176. Apparatus used for making pure oxygen	185
177. Gas reservoir made from a very shallow, wide, round cake pan	186
178. Dreser's apparatus for respiratory measurements	187
179. Technic for inserting a bladder cannula	188
180. Tracing showing action of morphine on oxygen consumption	191
181. Record showing the action of adrenaline on the rate of oxygen consumption, uterine contractions, blood-pressure and respiration	192
182. Schematic representation of the course of the right phrenic nerve in a dog	193
183. Dissection of lower part of neck and upper part of chest on right side in dog (Color plate)	194
184. Dissection of lower part of neck and upper part of chest and of axillary region in dog (Color plate)	194
185. Large needles for sewing with heavy twine	195
186. Brass tube with spear point	196
187. Arrangement of animal for recording lung volume changes	196
188. Apparatus for keeping the systematic blood-pressure at a constant level	197
189. Lung volume and blood-pressure record	198
190. Tracings showing the action of morphine	199
191. Tracings showing the action of pantopon	200
192. Tracings showing the action of peronine	201
193. Tracings showing the action of dionine	202
194. Tracings showing the action of narcotine	203
195. Tracings showing the progressive actions of narcophine, narcotine and morphine	204
196. Method of administering capsules, pills or tablets to dogs	205
197. Mercury bulb	206
198. Apparatus for recording bladder contractions	207
199. Same as Fig. 198. Dissection for the femoral vessels	208
200. Lung shield made of thin sheet brass	209
201. Method of recording volume changes of the lung by use of the lung shield	210
202. Tracing showing action of heroine and adrenaline	212
203. Tracing showing the action of codeine and epinine	213
204. Tracing showing the action of muscarine	214
205. Tracing showing the action of codeine on turtle's lungs	215
206. Three kinds of catheters	216
207. Dissection of the pelvis of dog	216
208. Arrangement of apparatus for recording convulsions in a frog	218
209. Tracing showing the action of strychnine	219
210. Greene's method of irrigating the heart	221
211. Tracing showing the action of strychnine on the turtle's heart	222
212. Glass oncometer for a small loop of the intestine	223
213. Glass ureteral cannula with rubber tube connection	225
214. Tracing showing the action of morphine	228
215. Tracings showing the action of picrotoxine	232
216. Tracings showing the action of brucine	233

FIG.	PAGE
217. Method of administering medicine to a dog by means of the stomach tube	234
218. Mouth gag for dogs, cats or rabbits	235
219. Dissection to expose the sciatic nerve	237
220. Method of destroying the cerebrum only in a frog	238
221. Tracing showing action of hydrastine	239
222. Innervation of the heart in the frog or turtle	240
223. Tracing showing the action of arecoline, hydrastinine and ad-renaline	242
224. Arrangement of a frog and apparatus for recording fatigue tracings	245
225. Showing a method for making cannulas with separable points	246
226. Structures in the neck of a rabbit showing the arrangement of the nerves on the left side (Color plate)	247
227. Glass cannula showing a special washout opening	248
228. Arrangement of two tambours to form a drop recorder	250
229. Tracing showing action of sodium sulphate	251
230. Tracing showing the action of curara	256
231. Innervation of the salivary glands in the dog (Color plate)	257
232. A turtle prepared for recording lung tracings	261
233. Arrangement of apparatus for recording lung contractions	262
234. Lung tracing from a turtle	263
235. Lung and heart tracings from a turtle	264
236. Diagrammatic representation of innervation of lachrymal glands	265
237. First incision for exposing the chorda tympani nerve, etc.	266
238. Dissection showing position and relation of hypoglossal and lingual nerves (Color plate)	266
239. Exposure of the lingual and hypoglossal nerves and salivary duets (Color plate)	266
240. Exposure of the chorda tympani nerve (Color plate)	266
241. Tracing showing the action of pilocarpine	274
242. General course of the nerves to the salivary glands (Color plate)	274
243. The submaxillary and sublingual glands and their duets, etc. (Color plate)	274
244. A dissection showing position and relations of pancreatic duets in dog	276
245. Position and relations and method of isolating large duct of pancreas in dog (Color plate)	278
246. Arrangement of apparatus for recording contractions of intestine.	279
247. Tracing showing the action of barium, adrenaline and atropine	280
248. Tracing showing action of barium and adrenaline	281
249. Tracing showing the action of arecoline and of atropine	282
250. Innervation of the retractor penis musele (Color plate)	282
251. Tracing showing the action of pilocarpine	283
252. Tracing showing the action of a fatal dose of barium chloride	284
253. Tracing showing the action of adrenaline and barium chloride	285
254. Tracing showing the action of a fatal dose of barium chloride	286
255. A form of apparatus used in recording lung tracings	288
256. A form of apparatus used in recording lung tracings	289

FIG.	PAGE
257. Adjustment of the apparatus shown in Fig. 255 in the chest of a dog	290
258. Method of making the first incision before trephining the skull	292
259. The trephine opening	292
260. Method of quickly cutting across the brain stem	293
261. Method of destroying the brain	293
262. Plugging trephine opening with cotton after brain is destroyed	294
263A. Tracing showing the action of pilocarpine and atropine	295
263B. Tracing showing the action of muscarine and atropine	295
264. Tracing showing the action of lodal	296
265. Tracing showing the action of arecoline	298
266. Tracing showing the action of arecoline and atropine	299
267. Tracing showing the action of nicotine	301
268. Tracing showing the action of nicotine	303
269. Method of applying a plethsmograph to the hind leg of a dog	304
270. Tracing showing the action of a fatal dose of nicotine	305
271. Arrangement of apparatus for recording intraocular pressure	308
272. Tracing showing the action of nicotine	309
273. Arrangement of apparatus for recording pulmonary blood-pressure	311
274. Dissection showing the method of ligating the left pulmonary artery	312
275. Second step in preparing to insert a cannula in the pulmonary artery	312
276. Third step in preparing to insert a cannula in the pulmonary artery	313
277. Method of inserting the special cannula into the artery	313
278. Special form of separable pointed cannula for pulmonary artery	315
279. Special (all-glass) form of cannula for the pulmonary artery	315
280. Tracing showing the action of adrenaline	317
281. Method of dissecting out the orbital fat and fascia to expose the optic nerve	319
282. Bone cutting forceps	320
283. Tracing showing the action of lobeline, arecoline and atropine	323
284. Tracing showing the action of lobeline	324
285. Tracing showing the action of lobeline	324
286. Tracing showing the action of pilocarpine	325
287. Tracing showing the action of lobeline	326
288. Tracing showing the action of lobeline	327
289. Tracing showing the action of tetramethylammonium chloride	329
290. Tracing showing the action of tetramethylammonium chloride	330
291. Tracing showing the action of pilocarpine, and tetramethylammonium chloride	331
292. Arrangement of apparatus for recording contractions from a uterine strip, or from an arterial ring, ureter ring, intestinal strip, ring of frog's stomach, etc.	333
293. Tracing showing the action of muscarine	335
294. Diagrammatic cross-section of the intestine (Color plate)	336
295. Tracing showing the action of nicotine, arecoline and atropine	336
296. Tracing showing the action of trimethylamine	340
297. Tracing showing the action of pilocarpine and trimethylamine	341

FIG.	PAGE
298. Arrangement of apparatus for perfusion of an excised organ . . .	343
299. Tracings showing action of sodium orthovanadate, barium chloride, and adrenaline	345
300. Tracing showing the action of heroine and adrenaline	348
301. Tracing showing effects of cocaine	352
302. Method of exposing the lymphatic ducts and connecting cannulas to collect the lymph or chyle (Color plate)	356
303. Metallic muzzle for administering an anesthetic to a dog	357
304. View of the reverse side of the metallic muzzle shown in Fig. 303	358
305. Arrangement of apparatus for observing the capillary circulation	362
306. Arrangement of animal and apparatus for recording uterine contractions	364
307. Tracing showing the action of barium chloride	365
308. Tracing showing the action of ergamine (histamine) and adrenaline	367
309. Tracing showing the action of ergamine	368
310. Tracing showing the action of tyramine	370
311. Tracing showing the action of adrenaline and ergamine	372
312. Tracing showing the action of ergamine and hordenine	376
313. Tracing showing the action in succession of arecoline, lodal, thebaine, lodal, hordenine and adrenaline	377
314. Tracing showing the consecutive actions of ergotoxine phosphate, pilocarpine, (ergotoxine) and adrenaline	378
315. Tracing showing the action of arecoline, ergotoxine, (arecoline) and adrenaline	379
316. Arrangement of apparatus for recording contractions of a uterine strip, intestinal strip, etc.	381
317. Arrangement of apparatus for recording contractions of the uterus in situ	382
318. Schematic representation of the involuntary nervous system (Color plate)	384
319. Method of isolating the thoracic duct at the root of the neck (Color plate)	384
320. Diagrammatic representation of the lymphatic system in a cat	386
321. Tracing showing the action of pituitrin	388
322. Tracing showing the action of pituitrin	389
323. Tracing showing the action of pituitrin	391
324. Schematic representation of the innervation of the eye (Color plate)	394
325. Diagrammatic representation of the structure and innervation of the eye (Color plate)	394
326. Plethysmograph for recording volume changes in hand and forearm	398
327. Dudgeon's sphygmograph arranged for recording tracings from the radial pulse	399
328. Tracing showing action of amylnitrite	400
329. Tracing showing the action of nitroglycerine	405
330. Tracing showing the action of digitoxin	409
331. Tracing showing the action of digitoxin	410
332. Tracing showing the action of digitoxin	411

FIG.	PAGE
333. Tracing showing the action of digitoxin	412
334. Tracing showing the final result of the action of digitoxin	413
335. Illustration showing principles involved in construction of Ed- munds' liver oncometer	416
336. Tracing showing the action of adrenaline	417
337. Spleen oncometer made of crimped sheet brass	421
338. Liver oncometer	422
339. Tracing showing the action of tetramethylammonium chloride	423
340. Arrangement of apparatus for recording tracings from an excised heart	425
341. Cat's heart	426
342. Dog's heart	427
343. Tracing showing the final action of aconitine	432
344. Tracing showing the action of veratrine	435
345. Arrangement of apparatus for spinning a drum	436
346. Tracing showing the action of veratrine	438
347. Tracing showing the action of sodium cyanide	442
348. Tracing showing the action of potassium cyanide	443
349. Tracing showing the action of sodium cyanide	444
350. Tracings showing the action of dilute sodium cyanide solution	445
351. Tracing showing the action of pilocarpine and β -tetrahydronaph- thylamine hydrochloride	450
352. Two tracings showing the action of a drug which markedly lowers blood-pressure	455
353. Arrangement of apparatus for perfusion of the vessels of a brain- less frog	459
354. Tracing showing the action of adrenaline sodium orthovanadate, amylnitrite and adrenaline	463
355. Tracing showing the action of vanadium	464
356. Tracing showing the action of vanadium	465
357. Arrangement of the ligatures for isolating segments of the in- testine	467
358. A schematic representation of an electric wiring system	471
359. Foot bellows	472
360. Diagrammatic representation of an artificial respiration machine	473
361. View of system of pulleys used to operate the interrupting valve	474
362. Lever gate valve	474
363. Diagram showing method of operation of lever gate reversing valves	475
364. Portable artificial respiration machine	475
365. Special form of interrupting valve	476
366. Special interrupting valve	477
367. A motor driven long paper kymograph	478
368. Detailed view of one plan of construction of the speed regulating device for the kymograph	479
369. Motor driven long paper kymograph	480
370. Hand drill	481
371. Blast lamp	482
372. Details of the mechanical construction of an adjustable tambour	483
373. A large bowled tambour	484

FIG.	PAGE
374. Method of tying head of a small screw into rubber membrane	484
375. Some of the more common types of gas pipe fittings	486
376. Small electric heater	487
377. Method of preparing two pieces of brass tubing for making a tracheal cannula	490
378. Method of making "straight" glass cannulas	492
379. Same as Fig. 378	492
380. Same as Fig. 378	492
381. Same as Fig. 378	494
382. Same as Fig. 378	494
383. Process for making frog clips	495
384. Method for making very small brass cannulas	496
385. Large stand with L-shaped base	497
386. Method of arranging the camera and arc light for copying	501
387. Method of suspending an adjustable arc light above the operating table	502
388. Measuring glass	504
389. Adjustable frame for cutting lantern slide mats	507
390. Frame for making blue prints	511

INTRODUCTION.

The unit of procedure adopted in this manual is the experiment. Each experiment is, as a rule, complete within itself, although in many instances an orderly sequence proceeding from the simple to the more complex, from the known to the unknown, has been introduced. The writer has at all times tried to hold in mind the fact that the instructor is not only teaching pharmacology but that he is also teaching medical students. And the mental and technical abilities and limitations of these students are quite as significant from the standpoint of the teacher as is the wide extent, the complexity, and the importance of the subject which he practically invariably has a too limited time to cover. It is constantly necessary for the teacher of pharmacology to bear in mind that the knowledge which his students possess of the fundamental principles of anatomy, neurology, physiological chemistry, pathology, and especially of physiology, is by no means complete, and much of the instructor's time must of necessity be consumed in again bringing to the attention of the students fundamental and often exceedingly elementary facts involved in the nature of subjects prerequisite to the course in pharmacology. And it will not infrequently severely tax the ingenuity of the teacher of pharmacology to determine by what means he can, within a brief period of time, best recall to the student's mind some fundamental principles, e. g., of physiology or neurology, without a knowledge of which further progress in pharmacology is totally impossible. The author has kept these points carefully in mind in preparing this manual, and many of the experiments, illustrations and tracings have been introduced quite as much with the object of teaching certain fundamental prin-

ciples of anatomy, chemistry, physiology, etc., as for their immediate use in the work on pharmacology.

It has been the author's aim to try to develop experimentally a knowledge of the general principles of pharmacological reactions, rather than to lay great emphasis on a vast array of details regarding the specific action of a long list of substances. There are more than 100,000 known organic preparations, with many more theoretically possible. In addition to this there are some 3,000 or 4,000 inorganic substances, salts, etc. A very large proportion of these bodies might be studied separately and individually so far as their pharmacological properties and reactions are concerned. And if we attempt to have our students make a fairly intensive study of only the one-thousandth part of all this vast array of chemical substances, the task is still so great that perhaps no human mind can grasp and carry within the memory at any one time the almost limitless extent of the specific details of the pharmacological reactions of which even this comparatively small number of drugs may theoretically be capable. And notwithstanding the more or less abortive attempts of nearly all recent writers and examining boards, to limit as far as possible the number of drugs which the student must study, the task of selection is still largely one for the individual instructor.

The experiments listed herein are, as a rule, arranged with reference to individual drugs. The simplest and easiest experiments on any given substance are usually placed at the beginning of the section dealing with that body. Being keenly aware of the difficulty often experienced in obtaining suitable experimental material the author has included a large number of experiments on frogs and turtles, the supply of which is less liable to variation than is that of the vastly more desirable mammalian material. Generally a number of experiments are given on each drug, especially if it be one of importance. It is intended that these experiments be assigned to the students

on the day before the experiment is to be performed in order that each member of the class may familiarize himself with the work he is expected to do. Many of the experiments may be done as demonstrations. It is usually advisable for each group to do a different experiment at any given laboratory period. This economizes on the amount of special apparatus required and also furnishes an opportunity for each group of students to compare its results with those obtained by the other groups. This arrangement also gives an opportunity for the instructor to devote most attention to those experiments where help is most needed.

The general anesthetics, being of fundamental importance for the progress of the course, are taken up first. Following this is a group of drugs chiefly characterized by their action on the central nervous system. After these come a series of substances possessing specific actions on some one or more parts of the involuntary nervous system. These are followed by drugs which act mainly on the circulatory system, then follow the antipyretics, a few miscellaneous drugs, and finally a few experiments on acids, alkalies, and some of the heavy metals.

The second part of the book contains two chapters, one on shop work and one on photography. These are chiefly of interest to the instructor, and it is advised that these be read in connection with the general preparation of apparatus, equipment, etc., for the course in pharmacology.

Any general text book on the subject of pharmacology may be used in connection with this manual, or if the instructor prefers to deliver a course of set lectures on the general field of pharmacology, no didactic text at all may be required. That is a matter for each teacher to decide for himself.

Usually drugs are taken up one at a time. It is desirable not to confuse the student more than can be helped by the introduction of too many drugs, especially if the actions of the drugs involve general pharmacological prin-

ciples with which the student is unfamiliar. It often occurs, however, that as the student gains in experience and in technical ability, drugs which have already been studied may be reintroduced either as a matter of review, or to demonstrate certain actions of other drugs which are not evident until brought to light by the changed response of certain structures to drugs injected secondarily, or to serve as a check on the action of the apparatus and the general technic employed in the experiment. For this latter purpose great use is made of adrenaline in these experiments. This often serves the double purpose of reviving an animal when it is in a very feeble condition, and also gives the student (*and instructor*) an immediate indication of the accuracy of the working of his apparatus and of the condition of the animal. It should be especially emphasized that the extensive use made of adrenaline in many of the experiments is solely for the purposes here indicated, and its frequent injection should not be considered in any sense as a useless repetition of the same experiment.

It is imperative to use the strictest economy with the experimental material. For this reason it is desirable for the students to learn everything possible from each animal used. Consequently many experiments are listed here in which a variety of reactions may be recorded at the same time. The instructor should use his judgment in the case of each group of students regarding the number of records which the group will probably be able to successfully secure. And he should not hesitate to eliminate any indicated part of the experiment in which he believes the group will fail. The author has, however, often been amazed at the excellent success which students with some experience may frequently obtain in carrying out exceedingly difficult and involved experiments. And the writer recommends that the instructor should not hesitate to permit a group of students to attempt to carry out a difficult experiment whenever he can advisedly do so. For it should be especially emphasized that a student's own failure may be of

vastly more interest and value to him than would be a perfect success of that same experiment demonstrated by the instructor or his assistants.

Many instructors advise that each student in the group take his turn at doing various portions of the routine work. In the writer's opinion this will probably not be the most valuable line of procedure in the long run. For while it may be very desirable for each student to acquire a certain amount of skill in performing each part of the experiment (and students usually want to do this at the start) the fact remains that the total time devoted to the subject is too short for any student to become an expert in carrying out all phases of the work. It will yield a greater percentage of pharmacological successes for each student to learn a given portion of the routine work well and to faithfully carry this out for each experiment. It should be emphasized that the chief object of the experimental course is not to teach surgery, but pharmacology. For while students may, and in a thoroughly satisfactory course perhaps do, acquire a very fair amount of the knowledge of surgery which they will later possess, this should be looked upon solely as a matter of secondary importance.

Practice dissections on dead animals are frequently described at the end of experiments. This is a matter of great importance and the instructor can often be of much help to the student by aiding in this work to see that it is properly done. These dissections usually precede experiments in which the dissected structures will be concerned.

A few words may be said about the matter of dosage. This is a difficult subject and the writer has been compelled to depend mainly on his own records and experience in this line, for most of the published dose tables, etc., are based on quantities of the drugs to be given by mouth. A further difficulty arises from the great variation in the size and resistance of different animals, and from the variation in potency of the different drugs as purchased in the open

market. The instructor is advised to make all the observations he can on this subject for the benefit of his students.

One of the most valuable things which a course in experimental pharmacology can offer to a student is the very great opportunity which is presented to develop his power to think, to observe, and to learn at first hand for himself. In nearly all of the experiments questions are asked which are intended to direct his attention to the most vital and important features of the work, and to encourage him to test out experimentally the truth or falsity of his own conclusions.

Every student of modern medicine must have been impressed at some time in his work by the very great aid which he has derived in his study of anatomy or neurology or operative surgery from the use of illustrations, diagrams, etc. These are frequently of the greatest use for rapidly reviewing work over which one has long since passed, or for quickly advancing one's knowledge into fields with which he may be less familiar. The author has carefully considered this phase of the subject in writing the present manual. And numerous illustrations, tracings, diagrams, etc., have been devised and presented with the special object of enabling the student, teacher or practitioner of medicine to quickly and accurately grasp the full meaning and significance of important actions of the drugs considered. To one who already possesses a moderate familiarity with the subject of modern pharmacology, a brief glance at the nature of many of the experiments presented, together with a rapid study of the accompanying tracings, may reveal the character and results of the effects which follow the application of drugs to the animal organism with a vividness which can be exceeded only by the knowledge acquired by the actual performance of the experiments themselves.

Finally it may be stated that originality and individuality, not only for the student but for the instructor as well,

should be encouraged in every way possible. For experimental pharmacology covers a wide range, and there is at present perhaps no phase of the whole field of medicine which promises more for the future alleviation of human suffering than does this, in a sense one of the oldest, and yet one of the newest of all the divisions of medical science.

A NOTE TO THE STUDENT.

When pursued under satisfactory conditions experimental pharmacology is one of the most valuable and interesting of all medical subjects. The province of this work is comparatively new, and unfortunately so far as the medical student is concerned, is but poorly developed. The student, as well as his teacher, will feel these limitations mainly in the lack of suitable apparatus and perhaps in many cases in a lack of sufficient experimental material. The apparatus as a rule is very expensive and usually is obtained only with considerable difficulty, while in a large number of instances equipment suitable for the performance of many of the most valuable and interesting experiments must be made up according to special directions. From this it is perfectly obvious that no two schools can expect to possess exactly the same kind of apparatus for the performance of any given series of experiments. The student will often find it necessary to carry out his work with apparatus entirely different from that described in the text and often perhaps with an equipment which is exceedingly unsatisfactory. He should by no means be discouraged thereby, for much of the most valuable experimental work of all history has been performed with crude and unwieldy apparatus, and often under most discouraging circumstances. To accomplish much with little is a sure sign of ability and the medical student who approaches the subject of experimental pharmacology at the present time will find numerous opportunities to demonstrate his aptitude in this direction. He should seize these opportunities with keenness and alertness and with a full appreciation of the advantage which he possesses over that of the medical student who *may* have been taught experimental pharmacology some ten or fifteen years ago.

Each experiment in this book was designed primarily to give the student an opportunity to learn to think, and secondarily to teach him some valuable point in connection with the drugs studied. The writer fully appreciates that there are certain difficulties and limitations beyond which the average medical student can not go, and for the satisfactory performance of the following experiments there has been assumed a certain standard of attainment which to the author's mind represents approximately that degree of training which the average sophomore student at the present time should have had when he takes up the study of experimental pharmacology. The student will feel constantly the necessity of drawing extensively upon his knowledge of anatomy, neurology, and physiology, and to a less extent upon his training in chemistry, physiological chemistry, pathology, bacteriology, and physics. And he must bear constantly in mind the practical clinical application and action of the great majority of the drugs with which he will experiment.

EXPERIMENTAL PHARMACOLOGY

PART I.

PRELIMINARY EXERCISE.

Assignment of Tables and Permanent Apparatus.

At a time previous to the first laboratory meeting if possible the students will arrange themselves according to instructions into groups of four or five each. It is generally desirable (especially if the students are unknown to the instructor) for the students to arrange these groups themselves. This should usually be done with due consideration of the relative degree of progress and of ability which each student possesses, students of approximately equal standing being grouped together.

This is a matter of considerable importance to the student, for no one cares to drag a poor student through several weeks of difficult experimentation, while on the other hand the poorer students should not be cheated out of their opportunities to learn because other more competent students do all of the work. The average of the grades which the students have received in previous courses is usually a fair basis for forming these groups.

For mammalian experiments students work in the groups of four or five (rarely three or six under special conditions). Each group of four (or five) is subdivided into sub-groups of two (or two and three) for work on frogs, turtles, etc.

Each group of students will be assigned to a table (or locker) in which the permanent apparatus of the group is already placed and is in perfect working condition. *This*

apparatus should be checked up quickly, and all omissions or imperfections should be reported to the technician for correction. A typewritten list of the apparatus will be given to each group. Each piece of permanent apparatus belonging to a given table is marked plainly with the number belonging to that table to prevent loss. The permanent list includes:

- 2 Simple keys (Fig. 135)
- 2 Heart levers (Fig. 62)
- 2 Stimulating electrodes (Fig. 1)
- 2 Sewing needles
- 2 Signal magnets (Figs. 3, 4, and 5)
- 2 Induction coils (or 1 induction coil with a double pole, double throw knife, switch, Fig. 1)
- 1 Manometer with signal magnet base line marker and tubing (Fig. 6)
- 1 Ether bottle, tubing and Hoffmann screw clamp or 1 anesthetic device with oxygen tank, burette, pinch clamps and tubing (Fig. 8)
- 3 (or 4) Tracheal cannulas (Figs. 9, 10, and 11)
- 8 Mohr's pinch clamps (Fig. 12)
- 3 Recording tambours with T-tubes and tubing (Figs. 13 and 14)
- 1 Stethograph drum (Fig. 15)
- 1 (or 2) Oncometers, T-tubes and tubing (kidney, spleen, or intestinal loop, see Figs. 16 and 17)
- 2 Frog boards (Fig. 46)
- 2 (to 4) Burettes, tubing and one funnel (small)
- 1 Large double clamp (to hold frog board, etc.)
- 4 (or 5) Large stands (Fig. 94)
- 2 Small stands
- 1 Pressure bottle, tube, rope and pulley (Fig. 6)
- 1 Dozen frog clips (Fig. 46)
- 1 Ball small twine
- 1 Ball heavy twine
- 1 Pad of absorbent cotton (a 3-inch section cut from a 1 lb. roll with a large sharp knife)
- 2 (or 3) Arterial cannulas (see Fig. 18). More may be needed
- 2 Beakers, 25 and 50 cubic centimeters (Fig. 19)
- 2 Small flasks
- 1 Tube for respiration faucet (for artificial respiration)
- 1 Dog board with mouth rod (Fig. 20)
- 1 Thermometer
- 1 Heart oncometer (cardiometer) (Fig. 108)
- 1 Small white evaporating dish (Fig. 22)
- 1 Bladder cannula (Fig. 23)
- 1 Spool white thread (heavy)
- 2 Medicine droppers (Fig. 64)
- 1 Injecting pipette for frogs (Fig. 127)
- 1 Graduated cylinder, 50 cubic centimeters (Fig. 24)
- 1 Porcelain dipper (casserole) (Fig. 25)

- 8 Pieces insulated connecting wire (No. 18)
- 2 Kymographs (Harvard) with 4 fans each (or long paper kymographs, Figs. 26 and 27)
- 2 Turtle boards (Fig. 28)
- 1 Specimen jar (Fig. 29)
- 6 Double clamps (Fig. 30)
- 4 Burette clamps (Fig. 30)
- 1 Battery jar, 4-inch (Fig. 31)
- 6 Test tubes
- 2 Small tables, 3 inches and 4 inches in height (to support kymographs, Fig. 32)
- 1 Test tube brush
- 1 Pound of ether

Each student will sign the following statement at the bottom of the typewritten list: "We, the undersigned, have received the above apparatus in good condition, except as noted, and for which we each stand responsible to the department.

Date.....

Signed 1. 4.
 2. 5.
 3. 6. "

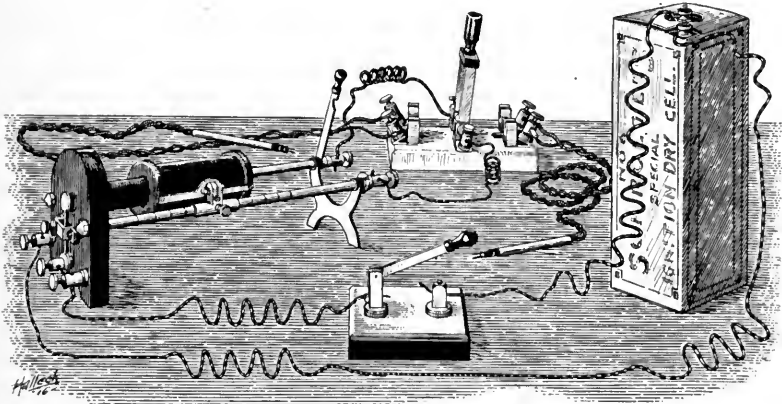

Fig. 1.—Harvard inductorium with dry cell and simple key in series. In the secondary circuit is a double pole double throw knife switch to which are connected two platinum electrodes. By use of this combination two groups of students can use one inductorium and dry cell without either group disturbing the apparatus of the other group.

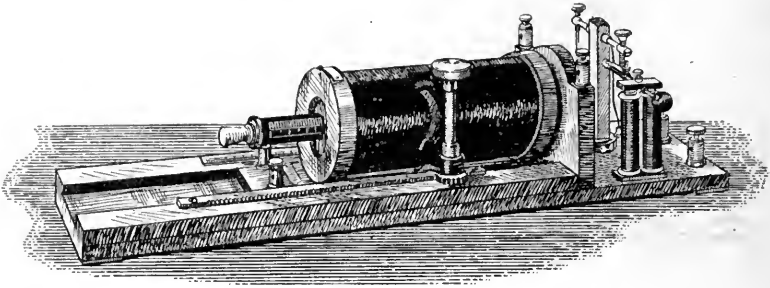

Fig. 2.—Du Bois-Reymond induction coil.

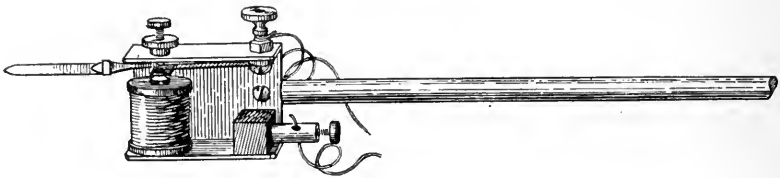

Fig. 3.—Harvard signal magnet.



Fig. 4.—Signal magnet.

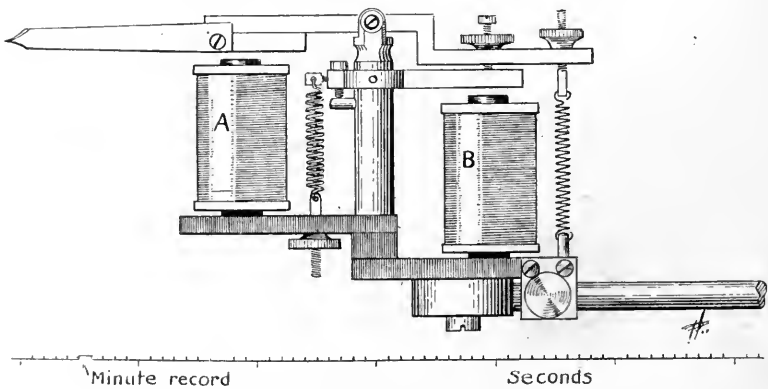

Fig. 5.—Hale's signal magnet. When this signal magnet is used with a Harvard time clock possessing a special adjustment for ten second and minute intervals, three time records may be recorded simultaneously. (W. Hale: *Jour. of Phar. and Exper. Ther.*, 1916, viii, p. 445.)

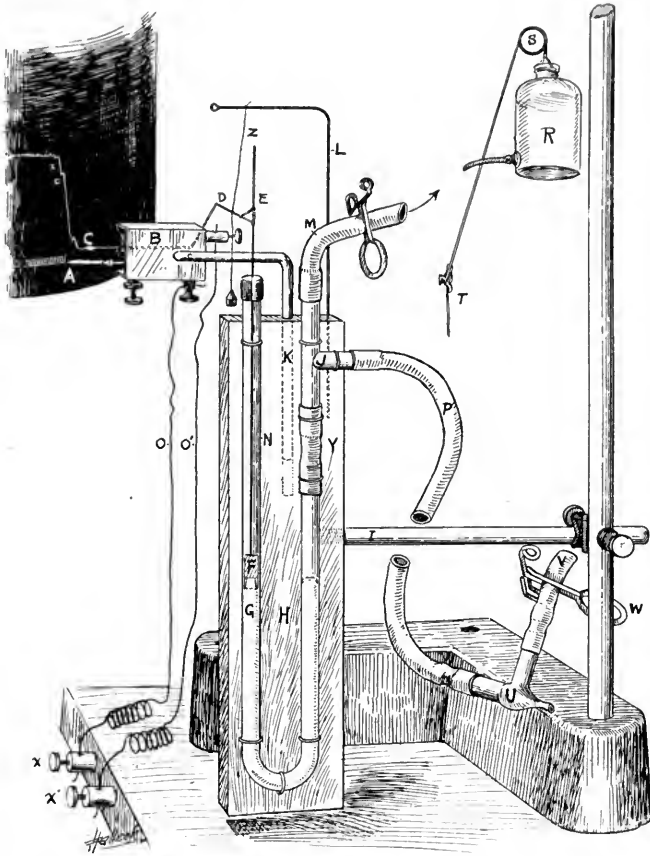

Fig. 6.—Mercury manometer and signal magnet. The arrangement of the tubing (*M*) connecting the pressure bottle (*R*) and the arterial cannula (and washout, *P*, *U*, *V*, *W*) to the manometer is also shown. The pressure bottle should be (adjustably) suspended about four or five feet above the table by means of a small rope (*T*) passing through a pulley (*S*) on the ceiling. *A*, pointer of signal magnet *B*, which can be made of a Harvard signal magnet. The rod of the signal magnet has been cut off and bent to pass down (adjustably) into the hole bored in the upper end of the manometer board (*H*) at *K*. *C*, writing point of *D*, the aluminum wire (No. 18) attached to the lower end of which the float *F*, is attached. The inner diameter of the glass tube *N*, should be slightly greater than one-fourth inch and the float is made (one inch long) from a one-fourth inch polished hard rubber rod. The lower end of the float is bored out with a $\frac{3}{16}$ inch drill to float (full of air) on the surface of the mercury *G*. Polished drill rod steel ($\frac{1}{32}$ inch in diameter) is used for the plunger which is driven into a small drill hole in the upper part of the float. *I*, supporting rod of the manometer. *J*, glass T-tube connected by rubber tubing (*Y*) to the right limb of the U-tube. *L*, adjustable brass (or iron) wire ($\frac{1}{8}$ inch) from which a thread (*Z*) supports a small weight to hold the writing point on the drum. *O*, *O*, wires running to the signal magnet base line marker (*B*) from *X*, *X*, binding posts which receive electric impulses from the time clock. It is better but more difficult and expensive for the U-tube to have a side outlet blown on the right hand limb in place of the T-tube here shown. The left hand limb of the U-tube should be twelve inches long. A little oil is placed around the float. The U-tube and T-tube are attached to the board by copper wires passed through holes and twisted together behind the board.

Special apparatus for individual experiments will be given out from time to time as needed.

Drum paper will be furnished, 10 sheets at a time, as required.



Fig. 7.—Harvard shielded electrodes.

Ether will be given out in 1 lb. cans on presentation of a signed order blank. Ether used beyond the amount estimated to be necessary will be charged for at cost.

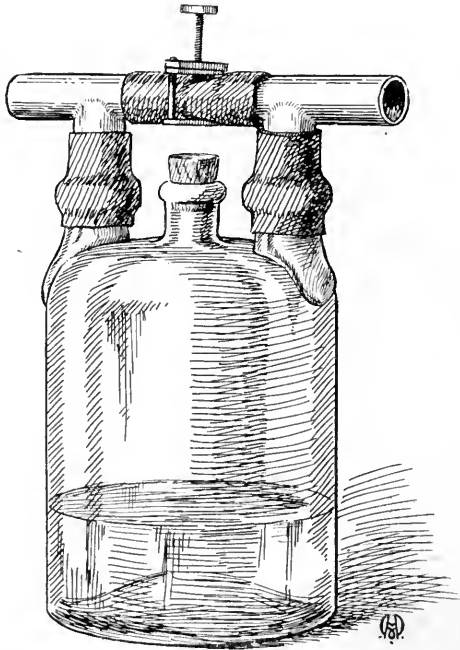

Fig. 8.—Ether bottle (3-necked Woulff, 500 c.c.) with regulating clamp. The short T-tubes are made of one-half inch brass tubing (see chapter on shop work).

Drugs and experimental material will be furnished by the department as needed. The cost of wasted material will be deducted from the student's breakage deposit.

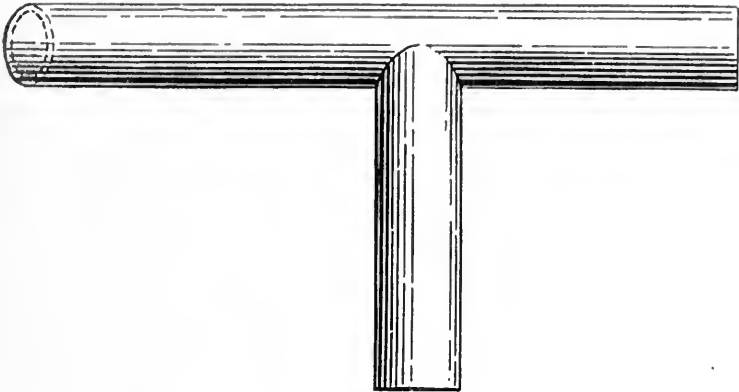

Fig. 9.—Large (one-half inch) size tracheal cannula.

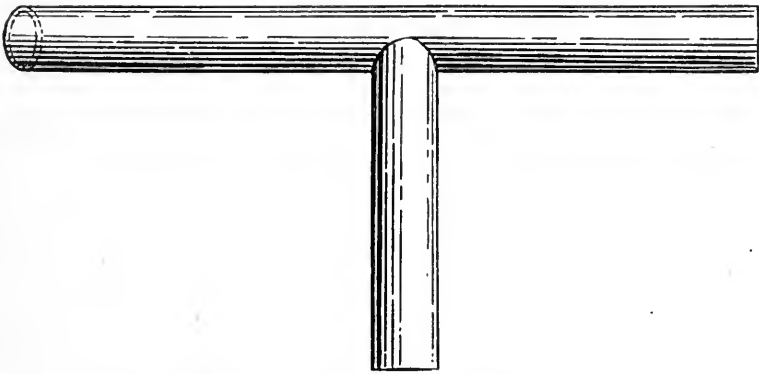

Fig. 10.—Medium (three-eighths inch) size tracheal cannula.

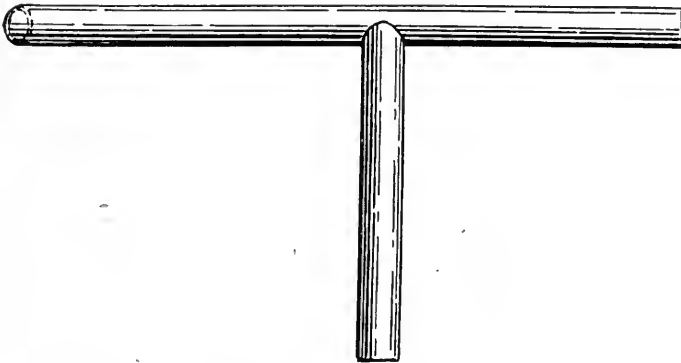

Fig. 11.—Small (one-fourth inch) size tracheal cannula.

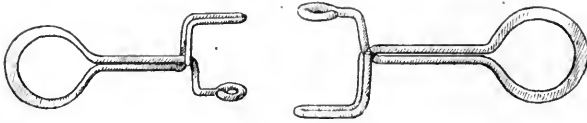

Fig. 12.—Mohr pinch cocks.

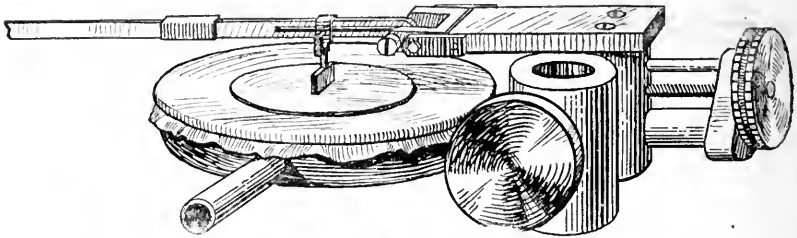

Fig. 13.—Marey tambour.

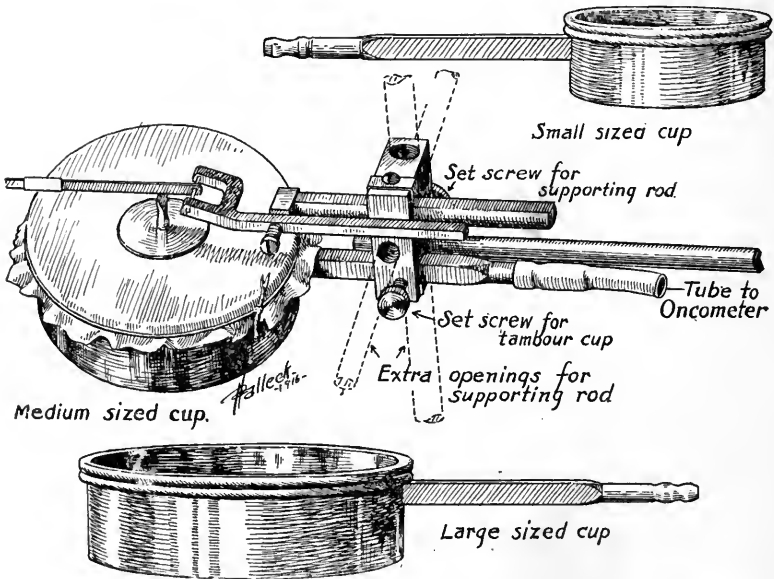

Fig. 14.—Adjustable tambour with three interchangeable bowls. All parts approximately half natural size.

It is exceedingly important for the student to have some *large-bowled* tambours. None of these are at present on the market and each laboratory must provide for itself. The ordinary Marey tambour is wholly inadequate for many forms of work because the bowl is entirely too small. The adjustable form here shown is highly recommended for all purposes for which tambours can be used. A mechanical drawing of this tambour is shown in the chapter on shop work where a *cheap form* of large-bowled tambour is also described.

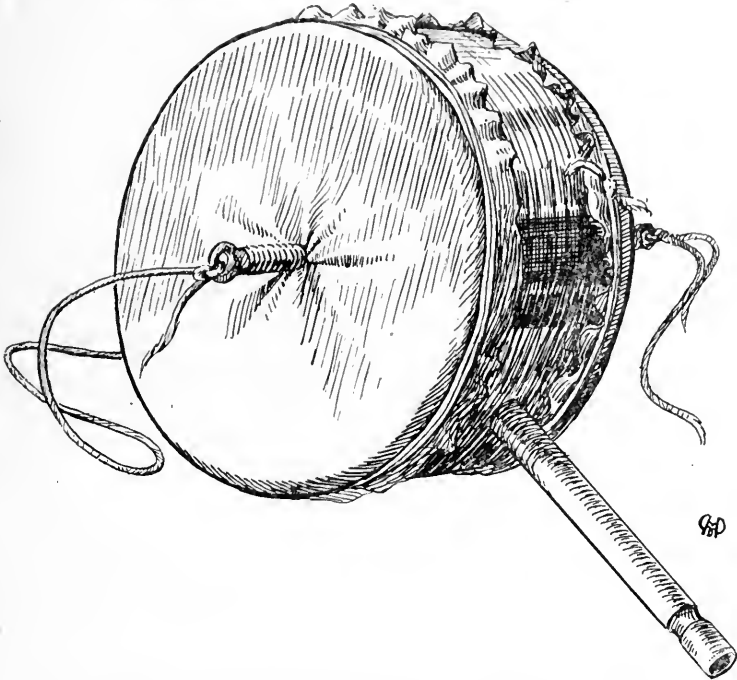

Fig. 15.—Stethograph drum, made of $2\frac{1}{2}$ inch brass tubing. The drum has a length of $1\frac{1}{4}$ inches and wire rings are soldered around the edges to act as flanges for holding on the strings used to tie down the rubber membranes. (For the method of tying on these membranes and attaching the screws in the center, see Fig. 374 in the chapter on shop work.) These stethograph drums are not on the market but can easily be made by any janitor or technician.

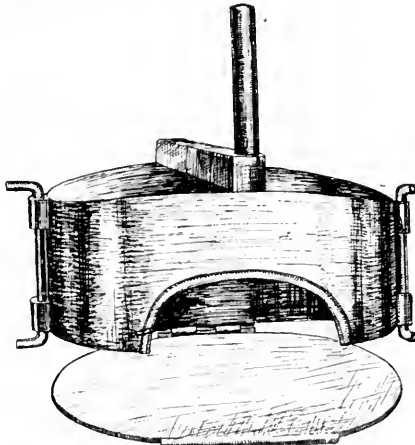

Fig. 16.—Kidney oncometer, about $\frac{2}{3}$ natural size, made of sheet brass. The lid is placed *under* the kidney and the box closes over the organ. The latches are turned inward. The opening out of the oncometer is at the rear as seen in the picture and the opening passes forward in the square tube into which the round connecting tube is soldered.

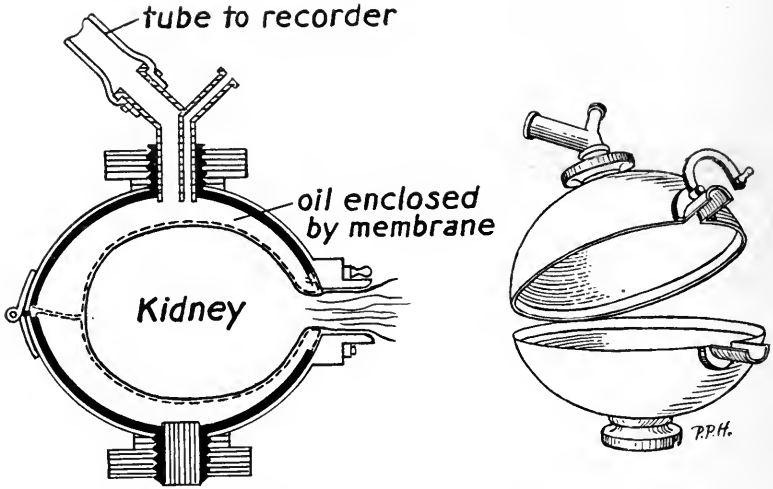

Fig. 17.—Roy's kidney oncometer.

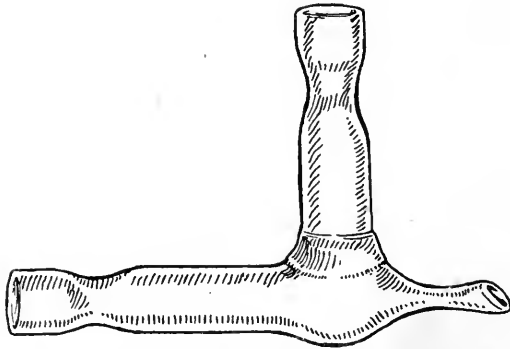

Fig. 18.—Arterial cannula, used also for injecting into veins. This is by far the best cannula for recording blood-pressure or injecting from a burette. Such cannulas are made to order by glass-blowing firms (see page 515). The opening in the point should be about $1/32$, $3/64$ or $1/16$ inch in diameter for most purposes. The usual difficulty is to get the smaller sizes.



Fig. 19.—Beaker.

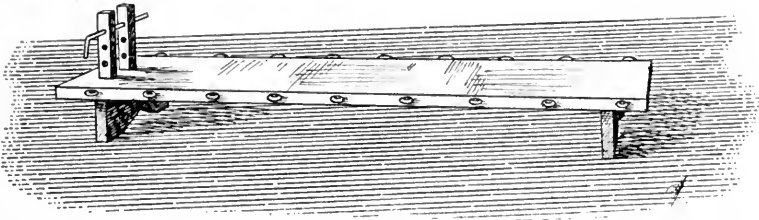

Fig. 20.—Dog board and mouth rod. Made of a pine board 1 foot wide and $.4\frac{1}{2}$ (or 5) feet long. Not on the market.

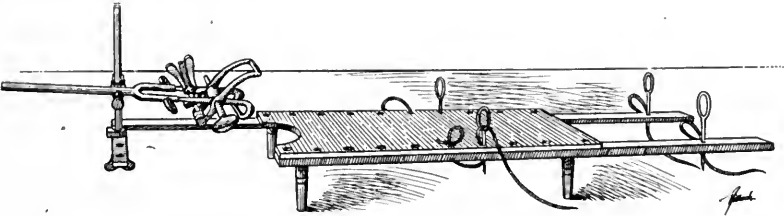

Fig. 21.—Animal board and head holder (for rabbits or cats).

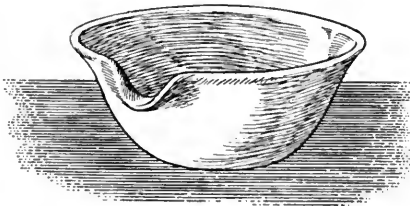

Fig. 22.—Small, white evaporating dish.

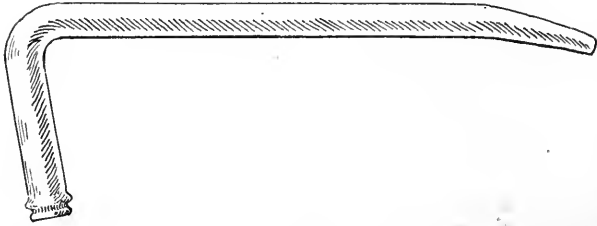

Fig. 23.—Glass bladder cannula, nearly natural size.

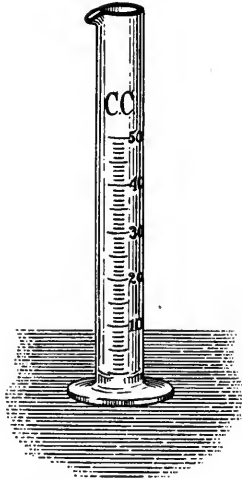

Fig. 24.—Graduated cylinder.



Fig. 25.—Casserole.

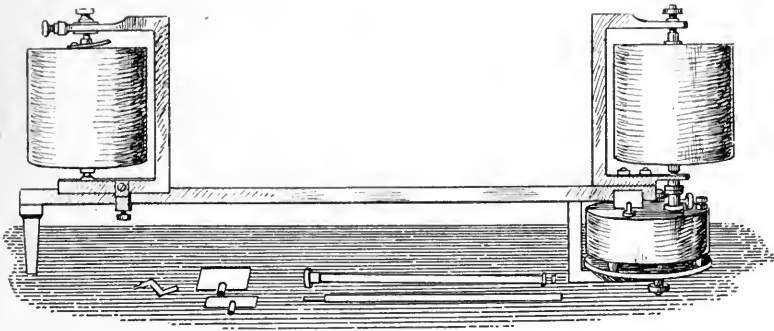

Fig. 26.—Harvard long paper kymograph.

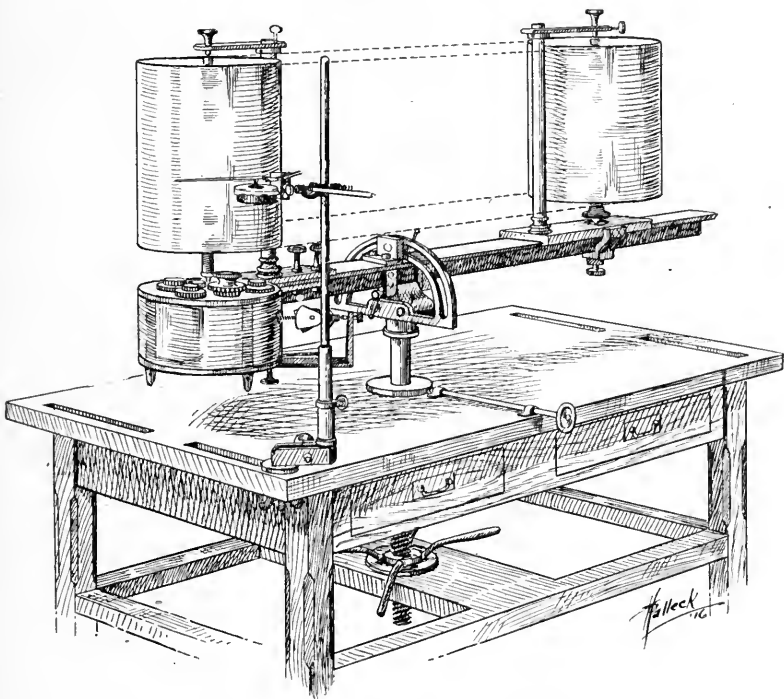

Fig. 27.—Hürthle long paper kymograph.

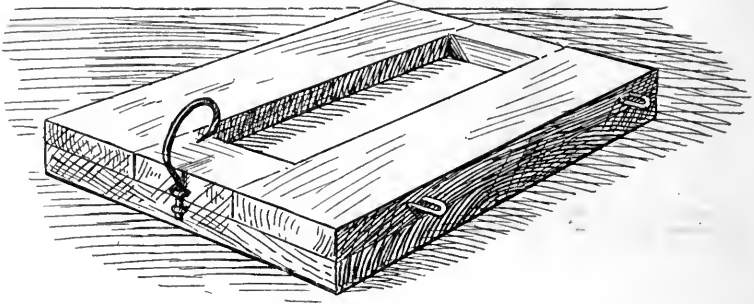

Fig. 28.—Turtle board, made of cheap, scrap, pine lumber (old goods boxes). A hooked wire (sharpened) is attached to the front end. The hook catches in the lower jaw ("chin") of the turtle. The feet are tied out tightly to the staples.

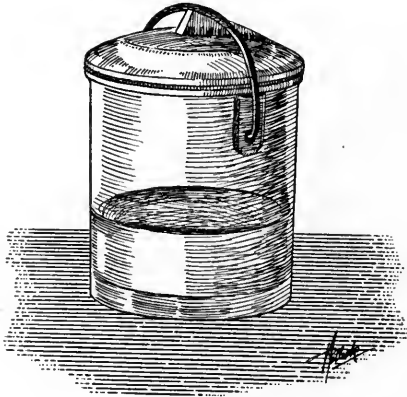

Fig. 29.—Specimen jar.

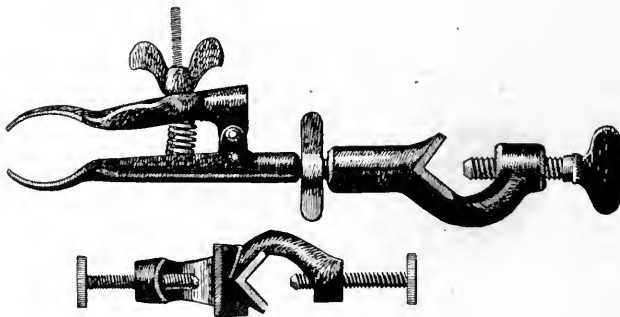

Fig. 30.—Upper picture, burette clamp; lower picture, double clamp (Harvard).

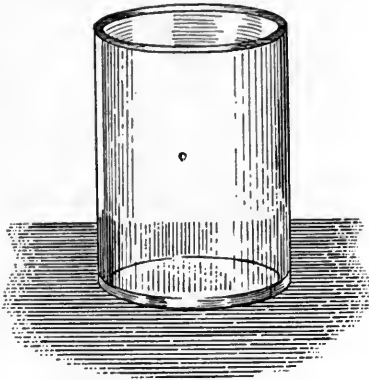

Fig. 31.—Battery jar (4x5 inches).

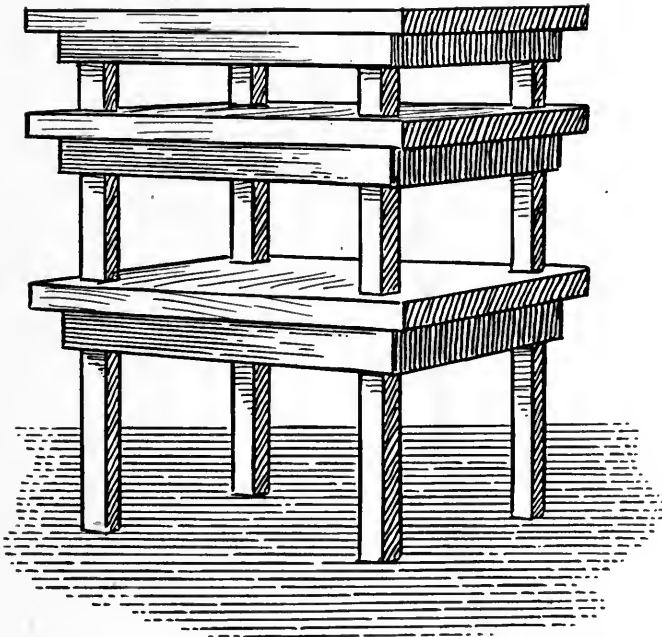

Fig. 32.—Small wood tables for supporting apparatus, Harvard kymographs, etc.

Each student should provide himself with a dissecting gown, a cheap note book for rough notes, and the following dissecting instruments:

- 1 (or 2) Serrefins (bull-dog artery clamps) (Fig. 33)
- 1 (or 2) Hemostats (Fig. 34)
- 1 Pair small sharp-pointed straight forceps (Fig. 35)



Fig. 33.—Serrefine.

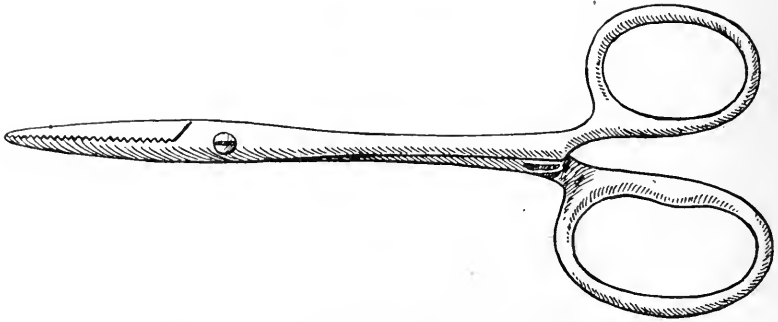

Fig. 34.—Hemostat.



Fig. 35.—Small sharp-pointed dissecting forceps.

In addition to this, *each group* of students should further provide itself with the following instruments for use of the group as a whole:

- 2 Good dissecting scalpels. (There is only a very limited use for the knife, hence not more than two need be provided. This may prevent many poor dissections and bad hemorrhages) (Fig. 36)
- 2 Aneurism needles (Figs. 37 and 38)
- 2 Pairs of large blunt-pointed dissecting forceps (Fig. 39)
- 1 Pair of smaller blunt-pointed dissecting forceps (Fig. 40)
- 3 Pairs of dissecting scissors, one large, two small (Fig. 41)
- 2 Dissecting probes (Fig. 42)
- 1 Large moderately sharp-pointed dissecting forceps to be used for inserting cannulas (Fig. 43)

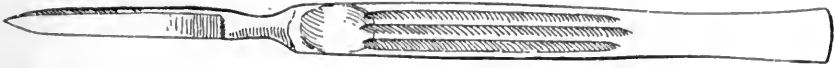

Fig. 36.—Scalpel.

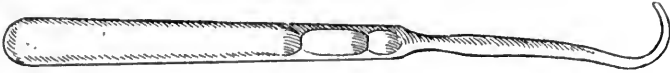

Fig. 37.—Small aneurism needle.



Fig. 38.—Large aneurism needle.



Fig. 39.—Large blunt-pointed dissecting forceps.

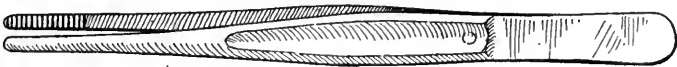

Fig. 40.—Small blunt-pointed dissecting forceps.

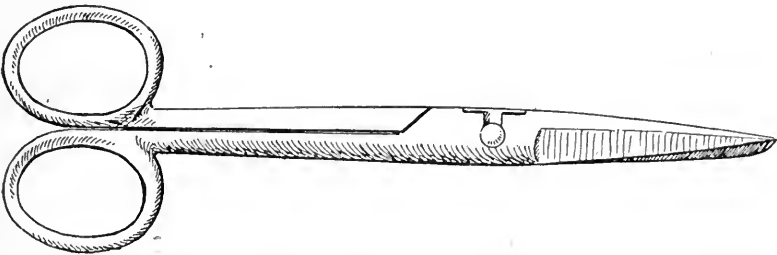

Fig. 41.—Dissecting scissors.



Fig. 42.—Dissecting probe (dental).

Students are warned not to buy the so-called "sets" of dissecting instruments. Also do not buy a lot of unnecessary instruments. Students who have had human dissection will usually already possess most of the necessary (and a good many unnecessary) instruments.

Each student must be provided with a permanent note book in which is written up a careful description of each experiment performed. This note book should be well bound, its dimensions should be about $7\frac{3}{4}$ inches by $10\frac{1}{4}$ inches, and it should contain about 150 pages. The paper should be of good quality and all permanent notes must



Fig. 43.—Large moderately blunt-pointed dissecting forceps.

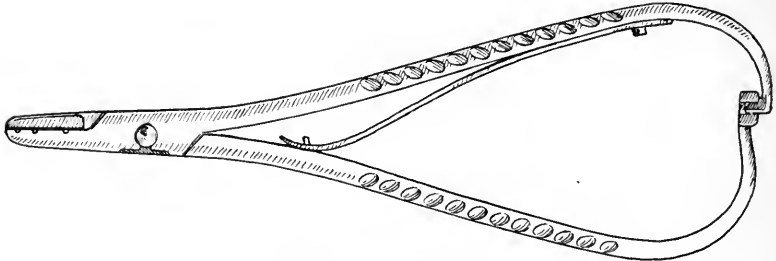

Fig. 44.—Needle holder.

be written in ink. Avoid typewritten or *loose leaf* note books. Either the original or blue print copies of all typical tracings obtained should be pasted in the permanent note book and fully explained in the notes. It is urged that notes be made brief, but strictly to the point. It requires only a few paragraphs for a student who fully understands an experiment to tell what he did, how he did it, and what his results show. A student should not hesitate to admit that any given experiment was a failure, or that part of his results or tracings are wrong. Such errors are frequent and will be understood at once by the instructor, and it is exceedingly valuable to the student to be able to

recognize his own failures and if possible to determine the cause of the failure. And it is of even greater importance to the student to be able to recognize and to show what results he *should have obtained* in an experiment which has apparently failed. Not only the student, but especially the instructor, should constantly be on the watch for atypical or unexpected results. Such chance observations have often furnished the basis for valuable discoveries.

Blue print copies of the best original tracings (*chosen by the instructor*) should be made in the department, usually by the technician, and should be furnished to the student at a price which is just sufficient to cover the cost of the blue print paper. (For directions for making blue prints, see chapter on photography, page 510.)

It is important that the permanent notes for each experiment be written up as soon as possible after the experiment is performed. The records or tracings should be labeled in full and great care should be used to make them as neat and accurate as possible. No more drum space than is absolutely necessary should be used in making each tracing. The drum paper should always be smoked *good and black*. This is important for blue printing and for publication if the instructor or anyone else should care to have any tracing reproduced. It is also necessary for making lantern slides. (See chapter on photography, page 500.)

Each group of students will be assigned to a table on which to work. If a sufficient number of tables and the floor space are available, it is advisable for each group to have two tables, one for the experiment and the other to be used as a side table for arranging apparatus, etc. When frogs or turtles are used then the two sub-groups (of two or three) may each have a table. If only one table is available, then for frog or turtle work the two sub-groups should work one at each end of the table. It is preferable that the drawers or lockers for the permanent apparatus be secured

by padlocks and that the students themselves furnish their own locks. This relieves the instructor of much unnecessary annoyance.

Special arrangements will be made for individual experiments or for those requiring apparatus which can not be

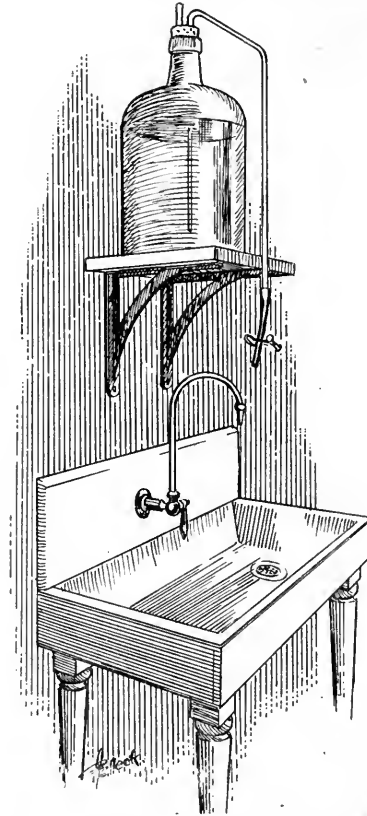

Fig. 45.—Large bottle for holding stock salt solution. Normal tap water saline (6 or 7 grams of NaCl to the liter) is suitable for most forms of frog or turtle work.

Locke's solution contains:—NaCl, 0.92%; KCl, 0.042%; CaCl₂, 0.024% (crystals); NaHCO₃, 0.015%; Dextrose, 0.1%. Ringer's solution contains:—NaCl, 0.6%; KCl, 0.0075%; CaCl₂, 0.01% (dried); NaHCO₃, 0.1%. Tyrode's solution contains:—NaCl, 0.8%; KCl, 0.02%; CaCl₂, 0.02% (crystals); NaHCO₃, 0.1%; MgCl₂, 0.01%; Na₂HPO₄, 0.005%; glucose, 0.1%. Dissolve the NaHCO₃ before adding the CaCl₂ in each case.

distributed to the class. Much variation will be found in this respect in various schools. Many pieces of apparatus must be made up to fit the experiment or the facilities of the laboratory. (See chapter on shop work, page 470.)

A salt solution (Locke, Ringer, Tyrode, etc.) will be placed in a large supply bottle in the laboratory. (Fig. 45.) Sodium citrate solution for blood pressure work will be supplied by the technician *as needed*. *Unnecessary wastage will be charged at cost.*

Specific detailed directions are given in the text for the performance of each experiment, but both students and instructors should be constantly on the watch for opportunities to improve the methods and technic given or to introduce new and better experiments. The writer believes this to be the best test of the vitality, spirit, and progress of any course and he never teaches the same set of experiments twice, but, on the contrary, he is constantly trying to improve or drop the old experiments and to add newer and better ones. This is even more true for apparatus, and the writer sincerely hopes that all students and teachers into whose hands this book may come will gladly contribute all that they can toward devising better, simpler, and cheaper apparatus.

More experiments are given in this book than the class will probably be able to perform. The instructor will select those *best suited for the class* and for the *facilities of the laboratory*. Experiments entirely different from those in the text may be substituted at any time.

Not more than fifteen minutes should be occupied in checking apparatus. Immediately thereafter proceed as follows:

EXPERIMENT I.

Ether. (Action on the Central Nervous System.—Cerebrum.)

1. Under an inverted battery jar (Fig. 31) place a full grown normal frog. Take a small piece of absorbent cotton and pour a few cubic centimeters of ether on it. Raise the edge of the battery jar a little and slip the cotton under

the jar. The ether vapor will fill the jar and the frog will presently begin to show symptoms from the action of the drug. Watch the animal closely. Are there pupillary changes? Can you distinguish such stages as that of imperfect consciousness, excitement, and anesthesia in the symptoms exhibited by the frog? Touch the animal from time to time and when all the reflexes have disappeared, remove it from the jar and quickly fasten it down to a frog board (Fig. 46) with clips, in the position shown in Fig. 47. *Do not injure the animal by unnecessary pressure.* Place a small piece of cotton over the frog's nose and mouth and pour a few drops of ether on the cotton.

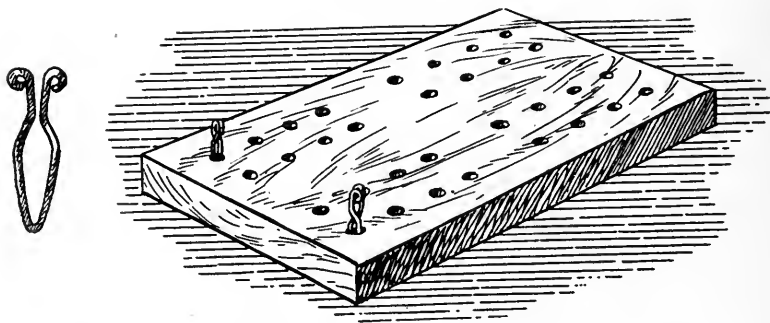

Fig. 46.—Frog board and clip (Härvard). (See chapter on shop work.)

With small scissors quickly make a median longitudinal incision in the skin above the brain. With the sharp point of a scalpel, held in the same manner as one holds a pen in writing, make a series of short shallow cuts in the skull directly in the median line over the cerebrum (Figs. 47 and 48). When an opening has been made through the skull, the sharp point of a small pair of scissors may be carefully inserted and the opening thus cut larger. Be careful not to injure the brain. Check hemorrhages with small plugs of cotton. Expose both lobes of the cerebrum and then with the point of the scalpel carefully remove from behind forwards the entire cerebrum. Check hemorrhages with cotton plugs for a while, but do not compress the optic

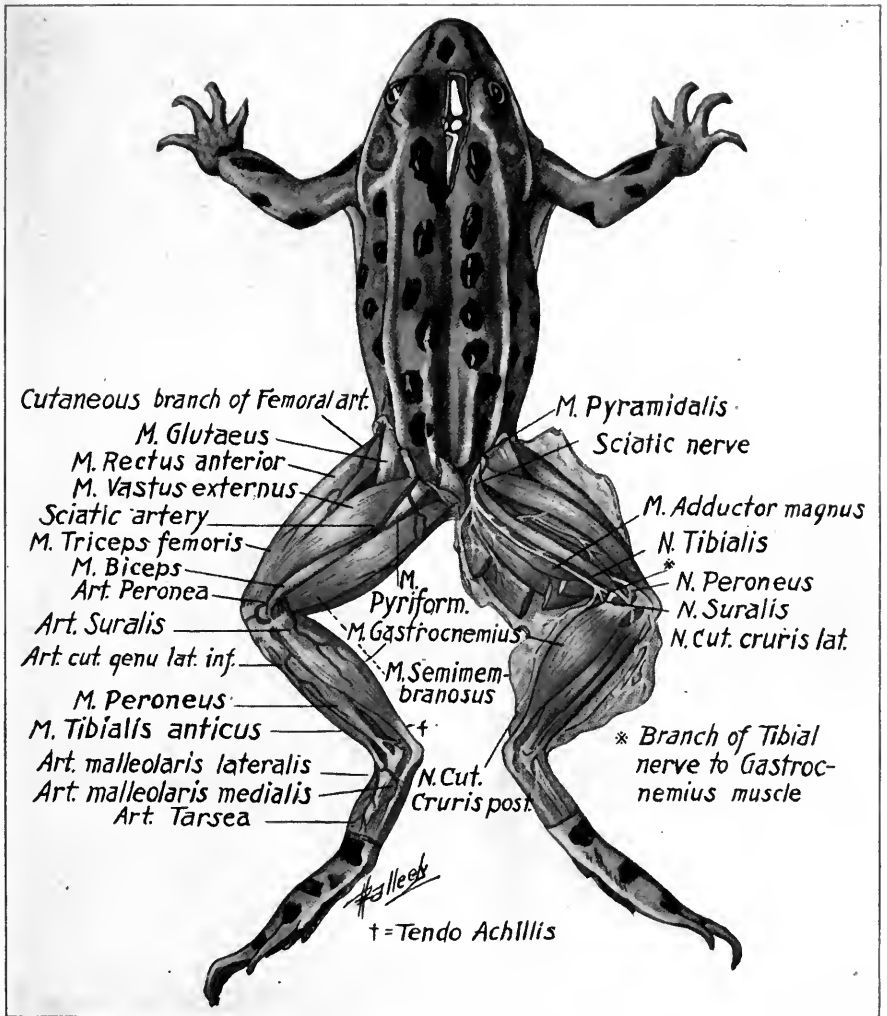
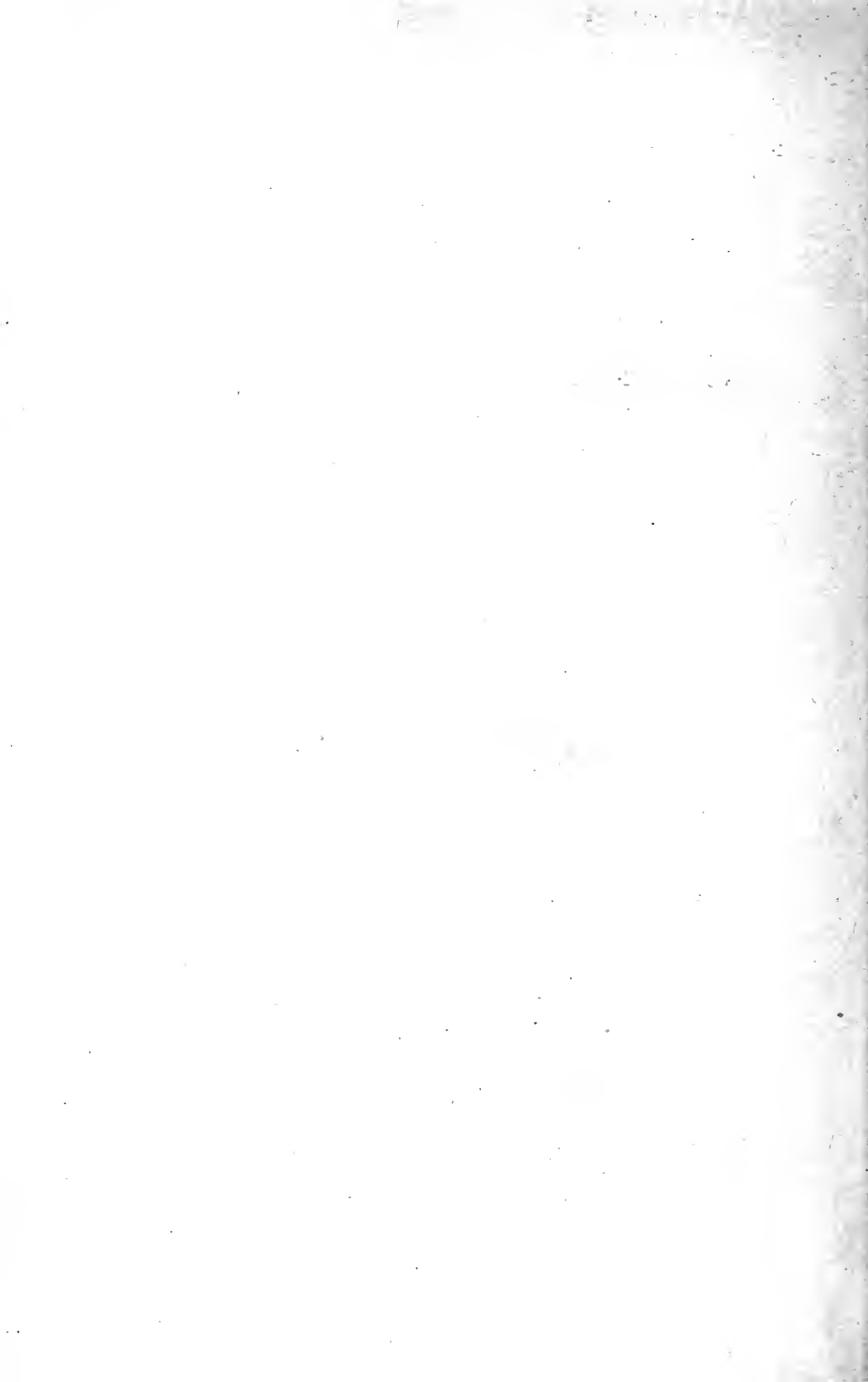

Fig. 47.—Dissection of a frog showing position of the brain, sciatic nerve and arteries and muscles of the hind limb.



lobes. Remove the cotton plugs and sew the skin together over the skull with a needle and thread, tie a thread (not tightly) around the *left hind foot* and place the animal on moist cotton in a casserole (Fig. 25) to recover.

The action of ether is largely manifested on the cerebrum, especially in higher animals. When the animal recovers,

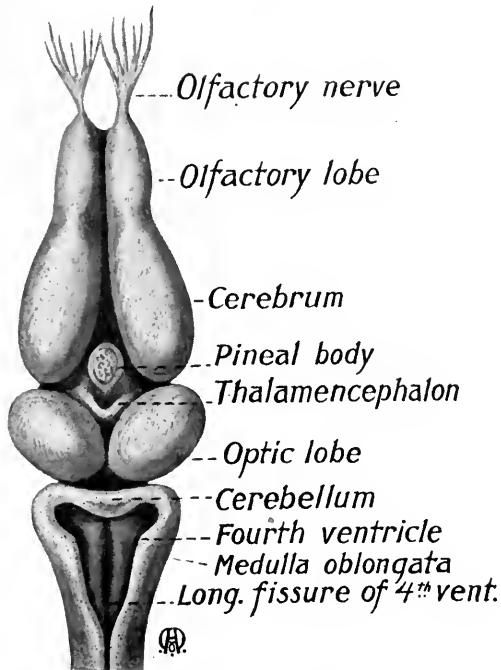

Fig. 48.—Frog's brain.

carefully compare its spontaneous and reflex actions with those of a frog which is just being anesthetized and also with the condition of the frog after the anesthesia is complete.

Chloroform. (Action on the Central Nervous System.— Optic Lobes.)

2. In the same manner as in the above experiment, anesthetize a frog with a *few drops* of chloroform. Expose the

right optic lobe and remove it. Be careful to avoid injuring the thalamencephalon or cerebellum. Do not use too much chloroform. It will produce a profound anesthesia and the animal may not survive. Tie a thread (not tightly) around the *right fore leg* and place the frog on moist cotton in a covered battery jar to recover. A few hours later (or next

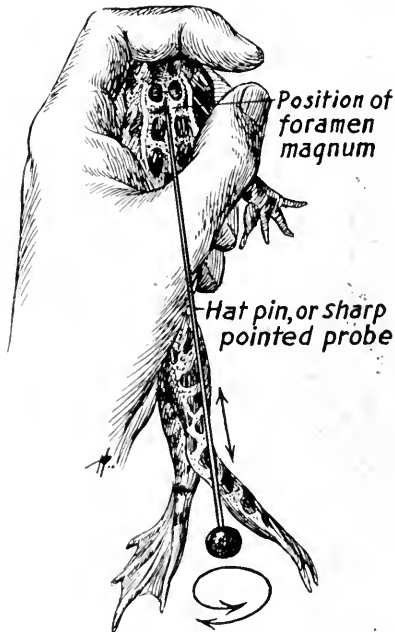

Fig. 49.—Method of pithing a frog. A towel is sometimes wrapped around the animal to facilitate holding it.

day) carefully observe the actions of the animal and compare these with those of the frog with the cerebrum removed. How do these symptoms differ from those exhibited by a frog which is just being anesthetized? Theoretically what symptoms should be shown by a frog which was injected with a drug that would depress the cerebrum alone? Or the optic lobes alone? Place both frogs in the water and observe their movements. It will be instructive if another frog can be operated on and the left optic lobe removed.

What relation do the optic lobes of the frog bear to the cerebellum of mammals?

3. Learn the technic of pithing a frog if you have not already done so. (See Fig. 49.)

Ether, Ethyl Chloride, Chloroform, Ethyl Bromide.
(Irritability and Conductivity of Nerve.)

4. (a) After pithing place a frog face downward on the frog board and dissect out the sciatic nerve from its origin

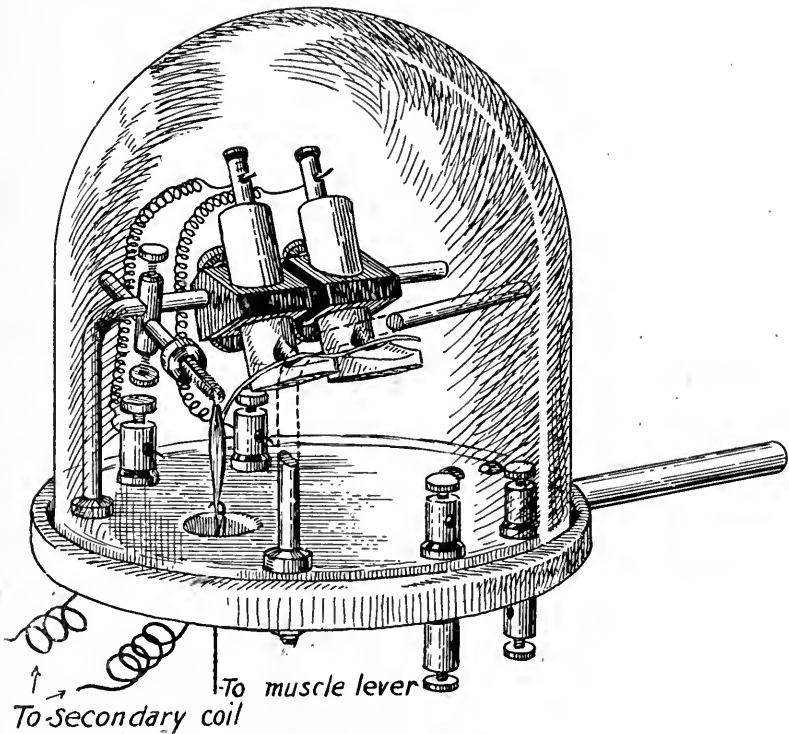

Fig. 50.—Harvard moist chamber.

at the spinal cord down to the knee. Avoid injuring the nerve. Tie a thread to the nerve and then dissect the gastrocnemius muscle (Figs. 47 and 60) loose from the bones of the leg. Cut the tendo Achillis long and then divide the

femur and thigh muscles, but leave the sciatic nerve intact and attached to the gastrocnemius muscle. Cut the tibia and fibula just below the knee and free the gastrocnemius from the remaining tissues of the leg.

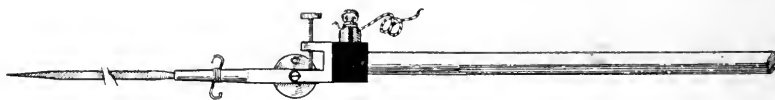

Fig. 51.—Harvard muscle lever.

The cut end of the femur should now be fastened in the clamp of a moist chamber (Fig. 50) and a pin hook is passed through the tendo Achillis as illustrated. The thread

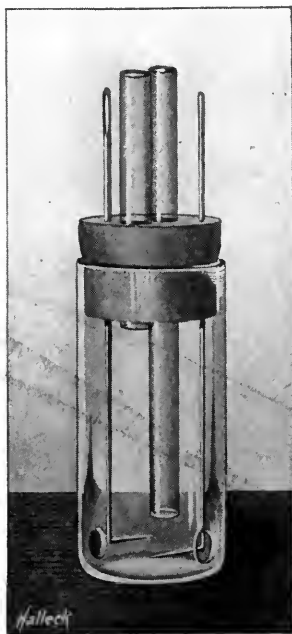

Fig. 52.—Harvard gas chamber.

passes down to a muscle lever (Fig. 51) which writes on a smoked drum. A gas chamber (Fig. 52) held in a burette clamp (Fig. 30) is placed in position near the muscle (to the

right in the illustration), and by help of the thread the sciatic nerve is drawn through the holes in the gas chamber and across the two needle electrodes which are connected to an induction coil arranged for single shocks. (See Fig. 1.) By means of a rubber tube, one of the side tubes of an ether bottle is now connected with one of the tubes leading into the gas chamber. The boot electrodes (which have been

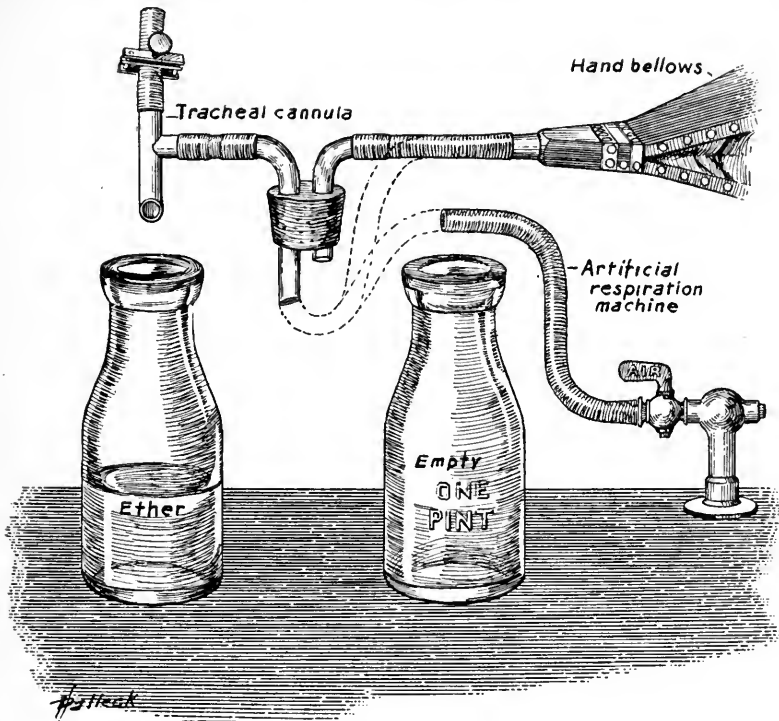

Fig. 53.—Ether bottles showing method of administering air and ether (chloroform) to an animal with the chest open, or for passing ether (chloroform) vapor through the gas chamber.

soaked in salt solution and now have been filled with zinc sulphate solution) may be placed just to the right of the gas chamber and the end of the sciatic nerve is laid across the tips of the boots. Keep the nerve and muscle moist with normal salt solution. The boot electrodes are also arranged so that single shocks may be sent through them when de-

sired. The drum should turn at a moderate speed. Some ether is now placed in the ether bottle and by means of a hand bellows a current of air and ether vapor can be passed through the gas chamber (Figs. 52 and 53). Just before the ether is applied several contractions of the muscle should be recorded to serve as normal controls. These controls should be obtained both from the needle and from the boot

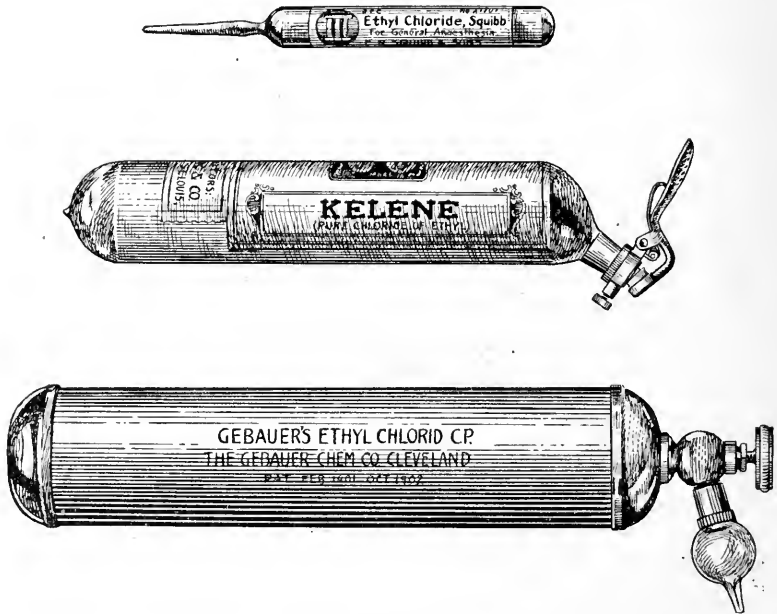

Fig. 54.—Three forms of containers for ethyl chloride. The Gebauer container is preferred.

electrodes. These records should be carefully preserved and compared with those obtained later. When the normals have been secured then pass a *small amount* of ether vapor through the chamber and then again stimulate the nerve with the needle electrodes. What action has the ether had on the *irritability* of the nerve? Stimulate with the boot electrodes. Has the *conductivity* of the nerve been affected? Is this a fair test?

(b) Blow out the ether vapor with pure air and repeat the stimulations. Does the nerve return to normal?

(c) With a Gebauer or Kelene tube (Fig. 54) spray a little ethyl chloride through the gas chamber. *Do not freeze the nerve.* Quickly repeat the stimulations and note the effects on the nerve. What do you observe?

(d) Blow out the ethyl chloride from the gas chamber and obtain new "normal" contractions of the muscle. If

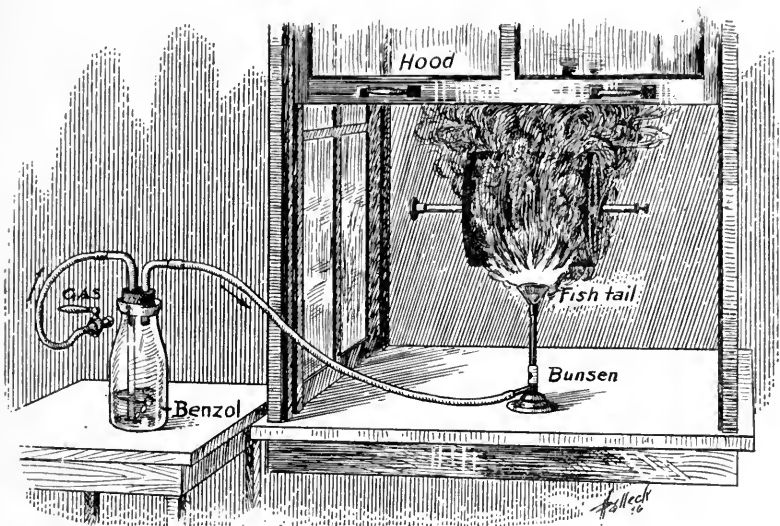

Fig. 55.—Method of smoking drums (in a hood). Benzol is placed in the one pint milk bottle.

the nerve is dead a new preparation should be made. Place a few drops of chloroform in the ether bottle and blow the vapor of this through the gas chamber. Again stimulate the nerve with the needle and with the boot electrodes. What do you observe? What can you say as to the relative action of ether, ethyl chloride, and chloroform on isolated nerve trunks? Ethyl bromide may also be tried similarly. Before taking down the apparatus stimulate the muscle itself directly a few times to determine its condition. This is easily done if a very fine copper wire instead of a thread

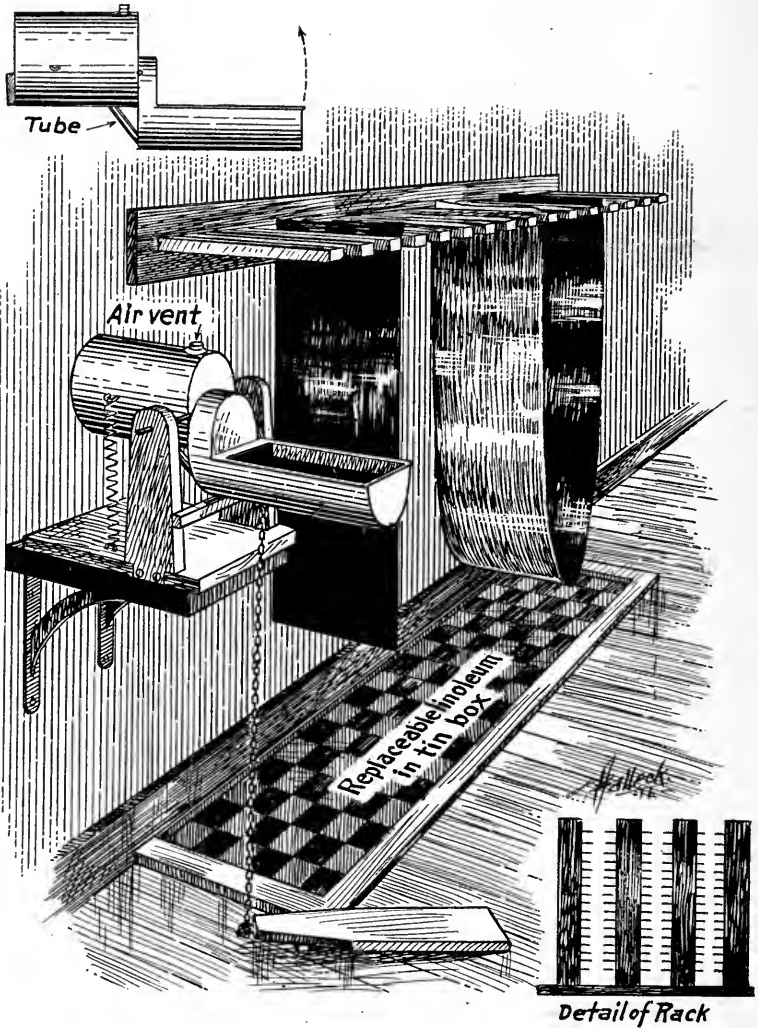

Fig. 56.—Automatic shellacing pan and drying rack for drum records. Varnish is made by dissolving the *best granular white shellac* in alcohol. A large excess of the shellac should be present, and solution is allowed to go on for a week or more (shake up thoroughly several times), at the end of which time the clear supernatant solution is decanted and placed in a well stoppered bottle to prevent evaporation of the alcohol. If this occurs small particles of the shellac precipitate out and may spoil the varnished records by being deposited as white specks all over the black surface of the tracing. Orange shellac is somewhat more soluble than the white but not so satisfactory because of the yellowish color it gives to the records. This is very undesirable if any records are to be blue-printed, photographed or used for publication. Cheap varnishes made of gasoline and rosin, etc., are sometimes used. A high grade brass lacquer (such as Kahlbaum's metallfurniss, farblos) may often be much diluted with alcohol and thus made into an excellent varnish for records.

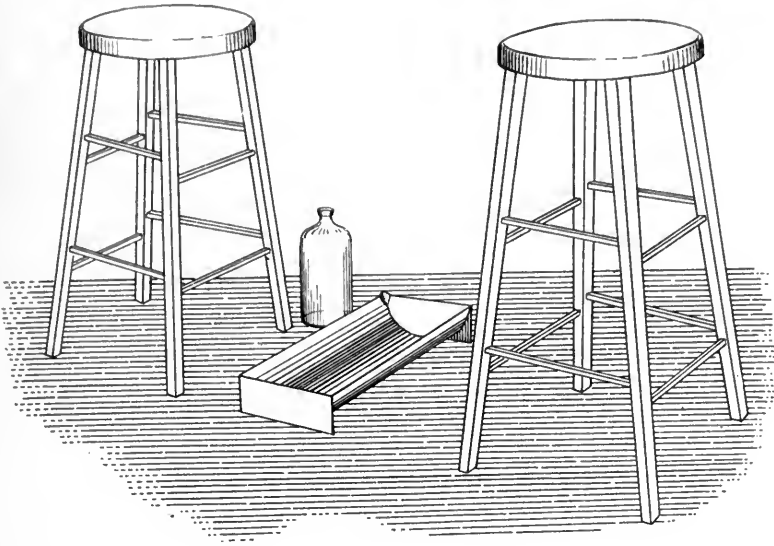

Fig. 57.—Varnishing pan (12 inches long, 7 inches wide), used for varnishing records from long paper kymographs. The record is cut apart on the drum, one person holding each end. The smoked surface is turned upward. One person steps on a stool (or short stepladder) and lifts one end of the record high in the air. The assistant dips the other end of the tracing into the varnish and lifts up his end of the record as the other end of the tracing is lowered. The tracing is suspended from each end like a hammock on the rack (shown in Fig. 56) to dry.

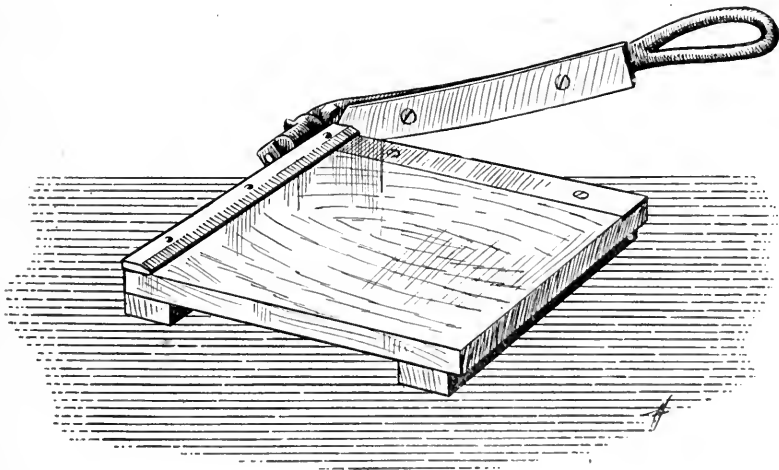

Fig. 58.—Print and tracing trimmer.

is used to connect the pin hook in the tendo Achillis to the muscle lever. The secondary terminals can then be attached to the muscle lever and to the muscle clamp.

Ethyl Chloride. (Local Anesthesia.)

5. Hold a Gebauer or Kelene tube about 10 or 12 inches from the hand and open the valve a little. A small spray of the drug will be forced out. Why? Direct this spray

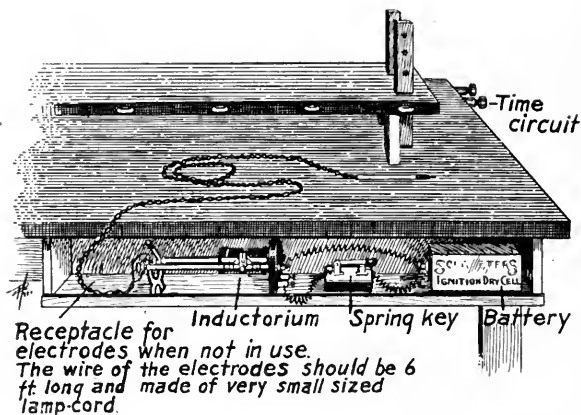
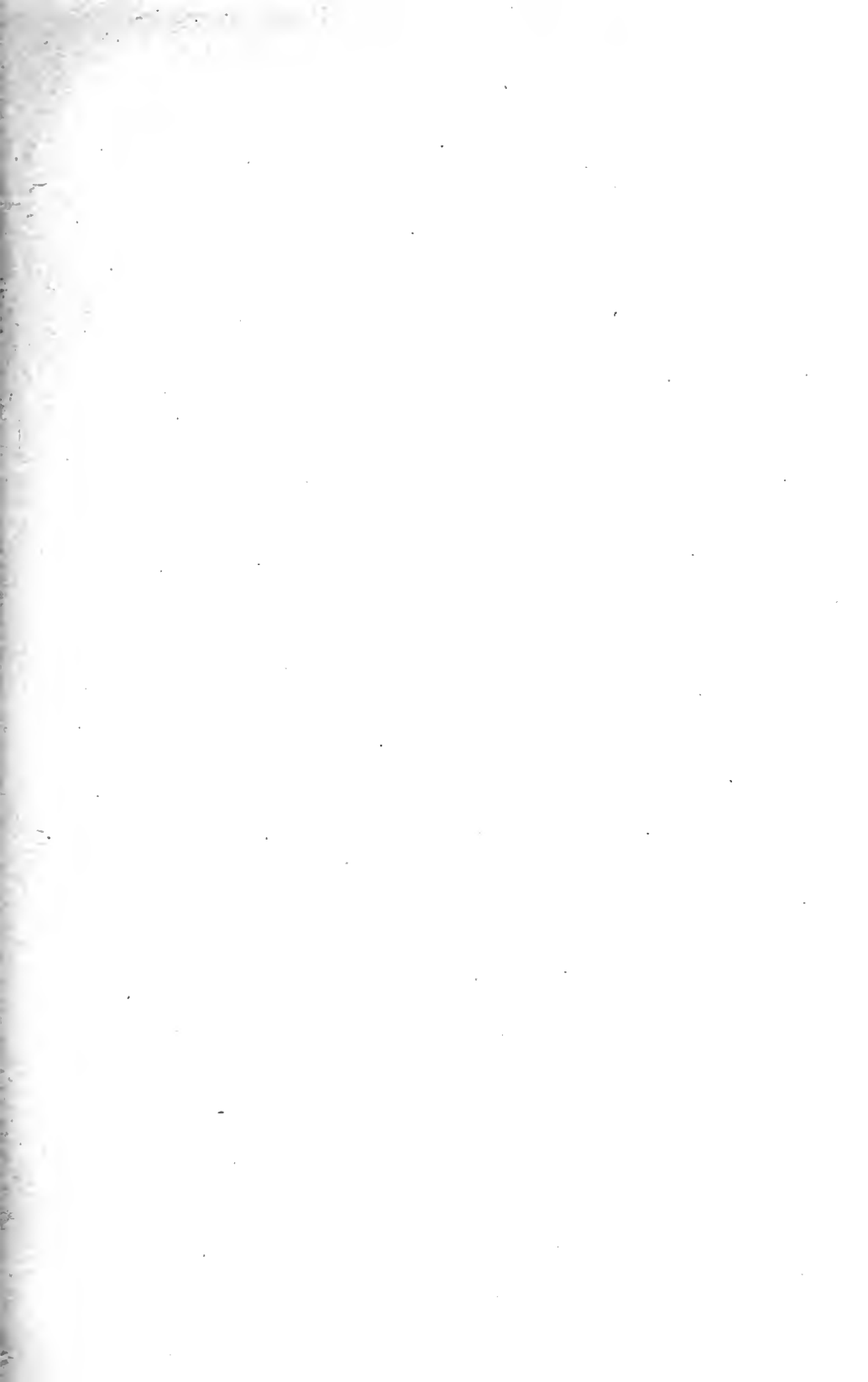

Fig. 59.—Convenient method of arranging the inductorium, battery, key, and electrodes to avoid tearing down the apparatus at each period. The inductorium is out of the way and always ready for use.

against the back of the hand. A white frost will soon appear on the skin and hairs. A few seconds after this frost begins to form stop the spray and quickly examine the sensibility of the skin in the area affected. To what is this action due? To what clinical use might this be applied? Can you think of other substances having a similar action? Is this action of ethyl chloride in any way similar to that of ether, ethyl chloride, or chloroform, on the irritability or conductivity of nerve trunks? What is the boiling point of ethyl chloride? If a local anesthetic be applied to a mixed nerve trunk will all the constituent fibers be equally affected at the same time?



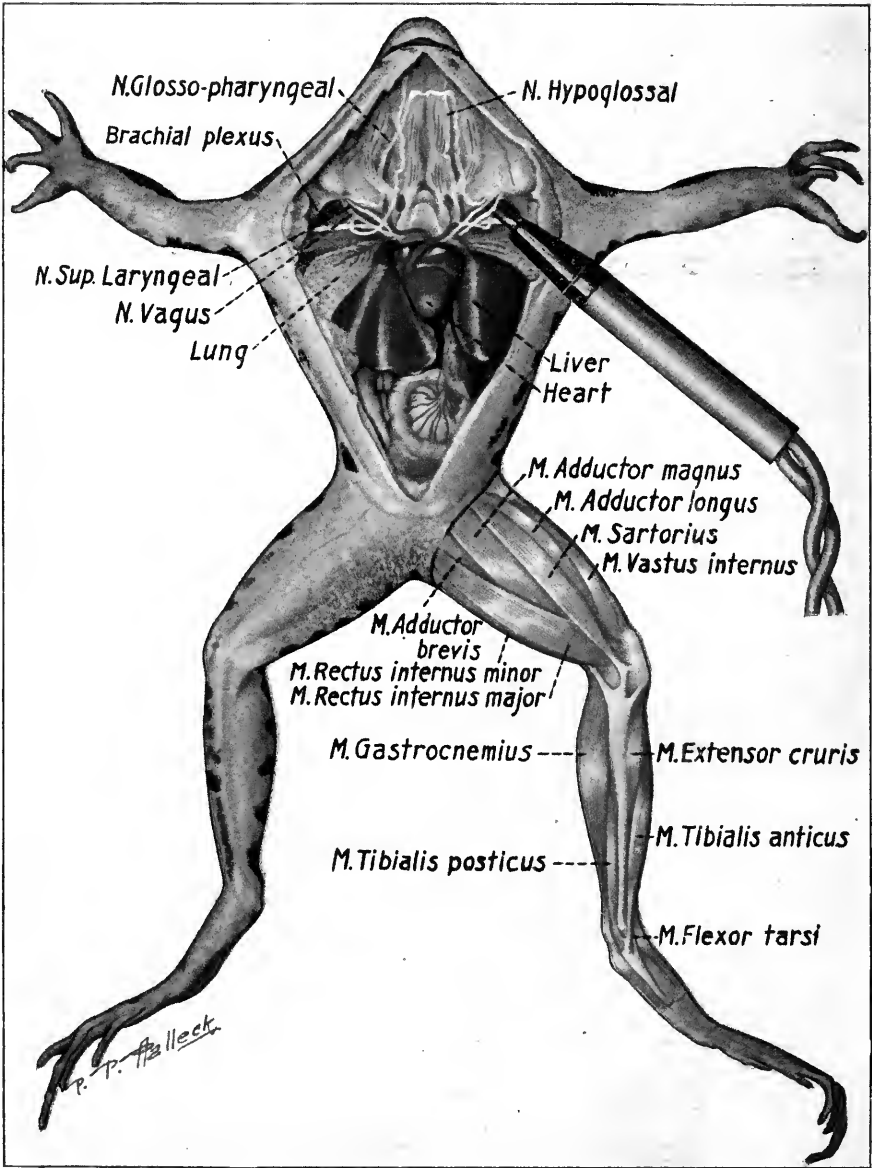

Fig. 60.—Dissection of a frog to show the position of the heart, vagus nerve and the muscles of the hind limb. The electrodes are in position for stimulating the vago-sympathetic trunk. It is often desirable to fasten the electrodes in this position (in a burette clamp) so that the animal may not be disturbed when the nerve is stimulated.

EXPERIMENT II.

Ether. (Action on the Heart.—Dissection for the Vagus Nerve in the Frog.)

1. Pith a frog and clamp it down to the board with the ventral side up, as shown in Fig. 60. With sharp scissors split the abdominal and thoracic walls in the median line forward into the skin over the floor of the mouth. If possible avoid dividing the abdominal vessels. Cut open the girdle of bones directly over the heart (which should be carefully avoided) with the scissors. Then pull the thoracic cavity widely open by stretching out the fore legs from side to side. Reset the clamps holding these legs. Refer to Fig. 60 and identify the glossopharyngeal, hypoglossal, and brachial nerves. Near the angle of the jaw dissect down carefully with a probe and fine-pointed forceps until the laryngeal branch of the vagus and the vago-sympathetic nerves come into sight. For the method of union between the sympathetic chain and the main trunk of the vagus nerve see Fig. 61. The sympathetic fibers pass forward in the thorax to the base of the skull where they turn backwards and unite with the vagus nerve to be distributed with the vagus to the heart, lungs, etc. When the vago-sympathetic nerve has been found it should be pulled outward a little and the points of the electrodes slipped beneath the nerve. With a tetanizing current of medium strength stimulate the nerve and see if the heart stops. This is to identify the nerve. *Do not stimulate the nerve any longer than is absolutely necessary*, for the nerve endings are easily fatigued and may not be able to stop the heart later after your apparatus is all arranged.

The heart is now freed from the pericardium and connected with a heart lever by means of a pin hook and a thread as shown in Fig. 63. The tip of the ventricle is attached to the pericardium by a small ligament called the

frenum. Pick this up with the forceps, sever it, and at the point where it is attached to the heart stick the pin hook (which should be small) through the tip of the ventricle. Adjust the heart lever to write about one-half inch from the lower edge of the drum and see to it that the tracing

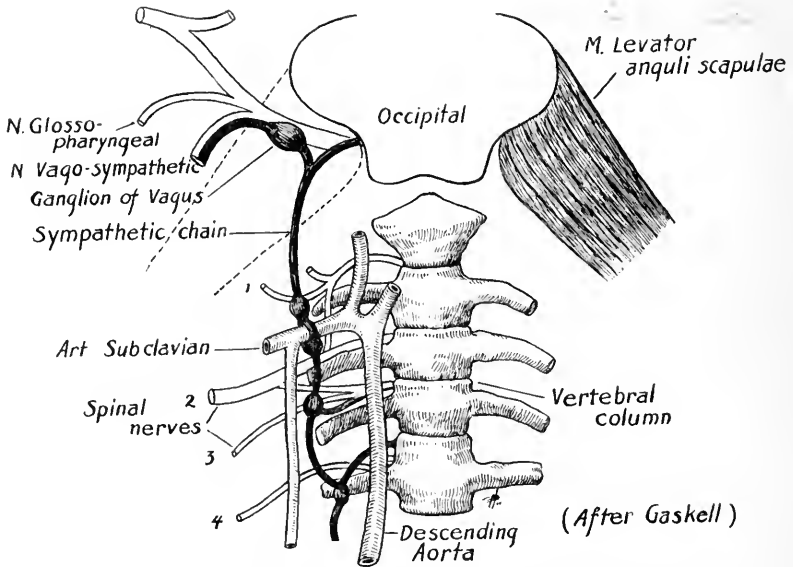

Fig. 61.—Diagrammatic dissection to show the origin and course of the sympathetic chain and the union of the vagus and the sympathetic fibers for the heart in the frog (Gaskell).

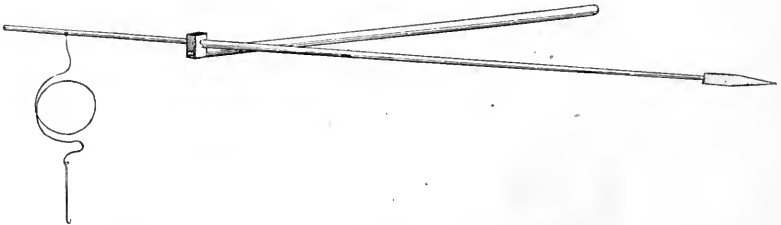

Fig. 62.—Heart lever. The rod is made of 3/16 inch round brass rod into the end of which a small hole is drilled. A small block of wood fiber or hard rubber is attached to the rod by a small wire nail which passes (loosely) through the wood fiber block and is then driven (tightly) into the hole in the end of the rod. The writing lever is a very thin strip split from a long (10 or 12 inches) section of a bamboo fishing pole. This lever, which is very light and limber, passes (tightly) through an oblong hole in the upper part of the wood fiber block. A paper or celluloid (used photographic film) writing point is attached by mucilage or by a cement made by dissolving a photographic film in acetone. These levers are entirely satisfactory for the hearts of frogs, turtles, for uterine strips, etc. They can be made easily and cheaply.

starts just to the right of the seam in the drum paper. The time marker can be arranged and the time recorded as the record of the heart beat is taken, or the time record may be put on after the heart tracings are finished if the speed of the drum is approximately constant. This latter procedure is advisable for the first few records. It is also advisable to use a signal magnet in the primary circuit arranged in such a manner that the exact moment and the

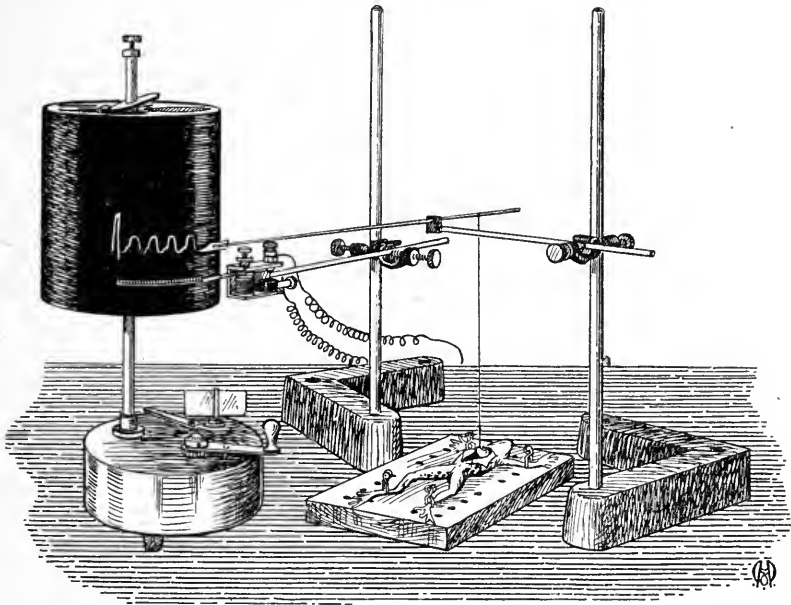

Fig. 63.—Arrangement of apparatus for recording frog heart tracings by the suspension method. The wires from the signal magnet are connected with the time clock.

duration of the stimulation may be recorded directly beneath the writing point of the heart lever. The heart tracing should have an amplitude of about one-half to one inch. The drum should have a slow or medium speed. If the Harvard drums are used it is often advisable to clamp a folded piece of paper on to the largest fan to thus further slow the speed. It may be necessary to put a small weight on to the long end of the heart lever to secure the desired amplitude of movement for the tracing.

When all adjustments are made start the drum and take a "normal" tracing. When about two inches of this has been recorded then stimulate the vagus nerve and get a record of the normal inhibition. It is important that the electrodes do not rest on the neck or thoracic muscles of the frog, for if such is the case these muscles will contract when the current is turned on and the frog will move thus spoiling the appearance of the tracing. Do not stop the heart longer than is necessary (2 or 3 beats). Then allow the heart to recover (the drum is kept running) from the inhibition and record another two inches of "normal" tracing. Then stimulate the vagus. This gives an opportunity to secure two sets of records.

Now back the drum away from the writing lever a little and turn it back to the starting point. Lower the drum

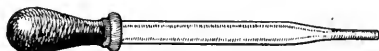

Fig. 64.—Medicine dropper for applying solutions to the heart.

so that the next round of the tracing will be about one-half inch above the first. Pull the drum forward and start it again and when about one inch of tracing has been recorded then drop on to the heart with a medicine dropper (Fig. 64) five or six drops of a saturated solution of ether in normal salt solution (solubility=1 to 9). When the tracing again comes directly over the place where the vagus was stimulated in the lower tracing stimulate the vagus again and determine whether or not the drug has affected the reaction of the heart to the inhibition. Now rapidly drop more ether solution on the heart and repeat the vagus stimulation directly over the second inhibition record in the normal tracing. Keep dropping on the drug and note carefully the effect on the rate and amplitude of the heart. Observe the appearance of the auricles and ventricles. Can you determine in your tracing those portions of the record made by the sinus, auricular, and ventricular contrac-

tions respectively? In which direction does the lever move in systole?

Take several rows of tracings, lowering the drum sufficiently to leave about three-eighths or one-half inch between each row of tracings. The record should thus read from *left to right* and from *bottom to top*. As the ether is dropped on, the action on the systole of the heart will soon become apparent. This should progress until the heart almost stops. Then irrigate the heart with normal salt solution a while and see if you can get it to recover. Stimulate the vagus from time to time and see if the power

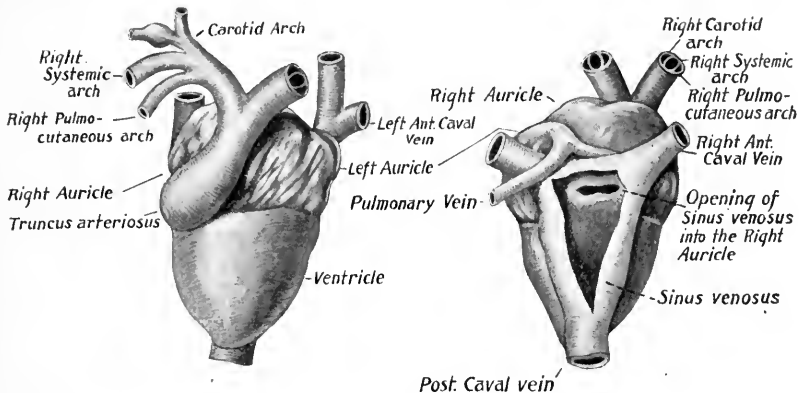

Fig. 65.—The anatomy of the frog's heart. (Modified from Wiedersheim.)

of inhibition is lost. How has the drug affected the heart? Is the innervation of the organ involved in the action or is this mainly a muscular affair? Does this experiment show any action of the drug on the cardio-inhibitory center in the medulla? When the heart tracings are finished then record the time in five second intervals in two or three rounds on the drum. These time records also serve as comparison lines to determine whether or not there has been an increase or a decrease of tone in the heart muscle. What effect would a decrease in heart muscle tone have on the position of the record with reference to a horizontal line drawn around the drum?

Chloroform. (Action on the Frog's Heart.)

2. Repeat the above experiment on a fresh frog using a saturated solution of chloroform in normal salt solution (solubility=1 to 200). Does chloroform affect the nervous inhibiting apparatus of the heart? What differences do you note between ether and chloroform as regards their cardiac action?

3. Familiarize yourself with the anatomy of the frog's heart (Fig. 65). How does the frog's circulatory apparatus differ from that of a mammal?

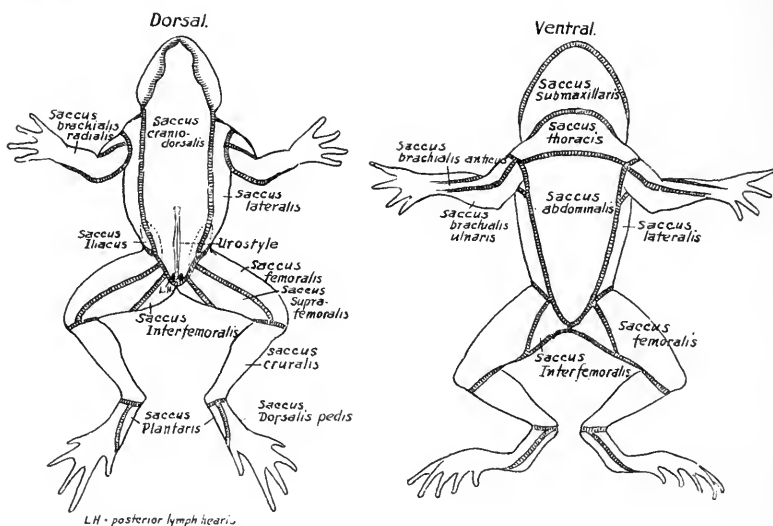

Fig. 66.—Diagrammatic representation of the lymph spaces of the frog. (Modified from Ecker.)

Chloroform. (Action on Lymph Hearts.)

4. Allow a frog to sit in a good light with the lower end of the urostyle turned toward a window. On each side of the lower end of the urostyle (*L.H.* in Fig. 66) note a series of feeble pulsations beneath the skin. This is caused by the beating of the posterior pair of lymph hearts. (The anterior pair of lymph hearts are located, one heart on each side, between the transverse processes of the third

and fourth vertebræ. Their beats cannot be observed from the exterior.) Count the rate of lymph heart beats and also the rate of the blood heart beats. (These can be seen beneath the skin of the chest.) If the frog breathes also count the rate of respiration. (How does a frog breathe?) Now place the frog under a battery jar and deeply anesthize it with chloroform. Remove the animal and again count the rate of beats of the heart, of the posterior lymph hearts (do these beat synchronously?), and the rate of respiration. What conclusions can you draw? Are these results due to a central or a peripheral action of the chloroform? (How is the beating of the lymph-hearts controlled? How is this mechanism provided for in the mammal?) Allow the frog to recover and observe its symptoms. How long before the frog becomes normal again?

EXPERIMENT III.

Turtle: Vagus Dissection. (Action of Ether on the Heart.)

1. Pick up a turtle and draw its head forward out of the shell. This may be done with a wire having a short sharp hook on one end. The hook is passed between the carapace and plastron and hooked into the anterior angle of the lower jaw below. Draw out the head and seize it between the first and second fingers of the left hand. Clasp the hand around the turtle's neck and pith it with a sharp probe or hat pin in the same way that the frog is pithed. It is advisable to pith the cord also by pushing a soft brass or iron wire down the spinal canal. The wire is introduced through the same opening by which the animal's brain was destroyed.

Catch the turtle's lower jaw in the hook of a turtle board (Fig. 28) in the manner shown in Fig. 67. Pull the hind legs outward and backward *firmly and forcibly* and fasten them to the board. This may be done with strings (heavy)

as shown in Fig. 67, but it can be done quicker and perhaps better by long sharp iron tacks which are driven through the feet and into the turtle board with a hammer.

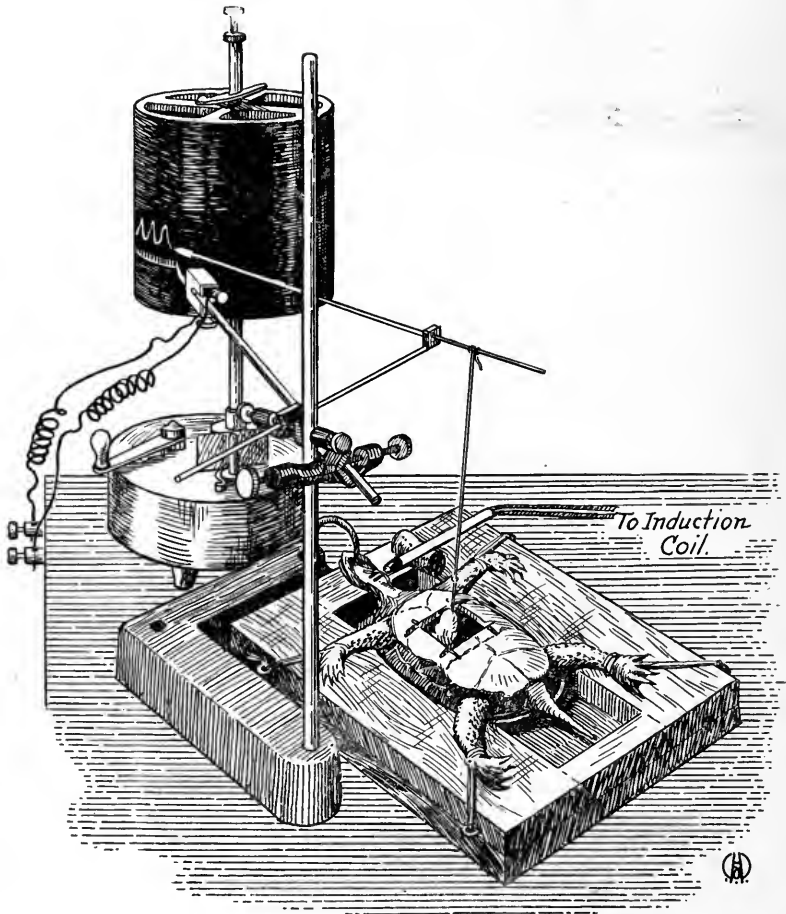

Fig. 67.—Arrangement of apparatus for recording turtle heart tracings by the suspension method. Note that only a small square opening is made in the plastron over the heart.

It is very important that the animal be fully stretched out so that it cannot move reflexly and spoil the tracings later. Next pull out laterally the fore limbs and fasten them down firmly.

Now by means of a hand bandage saw (Fig. 104), or with a circular saw on a small motor (Fig. 68), cut out a square opening in the plastron over the heart as shown in Fig. 67. With a scalpel handle pry up the square piece of plastron and then carefully strip loose the tissues below the square so as to avoid hemorrhage. There should be practically no bleeding. With scissors cut away the pericardium and expose the heart. Familiarize yourself with the anatomy of the turtle's heart (Fig. 69).

In the side of the neck make a longitudinal incision and

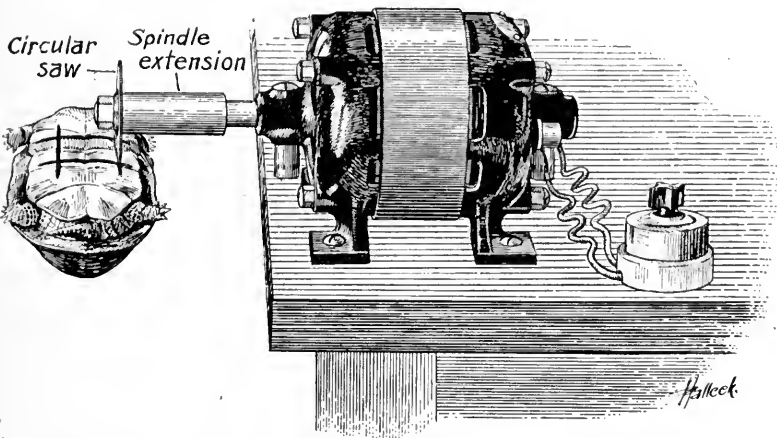

Fig. 68.—Method of sawing out a square in the plastron of a turtle by means of a circular saw (3 inches in diameter) attached to a small ($1/10$ horse power motor).

expose the carotid artery, the vagus nerve, and the sympathetic nerve (Fig. 70). To identify the vagus nerve place a thread around it loosely, lift up the thread, and with a moderately strong tetanizing current stimulate the nerve. Does the heart stop beating? If not, strengthen the current. The heart normally should entirely cease to beat when the vagus nerve is stimulated with a sufficiently strong current.

Arrange the turtle and apparatus to record a heart tracing as shown in Fig. 67. It may be desirable to use the signal magnet in the primary current for the induction coil

and thus let the signal magnet record the moment and duration of stimulation rather than the time. After the heart records have been secured then the time tracing (in five second, etc., intervals) can be put on the drum. The electrodes should be adjusted under the vagus nerve in such a way that they need not be disturbed or moved in any way when one desires to stimulate the nerve. Keep the nerve moist with normal salt solution. The record should be made in such a manner that it will read from left to right and from bottom to top. The amplitude of the beats should be about one inch. The drum should turn at a moderately slow speed. When all adjustments of the apparatus are completed record about one or two inches of the normal tracing and then stimulate the vagus nerve. The right nerve usually is more effective in stopping the heart than is the left. Allow the heart to recover (the drum should be kept going all the time) and when about one or two inches more of normal record have been obtained, stimulate the vagus (or the opposite vagus) again and thus get two sets of records. If there are three students in the group it is often advisable to thus make three sets of records so that each student can have one. The cardiac inhibitory powers of the vagi in the turtle are not nearly so easily exhausted by electrical stimulation as are those of the frog.

When enough normal tracings have been secured lower the drum so that about one-half inch will be left between the first round of the record and the second and start over from the beginning (left hand side) of the record again. When the second record reaches a point about one inch to the left of the place where the vagus nerve was stimulated in the first round then rapidly drop ten drops of a solution of ether in salt solution on the heart as was done with the frog's heart in Experiment II (1). When the record comes directly over the place where the vagus nerve was stimulated in the first round of the tracing stim-

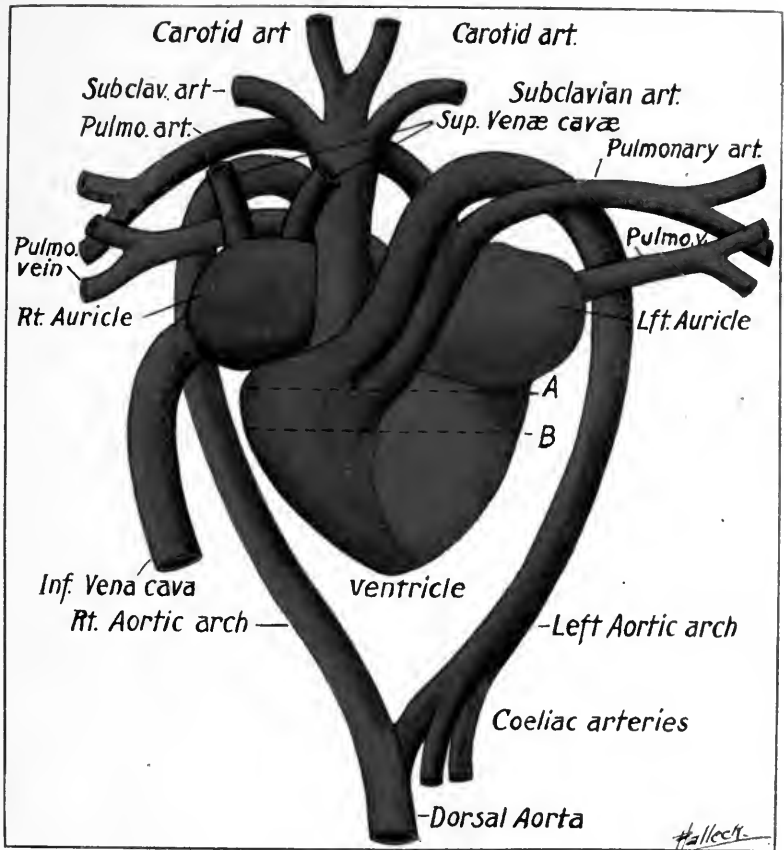
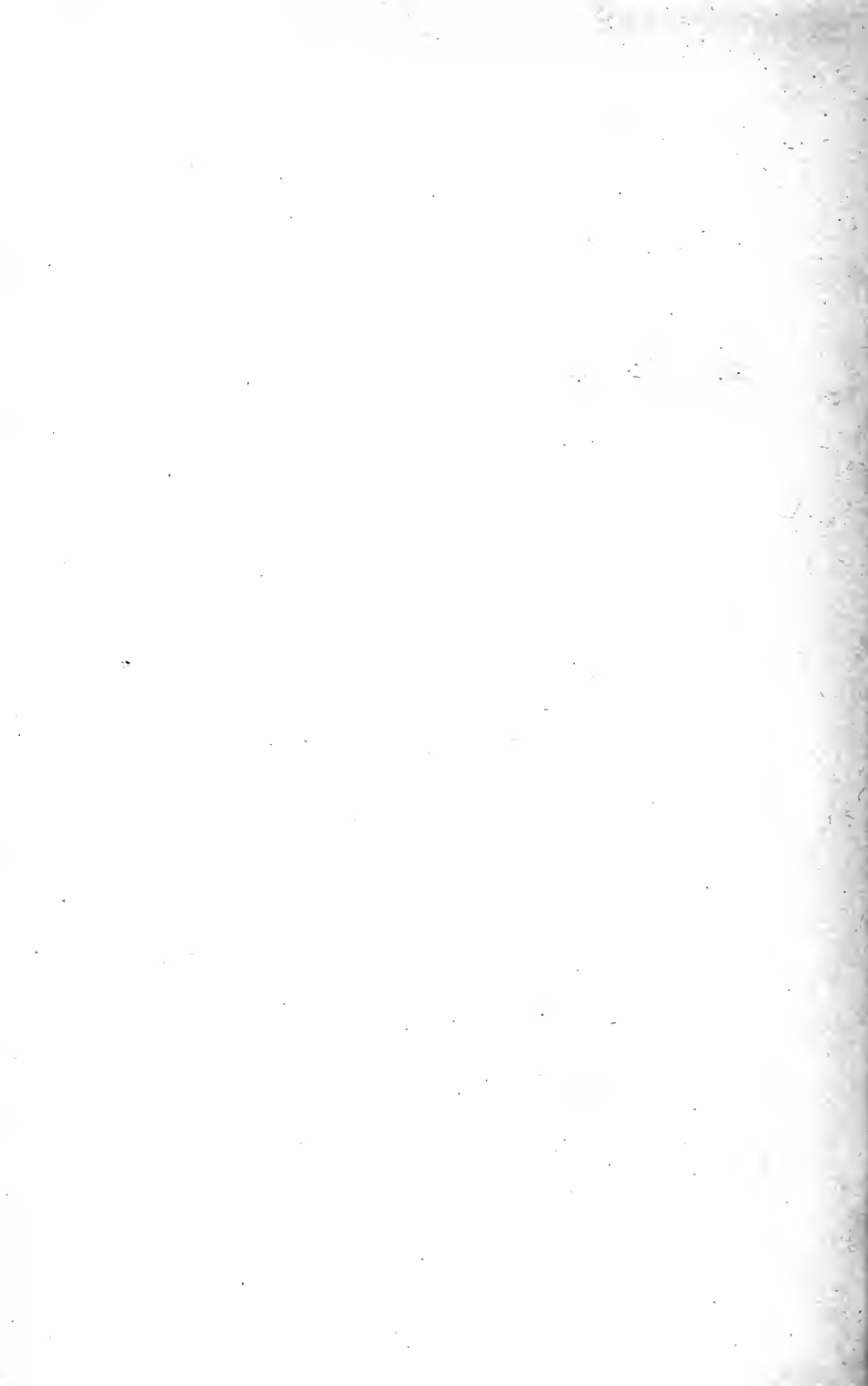

Fig. 69.—Diagrammatic representation of the turtle's heart. (Modified from Nuhn.)



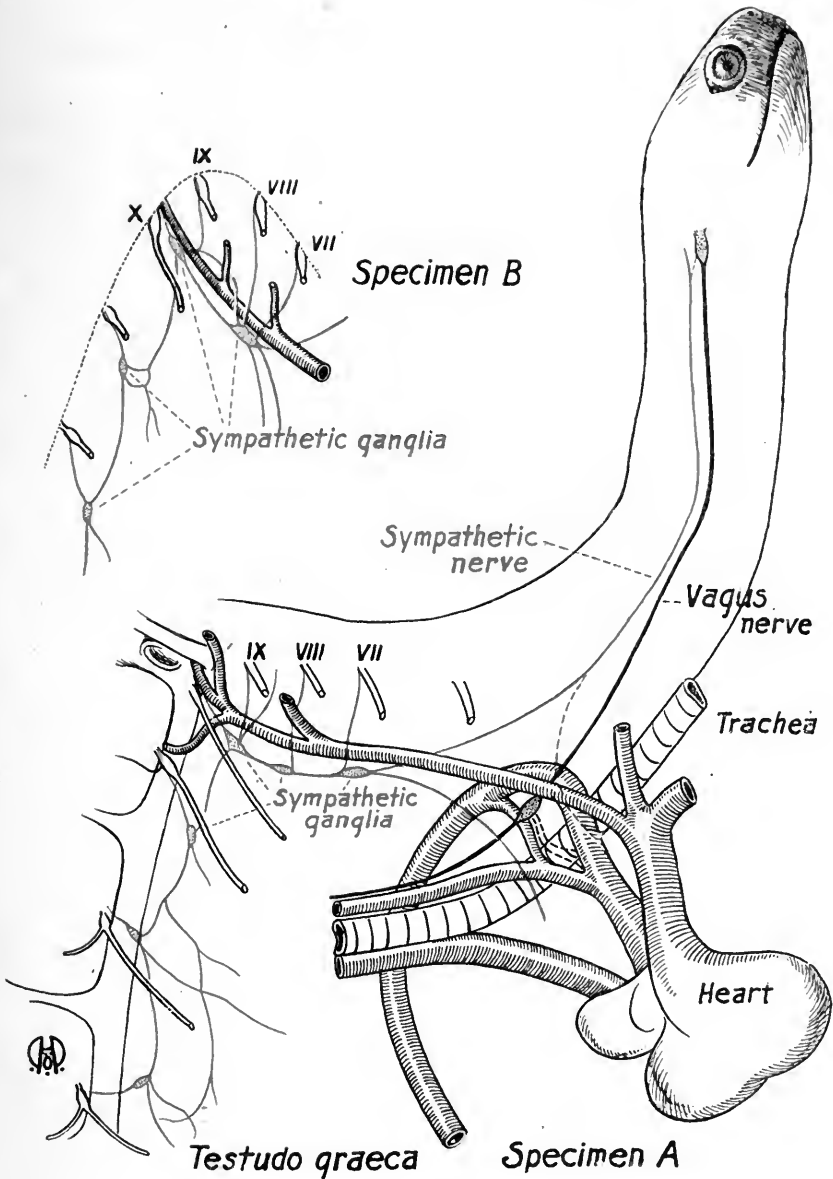

Fig. 70.—Schematic representation of the vagus and sympathetic nerves in a turtle (*testudo graeca*). (Modified from Gaskell.) Variations in the arrangement of the sympathetic fibers were frequently found by Gaskell. (The writer has seen no instance in which the arrangement and connections of the sympathetic fibers existed as shown in this illustration, but the general plan of distribution appears to be approximately the same in all specimens.)

ulate the same nerve again with the same strength of current and determine whether or not the nervous inhibitory mechanism has been affected by the ether. Is the amplitude, the rate, or the tone of the heart affected? If the tone of the muscle is lowered how will this affect the tracing? (After the records are all obtained, draw two or three parallel lines around the drum by rotating it against the writing point of a stationary signal magnet or tambour. By comparing the general rise or fall of a whole round of heart beats with this constant line any change in muscular tone will be observed at once.)

Apply ether solution to the heart rapidly and at the proper position stimulate the vagus nerve. Take several rounds of the tracings (lowering the drum a suitable distance between each two rounds) and observe the continued action of the drug on the heart. Does the vagus nerve become more or less effective in stopping the heart? How do you explain this action? The drum may be stopped for a while at the end of each round if the changes in the heart come on very slowly.

When the heart has almost stopped, then proceed to rapidly wash off the ether with warm normal salt solution. See if you can get the heart to recover. How do you explain any peculiar rises and falls in the general contour of your tracings? How can you prevent these in later records? Were you warned about this before?

Chloroform. (Action on the Turtle's Heart.)

2. Repeat the above experiment on a fresh turtle using a saturated solution of chloroform in tap water saline. Does the chloroform affect the nervous inhibitory apparatus of the heart? What difference do you note between ether and chloroform as regards their cardiac action?

EXPERIMENT IV.

Ether, Chloroform, Ethyl Bromide. (Dog: Respiration, Blood-pressure, Cervical Vagi, and Sympathetics.)

1. (a) Read the following directions over very carefully at least once before starting the experiment. It is exceedingly important that you learn the proper technic for the following procedures correctly at the start. Arrange the table for the experiment as shown in Fig. 117.

Anesthetization of the Animal.—(a) Treat the dog gently and kindly and do not irritate or frighten it. Two

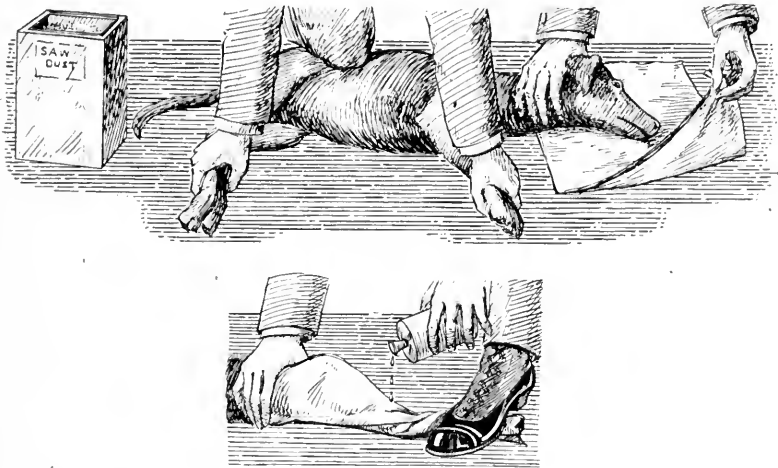

Fig. 71.—Method of etherizing a dog. The animal should not be frightened or hurt. (For description see text.)

(or three) students should apply the anesthetic. The animal is caught by the head and legs and gently placed on its *left side* (*why left?*). If the animal is vicious it should be muzzled at the start. The anesthetizer seizes the head gently but firmly and lays it down on a towel which has already been placed flat on the floor (Fig. 71). The head is held by the right hand and the ends of the towel are

brought up separately and wrapped about the head. The right hand then carefully seizes the towel and holds it tightly around the neck of the dog. The towel thus forms a kind of sack or tube around the dog's head. The distal end of this sack is now seized with the anesthetizer's left hand and twisted around two or three times and then placed flat on the floor where it is held down firmly with the anesthetizer's *left foot*. Both the anesthetizer and the assistant should stand *behind* the dog. (Why?) The assistant reaches forward over the animal and holds both fore feet in the left hand and the hind feet in the right hand. To prevent the dog from getting up the anesthetizer holds its head firmly down to the floor with his *right* hand and the assistant places one (or both) knees on its body. If the dog is muzzled, two students can thus control almost any dog with but little trouble. (In practice one seldom muzzles the dog.)

Caution.—There should always be kept in plain view and in easy reach in the laboratory a bottle of carbolic acid solution and a bottle of alcohol. These should be kept together and a toothpick with a little cotton wrapped around one end should be stuck in the cork of the carbolic acid bottle. One never knows when a student may be bitten by a dog, and as all dogs or cats are subject to rabies, any wound made by the animal's teeth or claws should be cauterized with carbolic acid *immediately*. This is done by wetting the cotton on the toothpick with the acid and applying it to the wound. In a few seconds the acid will penetrate the tissues as deeply as the virus has probably gone and then the acid should be carefully washed off with the alcohol. This dissolves out the acid and removes it. The acid may cause the tissues to take on a whitish, cooked appearance, but the alcohol often removes this entirely. *Do not kill the animal if the wound appears at all dangerous.* Save it carefully for diagnostic purposes. Consult a first-class bacteriologist or the city health department.

As shown in Fig. 71 the anesthetizer now drops some ether on the towel in front of the animal's nose. The dog will struggle some and should be held firmly. With sufficient ether the animal should be anesthetized in about two minutes. Be sure the dog gets sufficient air through the towel. *Watch the respiration closely.* The animal will

likely hold its breath at the start. The danger signal after this preliminary holding of the breath is *stoppage or great shallowness of the respiration*. Avoid this carefully. When the limbs become limp and drop down flaccidly when lifted and turned loose then touch the cornea gently and see if the dog winks. If not, hastily place it on a dog board on the table (Figs. 20 and 72). The animal's head is quickly drawn forward between the upright posts and the rod is pushed through between the teeth (just behind the long

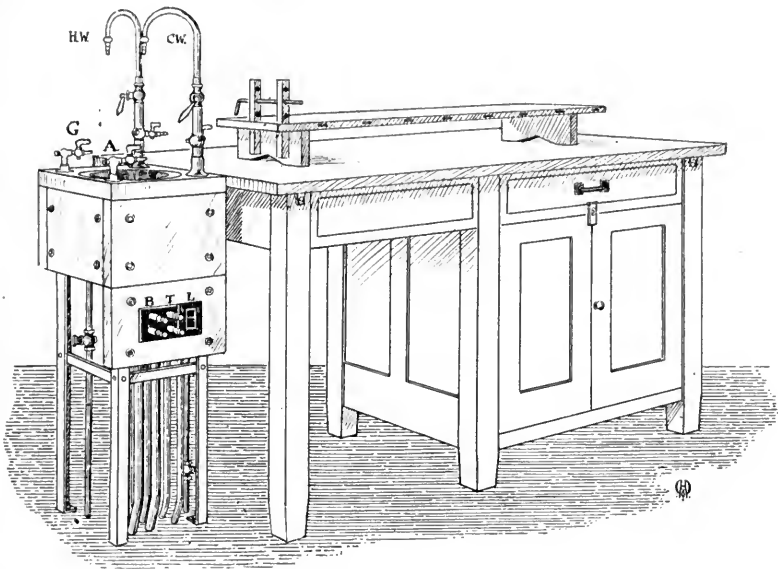

Fig. 72.—Laboratory table. The top of the table is $5\frac{1}{2}$ feet long and 33 inches wide. The height is 35 inches. The small square stand at the head of the table is 13 inches square at the top and has a small (7 inches) round sink in the center. Gas (*G*), air (*A*) (positive or negative pressure, constant or interrupted current), hot (*HW*) and cold (*CW*) water, inductorium or battery current (*B*), clock current (*T*), and drop light circuit (*L*) are all connected with the (immovable) square stand. The piping for the water, electricity, etc., runs in the floor. One locker and one large drawer are available on each side of the table. The dog board is in position on the table. The sink, etc., should be at the end of the table toward the window.

canines). A heavy twine about sixteen inches long should have been previously laid across the board just back of the upright posts. When the rod is pushed in this twine is then ready to be brought up at once and *tied as tightly as possible* around the dog's mouth *just back of the rod*.

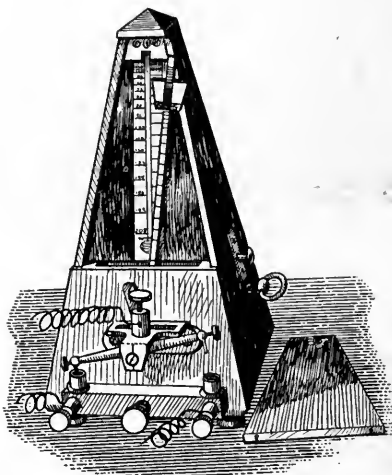

Fig. 73.—Metronome for operating the electric time signal.

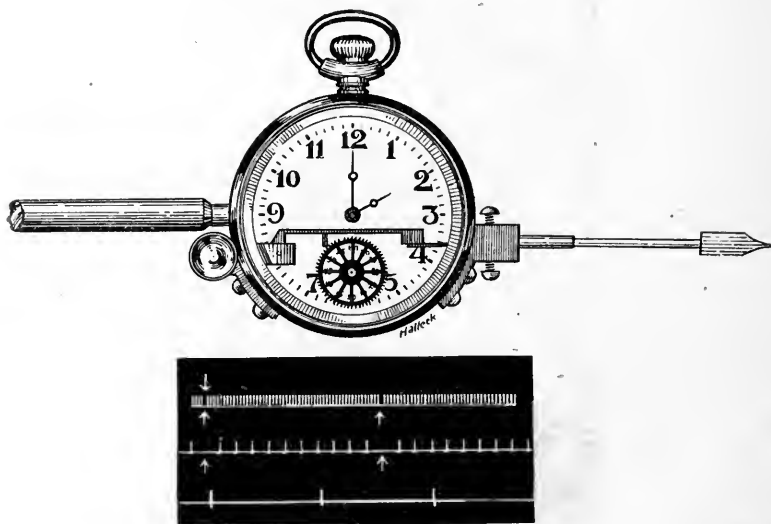

Fig. 74.—Lieb-Becker time marker made from an Ingersoll watch. Time intervals of 1 second, 5 seconds or 1 minute may be recorded. Obtainable from Mr. J. Becker, Terrace Avenue, Maywood, N. J. Price \$5.50. (See C. C. Lieb: *Jour. of Pharm. and Exper. Therapeutics*, 1917, 9, 227.)

The operator uses both hands to draw this string tight, and when the first knot is tied the assistant places his *right thumb* over the knot to hold it tightly while the second knot is tied. *Why should this string be tied so tightly?*

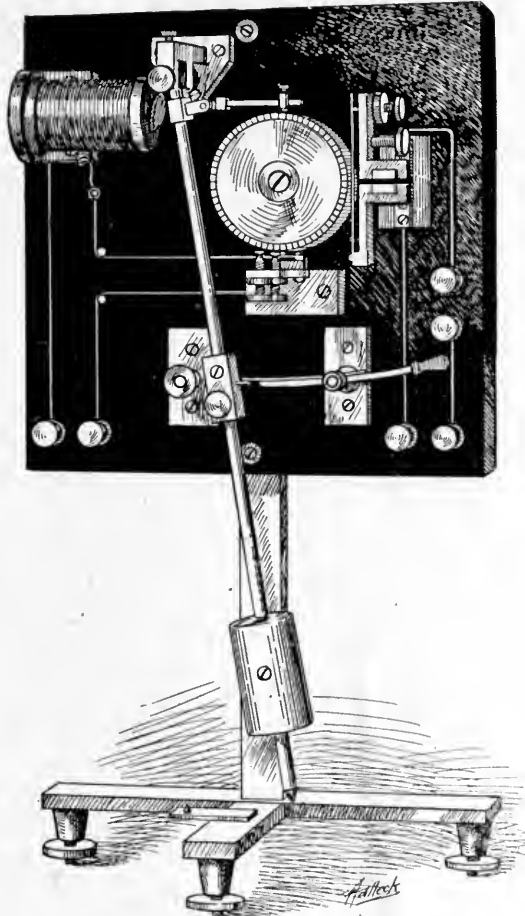

Fig. 75.—Harvard time clock.

The average student will probably find out before the first experiment is finished. The towel is now quickly tucked down over the dog's mouth and nose and a little ether is poured on. The most *steady and reliable* student in the

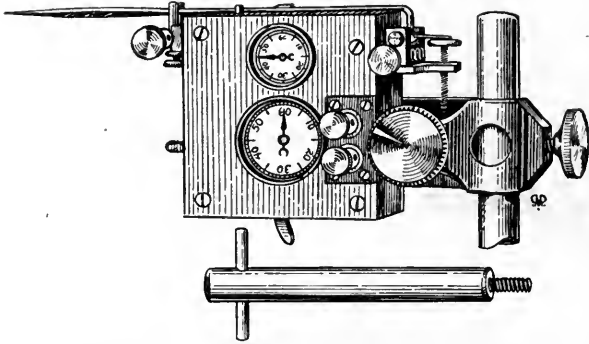

Fig. 76.—Jaquet chronograph (records in intervals of $\frac{1}{5}$ second and 1 second).

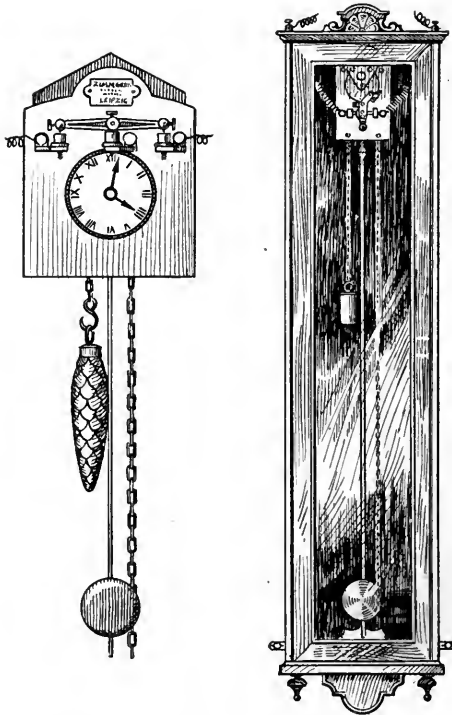

Fig. 77.—Two forms of time clocks. (Both made by E. Zimmermann, Leipzig and Berlin.) The large clock (Bowditch-Baltzar) marks intervals of 1, 2, 3, 4, 5, 10, 15, 20, 30 and 60 seconds.

group now takes charge of the anesthetic and henceforth *directs his attention solely to this work*. Quickly slip the cords (each of which has a slip noose, Fig. 79) over the

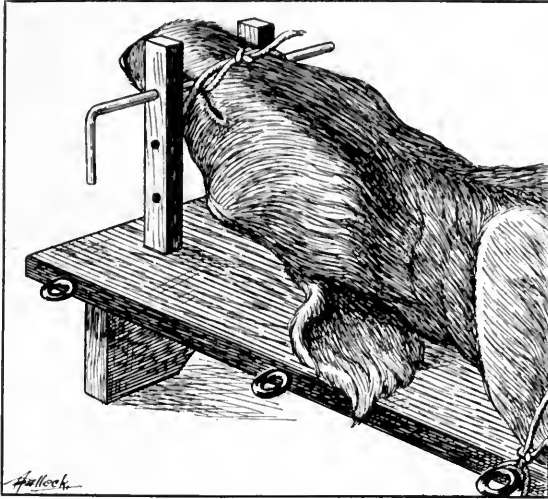

Fig. 78.—Method of fastening the animal's head to the dog board.



Fig. 79.—Heavy string with slip noose ready to put around the fore limb.

fore legs up to the elbows (Fig. 80). Draw these cords tightly and then wrap the ends around the screw eyes at the edge of the dog board (Fig. 81.) After the third or

fourth round draw the end of each cord in between the screw eye and the edge of the board. This will usually

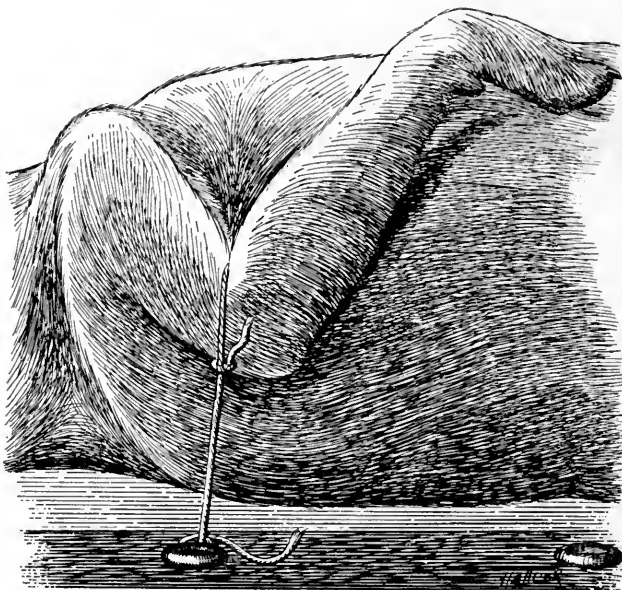

Fig. 80.—Method of attaching fore limbs to the dog board.



Fig. 81.—Method for quickly fastening the string to the board without tying any knots.

hold tightly and saves tying any knots which should be avoided if possible. Stretch out the hind legs and tie them down as shown in Fig. 82.

(b) **Insertion of Tracheal and Carotid Cannulas; Isolation of Vagi and External Jugular Vein.**—As soon as the animal is securely fastened down, a median incision is made in the skin and fascia over the trachea as shown in Fig. 83. Observe with great care the technic shown in the illustration and follow it carefully. Next take two aneurism

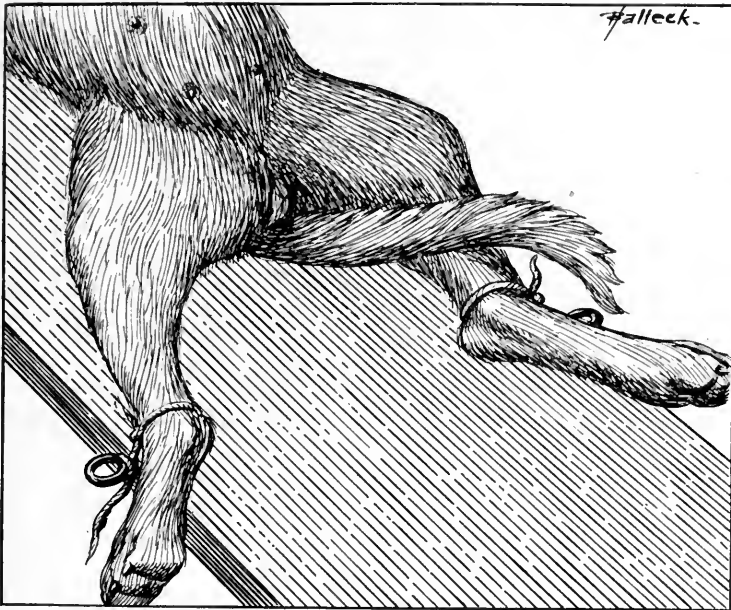

Fig. 82.—Method of fastening the hind limbs.

needles and separate the mesial borders of the sternohyoid muscles as shown in Fig. 84. This brings into view the trachea (Fig. 85) with the carotid sheath containing the carotid artery and vago-sympathetic nerves on each side (posteriorly) of the wind-pipe. Next take an aneurism needle and hook it under the trachea as shown in Fig. 86. With the largest forceps pick up by one end the heavy twine to tie in the tracheal cannula. While holding this in the forceps lift up the trachea with the aneurism needle and push the forceps (holding the twine) through the

fascia back of the trachea. About half the length of the forceps is pushed through below the trachea and the forceps are thus left in place to hold up the trachea. The end of the twine is taken out of the forceps and the twine is drawn through a *little over half its length* (Fig. 87). The

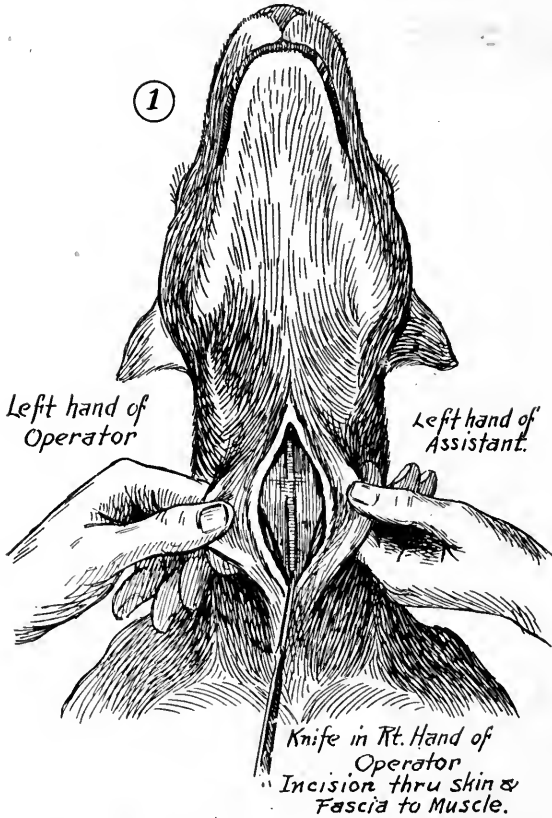

Fig. 83.—Method of incising the skin over the trachea.

twine is then tied loosely and with scissors the trachea is cut *crosswise about three-fourths in two* (Fig. 87). With *large sharp-pointed forceps* the operator (right hand) now holds open the cut portion of the trachea while the assistant (right hand) pushes in the tracheal cannula (Fig. 88). This is at once tied in and connected with the ether bottle

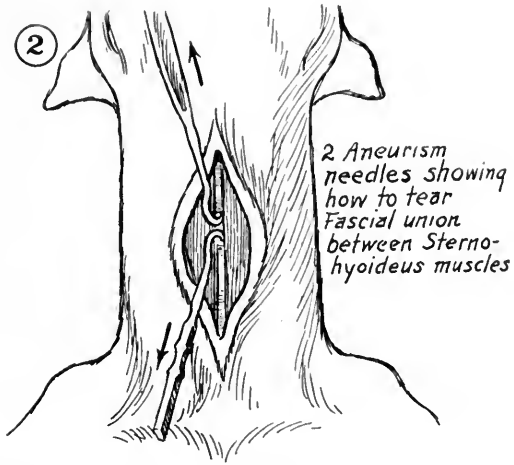

Fig. 84.—Separation of the borders of the sternohyoid muscles with two aneurism needles.

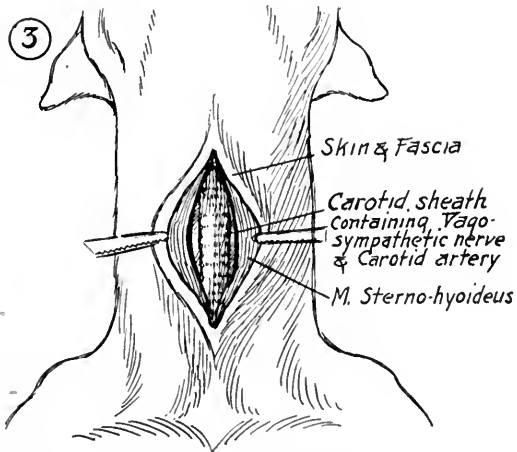

Fig. 85.—The trachea is exposed and the carotid sheath is seen just to the postero-lateral border of the windpipe.

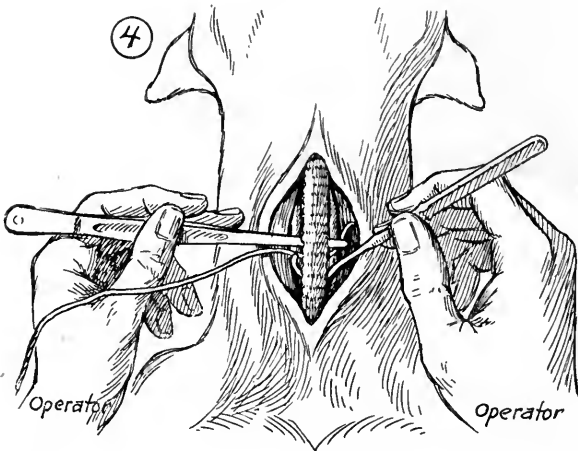

Fig. 86.—An aneurism needle is used to lift up the trachea while the forceps (holding the end of a heavy string) are passed beneath the trachea.

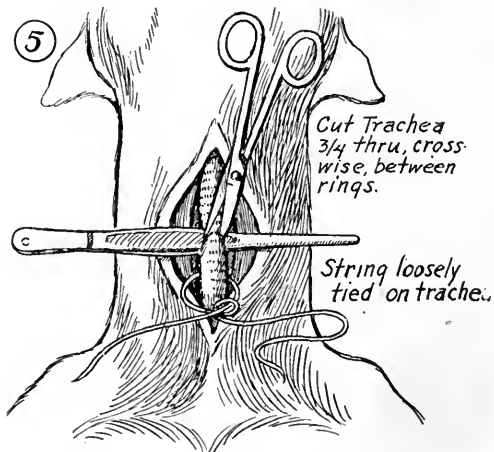

Fig. 87.—The string is tied loosely and the forceps are left in position to hold up the trachea which is cut *crosswise* about three-fourths in two with the scissors.

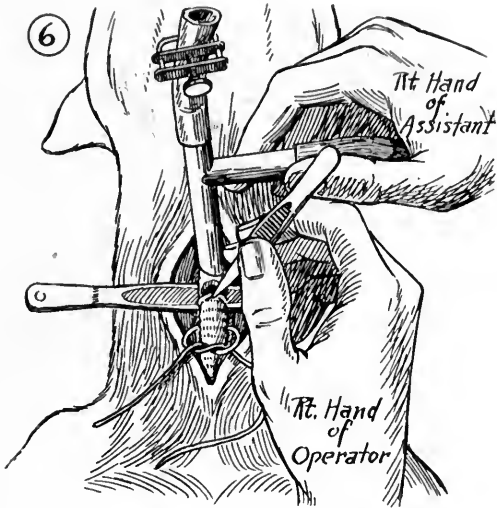

Fig. 88.—Insertion of the tracheal cannula.

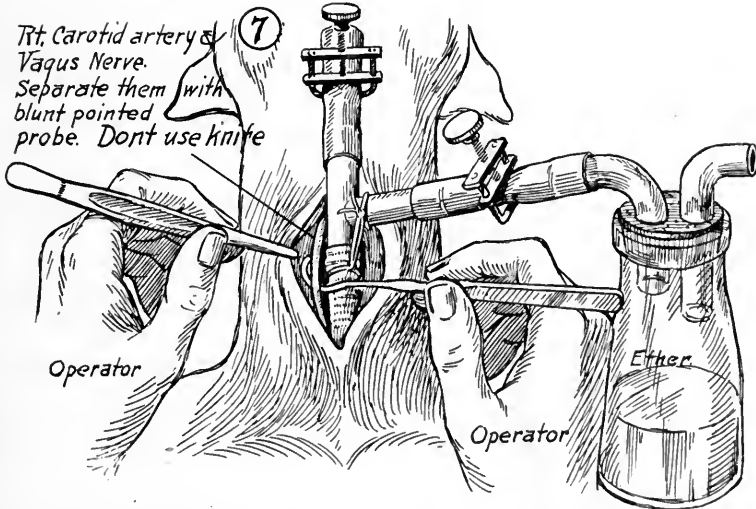

Fig. 89.—Lifting up the right carotid sheath on an aneurism needle. A blunt probe is then used to separate the vago-sympathetic trunk from the artery.

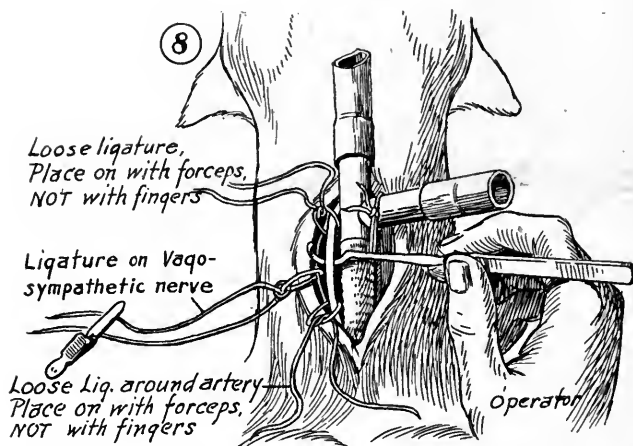

Fig. 90.—Ligation of the carotid (in two places) and vago-sympathetic nerve.

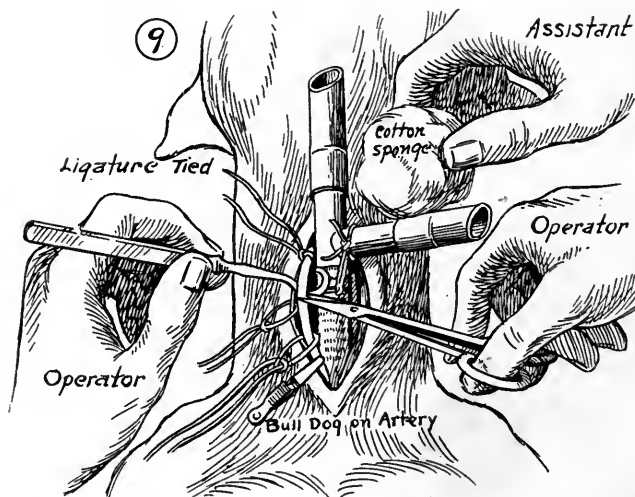

Fig. 91.—Opening the carotid artery. (The incision should be made nearer to the upper ligature and the scissors should point more toward the heart than the picture indicates.)

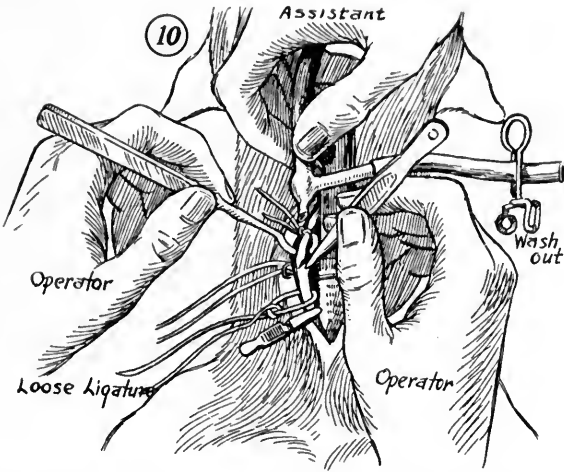

Fig. 92.—Insertion of the arterial cannula. The cannula and tubes contain no solution; this is run in later after the cannula is firmly tied into the artery.

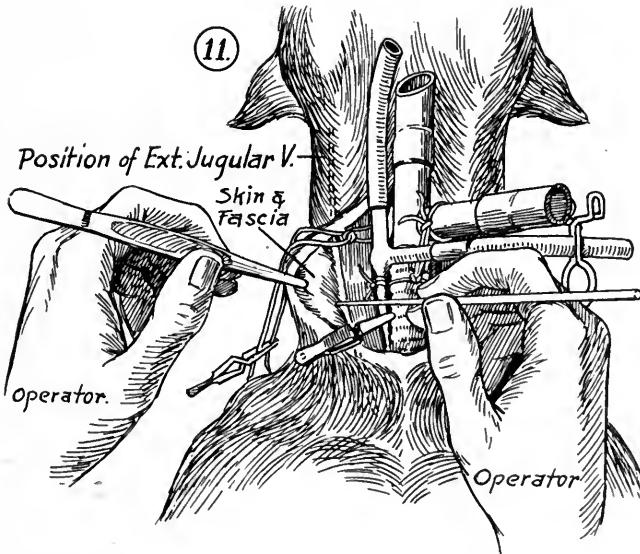

Fig. 93.—The cannula is tied into the artery. The right external jugular vein is dissected out by pulling the skin outward while the muscles and fascia are scraped back inward with the probe. The vein lies in the fascia as indicated.

and the screw clamp on the straight end of the cannula is adjusted to make the dog breathe just enough ether to keep the anesthesia constant (Fig. 89). The forceps beneath the trachea are withdrawn and the aneurism needle is hooked under the right carotid sheath which is lifted up out of the wound (Fig. 89). With a *blunt-pointed probe* the sheath is opened and the carotid artery and vago-sympathetic trunk are separated. A ligature is placed under the nerve and tied loosely. A bull-dog clamp is placed on the ends of this ligature (Fig. 90) which is now dropped down beside the neck. Similarly with forceps two more ligatures are placed on the carotid artery and tied loosely (Fig. 90). It is extremely important that the student learn to do these operations *with his dissecting instruments—not with his fingers* except to tie knots, etc. Many students bring with them from their anatomy courses an absurd notion that they should do most of their dissections with their fingers. Learn to use your dissecting instruments. That is the only royal road to first-class operative success. Place a bull-dog clamp (serrefin) on the carotid low down in the neck and tie tightly the upper ligature. The lower ligature lies close to the bull-dog (Fig. 91). Place the scissors ready to cut the artery about half in two at a point *just below* the upper ligature. (Why here?) The assistant holds a piece of cotton just over the end of the scissors to catch any blood that may fly out of the segment of artery as the operator cuts with the scissors (Fig. 91). With the large sharp-pointed forceps the operator now holds open the artery while the assistant pushes in the arterial cannula (Fig. 92) which is already connected with the manometer. The washout tube and clip are also on the side tube of the cannula. *There is no fluid in the cannula or tube connecting it to the manometer.* This fluid is run in *later when the operation at the neck is complete.* If the tip of the cannula does not enter the artery readily the cannula should be dipped into a beaker of water and then inserted into the artery. *This is the usual method to*

get a cannula into a vessel. The cannula is now tied in the artery (Fig. 93). (If desired for injections the right external jugular vein may also be dissected out just beneath the skin and fascia of the neck—Fig. 93.)

In a similar manner isolate and ligate loosely the left vagus nerve.

(c) **Insertion of Femoral Injecting Cannula; Dissection of Femoral Artery and Vein and Saphenous Nerve.**—Ob-

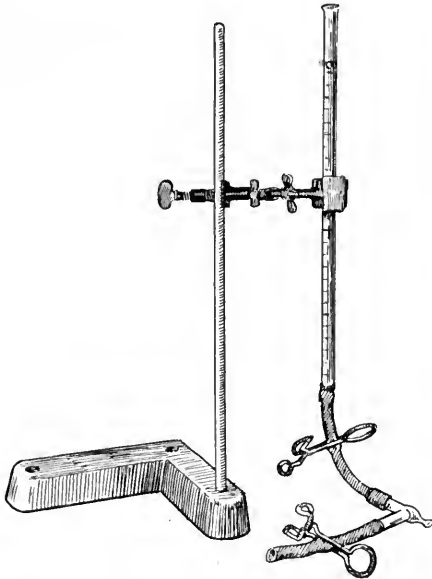

Fig. 94.—Burette, tubing, clips and cannula arranged for connecting with a vein for injection of drugs.

serve with great care the arrangement of the apparatus shown in Fig. 94. Solutions to be injected into the veins are placed in the burette. The cannula is tied in the vein, a bull-dog clamp being always left on the vein just proximal to the cannula. When injections are made the bull-dog is loosened and the dose is measured by opening cautiously the clip on the tube leading from the burette. As soon as the drug is injected the spring clip is closed and the bull-dog is replaced on the vein. This is a double check

for safety to prevent the unintentional injection of drugs. This cannula is exactly similar to the one in the carotid artery. Drug solutions in the burette can be changed quickly by running the solution out at the side (wash-out) tube. The burette is then rinsed with water and the second drug is poured into the burette. To get the air out of the tubing the two clips are opened a little and some of the drug solution is washed out at the side tube. The solution is caught in a beaker and returned to the burette.

When the burette is to be inserted at first some normal salt solution should be placed in the burette and a little of it run through the cannula. This wets the inside of the cannula (and tubes) and prevents air bubbles from sticking inside the cannula later on when the drug is poured in. Just as the cannula is inserted into the vein some of this salt solution is run out and the end of the vein next to the cannula is thus filled with solution and the air is driven out. If air is left in the tubes, cannula or vein, then the animal may die of air embolism when the drug is injected. *Always carry out this technic when putting an injecting cannula into a vein.*

To dissect out the right femoral vein consult Fig. 199. Place the tip of the finger in the inguinal region just at the lower outer edge of the abdomen. The pulsations of the femoral artery will be felt just beneath the skin. With the large forceps pick up a narrow fold of the skin directly over the pulsations and cut this fold away *with the scissors* as shown in the illustration. *Do not use a scalpel.* When the skin and fascia are thus cut away an opening resembling that shown in Fig. 95 will be made. With a blunt-pointed probe dissect away the fascia between the sartorius and adductor muscles. The vessels will be seen in the floor of this triangular space as shown in Fig. 96. Use only the *probe or blunt-pointed forceps* for the dissection. When about one-half inch of the vein has been freed from the fascia slip an aneurism needle under the vessel and lift

it up. Free it from fascia for a distance of three-quarters or one inch and then *with the forceps* place two ligatures loosely under it. Tie these loosely and place a bull-dog on the vessel close up to the proximal end of the freed space. The distal ligature is now tied tightly, the vessel is

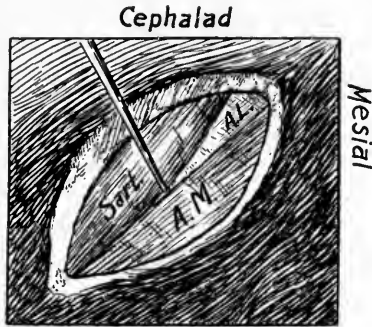

Fig. 95.—A blunt probe is used to dissect the fascia away from the femoral artery and vein.

lifted on the aneurism needle, and with the scissors a cut about three-fourths across the vessel is made close to the distal tied ligature. If the segment of the vessel was full of blood the assistant should hold a piece of cotton over

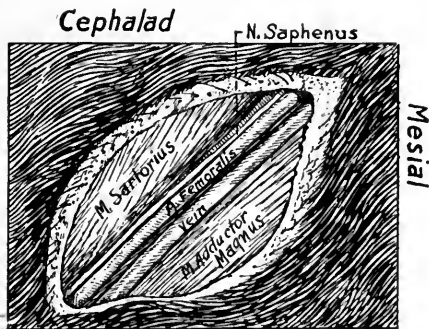

Fig. 96.—Position and relations of the vein, artery and nerve.

the points of the scissors as the cut is made. The operator now holds the vessel open (*supporting it on the hook of the aneurism needle*) with the large sharp-pointed forceps while the assistant inserts the cannula, running out a

little salt solution at the same time. The cannula is now tied in and the remaining salt solution is run out through the side tube. The relations of the vein, artery, and nerve are shown in Fig. 96. *You will need to know these relations well for future operations.*

Now pour into the empty burette about fifteen cubic centimeters of adrenaline solution 1-10,000 (Parke, Davis and Co., adrenaline chloride; or synthetic levorotatory adrenaline, Farbwerke-Hoechst Company, New York. The former is advisable). Wash out a little of the solution to get all air out of the tubes. Save the solution washed out and return it to the burette.

(d) **Recording Blood-pressure.**—Bring the writing point of the manometer (mercury) to the smoked surface of the drum. It is exceedingly desirable for the manometer to carry a signal magnet which marks the base line, or line of zero pressure, and at the same time marks the time intervals as recorded from a master clock, Jaquet chronograph, metronome, or other time recording device. The construction of the manometer is shown in Fig. 6. This illustration also shows the method of connecting the manometer to the pressure bottle. The best anti-coagulating solution to be placed in the pressure bottle for filling the tubes, right limb of the manometer and the cannula, is a solution of sodium citrate (5 to 10 per cent). (Several other salts, Na_2SO_4 , NaHCO_3 , MgSO_4 , etc., in varying strengths, are sometimes used.) The signal magnet point should mark about three-fourths of an inch *to the left of the manometer pointer*. This avoids breaks in the time record in the early part of the tracings. Hold a battery jar under the wash-out tube and open the corresponding clip. Now open the clip at the top of the manometer. The sodium citrate solution will quickly run down and fill the tubes, manometer, and cannula. All air will be washed out. Close the clip on the side tube while the upper clip remains open. In this manner run in citrate solution sufficient to raise the

pressure in the manometer until the manometer pointer writes about one and one-half inches above the base line. *Do not raise this pressure too high. Why?* See that both clips are tightly closed and then remove the bull-dog from the artery. The pressure in the manometer should rise sufficiently to lift the writing point about three-fourths or one inch higher than it was.

The pressure bottle should be suspended from a pulley at the ceiling and the bottle should be kept about four or five feet above the table. Some workers put the pressure bottle on the table and use compressed air to force the fluid out. The writer advises that this method be avoided at least in student work, for all the space on the table top is needed for other apparatus. Furthermore, it sometimes happens that students do not properly close the clip at the top of the manometer and then the dog may soon bleed to death by forcing blood out into the tubes and pressure bottle, while at the same time citrate solution rather quickly passes down into the carotid artery. This solution is very poisonous and soon kills the heart. If the bottle is suspended above the table the instructor can quickly see if any blood is backing up into the bottle. In addition it is much easier for the instructor to *see at a glance* just how much citrate solution each group of students has ahead for the experiment.

(e) **Recording Respiration.**—Near the middle of the thorax pass the long string of the stethograph drum under the dog (use the hook of an aneurism needle to reach under the animal) and bring it up on the opposite side. Adjust the two strings of the stethograph with a moderate tension and *clamp them together with a hemostat or bull-dog*. If too little movement is thus secured for the stethograph membranes place fairly large wads of cotton under the strings on either side of the chest. Now connect a rubber tube (which carries near the middle a T-tube with

a side tube and clip) to the stethograph drum and attach the other end of the tube to a tambour which writes on the drum. The respiratory record should be adjusted to give an amplitude of *about one inch* and should be recorded *below the blood-pressure* and about *one-half inch above the base line* (recorded by the time signal magnet on the manometer or by a signal magnet placed separately on a stand).

(f) **Adjustment of Writing Points.**—On the drum now adjust the writing point of the manometer in such a position that if the blood-pressure falls very low then the writing point will just barely pass down to the right of the respiratory tambour. *This is an important point in technic and must always be foreseen and provided for especially if three or four tracings are being recorded at the same time.* The anesthetist should have maintained an even anesthesia throughout these procedures. His guide is the depth and regularity of the respiration. After the blood-pressure record is started then it also furnishes valuable information regarding the depth of the anesthesia. The respiration, however, is the most important and should be watched closest. While the anesthetist is personally responsible for the life of the animal yet it is the duty of each student in the group to keep as careful and constant a watch on the animal as possible. Each animal lost carelessly should be carefully checked up against the anesthetist and his group, and should be duly considered in making out the respective grades at the end of the course.

There are certain objections to this method of recording the respiration, but it is probably the best one for student use.

(g) **Other Methods of Recording Respiration.**—Some workers record respiration by connecting the tambour to the side tube of the tracheal cannula. If ether is given through a bottle or if artificial respiration is suddenly

needed this method is of but little use. If the animal be kept under the influence of a hypnotic such as chloretone, then it may be of some use. It is best, however, that the method be avoided, at least by students. Cushny has devised a special apparatus for recording respiration where greater accuracy is required. The apparatus consists of a long narrow box with one-half or more of the ends (upper part) removed. The box can be turned bottom upwards over the animal as it lies on the operating table. A very thin flexible rubber membrane is stretched loosely inside the box, being attached (air tight) to the sides and ends. The bottom of the box (now turned upward) thus forms a closed cavity over the entire chest and abdomen of the animal (rabbit). When the animal inspires the rubber membrane will be lifted up and the air in the upper part of the box will be driven out through a tube to the recording tambour. Another tube in the box carries a short rubber tube and a screw clamp. This serves as an adjustable by-pass for the excess air if the tambour is too small to record all changes (as are all tambours now on the market). A small spirometer may also be used to record the respiratory movement by this method. (See also Cushny and Lieb, *Journal of Pharmacology and Experimental Therapeutics*, 1915, vi, 451.)

Another method of recording respiration consists in attaching a string to the tip of the ensiform (Xiphoid) cartilage by means of a pin hook. The string passes over pulleys to a lever (or to two connected tambours) which writes on the drum.

(h) **Beginning of the Records.**—Take the bull-dog off the carotid artery if this has not been done before and observe the blood-pressure tracing on the drum. Adjust the pointer and also the respiratory tambour if it is not already making a satisfactory record. *Do not proceed with the experiment until a perfectly satisfactory record is be-*

ing obtained. Be sure the drum is wound up and set for a slow speed.

Start the drum and take two inches of normal record.

2. Stimulate the right vagus nerve (the drum is kept going) with a moderately strong tetanizing current. What are the effects on blood-pressure and respiration? How do you explain this?

3. Open the left eye and while observing the pupil closely stimulate the left vagus nerve. What do you observe? How do you explain this? Repeat this on the right side.

4. Crowd on the ether vapor by shutting off the straight end (for air) of the tracheal cannula and shaking up the ether in the bottle. The dog thus breathes a very concentrated vapor. What effect has this on the respiration and blood-pressure? Do the heart beats become slower? Can you determine this with a mercury manometer? Increase in the amplitude (up and down) of the manometer strokes indicates a slowing of the heart. Why? What mechanical factors are involved? *Do not mistake the reflected effects of respiration on the blood-pressure for a change in the amplitude of each separate heart beat.* Allow the animal to return to normal. Stimulate the vagi nerves. Are they more or less active in affecting the heart and respiration than before? What nerves are concerned in these respiratory effects and over what paths do the impulses travel? At what points might an excess of ether affect these?

5. Give the animal a few breaths of chloroform vapor. This is best done by taking an empty ether bottle (1 pint milk bottle) and putting about two cubic centimeters of chloroform into it (Fig. 89). The cork of the ether bottle connected to the dog is now removed and inserted into the second bottle. The chloroform vapor will be quickly inhaled by the animal and there will be an immediate change in the blood-pressure and respiration. *Do not allow these changes to go too far.* Remove the chloroform bottle and allow the dog to recover. Replace the ether. This may be

repeated two or three times to secure more sets of records. Now inject one-fourth cubic centimeter of adrenaline. Do you get a normal effect? Ask the instructor about the appearance of this record. You may need a larger dose. Compare the effects of ether with those of chloroform on the blood-pressure and respiration. Which do you consider safer? Why?

6. Allow the animal to recover. Then place some ethyl bromide (3 or 4 c.c.) in a second milk bottle and attach it to the tracheal cannula. Compare the action of this drug with that of ether and chloroform. Learn the odor of each of these drugs.

7. If Harvard kymographs are being used one student should see to it that at least one well smoked extra drum is always available. Allow the animal to return to a satisfactory condition and then close off both openings from the tracheal cannula. The animal will soon become asphyxiated. Be sure you secure a good tracing of this. Observe carefully the changes in blood-pressure and respiration. How do you explain these? How do the respiratory movements affect the blood-pressure? Continue the asphyxia until either the heart or the respiration finally stops. What is the immediate cause of death? Now open the tracheal cannula and at once give the animal artificial respiration (the ether should be removed) either with a hand bellows, or better, by means of a special respiration machine (Fig. 360). Inject one cubic centimeter of adrenaline solution. The lungs should be inflated about twenty or twenty-five times per minute. Does this affect the heart or respiratory center? Continue it for ten minutes if the animal does not recover sooner. Stop when you detect sufficient signs of recovery and allow the animal to return to normal. Now give the animal sufficient chloroform to stop both heart and respiration. Immediately apply artificial respiration and try to revive the dog as you did before. Compress the chest over the heart

intermittently with both hands. Watch the movements of the manometer as you compress the heart. Does this affect the blood-pressure? Quickly inject from the burette two cubic centimeters of adrenaline solution and continue the artificial respiration and heart massage for ten minutes if the animal does not recover sooner. What treatment would you advise for threatened death under an anesthetic? How would you apply this treatment in a modern hospital? If the animal revives (it of course never comes out from under the influence of the anesthetic) then again clamp off the wind pipe and allow it to die of asphyxia.

8. If time permits make the following dissections: Open the chest by a median incision over the sternum. To do this incise the skin and fascia down to the sternum, and saw (Fig. 104) this through exactly in the median line. (See Fig. 105.) Pull open the chest from side to side and expose the lungs and heart (inside the pericardium). Inflate the lungs. Open the pericardium and expose the heart. Observe all the important structures in the chest. Cut the phrenic nerves where they lie on the pericardium. Could you make this dissection in a living animal?

9. Carefully clean up the table, manometer tubing, canulas, etc., and put away all your apparatus. *It is imperative for each group to clean up its own apparatus after each experiment.* The animal must be put in a garbage can or box with the others and should be burned in the furnace at the power or heating plant.

The records obtained during the experiment should be labeled at once. The appearance of the record can often be greatly improved by drawing a few straight lines horizontally through the tracings by rotating the drum against a stationary tambour pointer before the paper is removed from the drum. (See Fig. 190.) Rough notes should be made during the experiment. The record is varnished and dried, and the permanent notes should be written up as soon as possible.

EXPERIMENT V.

Ether, Chloroform, Ethyl Bromide. (Dog: Motor Areas, Blood-Pressure, Blood, Heart.)

1. Arrange a dog as in Experiment IV, for recording blood-pressure. Put adrenaline solution in the injecting burette (in the femoral vein). Be sure the anesthesia is regular and sufficiently deep.

2. Loosen the dog's mouth and the right fore leg. Turn the head and part of the chest over toward the left so as to leave the top of the head turned well over to the right. If the instructor advises it turn the dog's head entirely

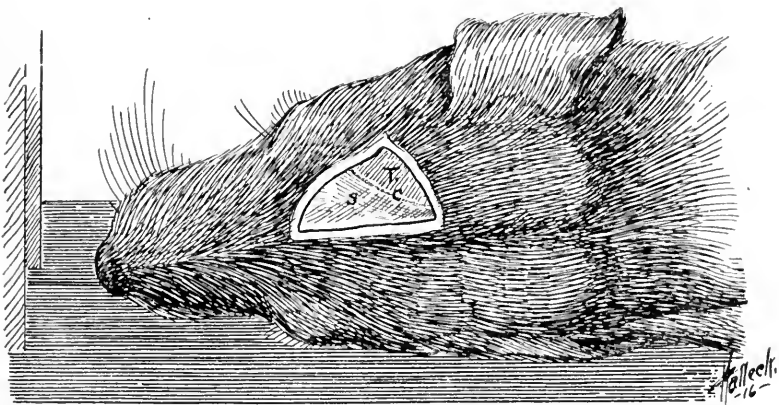

Fig. 97.—Removal of a triangular area of skin and fascia over the skull for a trephine opening.

over so that the top of the skull is directed upward. In this case watch that the respiration is not hampered or that the carotid or tracheal cannulas do not become disturbed by compression of the carotid artery or trachea. Observe Fig. 97 carefully. Make a median longitudinal incision in the skin and fascia down to the skull as shown in the illustration. With large scissors (Fig. 98) cut out a triangular piece of skin and fascia. At the place marked

“C” in Fig. 99 a curved line will mark the point of attachment of the temporal muscle (*T*). With a scalpel cut the edge of the muscle loose from the bone exactly in this line. Now dissect the muscle loose from the skull by cut-

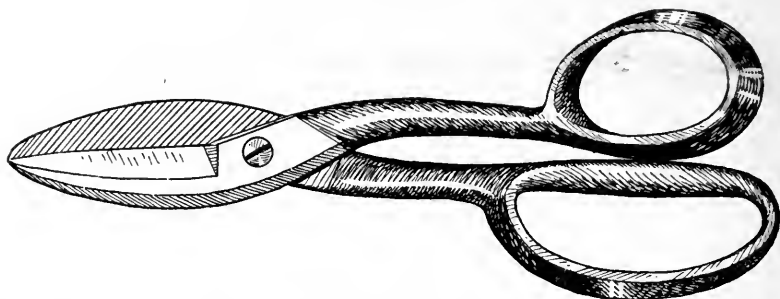

Fig. 98.—Six inch tinner's snips used for cutting thick skin and fascia, etc.

ting the periosteum from the bone and reflecting the muscle outward from the median line. Be sure to keep the dissection and cutting close down to the bone to avoid the

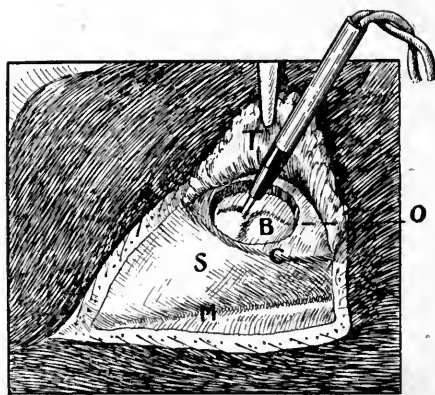

Fig. 99.—A trephine opening (*O*) has been made in the skull (*S*) and the dura mater (*B*) beneath is exposed. The electrodes can be applied to the dura mater over the various centers in the motor area. *C*, line of attachment of the reflected temporal muscle (*T*). *M*, median line beneath which is the great longitudinal sinus.

muscular blood vessels. Pull the reflected edge of the muscle upward with a hemostat as shown in Fig. 99. Now take a trephine instrument (Fig. 100) and at a point about

one-half or three-fourths inch from the median line make an opening through the skull. (It may be necessary later to enlarge this opening.) Be sure to keep far enough out from the median line to avoid the great longitudinal sinus inside the skull (*S*). (If this is opened accidentally quickly

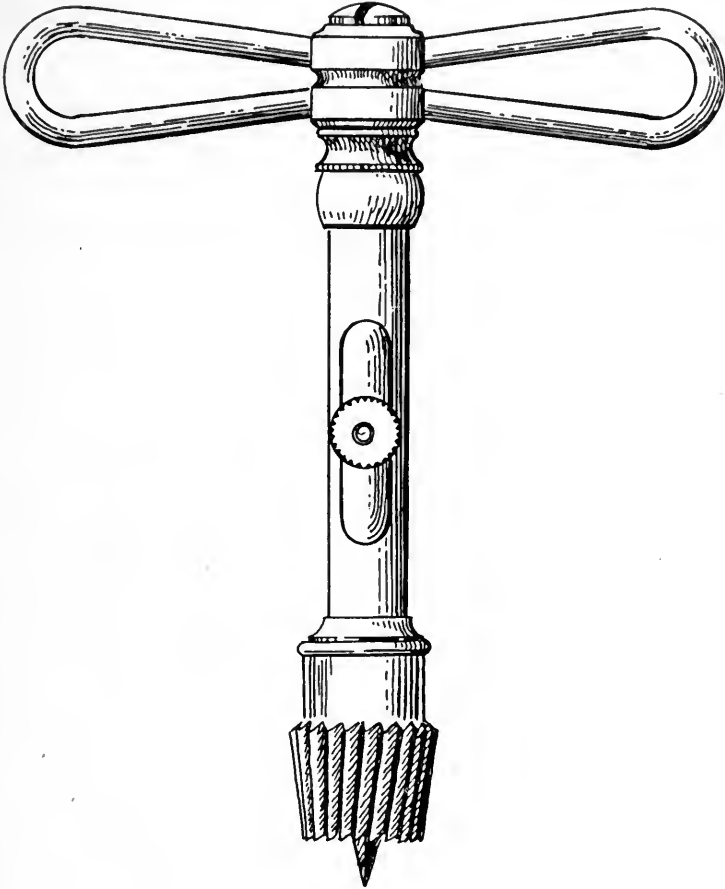

Fig. 100.—Trepine.

remove the trephine instrument and tightly plug the opening with cotton to stop the hemorrhage. Then turn the animal over and perform the operation on the left side.) Remove the button of bone and the dura mater over the

brain should be seen as shown in Fig. 99. Now allow the anesthesia to become as light as possible without letting the animal come out from under the influence of the ether too much. With the platinum electrodes (medium tetanizing current) begin to stimulate the exposed dura mater at various points. Try to pick out some centers for various muscular movements. Observe Fig. 101. Make careful

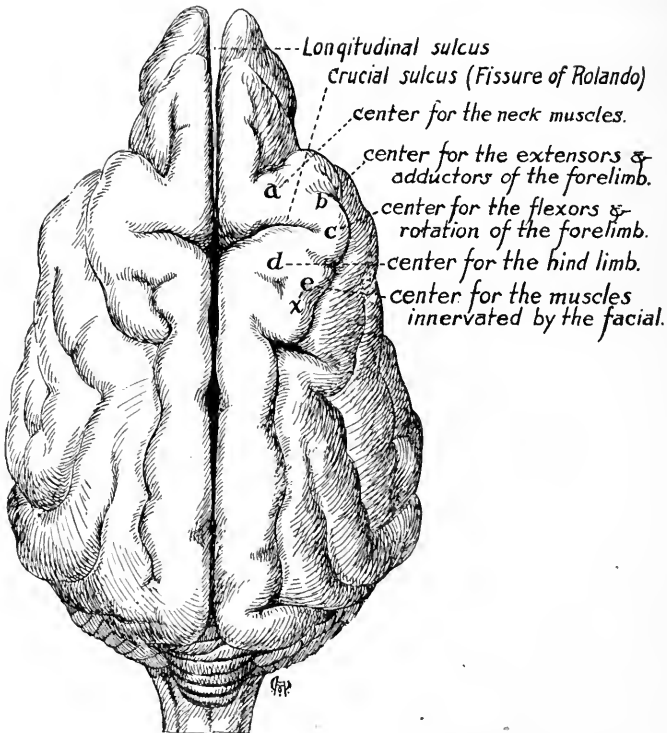

Fig. 101.—Upper surface of a dog's brain. (Modified from Sisson.)

note of the position of the electrodes for each of these centers and observe closely the extent and strength of the movements produced. *Be sure you understand the anatomy of the nervous paths by which these movements are originated and controlled.* Now deepen the anesthesia and again stimulate. Is there any change in the response of

the muscles? Again lighten the anesthesia and secure more "normal" movements. Now give the animal a little (*not too much*) chloroform and again stimulate. Are the movements affected in any way? How does this compare with ether? If the instructor advises it the action of ethyl bromide on the motor areas may be tried also. Replace the animal in the usual position and re-adjust your apparatus.

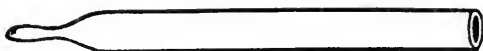

Fig. 102.—"Straight" glass cannula. Several different sizes of these are often needed.

3. Dissect out one femoral artery (Fig. 96) and place in it (pointing toward the heart) a small straight cannula (Fig. 102). Leave a bull-dog clamp on the artery proximal to the cannula. Into a test tube draw off about three or four cubic centimeters of blood from the artery, and at once pour an equal quantity of ether into the blood. Shake the two together for a few seconds and set the tube

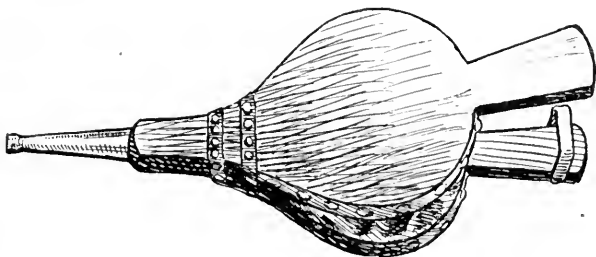

Fig. 103.—Hand bellows.

aside for two or three minutes. Then observe the appearance of the blood. Can you detect any changes? How do you explain this?

4. Repeat this with chloroform. Do these tubes of blood clot?

5. Repeat with ethyl bromide.

6. *Cardiometer*.—Arrange for artificial respiration. If

possible this should be done with a thoroughly reliable respiration machine (Fig. 360). If this is not available then use a hand bellows (Fig. 103). Prepare a needle and thread and four strong twine (heavy) strings about eighteen inches long.

With the scalpel make a median longitudinal incision in the skin and fascia over the sternum. The incision extends from the root of the neck to the end of the xiphoid cartilage. When the fascia and muscular layers come into sight a number of blood vessels will be seen passing mesially in pairs to the midline of the sternum where they pass into the chest. *Do not cut these vessels if it can be avoided*

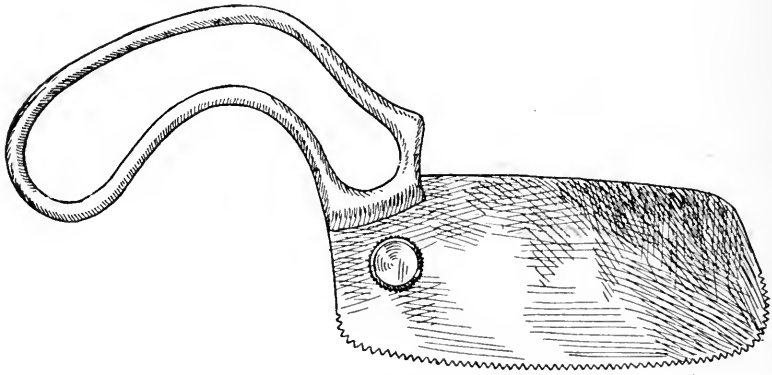

Fig. 104.—Bandage saw.

(which is sometimes impossible). In the center line it is usually possible to cut between the ends of each pair of vessels and thus avoid much hemorrhage.

If a vessel is cut clamp it with a hemostat. The bleeding should soon cease. Have plenty of absorbent cotton (in small wads) at hand to sponge off the operative field. When the center line of the sternum is reached then take a saw (Fig. 104) and saw open the chest as shown in Fig. 105. *Start the artificial respiration as soon as any opening is made into the chest. It is exceedingly important to keep the incision in the center line.* If this is done prac-

tically all important blood vessels will be avoided. Just inside the chest the mammary vessels will be found on each side of the midline. These vessels should be separated, each pair remaining attached to the under surface of its corresponding side of the sternum. If one of these vessels is cut it must be quickly caught with a hemostat and then a string is pushed (with the large sharp-pointed forceps) through the chest wall close to the *lateral sternal*

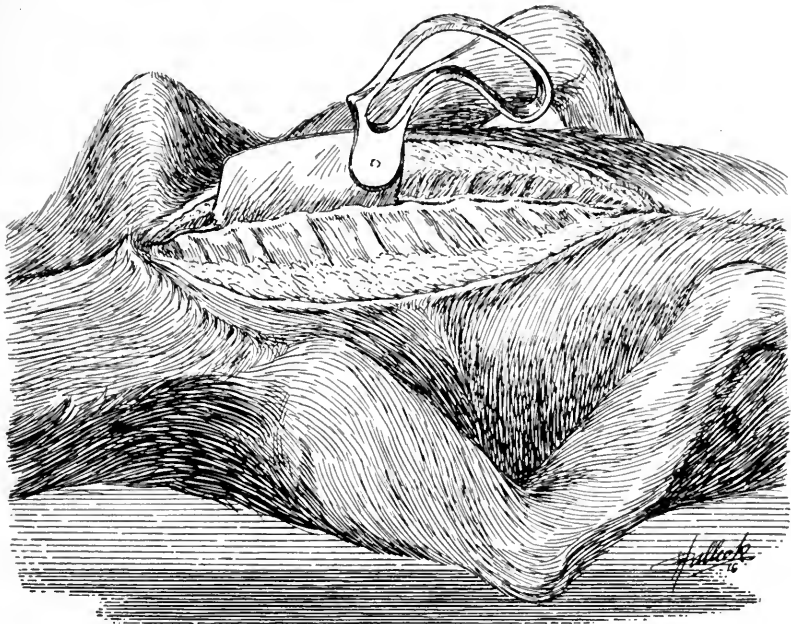

Fig. 105.—Method of opening the chest by a median incision.

border and the end brought around inside the chest. This string is now tied firmly and should shut off the vessel on *one side of the cut place*. But a second string is generally needed on the opposite side of the opening in the vessel to prevent hemorrhage from the other end of the vessel. *All hemorrhage should be checked before one proceeds with the experiment*. When all bleeding has stopped then (with the forceps) pass the four large twine strings through

the margins of the chest walls as shown in Fig. 106. Tie these ends, draw the chest wall open, and fasten the strings to the operating board as shown in Fig. 107.

This fully exposes the lungs and the heart which is covered by the pericardial sac. Did you see the anterior mediastinum? What became of it? With scissors open the pericardium in the midline. Then bring the cut edges of the pericardium out laterally and sew them (with two or three stitches on each side) to the chest wall. This forms a kind of hammock in which the heart lies. The animal must be given sufficient ether to keep it quiet all the time. Observe carefully the beating of the heart and the movements of the lungs. Did the blood-pressure fall much when you opened the chest? It should not. Does the heart rise and fall as the lungs are inflated and deflated? If so, try to reduce the extent of inflation a little and see if the animal does well (blood-pressure remains normal and convulsive movements do not appear). This rise and fall of the heart is the most troublesome thing concerned in the taking of heart tracings. Now take the cardiometer (Fig. 108) and stretch the rubber membrane outward from the opening, rolling part of the edge of the membrane back over the metal rim. Now place the cardiometer down over the heart (ventricles only, see Fig. 107) and bring the membrane down to the auriculo-ventricular groove. Roll the edge of the membrane off the metal part and allow the opening in the membrane to close around the auriculo-ventricular groove. Does the blood-pressure remain normal? If not, wait a little and if necessary readjust the cardiometer. Connect the cardiometer tube with a recording tambour which may write either above or below the blood-pressure, depending on whether the pressure is low or high respectively. Adjust all writing points and take two or three inches of "normal" tracing. The cardiometer record should be one or two inches in amplitude.

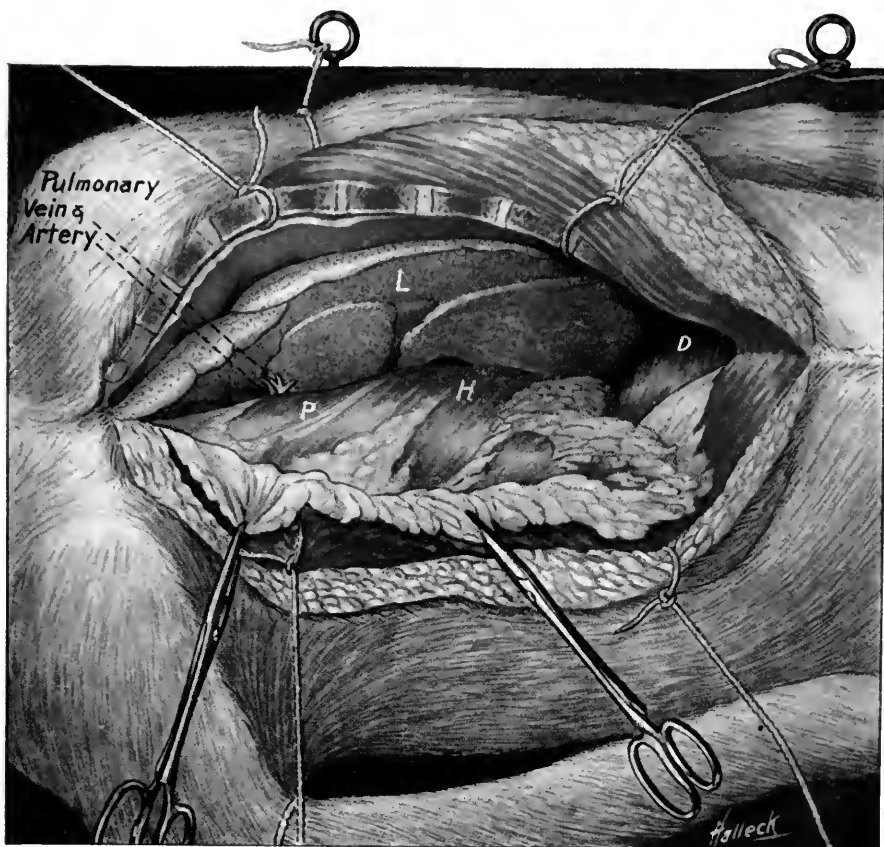
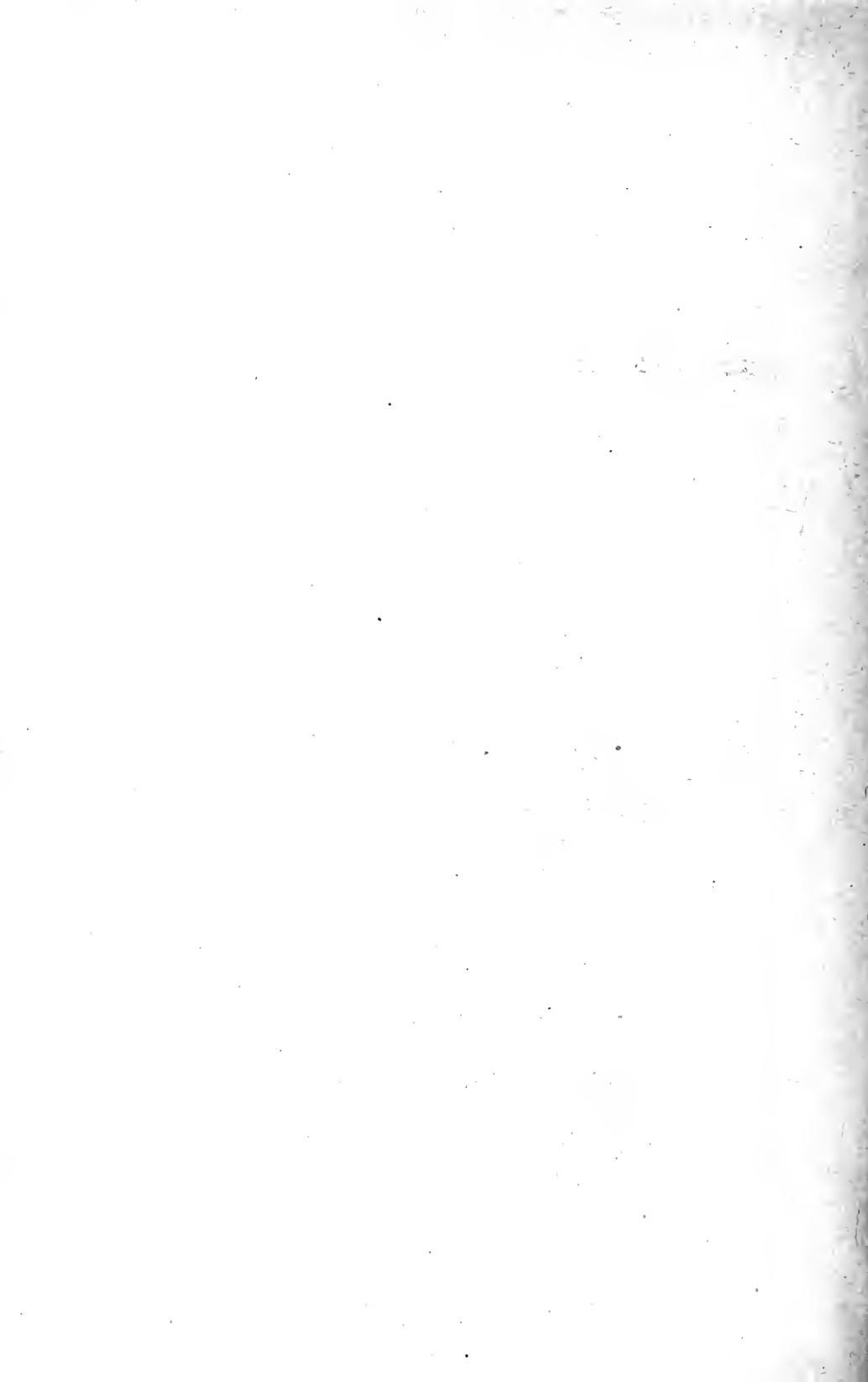

Fig. 106.—Method of exposing the left pulmonary artery and vein. *L*, lung. *P*, phrenic nerve lying on the pericardium (*H*) over the heart. *D*, the diaphragm.



Stimulate one vagus nerve and see how this affects the tracings. Allow the heart to recover and take two inches more of "normal" tracing. Now crowd on the ether and note the effect on the pressure and cardiometer tracings. What does the cardiometer tracing show with respect to the heart? Be sure you describe this fully and correctly in your notes.

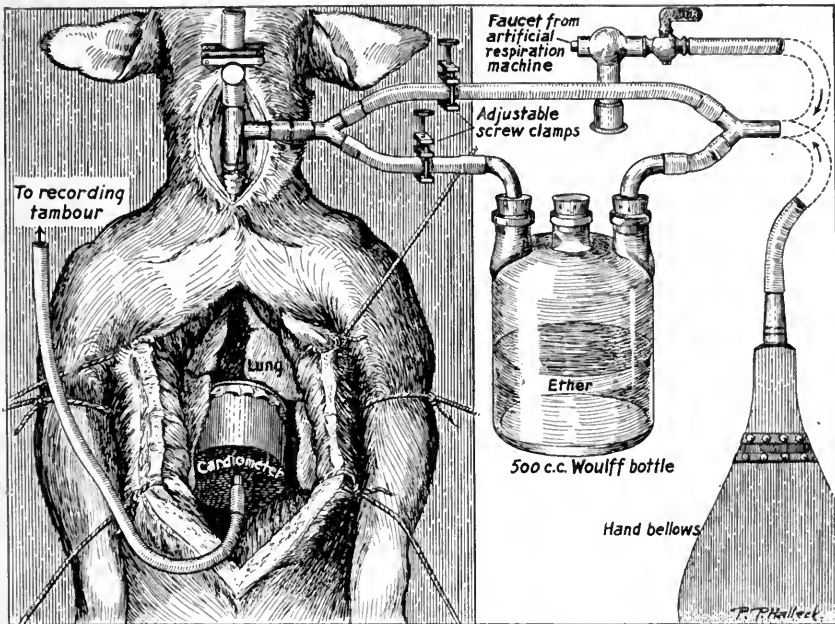

Fig. 107.—Method of applying the cardiometer over the ventricles. Artificial respiration is carried on either with a hand bellows or by an artificial respiration machine. The ether bottle has a by-pass so the amount of anesthetic can be regulated. The excess air escapes through the tube in the straight end of the tracheal cannula which is regulated by the screw clamp to give the desired amount of expansion and exhaustion of the lungs.

Allow the animal to recover and then give it some chloroform. How does this compare with ether? Now inject one-half cubic centimeter of adrenaline. How does this affect the heart? Is the drum going fast enough to show the individual heart beats?

Allow the animal to return to normal and then give it

some ethyl bromide. How does this affect the heart? Inject a little adrenaline and let the animal recover.

(It will be interesting to try ethyl chloride also. It can be sprayed into one of the rubber tubes going to the tracheal cannula. To do this an extra T-tube may be placed in the circuit.)

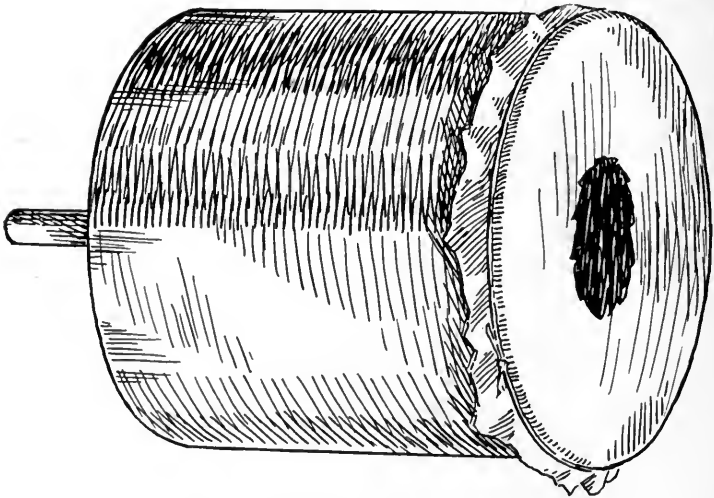

Fig. 108.—Cardiometer. (See also Fig. 143.)

7. Dissection of Pulmonary Artery and Vein.—Remove the cardiometer and cut the stitches that hold the pericardium to the chest wall. Pull the pericardium and heart all over toward the right side of the animal. Observe the left pulmonary veins at the root of the lung. Observe Fig. 106 closely. At the base of the heart observe the aorta passing back posteriorly and then turning caudalward. In the hollow of the arch of the aorta between it and the heart a curved eminence covered with white fascia will be seen coming from the base of the heart and passing downwards, outwards and backwards into the lung beneath the most prominent pulmonary vein. With a blunt probe carefully dissect away some of the fascia over the curved emi-

nence, and the left pulmonary artery can be seen passing out into the base of the lung. Place an aneurism needle beneath the artery, raise it up and clear a section of the artery about three-fourths of an inch long with the probe. Could you put a cannula into this artery and record the pulmonary blood-pressure? The heart will probably have ceased beating by this time. If it has not, stop the respiration and let the animal die. *If time permits it will be very instructive to try to revive the heart by massage and by injecting adrenaline.* Keep up the artificial respiration during these efforts.

EXPERIMENT VI.

Nitrous Oxide, Carbon Dioxide, Oxygen. (Frog: Central Nervous System.)

1. Place a frog in a one pint milk bottle as shown in Fig. 109. Arrange a nitrous oxide tank (and an oxygen tank also if the laboratory can afford one—if not omit the oxygen) as shown in the illustration. The apparatus shown in Fig. 110 may also be used if a nitrous oxide tank is not available. Observe (and count) the rate of the frog's respiration, lymph heart beats and heart beats. Note the size of the pupils, position which the frog assumes, etc. Now open the N_2O tank a little and run into the bottle a very small amount of the gas. Make a note of the time of day. *The outlet must be opened as the gas is run in, for these tanks may have 1000 pounds or more pressure to the square inch and would quickly burst the bottle or blow out the cork.* Watch the frog carefully as it begins to breathe the gas. Does it show any signs of suffocation? There was already sufficient oxygen in the bottle to run the frog some time. Gradually run in more N_2O and watch carefully for the first symptoms shown by the frog. As the atmosphere in the bottle becomes more and more filled

with the gas the frog will manifest distinct symptoms. How long does it take to completely anesthetize the animal? When this stage is reached count the respirations, lymph heart beats and heart beats. Inject a little oxygen from time to time and see if the animal comes out from

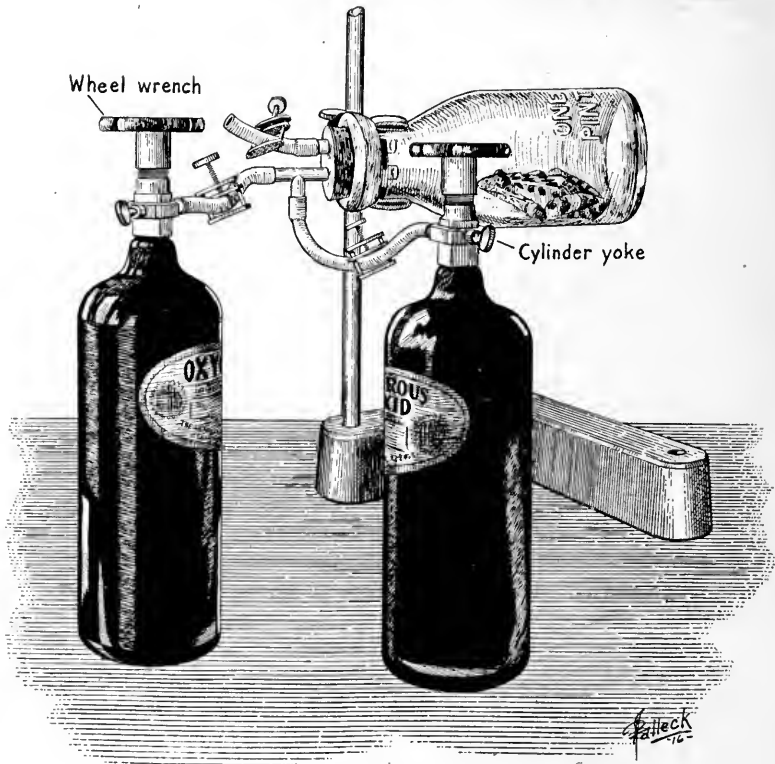

Fig. 109.—Administration of nitrous oxide or oxygen to a frog.

under the anesthetic. As the oxygen increases in the bottle the frog will recover. How long does this take and how long a time is required to anesthetize the frog in the first place? How does this anesthetic compare with ether or chloroform or ethyl bromide?

2. Place another frog in the bottle. Note the time of

day. Turn on the N_2O and fill the bottle at once with this gas (washing most of the air out of the bottle with the N_2O). How long does it take to anesthetize the frog? When

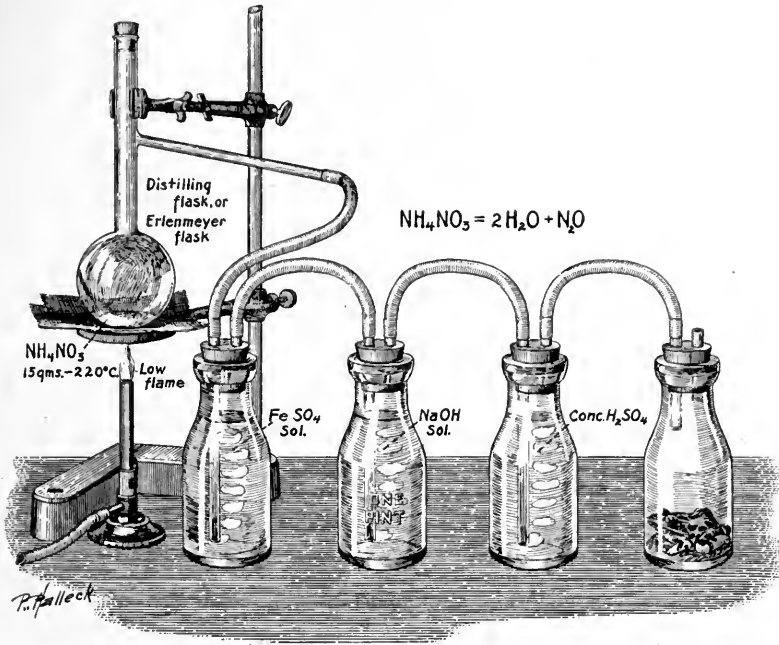

Fig. 110.—Method for making, purifying and administering nitrous oxide to a frog. Strong solutions of ferrous sulphate, sodium hydrate and concentrated sulphuric acid are placed in the wash bottles.

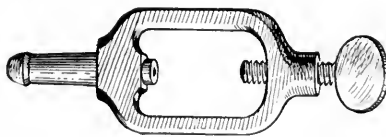

Fig. 111.—Yoke for tanks of oxygen, nitrous oxide or carbon dioxide. These yokes are attached to the tanks and a rubber tube is slipped over the nozzle of the yoke. When the valve of the tank is opened a little the oxygen passes out through the tube. The yokes can be obtained of dealers in surgical supplies or from the Lennox Chemical Company, Cleveland, Ohio (Price \$.75).

the animal is deeply anesthetized remove it quickly from the bottle and see how long it takes for complete recovery.

Keep a record of these periods of time. Does the frog again become completely normal?

3. Place another frog in the milk bottle. Now inject CO_2

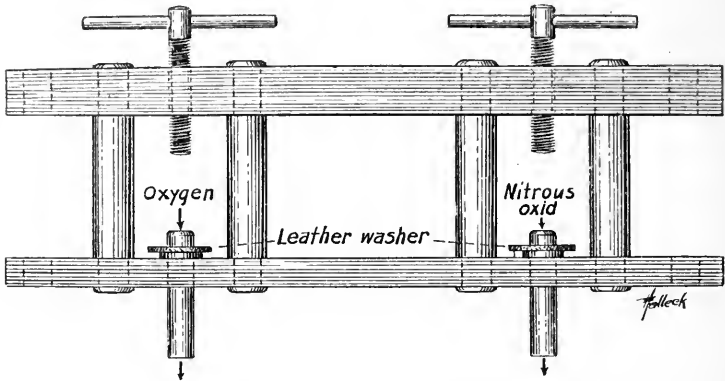

Fig. 112.—A double yoke for holding gas tanks. Made by bolting together two bars of iron.

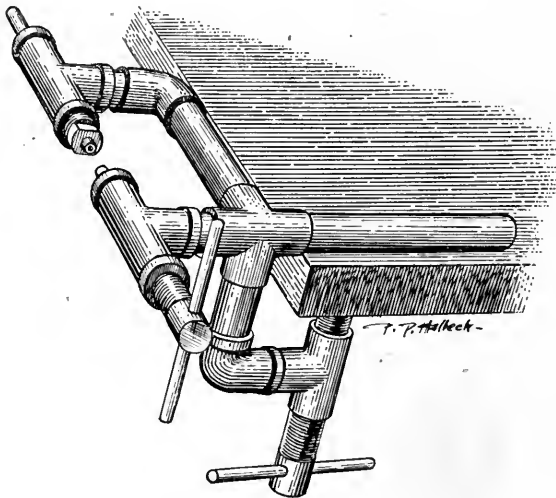

Fig. 113.—Yoke for holding gas tanks. Made of gas piping and fittings (see chapter on shop work).

into the bottle. This may be done from a tank or from a Guthrie generator (Fig. 114). Observe the effect on the

animal. How is the respiration affected? How does this compare with the action of N_2O ? If you have oxygen, run some of this into the bottle and see if this counteracts the CO_2 .

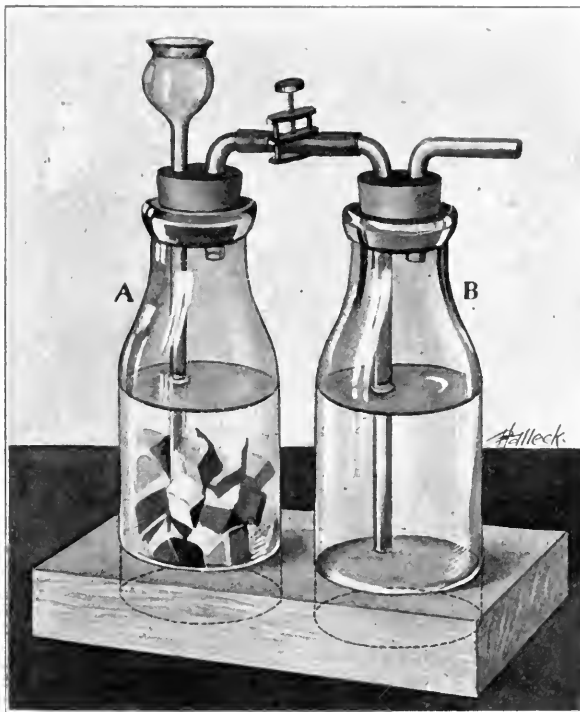

Fig. 114.—Guthrie's carbon dioxide generator. Two quart milk bottles are used to hold blocks of marble and dilute acid (A) and the wash water (bottle B).

EXPERIMENT VII.

Nitrous Oxide, Ethyl Chloride, Carbon Dioxide, Increased Atmospheric Pressure, (Decreased Atmospheric Pressure). (Frog, Guinea Pig, Rat, Kitten, or Pup.)

1. Place a frog and a guinea pig (or other small mammal—see that the frog is protected) in a large bottle arranged as illustrated in Fig. 115. Open the outlet and run

some oxygen into the bottle. What effect does this have on the animals? It is to be noted that this experiment permits comparison of the relative effects of the substances administered on warm-blooded and cold-blooded animals. The

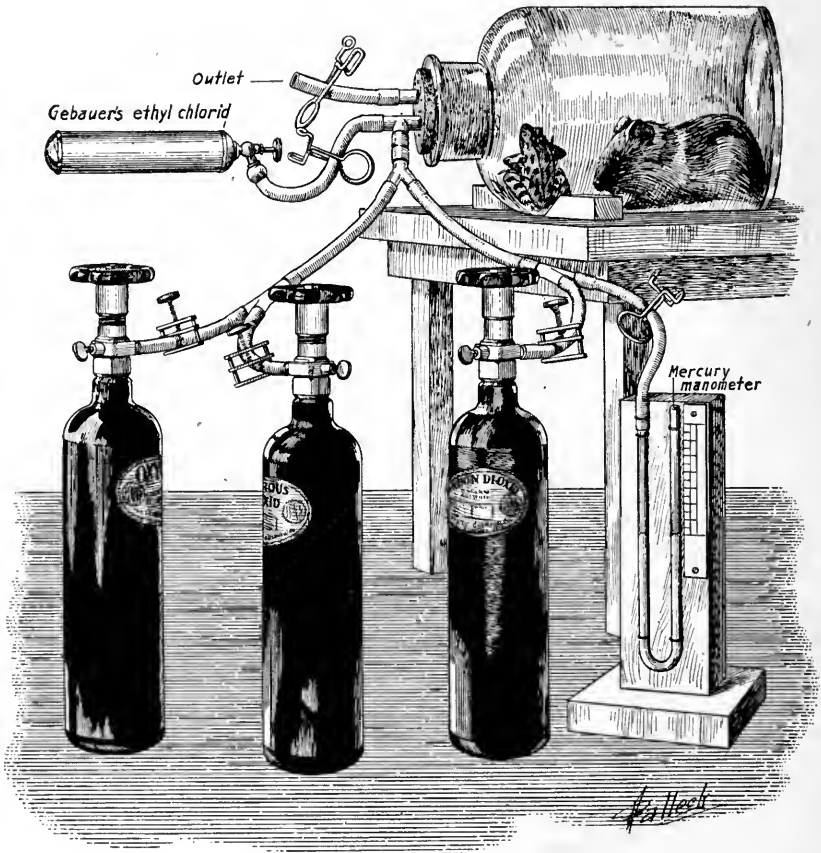

Fig. 115.—Method for studying the action of nitrous oxide, ethyl chloride, carbon dioxide, oxygen, increased (or decreased) atmospheric pressure on warm and cold-blooded animals.

skin absorption or excretion of the frog should be held in mind. Increase the amount of oxygen in the bottle. Then with the greatest caution raise the oxygen pressure in the bottle by closing the outlet and opening the clip on the tube

going to the manometer while more oxygen is run in. *Do not blow out the mercury by turning on the oxygen suddenly.* What effect has this increased pressure on the animals?

2. If a suction pump (or negative air pressure) is available this may now be used. Open the outlet and connect this to the suction pump or negative pressure faucet. Open the clip to the manometer and exhaust the air in the bottle as many centimeters of mercury as the oxygen pressure has been raised. What effect has this on the animals?

3. Wait a few minutes to note how the animals act and then again open the outlet and equalize the pressure inside and outside of the bottle. Roll up four or five sticks of sodium or potassium hydrate in wire gauze and put them in the bottle in such a position that the animals cannot touch the alkali. What is the purpose of this? Be sure the alkali does not rest directly on the bottom of the bottle. Why? Allow the animals to become quiet again and then begin to gradually run N_2O into the bottle, leaving the outlet open as gas is injected. Bring on the anesthesia by very gradual degrees and do not excite the animal if possible. Do you notice any symptoms of somnolence in either animal? Or do you note symptoms of excitement and convulsive jumping-like movements? After the animals become completely anesthetized begin to admit oxygen. How long does it take to produce complete anesthesia? Be careful that the oxygen does not become too low. If this occurs one animal may die. Which one? Is it possible for you to estimate how much oxygen (i. e., what per cent) you admit by closing the outlet and raising the atmospheric pressure in the bottle a given number of millimeters of mercury? Try to so balance the proportions of N_2O and oxygen in the bottle that you can maintain a regular anesthesia in the animals for ten or fifteen minutes.

4. Now gradually admit more and more oxygen and note

carefully the recovery symptoms. What principles are involved in nitrous oxide analgesia or anesthesia? How long does it take the animals to become normal? How does this compare with ether?

5. Remove the alkali and allow the animals to become normal, or much better, get two fresh animals (a small turtle may also be included if the bottle is large enough) and then with the animals in the bottle run in a little CO_2 . Note the changes in rate and depth of respiration if any occur. Add more CO_2 . Can you produce an anesthesia with CO_2 ? Read this up in your text. Compare the symptoms in the two (or three) animals. Allow the animals to recover.

6. **Paul Bert's Experiment.**—Replace the alkali in the bottle and again run N_2O into the bottle but leave the outlet open. In this way wash out the air and obtain almost a pure atmosphere of N_2O . *Do not waste any more gas than is necessary.* (As soon as marked symptoms of asphyxia appear add a little oxygen.) When nearly all of the air (nitrogen) has been run out of the bottle then close the outlet and wait a little if the animals are not unconscious and do not show too marked symptoms of asphyxia. Then slowly raise the pressure in the bottle by admitting oxygen. Paul Bert found that in an atmosphere consisting of eighty per cent N_2O and twenty per cent oxygen, but with the pressure raised one-fourth above the normal atmospheric pressure, a complete nonasphyxial anesthesia could be produced and maintained indefinitely. Can you repeat his experiment? What gas does an animal give off in its expired air? What is the fate and mode of excretion of absorbed nitrous oxide? In what form is it carried in the blood? How does this compare with ether and chloroform or ethyl chloride or ethyl bromide? What is the purpose of the alkali in these experiments?

7. Allow the animals to recover (or obtain fresh ones). Place them in the bottle (the alkali should also be in) and

then inject a small amount of ethyl chloride vapor. This is best done with a Gebauer tube as shown in the picture but other containers which may be used are also in the market (Fig. 54). If ampoules are used the neck should be filed a little and then the entire neck end of the ampoule is inserted like a cork (air tight) into the rubber tube going into the bottle. The outlet is opened and the neck of the ampoule is snapped off by bending the tube. The ethyl chloride is very volatile and at once rushes into the bottle. Wait a little while for the drug to act. It generally acts fairly rapidly but may require a little time for diffusion through the bottle and absorption into the animals' blood. How do the symptoms compare with those produced by ether or chloroform? How long does it take to produce complete anesthesia? If you add oxygen as needed, how long can you keep up this anesthesia with one dose of ethyl chloride? *Do not give more ethyl chloride than is absolutely necessary* or you may kill one or both of the animals. "Somnoform" or Brugg's mixture may be used also if the drugs are available (they can be bought from dental supply houses and are put up in ampoules). Similarly ethyl bromide may be used. *A small quantity* of this may be poured into the bottle through a funnel. Save all animals used until next day and observe if any permanent injury has been done to them.

EXPERIMENT VIII.

The Closed Method of Anesthesia. For Ether, Chloroform, Ethyl Chloride, Ethyl Bromide, (Nitrous Oxide), "Somnoform," etc., with Oxygen. Student Method. (Dogs or Cats.)

1. Observe carefully the construction of the apparatus shown in Fig 116. Arrange the table for operative work as shown in Fig. 117, but omit the ether bottle, substituting therefor the apparatus shown in the illustration. Into the

bottom of the large pan shown in Fig. 116 pour a layer of strong (not saturated) sodium (or potassium) hydrate solution about three-fourths inch deep. *The solution must not be warm.* Stretch the thin rubber bath cap air-tight over the rim of the large pan as illustrated. *Thereafter do not upset the pan, nor splash out the solution.* If the dog strug-

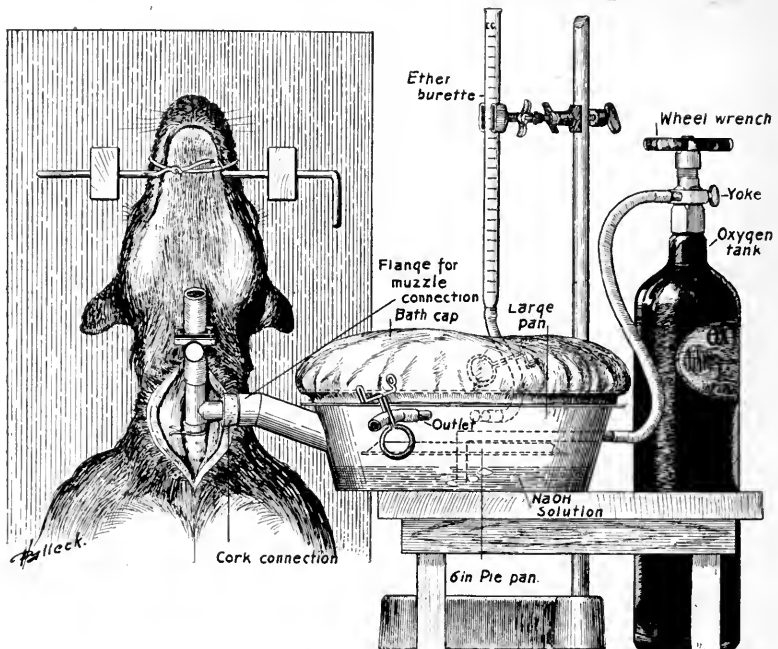

Fig. 116.—Apparatus used for closed ether (ethyl chloride, chloroform, nitrous oxide, etc.) anesthesia. A large, shallow, round cake pan covered by a thin bath cap holds the vapors or gases. The animal breathes into and out of the pan through a spout. Strong sodium (or potassium) hydrate solution (which must be cold) in the bottom of the pan absorbs the CO_2 eliminated. A diagrammatic view of the pan as seen from above is shown in Fig. 118. Oxygen is admitted as needed by the animal from the tank (or from the apparatus shown in Figs. 176 and 177). Ether or chloroform or ethyl bromide may be injected through the burette. Ethyl chloride can be sprayed in through one of the inlets. (See *Journal of Laboratory and Clinical Medicine*, 1916, ii, p. 94; also *ibid.*, 1916, ii, p. 145.)

gles this might occur, but such an accident is much more likely to happen as the result of awkwardness. Etherize the dog on the floor in the usual manner (Fig. 71). Then place it quickly on the operating board, tie it down and insert the tracheal cannula. The straight end of the can-

nula carries a short piece of rubber tubing and a screw clamp. Close the clamp and insert the side tube of the cannula into the hole in the cork, which closes the large spout from the pan. Run enough oxygen into the pan to lift the bath cap up about one inch above the top of the large pan. From the burette it will probably be necessary to inject about one or two cubic centimeters of ether into the pan before the anesthesia becomes deep enough. Do not be in too much of a hurry to add this ether, for the anesthesia should not be any deeper than is necessary. Hereafter the

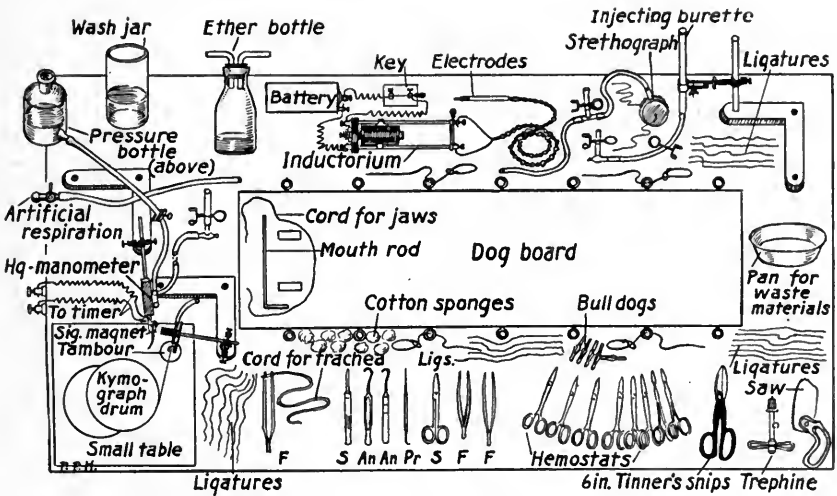

Fig. 117.—Arrangement of the apparatus on the table for performing an experiment.

anesthetist merely watches to keep a fair amount of oxygen in the pan and *at long intervals* from one-half to one cubic centimeter of ether may be injected *if needed*. The anesthesia should remain perfectly constant and regular if no leaks are present in the apparatus. These are not difficult to avoid. If the experiment is performed correctly the student will be impressed with the *ease and certainty* with which a perfect anesthesia can be maintained for long periods of time. If too much ether (or other anesthetic) gets into the pan open the screw clamp on the tracheal cannula

and allow some of the vapor to escape. Then refill the pan with oxygen. This method is new. Students are advised to study it carefully. Is there any danger of the respiratory medium becoming too moist? Are any volatile poisons given off in the breath that might accumulate in the breathing space? Will the smaller percentage of nitrogen in the air breathed by the animal influence the anesthesia? Will

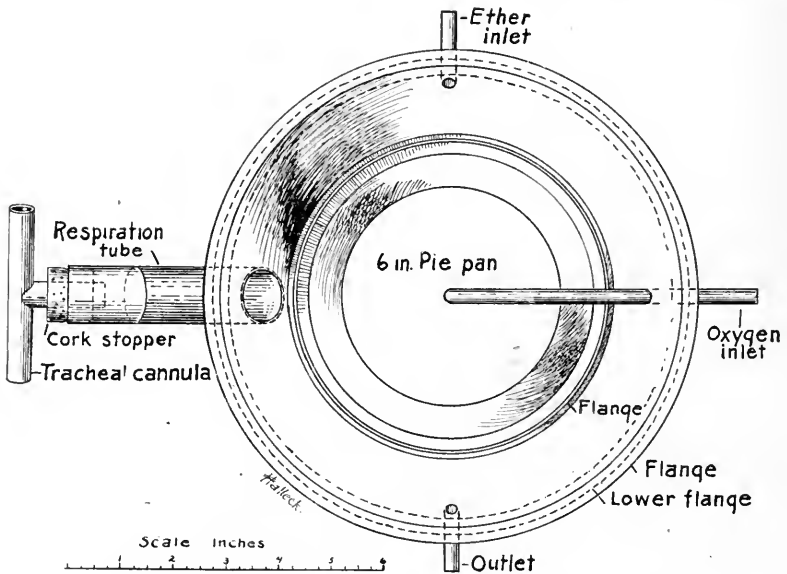

Fig. 118.—Diagrammatic view of the pan as seen from above.

the respiratory medium become too warm? Could you counteract this? How is the ether excreted? How is it absorbed and carried to the tissues? What combinations does it form in the body?

2. Arrange to record blood-pressure and respiration (stethograph). Connect an injecting burette to the left femoral vein. Isolate and ligate loosely (but do not clamp or injure) the right femoral artery. Place some adrenaline (1:10,000) solution in the burette. Or epinine solution (1:1000, Burroughs, Wellcome and Co.) may be used.

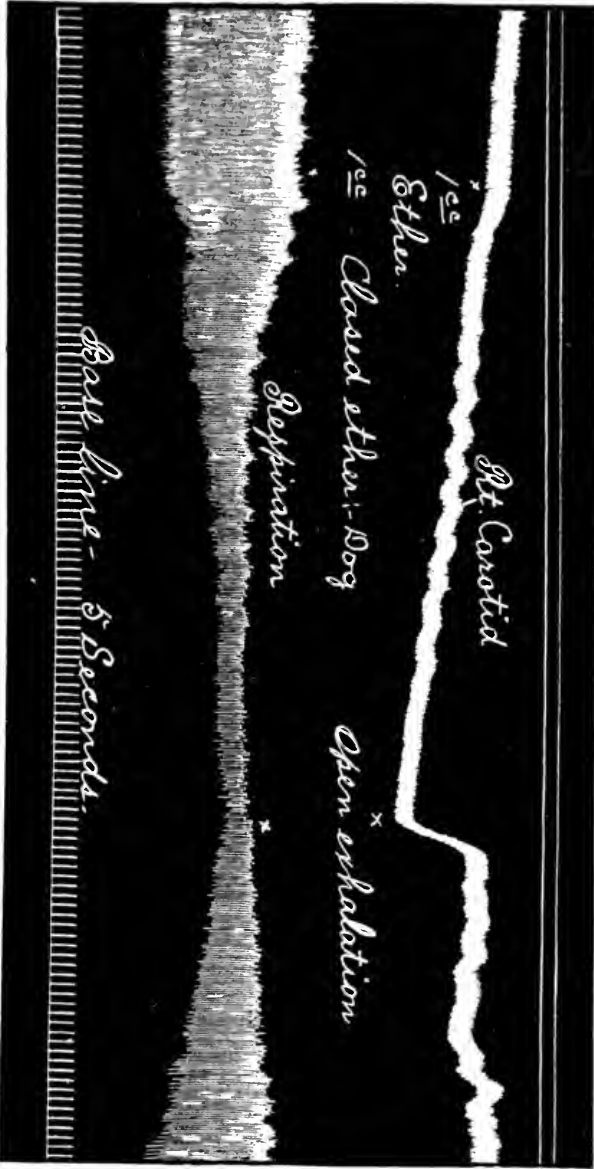

Fig. 119.—One c.c. of ether was injected at the point indicated. The animal was already lightly anesthetized. This 1 c.c. of ether caused a progressive slowing of the respiration (which also became more shallow) and a fall of blood-pressure. When the excess of ether vapor was allowed to escape and the animal breathed out into the open air recovery promptly occurred as the drug was eliminated by the lungs.

Arrange all writing points on the drum and take a few inches of normal record. How does this record of blood-pressure and respiration compare with that obtained when you used an ordinary ether bottle to maintain the anesthesia?

3. While the anesthesia is moderately light but perfectly regular, inject just enough oxygen to run the animal for about three minutes. Then with a screw clamp close off the injecting (oxygen) tube and change the oxygen



Fig. 120.—At the place marked "normal" the animal was breathing naturally. No drug had been administered and the animal was lying quietly on the table. At the point indicated some nitrous oxide was given. The respiration at once becomes deeper and more rapid.

tank for a nitrous oxide tank. Open the screw clamp on the injecting tube and run in as much N₂O as is possible without stretching the bath cap. This should be perfectly free to rise and fall and should not be under any tension. If the cap is stretched the animal cannot breathe well for the mechanical obstruction and may die. The drum runs at a slow speed as the N₂O is run in. How does this affect the blood-pressure and respiration? How does this compare with the injection of a drug through the femoral vein?

What is the action of N_2O on the heart? Is the anesthesia deepened?

4. After a sufficient time open the side clip from the pan and empty out the mixed gases. Close the clip and run in some fresh oxygen. Take some more normal record and then from a Gebauer ethyl chloride tube inject through the outlet tube of the pan a small amount of ethyl chloride.

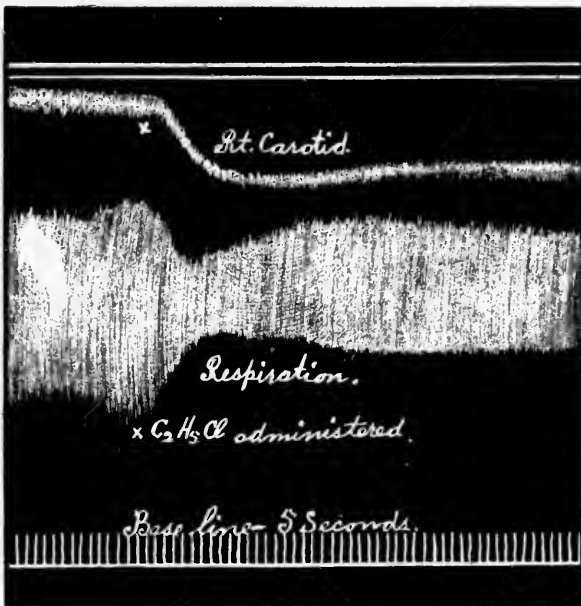

Fig. 121.—The animal was anesthetized with nitrous oxide. At the point indicated a little ethyl chloride was given (in addition to the nitrous oxide). The much more marked action of ethyl chloride on the blood-pressure and respiration is seen at once.

Do not give too much. How does this affect the blood-pressure and respiration? Is the anesthesia deepened? Which is the more powerful, ether or ethyl chloride? Empty out the ethyl chloride and allow the anesthesia to become fairly light.

5. Repeat No. 4, using ethyl bromide, “somnoform” or Brugg’s mixture instead of ethyl chloride. *Do not give*

more than one cubic centimeter of ethyl bromide (one-half cubic centimeter is much safer). This is a powerful drug.

6. After records are obtained empty out the vapors, open the screw clamp on the tracheal cannula and allow the dog to get fresh air for some time to recover. (The animal, of course, thus exhales the drugs into the open air.)

7. When the animal recovers close the tracheal clamp and let the anesthesia again become as regular as possible. Now through the burette inject into the pan one-half cubic centimeter of chloroform. *Do not give too much.* Obtain a record and then empty out the vapor as before. How does this record compare with those obtained with the other drugs? What conclusions can you draw concerning chloroform? What class of physicians make most use of chloroform?

Can you use the closed method for anesthesia when the chest is opened? This is a good point for the student to consider. Does this method present any advantages over the use of an ordinary ether bottle? What are the relative disadvantages?

8. Put about one cubic centimeter of chloroform into a *good* dental syringe carrying a small short needle. Now lift up the right femoral artery on an aneurism needle and at the same time let an assistant press down on the corresponding vein to shut off its return flow. Now with great care slip the syringe needle endwise into the lumen of the artery. Loosen the tension on the artery a little and as the blood again flows through carefully inject the chloroform. Feel of the leg. Is there produced a profound change in the tissues? If not, repeat the injection into the other femoral artery.

9. Kill the dog by asphyxia. Open the abdomen and dissect out and examine the spleen, pancreas and left kidney. To what is the spleen attached? Place it inside an

oncometer and close the abdomen with hemostats. Could you do this in a living dog? Remove the oncometer and put away all apparatus. Do not forget to wash out the tubing connecting the carotid to the manometer.

EXPERIMENT IX.

Intratracheal Insufflation.

1. Study carefully the principles involved in the construction of the apparatus shown in Fig. 122. A constant

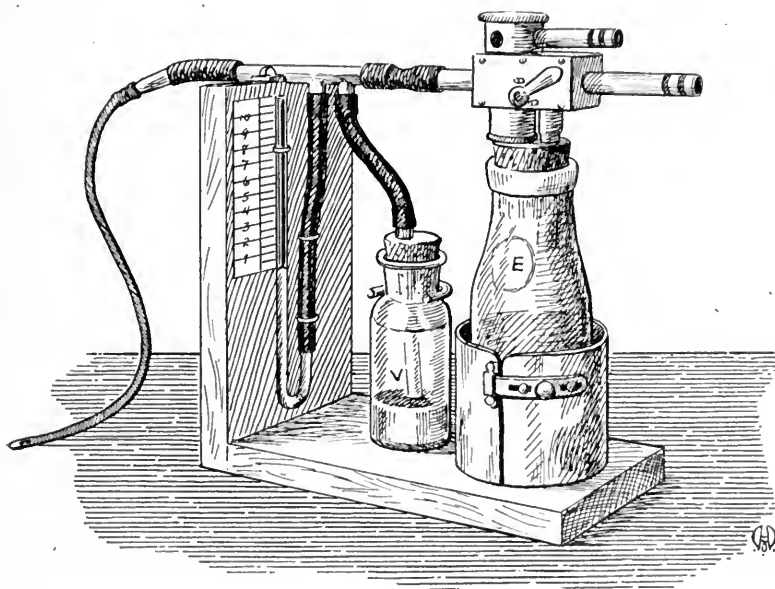

Fig. 122.—Apparatus for intratracheal insufflation. The tip of the catheter should be cut off just back of the "eye." Any similar sized rubber tube may be used instead of the catheter. The outer diameter of the tube should be about one-half (or a little less than) that of the inner diameter of the trachea.

current of air passes into the tube at the extreme right of the picture. By turning the small lever on the side of the ether valve, part or all (or none) of the air can be made to pass over the ether and then out through the rubber catheter at the left. (The cap and spout on the top of the

ether valve are not used in this experiment. The opening up into the cap should be closed with a cork.) Any ordinary ether bottle with a side pass as shown in Fig. 107 may be used for this purpose instead of the valve here shown. Just to the left of the ether bottle is a smaller bottle containing mercury. The cork in this bottle is perforated by

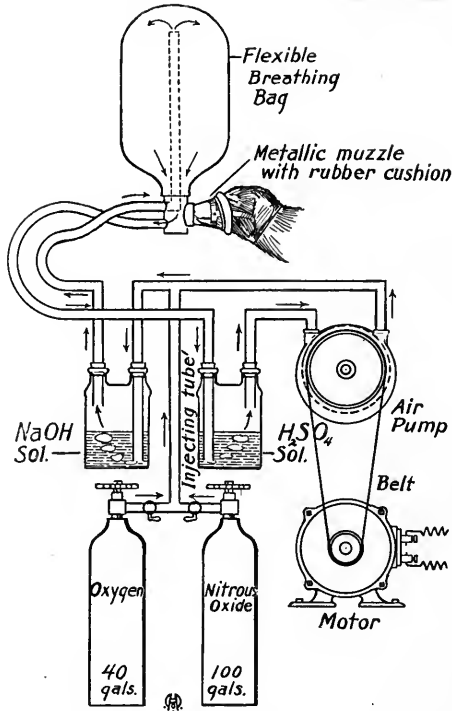

Fig. 123.—Schematic arrangement of an apparatus for administering nitrous oxide (ether, etc.) to an animal. The gas or vapor (ether) is washed (by means of the air pump) through NaOH solution (to remove CO_2) and through H_2SO_4 (to remove watery vapor). Oxygen is admitted as needed by the animal. The animal breathes into and out of the ventilated bag.

two holes through one of which a tube from the main air way dips down just below the surface of the mercury. This tube can be raised or lowered and thus serves as an adjustable pop-off valve to regulate the pressure if it becomes too great. To the left of the mercury bottle a mercury manometer and scale are placed. The manometer

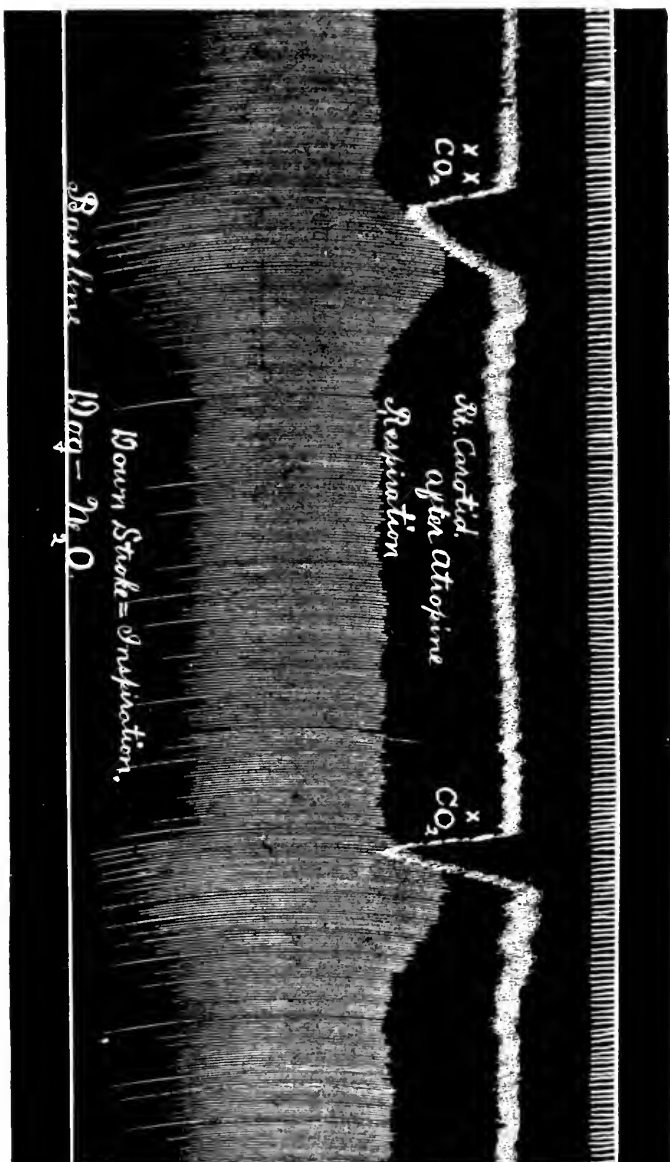

Fig. 124.—Tracing made by use of an apparatus similar to that shown in Fig. 123. At two places a small amount of CO₂ was run into the breathing bag (the pump was temporarily stopped.) The action on the respiration and blood-pressure is seen at once. In each case the CO₂ was cupped out of the bag immediately after the action became well marked.

connects with the main air way and when in use the mercury manometer should record a pressure of about twenty millimeters.

For an average sized dog the catheter may have an outside diameter of about three-sixteenths or one-fourth inch. The catheter is slipped into the trachea down to its bifurcation and then withdrawn a little. The animal should be etherized in the usual manner and then the catheter may be introduced through the larynx or through the tracheal cannula. The air and ether vapor blown in through the catheter escapes again from the lungs between the outer wall of the catheter and the inner wall of the trachea. As a rule, the dog will keep up shallow respiratory movements while the anesthesia is carried on by this method. Would it be advisable to turn the air current off for a few seconds at intervals of one or two minutes? It is advisable for the student to practice for some time with this method before attempting severe operations while using it. Meltzer, Auer and their associates at the Rockefeller Institute have extensively used and developed this method, while from the University of Minnesota Hirschfelder has reported excellent results with it in ordinary student experiments. Can you repeat these results? Could this method be used when the chest is opened? What precautions would you then take? Could you use the method to record changes in the volume of the lungs (see Figs. 187 and 257, also consult Experiments XXIX and LXX).

What are the advantages of this method? What are the disadvantages? This method may be used in some of the later experiments. It is often very convenient for maintaining a regular anesthesia.

This method has been much used for intrathoracic surgery, etc., and several different forms of apparatus for carrying on intratracheal insufflation have been devised and used. It is very desirable for the student to become familiar with the principles involved, and if possible, to have some experience in using the method.

EXPERIMENT X.

Alcohol. (Frog: Central Nervous System, Heart and Vago-sympathetic Nerve.)

1. Solutions of alcohol for injections or administration by stomach should, if possible, be made up from absolute alcohol. For the technic of injecting solutions into the lymph spaces of frogs see Figs. 125 and 126. Make up nine cubic centimeters of alcohol $66 \frac{2}{3}$ per cent strong. Into the anterior lymph sac of a frog inject either from a glass injecting pipette (Fig. 127) or with a hypodermic syringe (Fig. 126) one cubic centimeter of the alcohol solution. Do not injure the frog in any way in holding it, etc. Place the animal in a battery jar on some moist cotton and observe its actions closely. Touch it from time to time to observe the condition of the reflexes. Does the animal show any symptoms from the local irritation of the drug at the point of injection? Do these obscure the later systemic effects which come on after absorption of the drug by the circulation? How do the symptoms produced by alcohol compare with those produced by ether or chloroform or nitrous oxide? What organs are affected by alcohol as shown by this experiment? Does the frog become completely narcotized? If so, how long does the condition last? Does the animal recover completely? Place it in a battery jar on moist cotton for several hours to allow of recovery. The beating of the heart can be seen through the chest wall in front.

2. Pith a frog and dissect out the vagus nerve. Place the electrodes so that the nerve can be stimulated without disturbing the animal and arrange for taking a heart tracing. Take two inches of normal tracing and then stimulate the vagus nerve. Do you get a normal inhibition? (Do not stimulate the nerve too long or too often or you will wear it out. You can not then test the action of the drug

on the inhibitory mechanism.) It is usually advisable to take two records of normal vagus inhibition.

Now start a second round of the tracing and when the new record lacks about one inch of being directly over

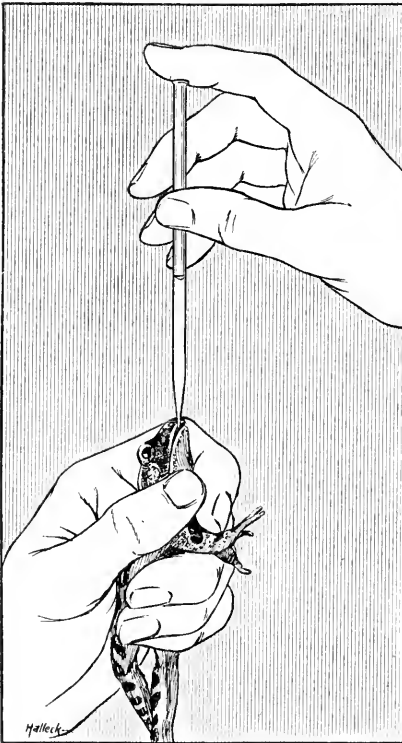

Fig. 125.

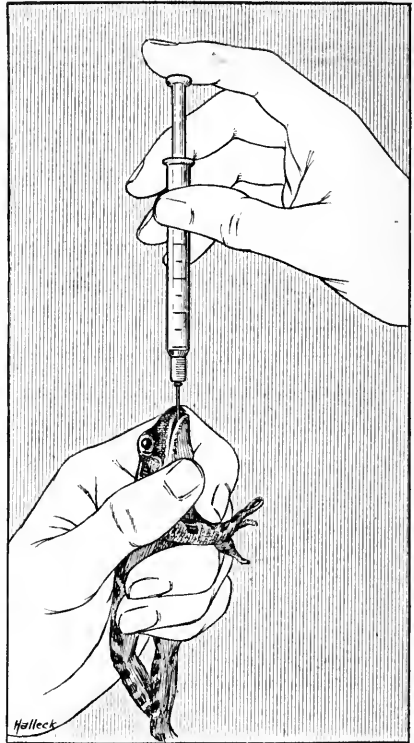

Fig. 126.

Fig. 125.—Injection of drug solutions into the anterior lymph sac of a frog. The narrow point of the injecting pipette is passed into the mouth, and the tongue (which is attached to the front part of the lower jaw) is pushed to one side. The point of the pipette is quickly but gently forced through the muscles in the floor of the mouth. The point will then be felt just beneath the skin over the under jaw. The pipette is now slipped down toward the chest. The skin is attached to the underlying muscles across the sternum but the point is passed through this attachment and into the lymph space in front of the abdomen. The finger is taken off of the upper end of the pipette and the solution is allowed to run slowly into the anterior lymph sac. Do not injure the frog by squeezing it.

Fig. 126.—Injection of solutions into the anterior lymph sac with a small hypodermic syringe.

the first vagus inhibition record, drop on the heart about ten drops of ten per cent alcohol. How does this affect the beat of the organ? At the moment when the record

reaches a place directly over the first inhibition record, stimulate the vagus nerve again. Do you now get an inhibition, or has the drug paralyzed some part of the local inhibitory apparatus? Drop on more alcohol and again stimulate the nerve over the second inhibitory record. The total length of the record from left to right should be about seven or eight inches with a moderate drum speed. About five or six rounds of tracing (in a series from the



Fig. 127.—Injecting pipette made of glass. About $\frac{2}{3}$ natural size.

bottom of the drum upwards) should be made. Add the alcohol freely to the heart during the second and third rounds, but on the later rounds, if necessary, use thirty or forty per cent alcohol. What is the general action of alcohol on the frog's heart as shown by your tracing? Does alcohol either paralyze or stimulate the inhibitory apparatus? How does this compare with ether or chloroform?

EXPERIMENT XI.

Alcohol. (Turtle: Heart and Vagus Nerve.)

1. Pith a turtle and fasten it down to the turtle board. Expose the heart and take a heart tracing (normal) including two or three vagus inhibitory records. Then apply twenty per cent alcohol to the heart as was done in Experiment X, and again stimulate the nerve. What effect does the drug have on the local inhibitory apparatus? If the heart muscle alone should be stimulated by the drug would the inhibition be greater or less when the nerve was stimulated after the drug was applied? How would the inhibition be affected if the muscle alone were depressed?

EXPERIMENT XII.

Ethyl Alcohol, Brandy, Whiskey, Wine, Methyl Alcohol, Amyl Alcohol. (Dog: Blood-pressure, Respiration, Esophagus.)

1. Etherize a dog and arrange for blood-pressure and respiratory tracings. Connect injecting burettes to both femoral veins. Isolate and ligate loosely both vagi, using great care not to injure them in the dissections or manipulation or by allowing a part of either nerve to lie outside the wound and to become so much dried up in the air that impulses can no longer be conducted over the nerve fibers.

Now pull the trachea to the left side and pick up the esophagus (pulling it toward the right) on a large aneurism needle. Make a longitudinal incision about three-fourths of an inch long in the side of the esophagus a little way below the larynx. Now pass through this incision into the lumen of the esophagus the finger cot on the end of the catheter as shown in Fig. 128. The end of the catheter should pass down the esophagus to a point about one or two inches above the cardiac sphincter. A ligature is then tied around the catheter at the esophagus incision tight enough to prevent the catheter from slipping out and with a hemostat the ligature ends are clamped (close to the esophagus) to the neck tissues at the side of the wound. The burette is now filled about half full of water and the catheter is moved in and out a little to get the water to run down into the finger cot. *It is important for the cot to be well filled with the water.* Place the cork in the burette and connect the tube in the cork to a medium sized tambour which is adjusted for a fairly large magnification. Arrange this tambour to write at the top of your records; next below this should be the blood-pressure (manometer) record, below this the respiration, and at the bottom should be the base line marked by a signal

magnet which records five or ten second intervals. If a metronome or Harvard clock is used, shorter time intervals must be employed. This may call for a faster drum speed. The rate should, however, be fairly slow. When

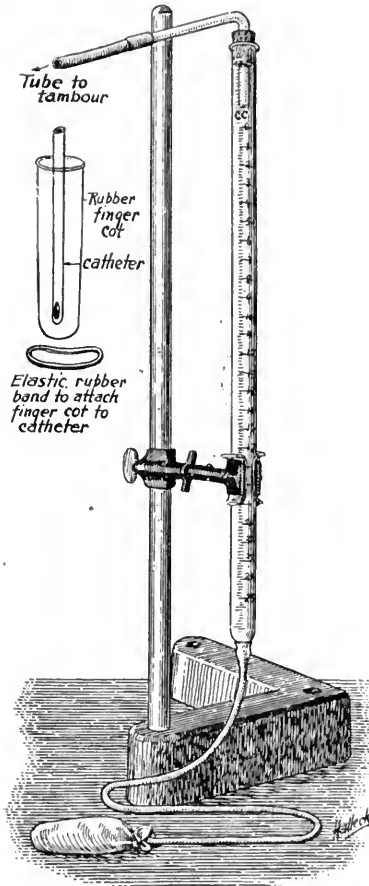

Fig. 128.—Arrangement of apparatus for recording esophageal contractions.

all adjustments are made start the drum and record one or two inches of normal tracing. Then with a medium strength tetanizing current stimulate the right vagus nerve for one-half second. Wait till the records all return to

normal and then stop the drum. Does the vagus stimulation stop the heart? How does it affect the respiration? Did you get a record from the esophagus? If so, how do you explain the cause of this last record? Could the record have been caused by the respiratory movements? Could

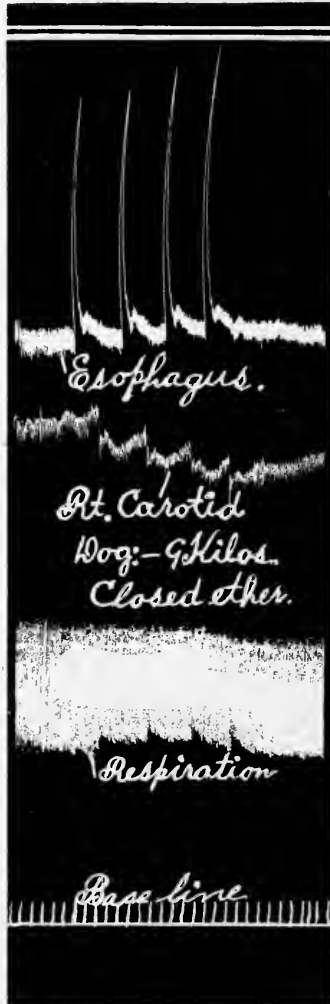

Fig. 129.—Four esophageal contractions, blood-pressure and respiration. The nerve was stimulated (for a moment only) four times by a tetanizing current.

you avoid this possibility in any way? Is the superior laryngeal nerve concerned in any way with your observations? Stimulate this nerve independently and study the results.

Place adrenaline solution in one injecting burette and twenty per cent alcohol (made from absolute alcohol) in the other. Start the drum and when about one inch of *satisfactory* normal tracing has been taken inject two cubic centimeters of the alcohol solution. The blood-pressure and respiration are slightly affected. This gives you a fair basis to estimate the resistance of the animal to the alcohol and to judge what size the next dose should be. If the

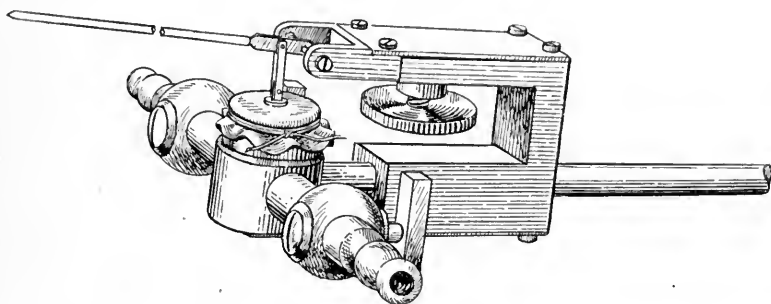

Fig. 130.—Harvard membrane manometer.

dog is small or very susceptible the dosage must be reduced. When the records have returned to normal inject as large a dose as you think the animal can safely stand and yet make a good recovery. This will likely range between five and fifteen cubic centimeters but may be much larger in many cases. Secure two or three good tracings from alcohol and then again stimulate one vagus nerve for a brief period. When the records return to normal stop the drum. How do the records obtained now compare with those made before the drug was given? If the animal seems very weak or about to die inject one-half cubic centimeter of adrenaline.

2. Empty the alcohol out of the burette (give it back to

the instructor) and fill the burette with brandy. What is the percentage of alcohol in brandy? How is brandy made? Start the drum and inject what you believe will be a fair sized dose for your animal. Do this two or three times and secure satisfactory tracings. How do these tracings compare with those obtained from alcohol?

3. Replace the brandy in the burette with whiskey. What is the percentage of alcohol in whiskey? Inject a fair sized dose and secure satisfactory tracings. This may be done two or three times if the animal is sufficiently resistant. But if the animal is weak, then the fewest injections possible should be given to secure typical tracings showing the action of each drug.

4. Substitute wine for the whiskey in the burette. How much alcohol is there in wine? What else is contained in wine? Inject one or two cubic centimeters and see how this affects the animal. Use larger doses if you can safely do so. How do the records obtained compare with those from alcohol, brandy and whiskey? How do you explain this? Inject some adrenaline and then allow the animal to recover.

5. Fill the burette with twenty per cent methyl alcohol. Inject one cubic centimeter and secure a record. How does the toxicity of this drug compare with that of ethyl alcohol? If it appears safe, a larger dose may be injected to secure satisfactory tracings. Does the alcohol which you have injected affect the anesthesia in any way?

6. Substitute a ten per cent mixture (shake well) of amyl alcohol and water for the methyl alcohol in the burette. Inject one-half cubic centimeter and secure tracings. What can you say about the toxicity of this body? Kill the animal with amyl alcohol. Which stops first, the heart or the respiration? Give some adrenaline, massage the heart and give artificial respiration to see if you can revive the animal. It is important for the student to learn

the methods used for reviving animals when they are near death, especially from threatened death under an anesthetic.

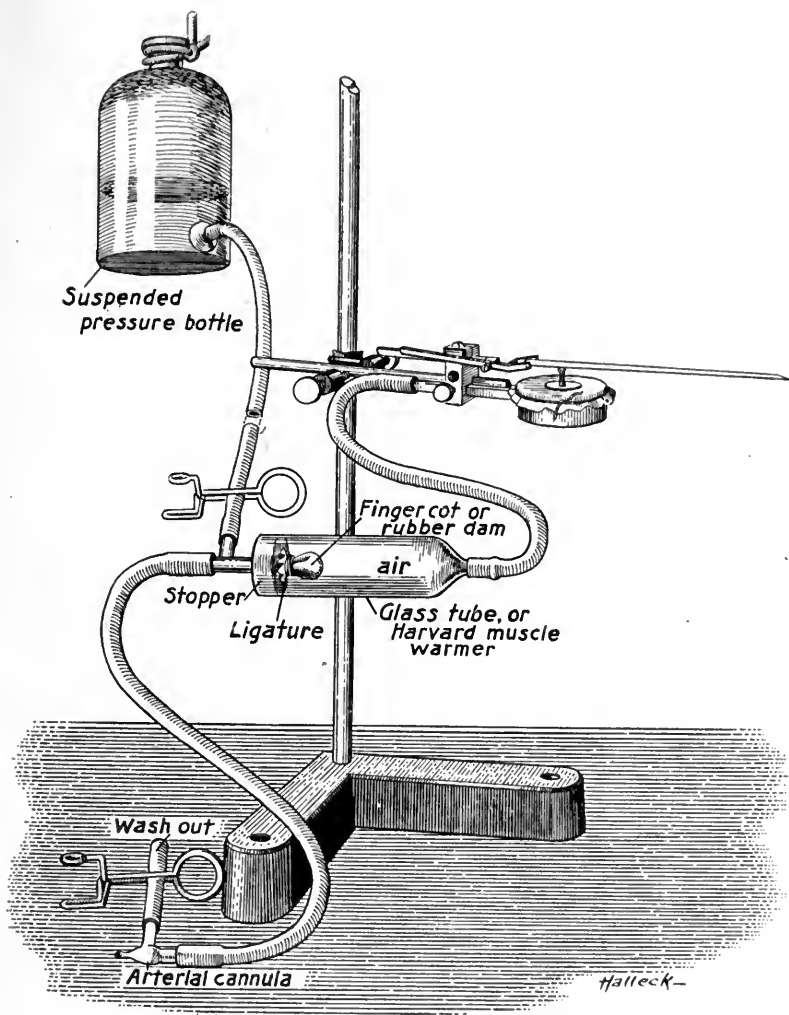

Fig. 131.—Arrangement of apparatus which may be used as a membrane manometer.

7. If time permits after the animal is dead, open the chest by a median longitudinal incision, sawing the ster-

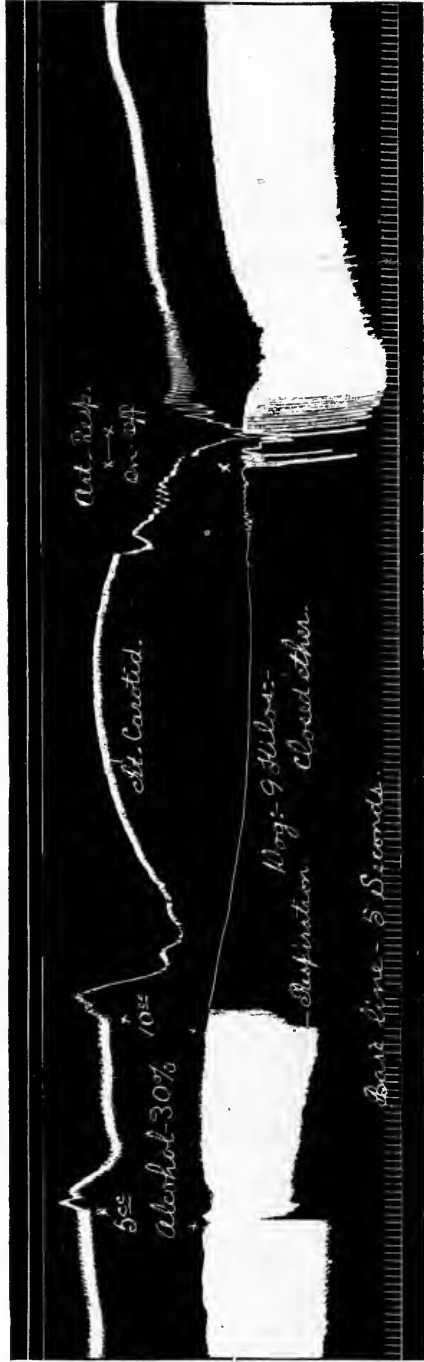

Fig. 132.—Action of alcohol on the blood-pressure and respiration. The apparatus shown in Fig. 116 was used and the animal was breathing a high percentage of pure oxygen. This probably accounts in part for the long period during which the respiration ceased while the blood-pressure remained fairly high. The animal soon recovered from the effects of the alcohol when the lungs were artificially inflated a few times.

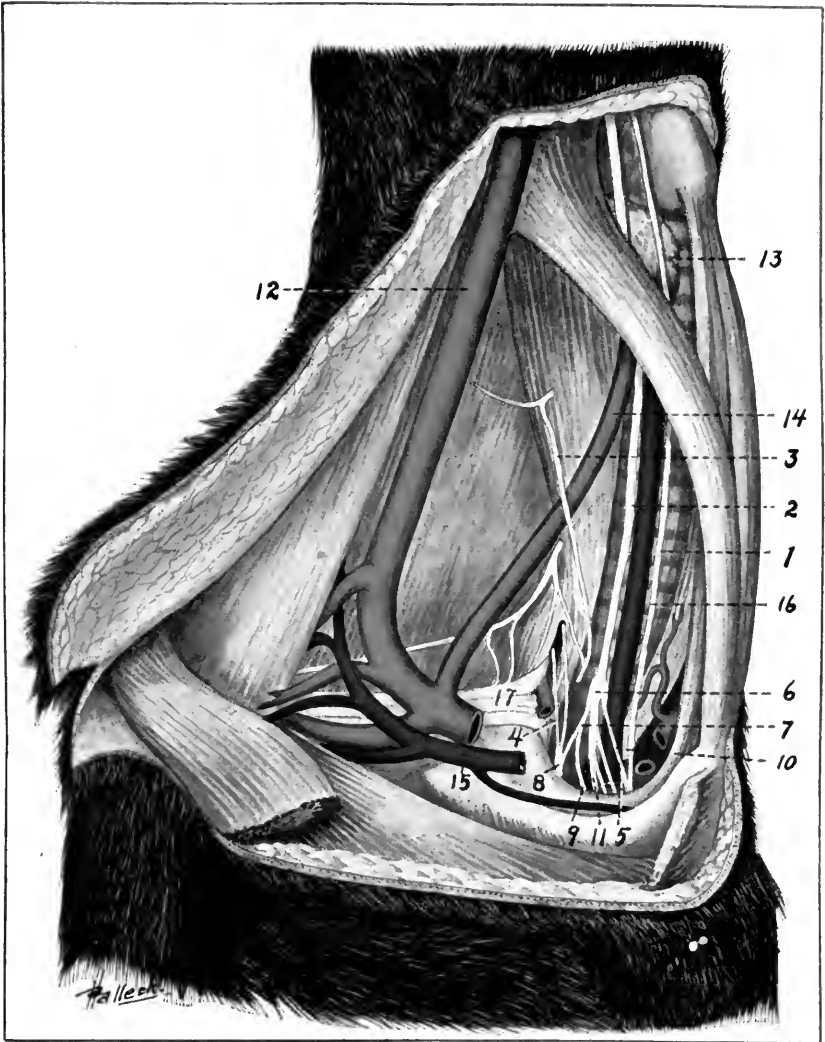
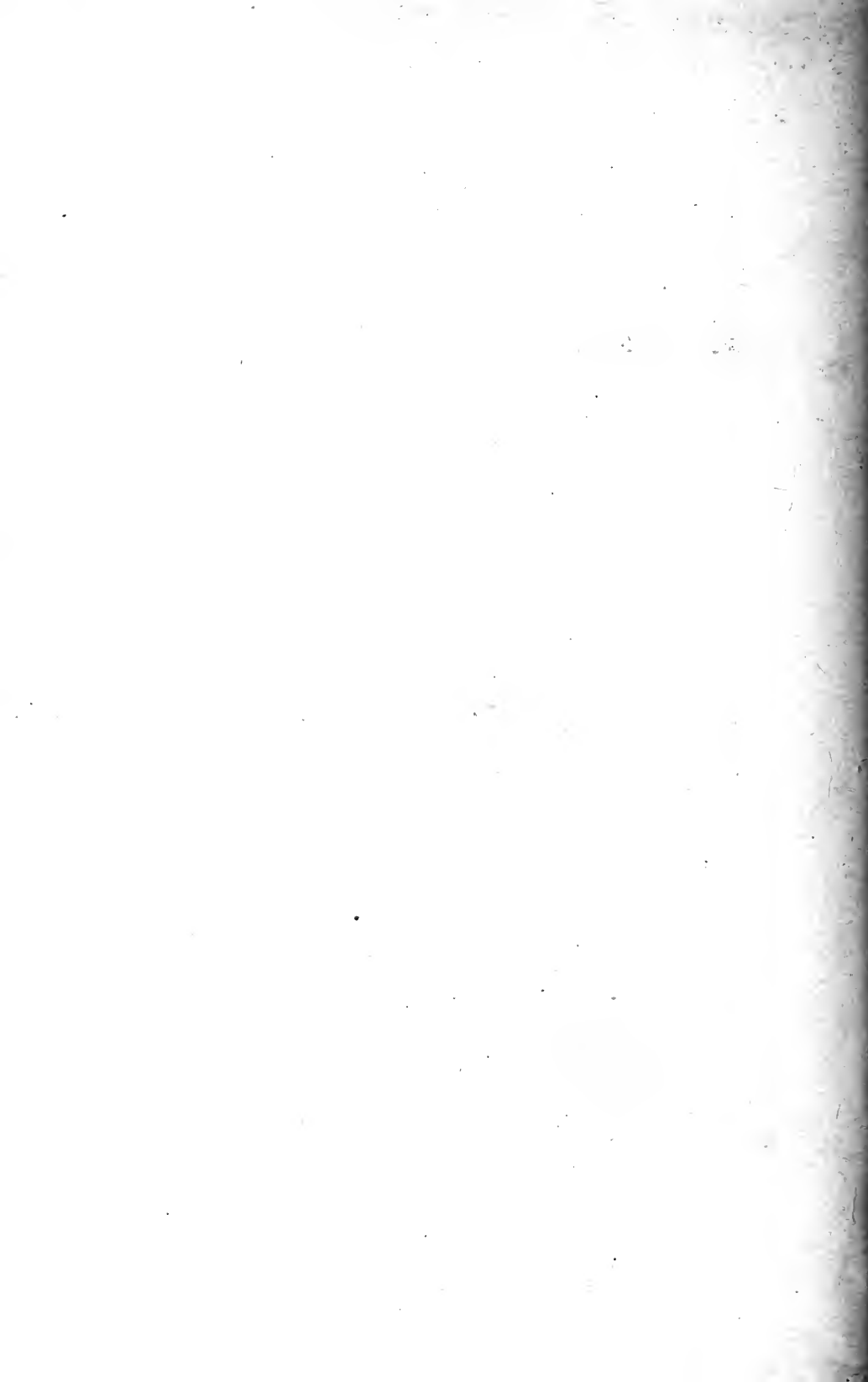

Fig. 133.—Dissection showing the vessels and nerves in the neck and upper part of the chest in a dog. (Modified from Schmiedeberg.) 1. Rt. inferior (recurrent) laryngeal nerve. 2. Vago-sympathetic nerve. 3. Phrenic nerve. 4. Vertebral nerve. 5. Rt. inferior (recurrent) laryngeal nerve. 6. Inferior cervical ganglion. 7. Cervical sympathetic nerve. 8. First thoracic ganglion. 9. Superior cardiac nerve. 10. Inferior cardiac nerve. 11. Vagus trunk. 12. External jugular vein. 13. Thyroid gland. 14. Internal jugular vein. 15. Subclavian artery. 16. Carotid artery. 17. Brachial plexus.



num open endwise, and make the following observations:

Isolate and trace out both phrenic nerves. Trace the vago-sympathetic trunks from the neck region down into the chest. Follow the right nerve closely in the tissues at the apex of the chest. At this point isolate the subclavian vein and tie two ligatures *tightly* around the vessel. *Be sure the ligatures are tied tightly enough not to slip off.* Cut the vein between the ligatures and follow the nerve down behind the vein to the subclavian artery. (See Figs. 133 and 184.) Isolate the annulus Vieussenii (ansa subclavia) and pick up the fibers that pass off toward the heart. Part of these fibers are from the vagus proper and if stimulated in the living animal will slow or weaken (or stop) the beating of the heart. A few of the remaining fibers are from the sympathetic system (Figs. 148 and 318) and when stimulated in the living animal will cause the heart to beat faster (accelerators) or stronger (augmentors). Could you perform a dissection like this in a living animal? What would be the most likely causes of failure? How could you avoid these? Open the pericardium, examine the auricles and ventricles. Isolate the left pulmonary artery and pass a ligature beneath it. Hunt for the thoracic duct. Where is it located in the chest? What does it resemble? With what might you confuse it? The writer has seen students look in the wrong side of the chest for the duct. What criticism would you offer in such a case?

EXPERIMENT XIII.

Whiskey or Brandy. (Reaction Time.)

1. Observe carefully the arrangement of the apparatus shown in Fig. 134. The subject of the experiment holds down (closed) the handle of key A; key B remains open. The writing point of the signal magnet does not move.

The operator holds key B. The drum is started off at a fast rate. While the subject watches the signal magnet closely the operator suddenly closes key B. The writing point of the signal magnet at once goes down. Instantly as the subject sees this he opens key A. The drum keeps running, the operator opens key B and the subject again closes key A. The operator now closes key B and the sub-

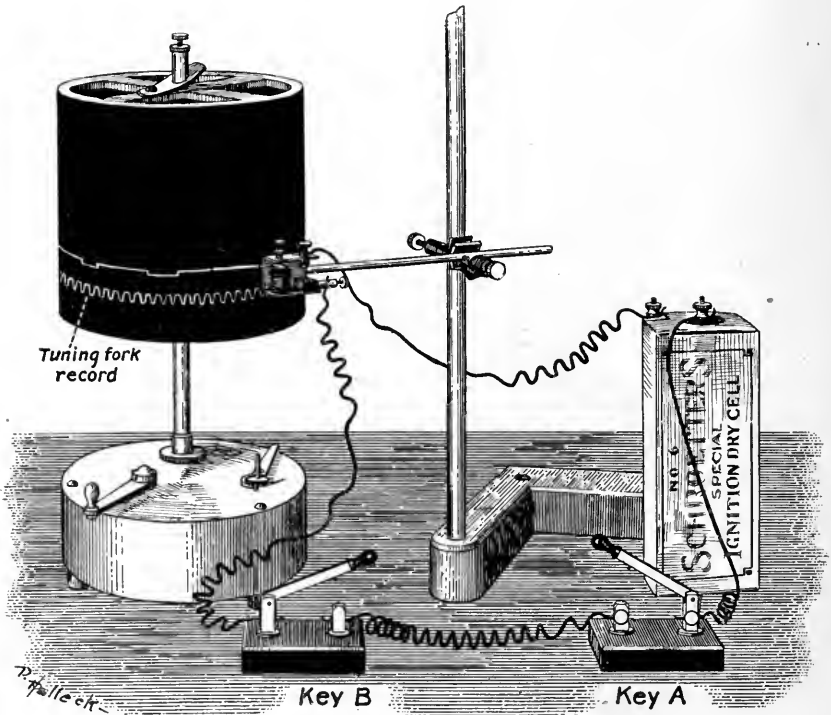

Fig. 134.—Arrangement of apparatus for recording reaction time for sight.

ject instantly opens key A. In this manner about twenty or thirty normal records are taken. With a vibrating tuning fork (Fig. 136) beating fiftieths or hundredths of a second, a time tracing (three or four may be needed) is now run around the drum. With a pair of dividers or a rule the average length of time which it takes the subject

to respond to a sight stimulus, i. e., his normal *reaction time for sight*, is estimated.

The subject now takes by stomach five or ten cubic centimeters of whiskey or brandy well diluted with water. A

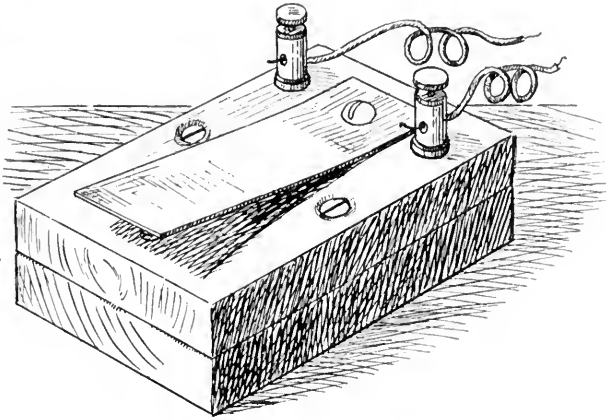

Fig. 135.—Simple key.

little sugar may be added to the water in order to induce the subject to take the drug more readily. After fifteen minutes the student's reaction time for sight is again

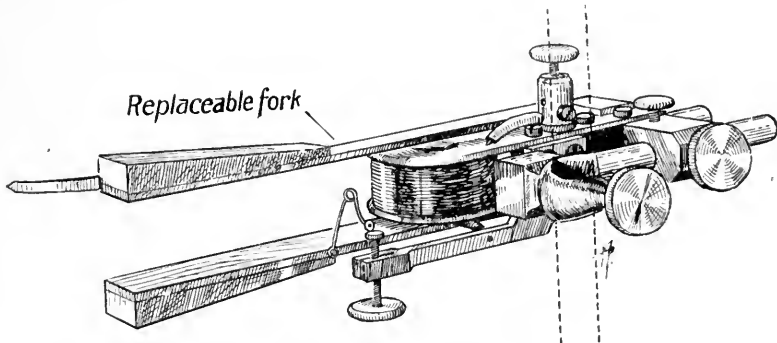

Fig. 136.—Electric tuning fork.

taken. Is there any change? How do you account for this? What portions of the nervous system are involved?

2. Arrange a telephone in the secondary circuit of an in-

duction coil as shown in Fig. 137. The subject holds the telephone to his ear and listens (with closed eyes) for the click of the closing of key B by the operator. At the instant the sound is heard the subject opens key A. The

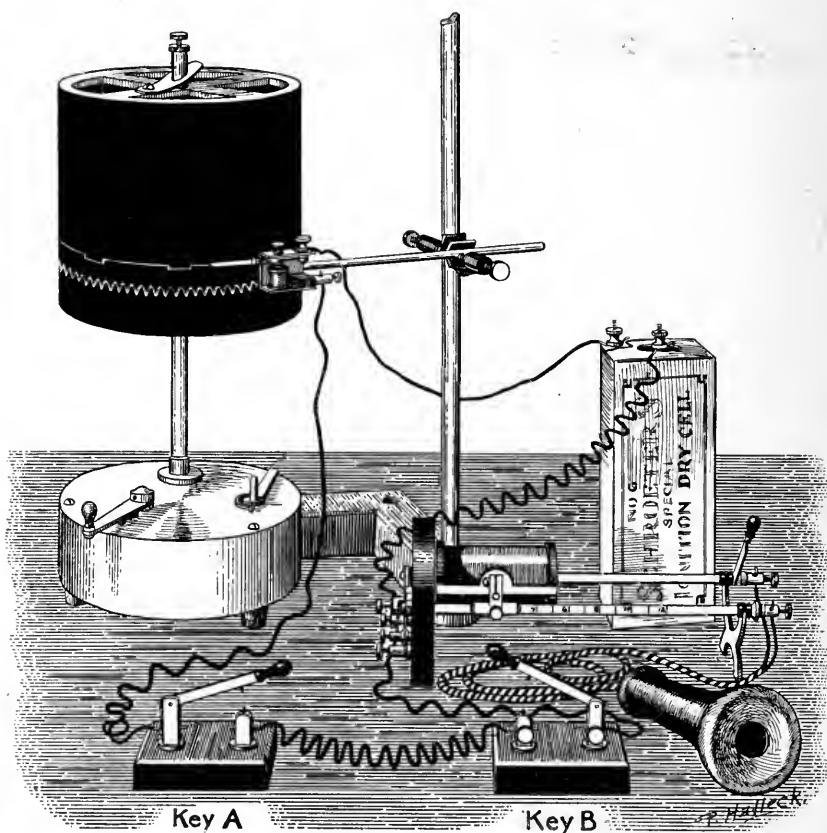

Fig. 137.—Arrangement of apparatus for recording reaction time for hearing.

reaction time for sound is thus recorded on the drum. Repeat this twenty or thirty times and estimate from the tuning fork record the average length of time required for the reaction.

The subject now takes some whiskey or brandy (or wine) as indicated above (1) and after fifteen minutes his reac-

tion time is again taken. Is there any change? What parts of the nervous system are concerned?

3. In a similar manner the effect of alcoholic drinks on the reaction time for touch may be recorded by allowing the subject to place his finger under key B in such a manner that he can just feel the closing of the key by the operator. The subject then opens key A.

4. If time permits, the reaction time for sight and sound may be taken again after three or four hours. Compare these results with the normals and with those obtained fifteen minutes after the drug was taken. What conclusions can you draw?

EXPERIMENT XIV.

Alcohol, Whiskey, Brandy, Wine. (Dog or Cat: Myocardiographic Tracings, Cardiac Sympathetic Nerves.)

1. Arrange for a perfectly constant and reliable source of artificial respiration before beginning the experiment.

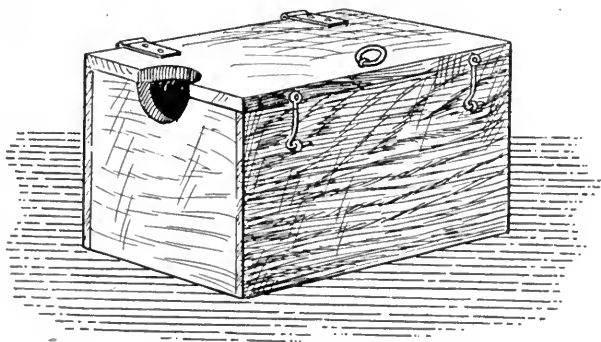

Fig. 138.—Box for anesthetizing cats.

If a cat is used, all the cannulas for vessels and the trachea must be *much smaller* than those used for dogs.

Etherize the animal in the usual fashion. If a cat is used it may be etherized in a special box (Fig. 138) or in

a bell jar (Fig. 139) or in an ordinary earthenware or glass jar covered with a glass plate. A tin bread box serves very well, especially if it has a glass window. Cotton may be placed in the neck of the bell jar and the ether dropped in on this. If a box like Fig. 138 is used, the animal's head is left out when the lid is closed and a towel on which the ether is dropped is placed over the cat's head. Cotton saturated with ether can be dropped in the earthenware jar or bread box.



Fig. 139.

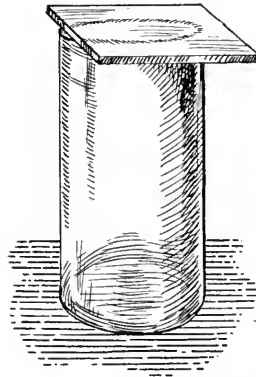

Fig. 140.

Fig. 139.—Bell-jar as used for anesthetizing cats.

Fig. 140.—Glass or earthenware jar covered by a glass plate. Used for anesthetizing cats, rabbits, etc.

Quickly tie the animal down on the operating board and arrange to take a blood-pressure tracing. Connect injecting burettes to both femoral veins. Record the normal rectal temperature. By a median incision open the chest. In a cat this is best done with tinner's snips (Fig. 98). (See Fig. 105, also read Experiment V, 6, page 108.) When the sternum is divided throughout its length pull the chest

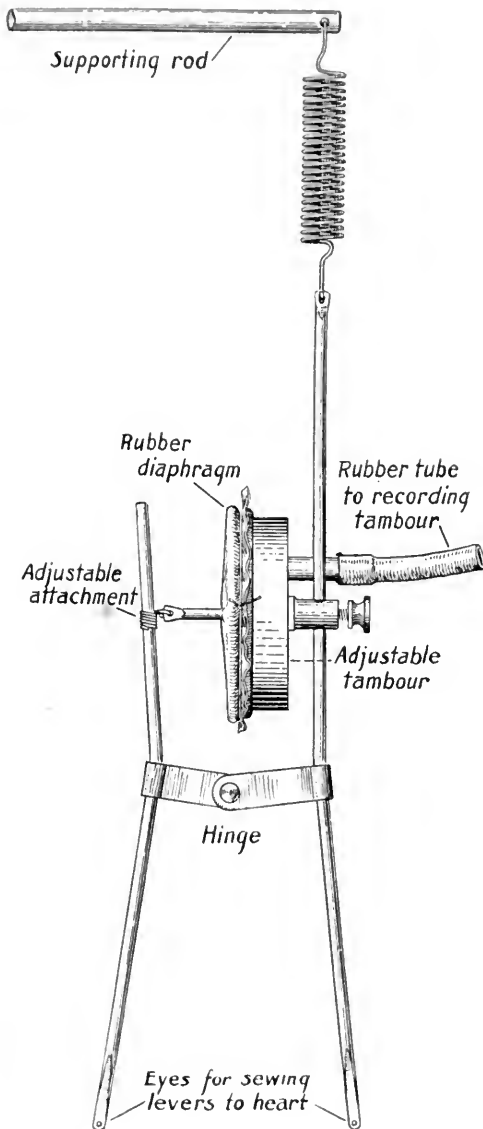

Fig. 141.—Myocardiograph.

open, tie four strong ligatures into the margins of the severed walls as shown in Fig. 106, and with these ligatures tie the chest firmly, leaving an opening about three or three and one-half inches wide in a dog. This opening will be smaller in a cat. Open the pericardium and stitch it to the chest walls.

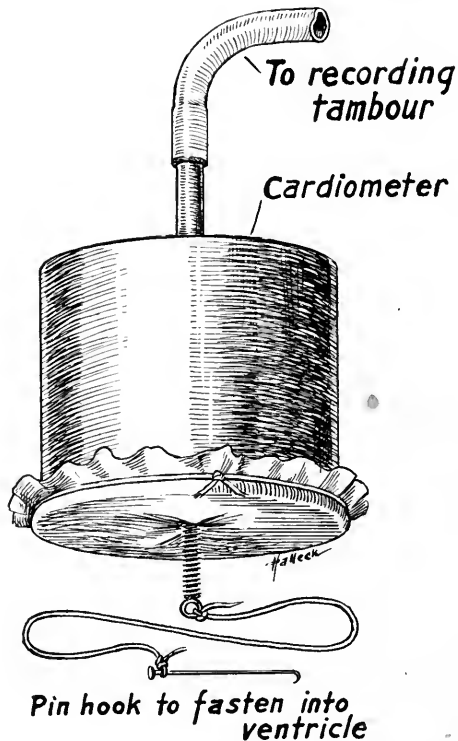

Fig. 142.—Cardiometer arranged for use as a myocardiograph. The pin is hooked into the heart muscle and the cardiometer is held in a clamp. The beating of the heart moves the membrane in and out. A tambour is used for recording.

Various forms of instruments are used to record heart tracings directly from the heart. One is shown in Fig. 141. If you have such an instrument, suspend it in a clamp from a stand over the heart. By two stitches made with a needle in the upper and lower ends of the left ventricle

fasten the lower ends of the two levers firmly to the heart. As the ventricle beats air will be forced in and out of the tambour on the apparatus. With rubber tubing connect the apparatus to a medium sized tambour which records below the blood-pressure on the drum. Cushny has devised a myocardiograph which may be used to advantage. (Eberbach and Son Company, Ann Arbor, Mich.) With this instrument the drum must be brought to the side of the animal. (See Fig. 317.)

If no special apparatus is available, then a pin hook can

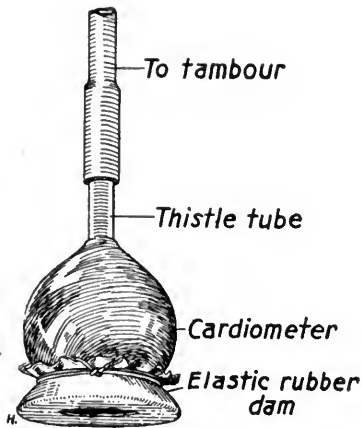

Fig. 143.—Cardiometer made from a large thistle tube. A hollow rubber ball with an opening cut in one side and a tube in the other may be made into a cardiometer by cementing a perforated rubber membrane over the opening in the side of the ball.

be attached to the heart. A string is tied to the pin and passed over pulleys to an ordinary (weighted) frog heart lever which writes on the drum. Or a rubber membrane (in the center of which a screw is attached, see Fig. 374) is tied over a cardiometer (Fig. 142) and the string attached to the heart by the pin hook is fastened to the screw in the membrane. The cardiometer is held in a clamp and connected with a recording tambour. Another method of recording heart tracings is shown in Fig. 144.

When all adjustments are made place adrenaline solu-

tion in one burette and thirty per cent alcohol in the other. Start the drum with a medium speed and take a short normal record. *If everything is satisfactory* then inject two cubic centimeters of alcohol if the animal is a dog, or one-half cubic centimeter if you have a cat. From the results

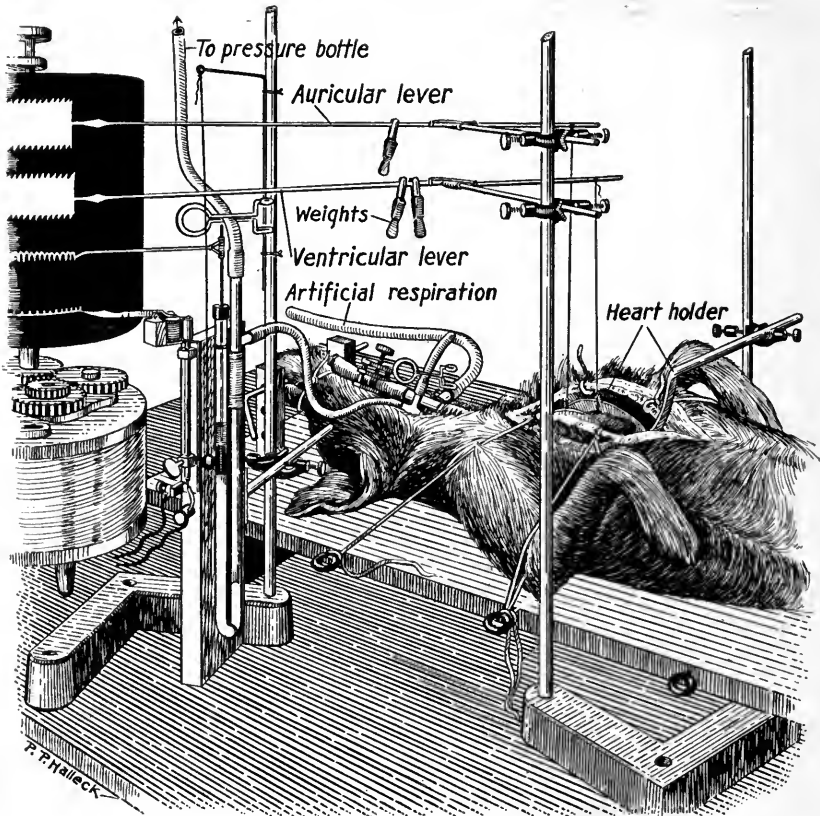

Fig. 144.—Arrangement of apparatus for recording the movements of one auricle and one ventricle. The heart is held in a special holder (Fig. 145) here but sometimes the pericardium is slit open and the edges are stitched to the sides of the chest so that the heart lies in a sort of hammock.

of this first dose you can estimate about what sized doses the animal will be able to overcome later. This will vary with each experiment and the student should early learn to estimate doses of drugs of low toxicity. With very pois-

onous drugs the dose must be given much more accurately. How does this first dose affect the heart tracing? Increase the dose and secure marked effects from the heart. Observe the appearance of the organ while the drug is acting. The respiratory movements of the lungs may disturb your cardiac apparatus and show notches at the top and bottom of your heart tracing. To check this reduce the respiratory movements as much as possible by shutting down the amount of air blown into the lungs. Note carefully any

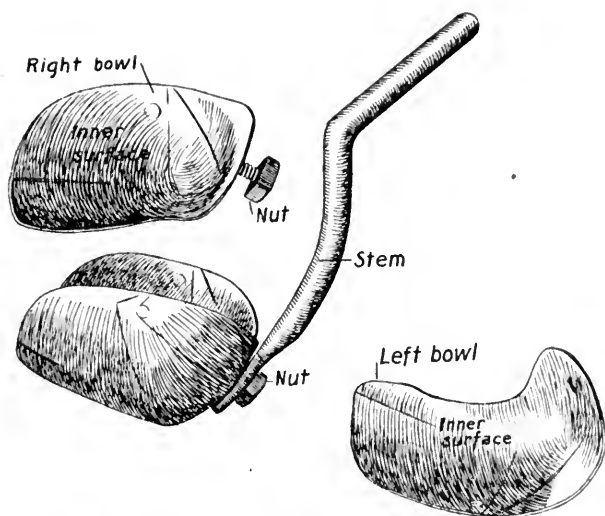

Fig. 145.—Special heart holder to keep the heart from moving with the lungs as they contract and expand from the artificial respiration.

effect this may have on blood-pressure. Watch your anesthesia carefully and do not give too much ether. Make one injection ($\frac{1}{2}$ c.c. for a dog, $\frac{1}{4}$ c.c. for a cat) of adrenaline and obtain a tracing showing the action of this drug on the heart.

2. Now obtain tracings showing the action of whiskey, brandy and wine. Can you use beer or champagne for intravenous injections? On what do you base your conclusions? Record the rectal temperature again and com-

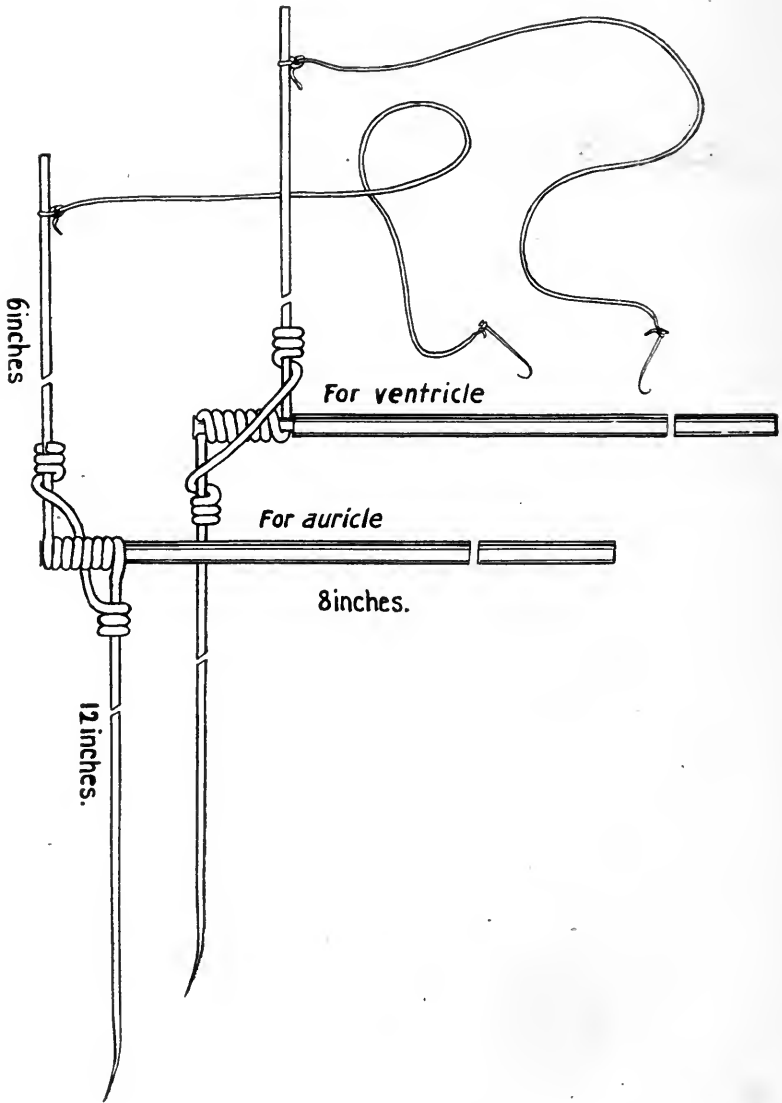

Fig. 146.—Heart levers for dogs. The writing lever is made of heavy aluminum wire which is coiled around a small wire nail to form the hinge. The nail is driven tightly into a small hole drilled in the end of a $\frac{3}{16}$ inch brass rod.

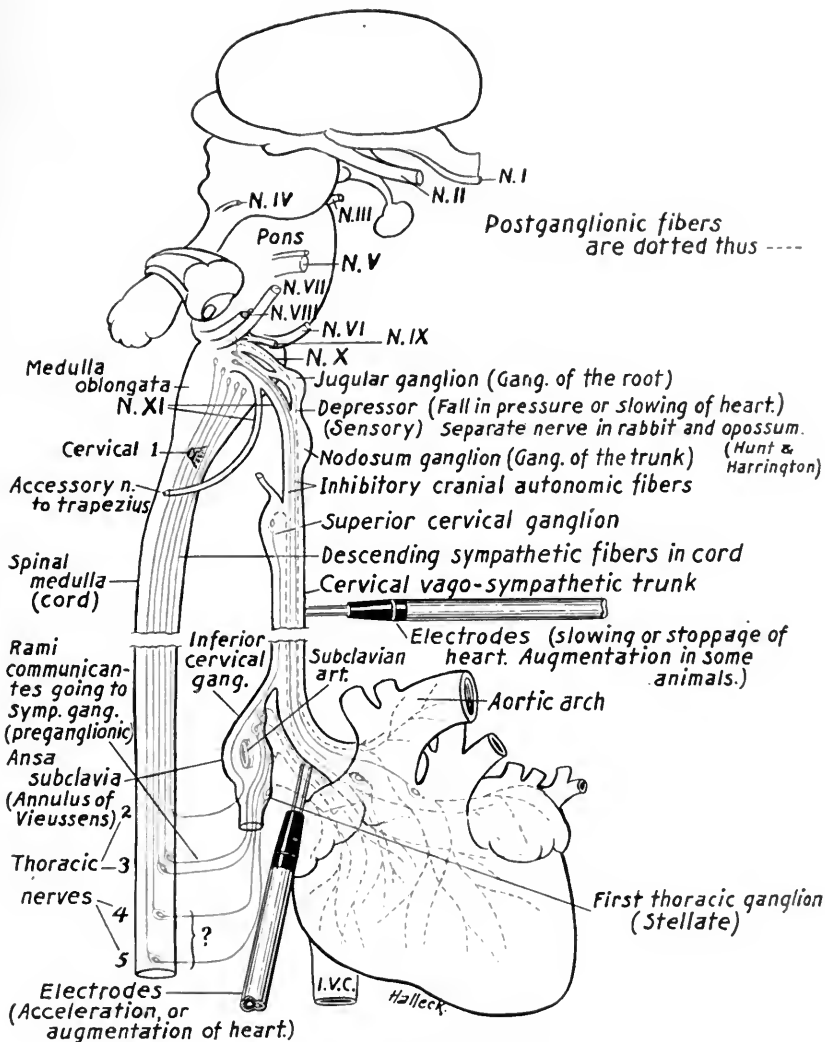
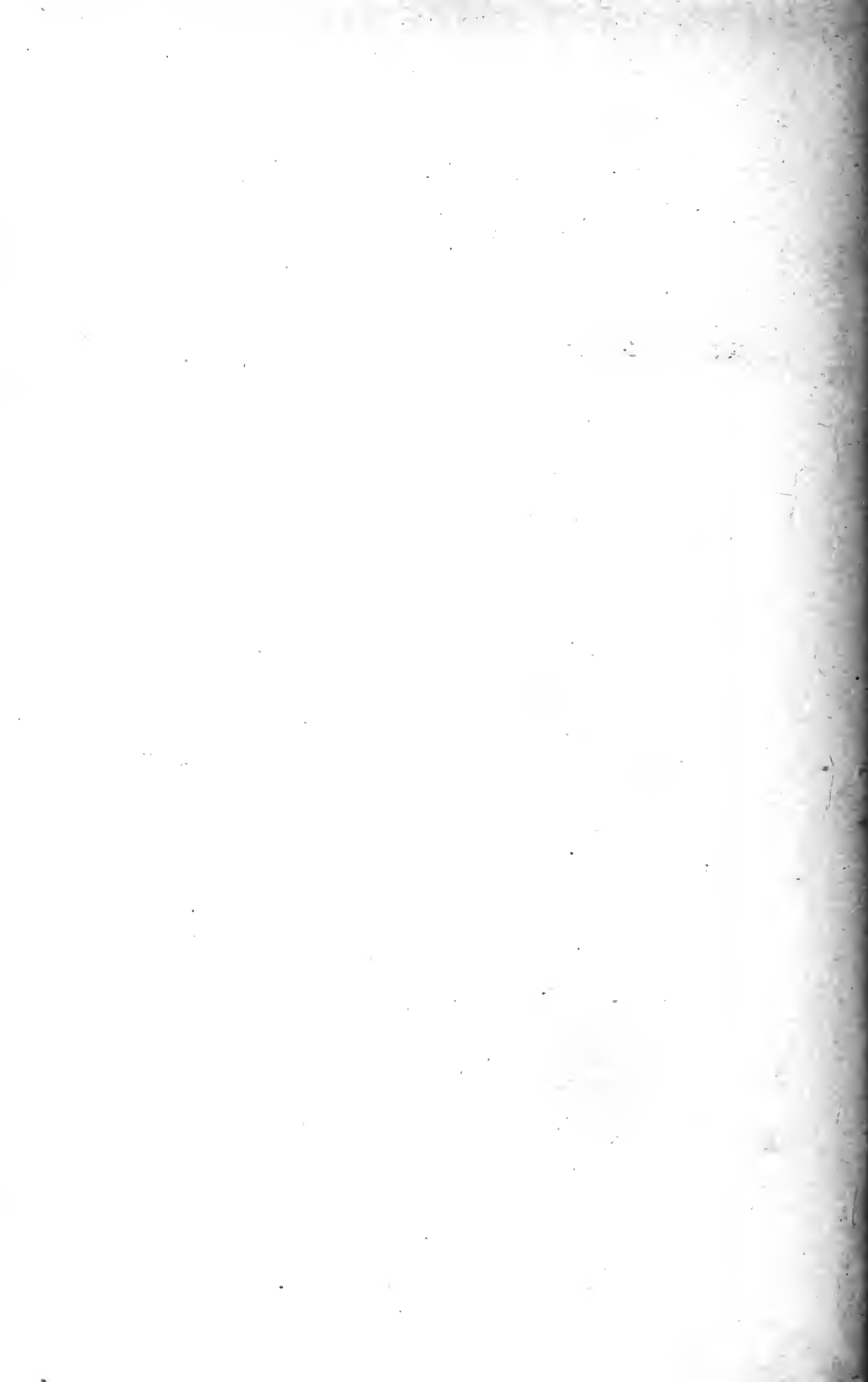

Fig. 147.—Schematic representation of the innervation of the heart.



pare this reading with the former one. What conclusions can you draw?

3. If the animal is in fair condition, isolate the right subclavian vein at the apex of the chest (see Figs. 133 and 184). Tie *tightly* two ligatures around the vein and section the vessel between the ligatures. Pick up the ansa subclavia (annulus Vieussenii) and stimulate some of the

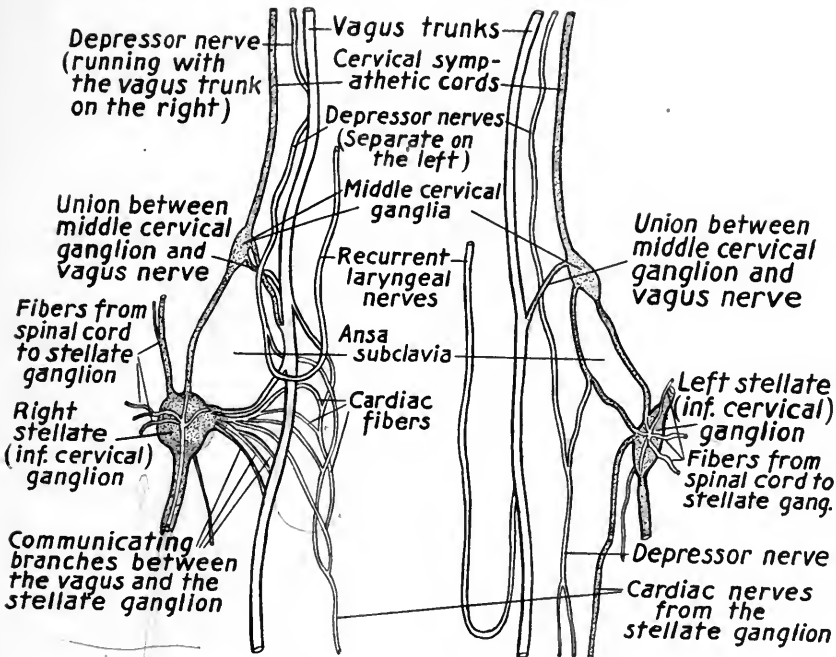

Fig. 148.—The innervation of the heart in the cat. (After Boehm.)

small fibers passing from the ganglia or the anterior loop of the annulus toward the heart. These will probably be derived from the vagus and the heart will then be slowed. Pick up some others of the small fibers lower down and stimulate them. You will probably find a fiber which does not cause any slowing of the heart and no *immediate* effect may follow its stimulation. But if you get a pure sympathetic cardiac fiber, stimulation of this nerve will, *after a*

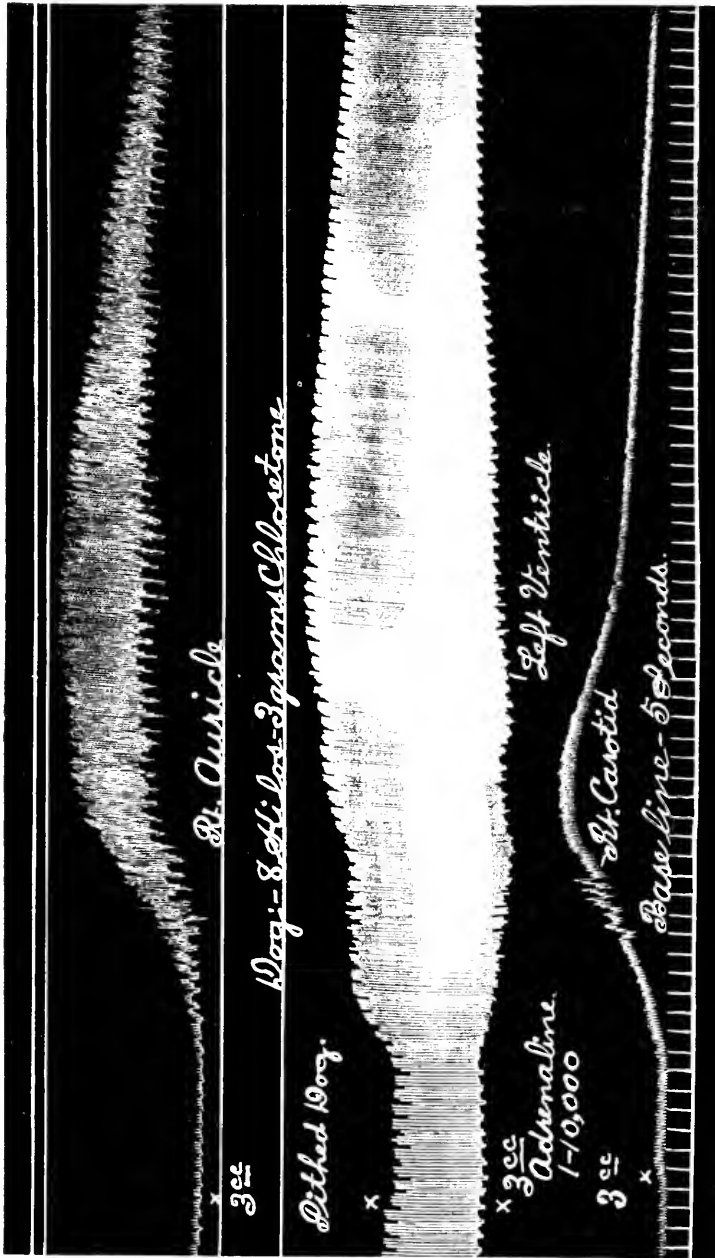

Fig. 149.—Myocardiographic tracings of the right auricle and left ventricle and the blood-pressure in a dog. The heart and blood-pressure were both greatly depressed at the beginning of the tracing. At the point indicated 3 c.c. of adrenaline solution were given intravenously. The action on the auricle, ventricle and blood-pressure is shown very well.

very perceptible latent period, cause a change in the heart beat either producing an acceleration of the rate or increasing the strength of the beat (augmentor effect). If possible, secure tracings showing these effects on the heart. How do these records compare with the action of adrenaline on the heart? Do you know of any other drugs that act on the heart similarly to adrenaline? Watch for these later in your course. Kill the animal by asphyxia.

EXPERIMENT XV.

Antiseptic Action of Alcohol.

1. Obtain four fermentation tubes (Fig. 150). Place a cake of yeast in two hundred cubic centimeters of water,

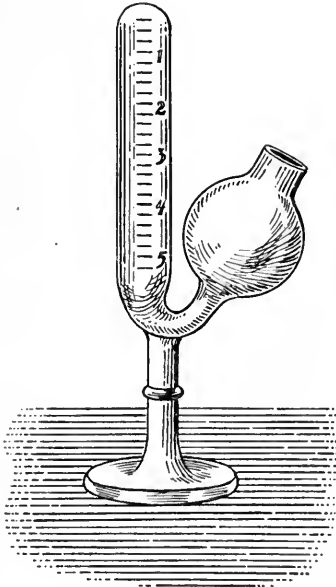

Fig. 150.—Fermentation tube.

add some glucose and shake up the mixture thoroughly. Pour out enough of the mixture to fill one fermentation tube, add sufficient absolute alcohol to the mixture to make

a *one per cent solution* and fill the tube. Similarly fill the other three tubes with the mixture, but place in the second tube *ten per cent of alcohol*, in the third, *forty per cent*, and in the fourth, *seventy per cent*. Be sure the air is all out of the tops of the tubes. Place these in an incubator at 37 degrees Centigrade (or in a warm room) until the next day. Then examine the tubes and record any observations you may make. A culture of colon bacilli may be used instead of yeast.

EXPERIMENT XVI.

Alcohol, Brandy, Urethane, Chloral. (Dog: Blood-pressure, Respiration, Cerebrospinal Fluid, Kidney or Spleen.)

1. Etherize a dog and arrange for blood-pressure and respiratory tracings. Provide two injecting burettes (one containing adrenaline, the other twenty per cent alcohol). Turn the dog's head to the left, trephine the skull (see Figs. 97 and 100; also read Experiment V, 2, page 103). Make the trephine opening in the skull as carefully as possible so the edges will be smooth and regular. With small scissors cut away the dura mater over the area covered by the opening. Do not injure the brain and try to avoid all hemorrhage. Now place a perforated (rubber) cork tightly in the opening so that solutions cannot leak around it. *The cork must not press on the brain.* The perforation in the cork carries a small (5/16 inch) glass tube. This tube is filled with salt solution and then connected by rubber tubing to a small water manometer (Fig. 151). From the funnel the manometer and tubing are filled with normal salt solution, the glass tube in the cork is filled with salt solution from a pipette, and the rubber tube is slipped over the glass tube. This makes a complete fluid connection between the cerebrospinal fluid in the subdural spaces and the meniscus of the salt solution in the left hand limb of the manometer. For adjustments in pres-

sure, the manometer can be moved up and down on the stand. The dog's head can now be rotated back to the original position and the pin put through between the teeth. Mark on the glass (or record from the scale) the level of the meniscus.

Adjust the apparatus to record blood-pressure and respiration. If you have a *small and very sensitive tambour* you may also connect this to the top of the manometer tube

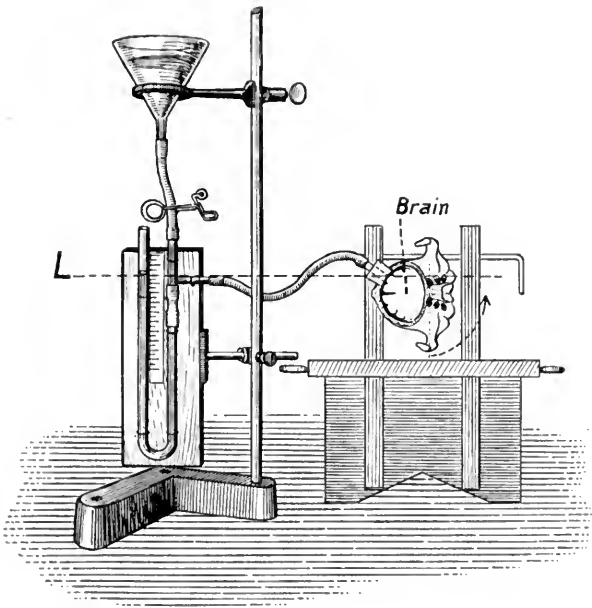

Fig. 151.—Arrangement of apparatus for recording the pressure of the cerebrospinal fluid.

(left) and try to record changes in the pressure of the cerebrospinal fluid. Otherwise simply observe and write down the variations which the manometer shows. Becht at the University of Chicago records intracranial pressure by means of a long glass tube inclined upward at a slight angle from the horizontal. In this way a slight increase in pressure moves the fluid in the small bore of the glass tube.

2. With a medium tetanizing current stimulate the right vagus nerve for a second or so. How does this affect the respiration, blood-pressure, and cerebrospinal pressure? What mechanical factors are involved? Now inject one-half cubic centimeter of adrenaline and repeat your observations. What mechanical factors are concerned?

When the records return to normal inject two cubic cen-

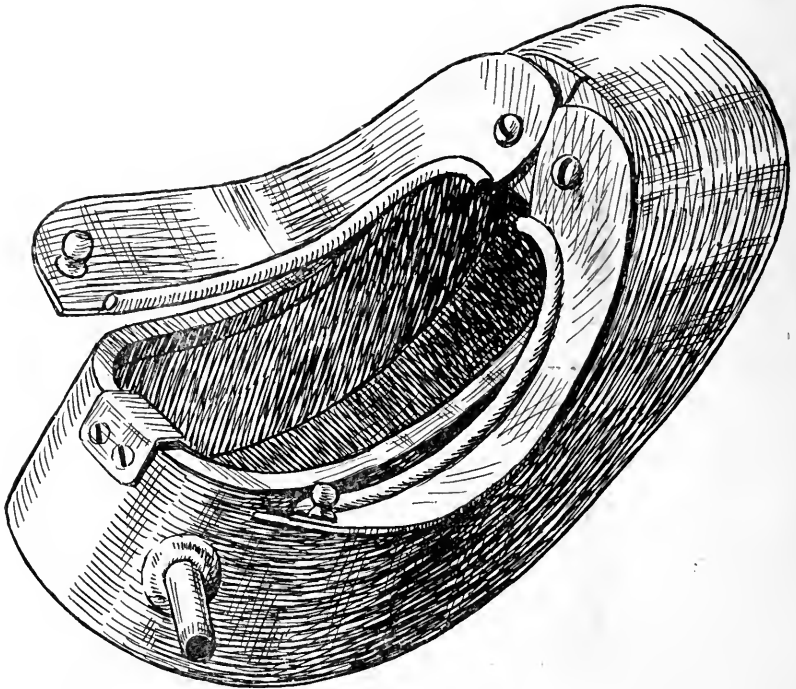

Fig. 152.—Spleen oncometer for dogs. A little less than natural size.

timeters of alcohol. Note the effect on the circulation and respiration and then estimate how much larger dose you can safely inject. When the records return to the normal inject more alcohol and watch carefully for changes in the cerebrospinal fluid. It may be necessary to inject three or four times to produce any results. What do you observe? How do you explain this? Stop the drum and wait ten minutes to allow the animal to recover and to see

if other changes occur in the pressure of the cerebrospinal fluid. The anesthesia should be as nearly perfect as possible while the above parts of the experiment are being performed.

3. With a median longitudinal incision now open the abdomen and place hemostats at each side on the edges of the wound. Pull upward and outward on these (two) hemostats and expose the viscera. *Do not manipulate these organs any more than you can help or the animal may pass into a condition of shock. Keep the intestines inside the abdomen.* If you have a spleen oncometer (Figs. 152 and 153) this is easiest for a beginner to adjust. Gently pull

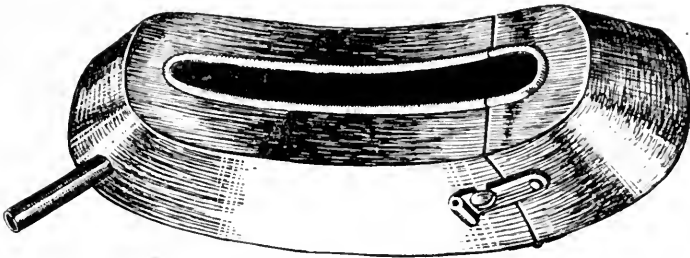

Fig. 153.—Spleen oncometer for dogs. About one-half natural size.

the spleen forward and fit it into the oncometer, close the instrument and place it back into the abdomen, attach the tube for the tambour and close the abdomen air tight with three or four hemostats. (Sew it up if you do not have hemostats.) *The abdominal wound must be closed tightly* and there should be no internal hemorrhage. If you have a kidney oncometer (Figs. 154 and 156) instead of one for the spleen, then refer to Fig. 158, and in the manner there shown expose the left kidney. Do not injure the renal vessels but gently lift up the kidney and slip it into the oncometer. Carefully avoid catching loops of the intestines or a piece of the omentum in the oncometer. Close the lid and fasten the latches (or put on the rubber band) and connect the tube for the tambour. Carefully replace the

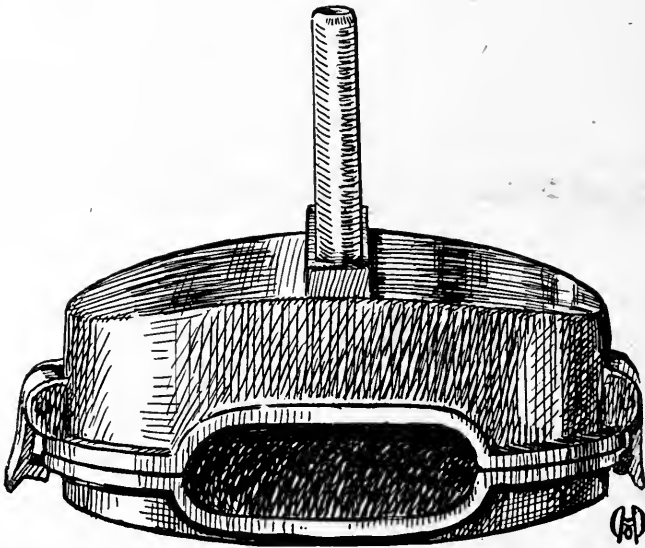

Fig. 154.—Kidney oncometer (natural size for medium sized dogs). Front view. Made of sheet brass.

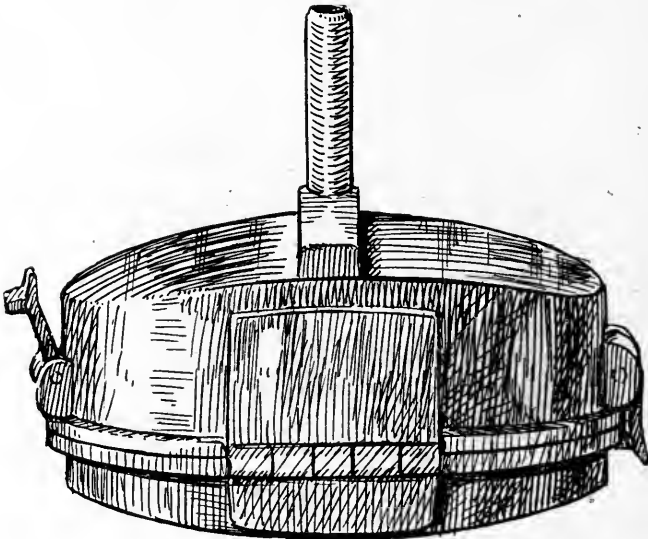

Fig. 155.—Rear view of same oncometer shown in Fig. 154.

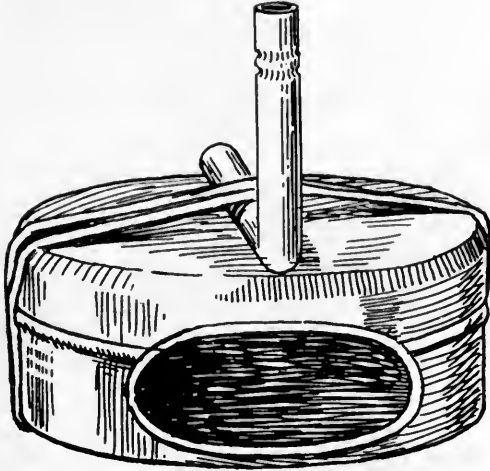

Fig. 156.—Front view of kidney oncometer made of a round metal pill or ointment box. Closed by a rubber band.

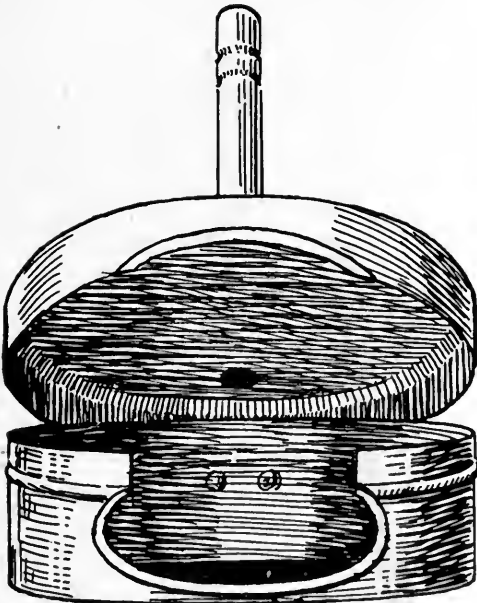

Fig. 157.—View showing the oncometer partly open. This oncometer can also be used well for a loop of the intestine.

intestines around the kidney and close the abdominal wound tightly.

The recording tambour should have a fairly large bowl and the magnification should be large. Adjust all writing

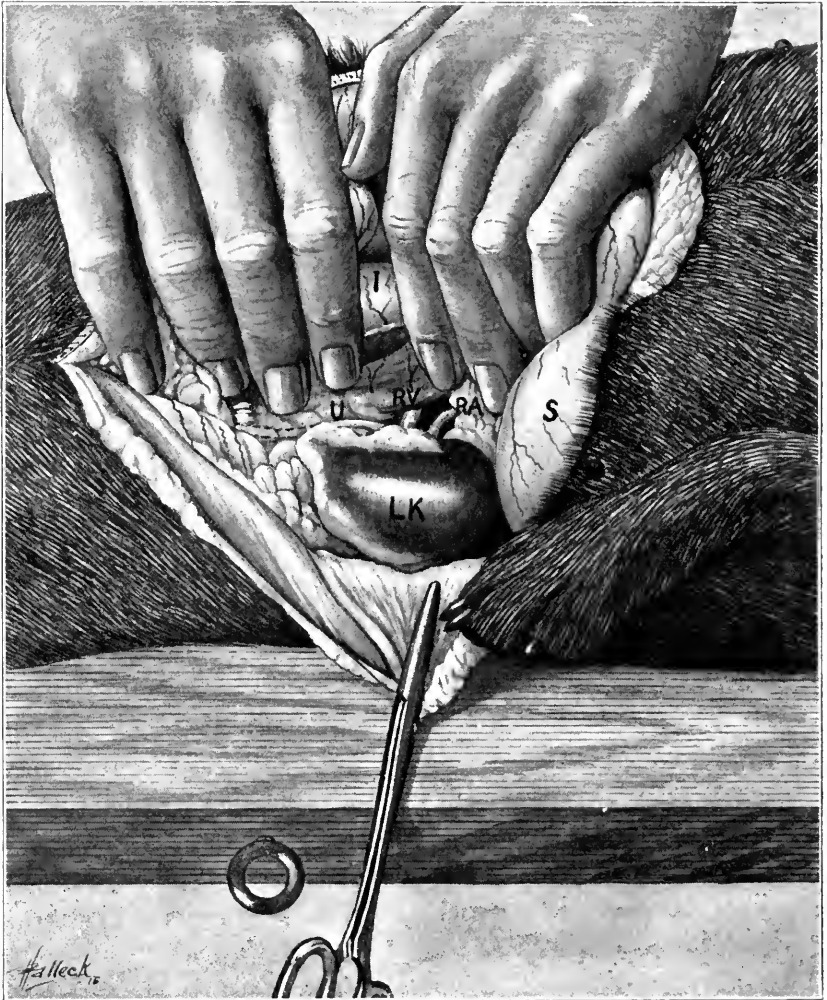

Fig. 158.—Dissection showing the method of exposing the kidney from a median incision. Do not cut across the side of the abdominal wall. When the kidney is placed inside the oncometer the abdomen is closed air tight with hemostats. *LK*, left kidney. *S*, stomach. *RA*, renal artery. *RV*, renal vein. *U*, ureter. *I*, intestine.

points on the drum, recording from above downward, on-cometer, blood-pressure, respiration, base line and time signal. *The writing points should not be in a straight line perpendicularly but should be so adjusted that each two adjacent pointers can just pass each other.*

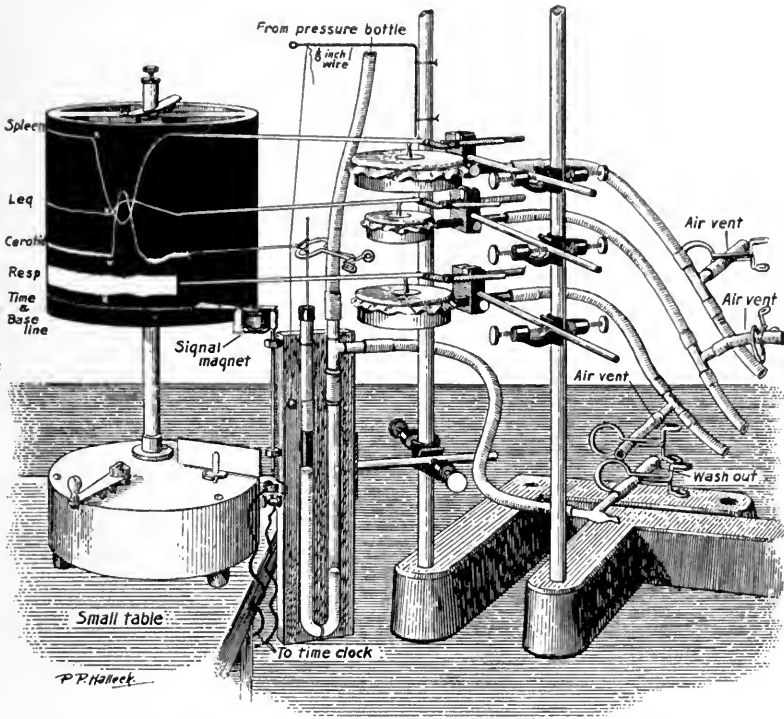

Fig. 159.—Arrangement of apparatus for making several records at the same time on the drum. The proper adjustment of these tambours, etc., is one of the most difficult parts of the whole experiment. Suitable stands which can be placed close together at the bottom aid greatly. (See chapter on shop work.)

4. Start the drum and inject one-half cubic centimeter of adrenaline. Make a small cross just under the position of each record at the moment of injecting the drug. Do you get a satisfactory record? The purpose of this injection is to show you what a good spleen or kidney volume tracing should look like.

Consult the instructor to get his opinion of your record.

Now stimulate one vagus nerve and record the result. When all the pointers return to normal inject a fair sized dose of alcohol. Does this affect the blood-pressure? How does the spleen or kidney tracing obtained now compare with the one produced by adrenaline? How do you explain this? What mechanical factors are involved? Inject another dose of adrenaline and see if you can determine two phases to the adrenaline action. How do you explain this? Now obtain tracings showing the action of brandy, urethane (ten per cent solution, two cubic centimeters for the first injection), and chloral (four per cent solution, one cubic centimeter for the first injection). The oncometer tracing is liable to become unsatisfactory after three or four records have been obtained from it. Can you determine what this is due to? (See Fig. 160.) How do urethane and chloral affect the blood-pressure and respiration? Which is the more active drug? Kill the animal by closing off the respiration. Do you get an oncometer tracing? How is the blood-pressure affected?

5. If time permits, carry out the following dissections: Open the chest by a median longitudinal incision and pull the heart (pericardium) over to the right side. Deep down in the chest (behind the diaphragm as it arches upward) and a little way latterly from the median line you will find the esophagus and the aorta. These can be traced down from the upper part of the chest and from the heart. Look for the vagus trunks on the esophagus (Fig. 161). Beneath the pleura at the side of the spinal column you can find the main branches of the thoracic sympathetic. Pick these up and trace them down behind the diaphragm. Open the abdomen, divide the diaphragm, and pull the stomach and liver to the right. Can you trace the passage of these sympathetic fibers from the chest down into the abdomen? Observe carefully the exact position which the fibers occupy and see into what kind of a structure they pass. If the stomach, liver and diaphragm were in their



Fig. 160.—Illustration showing the appearance of the blood-vessels in the ears of a white rabbit. (By permission of Seelig and Joseph.) "To show the contrast between the constricted vessels still connected with the vaso-constrictor center (left ear) and the control dilated vessels that have been disconnected from that center (right ear). Drawing made late in the experiment when the animal was apparently in a state of deep shock. The strong vaso-constriction in the left ear was replaced by a wide dilatation as soon as the connection of this ear with the vasomotor center was severed." (From Seelig and Joseph: *Jour. of Laboratory and Clinical Medicine*, 1916, i, p. 283.) This illustration shows the continued marked activity of the vaso-constrictor center in the *ears* of animals when they are apparently "in a state of deep shock." The student is urged to be constantly on the watch to see if he can observe a similar action of the center on the vessels of the kidney, spleen or intestinal loop as indicated by the character of the oncometer records in animals which do well in the early part of an experiment but pass apparently into "a state of deep shock" in the later stages of the experiment. In this case how would the oncometer records be affected?

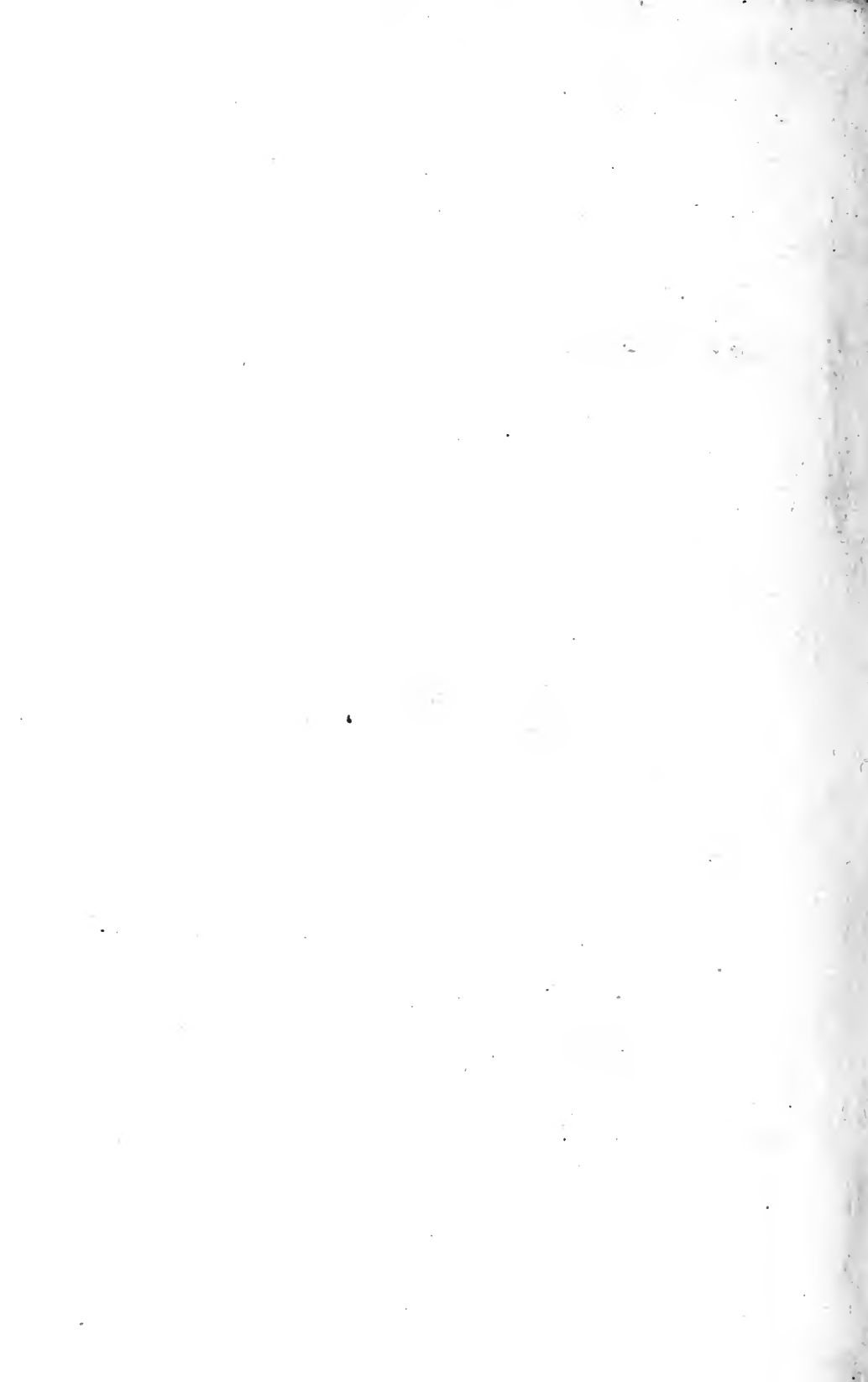

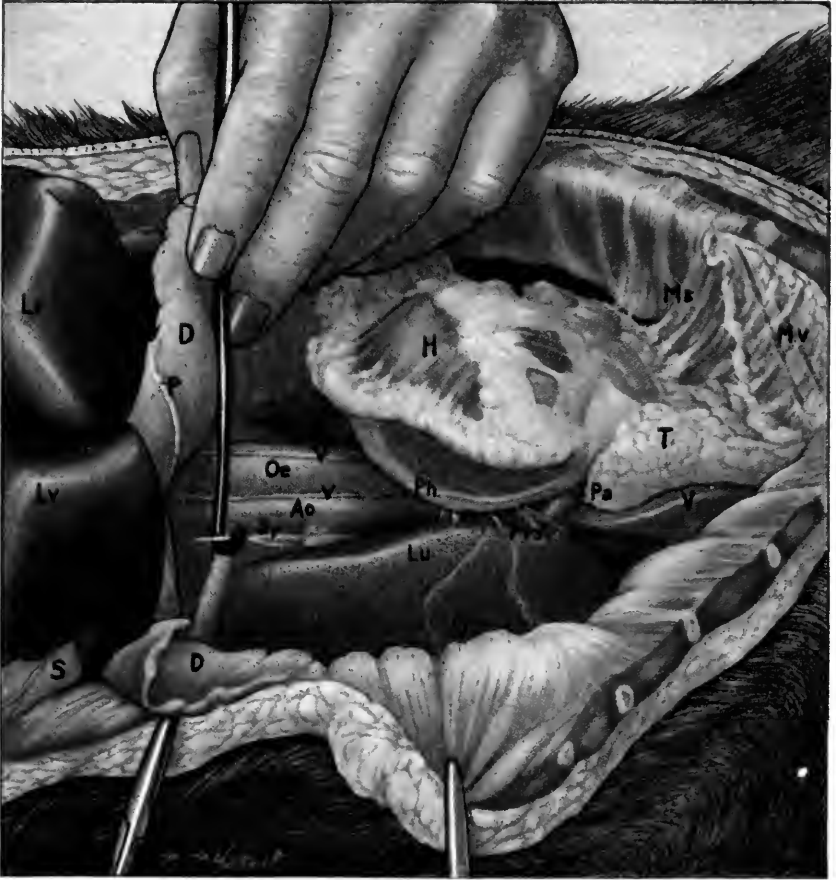
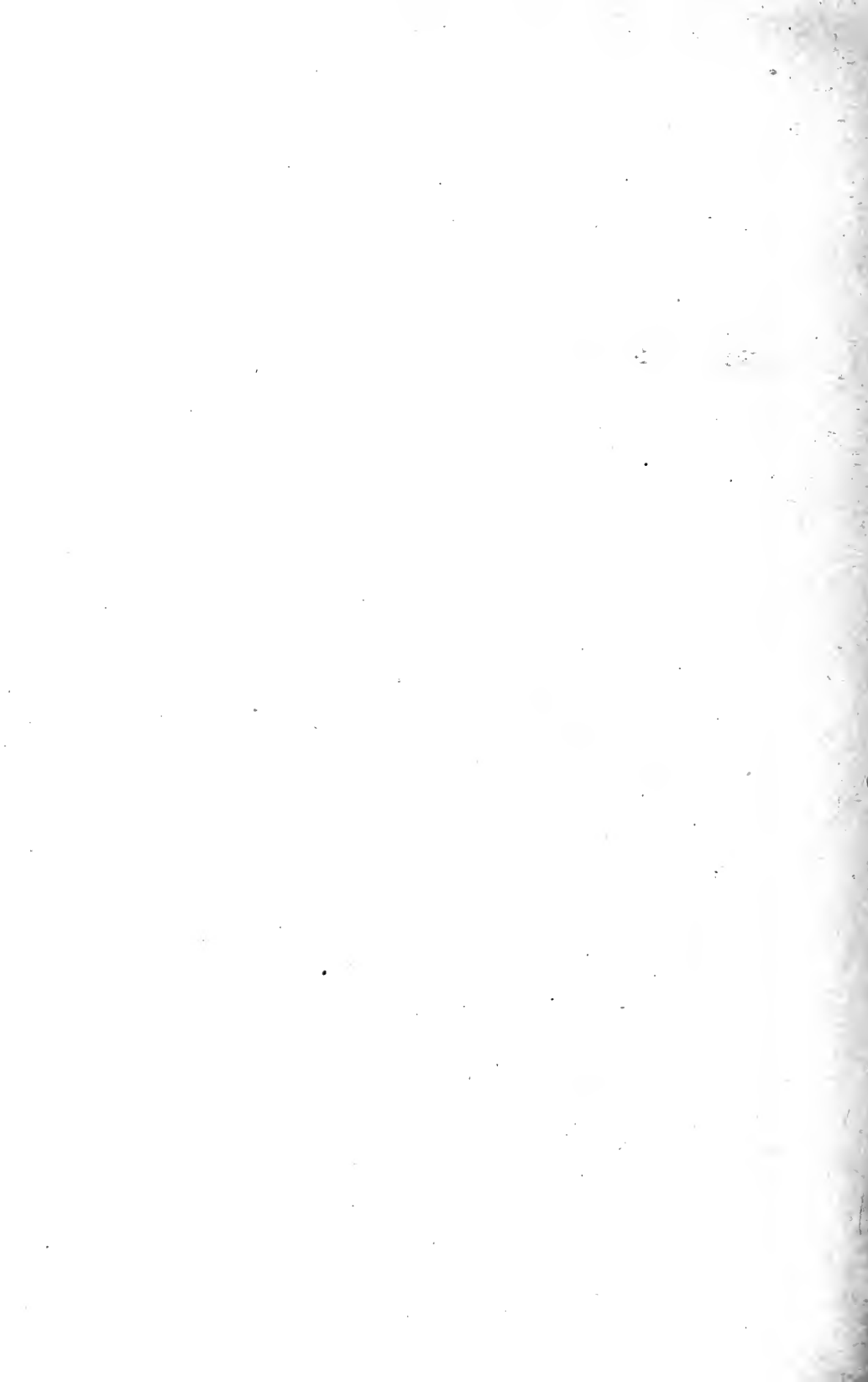

Fig. 161.—Dissection (dog) showing the position of the left pulmonary vessels and the sympathetic trunk in the chest above the diaphragm. *Ms*, mediastinum; *Mv*, mammary vessels (seen through the mediastinal membranes); *T*, thymus; *V*, vagus trunk; *Pa*, left pulmonary artery; *Pv*, left pulmonary veins; *H*, heart covered over by the pericardium. The connection of the pericardial sac to the diaphragm is torn loose from the diaphragm at the edge; *P*; *Ph*, left phrenic nerve lying on the pericardium; *Lu*, lower lobe of the left lung; *F*, *F*, branches of the vagus trunks on the esophagus; *Oe*; *Ao*, aorta; *Sy*, sympathetic trunk; *D*, *D*, diaphragm; *Lv*, liver; *S*, edge of stomach.



normal position, could you now find these same fibers in the abdomen? Consult Figs. 158 and 162. Perform a similar dissection on the right side. Could you find these

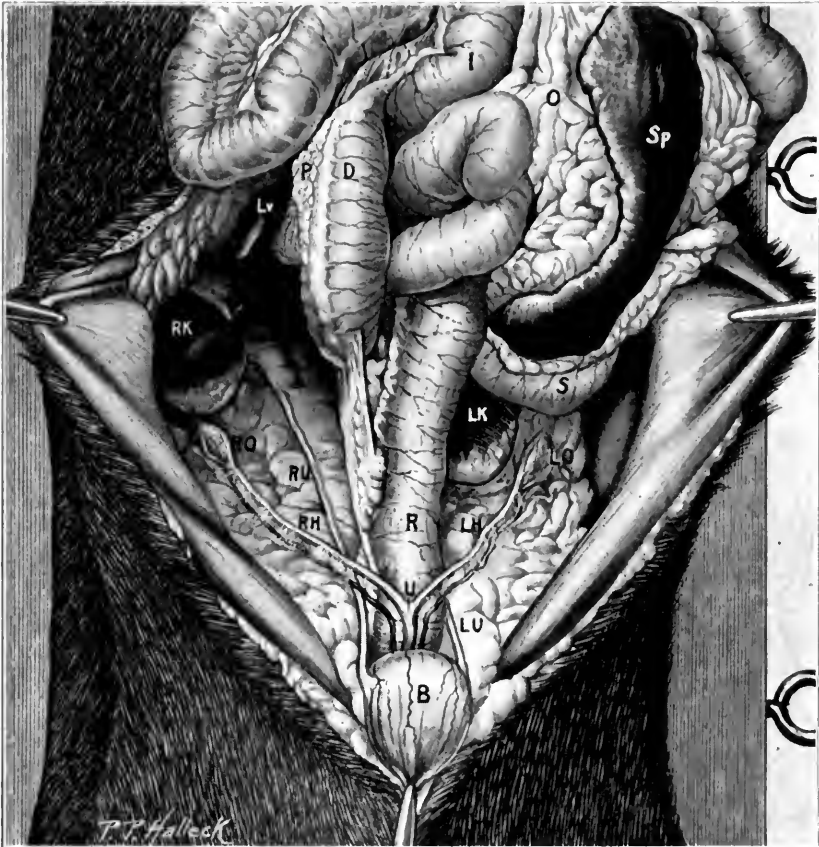

Fig. 162.—Dissection to show the abdominal viscera (dog). *I*, intestine; *O*, omentum; *D*, duodenum; *P*, pancreas; *Sp*, spleen; *L*, liver; *S*, stomach; *RK*, right kidney; *LK*, left kidney; *LO*, left ovary; *RO*, right ovary; *RU*, right ureter; *LU*, left ureter; *RH*, right uterine horn; *LH*, left uterine horn; *U*, uterus; *R*, rectum; *B*, bladder (pulled outward and downward).

fibers and stimulate them electrically in a living animal? On which side are the fibers easier to reach? What are the functions of the splanchnic nerves? Consult Fig. 318 to determine the general distribution of the visceral nerve.

EXPERIMENT XVII.

**Chloral Hydrate, Urethane, Paraldehyde, Chloretone.
(Frogs: Central Nervous System.)**

1. Into the anterior lymph sac (Fig. 66) of a frog inject (see Figs. 125 and 126) one cubic centimeter of four per cent chloral hydrate solution. Place the frog on moist cotton in a battery jar and observe its symptoms. Try its reflexes from time to time by touching it. Turn it over and see if it can regain its normal position. Are there any symptoms of stimulation? Some local irritation may be caused by the drug when first injected. How long does it take for the animal to become completely narcotized? How do the symptoms compare with those produced by ether, chloroform or nitrous oxide?

2. Into the anterior lymph sac of another frog inject one cubic centimeter of a ten per cent urethane solution. Carefully observe its symptoms, noting the condition of the reflexes, power of equilibrium, etc., from time to time. How does this drug compare with chloral or ether?

3. Inject another frog with one-half cubic centimeter of paraldehyde. Observe its actions carefully and compare these with those manifested by the other frogs. What structures or organs are chiefly concerned in the production of the symptoms you observe? How would a decerebrated frog act under paraldehyde?

4. Inject a fourth frog with chloretone solution. This solution can be made up as follows: Place about half a gram of chloretone crystals in a beaker and pour a few drops of absolute alcohol over the drug. The chloretone should soon dissolve. Now add water until faint traces of a precipitate (white) begin to appear. Then add *just enough* alcohol to redissolve the precipitate. Of this solution one or two cubic centimeters may be injected into the frog. (Chloretone is also sometimes dissolved in olive oil for administration to animals.)

Save all the frogs until next day and note all later symptoms. How does the length of duration of the anesthesia compare with that produced by ether or chloroform? Do any of the frogs recover? If not, smaller doses may be tried again.

EXPERIMENT XVIII.

Chloral Hydrate. (Action on the Frog's Heart.)

1. Pith a frog and arrange for recording heart tracings (see Fig. 63). Obtain one or two normal tracings (showing the effect of vagus stimulation). Start a new round on the drum and apply four per cent chloral hydrate solution to the heart with a medicine dropper. Stimulate the vagus nerve from time to time and note any changes. Continue the application of the drug until the heart stops. Time the record and draw three or four horizontal comparison lines around the drum between the records. These lines are made by rotating the drum by hand while a stationary tambour pointer or signal magnet pointer marks on the drum. How did the drug affect the tonus of the heart muscle? Was the inhibitory apparatus affected? Examine the condition of the auricles and ventricle.

EXPERIMENT XIX.

Chloral Hydrate. (Frog: Retinal Circulation With the Ophthalmoscope.)

1. Examine carefully an ophthalmoscope (Fig. 163). Fasten a frog to a board as shown in Fig. 164. Then with the ophthalmoscope look into the frog's eye from a position in front of the animal, but slightly from above and from the side. Turn the lenses in the instrument until you find one that permits you to see the red blood vessels in the fundus of the eye. Examine these carefully. Can you

detect any movement inside these vessels? The larger ones show a motion resembling that of a rapidly moving belt. Seek out some very fine vessels and watch for movements of the corpuscles. Can you distinguish individual corpuscles in these finer vessels? Find a place where a



Fig. 163.—Electric ophthalmoscope. The small (replacable) battery is concealed in the handle of the instrument.

very small vessel divides. Watch the movements of the corpuscles as they strike against the walls of the vessel at the point of division. Can you see this in the human eye?

Now carefully observe the *rate* and appearance of the corpuscle flow in some easily observed (very small) ves-

sels. Keep this observation carefully in mind for later comparisons.

Under the skin of the back inject with a hypodermic syringe one cubic centimeter of four per cent chloral hydrate solution. At intervals of five minutes or less again carefully observe the *rate* and appearance of the corpuscle flow in the *vessels previously examined*. Does the frog become deeply narcotized? How does chloral affect the heart?

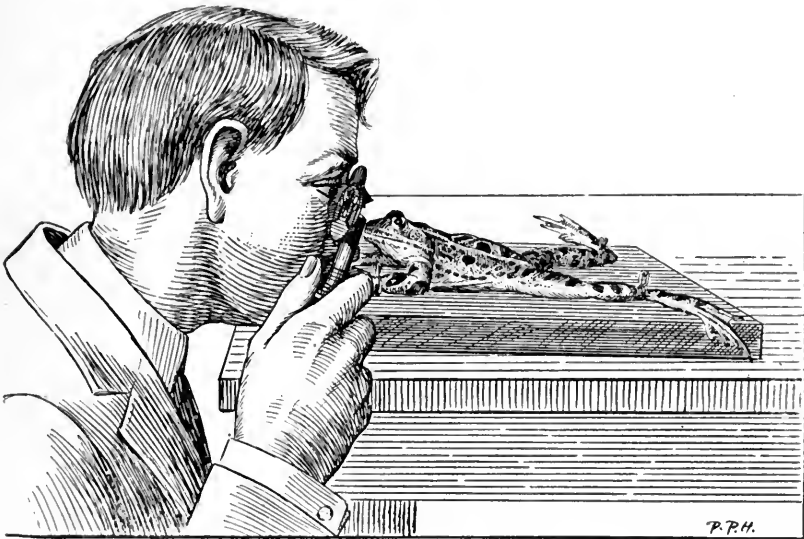

Fig. 164.—Position and method used for observing the retinal circulation in a frog. The ophthalmoscope shown in Fig. 163 is being used, but several other (cheaper) forms of ophthalmoscopes are on the market and may be equally well employed.

Are the muscular walls of the vessels directly affected by chloral hydrate? What conclusions can you draw from this experiment?

You may repeat this experiment using urethane or paraldehyde or chloroform to anesthetize the frog if you have time. Later in your course other drugs, such as nitroglycerine, amyl nitrite, arecoline, atropine, etc., may also be used in this experiment.

EXPERIMENT XX.

Chloral Hydrate, Adrenaline. (Turtle's Heart.)

1. Pith a turtle and take a normal heart tracing. Then drop on the heart four per cent chloral hydrate solution until the beats become slow. Then drop on adrenaline solution (1:10,000) and note carefully any change in rate or amplitude of the heart record. What structures are affected by each drug? What conclusions can you draw from the experiment?

EXPERIMENT XXI.

Chloral Hydrate and Alkalies.

1. Into a test tube containing two cubic centimeters of a four per cent chloral hydrate solution pour an equal volume of potassium hydrate solution. What do you observe? Smell the mixture. What do you note? A reaction represented by the following equation has taken place:

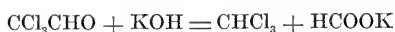

What bodies are formed? Are they soluble in water?

EXPERIMENT XXII.

Morphine. (Frog: Central Nervous System.)

1. Into the anterior lymph sac of a frog inject one cubic centimeter of four per cent morphine acetate solution. (The sulphate or hydrochlorate of morphine may be used instead.) Place the animal on moist cotton in a battery jar and observe its actions. Try the reflexes from time to time. Are the pupils affected? Is there any change in the respiratory movements? How does the action of the drug compare with that of nitrous oxide or chloral? If the frog becomes completely narcotized do not cast it aside

but carefully save it until the next day observing it several times in the meantime if possible. Do you note any changes in the reflexes at any time? Does the frog recover? What symptoms are exhibited during the recovery period? How do you explain this?

EXPERIMENT XXIII.

Thebaine, Codeine. (Frog: Central Nervous System.)

Inject a frog with one cubic centimeter of two per cent thebaine solution and a second animal with one cubic centimeter of two per cent codeine solution. Place the frogs on moist cotton in a battery jar and watch the symptoms produced by the drugs. Compare these animals with the one that got morphine.

EXPERIMENT XXIV.

Morphine. (Chemical Test for Morphine.)

1, Add a few drops of a dilute mixture of ferric chloride and potassium ferricyanide solutions to a morphine salt so-

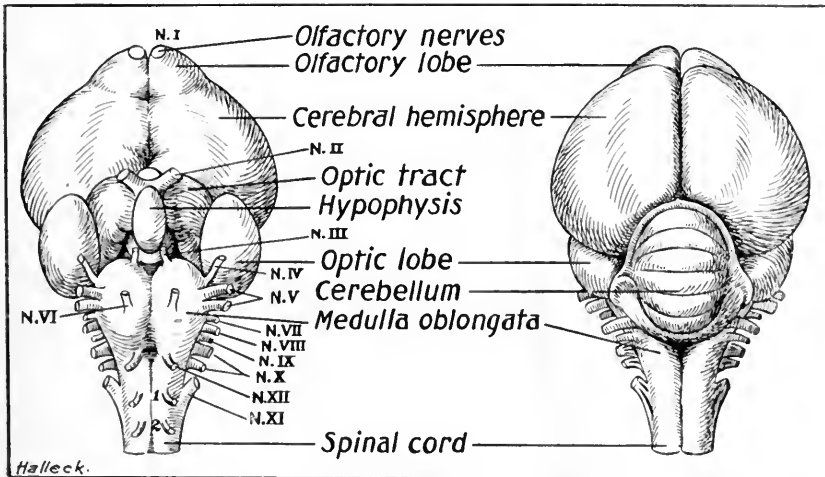
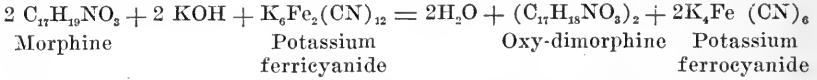

Fig. 165.—Ventral and dorsal views of a pigeon's brain. (Modified from Wiedersheim.)

lution. A deep blue color appears. Considerable morphine produces a precipitate of Prussian blue.

Potassium ferrieyanide oxidizes morphine to oxy-dimorphine:



Potassium ferrocyanide then forms Prussian blue with

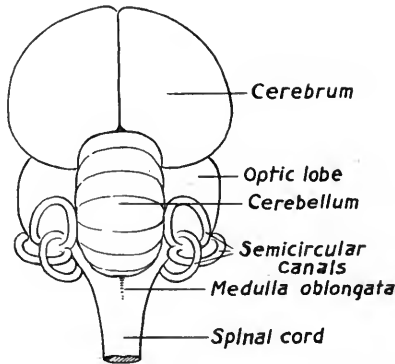

Fig. 166.—Posterior view of the brain and semicircular canals of a pigeon.

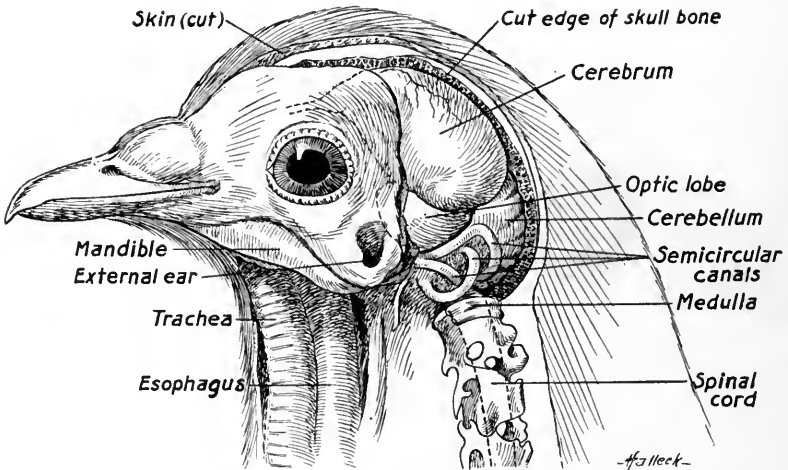

Fig. 167.—Lateral view of the head of a pigeon showing the brain, external auditory opening and semicircular canals.

ferric chloride (Autenrieth and Warren). The instructor may give you other tests for morphine if he desires to do so.

EXPERIMENT XXV.

Morphine. (Dog: Respiration, Excretion, Pupils, Central Nervous System, General Symptoms.)

1. Inject subcutaneously into a dog twenty milligrams (one cubic centimeter of two per cent solution) per kilo-

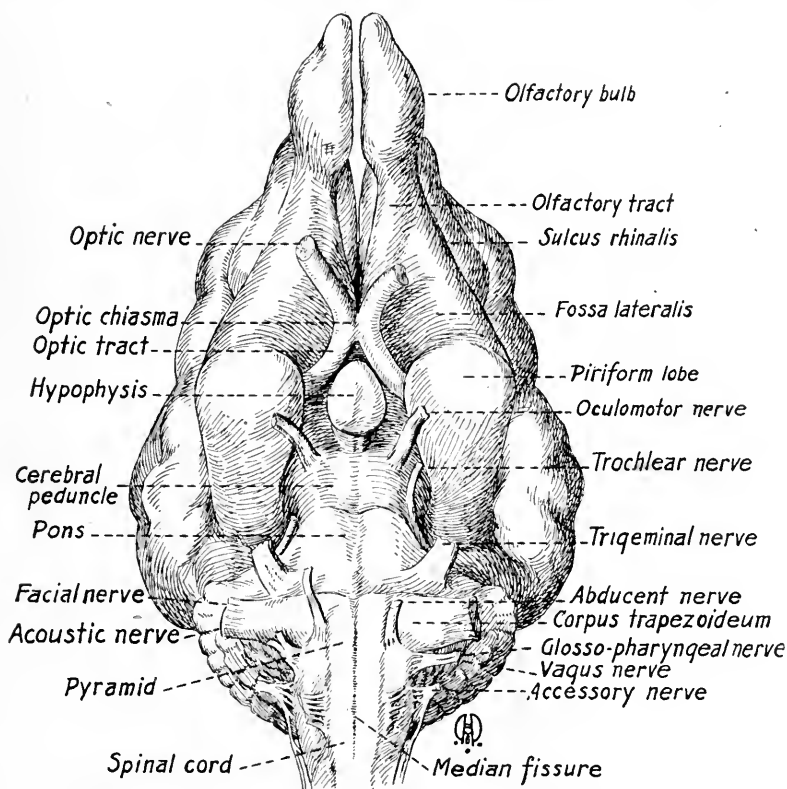

Fig. 168.—Base of the brain of a dog. (Modified from Sisson.)

gram of weight of morphine hydrochlorate (or the acetate or sulphate). Note carefully the size of the pupils and

watch for any change in these. Allow the animal to walk about the room and do not disturb it at first. How is the respiration affected? Does the animal vomit? If so, can you detect morphine in the vomitus? How is morphine excreted? Is there present an increase in the secretion of saliva? How do you account for this? Does the animal defecate? How is the intelligence of the dog affected? What later changes do you note in the respiration? Are there any symptoms of excitement? Take the rectal temperature. When the animal lies down and becomes quiet, then try its reflexes from time to time by pinching, loud noises, etc. Record the respiration on the drum and watch for irregularities (Cheyne-Stokes respiration). Are there any changes in the pupils? Consult several text-books to find out what action morphine has on the dog's pupil. Would the administration of ether to a dog that had previously received a dose of morphine in any way affect the action of the alkaloid on the pupil? Has the animal's temperature changed? Keep the animal in a quiet place (in a metabolism cage if possible) until next day and follow the course of the drug's action as fully as you can. Is the recovery complete? How long does this require? If the animal dies what will be the immediate cause of death? If you succeed in collecting any urine test this with Benedict's modification of Fehling's solution. Do you get a positive test? What does this show? If you do not have this solution use Fehling's or Haines' solution.

EXPERIMENT XXVI.

Fehling's Test for Reducing Bodies.

1. Into a test tube pour five cubic centimeters each of solutions A and B. Bring the mixture to a boil. Is there any change from a clear deep blue color? If so the solution is probably decomposed. If no change of color and no precipitate forms the solution is satisfactory. Add

drop by drop to this warm solution five or ten drops of the urine to be tested. Wait a little while and if no reduction (yellowish or reddish precipitate) appears, then again heat the mixture. A red or reddish-yellow precipitate indicates the presence of reducing bodies in the urine. (If no precipitate forms at once, set the tube aside for a few minutes and observe it later.) This is usually due to sugar, but other substances (e. g., glycuronic acid, etc.) may give a similar reaction. For tests to differentiaté between these bodies the student is referred to text-books on physiological chemistry.

EXPERIMENT XXVII.

Morphine. (Cat: General Symptoms, Central Nervous System.)

1. Inject into a cat subcutaneously twenty-five milligrams of morphine sulphate (or the hydrochlorate or acetate) per kilogram of body weight. Observe carefully the symptoms produced by the drug in this animal and compare them with those exhibited by the dog that was injected with morphine. What differences do you note as regards the pupils, intelligence, reflexes, convulsive tremors, etc.?

EXPERIMENT XXVIII.

Morphine, Codeine. (Dog: Respiration, Blood-pressure, Oxygen Consumption, Urine.)

1. Arrange a dog for recording blood-pressure and respiration. Place adrenaline in one injecting burette (femoral vein) and a morphine salt solution (one cubic centimeter equals five milligrams) in another burette (femoral vein). The dog should weigh about ten or twelve kilos. If you do not have suitable apparatus omit the oxygen deter-

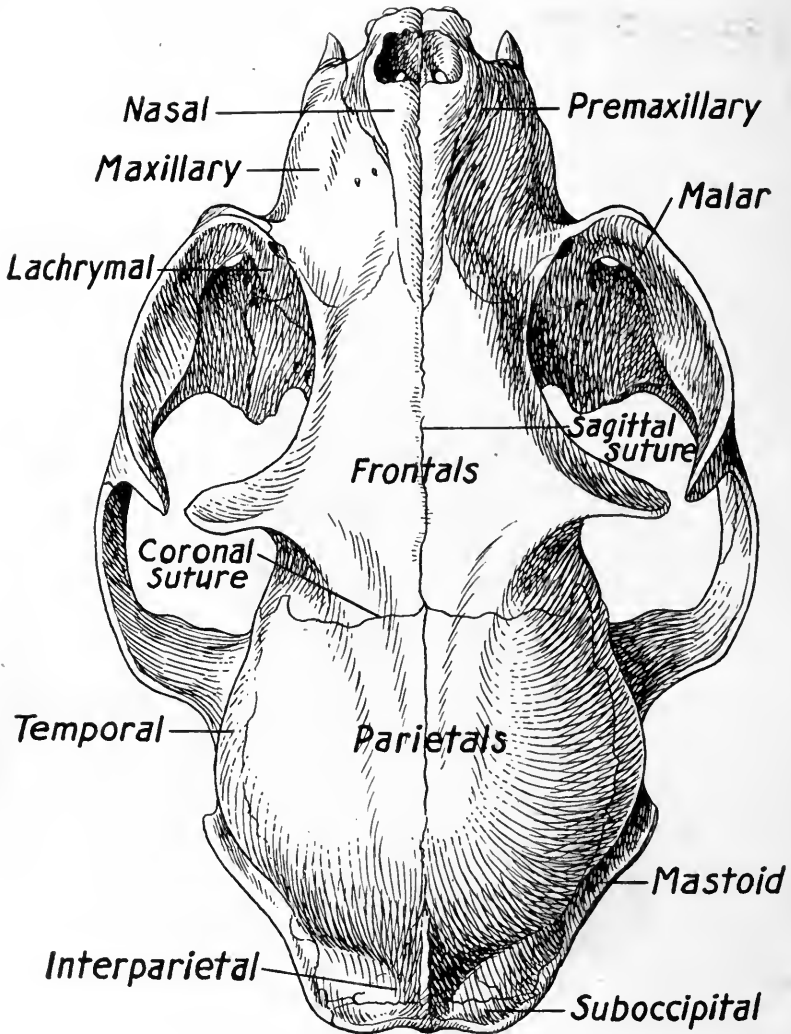

Fig. 169.—The upper surface of the skull of a cat. (Partially adapted from Jayne.)

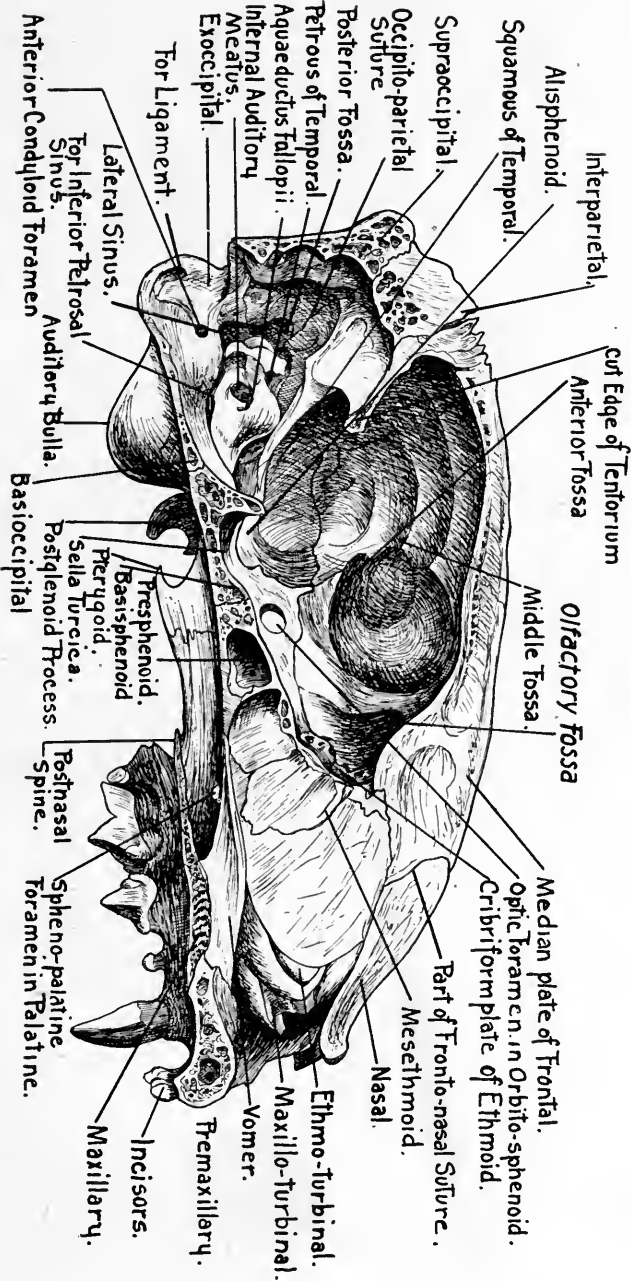

Fig. 170.—Mesial section showing the left half of the interior of a cat's skull. (Partially adapted from Jayne.)

mination and proceed with the remaining observations.

To determine marked changes in the rate of oxygen consumption by the animal an apparatus similar to that shown in Fig. 172 is required. (See also Fig. 175.) This consists essentially of the anesthetic apparatus shown in Fig. 116 but with the addition of a four or six inch *thin* aluminum (or pasteboard) disc which rests (stuck on with mucin-

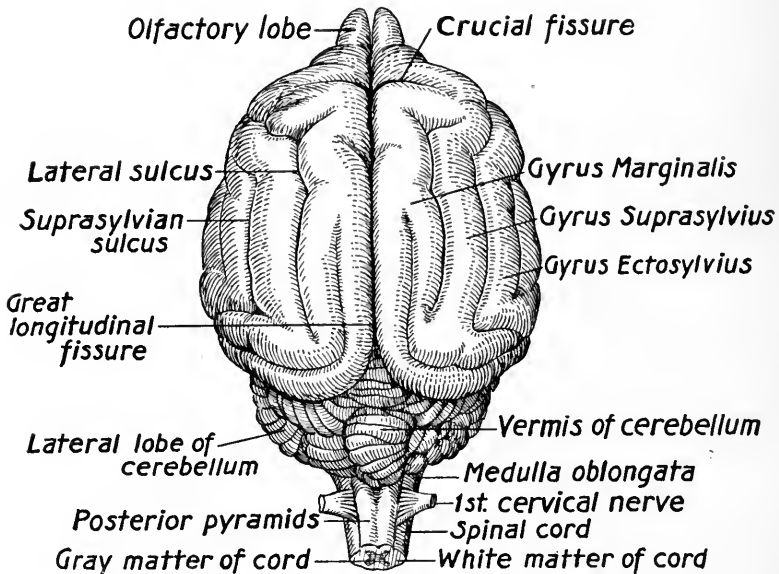

Fig. 171.—Dorsal surface of the brain of a cat. (Partially adapted from Davison.)

lage) on top of the bath cap covering the large pan in the bottom of which is placed strong (not saturated) sodium hydrate solution [$\text{Ca}(\text{OH})_2$ may also be added if desired] to the depth of about three-fourths or one inch. Oxygen is run into the breathing pan from the tank as needed. In the center of the aluminum disc are two small holes in which is tied a twine string about four feet long. One, two or three bull-dog forceps must usually be laid on the top of the disc to cause it to move down readily as the dog inspires. As the dog expires the disc moves upward. These

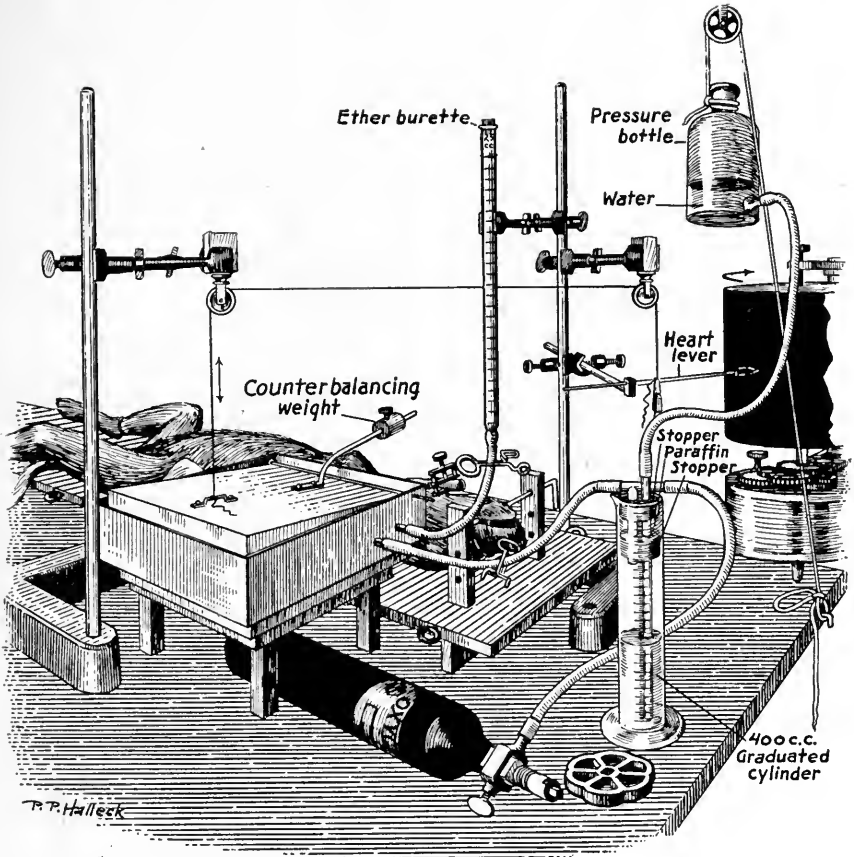

Fig. 172.—Arrangement of apparatus for recording and measuring the rate of oxygen consumption. (See also Fig. 175.) The side tube of the tracheal cannula opens into the interior of the large square pan. The trough (Fig. 173) is filled with water and the breathing pan dips up and down in the water. A layer ($\frac{3}{4}$ inch deep) of strong sodium or potassium hydrate solution is placed in the bottom of the inner pan to absorb the CO_2 exhaled by the animal. If the clip on the tube leading from the graduated cylinder to the pan be closed while the oxygen tank is opened a little, the water in the cylinder will be forced up into the pressure bottle. When the cylinder is thus filled with oxygen the tank valve is closed. The oxygen remains stationary in the cylinder but can be immediately run into the pan by opening the clip on the communicating rubber tube, as the water in the pressure bottle will quickly run down and displace the oxygen which is thus forced out into the pan. This causes the writing lever on the drum to make a sharp rapid descent. As the animal uses up the oxygen and the breathing pan slowly descends the writing point on the drum slowly goes up. (See Fig. 175.)

fairly rapid movements up and down correspond to the regular respiratory movements of the animal. But in addition to these rapid movements a larger and more pro-

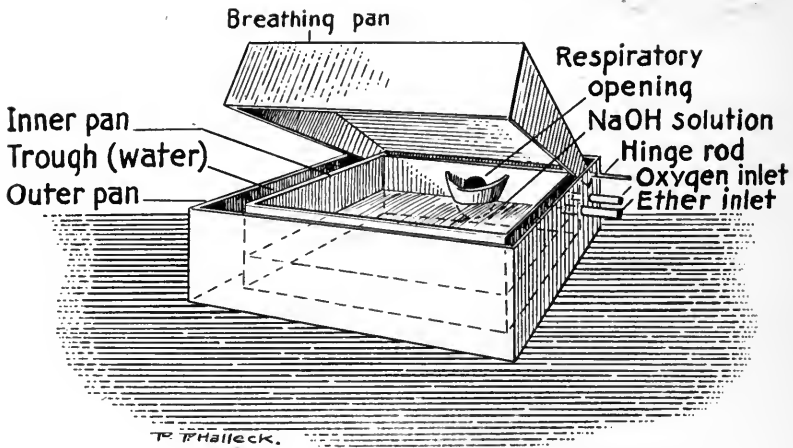

Fig. 173.—Inner construction of the pans shown in Fig. 172. These pans can be made of sheet brass or tinned iron. Pans which can be used for the purpose can often be purchased at a hardware store (or a ten cent store). (See *Journal of Laboratory and Clinical Medicine*, 1916, ii, p. 145; also *ibid*, 1916, ii, p. 94.)

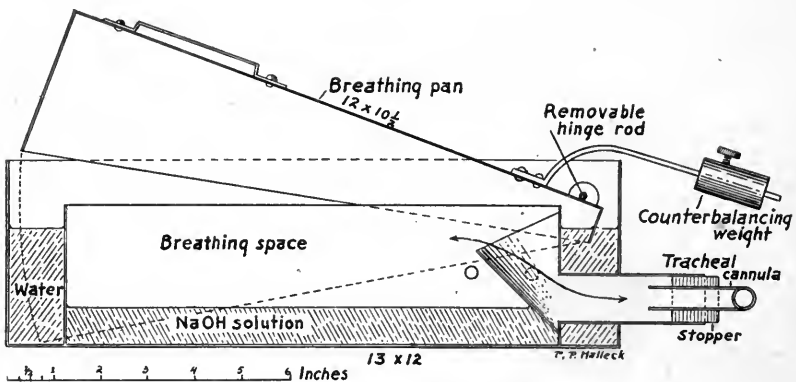

Fig. 174.—Lateral view of a cross-section of the apparatus shown in Fig. 172. The breathing pan is best made of very thin sheet brass (which is easily soldered and is not affected by alkalis as is aluminum). The pan should be carefully counterpoised with an adjustable weight. The dimensions are indicated in inches on the scale.

longed movement of the disc occurs. This corresponds to the injection of oxygen from the tank into the pan when the disc will be lifted up a considerable distance (perhaps

one inch), and then to the gradual consumption of this oxygen by the dog during which interval the disc will be falling (one inch). During all this time the exhaled carbon dioxide is being absorbed by the alkali solution. The twine string attached to the disc passes over two pulleys (one inch brass wheels—these should be of the best quality and can be bought at any good hardware store for about twenty or thirty cents apiece). The opposite end of the

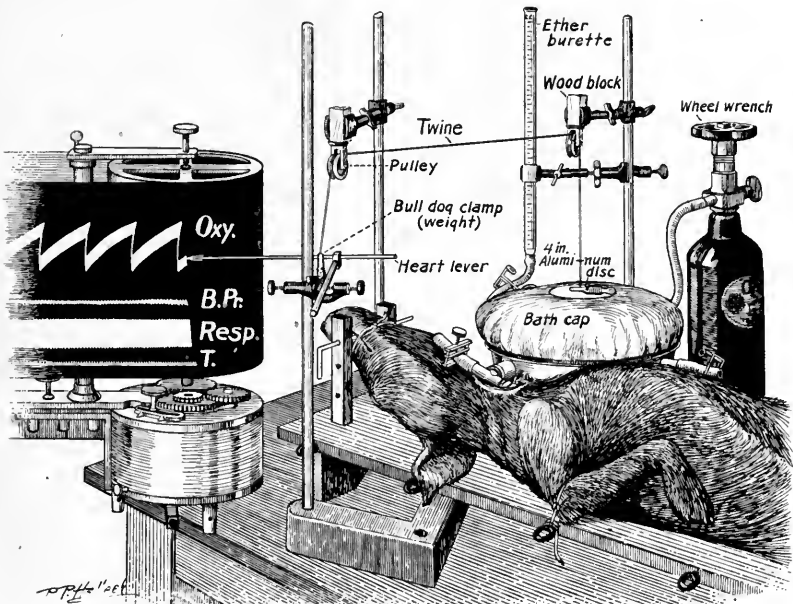

Fig. 175.—A simpler arrangement for recording the rate and amount of oxygen consumption by an animal. (See also Fig. 172.) There is more chance for "lost motion" by use of the flexible bath cap over the pan than with the apparatus shown in Fig. 172. (See *Journal of Laboratory and Clinical Medicine*, 1916, ii, p. 94.)

string is clamped on to the long arm of a frog heart lever by means of a bull-dog clamp. Two clamps may be needed to draw the lever down readily. These clamps serve not only to hold the string to the lever but act as balancing weights as well. The heart lever writes at the top of the drum, below this is the blood-pressure (mercury manometer), next the respiration (tambour connected to the

stethograph drum), and at the bottom is the base line and time marker. The drum should have an approximately constant *slow* speed.

The arrangement of the apparatus and records is shown in Fig. 175. The anesthesia should be fairly light and maintained solely with ether (since morphine is injected later). If the apparatus is in good condition the anesthesia will be approximately constant. Observe the character of the tracing on the drum, also Fig. 180. The thin narrow curved lines in the oxygen consumption record are made while the drum is standing still. This narrow line represents the downward movement of the lever as the pan is filled with oxygen. The extent of this down stroke is optional but should be regulated by the tension of the oxygen on the bath cap. The cap should not be filled so full as to stretch it, as this would cause too great a mechanical obstruction to the breathing of the animal. This must be carefully avoided. When the pan is filled sufficiently with oxygen the writing lever will have descended to a certain level on the drum. This level marks what may be termed the lower base line for the oxygen record. In filling the pan with oxygen at all later times see to it that the lever again descends to this same level as nearly as you can determine. This is done by watching the lever go down as oxygen is run in *very cautiously*. Conversely the highest point in the oxygen record may be called the upper base line for this record. If while the drum is stopped the lever be run down to the lower base line by adding oxygen to the pan, then just as the lever reaches the base line the injection of oxygen is stopped and the drum is started. (It is desirable that the drum start quickly and soon reach the maximum for that rate of speed.) As the drum runs the lever moves up and down a *short distance rapidly* at each inspiration and expiration. We are not much concerned now with these short, rapid movements as they correspond fairly closely with the respiration tracing from the stetho-

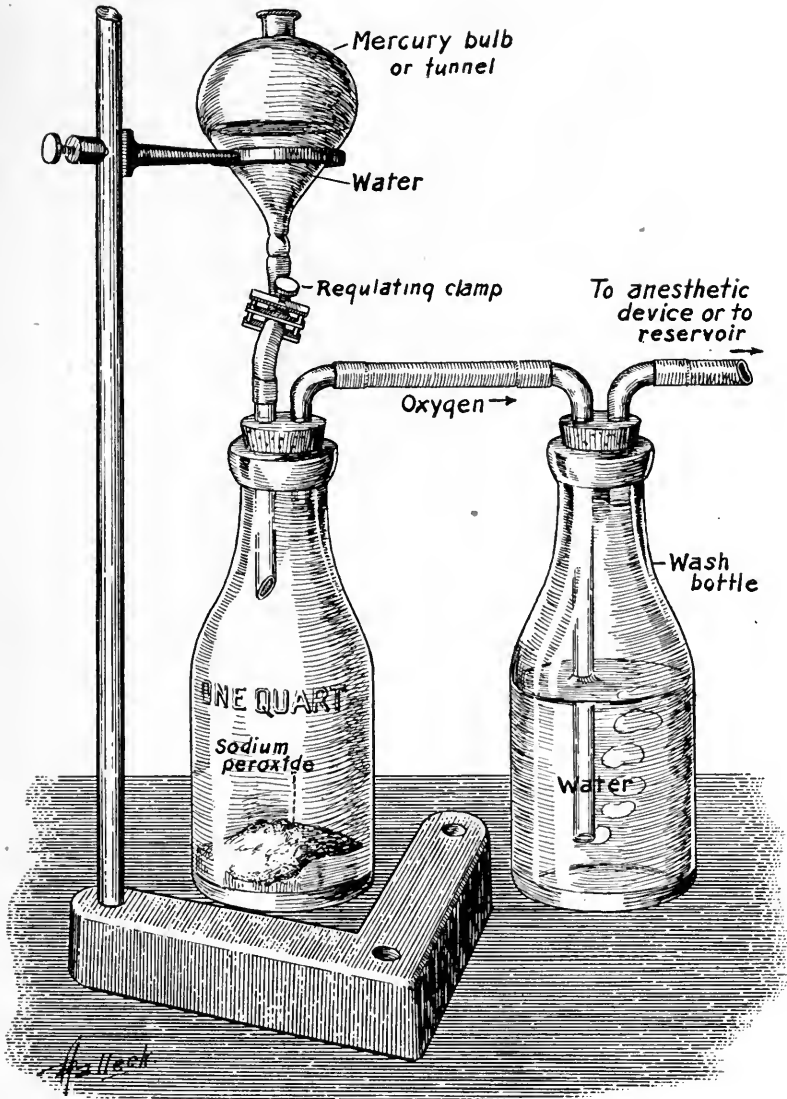

Fig. 176.—A cheap form of apparatus used for making pure oxygen. Sodium peroxide is placed in the left hand bottle and water is allowed to drop slowly down on to the Na_2O_2 from the mercury bulb above. Oxygen is liberated and at once bubbles over through the water in the wash bottle. In one experiment 74 grams of sodium peroxide generated sufficient oxygen to run a 15 kilo dog for one hour. At the end of this period the left hand bottle was exchanged for a second (quart milk bottle) containing a second 74 grams of sodium peroxide and this again liberated sufficient oxygen to run the animal another hour. In this experiment the closed anesthesia apparatus shown in Fig. 116 (see also Fig. 175) was used. It is advisable to use some kind of reservoir to catch the oxygen generated as the rate of liberation cannot be controlled accurately by the addition of the water.

graph drum. These movements do, however, with many drugs, record very profound and striking changes in the bronchioles. (Can you detect any evidence of this when morphine is injected into the femoral vein?) But the important point in the oxygen record is the gradual rise of the lever as the oxygen in the pan is consumed by the dog. The *rate* of this rise determines the rate of oxygen consumption. Watch carefully and when the lever reaches a satisfactory altitude (this will vary with each experiment and the student with a little practice can estimate about when to stop), which will generally be about two inches if a large drum is used (lower and less magnified if a small drum is used), then suddenly stop the drum and at

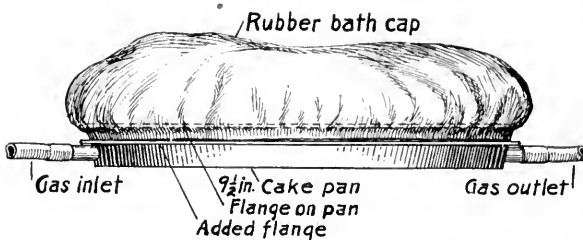

Fig. 177.—A simple gas reservoir made from a very shallow, wide, round cake pan with two spouts soldered into the walls. A large bath cap is stretched over the pan and serves to form an adjustable gas reservoir suitable for use with the apparatus shown in Fig. 176. A small spirometer (1 or 2 gallons) may also be used as a reservoir. The spirometer should be delicately counterpoised as the oxygen is not delivered from the wash bottle under a high pressure. A large, thin walled rubber bag may also be used.

once run a fresh supply of oxygen into the pan. The lever comes down and when the base line is reached stop the oxygen inflow and immediately start the drum. (If the drum is exceedingly slow the oxygen can be run in while the drum is turning. This is very convenient.) When the lever again reaches its former high point stop the drum and at once reinject oxygen. This gives a saw-tooth like record. And the *distance* between each two consecutive teeth or descending narrow lines in the record gives a measure of the relative amount of oxygen consumed during that period of time. If a drug which *slows* the con-

sumption of oxygen is given, then the *distance* between the consecutive descending lines will be increased; while a drug which increases the relative consumption of oxy-

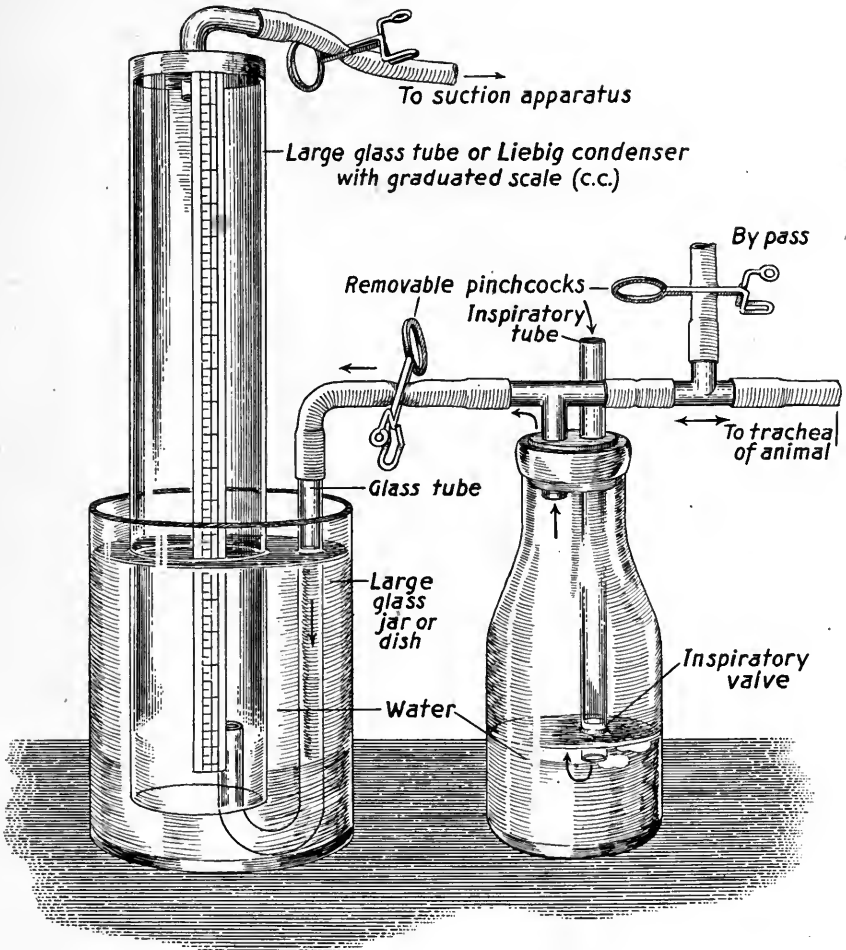

Fig. 178.—Dreser's arrangement of apparatus for recording the volume of air expired by an animal in a given length of time. The large glass tube (or Liebig condenser jacket) is filled with water which is supported up in the tube by the pressure of the atmosphere. The by-pass is closed and the clip on the tube leading from the milk bottle inspiratory valve is removed. When the animal inspires, air enters the inspiratory tube, bubbles through the water in the bottom of the bottle and thence passes to the lungs. At expiration the air passes through the straight course of the tubes to the large glass jar or dish and thence is liberated in the lower end of the large glass tube. The exhaled air then quickly displaces the water and rises to the upper part of the large glass tube where it can be measured on the scale.

gen will cause a decrease in the distance between consecutive descending lines.

If the instructor desires it is an easy matter to place a gas measuring device in the path of the oxygen inflow tube

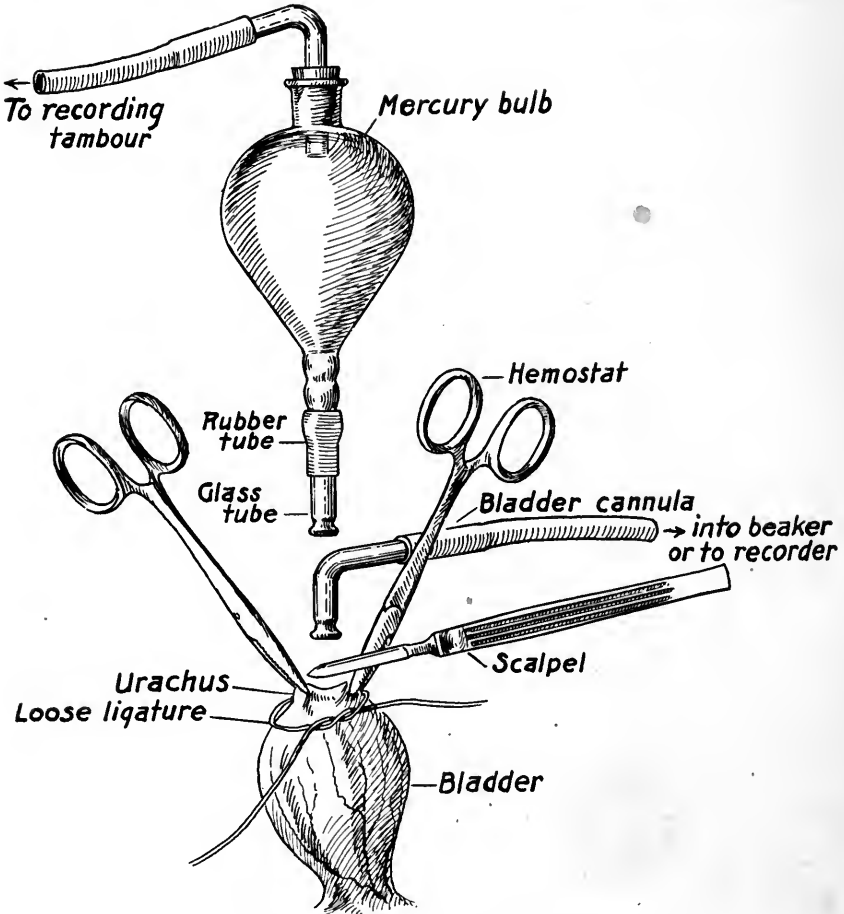

Fig. 179.—Technic for inserting a bladder cannula or for connecting a mercury bulb to record bladder contractions. (For discussion see text.)

and measure the amount of oxygen run in at each filling of the pan (see Fig. 172). This is instructive and is a valuable procedure in the beginning, but with a little practice the operator will be able to attain sufficient accuracy

by simply watching the lever as it writes on the drum. A monkey wrench is better than the regular wheel wrench to control the valve on the oxygen tank where careful regulation is needed. It is very desirable to have the tank fastened down with a clamp to the table (see Figs. 112 and 113).

To obtain urine for tests the abdomen is opened over the bladder which is caught in a hemostat at the urachus (Fig. 179). The bladder is then raised a little and a second hemostat is clamped on the opposite side of the urachus in such a manner that an opening can be cut with a scalpel or scissors just between the tips of the hemostats. Before this opening is made place a twine string around the upper part of the bladder (just below the points of the hemostats) and tie it loosely. Open the bladder (do not allow any urine to escape or blood to run down into the bladder if it can be avoided) and quickly insert the bladder cannula. Tie the ligature and replace the bladder within the abdomen which is closed by hemostats. Catch the urine in a beaker and test some early to see if it contains glucose.

When all apparatus is adjusted start the drum and take several records of the oxygen consumption in order to become familiar with the method and to get some normal records. Your success will depend largely on your ability to determine exactly when to stop and start the drum and to judge when the lever has gone high enough. This is the most difficult part of the experiment and should *always* be done by that member of the group who is best able to carry out this work.

Your "normal" oxygen records should be almost exactly alike both in form and in the distance they occupy on the drum.

Inject one cubic centimeter of morphine. Watch the oxygen records closely and make your changes promptly. When the records all return to normal inject three or four

cubic centimeters and record the results. Do you get what you expected? Does the anesthesia remain regular? How are the respiratory movements affected? Does the rate of oxygen consumption correspond with the rapidity or slowness of the respiratory movements or with the height of the blood-pressure? Would you have expected these results? Now take one or two normal oxygen records and then when the oxygen lever is getting pretty well up to the top of its course inject one-half cubic centimeter of adrenaline. Watch carefully to reset your oxygen record at the exact moment. *Be sure before the adrenaline is injected that the rise in the manometer writing point will not interfere (catch) with your oxygen lever.* Watch your oxygen record closely and make the changes promptly. Take at least two or three minutes to record this after the adrenaline is injected. Do you observe any peculiar changes in your records? If not, wait a while and repeat the adrenaline injection.

How does morphine affect the heart? Can you detect any change in the rate? Give more morphine from time to time (two cubic centimeters per dose), and see if you can bring on a Cheyne-Stokes form of respiration. Does the anesthesia become any deeper? Examine the pupils carefully. Are they in the same condition as were those of the dog in Experiment XXV? Does this agree with the text-book descriptions?

Inject as much morphine as you think (from the appearance of the respiration, blood-pressure, etc.) the animal can safely stand. You may not get a Cheyne-Stokes form of respiration, but many small repeated doses are very liable to bring it on. Variable but constantly repeated irregularities of the respiration often appear.

Allow the animal to recover a little if it will and then inject codeine (two cubic centimeters—1 c.c. = 5 mg.). Get a record of this and then increase the dose given. After a few injections (and within half an hour), marked symp-

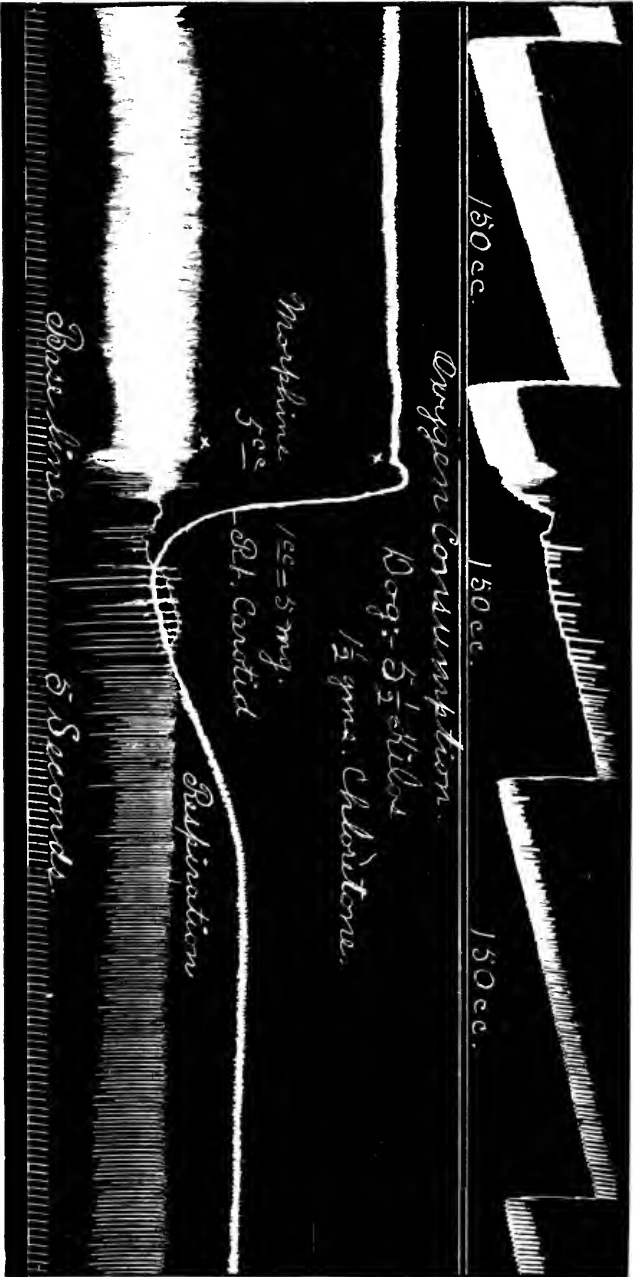

Fig. 180.—Record showing the action of a large dose of morphine on the relative rate of oxygen consumption, on the blood-pressure and on the respiration. Note that the rate of oxygen consumption is largely independent of the height of the blood-pressure and of the rate and depth of the respiration.

toms should appear. Test the urine for glucose. Is there any reduction? How do you account for this? Kill the animal with codeine.

2. If time permits carry out the following dissections.

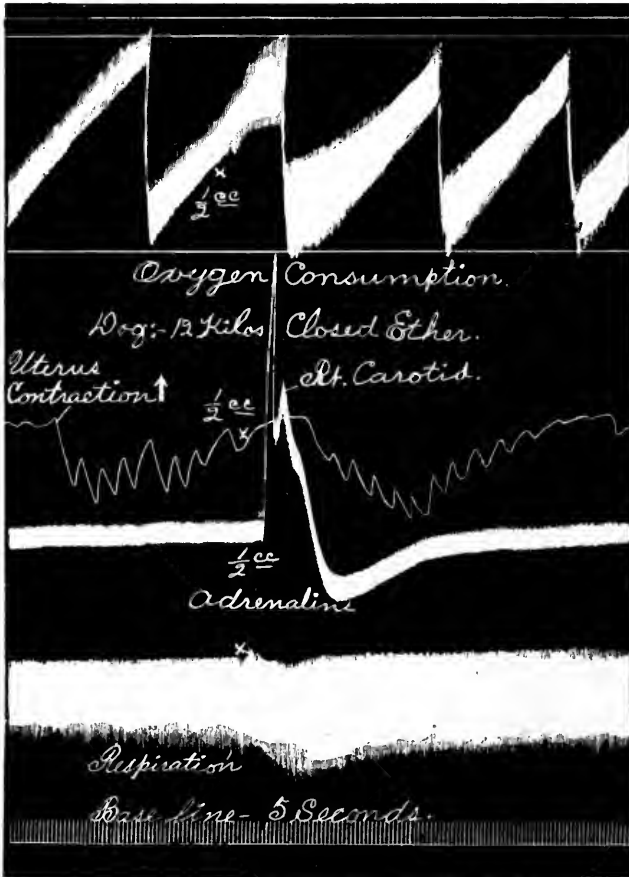

Fig. 181.—Record showing the action of adrenaline on the rate of oxygen consumption, uterine contractions, blood-pressure and respiration. There is a slight slowing down of the rate of consumption of oxygen which is mainly concordant with the period occupied by the fall in blood-pressure after the large initial rise. (See Journal of Laboratory and Clinical Medicine, 1916, ii, 145.)

Isolate both the internal and the external jugular veins on each side. (See Figs. 133 and 183.) Note carefully in just what portion of the neck tissues these vessels are

located. Could you pass a large needle in at the median incision in the neck and then push it out through the tissues in the side of the neck in such a manner as to include both the jugulars on one side in a ligature threaded through the eye of the needle? If you should thus tie a ligature loosely around a portion of the tissues in the side of the neck (including both veins), and then should lift up with a moderate degree of pressure on the ligature, what effect would this have on the back flow of blood through the veins to the heart? How much pressure does it take to shut off the flow through a vein? Carry your

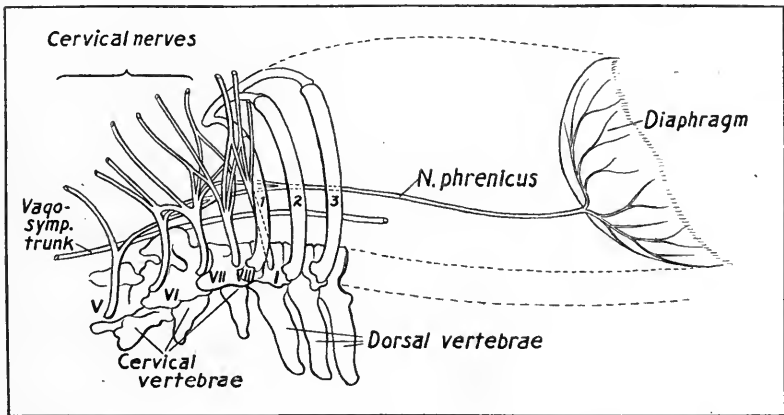

Fig. 182.—Schematic representation of the origin, course and distribution of the right phrenic nerve in a dog. (The origin varies in different animals.)

dissection well down on to the longus colli muscle in the right side of the neck (Fig. 184) and find the right vertebral artery. Pass a large aneurism needle under the vessel, lift it up and slip a ligature around it. What is the distribution of this vessel? Could you inject a solution from a hypodermic syringe into this vessel toward the head? How long a space would you have to operate on the vessel? If you do not find it readily, pick up the right subclavian artery and find the vertebral from this. Could you make the dissection *without getting into the chest cav-*

ity? Pick up the right phrenic nerve. What is the origin of this nerve? If you do not find it readily open the chest and locate it on the pericardium at the side of the heart. Trace it from here back up into the neck. Could you cut both phrenics in the neck *without opening the chest?* This is sometimes done to stop movements of the diaphragm when these interfere with certain records that are being made.

EXPERIMENT XXIX.

Morphine, Codeine, Pantopon, Heroine, Peronine, Dionine, Narcotine or Thebaine. (Spinal Dog: Bronchioles.)

1. This is a new field of experimentation for most medical schools. Many drugs act vigorously on the bronchioles and it is unfortunate for medical students not to have some opportunity to perform experiments to bring out these results, for the action of these drugs is often much more striking on the bronchioles (and perhaps frequently as important) than are the corresponding actions on the heart or other organs. Several methods will therefore be given in different experiments in order to give every laboratory a chance to carry out such experiments. The best (but perhaps the most complicated) method will be given in Experiment LXX. For peripherally acting drugs it is advisable to use spinal dogs. (Cats may also be used for this work but dogs are better.)

Before starting the experiment be sure to arrange for a reliable source of artificial respiration. This should be from an artificial respiration machine, but a hand-bellows fixed to open only a given distance (to regulate the stroke) may answer.

Etherize a dog and arrange it for a blood-pressure tracing. Place injecting burettes in connection with the femoral veins. One burette contains adrenaline (1:10,000), the other an opium alkaloid. Any one of those at the head

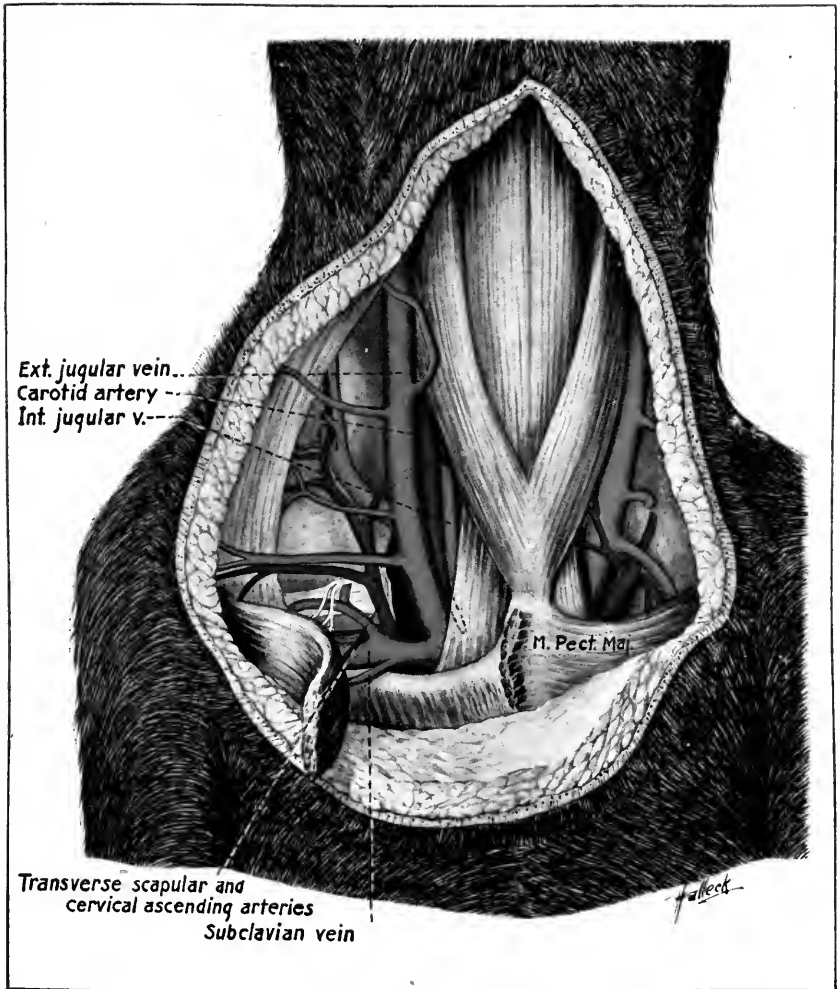

Fig. 183.—Dissection of the lower part of the neck and upper part of the chest on the right side in a dog. (Modified from Schmiedeberg.)

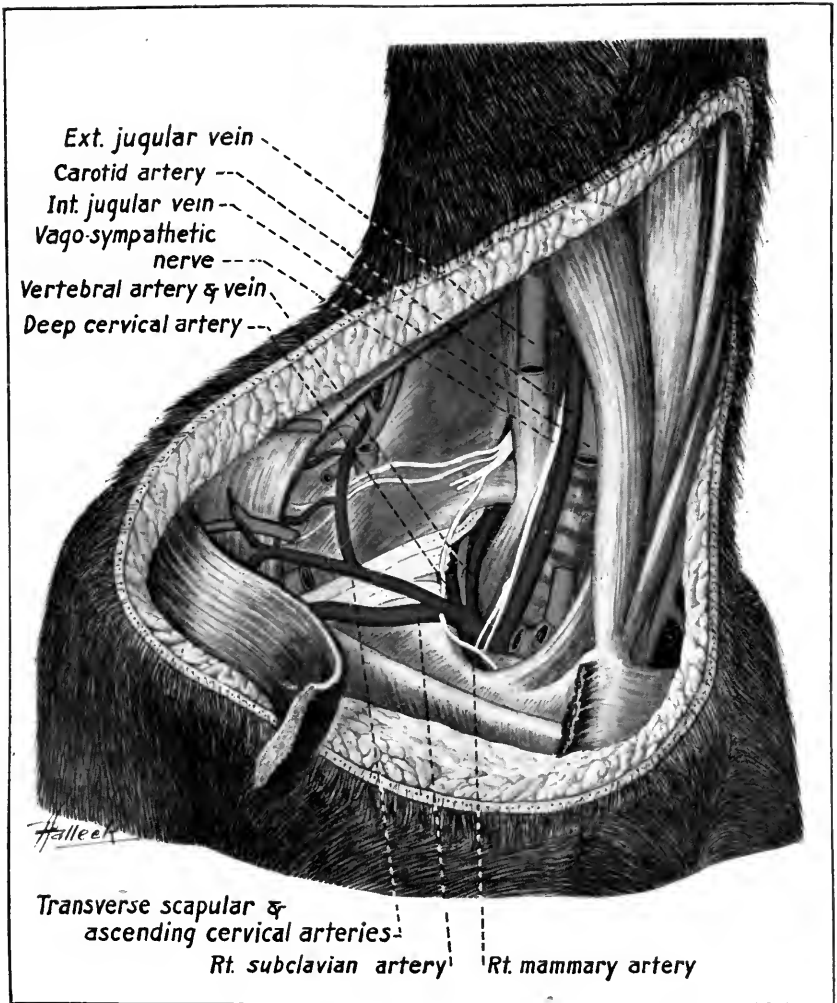
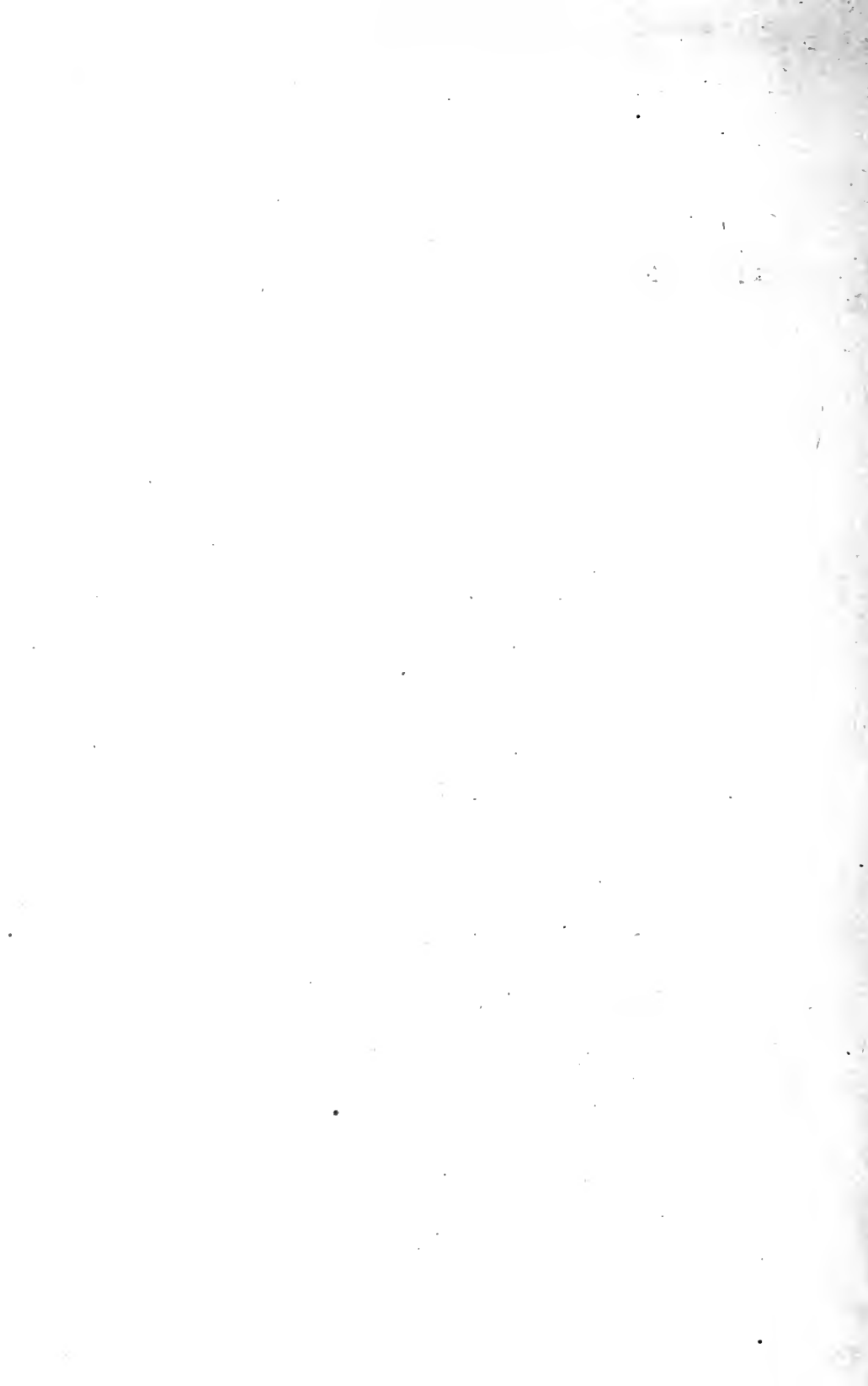

Fig. 184.—Dissection of the lower part of the neck and upper part of the chest and of the axillary region in a dog. (Modified from Schmiedeberg.)



of this section may be used, but either heroine, codeine or dionine will probably give the best results. *Be sure the drug is fresh and of first-class quality.* Codeine possesses some advantages in this respect. The strength of the solution chosen should be five milligrams to the cubic centimeter.

With great care to avoid opening the chest at the apex dissect down on the right side of the neck (see Experiment XXVIII, 2; also Figs. 183 and 184), and pick up the right vertebral artery. Place a ligature around the vessel and tie the ligature once *loosely*. The ends of this ligature are brought together and clamped with a *bull-dog* so it can be found readily. Now with a large (five or six inch)

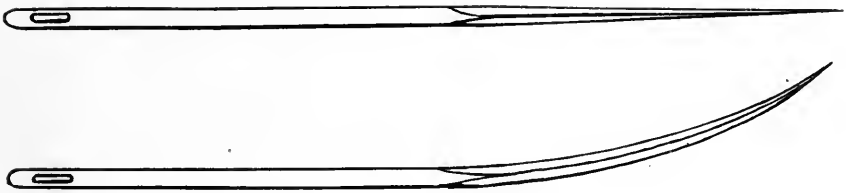

Fig. 185.—Large needles for sewing with heavy twine.

needle (Fig. 185) pass a ligature of heavy twine through the tissues in the side of the neck in such a manner that both jugular veins will be included. The carotid artery and vagus nerve must not be included. The ligature passes out through the skin at the side of the neck. The two ends of the ligature are brought together and tied once *loosely* and clamped with a *hemostat*. Another ligature is similarly placed on the opposite side so that in this way the chief venous return flow from the head can be quickly clamped off. Now fill a small syringe (two cubic centimeters) of *good quality* with chloroform. The point of the syringe should be as small and as short as possible. A cheap syringe is very liable to leak chloroform. Get all apparatus properly adjusted and then lift up the vertebral artery on an *aneurism needle* and insert the syringe point

into the lumen of the artery pointing toward the animal's head. This should be done with great care and *no chloroform should be emptied out in the wall of the vessel*. The assistant now takes hold of the ligatures (hemostats) that

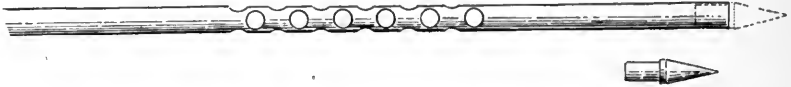

Fig. 186.—Brass tube ($7\frac{1}{2}$ inches long and $\frac{1}{4}$ inch in diameter) with (separable) spear point to be passed through the chest for recording lung volume changes. The holes cover a space about $2\frac{1}{2}$ inches long.

control the jugular veins and gets ready to close off (by pressure) these vessels. It is advisable for a second assistant to put a *bull-dog* clamp on the left carotid at this moment. The operator then injects the chloroform (one

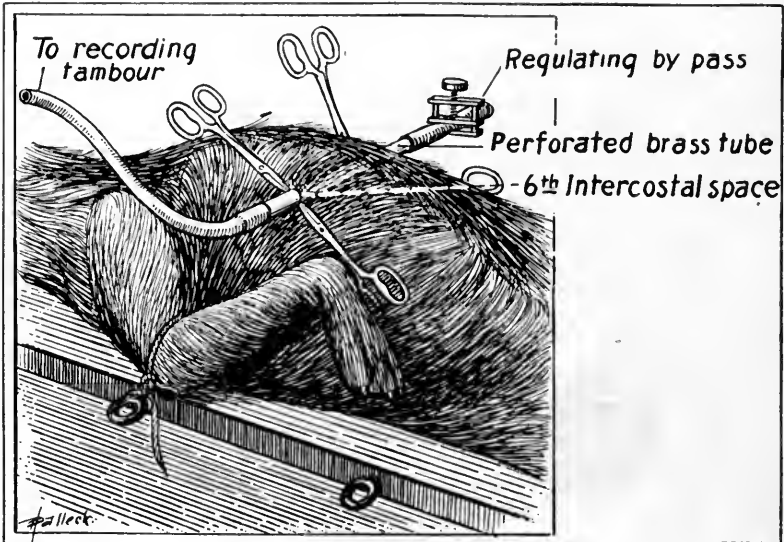

Fig. 187.—Arrangement of animal for recording lung volume changes. (For description see text.)

or two cubic centimeters) into the vertebral artery. This chloroform quickly reaches the brain and destroys all parts with which it comes in contact. The blood-pressure falls

rapidly and artificial respiration must be started at once. *Close off the jugulars immediately* and tie the ligatures firmly. Be sure the lungs are well inflated but do not burst them. Remove the ether quickly as no further anesthetic is needed. If your first injection does not succeed well, make a second one into the *left carotid artery*. Luckhardt

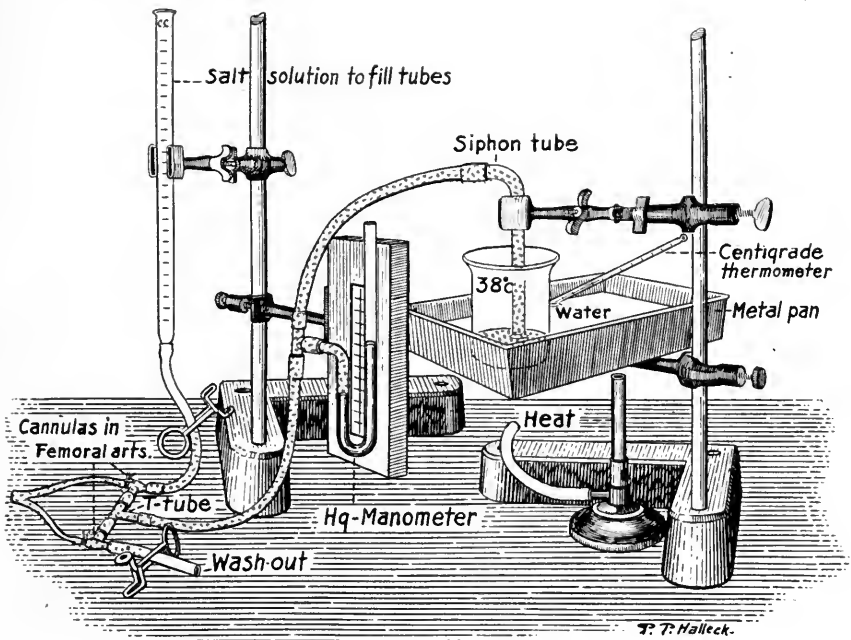

Fig. 188.—Arrangement of apparatus for keeping the systematic blood-pressure at a constant level during the action of drugs which produce marked changes in the caliber of the arterioles. The cannulas in the femoral arteries are connected with a siphon tube which dips in a beaker containing warmed salt solution (or whipped or hirudinized blood). Hirudin is injected intravenously to prevent clotting of the blood. The altitude of the beaker above the animal regulates the pressure which can be maintained in the blood vessels. This is read off from the mercury manometer. If the vessels contract blood is forced over into the beaker but the arterial pressure does not rise. When the vessels (arterioles) dilate the blood siphons back into the femoral arteries.

has succeeded well by making injections into the carotid artery alone. (Some workers have obtained good results by injecting a three per cent suspension of starch granules into the carotid artery.) This is easier than injecting the vertebral on account of the dissection, but the medulla may not be well reached through the carotid. In a

spinal dog the blood-pressure will be about one inch above the base line on the drum. Do not be alarmed so long as it remains this high and is not falling. If any of the chloroform gets back to the heart, the dog may die quickly. If the animal is about to die inject one-half or one cubic

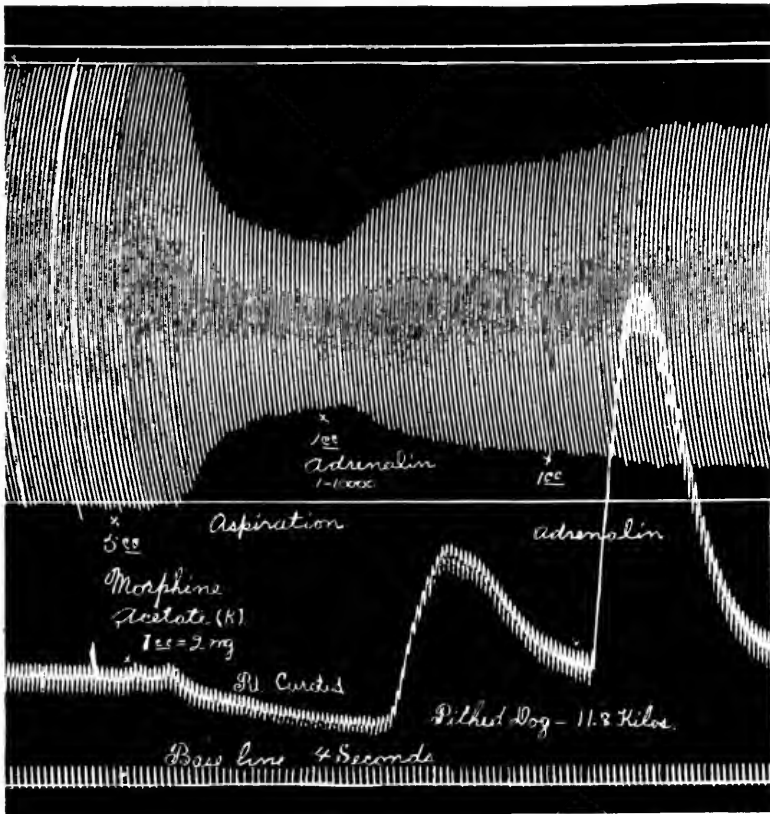

Fig. 190.—Blood-pressure and bronchiole tracings showing the action of morphine in a dog. These tracings were made by the method described in Experiment LXX, page 287.

centimeter of adrenaline. When the blood-pressure is regular, then pass a brass tube (Fig. 186) directly through the chest walls at the level of the ventral border of the sixth intercostal space (see Fig. 187). To do this make

an incision *through the skin* on each side in the proper place. Then push the spear point of the tube right through the muscular walls from side to side. Do this as the lungs are deflated. Be sure the tube passes inside the chest cavity and does not slip along under the parietal pleura just

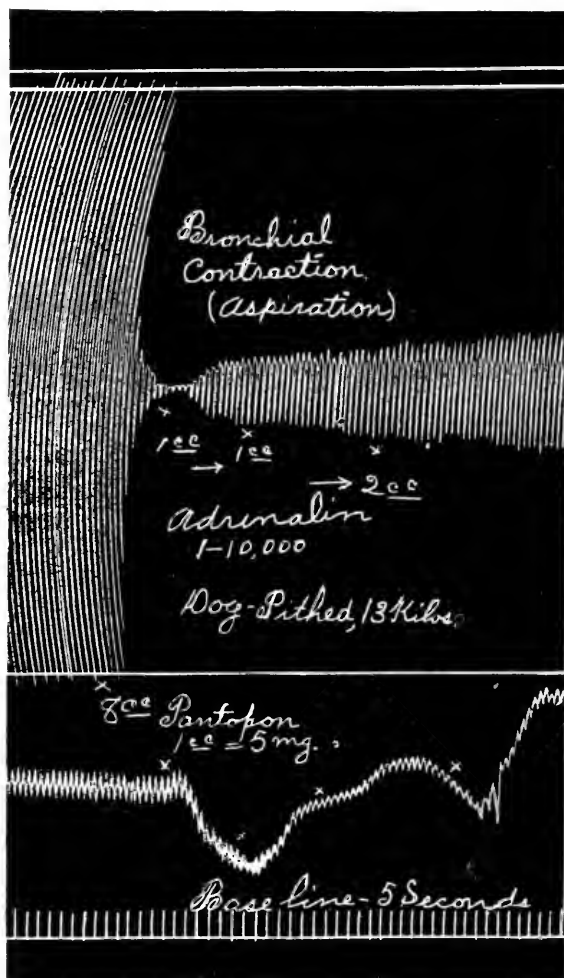

Fig. 191.—Blood-pressure and bronchiole tracings showing the action of pantopon. (Pantopon, or pantopium hydrochloricum, is the hydrochloric extract of the total alkaloids of opium—very soluble in water, sold by Hoffmann-LaRoche Chemical Works, New York.)

below the sternum. Remove the spear point from the tube and place on this end a piece of rubber tubing carrying a screw clamp. This is to regulate the amount of air going into the tambour which is attached to the other end of the tube. Clamp the brass tube tightly in the chest walls

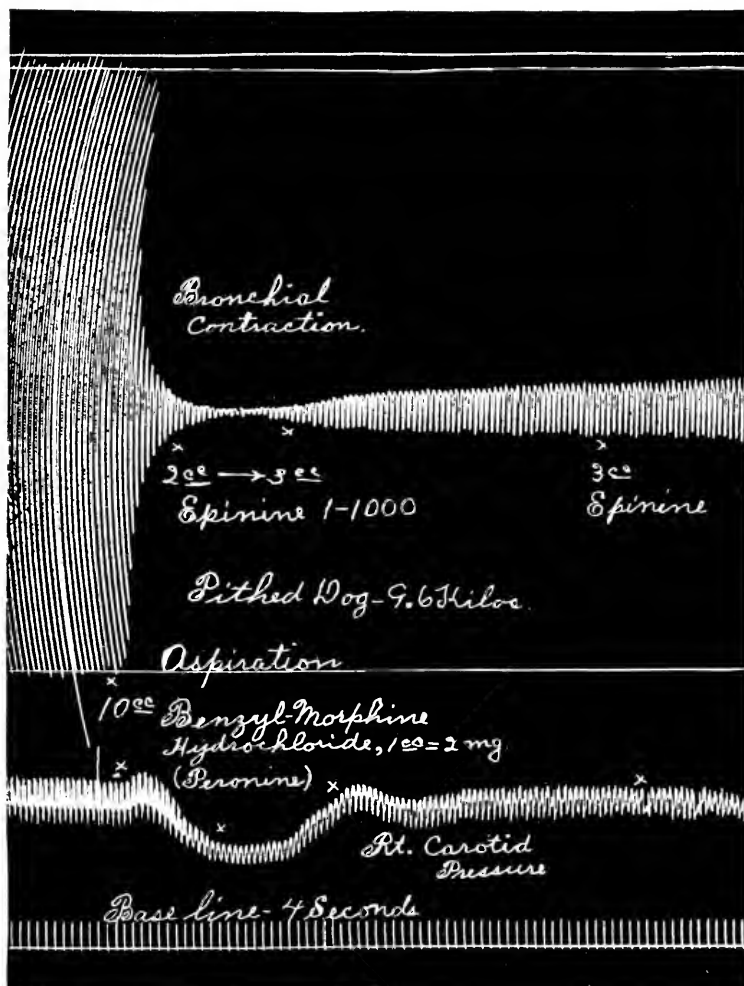

Fig. 192.—Blood-pressure and bronchiole tracings showing the action of peronine. "Epinine" failed to cause dilatation of the bronchioles and the animal died of asphyxia. It could easily have been saved by forcibly dilating the lungs mechanically to check the asphyxia.

by hemostats on each side. The tambour should have a large bowl (three inches, see Fig. 14). Bring the writing point of the tambour on to the drum above the blood-pressure and adjust the tambour to give a tracing about two or three inches high. The force of the respiration may have to be changed to give this. The rate of inflations

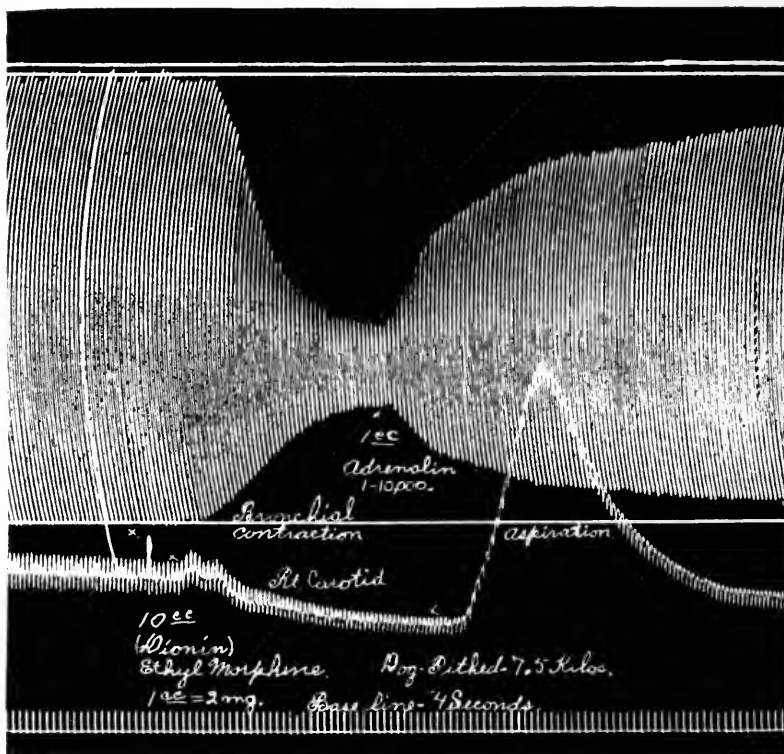

Fig. 193.—Blood-pressure and bronchiole tracings showing the action of dionine. Adrenaline caused a prompt dilatation. The method used is described in Experiment LXX, p. 287.

should be about twenty or twenty-five times per minute. Start off the drum (slow speed) and take one or two inches of normal record. Then inject five cubic centimeters of the opium alkaloid solution. The blood-pressure falls at once but the heart should not stop. What does the lung

volume show? Did you get what you should get? When the action of the drug has become very marked inject one cubic centimeter of adrenaline. How does this affect the blood-pressure and lung volume? Does the one depend

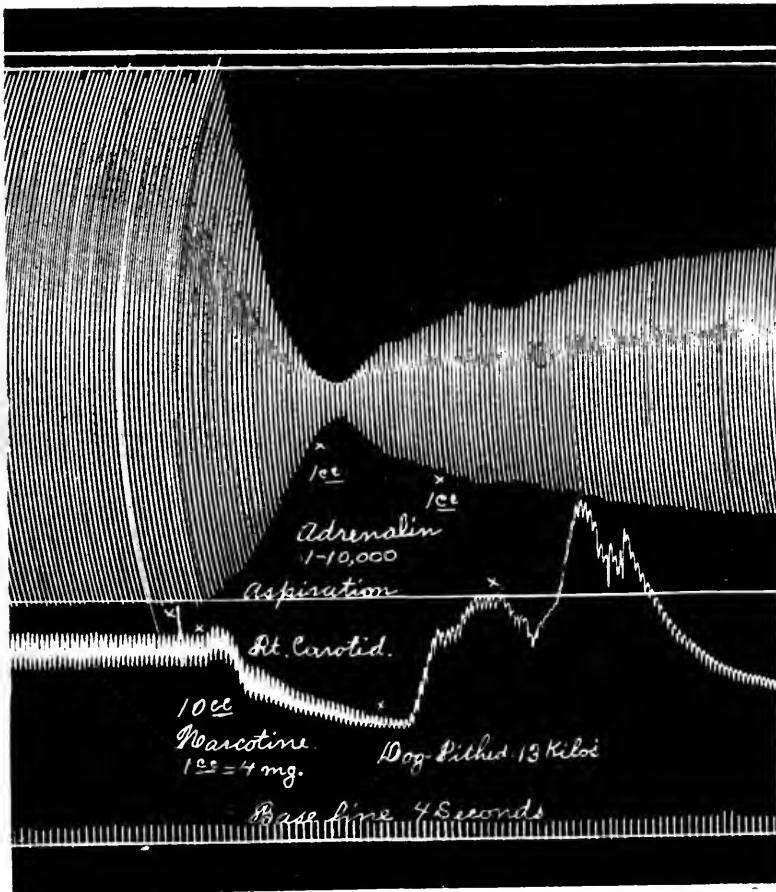

Fig. 194.—Blood-pressure and bronchiole tracings showing the action of narcotine.

on the other? (They do not—each is mainly independent of the other; see Figs. 188 and 189).

When the records again become normal then inject six cubic centimeters more of the opium alkaloid. Do you get a second lung volume tracing? Inject some adrenaline to

revive the animal. Now stimulate each vagus nerve in the neck to see the effect on the heart and lungs. What is the innervation of the heart and bronchioles? If the animal is still in a suitable condition, inject six cubic centimeters of a different opium alkaloid. Do you get lung records? Give some adrenaline to help revive the animal. The abdomen may now be opened by a three inch median

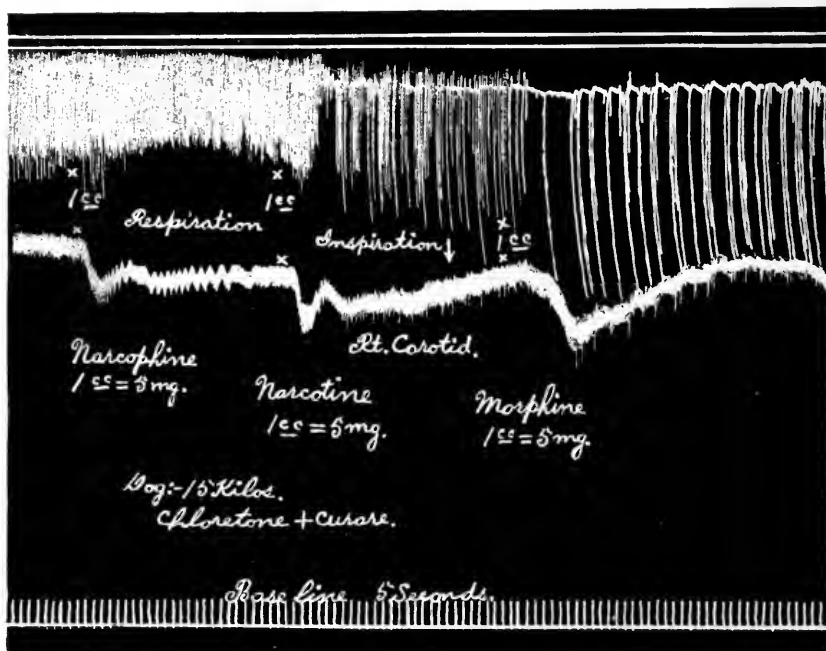

Fig. 195.—Respiratory and blood-pressure tracings from a dog showing the progressive actions of narcophine (Straub), narcotine and morphine. The peculiar irregularity of the respiration is developed early and leads to the Cheyne-Stokes type of respiration. What is the cause of Cheyne-Stokes respiration? Does the peripheral action of these drugs (note the size of the doses) have anything to do with the respiratory disturbances? The vagi were intact.

longitudinal incision down near the pubic symphysis and the bladder lifted up as described in Experiment XXVIII, page 189. The animal will probably be dead by this time. Could you thus pick up the bladder and place a cannula in it in this manner in a spinal dog without letting the ani-

mal die? How might you do such an experiment and avoid opening the abdomen after the brain of the animal was destroyed? What are the main differences that you note between the reactions and vitality of a spinal dog as compared with a normal animal?

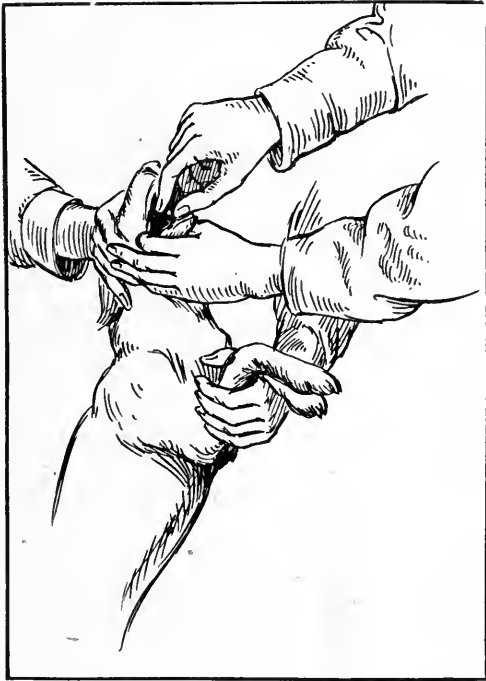

Fig. 196.—Method of administering capsules, pills or tablets to dogs. The tongue is pulled forward and the prepared dose is dropped far back in the mouth. The jaws are held closed and the animal is gently slapped under the throat, or a little water may be given. The method illustrated is frequently used in testing (standardizing) cannabis indica preparations. The U.S.P. doses are:—fluidextract 0.03 cubic centimeter, extract 0.004 gram and tincture 0.3 cubic centimeter per kilogram of body weight, for small or medium-sized, smooth-haired (preferably fox terrier) dogs. Doses not larger than these should produce incoordination (best observed when the animal is standing still) and slight ataxy in walking. The animal should be kept in a quiet room and the symptoms may not become marked (or even perceptible) for one or two hours. In three or four hours the symptoms entirely disappear. The administration of $\frac{3}{4}$ grain of "cannabinole" in oil (in globules) to a dog weighing about 4 to 6 kilos, is recommended for demonstrating marked symptoms. (For the method of standardization of cannabis indica, see U.S.P., ix, page 605.)

One may destroy the cerebrum only in an animal and thus leave the medullary centers intact. This is easiest done in a cat. Normal respiration may go on (no further anesthetic is needed) and the blood-pressure remains high.

EXPERIMENT XXX.

Heroine or Codeine. (Spinal Dog: Blood-pressure, Lung Volume and Bladder Contractions.)

1. Examine carefully the apparatus shown in Figs. 197 and 198. Arrange a dog (ten or twelve kilos) for record-

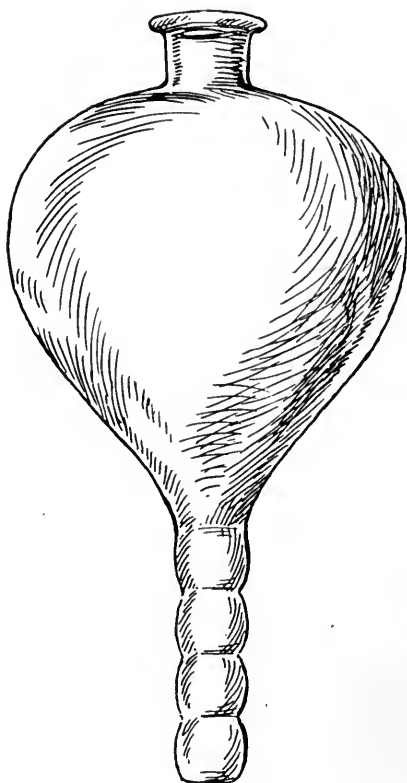

Fig. 197.—Mercury bulb.

ing blood-pressure. The injecting burettes contain heroine (one cubic centimeter equals five milligrams) and adrenaline (1:10,000). Arrange for artificial respiration.

Open the abdomen and pick up the bladder. Insert into it at the urachus a glass tube connected with a mercury

bulb. (See Figs. 198 and 199 for technic and apparatus; also see Experiment XXVIII, page 189.) Use a large bowled tambour to record the bladder contractions. If the bladder is full of urine do not allow more of this to escape than can be avoided. Arrange the mercury bulb as shown in Fig. 199 and fill the bulb about two-thirds full of warm salt solution. Insert the cork which carries a glass tube to connect with the tambour. It is best not to connect the tambour tube until the lung shield is inserted and the dog

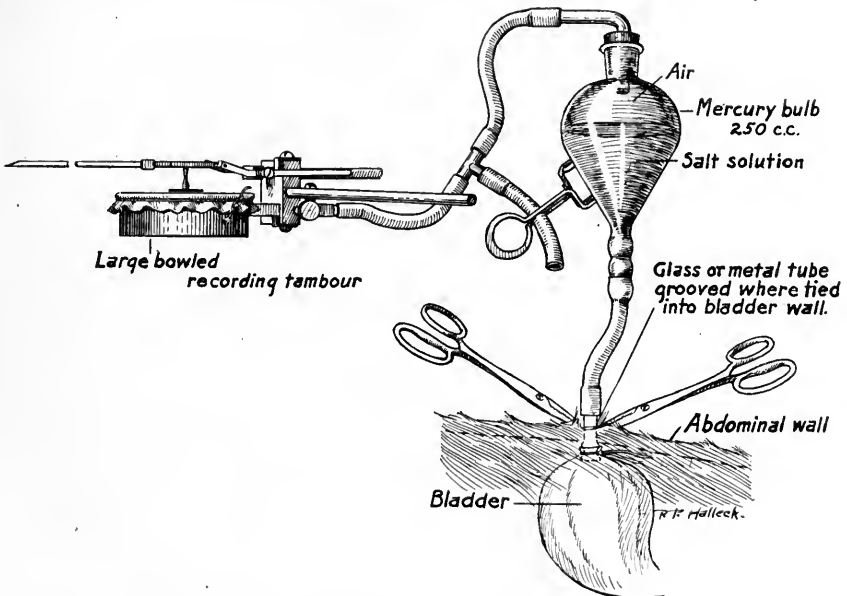

Fig. 198.—Arrangement of apparatus for recording bladder contractions. A catheter passed through the urethra may also be used sometimes to connect to the mercury bulb.

is pithed, as the bladder tambour and tube would be in the way of the operation. Place a hemostat on the penis or vulva of the animal to prevent urination.

By a median longitudinal incision open the thorax (start artificial respiration at once) and expose the right lung and the heart (do not open the pericardium). The anterior mediastinum should, if possible, be gently turned over to the left. *Pick up both phrenic nerves and cut them. Why?*

The lung shield (Fig. 200) should be dipped in warm water and inserted in the chest in such a manner that the large notch at the lower border of the shield will just pass over the pedicle and vessels of the right lung. The flanged portion which turns outward at the right hand end of the shield rests on the anterior surface of the diaphragm. There is a groove in the shield between the large notch and the out-turned flange. This groove is for the passage (me-

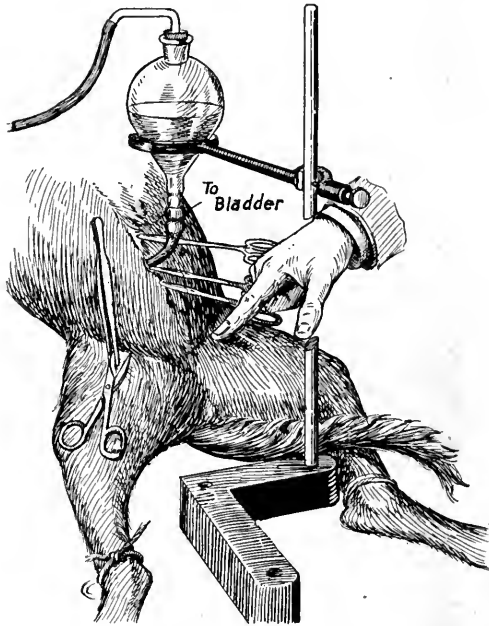

Fig. 199.—The forefinger is placed over the inguinal region just at the lower edge of the abdomen. The beating of the femoral artery should be felt just beneath. An incision should be made just over the area. Note the little fold of skin picked up by the forceps while the scissors are used to cut away the skin and fascia. *Do not use a scalpel here.* The arrangement of the mercury bulb for recording bladder contractions is also shown.

sially) of the inferior vena cava. This must not be closed off or the dog will die. Now cut a small hole in the skin of the right side about the position of the anterior border of the sixth intercostal space. Pass an aneurism needle through the muscular wall (through the skin incision) and into the chest. *Be sure the parietal pleura does not peel*

off and keep the aneurism needle from entering the chest cavity proper. Beside this aneurism needle insert another in the same opening and pull the sides of the opening thus made far enough apart to insert the bent end of the glass tube shown in Fig. 201. Be sure the pleura does not close the inner end of the tube. This is the most common source of failure in this experiment. The edge of the lung may also move up when inflated and close the tube. Watch this.

With hemostats clamp the glass tube (catching the strings) air-tight in the chest wall. Now close the chest

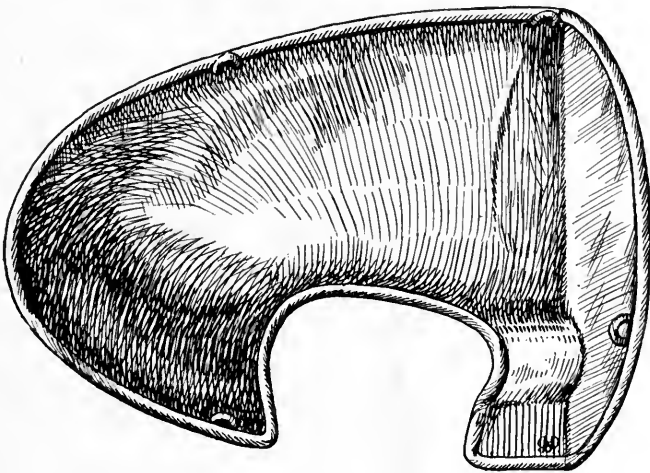

Fig. 200.—Lung shield made of thin sheet brass with a wire rim soldered around the edge to add strength. A little more than one-half natural size. The large notch passes down over the pedicle of the right lung. To the right of the large notch is seen a grooved channel for the passage (mesially) of the inferior vena cava. (For method of use see text.)

and fasten it air-tight either with hemostats or by sewing. Connect the glass tube to a large bowled recording tambour. This records the lung volume changes. The record should be about *two to three inches high*. The adjustable by-pass may be opened to allow excess air (which the tambour can't hold) to escape. (Air also will then enter the by-pass again when the lungs collapse. This exchange is approximately constant, however, with regular artificial respiration and will not interfere with the validity of the

record.) The animal should be firmly tied down to the operating board so the chest cannot move too much.

Now pass ligatures through the sides of the neck as described in Experiment XXIX, page 195 (see also Experiment XXVIII, 2, page 192 and Figs. 183 and 184). Isolate the left carotid artery and arrange to inject chloroform (one or two cubic centimeters) into it. Proceed as in Experiment XXIX to destroy the animal's brain, but try to

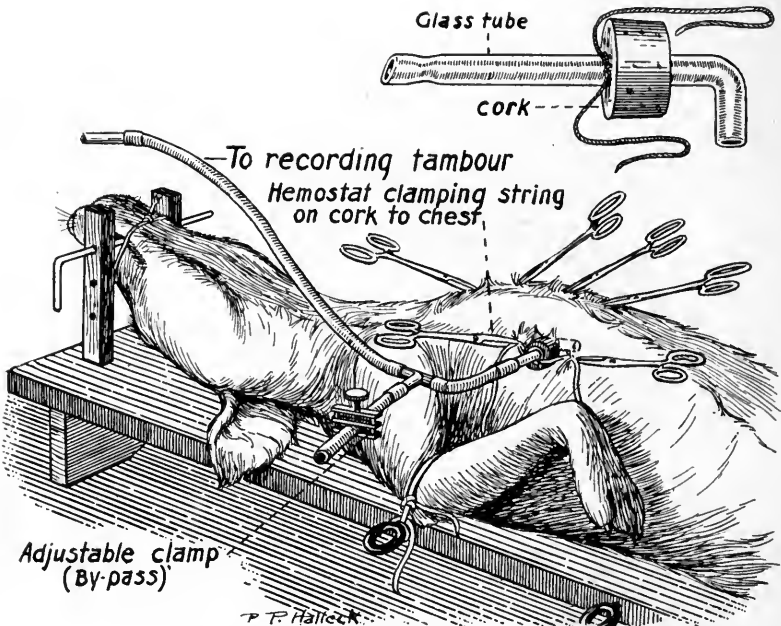

Fig. 201.—Arrangement of apparatus for recording the volume changes of the right lung by use of the lung shield. The glass tube shown in the upper part of the illustration has its bent end passed into the chest cavity.

do this by injecting the chloroform into the left carotid artery alone. If you succeed well in this you can avoid dissecting out the right vertebral artery. The blood-pressure should come down at least to a height of one or one and one-half inches above the base line as seen on the drum. If the pressure does not fall, or even goes up higher, the injection has not succeeded. A very high pressure thus

produced may last for some time and is very liable to cause the heart to stop (possibly from the extra strain). The respiratory movements of the dog should stop entirely. If they do not, wait a little while and make a second chloroform injection. Sometimes the diaphragm will contract at every beat of the heart. This is due to an action current generated by the heart where the phrenics pass over it. These nerves should therefore be cut *between the heart and the diaphragm* (while the chest is open).

The animal should now lie quietly and the blood-pressure should be about one inch or a little less above the base line on the drum. Just above the blood-pressure should be the lung volume record (about two or three inches in height), and above this about one-fourth inch should be placed the tambour record for the bladder which is now connected up to the mercury bulb. Take about one inch of normal tracing. If everything is satisfactory then inject five cubic centimeters of heroine (or codeine) solution. Is there any change in the bladder? If not it may have been completely empty and contracted before the drug was injected. Do you get any lung volume change? How do you account for this? What mechanical factors are involved? How does positive artificial respiration differ from natural respiration? As soon as you get a well marked action from the drug injected, then run into the vein one cubic centimeter of adrenaline. How does this affect your record? How do you account for this? Of what clinical use might this be? What effect does this have on the bladder? How do you explain this?

Wait until the records return to normal and then inject eight cubic centimeters of the second alkaloid (codeine or heroine, or vice versa, depending on which drug was injected the first time). How does this drug affect the bladder and lungs? The dose is larger than the first one given. How do these doses compare with those given to dogs to narcotize them before operations? Has the first injection

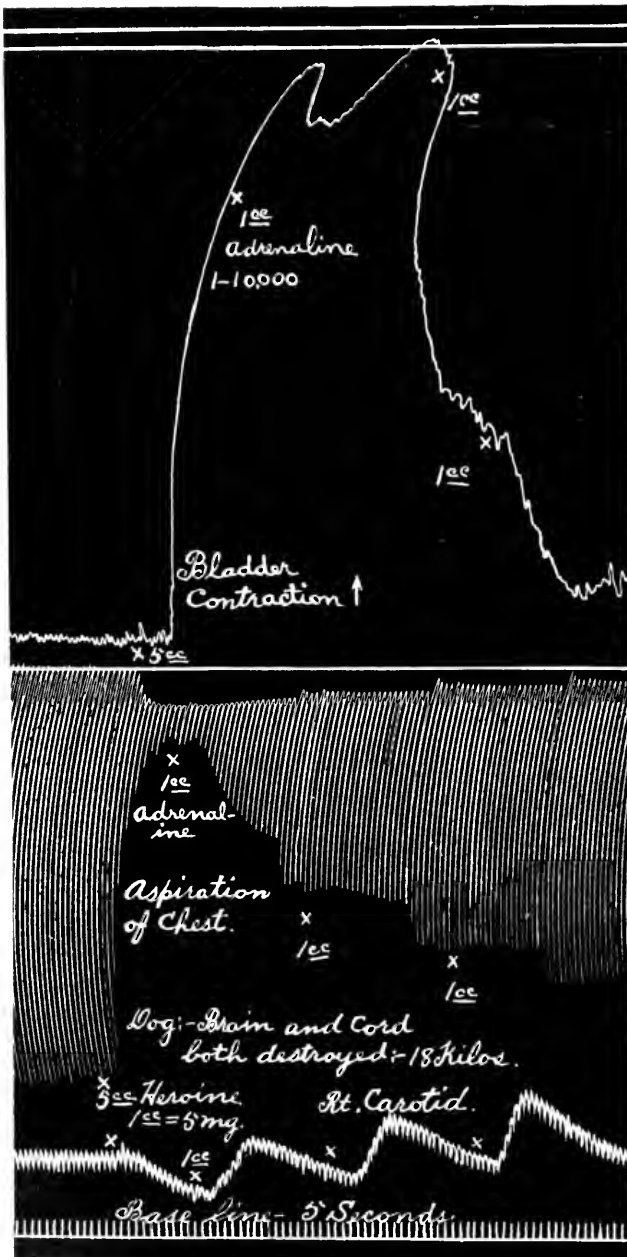

Fig. 202.—Bladder contraction, lung volume change (bronchioles) and blood-pressure from a dog, showing the action of heroine and adrenaline. Both brain and cord were destroyed. The tracing was made by the method described in Experiment LXX.

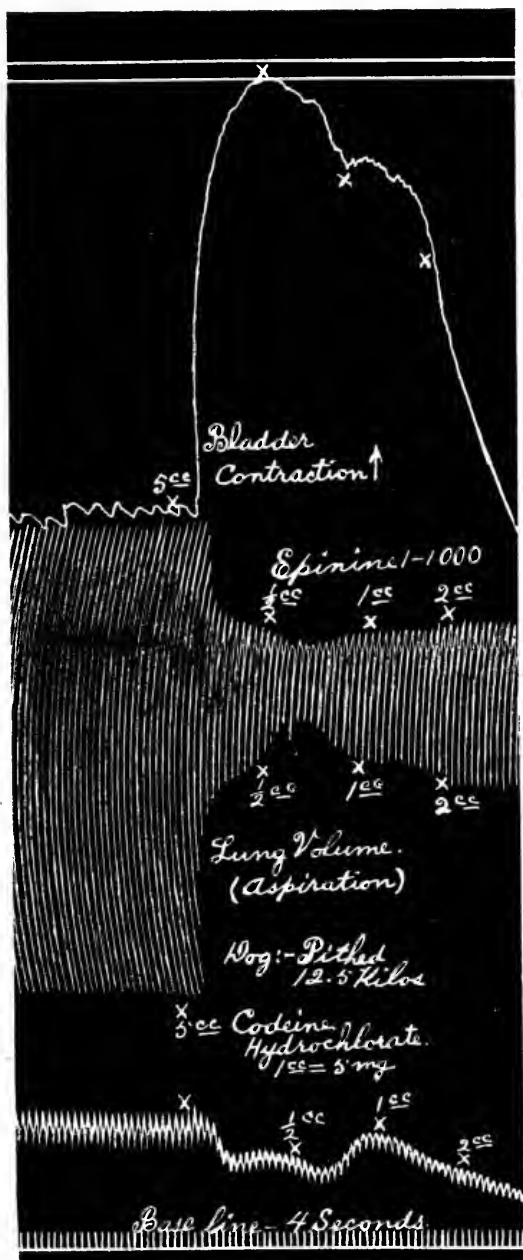

Fig. 203.—Tracing showing the action of codeine and "epinine" on the bladder, bronchioles and blood-pressure in a pithed dog.

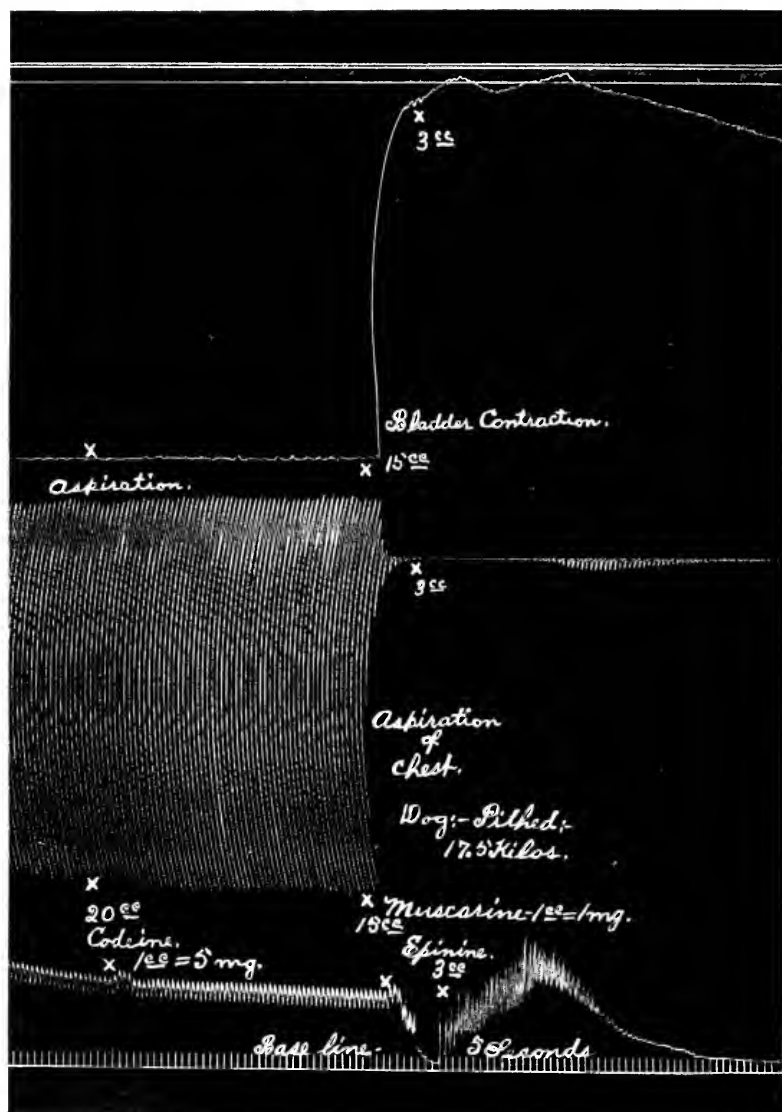

Fig. 204.—Tracing showing the action of muscarine (and “epinine”) in a pithed dog after the animal had become irresponsive to codeine injections.



Fig. 205.—Tracing from a turtle showing the action of codeine on the lungs. (See Figs. 232, 233, 234 and 235.) The two abrupt, high contractions were due to the sudden movements of certain skeletal muscles which moved the lungs. The slow, gradual curve was due to the contraction and relaxation of the lungs. The drug was injected into the heart.

caused any permanent change in the lungs or bladder that you can detect by the results of your second injection? Give more adrenaline to revive the animal. Do you see the reflected effects of the filling and emptying of the heart

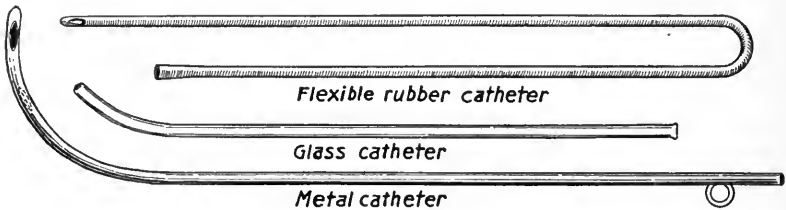

Fig. 206.—Three kinds of catheters.

in your lung tracing? Stop the artificial respiration for a few seconds and watch for the heart action to affect the lung tracing.

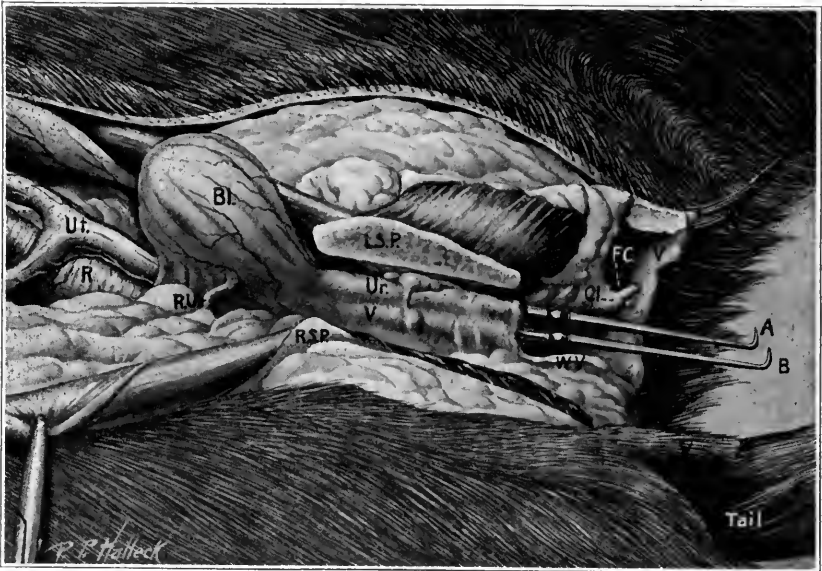

Fig. 207.—Dissection showing the position and relation of the organs and structures within the lower pelvis (dog). The pubes were sawed apart and the left side of the bone shows as *L.S.P.* *A*, probe passed into the urethra, *Ur*; *B*, probe passed in the vagina, *V*; *R.S.P.*, right edge of the (divided) symphysis pubis; *V*, vulva; *F.C.*, fossa clitoridis; *Cl*, clitoris; *W.V.*, vaginal wall; *Bl*, bladder; *R.U.*, right ureter entering the bladder; *R*, rectum; *Ut*, uterus.

The animal will probably be very low by this time. If it is still alive and the pressure is high enough inject some other of the opium alkaloids, such as dionine, thebaine or peronine, and try to counteract this effect by injecting "epinine" (1:1000—Burroughs, Wellcome and Company, New York). "Epinine" is nearly related chemically and pharmacologically to adrenaline.

2. After the animal dies, if it is a female, try to pass a catheter (Fig. 206) through the urethra into the bladder. Consult Fig. 207 to do this. A catheter made of a very small glass tube slightly curved at the end is very satisfactory for this purpose. Could you thus pass a catheter in a living animal? Isolate the left kidney (or the spleen) and place it in an oncometer. Place a loop of intestine in an oncometer (see Fig. 157).

EXPERIMENT XXXI.

Strychnine. (Frog: Action on the Cord.)

1. Pith a frog and attach it to a frog board. Dissect loose the right tendo Achillis and gastrocnemius muscle but do not injure the tissues of the thigh. Cut the tendo Achillis long and drive a carpet tack through the knee joint region (avoid the artery and sciatic nerve) as shown in Fig. 208. The tack gives a firm point of attachment for the gastrocnemius muscle. Then place the frog board in a large clamp and arrange all apparatus as shown in the illustration. The drum should have a fairly rapid speed and the muscle lever should write near the bottom of the drum (leaving enough space below for the time record). With a hypodermic needle inject into the dorsal lymph sac of the frog one cubic centimeter of strychnine sulphate solution (one cubic centimeter equals one-half milligram). Wait about three minutes for the drug to be absorbed and then start the drum. The frog will soon show a marked

reaction and it is important to record the *first* manifestations of this effect. The drum is kept running and presently further results will be obtained. When the first round is completed lower the drum and take a second round. Blow against the frog and note the results. How do the contractions obtained on the first round compare with those of the second? After the two rounds are com-

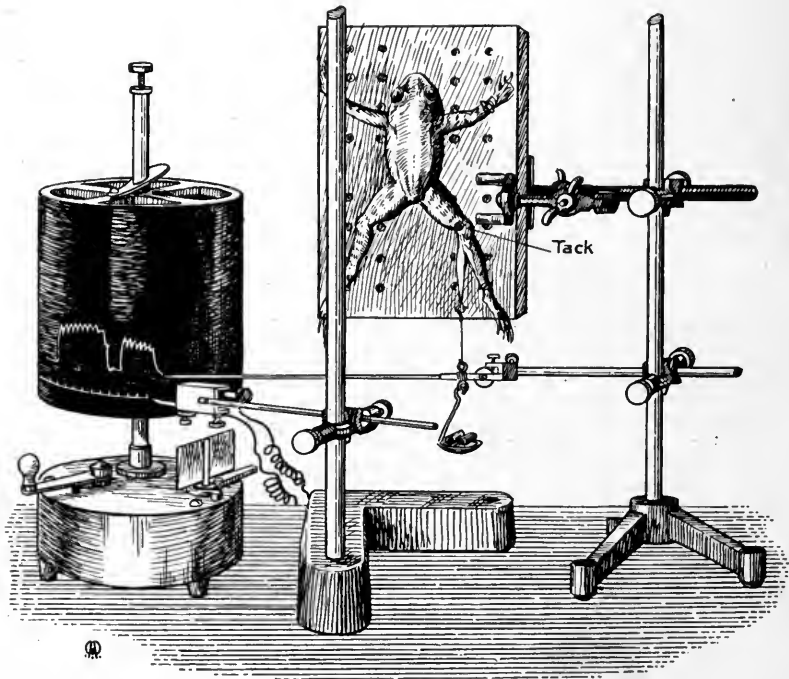

Fig. 208.—Arrangement of frog and apparatus for recording the contractions of the gastrocnemius muscle during convulsions. The animal's brain is destroyed.

pleted dissect out the sciatic nerve on the back of the right thigh (see Fig. 47, page 54) and cut the nerve in two. Now stimulate the frog (blow against it) and note the results on your records. What does this show? What can you say regarding the action of strychnine? Pass a soft copper wire down the spinal canal and destroy the cord.

What effect has this on the convulsions? Can you locate the seat of action of the drug from this experiment? In what other ways might you test out your conclusions?

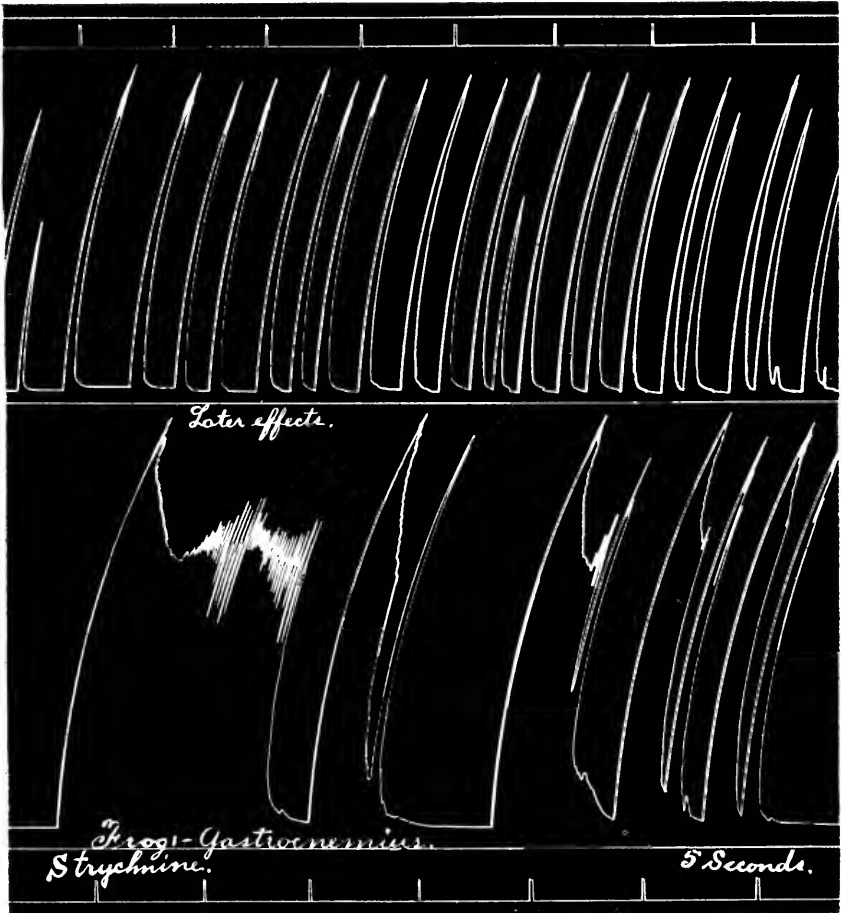

Fig. 209.—Tracing showing the action of strychnine on the frog made by the contractions of the gastrocnemius muscle as arranged in Fig. 208.

This is the usual method for obtaining graphic records to illustrate the action of convulsant poisons. This action can usually be shown quite well on frogs, and since frogs are cheaper and more easily managed than mammals, they are generally used for this purpose. The cerebrum is destroyed.

EXPERIMENT XXXII.

Strychnine. (Frog: Heart and Vago-sympathetic Nerve.)

1. Pith a frog and destroy the spinal cord with a soft copper wire. Examine the beating of the lymph hearts (see Fig. 66) *before* and after the cord is destroyed. How is the beat of these affected? Fasten the frog down, ventral side upward, and dissect out the vagus nerve (Fig. 60). Arrange to record heart tracings on a moderately slow drum (Fig. 63). Take about one inch of normal tracing and then stimulate the vago-sympathetic nerve and record the inhibition and recovery. Take two inches more of the normal record and repeat the stimulation. Lower the drum and start a second round. Drop on to the heart a few drops of strychnine sulphate solution (one cubic centimeter equals one-half milligram) and after a few seconds again stimulate the nerve. This stimulation record should be directly above the first inhibition record in the first round on the drum. Apply more drug to the heart and stimulate again. Be sure the stimulating current is not too strong and do not continue its application to the nerve any longer than is absolutely necessary or the nerve (or its endings) may be affected. Apply more drug and then stimulate again. How is the beat of the heart affected? Is the muscle of the heart directly concerned in this? What are the later effects of strychnine on the heart when thus applied? How does strychnine affect the innervation of the *frog's* heart?

EXPERIMENT XXXIII.

Strychnine. (Turtle: Heart and Vagus Nerve.)

1. Pith a turtle and fully destroy the cord by pushing a soft copper or iron wire (No. 14 or 16) down the spinal

canal. Arrange for taking heart tracings. Dissect out the vagus nerve in the neck (Fig. 70) and record a normal inhibition at two places in the lower round on the drum. Lower the drum and start a second round. Apply strychnine solution (one cubic centimeter equals one milli-

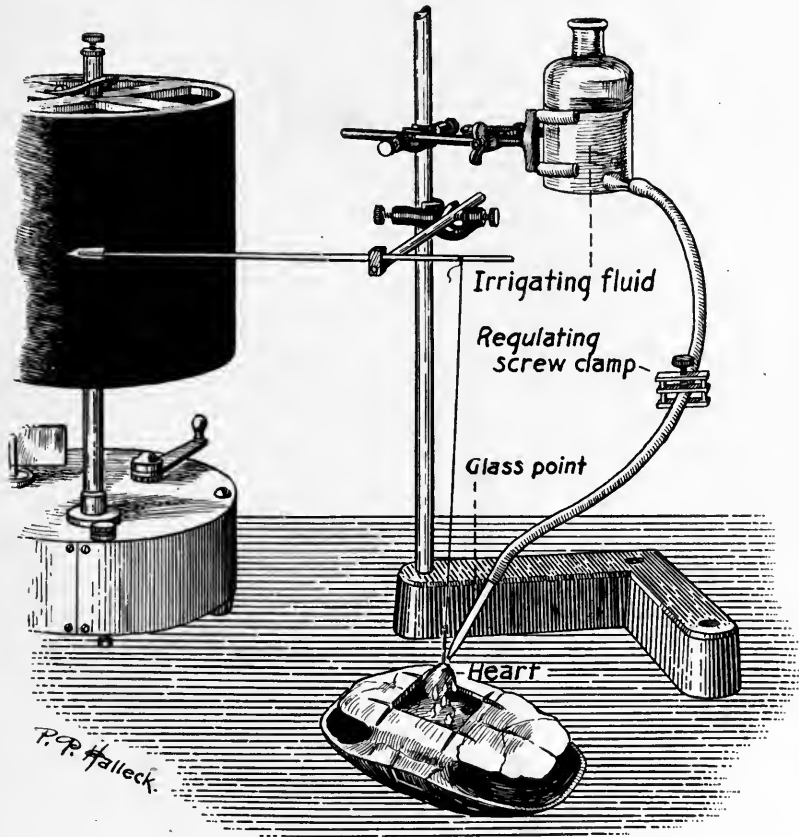

Fig. 210.—Greene's method of irrigating the heart.

gram) to the heart with a medicine dropper or according to Greene's method (Fig. 210) for irrigating the heart. Do you notice any immediate change in the appearance of the heart beat? Might this be due simply to the fluid moistening the heart muscle (as normal salt solution would do) or

to temperature changes caused by applying the solution? How could you avoid these possible effects? Stimulate the vagus nerve again and record the results. What do you observe? Apply more drug (the record is made as in Experiment XXXII) and try stimulating the nerve from time to time. Are any changes observed? How do you



Fig. 211.—Tracing from the heart of a turtle showing the action of strychnine. At the short bar the vagus trunk was stimulated and stopped the heart for a brief period. Subsequently a solution of strychnine was dropped on the heart (at X). The rate of beat was apparently slightly accelerated. Later (at R.V.S.) the vagus trunk was again stimulated but could not slow or stop the heart. What structures were affected by the drug?

account for this? How does this compare with the results obtained by other students? Did the turtle have any convulsions? How do you explain this?

EXPERIMENT XXXIV.

Strychnine. (Dog: Blood-pressure, Respiration, and Kidney, Spleen or Intestinal Loop.)

1. Arrange a dog for taking blood-pressure, respiration, and an oncometer tracing of either the spleen, left kidney

or a small loop of the intestine. For the latter record an instrument similar to the one shown in Fig. 212 may be used, or the ointment box kidney oncometer (Fig. 157) may be employed. It is necessary not to get too large a loop of intestine into the oncometer. Three inches of the small intestine bent into a small loop is sufficient. It is very desirable to fasten safety-pins through the ends of the loop as shown in Fig. 212 to prevent more of the intestine from working into the oncometer after the experi-

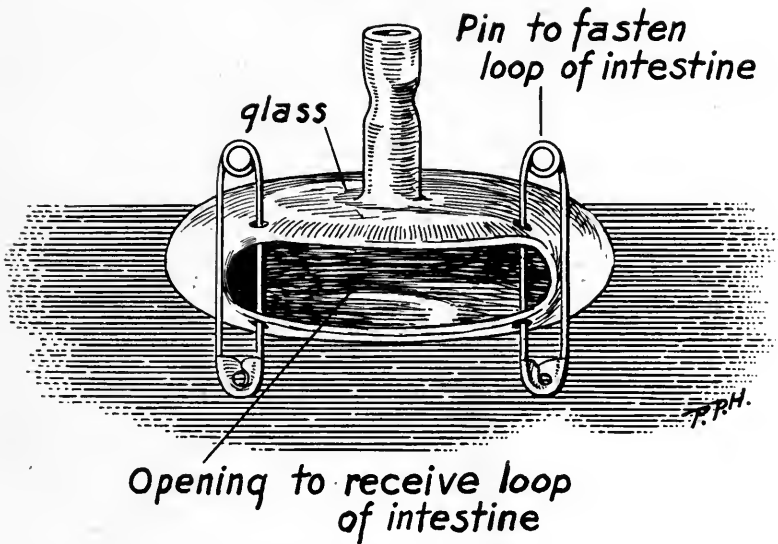

Fig. 212.—Glass oncometer for a small loop of the intestine. The safety pins should be passed through the edges of the wall of the intestine to prevent more of the intestine from working into the oncometer or any part of the loop from getting out. About three-fourths natural size.

ment has started. This may also be accomplished by sewing a stitch through each end of the loop with a needle and thread and tying the thread in the small holes of the oncometer. If the gut is allowed to keep crawling more and more into the instrument as the experiment goes on the records will soon be spoiled. When the oncometer is adjusted then attach the tube for the recording tambour and *close the abdomen securely* with hemostats or stitches.

Why is this so important? The injecting burettes contain adrenaline and strychnine sulphate (one cubic centimeter equals one-half milligram).

Adjust all writing points (so they will pass each other) on the drum. Keep the anesthesia moderately deep and as even as possible. The oncometer tracing should be the upper record, the blood-pressure next below, then the respiration, and at the bottom of the drum should be the base line and time marker. The student (and the instructor) should make careful observations in each experiment to determine about what sized tambour bowls and what magnification should be used for each organ from which records are obtained. This will necessarily vary largely with different types of tambours and must be determined in each laboratory from experience.

Take about one inch of *satisfactory* tracings and then inject one cubic centimeter of strychnine. What is the result? Note the time of day. After the pointers return to normal (which should be in a short time) inject one cubic centimeter of strychnine again. When the records are again back to normal inject one-half cubic centimeter of adrenaline. Do you get satisfactory records? What is the action of small (therapeutic) doses of strychnine on the heart and circulation? Slowly, from time to time, inject one cubic centimeter doses of strychnine and allow the animal to lie perfectly quietly. Is there any change in the blood-pressure as the action of the drug comes on slowly? After a time there will be a sudden reaction. Be sure the drum is going and that you record the result well. Do not give any more drug for a while then and wait for further developments. How is the oncometer record affected? How do you account for this? Be sure you are ready to give artificial respiration if it is needed. Observe carefully the actions of the face and mouth muscles when the animal shows most marked symptoms. What is meant by the expression "*risus sardonicus*"? Are there any spe-

cial pupillary changes? Do you get any results resembling a Cheyne-Stokes respiration? Deepen the anesthesia a little and see if you can depress the action of the drug a little. Try touching the animal from time to time or jar the board a little and note the effect. What parts of the central nervous system are mainly affected? What is the difference between epileptiform, clonic and tonic convulsions? How do you explain these? How long did it take for the action of the drug to come on? Do you get satisfactory oncometer tracings? What mechanical factors are concerned in the production of these? Your apparatus should be carefully arranged so you can hold the stands, etc., down *firmly* on the table to prevent them from being shaken out of place.

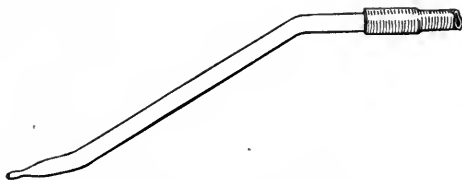

Fig. 213.—Glass ureteral cannula with rubber tube connection. About one-half natural size.

Inject some adrenaline into the vein. How does this affect the animal? Secure records of as many typical convulsions as you can. Many of these will probably be spoiled by movements of the apparatus. Crowd on enough ether to check the convulsions, then open the bladder and insert a cannula (or pass a catheter if you can) and close the abdomen firmly with hemostats. Draw off some urine and test it for reducing substances. What action will strychnine have on the glycogen stores of the body? How is this brought about? What mechanisms are concerned? How is strychnine excreted? Could you get a positive test for it in the urine? How long does the drug remain in the body before it is excreted? What bearing does this have on the treatment of strychnine poisoning?

Kill the animal by a large dose of the drug. What is the immediate cause of death?

If time permits open the abdomen and dissect out both ureters (Fig. 162) and trace their course to the bladder. Could you tie a cannula (Fig. 213) in each ureter and collect the urine from each kidney separately? What is the innervation of the ureters?

EXPERIMENT XXXV.

Strychnine. (Ether, Morphine, Chloral Hydrate.) (Dog: Blood-pressure, Respiration, Oxygen Consumption, Air Embolism.)

1. Read over carefully the section on oxygen consumption given in Experiment XXVIII, page 177. The apparatus there used is of a very simple form and will be available in most laboratories. A better but somewhat more complicated form is shown in Fig. 172. This figure shows in addition a special arrangement for measuring the oxygen each time it is run in. If only enough water be placed in the pressure bottle to allow 200 or 300 cubic centimeters (the bottom of the bottle must first be filled up to the level of the spout) to run down into the graduated cylinder at a time, then the measuring of this amount of oxygen before it is run into the pan becomes automatic and can quickly be done each time. If the oxygen tank be opened a little oxygen will be forced through the T-tube into the graduated cylinder. This oxygen is under pressure and will drive the water in the cylinder up into the pressure bottle. If it is especially desired for greater accuracy, the bottle can then be lowered to the level of the graduated cylinder to avoid compression of the oxygen while its volume is being measured, but this is not generally necessary, for the compression of the oxygen in the graduated cylinder by the column of water up to the pressure bottle will be the same each time and

will thus not change separate readings on the drum. This automatic measuring of the oxygen saves time and should be done by the student who manages the apparatus on the drum. The measuring device can also be used on the simple apparatus shown for Experiment XXVIII if desired.

Several very interesting and important actions of certain drugs can be recorded either with the apparatus shown in Fig. 172 or with that illustrated in Fig. 175. Thus the short, rapid, up-and-down movements of the heart lever records the respiration of the animal even more accurately than does the stethograph around the body. In addition the actual relative amount of gases passing in and out of the lungs at any given period can be compared. And any general change in the volume of the lung contents (contraction or relaxation of the bronchioles) is well shown. For the latter purpose the short respiratory excursions of the heart lever on the drum should be magnified to write about one or one and one-half inches in amplitude.

Arrange a medium sized dog for recording blood-pressure and respiration. The injecting burettes contain adrenaline and morphine (one cubic centimeter equals five milligrams). Attach the apparatus for recording oxygen consumption and take a normal record. This will involve at least one (and better two or three) complete notches on the oxygen record. Now deepen the ether anesthesia a little (*not too much*) and see if this slows down the oxygen consumption. What would you expect the ether to do? Now get the animal into a perfectly satisfactory condition and inject three cubic centimeters of morphine. How does this affect the oxygen record? Can you determine whether the observed result is due to a central or to a peripheral action of the drug? Are there any evidences of bronchial changes? Explain. Inject one cubic

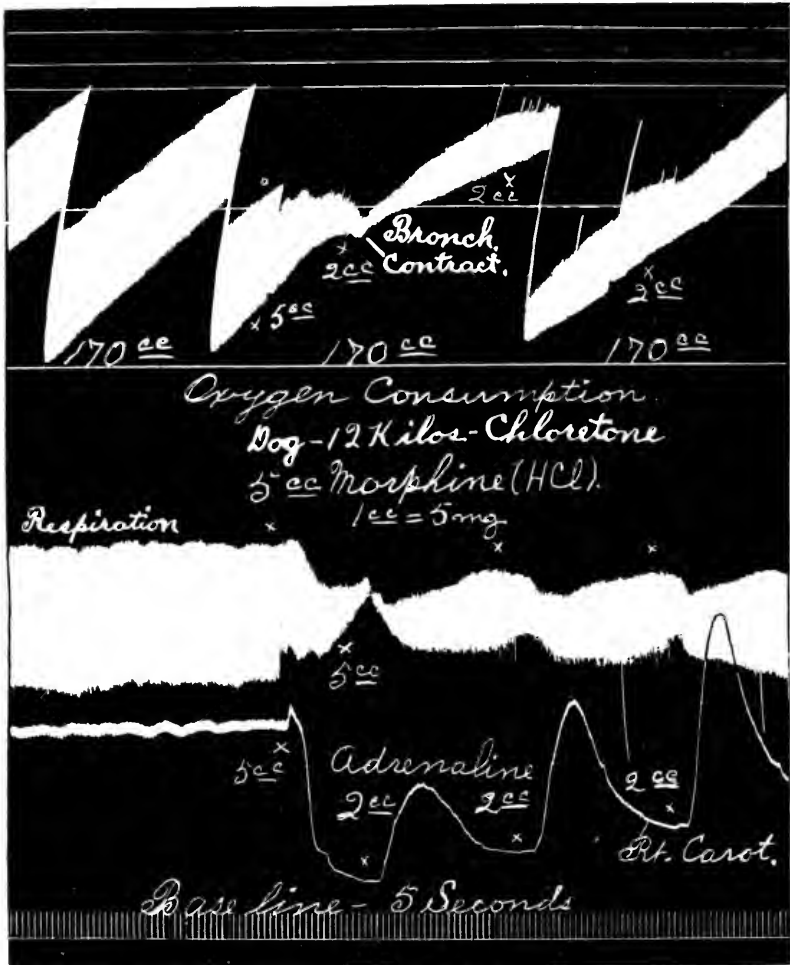

Fig. 214.—Tracing showing the action of morphine (and adrenaline) on the rate of oxygen consumption, on the bronchioles, respiration and blood-pressure in a dog. At the point marked "bronch. contract." in the upper record it will be seen that the curve actually turns downward for a short distance. This is due to the marked contraction of the bronchioles forcing a part of the supplemental (or reserve) air out of the lungs. This is probably also reflected on the respiratory tracing by limiting the expansion of the chest. Adrenaline counteracts this broncho-constricting action of morphine and the three injections of adrenaline each causes a marked increase in the depth of respiration which lasts approximately during the period that the action of the adrenaline can be seen on the blood-pressure. Experimentally it has been shown by Guber at Zurich that animals poisoned by a minimal fatal dose of morphine recover if they be injected with adrenaline. How would you explain the prevention of death (from the morphine) in these cases by adrenaline?

centimeter of adrenaline. How does this affect the record? Now give a second dose (three cubic centimeters) of morphine and see what effect this has on the rate of oxygen consumption. Take three or four notches in the oxygen record to get the prolonged effects of the drug.

Now arrange for all the drum space you can command and prepare to record the rate of oxygen consumption after strychnine. It is to be recalled that the CO_2 exhaled by the animal may vary quite as much as the rate of oxygen consumption for short periods of time. If a considerable excess of CO_2 is excreted it can affect the record somewhat before it is absorbed. Will this mean a prolongation or a shortening of the oxygen record? Will it add to or subtract from the relative length of time which a given injection of oxygen will last? Consider this point carefully in observing the manner in which strychnine acts on the metabolism.

Arrange all writing points and inject one cubic centimeter of strychnine (one cubic centimeter equals one-half milligram). Wait a little and then repeat the injection (one cubic centimeter). Continue this at brief intervals, recording carefully the rate of oxygen consumption all the time. Be sure the animal cannot shake down your apparatus when the convulsions come on. Continue giving strychnine until convulsions are fully developed. How do these affect the rate of oxygen consumption? What becomes of the oxygen taken up by the animal? What is the respiratory quotient? How is it determined? Examine the pupils during and after a convulsion. What do you observe? Crowd on ether and see if you can stop the convulsions. How does this now affect the oxygen consumption? Lighten the anesthesia and empty the strychnine out of the burette. Fill the burette with chloral hydrate solution (four per cent) and then just after a convulsion inject one cubic centimeter of the solution. How

does this affect the convulsions, blood-pressure, respiration and oxygen consumption? Inject more chloral from time to time and observe its general action as fully as you can. If the animal is still alive empty the chloral out of the burette, then take the burette out of the clamp and place the upper end of the empty burette in your mouth. Take the bull-dog off the femoral vein and blow some air into the vein. Replace the bull dog and watch the action of the air on the animal. What is meant by air embolism? How may it be produced? How does it act inside the heart chambers? In the vessels? Blow more air into the vein if necessary to kill the animal. What conclusions can you draw from this?

Caution.—The alimentary canal of the dog contains large numbers of tape worms and *their eggs*. If these eggs are swallowed by other animals infection may occur.

If time permits, dissect out the nerves to the bladder (and uterus if the animal is a female).

EXPERIMENT XXXVI.

Strychnine. (Student: Reaction Time.)

1. Test the acuteness of hearing of the student who is to act as the subject of the experiment. Do this by allowing the student to sit at a table (at complete rest) with his ear or the side of his head against a heavy stand (which must not be moved later). A watch is now moved away from the ear of the subject until the ticking can just be heard (note the position of the watch, i.e., which side is toward the subject). Mark this distance on the table or otherwise and then take the watch back to the point where the ticking just fails to be heard. Mark this point.

2. Now refer to the arrangement of the apparatus shown in Figs. 134 and 137 (also see Experiment XIII, 1,

page 144) and record the subject's normal reaction time for sight, touch and sound.

3. Take two tubes of oil (or water color) paint, one white, the other red (other colors may also be used), and with a brush on a white tile surface (pill tile) make a series of mixtures of white and red varying only the slightest degree in color. Also make several just alike. Number these and let the subject note all those between which he can just distinguish a difference. Record these results.

4. Now let the subject take a therapeutic dose of strychnine.

Caution.—Strychnine is very poisonous. The average dose is one-sixtieth of a grain, but many physicians give doses as large as one-thirtieth of a grain. The drug is probably best taken in the form of tablets (one-sixtieth grain) as mistakes are thus less liable to occur regarding the size of the dose.

5. Wait fifteen or twenty minutes (or longer) for the drug to be absorbed and then again test the acuteness of hearing, the reaction time for sight, touch and sound, and the acuteness of color sense with the painted spots on the tile (be sure these have not changed their color or appearance by drying—the spots should be thoroughly dry before the subject sees them the first time). Has the strychnine affected any of these reactions? Where did the drug act to do this? Is the reaction in the nature of a stimulation or a depression? How does this compare with alcohol?

EXPERIMENT XXXVII.

Picrotoxine. (Frog: Action on Medulla and Cord.)

1. Examine the arrangement of the apparatus shown in Fig. 208. Pith a frog (*cerebrum only*) and arrange it thus for recording contractions of the gastrocnemius muscle. Under the skin of the back inject one cubic centimeter of picrotoxine solution (one cubic centimeter equals

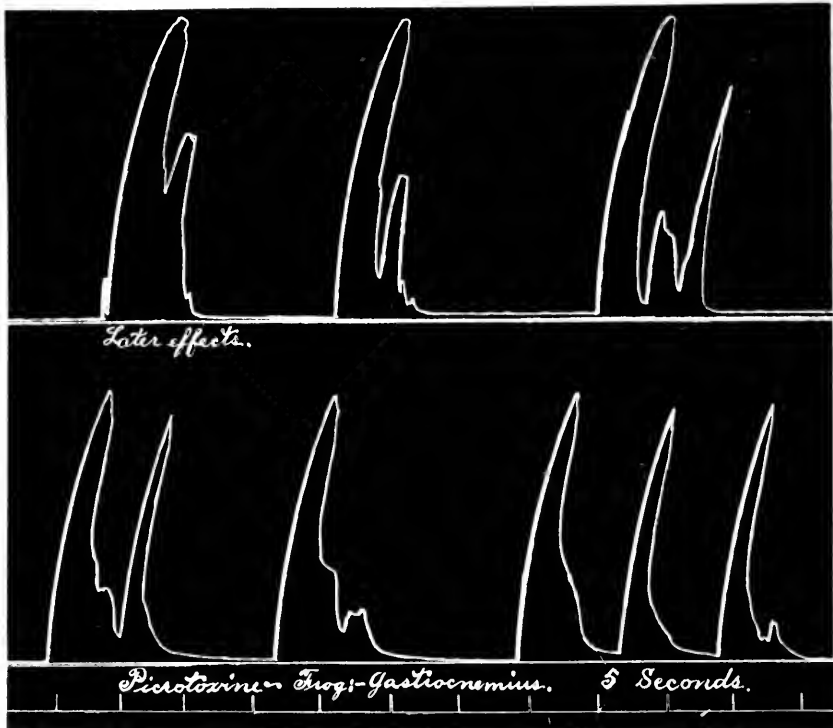

Fig. 215.—Tracings from the gastrocnemius muscle of a frog injected with picrotoxine.

one-half milligram). Wait about three to five minutes for the drug to be absorbed, then start the drum at a moderate rate of speed. After a short time the frog will begin to manifest certain symptoms. Record these (on the lower part of the drum—the muscle contraction record should have an amplitude of about one and one-half or two inches) and when the first round of the drum is completed lower it and wait a short while. Then take a second round of contractions on the upper half of the drum. How do the last contractions compare with the first ones obtained? Have you studied any other drug having a similar action? How do you explain the results?

Note.—A method for destroying (cutting off) the cerebrum while leaving the medulla intact is described on page 238.

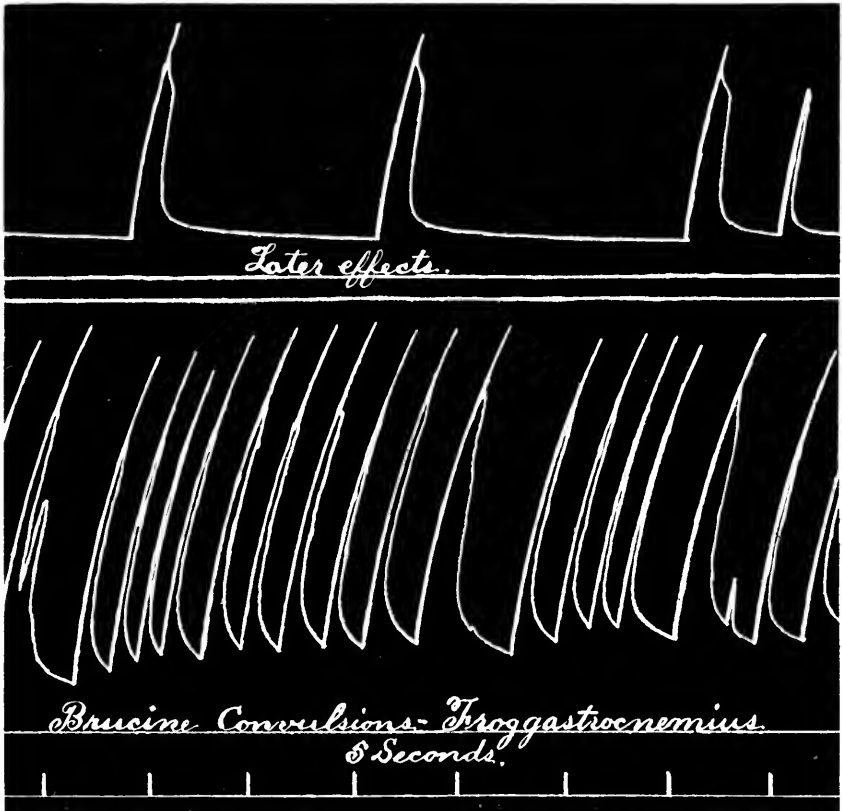

Fig. 216.—Tracings from the gastrocnemius muscle of a frog injected with brucine.

EXPERIMENT XXXVIII.

Picrotoxine,* Chloretone. (Dog: Blood-pressure, Respiration and Kidney, Spleen or Intestinal Loop Volume.)

1. Dissolve three grams of chloretone in about eight cubic centimeters of absolute alcohol. Then add water until a slight precipitate starts to form. Then add a few drops more of alcohol to dissolve the precipitate. Now observe carefully the method of giving drugs to dogs illustrated in Fig. 217. The dog for this dose of chloretone

*Picrotoxine is not often used in medicine.

should weigh about eight or ten kilograms. Some dogs are considerably more susceptible to the drug than others. One student holds the animal between his knees and reaches forward to grasp the dog around the nose and mouth with both hands *firmly*. The assistant slips a gag (Fig. 218) into the dog's mouth just behind the eye teeth.



Fig. 217.—Method of administering medicine to a dog by means of a stomach tube.

The mouth is now held closed and this prevents the dog from biting or dropping out the gag. A second assistant should hold the dog's feet to keep it from scratching. Sometimes the hind feet must be held also. An ordinary soft rubber stomach tube (or one-fourth inch rubber tube with a pointed end) is now passed through the hole in

the gag and back into the dog's mouth. Push the tube into the pharynx and wait a little. The animal will make swallowing movement and these help to direct the tube into the esophagus. When the tube is safely started it can be readily pushed down into the stomach.

Caution.—It not infrequently happens that the tube passes through the larynx and into the trachea. If the drug be injected into the lungs the animal will die in a few moments. This accident must be carefully avoided by using great caution in getting the tube started far back in the dog's mouth. Also when the drug is given pour a little of the solution into the funnel and wait to see what results this has. Breathing sounds may sometimes be heard by listening at the end of the inserted tube if it is in the lungs but these are untrustworthy as similar sounds are often heard when the tube is in the stomach.

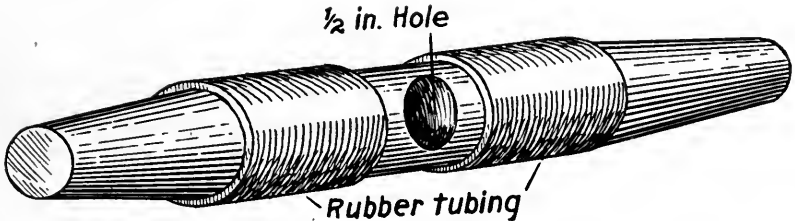

Fig. 218.—Mouth gag for dogs, cats or rabbits. Made of wood.

Allow about ten or fifteen minutes for the drug to act. If the stomach was filled with food the result will not be the same as if the stomach was empty. The animal often becomes very lively and playful at first, but soon gets weak and unsteady, especially in the hind limbs. After a time it lies down and becomes drowsy or even unconscious. If the dose was too small give a second small amount after fifteen minutes. If the first dose was large enough (*and too marked depression should be carefully avoided*) then give a little ether to bring on complete anesthesia and arrange the animal for blood-pressure, respiratory and oesophagus (kidney, spleen or intestinal loop) tracings. Isolate both vagi and place loose ligatures around them. It may be necessary to give small amounts of ether to keep the anesthesia sufficiently deep at least in the beginning

of the experiment. The injecting burettes contain adrenalin and picrotoxine (one cubic centimeter equals one-half milligram).

When the operations are completed adjust the writing points on the drum and take a normal record. Stimulate each vagus nerve and get records. How does this affect the respiration and circulation? Now inject one cubic centimeter of picrotoxine and get records of the results. Note the time of day. Inject more picrotoxine from time to time in small doses (one-half or one cubic centimeter) and keep a close watch on the heart action as shown by the *amplitude* of the manometer tracing and by the *rate of heart beat*. There should be a slowing of the heart and a fall of pressure. Both of these should be brought on very slowly and cautiously by small repeated doses. (Too large a dose of chloretone weakens the heart considerably and must be watched in this experiment. It also depresses the medulla somewhat.) The heart beat should become slow enough after a time to give a pressure tracing with an amplitude of about ten or twelve millimeters (one-half inch) to each stroke of the manometer pointer. When this stage is reached lift up both vagi and tie the ligatures *tightly*. Does this affect the heart? If not quickly cut both vagi centrally to the ligatures. Does this affect the blood-pressure? Does the respiration remain normal? How do you account for any changes observed? Did you get satisfactory records of all these changes? If not why did you fail? Can you do better next time?

Now stimulate the central end of one vagus nerve. How does this affect the animal? What nervous paths are concerned in this? Stimulate the peripheral end of the nerve and note the effect.

Inject more picrotoxine. How does the action here compare with that in the frog? Inject some adrenaline. Do you get normal effects from this dose? Is the heart

slowed? How is the respiration affected? Now give several doses of picrotoxine to kill the animal. What is the immediate cause of death so far as you can judge by this experiment?



Fig. 219.—A dissection showing the position in which an incision should be made for finding the sciatic nerve and placing a ligature around it for stimulation.

If time permits dissect out both sciatic nerves from the outer and posterior aspect of each hind limb (see Fig. 219). Ligate these nerves loosely and examine them carefully as

to size, relations, and the best way to dissect them out quickly. It is sometimes of much help to dissect out one of these nerves and stimulate it to start up the respiration in an animal that has stopped breathing but in which the blood-pressure remains fairly high.

EXPERIMENT XXXIX.

Hydrastine. (Frog: Spinal Cord.)

1. With a pair of scissors cut off the front part of the head of a frog (including the cerebrum) as shown in Fig. 220. Arrange the animal for recording muscular contractions as shown in Fig. 208.

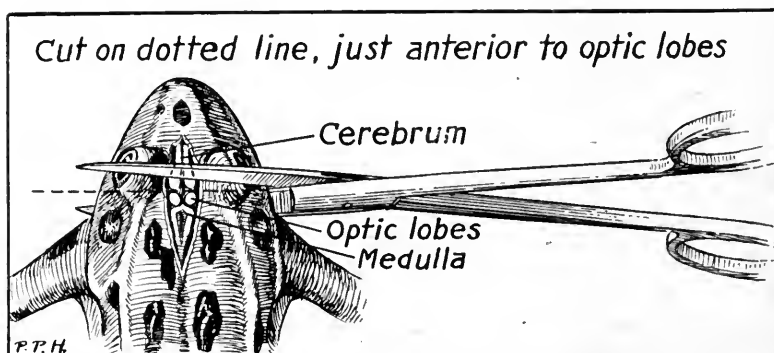

Fig. 220.—Method for destroying (removing) the cerebrum but leaving the rest of the brain intact in a frog. Note the position of the section.

Under the skin of the back inject one cubic centimeter of hydrastine (sulphate or hydrochloride) solution (one cubic centimeter equals two milligrams). Wait two or three minutes for absorption to occur and then start the drum at a fairly rapid speed. After a little while there should be a marked reaction. Try to record the *first action* manifested by the frog. Finish the first round on the drum, then lower the drum and take a second round. How do the reactions shown on the last round compare with those in

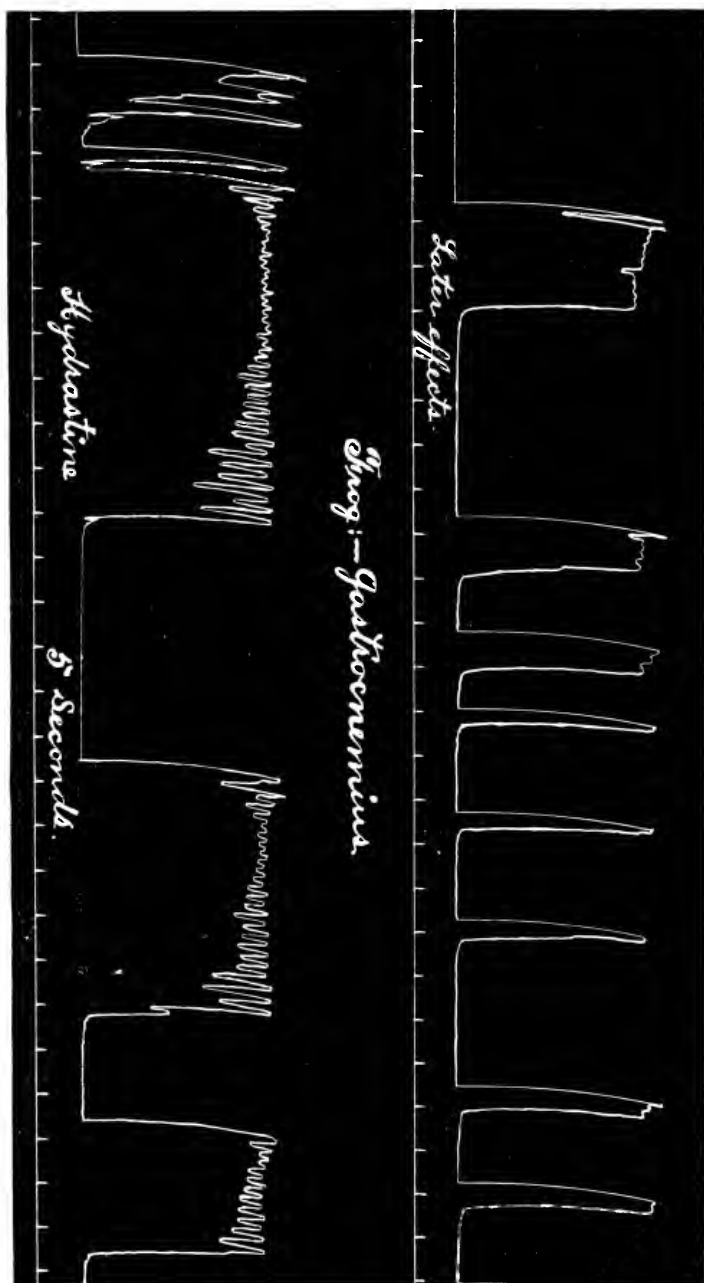

Fig. 221.—Tracing from the gastrocnemius muscle showing the action of hydrastine on a frog.

the first round. How do you explain these effects? Cut the sciatic nerve to the muscle you are using. Is the action of the drug central or peripheral? Stimulate the muscle itself directly a few times with single shocks. What does this show?

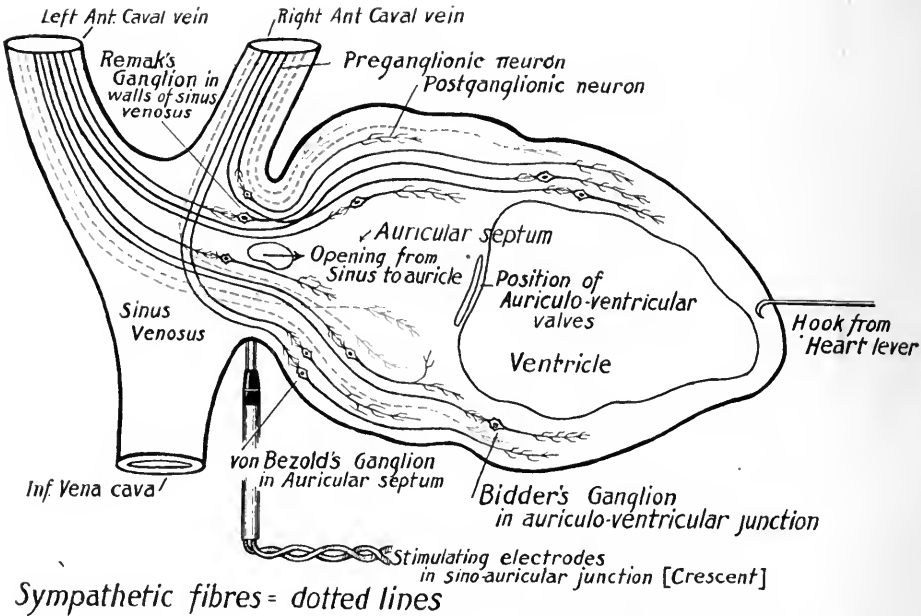

Fig. 222.—Diagram to show the innervation of the heart in the frog or turtle.

EXPERIMENT XL.

Hydrastine. (Frog: Heart and Vagus Nerve.)

1. Pith a frog and dissect out the vagus nerve (Fig. 60). Arrange to record heart tracings and take one inch of normal record. Stimulate the vagus nerve and get a normal inhibition. Then pour on the heart a few drops of hydrastine sulphate solution (one cubic centimeter equals five milligrams). How does this affect the beat? Stimulate the vagus nerve again and record the result.

What do you observe? How do you account for this? Drop on some more of the drug and again stimulate the nerve. Is there any change? Now take up the electrodes and (while the drum is going) turn on a strong (tetanizing) current. With the extreme tips of the electrodes just touch *for a moment* the tissues at the base of the heart just where the sinus venosus joins the right auricle. This is about the point where the inferior vena cava passing forward would bend up toward the right auricle. The inferior (caudal) border of the tissue which forms the connecting tube between the sinus venosus and the right auricle is called the *crescent*. What result do you observe following a brief stimulation of this area? (Examine Fig. 222.)

EXPERIMENT XLI.

Hydrastine. (Turtle: Heart and Vagus Nerve.)

1. Pith a turtle (brain and cord) and take a normal heart tracing showing vagus inhibition in two or three places. Lower the drum and start a second round of the tracing. Drop some hydrastine solution (one cubic centimeter equals five milligrams) on the heart. Record the results and then stimulate the vagus nerve again. What do you observe? Apply more drug and stimulate again. Now stimulate the *crescent* and note the results. What do you observe? Can you explain this?

EXPERIMENT XLII.

Caffeine. (Frog: Central Nervous System, Muscles.)

1. Cut off the front part of the head of a frog (Fig. 220) and inject two cubic centimeters of caffeine solution (the free drug, not a salt, is preferable—use a saturated solution in warm water) into the anterior lymph sac (Fig.

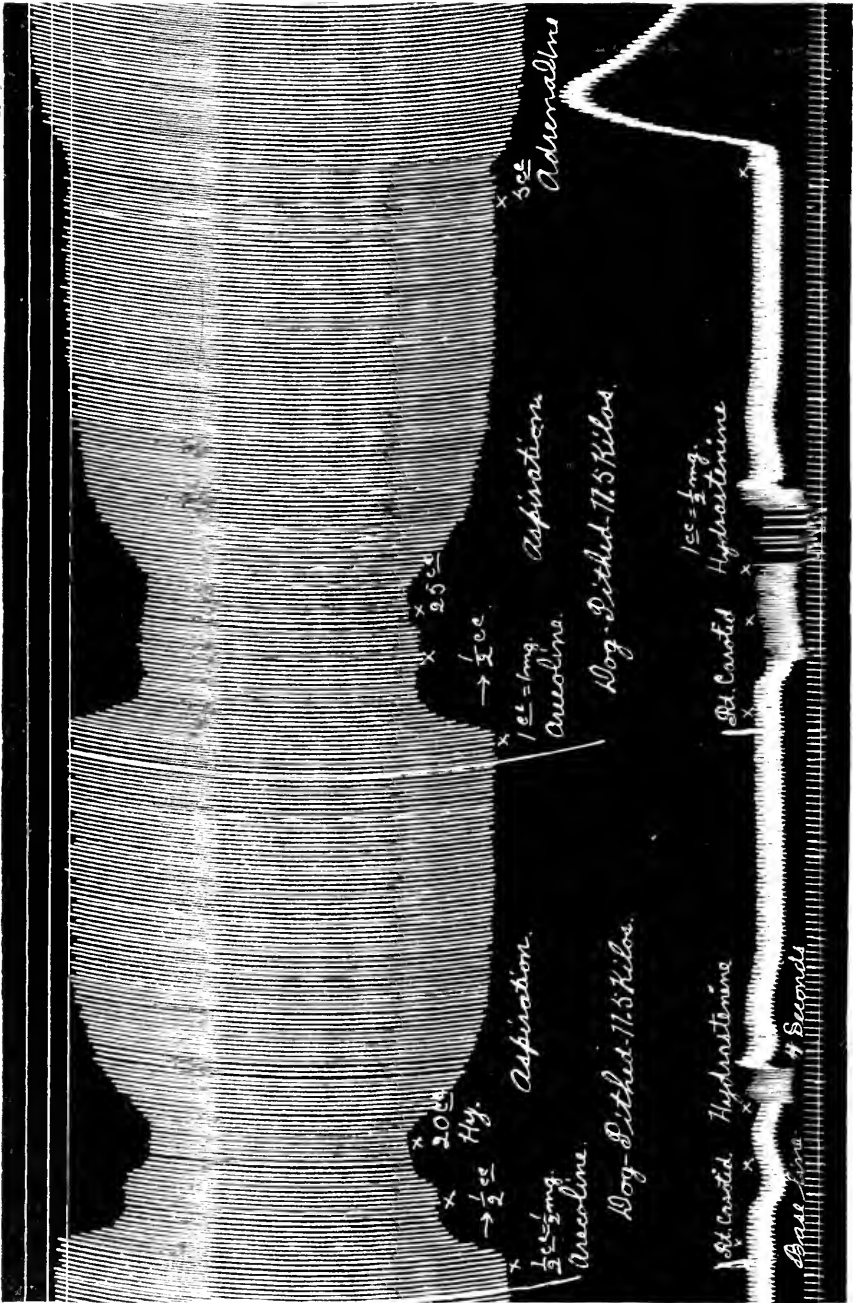

Fig. 223.—Bronchiolar and blood-pressure tracing showing the action of auroline, hydrastemine and adrenaline in a pitthed dog. Made by the method described in Experiment I.XX.

66). Place the frog in a battery jar and examine it from minute to minute. Do you note any *immediate* symptoms? Touch the muscles of the hind legs from time to time and note any changes. Does the animal have convulsions? If so, of what character are they? Keep the animal under observation until it dies, watching the muscles carefully. Do you observe any changes in these? If so, what explanation can you offer?

EXPERIMENT XLIII.

Caffeine. (Frog: Muscle and Nerve.)

1. Pith a frog and isolate both gastrocnemius muscles and both sciatic nerves (attached to the muscles, i.e., nerve muscle preparations). Determine the normal *minimal stimulation* to cause contraction in nerve *A* and muscle *B*. Pour a small amount of caffeine solution into each of two watch glasses. Into watch glass *A* place the nerve of one of the muscle nerve preparations and into watch glass *B* place the muscle of the second preparation. From moment to moment stimulate the nerve of preparation *A* and the muscle of preparation *B* with single shocks. What action has caffeine on the vitality of nerve trunks and of muscle? Which is affected first? Watch the muscle closely and note any gross changes in appearance, color, length, solidity, etc. What do you observe? What explanation can you offer? Tease out some small fibers from muscle *A* and place them on a slide and examine with a compound microscope. Can you see the cross striations well? Cover the fibers with a cover glass and while watching the fibrils closely run a few drops of caffeine solution under the edge of the cover glass in such a manner that the solution reaches the fibrils you are watching. What effect has this on the muscle fibers? How are the cross and longitudinal markings affected? How do you explain this?

EXPERIMENT XLIV.

Caffeine. (Frog: Heart and Vagus Nerve.)

1. Take a normal heart tracing from a pithed frog (showing vagus and crescent inhibition). Drop caffeine (saturated solution) on the heart and record the effects. Stimulate the vagus nerve and note the action of the drug on the inhibitory nervous mechanisms. Apply more drug and again stimulate. Stimulate the crescent also and see if it is affected. Take several rounds of the tracing on the drum to get a good insight into the action of the drug on the heart muscle. How does this compare with the action on the mammalian heart?

EXPERIMENT XLV.

Caffeine. (Turtle: Heart and Vagus Nerve.)

1. Repeat the previous experiment on a pithed turtle. Can you see any changes in the *tone* of the heart muscle as indicated in your records?

EXPERIMENT XLVI.

Caffeine. (Man: Reaction Time.)

1. As in Experiment XXXVI (and XIII) determine the normal reaction time of a student. Then allow the student to drink one or two cups of strong tea or coffee (or take three grains of caffeine powder in capsules) and at intervals of one-half, one hour and one and one-half hours later again take the student's reaction time. What do you observe? How do you explain your results? On what parts of the central nervous system has the caffeine acted to produce the results observed?

EXPERIMENT XLVII.

Caffeine. (Frog: Muscular Work.)

1. Pith a frog and ligate the right thigh tightly so as to shut off the circulation. Fasten the animal down on a

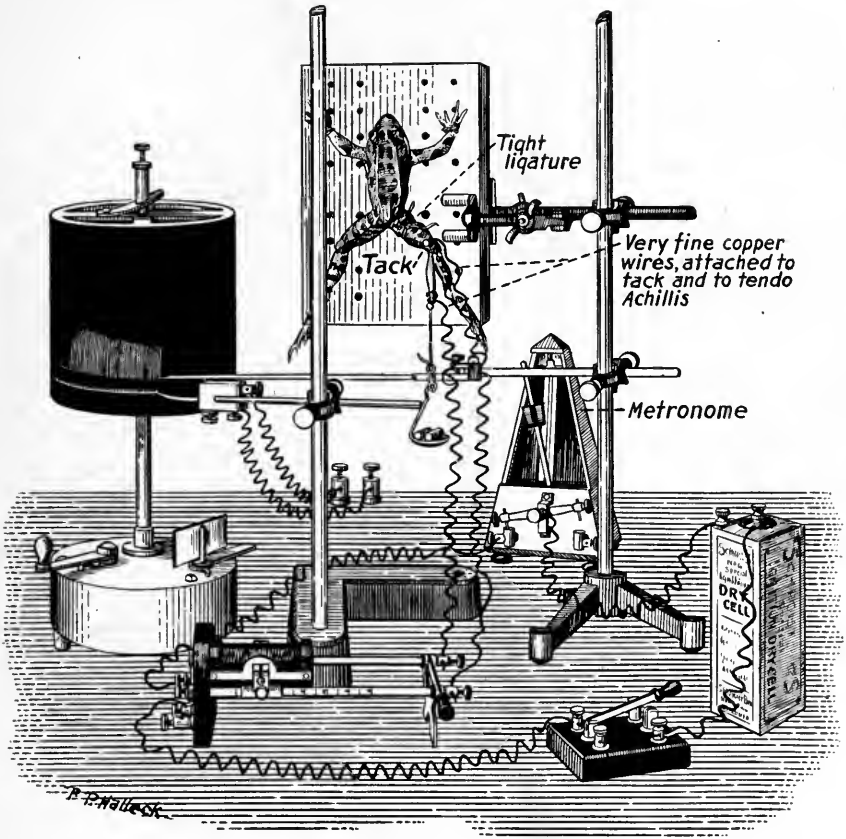

Fig. 224.—Arrangement of a frog and apparatus for recording "fatigue tracings" from the gastrocnemius muscle. The drum should have a slow speed. (For description see text.)

board as shown in Fig. 224. Isolate the tendo Achillis of the right leg and arrange as illustrated for stimulating with single shocks. The primary current is best interrupted by a metronome as illustrated, but if this is not

available then a student can interrupt the primary current with a simple key by hand (once in one or two seconds). The drum must have a slow speed. The secondary shocks are carried directly to the muscle by very fine copper wires one of which is attached to the carpet tack which is driven through the frog's right knee into the frog board to hold the upper end of the gastrocnemius muscle firmly in place when the muscle contracts. The other wire is tied to the tendo Achillis. Now inject into the dorsal lymph sac one cubic centimeter of five-tenths per cent caf-

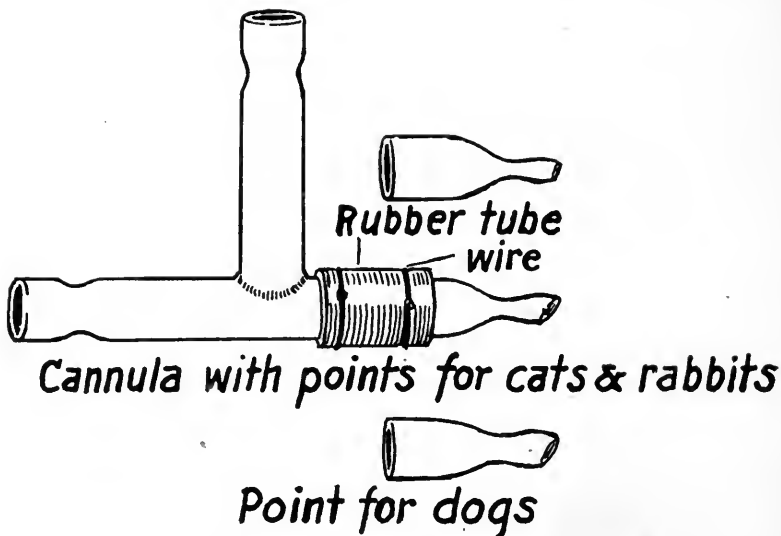
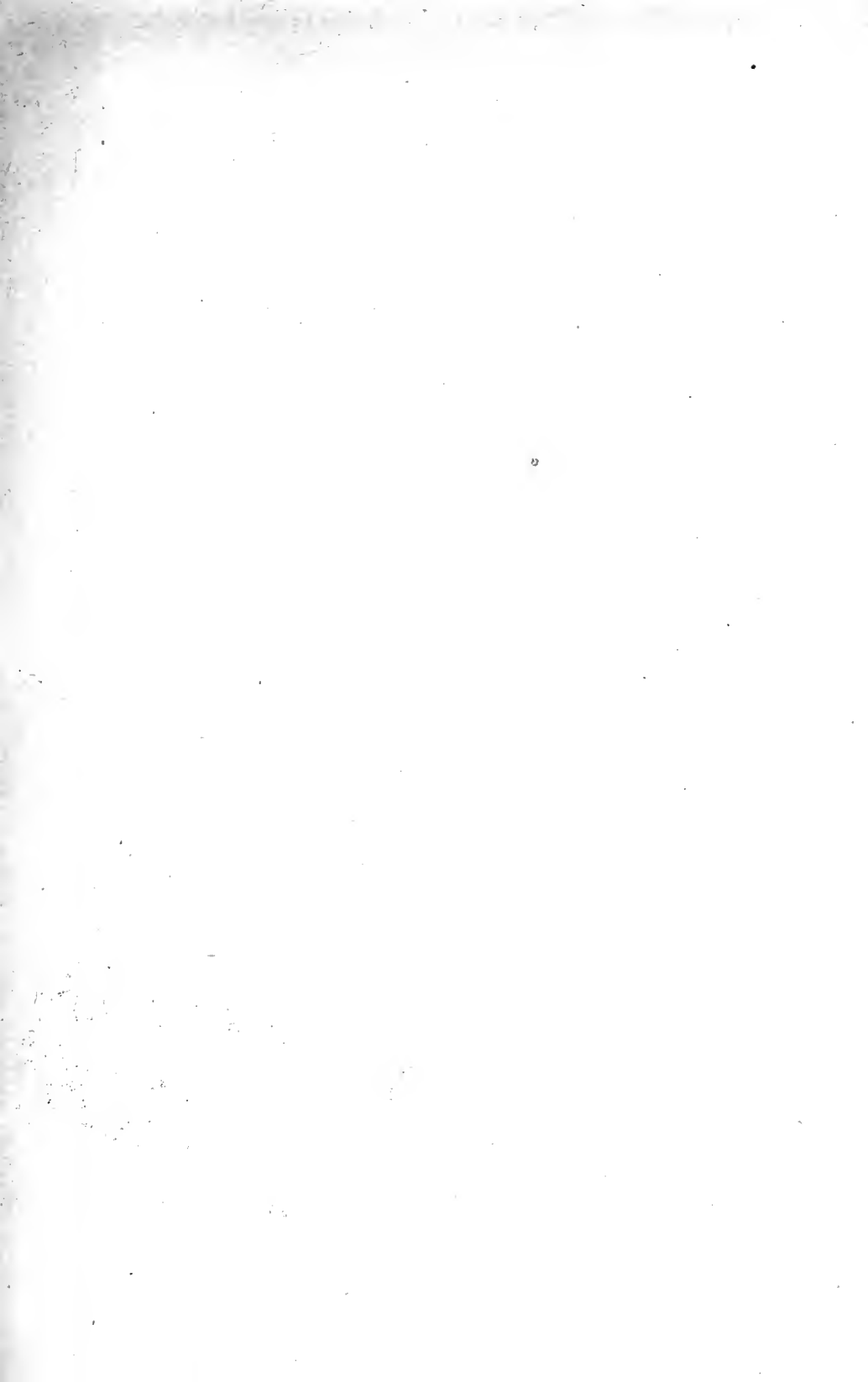

Fig. 225.—A method for making cannulas with separable points. One end of the "T" of a glass (5/16 inch) T-tube is cut off short and short glass points are attached by means of a piece of rubber tubing. It is vastly easier to make the small points than to blow a T-tube and to make a cannula entirely of glass. (The points illustrated are larger than they should be for rabbits and cats.)

feine solution (Greene) and allow this to be absorbed while the experiment is going on.

When all adjustments are made start the drum and record a normal "fatigue curve" from the right gastrocnemius. (For a description of fatigue curves see any manual on experimental physiology.) This curve should be taken on the lower half of the drum.



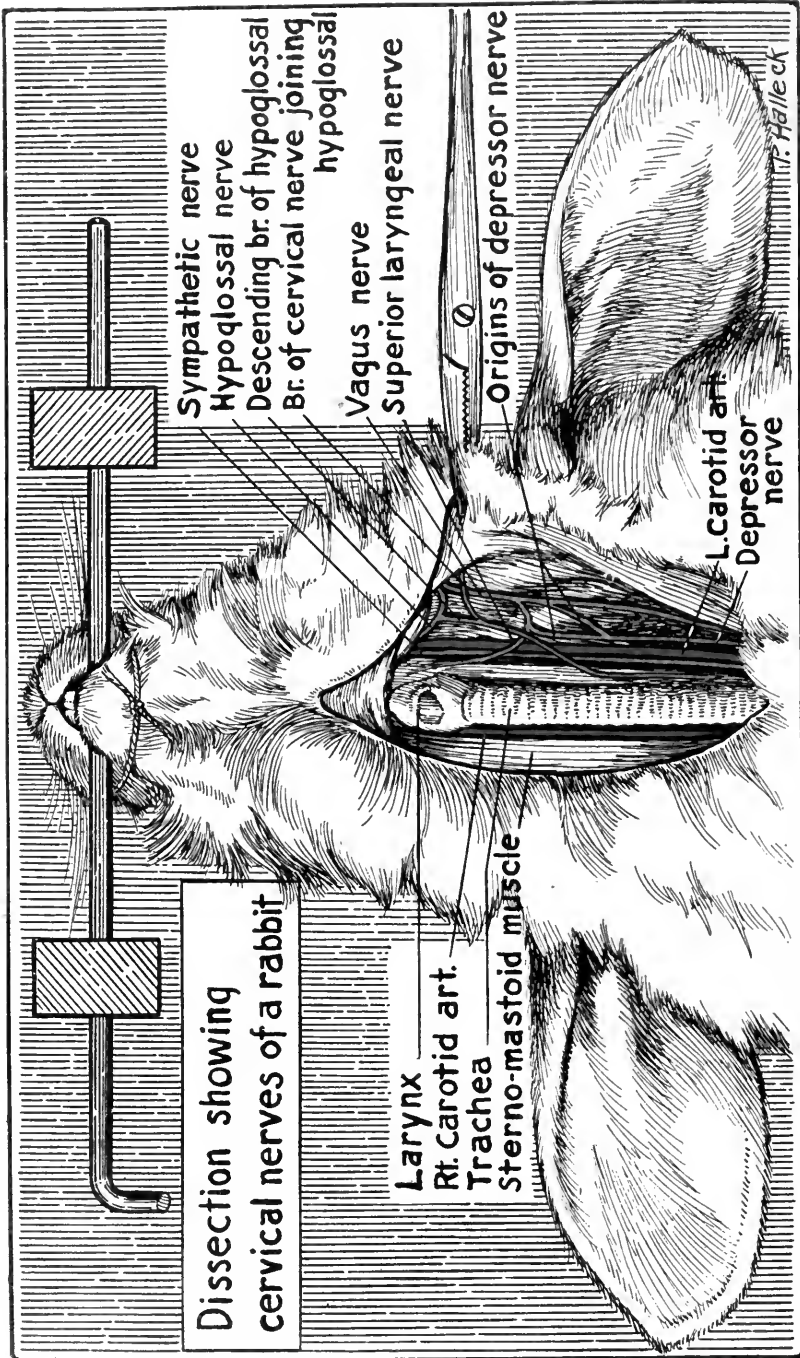

Fig. 226.—Dissection of the structures in the neck of a rabbit showing the arrangement of the nerves on the left side.

When the muscle is exhausted then ligate the left thigh tightly and drive a second carpet tack through the left knee to hold the left gastrocnemius firmly. Isolate the left tendo Achillis. Disconnect the stimulating wires, remove the frog board from the large clamp and turn the frog board around on a perpendicular axis so that the frog will be on the side away from the apparatus. Also remove the large clamp, turn it over on a horizontal axis and re-attach it to the stand. Replace the frog board. The left leg of the frog will now occupy practically the same position that the right leg formerly had. Attach the stimulating wires and connect the tendon to the muscle lever. The load, magnification, tension, etc., of this muscle must be the same as that used with the right muscle. About twenty minutes should now have elapsed for absorption of the caffeine.

Start at the beginning of the upper half of the drum and record a fatigue curve of this muscle, which will now show the effect which caffeine has on muscular work. The rate of stimulation should not vary (once in one or two seconds) for each curve. How does the normal fatigue curve compare with the caffeine curve? What conclusions can you draw?

EXPERIMENT XLVIII.

Caffeine. (Rabbit: Diuresis, Cervical Nerves, Depressor.)

1. Dissolve two grams of urethane in about twenty-five cubic centimeters of water. Select a full grown rabbit and with a catheter used as a stomach tube inject the urethane into the rabbit's stomach. [Pass the tube through the hole in a wood gag (Fig. 218) held in the animal's mouth.] Wait about ten or fifteen minutes for the drug to be absorbed and then give the animal a *little* ether to bring on complete anesthesia. Use *great care* in this for rabbits *die very readily*. Insert a tracheal can-

nula (one-fourth inch diameter) and connect up the ether bottle (or anesthetic device shown in Fig. 116). *Use the greatest care in giving the ether not to kill the animal.* Into the *femoral vein* tie a *very small* injecting cannula (Fig. 18) connected to a burette containing caffeine solution (.5%). Record the respiration on the drum.

Open the abdomen over the bladder and insert a bladder cannula (Fig. 23). Arrange the cannula to empty into a graduated cylinder and when all preparations are made wait ten or twenty minutes to record the *normal* rate of urine secretion. Test this with Fehling's solution. Then *cautiously* inject one-half cubic centimeter of caffeine solution into the vein. Watch the effects of this on the respiration closely. From time to time as the animal will

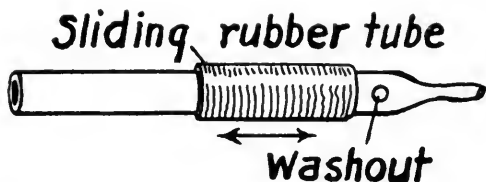

Fig. 227.—An easily made glass cannula showing a sliding rubber tube which may be used to open or close the small opening blown in the side of the tube and used as a "washout."

tolerate it inject more caffeine in one-half cubic centimeter (or smaller) doses. Is there any change in the rate of urine flow? Collect the urine for each ten minute interval. Test for reducing bodies again. Is sugar present? If so, how do you account for it?

If you have time, consult Fig. 226 to learn the arrangement of the vagus, sympathetic and depressor nerves in the neck of the rabbit, and then carefully dissect out these nerves. Using a *very small* arterial cannula (Figs. 225 and 227) connect the right carotid artery to the manometer and take a blood-pressure tracing. Stimulate the depressor nerve (peripherally) and note the effect. How do you explain this result? Inject more caffeine and see if

you can obtain any idea of the action of the drug on the heart and circulation. Kill the animal with a large dose of caffeine. After the animal is dead dissect out the vagus, sympathetic and depressor nerves in the other side of the neck.

EXPERIMENT XLIX.

Caffeine, Sodium Sulphate. (Dog: Blood-pressure Diuresis, Respiration, Sciatic Nerve.)

1. Dissolve three or four grams of chloral hydrate in a little water and inject the solution into the rectum of a medium sized dog. See that the solution does not run out again immediately after injection. In ten minutes anesthetize the animal fully with ether (or etherize the animal at the start and omit the chloral or give it by stomach—it is advisable to give the chloral, however). Arrange to record blood-pressure, respiration and the rate of urine flow. Place caffeine (.5%) and adrenaline in the injecting burettes.

Open the abdomen and lift up the bladder. At the posterior side of the base of the bladder you will find the ureters entering the bladder from each side (see Fig. 162). Pick up the ureters and place in each a ureteral cannula (Fig. 213) and arrange to record the rate of urine secretion by obtaining a record on the drum of the drops falling from the cannulas. To do this arrange two tambours as shown in Fig. 228 in such a manner that each drop of urine falls on a small metal disc attached with wax (colophonium or ceiling wax) to the writing point of the first tambour. The second connected tambour records these drops on the drum.

Consult Fig. 219 and dissect out the sciatic nerve in one hind limb. While recording blood-pressure and respiration stimulate the nerve with a medium strength Faradizing current. What do you observe? Can you think of a

condition in which this procedure might be of help in reviving an animal? Try this on the next animal you have in which the respiration ceases, especially if the blood-pressure remains fairly high.

Adjust all writing points, allow the animal to return to normal (keeping the anesthesia as regular as possible) and

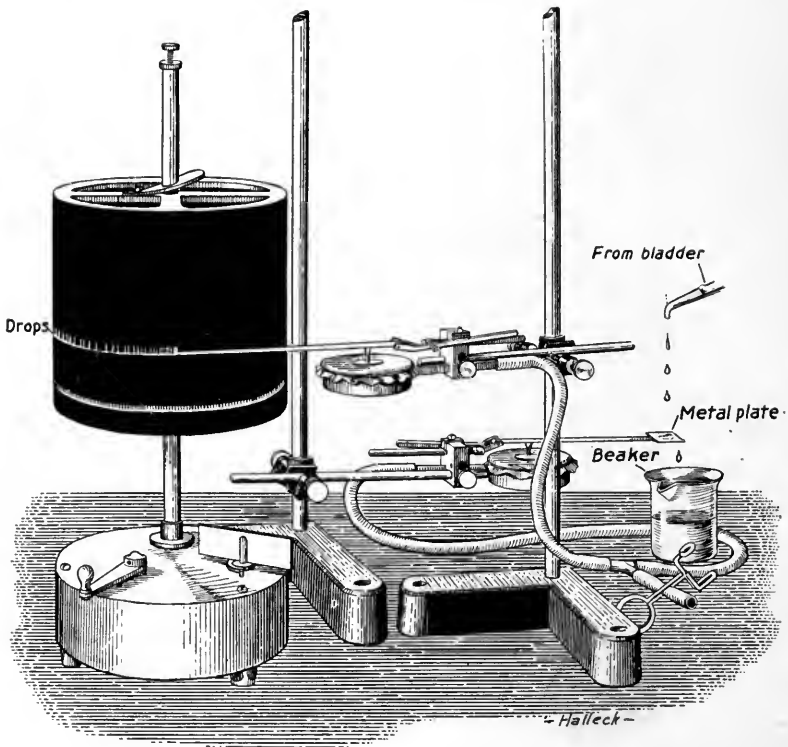

Fig. 228.—Arrangement of two tambours to form a drop recorder.

wait ten or twenty minutes to record the *normal rate of urine flow*. When this is obtained (not a drop of urine may have been secreted during this period, in which case simply watch for the flow to start up) then proceed to give the caffeine. Watch for the effect on respiration and the circulation. Inject one cubic centimeter of caffeine. What do you observe? Increase the dose if the animal will



Fig. 229.—A record of the blood-pressure, respiration and rate of urine flow (drops) in a dog to which sodium sulphate was administered intravenously. At each "x," an injection of 4% Na_2SO_4 was made as indicated.

stand it and continue giving the drug until several centimeters are injected. Wait a while to observe the effect on urine flow. This often fails in dogs. Why? Will the chloral influence the result in any way?

Wait for fifteen or twenty minutes for the caffeine to act. Be sure the dose given was large enough. Then allow the animal to become as nearly normal as possible and get a new *normal* rate of urine flow. Test the urine for sugar. What do you observe? Explain.

Now empty the caffeine out of the burette and fill it with four per cent sodium sulphate solution. Inject one cubic centimeter. Increase the dose rapidly (twenty cubic centimeters or more may be given at a time often without killing the animal) and watch the effect on blood-pressure, respiration and urine flow. What do you observe? How does this compare with the action of caffeine? If the animal is still in fair condition substitute a four per cent solution of sodium phosphate (or nitrate or chloride) for the sodium sulphate and inject a considerable quantity of this salt. How is the rate of urine flow affected? What theories of urine secretion do you know? On the basis of these explain the action of the drugs injected. Keep a record of the amount of solution injected in each ten minute interval and see if you can collect an equal volume of urine in a beaker in the same time. This can sometimes be done, especially with rabbits. Kill the animal by a large injection of one of the salts mentioned (watching the urine flow as the drug is acting), then dissect out the pancreas and see if you can find its lower duct (Figs. 244 and 245). Could you put a cannula in the duct while the animal was alive? Dissect out the gall bladder, the cystic duct, and the common duct. What are the relations of the pancreatic ducts and the bile ducts as they pass through the wall of the intestine?

EXPERIMENT L.

**Diuretine, (Sodium-theobromine-salicylate), Agurine,
(Sodium-theobromine-acetate). (Rabbit: Diuresis
and Respiration.)**

1. Give by stomach two grams of urethane dissolved in twenty-five cubic centimeters of water to a good sized rabbit. Wait ten minutes for the drug to be absorbed and then give the animal a *little* ether to complete the anesthesia. Arrange to record (or collect or both) the drops of urine as they fall from a bladder cannula (or from two ureteral cannulas). Place a cannula in the femoral (or jugular) vein and connect up a burette. Fill this with diuretine one per cent (or agurine, one per cent). Arrange to record the respiration. Count the pulse rate per minute.

When all preparations are made wait ten or twenty minutes to obtain the *normal rate of urine flow*. Then inject one-half cubic centimeter of diuretine [(Knoll and Company, 45 John St., New York) or agurine] and record the effect on the respiration. Count the pulse rate and see if it is affected. Now give more of the drug from time to time and try to bring on the effect gradually, watching carefully not to kill the animal by an overdose. What do you observe? How do you account for this? If your drop recorder does not work well then let a student operate the recording signal magnet by means of a simple hand key placed in series with a dry cell and the signal magnet. The student can make and break the current each time a drop falls. If you are skillful enough you can make a device to record each drop by electrical contact. But do not spend too much time at this.

When you have obtained as marked results as possible from the diuretine (or agurine or both) then if the rabbit is still in suitable condition fill the burette with one of the following solutions:

- 2% sodium nitrate,
- 2% sodium phosphate,
- 2% sodium chloride,
- 2% ammonium chloride,
- 2% ammonium acetate.

Arrange to observe the full action on urine secretion and *cautiously* inject one-half cubic centimeter (or less) of the solution in the burette. With great care gradually inject more of the solution from time to time as rapidly as the animal can tolerate it. What effect has this on the urine flow? Continue the administration as long as satisfactory results can be obtained.

EXPERIMENT LI.

Urea, S. A. Matthews' Solution, or Saline Diuretics. (Rabbit or Cat: Diuresis.)

1. Repeat the above experiment with a rabbit or cat (using two grams of urethane for an average sized animal, or 1.7 cubic centimeters per kilogram of paraldehyde for a rabbit—Edmunds) but after securing the normal rate of urine flow begin to inject one of the following:

A. *Urea* (5% solution).

B. *S. A. Matthew's solution*:

NaCl, 3.67 grams.

Na₂SO₄, 10.1 grams.

Sodium Citrate, 3.36 grams.

CaCl₂, 0.136 grams.

Water, 1000 c.c.

C. *Three per cent solution of any of the following*:

Sodium sulphate.

Sodium phosphate.

Sodium nitrate.

Ammonium nitrate.

Sodium chloride.

Sodium iodide.

Use great care in making the injections. Begin with very small doses and inject more as the animal is able to tolerate it.

What conclusions can you draw with reference to the diuretic action of these substances? How do they act?

EXPERIMENT LII.

Curara. (Frog: General Action, Claud Bernard's Experiment.)

1. Pith a frog (cerebrum only) and make a small incision over the back of the right thigh (see Fig. 47). Dissect up a short length of the sciatic nerve. *Do not cut or injure the nerve.* Pass a thread beneath the nerve and tie off the tissues of the thigh tightly so as to completely stop all circulation in the right (gastrocnemius) muscle and foot. With single shocks stimulate the exposed nerve once or twice to see how the muscles act in the isolated part of the leg. Also stimulate the tissues at the back of the head over the upper end of the cord once or twice to get the normal reactions. Put a drop of acetic acid on the left hind foot and see if the animal moves the limb. Brush off the acid. Count the rate of lymph heart beats.

Into the ventral lymph sac inject one cubic centimeter of a saturated solution of curara. Wait three minutes and then begin to retest the reflexes from time to time as the drug is absorbed. How is the rate of beat of the lymph hearts affected? Will the animal jump when stimulated? As the action of the drug becomes very marked stimulate again the exposed sciatic nerve. (Keep the nerve moist with salt solution where it is exposed.) Apply a drop of acetic acid to the skin of the back. Is there any response? If so, where? Stimulate the upper end of the cord. What muscles

respond? Stimulate the left gastrocnemius (through the skin) directly. Does it contract? What conclusions can you draw? Where does curara act? Does your experiment prove the nerve trunks are not paralyzed? Are the sensory nerve endings paralyzed? Does your experiment give you a chance to test this point? Count the lymph heart rate

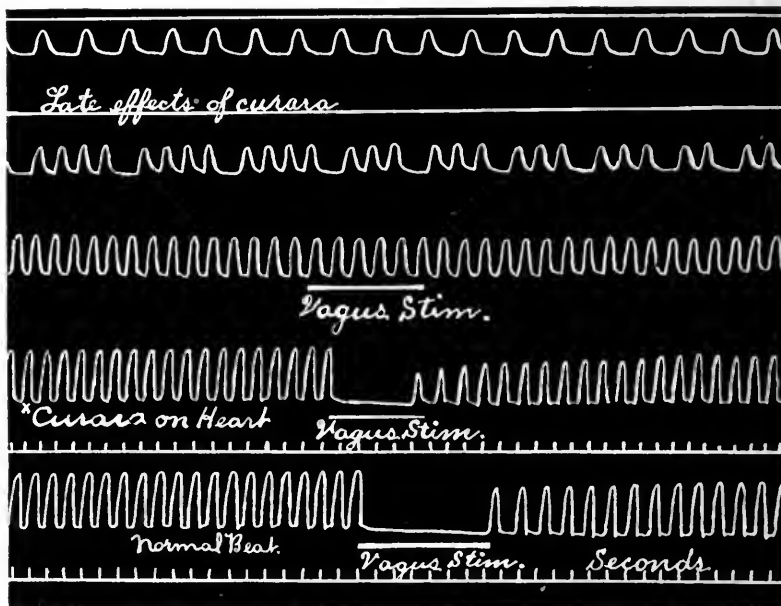

Fig. 230.—Tracing showing the action of a solution of curara dropped on the heart of a frog. Lower line normal, showing the inhibition caused by stimulation of the vagus trunk. Second line, curara was applied at "x" and the vagus was again stimulated as shown by the short line and legend. Third line, the application of the drug was continued and the vagus trunk was again stimulated as indicated. No noticeable results follow the stimulation. Why not? Fourth and fifth lines, application of the drug was continued and its action on the heart is shown.

again. What conclusions can you draw from this? What is the action of curara on the central nervous system? (See McGuigan: *Journal of Pharmacology and Experimental Therapeutics*, 1916, viii, p. 471.)

Do you know of any other substances possessing an action on motor nerve endings in striated muscles like curara does? How does this drug differ from atropine in its action on nerve endings?

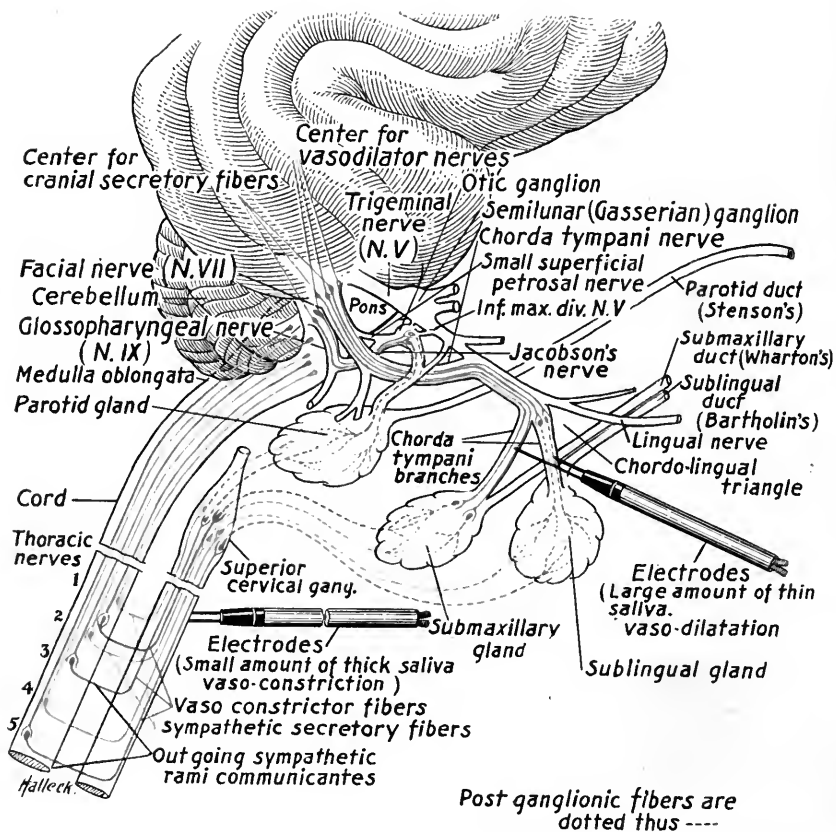

Fig. 231.—Diagrammatic representation of the innervation of the salivary glands in the dog.

EXPERIMENT LIII.

Curara. (Frog: Heart and Vago-sympathetic Nerve.)

1. Pith a frog and arrange to take a heart tracing. Stimulate the vagus nerve and get a normal inhibition. Drop on the heart a few drops of a saturated curara solution. What do you observe? Now stimulate the nerve again and record the result. Has any change been produced? If not apply more curara and stimulate again. Now stimulate the crescent and record the result. What do you observe? How do you explain this? Apply more of the drug to bring out the later action on the heart.

EXPERIMENT LIV.

Curara. (Turtle: Heart and Vagus Nerve.)

1. Repeat the above experiment on a pithed turtle. How do the results obtained with this animal compare with those from the frog? What is the innervation of the turtle's heart? How does it differ from that of the frog?

EXPERIMENT LV.

Curara, Strychnine. (Dog or Cat: Blood-pressure, Respiration, Urine, Sciatic Nerve. Dog: Salivary Ducts and Nerves.)

1. Weigh a medium-sized dog and give it by stomach three hundred milligrams of chloretone per kilo of body weight. Dissolve the chloretone in ten cubic centimeters of alcohol (absolute) and dilute the solution as much as possible with water. Add a little alcohol to redissolve any precipitate formed. After ten minutes etherize the animal and attach it to the operating board. Arrange to record blood-pressure and respiration (stethograph). The injecting bu-

rettes contain strychnine (one cubic centimeter equals one-half milligram) and adrenaline. (If a cat must be used give it two grams of urethane in twenty-five cubic centimeters of water by stomach, or give 1.7 cubic centimeters of paraldehyde per kilogram of animal—Edmunds.)

Insert a bladder cannula into the fundus of the dog's bladder, draw off a little urine and test it with Fehling's solution. Do you get a reduction? If so how do you explain it? Now consult Fig. 219 and dissect out the sciatic nerve *using great care not to disturb the vessels of the leg*. (These are carefully avoided so the curara can be well distributed to the muscles innervated by the sciatic.) Stimulate the sciatic with a medium strength Faradizing current and note the effect on respiration and blood-pressure and on the muscles of the leg below the point of stimulation.

Beneath the skin of the back or side inject with a hypodermic syringe twenty cubic centimeters of a saturated solution of curara (Merck's). This dose is exceedingly large if the drug is pure, but it is usually impossible to get a first-class preparation of the substance in this country. Note the time of day and observe how long a time is required for the drug to act (slow or weaken or stop the respiration). How is the blood-pressure affected? (It may be necessary to give more of the drug later.) Be on the watch for the respiration to become shallow. How does this affect the blood-pressure? Be sure to keep the anesthesia going if the dose of chloretone was not sufficient to completely maintain the narcosis. *This drug is supposed not to prevent sensation*, hence the animal must be kept anesthetized. As the respiration begins to fail give artificial respiration. This must be maintained during the remainder of the experiment.

From time to time briefly stimulate the vagus nerve with a medium tetanizing current and note the effect on the heart. Do you observe any change after the action of the drug has become very marked? Is there any change in

the reaction of the pupil when the vago-sympathetic trunk is stimulated?

Collect a few drops of urine and test with Fehling's solution. Is there any reduction? How do you account for it?

Pick up the sciatic and stimulate it again with the same strength of current as that used the first time. Do you get a response? What conclusions can you draw? How does electrical stimulation compare with the natural nervous impulse?

Now get the animal in as good condition as possible and while recording the blood-pressure inject one cubic centimeter of strychnine. Follow this up rapidly with more injections as fast as the animal can well tolerate the drug. Watch for convulsions. Do you get these? What muscles are affected by curara? What ones are not affected? Does the action of strychnine extend to any of those *not affected by curara*? If so what manifestations of this action would you expect? Are these present? Is there any change in blood-pressure? If so how long is this change present as compared with the action of strychnine in a noncurarized animal? Explain this. Stimulate the vagus and sciatic nerves again and note the results on the heart and leg muscles. Is there any change in blood-pressure when the sciatic is stimulated? If so how does this compare with your normal record? What structures are involved and how are they affected (Bayliss: *Journal of Physiology*, lxxx, 353)?

Dog.—Consult Figs. 237, 238, 239 and 240 and dissect out the submaxillary and sublingual ducts. Also dissect out the chorda tympani nerve. For the general distribution of nerves to the salivary glands see Fig. 231. If the animal is still in suitable condition try to insert a cannula (Fig. 102) into Wharton's duct as indicated in Figs. 238, 239, and 240. Stimulate the chorda tympani nerve and see if you can observe any effects on the rate of salivary secretion. What action has curara on the salivary apparatus? Have you demonstrated this? Kill the animal with a large dose of

strychnine. After death dissect out the ducts and chorda tympani nerve on the opposite side. Can you easily differentiate between the two ducts? Can you locate the chordo-lingual triangle? Cut out (*label*) both eyes and place them in thirty per cent alcohol. Save for dissection later.

EXPERIMENT LVI.

Coniine. (Frog: Heart and Vagus Nerve.)

1. Pith a frog, arrange for taking a heart tracing and stimulate both the vagus trunk and the crescent. Get records showing the inhibition from each of these. Drop two or three drops of a one per cent coniine solution on the heart. How does this affect the record? Now stimulate the vagus and crescent again and record the results. What do you observe? How do you explain this? What other structures are similarly affected by coniine? Make a diagram of the innervation of the heart (Fig. 222) of the frog in your permanent note book and indicate on it the structures affected by coniine and state the nature of this action. Apply sufficient coniine to the heart to bring it to a standstill. Do you know of any other drugs that act like coniine? Watch for these later.

EXPERIMENT LVII.

Coniine. (Turtle: Heart and Vagus Nerve, Lungs and Sympathetic Nerves.)

1. Repeat Experiment LVI on a turtle and secure records to show the action of the drug. After a record showing the specific action of the drug on the ganglia has been obtained (how would you prove this?) then unhook the heart lever and remove the turtle from the drum. (It is often advisable to use a fresh turtle for this part of the experiment. Large turtles are preferred.) Consult Fig. 232

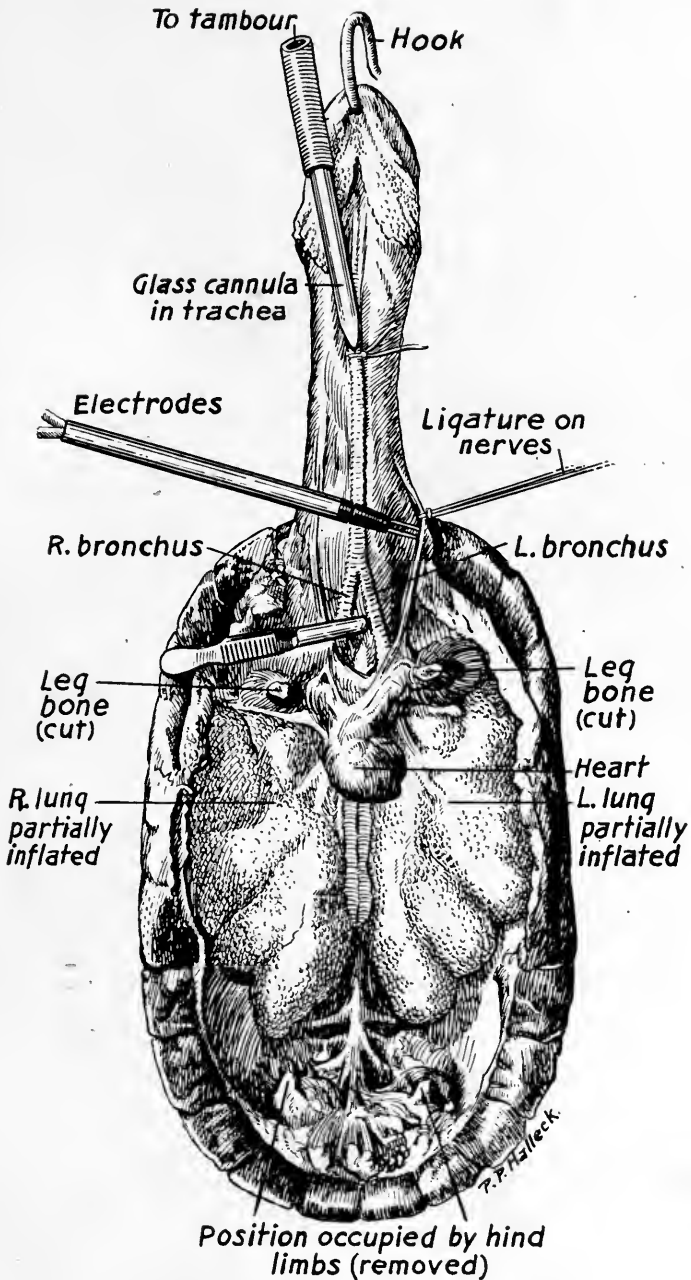

Fig. 232.—A turtle with the brain and spinal cord destroyed and with the plastron and most of the viscera, limbs and skeletal muscles removed to expose freely the partially inflated lungs. A bull-dog is placed on the right bronchus to exclude the right lung from communication with the recording tambour which is connected with the left lung by means of the glass cannula tied in the trachea. The electrodes are shown placed under the left vagus trunk. The heart beats freely. Stimulation of the vagus nerve causes a marked contraction of the corresponding lung. (See Fig. 233 for arrangement of the recording apparatus.)

and note carefully what has been removed. Cut the plas-tron loose at each side and remove it. Lift up the intestines and liver and with *great care dissect them loose from the lungs*. To do this put a cannula (Fig. 233) into the trachea and attach a rubber tube. Then with the mouth blow the lungs up as indicated in the illustration and clamp off the rubber tube. This holds the lungs partially distended and

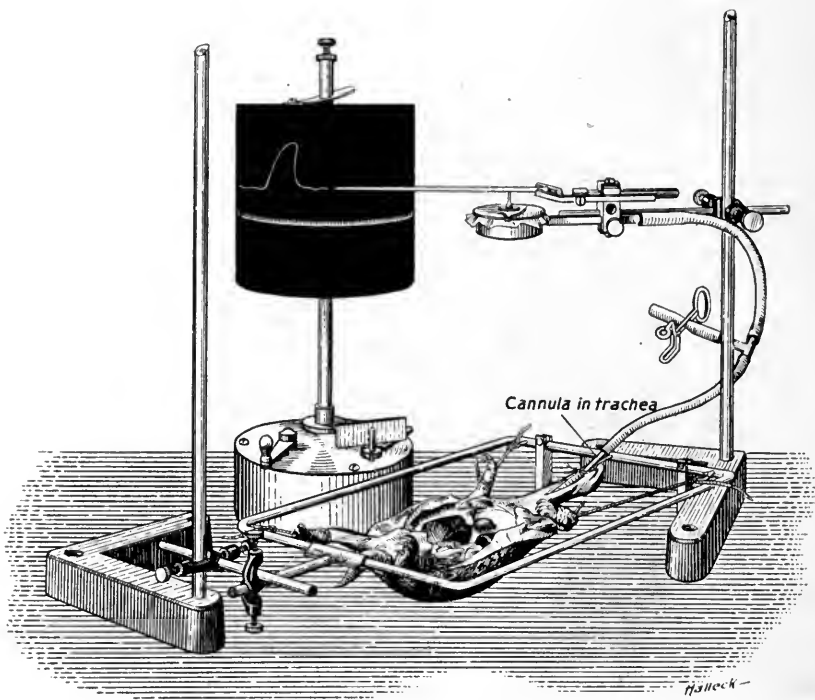

Fig. 233.—Arrangement of apparatus with a turtle held in a Higgin's turtle frame (of 3/8 inch iron rod with hooks at the corners to which the limbs are tied) for recording lung contractions. A very sensitive large-bowled tambour with a large magnification is used, and the lungs are partially inflated by forcing a little air (with the mouth) into the side outlet of the tubing. This puts the tambour and the lung both under moderate tension and in direct communication. When the lung contracts the tambour pointer rises but when the lung relaxes the pointer descends as the rubber membrane on the tambour forces the air back into the lung. Drugs are conveniently administered by injection into the heart with a fine pointed hypodermic syringe.

greatly aids in the dissection. Use great care not to puncture the lungs. If you do this, find the hole, lift up the edges of the opening and tie a ligature around the puncture.

When the entrails are removed then cut out all the skeletal muscles you can including the entire hind limbs and most of the muscles of the fore limbs. This exposes the lungs practically free from skeletal muscles.

Connect the tracheal cannula with a tambour (very sensitive, medium-sized bowl) and bring the writing point on to a slow drum. Observe the way the bull-dog is placed in the

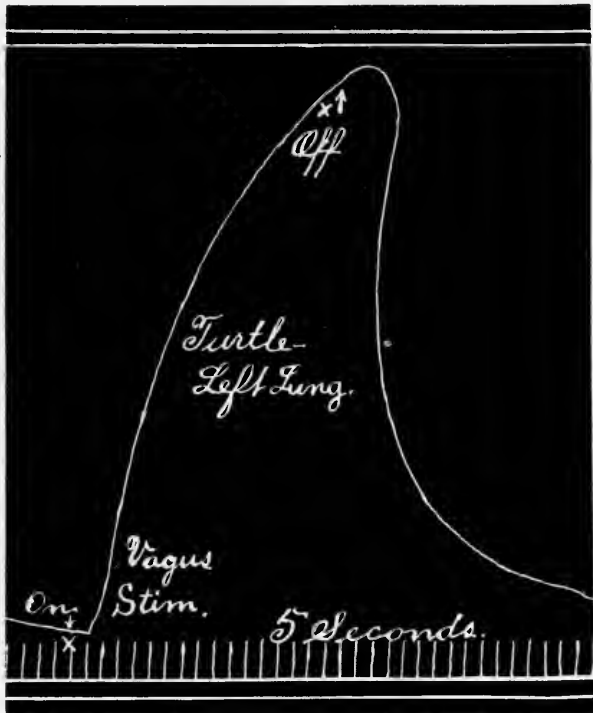

Fig. 234.—Tracing showing the contraction of the left lung of a turtle when the left vagus nerve was stimulated electrically.

figure. In a similar manner clamp off one bronchus and then pick up the main trunks of the vagus and sympathetic nerves on the opposite side well up in the neck. See that the lung is *partially inflated* and the tambour *under a slight tension*. Start the drum, and with a fairly strong tetanizing current stimulate the vagus and sympathetic trunks

(see Fig. 234). What do you observe? What are your conclusions? Consult your text-book on physiology for further explanation regarding the innervation of the lungs. Now

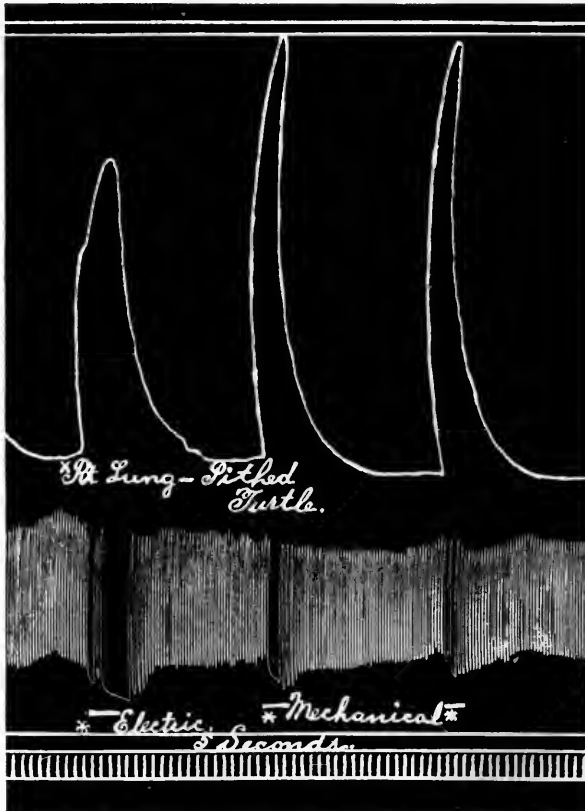

Fig. 235.—Lung and heart tracings from a turtle showing the effect of electrical stimulation of the right vagus nerve (first contraction and inhibition) and of mechanical stimulation (tearing) of the same nerve (second and third records).

make a careful dissection of the nerves (and sympathetic branches) on the opposite side of the neck. Make a sketch of these nerves for future reference.

It is exceedingly desirable in making the preliminary dissection to remove as much as possible of the skeletal musculature. This prevents movements which may be confused with the lung contractions.

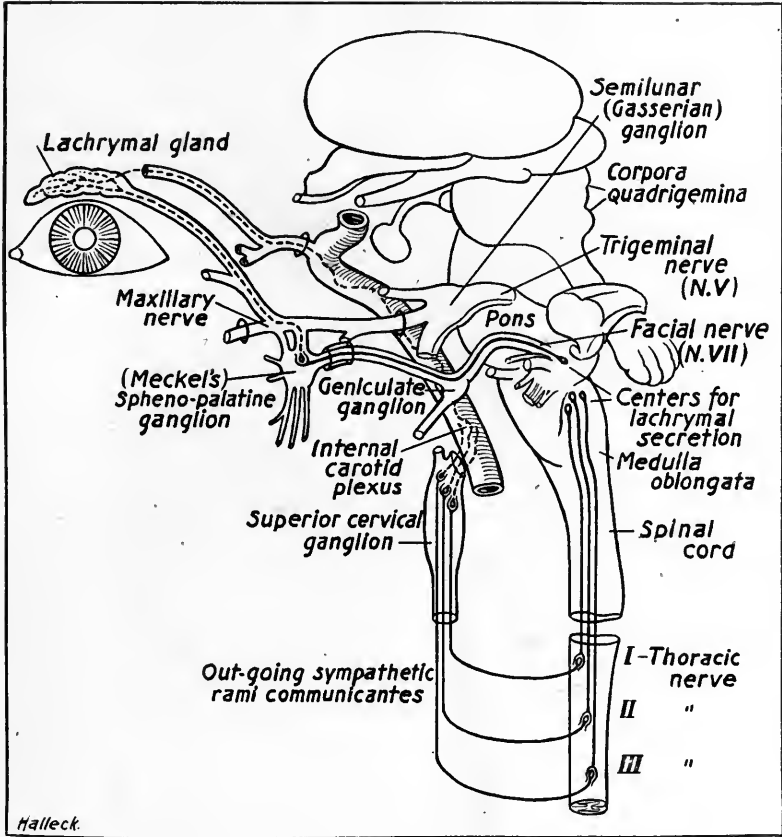

Fig. 236.—Diagrammatic representation of the innervation of the lachrymal glands.

EXPERIMENT LVIII.

Coniine. (Dog: Blood-pressure, Respiration, Salivary Glands and Kidney, Spleen or Intestinal Loop.)

1. In the usual manner prepare a dog (ten or twelve kilos) for recording blood-pressure and respiration. The animal may be given morphine, twenty milligrams (one cubic centimeter of two per cent solution) per kilogram of body weight half an hour before the operation, or ether alone may be used. The injecting burettes contain coniine

(one per cent) and adrenaline. (Poor samples of coniine are frequently obtained.) Isolate and ligate loosely both vago-sympathetic nerves.

Consult Figs. 237, 238, 239, and 240, and dissect out Wharton's duct. Place a cannula (*very small*) in the duct and fasten it with a ligature (thread). Dissect out the chorda tympani nerve and when you can see it clearly lying across the tip of the sublingual gland then place the ends of the

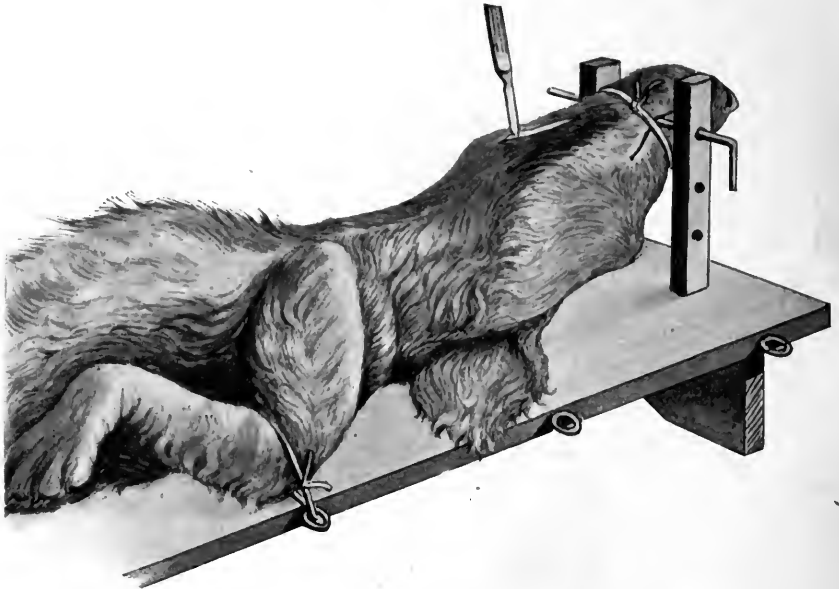

Fig. 237.—A dissection showing the position and extent of the first incision for exposing the chorda tympani nerve and the ducts from the submaxillary and sublingual glands.

electrodes on the nerve and stimulate it. Do you get a normal result? If not why did you fail? (Dissect out the opposite duct and nerve if necessary.) Consult Fig. 231 for the general distribution of nerves to the gland. Are any other glands thus innervated? If so what ones?

Open the abdomen and place an oncometer on a kidney (left), spleen or an intestinal loop. Close the abdomen with hemostats and arrange all writing points in the following

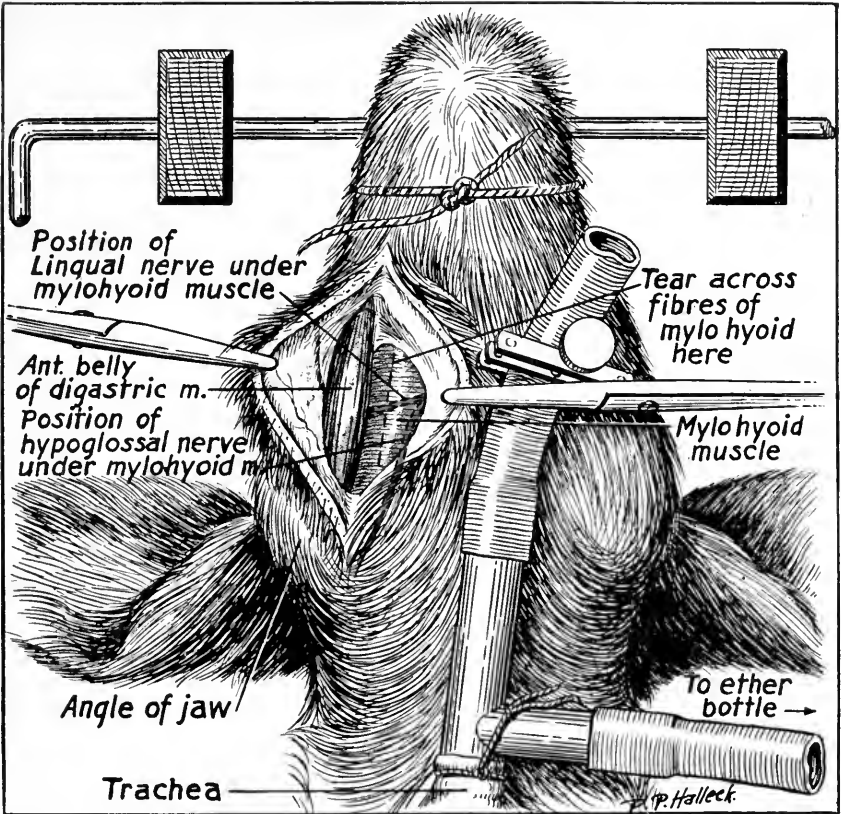

Fig. 238.—Dissection showing the position and relation of the hypoglossal and lingual nerves (dotted and colored yellow) beneath the thin, band-like mylohyoid muscle which is to be torn across with a blunt probe (not with a scalpel) to expose the nerves (and ducts) beneath.

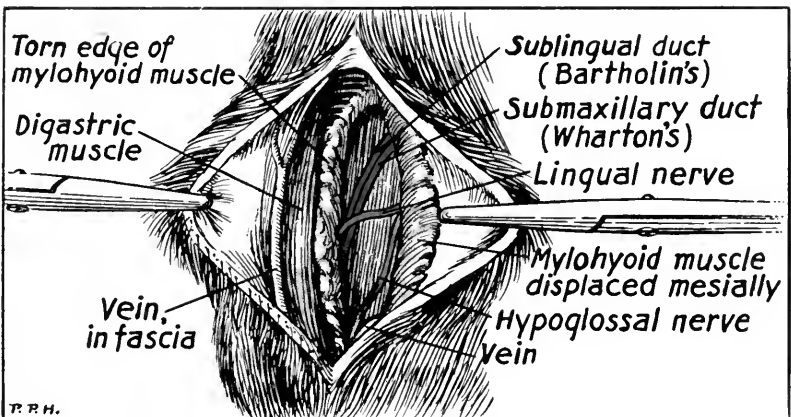

Fig. 239.—The mylohyoid fibers have been torn across and the two ducts and the lingual and hypoglossal nerves are exposed.



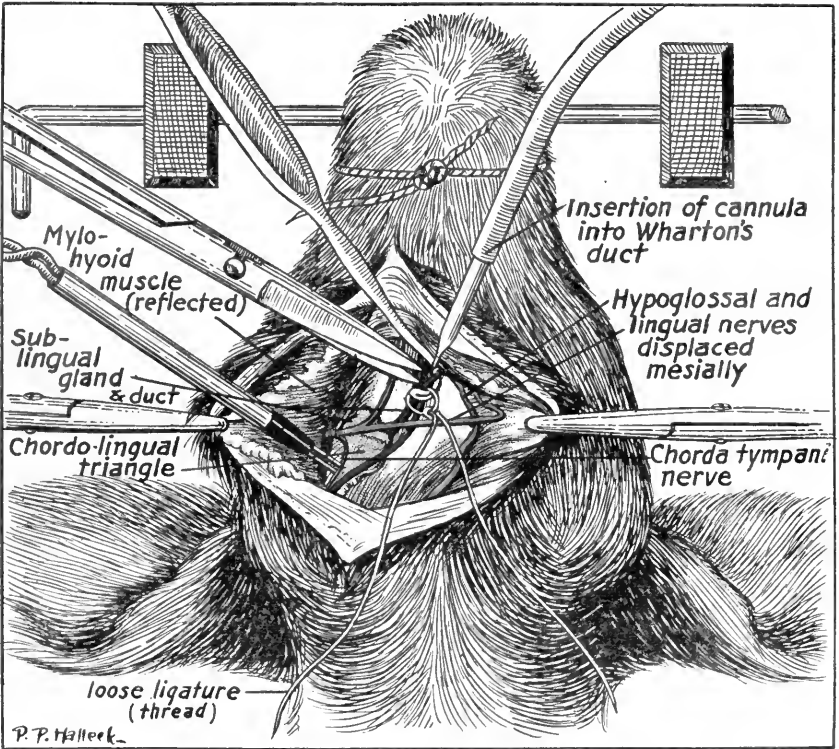

Fig. 240.—Exposure of the chorda tympani nerve, Wharton's duct and Bartholin's duct. Method of procedure for inserting a cannula into Wharton's duct.



order from above down, oncometer, blood-pressure, respiration, base line and time signal. Take a normal record, including a vagus stimulation, and then inject one cubic centimeter of coniine solution. Watch the pupils as the drug is injected. Do you obtain satisfactory results? How did the heart beats appear just after the drug was injected? How do you account for this? Stimulate the vagus nerve again and record the result. Has any more saliva been secreted? How do you account for any changes in the oncometer tracing. Inject a small dose of adrenaline to see if your apparatus, etc., is working satisfactorily.

Inject a second dose of coniine. This may be larger or smaller than the first dose depending on the reactions brought about by previous injections. Do you get a fall in blood-pressure? If so how do you explain it? If you get a rise what is the cause of this? Stimulate the vagus again and explain its action on the heart. Observe the corresponding pupil while the nerve is stimulated. Stimulate the chorda and see if any change has been produced in it as shown by the salivary secretion. Explain any changes observed. From time to time give more coniine as the animal will tolerate it. Be ready to apply artificial respiration if necessary. At intervals stimulate the vagi and chorda and if a response fails to be obtained explain its cause. Then follow the course of the chorda tympani back under the jaw bone as far as you can (do not injure the duct) and finally push the electrodes far down into the hilus of the gland and stimulate. Can you cause any visible increase in the flow of saliva by this procedure? What is the purpose of this part of the experiment? Give some adrenaline and see if the pupils respond normally.

Open the abdomen, follow the right side of the stomach around posteriorly and pick up the duodenum. In the angle between this and the stomach (inferiorly) is located the pancreas. Refer to Figs. 244 and 245 and find the lower end (tail) of the pancreas. Follow this to the place where

its attachment to the duodenum begins. The large duct (Fig. 245) opens into the intestine about one-half inch above this attachment. To find the duct take a probe and with great care gently dissect the anterior edge of the pancreas away from the wall of the intestine. The duct will be found passing from the substance of the pancreas obliquely downward and inward through the intestinal wall. Pass a ligature beneath the duct as shown in Fig. 245 and then open the duct in the substance of the bowel wall. Insert a small cannula and tie it in with the ligature. Attach a short rubber tube to the cannula and bring it outside the abdomen which is now closed with hemostats.

Give another dose of coniine and see if you get any secretion from the pancreas. Stimulate the vagi nerves and note any effect on pancreatic secretion. Kill the animal with a big dose of coniine. Immediately after death quickly open the thorax, pick up the phrenic nerves and stimulate them with a weak tetanizing current. Does the diaphragm contract? What theories do you know concerning the cause of death under coniine (Cushny: *Journal of Experimental Medicine*, i, 202)? Dissect out the small duct of the pancreas. What is the innervation of the pancreas? How is its secretion controlled?

EXPERIMENT LIX.

Atropine. (Frog: Heart and Vagus Nerve.)

1. Pith a frog and take a normal heart tracing showing the effects of stimulating the vago-sympathetic nerve and the crescent. Then while the drum is going pour two drops of atropine sulphate solution (one cubic centimeter equals one milligram) on the heart. After a few seconds stimulate the vagus trunk again. What do you observe? How do you explain it? Now stimulate the crescent. What do you observe? How do you explain this?

2. Cut out both of the frog's eyes. Examine the size

of the pupils carefully. Place one eye in a watch glass full of normal salt solution and the other in atropine solution. Place both glasses aside for ten or twenty minutes. Then again compare the size of the pupils. Do you note any variations? Explain the results.

EXPERIMENT LX.

Atropine. (Frog: Muscle and Nerve.)

1. From the frog used in Experiment LIX prepare two muscle nerve preparations from the sciatic nerves and gastrocnemius muscles. Fill a watch glass with atropine solution and place the nerve of preparation A and the muscle of preparation B in the solution. From time to time stimulate both nerves with single shocks and determine whether or not atropine affects either nerve trunks or striated muscle. Compare this with the action of curara. Stimulate the muscles directly a few times. What conclusions can you draw?

EXPERIMENT LXI.

Atropine. (Turtle: Heart and Vagus Nerve.)

1. Repeat the experiment on the heart and vagus innervation described in Experiment LIX, 1, on the turtle. What conclusions can you draw from your results?

EXPERIMENT LXII.

Atropine. (Cat, Guinea Pig, Rat, Dog, Pigeon, or Chicken: Pupil.)

1. Secure a dog, guinea pig or rat and a pigeon or chicken. Into the *right eye* of each animal pour several drops of a one per cent solution of atropine with a medicine dropper. Place the animals aside and examine from time

to time to see if any changes are produced in the eyes. If so what explanation can you offer. If no change is produced what explanation can you give?

EXPERIMENT LXIII.*

Atropine. (Dog, Cat or Rabbit: Blood-pressure, Respiration, Heart and Vagus Nerve,—Dog, Salivary Secretion and Chorda Tympani, Sweat Nerves, Pancreatic Secretion.)

1. Anesthetize a dog, cat (two grams urethane by stomach) or rabbit (two grams urethane by stomach) and arrange for recording blood-pressure and respiration. Isolate and ligate loosely both vagus nerves. The injecting burettes contain atropine (one cubic centimeter equals one-half milligram) and adrenaline (1:10,000).

If a dog is used dissect out Wharton's duct and place a cannula in it (Figs. 237, 238, 239, and 240). Also isolate the chorda tympani nerve and stimulate it once or twice to observe the normal rate of salivary secretion. Some operators tie a ligature on the chorda and cut the nerve centrally to the ligature. In this manner the ligature can be used to lift the nerve as desired. Generally it will be sufficient to stimulate the nerve in position without ligating it. (The dissection may be tried on a cat or rabbit if the instructor so advises.)

Stimulate the vagi and obtain normal records of the effects on the heart, blood-pressure and respiration. Observe the pupils (on the same side) as each vagus nerve is stimulated.

If time permits, the student may dissect out the sciatic nerve (in dog) and stimulate it to observe the secretion of sweat on the sole of the foot. To do this take a piece of wet cotton and wash the pads of the foot off well, then dry

*If more than one group performs this experiment, the second group may use scopolamine—one cubic centimeter equals one milligram—instead of atropine.

them and place the foot in such a manner that a good light can fall at a slight angle on to the pads. A hand lens may be used to considerable advantage. Stimulate the corresponding sciatic nerve and watch for minute droplets of sweat to form on the pads. On that side of the animal it is advisable not to place a cannula in the femoral vein but insert the cannula in the external jugular vein instead. Do not injure the circulation in isolating the sciatic nerve.

Arrange all writing points on the drum (medium speed) and while taking a normal (*satisfactory*) record begin to stimulate one vagus nerve with a weak or medium strength of current (tetanizing). The current should be of just great enough strength to slow the heart markedly but not to completely stop it. Do not continue this any longer than necessary or the vagus endings may be worn out. While thus holding the heart down to a slow rate by a constant stimulation (increase the strength of the current if necessary) of the nerve inject two cubic centimeters of atropine solution (for a dog,—if a cat or rabbit is used inject one-half or one cubic centimeter of atropine solution).

Continue the stimulation. Do you observe any change after the drug has had time to be carried to the heart in the blood? (Remember the circulation is slow and sluggish when the heart beats but slowly and the pressure is low). How do you explain your findings? Now inject another dose of atropine as soon as the animal can tolerate it. Then stimulate the opposite vagus nerve and note the effect on the heart rate and blood-pressure. Stimulate the chorda tympani and note the effect on salivary secretion. How do you explain this?

Examine the sole of the foot (dog) carefully for sweat droplets (remove these if any are present) and then stimulate the sciatic again. What conclusions can you draw? Were you able to get a sweat secretion by stimulation of the sciatic before the drug was injected? If not what does this part of the experiment show? Again stimulate one vagus

and watch the effect on the (corresponding) pupil. What changes, if any, do you note? How do you explain these?

What effect has atropine in small doses on the blood-pressure and respiration? A poisonous drug suddenly injected into the circulation often gives a fall of pressure due, according to some authorities, to irritation of the heart. Do you believe this explanation is sufficient to account for such changes? The vasomotor centers and the vessels, etc., may also be specifically involved. What action has atropine on the vasomotor apparatus?

If the experiment is performed on a *cat* or *rabbit* kill the animal with a large dose of the drug and secure a death record. If a *dog* is used inject a little adrenaline and observe the action of this on the pupil (explain). Open the abdomen and insert a cannula (Figs. 244 and 245) into the pancreatic duct. Inject twenty cubic centimeters of .4% hydrochloric acid into the duodenum with a large hypodermic syringe and wait ten or twenty minutes to see if there is any secretion of pancreatic juice. How is the secretion of the pancreas controlled? What action has atropine on this mechanism? What effect will stimulation of the vagus nerves now have on the pancreas? Try this (use slowly repeated single shocks). Inject some adrenaline and see if this affects the secretion.

Kill the animal with a large dose of atropine, securing a death record of the blood-pressure and respiration. What is the immediate cause of death?

2. If time permits after the animal is dead, consult Fig. 281 and dissect out the optic nerve at the posterior side of the eye ball. Be careful not to injure the blood vessels. With scissors cut the skin and fascia outwards (backwards) from the outer canthus of the eye. Then seize the fascia over the back of the eye ball with forceps and roll the ball forward (inward). A mass of orbital fat and fascia will be seen behind the eye. Carefully dissect this away and watch for the optic nerve which is about three millimeters in di-

ameter as it enters the eye ball. Place the tips of the electrodes on the nerve and carefully work the points into the substance of the nerve trunk. Watch the pupil closely and stimulate. Is there any action? Perhaps the animal has been dead too long. Do you think of any other reason? Master the technique of the operation for you will want to repeat it later. What is the innervation of the iris? How do these nerves get into the eye? Can you reach them in the way you have proceeded here? What are mydriatics? Myotics? Cycloplegiacs?

EXPERIMENT LXIV.

Scopolamine. (Frog: General Symptoms.)

1. Into the anterior lymph sac of a frog inject one cubic centimeter of scopolamine (one cubic centimeter equals five milligrams). Put the animal in a quiet place and observe the symptoms produced. What conclusions can you draw? Examine the pupils from time to time and note the action on the lymph heart beats. Give a larger dose if necessary to bring on marked symptoms.

EXPERIMENT LXV.

Pilocarpine, Atropine. (Frog: Heart and Vagus Nerve.)

1. Pith a frog, take a normal heart tracing showing vagus and crescent inhibition and then while the drum is running at a fairly slow speed begin to drop on to the heart pilocarpine (nitrate or hydrochlorate) solution (one cubic centimeter equals one milligram). Watch for a slowing of the beat. The heart may be entirely stopped. How do you account for this? When the slowing has become very marked pour about three or four drops of atropine solution (one cubic centimeter equals one milligram) on to the

heart and note the effect on the heart rate. How do you explain this? Stimulate the vagus and crescent again.

2. Cut out both eyes and place one in a normal salt solution, the other in salt solution containing pilocarpine (one cubic centimeter equals five milligrams). Place the eyes aside for ten or twenty minutes and examine the pupils again. Can you detect any pupillary changes? What explanation can you offer?

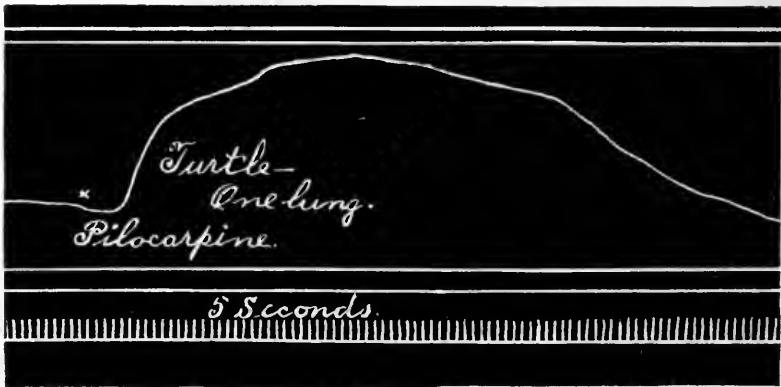

Fig. 241.—Lung tracing from a turtle showing the action of pilocarpine.

EXPERIMENT LXVI.

Pilocarpine or Arecoline and Atropine. (Frog: Retinal Circulation.)

1. Arrange a frog as shown in Fig. 164 and examine its retinal blood vessels with an ophthalmoscope. Find one or two very small vessels, preferably showing a branching so that the individual corpuscles can be seen moving into each division. Get a good notion of the rate of this movement for later comparison.

Under the skin of the back inject two cubic centimeters of pilocarpine solution (one cubic centimeter equals two milligrams) or arecoline hydrobromide (one cubic centimeter equals one milligram, Merck and Co.) solution.

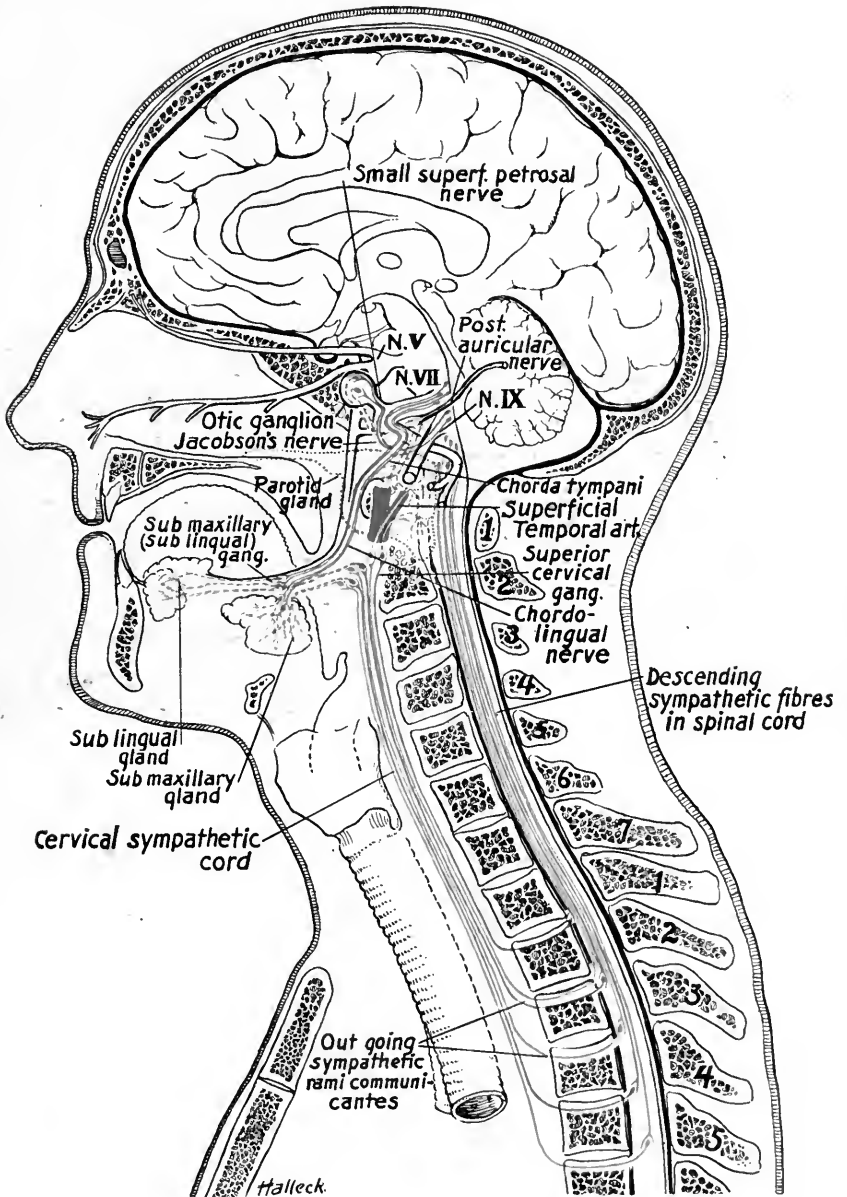
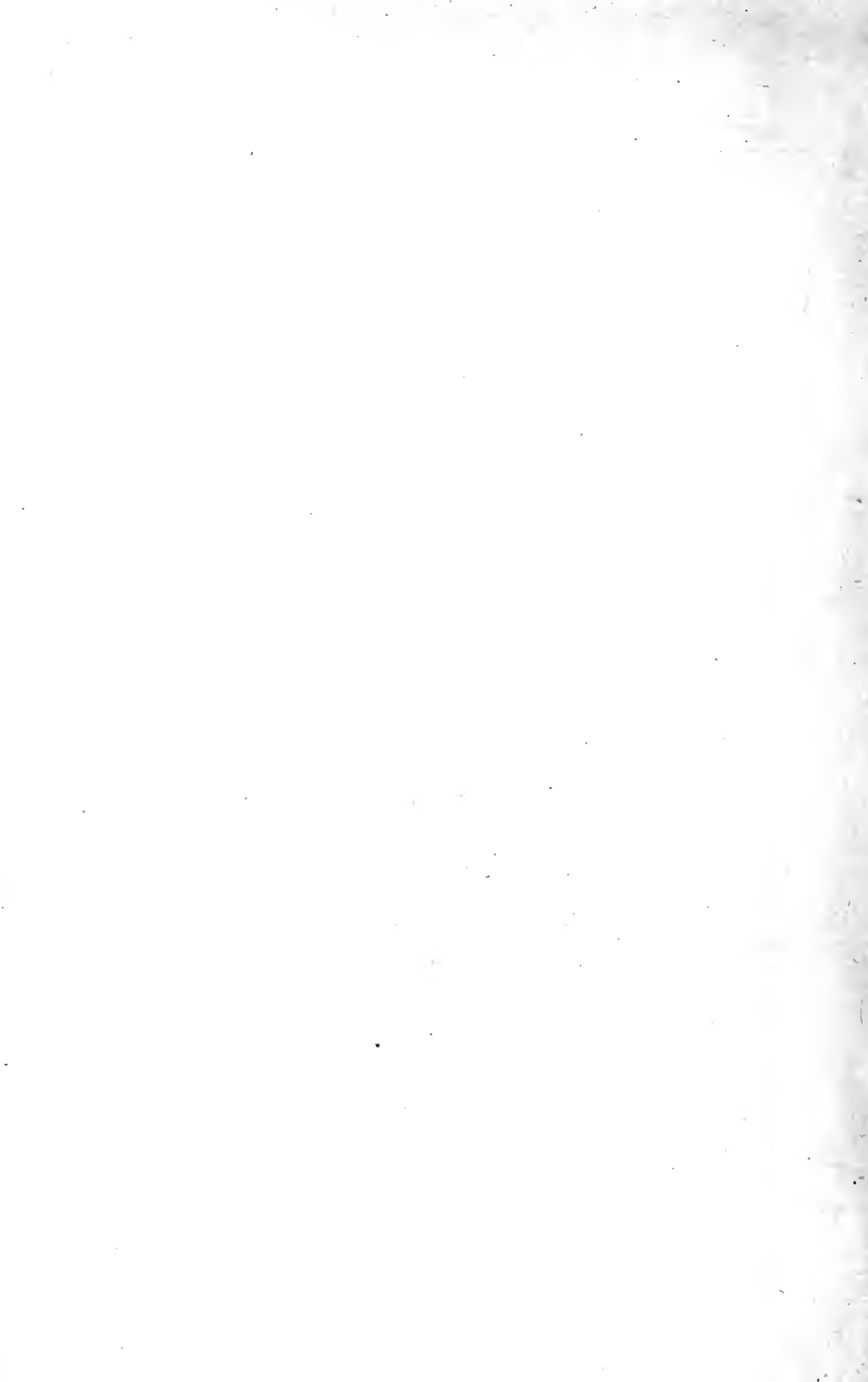

Fig. 242.—Schematic representation of the general plan of distribution of the nerves from the medullary centers to the salivary glands. This distribution is typical for a considerable number of other structures, glands, muscles, etc., located in the head. (Partially adopted from Eycleshymer and Schoemaker.)



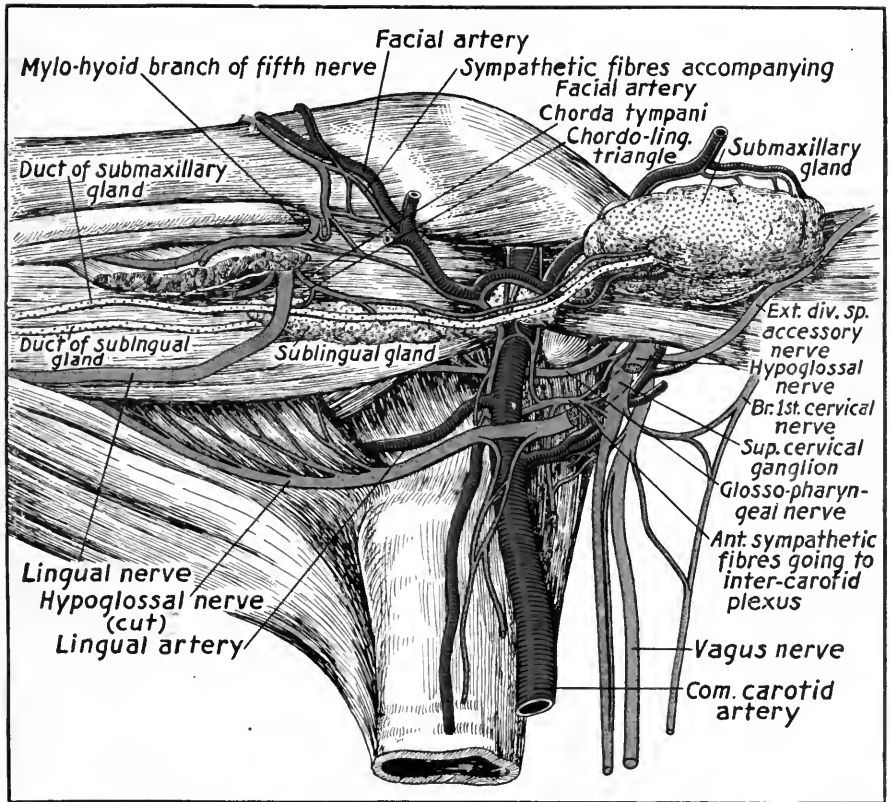

Fig. 243.—Dissection of the submaxillary and sublingual glands and their ducts, certain cranial nerves and arteries and of the cervical sympathetic trunk and the superior cervical ganglion. (Modified from Claud Bernard.)



From moment to moment observe the eye ground and watch for any change in the rate of capillary movement.

If you succeed well in getting a change, then with a fine pointed hypodermic syringe inject into the pericardium one-half cubic centimeter of atropine solution (one cubic centimeter equals one milligram). What changes do you observe in the retinal circulation? How do you explain this?

EXPERIMENT LXVII.

Pilocarpine or Arecoline and Atropine. (Dog, Cat, Rabbit, and Pigeon or Chicken: Pupil.)

1. Into the *right eye* of as many of these animals as may be available inject about twenty drops of pilocarpine (one cubic centimeter equals five milligrams) or arecoline (one cubic centimeter equals three milligrams) solution. Open the lids and fill the conjunctival sac as completely as possible and keep the solution in as long as you can. Into the *left eye* of each animal drop atropine solution (one cubic centimeter equals four milligrams). Leave the animals alone quietly and at intervals of a few minutes compare the two eyes. Do you note any pupillary changes? Explain these.

EXPERIMENT LXVIII.

Pilocarpine, Atropine. (Dog: Blood-pressure, Respiration, Salivary and Pancreatic Secretions.)

1. Anesthetize a ten kilo dog (ether only) and arrange to record blood-pressure and respiration. Insert a cannula in Wharton's duct (Figs. 237, 238, 239 and 240) and dissect out the chorda tympani. Stimulate it and get a normal secretion.

Open the abdomen and insert a cannula into the large

pancreatic duct (Figs. 244 and 245). Stimulate the vagus nerve with a series of single shocks repeated at frequent intervals (does this stop the heart?) and see if you can get a flow of pancreatic juice. Keep this up for five or ten minutes if necessary.

Three injecting burettes should be used, one in each femoral vein and one in the left external jugular vein.

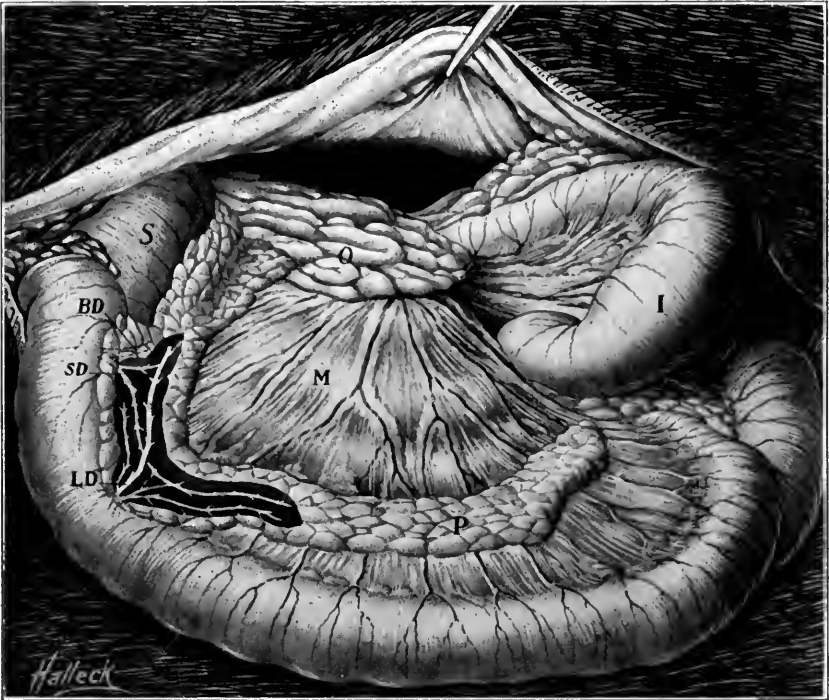

Fig. 244.—A dissection showing the position and relations of the pancreatic ducts in a dog. *I*, intestine; *O*, omentum; *M*, mesentery; *S*, stomach; *P*, pancreas (tail); *BD*, position of bile duct (dotted, beneath the pancreas); *LD*, large duct, and *SD*, small duct of the pancreas. The pancreas is partly cut away to show the position of the ducts.

This latter one contains adrenaline, the other two contain atropine (one cubic centimeter equals one milligram) and pilocarpine (one cubic centimeter equals one milligram).

Observe the size of the pupils carefully. Then adjust all writing points and take a short normal record. Inject one cubic centimeter of pilocarpine solution. What is the ac-

tion of this drug on the heart and circulation? Is there any action on the glands? *Be sure no atropine gets into the vein until you are entirely ready for it.*

When the animal recovers inject more pilocarpine. Be sure you get in enough to bring out the action of the drug well. The animal is not likely to die early if small doses are used. Note the action on the pupils, salivary glands and pancreas. How do you explain this? Inject one-half cubic centimeter of adrenaline and see how this counteracts the action of the pilocarpine. Examine the pads of the feet and see if any small sweat drops are forming. (Remember the circulatory disturbance you have caused in the hind limbs.) Inject more pilocarpine and try to get as marked action on the heart as possible. In a good typical case a long series of carotid tracings may be obtained in which separate heart beats may have an amplitude of from one-half up to three-fourths of an inch. When this stage is reached quickly observe the rate of salivary and pancreatic secretion and then inject one cubic centimeter of atropine. This will not reach the heart for some time. *Wait* and see what happens. Explain all results observed. On what structures does each drug act? If necessary inject one cubic centimeter more of atropine. Now inject one-half cubic centimeter of adrenaline to restore the animal. Stimulate the chorda tympani and the vagi. What effect has this on the salivary or pancreatic secretion? How does the vagus stimulation affect the heart, blood-pressure, and respiration?

Observe carefully your record of respiration just after the pilocarpine was first injected. Is there a peculiar decrease in amplitude with some difficulty in either expiration or inspiration? What possible explanation can you offer for this? How did the atropine affect it?

Inject one cubic centimeter more of pilocarpine. Is the heart slowed? On what structures does atropine antagonize the action of pilocarpine? What is the action of pilo-

carpine on the adrenal glands? (Dale and Laidlaw: *Journal of Physiology*, 1912.)

Kill the animal with a large dose of pilocarpine and obtain a death record. Watch the pupils as the drug is injected. What do you observe? What is the immediate cause of death?

If time permits open the chest and fit into it a piece of apparatus like that shown in Fig. 255 (or Fig. 256, if you happen to have this). Close the chest with hemostats as shown in Fig. 257. Could you do this in a living animal? Remove and wash all your apparatus.

EXPERIMENT LXIX.

Pilocarpine, Arecoline, Adrenaline, Atropine, and Barium. **(Dog: Bladder, Intestine, Respiration, Blood-pressure.)**

1. Etherize a dog and arrange to record blood-pressure and respiration. Open the abdomen and connect a mercury bulb to the bladder in the manner shown in Figs. 179 and 199 and arrange to record bladder contractions on the *upper* part of the drum (the tambour pointer will *rise* when the bladder contracts—allow space for this.)

Observe the apparatus shown in Fig. 246 for recording intestinal contractions. Arrange a burette, catheter and finger cot (or rubber glove finger) as shown and make a small longitudinal incision in a loop of the small intestine. Slip the end of the catheter over which the finger cot is attached about four or five inches down the lumen of the intestine from the incision. (The tip of the catheter reaches entirely to the end of the finger cot and thus forces the cot along.) Fill the burette half full of water and move the catheter in and out a little to be *sure the finger cot is filled with water* and that the air is expelled. Stitch together the incision in the intestine around the catheter and close abdomen with hemostats. The intestinal tambour should



Fig. 245.—Dissection showing the position and relations and the method of isolating the large duct of the pancreas in a dog. The method for inserting a cannula into the duct where it lies within the wall of the intestine is also shown.



write just below the bladder (the pointers must be able to pass each other), below this are the blood-pressure, respiration and base line. The injecting burettes contain pilo-

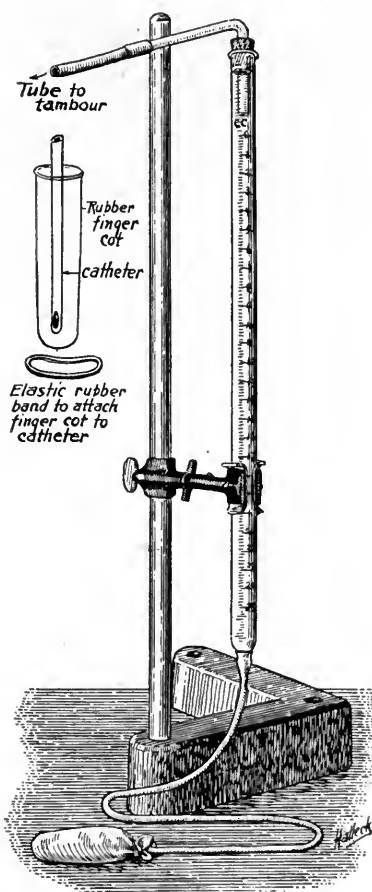

Fig. 246.—Arrangement of apparatus for recording contractions of the intestine. (For discussion see text.)

carpine (one cubic centimeter equals one milligram) and adrenaline.

Take two inches (or less) of normal record and then inject one cubic centimeter of pilocarpine. A pronounced result should be obtained in all the tracings. Do you get

this? Wait for the action of the drug to become well developed. If you are *sure* the dose was too small then inject a second (but one cubic centimeter is usually sufficient for

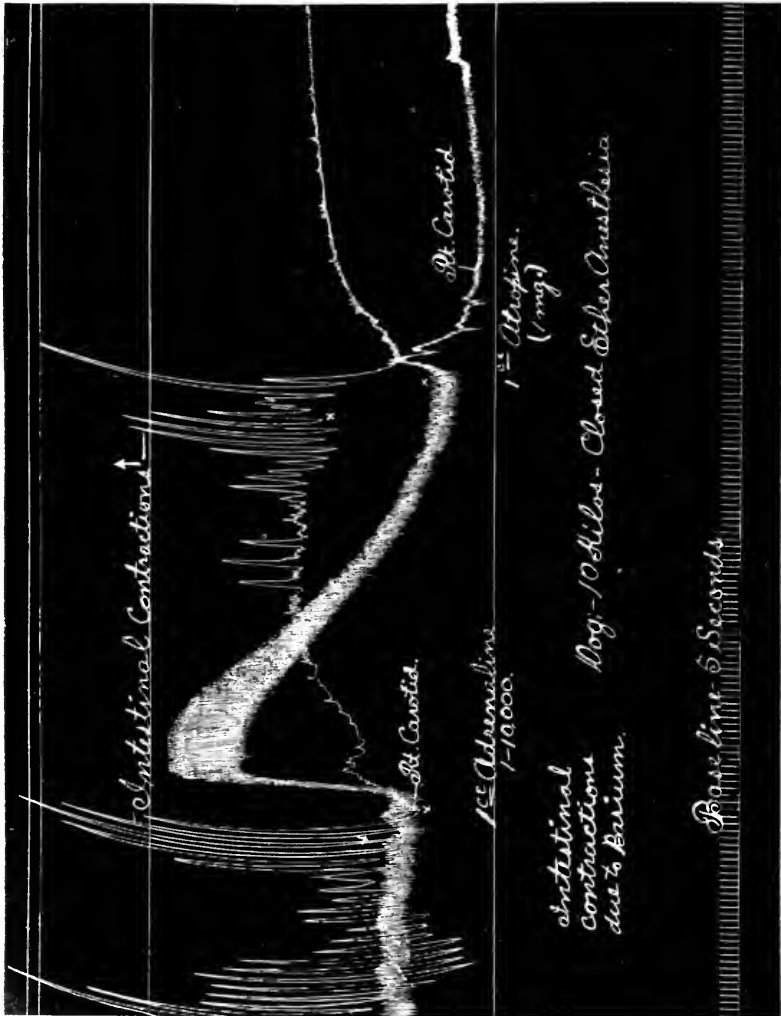

Fig. 247.—Tracing showing the action of barium, adrenaline and atropine on the blood-pressure and intestinal contractions in a dog. The barium had been given just before this tracing begins. Its action on the intestine is quite evident but the contractions are checked, first by adrenaline (which stimulates the inhibitory endings) and second by atropine. How do you explain this latter action?

average sized dogs). When the effects are well marked inject one-half cubic centimeter of adrenaline. What pilocarpine reactions does this counteract? Your records should show marked results.

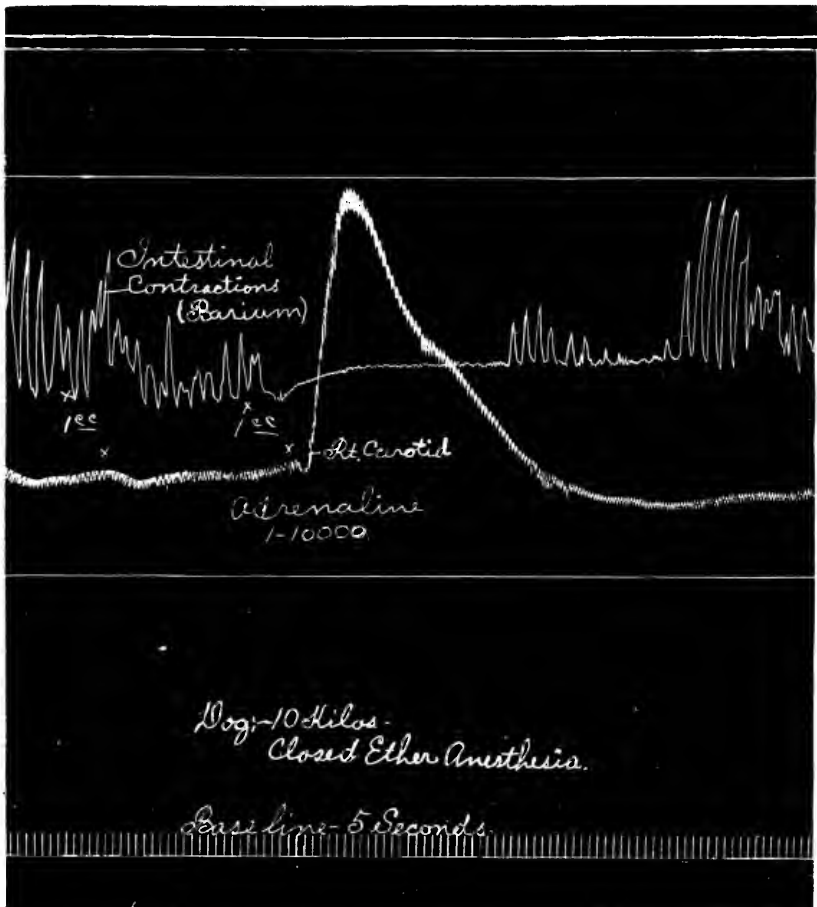

Fig. 248.—Tracing showing the comparative extent of duration of the action of barium and of adrenaline on intestinal contractions and on the blood-pressure in a dog.

Allow the animal to return to normal and then repeat the pilocarpine and adrenaline injections.

Allow the animal to recover for a few minutes and meanwhile empty the pilocarpine out of the burette and replace

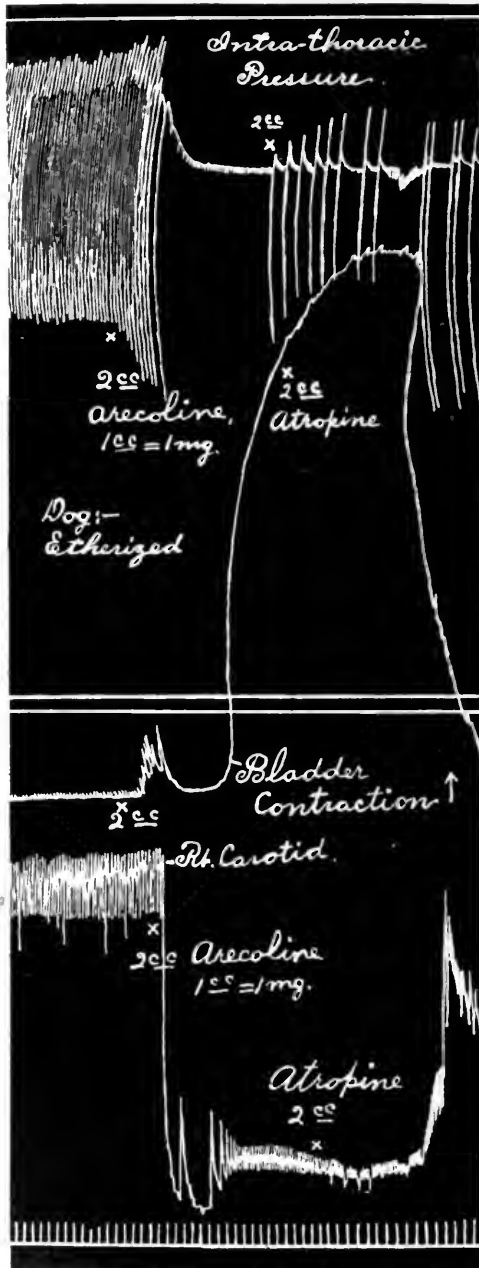

Fig. 249.—Tracing showing the action of arecoline and of atropine on intrathoracic pressure, bladder contractions and blood-pressure in a dog. Intrathoracic pressure was recorded by means of a tambour with a moderately tightly stretched rubber membrane. The tambour was connected with a glass tube which was passed into the chest cavity (without letting air into the chest). Arecoline strongly contracts the bronchioles and thus shrinks the volume of the lungs. This drew air out of the tambour into the chest and caused the writing point to write at a lower level. The bladder and heart both show a marked reaction to the drug. These effects are partially counteracted by the atropine.

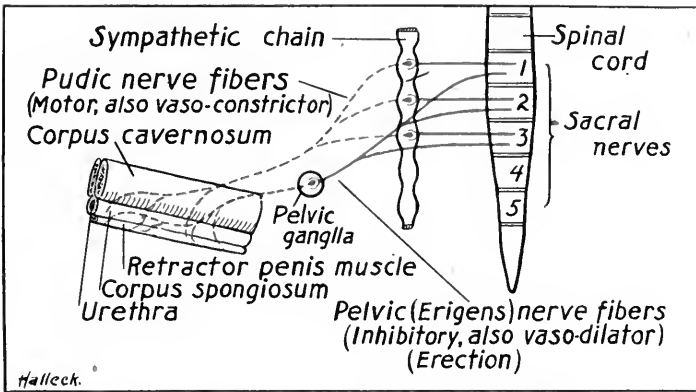
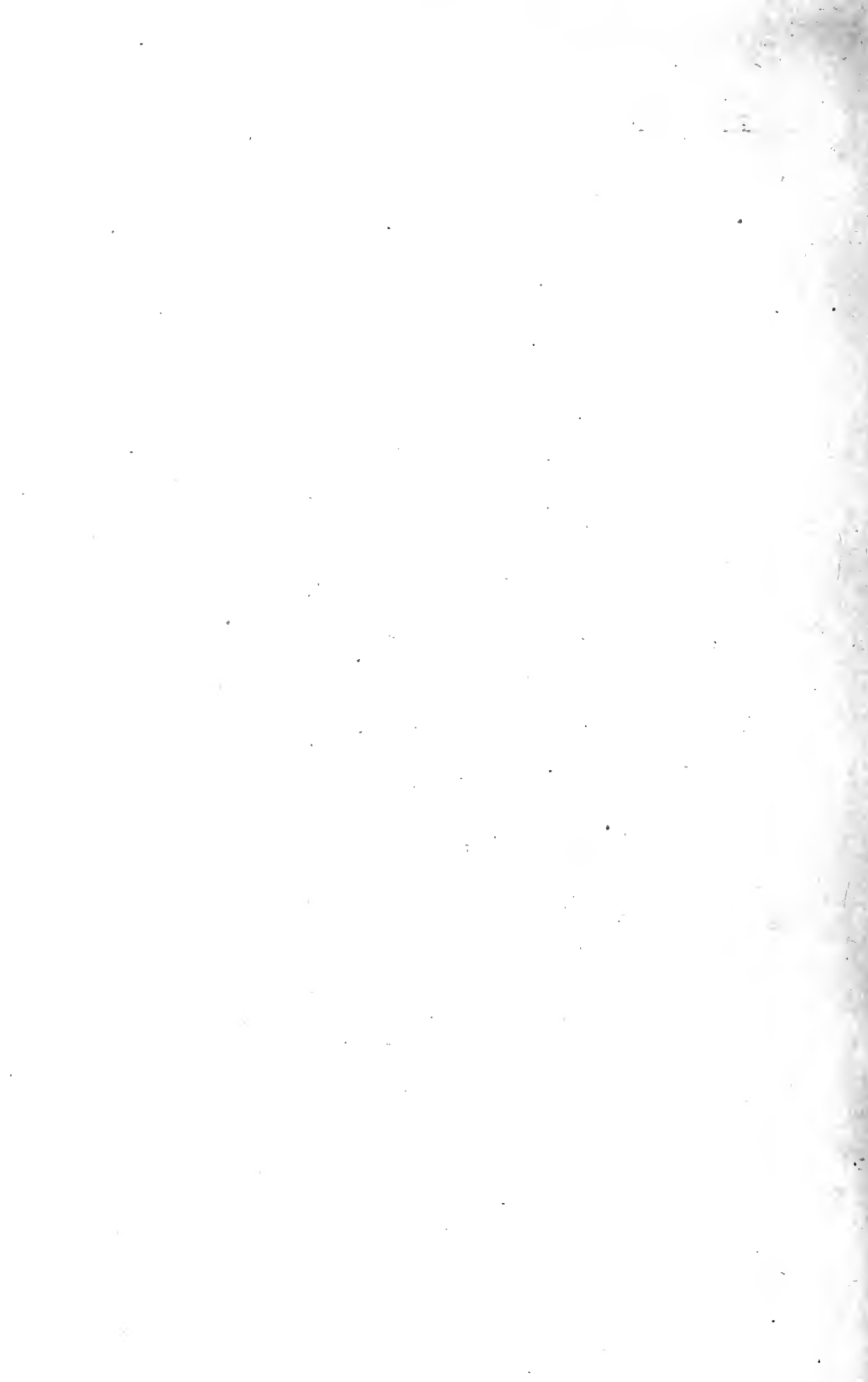

Fig. 250.—Schematic representation of the innervation of the retractor penis muscle. The vasomotor innervation for the region is also indicated.



it with arecoline solution (one cubic centimeter equals one-half milligram).

Adjust all writing pointers and take a normal record. Inject one cubic centimeter of arecoline. This will give pro-

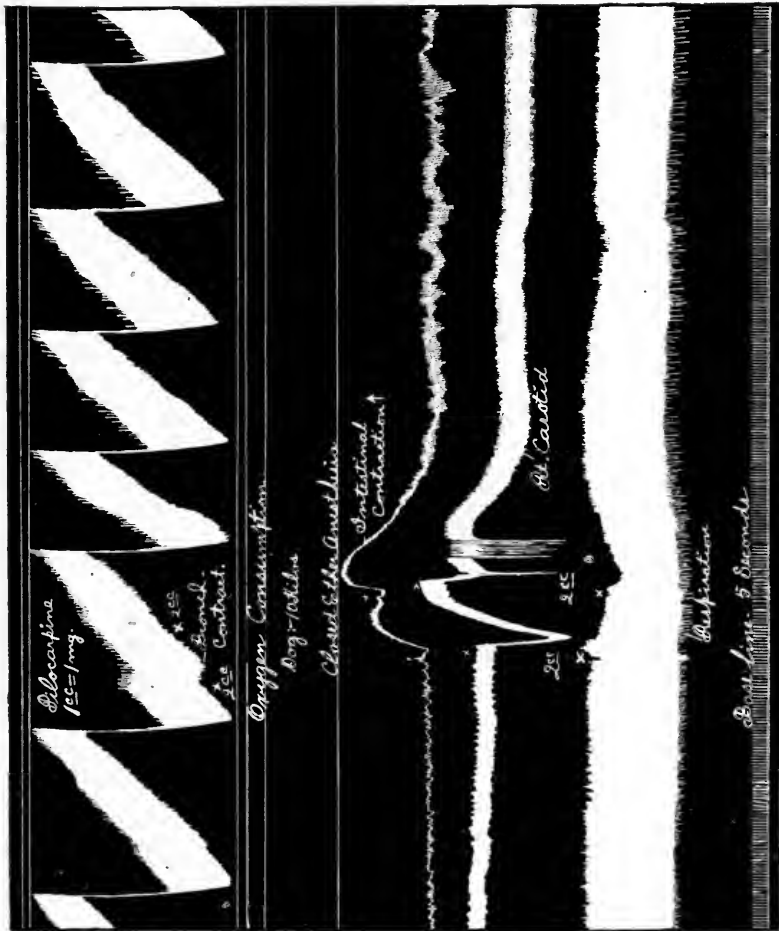

Fig. 251.—Tracing showing the action of pilocarpine on the rate of oxygen consumption, intestinal contractions, blood-pressure and respiration.

found results. Wait for the drug to act and when the symptoms are very marked inject adrenaline (probably three-fourths cubic centimeter). Wait for the animal to

recover as much as possible. Give a second dose of adrenaline if necessary. Then empty out the adrenaline (be sure the bull-dog on the vein does not leak) and fill this burette with twenty cubic centimeters of atropine solution (one cubic centimeter equals one milligram.)

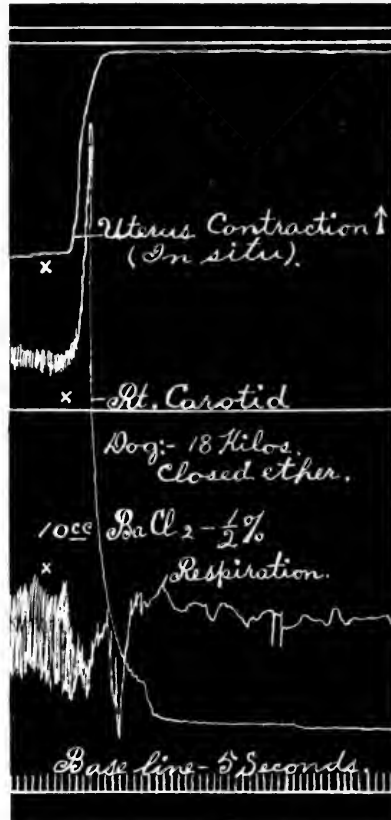

Fig. 252.—Tracing showing the action of a fatal dose of barium chloride on uterine contractions, blood-pressure and respiration.

Get the animal into as good condition as possible and then inject one cubic centimeter (or one and one-half cubic centimeters) of arecoline. Wait for the action of the drug to become well developed and then inject one cubic centimeter of atropine. Wait for this to be carried to the heart. What

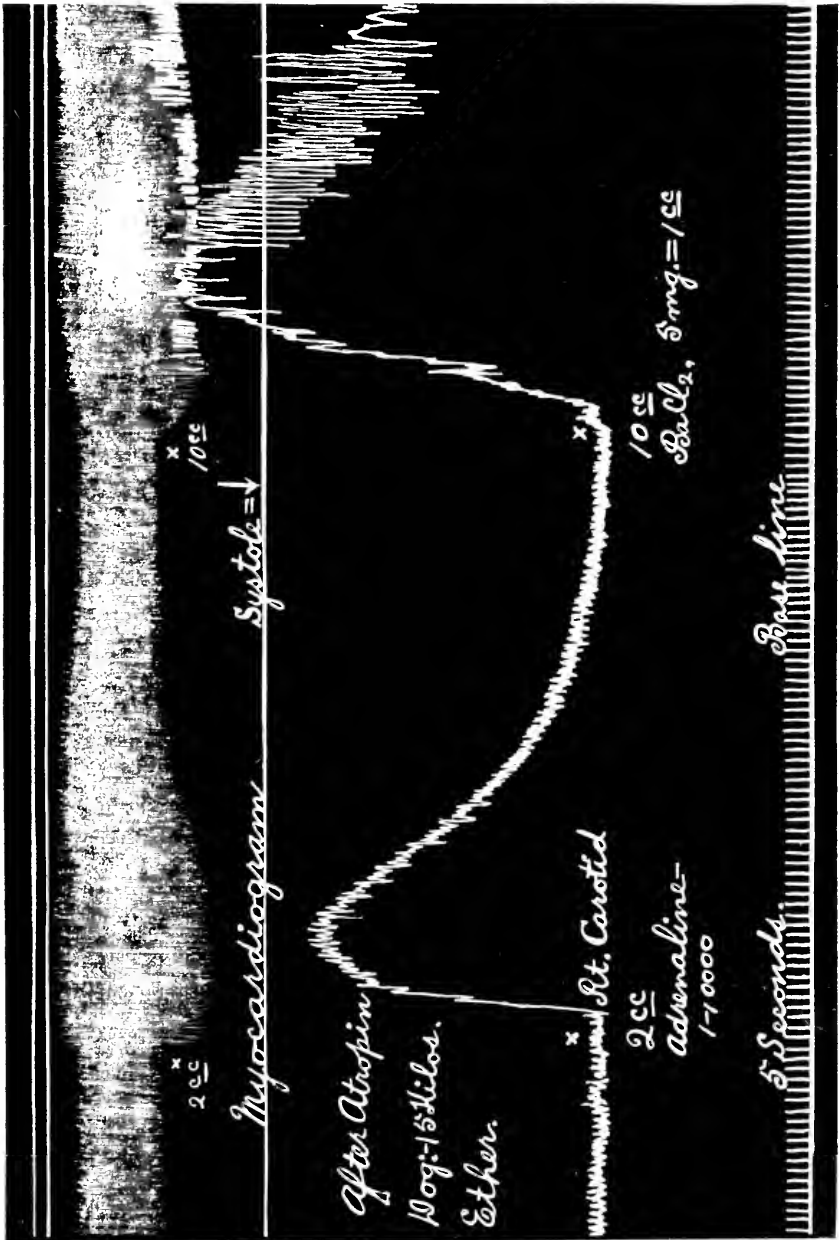

Fig. 253.—Tracing showing the action of adrenaline and barium chloride (after atropine) on the heart (myocardiogram) and blood-pressure.

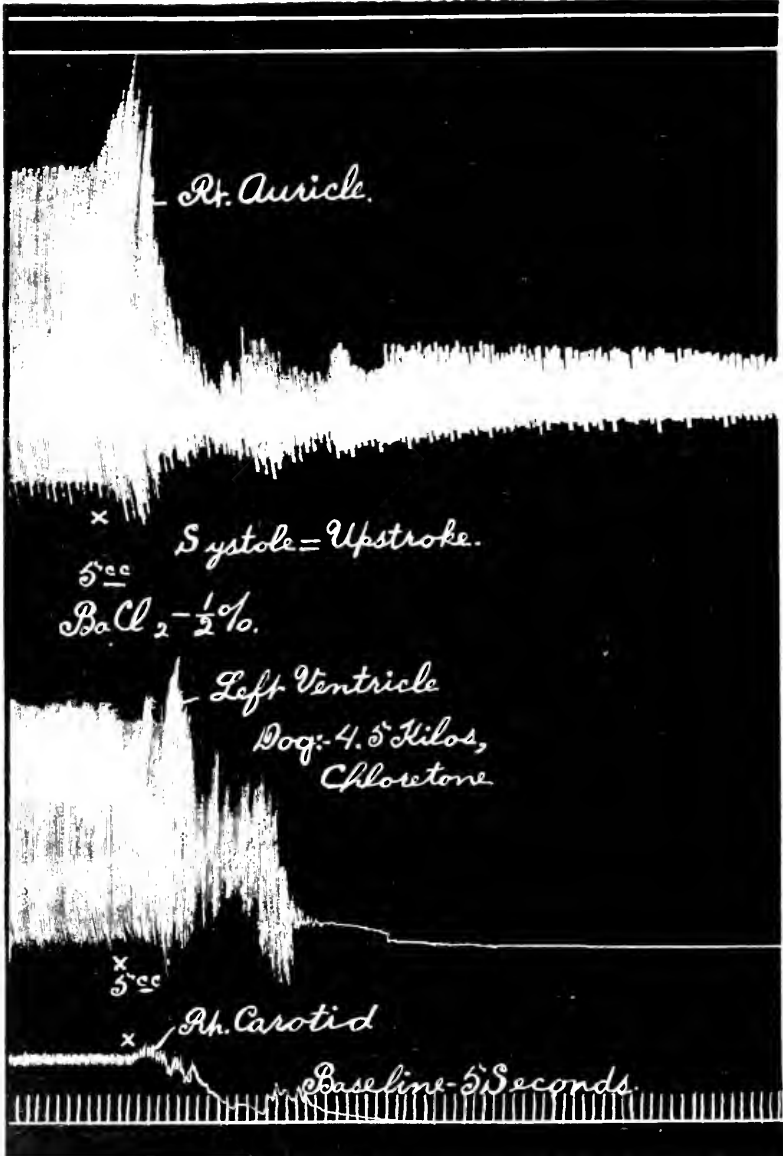

Fig. 254.—Tracing showing the action of a fatal dose of barium chloride on the heart (myocardiogram, right auricle and left ventricle) and blood-pressure in a dog. Note that the auricle continues to beat long after the ventricle has stopped.

do you observe? How do you account for it? Pilocarpine acts very much like arecoline (as does also muscarine) but arecoline is much more powerful.

Does atropine counteract all the actions of pilocarpine or arecoline? Do your records show this? Inject one-half cubic centimeter more of atropine. Then empty the atropine out of the burette and replace it with barium chloride solution (one-half per cent). Arrange all writing points and inject one cubic centimeter of arecoline to see if it acts as it previously did. Empty out the arecoline and replace it with adrenaline. If the dog weighs ten kilos or more then inject five cubic centimeters of the barium solution (a smaller dose for a smaller dog). It will take about one-half minute for the action of the drug to become well marked (if the animal was in fair condition when the drug was injected). The reaction should be very marked. When this occurs inject one and one-half cubic centimeters of adrenaline. Does this counteract any of the actions of barium? On what structures does barium act? Did the previous administration of atropine affect this in any way? Kill the animal with a big dose of barium and just after the death record is made quickly open the chest (with large tinner's snips) and observe the heart action. What is delirium cordis? What is fibrillation?

EXPERIMENT LXX.*

Pilocarpine, Adrenaline, Arecoline, Atropine, Barium. **(Spinal Dog: Blood-pressure and Bronchioles.)**

1. Etherize a dog (ten kilos) and arrange for blood-pressure records. Place injecting burettes in both femoral veins and one in the left external jugular. These burettes contain adrenaline (1:10,000), pilocarpine (one cubic centimeter equals one milligram) and arecoline (one cubic

*Cats may be used for this experiment, but dogs are *greatly* to be preferred.

centimeter equals one-half milligram). (Muscarine—one cubic centimeter equals one milligram—may be substituted for one of the last two drugs or be used separately if it is available.)

Observe carefully the apparatus shown in Fig. 255.

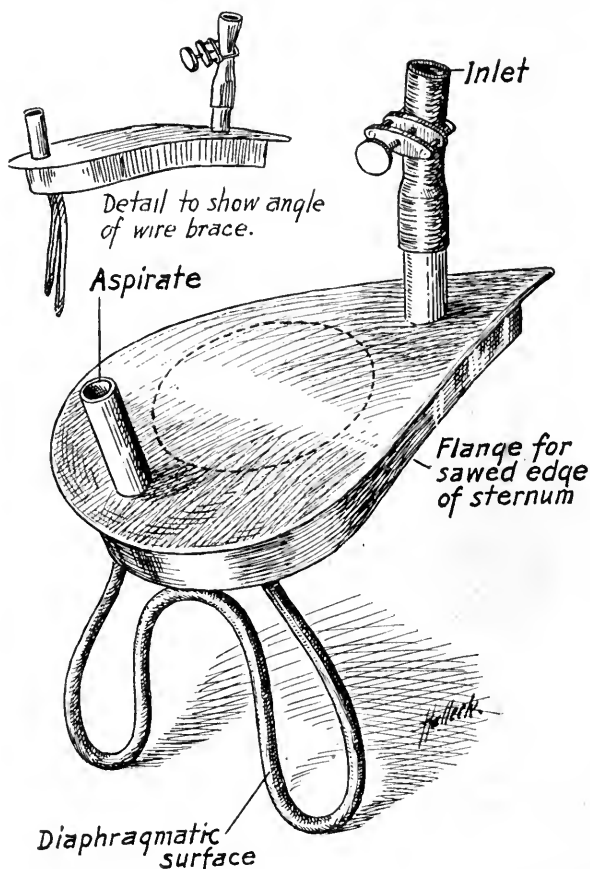

Fig. 255.—A form of apparatus (approximately one-half natural size) made of sheet brass to place in the chest to hold the walls rigidly wide open and air tight while the records of changes in the caliber of the bronchioles are taken. A dotted circle in the center of the curved plate shows where a window may be placed to great advantage if sufficient shop facilities are available to do this. The window may be made of a sheet of celluloid (such as is used in automobile curtains) or of glass, and if the window is removable this also adds to its usefulness. The curved wire at the base is made of $\frac{3}{16}$ inch brass rod. Any tinner should easily be able to make up at a very small cost such a piece of apparatus, which can be made of "tin" (tinned iron) or galvanized sheet iron. The instrument may be used for recording bronchial contractions by use of either positive or negative artificial respiration, but the latter (aspiration of the chest) is greatly to be preferred. (For the method of use see text.)

This apparatus works best when the air is intermittently aspirated out of the chest (25 or 30 times per minute—45 millimeters of mercury negative pressure with the by-pass or inlet adjusted to give proper strength of suction to fill the lungs well). In the absence of a machine capable of giving negative interrupted pressure (see Fig. 360) positive artificial respiration may be used in the ordinary manner by blowing air into the trachea. Even a hand bellows may be used for this, but a power driven machine is

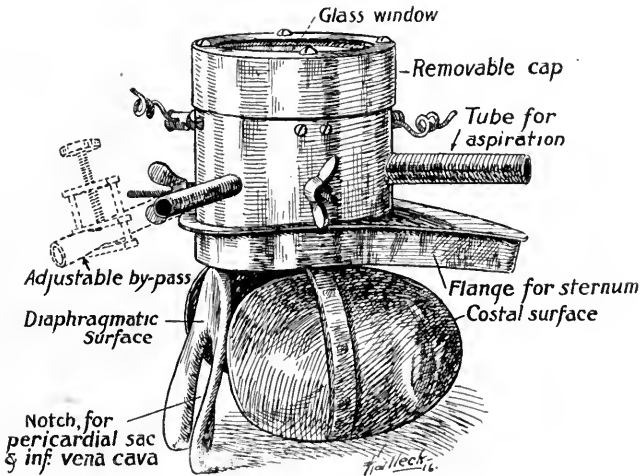

Fig. 256.—Another form of apparatus for insertion into the chest to record bronchial changes. About one-third natural size. The three wings at the bottom are placed inside the chest and are adjustable (by the thumb nuts) to fit various sized chests. When the cap (with a glass or celluloid window) is removed, the hand may be passed into the chest to massage the heart, etc. The movements and changes in the lungs and heart can be seen through the window. (For the method of use see text.)

greatly to be preferred. The apparatus shown in Fig. 256 may also be used for the lungs.

The chest of the animal is now opened by a median longitudinal incision, the apparatus is inserted as shown in Fig. 257 and the edges are clamped around air tight with hemostats. It is often advisable to sew one or two stitches of heavy twine from side to side through the skin of the upper end of the chest. The flange of the apparatus catches the sawed edges of the sternum on each side and

thus holds the chest open. As soon as the chest is opened artificial (positive) respiration is begun. Two forms of apparatus for thus giving ether to an animal are shown in Figs. 53 and 107. The artificial respiration thus begun is kept up throughout the experiment *if only positive pressure* is available. But if negative (interrupted) pressure is available this is substituted *immediately after the animal is pithed*.

If *positive pressure* is used then the closed chest acts as

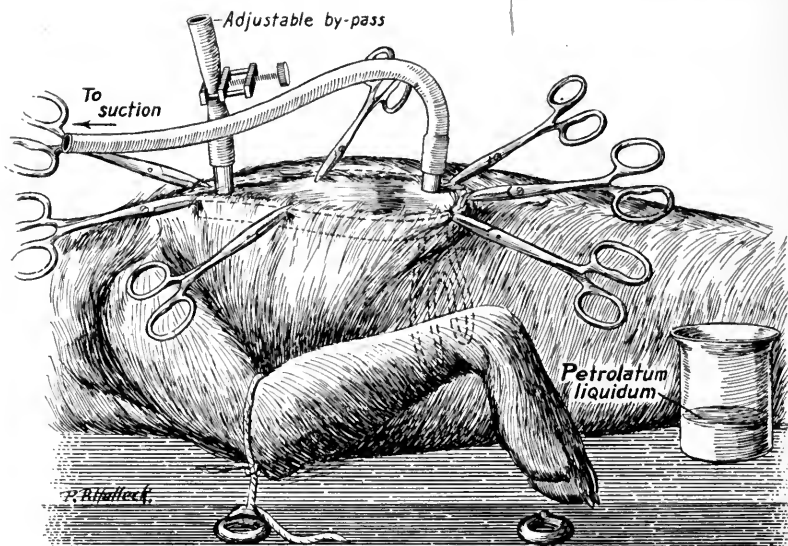

Fig. 257.—Adjustment of the apparatus shown in Fig. 255 in the chest of a dog. The sawed edge of the sternum catches against the flange of the apparatus and the skin and fascia are brought up and clamped tightly with hemostats to the edges of the plate. One or two stitches may be taken to draw the chest together at the front end of the apparatus. If positive artificial respiration is used this apparatus simply converts the chest into a rigid-walled plethysmograph or oncometer for the lungs and heart. A glass (or celluloid) window aids greatly by allowing the operator to see when the lungs are being sufficiently inflated.

an oncometer and the tube to the recording tambour (which should have a *large bowl*) is connected to the tube labeled “aspirate” in Fig. 255. Thus when the lungs are blown full of air through the trachea and are thus expanded air will be forced out of the chest and into the tambour the pointer of which will rise. Conversely when the lungs col-

lapse air will be drawn into the chest from the tambour and the pointer will descend. If the bronchial muscles contract or dilate the extent of this movement will be correspondingly decreased or increased. The extent of expansion or contraction of the lungs can be controlled by the screw clamp on the tracheal cannula (if the volume of air delivered by the respiration machine at each inflation cannot be independently controlled). The extent of movement of the tambour pointer, i. e., of the amount of air entering or leaving the tambour bowl, can be controlled by the screw clamp on the "inlet" of Fig. 255.

If *negative pressure* is used this is applied only after the dog is pithed (this being determined by the administration of the ether which is better done by positive artificial respiration). Figure 257 shows the way to arrange the tubes to the apparatus. In this case the *tube to the recording tambour* is attached to the side tube (or better the end) of the tracheal cannula (the ether bottle is removed, for it is no longer necessary as the animal will then be pithed). The other opening of the tracheal cannula carries a piece of rubber tubing and a screw clamp. This clamp is used to regulate the facility with which air passes into and out of the trachea and lungs. This regulates the size of the tambour stroke on the drum. Closing the clamp down increases the amplitude of the tambour stroke; opening the clamp decreases the stroke. The attachment of the tambour here and the removal of the ether bottle can be done only after the animal is pithed.

When the apparatus is adjusted pith the animal. To do this consult Figs. 258, 259, 260, 261, and 262.

Unfasten the dog's head and turn it on the *left* side. *The anesthetist watches carefully to see that the chest or trachea is not compressed and that the animal gets sufficient air while this part of the operation is performed.* With a scalpel make a median incision over the skull and with large tin snips cut the skin away in a V-shaped area

(Fig. 258). With a scalpel cut close to the bone and dissect loose the right temporal muscle. Reflect this upward and hold it up with forceps. Take a trephine instrument

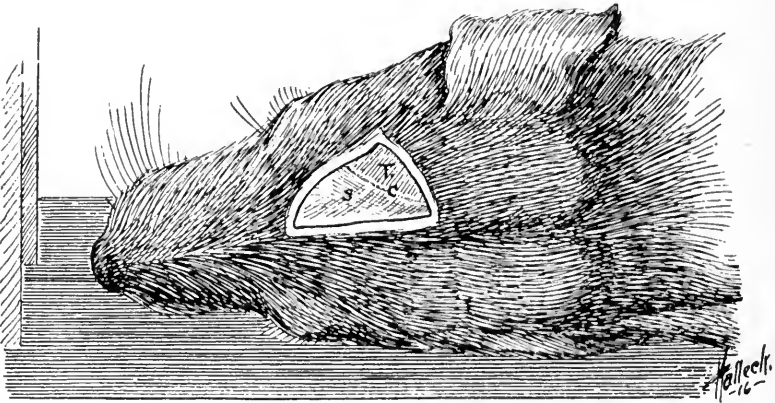

Fig. 258.—Method of making the first incision before trephining the skull. The longitudinal (mesial) edge of the opening is cut with a scalpel. The triangular piece of skin and fascia is then lifted with forceps and cut away with heavy (6 inch) tinner's snips.

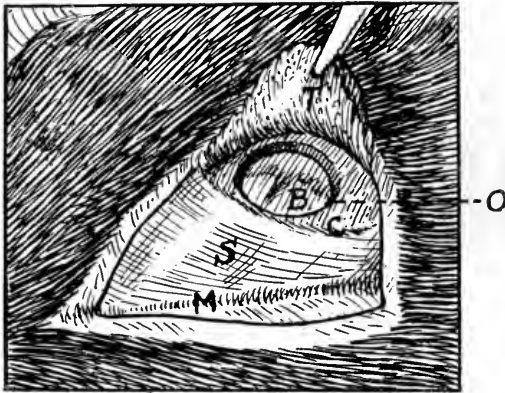

Fig. 259.—The trephine opening is made about one-half to three-fourths of an inch outward from the median line to avoid the great longitudinal sinus.

(Fig. 100) and make an opening in the skull (Fig. 259). *Be careful to avoid the longitudinal sinus—the opening should be one-half to three-fourths of an inch away from*

the median line. Place a wad of cotton in the forceps and hold this in the left hand ready to cover the trephine opening. Pass a long narrow scalpel blade into the opening.

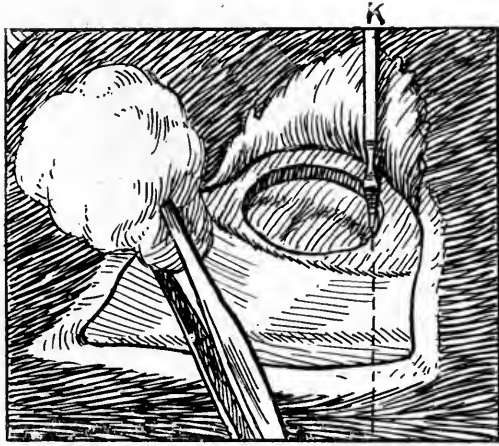

Fig. 260.—Method of quickly cutting across the brain stem with a long narrow bladed scalpel while a wad of cotton is held in the forceps ready to crowd into the trephine opening to check all loss of blood.

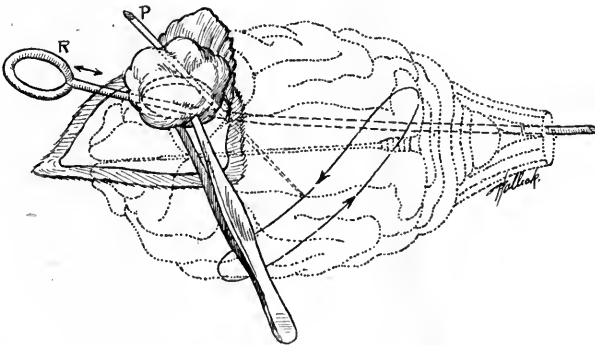

Fig. 261.—The cotton is held down firmly in the trephine opening while a probe is slipped in past the cotton and is moved quickly and thoroughly about in a circular manner to destroy every part of the brain. If the cord is also to be destroyed this is done by passing a long fairly flexible wire (one-eighth inch soft brass rod) through the trephine opening and out through the foramen magnum into the spinal canal. The head and neck may be moved a little to assist in passing the rod down the spinal canal to destroy the cord.

and cut quickly across the brain stem. Remove the scalpel and close the opening with the cotton. No blood should escape. Into the upper end of the opening beside the cot-

ton pass a probe (Fig. 261) and with a circular motion destroy every part of the brain. Keep the cotton plugged tightly in the opening. If it is desired to destroy the cord a one-eighth inch soft brass wire slightly curved at the end may be inserted past the cotton and forced through the foramen magnum and down the spinal canal. Bend the animal's neck and head a little to assist in getting the rod to enter the canal easily. Remove the rod, plug the opening tightly with cotton, and replace the animal's head into its original position. Remove the ether quickly, the animal will lie perfectly still and the blood-pressure will

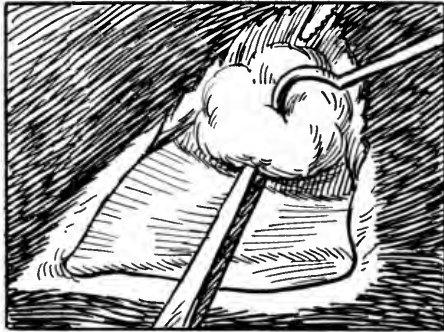

Fig. 262.—After the brain (and cord, if desired) is destroyed the trephine opening is plugged tightly with a wad of cotton forced in by the hooked end of an aneurism needle. The animal's head is then quickly returned to the usual position.

fall to a height of about three-fourths to one inch above the base line as seen on the drum.

If *negative pressure* is used change to this now. If positive pressure is used attach the tambour and adjust all writing points on a slow drum, lung tracing at the top, below this the blood-pressure, and then the base line and time signal. The lung tracing should have an amplitude of about three inches. Be sure the manometer pointer will pass up just to the *right* of the tambour pointer.

Take one-half or one inch of normal record. Inject one cubic centimeter of pilocarpine. *Wait a little for the effect to develop well.* Then inject one-half cubic centime-

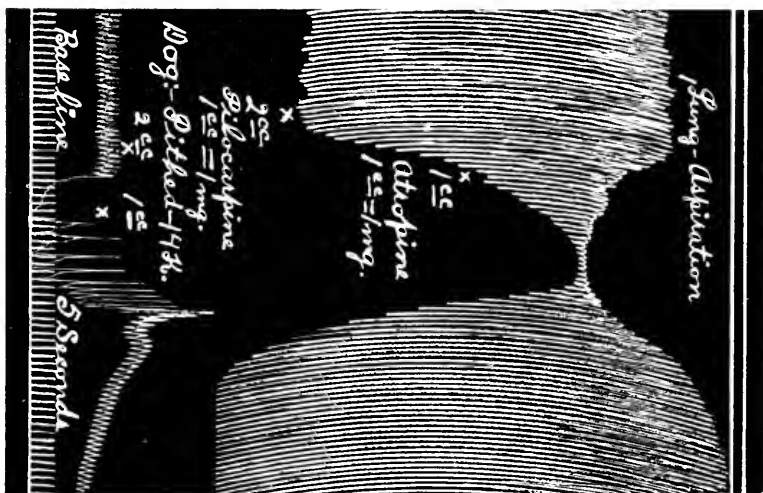

Fig. 263A.—Tracing showing the action of pilocarpine on the bronchioles and blood-pressure in a pithed dog. Pilocarpine causes marked bronchoconstriction and slowing of the heart which atropine counteracts.

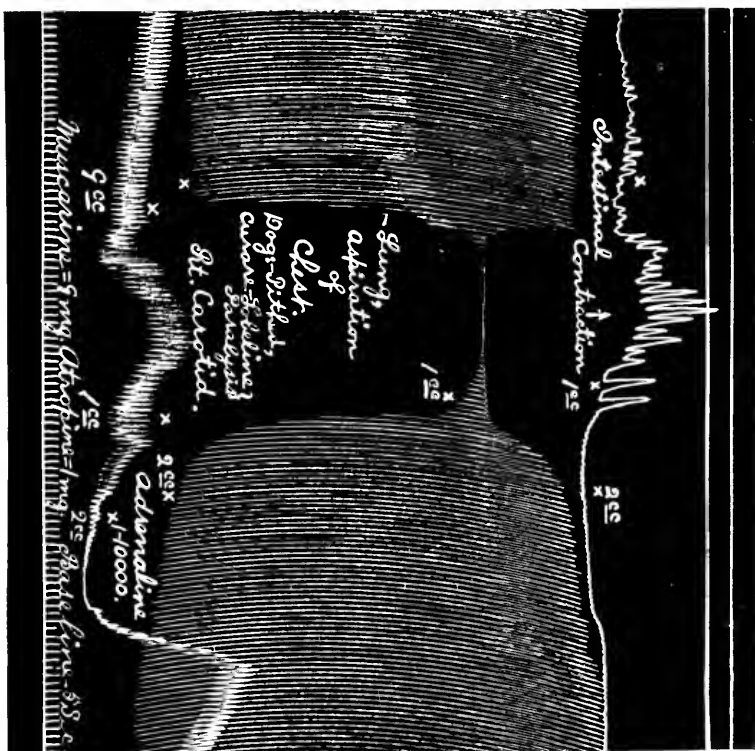

Fig. 263B.—Tracing showing the action of muscarine and atropine on intestinal contraction, on the bronchioles, and on blood-pressure in a spinal dog which had been curarized and in which sufficient lobeline had been injected to produce ganglionic paralysis.

ter of adrenaline. *Wait*—the blood circulates slowly. What do you observe? How do you explain it? What mechanical factors are concerned? A second contraction

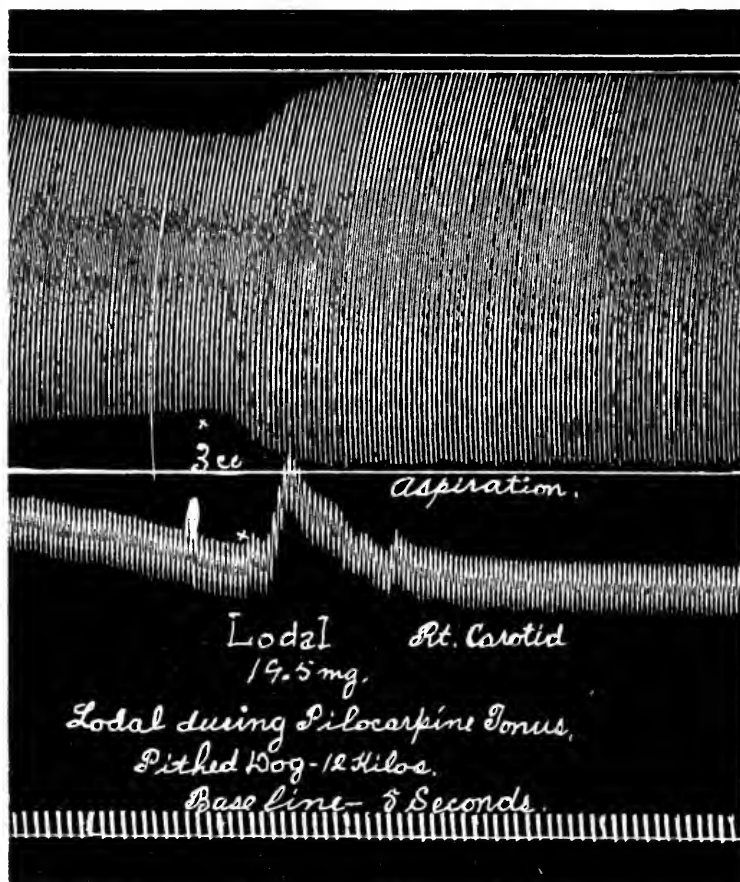

Fig. 264.—Tracing showing the action of local (Burroughs, Wellcome and Co.) on the blood-pressure and bronchioles in a spinal dog. The animal had received a dose of pilocarpine a little while before this tracing begins and the bronchioles were partially contracted (tonus) from the action of the pilocarpine which exercises a prolonged effect on the broncho-constrictor nerve endings.

of the bronchioles will likely come on as the effect of the adrenaline passes off. Wait for this and give a second injection of adrenaline. (If the first dose of pilocarpine was

too small—this is seldom the case—then a second may be given but this reduces the vitality of the animal markedly and is best avoided.)

Get the animal into as good condition as possible and (take a normal) inject one cubic centimeter (*less if the animal is small*) of arecoline solution. The response will probably be profound. *Wait* for the heart to beat slowly again. When the bronchioles are greatly constricted inject one cubic centimeter of adrenaline. *Wait* for the drug to be carried around. The result should be striking. How do you explain this? (If the first dose of arecoline was too small—this is seldom the case—then a second may be given but this is best avoided.)

Empty out the pilocarpine (*be sure the bull-dog on the vein does not leak*) and fill the burette with atropine solution (one cubic centimeter equals one milligram).

Take a normal record and inject one cubic centimeter (or one and one-fourth cubic centimeters) of arecoline. When the action is marked inject one cubic centimeter of atropine. *Wait* for the drug to circulate. What do you observe? Explain all mechanical factors. Inject one-half cubic centimeter of arecoline. What conclusions can you draw?

Empty out the arecoline and fill the burette with one-half per cent barium chloride solution. Barium acts *presumably* directly on the smooth muscle fibers. *Remember the animal has had atropine.* Take a normal record (the animal will probably be greatly weakened by this time) and inject five cubic centimeters of barium solution (three cubic centimeters if the animal is small). What do you observe? It will take some time for the action to become marked. Is the heart irregular? Barium acts somewhat like digitalis and in some respects resembles adrenaline. Do the bronchioles contract? If so inject two cubic centimeters of adrenaline. Do they respond to this? Kill the animal with a big dose of barium. How does barium act on

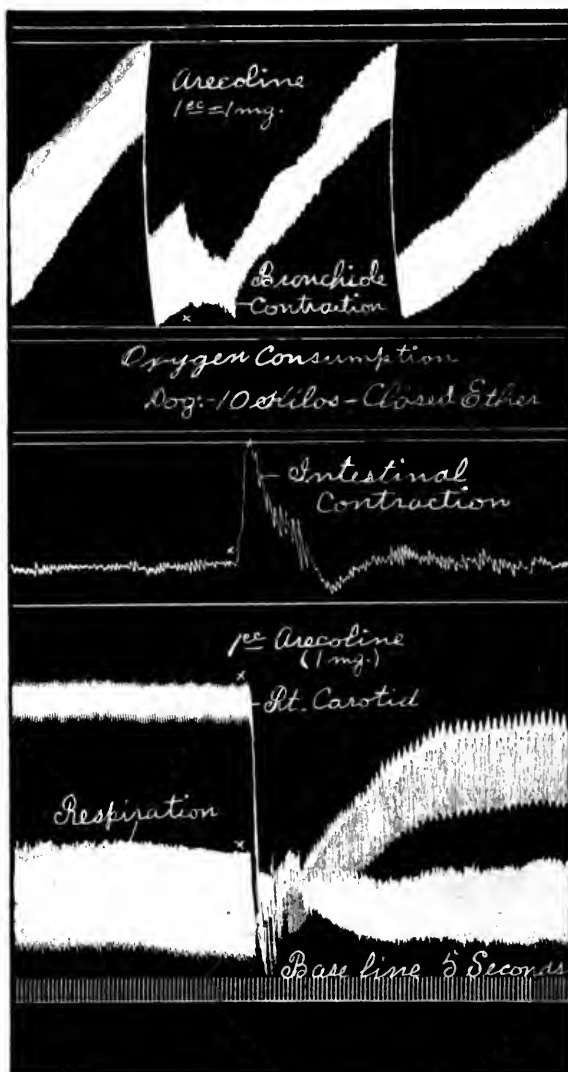

Fig. 265.—Tracing showing the action of arecoline on the rate of oxygen consumption (and the broncho-constriction), intestinal contraction, blood-pressure and respiration in a spinal dog.

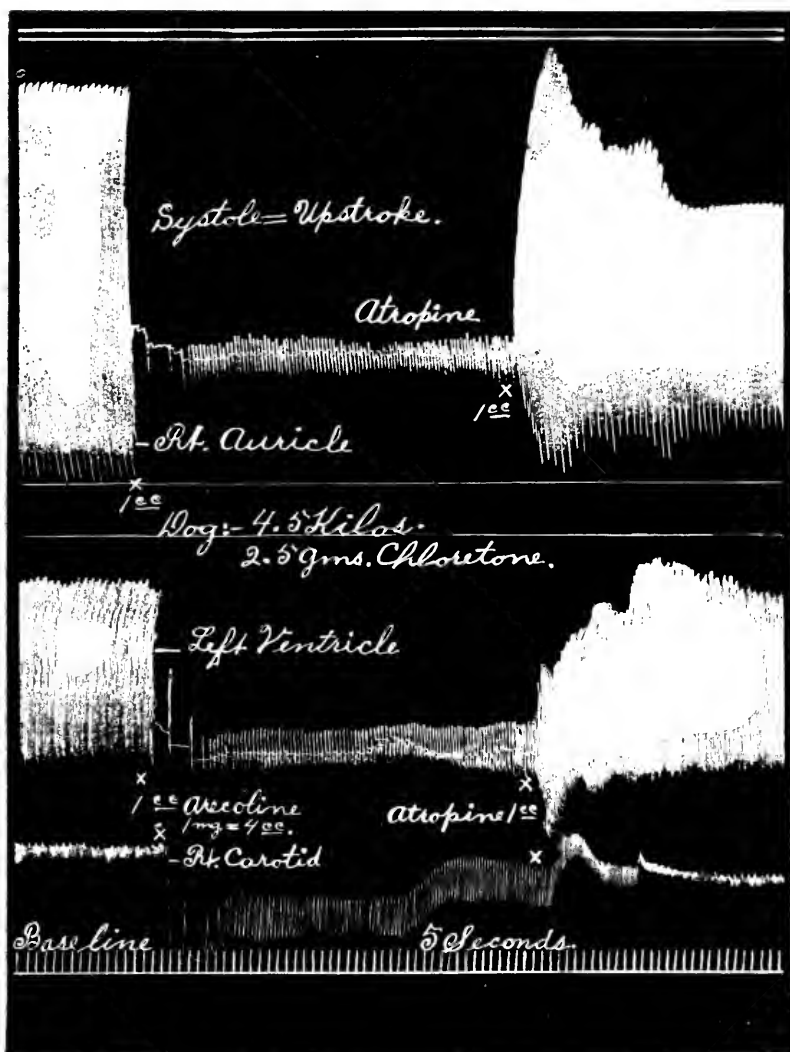

Fig. 266.—Tracing showing the action of arecoline and atropine on the heart (myocardiographic record, right auricle and left ventricle) and blood-pressure in a dog.

the heart? Discuss in full the action of pilocarpine, arecoline (muscarine), atropine, adrenaline and barium on the bronchioles. What part do the medullary centers play in this action? What is the innervation of the bronchioles? (See Dixon and Ransom: *Journal of Physiology*, 1914.)

EXPERIMENT LXXI.

Nicotine. (Frog: General Symptoms.)

1. Into the anterior lymph sac of a frog inject one-half cubic centimeter of one-half per cent nicotine solution. Place the animal in a sink and watch its actions. Do you observe anything peculiar about its attitude? When the dose is too large the animal may die too quickly to show typical effects. Make a sketch of the position of the limbs after the action of the drug becomes marked. Watch and see if this stage passes off. Save the frog and observe it as often as possible for several hours. Do you note any convulsions at any time? On what structures does nicotine act to produce these results?

EXPERIMENT LXXII.

Nicotine. (Frog: Heart and Vagus Nerve.)

1. Pith the frog and take a normal heart record showing both vagus (trunk) and crescent inhibition. Pour two drops of nicotine solution (one per cent) on to the heart. Wait a few seconds. Do you get an immediate effect? How do you explain this? If there is a change in the heart rhythm does this continue or is there a return to normal? Stimulate the vagus and note the effect on the inhibition of the heart. How do you explain this? Stimulate the crescent. Explain your results. How does nicotine cause these two results? Is the heart muscle directly

affected? Apply more of the drug and observe the later action on the heart. What is the innervation of the heart (Fig. 222)?

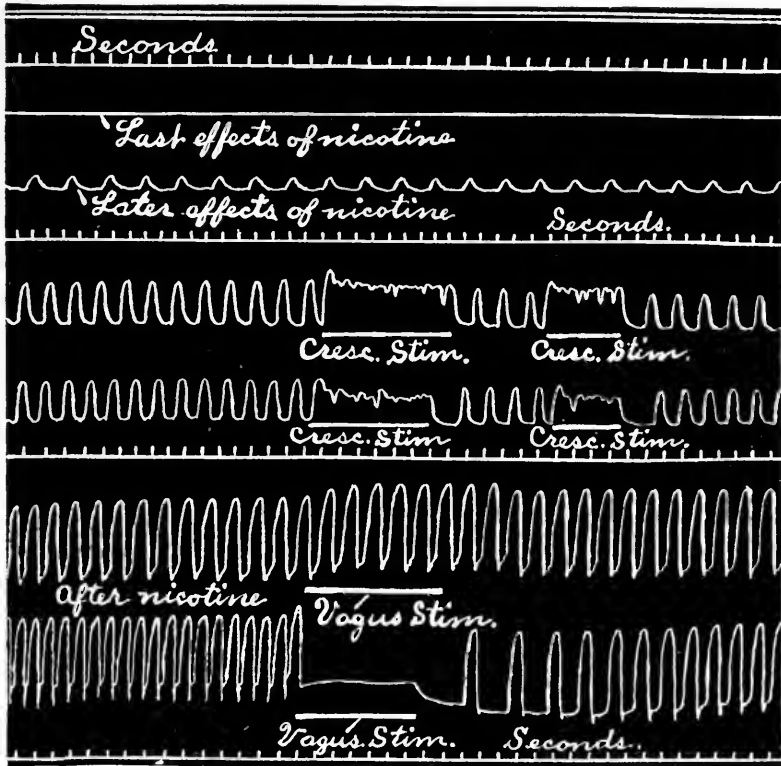

Fig. 267.—Frog heart tracing showing the action of nicotine. The vagus trunk was stimulated as indicated. In the normal (lower) tracing inhibition occurs but after nicotine (second tracing) no inhibition follows. How do you explain this? Stimulation of the crescent in the next two lines still is followed by inhibition. The final effects of the drug are shown in the last two (upper) tracings.

EXPERIMENT LXXIII.

Nicotine. (Turtle: Heart and Vagus Nerve.)

1. Repeat the above experiment on a turtle which is a more satisfactory animal for the experiment than is the frog. Why?

EXPERIMENT LXXIV.

Nicotine. (Turtle: Lungs.)

1. Pith a turtle, brain and cord. Remove the plastron as shown in Fig. 232. Consult also Fig. 233. Arrange a cannula in the wind pipe and a small (very sensitive) tambour to write on the drum. The magnification for the writing point should be large. Partially inflate the lungs (blow them up from the air vent in the tambour tube) and adjust the tambour on the drum. (A heart tracing may be taken also when the nerves are stimulated, but it is difficult to get a satisfactory heart tracing when drugs are injected into the heart. It is possible to inject drugs into the large vein running into the liver but this requires considerable care and when *lung records only* are wanted the heart is best left alone.)

Dissect out the vagus and sympathetic nerves on one side of the neck and stimulate them. Do you get a satisfactory record? Go far down in the tissues at the side of the neck and find the sympathetic branch which joins a ganglion on the vago-sympathetic nerves. Stimulate this branch and see if you can get a lung tracing from it. (The opposite lung may be *temporarily* shut off by a bull-dog on the corresponding bronchus.)

After one or two records of the lung contraction following nerve stimulation have been secured then remove the bull-dog from the bronchus, see that both lungs are moderately distended and that the tambour is properly adjusted on the drum. Start the drum and with a fine-pointed hypodermic syringe inject into the ventricle one or two cubic centimeters of one-half per cent nicotine solution. The circulation is sluggish in the turtle and some time may elapse before the drug reaches the lungs. Wait for the effect to come on. Be sure the turtle is in a satisfactory condition (not diseased or weakened in any way) and that



Fig. 268.—Turtle lung tracing showing the action of nicotine. (Moderately fast drum.)

the heart beats well. A marked effect should be produced. Explain the action of the drug in this case. It will be instructive if you can compare the action of nicotine on the turtle lung with the corresponding action on a dog's lung.

EXPERIMENT LXXV.

Nicotine, Arecoline, Atropine. (Dog: Blood-pressure, Respiration, Limb Volume, Intestinal Contraction.)

1. Etherize a dog and arrange for blood-pressure, respiration and intestinal contraction (Fig. 246). Examine a plethysmograph for the hind limb of a dog (Fig. 269). Rub soapsuds around the left hind leg close up to the body of the animal. Take a razor and shave the hair all

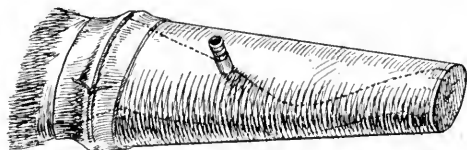

Fig. 269.—Method of application of a plethysmograph to the hind leg of a dog.

off in band about one and one-half inches wide entirely around the leg. (A strong solution of sodium sulphide may be used to remove the hair by rubbing the solution over the selected area. The hair can then be readily scraped off. But this is a filthy method. A cheap safety razor is best.) The hair must be removed or the rubber band of the plethysmograph will leak air around the limb. Attach the plethysmograph as illustrated and connect it to a small bowled very sensitive tambour. From above down, the records on the drum should be—leg volume, intestine, blood-pressure, respiration, base line and time signal. Injecting burettes should be placed in the right femoral and the left jugular veins. These contain nicotine (one-half per cent) and adrenaline.

Take a normal tracing (stimulate the vagi and get the cardiac effect) and then inject one cubic centimeter (*less if the animal is small*) of nicotine solution. Watch the pupil as the drug is injected. What do you observe? Wait

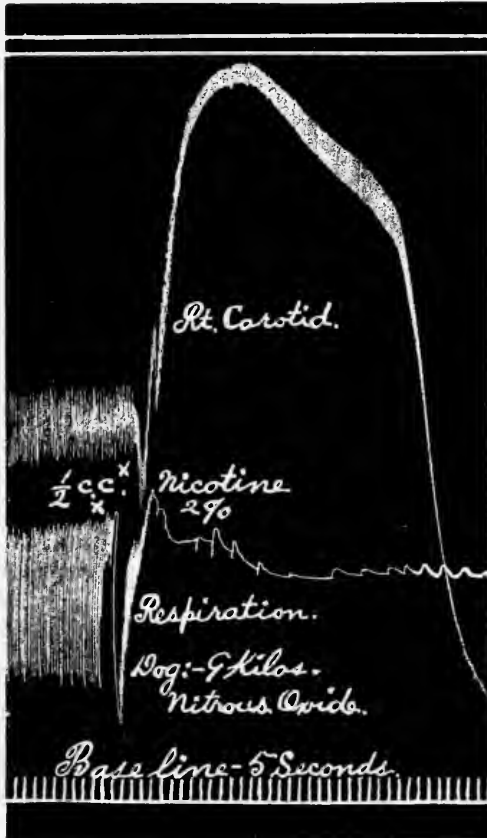

Fig. 270.—Tracing showing the action of a fatal dose of nicotine on the blood-pressure and respiration of a dog anesthetized with nitrous oxide. Can you see the evidence of a preliminary stimulation (followed by paralysis) of the cardio-inhibitory ganglia?

for the effects to pass off. What do your records show for the intestine and leg? How can you explain these? Inject one-half cubic centimeter of adrenaline. How does this drug compare with nicotine in action? On what struc-

tures does nicotine act and what is the nature of this action? Do your records show this? Inject another dose of nicotine of such size as your animal will probably tolerate well.

Stimulate the vagus nerve and see how this affects the heart. Do you get an inhibition? If so give another dose of nicotine and again stimulate the vagus. What are your conclusions? How could you prove this? Observe one pupil and stimulate the corresponding vago-sympathetic trunk. Does the pupil contract or dilate? How do you explain this? What is the action of nicotine on the pupil?

Empty the nicotine out of the burette and place arecoline solution (one cubic centimeter equals one-half milligram) therein. Inject one cubic centimeter of arecoline (*less if the animal is small*) and get a record. Observe the pupil as the drug is run in. Has the nicotine affected the action of this drug in any way? *Wait* for the drug to act. Inject one-half cubic centimeter of adrenaline to revive the animal (give a second dose if necessary.)

Empty out the adrenaline and fill the burette with atropine solution (one cubic centimeter equals one milligram). Take a normal record and then inject one cubic centimeter (or one and one-half cubic centimeters) of arecoline. When the action is very marked inject one cubic centimeter of atropine. *Wait*—the circulation is slow. Do you get the proper response to the drug? How do you explain this? Inject one-half cubic centimeter more of atropine.

Empty out the arecoline and fill the burette with nicotine. Start the drum and inject one cubic centimeter of nicotine. Does your record correspond with the theoretical action of the drug? How do you explain this? What structures are involved? Kill the animal with a large dose of nicotine. Discuss in full the counteraction of these drugs. Open the chest, dissect out the left pulmonary artery and place a ligature under it. (See Figs. 274, 275, 276, and 277.) Slip this ligature as far out on the artery as possible

and tie. Lift the ends of the ligature up and draw the lung upward into view. Clamp the ends of the ligature to the chest wall. Could you put a cannula into the artery (as shown in the illustrations) while the heart was *beating and disturbing your operations considerably?*

EXPERIMENT LXXVI.

Nicotine, Adrenaline, Pilocarpine, Atropine. (Dog: Blood-pressure, Intraocular Pressure, Respiration and Kidney, Spleen or Intestinal Loop Volume.)

1. Give a dog a small dose of chloretone and then etherize it. Arrange for blood-pressure, respiration and kidney, spleen or intestinal loop volume records.

Observe the arrangement of the apparatus shown in Fig. 271. A medium sized syringe point is thrust into the anterior chamber of the eye as shown in the upper right hand corner of the picture. The cornea is composed of tough, dense tissue and the syringe point will not leak around the outside if the needle is *not moved from side to side* after it is inserted (at an acute angle) through the cornea. The needle is attached to a rubber tube which connects with a water manometer (filled with normal salt solution). The needle and the end of the rubber tube are held in a hole in a cork which is clamped in a burette clamp which can be brought close to the eye. The manometer is filled with salt solution from the mercury bulb and the tubes (washout also) and needle are filled with the solution, a little of the solution being allowed to run out of the needle as it is inserted through the cornea. It is advisable to use an extra stand to hold the needle (burette clamp) close up to the eye. The amount of pressure in the tube is regulated by raising or lowering the manometer. The recording tambour should be small. No fluid should be in the tube leading from the manometer to the tambour. The injecting

burettes contain nicotine (one-half per cent) and adrenaline. Stimulate the vagus nerve on the side on which the eye record is being taken. What conclusions can you draw?

Bring all writing points on to the drum and take a normal record. Inject one cubic centimeter (twelve kilo dog, *less if the animal is smaller*) of nicotine and record the

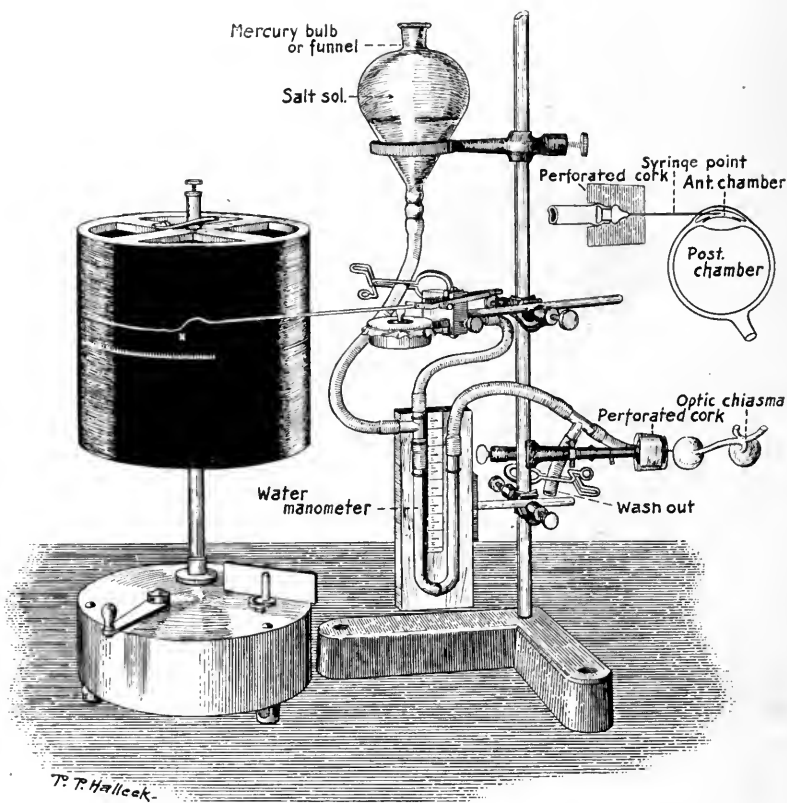

Fig. 271.—Arrangement of apparatus for recording intraocular pressure.

result. Stimulate the vagus nerve again and see what happens. Explain. Inject one-half cubic centimeter of adrenaline. Wait a sufficient time for the results to wear off. What conclusions can you draw? What mechanical factors are involved? Inject one cubic centimeter more of

nicotine. How does this record compare with your first one? What is the action of nicotine on the heart muscle?

Stimulate the vagi from time to time and note any change in reaction. When an inhibition of the heart can no longer

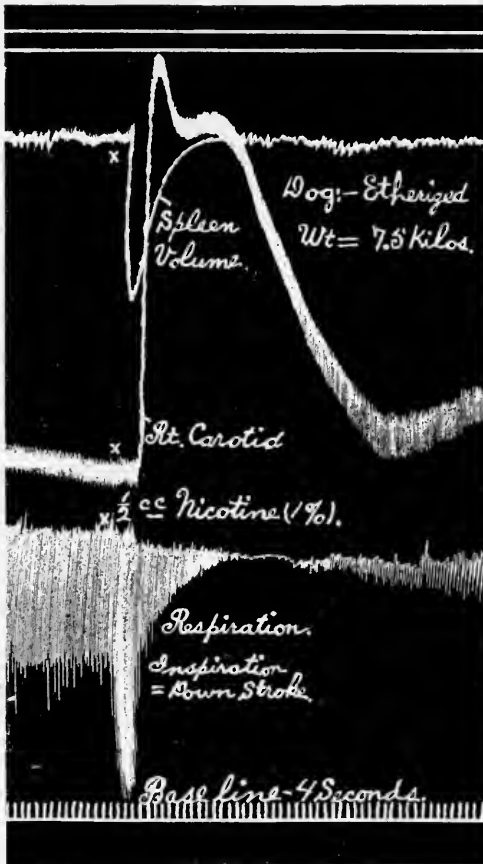

Fig. 272.—Tracing showing the action of nicotine on the spleen volume, blood-pressure and respiration in a dog (etherized). Compare this record with one made by adrenaline (or coniine).

be obtained (inject more nicotine *if necessary*) then empty out the nicotine and fill the burette with pilocarpine solution (one cubic centimeter equals one milligram).

Inject one cubic centimeter of pilocarpine. Wait for the

drug to act. When the effects are well marked inject one-half cubic centimeter of adrenaline. What conclusions can you draw from your records?

Inject one-fourth cubic centimeter more of adrenaline (if necessary) to get the animal into as good condition as possible. Then empty out the adrenaline (save it) and fill the burette with atropine solution (one cubic centimeter equals one milligram).

Inject another dose (estimate the size to get the results) of pilocarpine and when the reaction comes on inject one cubic centimeter of atropine. Do you get what you should get? What conclusions can you draw? Stimulate the vagus nerve and see if your eye record is affected. What is the relation between the cervical vagus nerve trunk and the eye in the dog? How does this compare with a man? If you get any eye records study and explain carefully the exact cause of these records. Are they due to *local* or *remote actions* of the drugs concerned?

Empty out the pilocarpine and put barium chloride solution in the burette. Inject five cubic centimeters (one-half per cent) of the solution. Obtain as good records as you can. Then inject sufficient barium to kill the animal. Discuss the action of the drugs used in this experiment. Compare your results with those obtained by other members of the class.

EXPERIMENT LXXVII.

Nicotine, Adrenaline, Barium. (Dog: Pulmonary Blood-pressure, Carotid Pressure.)

1. Etherize a dog (twelve or fourteen kilos preferred). A small dose of chloretone may be given to some advantage. Arrange for a perfectly reliable artificial respiration (a power driven machine is greatly to be preferred). Isolate and ligate loosely both vagi. Arrange to record carotid blood-pressure. The injecting burettes contain nic-

otine (one-half per cent) and adrenaline (1:10,000). Place the pulmonary manometer in position on the drum. Its base line should be about one-half inch above the carotid pressure and the carotid writing point should be able to pass up *just to the left* of both pulmonary pointers (see Fig. 273).

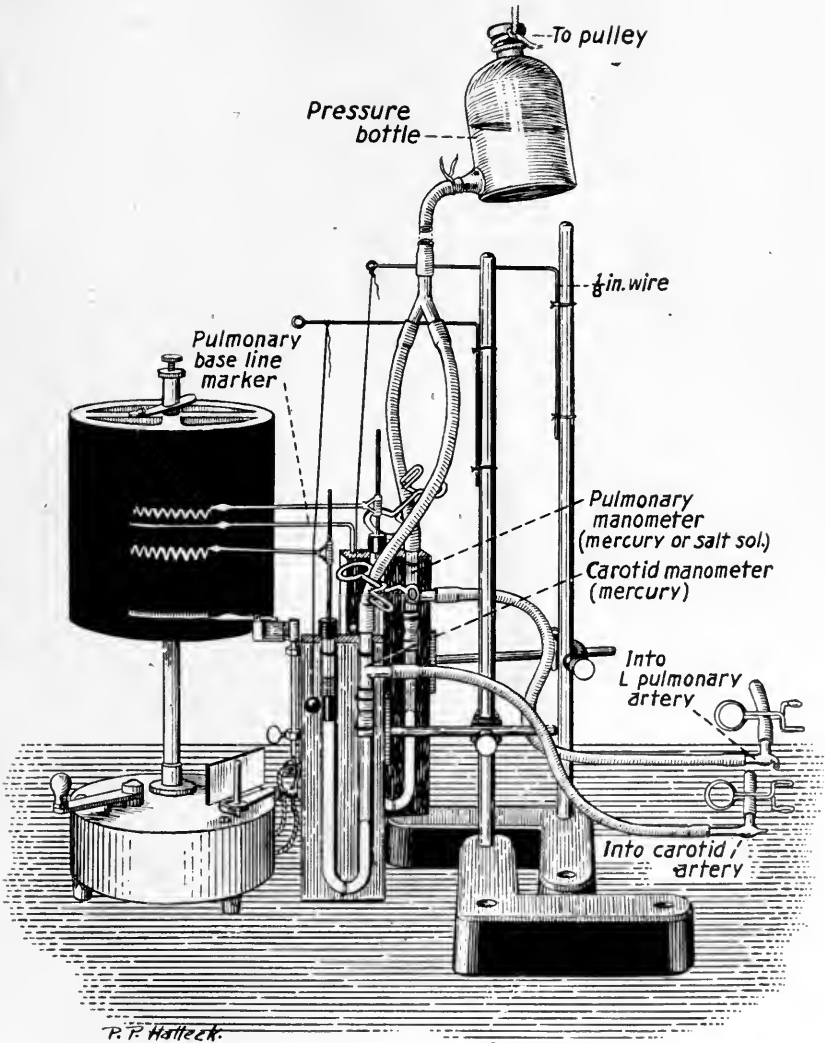

Fig. 273.—Arrangement of apparatus for recording pulmonary blood-pressure.

By a median longitudinal incision open the thorax. For the method of giving ether when the chest is open see Figs.

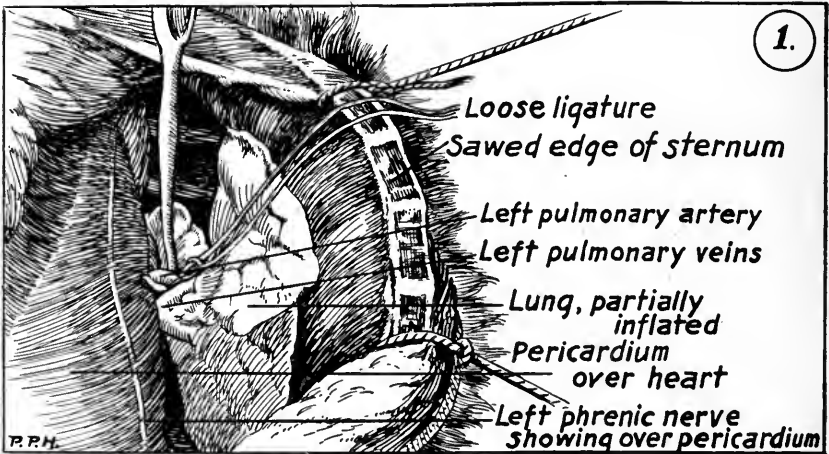

Fig. 274.—Dissection showing the method of lifting up the left pulmonary artery with an aneurism needle and tying a ligature loosely around the artery far out next to the lung tissues.

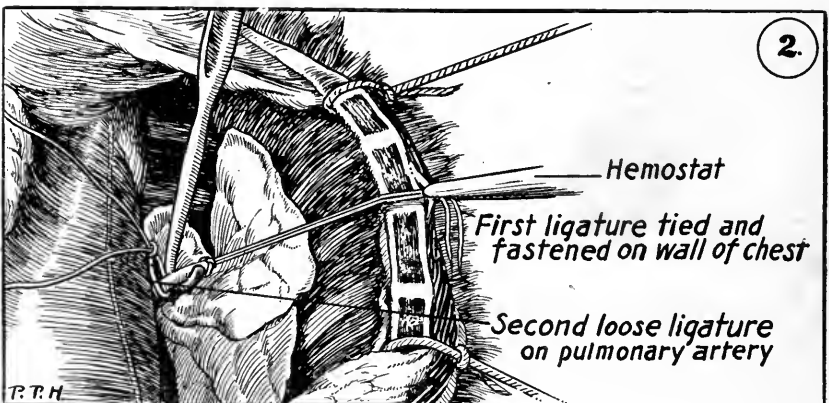

Fig. 275.—The first ligature is tied tightly (at the edge of the lung) and with a hemostat the end of the ligature is clamped to the edge of the chest wall in such a manner as to lift up and support the outer end of the artery (and the left lung). A second (loose) ligature is placed around the artery ready to tie in the cannula.

53 and 107. With four large ligatures tie the chest widely open as shown in Fig. 106.

Consult the Figures and seek for the left pulmonary

veins. The left pulmonary artery lies just posteriorly and cephalad to the vein which is nearest the apex of the chest. Keep to the left of the anterior mediastinum if possible.

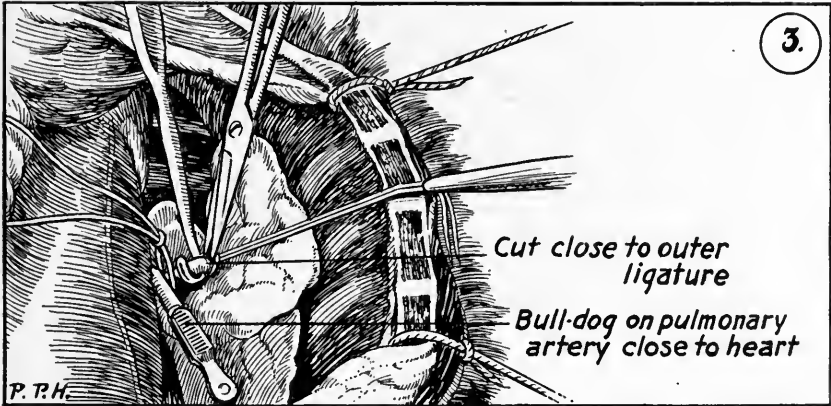

Fig. 276.—A special bull-dog is placed on the vessel near the heart and a notch is cut in the artery close to the outer ligature with the scissors.

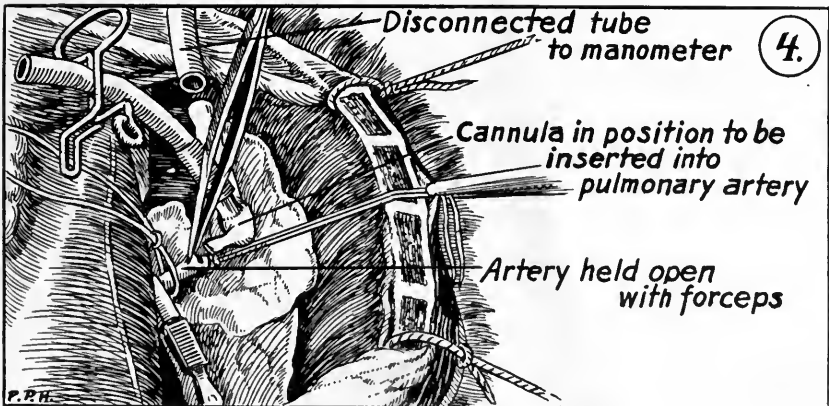

Fig. 277.—Method of inserting the special cannula into the artery. (For discussion see text.)

This keeps the heart on the right side. It is usually advisable to pick up the mediastinum and clamp it to the tissues at the right sawed edge of the sternum. This securely

holds the heart over in the right side of the thorax and thus gives a freer field for the operation. With a probe (*blunt point*) carefully dissect loose the pleural (fascia) covering over the area between the arch of the aorta and the adjacent pulmonary vein. Beneath this fascial covering you will find the pulmonary artery.

Consult Fig. 274 and carefully pass a large aneurism needle beneath the artery. Free as long a space of the artery as you can readily isolate. This will average about three-fourths of an inch. Pass a twine ligature around the vessel and tie it loosely (Fig. 274). Now with large forceps (using one finger to help hold the twine) slip the ligature outward into the edge of the left lung as far as you can and then tie tightly. Take hold of the ligature and lift up the lung as far as you can safely raise it, pass the ligature out over the chest wall and clamp it with a hemostat to the chest wall. With the aneurism needle still under the vessel pass a second ligature around the artery and tie it *loosely*. A *weak-sprunged, rounded-edged* bull-dog clamp is now placed on the artery as near to the heart as possible. The loose ligature is placed just peripheral to the bull-dog.

With the aneurism needle now lift the outer end of the vessel and cut it about one-half across (Fig. 276) with the scissors. With his *right hand* the operator now passes one of the points of the large sharp-pointed forceps into the lumen of the vessel and holds it open (the aneurism needle is held under the vessel with the operator's *left hand*) while the assistant inserts the short, wide tip of the cannula (Figs. 278 and 279) into the vessel. The operator and assistant (each using one hand) now tie the loose ligature around the vessel thus fastening the cannula in securely. It is advisable to leave the washout tube on the cannula while it is being placed in the vessel but the manometer tube is best left off until the cannula is securely fastened in the vessel. This is done on account of the dif-

faculty of manipulating so many pieces in the chest at one time. The beating of the heart greatly increases the difficulties of the operation. The artery has *thin* walls and a sharp-edged or strong-springed bull-dog will sometimes quickly wear a hole in the vessel from the constant rubbing

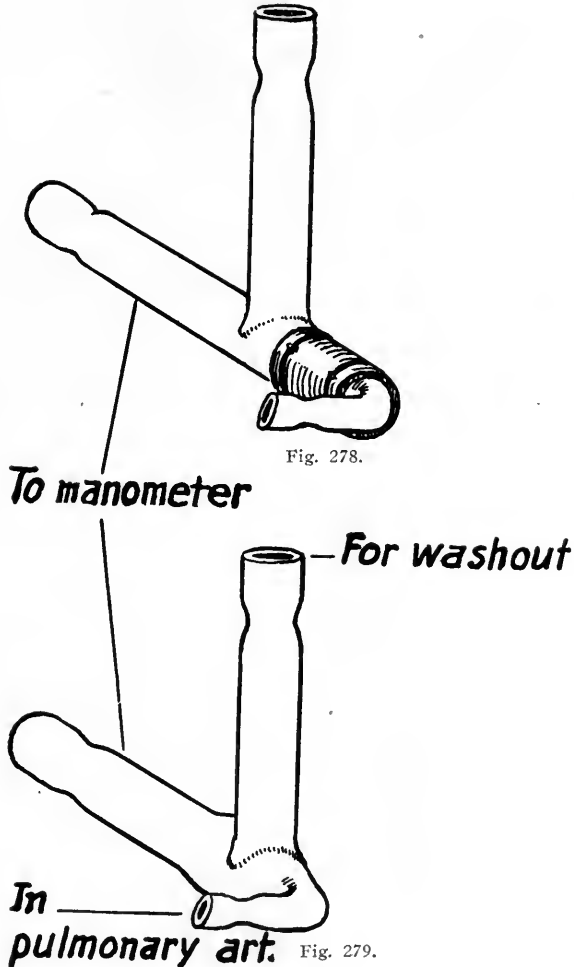

Fig. 278.—Special form of separable pointed cannula for the pulmonary artery.

Fig. 279.—Special (all-glass) form of cannula for the pulmonary artery. The opening in the point should be about one-eighth inch in diameter (the pulmonary artery is large).

of the ventricle before the manometer can be connected up.

The pulmonary manometer should have its own independent base line (which can be a wire fastened to the board of the manometer). It is most instructive to the student to use mercury in this manometer but sometimes water or salt solution is used instead. The comparison with the carotid pressure is seen at once if mercury is used.

Sodium citrate solution is used to prevent coagulation. A T-tube placed in the tube going down from the pressure bottle permits each manometer to have its own supply of citrate solution. When the cannula and tubing are all adjusted for the pulmonary pressure (*the manometer should have been fully adjusted previously*) then wash out the tubes and manometer with citrate solution and fill the tubes full *but leave no positive pressure in the tubes. This is of great importance.* To accomplish best results a slight *negative pressure* in the tubes is advisable. To get this fill the tubes and close both pinch cocks. Then open *only* the one on the washout. The pressure falls to zero in the manometer. Now between the thumb and finger squeeze the tube from the artery to the manometer. A small amount of the citrate solution runs out. Now close the washout and let go the tube. A slight negative pressure shows in the manometer but the tubes are full of solution and no air is left in them.

Work rapidly now for the animal may die soon and a clot is very liable to form in the pulmonary cannula. Adjust all writing points, remove the pulmonary bull-dog and take a short normal tracing. Inject one-half cubic centimeter of adrenaline and get a record. What effect has this on pulmonary pressure? Does the pressure rise higher in the right lung than it does in the left? Does your experiment demonstrate this? Explain. What nervous structures are involved in this reaction?

As soon as the normal is reached inject a dose of nicotine (three-fourths cubic centimeter). Do you get a satis-

factory record? How does nicotine affect the pulmonary blood-pressure? What structures are involved? What mechanical factors are concerned?

If you get a pulmonary clot put on the bull-dog and wash

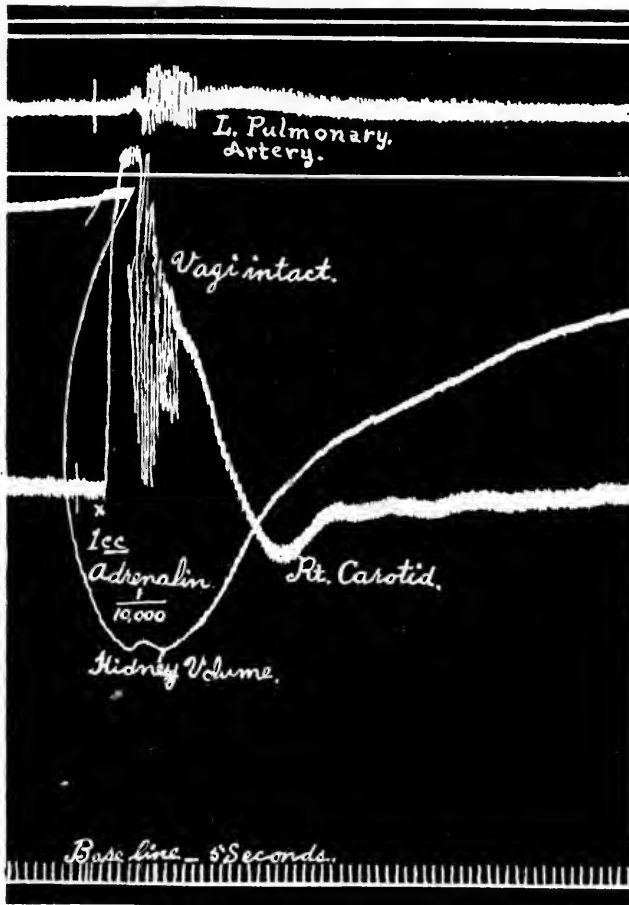

Fig. 280.—Tracing showing the action of adrenaline on the pulmonary pressure, kidney volume and blood-pressure (right carotid) in a dog. The straight line just below the pulmonary pressure tracing is the pulmonary base line.

out the blood but be sure no *positive* citrate pressure is left in the tubes. This is necessary because strong (five to ten per cent) sodium citrate solution is very poisonous to the

heart and a small amount can easily pass back from the pulmonary artery into the right ventricle. This may kill the heart immediately. Could you use hirudin for this purpose? What objections could you offer?

The average group of students will not get more than two good pulmonary pressure records from one dog. If the animal is still in suitable condition inject five cubic centimeters of barium chloride solution (one-half per cent). What conclusions can you draw? In how many ways may drugs affect the pulmonary blood-pressure? How many of these does your experiment illustrate? What differences are there between the systemic and pulmonary circulation? Historically which of the systems was first discovered? By whom? Kill the dog with a dose of barium.

EXPERIMENT LXXVIII.

Nicotine, Pilocarpine, Atropine. (Dog: Intraocular Nerves, Salivary Glands, Oxygen Consumption, Blood-pressure and Respiration.)

(For the anatomy of the eye, see Experiment CXVII, page 394.)

1. Give a dog (10 kilos) a moderate or small dose of chloretone and follow this with ether. Arrange to record blood-pressure and respiration. Consult Fig. 281 and dissect out the optic nerve in the right eye. (Consult Experiment LXIII, 2). Study Fig. 281 carefully and dissect out the orbit until the eye ball can be rolled around forward (inward) enough to bring the trunk of the optic nerve into view. The skin around the outer canthus should be cut away and sometimes the bones of the orbit must also be chipped out a little with bone forceps. Try to avoid disturbing the blood vessels entering the eye from behind. When the nerve is isolated place the platinum electrodes against the nerve sheath and, while watching the pupil,

stimulate the nerve. The pupil may dilate (sympathetic fibers), contract (oculomotor fibers) or remain stationary (both sets of fibers or none of either). The electrodes are moved a little and the points can be worked cautiously down into the nerve trunk. Stimulate (for a moment only) at each new position of the electrodes, the pupil being watched carefully all the time. At some point in the stimulation the pupil will show a marked contraction at once. This is striking when properly done and will be well worth the time necessary to do the dissection within the orbit with especial care. Let each member of the group see the con-

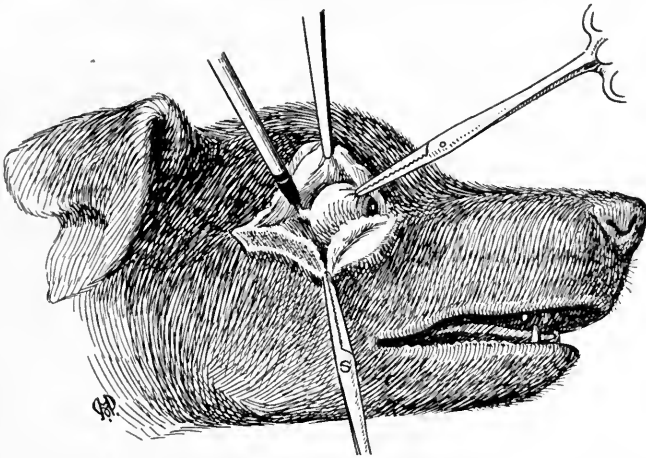

Fig. 281.—Method of dissecting out the orbital fat and fascia to expose the optic nerve. The position of the electrodes for stimulating the third nerve fibers is shown. The eye-ball is rolled forward (inward) somewhat to bring the optic sheath into view.

traction and keep the observation in mind to check your later results.

Now turn the dog's head back into the usual position and insert a cannula into Wharton's duct. Stimulate the chorda tympani nerve and obtain a normal secretion.

Arrange the apparatus for recording oxygen consumption and if necessary put a small amount of ether into it (but avoid the ether if you can). Into the femoral veins place injecting cannulas, the burettes to which contain nicotine ($1\frac{1}{2}\%$) and adrenaline. Take some normal record (including at least one or two notches of the oxygen record).

A good nicotine solution can often be made by scraping out the contents of the bowls and stems of two or three tobacco pipes. The material is dissolved in salt solution and filtered before being placed in the burette for injection. The results are often striking.

Inject a dose of nicotine (perhaps three-fourths of a cubic centimeter. This will vary with the size of the animal and also with the quality of the drug as usually obtained in the open market). Watch the pupils (both) as the drug is injected. Do you get a typical blood-pressure record? If it seems necessary inject some adrenaline to help restore the animal (watch the pupils as the drug is

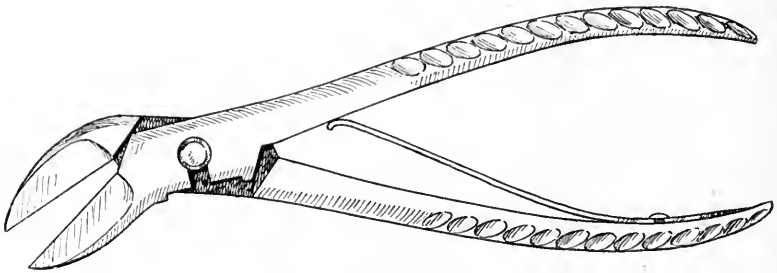

Fig. 282.—Bone cutting forceps.

injected). What did your oxygen record show? On what does this depend? Inject another dose of nicotine (estimate the size to suit the tolerance of your animal). Stimulate one vagus nerve and see if the heart is inhibited. If it is, give a little more nicotine *cautiously*. Stimulate the chorda tympani and see if secretion follows. When, on stimulation, the vagus no longer can inhibit the heart, empty out the nicotine and fill the burette with pilocarpine solution (one cubic centimeter equals one milligram). Substitute atropine for the adrenaline in the other burette. Inject one cubic centimeter of pilocarpine. What action has this on the salivary secretion and heart? Have you injured the vessels going to the salivary glands? Wait a little and if the animal will tolerate it well inject another

dose of pilocarpine. Wait for the action of the drug to become well developed. How is the heart affected? Stimulate one vagus nerve and see if this slows or accelerates the heart. If it beats faster or if the pressure rises how do you explain the result? Is this a natural phenomenon or have the drugs caused it in some way? When the action of pilocarpine is well marked (give more of the pilocarpine if *absolutely* necessary) inject one cubic centimeter of atropine solution (one cubic centimeter equals one milligram). Do you get typical results on the heart and blood-pressure? Stimulate the chorda tympani and see if secretion follows. Another smaller dose of atropine may be given if the animal will probably tolerate it well.

Now stimulate the oculomotor nerve again and see if you get a contraction of the pupil. Stimulate the vago-sympathetic in the neck and see if the pupil dilates. If time permits dissect out the oculomotor nerve on the left side and stimulate it to see if contraction of the pupil will occur. Kill the animal with a big dose of atropine. If you do not have enough solution to do this (how much does it take?) then inject nicotine in addition. Examine the respiratory tracing just after the pilocarpine was injected. Do you note a decrease in the amplitude of the respiration with some difficulty in either expiration or inspiration? How do you account for this? Is it central or peripheral? How did the atropine affect this? Did the atropine act centrally or peripherally? Could you obtain such phenomena as this in an animal whose head had been removed from the body?

After the animal is dead pick up one vago-sympathetic nerve trunk in the neck and follow it up toward the base of the skull. Dissect out the superior cervical ganglion and determine its relations to the surrounding structures. From this ganglion sympathetic fibers pass to the various organs, glands, involuntary muscles, etc., of the head. (See Fig. 243.)

EXPERIMENT LXXIX.

Lobeline. (Frog or Turtle: Heart and Inhibitory Nerves.)

1. Pith a frog or turtle and take a heart tracing including both vagus and crescent stimulation records. Make up a solution of lobeline sulphate containing approximately one milligram of the drug to one cubic centimeter of distilled water. Lobeline sulphate is a dark, thick, viscid substance and is difficult to weigh or measure but dissolves readily in water.

While taking a record on the drum pour a few drops of the solution on the heart. Do you note any *immediate* action? Stimulate the vagus nerve and note the action on the heart. Now stimulate the crescent and see if you obtain the usual result. What conclusions can you draw? Have you obtained similar results with any other drug? Could you prove your conclusions in any other way? Apply more of the drug to the heart to see the later results. How does lobeline act? (See Edmunds: American Journal of Physiology, xi, p. 79.)

EXPERIMENT LXXX.

Lobeline, Pilocarpine. (Turtle: Lung Tracing.)

1. Arrange a turtle for taking lung tracings (consult Experiment LXXIV, 1). When all adjustments are made take one-half inch of the normal (quiescent) record and then inject into the ventricle with a very fine-pointed hypodermic syringe one or two cubic centimeters of lobeline solution (one cubic centimeter equals one-half milligram). Do not disturb the lung tracing by manipulating the heart carelessly. Do you get a satisfactory lung record? How do you explain this action of the drug? On what structures does lobeline act? Where are these structures located in

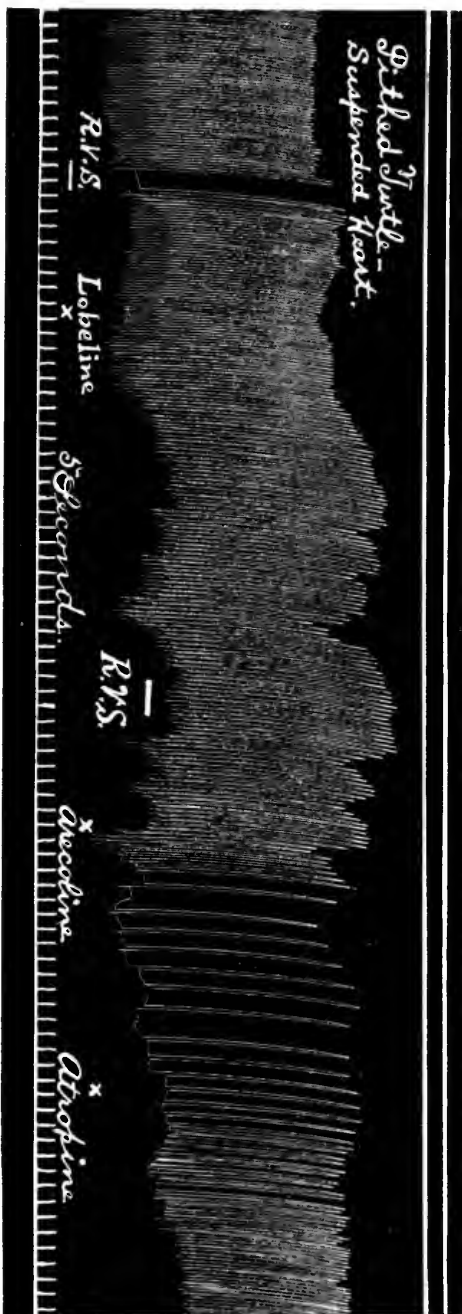

Fig. 283.—Turtle heart tracing showing the action of lobeline, arecoline and atropine. At R.V.S. the right vagus trunk was stimulated, both before and after lobeline was applied. The first produces inhibition, the second does not. Why not? Arecoline and atropine both act after lobeline.

the turtle? Do you have any evidence that these structures exist in the turtle?

As soon as the curve returns to normal prepare to in-

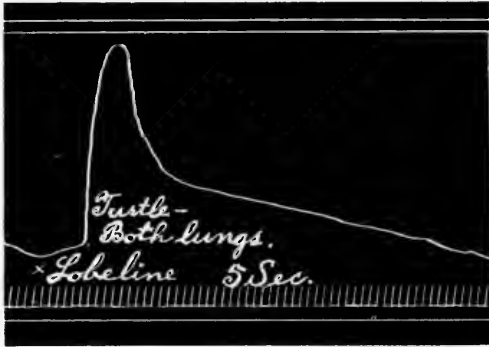

Fig. 284.—Turtle lung tracing showing the action of lobeline.



Fig. 285.—Turtle lung tracing showing the action of lobeline.

ject pilocarpine (one cubic centimeter equals one-half milligram). The heart may not be beating very strongly and if this is the case it may be advisable to wait a few minutes for the heart to recover. A few drops of a dilute (1:10,000)

adrenaline solution may be poured on the heart to advantage.

Prepare to take a second record and then inject one or two cubic centimeters of pilocarpine solution into the heart. Wait for the drug to act as the heart may be slowed or stopped and the solution may not reach the lung tissues for some time. Do you get a satisfactory record? How do you explain this? On what structures does pilocarpine act? Do you have any evidence that such structures exist in the turtle's lungs? What general conclusions can you draw from the experiment?

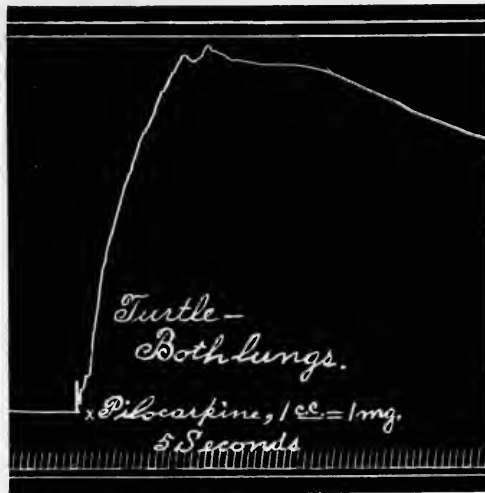

Fig. 286.—Turtle lung tracing showing the action of pilocarpine.

EXPERIMENT LXXXI.

Lobeline, Adrenaline, Pilocarpine, Tetramethylammonium chloride. (Dog: Bladder Contraction, Blood-pressure, Respiration, Pupil.)

1. Arrange an eight kilo dog (the animal may be given a small dose of chloretone—150 milligrams per kilogram of weight) for recording blood-pressure, bladder contrac-

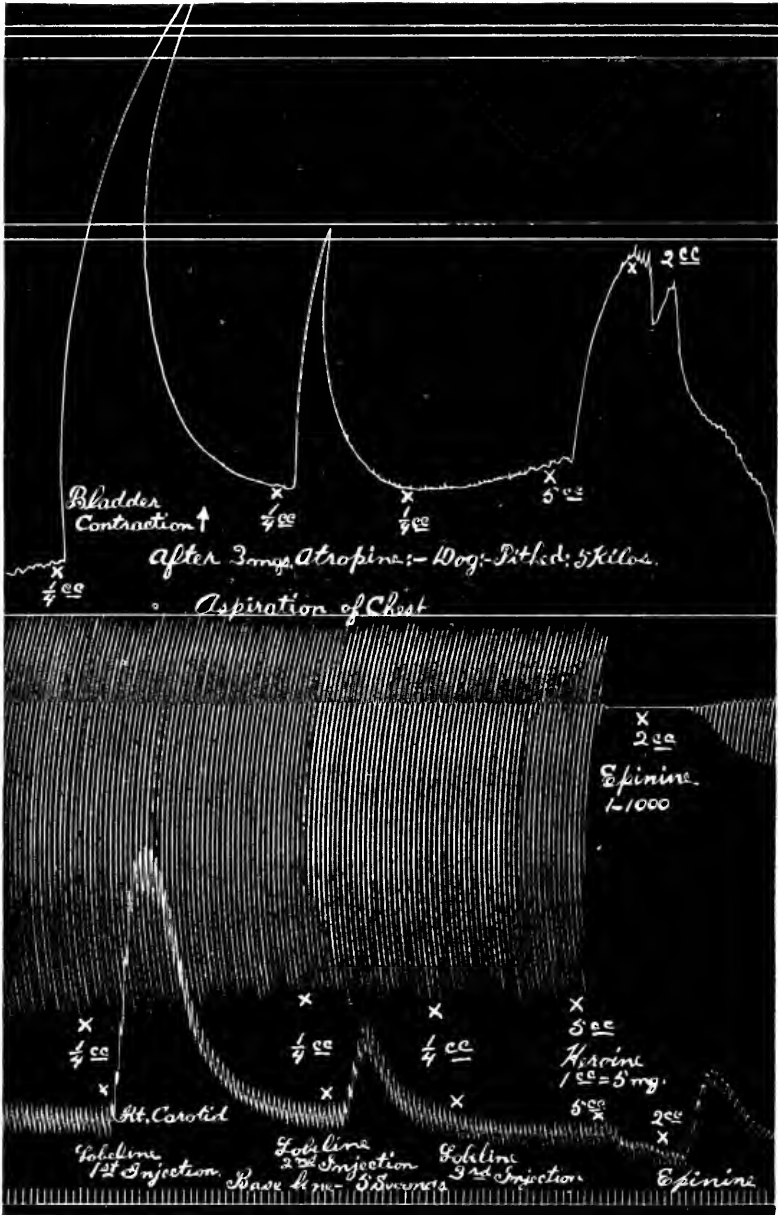

Fig. 287.—Tracing showing the action of lobeline (three injections) and heroine on the bladder, bronchioles and blood-pressure in a spinal dog that had previously received 3 milligrams (intravenously) of atropine.

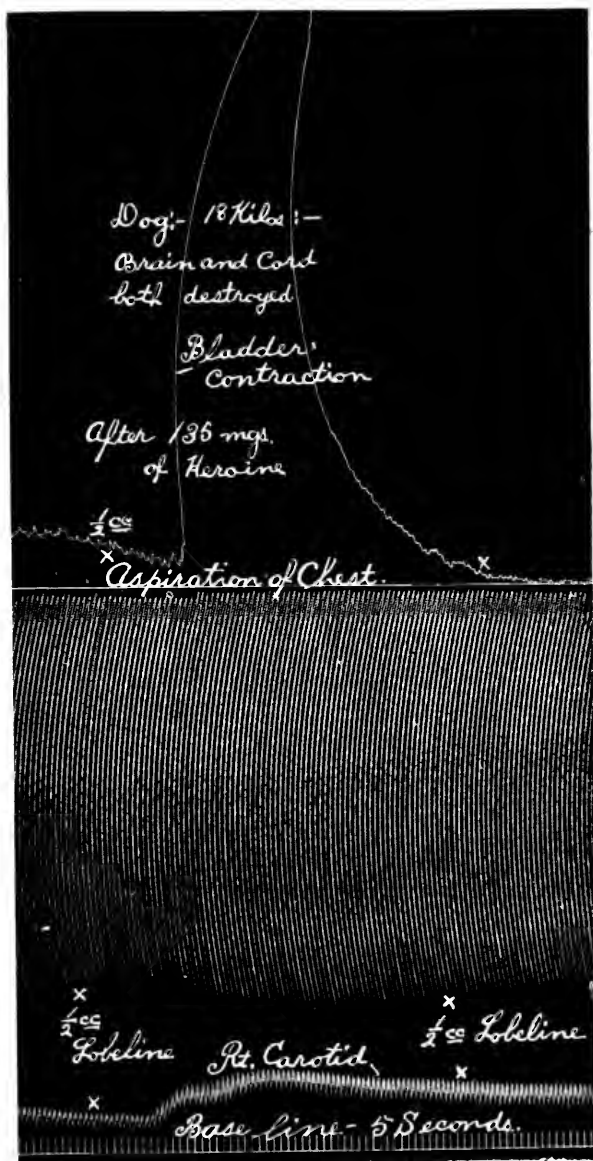

Fig. 288.—Tracing showing the action of lobeline (two injections) on the bladder, bronchioles and blood-pressure in a spinal dog which had previously received a sufficient amount (135 mgs.) of heroine to render the animal insusceptible to the specific action of the drug on the bladder and bronchioles. Evidently here the first dose of lobeline produced ganglionic paralysis as shown by failure of response to the second dose.

tions, and respiration. Isolate and ligate loosely both vagi nerves. Stimulate one and watch the corresponding pupillary response. Keep this in mind for later comparisons. The three injecting burettes contain lobeline (one cubic centimeter equals one-half milligram), adrenaline (1:10,000) and pilocarpine (one cubic centimeter equals one milligram).

Take one inch of normal tracing. The bladder record (leave space for an upward contraction) should be on the upper part of the drum; below this are the blood-pressure, respiration and base line in succession. Be sure the bladder tambour and manometer pointer will just pass each other on the drum (the tambour to the left). When all is ready watch both pupils closely and inject one-half cubic centimeter of lobeline solution. There should be an immediate and profound response. Do the pupillary, bladder and vascular responses all correspond? On what anatomical structures does the drug act to produce each of these reactions? Could you find these structures in a dissection of the animal? Allow the animal to return to normal.

Inject one-fourth cubic centimeter of lobeline. Do you get a response corresponding to that produced by the first dose of the drug? How do you explain this? Could you prove the truth or falsity of your conclusions? How would you do this? When the records return to normal inject one cubic centimeter of pilocarpine solution. What is the action of pilocarpine after lobeline? Do these drugs counteract each other in any respect? Do your records show this? Explain the results fully. Inject a second dose of pilocarpine if necessary to get satisfactory records.

Inject one-half cubic centimeter of adrenaline and see if the lobeline and pilocarpine have changed the response of the animal to the adrenaline in any way. Watch the pupils closely as the adrenaline is injected. Now stimulate each vagus nerve and see how the heart, blood-pressure

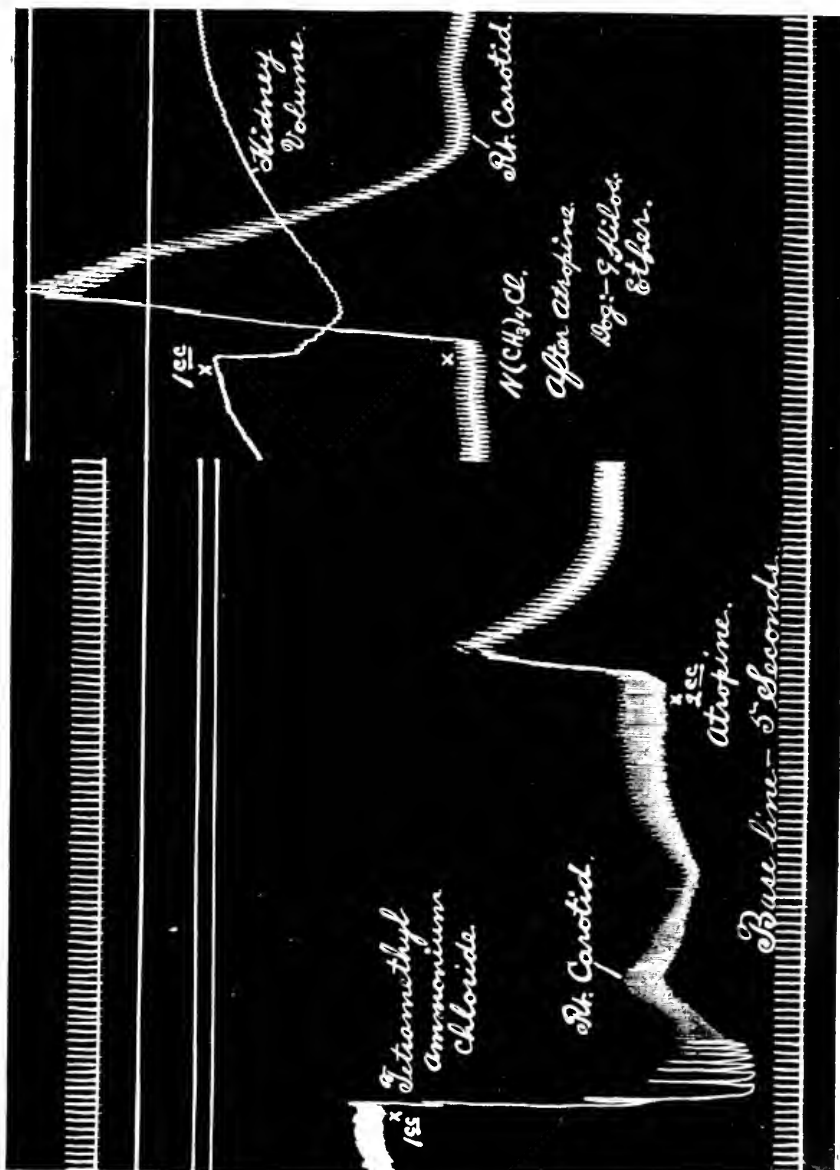

Fig. 289.--Blood-pressure (and kidney volume) tracing showing the action of tetramethylammonium chloride before and after the injection of atropine. The first dose of tetramethylammonium chloride caused a great fall in pressure because the vagus endings in the heart were intact. The second dose, however, following paralysis of the vagus endings by atropine, caused a great rise in pressure. The kidney volume also actively shrinks. To what is this action due?

and pupils are affected. Is the respiration changed by the stimulation? Have any of these phenomena been influenced in any way by the drugs? If so, what anatomical structures were involved and how were they affected? Are these structures ever involved in pathological conditions

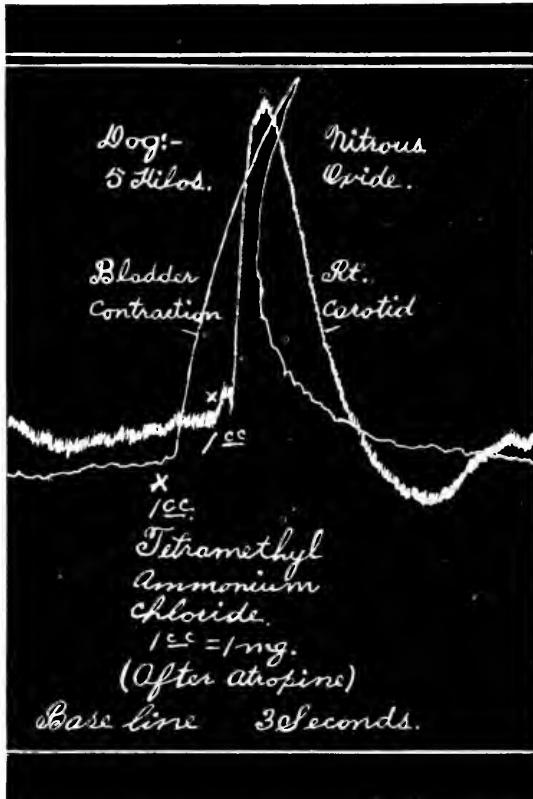

Fig. 290.—Tracing showing the action of tetramethylammonium chloride on the blood-pressure and bladder contractions in a dog which had previously received a dose of atropine. Animal anesthetized by nitrous oxide.

such as typhoid fever or pneumonia? What symptoms would these reactions probably produce in a non-anesthetized animal?

If the animal is still in suitable condition empty out the pilocarpine and fill the burette with a solution (one cubic

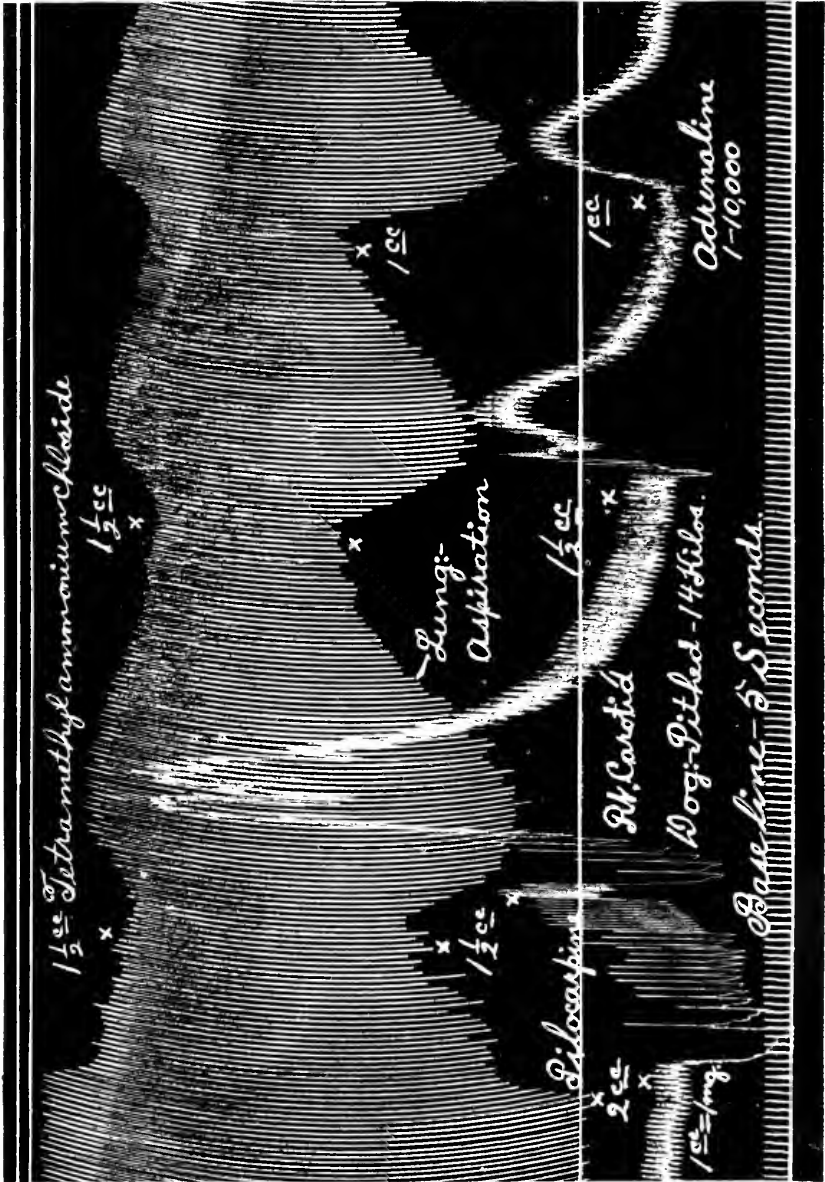

Fig. 291.—Tracing showing the action of pilocarpine, tetramethylammonium chloride (two injections) and adrenaline on the bronchioles and blood-pressure in a spinal dog. Note the peculiar combination of cardio-inhibition and vaso-constriction produced by the tetramethylammonium chloride which also dilates the bronchioles, while pilocarpine, which likewise causes cardio-inhibition, produces contraction of the bronchioles. Adrenaline has still a different action. How do you explain these various phenomena?

centimeter equals one milligram) of tetramethylammonium chloride. Inject one cubic centimeter and determine what action this drug has after lobeline. What structures are affected by the drug and how are they influenced? Kill the animal with a big dose of the tetramethylammonium chloride. Was the bladder contracted before the last drug was injected? If so, you may miss part of the action of the drug.

EXPERIMENT LXXXII.

Lobeline, Nicotine, Pilocarpine. (Guinea Pig, Cat, Dog, or Rabbit: Uterus Strip.)

(Consult also the following experiment. One animal may be used for both experiments.)

1. Examine carefully the apparatus shown in Fig. 292. (Consult also Fig. 316). This simple arrangement is sufficient for ordinary qualitative results but the more elaborate apparatus should be used for especially important experiments such as drug assaying by the uterine strip method.

The animal used in this experiment may often be obtained from another group of students who have already performed another experiment. It is important to save as many animals as possible. If a dog or cat is used it must first be etherized, then one horn of the uterus (including the ovary) is dissected out very carefully so as not to injure the tissues. From this a small uterine strip is prepared and with a bent pin hook one end of the uterine strip is attached to the lower end of the bent glass tube as shown in the picture. By another pin hook and a small thread the upper end of the tissue is attached to the short arm of the heart lever. The lever is weighted on the long end by a (movable) bull-dog clamp. If a guinea pig is used (and these animals are very satisfactory) it may first be anes-

thetized or its head may be instantly cut off with a hatchet or sharp hand ax. The animal may be anesthetized with nitrous oxide (see Experiment VII) if it can be killed in a few seconds after it is removed from the large bottle. Ethyl chloride may also be used instead of ether.

As soon as the uterine strip is adjusted in the beaker, warm (38°) normal salt solution (or Locke's solution, etc.)

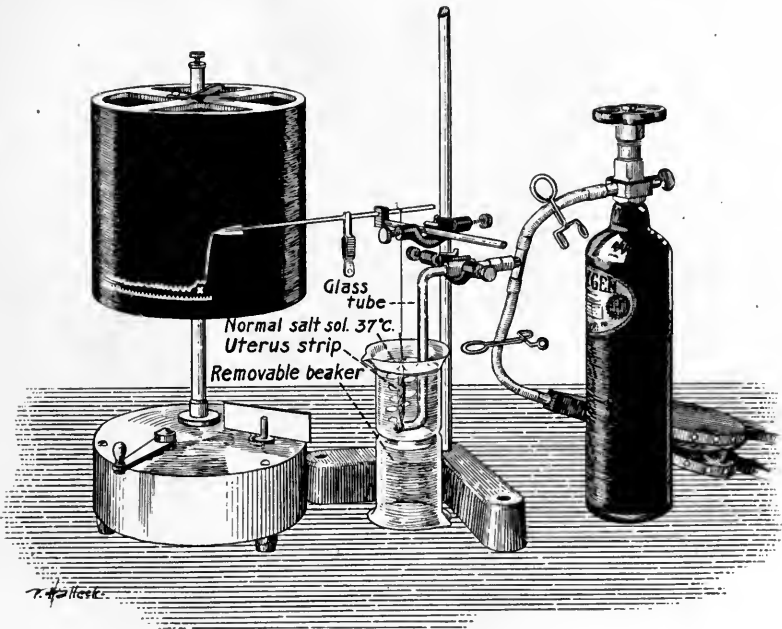

Fig. 292.—Arrangement of apparatus for recording contractions from a uterine strip, or from an arterial ring, ureter ring, intestinal strip, ring of frog's stomach, etc.

is placed in the beaker. The writing point of the lever is brought on to the drum which is started at the slowest speed. Small rhythmic contractions should be recorded. When sufficient normal records have been taken (there are great variations in the normal contractions exhibited by different uteri) then with a pipette pour one or two (or more) cubic centimeters of a solution of lobeline (one cubic centimeter equals one milligram) into the beaker.

The oxygen should be bubbling slowly but constantly through the solution. This serves not only to oxygenate the solution but also stirs it. Do you get a response to the lobeline? How do you explain the result? After a few minutes slip the lower beaker out and replace the upper one by another containing fresh warm salt solution. How does the uterine strip respond to this? Take some more normal tracings and then pour one or two (or more) cubic centimeters of nicotine solution (one per cent) into the beaker. Discuss your results fully. Change the beaker again replacing it with one containing fresh warm salt solution. Get some more records and then pour a small amount of pilocarpine solution (one cubic centimeter equals two milligrams) into the beaker. Discuss the results in full. Add some atropine solution to the beaker and see if this affects the uterine strip. (The size of the "dose" of the drugs used in this experiment may have to be varied a great deal in different experiments. The doses here given will often be too large but the student can test this out for himself.)

EXPERIMENT LXXXIII.

Adrenaline, Lobeline, Nicotine, Pilocarpine, Atropine.

**(Guinea Pig, Rabbit, Dog, Cat, Frog:
Intestinal Segment.)**

(Consult the previous experiment to save animals.)

1. Repeat the above experiment using a small ring cut from the small intestine of one of the above mentioned animals. Do not injure the intestine if it can be avoided in making your dissection. Be sure the intestinal ring is properly weighted (try different weights to select the right one) and then record some normal contractions. Add some adrenaline (1:10,000) to the beaker and record the results. How do you explain this? Change solutions and

when normal contractions again occur add some lobeline solution to the beaker. Explain the results. If a contraction is produced counteract this by adding adrenaline to the beaker. Repeat this process with nicotine and pilocarpine. (It may be necessary to use a fresh ring of in-

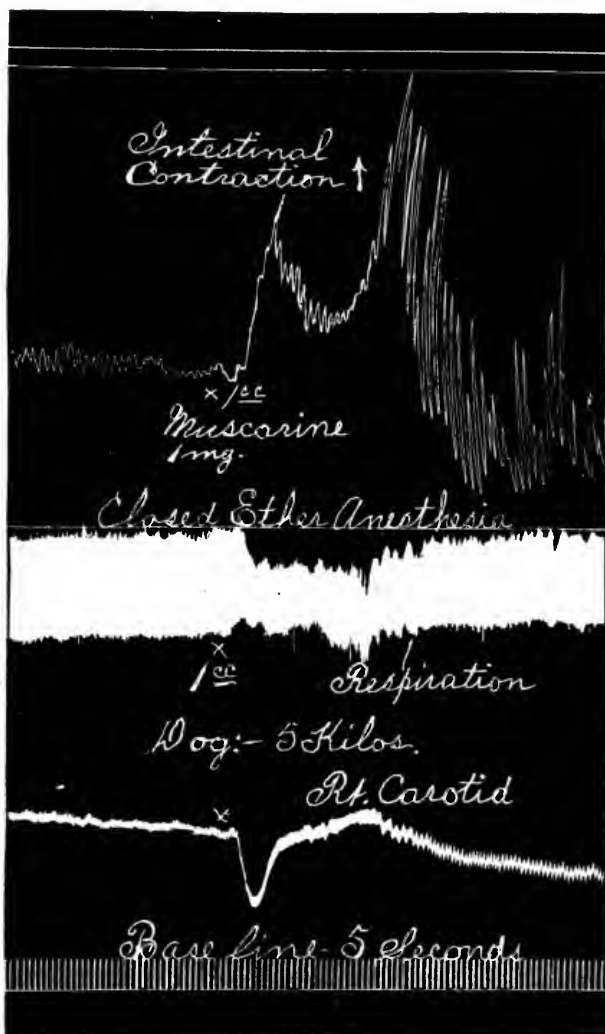

Fig. 293.—Tracing showing the action of muscarine on intestinal contractions, respiration and blood-pressure in a dog.

testine.) Again add pilocarpine to the beaker and if a contraction is produced then add atropine solution (one cubic centimeter equals five milligrams). Do you obtain satisfactory results? State in full your conclusions. Add some barium chloride (one-half per cent solution) to the beaker and note the results.

A part or all of the experiment may be repeated by using a longitudinal strip of the small intestine. What effect does adrenaline have on longitudinal strips? What is the innervation of the small intestine? (Fig. 318).

The experiment may be repeated using a ring of the stomach of a frog.

EXPERIMENT LXXXIV.

Muscarine, Atropine. (Turtle: Lung Tracings.)

1. Prepare a turtle for taking lung tracings. Inject into the heart one or two cubic centimeters of muscarine solution (one cubic centimeter equals one-half milligram) and record the result. Do you get a contraction of the lungs? How do you explain your results? Is the heart beating well? Inject one or two cubic centimeters of atropine solution (one cubic centimeter equals one-half milligram). Do you get a contraction or a relaxation of the lungs? How do you explain the results? Perhaps you may want to repeat the injection of atropine on a second turtle. How do your results compare with those obtained in a dog or cat?

If the lungs relax after a contraction can the relaxation be recorded if the weight of the liver and intestines is resting on the pulmonary sacs? Could you modify the experiment to advantage in any way? It is usually advisable to dissect out the liver and intestines and most of the skeletal muscles before trying to record lung contractions. Do not injure the vessels going to the lungs.

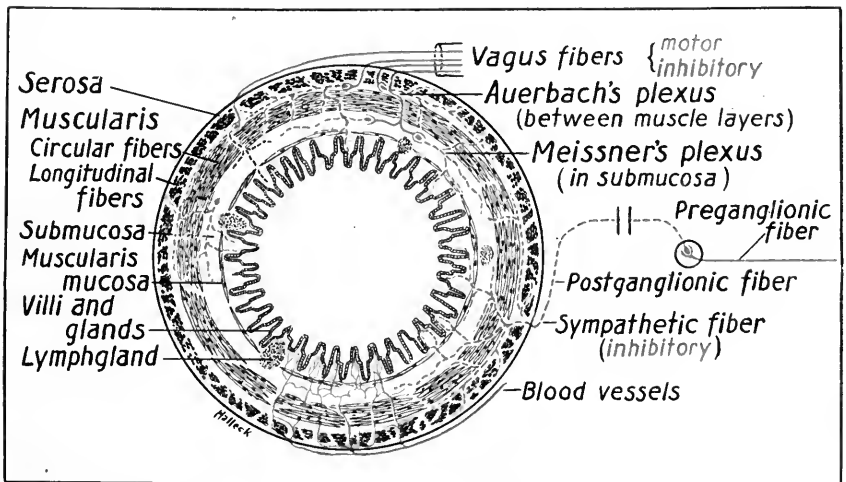

Fig. 294.—Diagrammatic cross-section of the intestine (small) to show the manner of its innervation. See also Fig. 318.



EXPERIMENT LXXXV.

Physostigmine. (Frog: Heart Tracing.)

1. Pith a frog and obtain heart tracings showing the action of physostigmine (eserine). The salicylate of eserine is the best salt to use, the sulphate is deliquescent—one cubic centimeter equals one milligram. The solutions should be freshly prepared for each experiment.

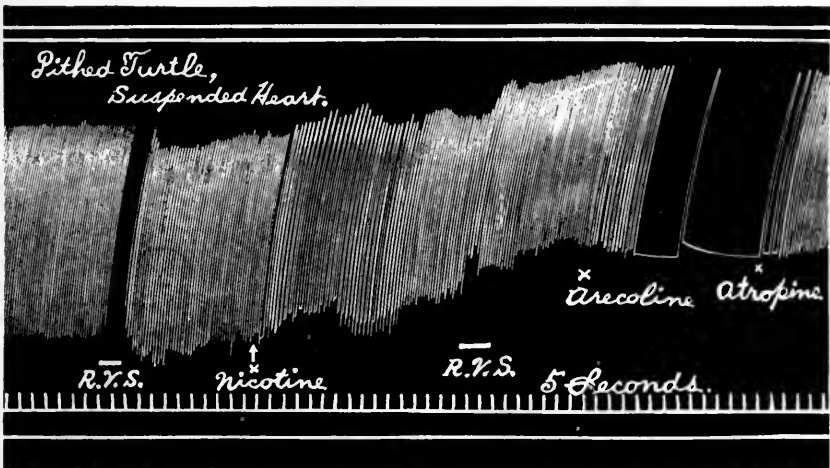

Fig. 295.—Turtle heart tracing showing the action of nicotine, arecoline and atropine. At the places marked *R.V.S.*, the right vagus nerve was stimulated. Before nicotine inhibition is produced but this is absent after the drug is applied. Note the temporary slowing of the heart immediately following the application of the drug. How do you explain this? The beat again becomes rapid but arecoline slows it while atropine causes a return of the normal rate. Explain the actions.

Does the drug have any action on the inhibitory apparatus of the frog? Compare this with pilocarpine.

EXPERIMENT LXXXVI.

Physostigmine, Atropine, (Sodium Nitrite. (Frog: Stomach Ring.)

1. Prepare a ring of the stomach of a frog and arrange it in the manner shown in Fig. 292 for recording contractions on the drum. Is the muscle ring already in a state of

strong tonic contraction? If it is, can it contract any further? Adjust the weight and pour into the beaker one or two cubic centimeters of eserine solution. (Add more drug if necessary.) What conclusions can you draw? Add some atropine to the beaker and note the results.

The experiment may be repeated (a fresh stomach ring may be needed) and after the eserine action has been well developed sodium nitrite solution (one-half per cent—a few cubic centimeters) can be added to the beaker. What do you observe? What conclusions can you draw? On what structures and in what manner does each drug act? Of what clinical significance is each of these actions?

EXPERIMENT LXXXVII.

Physostigmine. (Turtle: Heart Tracing.)

1. Repeat Experiment LXXXV using a turtle instead of a frog. Does the drug act in any way on the crescent ganglia or the post ganglionic fibers? Compare this with nicotine and arecoline.

EXPERIMENT LXXXVIII.

Physostigmine, (Adrenaline, Atropine). (Turtle: Lung Tracing.)

1. Arrange a turtle for recording lung tracings and then inject into the heart one or two cubic centimeters of eserine solution (one cubic centimeter equals one-half milligram). What action has the drug in this case? Is this a ganglionic or nerve ending reaction? Could you prove your conclusion? Now make a second injection of eserine into the heart (if it has not already become too weak or stopped) and follow this with an injection of adrenaline (1:1000). Atropine may be used instead of adrenaline (or better a second experiment on a fresh animal may be performed).

What conclusions can you draw? Do atropine and adrenaline act on the lungs of the turtle in the same way that they do on the dog's lungs? Could you prove your conclusions?

EXPERIMENT LXXXIX.

**Physostigmine, Hyoscine, Adrenaline, (Trimethylamine).
(Dog: Respiration, Blood-pressure, Intestinal
Contractions.)**

(See following experiment.)

1. Arrange a dog (a cat or rabbit may be used) for recording blood-pressure, respiration, and intestinal contractions. (For the latter purpose use the finger cot, catheter, burette, and tambour method.) The three injecting burettes contain physostigmine (one cubic centimeter equals one-half milligram), hyoscine (one cubic centimeter equals one milligram—atropine or hyoseyamine may be substituted—could you use homatropine?) and adrenaline (or trimethylamine hydrochloride—one cubic centimeter equals one milligram).

Take a normal record and then inject two cubic centimeters (for a cat or rabbit one-half cubic centimeter) of physostigmine. How is the respiratory tracing affected? Do you get normal results from the heart and intestine? Was the dose too large or too small? The instructor may be able to advise you on this point, because he can observe the action of the same drug solution you are using in the experiments performed by other members of the class. As soon as the action of the eserine becomes well marked inject a dose (one-half cubic centimeter for a dog) of adrenaline (or trimethylamine, one cubic centimeter). What action has this on the respiration? Does it counteract the eserine? Explain the relations of these two drugs to the respiration both centrally and peripherally. How is

the eserine intestinal reaction affected by adrenaline? What structures are involved and how are they affected? What is the innervation of the intestine? Would it be advisable for a physician to understand this innervation? How could he best learn the nervous control of the intestinal movements?

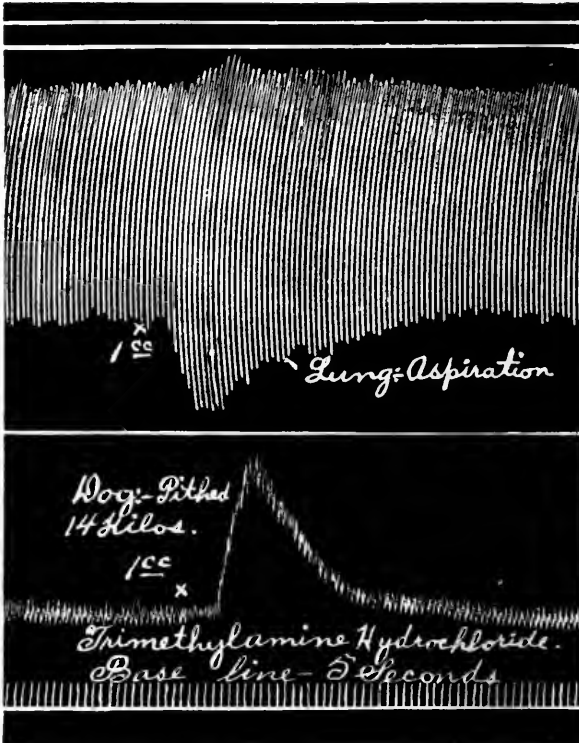

Fig. 296.—Tracing showing the action of trimethylamine on the bronchioles and blood-pressure of a spinal dog. The bronchioles were in a state of moderate contraction from the effects of a dose of pilocarpine at the beginning of the tracing. Record made by aspiration of the chest. (See Experiment LXX.)

Wait till the animal returns to normal. Take another starting record and inject a second dose of physostigmine. You can estimate the correct size of this dose from the results of your first injection. When the action of the drug becomes marked on the animal quickly observe the mouth

for saliva, the pupils for change in size, and the respiratory movements for difficulty in expiration or inspiration. At once inject one cubic centimeter of hyoscyne (for a dog,

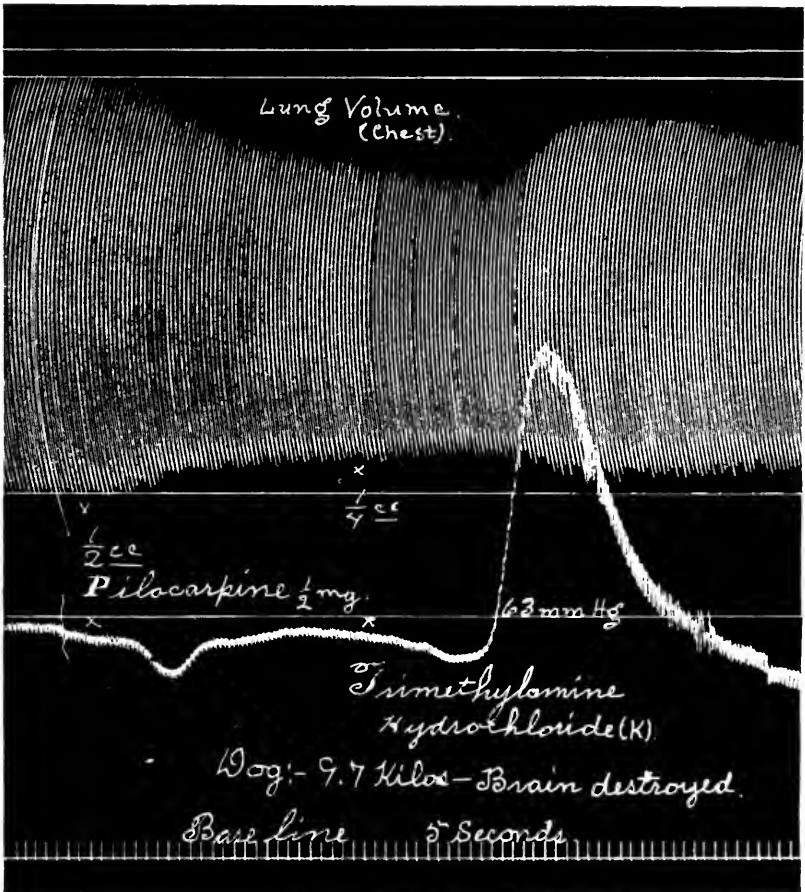

Fig. 297.—Tracing showing the action of pilocarpine and trimethylamine on the bronchioles and blood-pressure in a spinal dog. Record made according to the method described in Experiment XXIX.

one-half cubic centimeter for a cat or rabbit) and observe the effects. What conclusions can you draw? Atropine or hyoscyamine may be substituted for the hyoscyne. How does the action of eserine compare with that of pilocarpine

or muscarine or arecoline? What differences do you note? Stimulate one vagus nerve to see if the heart can be inhibited. If so give another dose of hyoscyne (or atropine or hyosecyamine).

If the animal is still in fair condition inject another dose of physostigmine to see if the respiration, intestine and circulation are affected in the same way as they were before the atropine was given. Do you observe any fine muscular tremors over any parts of the animal? Were these present before the atropine was given? Has the atropine affected the tremors in any way? Explain. If you get a marked intestinal reaction then inject one cubic centimeter of adrenaline and see what occurs in the intestinal record. Explain fully.

Kill the animal with a large dose of eserine. Which stops first, the heart or respiration? Save the animal for the following experiment.

EXPERIMENT XC.

Adrenaline, Sodium Nitrite, Barium Chloride. (Dog, Cat or Rabbit: Perfusion of Kidney.)

(See preceding experiment. Dog's kidneys are much to be preferred.)

1. Observe carefully the arrangement of the apparatus shown in Fig. 298. The water motor has a wire rod attached eccentrically by a screw to the end of the shaft. This rod passes up to the shelf above and ends in a curved hook which moves rapidly up and down and thus interrupts the flow of normal salt solution (or diluted, defibrinated blood) from the pressure bottle (or bottles) above. This mechanical interruption fairly closely approximates the action of the heart in producing a pulsation in the arteries carrying blood to the various organs.

The apparatus should all be set up and in full working

condition with the water bath heated to 38 or 39 degrees Centigrade before the animal is killed. Also a dish of warm salt solution, three small cannulas (for the kidney vessels and ureter), threads and a rubber bulb (1 or 2 oz.) carrying a small pointed cannula should be prepared. The bulb is used to flush out the vessels of the kidney immediately

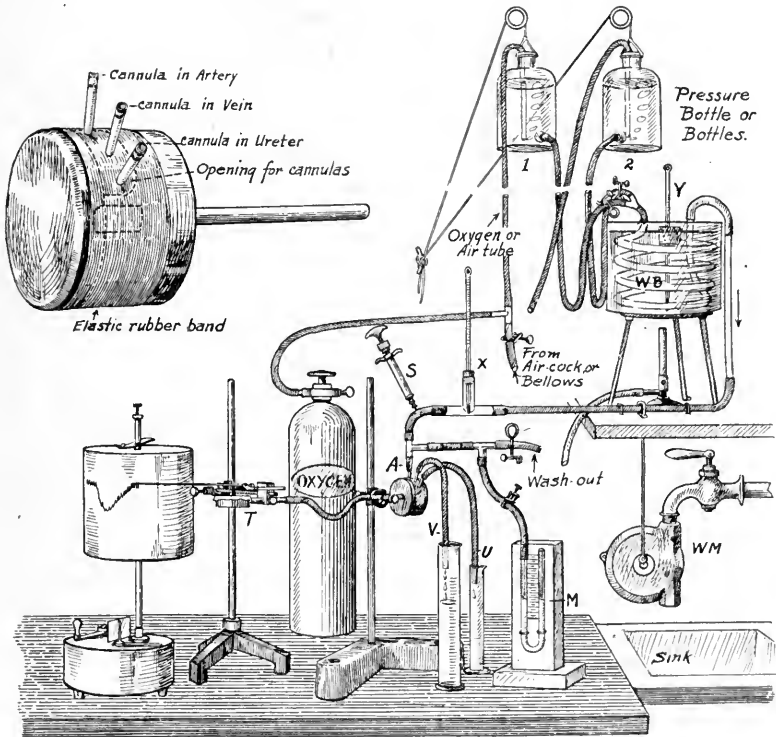

Fig. 298.—Arrangement of apparatus for perfusion of an excised organ. (For discussion see text.)

after excision. This prevents clots from forming in the capillaries and smaller vessels of the organ.

As soon as the animal dies the abdomen is opened and the left kidney is carefully excised, leaving the artery, vein and ureter as long as possible. The kidney is immediately transferred to the dish of warm salt solution, the rubber

bulb is drawn full of the solution and the point of the cannula is inserted into the cut end of the renal artery. The cannula can be held in temporarily while the bulb is squeezed with a moderate but firm pressure. The blood is soon flushed out of the kidney vessels. Cannulas are then quickly tied in the renal artery, vein and ureter. The kidney is transferred to the small chamber shown in the upper left hand corner of Fig. 298. This chamber is made of a large, deep metal pill box having a notch cut out of the upper side. Through this notch the three cannulas are passed and then the broad rubber band (which was already around the box) is slipped over the notch while the three cannulas in order are passed through holes (air tight) made in the rubber band. The lid is then placed on the box and the rubber band is slipped over the seam between the lid and the box proper thus making the chamber air tight. The box is then connected up as shown in the picture and the stock solution is started through the tubes (from which all air has been previously expelled). The motor is started and the pressure bottle is raised to a height just sufficient to give the maximum excursion to the tambour pointer at each pulsation of the fluid in the tubes. The solution passes through the kidney slowly and fresh (warm) solution should be run down into the tubes occasionally.

When all adjustments are made take one-half inch of normal record and then with a hypodermic syringe inject some adrenaline solution in the tube above the artery as illustrated. A response should be obtained at once on the drum if the circulation through the kidney is good. Wait for the kidney to expand again. How do you explain these results? As soon as the contraction wears off (or a little before) inject one or two cubic centimeters of sodium nitrite solution (one-half per cent) into the rubber tube. Note the effect when this reaches the kidney. Explain the results in full.

When a satisfactory record has been obtained examine the temperature of the solution entering the kidney and if necessary change the pressure of the perfusion fluid. (It may be advisable to flush out the organ by temporarily increasing the pressure considerably.) When everything

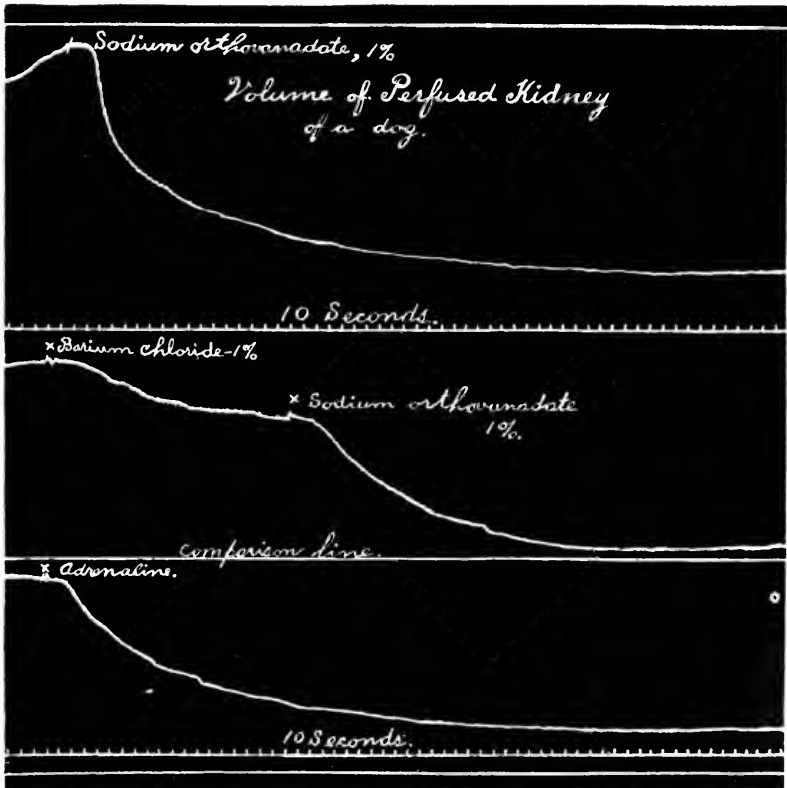

Fig. 299.—Tracings made by the use of the apparatus shown in Fig. 298, showing the action of sodium orthovanadate, barium chloride, and adrenaline on the volume of an excised kidney from a dog. (For discussion see text.)

is again ready inject one or two cubic centimeters of barium chloride solution (one-half per cent). Wait for the drug to pass into the kidney. The circulation often becomes slow in organs thus perfused. Do you get a satisfactory record? Explain the action of the drugs studied.

The right kidney or the spleen of the same animal may be used by other members of the class if sufficient apparatus is available. The motor and the pulsations in the perfusion fluid may be omitted if the apparatus cannot be obtained. The interrupted pressure is, however, much to be preferred as it is more effective in keeping up the circulation through the organ (and edema of the tissues may be prevented or much delayed in its appearance). The tin box chamber (oncometer) may be omitted and the rate of perfusion determined by counting the drops of solution leaving the vein. It is advisable, however, to get a volume record of the organ.

Many forms of perfusion apparatus have been devised and the student may find it necessary to use an outfit very different from that here described. (For description of an excellent perfusion apparatus, see Richards, A. N., and Drinker, C. K.: *Journal of Pharmacology and Experimental Therapeutics*, 1915, vii, pp. 467 to 483.)

EXPERIMENT XCI.

Physostigmine, Atropine, (Heroine), Adrenaline. (Spinal Dog or Cat: Bronchioles, Blood-pressure, and Bladder Contractions.)

1. Arrange a spinal dog (or cat if dogs are not available) for recording blood-pressure, bladder and bronchiole contractions. It is very advisable that the lung records be obtained by the aspiration method using the apparatus shown in Fig. 255. Pith the animal by destroying the brain through a trephine opening (Fig. 260). (Also read Experiment LXX.) The arrangements for recording the bladder contractions should be made (except attaching the recording tambour as this would interfere with the operations) before the apparatus used to hold the chest open is inserted and this should be done (*under positive artificial respiration*) before the animal is pithed, *which is the last operation*.

tion done before the records are started. This sequence of operative procedures is followed in order to save the vitality of the animal as much as possible—a spinal animal may not stand operations well. The injecting burettes contain eserine (one cubic centimeter equals one milligram), adrenaline (1:10,000), and heroine (one cubic centimeter equals five milligrams—other opium alkaloids, e. g., codeine, etc., may be used instead of heroine).

When all apparatus is arranged take half an inch or more of normal record and then inject one cubic centimeter (dog) of eserine. Do you get satisfactory bladder and lung records? A moderate dose of physostigmine has been found to render the endings of the vagi nerves in the bronchoconstrictor muscles more irritable than normally. Allow the animal to recover as much as possible from the drug and then stimulate each, or both, vagus nerves and determine exactly what influence they possess over the caliber of the bronchioles. Use varying strengths of the Faradizing current and also try varying lengths of duration of stimulation. It may be further instructive to use a series of single shocks of varying strengths and duration to bring out any bronchial changes. What conclusions can you draw? (See Dixon and Brodie: *Journal of Physiology*, 1903, xxix, p. 119; also Dixon and Ransom, *ibid*, 1912.)

Get the animal into as good condition as possible (give adrenaline if necessary) and then inject a second dose of eserine. When the effects come on inject one-half cubic centimeter of adrenaline to counteract the eserine. Do your records show normal results? Was the dose of eserine of the right size? (You must learn to estimate the dose to suit your animal often—the instructor can help you here.)

When the animal recovers give another dose of eserine or, if a bronchial constriction returns after the adrenaline effects wear off, *omit the eserine* and then inject one cubic centimeter of atropine solution (one cubic centimeter equals

one milligram—dog) and thus counteract the eserine action. How does the bladder respond to these drugs?

If the animal is still in a suitable condition inject five cubic centimeters of heroine or other (phenanthrene) derivative of opium (dose for an eight kilo dog) and see if

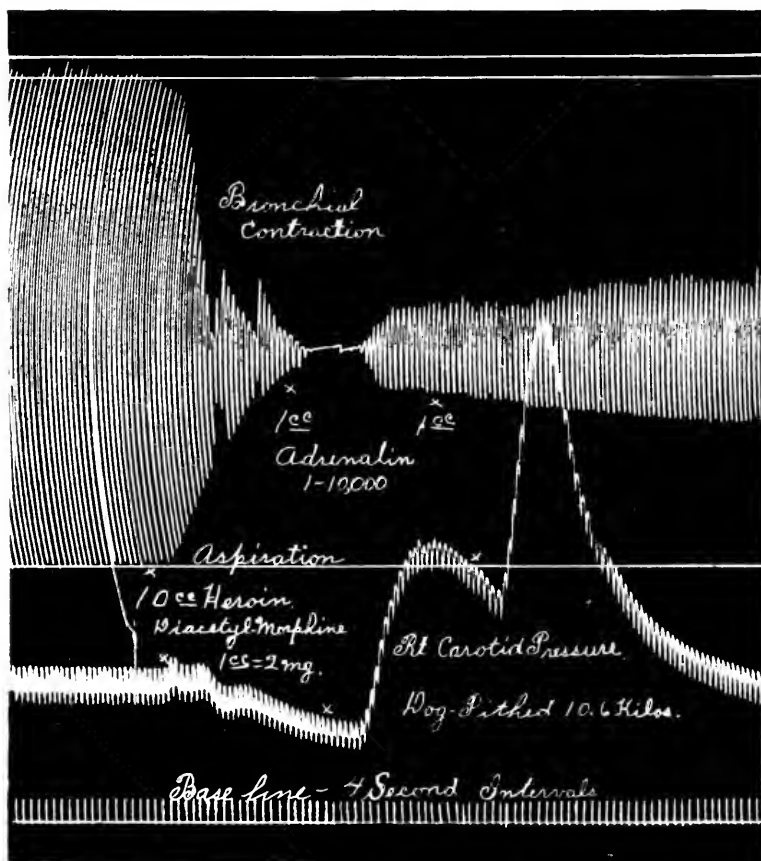

Fig. 300.—Tracing showing the action of heroine and adrenaline on the bronchioles and blood-pressure in a spinal dog. Made by aspiration of the chest.

you can get a bronchoconstriction or a bladder contraction after atropine. Counteract this with adrenaline (one and one-half cubic centimeters—dog).

How does eserine affect the respiration in a normal ani-

mal? Does the action of the drug on the bronchioles in this experiment indicate any way in which the drug might affect the normal respiration aside from its direct action on the respiratory center? Do you know of any disease in which the lungs *may be* affected in a manner similar to that brought about by eserine? Do you know of any remedy that might be used to counteract each condition? How might the remedy be applied? Stop the artificial respiration and kill the animal.

2. After death (if you have used a dog) shave the hair off of an area about three inches long and three inches wide over the lower part of the dorsal region of the spine. With a scalpel make a small incision in the skin about one-half inch to one side of the mid-line of the spinal column. A small trocar or a long syringe needle (or even a knitting needle) is now passed into the spinal canal, the needle or trocar being directed inward, mesially and slightly toward the head. By consulting a text-book on anatomy the student can determine about what relation the point of insertion of the needle through the skin should bear to the lower end of the nearest spinous process. See if you can get some spinal fluid to run out of the needle after it is inserted. Two or three punctures may be made for practice. The needle is then left in position and the tissues are dissected away around the needle down to the vertebræ and the position and relations of the needle are carefully studied. If you failed to pass the needle into the spinal canal what was the cause? Could you now succeed in a living animal? Sketch in your note book the relations of the spinous processes to the openings into the spinal canal and save for reference. Examine the size, structure and relations of the spinal cord. Can you isolate the posterior and anterior roots and the spinal ganglia? What are the functions of these structures?

EXPERIMENT XCII.

Cocaine. (Frog: Central Nervous System.)

1. Pith a frog (cerebrum only) and wait a while for the animal to recover from the shock. Then inject into the anterior lymph sac one cubic centimeter of cocaine hydrochloride solution (one cubic centimeter equals five milligrams—one-half per cent).

Observe the symptoms produced and save the animal for several hours (if it lives) to note the later action of the drug. What conclusions can you draw? Do you find any evidence of central nervous stimulation? How is the rate of beat of the lymph hearts affected?

EXPERIMENT XCIII.

Cocaine, Physostigmine. (Rabbit, Cat, Dog, Pigeon, Sparrow, Chicken, Rat: Action on Pupil.)

1. Into the *right eye* of as many of the above animals as you can obtain inject ten drops of a one per cent solution of cocaine hydrochloride. Open the lids, drop in the solution and try to hold the eye open a while to insure absorption. Wait ten minutes (examine the pupils from time to time) and then inject into the *left eye* of each animal ten drops of a solution of eserine (one cubic centimeter equals five milligrams). Observe both pupils carefully from time to time and when the actions of the drugs come on try the light reflex to see if the pupil contracts when a bright light (pocket flash light, lighted match, or bright light from a window, etc.) is *suddenly* thrown into the eye. On what does this light reflex depend? Explain in detail the nervous paths involved in its production. What differences do you note in the actions of the two drugs? On what structures does each act and how? How do these drugs affect the intraocular pressure? How is this brought about?

EXPERIMENT XCIV.

Cocaine, Novocaine. (Local Anesthetic Action.)

1. Cut a piece of filter paper one-half inch square and saturate it with two per cent cocaine hydrochloride solution. Place the filter paper on the *right side* of the upper surface of the tongue. Repeat this for the *left side* of the tongue but use a two per cent novocaine solution in this case. *Do not swallow any of the solutions.* Keep the pieces of paper on the tongue for a few minutes (the same for each drug) and then remove them. From time to time test the sensitiveness of the two spots on the tongue to touch, pain (pin point) and to minimal induction currents. What can you say regarding the comparative local actions of the cocaine and novocaine? If larger areas of the tongue are covered by the solutions (to include the taste organs, especially the tip and edges of the tongue) then the taste sensations for sweet, salt, acid and bitter may be tested. On what parts of the tongue are the taste organs to detect each of these sensations located? What conclusions can you draw from the experiment? Are the sensations of heat and cold affected or could you determine this from your experiment? Explain in detail.

EXPERIMENT XCV.

Cocaine. (Frog or Turtle: Heart Tracing.)

1. Pith a frog or turtle and test the action of cocaine on the heart and cardiac nervous mechanism using a solution containing two milligrams to one cubic centimeter of solution. Stimulate the vagus before and after the drug is applied. Repeat this carefully in each case for the crescent also. What conclusions can you draw? Have you tested other drugs having a similar action? If so what ones?

What structures are involved in this action? Keep taking records and watch for a characteristic grouping of the beats in fours, threes, twos, etc. The drug is especially liable to produce this result.

What action would nicotine or lobeline or pilocarpine or strychnine have on the frog or turtle heart after cocaine had produced its first effect on the organ? Is this action the same in the mammal? Explain.

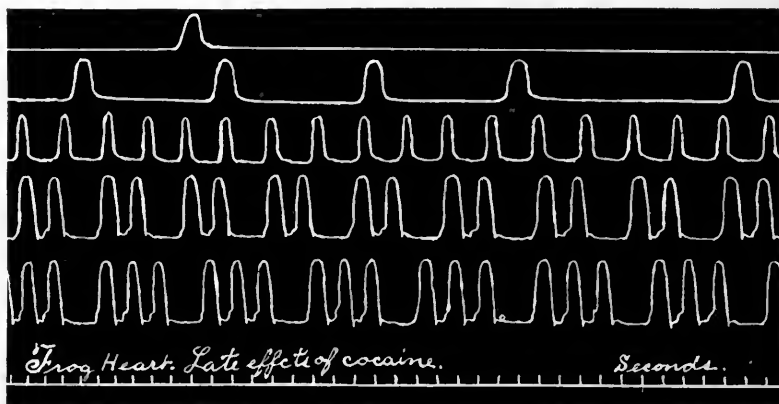

Fig. 301.—Frog heart tracing showing the later effects of cocaine. Note the grouping of the beats. The earlier effects on the innervation of the heart are not shown in the tracing.

EXPERIMENT XCVI.

Cocaine. (Frog: Action on Muscular Work.)

1. Arrange your apparatus as shown in Fig. 224. Pith a frog and ligate the right thigh tightly to stop the circulation in the corresponding gastrocnemius muscle. Into the dorsal lymph sac inject one cubic centimeter of cocaine solution (one cubic centimeter equals two milligrams). Arrange the frog with its right gastrocnemius muscle attached to the lever as shown in the picture. The secondary wires are made of very fine flexible copper and carry the current directly to the muscle. Keep the muscle damp

with normal salt solution. Meanwhile the drug is being carried to the other gastrocnemius muscle.

When all is ready take a normal fatigue tracing on the lower part of the drum. Then lower the drum and reverse the frog board and corresponding pieces of apparatus as described under caffeine (Experiment XLVII, page 245). Ligate the left thigh and take a fatigue tracing from the left gastrocnemius muscle which has in the meantime come under the influence of the cocaine. How do the two curves compare as to height of contractions and relative amount of work done? If there is a difference to what is it due? Are any nervous structures involved? Are you sure the rate of stimulation remained the same in both tracings? Would a slight variation in this produce much effect on the tracings? How does the action of cocaine compare with that of caffeine on muscular work?

EXPERIMENT XCVII.

**Cocaine, Novocaine, Barium, Adrenaline. (Dog or Cat:
Respiration, Blood-pressure, Intraocular Pressure,
Local Vascular Action and Intestinal
Contractions.)**

1. Arrange a dog (or cat) for recording blood-pressure, respiration and intestinal contractions, the latter by means of the finger cot, catheter, burette and tambour method. While the abdomen is open pick out a small area of the intestinal or mesenteric wall where the tissues look pink (many small vessels) and paint the area with cocaine hydrochloride solution (two per cent). Also paint a second area with novocaine solution (two per cent). Do not expose the viscera more than can be helped but observe these two areas closely for several minutes to see if any change in the appearance of the tissues occurs. If so how do you explain it? On a third small area of the *intestine* put one

drop of barium chloride solution (one per cent). Watch this area for a few minutes and record your results. A fourth area should be treated with one drop of adrenaline solution (1:10,000). Watch this spot a while and compare all the areas together. What conclusions and what explanations can you offer?

Close the abdomen and arrange to record the intraocular pressure (see Fig. 271). The injecting burettes contain cocaine hydrochloride (one cubic centimeter equals five milligrams) and adrenaline (1:10,000). On the drum the highest record should be the intraocular pressure, next below the intestinal record, then the blood-pressure, respiration and base line (showing the time intervals).

Take a short normal record and inject one-half cubic centimeter (dog) of cocaine solution. From time to time cautiously inject more cocaine and note the reactions of the animal to the drug. Observe the pupils, palpebral fissure, nictitating membrane and eye ball as a dose of the drug is injected. Are there any movements of any of these organs? Continue the observations and stimulate the corresponding vagus nerve. What effect does this have on the palpebral fissure? How do you explain it? Does the eye ball move? If so what muscles do this and what is their innervation? Has the intraocular pressure been affected?

Inject one-half cubic centimeter of adrenaline while still observing the eye and record the results. Explain all phenomena observed.

Continue to inject cocaine slowly from time to time and watch for irregularities in the respiration.

(The animal should not have been given any morphine. It is a very good rule never to give morphine to animals for ordinary experiments unless there is some special reason for so doing. Ether is the best anesthetic, and a small amount of chloretone may often be given to some advantage but even this frequently causes serious *cardiac* or respiratory disturbances.)

Cocaine often causes Cheyne-Stokes respiration. Can you produce this in your animal? (What other drugs often give this form of breathing?)

What action has cocaine on the intraocular pressure? Does your experiment demonstrate this? Will the method of application of the drug affect the result? If so drop some cocaine solution into the eye from which you are making your records. Does this have any effect? Will it be absorbed? Watch the pupils.

What action have small doses of cocaine on the blood-pressure? Is this action increased by larger doses? What is the treatment for cocaine poisoning? Would you advise giving a drug to lower the blood-pressure in this condition? Would the presence of an anesthetic in your animal make any profound change in the pharmacological action of cocaine? Have you used pure drugs? What are your conclusions?

Wait a reasonable time for Cheyne-Stokes respiration to develop. Then empty out the cocaine solution and place barium chloride solution (one-half per cent) in the burette. Adjust all writing points and take a normal record. Inject four cubic centimeters (dog) of barium solution (five cubic centimeters if the dog weighs ten kilos or more) and get a record showing the action of the drug. How is the intestine affected? The intraocular pressure?

Again empty out the barium and refill the burette with novocaine solution (one cubic centimeter equals five milligrams). Get the animal into as good condition as possible (give adrenaline if necessary) and then take a normal record. Inject one-half cubic centimeter of novocaine solution and compare the action with that of cocaine. Inject a larger dose. Which is more toxic, cocaine or novocaine? (Your animal may not be nearly so sensitive now to small doses of drugs as it was in the beginning.)

Empty out the novocaine and refill the burette with cocaine solution. Adjust all writing points and inject a large

dose of cocaine to get a death record. Are convulsions produced? What conclusions can you draw? Which is more poisonous, cocaine or pilocarpine?

2. After the animal dies dissect out the thoracic duct at the root of the neck. See if you can do this without penetrating the chest cavity. (See Figs. 302 and 319.) Do you find the lymphatic vessel coming from the head region?

3. Turn the body of the animal over on its side and dissect out a section of the back bone covering two or three vertebræ. Cut away the laminae and remove the spinous processes from two or three vertebræ. Can you isolate the cord? How large is it? Can you make out the anterior and posterior nerve roots? Locate a posterior nerve root ganglion. What is the function of this ganglion? Does this bear any relation to the action of cocaine? If so what? Could you pass a long hypodermic needle through the skin and tissues of the back down into the spinal canal? Study the anatomy of these structures carefully and try to decide on what technic you would use in making a spinal puncture.

EXPERIMENT XCVIII.

Novocaine. (Dog: Spinal Anesthesia.)

(This experiment should be performed only at the discretion of the instructor, and then by students who have some knowledge of aseptic operations. It may be done as a demonstration.)

1. Sterilize by boiling in water for five minutes a good hypodermic syringe having a large needle at least two inches long. Prepare a novocaine solution (two per cent) and sterilize it by boiling for a brief period of time. *Cool the solution* but see that it does not become contaminated with any organisms. (Keep it in a sterile test tube plugged with sterile cotton). Place on the operating table a razor (clippers are also desirable), a pan of strong soapsuds,

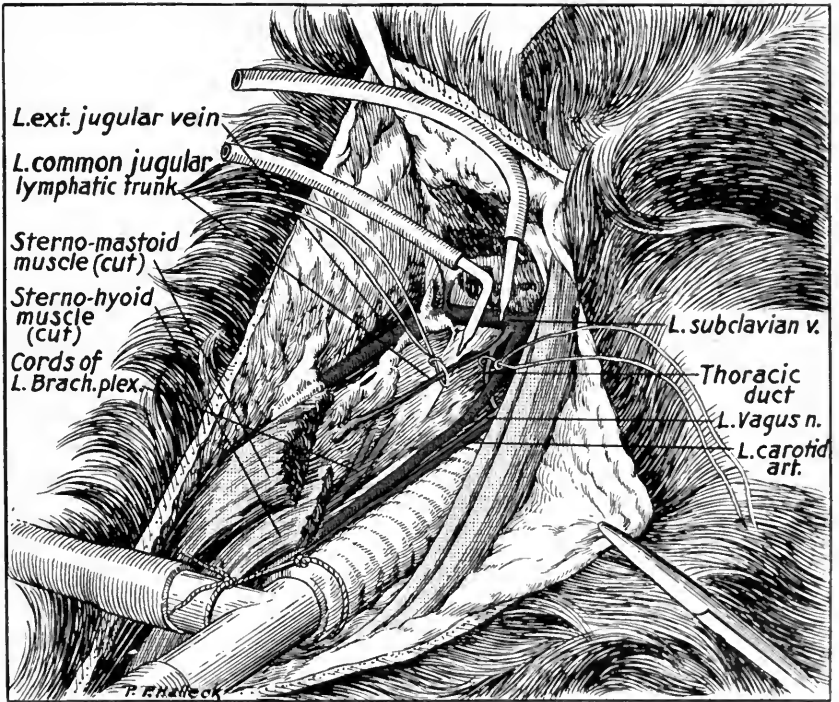
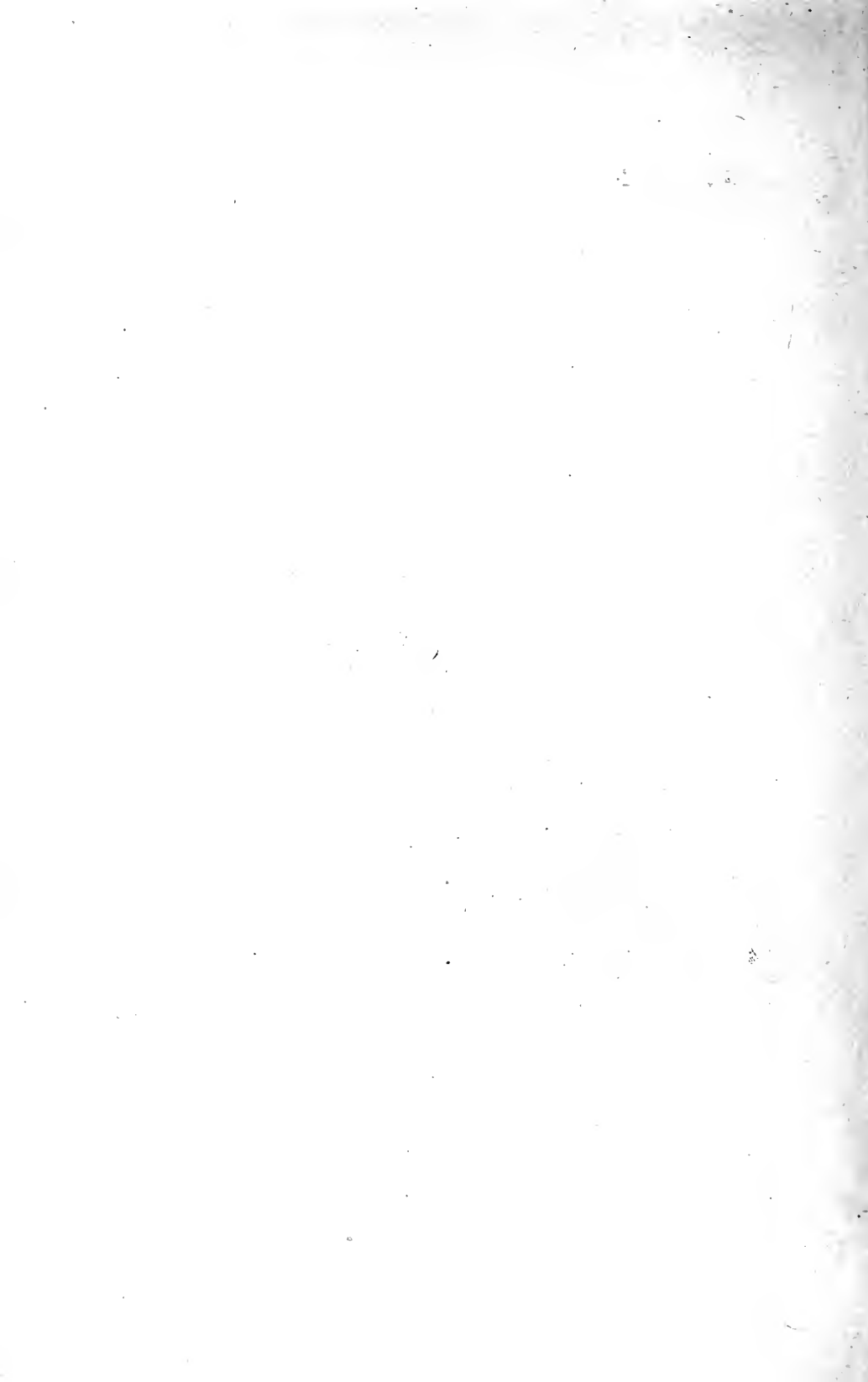

Fig. 302.—Dissection showing the method of exposing the lymphatic ducts and connecting cannulas to collect the lymph or chyle. It is very desirable to avoid entering the apex of the chest cavity when a cannula is placed in the thoracic duct.



some cotton sponges, a bottle of alcohol (95%), a bottle of tincture of iodine, a large pan containing a liter of water and a bottle of liquor cresolis compositus. Two or three sterile towels may be used to advantage.

The operator washes and scrubs his hands thoroughly with soap and water and waits for the assistant to prepare the animal.

When all preparations are made a dog weighing preferably about ten kilos is gently placed on its left side on the operating board and tied down. Do not excite or scare

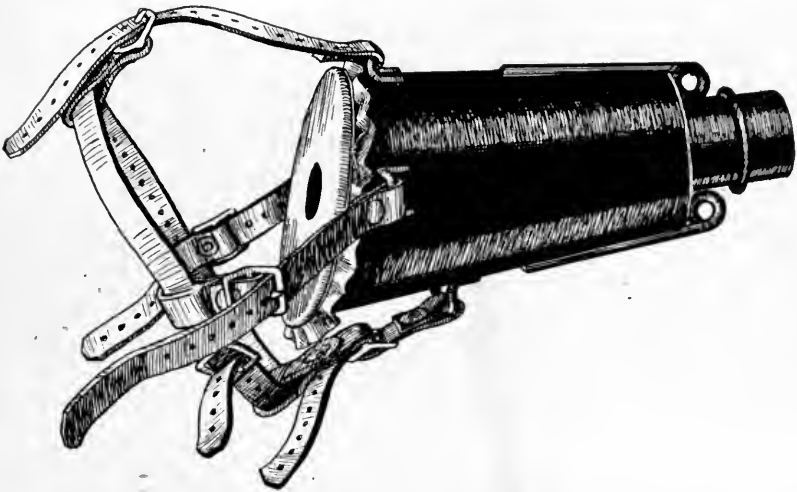

Fig. 303.—Metallic muzzle (made of sheet brass) for administering an anesthetic to a dog by the closed method. A heavy, perforated rubber membrane is tied (with wire) over the rear end of the muzzle. The animal's nose and mouth are thrust through the opening in the rubber membrane.

the animal. Nitrous oxide and oxygen are then administered to the animal until it becomes unconscious. This is best done with an apparatus like those shown in Figs. 116, 118, and 172. It usually requires *at least ten minutes* to get a dog fairly deeply anesthetized with nitrous oxide (and oxygen). It is assumed that the students have previously had some experience in giving nitrous oxide to dogs in the experiments in the earlier part of the course. The animal has the metal muzzle (Fig. 303) placed over its nose

and mouth and the muzzle is connected to the apparatus directly, the muzzle flange being slipped over the spout on the pan. The connection is made air tight by a broad rubber band. The pan is filled with pure N_2O and the anesthesia is brought on as rapidly as possible. Oxygen is added *in small quantities as needed*. (The usual mistake is in giving too much oxygen.) Watch the pulse by keeping

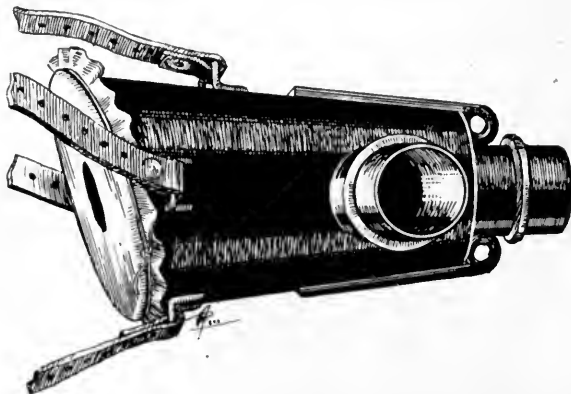

Fig. 304.—View of the reverse side of the metallic muzzle shown in Fig. 303. The flange which is not being used is closed by a rubber stopper.

one finger over the left femoral artery all the time. The heart will become slow but a little fresh oxygen will accelerate it (this sometimes acts almost like giving adrenaline so far as one can tell by feeling the pulse).

As soon as the animal becomes quiet an assistant scrubs an area about four inches in diameter over the lumbar portion of the spinal column vigorously with soap and water. The hair over the area is then clipped and the skin is shaved closely. The area is washed thoroughly with alcohol and allowed to dry. Tincture of iodine is then painted (with a small cotton sponge) thoroughly over the area.

An assistant now pours about half an ounce of the compound cresol solution (lysol may be used) into the water in the large pan. The operator mixes the cresol (or lysol) in the water and thoroughly scrubs his hands in the solution.

Some alcohol may now be poured on the operator's hands (he should not wipe this off). The operator now takes up the syringe which had been laid on a sterile towel to cool. Great care must be used to see that neither the syringe nor the operator's hands touch anything which has not been sterilized. The operator now draws the barrel of the syringe full of the novocaine solution. The syringe point is then detached from the barrel of the syringe which is laid aside on the sterile towel (or in a sterile pan—a metal pan can be quickly sterilized by pouring a few cubic centimeters of 95% alcohol into it, flowing the alcohol over all the inner surface of the pan and then setting fire to the alcohol. When the pan cools it is ready for use.)

The operator selects a point of entrance for the needle about three-eighths of an inch to the right side of the mid-line and a little caudalward from the tip of the spinous process of one of the anterior lumbar vertebræ. The needle is inserted by directing it slightly toward the mid-line and a little in the direction of the head. If the needle hits the spinal canal correctly some spinal fluid may escape. (It is very desirable to have a needle which carries a plunger inside, i. e., a trocar and cannula to fit the hypodermic syringe. In this case the plunger is withdrawn after the needle is inserted and fluid can flow out more readily.) When the needle is inserted into the canal the barrel of the syringe is picked up, any air which it may contain is expelled after which the barrel is attached to the needle (which has been left in place) and one cubic centimeter of novocaine solution is injected into the spinal canal. The needle is then withdrawn and the opening may be covered with a drop of collodion.

The animal is quickly untied and the muzzle is removed. If the gas has been given properly and the dog was a suitable subject for this form of anesthesia (*some dogs cannot be anesthetized well at all with gas*) recovery from the N_2O should occur in a few minutes. Place the animal on the

floor in a quiet place and watch it carefully. Is there any disturbance of motion in the hind legs? If so does this extend to the fore legs also? After a few minutes test the hind limbs for sensation and see if the animal feels pain on being pricked gently with a pin or stimulated with an induced current, etc. Are there respiratory or cardiac disturbances? Was the dose too large or too small? Is there any disturbance of heat or cold sensations in the hind limbs?

Keep the animal under a close observation for several days, watching particularly for signs of infection or meningitis. How long does it take for the effects of the drug to pass off? *If signs of infection appear the animal must at once be chloroformed.*

On what structures within the spinal canal does the drug act to produce the symptoms observed?

Could you demonstrate this action on a mixed (sensory and motor) nerve in any of the peripheral nerves of the body? If so how would you do the experiment? Would the vagus be a suitable nerve?

EXPERIMENT XCIX.

Ergot. (Rooster: Action on Comb.)

1. A white Leghorn rooster should be selected for the experiment. The rooster should not be fed for twenty-four hours before the experiment is performed.

Examine the color, temperature and general appearance of the comb and wattles. Then with a hypodermic syringe inject deep into the breast muscles five cubic centimeters of a *first-class preparation* of fluid extract of ergot (Squibb's is usually satisfactory). (The drug may also be given into the crop with a soft rubber catheter.)

Place the animal in a quiet place and observe it carefully from time to time for at least one or two hours. Do you

note any change in the appearance of the comb and wattles? If so at what time after the injection is the change at its maximum? If you had a standardized preparation and a non-standardized preparation of the fluid extract of ergot could you compare the relative strengths of these two solutions by their relative actions in the same sized doses on roosters of approximately the same size, age, and sensitivity to the drug? This is one of the methods sometimes used to standardize ergot. (For literature, see Edmunds and Hale: Bulletin No. 76, Hygiene Laboratory, U. S. Public Health and Marine Hospital Service; also Pittenger: Biochemic Drug Assay Methods, P. Blakiston's Son & Co.)

EXPERIMENT C.

Ergot. (Frog: Capillary Circulation.)

1. Take a thin board about four inches wide by seven or eight long (a cigar box lid is very satisfactory) and cut a hole about one inch in diameter in one end and near the side as shown in Fig. 305. Fasten a frog, ventral side downward, on the board as indicated with strings (except the right hind leg). Draw the web of the right hind leg over the hole in the board and fasten (with twine strings) the toes in an extended position to spread the web out well. Place the board on the stage of a microscope and examine the capillary circulation in the web. Note carefully the size and appearance of the capillaries and the *rate of flow* of the corpuscles. Make a sketch to show what you see, observing especially the size of some of the vessels which you see where they bear a certain relation to the pigment spots. If the diameter of the arteriole changes can you detect the variation by reference to the pigment spots?

Under the skin of the back inject one-half cubic centimeter of fluid extract of ergot and watch the circulation carefully from time to time as the drug is absorbed. Do you get any change in caliber? If so how do you explain

it? (Greene). Does the alcohol in the drug have anything to do with your findings? Is the *rate of movement* of the corpuscles affected?

Meanwhile observations may be made on the retinal ves-

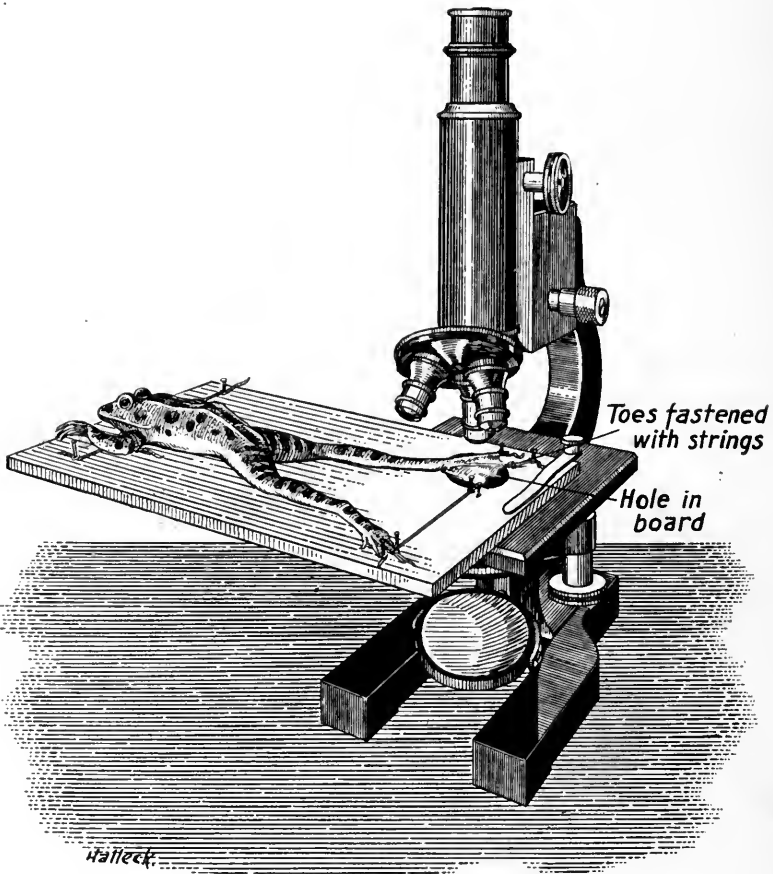

Fig. 305.—Arrangement of apparatus for observing the capillary circulation in the web of a frog's hind limb.

sels with the ophthalmoscope (room darkened). Do you note any change here? What conclusions can you draw? A second frog may be injected with alcohol (same strength as that in the extract) and the results compared with those from the ergot frog.

EXPERIMENT CI.

Tyramine. (Frog: Capillary Circulation.)

1. Repeat the above experiment on a fresh frog using a solution of tyramine (parahydroxyphénylethylamine—Burroughs Wellcome and Co., New York). The solution may be made up from the hypodermic tablets (one cubic centimeter equals four milligrams). Inject one cubic centimeter. Repeat the observations and state your conclusions. What are the active principles found in ergot? (See Dale, Barger, Laidlaw, Dixon: *Journal of Physiology*, xxxiv, xxxix, xli, xliii; *Biochemical Journal*, ii; *Archiv für experimentelle Pathologie und Pharmakologie*, lxi.)

EXPERIMENT CII.

Ergamine. (Turtle: Lung Tracing.)

1. Prepare a turtle to record a lung tracing. Take a normal and inject one cubic centimeter of ergamine solution (five cubic centimeters equal one milligram) into the heart. Record the results and discuss your conclusions in full. Give different sized doses if necessary to get good results.

EXPERIMENT CIII.

Ergotoxine, Ergamine, Adrenaline, Barium. (Dog or Cat: Blood-pressure, Respiration, Uterine Contractions—Barbour's Method.)

1. Arrange a dog (or cat) for taking blood-pressure and respiration tracings. Open the abdomen and gently move the intestines upward toward the diaphragm. Expose the uterine horns and ovaries. With great care dissect the ovaries loose from the underlying tissues and then gently raise the two horns upward and slowly dissect loose the

vessels and tissues holding the uterus down. Use the greatest care not to injure the blood-vessels or nerves going to the uterine horns both of which are brought together at the upper ends. These ends are now tied with a thread which is passed through a metal tube as shown in Fig. 306.

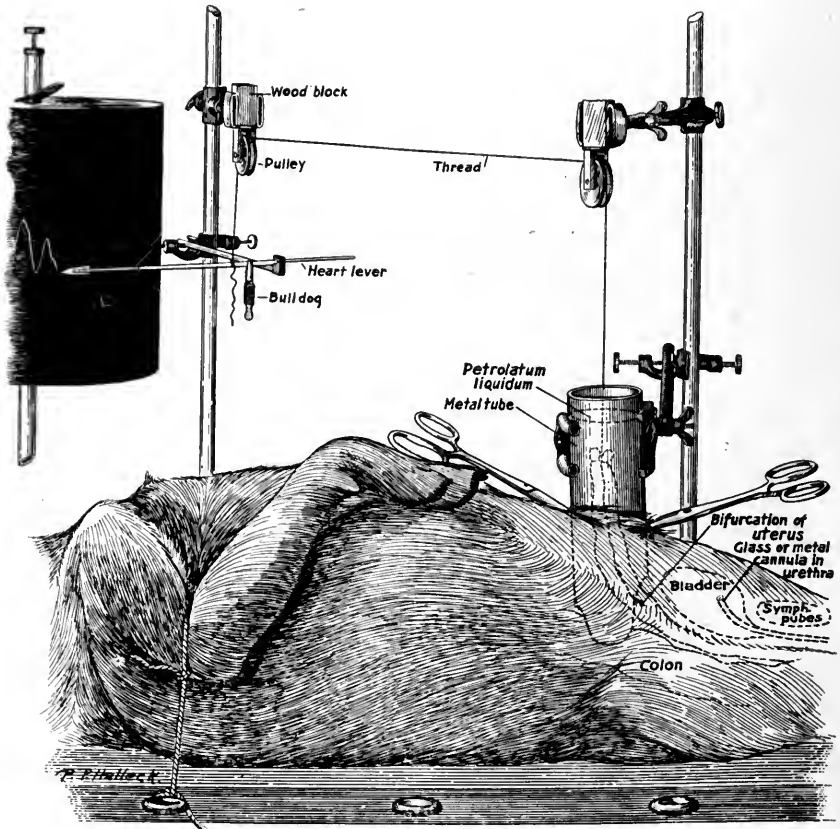

Fig. 306.—Arrangement of animal and apparatus for recording uterine contractions according to the method of Barbour. (See *Jour. of Pharm. and Exper. Therapeutics*, 1915, vii, p. 547.)

The tube is lowered into the abdomen over (around) the uterus, the two horns of which are pulled up as illustrated. The tube is placed down in position (be sure the bladder—which should be empty—is not caught inside the lower end of the tube) and the abdomen is closed air tight with hemo-

stats. The tube is held in a large clamp attached to a stand. The thread is brought upward over a very sensitive pulley (one with jeweled bearings is preferred) about one inch in diameter and thence is directed toward the drum where it passes over another pulley and is then connected to a frog heart lever which records the contractions.

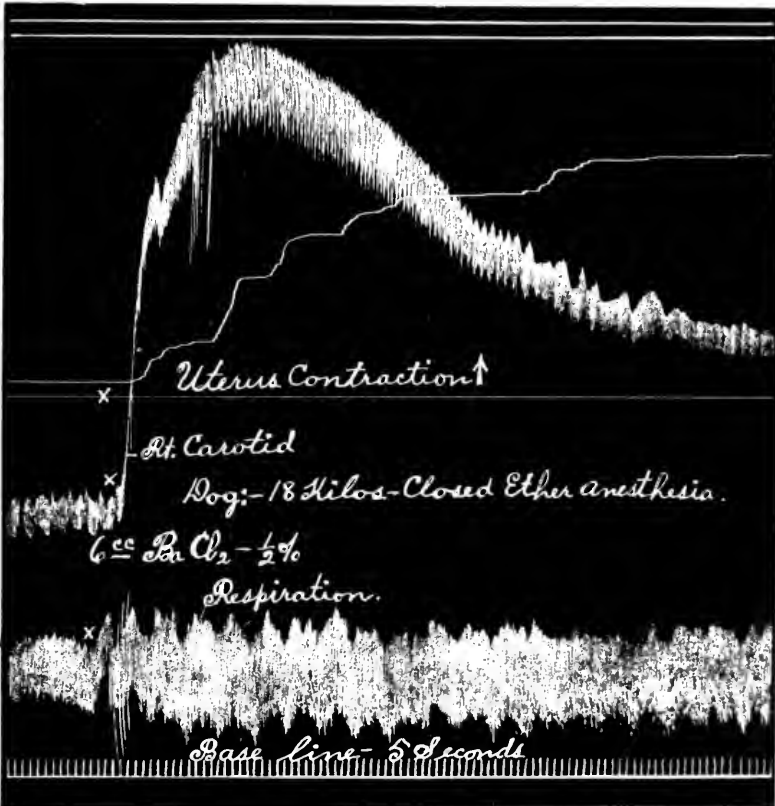

Fig. 307.—Tracing showing the action of barium chloride on the uterus, blood-pressure and respiration in a dog. Tracing obtained by Barbour's method.

The injecting burettes contain adrenaline, ergamine and ergotoxine phosphate. *Ergotoxine phosphate* is sold by Burroughs, Wellcome & Co., New York and London. It is a fine brown powder (one gram vials, \$7.00 or \$8.00 each) in-

soluble in water and is dissolved as follows: Weigh out the required amount, perhaps one hundred milligrams, and place it in a *dry* beaker. Over the powder pour three or four drops of ten per cent sodium hydrate solution and stir the powder into the solution. Two or three drops of water are slowly added from time to time as the drug goes into solution. When all the powder is dissolved water is added to bring the solution to the desired strength (one cubic centimeter equals five milligrams). Since the drug is expensive it is sometimes advisable to make up only a small amount and inject each dose directly into a vein (femoral or external jugular) with a hypodermic syringe.

The metal tube in the abdomen is filled high enough to cover the uterine horns with petrolatum liquidum (liquid paraffin). This protects the uterus against cooling or drying.

When all adjustments are made arrange the writing points on the drum (slow speed) with the uterine record at the top. Take a normal and determine what weight (tension) the uterus can best counteract. When all is ready watch the pupils closely and inject two cubic centimeters of ergotoxine (dog—7 or 8 kilos) and record the results. How does the record compare with one made by adrenaline? How long does the change in blood-pressure last? Wait till the drug has shown its action (perhaps four to six inches on a slow drum). Did the uterus contract? How do you explain this? There is great variation in this respect in different animals and species. Inject one-half cubic centimeter of adrenaline. How does this drug act now as compared with the result in a normal animal? Do you note any changes? (The *size of the dose of ergotoxine* is of importance here—more can be injected later.)

Get the animal into as good condition as possible and take a normal. Watch the pupils and inject two cubic centimeters of ergamine (histamine—Burroughs, Wellcome & Co.—put up in hypodermic tablets—make solution ten cubic

centimeters to one milligram) and record the results. Do you get a contraction of the uterus? How is the blood-pressure affected? The respiration? If the animal is about to die inject one cubic centimeter of adrenaline and see how this counteracts the respiratory and vascular actions of the ergamine. Does this affect the uterus? In what ways may the adrenaline act to change the respiration of *this* animal? Wait a while and let the animal recover (if necessary).

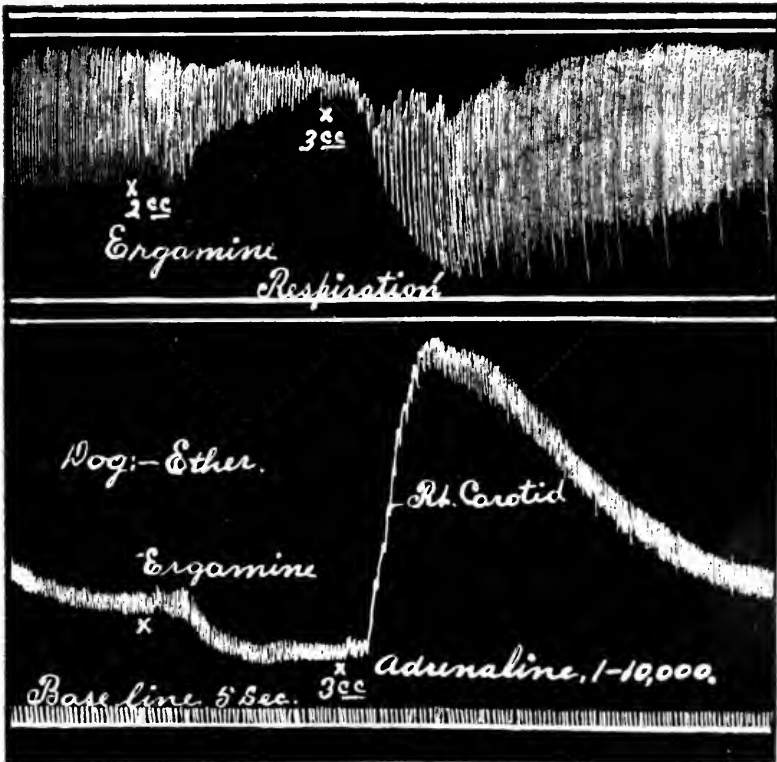

Fig. 308.—Tracing showing the action of ergamine (histamine) and adrenaline on the respiration (stethograph drum around chest) and blood-pressure in a dog. Ergamine causes profound tetanic contraction of the bronchioles and shrinkage of the volume of the lungs. This makes more difficult (and hence decreases) the normal respiratory movements. This action may be accompanied by more or less depression of the respiratory center by the drug but the peripheral action is so powerful that it must be greatly concerned in the decrease of the respiratory movements. Adrenaline (which dilates the bronchioles) promptly relieves the respiratory embarrassment. Down stroke is inspiration. Does the animal have difficulty in inspiration or expiration? How does the adrenaline affect this? How is the intrathoracic pressure affected?

Were the records from the ergamine satisfactory? If so no more of the drug need be given at present, but if the records were poor (dose too small or too large) a second injection

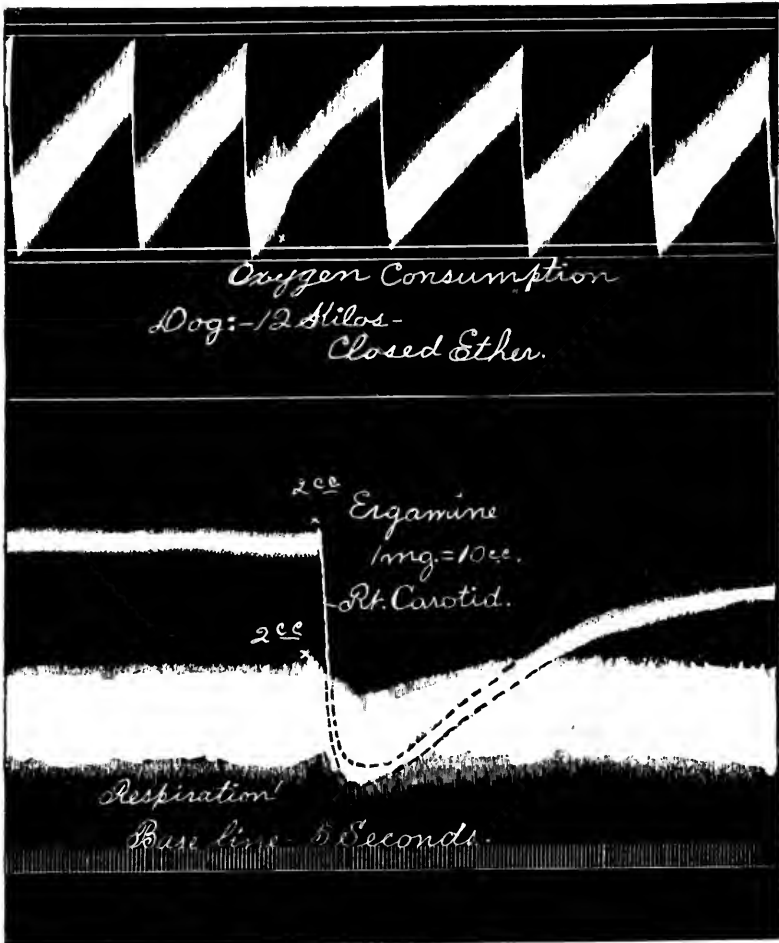

Fig. 309.—Tracing showing the action of ergamine (histamine) on the rate of oxygen consumption, blood-pressure and respiration in a dog. The marked fall in blood-pressure is not accompanied by a correspondingly great change in oxygen consumption.

may be given, the dose being estimated from the previous results. Let the animal recover (giving one-half cubic centimeter of adrenaline if necessary).

Now inject cautiously in *small repeated doses* several cubic centimeters of ergotoxine. How is the blood-pressure affected? Examine the pupils from time to time and note any change. Stimulate one vagus nerve and observe the effect on the corresponding pupil and the heart. Does the blood-pressure fall to a low level and remain there? Does the ergotoxine now fail to raise the blood-pressure (in the same sized dose as that first given)? Get the animal into as good condition as possible and inject one cubic centimeter of adrenaline. Do you get a marked rise in blood-pressure? Does the uterus react? Was the dose large enough? Explain your results in detail. What structures have been involved and how are they affected? Do your results correspond with those described in the literature?

Empty out the ergamine, fill the burette with one-half per cent barium chloride and inject five cubic centimeters (dog). Do you get a rise in blood-pressure or a contraction of the uterus? On what structures does the barium act? Have these been affected by the other drugs?

Kill the animal with barium. After death dissect out the thoracic duct in the neck and place a thread around it. (See Figs. 302 and 319.) Also dissect out the left pulmonary artery (Figs. 274, 275, 276, and 277).

EXPERIMENT CIV.

Ergamine, Adrenaline, Tyramine, (Codeine or Heroine).

**(Dog: Blood-pressure, Pulmonary Blood-pressure,
Respiration.)**

1. The dog should weigh at least eight or ten kilos. It is advisable to give a small dose of chloretone. Arrange for recording blood-pressure and set up the two manometers (one for the pulmonary pressure) as shown in Fig. 273. Read over the directions for Experiment LXXVII, p. 310, carefully, and prepare to follow out the technic given there



Fig. 310.—Tracing showing the action of tyramine on the blood-pressure of a dog.

for recording pulmonary blood-pressure. In this present experiment, however, arrange first to take a record of the action of tyramine. Record the blood-pressure (carotid) and the respiration (stethograph).

Tyramine is sold in the form of hypodermic tablets (0.020 gram— $\frac{1}{3}$ gram each) by Burroughs, Wellcome & Co. Make a solution containing five milligrams to one cubic centimeter. (It may be advisable to inject this with a hypodermic syringe into the external jugular or femoral vein to avoid using more drug than is necessary.)

Adjust the writing points on the drum, take a normal record and inject one cubic centimeter. You should get a rise in pressure which persists for some time. Wait for the effects of this to wear off and save your animal as it will need all the vitality it has for the next part of the experiment. On what structures does tyramine act? To what other drug is it most similar in action? How does it differ from ergotoxine?

Remove the stethograph and insert a cannula (see Fig. 279) into the left pulmonary artery. The injecting burettes (femoral veins) contain ergamine (ten cubic centimeters equal one milligram, see Experiment CII) and adrenaline (1:10,000). Be sure the artificial respiration is being carried out satisfactorily and that the animal does not get too much (nor too little) ether.

Adjust the writing points, take a normal and inject one-half cubic centimeter of adrenaline. Is your adrenaline preparation satisfactory? (Many samples are spoiled before the bottles are opened and an exposed solution rapidly deteriorates.) (See Fig. 311.)

When the records return to normal *watch the lungs closely* and inject two cubic centimeters of ergamine solution (or less if the animal is small) and record the results. How is the carotid pressure affected? Did you see any change in the relative *extent of expansion and contraction* of the lungs with each inflation from the respiration ma-

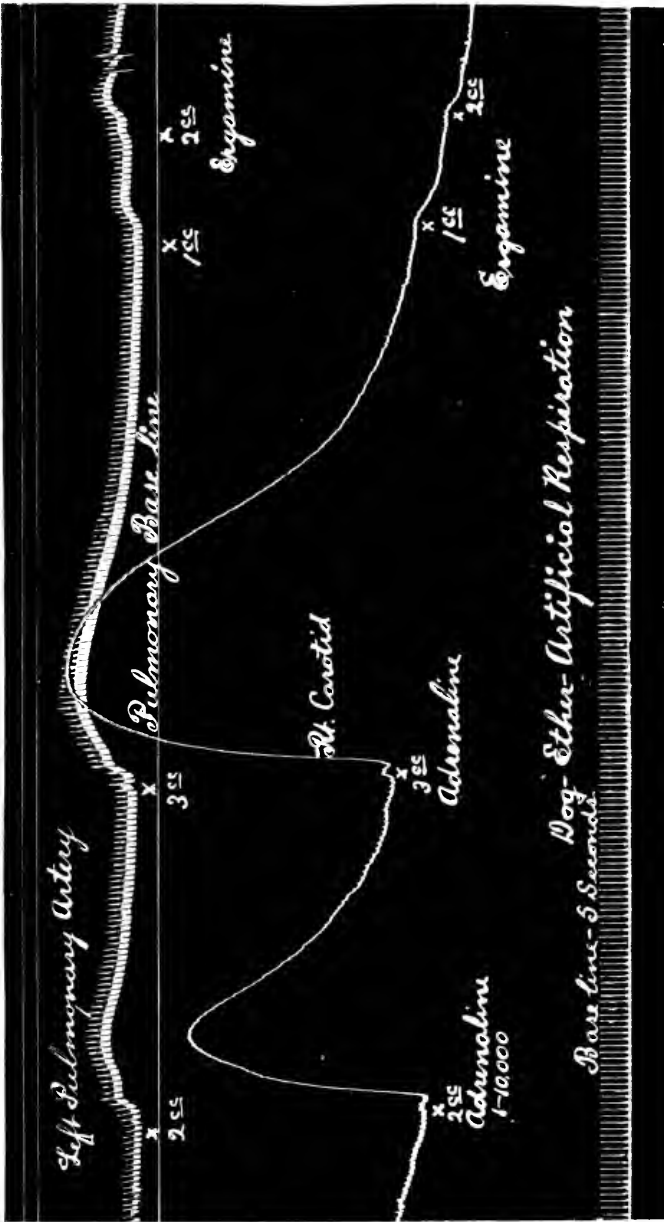

Fig. 311.—Tracing showing the action of adrenaline (two injections) and ergamine (two injections) on the pulmonary blood-pressure (mercury manometer) and carotid blood-pressure (mercury manometer). From a student experiment.

chine? If your drug was pure and the dose suited to the dog you should see the lung changes. To what do these correspond? Was the pulmonary blood-pressure affected? How was this brought about? What structures were involved and how were they affected? (See Cloetta: *Archiv für experimentelle Pathologie und Pharmakologie*, 1914). What relation does a dilatation of the bronchioles bear to the pulmonary pressure? What relation does a contraction of the bronchioles bear to the pulmonary pressure?

If the animal is still in a fair condition give it a dose of adrenaline and change the ergamine solution for one of codeine or heroine (one cubic centimeter equals five milligrams). You must work quickly for the animal may die at any time. Inject five cubic centimeters of the codeine (or heroine) solution (*watch the lungs*) and compare the pulmonary reaction here with that under ergamine.

Kill the dog with one of your solutions. Make a diagram showing the complete innervation of the lungs.

EXPERIMENT CV.

Ergamine, Adrenaline (or Hordenine), Atropine. (Spinal Dog, or Cat: Bronchioles.)

(Bladder contractions may also be recorded if desired.)

1. A number of methods have previously been described for recording bronchial contractions. With positive artificial respiration in a spinal dog a perforated brass tube can be passed through the chest, or by use of the lung shield (Fig. 200) a bent glass tube can be inserted through the right chest wall to record changes in the right lung only, or by use of the special forms of apparatus shown in Figs. 255 and 256 the entire chest cavity can be used as a plethysmograph from which a tube is led off to the *large bowled* recording tambour (Figs. 14 and 372). With the negative pressure method of carrying out artificial respiration by means of aspirating the chest cavity after one or the other

of the special pieces of apparatus shown in Figs. 255 and 256 have been inserted into the chest the *best results* can be obtained. The writer recommends that all laboratories which can afford it build some such form of universal artificial respiration machine as those shown in Figs. 360 and 364 or that where both positive and negative air pressure is already available to the laboratory a universal valve like those shown in Figs. 365 and 366 be obtained. Cats can be used very well for lung tracings by the aspiration method, in fact in some respects they are better than dogs, but the larger size and greater vitality of dogs make them preferable as a rule.

By one of the methods previously given arrange to take a record of the bronchial muscle changes and to record the right carotid blood-pressure. The arrangements for recording blood-pressure should be *completed* first. The injecting cannulas are next inserted and the burettes are filled with ergamine solution (ten cubic centimeters equal one milligram) and with adrenaline (1:10,000) or hordenine (one cubic centimeter equals ten milligrams—this can be bought of Burroughs, Wellcome & Co.—1 gram \$1.80, soluble in water on heating).

The chest is now opened (if this method is to be used) and the apparatus is inserted (using positive artificial respiration). Two courses are now open as follows:—1st, If positive artificial respiration (a hand bellows may be used if nothing else is obtainable) must be used throughout the experiment the tambour tube is now connected to the apparatus in the chest and a record about three inches in amplitude on the drum should be arranged for by making the proper magnification for the writing point, regulation of the expansion of the lungs, etc. If one has a well-fitting piece of apparatus in the chest he need not necessarily pith the dog by this method but it is usually advisable to do so to keep the animal quiet and to avoid the anesthetic. 2nd, If negative artificial respiration can be used, then after the

apparatus is *fully adjusted* in the chest the animal is pithed and the recording tambour is attached to the *straight end* of the tracheal cannula, the side tube of the cannula having a short rubber tube with an adjusting screw clamp (Hofmann's) attached to it. The ether is removed as a spinal animal needs no further anesthetic at all. Pithing is carried out by trephining the skull and destroying the brain and upper part of the cord as described and illustrated in Experiment LXX, page 292. (Experiment LXX should be read over before this one is started as the technic is the same in each and the figures given there will be needed for the present experiment.)

After the dog is pithed the head is returned to its former position and the shift from positive to negative artificial respiration is made. The recording tambour is attached (by a glass reducer) to the short piece of three-eighths inch rubber tubing on the straight end of the tracheal cannula and the *large bowled tambour* is adjusted to give a record of about three inches in amplitude placed just above the blood-pressure (which should be about three-fourths to one inch above the base line). Inspiration corresponds to the downstroke of the tambour.

When all adjustments are made take three-fourths or one inch of normal record (be sure everything is working all right—otherwise readjust the apparatus). Now with care stimulate each or both vagus nerves and determine exactly what influence these have on the bronchioles. What conclusions can you draw? Explain in detail. Take another normal and then inject one cubic centimeter (*dog*) of ergamine solution. You should get an immediate response. If you do not the dose may have been too small (possibly deteriorated drug—but this is rare) and you can let the animal recover and then give a larger dose. The right sized dose will give a profound bronchoconstriction. When this is at its maximum inject one-half cubic centimeter of adrenaline (or four cubic centimeters of hordenine solution) and note

the results. (See Fig. 312.) What structures are involved and how are they affected?

As soon as you get one good tracing from the ergamine then empty it out and fill the burette (or connect a third

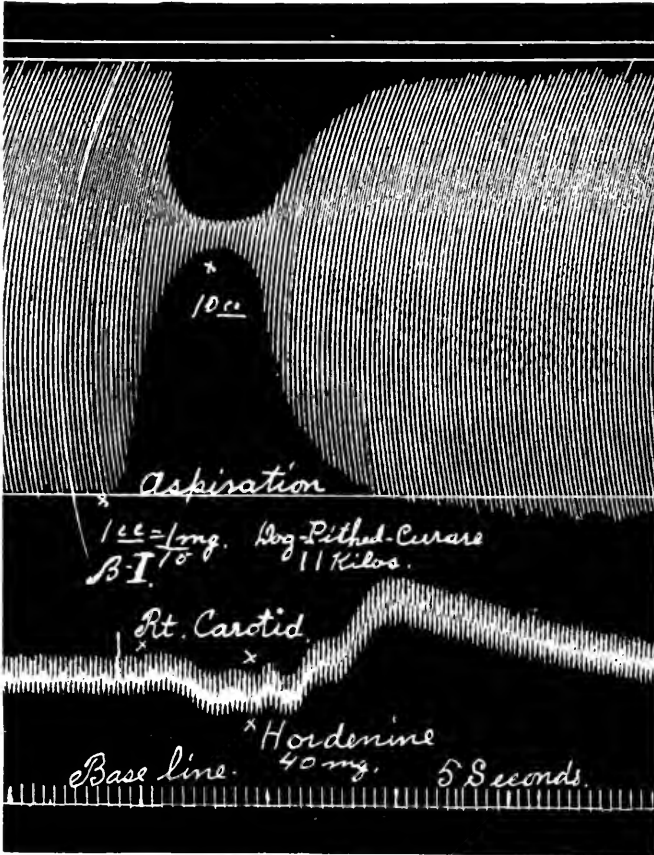

Fig. 312.—Tracing showing the action of ergamine (histamine, β -iminazolyethylamine) and hordenine on the bronchioles and blood-pressure in a spinal dog. Curara had been given.

burette to an external jugular vein) with atropine solution (one cubic centimeter equals one milligram). Start the drum and inject one cubic centimeter of the atropine. Then stimulate the vagus nerves and see if the bronchioles or

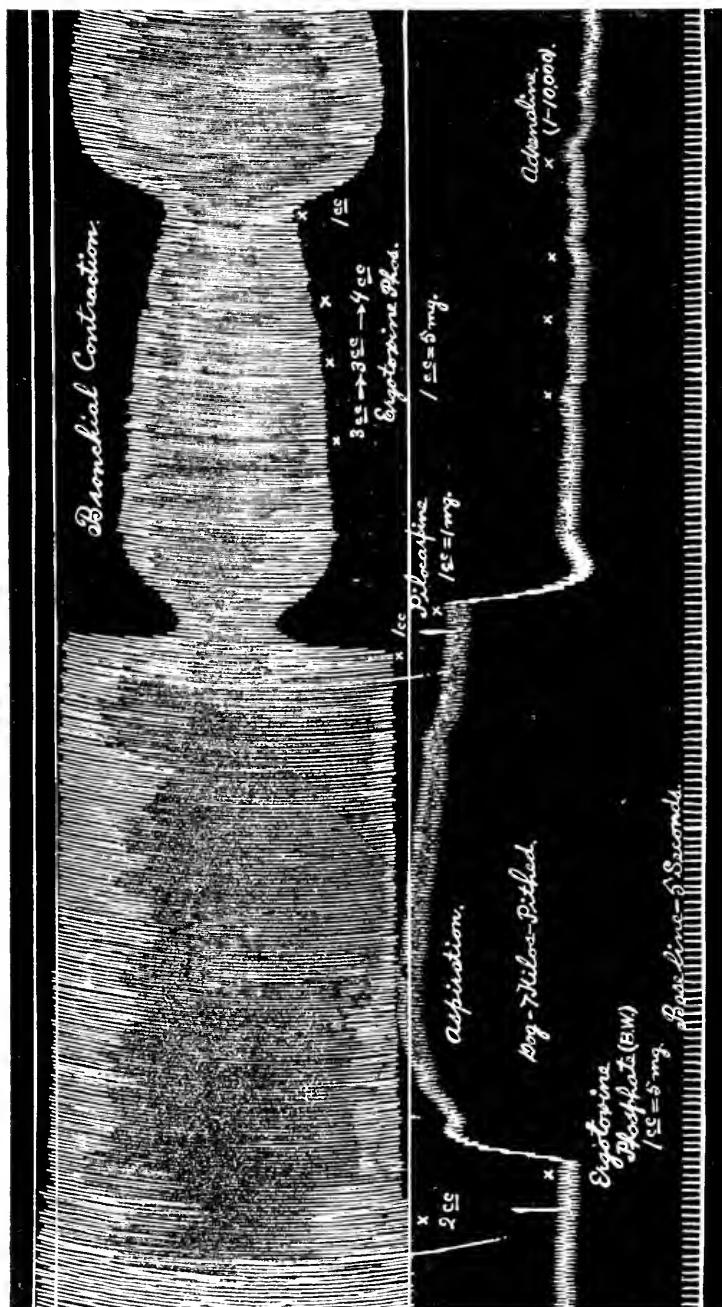

Fig. 314.—Tracing showing the consecutive actions of ergotamine phosphate, pilocarpine, (ergotamine) and adrenaline on the bronchioles and carotid blood-pressure in a spinal dog. The tracing shows that ergotamine neither contracts nor dilates the bronchioles nor changes in any way the action of pilocarpine or adrenaline on them. Also that moderate doses of ergotamine cause a rise in blood-pressure (stimulation of vaso-motor nerve endings) but that large doses of ergotamine paralyze these same endings (myoneural junctions) and that thereafter adrenaline will not cause a rise in blood-pressure (but produces a fall, especially if the pressure be high) and still dilates the bronchioles in practically a normal manner.

heart respond. What conclusions can you draw from this? Replace the ergamine into the burette (if it was emptied out before) and take a normal record. Inject a dose of ergamine (gauge the size by your previous experience—the dose should be a little larger than that which was previously just sufficient to produce a maximum effect, for the animal becomes a little less sensitive all the time to the drugs).

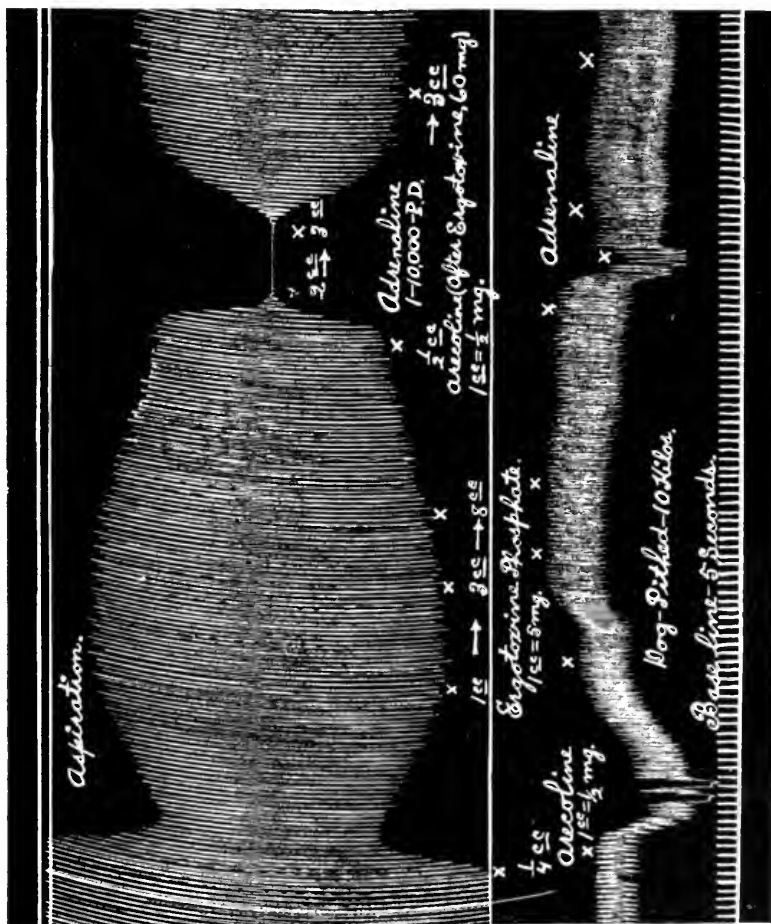

Fig. 315.—Tracing showing the action of arecoline, ergotoxine, (arecoline) and adrenaline on the bronchioles and blood-pressure in a pithed dog.

Do you get a satisfactory record? Has the atropine changed the influence of the drug on the bronchioles? What does this prove? How does the action of hordenine compare with that of adrenaline?

If the animal is still in a suitable condition (which is improbable) you may try to get another contraction of the bronchioles from ergamine and then follow this with an injection of tyramine. This drug is described as acting in many respects like adrenaline. Will it dilate the bronchioles? Stop the artificial respiration and kill the animal. Dissect out both eyes and preserve them in fifty per cent alcohol (or ten per cent formalin) for dissection later.

EXPERIMENT CVI.

Ergotoxine, Ergamine. (Cat, Guinea Pig, Dog, Rabbit: Uterine Strip.)

1. From one of the animals mentioned prepare a uterine strip and arrange to record its contractions as illustrated in Fig. 292 (or as in Fig. 316 if you have the apparatus). The drum should have a very slow speed.

When all is ready take a normal record and see if you can determine whether or not the muscle is in a strong tonus, and if it is properly weighted. A good deal of experience is required to get the best results from the strips. Add one or two cubic centimeters of ergotoxine solution (one cubic centimeter equals five milligrams) to the salt solution in which the strip is suspended. Do you get a contraction? If not add some more drug. Wait and see what happens. What conclusions can you draw?

After a time change the salt solution and allow the strip to record a normal contraction. Do you need to change the weight? Now add two cubic centimeters of ergamine (five cubic centimeters equal one milligram) to the salt solution. What do you observe? Is it necessary to add more erga-

mine? What conclusions can you draw? Change the salt solution and then see if you can get a contraction of the strip by adding barium chloride (in one-half per cent solution) to the beaker. On what structures does each of these drugs act?

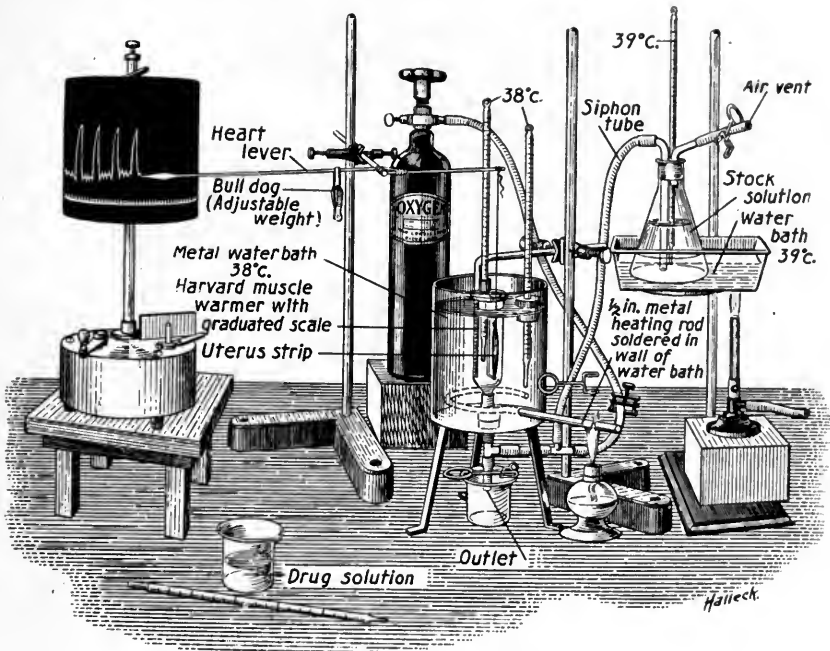

Fig. 316.—Arrangement of apparatus for recording contractions of a uterine strip, intestinal strip, or ring, etc. The metal water bath is made of a cheap metal water pail with a heating rod soldered through the side at the bottom. A short metal tube is soldered into a 1-inch opening in the bottom to receive a perforated cork for connecting with the Harvard muscle warmer inside.

EXPERIMENT CVII.

Ergot. (Cat: Action on Uterus.)

1. Secure a gravid cat as near full term as possible. Under the skin of the back inject with a hypodermic syringe two cubic centimeters of a good fluid extract of ergot. Put the animal in a quiet place and observe it carefully from time to time for several hours following. Discuss your conclusions in detail.

EXPERIMENT CVIII.

**Pituitrin, Ergamine, Adrenaline. (Dog, Cat, or Rabbit:
Uterine Contractions, Blood-pressure.)**

1. Cats are preferred for the experiment. Observe carefully the arrangement of the animal and the apparatus

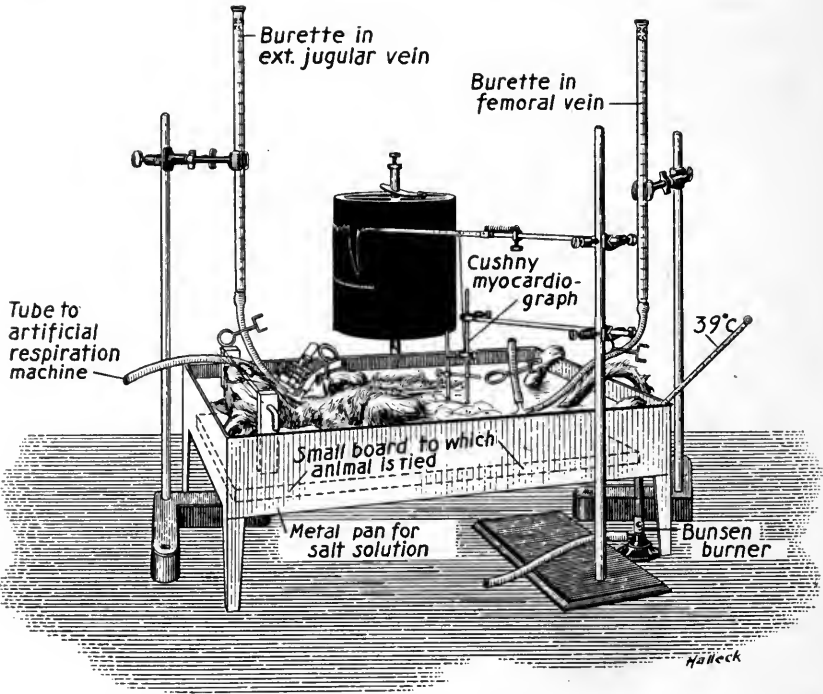

Fig. 317.—Arrangement of apparatus for recording contractions of the uterus *in situ*. (The experiment is difficult and often yields unsatisfactory results.) A somewhat similar arrangement may be used for recording intestinal contractions.

shown in Fig. 317. The animal is given .3 to .4 gram per kilogram of body weight of chloretone (dissolved in alcohol) by stomach tube. Artificial respiration may be given throughout the experiment. Arrangements are made for recording the blood-pressure (omit this if sufficient apparatus is not available), and injecting cannulas are connected with one femoral vein and one external jugular. These con-

tain ergamine (ten cubic centimeters equal one milligram) and pituitrin (one cubic centimeter to five cubic centimeters of water—Parke, Davis & Company's preparation is usually satisfactory, but several other extracts are on the market).

The metal box in which the animal is placed is now filled with 0.9 per cent salt solution which is thereafter kept at 39° C. by a bunsen burner. This prevents exposure of the viscera to the cold air and avoids drying of the tissues.

The abdomen is now opened by a long median incision and the intestines and bladder are pulled gently to one side and fastened beneath the salt solution, thus exposing the uterine horns. One of these is followed up to the ovary which is gently dissected loose from its attachments (using great care not to disturb the blood-vessels) and the distal end of the uterine horn may also be freed a little from the body wall to permit freedom for its movements if contractions occur. A myocardiograph (Cushny's, Wigger's, etc., or Fig. 141) is now placed down over the abdomen. A small round needle is used to pass two stitches of fine thread through the uterine horn about one inch apart. These stitches are used to attach the levers of the myocardiograph to the uterine horn. A very light recording lever (heart lever or light muscle lever) is attached to the myocardiograph and arranged to write on the drum above (and slightly to the left of) the blood-pressure record. The lever is weighted as nearly as can be estimated to suit the strength and tone of each uterine horn.

When all adjustments are made a normal record is taken and then one-half cubic centimeter (for a full grown cat) of the pituitary solution is injected. Do you get a rise in blood-pressure? You should do so and this rise lasts for a considerable time. Wait for the curve (blood-pressure) to come back to normal. (Inject a larger dose if necessary to get a good record.) Did you get a uterine contraction? What explanation can you offer? Does this have any clinical significance?

Now inject one-half cubic centimeter of ergamine (cat) and see what effect this has. Do you get a fall in blood-pressure? Will the animal be likely to die? (If so, give it a small dose of pituitrin.) Did the uterus contract? If so on what tissues did the drug act and how were they affected? Wait a while for the animal to recover and observe any later actions of the drug. After a time more ergamine may be injected to get another record.

If the animal is still in suitable condition adrenaline solution may be substituted for one of the solutions in the burette and a dose of this drug injected. How does the action of adrenaline on the uterus compare with that of the other drugs given? What is the innervation of the uterus? (See Fig. 318.) Kill the animal by giving a large dose of one of the drugs you have. What can you say about changes in the innervation of the gravid uterus in the cat? Does this hold also in the human uterus? Can you find this point in the literature?

This method of recording uterine contractions is sometimes used to standardize ergot preparations by comparing the strength of the unknown solution with that of a standard preparation. (For literature, see Edmunds and Hale: *loc. cit.*; Dale, Dixon, Laidlaw, Barger: *loc. cit.*, p. 363; Pittenger, P. S.: *Biochemic Drug Assay Methods*, P. Blakiston's Son & Co.; also Dale: *Biochemical Journal*, iv, p. 427.)

EXPERIMENT CIX.

Pituitrin, Ergamine, Levulose, Adrenaline. (Dog: Thoracic Duct, Blood-pressure, Bladder Contractions, Respiration.)

(Give the dog one-half pint of cream to drink three hours before the experiment.)

1. Arrange a dog for recording blood-pressure, respiration and bladder contractions. Do not disturb the viscera

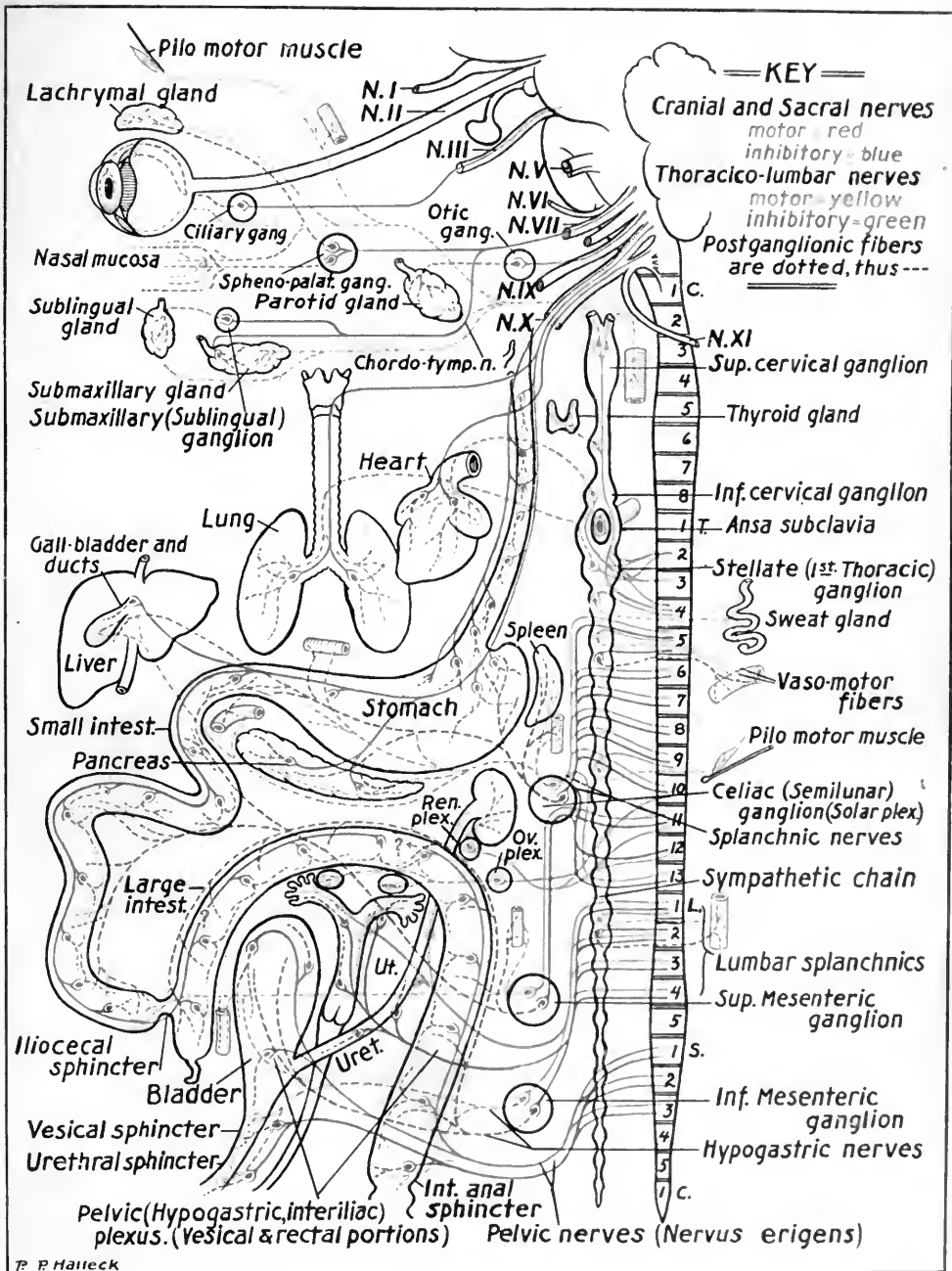

Fig. 318.—Schematic representation of the involuntary nervous system.

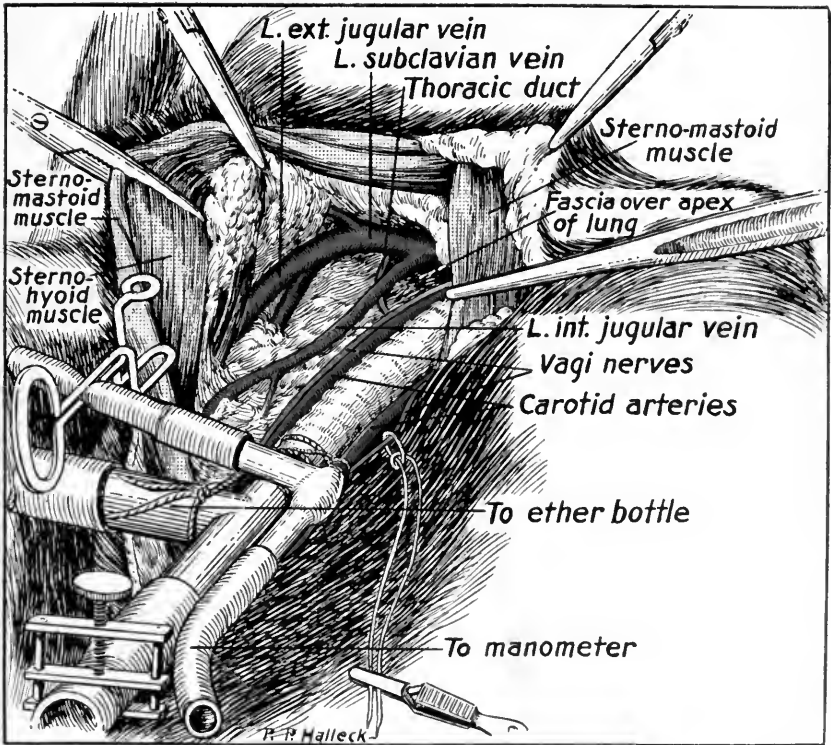
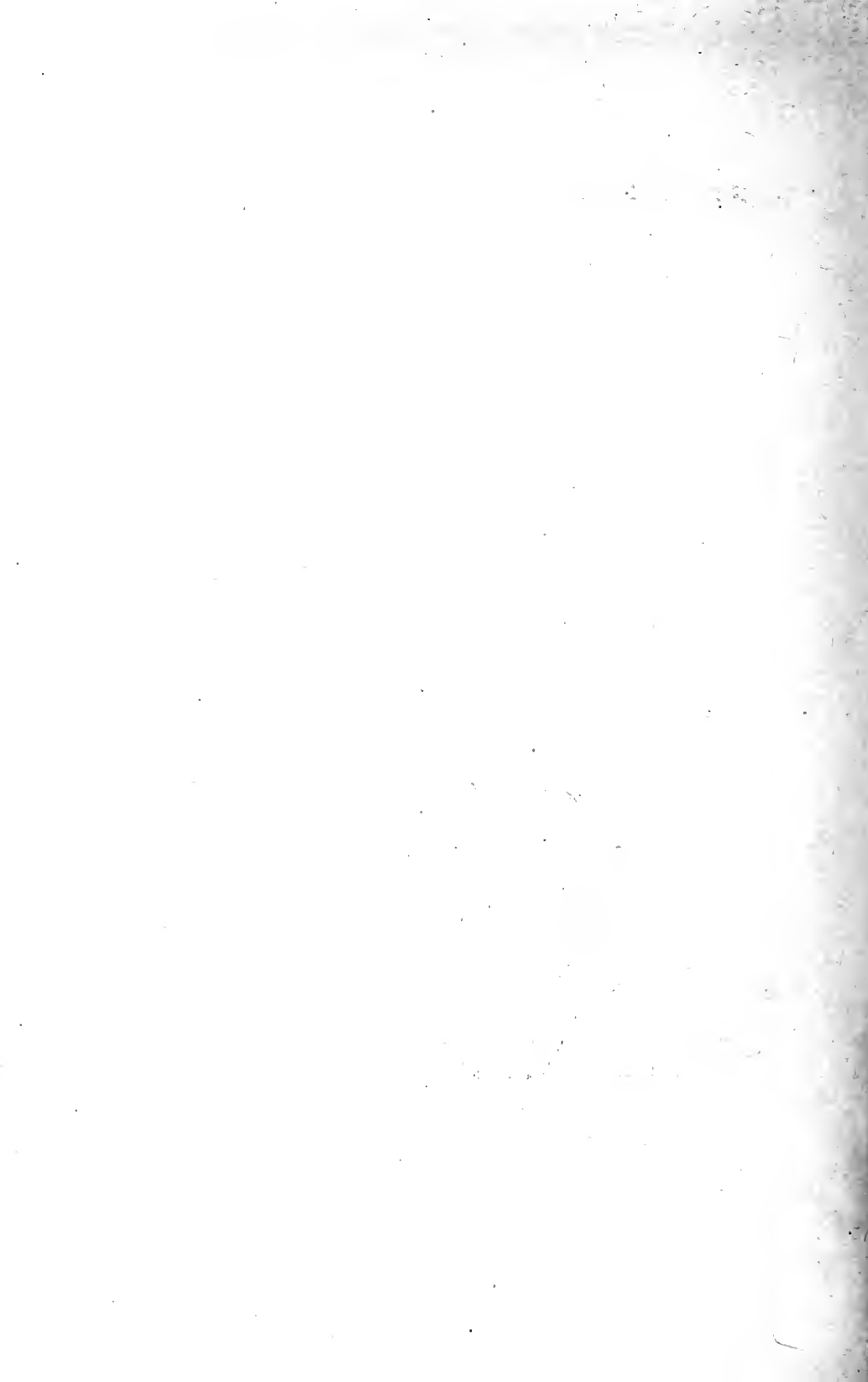

Fig. 319.—Dissection showing the method of isolating the thoracic duct at the root of the neck. Care should be taken not to perforate the parietal pleura at the apex of the chest if it can be avoided in making the dissection.



any more than can be helped in putting in the bladder cannula. Clamp the penis or vulva with a hemostat to prevent urination.

Consult Figs. 319 and 302 and dissect out the thoracic duct. Place a cannula in it and collect the lymph as it drops from the small rubber tube placed on the cannula. The cannula must be very small, the opening in the end should be about the size of a very small thread and the outside of the tip of the cannula should not exceed $\frac{1}{2}$ or $\frac{3}{64}$ of an inch in diameter. Try to avoid penetrating the chest cavity at the apex in dissecting out the duct. If the chest is opened it may be necessary to give artificial respiration during the rest of the experiment. If the cream has reached the intestine and is being absorbed well (two to three hours after meal) the thoracic duct in the neck should be of a whitish or yellowish-white color and in an average sized dog will be about $\frac{1}{16}$ or $\frac{3}{32}$ of an inch in diameter. The duct is composed of exceedingly thin and delicate tissue and can be easily torn off and lost in the dissection, the student perhaps not seeing it at all at any time. A little pressure will compress the duct and check all out-flow from it.

(Those students who have sufficient technical skill may also insert a cannula in the lymphatic duct coming from the head and collect lymph from both ducts at the same time. There is a very marked difference and the experiment is well worth doing.)

The injecting burettes contain pituitrin (1 to 5—Parke, Davis & Co.), ergamine (ten cubic centimeters equal one milligram) and adrenaline (1:10,000).

When all adjustments are made take a normal tracing, watch the pupils and inject one cubic centimeter of pituitrin solution (dog, eight kilos or more). Do you get a rise in pressure, contraction of the bladder and a change in the rate and depth of respiration? If the dose was sufficient, as it probably was, allow the animal to return to normal and wait until the normal rate of lymph flow is determined

(number of drops per minute). The rubber tube or cannula may become clogged. If so pass a stiff twine string down the cannula and try to remove the clot.

The pituitrin is now emptied out and the burette is filled

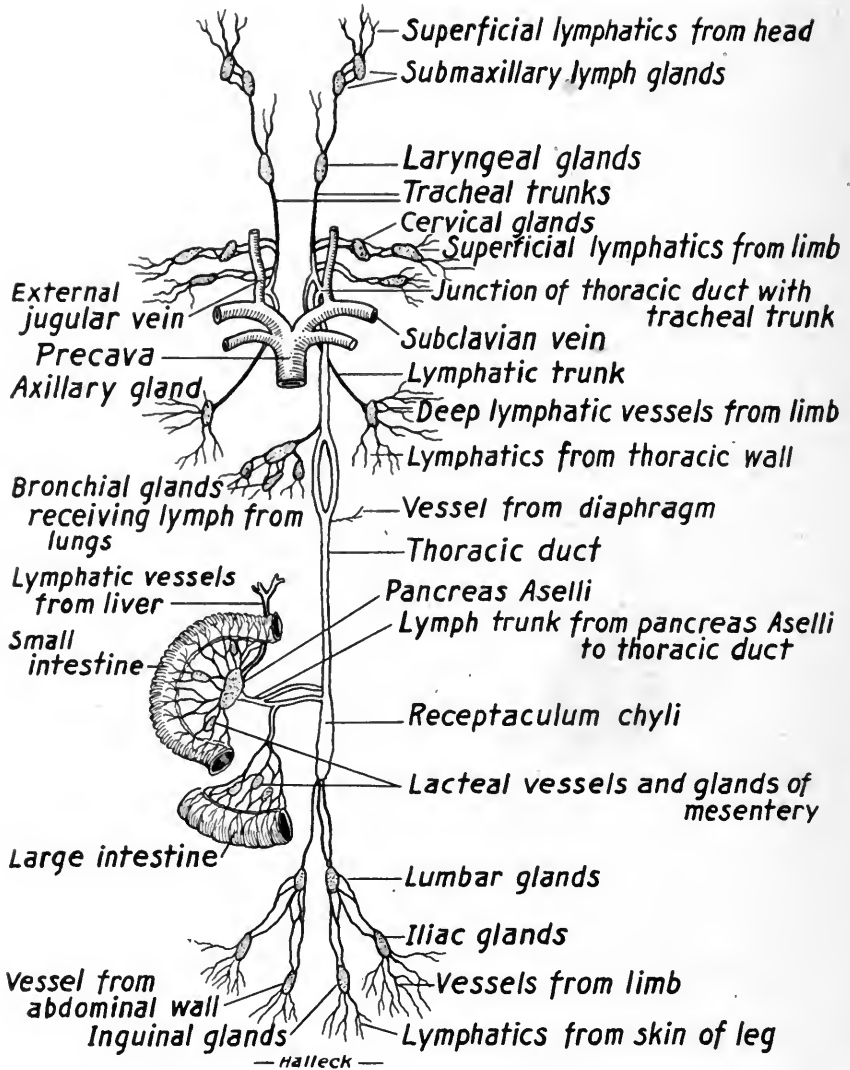

Fig. 320.—Diagrammatic representation of the lymphatic system in a cat. (Partially adopted from Davison.)

with levulose solution (five or ten per cent). In small repeated doses (one-half or one cubic centimeter) several cubic centimeters of the levulose solution are injected. Wait then and see how the rate of lymph flow is affected. (How is the lymph flow from the head affected? Is this rate of flow maintained or does it decrease after a time?)

After some time note the rate of lymph flow and adjust all writing points. Observe the pupils and inject one cubic centimeter of ergamine. Do you get satisfactory records? If the dose was too small wait a while and inject a larger one to get good results. How did the bladder respond? How does this compare with pituitrin?

Inject adrenaline and see how this affects the lymph flow, bladder, pupil and respiration.

With what other lymphogogues are you acquainted? You may try some of these on the animal if it is still in suitable condition. Kill the animal with an injection of some of the drugs you have. Always get a death record in such cases and see which stops first, the heart or the respiration.

How may drugs affect the rate of secretion or of flow of lymph? How is the formation of lymph controlled? What can you say about the innervation of the lymphatics? How does atropine affect lymph secretion?

EXPERIMENT CX.

Pituitrin. (Frog: Capillary Circulation.)

1. As in Experiment C, page 361, arrange a frog for observing the capillary circulation in the web of the foot (Fig. 305). Observe carefully (for comparison) the normal rate of capillary flow and then inject one-half cubic centimeter (or more) of pituitrin under the skin of the frog's back. From moment to moment again observe the circulation in the web and see if any change occurs. If you note a change keep a careful watch on the animal from time to time for

two or three hours and see if there is a return to normal. Keep the animal covered with a thin layer of wet cotton.

EXPERIMENT CXI.

Pituitrin. (Frog or Turtle: Heart Tracing.)

1. Pith a frog or turtle and take a normal heart tracing showing vagus inhibition. Irrigate the heart with some pituitrin solution (1 to 5) and determine the action of the substance on the heart. Is the inhibitory apparatus involved in any way? How is the musculature of the heart affected?

EXPERIMENT CXII.

Pituitrin. (Turtle: Lung Tracing.)

1. Arrange a turtle for recording lung tracings. Stimulate one vagus nerve and see if you get a contraction of the

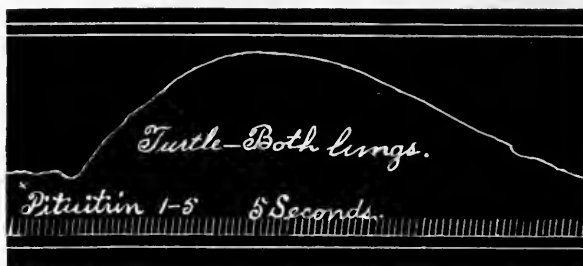

Fig. 321.—Turtle lung tracing showing the action of pituitrin.

lung. The magnification of the tambour tracing should be large. Take a normal and inject into the heart one cubic centimeter of pituitrin solution (1 to 5). What conclusions can you draw from your results?

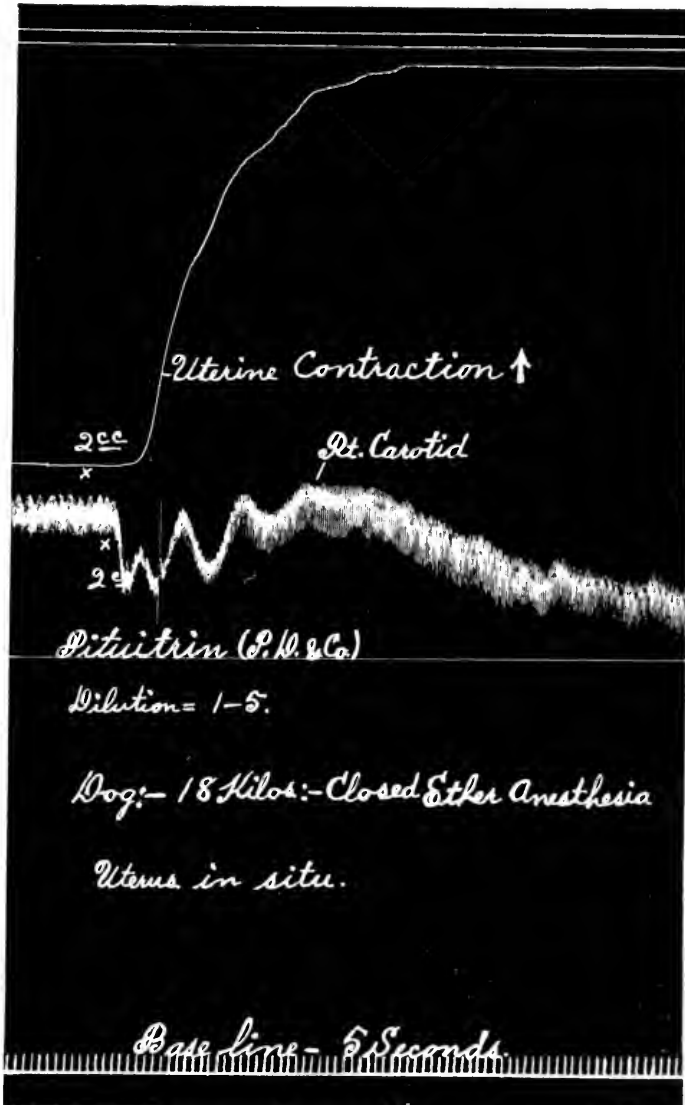

Fig. 322.—Tracing showing the action of pituitrin on the uterine contractions and blood-pressure in a dog. Made by Barbour's method.

EXPERIMENT CXIII.

Pituitrin. (Guinea Pig, Cat, Dog, Rabbit: Uterine Strip.)

1. Cats or guinea pigs are preferred. Prepare a uterine strip and record its contractions. (See Experiment CVI, also Figs. 292 and 316.) After the strip is properly weighted and a short record has been taken add to the solution surrounding the strip one cubic centimeter of pituitrin (1 to 20). Do you get a satisfactory contraction? Wait a while, the drum runs at a very slow speed. If after some minutes no change has been produced replace the salt solution with a fresh supply and inject a larger dose of pituitrin. Could you standardize the size of the dose by the size of the contraction the uterine strip gives? If you had a standard preparation of pituitary extract could you compare with this the strength of an unknown sample? If one-half as large a dose of the unknown sample were required to give a tracing three inches high, as was required of the standard preparation, what could you say of the relative strengths of the two samples? How much would you dilute the unknown preparation to bring it to the same strength as the standard? This is essentially the method commonly used to standardize (assay) pituitary preparations for the market. (For literature, see Dale and Laidlaw: *Journal of Physiology*, 1910-11, xli, p. 318; Dale and Dixon: *ibid*, 1909, xxxix, p. 25; Dale and Laidlaw: *Journal of Pharmacology and Experimental Therapeutics*, 1912, iv. p. 75; Hamilton, H. C.: *Journal American Pharmaceutical Association*, 1912; Roth, G. W.: *Bulletin Hygiene Laboratory*, No. 100; also *Journal Pharmacology and Experimental Therapeutics*, 1914, v. p. 557; Fenger: *Journal Biologic Chemistry*, 1916, xxv, p. 417; Frankl-Hochwart und Fröhlich: *Archiv für experimentelle Pathologie und Pharmakologie*, 1910, lxiii, p. 347; Hamilton and Rowe: *Journal of Laboratory and Clinical Medicine*, 1916, ii, p. 120.)

EXPERIMENT CXIV.

**Pituitary Extract, Adrenaline, Atropine, Barium. (Dog:
Bronchial Contraction.)**

1. By one of the methods previously used arrange a dog for recording bronchial contractions. When all adjustments are made stimulate the vagus nerves and see how the

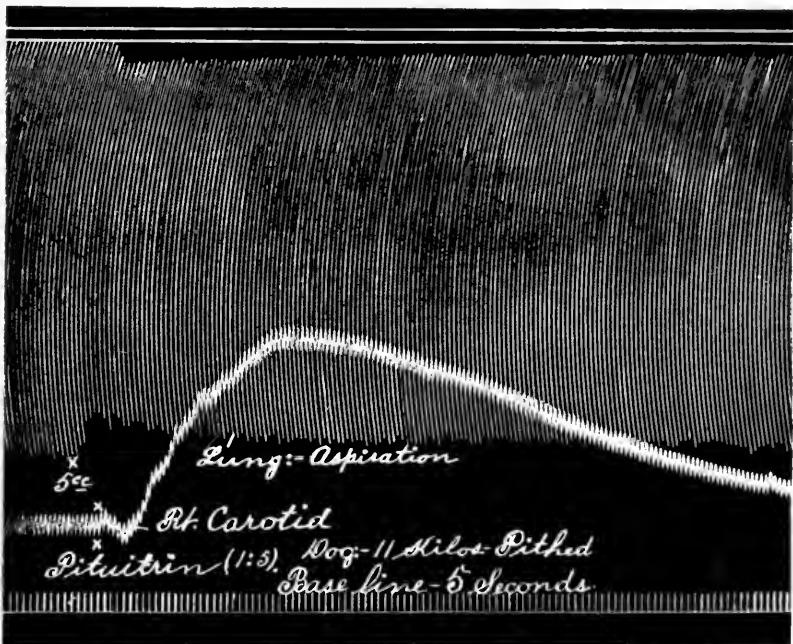

Fig. 323.—Tracing showing the action of pituitrin on the bronchioles and blood-pressure in a spinal dog.

bronchioles react, then inject two cubic centimeters (dog—eight to ten kilos) of pituitrin solution (1 to 5). Do you get a satisfactory record? What is the action of pituitary extract on the bronchioles? Is this a muscular or nervous affair? What action has pituitrin on the sympathetic nervous system? How does this compare with adrenaline and tyramine?

This dose was probably large enough (for some animals too large—the instructor may advise you about this) but if you think advisable try another dose to see if you can get more satisfactory results.

When the animal recovers give one cubic centimeter of atropine, then stimulate the vagi and see if the heart is inhibited (how are the bronchi affected?). Give a little adrenaline to revive the animal and inject another dose (estimate the size) of pituitrin. How are the bronchioles affected now after the atropine? Would you advise the use of pituitrin in bronchial asthma? How do your results in this experiment compare with those obtained on the turtle lung? Kill the animal with a large dose of barium chloride solution (one-half per cent). How does this affect the bronchi?

EXPERIMENT CXV.

Pituitrin, Adrenaline, Aconitine. (Dog: Urine Secretion, Intestinal Contractions, Blood-pressure, and Respiration.)

1. Arrange a dog for recording the blood-pressure, respiration and intestinal contractions (by the fingercot-burette method). The injecting burettes contain pituitrin (1 to 5) and adrenaline (1:10,000). Carefully isolate both ureters (Fig. 162) and place a ureteral cannula (Fig. 213) in each. Arrange the cannulas to collect the urine flow in a beaker. Record on the drum the rate of drop flow with a signal magnet (worked by a simple key in circuit with a dry cell). Close the abdomen with hemostats and wait ten or twenty minutes to get the normal rate of urine flow. (The drum should have a very slow speed.)

When the normal rate of urine flow has been determined (if no urine is excreted after twenty minutes go on with the experiment and watch for the flow to begin), take a normal record and then inject one cubic centimeter (for eight

to ten kilo dog) of pituitrin solution. How does this affect the blood-pressure? What happens to the respiration? Is this a central or a peripheral action? After the records return to normal (see that all pointers are recording properly) inject a second dose of one cubic centimeter and compare the results produced by this with those obtained from the first injection. As soon as the records again reach the normal (keep the anesthesia regular) inject a third dose of one cubic centimeter. Does the animal become more or less sensitive to the drug? Is the rate of urine flow affected in any way? If so how do you explain it? Is the change as great as you expected? How does it compare with caffeine or sodium sulphate? Continue giving pituitrin until five or six (or more) cubic centimeters have been given, watching for changes in the rate of urine flow in the meantime. Do the intestines show any signs of increased activity? If so is this a nervous or muscular affair? Inject some adrenaline and see how this affects the urine flow and intestinal records. Do you see any signs of a tolerance being developed for the pituitrin? If so to what is it due? Does this occur with any other drugs? Could you standardize an unknown pituitary extract by comparing the action of various sized doses of the unknown with a standard dose of a standard pituitary extract on the blood-pressure? This method is sometimes used to assay pituitary extracts. In that case small sized doses are given and a considerable period of time (fifteen minutes or more) is allowed to elapse between each two injections.

If the animal is still in fair condition place a solution of aconitine "potent" (*ten cubic centimeters equal one milligram*) in the burette and determine what is the very least amount of the substance required to kill the animal. The injections must be made cautiously. Watch for postmortem intestinal contractions. Open the chest and see if the heart is fibrillating.

EXPERIMENT CXVI.

Pituitrin, Adrenaline, Vanadium. (Dog: Pulmonary Blood-pressure.)

1. In the manner described in Experiment CIV, p. 369 (also in Experiment LXXVII, p. 310) arrange a dog for recording pulmonary blood-pressure. The injecting burettes contain pituitrin (1 to 5) and adrenaline (1:10,000). When all adjustments are made take a normal record and then inject one cubic centimeter pituitrin solution. Do you get a change in pulmonary pressure? Would you advise the use of pituitary extract in a pulmonary hemorrhage from a tuberculous lesion? What structures are affected by the drug in the lungs? Would the drug be advisable in bronchial asthma?

After a record showing the action of pituitrin on the pulmonary pressure has been obtained get the animal into as good condition as possible and fill one burette with a solution of sodium orthovanadate (two per cent—when the drug is dissolved in the water the solution is slightly alkaline). Add a very small amount of hydrochloric acid to neutralize the alkalinity. A bright, clear, orange-yellow solution will be produced. Take a normal record and inject two cubic centimeters of the vanadium solution. Was the dose large enough? If not, possibly you can still get another record with a larger dose. Kill the animal with the vanadium solution. What conclusions can you draw from the experiment? On what structures does the vanadium act?

EXPERIMENT CXVII*

Dissection of the Eye.—Its Anatomy and Pharmacology.

Consult Figs. 324 and 325. It is advisable to read the section on the anatomy of the eye in some good text-book on anatomy.

*It is expected that this experiment may be performed on a day when no other experimental material is available.

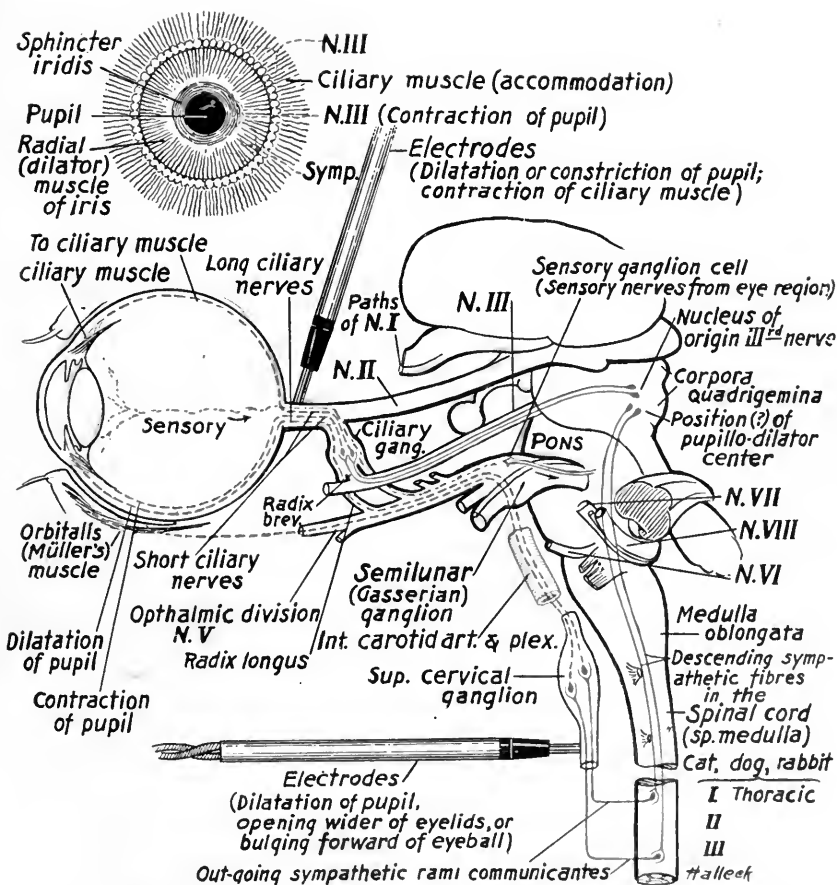
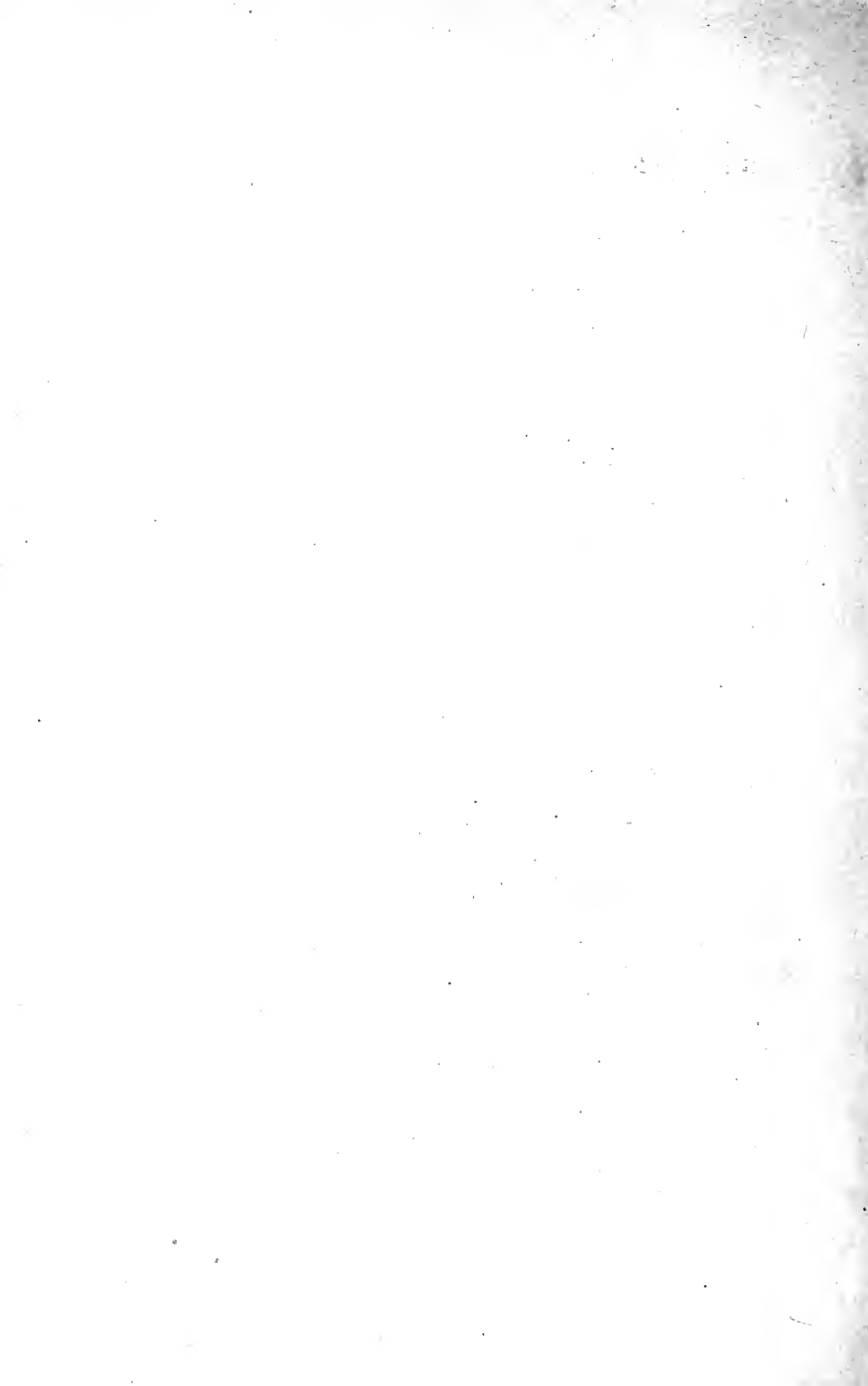

Fig. 324.—Schematic representation of the innervation of the eye. Postganglionic fibers are shown as broken lines.



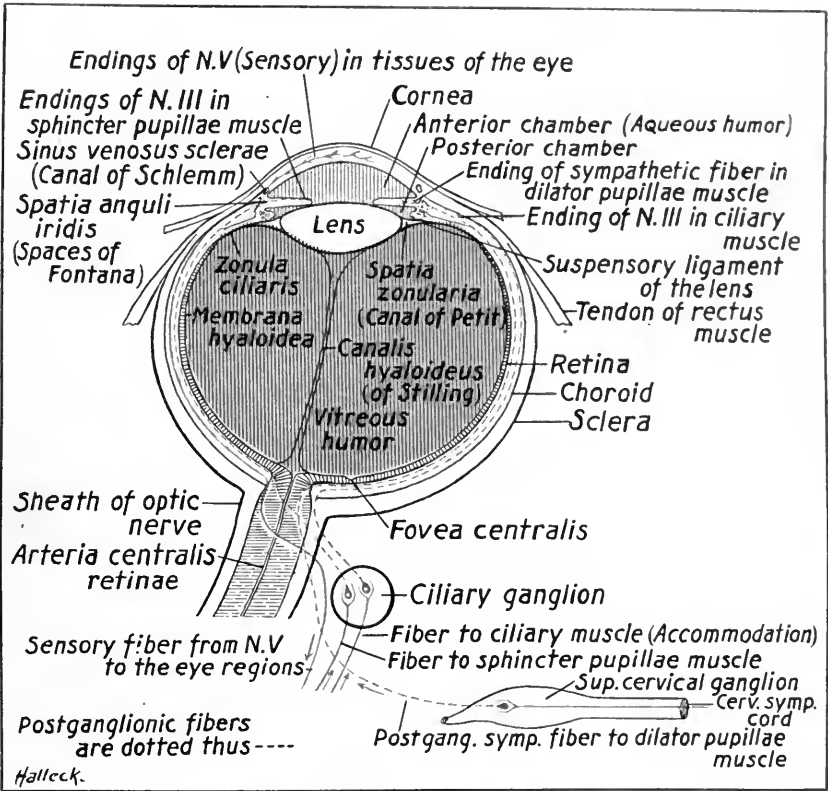
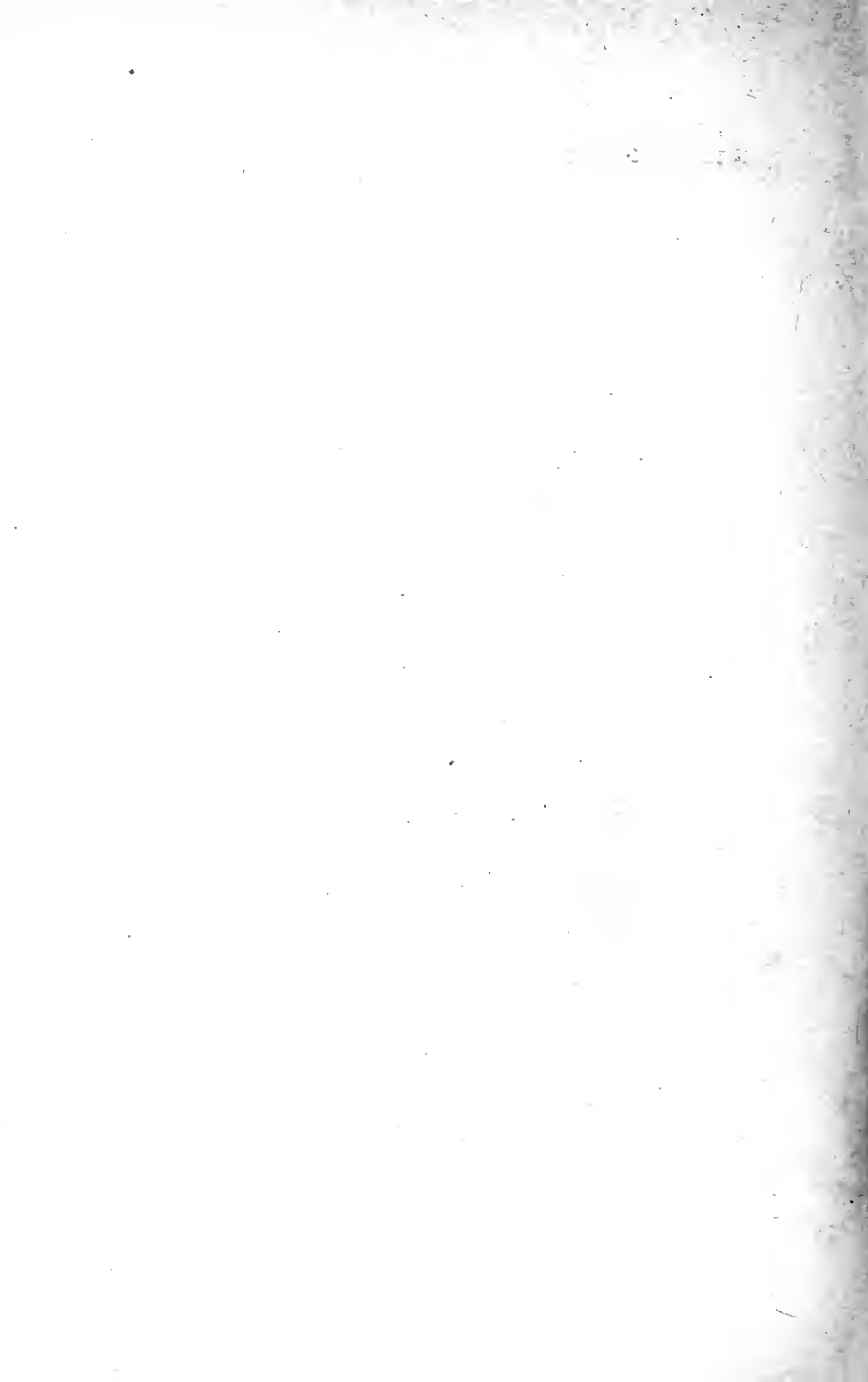

Fig. 325.—Diagrammatic representation of the structure and innervation of the eye.



The eyes saved previously from dogs may be used for dissection, or eyes from hogs or cattle may be secured (in weak formalin solution) from the slaughter house.

Dissect away the fascia from the outside of the eye-ball and isolate and identify the extrinsic muscles. Are there any variations in these in different species of animals? What is the innervation of these muscles?

Isolate the optic nerve and follow it to the sclera. Dissect off the extrinsic muscles and free the eye from fascia. Do you have a right or a left eye? Locate on the eye-ball a point directly outside the area which should be occupied by the fovea centralis. Do the lower animals possess this structure? What is its function? Over this area cut a window about one-eighth inch square in the sclerotic down to the choroid. Hunt for the fibers of the ciliary nerves which pass forward in the interspace between the sclera and the choroid. In the normal animal what reactions would follow electrical stimulation of these fibers? With care enlarge the opening in the sclerotic a little and then dissect away the choroid which forms the floor of the opening.

Use great care not to penetrate the retina which will be exposed when the choroid is removed. If the eye has not been long in the formaldehyde or alcohol the cornea and lens may still be transparent enough to allow an image to be formed on the retina (this is best shown in fresh eyes).

Take a sheet of brown wrapping paper a foot square and roll it into a tube with an opening just large enough to hold the eye at one end. Place two rubber bands around the tube to prevent unrolling. The eye is placed in the end of the tube with the opening in the sclerotic and choroid coats turned outward, i.e., the cornea and lens are directed to look through the tube. Point the open end of the tube toward an incandescent light or bright window and watch carefully in the exposed area at the back of the eye for an image of the light or window. If you detect any image state fully its characteristics and peculiarities.

Examine the cornea and pupil. Place the eye in a pan of water and make an incision around it in the line of the equator so as to separate the front half from the rear half. The incision may go through all three coats, but the vitreous humor should not be disturbed. Lift off the rear half of the coats and look into the cup thus formed. What color is the retina? Of what is it composed? What drugs act on the structural elements of the retina? What particular parts of the retina are involved in this action? Define the optic disc and the central artery of the retina. What is meant by the optic cup? What relation does it bear to the macula lutea? Separate the sclerotic from the choroid and define the lamina fusca. Hunt for the ciliary nerves (and vessels) between the sclera and choroid. How do these nerves get into the eye-ball? Define the lamina cribrosa sclerae.

Now take up the anterior half of the eye to which the vitreous humor probably remains attached. Look for the hyaloid membrane. What are its functions? To what is it attached? Gently separate the vitreous humor from the lens and ciliary processes and let it float in the water. Describe its color, consistency and functions. Have you seen anything of the ora serrata? Now examine the ciliary processes and discuss their relations to the choroid and to the lens. Where are the ciliary muscle fibers? What is the innervation of this muscle? What are its points of origin and of insertion? What are its functions? What drugs act on it and how do they act?

With care dissect away a small sector of the suspensory ligament of the lens. What is the canal of Petit? Where are the spaces of Fontana located and what is their function? What drugs may influence this function and how? What is the canal of Sclermm? Remove the entire lens. If it is sufficiently transparent lay it over some small print and see if the letters can be seen through the lens. How many forms of lenses do you know? To which of these does the

crystalline lens belong? How is the eye focused for varying distances? What part does the lens play in this process? Make two diagrams to show these actions. What drugs may influence these processes and how do the drugs act?

Examine the iris. Locate the anterior and posterior chambers. With what is each filled? May drugs influence these chambers in any way? If so how? Can you find any evidence of the existence of dilator muscle fibers for the pupil? Where would you look for these? What is the innervation of this set of fibers? What drugs act on the dilator mechanism and where and how do these drugs act? How is the intraocular pressure controlled? How may drugs influence this? Can you find the sphincter muscle of the iris? How is this muscle innervated? What part does it play in accommodation? What drugs may affect this muscle and how and where do they act? Compare the iris of a bird with that of a mammal as regards the action of atropine, pilocarpine and cocaine. Make a diagram showing the structure and innervation of the eye and indicate thereon with ledger lines the points where all drugs which affect the eye and with which you are familiar act. Indicate the nature of these actions with a plus (+) sign for stimulation and a minus (—) sign for depression and paralysis. Describe all nervous paths and elements involved in the pupillary light reflex. What is an Argyll-Robertson pupil?

EXPERIMENT CXVIII.

Amyl Nitrite. (Student: Plethysmographic Record, General Action.)

1. Arrange your apparatus for taking a volume record of the arm as shown in Fig. 326. When all adjustments are made fold a handkerchief over a three (or five) minim amyl nitrite pearl and prepare to break the pearl by squeezing

it with a pair of pliers. (Pearls, or ampoules, are now prepared by several firms already covered by cloth so that glass particles can not fly off from the ampoule when it is broken.) Bring the pearl (or ampoule) up close to the subject's nose and allow the vapors of the drug to be breathed in at once as the glass container is snapped by the pliers. Be sure you already have a normal plethysmographic record started (on a slow drum) before the pearl is broken.

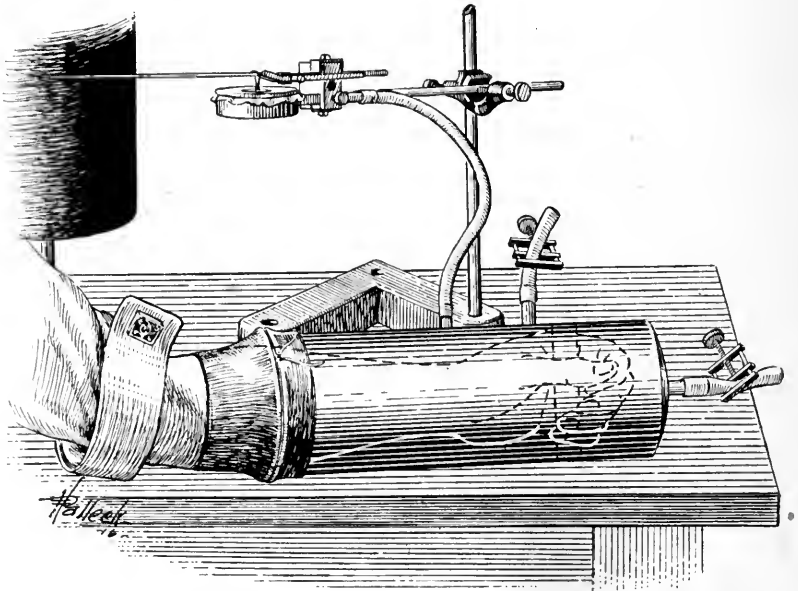

Fig. 326.—Plethysmograph for recording volume changes in the hand and forearm. The rubber band that connects the plethysmograph to the arm may be made of the wrist or arm portion of a rubber glove (which may be bought in a ten cent store).

The subject should be sitting (or lying) in a perfectly comfortable position so that he will not move the hand into and out of the plethysmograph while the record is being taken. The drug is very volatile and in a few seconds it will have practically all disappeared.

What does your record show? How do you explain the results? What general sensations does the subject feel? Watch his face and neck closely for any flushing of the skin

that may occur. Count his pulse and compare with the normal. Be sure to observe his rate and depth of breathing as the drug is inhaled. How do you account for the changes observed?

EXPERIMENT CXIX.

Amyl Nitrite. (Student: Pulse Tracing.)

1. Attach a sphygmograph to the wrist as shown in Fig. 327. Take one or two normal tracings and then prepare a strip of paper ready to record the action of amyl nitrite on

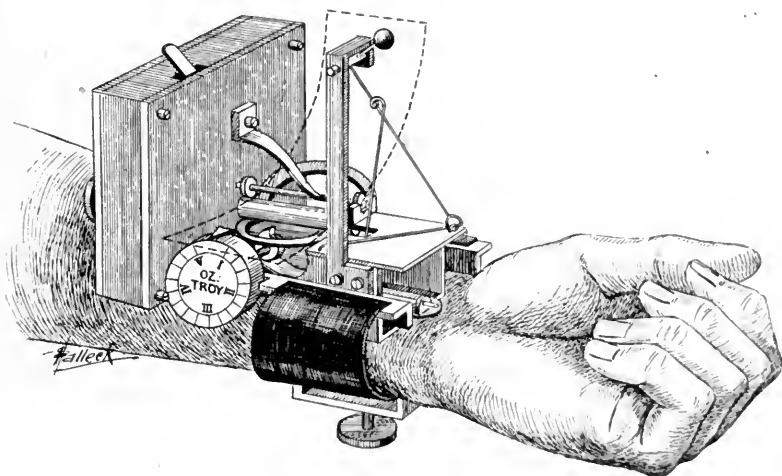

Fig. 327.—Dudgeon's sphygmograph arranged for recording tracings from the radial pulse.

the pulse. The subject should be in a perfectly comfortable position. When all is ready break the pearl or ampoule and let the subject inhale the vapors. When the effects come on markedly (in about ten seconds) start the clock work and run the paper through rapidly to record the changes in the form of the pulse curve. What can you say about the diastolic wave? What is its origin and significance? How does amyl nitrite affect it? What other

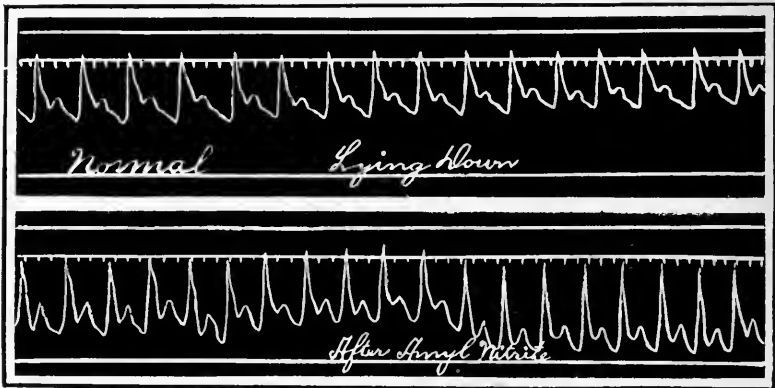

Fig. 328.—Tracing made with Dudgeon's sphygmograph showing the normal pulse record and a pulse record as affected by inhaling amyl nitrite.

changes are produced in the pulse curve? How does the drug produce these?

EXPERIMENT CXX.

Amyl Nitrite. (Student: Corpuscles in Retinal Vessels.)

1. Obtain a piece of blue glass about four inches square. (It is often better to use two pieces of glass placed together to intensify the color.) Let the subject of the experiment lie down at perfect rest on his back before a large window through which he can see a large expanse of clear blue sky. (The sun should not shine on the student's face or on the blue glass plate.) The student now holds the glass near his face and looks through the glass up into the clear sky. He accommodates his eyes for a long distance and remains as perfectly at rest as possible. Presently a considerable number of small, almost circular, shadowy, ill-defined objects will begin to appear in the field of vision. These objects have a rapid, squirming motion, reminding one of the movements of an angle worm in water. The objects fit into sight suddenly, squirm about for an instant and then suddenly disappear. These objects are believed to be the

shadows of the corpuscles circulating in the capillaries of the retina in front of the rods and cones. Observe carefully (but do not try to fix the eye on any given point) about how numerous these objects are in the field of vision. If the number were suddenly doubled or reduced by half, could you detect the difference? Do not strain your eyes in watching for the objects as efforts in this direction will avail nothing and may even appear to decrease the number of shadows visible. Can you make out the shape of individual corpuscles? Do the shadows appear to move in set paths, i.e., within the lumen of the capillaries? Do any two or more shadows follow the same course as near as you can judge? When the student has learned the appearance of these shadows well and can readily estimate any considerable change in their number then, as the subject keeps watching the shadows, an amyl nitrite pearl is broken near his nose and he quickly breathes in its vapors. Watch his respiratory movements closely. Does his face flush? The subject should not know what change to expect in the number or movement of the corpuscle shadows seen by him. In what ways may amyl nitrite influence the appearance of these shadows? Explain in detail.

EXPERIMENT CXXI.

Amyl Nitrite. (Student: Retinal Blood Vessels.)

1. Through the center of a stiff, opaque card (calling card, or smoked, varnished drum paper) a pin hole is made. The card may be about two by three inches in size. The subject sits down at perfect rest in front of a window through which he can see a considerable expanse of clear, blue sky. A few objects, as the top of a building or a tree, may well be located about 200 to 400 feet in front of the window, so the subject by lowering his field of vision a little can see the upper part of these objects. The purpose of

this is to give the student a chance to know when he has his eyes focused for a long distance (with which point most students are unfamiliar).

The subject looks out into the clear sky (avoid sunlight) and holds the card in his right hand in front of and near to his right eye. The left eye is closed. The right eye looks through the pin-hole in the card and is focused for a long distance, i.e., the ciliary muscle is completely relaxed and the pupil is dilated. The card is now moved in a rotary manner in such a way that the pin-hole will describe a small circle in front of the pupil. The diameter of this circle should be about one-eighth of an inch or less and the circular movement should be repeated at the rate of about two or three times per second. Thus a small ray of light will pass from the window through the pin-hole in the card, through the pupil and back on to the retina. Since the pin-hole is being constantly moved in a circle this ray of light will also be continually traveling round and round in a circle over the region of the fovea in the retina. This is a very unusual manner for light to enter the eye. As a result the blood vessels which are located in the anterior layers of the retina cast back their shadows on to the rods and cones in the posterior layers of the retina in such an unusual manner that these shadows are recognized by the subject. Their form and general distribution can be easily made out. It usually takes a long time for a student to learn to recognize these shadows correctly. He should focus his eyes for a long distance and keep moving the pin-hole round and round as he gazes through it up into the clear sky. The vessels, when finally recognized, will appear very much like the leafless tops of a number of trees ranged in a circle in such a manner that the tops all point toward the center but do not quite reach it, so that a small clear space is left entirely free from vessels in the center. This clear space corresponds to the macula lutea or yellow spot. What do you know about this area?

When the subject has learned to recognize clearly the size and appearance of these retinal vessel shadows he may determine the action of amyl nitrite on them. He should sit (or lie) at perfect ease, and his right hand should be free to keep up the circular movement of the card. While the card is moving and the vessels are being closely observed an amyl nitrite pearl is broken near the subject's nose and the vapors are rapidly inhaled. The subject watches carefully for any change in the size or distribution (extension toward the macula or withdrawal therefrom) of the retinal vessel. How may amyl nitrite affect these vessels? Explain in detail.

EXPERIMENT CXXII.

Amyl Nitrite. (Student: Effect on Vision.)

1. On the white, glazed surface of a sheet of drum paper make a circular spot one-fourth inch in diameter with black India ink. Behind the drum paper place several sheets of perfectly white writing paper (or a sheet of white cardboard) to give a perfectly white background to the drum paper. The subject now sits quietly and looks at the black spot while amyl nitrite vapors are administered to him. Around the black spot the subject watches for rings of different colors to appear. If these are observed how many are there, what is their arrangement, and what colors are seen? How long do they last? How does amyl nitrite act to produce this effect? What is the embryological origin of the retina?

If time permits it will be instructive to make a white spot on a black background and repeat the experiment by inhaling amyl nitrite vapors while looking intently at the white spot. Do you know of any other drugs which will affect color vision? On what nervous structures may such drugs act? What relation does the retina bear to the cerebral cortex?

EXPERIMENT CXXIII.

**Amyl Nitrite, Nitroglycerine, Sodium Nitrite. (Dog:
Blood-pressure, Respiration, Spleen or Intestinal
Loop Volume, Blood.)**

1. Prepare a dog for recording blood-pressure, respiration and the volume of either the spleen or a small loop of the intestine. The injecting burettes contain nitroglycerine (one-fourth per cent—the U. S. P. form is one per cent) and sodium nitrite (one per cent). Place a straight cannula in one femoral artery pointing toward the heart. Into a test tube draw off through this cannula five cubic centimeters of blood and add to the blood two cubic centimeters of two per cent sodium chloride solution. Set the tube aside and draw off five more cubic centimeters of blood into a second test tube. Add to this tube two cubic centimeters of two per cent sodium nitrite solution. Shake up both tubes and let them stand for some time. Do you note any changes in either one? If so what and how marked is the change? If a spectroscope is available a one-half or one per cent solution of each may be made and compared as regards their spectra after the remainder of the experiment is finished.

Take a normal record and prepare to give the animal some amyl nitrite. Proceed with this as follows: Keep the anesthesia as regular as possible. Open the side tube of the tracheal cannula and let the animal breathe mainly through this. Place a pearl on a towel and seize the pearl with a pair of forceps through the towel from below. Invert the towel so as to form a very small tent-like chamber over the end of the side tube of the tracheal cannula. Be sure glass particles do not fly into the wind pipe. When all is ready (a good normal record is being taken) snap the pearl and let the animal breathe the vapors. The effect should come on promptly. It will not last long and after

the animal fully recovers another set of records may be taken by administering a second pearl. (Under special conditions you may sometimes want to administer amyl nitrite to the animal by placing the drug in an empty ether bottle through which the animal is allowed to breathe temporarily.) Do you note any effects on the spleen or loop of

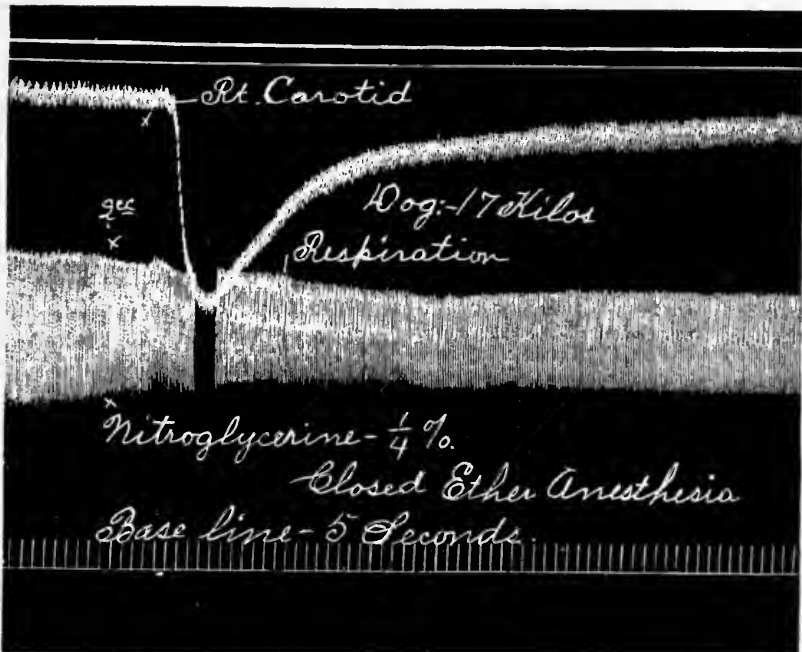

Fig. 329.—Tracing showing the action of nitroglycerine on the carotid pressure and the respiration in a dog.

intestine? If so how do you account for the action? Is it an active or a passive affair? What mechanical factors are involved? Explain any changes observed in the blood-pressure and respiration.

When the animal fully recovers take a normal record and then inject two cubic centimeters of the nitroglycerine solution. Do you get a satisfactory record? (If not a sec-

ond dose may be given later.) Explain your results in detail.

Let the animal recover, take a normal and then inject one cubic centimeter of sodium nitrite solution. Do you get a satisfactory record? (If not a second dose may be given later.) Explain your results in detail. For what purpose do you infer nitrites might be used clinically?

If the animal is now in poor condition kill it with a large dose of nitrite. How much is required? But if the animal is in fair or good condition (as it probably will be) then allow it to recover as fully as possible and proceed to perform the next experiment on it.

EXPERIMENT CXXIV.

Nitrites, Pilocarpine, Adrenaline. (Dog: Bronchial Action.)

1. Arrange to record bronchial contractions by one of the methods previously given. (If the animal from Experiment CXXIII is used remove the spleen or intestinal oncometer and close the abdomen tightly.) The injecting burettes contain one per cent nitroglycerine, pilocarpine (one cubic centimeter equals one milligram) and adrenaline (1:10,000).

Pith the animal, adjust the recording instruments and take a short normal record. Inject one cubic centimeter of pilocarpine. This should produce a bronchoconstriction which will last for several minutes if no other drugs are given. When the bronchoconstriction becomes marked then inject two cubic centimeters of nitroglycerine solution. What action has this on the bronchioles? Would you advise nitrites for bronchial asthma? Give one-half cubic centimeter of adrenaline.

If the animal is still in suitable condition a further injection of pilocarpine (to produce an initial bronchocon-

striction) may be given and this can be followed by an injection of sodium nitrite to determine the action of this body on the bronchial musculature. This is a point of considerable clinical interest. How does adrenaline compare with the nitrites as regards its power to dilate the bronchioles? Would it make any difference whether the bronchoconstriction was due to nervous origin (as is the case with pilocarpine) or to a direct muscular stimulation (as occurs with ergamine)? Which of these conditions exists in clinical bronchial asthma? Stop the artificial respiration and kill the animal.

After the animal is dead open the chest, dissect out the heart and study carefully the position and relations of both auricles and both ventricles. Inflate the lungs and see how much these would be in the way in taking myocardiograms.

EXPERIMENT CXXV.

Digitoxin. (Frog: General Action.)

1. Destroy the cerebrum only of a frog and inject one cubic centimeter of digitoxin solution (one cubic centimeter equals one milligram—dissolve the digitoxin in a few drops of alcohol and then dilute with water, adding more alcohol if necessary to prevent precipitation of the drug. Use as little alcohol as possible.) Put the frog in a quiet place and see if any generalized symptoms appear. Does it have convulsions? If the frog dies at any time immediately cut open the chest and observe carefully the condition of the heart. Has it just stopped beating or is it still pulsating? Digitalis solutions are often standardized by giving just a sufficient dose of the preparation to stop the heart of a frog in one hour. This dose of the standard solution is taken as a basis, by comparison with which newly prepared solutions are standardized. Examine carefully the condition of the ventricle and of the auricles. Are these chambers in systole or diastole? How do you account for the condition?

EXPERIMENT CXXVI.

Digitoxin. (Frog: Heart Tracing.)

1. Pith a frog and take a normal heart tracing showing both vagus and crescent inhibition. Then drop onto the heart slowly a solution of digitoxin (five cubic centimeters equal one milligram—dissolve the drug in a little alcohol and dilute to the desired strength, adding more alcohol if absolutely necessary.)

After the drug has acted for a little time stimulate the vagus nerve and see if the inhibitory apparatus is paralyzed. How is the tone of the heart affected? Is this a nervous or a muscular action? Continue the application of the drug and record the entire action on the heart. When this heart stops compare its condition with that of the heart of the frog used in the preceding experiment. What conclusions can you draw?

EXPERIMENT CXXVII.

Digitoxin. (Turtle: Heart Tracing.)

1. Repeat Experiment CXXVI using the turtle's heart instead of that of the frog. Is the inhibitory apparatus affected?

EXPERIMENT CXXVIII.

Digitoxin. (Dog or Cat: Blood-pressure and Respiration.)

1. Etherize a dog or cat and take a normal record of blood-pressure and respiration. The injecting burette contains digitoxin solution (ten cubic centimeters equal one milligram—dissolve the drug in alcohol and dilute with water to the proper strength, adding more alcohol *if absolutely necessary*). When the normal is recorded (be sure the manometer pointer can pass just to the right of the re-

spiratory tambour) inject slowly and cautiously one-half cubic centimeter of the drug.

Caution: Digitoxin preparations on the market are exceedingly variable in strength and composition. Each preparation must be tested before the size of the dose for an animal can be determined. The object here is to give very small doses and bring on the action of the drug very slowly.

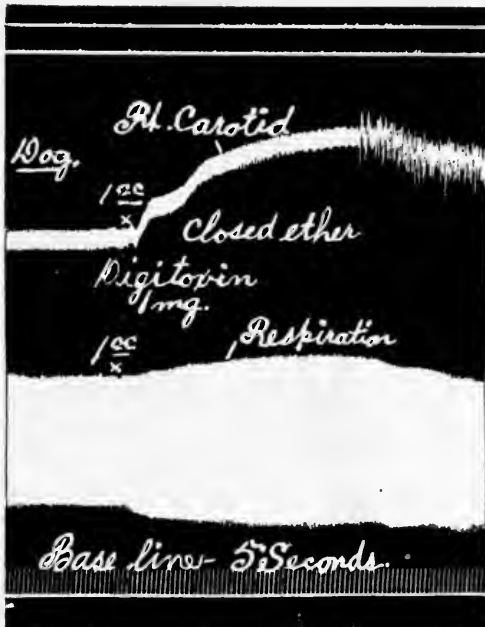

Fig. 330.—Tracing showing the action of one milligram of digitoxin on the blood-pressure and respiration in a dog. Slow drum.

Watch for any slight changes in the amplitude of the manometer tracing. The drug should first slow the heart slightly. The pressure may be somewhat elevated during this period which corresponds to the therapeutic (1st) stage. As the action of the drug becomes more marked the heart is greatly slowed (2nd stage) provided the inhibitory apparatus is working normally. The center is stimulated by the drug and this indirectly slows the heart by inhibition. Give a few small injections slowly from time to time at first

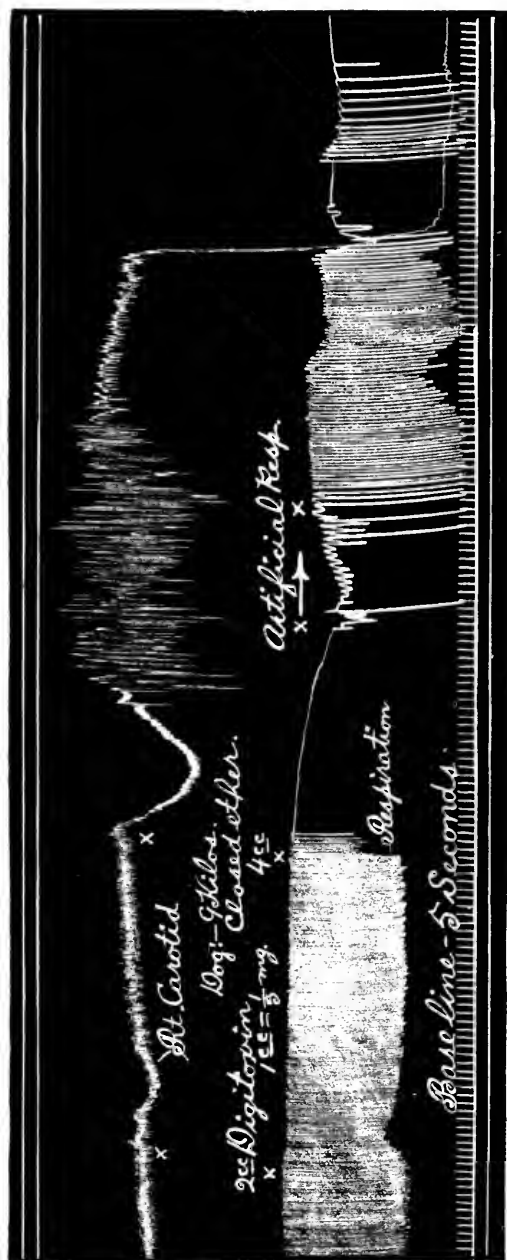

Fig. 331.—Tracing showing the action of two injections of digitoxin on the carotid pressure and respiration of a dog. Artificial respiration was given for a brief period at the point indicated. The heart finally passed into delirium cordis and the blood-pressure rapidly fell to zero.

to avoid killing the animal too quickly (some preparations are exceedingly poisonous). As soon as you determine the tolerance of the animal to the solution make larger and more frequent injections, watching carefully for the marked

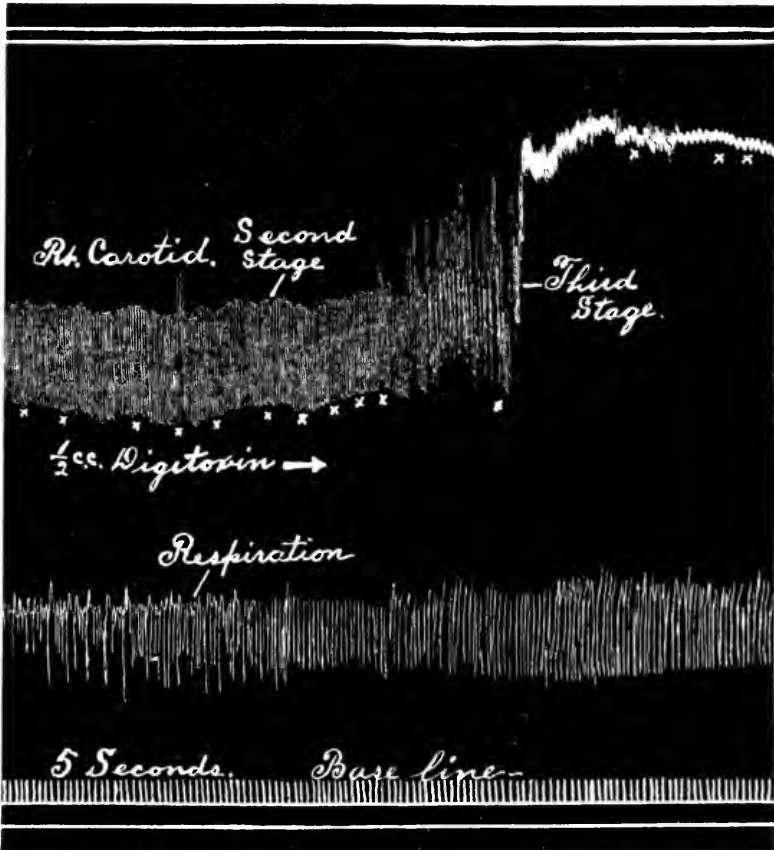

Fig. 332.—Tracing showing the blood-pressure and respiration of a dog under the influence of digitoxin at the time when the second stage passed over into the third stage. Several small doses of the drug were given from time to time to bring on this action.

slowing of the second stage to appear. When once you see clearly that this slow stage is beginning then stop all injections and wait for the drug to act. There will then probably be sufficient drug in the animal to cause death and it

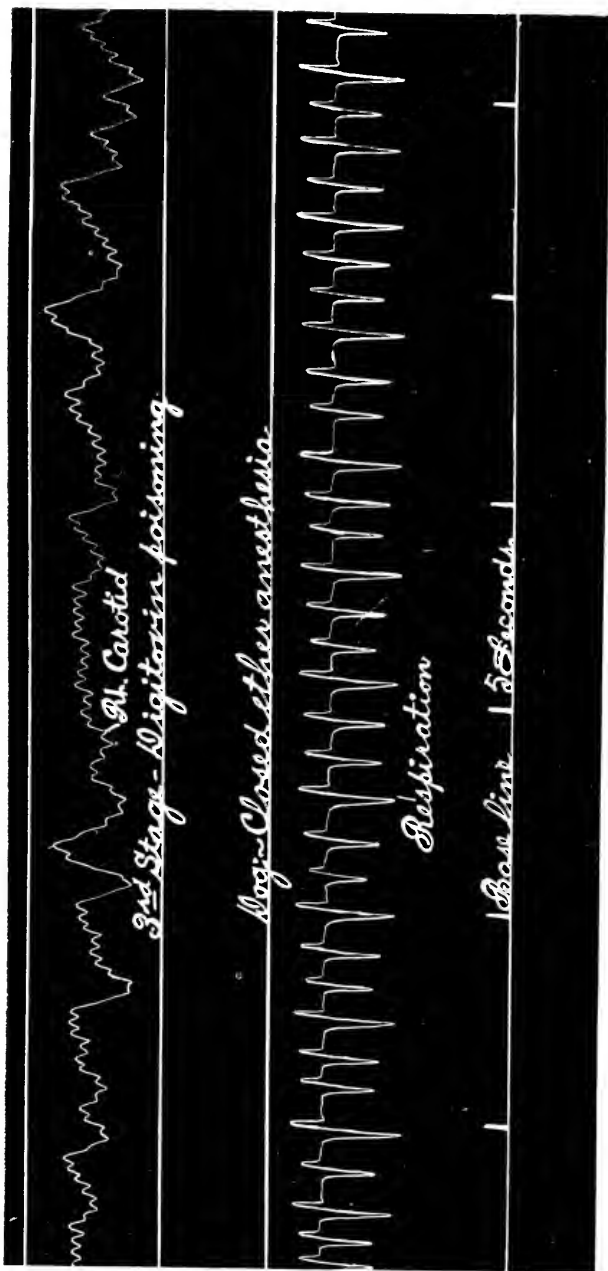

Fig. 333.—Tracing showing the action of digitoxin (third stage) on the heart and respiration as recorded on a fast drum.

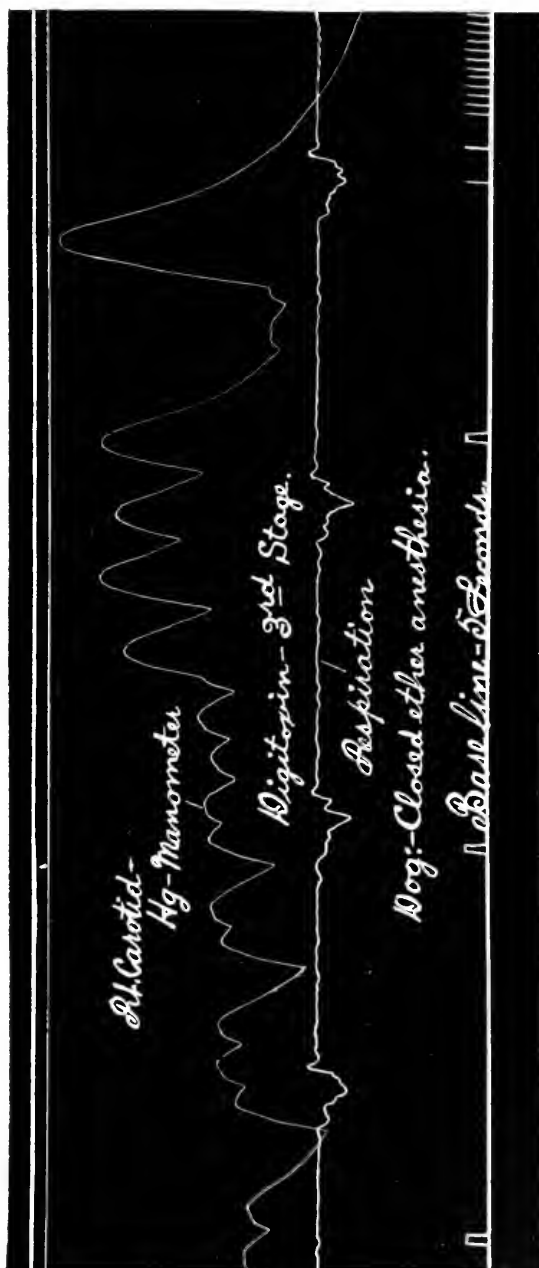

Fig. 334. Tracing showing the final result (end of third stage) of the action of digitoxin on the carotid pressure and respiration in a dog. Very fast drum.

is desirable to prolong the later stages as much as possible to bring out the action of the drug well.

When marked slowing is present (vagus center stimulated) the blood-pressure may be considerably lowered. After a time irregular heart beats appear and the elevation of the pressure varies from moment to moment. Watch carefully now, for great irregularity of the heart may suddenly appear at any time, i.e., the vagus may lose control of the heart whose muscle fibers become so irritable that the organ breaks loose from the inhibition and begins to beat very rapidly, and irregularities, extra systoles, etc., soon appear. When this very rapid (3rd) stage appears the pressure may continue high for a little while but delirium cordis (fibrillation) is likely to appear at any moment. When it does the pressure will fall to zero at once, perhaps from a considerable height. The respiration will stop at about the same time as a rule. Watch carefully for the animal to die, and as soon as the pressure suddenly falls to zero (*and remains there*) open the chest quickly with large tinner's snips and observe the condition of the heart. It should be fibrillating. Are the chambers in systole or diastole. Place your hand on the heart and note the character of the movements. How long does the fibrillation last? Can you determine the three stages of the drug's action on the heart as shown by your record? What conclusions can you draw from the experiment? How much drug is required to kill the animal? Could you assay the strength of an unknown preparation of digitalis by comparing the size of the lethal dose of the preparation with the size of the fatal dose of a standardized preparation? On this basis a number of methods for assaying the strength of preparations of digitalis and related bodies have been proposed. (For literature, see Houghton, E. M.: *The Lancet*, 1909, June 19; Hatcher and Brody: *Journal of Pharmacology*, 1910, August, p. 362; Famulener and Lyons: *Proceedings of the American Pharmaceutical Association*,

1902, p. 417; Vanderkleed and Pittenger: *Journal of the American Pharmaceutical Association*, 1913, xi, p. 558; Edmunds: *Hygienic Laboratory Bulletin No. 48*; Hatcher: *Journal of the American Medical Association*, 1910, ii, p. 1697; U. S. P. ix, p. 606; Pittenger and Vanderkleed: *Journal of the American Pharmaceutical Association*, 1915.)

EXPERIMENT CXXIX.

Digitoxin, Strophanthin, Nitroglycerine. (Dog: Pulmonary Blood-pressure, Carotid Pressure.)

1. Arrange a dog for recording carotid and pulmonary blood-pressure tracings according to the method learned previously. Place digitoxin solution (five cubic centimeters equal one milligram) in one injecting burette and strophanthin solution (five cubic centimeters equal one milligram) in the other.

When all adjustments are ready take a short normal record and inject one cubic centimeter of digitoxin. Wait for the animal to recover. When the records return approximately to normal inject one cubic centimeter of strophanthin. Do you get satisfactory records from both drugs? How is the pulmonary blood pressure affected? Does this correspond with the systemic circulation? Do the two drugs act alike on the pulmonary vessels? Which is the more powerful? If these doses were too small to produce any noticeable result give another larger injection of each one to secure satisfactory tracings.

Now empty the digitoxin out and fill the burette (or, better, connect a third burette to a neck vein at the start) with one-half per cent nitroglycerine. Take a normal quickly and then inject one cubic centimeter of the nitroglycerine solution. Do you get a satisfactory record? If so how is the pulmonary pressure affected? Does this have any special clinical significance? How does it compare with digitoxin?

Replace the digitoxin in the burette and continue the records. Inject more digitoxin and strophanthin from time to time and slowly bring on the action of the drugs. Watch that the animal does not die suddenly from *some unknown cause* and the drugs be accepted as the cause of death. Ani-

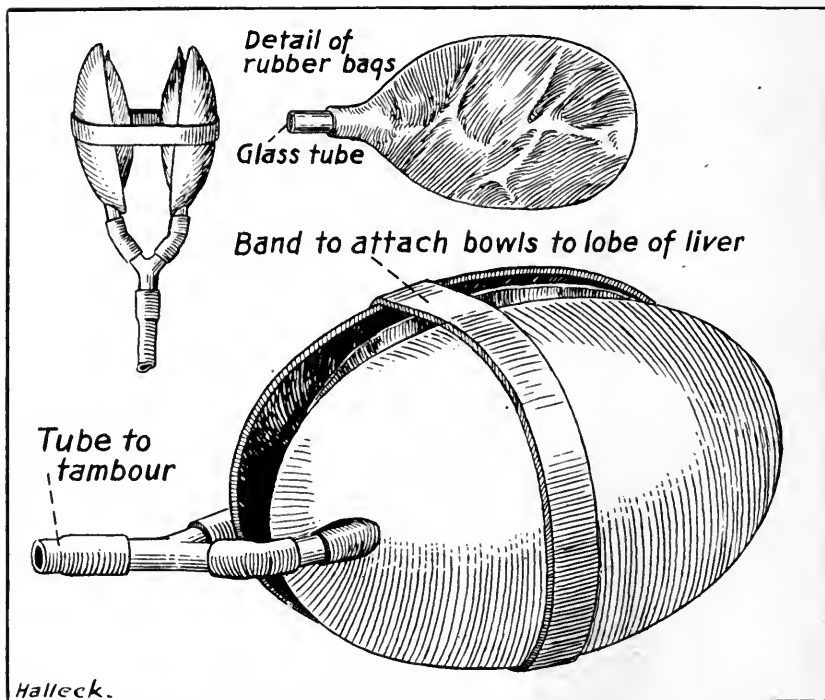

Fig. 335.—Schematic illustration showing the principles involved in the construction of Edmunds' liver oncometer. The two curved spoon-shaped pieces are made of dental impression compound. This is a brownish substance (resembling sealing-wax) which softens and becomes easily moulded with the hands when placed in hot water for a while, but hardens on cooling. Obtainable from dental supply houses. Thin flat rubber bags fit inside the curved pieces and these bags fit just over the outside of the left lobe of the exposed liver. Records are made by air transmission to a tambour.

mals arranged for recording pulmonary blood-pressure often do not live long and it is important to work rapidly and accurately. Can you detect any evidence that the heart has been especially stimulated or strengthened by the drugs? Do you know of any other drugs previously studied

that resemble the effects of digitalis in certain features of their action?

Crowd on enough digitoxin or strophanthin to kill the animal after a few minutes. If you detect the marked slow-

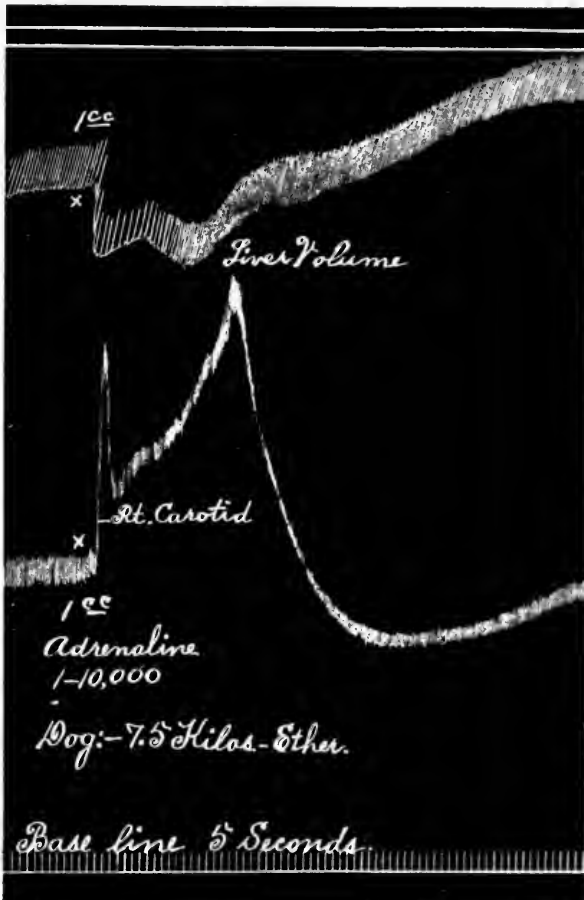

Fig. 336.—Tracing showing the action of adrenal'ne on the volume of the left lobe of the liver and on the blood-pressure. Made with the apparatus shown in Fig. 338.

ing of the heart indicative of the second stage then stop giving drugs and wait for the full effects of the substances to develop. Do you get the third stage of great irregularity followed by delirium cordis and death?

After a time kill the animal with a large dose of one of the drugs if it has not already died as indicated above. Watch the heart closely throughout the experiment and see if you can follow the changes occurring in the auricles and ventricles. If delirium cordis sets in which chambers are affected by it first? Is this of any clinical significance? Can you detect this on the carotid record? Would this signify anything of importance from a clinical standpoint? Are the vagus endings in the heart paralyzed during the third stage? Could you determine this point during your experiment in any way?

EXPERIMENT CXXX.

Digitoxin. (Dog: Heart Tracings, Carotid Pressure.)

1. Arrange a dog for recording tracings from both auricle and ventricle as was done in previous experiments. If simple heart levers are used the right auricle and right ventricle will probably be the easier for the student record. If a Cushny myocardiograph is available the left ventricle can very well be used. If only one chamber can be recorded then the left ventricle is preferred.

The records should be arranged with the auricular tracing at the top of the drum, below this the ventricular tracing, then the carotid pressure, and finally the base line (showing the time also). The injecting burette contains digitoxin (five cubic centimeters equal one milligram).

When all adjustments are made take a normal record and begin to inject digitoxin in *very small* repeated doses, waiting a little while between each dose to see what its effect will be. The object now is to bring on the action of the drug slowly and to watch to record the changes in each chamber as the three stages develop. When the marked slowing of the second stage first begins to appear (due to stimulation of the inhibitory center in the medulla) watch carefully to see whether the auricles or ventricles first

show the retardation. Do the two auricles beat in alternate rhythms or synchronously? Does this hold true for the ventricles also? Stimulate one vagus nerve from time to time (do not injure the nerve by drying, etc., or by too strong a current) and see if its connections with the heart muscle are destroyed at any time. Inject more drug from time to time until the second stage is well developed. Wait then and *do not give any more drug* unless it appears to be *absolutely necessary* to bring on the last stages.

When the stage of irregularity appears (third stage) observe carefully which chambers of the heart first take up the rapid rhythm. Is this due to paralysis of the vagus endings?

Caution: Sometimes the second stage of marked slowing is not developed in the heart (inhibitory mechanism weakened or paralyzed) and the pulsations take on a rapid character early in the intoxication and the stage of irregularity may follow after a brief interval. Slow administration of the drug at first is best calculated to bring on the stage of marked inhibition.

When the heart becomes very irregular observe the corresponding changes in pressure. Watch for the sudden development of delirium cordis (fibrillation) and note which chambers first show this phenomenon. Do the other chambers begin fibrillating at once or only after a considerable interval? How does delirium cordis affect the blood-pressure? What can you say about delirium cordis in the frog or turtle?

Do you get satisfactory tracings from the heart showing all the stages of the poisoning? Do you believe it would be possible to standardize digitalis preparations according to the amount of the drug necessary to bring on the different stages in the heart action? On what do you base your conclusions? What is the cause of death in digitoxin poisoning? The administration of the drug should be continued (at long intervals) until the animal dies—which will probably be rather suddenly. Judging from your experiment what should be the clinical symptoms of the first or thera-

peutic stage of the action of digitoxin? Discuss the action of the drug on the heart in detail.

EXPERIMENT CXXXI.

Digitoxin, Strophanthin. (Dog: Diuresis, Spleen Volume, Leg Volume, Blood-pressure and Respiration.)

1. Arrange a dog for recording blood-pressure and leg volume. Then open the abdomen and isolate both ureters near the bladder. Place a cannula in each ureter and arrange to collect the urine secreted. Now place the spleen in an oncometer and arrange to record the volume changes of the organ. On the drum the spleen volume should be at the top, next below the leg volume, then the blood-pressure and respiration with the time marked on the base line. The rate of urine flow may be recorded with a signal magnet by a hand key and dry cell if desired. The injecting burettes contain digitoxin (ten cubic centimeters equal one milligram) and strophanthin (ten cubic centimeters equal one milligram).

When all is ready wait a while to get a record of the normal rate of urine secretion. Then take a normal record and inject one cubic centimeter of digitoxin solution. Is the dose too small? Give one cubic centimeter of strophanthin. Which affects the animal the most? Inject a few more doses very cautiously and then wait for some time to see if the rate of urine flow is changed. If it is how does this compare with the action of caffeine or sodium sulphate?

After time has been given for an action on the kidney to develop (is this certain to occur?) then adjust all writing points and take a normal. Then inject a good sized dose of digitoxin as estimated from your previous experience with the drug and with the animal. How does this affect the spleen and leg? Do the other records show a corresponding action? Wait a while and give a similar injection of strophanthin. How does the action of this drug compare

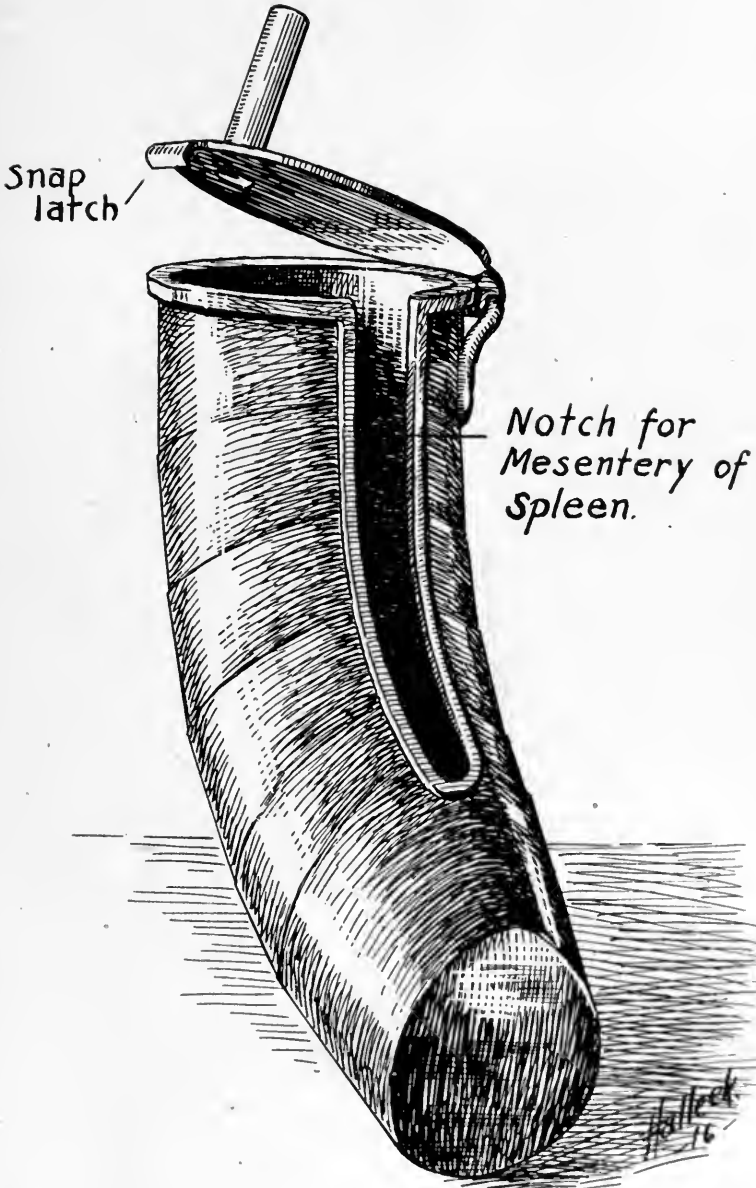

Fig. 337.—Spleen oncometer made of crimped sheet brass soldered together. Nearly natural size. (For a dog.)

with the digitoxin? Are the vessels of the internal organs and of the leg both affected in the same way and in corresponding degrees by these two drugs? (See Edmunds:

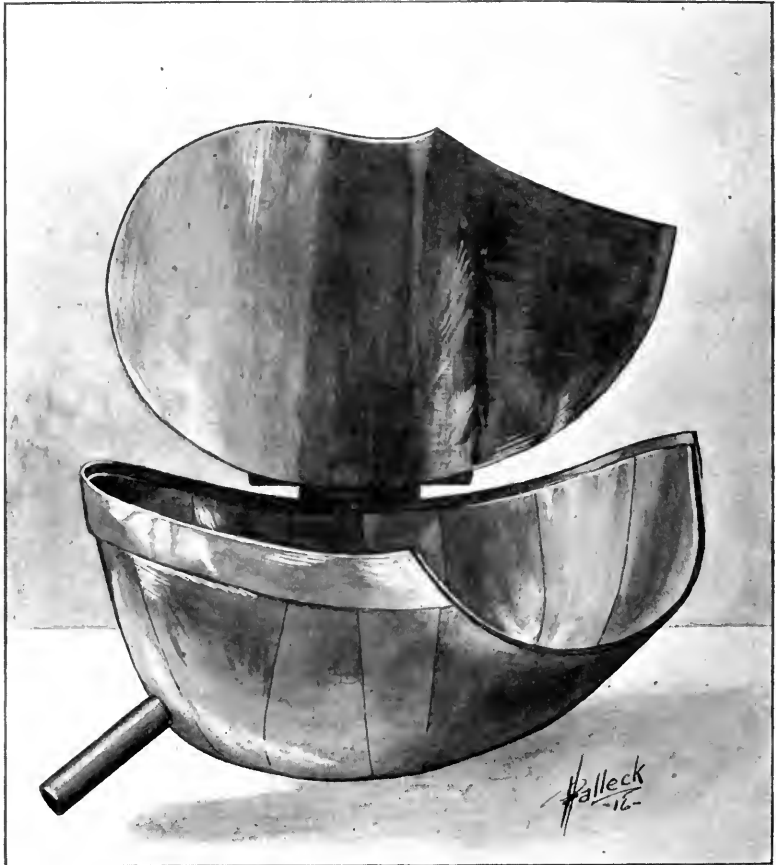

Fig. 338.—Liver oncometer, for the left lobe of the liver of a dog. Made of crimped sheet brass. The lid (raised up) is slipped under the lobe and the cup-like part closes over the lobe to inclose it. The “pedicle” of the lobe passes through the large notch at the right in the picture. The spout is connected to a tambour and the abdomen is closed air tight.

American Journal of Physiology, xviii, p. 129.) What can you say about the action of the digitalis series of drugs on the medullary centers? (See Hatcher and Eggleston: Jour-

nal of Pharmacology and Experimental Therapeutics, iv, p. 113.)

Do these large injections of the drugs affect the kidneys?

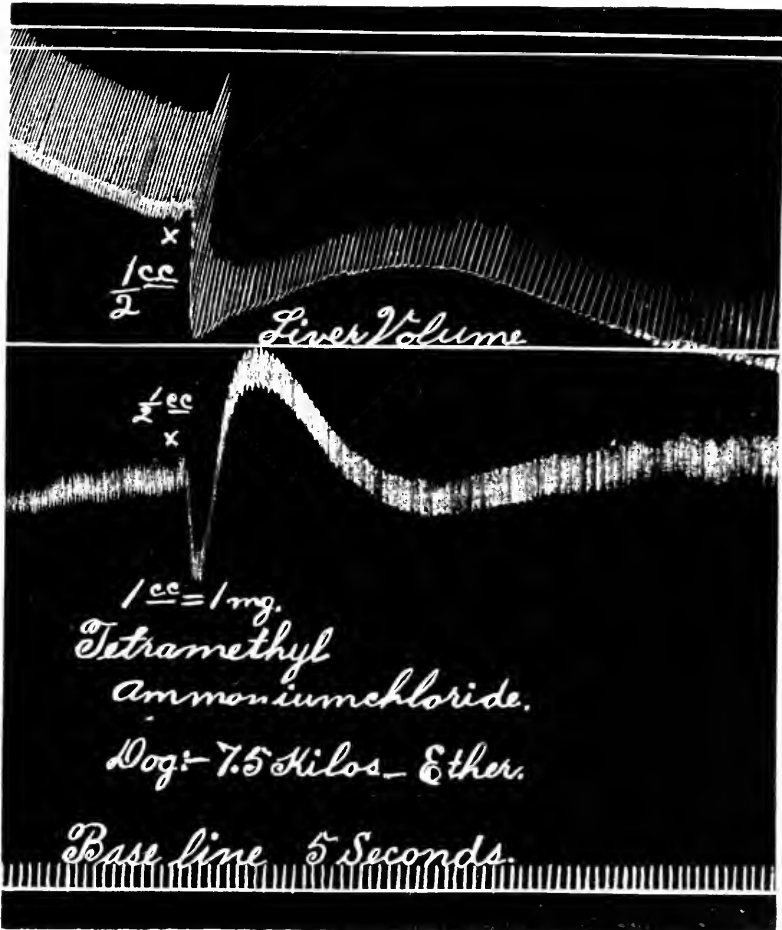

Fig. 339.—Tracing showing the action of tetramethylammonium chloride on the liver volume and blood-pressure in a dog. The respiratory movements show in the oncometer tracing. The animal was breathing deeply. Made with the oncometer shown in Fig. 338.

In what ways might they influence the secretion of urine? When satisfactory records have been obtained inject a large dose of one of the drugs and get a death record.

Have you shown all three stages of the heart action in your experiment? What general conclusions can you draw from the experiment?

EXPERIMENT CXXXII.

Adrenaline, Potassium Chloride, Digitoxin, Strophanthin.
(Cat, Rabbit, Dog: Heart Perfusion—Langendorff Method.)

1. Set up your apparatus with great care in the manner shown in Fig. 340. Prepare several liters of stock salt solution (Locke's preferred). Place two liters of the solution in the pressure bottle and heat the water bath to 39 degrees centigrade. Place water in the heart warmer (a hot water funnel may be substituted for the cheap heart warmer here shown) and heat the warmer to 39 degrees centigrade.

When all apparatus is arranged, including the adjustment of the cannula (lower end of a glass T-tube with a neck drawn on it) for insertion into the aorta, then etherize the animal and connect a burette to one femoral vein. A straight cannula is placed in one carotid pointing toward the heart to bleed the animal. Draw off as much blood as will flow readily out of the carotid and whip this until the fibrin is all removed. Meanwhile siphon off a liter and a half of the warmed salt solution from the pressure bottle and inject a liter or more of the warm solution into the femoral vein. This will revive the animal somewhat and it may then be bled further from the carotid. All the blood is carefully saved, whipped free from clots, filtered through cloth or cotton and placed in the pressure bottle (which contains now one-half liter of warmed salt solution). This mixture of whipped blood and salt solution forms the stock perfusion fluid. More salt solution can be added to it to bring the volume up to four or five times its original amount or more.

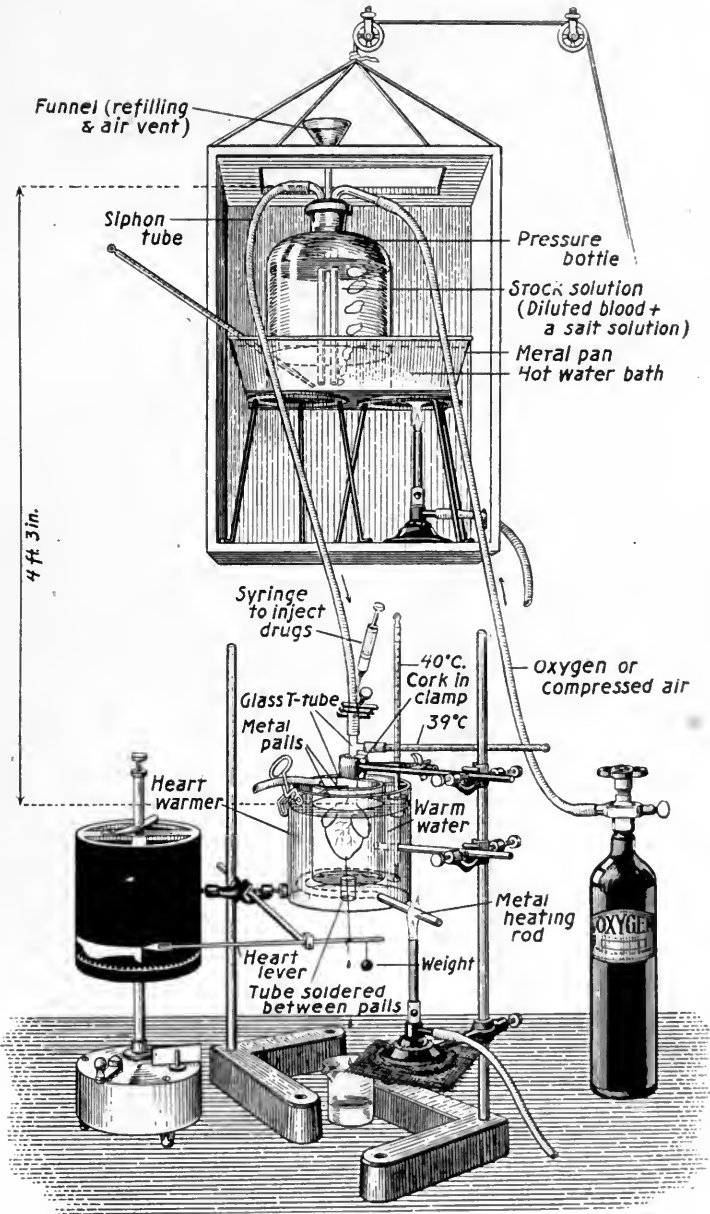

Fig. 340.—Arrangement of apparatus for recording tracings from an excised heart (Langendorff method). The heart warmer is made of two cheap metal palls held together by a metal tube soldered between them at the bottom. Through this tube passes the thread attached by a pin hook to the heart. The space between the palls is filled with water heated by the flame of a Bunsen burner applied to the heating rod.

When no more blood can be obtained from the animal (by injecting salt solution) then quickly open the chest by a median incision with tinner's snips and carefully excise the heart and lungs. Do not injure the vessels or tissues of the heart and watch that the auricles are not cut away. The aorta should be left an inch or more long. Cut off the lungs and free the heart as much as possible from fascia but do not tear the vessels. Tie all the large branches of the aorta, slip the main aortic trunk over the perfusion cannula (do

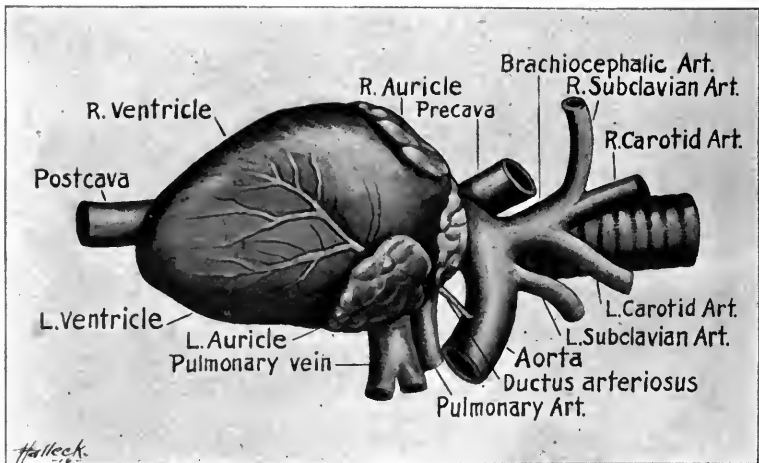

Fig. 341.—Cat's heart.

not insert the cannula far enough to interfere with the semilunar valves or the coronary arteries) and tie the cannula in. Let the air all out of the perfusion tubes (by opening the outlet and running down some of the perfusion fluid while the aorta just below the cannula is closed by a bulldog). Remove the bulldog and start the perfusion. Oxygen should be started to bubbling slowly through the stock solution. (Compressed air may be used instead of oxygen.) The temperature of the perfusion solution should be kept at about 39 degrees centigrade. The heart may not beat at first, but after a time the beats will begin and soon become

strong and vigorous. Then take a normal record. Return the fluid which has already passed through the heart to the stock solution and prepare to inject some adrenaline with the hypodermic syringe through the wall of the rubber tube just above the heart. Two cubic centimeters of 1:10,000 solution may be injected slowly and steadily. How does this affect the record? How long does the action on the heart last? *Do not return the solution into which any drug*

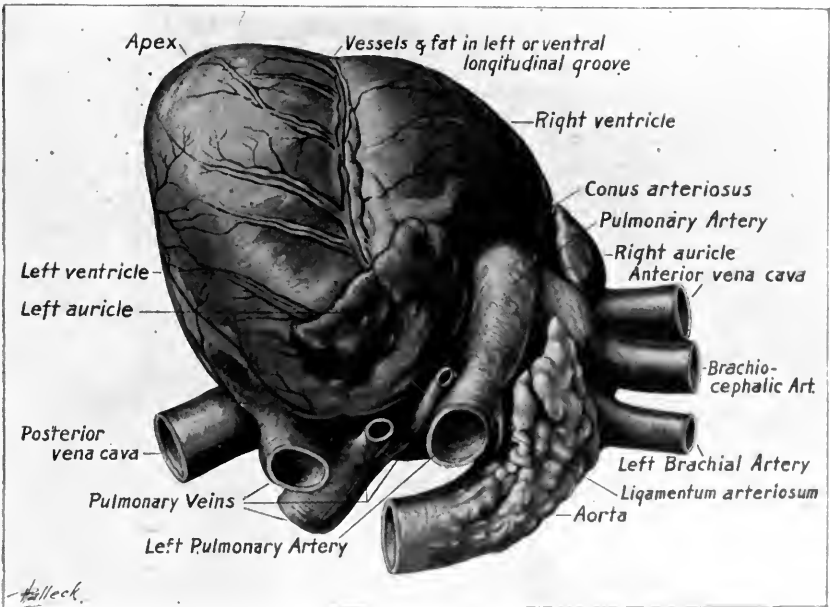

Fig. 342.—Dog's heart.

has passed to the stock solution. Change beakers to catch the outflow as soon as the drug has all passed out.

When the heart returns to normal inject some potassium chloride solution (one per cent) and get a record of the result. Follow this with a solution of digitoxin (five cubic centimeters equal one milligram). Do not inject too much. How does this affect the heart? When a satisfactory record has been obtained (give more digitoxin if necessary) then inject a second dose of potassium chloride and follow this

with strophanthin (five cubic centimeters equal one milligram). How does this affect the heart? Do you get satisfactory records? If the heart is in a suitable condition other drugs which may be tried are camphor, strychnine, pilocarpine, atropine, adonidin, calcium chloride, caffeine, chloroform, apomorphine, nicotine, cocaine, etc. It may be advisable to kill the heart with digitoxin. If this is done watch carefully to see if delirium cordis is produced and if so what chambers are first affected. Also in what part of the cardiac cycle does the heart stop? Does it stop in systole or diastole in the intact animal? What explanation can you offer? What general conclusions can you draw from the experiment? What part do the coronary arteries and veins play in the experiment? What are the sinuses of Valsalva? What is their function? Will the absence of intraventricular or intra-auricular pressure in any way invalidate your observations?

There are several other methods for studying the action of drugs on the isolated heart, e.g., those of Frank, Martin, Bock, Starling, Heymans and Kochman, etc. (See Heinz: *Handbuch der Pathologie und Pharmakologie*, i, 2, pp. 669 and 846 et seq.; also Sollmann: *A Text-book of Pharmacology*, 2nd edition, 1906, W. B. Saunders Co., pp. 895 and 953.)

EXPERIMENT CXXXIII.

Aconitine. (Frog: General Action.)

1. Destroy the cerebrum only of a frog, wait for the shock to wear off and then inject one cubic centimeter of aconitine solution (aconitine "potent," five cubic centimeters equal one milligram) into the dorsal lymph sac. Watch the symptoms carefully and see if there is any stimulation of the central nervous system. Are the muscles affected? What general conclusions can you draw?

EXPERIMENT CXXXIV.

Aconitine. (Frog: Heart Tracing.)

1. Determine the action of aconitine on the heart and inhibitory apparatus of a frog. *Leave the medulla intact.* Inject the drug into the dorsal lymph sac with a hypodermic syringe. The action on the heart is of some special interest because of the peculiar behavior of the organ under the action of the drug. This heart action has been thought to be of some value in identifying aconitine. What can you say regarding the chemical tests for the identification of aconitine? Do you know of any other drugs that act on the frog's heart in a manner similar to that of aconitine?

EXPERIMENT CXXXV.

Aconitine. (Turtle: Heart Tracing.)

1. Repeat the above experiment using a turtle instead of a frog. Apply the drug directly to the heart. What general conclusions can you draw?

EXPERIMENT CXXXVI.

Aconitine. (Dog: Blood-pressure, Respiration, Temperature.)

1. Arrange to record the blood-pressure, respiration and temperature (rectal thermometer). After the experiment starts make a record of the temperature reading every three or five minutes. Place aconitine solution (aconitine "potent," ten cubic centimeters equal one milligram) in the injecting burette. Isolate and ligate loosely (*but do not injure*) both vagus nerves. When all is ready take a normal tracing and then inject one-half cubic centimeter of aconitine solution. Some samples of aconitine are exceed-

ingly poisonous and the doses must at first be small and guarded or the animal may be killed immediately and the details of the action of the drug cannot be made out. The object now is to give small, repeated injections and bring on the action of the drug *very slowly*.

If everything is working satisfactorily you should observe after a time a slight slowing of the heart. This is manifested by a gradual increase in the amplitude of the manometer tracing. The pressure will slowly become lower. Do not crowd on the drug but wait patiently for the vagus center to be roused to greater and greater activity. Meanwhile the heart muscle is becoming slowly more and more irritable. But if the inhibitory apparatus is normal it will at first get the upper hand and the heart should finally be greatly slowed. Is there any way by which you could prove that the heart slowing is due to stimulation of the vagus center? Continue the injections *very cautiously* and when the heart becomes noticeably slower then stop the injections and wait to see if the action of the drug does not become progressively more marked without further injections. In some experiments the heart may become so slowed that the manometer tracing will show an amplitude of one-half to three-fourths of an inch for each separate heart beat. When this stage is approached then carefully lift up both vagus nerves and quickly cut them with the scissors. What effect has this on the blood-pressure and heart beat?

Caution: Do not mistake the carotid artery and cut it instead of one vagus nerve as the author has seen a student do. What would you do if this accident occurred?

Wait a while now and see if the action of the drug develops further without giving any more of the poison. How does the heart beat? Can you determine the true action of the heart by watching the mercury manometer? Does the pressure become exceedingly irregular? It should do so and then after a longer or shorter period (usually only a

few minutes) the heart suddenly goes into delirium cordis and the pressure quickly falls to zero. It may be necessary to give a little more of the drug to produce the final effects within a sufficiently short time.

How did section of the vagi affect the respiration? What was the very first abnormal action which your animal showed as seen in your tracing? Examine the respiratory record closely. What general conclusions can you draw? If the vagi had not been cut what would have happened to the heart? If two or more experiments are performed at the same time one group of students should cut the vagi, a second group should give one milligram of atropine and a third should let the action of the aconitine proceed without interfering in any way. Immediately after the animal dies open the chest quickly and see if the heart is fibrillating.

EXPERIMENT CXXXVII.

Aconitine. (Dog: Heart Tracings, Blood-pressure.)

1. As in Experiment CXXX under digitoxin, arrange to record blood-pressure and heart tracings from a dog. Place aconitine solution (ten cubic centimeters equal one milligram) in the burette.

When a normal record has been taken then very slowly and cautiously inject small repeated doses of aconitine. The object is to bring on the action very slowly and to let each phase of the heart reaction be fully developed. Watch the chambers of the heart and see which ones first show abnormalities. Over what chambers of the heart do the vagus nerves exercise the fullest control? Can you see any evidence of this by watching the heart as the action of the drug comes on?

Do you get the stage of marked slowing as in the previous experiment? Do the two auricles beat together or in different rhythm? Is this true for the ventricles also? Does

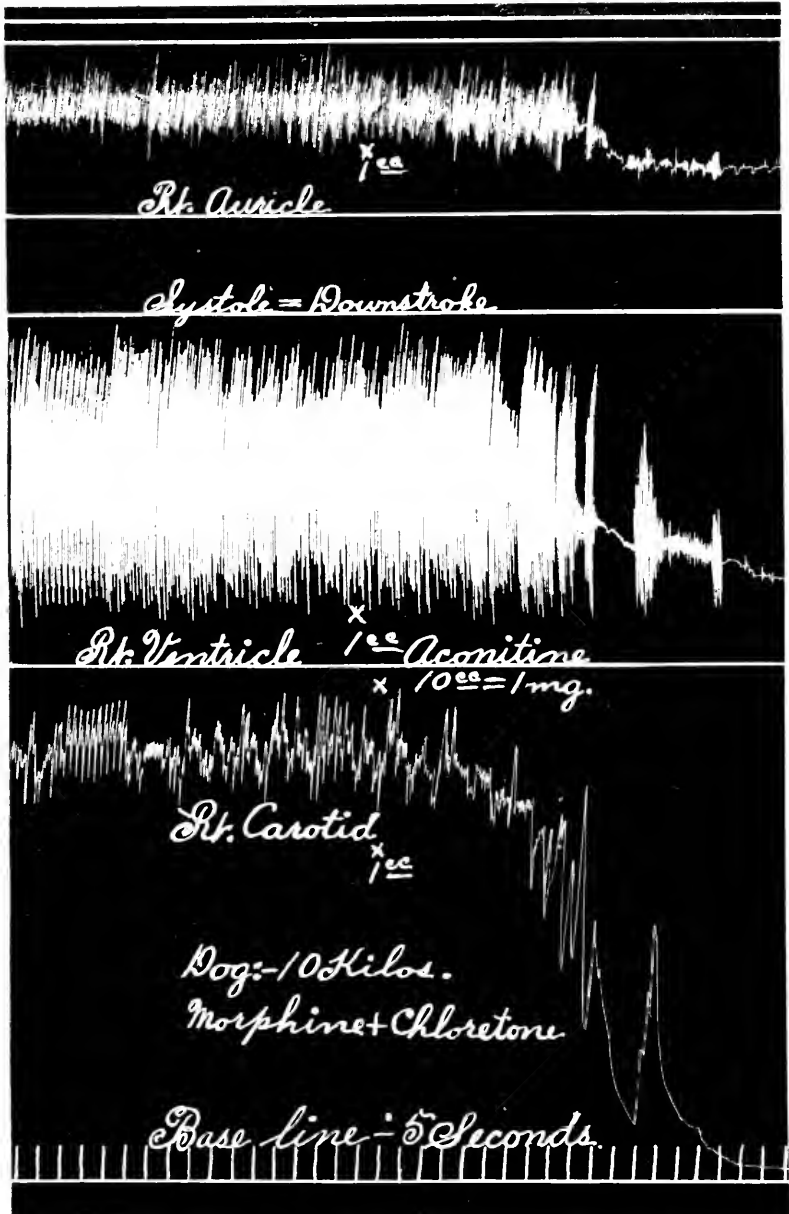

Fig. 343.—Tracing showing the final action of aconitine on the heart (myocardiogram, right auricle and right ventricle) and blood-pressure in a dog. The contractions are very fast and irregular.

this hold in the case of the frog? Watch for the sudden appearance of irregular heart beats, extra systoles, etc. In what chambers are these first developed? Can you get satisfactory records of the heart movements when the rate is exceedingly fast? Watch for the sudden development of delirium cordis. What happens to the blood-pressure when this occurs? After the heart begins to fibrillate stimulate the vagi and see if you can stop the fibrillation. What conclusions can you draw? Feel of the heart and describe the nature of the fibrillary contractions.

EXPERIMENT CXXXVIII.

Aconitine. (Student: Local Action.)

1. Saturate a piece of filter paper one-fourth inch square with a solution of aconitine (ten cubic centimeters equal one milligram) and place the filter paper on the tongue. Do not swallow any of the solution. After a little while remove the paper and note the sensation produced on the tongue. What conclusions can you draw? (If the solution was too weak a stronger one may be used.)

EXPERIMENT CXXXIX.

Veratrine. (Frog: General Action.)

1. Destroy the cerebrum only of a frog, wait for the shock to disappear and then inject one cubic centimeter of veratrine sulphate solution (ten cubic centimeters equal one milligram) into the dorsal lymph sac. Place the animal on a table and wait a little while for the drug to be absorbed. From time to time touch the animal gently and get it to jump. Do you notice anything unusual about its movements? Does it have trouble in extending or relaxing its muscles? Does it have spontaneous convulsions? Examine the skin to see if there is an increased cutaneous secre-

tion. The animal after a time will be able to jump very well but will alight with the hind legs extended and the fore legs passed back along the flanks. Only with difficulty can the animal then draw up its hind limbs. What is the cause of this difficulty? After some time (if the dose was large enough) the animal becomes completely paralyzed and dies. Then expose the heart and note whether it stopped in systole or diastole. In what condition does the heart usually stop? Is this true for a mammal also? What can you say of the general action of veratrine?

EXPERIMENT CXL.

Veratrine. (Frog or Turtle: Heart and Inhibitory Apparatus.)

1. Arrange a frog or turtle for taking heart tracings. Make a normal record (showing both vagus trunk and crescent inhibition). Pour a few drops of veratrine (sulphate or hydrochloride) solution (ten cubic centimeters equal one milligram) on the heart and record the effect. After the drug has acted a few moments stimulate the vagus nerve again and see if the heart is inhibited. Also stimulate the crescent and see what happens. What conclusions can you draw? Apply more of the drug and record the full action on the heart. Is there any visible difference between the action on the ventricle and that on the auricles? Would your method of suspension obscure the appearance of the behavior of the heart under the drug?

EXPERIMENT CXLI.

Veratrine. (Frog: Skeletal Muscle.)

1. Set up your apparatus as shown in Experiment XLVII, p. 245 (see also Experiment XCVI under cocaine), for recording muscular contractions. Then pith a frog and ligate

the *left* thigh tightly. Under the skin of the back inject two cubic centimeters of veratrine solution (five cubic centimeters equal one milligram) and attach the animal to the frog board as illustrated. Connect the secondary wires to the tendo Achillis and to the carpet tack. *Do not stimulate the muscle* as the first contraction is the one which will in

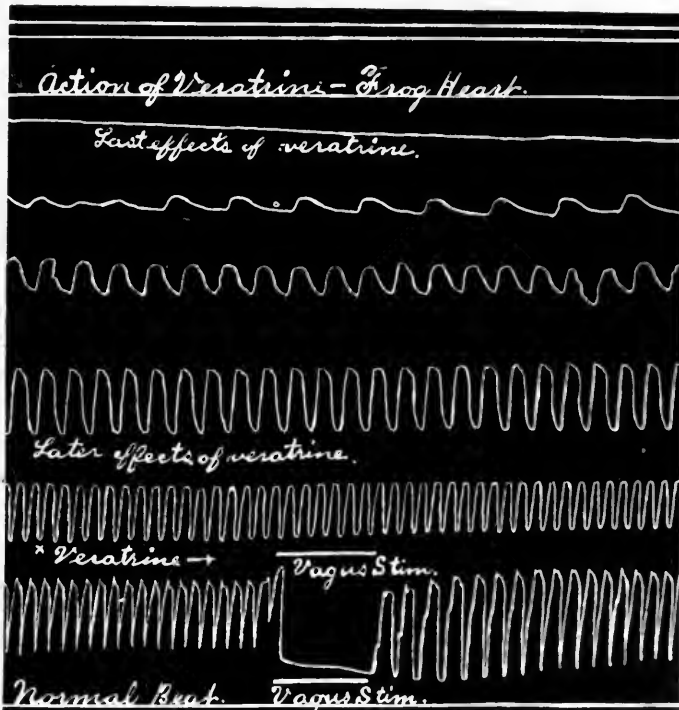

Fig. 344.—Frog heart tracing showing the action of veratrine. The vagus trunk was stimulated as indicated. Inhibition occurred before but not after veratrine was applied. What action did the drug have here? How would you prove your conclusions?

all likelihood show the action of the drug the best and this one should be recorded. Adjust the inductorium connections for single shocks and use only the *break shock* to stimulate the muscle. About ten or fifteen minutes should be allowed for absorption of the drug. When everything is *entirely ready* start the drum (medium speed) and when

the muscle lever has recorded a line half an inch long (be sure the lever is properly weighted and adjusted) stimulate the muscle with *one single shock*. The muscle should contract quickly but the relaxation is much prolonged and usually shows certain peculiarities. Let the drum run and

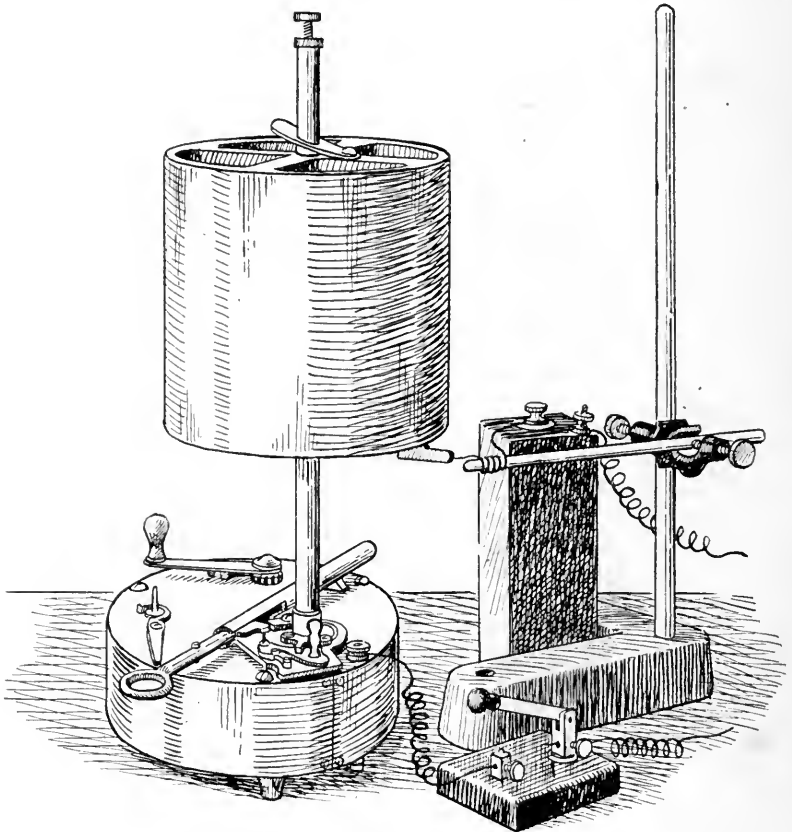

Fig. 345.—Arrangement of apparatus for spinning the drum a single round at a time and stimulating a muscle or nerve with a single shock during the revolution of the drum. (See Jour. Amer. Med. Assoc., 1911, 56, 1705.)

record the full relaxation but as soon as the lever again reaches the base line stimulate the muscle again with one single shock. Record this contraction and when the lever again comes down to the base line repeat the stimulation. A series of contractions will thus be secured. The charac-

ter of these contractions changes rapidly with each succeeding curve until a perfectly normal record may be secured. Explain the nature of this change in the contraction curves. Why are there undulations at the top of the curves? What effect has fatigue on the action of the drug? Let the muscle rest a while and see if you can get a second series like the first. Now take a few contraction records from the normal (left) gastrocnemius muscle to compare with the curves showing the drug action.

EXPERIMENT CXLII.

Veratrine. (Turtle: Lung Tracing.)

1. Arrange a turtle for recording lung tracings. Inject two cubic centimeters of veratrine solution (ten cubic centimeters equal one milligram) into the ventricle and note the action on the lungs. If this does not give you a record then pour some of the solution over the lungs (local application). Do you get a record? If so on what structures did the drug act to produce the result? (It is very advisable to remove all the intestines, liver and bladder and as much as possible of the skeletal muscles from the turtle before making a test on the lungs, for sometimes the skeletal muscles suddenly contract and obscure the results. The cord should also be thoroughly pithed. One can then look at the lungs closely and see if they contract.)

EXPERIMENT CXLIII.

Veratrine, Adrenaline. (Dog: Blood-pressure, Respiration, Intestinal Contraction.)

1. Arrange a dog for recording blood-pressure, respiration and intestinal contractions. The burettes contain veratrine (ten cubic centimeters equal one milligram) and adrenaline (1:10,000).

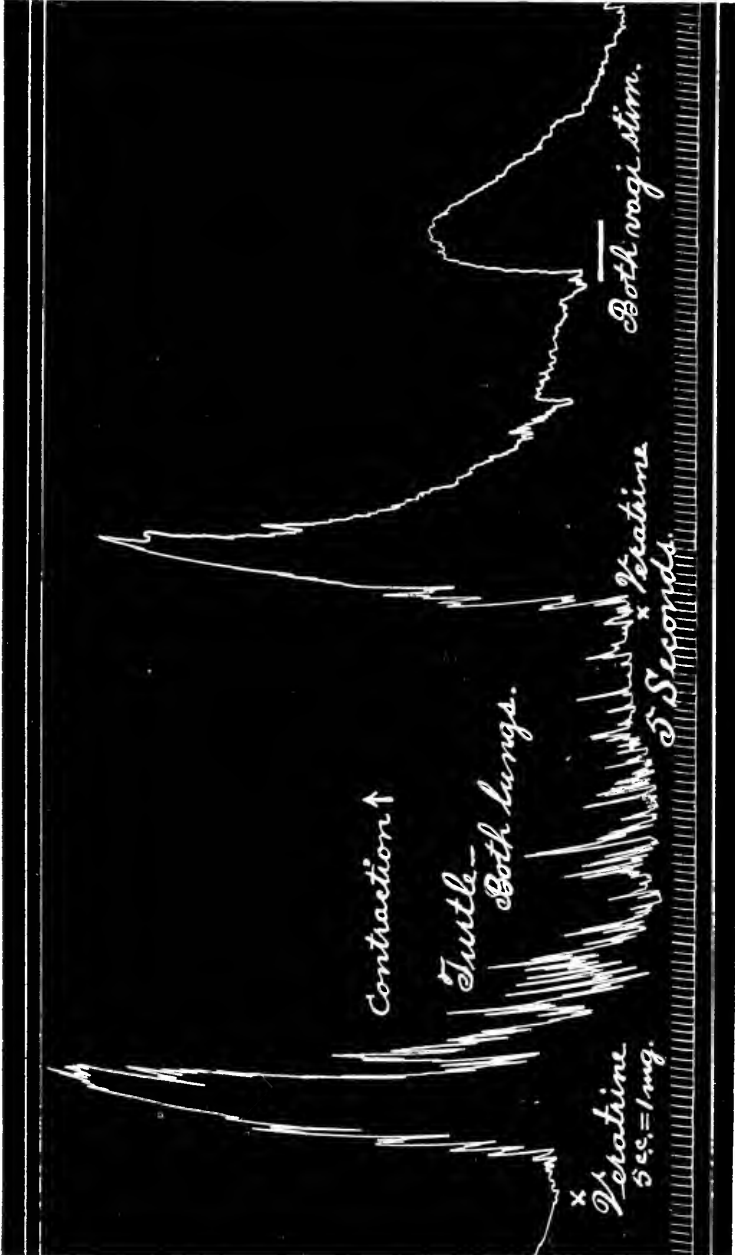

Fig. 346.—Tracing showing the action of veratrine on the lungs of a turtle. Two injections were made into the heart. At the right of the tracing both vagi were stimulated.

When all adjustments are made take a normal and inject one cubic centimeter of veratrine solution. Do you get an intestinal record? The dose was probably too small but the toxicity of commercial preparations varies greatly and some samples are exceedingly poisonous. When once you have determined the dose which your animal can withstand then inject a larger amount and watch for intestinal contractions. (One group of students should also record the bladder contractions.) The respiration should be affected rather early. Watch for the heart to become slower. This will be seen in the increased amplitude of the manometer tracings.

The action of the drug should now be brought on slowly as with aconitine and digitoxin. This is the best way to bring out the central vagal stimulation which slows the heart. The beating of the heart should finally become very slow and the amplitude of each beat as recorded by the manometer may reach half an inch or more in length. If you succeed in getting this action then suddenly cut both vagus nerves and see if the heart accelerates as after aconitine. Does veratrine make the heart more irritable? Do you get a stage of irregular heart beats as occurs with aconitine? Kill the animal by repeated injections of the drug. What general conclusions can you draw from the experiment? If another group of students are performing the experiment at the same time then one group can give the animal an injection of one cubic centimeter of atropine (one cubic centimeter equals one milligram) instead of cutting the vagus nerves. A third group may let the veratrine take its regular course of action, neither cutting the vagi nor giving atropine. The groups can compare their results.

Examine your respiratory record closely and see whether any indications of a Cheyne-Stokes type of breathing are present. Is the respiratory disturbance due to a central or a peripheral action?

EXPERIMENT CXLIV.

Veratrine. (Dog: Heart Tracings, Blood-pressure.)

1. Record heart tracings from a dog showing the action of veratrine. Proceed as in Experiment CXXXVII, p. 431, or Experiment CXXX, p. 418.

(Cardiometer tracings, from the ventricles, may also be recorded in another animal.)

EXPERIMENT CXLV.

Apomorphine. (Dog: Vomiting Center.)

1. Inject subcutaneously into a dog (eight to ten kilos) one or two cubic centimeters of apomorphine hydrochloride (one cubic centimeter equals five milligrams). Leave the animal in a quiet place and observe its actions from time to time for three or four hours. Is there any noticeable action on the cerebrum or cerebellum? What general symptoms are produced? What conclusions can you draw from the experiment? Are the pupils affected? Is there salivation? If so how do you explain it?

EXPERIMENT CXLVI.

Ipecac. (Dog: Emesis.)

1. Administer by stomach to a dog (eight to ten kilos) three cubic centimeters of the fluid extract of ipecacuanha. Leave the animal in a quiet place and observe its actions from time to time for three or four hours. What general symptoms are produced? What conclusions can you draw from the experiment? What are the chief differences between the actions of apomorphine and ipecac?

EXPERIMENT CXLVII.

Sodium Cyanide, (Hydrocyanic Acid), Sodium Sulphide, Hydrogen Peroxide. (Dog: Respiration, Blood-pressure, Oxygen Consumption, Blood, Glycosuria.)

1. Arrange a dog (give a small dose of chlorotone) for recording *blood-pressure, respiration*, and oxygen consumption. The injecting burettes contain either sodium cyanide (one-half per cent) or hydrocyanic acid (one-half per cent—the official form is supposed to be two per cent, but is usually much weaker and often unreliable) and sodium sulphide (one per cent).

When all adjustments are made take a normal record showing at least one or two notches for the oxygen consumption tracing. Then inject one-half cubic centimeter of the cyanide solution. Marked results should be shown on all three tracings. The dose may be too small if your drug was deteriorated (as is very often the case—*only fresh preparations* should be used). Very small doses of the cyanides do not affect, or possibly, may even slightly increase the rate of oxygen consumption. Large doses decrease the rate and your records should easily show this action.

When the animal returns to normal again inject a dose (perhaps one cubic centimeter) of cyanide and note the effect. Get the oxygen consumption record over three or four notches to see the prolonged action of the drug on this function. Let the animal recover and give a third injection of cyanide. When the symptoms become marked inject one cubic centimeter of the sodium sulphide solution (sodium hyposulphite may be substituted) and determine whether or not this aids materially in the recovery of the animal. What antidotes do you know for cyanide poisoning? How are these administered? How quickly could this be done? How quickly will the cyanide act?

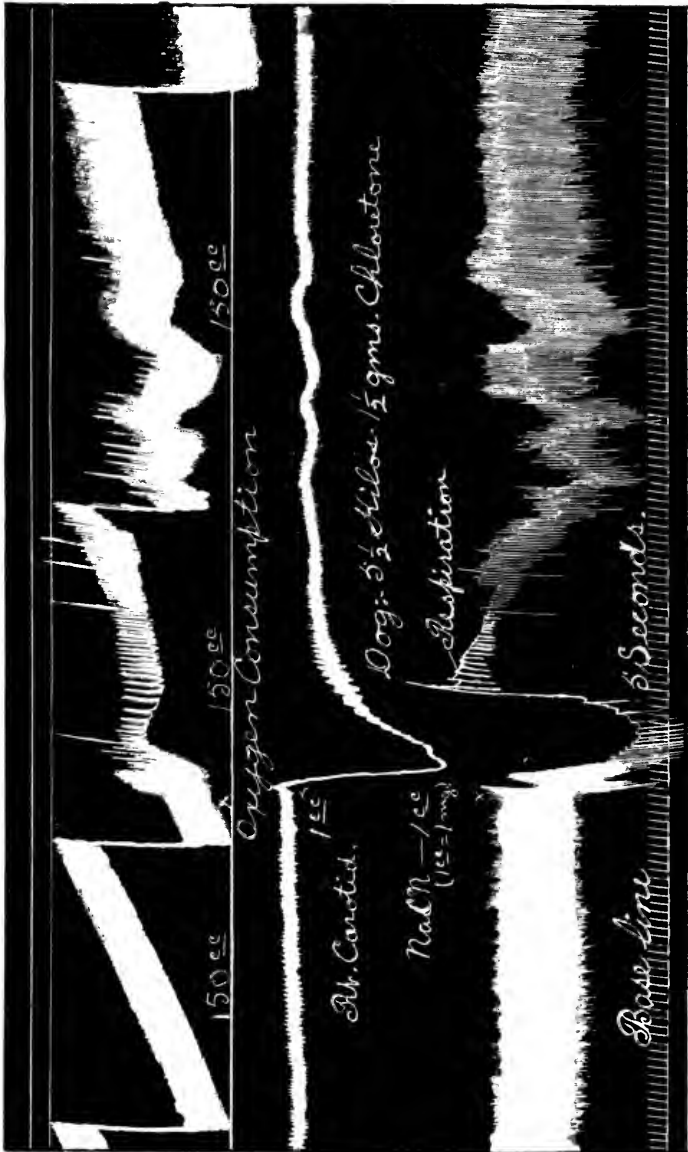

Fig. 347.—Tracing showing the action of sodium cyanide on the rate of oxygen consumption, blood-pressure and respiration of a dog. Oxygen was given in 150 c.c. quantities at a time.

Allow the animal to recover and watch carefully for the appearance of an irregular form of respiration. Cheyne-Stokes respiration is often produced by cyanides. Inject some more sodium sulphide after a time to see how the drug acts then. How does the sulphide affect the oxygen consumption?

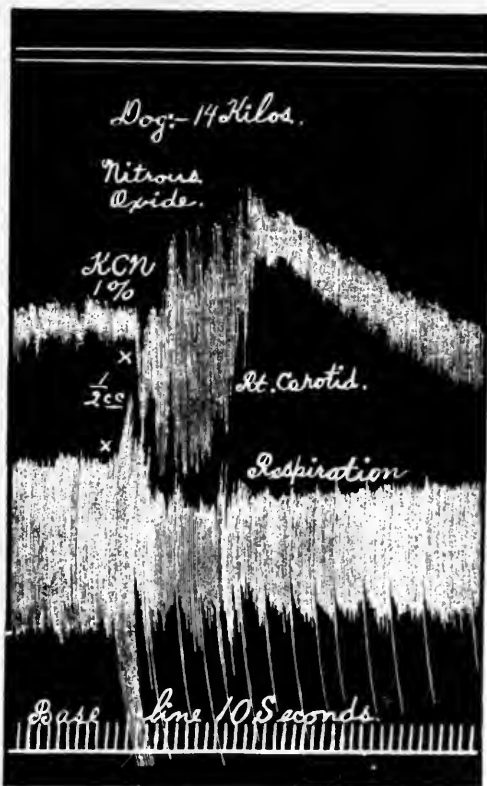

Fig. 348.—Tracing showing the action of potassium cyanide on the blood-pressure and respiration of a dog anesthetized with nitrous oxide.

If the animal is still in fair condition (as it probably is) insert a straight cannula into one femoral artery and draw off five cubic centimeters of blood into a test tube. Then pour one cubic centimeter of your cyanide solution into the blood, shake up the mixture and examine its color closely.

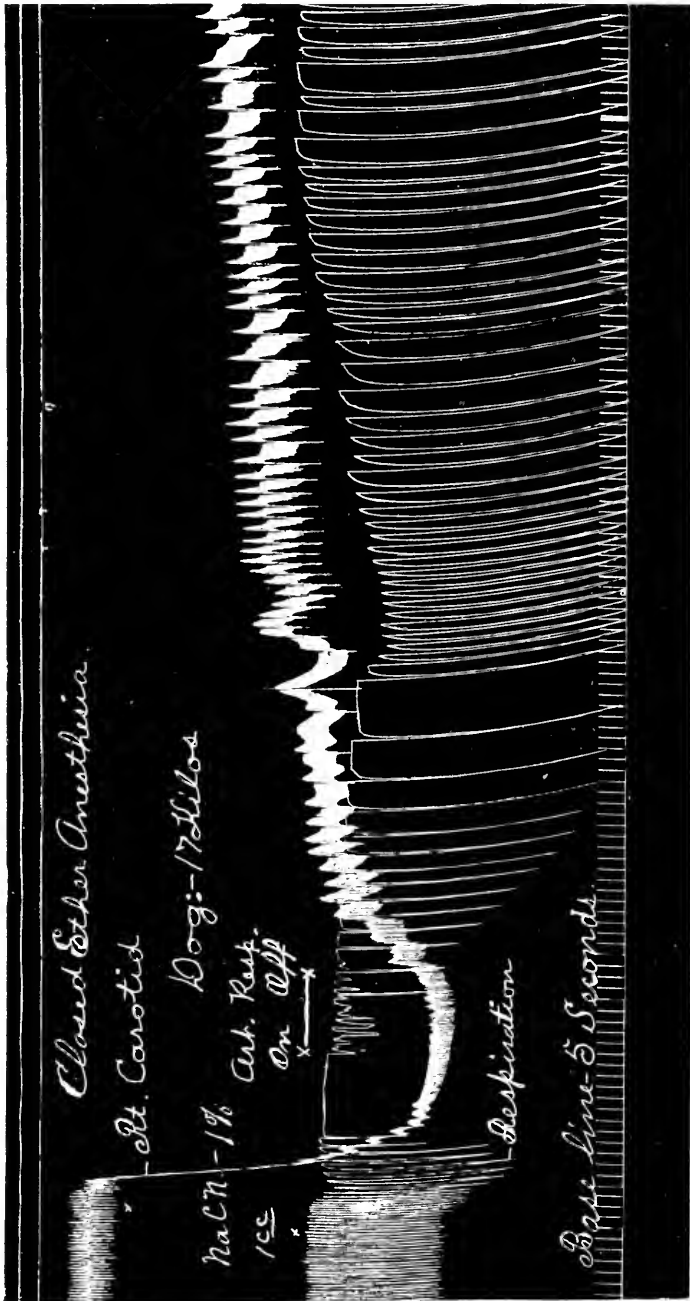

Fig. 349.—Tracing showing the action of sodium cyanide on the blood-pressure and respiration of a dog. Note that the respiration takes on a kind of Cheyne-Stokes appearance.

Set the tube aside and see whether or not clotting occurs. What action have cyanides on the coagulation of blood?

- How is this brought about?

Draw off another five cubic centimeters of blood and

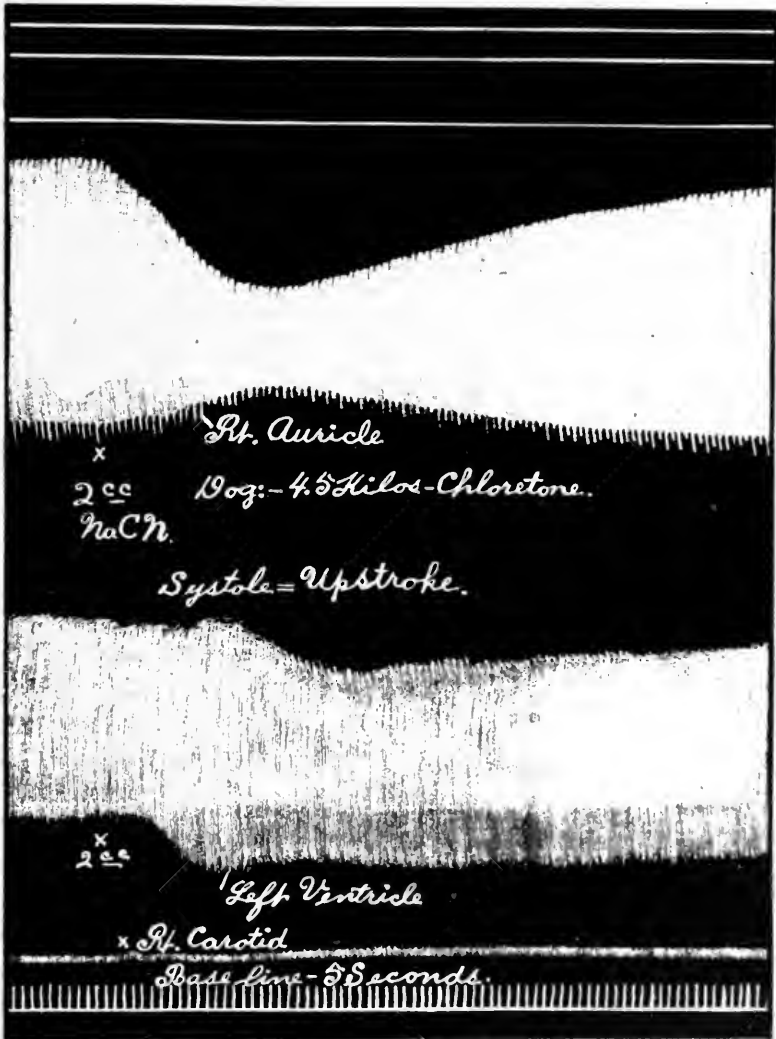

Fig. 350.—Myocardiographic and blood-pressure tracings showing the action of 2 c.c. of a dilute sodium cyanide solution.

then pour a few drops of hydrogen peroxide into the test tube. What happens when the peroxide mixes with the blood? Is the color of the blood changed? Now draw off another five cubic centimeters of blood and pour two cubic centimeters of cyanide solution into the test tube. Shake up the mixture and then add hydrogen peroxide to the test tube. Do you get any frothing of the mixture? Why? Does the solution remain bright red? How do you explain this? Save the test tubes and examine each (in one-half or one per cent solution) spectroscopically (if you have a spectroscope) after the animal dies. A tube of normal blood to which a little (one per cent) sodium citrate solution has been added may also be saved for comparing the spectra of the different samples.

Now pass a catheter into the bladder (if you can) and draw off some urine. If you cannot pass the catheter, open the abdomen, isolate the bladder, and insert a large hypodermic needle through the bladder wall and draw off some urine. Test this urine with Fehling's or Haine's solution for sugar. If you get a positive test, how do you explain the cause of the glycosuria? What factors are involved and what is the mechanism of their action? Do you know of any other drugs that have a similar action? Give a large dose of cyanide and as soon as the respiration stops start artificial respiration to see if you can revive the animal. This is often successful when the dose is not too large. Recovery usually occurs fairly rapidly if the dose is of moderate size. Kill the animal with cyanide. What is the size of the fatal dose? How does this compare with aconitine or strychnine? Discuss in full your observations on the blood-pressure, cardiac inhibition, nutrition, treatment, respiration and coagulation of the blood.

It will be instructive to keep the dead animal for a few hours to see if the blood clots in the vessels. The color of the blood should also be noted after a few hours. Is rigor mortis hastened or delayed in its appearance?

EXPERIMENT CXLVIII.

Quinine. (Frog: General Symptoms.)

1. Destroy the cerebrum of a frog and inject into the anterior lymph sac one cubic centimeter of quinine hydrochloride solution (one cubic centimeter equals ten milligrams). Put the frog in a quiet place, count the rate of lymph heart beats and of the heart beats. Observe the animal carefully as the action of the drug comes on. Are there any signs of central nervous stimulation? How is the rate of beat of the heart and of the lymph hearts affected? Do the reflexes persist? Can you elicit a pupillary light reflex? Save the animal to see if it survives the action of the drug? What conclusions can you draw from the experiment?

EXPERIMENT CXLIX.

Quinine. (Frog or Turtle: Heart Tracing.)

1. Arrange a frog or turtle for taking heart tracings. Make a normal record showing vagus stimulation. Then irrigate the heart with quinine hydrochloride solution (one cubic centimeter equals ten milligrams). What effect has the drug on the heart muscle and on the nervous inhibitory apparatus?

EXPERIMENT CL.

Quinine. (Frog: Action on White Corpuscles—Binz's Experiment.)

1. Pith a frog and make a longitudinal incision in one side of the abdomen. Carefully pull a loop of intestine (*leaving the mesentery intact*) out through the incision. Place the frog on a thin board similar to that illustrated in Fig. 305, but which has a circular hole about one inch in

diameter in the side nearest the microscope. This hole should be near the middle of the *length* of the board and about one-fourth inch from the side of the board (next to the microscope). A cork is passed into the hole (tightly) and then a second hole about one-half inch in diameter is bored through the cork so that the mesentery of the frog can be stretched out over the hole in the cork and thus brought under the objective of the microscope. Pin down the loop of the intestine to the upper surface of the cork and thus secure a flat surface of the mesentery for observations. The upper surface of the cork should be about one-fourth inch above the surface of the board. Use the low power objective and observe the blood flow through the mesenteric capillaries. Examine the white corpuscles carefully. Observe how they move along next to the capillary walls or pass out slowly into the tissues. Do you see any lymphocytes? The exposure and manipulation of the tissues of the mesentery will produce sufficient inflammation to cause an accumulation of leucocytes in the area involved. After you have fully familiarized yourself with the appearance and action of these leucocytes then inject into the anterior lymph sac of the animal two cubic centimeters of quinine hydrochloride solution (one cubic centimeter equals ten milligrams) and watch the actions and distribution of the leucocytes as the drug is absorbed. Do the white corpuscles still cling to the lining of the vessels, or do they pass out into the neighboring tissues? What conclusions can you draw? What relation does the action of the quinine on the white corpuscles bear to the action of quinine on the plasmodium of malarial fever? What general conclusions can you draw from the experiment?

Quinine is often injected intravenously in *severe* cases of malarial infection in man. This form of treatment is effective, and rapid results may be obtained. From the above experiment what action do you infer the quinine thus thrown rapidly into the blood will have on malarial organisms (provided the concentration of the drug is great enough)?

EXPERIMENT CLI.

Antipyrine. (Frog: General Action.)

1. Into the anterior lymph sac of a frog inject two cubic centimeters of antipyrine solution (one cubic centimeter equals ten milligrams). Put the frog in a quiet place and observe its actions closely. Are the reflexes stimulated or depressed? Is there developed somnolence or convulsions? How is the central nervous system affected?

EXPERIMENT CLII.

**Antipyrine, β -tetrahydronaphthylamine Hydrochloride.
(Dog: Respiration, Blood-pressure, Leg Volume.)**

1. Arrange a dog for recording blood-pressure, respiration and the volume changes of the left hind leg (plethysmograph). Take the animal's temperature at ten minute intervals. Place antipyrine solution (one cubic centimeter equals ten milligrams) and β -tetrahydronaphthylamine hydrochloride (one cubic centimeter equals five milligrams) in the two injecting burettes (in the right femoral and left external jugular veins).

Take a normal record and then inject one cubic centimeter of antipyrine. How is the heart affected? The respiration? Do you get a change in leg volume? If so what does this signify? Wait for the animal to return to normal.

Inject two cubic centimeters of β -tetrahydronaphthylamine solution (watch the pupils and eyelids closely as this is done). Do you get a change in leg volume? (The rubber cuff must fit tightly to the skin of the leg which must be shaven closely—you cannot make the cuff hold air if the hair is left on the leg. *Avoid vaseline for this purpose.*) How does the action of the β -tetrahydronaphthylamine compare with that of antipyrine on the blood-pressure, respiration, temperature controlling mechanism and leg vol-

ume? Is it possible to determine the action of such drugs as antipyrine or β -tetrahydronaphthylamine on the heat regulating mechanism in a brief interval of time, e. g., in ten minutes? On what do you base your conclusions?

From time to time inject more antipyrine and see what later actions the drug has. Further injections of β -tetra-

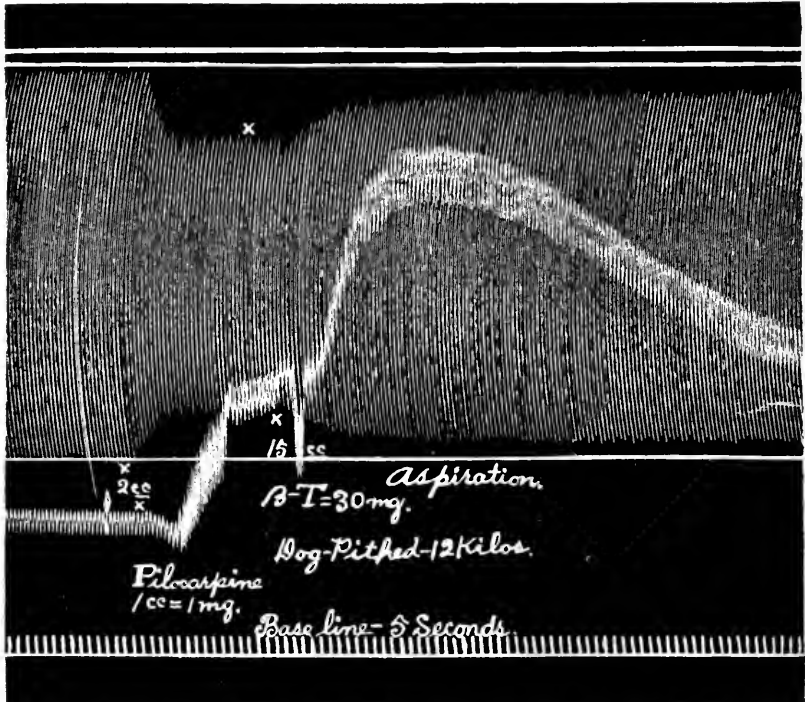

Fig. 351.—Tracing showing the action of pilocarpine and β -tetrahydronaphthylamine hydrochloride on the bronchioles and blood-pressure in a spinal dog.

hydronaphthylamine may also be made to get satisfactory tracings. Kill the animal with antipyrine. What symptoms are produced and what is the immediate cause of death?

β -tetrahydronaphthylamine belongs to a class of drugs to which the name “sympatho-mimetic” has been applied. Adrenaline is the best known member of this group. These drugs act on one or more parts of the involuntary nervous system (see Fig. 318).

EXPERIMENT CLIII.

Antipyrine, Peptone. (Two Rabbits: Temperature Regulation.)

1. Four hours before the class meets administer hypodermically to each of two rabbits (one for a control) one-tenth of a gram per kilogram of weight of Witte's peptone (in twenty per cent solution). Record the temperature of both rabbits and then give one by stomach one-tenth gram per kilogram of weight of antipyrine. Record the temperature of each animal at fifteen minute intervals, and determine whether or not the temperature is affected by the antipyrine.

EXPERIMENT CLIV.

Quinine, Peptone. (Two Rabbits: Temperature Regulation.)

1. Repeat the above experiment but substitute quinine hydrochloride (one-tenth gram per kilo) for the antipyrine. Does this affect the temperature in any way? Discuss the manner of action of antipyrine and of quinine on the heat regulating mechanism and on the reduction of fever temperature.

EXPERIMENT CLV.

Phenacetine, Acetanilide or Aspirin (Acetylsalicylic Acid). (Fevered Animal: Temperature.)

1. Watch the stock of animals during the period when the antipyretics are being studied and if an animal becomes ill with a rise in temperature then administer to it by stomach one-tenth gram per kilogram of weight of phenacetine, acetanilide, or aspirin. Record the temperature at fifteen minute intervals and see if any change occurs.

How long will it probably be before the fever returns if the drug lowers the temperature to normal? Which of these three drugs is most effective in lowering the temperature?

EXPERIMENT CLVI.

Acetylsalicylic Acid (Aspirin). (Student: Headache.)

1. Watch for a student or other person who has a headache due presumably to "migraine." Consult the instructor and if the person affected with the headache is otherwise normal give him by stomach a five grain tablet of acetylsalicylic acid. Observe the action of the drug and see if the headache is not decreased in about fifteen or twenty minutes. The drug, in reasonable doses, is not dangerous and often entirely stops certain types of headache. After half an hour another five grain tablet may be taken if absolutely necessary. Do you know of any other drugs that might be used here instead of the acetylsalicylic acid? If so what sized doses should be given?

EXPERIMENT CLVII.

Phenylsalicylate (Salol). (Student: Excretion, Absorption.)

1. Take by mouth a capsule containing five grains of salol. This is decomposed, on reaching the intestine, into phenol and salicylic acid. Test the urine for salicylic acid by adding a few drops of ferric chloride when a violet coloration appears. A positive test should be observed in one to one and one-half hours. This is Ewald's test for the motility of the stomach but a dose as large as one gram has been recommended for this purpose. The U.S.P. dose is five grains. (For literature, see Hanzlik, P. J.: Reports of Therapeutic Research Committee, A. M. A., 1914, 3, 131.)

EXPERIMENT CLVIII.

**β -tetrahydronaphthylamine Hydrochloride, Pilocarpine.
(Dog: Oxygen Consumption, Blood-pressure,
Respiration.)**

1. Arrange a dog (eight or ten kilos) for recording oxygen consumption, blood-pressure and respiration. (Give a small dose of chloretone.) The injecting burettes contain β -tetrahydronaphthylamine hydrochloride (one cubic centimeter equals five milligrams) and pilocarpine (one cubic centimeter equals one milligram.)

When all adjustments are made take a normal record (showing at least two notches of the oxygen record). Then inject two cubic centimeters of the β -tetrahydronaphthylamine (watch the pupils) and record the results: How is the rate of oxygen consumption affected? Wait for the drug to act and see if all records return again to normal.

Then give one cubic centimeter of pilocarpine. Watch the rate and depth of the respiratory movements as the drug begins to act and wait a little while for this to develop. The action of pilocarpine is rather prolonged and may increase in intensity for about one minute, or in some organs for even a longer period. Is there any difficulty in either expiration or inspiration? What did the oxygen record show just after the pilocarpine was injected? How do you account for this? What kind of an effect on the oxygen record would a drug show if it acted in a manner exactly the opposite to that of pilocarpine?

When the pilocarpine action becomes well marked (give another one cubic centimeter if absolutely necessary) then inject a dose (probably three or four cubic centimeters of β -tetrahydronaphthylamine—estimate a good sized dose by your previous result) and see how this drug counteracts the pilocarpine. How is the oxygen record affected? How do you account for this? Do you know of any other drug that resembles β -tetrahydronaphthylamine in action?

Record the temperature of the animal from time to time and see if you can produce a hyperthermia by injecting β -tetrahydronaphthylamine. Will the narcosis prevent this rise in temperature in your animal? How does the drug act to produce a fever temperature? Kill the animal by injecting β -tetrahydronaphthylamine. After death test the urine for reducing bodies. What conclusions can you draw from the experiment? Are the adrenal glands especially involved in any way in this experiment? If so, how? Are there any other drugs that have this action?

EXPERIMENT CLIX.

Carbolic Acid (Phenol). (Frog: General Action.)

1. Into the anterior lymph sac of a frog inject one cubic centimeter of a one per cent solution of carbolic acid. Put the frog in a quiet place and observe its symptoms. Do you note depression or are there convulsions? What structures are involved in the action of the drug?

EXPERIMENT CLX.

Carbolic Acid, Sodium Sulphate. (Dog: Local Action, Respiration, Blood-pressure, Spleen Volume, Antidote.)

1. Arrange a dog for recording blood-pressure, respiration and the volume changes of the spleen. The injecting burettes contain carbolic acid (one-half per cent) and sodium sulphate (three per cent).

With a razor shave the hair off of a spot on the dog an inch or more in diameter. In the center of this spot put a drop of phenol liquefactum (U.S.P. about 90 per cent—make this from the crystals by adding a very little water to some of the substance in a test tube and heating gently till solution is effected. How does this preparation differ from

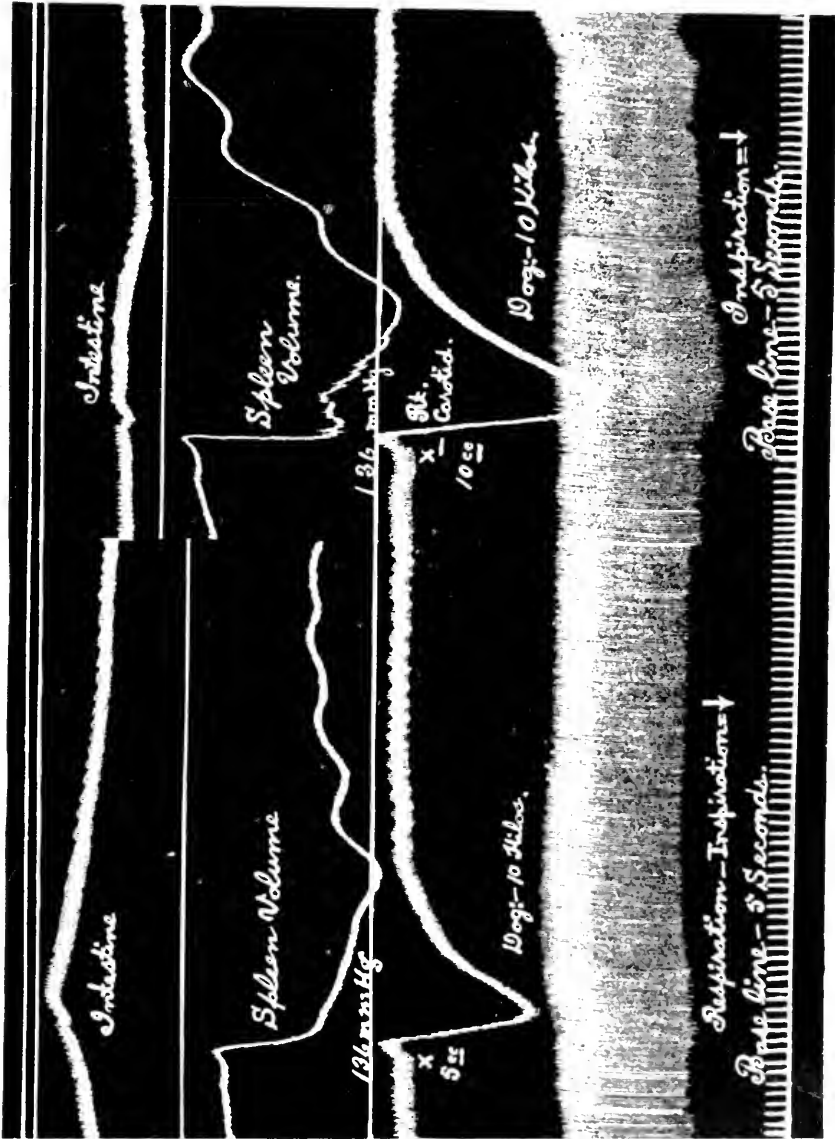

Fig. 352.—Two tracings (joined together) showing the action of a drug which markedly lowers blood-pressure, on the intestinal volume, spleen volume, blood-pressure and respiration. See if you can find a drug which produces this kind of a tracing and determine the difference between active and passive effects on oncometer tracings.

a simple solution of the crystals in water? Only about five per cent of the drug can be dissolved in water.)

Watch the action of the drug on the skin closely, noting color changes, etc. After a short time wipe off the phenol and see what kind of a scar is left. Quickly sponge 95 per cent alcohol thoroughly over the spot and see how the color and appearance of the area are affected. Of what practical use may this be to you? What antidote would you apply if carbolic acid had been swallowed? In what strength would you use the antidote and what precautions would you take to prevent its absorption? Proceed quickly with the experiment.

When all adjustments are made take a normal record and inject five cubic centimeters of carbolic acid solution. Wait for the drug to act. When the records return to normal again inject five cubic centimeters of the phenol solution. What differences do you note between the effects produced by the two injections? After a time inject more of the phenol and bring on a marked reaction (be sure the sodium sulphate is ready and that the injecting cannula is not closed off by a clot). When the animal is greatly depressed note its condition (muscular twitchings, etc.) closely and begin to inject the sulphate solution (in two cubic centimeter doses frequently repeated). What effect has this on the animal? How do you explain the result? See if you can get the animal to return to normal.

After a time stimulate one vagus nerve and see if the heart is inhibited. Does this affect the respiration? Now take a very small pledget of cotton, soak it in phenol liquefactum and place it on the vagus trunk for one minute. Remove the cotton and stimulate above the poisoned area. Repeat the stimulation below the area. How does each stimulation affect the heart and respiration? What conclusions can you draw?

With a stomach tube inject fifty cubic centimeters of five per cent carbolic acid into the dog's stomach and wait

for the animal to die. After death pass a trocar into the bladder (or catheterize) and draw off some urine. Test this for albumen (nitric acid test) and for reducing bodies (Fehling's test). Put five cubic centimeters of urine in a test tube and add a few drops of ferric chloride solution. If you get a color reaction what does it mean? Put some of the urine in a beaker and set it aside until next day to observe any later changes in color. Open the stomach carefully (over a sink) and examine closely the condition of the gastric mucosa. What would the stomach lining show if sectioned and examined histologically? Do this if you can. What conclusions can you draw? How is carboic acid excreted? What is the fate of the drug in the tissues? (See Sollmann, Brown, Clarke: *Journal American Medical Association*, 1906, March 17, and 1907, March 23; also *Journal of Pharmacology*, i, p. 409.)

EXPERIMENT CLXI.

Phloridzin, Adrenaline. (Rabbit: Glycosuria.)

1. Dissolve one-fourth gram of phloridzin in warm water, and inject it subcutaneously into a rabbit. Obtain a sample of the urine at the end of two hours, by pressure on the abdomen with the thumb or by passing a catheter, and test for sugar. If none is present wait some time longer and again test the urine (Stewart). Glycosuria may also be produced by injecting subcutaneously into a rabbit one or two cubic centimeters of adrenaline (1:1000). The rabbits should be placed in a cage where the urine can be collected.

EXPERIMENT CLXII.

Potassium Iodide. (Student: Absorption, Excretion.)

1. Take by mouth a capsule containing five grains of potassium iodide. (Iodides have to be used with care in cases of pulmonary phthisis.)

At one minute intervals after the drug is swallowed test the saliva (on a white pill tile or glass plate on a sheet of paper) by adding saliva to three per cent starch paste (slightly acidified by HNO_3). A positive test should appear within ten to fifteen minutes if absorption be normal.

Test the urine by adding a few drops of chlorine water and starch solution. What conclusions can you draw?

EXPERIMENT CLXIII.

Alkalies, Acids, Sodium Nitrite, Adrenaline. (Frog: Perfusion of Vessels.)

1. Pith a frog, expose its heart and tie a fine cannula into one aorta (pointing away from the heart) including the other aorta in the ligature. Hang the frog up by the lower jaw and place a graduated cylinder beneath the animal. By means of a Y-tube connect two funnels (or small bottles with outlets at the bottom) to the cannula in the aorta. Suspend the funnels or bottles at a height of six or seven inches above the heart. One funnel (or bottle) is filled with NaOH solution (one-tenth per cent in Ringer's or tapwater saline solution) and the other with HCl solution (one-tenth per cent in Ringer's or tapwater saline solution). Snip the sinus venosus so that the fluid can pass through the entire system of blood vessels from the beginning of the aorta. Be sure all the air is out of the tubes and that the flow of each solution can be stopped or started by means of clips on the connecting tubes. Fill the tubes with the acid solution and start the perfusion. Catch the outflow below the frog in the graduated cylinder and determine its amount for three or five minute intervals.

Then change to the alkali solution and measure the outflow for a corresponding length of time. Which substance dilates the arterioles?

Empty out the acid solution and substitute therefor Ringer's solution containing one-half per cent sodium ni-

trite. Perfuse this through the vessels of the animal and see how the outflow is affected. Empty the alkali solution and place Ringer's solution in the funnel (or bottle) and add one-half cubic centimeter of adrenaline solution

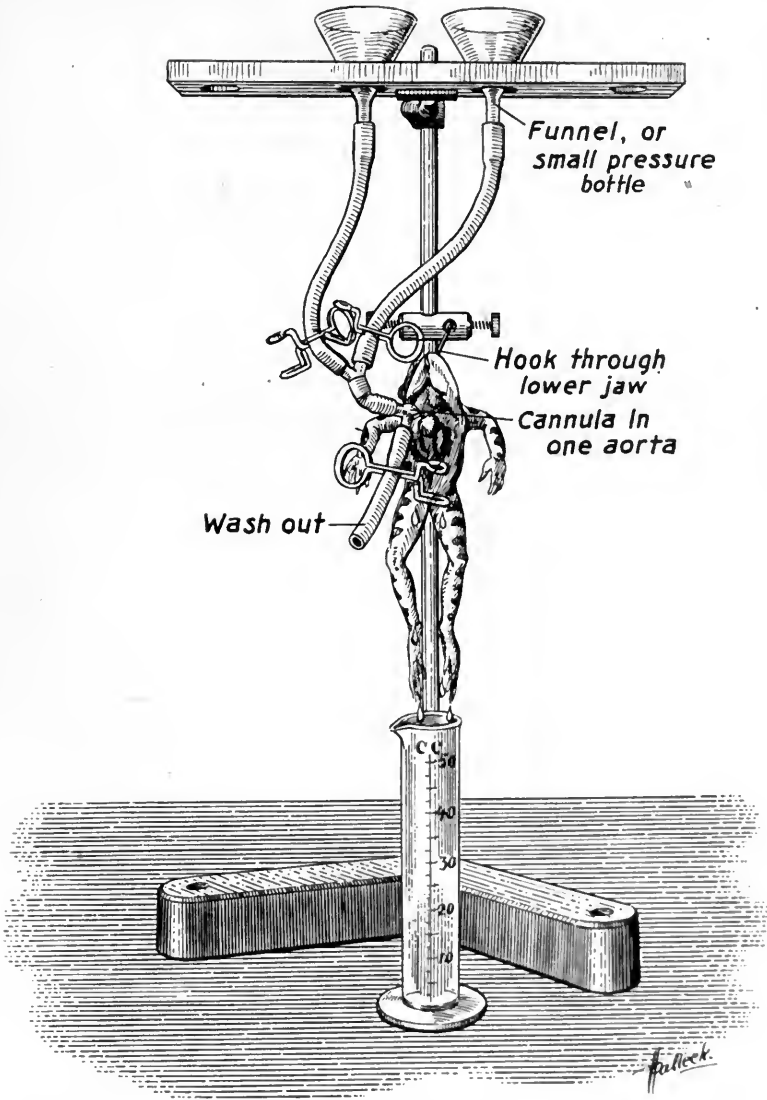

Fig. 353.—Arrangement of apparatus for perfusion of the vessels of a brainless frog.

(1:1000) to the Ringer's solution. Perfuse this solution through the animal and compare the outflow with that from the other solutions. What conclusions can you draw? How do acids and alkalies compare with adrenaline and nitrites as regards their effects on the arterioles?

EXPERIMENT CLXIV.

**Magnesium, Calcium. (Rabbit: Anesthesia, Antagonism.—
Meltzer and Auer.)**

1. Into a rabbit inject subcutaneously 1.7 grams of magnesium sulphate (in twenty-five per cent solution) per kilogram of weight. Watch the animal closely and observe that in thirty or forty minutes deep anesthesia is produced.

A ten cubic centimeter hypodermic syringe with a very fine point is now filled with three per cent calcium chloride solution. Place a bull-dog on the lateral margin of the rabbit's ear near the head and block the flow of blood in the marginal ear vein which will become engorged with blood. Insert the syringe point into the vein (pointing toward the heart), remove the bull-dog and inject about eight cubic centimeters of the calcium chloride solution. Handle the animal carefully and observe what effect the calcium has. What conclusions can you draw? What explanation can you offer? Could you use magnesium chloride instead of the sulphate? Would it simplify the conditions if corresponding salts (chloride) of the metals were used?

EXPERIMENT CLXV.

**Arsenic. (Dog or Rabbit: Respiration, Blood-pressure,
Peristalsis, Renal Action, Blood.)**

1. Prepare a dog (or rabbit—two grams of urethane) for recording blood-pressure, respiration and intestinal contractions. Insert a bladder cannula (avoid hemorrhage into

the bladder) or pass a catheter and draw off all the urine in the bladder. Test this for glucose, albumen and casts (centrifuge and use the precipitate for microscopic observations). The injecting burette contains sodium arsenate solution (one per cent).

Draw off one cubic centimeter of blood from the femoral artery and add to it one-half cubic centimeter of one per cent copper sulphate solution. Draw off another cubic centimeter of blood and add to it one-half cubic centimeter of sodium arsenate solution (one per cent). Shake up both tubes and observe them carefully. What conclusions can you draw? Of what immediate importance is this to you?

When all adjustments are made take a normal, record the time of day and inject one cubic centimeter of arsenic solution. How are the blood-pressure and respiration affected? Wait a while and then inject another cubic centimeter. How does the reaction to this dose correspond with that produced by the first dose?

Continue the injections (small) slowly and allow the drug to be fully distributed to all the tissues. The drug should act for a long time (several hours) to produce the most marked lesions. Keep the animal alive as long as you can and from time to time inject as much of the arsenic as the animal will tolerate. Obtain specimens of urine occasionally and test for albumen and for reduction of Fehling's solution. Do you detect any indications of an action on the alimentary tract? How does the drug act here? What renal structures are especially affected by the substance?

Near the end of the exercise kill the animal with the drug. Test the urine for albumen, glucose, and casts. Are there any blood cells in the urine (centrifuge and put a drop of the sediment on a slide, cover with a cover slip and examine microscopically)? Open the abdomen, pick up the small intestine and incise it longitudinally. What is the nature of the contents? Examine the mucosa carefully for congestion and hemorrhages. Save a piece of the

intestine and examine it histologically for changes in the mucosa, etc. Is the stomach similarly affected? How did the drug reach these organs? Excise one kidney, preserve and section it for microscopic examination. Examine the liver, lungs, spleen, mesentery, etc., and see if you can detect any abnormal changes in them. What general conclusions can you draw from the experiment?

EXPERIMENT CLXVI.

Antimony (Tartar Emetic). (Dog: Emesis.)

1. Stir up forty to fifty milligrams of tartar emetic (Antimonii et Potassii Tartras) in thirty cubic centimeters of water and administer through a stomach tube to a dog. Put the animal in a quiet place and observe its symptoms for half an hour. What conclusions can you draw? Explain in detail the action of the drug. Do you know of any other substance having a similar action?

EXPERIMENT CLXVII.

Vanadium, Sodium Hydroxide, Ammonia. (Dog: Blood-pressure, Respiration, Spleen Volume, Reflex and Local Actions, Intestinal or Bladder Contractions.)

1. Arrange a dog for recording blood-pressure, respiration, spleen (or kidney) volume and intestinal or bladder contractions. *Do not insert a tracheal cannula at first but carry on the anesthesia by dropping ether on a towel wrapped around the dog's nose and mouth.* The injecting burettes contain ammonium chloride solution (two per cent) and sodium orthovanadate solution (one per cent,—dissolve the vanadium in water and neutralize with a small amount of hydrochloric acid. A deep golden yellow solution is produced).

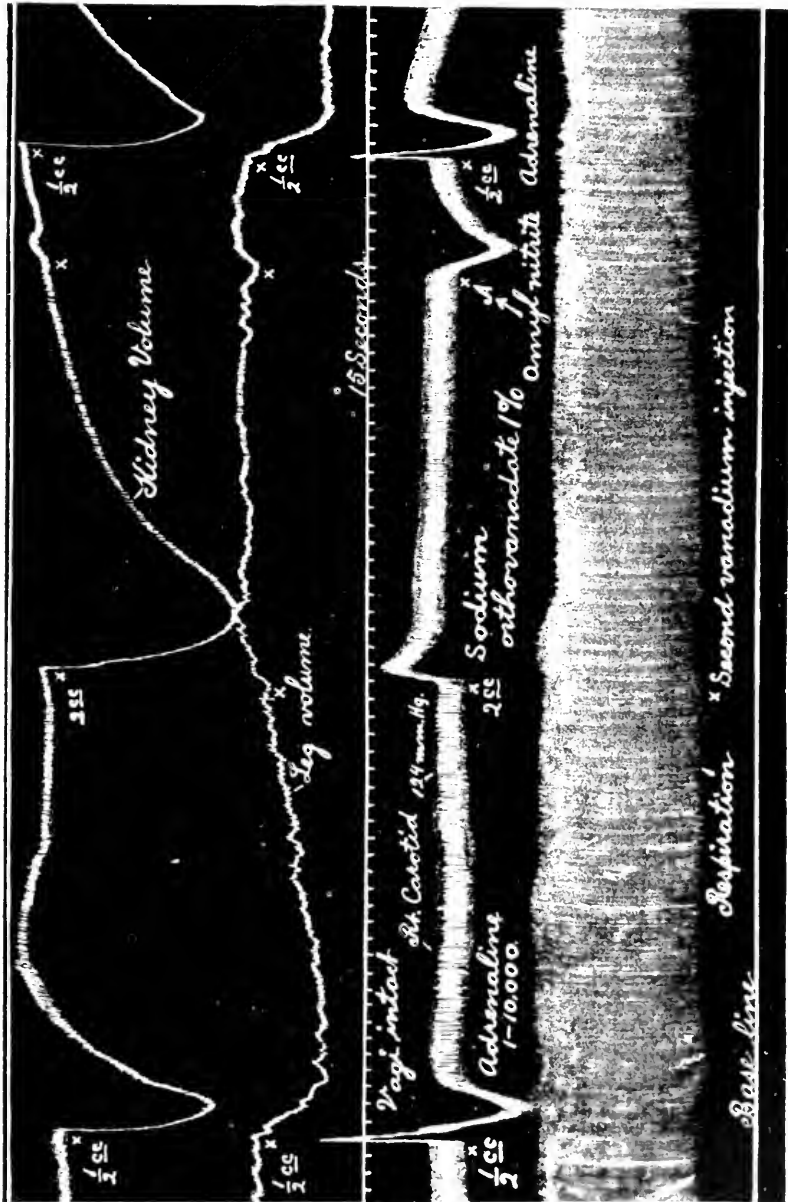

Fig. 354.—Tracing showing the action of adrenaline sodium orthovanadate, amyl nitrite and adrenaline on the kidney volume, leg volume (hind limb), blood-pressure and respiration of a dog. The first injection of vanadium usually produces a more marked reaction than those following.

When all adjustments are made take a normal record and then pour a few drops of ammonium hydroxide solution on the towel so that the animal inhales the vapors. How does this affect the respiration, bladder, spleen volume and heart rate? How do you explain the results? What nerves are involved in the reactions?

Remove the ammonia and insert a tracheal cannula.

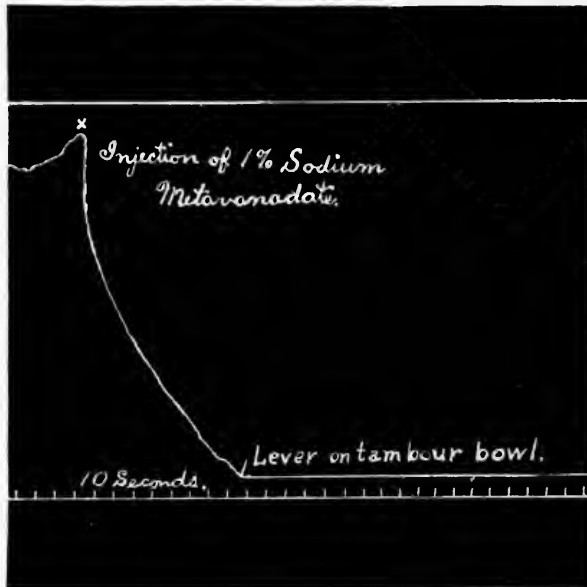

Fig. 355.—Tracing showing the action of vanadium on the volume of an excised, perfused segment of the small intestine of a dog.

Take a normal record and then inject one cubic centimeter of the ammonium chloride solution. Is this action identical in its origin with that produced by the inhalation of ammonia fumes? Inject a larger dose of ammonium chloride to get satisfactory records if the first ones were not good enough (but save the vitality of the animal as much as possible). Empty out the ammonium chloride solution and place adrenaline (1:10,000) in the burette.

Allow the animal to recover as fully as possible. Take

a normal record (see that all writing pointers are properly adjusted) and inject two cubic centimeters of vanadium solution. Wait for the action of the drug to wear off and then inject one-half cubic centimeter of adrenaline. How do the two sets of records compare? Do you know of any other metal having an action similar to vanadium? If necessary (to get good records) inject another (perhaps larger) dose of vanadium. On what structures does vanadium act? Can you determine this point from your experiment? (Could you separate the possibility of actions occurring on

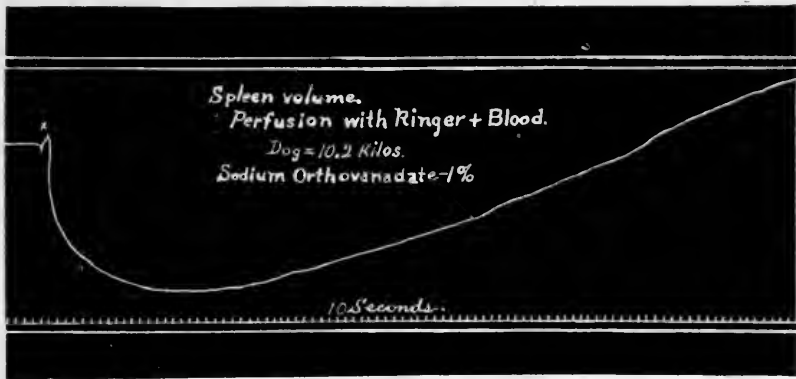

Fig. 356.—Tracing showing the action of vanadium on the volume of the excised, perfused spleen of a dog.

both nerve endings and smooth muscle fibers by taking a record of the bronchial contractions—in another animal—produced by vanadium after atropine has been given?) Have you seen any indications of an action on the intestine? How do you account for this? Does the metal have a selective action for the intestine? Do you know of any other metal that has a similar action?

After enough vanadium records have been obtained then inject into the stomach with a stomach tube one hundred cubic centimeters of ten per cent (or twenty per cent) sodium hydrate solution. Wait for the animal to die. (Be sure the anesthesia is deep and regular before the NaOH

is injected.) Clip the hair and shave a small area on the animal's side. Wet a pledget of cotton with twenty per cent sodium (or potassium) hydrate solution and lay the cotton on the prepared area. Let it stay for some time and then examine the condition of the skin on the area. What conclusions can you draw? Wet another pledget of cotton with dilute acetic acid and place this on the area. See if this in any way changes the character of the results produced by the alkali. What conclusions can you draw?

After death remove the stomach and the upper end of the small intestine (cut between double ligatures) and open the stomach (over a sink). What changes do you find in the stomach walls? Would you recognize such a stomach at autopsy in a case of poisoning? Did the alkali pass into the small intestine? If so how far down did it go? Did the vanadium have anything to do with the lesions you have observed? Examine (open) the remainder of the small intestine and the large intestine for congestion of the mucosa, petechial hemorrhages, etc. If these are present how were they produced? What general conclusions can you draw regarding the action of vanadium and of the strong alkalis?

EXPERIMENT CLXVIII.

Acid, Alkali—Rhubarb, Croton Oil, Magnesium Sulphate.

(Dog: Antagonism of Acids and Alkalies, Absorption and Excretion of Rhubarb, Local Action of Croton

Oil and Magnesium Sulphate—Moreau's

Experiment.)

1. Etherize a dog and arrange to record blood-pressure and respiration. Insert a bladder cannula (or catheter) and collect the urine. Test some urine at once by adding a little ten per cent sodium hydrate to a few cubic centimeters of urine. If no color change occurs add a drop or

two of phenolphthalein solution. The injecting burettes contain one-half per cent lactic acid and one per cent sodium carbonate solution.

Open the abdomen and with the greatest care not to manipulate the intestines more than can be helped, pick up the duodenum and with a hypodermic syringe inject into the lumen of the gut five cubic centimeters of fluid-extractum rhei, U.S.P. Replace this part of the intestine and then going as far as possible down the small intestine pick up the ileum and tie four ligatures around the gut as shown in Fig. 357, thus isolating three loops of the intestine each about three inches long. Into the first of these loops

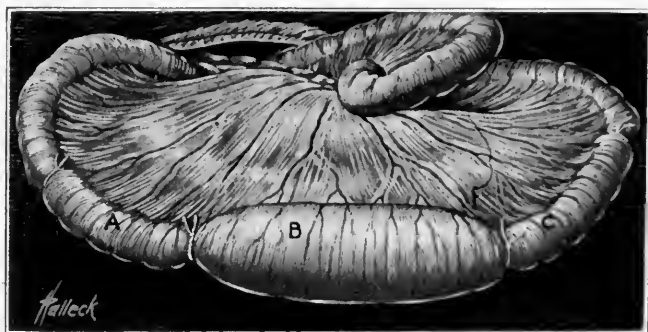

Fig. 357.—Arrangement of the ligatures for isolating segments of the intestine in Moreau's experiment.

(which should be tied with a colored ligature) inject five cubic centimeters of normal salt solution. Into the middle loop inject five cubic centimeters of normal salt solution to which half a drop of croton oil has been added. Into the third loop inject five cubic centimeters of twenty-five per cent magnesium sulphate solution. Carefully replace the intestine, close the abdomen and prepare to take some records on the drum. If the animal is doing well it is preferable to wait half an hour or so to allow the drugs in the intestine to act. As soon as some urine is secreted observe its color closely. Then add a little sodium hydrate and note any changes. What are the active principles of rhubarb?

What is emodin? How is rhubarb excreted? How is the urine influenced by the drug? What does the addition of alkali to the urine show? Do you know of any other drugs that produce similar results?

Take a normal tracing and inject one-half cubic centimeter of lactic acid solution. Wait a little while for the acid to act. Are there any symptoms of embolism? Inject more acid from time to time and note the action on respiration, blood-pressure and the heart. Do you know of any pathological condition in which similar symptoms may occur? Inject acid until very marked symptoms are produced. Be able to describe these symptoms accurately. Now inject some of the sodium carbonate solution and see how this affects the animal. Continue the injections of carbonate for a while and see if you can get the animal to return to normal. In what pathological conditions might the injection of sodium carbonate solution be of benefit?

Get the animal into as good condition as possible and then inject into the stomach fifty cubic centimeters of ten per cent nitric acid. (Be sure the anesthesia is satisfactory.)

Examine the color of the urine secreted. Add a few drops of ten per cent NaOH solution and explain any change that may occur.

Open the abdomen and examine the intestinal loops. What is the condition of each? The normal salt solution should produce no change. The croton oil produces an inflammatory exudate. This is a different action from that produced by ordinary therapeutic doses of the purgatives, such as castor oil. How do these bodies act in therapeutic doses? The magnesium sulphate should attract more fluid into the intestinal loop by osmosis. Do you find this to be the case? What can you say about the ease of absorption of the saline purgatives? How do these bodies act therapeutically? Does your experiment demonstrate this point? What is the Bayliss-Starling intestinal reflex?

After the animal is dead excise the stomach and examine the walls and mucosa carefully. Do you find any changes? Could you recognize these at the autopsy in a case of poisoning? How do the lesions compare with those produced in the stomach by NaOH solution? Are there any characteristic color changes in the involved tissues? If a patient thus poisoned by swallowing a corrosive poison should recover with what later complications might he be affected? Would this hold for carbolic acid also? What do you know about cicatrix (scar) formation after corrosive poisoning? From what cause may persons thus affected die?

Pour a few drops of sulphuric acid on a small area of the stomach mucosa. Watch the changes in the appearance of the tissues. Repeat with hydrochloric acid.

PART II.

CHAPTER I.

SHOP WORK.

The Shop.—One of the most valuable assets which a modern pharmacological laboratory can possess is a well-equipped shop controlled by a skilled mechanic. While the expense of these may be too great for many laboratories their value should be duly emphasized, in order that those who may, from time to time, find themselves in position to equip a shop, or to hire a mechanic, may not hesitate to do so. It is always advisable to buy a first class equipment if the available funds are sufficient. But if only a small amount of money is obtainable the judicious expenditure of the sum *for the right tools and supplies* may yield exceedingly satisfactory returns. And if a special mechanic cannot be obtained the technician or diener, or the members of the teaching staff themselves, may often secure most satisfactory results from a few hours' work in the shop. It is the purpose of this chapter to indicate briefly the nature of the equipment which, in the author's opinion, a shop should contain, and further, to give a few directions for carrying out some of the more elementary and essential mechanical processes which will be of greatest service in the laboratory.

When plenty of space is available the shop should be in an independent room which should be, if possible, at least twenty feet square. A room twenty by twenty-five (or even thirty) feet in its dimensions is preferable if it can be obtained. This point should be carefully considered in the building of new laboratories. If possible the shop should receive an abundant supply of light from the north,

and a good supply of artificial light should be provided, especially in the form of drop lights, etc., placed near the work benches, the lathe, or other special machines. If only a small room can be provided for the shop (as is often the case) then the arrangement of the machinery,

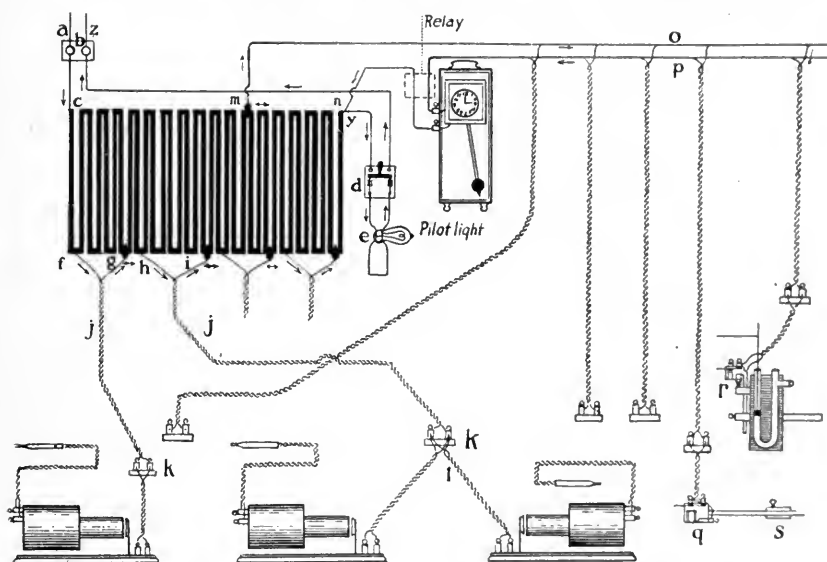

Fig. 358.—A schematic representation of an electric wiring system for using an ordinary 110 volt, direct current for regular laboratory purposes, i. e., for induction coils, signal magnets, etc. Beginning at C, and ending at Y, is a resistance frame made of a large number of strips of thin tinned iron ($\frac{3}{8}$ inch x 28 inches). These strips are joined together at alternate ends so the current passes in series through the total length of all of the strips. Small coils of special resistance wire may be used for this purpose and is more compact. If "tin" strips are used these should be arranged on frames, each frame holding about 50 or 60 strips (the strips are 28 inches long) and about 7 such frames should be placed side by side in an insulated cabinet. All frames are connected together in series and the current leaving at Y in the illustration passes through the switch and thence forms a loop below the pilot light which is connected in parallel (shunt) to the main current wires. The current leaves the frame at Z. Small currents for inductoria, etc., are picked off from the main frame at various points shown at fg, hi, mn, etc. The drop (lamp cord) wires (j, j) pass to the tables for the inductoria, signal magnets, etc. The strength of current going to each table can be controlled at will by varying (by means of a sliding contact) the distance between fg, or hi, etc. At mn, a current is taken off for the clock circuit. In series with one of these wires is placed the master time clock. It is advisable to place a (storage) battery and small (telegraphic) relay in this circuit to protect the delicate contacts of the clock which may be burned out by too strong a current. From the main time circuit wires, O P, the signal magnets, manometer base line signals, etc., receive the time signal currents. Signal magnets, etc., must be insulated from the rest of the apparatus if the main feed wires to the building are grounded at any place. The wood board of the manometer suffices for this instrument here, but metal signal magnets may be insulated by small pieces of wood fiber tubing (S in the figure) which are held by the double clamps. Also metal writing points of signal magnets should not be brought against drums until the paper has been pasted on the drum. (For further details, see Jour. Amer. Med. Assoc., 1912, 58, 1011; also see Von Hees, Science, 1914, 40, 566; also Yandell, Henderson, *ibid.*, 1915, 41, 910, and McPeck, Reed and Beck, Journal of Laboratory and Clinical Medicine, 1916, ii, 139.) Alternating current is not suitable for this work unless it can be changed to a direct current by a special transformer (see catalogues of electrical supply houses).

tools, lighting, etc., must be worked out independently in each laboratory. An arclight which can be raised or lowered by means of a rope passing over a pulley is probably the best source for artificial light. In institutions where only a very limited floor space is available the shop work may be carried out in one end, or even in one corner, of the class laboratory itself. This arrangement is by no means ideal but it may be effective. And much valuable work has been done under just such circumstances as these. The work bench or heavy table should be placed near a

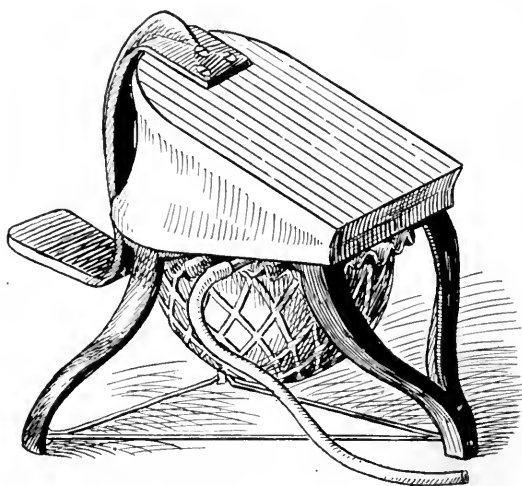

Fig. 359.—Foot bellows.

window if possible. A second table for work on small articles should also be provided.

When possible the shop should be located in a portion of the building from which noises arising from the mechanical work cannot be heard in the libraries, *in other departments*, or in the lecture room of the pharmacological department. In buildings constructed of concrete or other similar material, vibrations from the shop caused by the operation of a heavy lathe, etc., may sometimes disturb delicate apparatus in rooms located even at very considerable distances from the shop, or in some instances, perhaps in

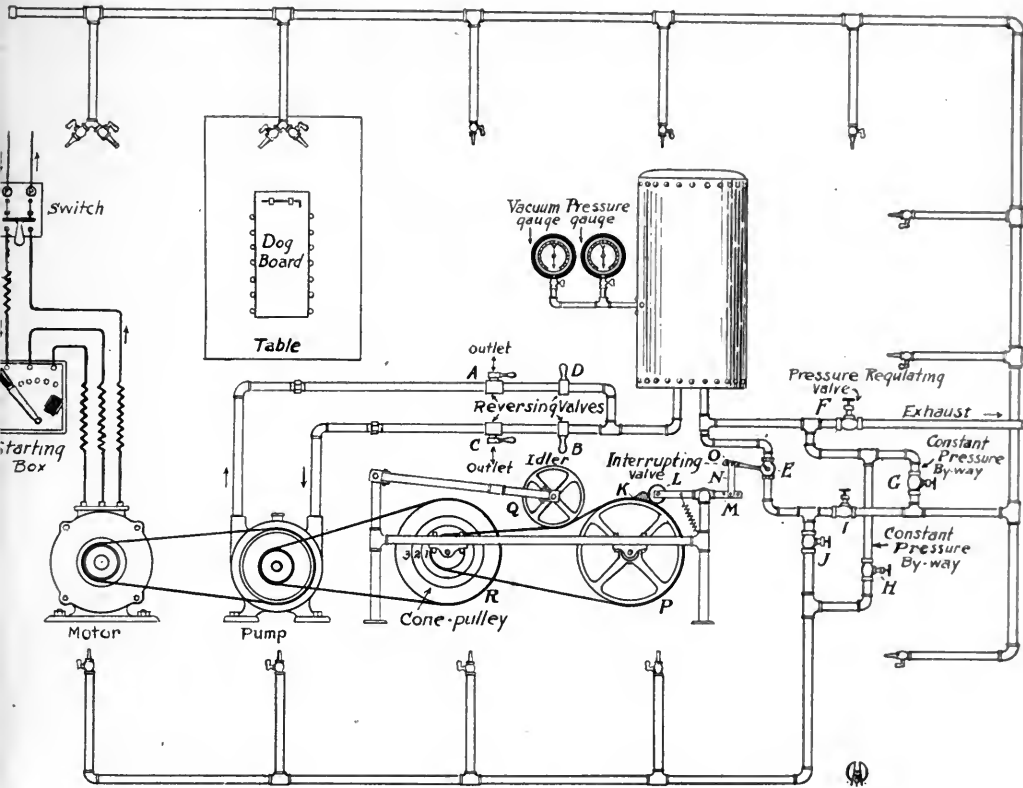

Fig. 360.—Diagrammatic representation of an artificial respiration machine. The $\frac{1}{2}$ horse power motor turns a rotary air pump. Crowell's rotary air pumps (for both pressure and vacuum) are advised but other forms of pumps are on the market. The second size (2-A) is sufficient for 10 or 20 dogs at one time but a $\frac{1}{2}$ horse power motor should be used as the interrupting air valve should also be operated by power from the motor. By opening valves *A, B*, with valves *C, D*, closed, a vacuum will be produced in the tank when the pump runs. By reversing all these valves positive pressure will be produced in the tank. These valves should be lever gate valves (Fig. 362) which can be opened or closed instantly. Thus changes from positive to negative pressure (or the reverse) can be made in about one second without stopping the pump. In some cases it is possible to accomplish this by reversing the motor. From the tank air is piped (three-fourths or one-half inch gas piping) to all parts of the laboratory. Two main lines of piping around the room are shown in the figure. The feed pipe from the tank divides into two parts and each of these two divisions supplies both of the main lines of piping around the room. The purpose of this is to give an opportunity for one set of pipes to carry a constant supply of air (either positive or negative) while the other line may be carrying an interrupted current (either positive or negative). If two tanks are used both positive and negative pressure may be had simultaneously, but with only one tank as illustrated here only one pressure (either positive or negative) can be had at one time. The pipe carries an interrupting valve (*E*), (lever gate valve, Fig. 362) which is interrupted at regular intervals (from 25 to 40 times or more per minute). The large (8 or 10 inch) wheel *R*, turns the spindle holding the cone pulleys, 1, 2, 3, which in turn carry the belt (one-inch flat leather tied together with *belting wire*) which turns the wheel *P*. The wheel *P*, is 8 or 10 inches in diameter and has a four-inch face. Thus the flat (one-inch) belt can be placed on either small pulley and still be slipped along the surface of the wheel *P*. On the outer edge of *P*, is a hill-shaped lug which raises and lowers the pulley *L*, at each revolution of *P*. It is important for *L*, (which works the lever *M*, and the bar *N*, which operate the lever gate valve *E*) to be raised and lowered quickly but noiselessly, hence the hill-shaped elevation up and down the sides of which the

pulley *L* rolls. *The valve E must be opened and closed quickly.* This lets a gush of air enter (or leave) the main lines of piping. If these lines were very short this sudden gush of air might burst an animal's lungs. It is to be emphasized, however, that the pipe lines are long (100 feet or more of piping may be used) and that the air suddenly compressed in these pipes will escape only gradually at the small faucets at the tables. Thus the period of inflation of the lungs may be as long as the period of deflation. The danger is that air may continue to escape *over nearly all the period between each two successive openings* of the valve. *A slowly opening and closing valve is nearly sure to cause this difficulty.*

At *F* is shown a *pressure regulating valve*. The *exhaust pipe* leading from this should pass up inside a hood-draft opening in the wall or out through a window casing, etc., to the outside of the building. The valve *F* is a screw valve and when it is set for a certain opening then the excess air compressed in the tank will constantly escape at practically the same rate through the valve *F*. Thus the pressure in the tank is regulated. The pressure gauge is used for this regulation. For (positive) artificial respiration usually from 3 to 5 pounds pressure is needed. Blast lamps, etc., can be operated by this same air system. A special (pop-off) pressure regulating valve for the tank is on the market, but this valve makes a most hideous and disgusting noise in the laboratory. It is better to simply let the excess air escape to the outside of the building through the valve *F*.

The tank need not be large. A ten or twenty gallon hot water tank is sufficient.

The rotary pump costs about \$26.00. (A smaller size, 1-A, listed at \$20.00 may be used for smaller laboratories.) A $\frac{1}{2}$ horse power motor costs from about \$30.00 to approximately \$60.00. The tank may cost from \$4.00 to \$8.00. If a laboratory possesses fair shop facilities of its own such an air system can be installed for about \$75.00 to \$100.00. The most difficult part is the construction of the apparatus to operate the interrupting valve. This should be firmly and reliably constructed. For ten years the writer has used an artificial respiration machine similar to that described above. The outfit can be thoroughly recommended.

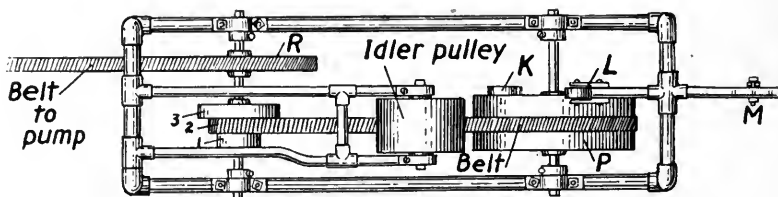

Fig. 361.—View of system of pulleys used to operate the interrupting valve. Seen from above. The framework is made of gas pipe and fittings. The cross on the right hand end of the frame and the two tees on the left end are bored out to rotate on the end bars. Thus the two hinges are formed. This valve operating device can also be used in laboratories where compressed air from the power plant is supplied to the buildings. Hanzlik has recently described a multiple pump system for artificial respiration. (See *Journal of Laboratory and Clinical Medicine*, 1916, i, 688.) Several artificial respiration machines using bellows, etc., are on the market. For student purposes these should be avoided.

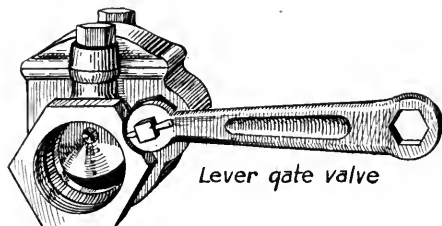

Fig. 362.—Lever gate valve (Lukenheimer, "Handy valve"). These are stock valves and cost from 40 cents to \$1.00. They are able to withstand 125 pounds steam pressure.

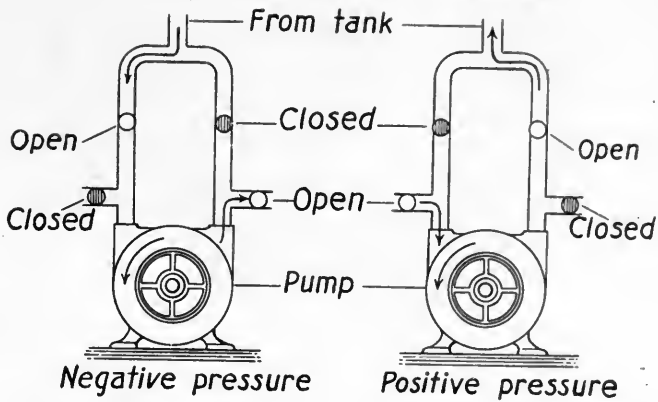

Fig. 363.—Diagram showing the method of operation of the lever gate reversing valves.

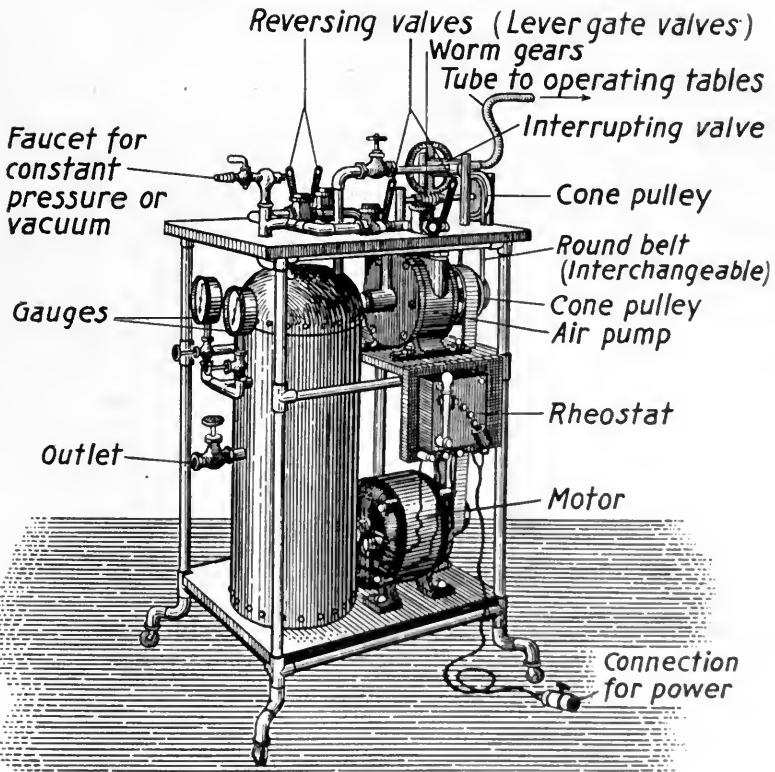

Fig. 364.—Portable artificial respiration machine. Based on the principles illustrated in Fig. 360. There are several varieties of cheap, small-sized rotary pumps on the market. For a small portable machine like this for research purposes these small pumps are sufficient. The special interrupting valve turned by worm gears is shown better in Fig. 366.

every room in the building. It is important to consider this point in the construction of new laboratories.

Equipment.—The following list of tools and supplies is by no means complete and is intended merely to serve as a guide for those who may care to prepare themselves to do a certain amount of shop work but who may have had no previous training in this field.

The author has attempted to arrange the tools, etc., as nearly as possible in the direct order of their usefulness in the laboratory and with reference to the amount of money

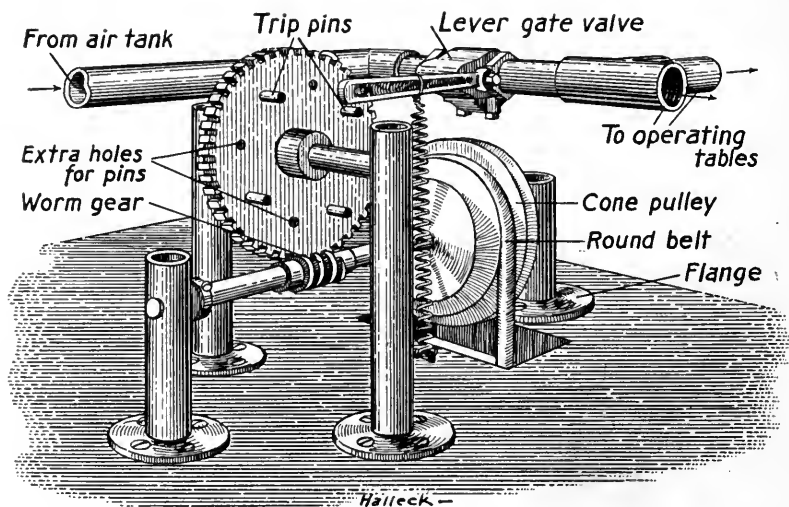

Fig. 365.—Special form of interrupting valve using cone pulleys, worm gears, and having adjustable trip pins to open the lever gate valve. This valve can be used where compressed air is already furnished to the laboratory from the power house. Air thus supplied is often under high pressure (35 to 70 pounds or more). There are special reducing and regulating valves on the market to reduce this pressure as it is received into a special tank in the laboratory. One can use a pressure of 35 pounds for artificial respiration if he has a suitable interrupting valve, one which opens only a little ways and for a very brief period. Excessive quantities of air are usually passed to the animal but most of this escapes at once through the side tube of the tracheal cannula. *This should always be wide open before artificial respiration is started.* The instructor should fully impress this on the students.

which the department may be able to spend for the shop equipment. Thus the list begins with those cheap hand tools which are most likely to be of the greatest service in laboratories where the funds are limited. As the number of tools multiplies in the list the degree of usefulness is

supposed, as nearly as possible, to keep pace with the increased expense. In this connection, however, a special exception may be made with reference to the lathe which is the most important *high-priced* piece of machinery that the shop can possess. Thus if the funds permit the purchase of a lathe at all this is perhaps best done immediately

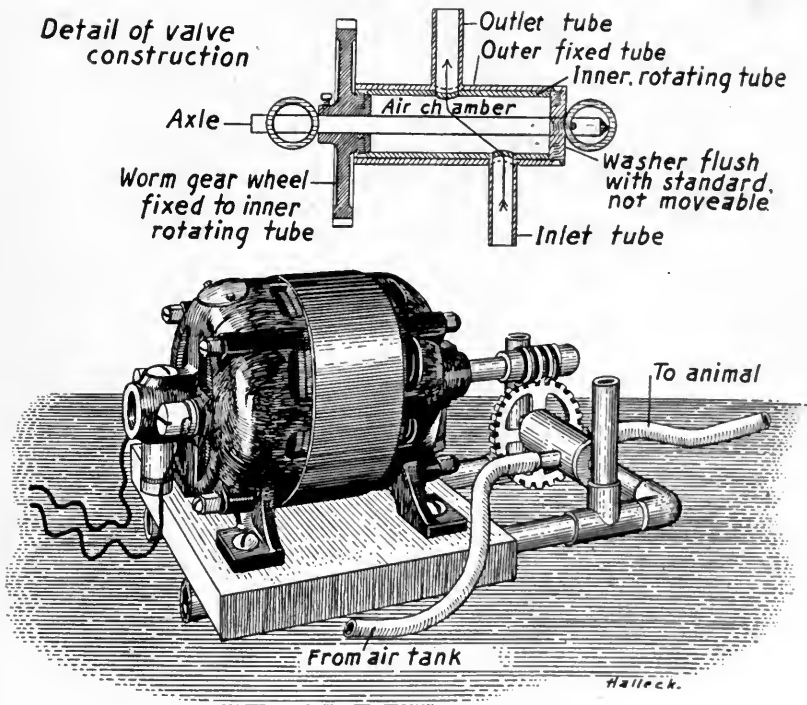

Fig. 366.—Special interrupting valve driven by a small (1/10 horse power) motor. The details of the construction of the valve are shown in the upper part of the illustration. This valve is essentially like one devised by Cannon, Martin and Mendenhall. Gates has also used a principle like this in connection with a pump and motor combined in one apparatus. A valve of this form should be used *close to the animal*, since if the air is piped a long distance the slow turning on and off of the air permits compression in the tubes and a prolonged, wave-like blowing at the outlet faucets.

after the first thirty items in the list have been provided for. On the other hand if a lathe cannot be bought then the items may very well be bought in approximately the order in which they appear in the list. It is to be noted, of course, that each mechanic will have many small items to add to

the list, and these items—mainly special forms of hand tools, attachments, etc., and special supplies—will vary according to the training which the mechanic has had and with reference to the special work which the department

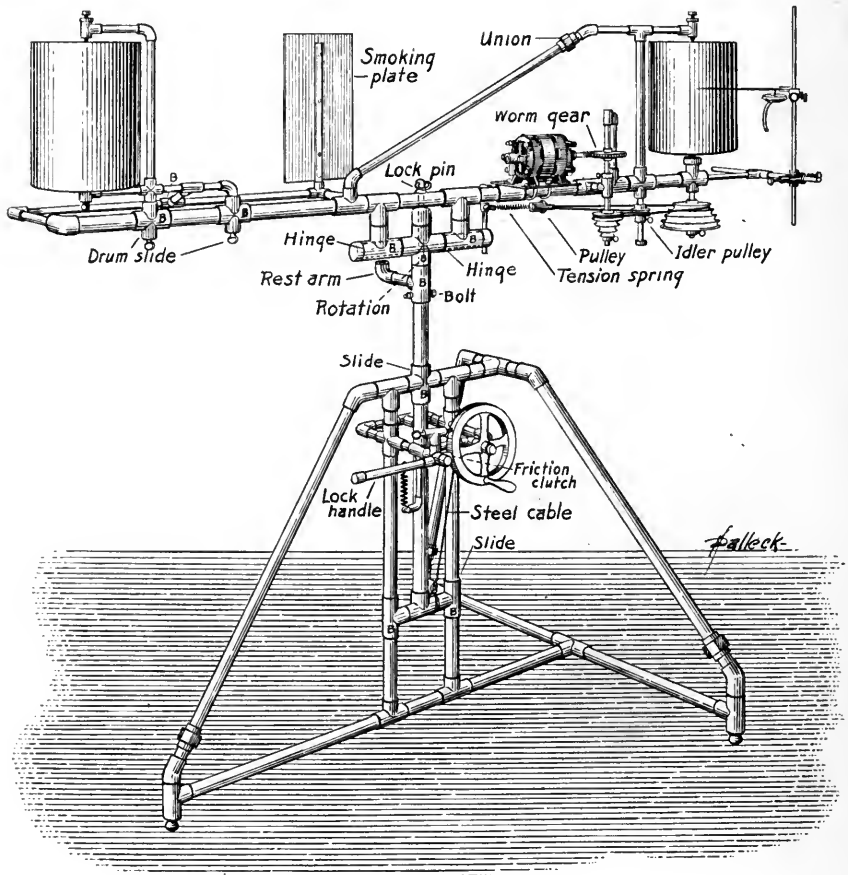

Fig. 367.—A motor driven long paper kymograph constructed mainly of gas pipe and fittings.

may want done. A few (approximate) prices are indicated in the list for items on which errors are especially liable to be made in purchasing or for articles of great use in the shop.

List of Equipment.

1. Pliers (5 inch flat-nosed, 9 or 10 inch flat-nosed, 5 inch end cutting).
2. Screw drivers (small, 20 cents, and large, 30 cents; Yankee, \$1.50).
3. Files (8 inch flat, 4, 6, 10, 12 inch flat, 6, 4, 8, 10, 12 inch round, square and three cornered).
Knife edge files, wood files and rasps should be bought if possible.
4. Hammers (claw hammer, 50 cents; medium sized riveting, 50 cents). A hatchet (50 cents) is desirable.
5. Small vise (\$1.75). The jaws should open parallel, not like a pair of pliers.

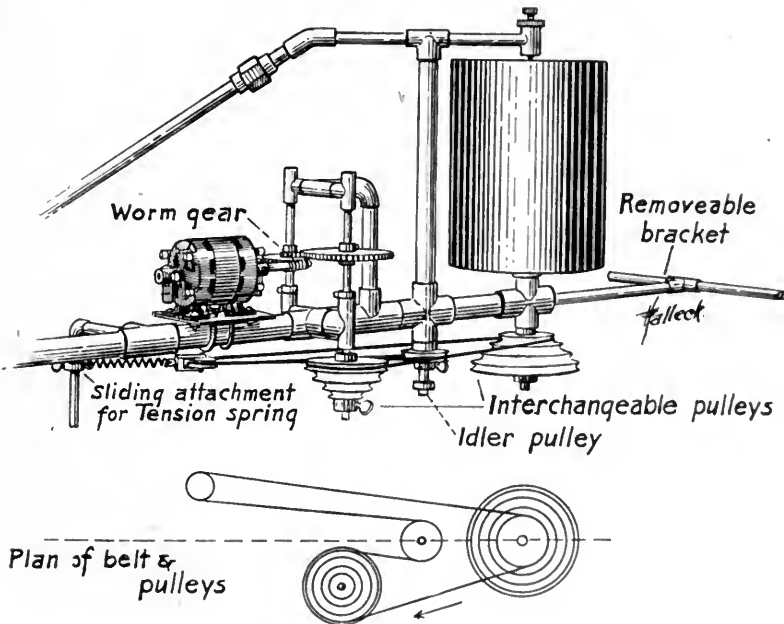

Fig. 368.—Detailed view of one plan of construction of the speed regulating device for the kymograph shown in Fig. 367. The arrangement of the speed regulation depends largely on the speed of the motor, and hence different gears must be used for different motors.

6. Tinner's snips (6 inch, 50 cents; large size, \$1.25).
7. Hand saw (24 to 26 inch, \$1.00 to \$1.50).
8. Hack saw, 8 to 12 inch adjustable (\$1.00) and blades (10 and 12 inch, fine teeth, 60 cents per dozen).
9. Hand drill (Fig. 370, \$2.50) and several dozen twist drills. These run in sizes from No. 60 (a little less than $\frac{3}{64}$ inch in diameter) to No. 1 (a little less than $\frac{1}{4}$ inch in diameter). Drills larger than No. 1 are usually indicated in inches, the diameter increasing $\frac{1}{64}$ inch for each succeeding size. A good supply of drills should be kept on hand. The

small sizes cost about 10 cents apiece, the larger sizes up to 1/2 inch average 20 cents to 25 cents apiece. Very fine (jeweler's) twist drills may also be needed for special work.

10. Nails (wire). 1 or 2 pounds of each size—about 6 or 8 sizes are needed.
11. Brass. A good supply of this should be available since a great many pieces of apparatus can be made from this metal. In large cities brass

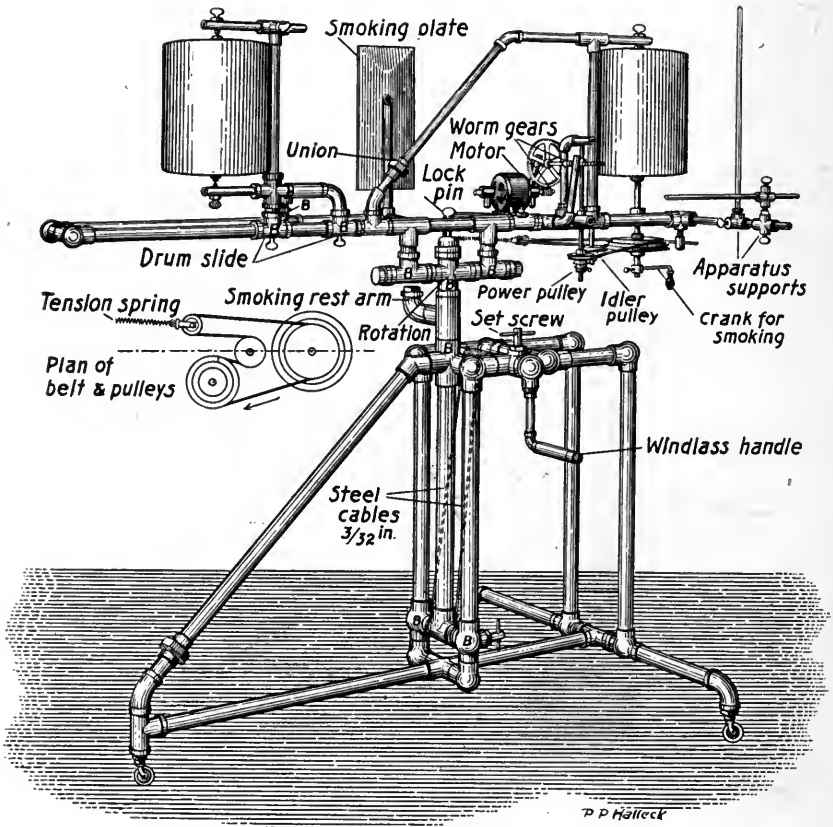

Fig. 369.—Another form of motor driven long paper kymograph. (For detailed description, see *Journal of Laboratory and Clinical Medicine*, 1917, ii, p. 424.)

can often be bought as needed, but in small towns a stock should be kept on hand. The tubing varies in size from about 1/32 inch up to 4 or 5 inches. In some places even larger sizes can be obtained. The wall thickness is usually about 1/32 inch but other sizes are available. The 1/8, 3/16, 1/4, 3/8, 1/2 and 1 inch sizes are most used in the laboratory (especially the 1/4 inch size). The cost varies from about 50 cents to 60 cents per pound for the larger sizes, much higher for the very small sizes (1/16 inch, etc.). Round brass rod from 1/8 inch up to 1/2 inch

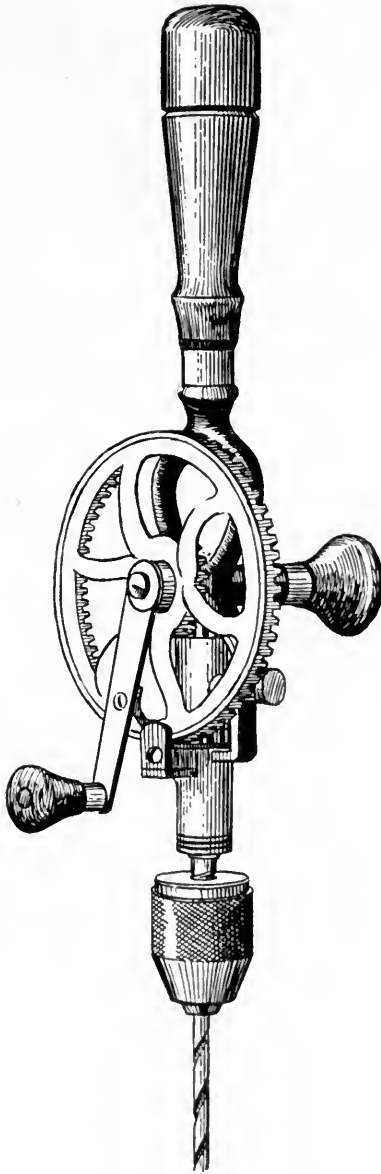

Fig. 370.—Hand drill. Should hold drills from zero up to $\frac{3}{8}$ inch in diameter.

in diameter is needed in abundance. Larger sizes up to 1 or 2 inches are especially required if lathe work is done. The 1/8, 3/16, and 1/4 inch sizes are used most (these are the least expensive). The price now averages about 50 cents per pound. Square brass rod can be bought approximately the same as the round (3/16 and 1/4 inch most used). Hexagon rods and sawed rods are also available. Sheet brass is made in thicknesses varying from about that of a very thin sheet of paper up

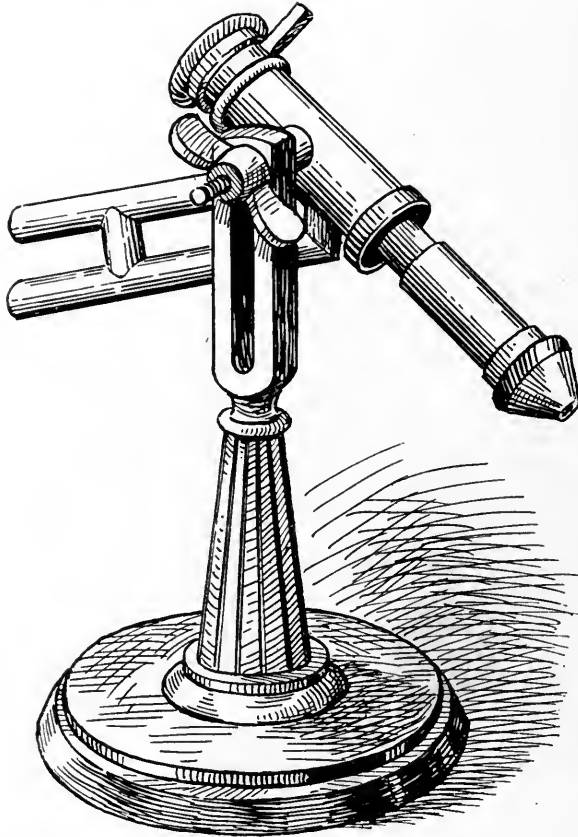

Fig. 371.—Blast lamp. (Buffalo Dental Mfg. Co., Buffalo, N. Y.)

to 1/2 inch or more. It is often available only in rolls one foot in width but larger firms have rolls varying in size from perhaps 1/2 or 1 inch up to 12 inches. Sheet brass is of the greatest use in the laboratory not only for repairing or making regular student apparatus but especially for experimental work and research. The most used thicknesses are approximately 1/64, 1/32, 3/64 and 1/16 inch. A small supply of 1/8 and 1/4 inch (and even 3/8 and 1/2) brass plate is also exceedingly desirable. Spring brass wire (Nos. 14, 16, 18) should also be in stock.

12. Blast lamp, (Fig. 371, \$4.50) and foot bellows (Fig. 359, \$5.00) or compressed air and tubing. These are mainly used for soldering (or brazing) and are exceedingly useful. If no gas supply is available an alcohol lamp (20 cents) and a small mouth blowpipe (20 cents) may be used for soldering many *small* articles.
13. Solder and soldering acid. Solder is best obtained in the form of a heavy coiled wire about 1/8 inch in diameter (string solder). This form is especially adapted for soldering with a blast lamp (which is by far the best method for this kind of work). Soldering acid is made by put-

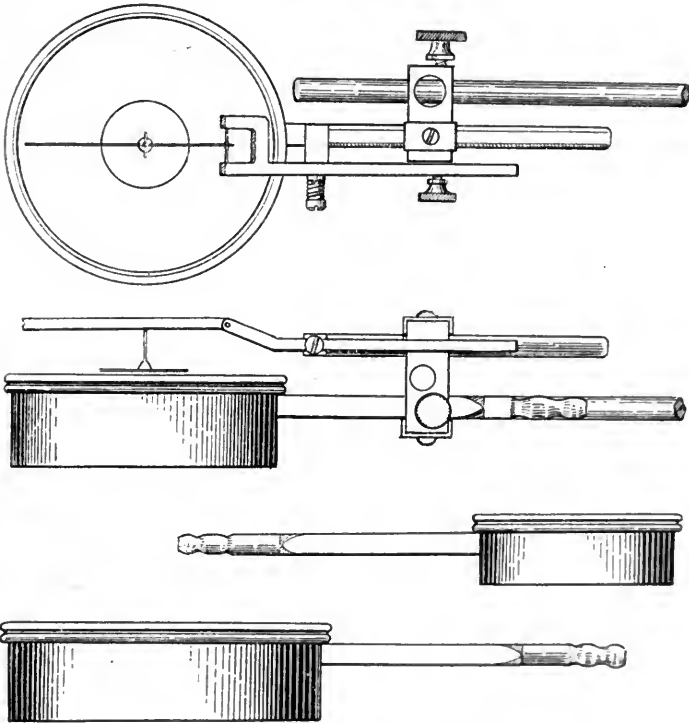

Fig. 372.—Details of the mechanical construction of the adjustable tambour shown in Fig. 14. One-half natural size. It is recommended that all laboratories which have sufficient shop facilities make up at least a few such tambours as this for recording special results where large volume changes in the tambour are required. Upper picture, seen from above; middle picture, seen from the side; the two lower pictures, the smallest and largest tambour bowls. All parts made of brass. Thin sheet aluminum writing points are used. These may be cut on a hard board from thin sheet aluminum with a penknife and a metal ruler.

ting about 2 or 3 ounces of hydrochloric acid in a 6 or 8 ounce wide-mouthed bottle and dropping in more granulated zinc than the acid can dissolve. The bottle is placed in a hood so long as fumes are given off from the mixture. A glass tube (8 or 10 inches long) is placed in the bottle to be used as a pipette for placing the acid on the articles to be soldered.

The above tools and supplies are sufficient for the making of most forms of oncometers, heart levers, simple muscle levers, plethysmographs, simple forms of tambours, T-tubes, tracheal or arterial cannulas, frog clips, mercury

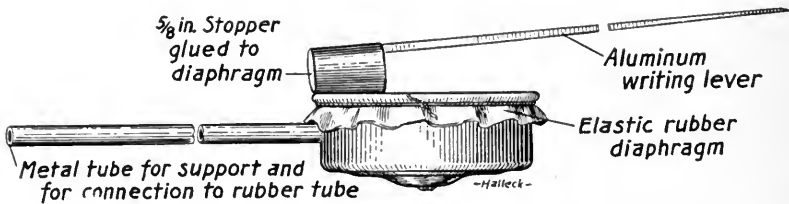

Fig. 373.—A cheap form of large bowled tambour made from a nickel plated metal tumbler holder bought in a ten cent store. The stem of the holder was filed off, a hole was punched in the side of the "bowl" and a $\frac{1}{4}$ inch brass tube 7 inches long was soldered into the hole. The "bowl" had a round flange at the rim over which the rubber membrane was tied. A cork attached with mucilage to the membrane carries the writing point. The brass tube is connected to the receiving apparatus by rubber tubing. Many small vessels can be found in ten cent stores from which tambours, cardiometers, etc., can thus be cheaply constructed. Soldering is a great aid in this work.

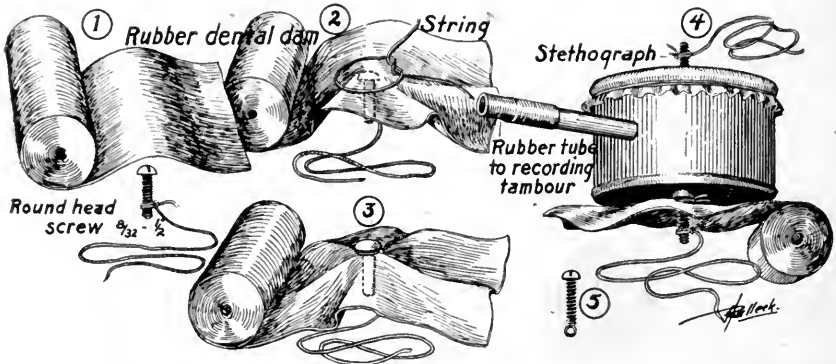

Fig. 374.—Method of tying the head of a small screw into a rubber membrane to be used over the end of a stethograph drum. No opening should be made in the rubber dam. Dental dam, obtainable from dental supply companies, is recommended for stethographs, tambours, etc. At 5, is shown a screw with a small ring soldered on to the end to which the string is tied.

manometers, operating boards, etc., and for doing a great variety of repair work, electric wiring, etc.

14. Oil can (15 cents to \$1.25) and 1 gallon of machine oil.
15. Copper wire, plain (Nos. 14, 16, 18), iron wire, plain (No. 18). These are often used for holding pieces of apparatus together until the parts can be soldered.
16. One jack plane. (A smoothing plane and a block plane are also desirable.)

17. A work bench for wood and two bench hooks. The work bench should have two wood vises. (Best obtained from Sears, Roebuck and Company, Chicago.)
18. One brace and set of wood bits (6 to 12 in number). Two screw head counter sinks, one for wood, the other for metal and to be used in a brace, are also desirable.
19. Try square.
20. Iron carpenter's square (18x24 or 12x18 inches).
21. A small anvil (\$2.00). A heavy anvil should also be provided and is required for the heavier shop work (\$5.00).
22. Small stock and dies for machine threads (\$4.00 to \$7.00). Several extra sets of dies and about 20 taps should be bought. The most used sizes are 4/36, 8/32, 3/48, 2/56, 14/20, 12/24, but several extra taps of larger size should be in stock since machine screws can be easily purchased to fit holes threaded with these taps. (If heavy work is to be done a blacksmith's stock and dies should be purchased.)
23. Wood screws, 5 or 6 sizes, both with flat heads and with round heads. An assortment of small-sized wood bolts should be in stock.
24. Machine screws. These vary in size, length and style of the head. The heads are either round, flat or filister, and each style is often needed. The 1/8, 1/4, and 1/2 inch lengths are most used, but longer lengths, especially of the larger sized screws should be in stock. The diameters and threads most used are 4/36, 8/32, 3/48, 2/56, 14/20, 12/24, but several extra sizes of larger screws should be in stock. Brass screws can be purchased of practically the same sizes and styles as the iron ones but dealers often do not carry these in stock.
25. Scratch awl.
26. Monkey wrench (6 inch).
27. Fish tail burner. This is also needed for smoking drums.
28. Punch for metal (or sharp nail set) and cold chisel.
29. Hand bracket saw and blades (for metal).
30. Heavy end cutting pliers. These should be large enough to readily cut in two quarter-inch iron wire.

A marked change in the scope and character of the work which can be done in the shop will be introduced by the purchase of the remaining items in the list.

31. Pipe stock and dies—about 6 sets of dies and taps, but several more sets are greatly to be desired. The common sizes are 1/2, 3/8, 1/4, 3/4, 1/8, and 1 inch. The *right hand* taps for these may be omitted but are desirable. The corresponding *left hand* dies and taps are often of great use. Extra dies (and taps) are also desirable if work with large size piping is to be done.
32. A great many pipe fittings, tees, elbows, crosses, nipples, unions, thimbles, side outlet elbows, side outlet tees, side outlet crosses, return bends, reducers, faucets, valves, street elbows, 45° elbows, flanges, etc., etc., are easily available from dealers in plumber's and gas fitter's supplies. These fittings are cheap, strong and durable. Generally one will need to buy a supply of gas piping (1/8, 1/4, 3/8, 1/2, 3/4, or 1 inch, etc.

in size) to go with the fittings. Many of these fittings (and piping) can be bought in brass but at considerably higher prices. *All stock fittings* have right hand threads cut in them but a left hand tap can be run down into these fittings (best done in a lathe) and left hand threads thus cut across the right hand ones. Thus one can frame up a square with gas piping using regular fittings but the left hand joints may not be suffi-

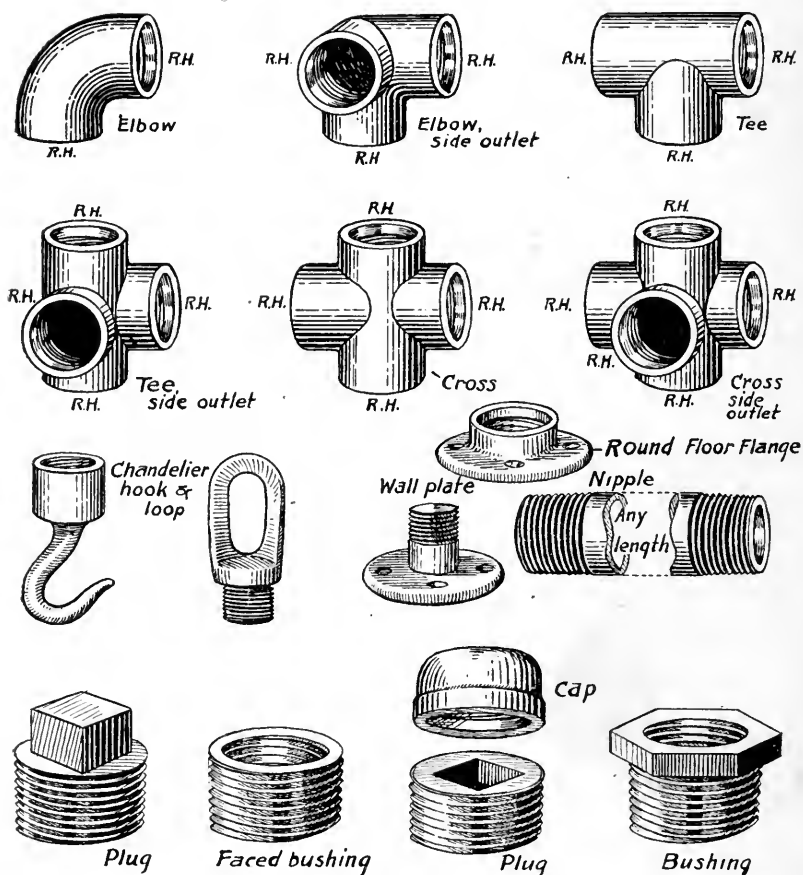

Fig. 375.—Some of the more common types of gas pipe fittings. Special forms can be found in catalogues of plumbers' and gas fitter's supply houses.

ciently tight to hold water or steam. (See Fig. 375.) If one knows exactly what fittings, etc., are available he can often make out an order for exactly the pieces which he may need for an extensive piece of work and purchase from a gas fitter's or plumber's supply house the fittings, piping, etc., all completely threaded and ready to screw together with a wrench. The author has sometimes been surprised at the cheapness with which such equipment may be purchased. This procedure is

especially liable to be of use to those who may care to install an artificial respiration system in an old laboratory or to those who have but few shop facilities of their own. It is advisable to obtain a catalogue of gas fitter's or plumber's supplies, e.g., that of the Crane Company, 836 South Michigan Avenue, Chicago.

33. Large vise (\$9.50) the jaws should open parallel and there is little danger of getting too large a vise. One with 4½ inch jaws opening seven or eight inches is advisable. (A satisfactory vise is the No. 20, made by the Prentiss Vise Company, New York.)
34. Stillson wrenches, 6 inch and 10 inch.
35. Pipe cutter.
36. Mitre box and saw (\$10.00 to \$12.00).
37. Heavy hammer (Adze-eye, ball peen, machinist's hammer, 1 pound, \$1.35).

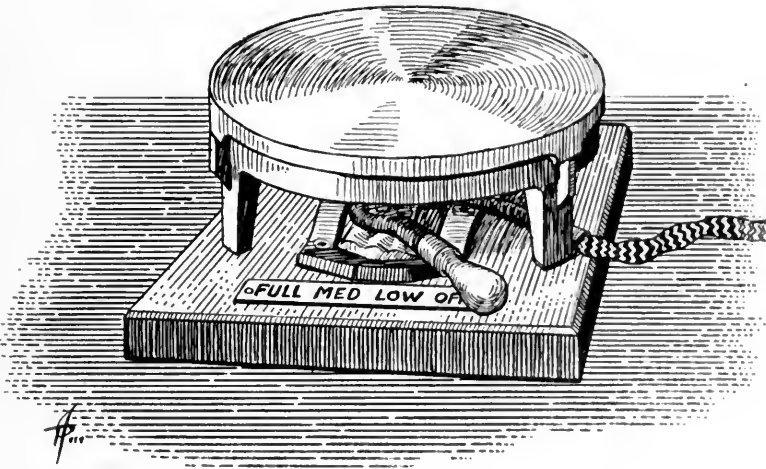

Fig. 376.—Small electric heater. Useful for dissolving drugs, etc.

38. Supply of iron rods (round, square, flat strips, etc.) and angle- and T-iron. These iron rods, strips, T-iron, angle iron, etc., are not very expensive and can often be used (especially the smaller sizes) instead of brass.
39. Hand emery wheel (\$5.00). If a power emery wheel (which is greatly to be preferred) is obtainable then the hand emery wheel can be omitted. Burnishing and polishing can usually be done by placing burnishing wheels on the same head that holds the (power) emery wheel.
40. Calipers, (2 sets, 3 inch and 5 inch—inside calipers, 3 inch, are also needed).
41. Wire gauge.
42. Screw thread gauges (2 are generally necessary to get a full range of different thread sizes).
43. Drill gauge.

44. Turning lathe for metal. There are many varieties of these lathes on the market, varying in price from about \$50.00 to approximately \$1000.00 for such sizes as might be bought by the department. It is strongly advisable not to buy a low-priced, cheaply constructed lathe. The author has found the Star lathes (Seneca Falls Manufacturing Company, Seneca Falls, New York) very satisfactory. Small lathes are to be avoided, and the 16 inch (or 13 inch) swing size is better than the 11 inch, which in turn is to be preferred rather than the 9 inch size. The lathe should have automatic longitudinal and cross feeds, should be able to cut a large range of threads and should be so constructed that a full set of attachments, such as a taper cutting device, a milling device, etc., can be readily attached at any later date. Exposed gear wheels around the head stock are to be avoided and especial care should be taken to see that changes from one thread to another in the thread-cutting device can be made quickly and easily. In the best lathes this is largely done by simply shifting levers, in the cheaper lathes an unwieldy number of separate and independent iron gear wheels must be taken off and replaced by others to produce most or all of the shifts in threads.

It is very convenient to have a motor-driven lathe, i.e., one with the driving-motor attached directly to the lathe. This makes the lathe entirely independent of the other machinery in the shop, but it is slightly more expensive (if several other motor-driven machines are used) than is the arrangement whereby one motor is used to drive a power shaft from which all the machinery in the shop is actuated. This also applies to most of the other motor-driven machines.

A few attachments are usually sold with the lathe but many others are always needed. A full set of turning tools should be secured, and the following are needed:

46. Three chucks—Cushman, universal, one as large as the lathe will carry, one $2\frac{1}{2}$ inches and one about 4 inches in diameter. Each chuck should have 2 sets of jaws. Chucks are very expensive and if only 1 can be bought this should be about 4 inches in diameter. In addition a Jacob's drill chuck (holding drills at least up to $\frac{1}{2}$ inch in diameter) should be purchased. This chuck should be fitted to the lathe.
47. Armstrong cut-off tool (and bits), Armstrong boring-out tool, and a threading tool.
48. Crotch center, screw face plate, tail face plate, two lathe dogs, and a nurling tool.
49. A power-driven drill press. It is convenient to have the motor attached to the drill press but this is more expensive than the power shaft arrangement. The drill press should have *hand feed* (and power feed also if possible) and should drill to the center of at least a 12 or 14 inch circle (or larger if possible).
50. A wood lathe. (Burnishing, buffing and polishing may also be done by especially attaching buffing wheels to the wood lathe.)
51. A shaper (planer) for metal.
52. A power hack saw (\$25.00).
53. A milling machine (\$500.00).
54. If much wood work is done a wood former (\$20.00) may also be useful.

To this list every mechanician will want to add various hand tools, etc. The expense of these, however, will not, as a rule, be very great at any one time, for such equipment is usually needed for special pieces of work, and the tools required can be bought from time to time as the funds are available.

Mechanical Procedures.

A few paragraphs may be devoted to some of the most elementary and useful mechanical procedures which may be carried out in the shop. The first of these is soldering. The metals best suited to this work are brass, copper, tinned iron and wrought iron. Cast iron is scarcely suitable. Galvanized (sheet) iron is soldered readily. The process is exceedingly simple, and easily carried out if the parts to be soldered together are not very complicated. The most difficult feature of the process is to hold the various pieces in the proper position until the solder can be applied. This is usually best done either by tying the pieces together in the right position with wire (copper or soft iron, smooth, No. 16 or 18) or by fastening the pieces down to a board or block of wood in the proper position by means of small nails driven into the wood.

A blast lamp burning gas and supplied with compressed air (easily obtained from a rotary pump such as should be used for artificial respiration) is the best method to be used for melting the solder. A foot bellows may be used to supply the air. A blast lamp exactly like the one shown in Fig. 371 should be provided.

Small articles can be soldered with a spirit lamp and mouth blowpipe but this is both tedious and tiresome except for the very smallest articles. Timmers and some mechanics use a soldering copper but this is a crude method and often entirely unsuited for much of the work required in making ordinary pieces of apparatus. But a soldering copper is of service in the soldering of aluminum for which

special aluminum solder must be bought. No acid is used in aluminum soldering but the scraped metal surfaces are heated and the aluminum solder is rubbed on the proper places with the (very) hot soldering copper. The author has not found a blast lamp very satisfactory for aluminum soldering.

For ordinary soldering on brass, etc., a small flame from the blast lamp is best. Fig. 377 shows the method of applying the flames in making a brass T-tube or tracheal

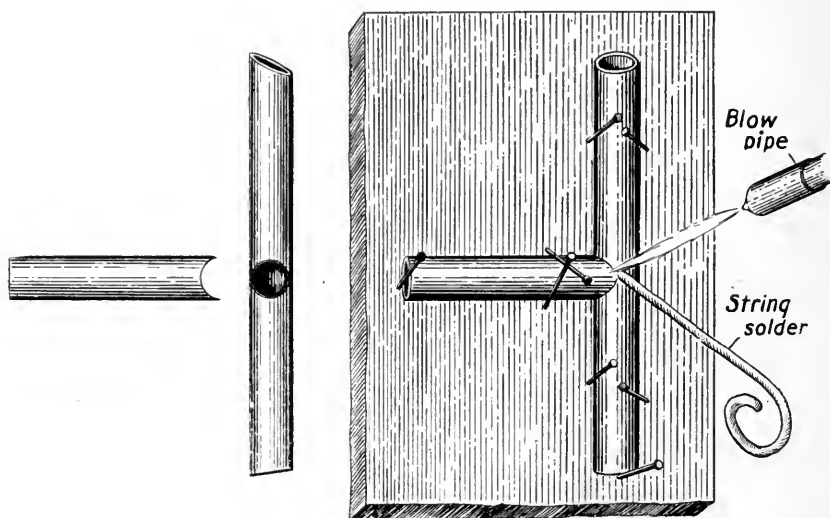

Fig. 377.—Method of preparing two pieces of brass tubing for making a tracheal cannula, and the process used for holding and soldering the pieces together.

cannula. But soft solder will not stick to the brass, etc., unless a soldering acid is used. This soldering acid or fluid is made by placing granulated zinc in hydrochloric acid and allowing the acid to dissolve all of the metal possible. An excess of zinc should be left in the bottom of the bottle. The acid is applied to the article by means of a glass tube used as a pipette. Fig. 377 also shows the two pieces of brass tubing which have been filed (or sawed) off of a long brass tube. These two short pieces are filed with a round file as shown in the illustration, an opening being

made near the middle of the longer piece by cutting into the side of the tube with the round file, while one end of the short piece is cut in circularly to fit over the opening in the longer piece. These pieces are fitted together and then fastened down to a small block of wood by a few small nails. The joint is then heated fairly hot (to remove grease, etc.) with the flame and then a few drops of the acid are applied to the joint. This acid is at once vaporized by the heated metal but in this process the acid penetrates every portion of the joint. The flame is now reapplied and at the same time the end of a piece of wire solder (string solder) is placed on the joint. The solder melts quickly and runs into every part of the joint. Beginners usually get on too much solder. Only a small amount is needed as a rule and more may even do harm. The flame can be directed beneath the tube to insure soldering of the lower part of the joint. More acid can be applied if the solder does not stick at the first application. As soon as the joint is seen to be run full of solder the flame is removed and no more solder is applied. Cold water is poured over the tubes and the soldering is complete. The cannula is now removed from the board and a fine rasp or wood file (*not a fine file for metal*) is used to file away any excess lumps of solder and make the joint smooth and regular.

This operation is typical for most of the soldering required in the laboratory. But a further complication arises if two pieces are to be soldered together close to a joint which has already been soldered. In this case heat from the flame may melt apart the first joint while the solder is being applied to the second. This can usually be avoided by wrapping the first joint with wet cotton or a wet cloth (probably tied on with soft copper wire) while the second joint is soldered.

The making of oncometers for the kidney, spleen or intestinal loop, etc., can be readily done by simply cutting out pieces of sheet brass into the proper shape and then

soldering the edges together as above described. The method is quite similar to that which one would employ if he desired to make a pasteboard case to cover an irregularly shaped object such as an ink bottle. He would simply cut out pieces of the pasteboard to fit the various surfaces of

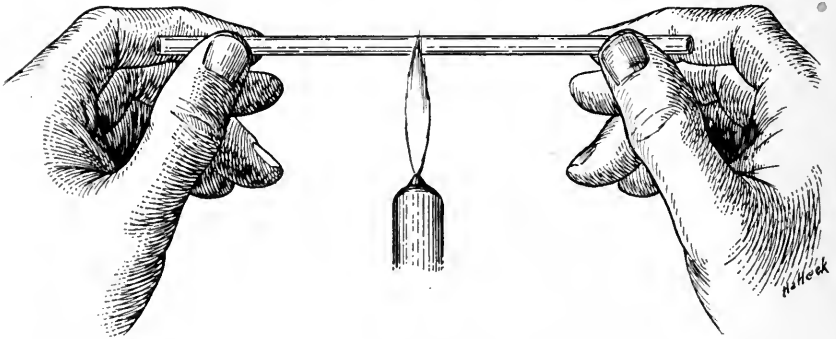

Fig. 378.—First step in the making of small "straight" glass cannulas.

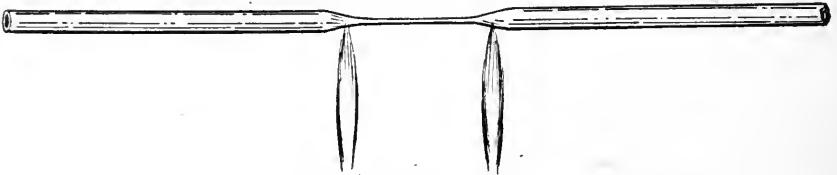

Fig. 379.—The "shoulders" of the cannulas are carefully heated in a needle-pointed flame and drawn out a little to form the "necks" on the two cannulas.

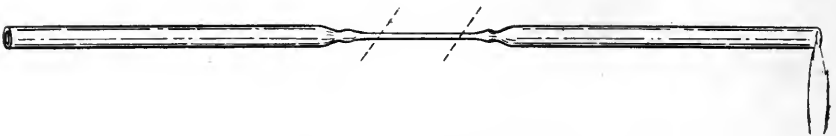

Fig. 380.—The points of the cannulas are broken off at the file marks and the large end of each cannula is rounded in the flame.

the bottle, bending those which covered curved areas, and then he would fasten the edges together with glue or mucilage.

Pieces of iron may be brazed by heating them red hot, covering the areas to be brazed with powdered borax (which promptly melts) and then putting small pieces of

brass on the joint while applying a very intense blast lamp flame. The brass melts and passes into all the crevices between the adjoining pieces of iron. When the parts are cooled a very firm joint should be formed.

Glass Blowing.—Only two of the most common operations need be mentioned here, for the making of complicated articles of glass requires great skill and long practice and training. It is, however, often almost imperative for the instructor or mechanic to be able to make a few things from glass tubing. These articles are usually cannulas, and tubes which are bent in various directions. Very fine pointed cannulas are so easily broken and are so frequently needed that it is a matter of special importance for the simpler forms to be made in the laboratory. Figs. 378, 379, and 380 show essentially the processes involved. Very fine cannulas, as those needed for Wharton's duct or the thoracic duct, should be made of small tubing (about $3/16$ inch outside diameter). The glass is heated up slowly at first (best in a smoky flame) to avoid cracking. A very small flame is then used to heat a short length ($1/4$ to $1/2$ inch) of the tube. When the glass softens (the tube is rotated constantly) the heated part is then drawn out for a distance of two or three inches, depending on the size of the point desired for the cannula. The glass is then allowed to cool enough to harden. The flame is then made exceedingly small and is directed against one of the "shoulders" of the drawn out portion of the tube. The tube is kept rotating and as soon as the glass in the "shoulder" begins to become fairly soft it is quickly drawn out a little and a "neck" is thus made for the cannula as shown in Fig. 379.

The process is repeated for the other "shoulder" and two cannulas are thus formed but are held together by a narrow length of the drawn out tubing. With the sharp corner of a file a scratch is made a little beyond the point where the tip of each cannula should be. The tube is snapped off at each of the scratches and then the points of the cannulas are carefully rounded by heating in a very small yellow flame.

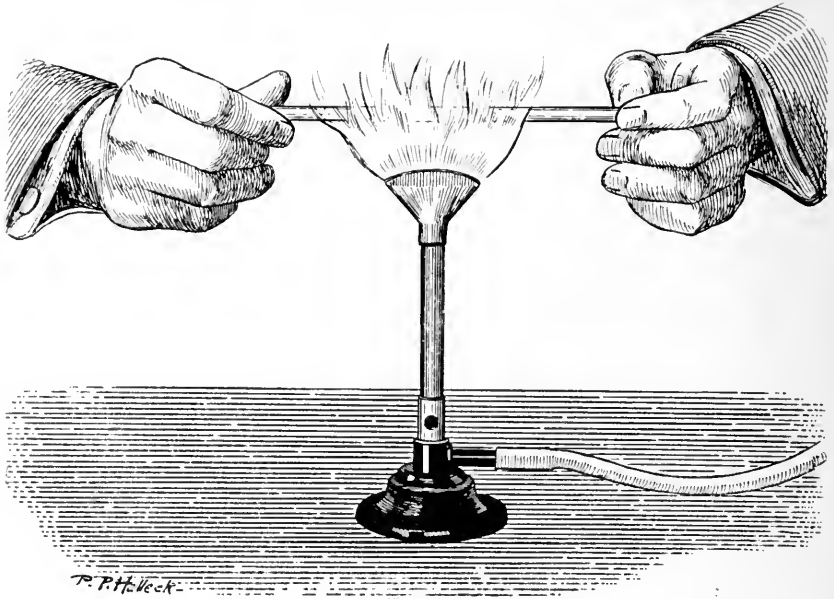

Fig. 381.—Heating a tube before bending. The tube is constantly turned in the fingers.

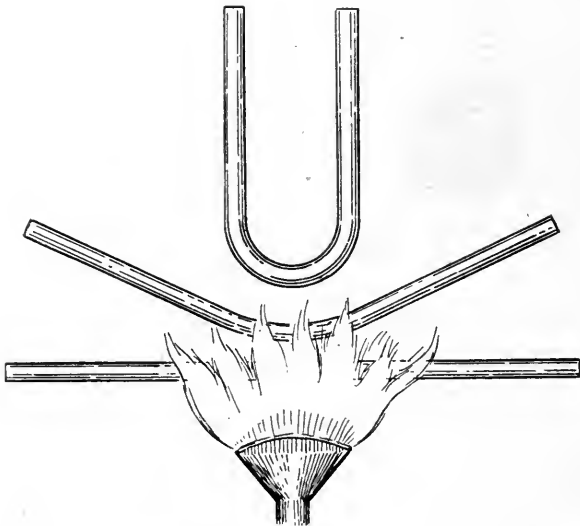

Fig. 382.—When the tube is sufficiently soft it is bent upward to the desired angle.

A special form of emery wheel or a file may be used to slant the end of the cannula before the point is rounded. The danger here is that the points may be heated too hot and become sealed off. The outer edge of a very small yellow flame is employed for this work. Each cannula as a whole is then cut off from the main length of the glass tube by scratching a ring around the tube with a file and snapping the cannula off at the ring. The rough ends thus formed are rounded by heating gently in the flame and the cannula is made. It should be cooled slowly.

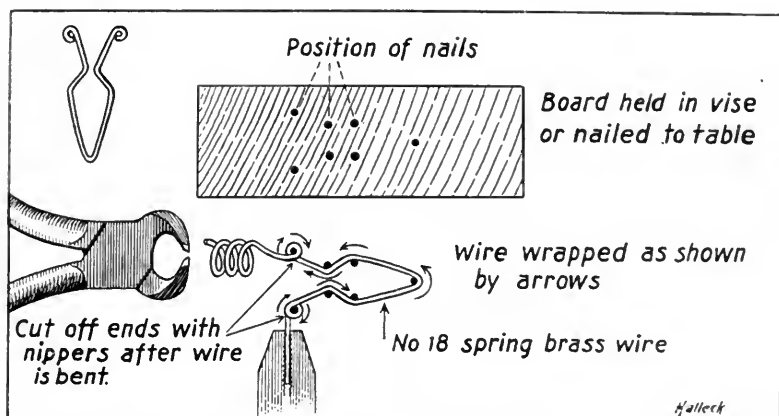

Fig. 383.—Process for making frog clips.

For the purpose of bending, glass tubes should be heated in the flame from a fish tail burner (the tube is constantly rotated) as shown in Fig. 381. As the glass softens over a sufficient length of the tube the two ends of the tube are bent upward and brought to the proper angle as shown in Fig. 382. This is the method used for bending manometer tubes, etc. The danger usually is that not a long enough length of the tube may be heated before the bend is attempted. The bent tube should be cooled very slowly to avoid cracking.

Frog Clips.—These can be made cheaply and easily by the method shown in Fig. 383. The seven small nails driven

into the end of a small board should have their heads filed off so the bent wire clip can be easily removed.

Brass Arterial Cannulas.—Fig. 384 shows the method used for making small brass arterial cannulas. A round brass rod of suitable size is held in the lathe chuck and turned down to the right size and shape. After the outside of the cannula is entirely finished then a very small drill is passed through the cannula (from the small end). The cannula can then be cut off to the proper length and again placed in the chuck in a reversed direction when a larger drill can be run down the large end of the cannula to near the shoulder. By this means exceedingly strong and

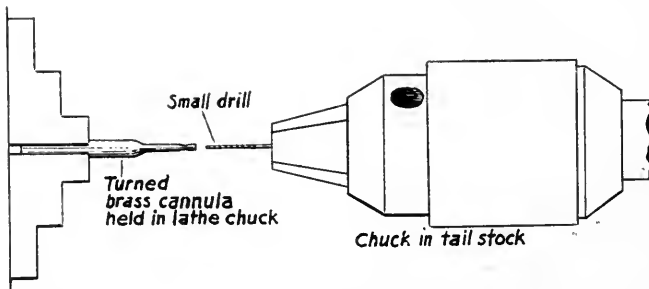

Fig. 384.—Method for making very small brass cannulas. (For discussion see text.)

small pointed cannulas can be made. They are much more durable than similar glass ones but hardly so satisfactory for most purposes. Many sizes can, however, be made and since these metal cannulas can be soldered into brass tubes in pairs or in any other desired fashion they often can be used for a variety of purposes, and also in laboratories where similar glass cannulas are wholly unobtainable.

Stands and Castings.—Fig. 385, which shows a stand with a right-angled base, may be taken as typical of a large number of articles which may be secured cheaply and easily in the laboratory. This stand (which is exceedingly satisfactory in practice) was obtained by first making a wooden pattern of the form and dimensions indicated in the illustration. This pattern was then sent to a foundry where

several dozen of the bases were cast of iron (at a cost varying between four cents and ten cents per pound). The three holes in the top of the base were then bored and threads were cut in the holes so that the rod could be screwed into either hole as desired. The rods were made of galvanized iron pump rod $7/16$ inch in diameter. All of the metal work can be done at the average foundry, and much more cheaply than such stands can be obtained by

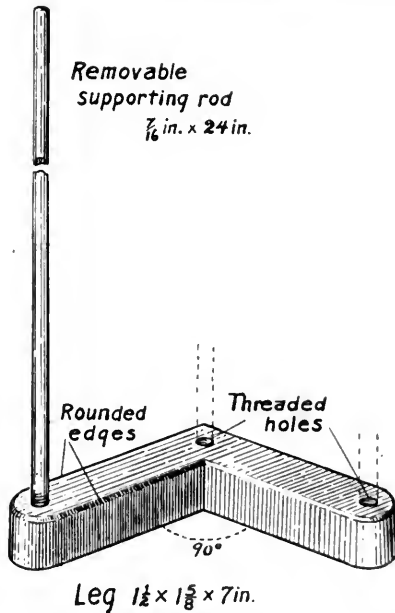

Fig. 385.—Large stand with L-shaped base. The supporting rod can be screwed into either hole. (For discussion see text.)

purchase in the open market. It is cheaper (and often quite satisfactory) to have only one hole bored in the base (the right hand hole as seen in the picture) but to let this hole be bored entirely through the base. The rod is then driven into this hole and riveted from the bottom.

In many places castings made of brass or bronze are obtainable and are often of especial value because it is possible to easily solder other pieces to the castings. For research purposes this is often a very valuable possibility.

Lacquering.—It often happens that one wishes to preserve the appearance of a new piece of apparatus and to prevent oxidation of the metal. For *brass articles* this can often be readily done by lacquering. A good coat of lacquer is often more satisfactory than nickel plating for the nickel is very liable to corrode in the atmosphere of a laboratory.

Lacquering can only be done satisfactorily after the metal has been well burnished and polished. This is done by means of cloth (or felt) buffing wheels (costing about 25 to 50 cents apiece), which are turned at a high speed (2000 or more revolutions per minute) while the metal articles are held against the rotating edge of the wheel. The buffing wheels can usually be placed on the same head as that used to turn the (power) emery wheel. Or the buffing wheel may be placed on an arbor which can be held in the chuck of a lathe and turned at the highest speed obtainable with the lathe. For the first or coarse buffing a substance called tripoli (which resembles a bar of soap into which a large amount of powdered pumice stone had been mixed while the soap was melted) is rubbed on the buffing wheel. The metal instrument is then brought against the wheel and is quickly rubbed smooth, and file scratches, etc., may be completely removed by grinding off the outer layers of the metal. The finer polishing is then finished on a second (cloth) wheel to which a substance called rouge (resembling a very fine, dry, reddish bar of soap containing a still finer powder of pumice stone) is applied. This wheel gives the brass a very high degree of polish and the instrument should be wiped off with a clean, dry towel after this buffing is completed.

The best lacquer the author has used was obtained from the Kahlbaum chemical works and was called *metall furniss (Hoch gold)*. This lacquer should be diluted several times with *pure ethyl alcohol*. A very thin solution is thus obtained and should be applied *very quickly* with a wide, flat camel's hair brush. Small articles can best be dipped into the solution. Drying should occur very rapidly and it is usually not possible to overlap two separate coatings of the

lacquer without getting a very bad looking patch where the two coats came together. This is avoided by coating the whole article quickly and completely at the first application.

From this brief discussion the value of shop facilities, especially to laboratories whose equipment is small, may be readily appreciated. A further very important reason for the existence of a shop in each laboratory is the stimulus which it will serve to offer to the members of the staff to carry out new experiments, and to investigate new problems which new apparatus and new facilities made available by the shop will create.

CHAPTER II.

PHOTOGRAPHY.

In all pharmacological laboratories (*especially if any original work is being done*) circumstances often arise in which it may be desirable to do some one or more forms of photographic work. In all laboratories where the expense can be afforded the author recommends that a dark room and a good photographic outfit be provided.

The present chapter is intended only to very briefly discuss a few of the more fundamental processes which may be of the widest applicability in the laboratory. These processes involve particularly the routine production of negatives and prints, developing, fixing, printing, etc., the making of blue-prints, lantern slides, copying, etc. A full description of the theory and finer details of photographic work is not attempted here since those who will most care to make use of the suggestions offered in this chapter will already have had more or less experience in photographic work, especially in the making of ordinary photographs with a hand camera, etc.

For several years the author has used in the laboratory an ordinary view camera (8x10 size). The lens used with the camera is a Bausch and Lomb, protar VII A, size 5x7. Either the front or the back half of the lens can be used separately and will then cover a somewhat larger area on the plate. This outfit has been very satisfactory for laboratory purposes, especially for copying and lantern slide making. There are many forms of lenses and cameras on the market, the majority of which are not suited for laboratory purposes. It is best to buy these articles only from well established and reliable firms which will supply outfits properly adapted for doing exactly the work which the

director of the laboratory describes. This will involve particularly a lens which is capable of being used to photograph objects at very close range, e.g., at a distance of 12, 10, or even 6 inches. This is required in copying such objects as

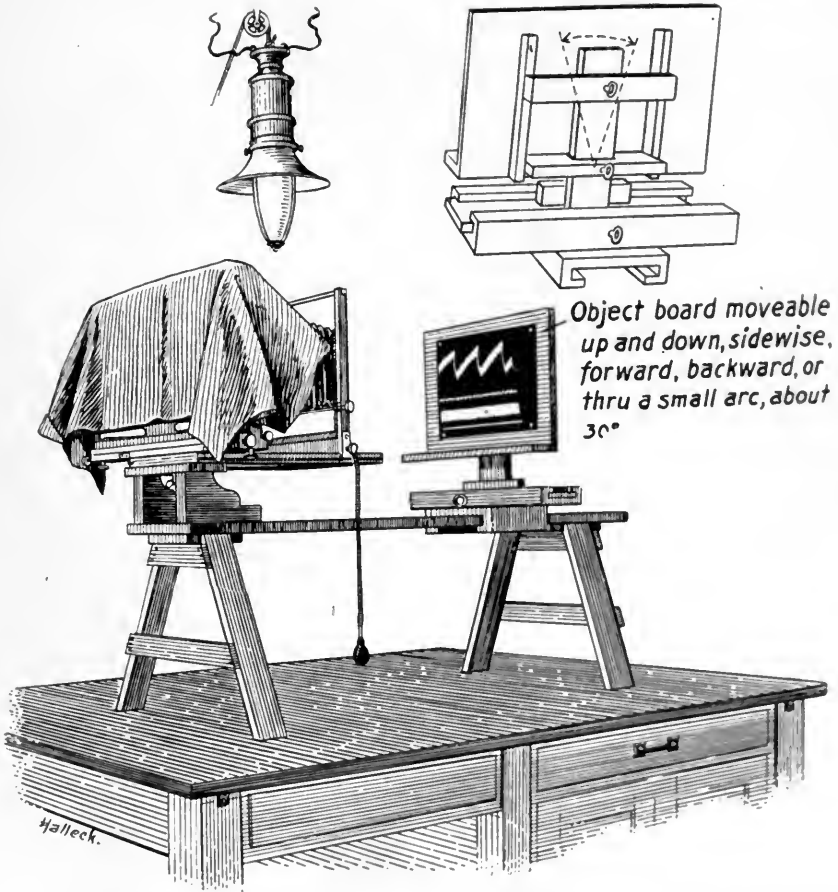

Fig. 386.—Method of arranging the camera and arc light for copying. The pulley supporting the arc light should be attached to the ceiling. (Second hand arc lamps can often be bought of the Gregory Electric Company, Chicago, Ill.)

printed pages (which is often of great service when one wishes to keep an exact record of an article in a borrowed journal, etc.) and for making lantern slides of pictures, tables, charts, tracings, etc., from books or kymographic

records. A cheap lens or one usually supplied with an ordinary view camera will not do this work.

The average time required for an exposure of a plate in the light of the laboratory (from 9 A. M. to about 2 or 3 P. M.) will be about twenty to twenty-five seconds. The plate is

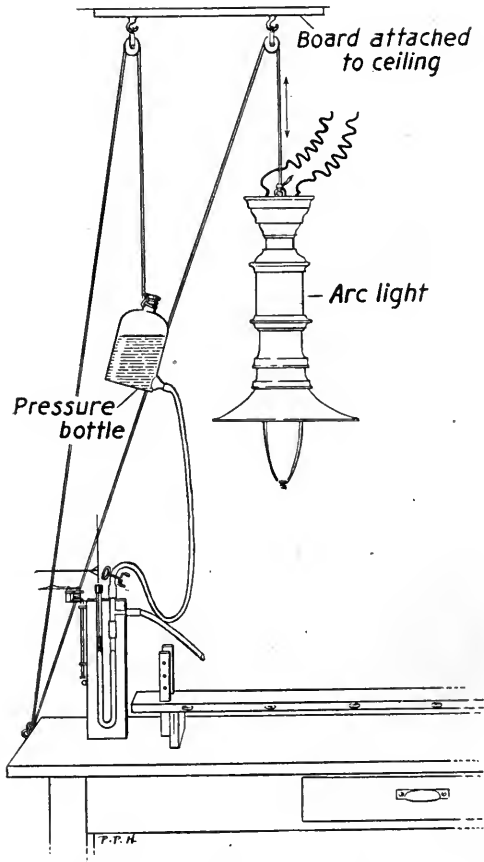

Fig. 387.—Method of suspending an adjustable arc light above the operating table. The lamp should be 2 or 3 feet above the field of operation.

then taken into the dark room and developed. For lantern slides the negatives should be thoroughly developed and should be considerably darker than is required for making ordinary paper prints. If only a small amount of work

is to be done it is better to buy developer already put up in tubes or packages, one of which is dissolved in the proper amount of distilled water just at the time it is needed. And this procedure is perhaps always advisable if sufficient funds are available. It is, however, somewhat cheaper to make up stock solutions of developer to be kept on hand. As stock developing solutions the Hammer Dry Plate Company recommends the following:

Pyro Developer.

Solution No. 1:

Pure water	16 oz.
Sodium sulphite, anhydrous	2½ oz.

Solution No. 2:

Pure water	16 oz.
Sodium carbonate, C.P.	1¼ oz.

Solution No. 3:

Pure water	24 oz.
Oxalic acid	15 grains
Pyro	1 oz.

To develop use:

Pure water (winter)	6 oz.
Pure water (summer)	8 oz.
No. 1	½ oz.
No. 2	½ oz.
No. 3	½ oz.

Use pure water, distilled, rain water filtered or river water boiled and filtered, in mixing the solutions. Keep the solutions in tightly stoppered bottles. In using crystals use twice the weight given. If negatives are too strong use more water, if too weak or thin use less water. If the negatives have too much of a straw color use more of No. 1, but if the negatives have too blue a cast use less of No. 1. All chemicals should be thoroughly dissolved while mixing them. The anhydrous sulphite and carbonate of sodium are much to be preferred. Wash the plates well before placing them in the fixing bath.



Fig. 388.—Measuring glass, graduated in ounces.

Metol Hydrochinon Developer.

Solution No. 1:

Pure water	80 oz.
Metol	$\frac{1}{2}$ oz.
Hydrochinon	$\frac{1}{4}$ oz.
Sodium sulphite, anhydrous	3 oz.

Solution No. 2:

Pure water	80 oz.
Sodium carbonate, C.P.	$2\frac{1}{2}$ oz.

To develop use:

Pure water	2 oz.
No. 1	1 oz.
No. 2	1 oz.

The metol must be thoroughly dissolved, then add the hydrochinon and sulphite.

The plain fixing bath is made as follows:

Pure water	16 oz.
Sodium hyposulphite	4 oz.

Negatives should be left in this bath some little time after the whiteness disappears. This bath must not be used after it is discolored.

After fixing the negatives should be thoroughly washed and then placed in a rack to dry.

A negative or lantern slide that is too dark may sometimes be reduced (made lighter) by placing it for a little while in the following solution:

Solution No. 1:

Potassium ferricyanide	1 oz.
Water	16 oz.

Solution No. 2:

Sodium hyposulphite	1 oz.
Water	16 oz.

Dissolve the ferricyanide in a dark bottle (or wrap the bottle in opaque paper) as it is affected by the light. Reduction should be carried out in subdued light, never by a strong daylight. Take a sufficient quantity of No. 2 to cover the negative in a tray and add a small quantity of No. 1, then immerse the negative. Remove several times during the operation and wash off the chemicals to avoid staining. Wash thoroughly after the desired reduction has been obtained.

Lantern slides if made from negatives are printed in a printing frame in the same manner as that in which a print is made. The slide is then developed in the same way as a negative is developed and in the same developing solution.

It is to be noted that lantern slide plates are $3\frac{3}{4} \times 4$ inches in dimensions, i. e., a quarter of an inch shorter than the corresponding standard dry plate which is $3\frac{1}{4} \times 4\frac{1}{4}$ inches. This size of plate is used to make the negatives from which the lantern slides are printed.

It often happens that in the laboratory lantern slides can be made up directly from the objects themselves without the labor and expense of making negatives. This is especially true for slides of black tracings such as are made in pharmacological experiments. The method is as follows: Kits will generally have to be used to step the size of the plate holder down to $3\frac{1}{4} \times 4\frac{1}{4}$ inches. A narrow strip of wood (about the size of a tooth-pick) is glued into the inner edge

of each end of the kit. This will reduce the size of the kit opening to approximately $3\frac{1}{4} \times 4$ inches. The regular lantern slide plate is placed in this opening and the kymograph record is photographed directly onto the lantern slide. Developing is carried out exactly as with a negative but the image usually shows up very quickly and over-development should be carefully avoided as this gives dark areas over part or all of the slide. The slide is developed, fixed, washed and dried and is then ready for the mat, cover and binding strips.

It is of particular importance to note that lantern slides of black kymograph tracings should be made *before the tracing is varnished*. In this condition an absolutely dull, jet black background is presented in which the record shows as perfectly clear white lines. This kind of an object is most favorable for photographing. The paper on which the records are made should always be smoked good and black. From small kymographs the records may conveniently be removed and pinned to a copying stand as shown in Fig. 386. The most convenient form of light for this purpose is an electric arc light which can be raised or lowered to suit the height of the table, etc. The light should hang just over the front part of the camera. Two arc lights (one on each side) or mercury vapor lamps possess certain advantages over the arrangement illustrated but are considerably more expensive.

Records on large kymographs may readily be photographed on to lantern slide plates while the paper remains on the drum. The camera is placed on a tripod and focused on the record which may be lighted either by an adjustable arc light or by daylight. The image on the lantern slide should be made well within the limits of the plate, a margin of $\frac{1}{4}$ to $\frac{1}{2}$ inch being left around the border of the plate for the mat. Note that lantern slides are always used in the lantern with the long dimensions of the slide placed hori-

zontally. Therefore the image must stand erect *across* the plate.

Various forms of mats are sold for lantern slides. These are thin black paper sheets made the size of the slide on the outside but have openings (round, oval, oblong, etc.) of different sizes cut out of the center. In the completed slide the picture is seen through the opening and the border of

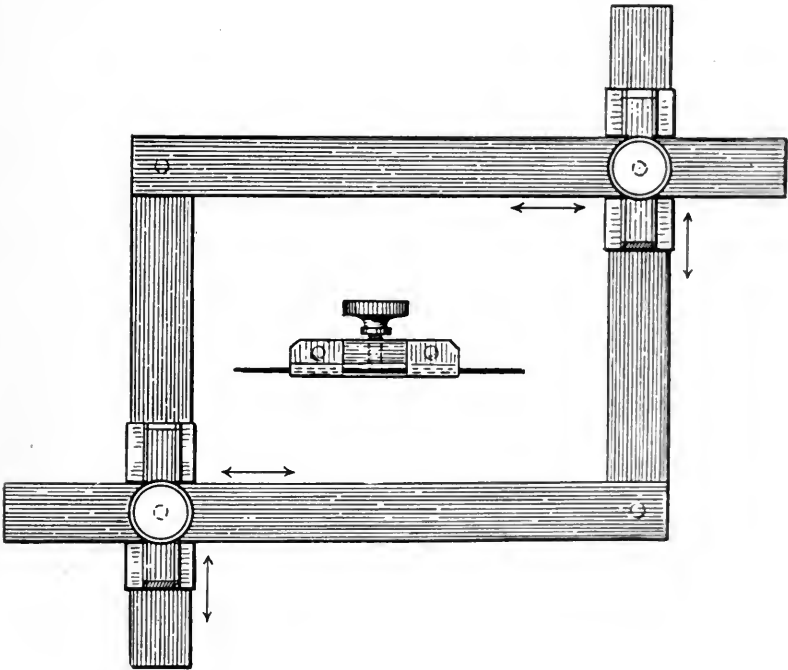

Fig. 389.—Adjustable frame for cutting lantern slide mats. About two-thirds natural size.

the image on the screen is of the same shape as the opening in the mat. It is often convenient and more satisfactory to make these mats by use of a small adjustable frame (Fig. 389) which is laid down over the slide and adjusted to the size and shape of the image desired for presentation on the screen. The frame is then set (by thumbscrews) and placed over a sheet of (black) paper (wrapping paper is sufficient). With a penknife the opening is cut out of the paper. The

slide is now adjusted over the opening in the paper and the outer edges of the paper are trimmed to fit the slide. The mat is now placed on the film side of the slide and a clear glass *cover* is laid over the mat. A *paper* binding strip is cut into four pieces to fit the edges of the slide and are moistened and stuck around the slide in such a manner as to bind the two plates of glass firmly together with the mat between them. After drying of the binding strips the slide is ready for the lantern.

A dilute aqueous solution of eosin may be used to stain a slide a red or pinkish color. An aqueous solution of uranine is used to stain slides yellow. In each case the staining is done just after the slide has been finished (i. e., when thoroughly washed just after being taken out of the fixing bath). If the slide has already dried it must be wet again before it is placed in the staining solution.

Pictures in books, tables printed in journals, ordinary photographs of dissections or the performance of experiments, etc., may often be used to great advantage for teaching purposes if photographed and presented in the form of lantern slides. For copying of this kind an adjustable stand of which many forms have been devised (Fig. 386) is needed.

Ordinary prints are generally best made on developing papers of which several varieties are on the market. It is preferable to buy the prepared tubes of developer (for each kind of paper) for this purpose, but it may be cheaper to use a stock developer. The following is recommended for "Cyko" paper:

Developer.

	<i>Avoirdupois</i>	<i>Metric</i>
Pure water	40 oz.	1000 c.c.
Metol	15 grains	1 gram
Sodium sulphite (dried powder)	1 oz.	28 grams
Hydrochinon	60 grains	4 grams
Sodium carbonate (dried powder)	$\frac{3}{4}$ oz.	21 grams
Potassium bromide (10% solution)	40 drops	40 drops

Dissolve the chemicals in the order named. While the above amount of bromide is usually sufficient, it may at times be found that in order to produce clear whites, more bromide must be added by using a few drops of the following solution:

10% Bromide Solution.

	<i>Avoirdupois</i>	<i>Metric</i>
Potassium bromide	1 oz.	50 grams
Water	9 oz.	450 c.c.

Developing is carried out as follows:—Put sufficient developer in the tray to cover the prints quickly. Immerse the print face up by placing one edge under the solution and giving it a quick push so as to instantly cover the surface. Remove any air bells with a tuft of cotton. Allow the print to remain until the image has reached the desired depth. The developing and fixing must be conducted in an orange or yellow light or very weak lamp light. If too strong a light is used the whites will fog.

After developing, the prints should be quickly put in the fixing bath. A simple solution of sodium hyposulphite in water (1 oz. to 4 oz.) may be used for fixing prints for temporary uses but for more satisfactory work an acid fixing bath made up as follows is advised:

Fixing Bath.

	<i>Avoirdupois</i>	<i>Metric</i>
Water	64 oz.	2000 c.c.
Hyposulphite of soda	16 oz.	500 grams

Dissolve and then add the following acid hardener:

	<i>Avoirdupois</i>	<i>Metric</i>
Water	5 oz.	150 c.c.
Hyposulphite of soda (dried powder)	½ oz.	15 grams
Acetic acid	3 oz.	90 c.c.
Alum (powdered)	½ oz.	15 grams

This fixing bath is also recommended for plates and films. It will keep indefinitely and therefore may be made up some time in advance. One pint of the bath should fix at least fifty 4x5 prints. The acid fixing bath can be used

repeatedly. It will by degrees become alkaline by the gradual addition of developer adhering to the prints. It should be discarded entirely when it becomes frothy, and a fresh bath prepared.

In fixing, the prints should be placed in the bath face downward. They should be kept well separated and in motion for a few seconds until the solution is evenly distributed over them. From 15 to 20 minutes should be a sufficient length of time to insure proper fixing. The prints should then be thoroughly washed in water and dried. This may be done by spreading them out face upward on a large sheet of paper in a quiet place where dust, etc., cannot fall on them.

After the prints are thoroughly dried they may be trimmed to the desired size and mounted by applying mounting paste to the back of the print with a brush, after which the print is placed in position on a card mount and rolled down smoothly with a squeegee roller.

Blue Prints.—One of the simplest of all photographic processes is the making of blue prints, which require only to be printed and then washed thoroughly in water. Blue print paper is sensitized by the application to the paper of a solution of ferric ammoniocitrate and ferricyanide of potassium. The process may be carried out as follows:

	<i>Solution A</i>	
Ferric ammonium citrate		1 $\frac{7}{8}$ oz.
Water		8 oz.
	<i>Solution B</i>	
Potassium ferricyanide		1 $\frac{1}{4}$ oz.
Water		8 oz.

To make the sensitizing bath, take equal parts of each solution in a tray or flat dish a little larger than the paper you wish to sensitize. Float the paper on this bath for two or three minutes, being very careful to avoid any air bubbles that may prevent the solution from reaching the paper. Hang up the paper to dry. This whole process of sensitizing

and drying (and preserving) the paper should be carried out in the dark room by the ruby light. The paper should not dry too slowly.

The two stock solutions will keep indefinitely, but should be mixed only immediately before use as they soon spoil after mixing.

Any fine grained white paper may thus be sensitized. For all routine work in the laboratory, however, it is advisable to buy ready prepared blue-print paper. This should be of the finest quality as the success or failure of the whole work depends on the quality of the paper. It can be bought in rolls about 30 to 36 inches in width and of practically any desired length (from F. Weber & Co., Philadelphia,

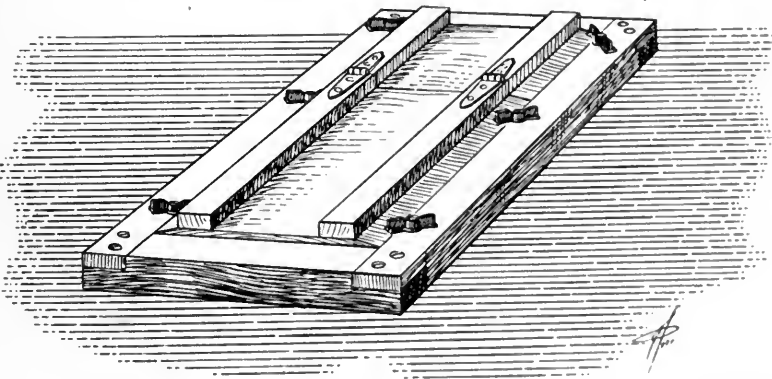

Fig. 390.—Frame for making blue prints. This frame is 18 inches long by 8 inches wide. It is often advisable to use considerably larger frames if many blue prints are to be made.

St. Louis, and Baltimore). It should be thoroughly protected from the light and should be fresh when used. The paper bought should be a *light weight variety* suitable for *printing in sunlight*.

The most important use for blue-print paper in the laboratory is for the making of multiple copies of the kymograph records obtained by students. For this work a large printing frame (several of these should be provided) as shown in Fig. 390 is used. These frames are about 8

inches wide by 18 inches long. They are made exactly like the ordinary photographic printing frames and a glass plate is placed in the front of the frame. Against this plate the varnished black tracing (which should have been smoked thoroughly black) is placed (facing outward). Over the tracing a suitable sized piece of blue print paper is placed (this is done in the dark room) facing outward, i. e., the blue side of the paper rests against the back of the tracing. The back is clamped into the frame and the bright sunlight is allowed to shine through the glass for a period varying from five to fifteen minutes depending on the quality of the blue-print paper, the character of the black tracing and the brightness of the sun. With a very bright sunlight and first class printing paper the exposure should not exceed ten minutes on the average (and may often not require over five minutes). But much blue-print paper on the market is not this sensitive. Poor paper should be scrupulously avoided. Only experience can serve as a very reliable guide to one in determining when an exposure has been carried far enough. The statement is made that, for ordinary photographic negatives, the printing should be carried on until the shadows, that is, the darkest parts of the picture, assume a bronzed appearance. In printing kymographic records the printing should be carried on until the print looks considerably darker than one would at first suspect to be necessary, for the washing removes some of the coloring material.

As soon as the printing has gone far enough the paper is taken out and washed thoroughly in clear water. The print is then hung up to dry after which it can be properly trimmed and pasted in the note book.

It is strongly advisable for some one who is employed by the laboratory (technician, etc.) to make up all blue-prints required by the students. These prints can be sold to the students for about one-half or one cent apiece (which practically covers the cost of the paper), and the proceeds of the sale should go to the person who makes the prints. In most

schools the students will not have sufficient time to make up their own blue-prints. Much time may be saved in printing if very large frames (two feet square or larger) are used since the whole frame can be filled and printed at one time. The instructor should see that blue-prints are made only from typical and satisfactory records, and each print should be made as small as possible to include the required portion of the record. Copies of kymographic records may also be printed on regular photographic printing paper and developed and fixed in the usual manner. This is more expensive but is often available for special work.

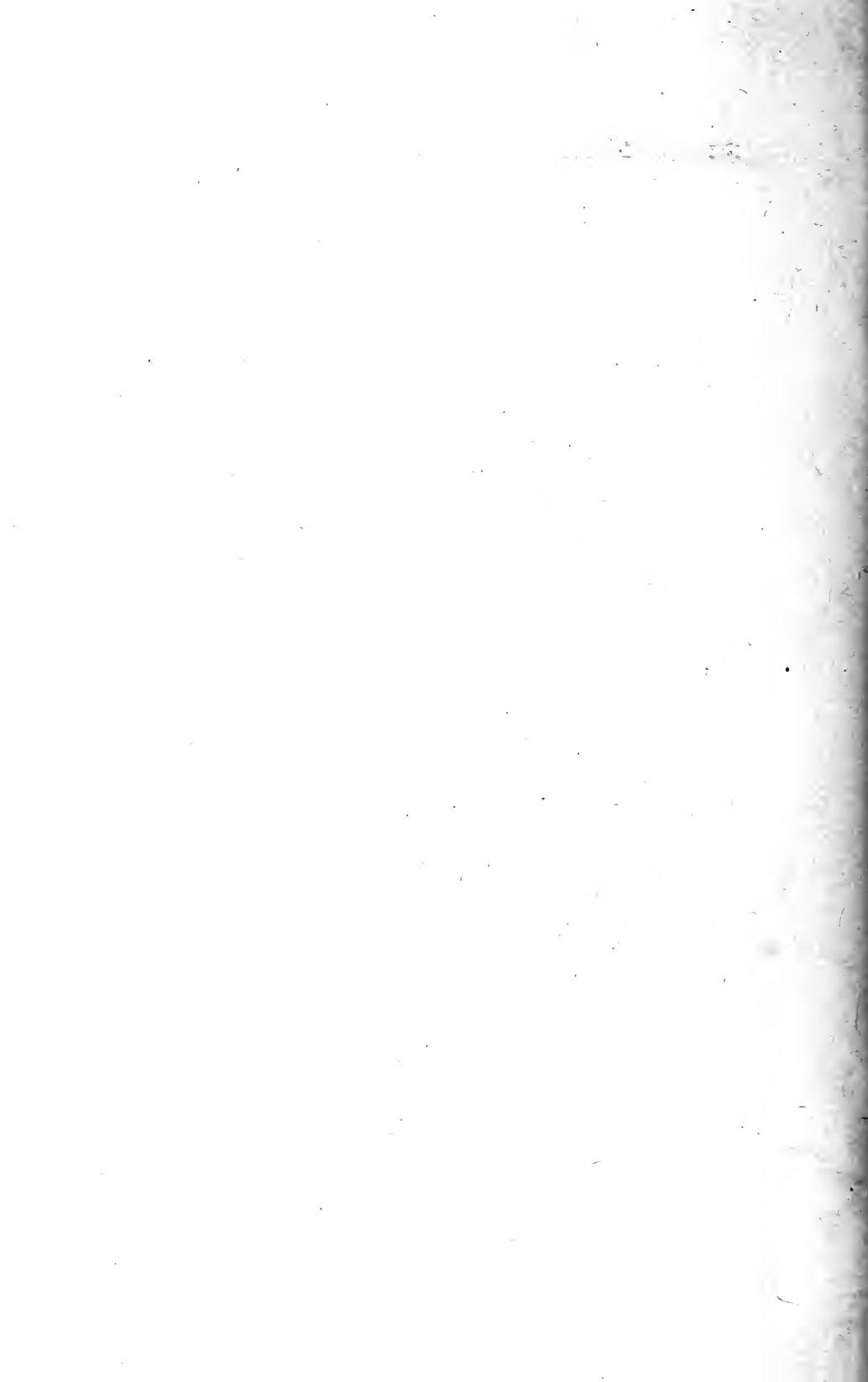

A LIST OF DEALERS IN APPARATUS, TOOLS, SUPPLIES, EQUIPMENT, ETC.

The following list of dealers in apparatus, tools, supplies, equipment, etc., is by no means complete, but is merely offered for the benefit of those who may not know the sources from which certain desired articles can be obtained. In all large cities laboratory workers will be familiar with local firms from which a considerable proportion of the usual laboratory supplies, etc., may be obtained. But special articles (and these are often needed) may be difficult to secure. It is hoped that the appended list may be of some aid in this direction.

- Armstrong Bros. Tool Co.*, Chicago, Ill.
(Tool holders and metal cutting tools.)
- American X-Ray Equipment Co.*, 401-405 East 33rd St., New York City, N. Y.
(X-ray apparatus, etc.)
- The Anglers Co.*, 913 West Randolph St., Chicago, Ill.
(Biological supplies, *frogs*, etc.)
- AnSCO Company*, Binghamton, N. Y.
(Photographic supplies.)
- Armour & Company*, Chicago, Ill.
(Pituitary extract.)
- Baird & Tatlock, Ltd.*, 14 Cross St., Hatton Garden, London, E. C.
(Physiological apparatus.)
- Brown & Sharpe Mfg. Co.*, Providence, R. I.
(Small hand tools and machining supplies.)
- Buffalo Dental Mfg. Co.*, Buffalo, N. Y.
(Laboratory and workshop appliances, blast lamps, etc.)
- Benedict & Burnham Mfg. Co.*, Waterbury, Conn.
(Seamless nickel tubing.)
- Chas. H. Besley Co.*, 118-124 N. Clinton St., Chicago, Ill.
(Brass, copper, gears, tools, machine supplies, etc.)
- J. T. Baker Chemical Co.*, Phillipsburg, N. J.
(Chemicals.)
- James G. Biddle*, 1211-13 Arch St., Philadelphia, Pa.
(Electrical instruments and laboratory supplies.)
- Burroughs, Wellcome & Co.*, 35-39 West 33rd St., New York City, N. Y.
(Drugs and physicians' supplies.)

- Boston Gear Works*, Norfolk Downs, Mass.
(Gears, racks, clutches, roller chains, etc.)
- Bausch & Lomb Optical Co.*, Rochester, N. Y.
(Optical goods, balopticons, lenses, microscopes, and supplies.)
- J. G. Blount*, Everett, Mass.
(Grinding and polishing machinery, speed lathes, etc.)
- Becton-Dickinson & Co.*, Rutherford, N. J.
(Clinical thermometers.)
- Bishop Gutta-Percha Co.*, 420 East 25th St., New York City, N. Y.
(Sheet gutta-percha.)
- W. J. Boehm*, West Randolph St., Chicago, Ill.
(Blows glass arterial cannulas.)
- Burke & James, Inc.*, 240 E. Ontario St., Chicago, Ill., and 225 Fifth Ave.,
New York City, N. Y.
(Photographic supplies, etc.)
- Crane Co.*, Chicago, Ill., and St. Louis, Mo.
(Steam fittings, gas fittings, and plumbers' supplies.)
- S. W. Card Mfg. Co.*, Mansfield, Mass.
(Taps, dies, screw plates, etc.)
- Crowell Mfg. Co.*, 296-298 Taaffe Place, Brooklyn, N. Y.
(Air compressors, vacuum pumps, and pressure blowers.)
- Central Scientific Co.*, 345-359 West Michigan St., Chicago, Ill.
(Biological apparatus and supplies.)
- Commercial Electrical Supply Co.*, 15th and Pine Sts., St. Louis, Mo.
(Electrical supplies.)
- Canedy-Otto Mfg. Co.*, Chicago Heights, Ill.
(Forges, blowers, punches, shears, drills, etc.)
- Cooper Hewitt Electric Co.*, 8th and Grand Sts., Hoboken, N. J.
(Electric lamps.)
- Cramer Dry Plate Co.*, Shenandoah and Lemp Aves., St. Louis, Mo.
(Photographic dry plates.)
- Edward P. Dolbey & Co.*, 3613 Woodland Ave., Philadelphia, Pa.
(Chemicals and laboratory apparatus.)
- Defender Photo Supply Co.*, Argo Park, Rochester, N. Y.
(Photographic dry plates, paper, etc.)
- Detroit Copper & Brass Rolling Mills*, Detroit, Mich.
(Copper or brass sheeting, tubing, rod and wire.)
- Detroit Dental Mfg. Co.*, Detroit, Mich.
(Impression compound and dental supplies.)
- Day Rubber Co.*, 415-417 North 4th St., St. Louis, Mo.
(Rubber supplies.)
- Louis Dejonge & Co.*, P. O. Box 553, New York City, N. Y.
(White coated paper.)
- Eimer & Amend*, 205-211 Third Ave., New York City, N. Y.
(Laboratory apparatus, chemicals and drugs, importers.)
- Eberbach & Son Co.*, Ann Arbor, Mich.
(Laboratory supplies, special pharmacological apparatus.)

- Farbwerke-Hoechst Company*, New York City, N. Y.
(Special drugs, novocaine, salvarsan, pyramidon, etc.)
- Ft. Wayne Electric Co.*, Ft. Wayne, Indiana.
(Motors and electrical supplies.)
- G. Gennert*, New York, Chicago, Los Angeles, and San Francisco.
(Photographic supplies, etc.)
- Gregory Electric Co.*, 16th and Lincoln Sts., Chicago, Ill.
(Second hand motors and electric supplies of all kinds.)
- Goodyear Rubber Co.*, 411 North 4th St., St. Louis, Mo.
(Rubber supplies.)
- Hoffmann-LaRoche Chemical Works*, New York City, N. Y.
(Opium alkaloids, pantopon, etc.)
- Hammer Dry Plate Co.*, Ohio Ave. and Miami St., St. Louis, Mo.
(Photographic dry plates.)
- Hettinger Bros. Mfg. Co.*, Kansas City, St. Louis, Mo., or Oklahoma City, Oklahoma.
(Dental wax and dental supplies.)
- Harvard Apparatus Co.*, Back Bay Post Office, Boston, Mass.
(Physiological laboratory apparatus.)
- Henry Heil Chemical Co.*, 210-214 S. Fourth St., St. Louis, Mo.
(Laboratory apparatus, chemicals and supplies, importers.)
- F. A. Hardy & Co.*, Chicago, Ill.
(Optical goods.)
- International Equipment Co.*, 352 Western Ave. (Brighton), Boston, Mass.
(Centrifuges and mechanical apparatus.)
- Kny-Schcerer Co.*, 404-410 West 27th St., New York City, N. Y.
(General laboratory supplies, chemicals, importers.)
- C. A. F. Kahlbaum*, Berlin, Germany.
(Chemicals.)
- L. E. Knott Apparatus Co.*, Boston, Mass.
(Biological apparatus and supplies.)
- Kimble-Durand Glass Co.*, Chicago, Ill., New York City, and Vineland, N. J.
(Laboratory glassware, glass blowing, cannulas, etc.)
- Kewaunee Mfg. Co.*, Kewaunee, Wis.
(Laboratory furniture and equipments.)
- The Libbey Glass Co.*, Toledo, Ohio.
(Chemical glassware.)
- Lennox Chemical Co.*, 1201-1215 East 55th St., Cleveland, Ohio.
(Oxygen, nitrous oxide and carbon dioxide.)
- E. Leitz & Co.*, 30 East 18th St., New York City, N. Y.
(Microscopes, optical goods, etc.)
- Lenz Apparatus Co., Inc.*, 9-11 East 16th St., New York.
(Chemicals, drugs, stains; chemical, medical, surgical and physical apparatus; glassware.)
- Eli Lilly & Co.*, Indianapolis, Ind.
(Biological and pharmaceutical products.)

- John T. Milliken & Co.*, St. Louis, Mo.
(Pharmaceutical supplies.)
- H. K. Mulford Co.*, Philadelphia, Pa.
(Biological and pharmaceutical supplies.)
- George Murphy, Inc.*, 57 East 9th St., New York City, N. Y.
(Photographic supplies, lantern slide labeling strips, etc.)
- McIntosh Stereopticon Co.*, 460 Atlas Block, Chicago, Ill.
(Stereopticons and optical supplies, lantern slides, etc.)
- V. Mueller & Co.*, 1779 Ogden Ave., Chicago, Ill.
(General surgical supplies.)
- Murray Oxygen Co.*, 449 West 53rd St., New York City, N. Y.; 309 South 5th St., Philadelphia, Pa.; 102 Utica St., Boston, Mass.
(Oxygen and nitrous oxide.)
- E. Maehlett & Son*, 153 East 84th St., New York City, N. Y.
(All kinds of glass blowing.)
- Morse Twist Drill & Machine Co.*, New Bedford, Mass.
(Twist drills, chucks, cutters, dies, taps, and machinists' tools.)
- Mallinckrodt Chemical Works*, 2nd and Mallinckrodt Sts., St. Louis, Mo.
(Chemicals for medicinal, photographic, analytical and technical purposes, ether for anesthesia, etc.)
- Merek & Co.*, 4528 S. Broadway, St. Louis, Mo., and Rahway, N. J.
(Drugs and chemicals.)
- The Miller Rubber Co.*, Akron, Ohio.
(Finger cots.)
- Norton Company*, Worcester, Mass.
(Alundum and crystalon grinding wheels.)
- E. R. Neuenfeldt & Co.*, 225 North Clark St., Chicago, Ill.
(Turtles, frogs, etc.)
- C. F. Palmer*, 6 Upper Tulse Hill, Brixton, London, S. W.
(Brodie's physiological apparatus, etc.)
- Palo Company*, 90-94 Maiden Lane, New York City, N. Y.
(Laboratory supplies and assayers' materials.)
- Pike Mfg. Co.*, Pike, N. H.
(India oil stones.)
- Pennsylvania Flexible Metallic Tubing Co.*, People's Gas Bldg., Chicago, Ill.
(Flexible metal tubing.)
- Powers-Weightman-Rosengarten Co.*, Philadelphia, Pa.; New York City, N. Y., and St. Louis, Mo.
(Chemicals and drugs.)
- Parke, Davis & Co.*, Detroit, Mich. (Branch houses in other cities.)
(Drugs, extracts, tinctures, etc.)
- The Robbins & Myers Co.*, Springfield, Ohio.
(Motors and electrical supplies.)
- A. A. Sphung*, North Judson, Indiana.
(Turtles, frogs, etc.)
- Southern Oxygen Co.*, South Washington, Virginia.
(Oxygen and hydrogen.)

- J. T. Slocomb Co.*, Providence, R. I.
(Machinists' tools.)
- Sears, Roebuck & Co.*, Chicago, Ill.
(Supplies in general.)
- Sharp & Smith*, 92 Wabash Ave., Chicago, Ill.
(Hospital supplies, surgical instruments, etc.)
- E. R. Squibb & Sons, Manufacturing Chemists*, New York City and Brooklyn, N. Y.
(Ether and chemicals.)
- Stanley Rule & Level Co.*, New Britain, Conn.
(Small hand tools.)
- Spencer Lens Co.*, Buffalo, N. Y.
(Microscopes, lenses, and optical goods.)
- The Silver Mfg. Co.*, Salem, Ohio.
(Woodworking and blacksmiths' tools.)
- E. H. Sargent & Co.*, 143-145 Lake St., Chicago, Ill.
(Scientific laboratory apparatus, chemicals, rubber tubing, etc.)
- Standard Scientific Co.*, 147-153 Waverly Place, New York City, N. Y.
(Standard apparatus and chemicals.)
- Scientific Materials Co.*, 713-719 Forbes St., Pittsburgh, Pa.
(Laboratory supplies and chemicals.)
- Seneca Falls Mfg. Co.*, Seneca Falls, N. Y.
(Lathes and attachments.)
- Talbot Dyewood & Chemical Co.*, Billerica, Mass.
(Acids and chemicals.)
- Thau & Nolde*, Frisco Bldg., St. Louis, Mo.
(Dental rubber dam and dental supplies.)
- Arthur H. Thomas Company*, West Washington Square, Philadelphia, Pa.
(Laboratory apparatus and chemicals, importers.)
- Truax, Greene & Co.*, 42-44-46 Wabash Ave., Chicago, Ill.
(Laboratory apparatus, chemicals, surgical supplies, etc.)
- Victor Animatograph Co., Inc.*, Davenport, Iowa.
(Portable stereopticons, sundries, lantern slides, etc.)
- Victor Electric Corporation*, Jackson and Robey Sts., Chicago, Ill.
(Laboratory electric equipments, X-ray machines, etc.)
- F. Weber & Co.*, Philadelphia, St. Louis, and Baltimore.
(Draughtsmen's and engineers' supplies, artists' materials, blue print paper.)
- Wilmot Castle Co.*, Rochester, N. Y.
(Bacteriological apparatus, etc.)

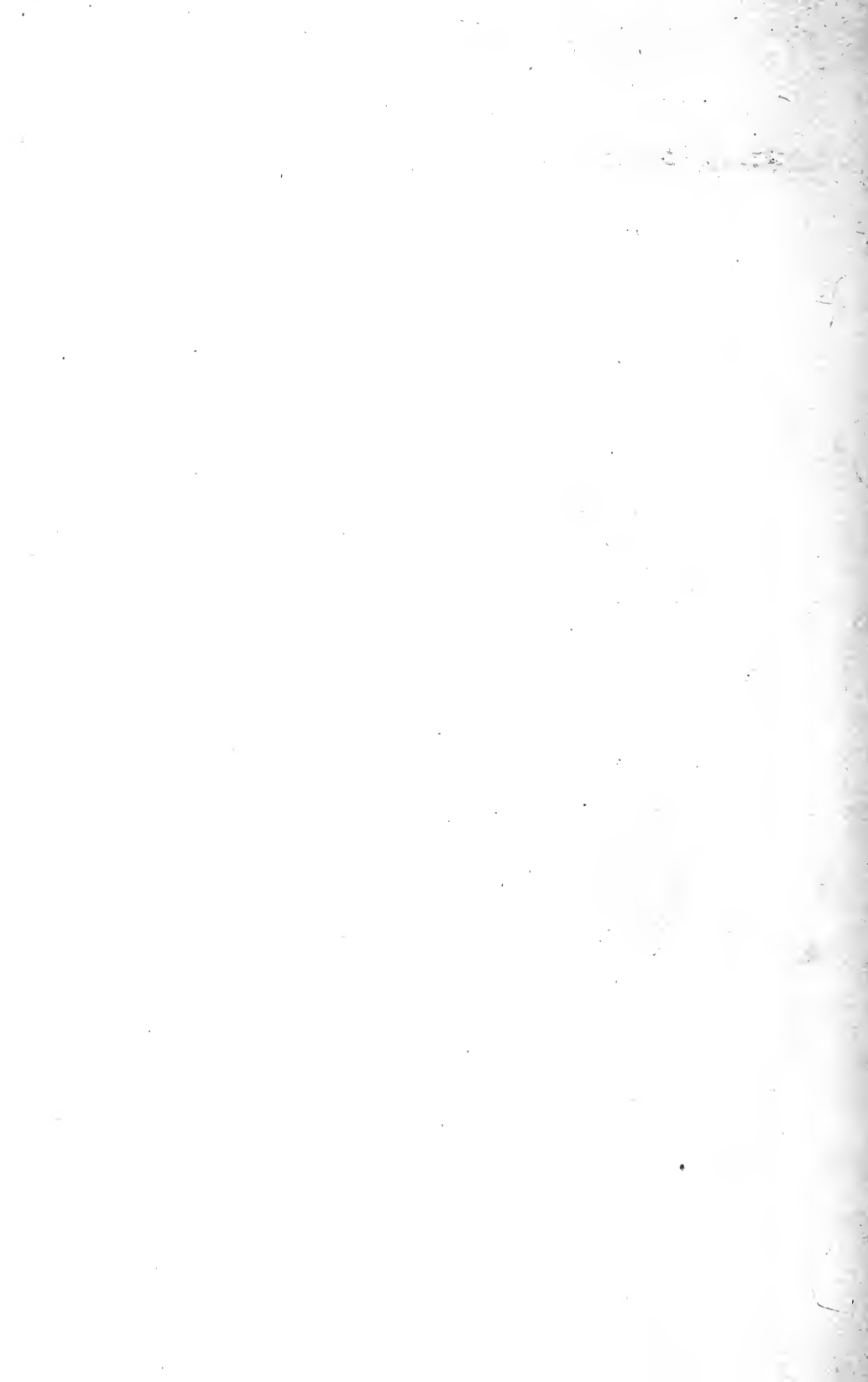

GENERAL INDEX

A

- Abdominal viscera, dog, dissection to show, 167
- Absorption, of ether, 124
through skin in frog, 118
- Acetanilide, action on fever, 451
- Acetylsalicylic acid, action on fever, 451
- Acid, acetylsalicylic, 451
action in migraine, 451
and alkali, 466
carbolic, antidote for, 454, 456
general action on dog, 454
general action on frog, 454
hydrocyanic, 441
soldering, 483
- Acids, action of, on frog's blood-vessels, 458
- Aconitine, 392
action on blood-pressure, respiration, and temperature, 429
on frog's heart, 429
on heart and blood-pressure, 431, 432
on turtle's heart, 429
general action of, on frog, 428
local action, 433
- Adjustable tambour, 40, 483
- Administration of tablets to dog, 205
- Adrenal glands, action of pilocarpine on, 278
- Adrenaline, action on bladder and intestine, 278, 280, 281, 282
on blood-pressure after ergotoxine, 378
on bronchioles, 387
on bronchioles, after ergotoxine, 378, 379
on dog's heart, 156
on frog's blood-vessels, 458
on intestinal segment, 334
on liver, 417
on lymph flow, 384
on perfused kidney, 342
on pulmonary blood-pressure, 310-318, 369, 372
action rate of oxygen consumption, 192
glycosuria, 457
- Adrenaline—Cont'd.
in reviving heart, 113
synthetic, 96
- Agurine, 253
- Air embolism, 226
- Air pumps, 473, 474, 475, 476, 477
- Alcohol, action on blood-pressure and respiration, 136, 142
on frog, 133
on turtle's heart, 135
antiseptic action of, 157
ethyl, methyl, amyl, 136
- Alkali and acid, 466
- Alkali to absorb CO₂, 119
- Alkalis, action on chloral hydrate, 172
action on frog's blood-vessels, 458
- Aluminum soldering, 489
- Ammonia, 462
- Amylnitrite, action of, on corpuscles in retina, 400
on retinal vessels, 401
on sphygmograph, 399, 400
on vision, 403
general action of, 404
plethysmograph and general action, 397, 398
- Analgesia, nitrous oxide, 120
- Anatomy of, cat's heart, 426
dog's heart, 427
eye, 394
frog's brain, 55
frog's heart, 69
- Anesthesia, by ethyl chloride, 127
by intratracheal insufflation, 120
closed method of, 121, 122, 127
local, 351
nitrous oxide, 119
spinal, 356
- Anesthetization of dog, 77
- Aneurism needles, 49
- Animal operating boards, 43
- Animals, disposal of dead, 102
- Annulus Vieussenii, 143, 155
- Ansa subelavia, 143, 155
- Anticoagulating solutions, 96
- Antimony (tartar emetic), 462
- Antipyrine, action on blood-pressure, respiration and leg volume, 449

- Antipyrine—Cont'd.
 action on fever, 451
 frog, general action, 449
- Antiseptic action of alcohol, 157
- Anvils, 485
- Apomorphine, emesis, 440
- Apparatus, arranged for several records on drum, 165
 for administering nitrous oxide, 130
 for intratracheal insufflation, 129
 for perfusion of excised heart, 425
 for recording, cerebrospinal fluid pressure, 159
 esophageal contractions, 137
 fatigue tracings, 245
 pulmonary blood-pressure, 311
 rate of oxygen consumption, 180-183
 reaction time, 143, 146
 individual, 48
 permanent, list of, 34
- Arc light, adjustable, 500, 501
- Arecoline, action of, on bladder and intestine, 278, 298
 on blood-pressure, 278, 282, 298
 on bronchioles, 278, 298
 on frog's retinal circulation, 274
 on heart, 299
 on intrathoracic pressure, 282
 on pupil, 275
 on respiration, 298
- Armstrong, boring out tool, 488
 cut off tool, 488
 threading tool, 488
- Arrangement of operating table, 123
- Arsenic, general action, 460
- Arterial cannula, 42
- Arterial cannulas, brass, method for making, 496
- Artery, carotid, dissection for, 90
 femoral, 107
 mammary, 194
 pulmonary, 112, 306, 313, 314
 subclavian, 142
 vertebral, 193, 195
- Artificial respiration, 108, 111
- Artificial respiration faucet, 111
- Artificial respiration machines, 473-477
- Asphyxia, death by, 128
- Aspirin, action on fever, 451
 action on headache, 451
- Assay of digitalis, 414
- Assay of ergot, rooster's comb, 361
- Assignment of tables, 33
- Atmospheric pressure, increased action of, 117, 118
- Atmospheric pressure—Cont'd.
 reduced action of, 119
- Atropine, action of, on bladder and intestine, 278, 280
 on blood-pressure, respiration and heart, 270, 275
 on bronchioles, 287, 295
 on intrathoracic pressure after arecoline, 282
 on chorda tympani nerve, 270
 on frog's heart and vagus nerves, 268, 273
 on frog's muscle and nerve, 269
 on frog's pupil, 269, 275
 on frog's retinal circulation, 274
 on intestinal segment, 334
 on pancreatic secretion, 270, 275
 on pupil, 269
 on ring of frog's stomach, 337
 on salivary secretion, 270, 275
 on sweat secretion, 270
 adrenaline, action of on blood-pressure, respiration and bladder, 346
- Attaching animal to operating board, method of, 83
- B
- β -iminazololyethylamine (see Ergamine)
- β -tetrahydronaphthylamine hydrochloride, 449, 450, 453
- Bandage saw, hand, 108
- Barbour's method for recording uterine contractions, 363, 364
- Barium, 363, 365
 action of, on bladder, 278
 on blood-pressure and respiration, 278
 on bronchioles, 287
 on intestinal contractions, 353
 on intestine, 278, 280
 on intraocular pressure, 353
 on heart, 285, 286
 on perfused kidney, 342
 on pulmonary blood-pressure, 310-318
- Bath, fixing, for plates, 504
- Battery jar, 47
- Bayliss-Starling intestinal reflex, 468
- Beaker, 43
- Becht's method for recording changes in cerebrospinal fluid, 159
- Bell-jar for anesthetizing cats, 148
- Bellows, foot, 472
 hand, 107

Bench, work, 485
 Bending glass tubes, 494
 Benedict's test for glucose, 176
 Bernard's experiment, 255
 Bert's experiment, 120
 Binding strips for lantern slides, 508
 Binz's experiment, 447
 Biological supplies, dealers in, list of, 515
 Bits, 485
 Bladder, action of, adrenaline, atropine, arecoline, barium on, 278
 lobeline, adrenaline, pilocarpine and tetramethylammonium chloride, 325
 cannula, 44
 method of inserting, 188
 contractions, 346
 recording, 296
 recording apparatus for, 207
 innervation of, 384
 Blast lamp, 482, 483
 Blood, action of, cyanides on, 441
 nitrites on, 404
 Blood-pressure, action of, chloroform on, 77
 digitoxin on, 408-413
 ether on, 77
 ethyl bromide on, 77
 ethyl chloride on, 127
 nitrous oxide on, 126
 somnoform on, 127
 tetramethylammonium chloride on, before and after atropine, 329
 compensation of, 196
 in spinal dog, 211
 recording, method of, 96
 Blowing of glass, 492-495
 Blow pipe, 489
 Blue print paper, 510, 511
 Blue prints, 51
 method for making, 510-513
 Boards, operating, 43
 frog, 54
 Bone cutting forceps, 326
 Bottle, pressure, 37, 97
 Box for anesthetizing cats, 147
 Brace and bits, 485
 Brachial plexus, dog, 142
 Brain of cat, dorsal view, 180
 of dog, base, 17
 motor areas, 106
 of frog, 54, 55
 Brandy, 136
 Brass castings, 497
 Brass lacquering, 498

Brass, supplies of, 480
 Brazing, 492
 Bronchial changes, independent of pulmonary pressure, 198
 Bronchiole changes, method of recording, 196, 206, 210, 227, 228, 278, 288, 290, 291, 298
 Bronchiole tracings, special apparatus for obtaining, 288-290
 Bronchioles, action of, ergamine on, 373, 376
 opium alkaloids on, 194
 nitrites on, 406
 Brucine, action of, on frog, 233
 Brugg's mixture, 127
 Bulb, mercury, 206
 Burnishing, 487

C

Caffeine, action of, on blood-pressure and respiration, 249
 on frogs, 241
 on heart and vagus nerve, 244
 on muscles, 243
 on nerves, 243
 diuresis, 247, 249
 effect on reaction time, 244
 Calcium, antagonizes magnesium anesthesia, 460
 Calipers, 487
 Cameras, 500
 Canals, semicircular, in pigeon, 174
 Cannabis indica, action on dog, 205
 Cannula, arterial, glass, 42
 bladder, 44
 carotid, method of inserting, 85
 insertion of, in pancreatic duct, 268
 insertion of, into Wharton's duct, 266
 straight, glass, 107
 tracheal, method of inserting, 85
 method of making, 490
 ureteral, 225
 with special points, 247
 with special washout, 248
 Cannulas, brass, method for making, 496
 glass, blowing, 492, 495
 special for pulmonary artery, 315
 tracheal, 39
 Capillary circulation, action of ergot on, 361, 362
 method of observing, 362
 Carbolic acid, 454, 456
 Carbon dioxide, action on blood-pressure and respiration, 131
 on frog, 113

- Carbon-dioxide—Cont'd.
 generator, Guthrie's, 116
 tank yokes, 115, 116
- Cardiac nerve, inferior, 142
 superior, 142, 257
- Cardiac sympathetic nerves, 155
- Cardiographic tracing, action of
 adrenaline on, 156
- Cardiographic tracings, method of
 recording, 152
- Cardiometer, 107, 110, 112
 thistle tube, 151
 used as a myocardiograph, 150
- Carotid artery, 274
 dissection for, 90
 dog, 142
 rabbit, 247
- Casserole, 44
- Castings, for stands, etc., 496
- Cat, dose of paraldehyde for, 254
 dose of urethane for, 254
 lymphatic system of, 386
- Catheter for intratracheal insufflation, 132
- Catheters, 216
- Cat's brain, dorsal view of, 180
- Cat's heart, 426
- Cat's skull, mesial section of, 179
 upper surface of, 178
- Cause of death under coniine, 268
- Center, crotch, 488
- vasoconstrictor, action of, in
 shock, 166
 vomiting, 440
- Cerebrospinal fluid, action of alcohol on, 158
- Cerebrum, anatomy of, in frog, 54, 55
 cutting off, in frog, 238
 removal of, in frog, 54
- Cervical ganglion, inferior, 142
 superior, 274, 394
- Cervical sympathetic nerve, 142, 194, 247
- Cervical sympathetic, dog, 77, 274
- Cervical vagi, dog, 77
- Chamber, gas, 58
- Chemical supply houses, list of, 515
- Chest, opening, 102
- Chest oneometers, 288, 289
- Cheyne-Stokes respiration, 176, 190, 355
- Chloral hydrate, 229
 action of, alkalis on, 172
 on frog, 168
 on frog's heart, 169
 on retinal circulation, 169
 on turtle's heart, 172
- Chloretone, 354
 action of, on frog, 168
- Chloroform, action of, on blood-pressure and respiration, 77, 120
 on conductivity and irritability of nerve, 57
 on dog or cat, 121
 on frog, 55
 on frog's heart, 70
 on frog's lymph hearts, 70
 on turtle's heart, 76
 injection into artery, 128
 injection into carotid artery, 210
 injection into vertebral artery, 195
- Chorda tympani, stimulation of, 266
- Chorda tympani nerve, 257, 259, 266
 action of atropine on, 270
- Chordo-lingual triangle, 257
- Chronograph, Jaquet, 82
- Lieb-Becker, 80
- Chuck, Jacob's drill, 488
- Chuck's for lathes, 488
- Clamp, bull-dog, 48
 burette, 46
 double, 46
- Clips, frog, method for making, 495
- Clock, time, 80-82
- Closed anesthesia, 121, 122
- Cocaine, action of, on blood-pressure, respiration and intestine, 353
 on frog, 350
 on frog's heart, 351, 352
 on intraocular pressure, and local vascular action, 353
 on muscular work, 352
 on pupil, 350
 local anesthetic action, 351
- Cocks, Mohr pinch, 40
- Codeine, action on bronchioles, 194
 on bronchioles and bladder, 106, 213, 214
 on frog, 173
 on oxygen consumption, 190
 on turtle lung, 215
- Compressor, for air, 473, 475, 489
- Coniine, action of, on blood-pressure and respiration, 265
 on frog's heart and vagus nerve, 260
 on intestinal loop, 265
 on kidney, 265
 on salivary nerves, 265
 on spleen, 265
 on turtle's heart and vagus nerve, 260

Convulsions, brucine, 233
 recording in a frog, 218
 strychnine, 224
 Copper, soldering, 489
 Copper wire, 484
 Copying, 500, 501
 Counter sinks, 485
 Crotch center, 488
 Croton oil, 466
 Crowell air pumps, 473, 489
 Curara, action of, on blood-pressure
 and respiration, 257
 on central nervous system, 256
 on frog, 255
 on frog's heart, 256, 257
 on salivary nerves, 257
 effect of, on strychnine action, 257
 Cushny's method for recording res-
 piration, 99
 Cushny's myocardiograph, 151
 Cutter, pipe, 487
 Cyanides, general action, 441
 Cycloplegics, 273
 Cylinder, graduated, 44

D

Dealers in supplies and equipment,
 list of, 515
 Delirium cordis, 287
 Dental rubber dam, attachment of,
 to stethograph, 484
 Depressor nerve in rabbit, 247
 Developers, 502, 503, 504, 508, 509
 Developing, 503
 Developing prints, 509
 Diagram of the involuntary nervous
 system, 384
 Diaphragm, dissection for, 110, 166
 Dies, 485
 Digastric muscle, 267
 Digitoxin, action of, on blood-pres-
 sure and respiration, 408
 on diuresis, spleen volume, leg
 volume, 420
 on heart (dog), 418
 on heart (frog or turtle), 408
 on perfused heart, 424, 425
 on pulmonary blood-pressure, 415
 general action of, on frog, 407
 Dionine, action of, on bronchioles,
 194, 202
 Dish, evaporating, 43
 Dissecting forceps, 49
 Dissecting probe, 49
 Dissecting scissors, 49
 Dissection, for intraocular nerves, 319
 for salivary glands and ducts,
 267, 274

Dissection—Cont'd.

for vagus nerve, in frog, 65
 of brain and semicircular canals,
 pigeon, 174
 of eye, 394
 of vagus and sympathetic nerves
 in turtle, 75
 to show left kidney, 164
 to show lymphatic ducts, 356, 384
 to show pelvic organs in dog, 216
 to show pulmonary artery, 312
 Diuresis, caffeine, 247
 Diuretine, 253
 Dog, action of, alcohol on, 136
 cannabis indica on, 205
 carbon dioxide on, 131
 chloroform on, 77
 dose of chlorotone for, 233
 ether on, 77
 ethyl bromide on, 77
 heart levers for, 154
 spinal, 206
 Dog boards, 43
 Dog's brain, base of, 175
 motor areas of, 106
 Dog's heart, 427
 Double pole double throw knife
 switch, 35
 Dreser's method for measuring ex-
 pired air, 187
 Drill chuck, Jacob's, 488
 Drill, hand, 479, 481
 Drill press, 488
 Drills, 479, 488
 Drum, Harvard long paper, 45
 Hürthle, 45
 records, varnish for, 62
 stethograph, 41
 Drum spinning attachment, 436
 Drums, smoking, 61
 Duet, Bartholin's, 257, 267, 274
 Stenson's, 257
 thoracic, collection of lymph
 from 356, 384
 thoracic, dissection for, 144
 thoracic, in a cat, 386
 Wharton's, 257, 267, 274
 Duets, lymphatic, thoracic, 356, 384,
 386
 pancreatic, 226, 252, 268, 278
 Dudgeon's sphygmograph, 399

E

Ear, rabbits, vessels in shock, 166
 Edmund's liver oncometer, 417
 Electric tuning fork, 145
 Electric wiring system, 471
 Electrodes, shielded, Harvard, 38

- Embolism, air, 226
 Emery wheel, 487, 495
 Emesis, 440
 Emodin, 468
 Epinine, 124
 Equipment and supplies, list of dealers in, 515
 Equipment of shop, 470
 Equipment, list of, for shop, 479
 Ergamine, 363
 action of, on bronchioles, 373, 378
 on lymph flow, 384
 on oxygen consumption, 268
 on pulmonary blood-pressure, 369, 372
 on respiration, 367
 on turtle lung, 363
 on uterine strip, 380, 381
 on uterus in situ, 382
 Ergot, action of, on capillary circulation in frog, 361
 on rooster's comb, 360
 on uterus of cat, 381
 Ergotoxine, 363
 action on uterine strip, 380, 381
 effect of, on bronchioles, 377, 378
 Ergens nerve, 282
 Eserine, 342
 Esophageal contractions, 136, 137
 Ether, action of, on blood-pressure and respiration, 125
 on conductivity and irritability on nerve, 57
 on dog or cat, 121
 on frog, 53
 on frog's heart, 65
 bottle, milk bottle, 59
 bottle, with by-pass, 111, 126
 bottle, Woulff, 38
 Etherization of dog, method of, 77
 of frog, 53
 Ethyl bromide, action on dog, 110
 on dog or cat, 121
 Ethyl chloride, action of, on blood-pressure and respiration, 127
 on dog or cat, 121
 administration, 121
 and bromide, action on conductivity and irritability of nerve, 57
 containers, 60
 local anesthesia, 64
 Experiment, Paul Bert's 120
 Expired air, Dreser's method for measuring, 187
 Exposures photographie, 502
 External jugular vein, 142, 194
 Extra drums for records, 101
 Eye, dissection of, 394
 innervation of, 394
 pharmacology and anatomy of, 394
 symptoms, certain ones following
 adrenaline and cocaine, 354
 Eyes, excision of, 260
- F
- Fatigue of vagus endings, 133
 Fatigue tracings, apparatus for recording, 245
 Fehling's test for glucose, 176
 Femoral artery, 107
 Fermentation tube, 157
 Ferrie chloride, 452
 Fever, 451
 Fibrillation of heart, 287
 Files, 479
 First thoracic ganglion, 142
 Fish tail burner, 485
 Fittings, gas pipe, 485, 486, 487
 Fixing plates or slides, 504
 Fluid, cerebrospinal, action of alcohol on, 158
 recording changes in, 158, 159
 Foot bellows, 472
 Foot of a dog, sweat secretion in, 271
 Forceps, blunt pointed, 49, 50
 bone cutting, 320
 small sharp pointed, 48
 Fork, tuning, electric, 145
 Former, for wood, 488
 Frames for blue printing, 511
 Frog, action of, alcohol on, 133
 caffeine on, 241
 carbon dioxide on, 113
 cocaine on, 350
 curara on, 255
 morphine on, 172
 nicotine on, 300
 nitrous oxide on, 113
 oxygen on, 113
 capillary circulation in, 362, 363
 destruction of cerebrum in, 238
 exposure of brain, 54
 gastrocnemius muscle, 54
 injection into anterior lymph sac, 134
 method of exposing the heart of, 65
 method of pithing, 56
 retinal circulation, 171
 sciatic nerve, 54
 vagus nerve, 65
 Frog board, 54

Frog clips, method for making, 495
 Frog heart, action of, cocaine on, 351
 curara on, 256
 nicotine on, 300, 301
 method of applying drugs to, 68
 Frog heart and nerves, action of
 lobeline on, 322
 Frog heart lever, 66
 Frog's blood-vessels, perfusion of, 458, 459
 Frog's stomach, ring of, 336

G

Gag, mouth, 235
 Ganglia, spinal, 349
 Ganglion, first thoracic, 142
 inferior cervical, 142
 Meckel's (spheno-palatine), 265
 superior cervical, 265, 274
 Ganglionic paralysis by lobeline, 322, 323, 326
 Gas reservoir, 186
 Gauge drill, 487
 pressure, 474
 screw thread, 487
 wire, 487
 Gebauer's ethyl chloride container, 60
 Generating oxygen, method for, 185
 Gland, thyroid, 142
 Glands, lachrymal, innervation of, 265
 salivary, innervation of, 257, 266, 274
 Glass blowing, 492-495
 Glucose, action of yeast and alcohol on, 157
 in urine, 176
 Glycogen stores, action of strychnine on, 224
 Glycosuria, from adrenaline, 457
 from cyanides, 441
 from phloridzin, 457
 Green's method of irrigating the heart, 221
 Grouping of students, 33
 Guinea pig, uterine strip of, 332, 333
 Guthrie carbon dioxide generator, 116

H

Hack saw, 479, 488
 Hale's signal magnet, 36
 Hammers, 479, 487
 Hand bellows, 107
 Hand bracket saw, 485
 Hand drill, 479, 481

Hand emery wheel, 487
 Hand saw, 479
 Handy valve, 474
 Hatchet, 479
 Harvard, gas chamber, 58
 inductorium, 35
 membrane manometer, 139
 moist chamber, 57
 muscle lever, 58
 signal magnet, 36
 simple key, 35
 time clock, 81
 Heart, action of, arecoline and atropine on, 299
 atropine on, 271
 barium on, 285, 286
 cocaine on, 351, 352
 digitoxin on, 408, 418
 ether on, in frog, 65
 affected by high blood-pressure, 211
 and vagus nerves, action of nicotine on, in frog, 300, 301
 action of nicotine on, in turtle, 301
 cat's, 426
 dog's, 427
 effect of respiration of, 110
 frog, action of alcohol on, 133
 frog, anatomy of, 69
 method of irrigating, 221
 nerves to, in a dog, 142, 154
 revival of, 113
 slowing by picrotoxine, 236
 turtle, exposure of, 73
 turtle's, 74
 Heart beat, reflected on lung tracings, 216
 Heart lever for frog, 66
 Heart levers, for dogs, 154
 Hearts, action of chloroform on, 70
 lymph, frog, 70
 Heart tracings, method of recording, in a dog, 152
 Heater, electric, 487
 Heavy end cutting pliers, 485
 Hemostat, 48
 Heroine, 346, 348
 action after lobeline, 326
 action of, on bronchioles and bladder, 206, 212
 Hirudin, to prevent coagulation, 197
 Hordenine, action of, on bronchioles, 373, 376, 377
 Hydrastinine, action of, on bronchioles, 242
 Hydrastine, action of, on frog, 238
 on frog's heart, 240
 on nerves of frog's heart, 240
 on nerves of turtle's heart, 241

Hydrastine—Cont'd.
 convulsions, record of, 239
 Hydrochinon, metol, developer, 504
 Hydrocyanic acid, general action,
 441
 Hydrogen peroxide, 441
 Hydrophobia, danger of, 78
 prophylaxis against, 78
 Hyoseine, 342
 Hyoseyamine, 342

I

Incision for femoral artery, method
 of, 208
 Incision for femoral vein, method of,
 208
 Independence of bronchial changes,
 198
 Inductorium, Du Bois-Reymond, 36
 Harvard, 35
 holder, 64
 Inferior cervical ganglion, dog, 142
 Inferior (recurrent) laryngeal nerve,
 142
 Inhibition of frog's heart, 133, 134
 Injecting burette, 93
 method of connecting vein, 93
 Injecting pipette, glass, 135
 Innervation of, frog's heart, 240
 heart, 142, 154
 intestine (small), 336, 384
 pancreas, 268
 retractor penis muscle, 282
 salivary glands, 257
 vessels in rabbit's ear, 166
 Insertion of bladder cannula, 188
 Insertion of cannula, carotid, 85, 91
 femoral vein, 93, 95
 tracheal, 85
 Insertion of cannula into pancreatic
 duct, 278
 Insertion of lung shield, 208
 Internal jugular vein, 194
 Intestinal contractions, action of,
 adrenaline on, 353
 barium on, 353
 cocaine on, 353
 physostigmine on, 339
 apparatus for recording, 279
 method for recording, 278
 Intestinal loop, action of nicotine
 on, 307
 Intestinal loop oncometer, 223
 Intestinal segment, action of adre-
 naline, lobeline, nicotine,
 pilocarpine and atropine, 334
 method of recording contractions
 of, 334

Intestine, action of adrenaline, atro-
 pine, arecoline, barium and
 pilocarpine on, 278
 innervation of, 336, 384
 Intestines, action of arsenic on, 460
 Intraocular pressure, action of co-
 caine, barium and adrena-
 line on, 353
 action of nicotine on, 308
 method of recording, 308
 Intrathoracic pressure, action of
 arecoline on, 282
 method for recording, 282
 Intratracheal insufflation, 129
 Involuntary nervous system, dia-
 gram of, 384
 Iodide of potassium, 457
 Iodine, tincture of, 358
 Ipecac, vomiting, 440
 Iris, innervation of, 384, 394
 Iron rods, etc., supply of, 487
 Irrigation of heart, 221

J

Jack plane, 484
 Jacobson's nerve, 256, 274
 Jaquet chronograph, 82
 Jar, specimen, 46
 Jars for anesthetizing cats, 148
 Jugular vein, dissection for, 91, 142,
 194
 external, 85

K

Kelene tube, 60
 Key, double pole double throw, 35
 simple, 145
 simple Harvard, 35
 Kidney, action of, agurine on, 253
 ammonium acetate on, 254
 ammonium chloride on, 254
 arsenic on, 460
 caffeine on, 247, 249
 diuretic on, 253
 Matthews' solution on, 254
 sodium chloride on, 254
 sodium iodide on, 255
 sodium nitrate on, 254
 sodium phosphate on, 254
 urea on, 254
 dissection for, 128
 left, exposure of, 164
 perfusion of, 342
 Kidney oncometer, 41, 162, 163
 Roy's, 42
 Kidney volume, action of nicotine
 on, 307
 Kits for plate holders, 505

- Kymograph drum, method of smoking, 61
 Kymograph, long paper, 478-480
 Kymograph records, blue prints, 511
 prints of, on developing paper, 513
 Kymographs, 45
- L
- Laboratory supplies and equipment, dealers in, 515
 Laboratory table, with sink attached, 79
 Lachrymal gland, innervation of, 265
 Lacquering, 498
 Lamp, blast, 482
 spirit, 489
 Langendorff method for perfusion of the excised heart, 424, 425
 Lantern slides, 51, 500, 502, 505, 506
 frame for making mats for, 507
 staining of, 508
 Laryngeal nerve, superior, 139
 Latent period of cardiac sympathetic nerves, 157
 Lathe, 477, 488
 Left pulmonary artery, dissection for, 110, 166
 Left pulmonary vein, dissection for, 110, 166
 Leg volume, action of digitoxin and strophanthin on, 420
 Lenses, 500
 Lever, frog heart, 66
 Levers, heart, for dog, 154
 Levulose, action of, on lymph flow, 384
 Light, arc, for copying, 501, 502, 506
 Light, arc, for laboratory, 472
 Lingual nerve, 266, 274
 Liquor cresolis compositus, 357
 List of apparatus, permanent, 34
 List of dealers in supplies and equipment, 515
 List of equipment for the shop, 479
 Liver, 166
 action of adrenaline on, 417
 tetramethylammonium chloride on, 423
 innervation of, 384
 Liver oncometer, brass, 422
 Edmund's, 416
 Lobeline, action of, after heroine, 327
 on bladder, blood-pressure, respiration and pupil, 325
 on frog or turtle heart, 322, 323
 on intestinal segment, 334
 on turtle lung, 322, 324
 on uterine strip, 332, 333
- Local anesthesia, ethyl chloride, 64
 Locke's solution, 52
 Lodal, 337
 action of, on blood-pressure and bronchioles, 296
 Long paper kymographs, 478, 479, 480
 Longitudinal sinus, 105
 Lung, left, position of, 166
 movements of, 110
 turtle, action of codeine on, 215
 turtle, action of pilocarpine on, 274
 Lung shield, 208, 209
 Lung tracings from a turtle, 260-264
 Lung volume changes, recording, 196, 206, 210
 Lungs, inflation of, 197
 innervation of, 384
 Lungs of turtle, 260-264
 innervation of, 260, 261, 263, 264
 Lymph hearts, action of chloroform on, 70
 Lymph heart beats, action of curara on, 255
 Lymph sac, injections into, 134
 Lymphatic system in cat, 386
 Lysol, 357
- M
- Machine for artificial respiration, 473-477
 Machine, milling, 488
 Magnesium, anesthesia, 460
 antagonism of calcium, 460
 Magnesium sulphate, 466
 Mammary artery, 194
 Mammary vessels, 109, 166
 Manometer, membrane, 139
 substitute for, 141
 mercury, 37
 Mat trimming frame, 507
 Material supplied by dealers, 515
 Mats for lantern slides, 507
 Mechanical procedures, 489
 Meckel's ganglion, 265
 Mediastinum, 166
 Mediastinum, anterior, 110, 207
 Medicine dropper, 68
 Medicine, method of giving to dog, 234
 Meningitis, 360
 Mercury bulb, 206
 Mercury vapor lamps, 506
 Method, Barbour's for recording uterine contractions, 363, 364
 Langendorff, for perfusion of heart, 424, 425

- Method for, adjusting plethysmograph on hind limb, 304
 generating oxygen, 185
 recording, pulmonary blood-pressure, 310-318
 oxygen consumption, 180-184
- Method of, observing capillary circulation, 262, 263
 perfusing excised kidney, 342, 343
 pithing a dog or cat, 291-294
- Metol hydrochinon developer, 504
- Metronome, 80
- Migraine, action of aspirin on, 451
- Milling machine, 488
- Moist chamber, Harvard, 57
- Monkey wrench, 485
- Moreau's experiment, 466, 476
- Morphine, action of, on blood-pressure and respiration, 177
 on bronchioles, 194, 199
 on cat, 177
 on dog, 175, 204
 on frog, 172
 on oxygen consumption, 177, 191
 on pupils, 175
 do not give to animals without special reason, 354
 dose of, for dog, 175
 excretion of, 175
- Motor areas, action of, chloroform on, 103
 ether on, 103
 ethyl bromide on, 103
 exposure of, 103
 in dog's brain, 106
 stimulation of, 104
- Mouth gag, 235
- Muscarine, action of, on bronchioles, bladder and blood-pressure, 214, 295
 on intestinal contractions, 335
 on turtle's lung, 336
- Muscle, action of veratrine on, 434
 and nerve, action of, atropine on, 269
 action of caffeine on, 243
 longus colli, 193
 nerve preparation, 243
- Muscular work, action of, caffeine on, 245
 cocaine on, 352
- Muzzle, for dog for anesthesia, 357, 358
- Mydriatics, 273
- Mylohyoid muscle, 267
- Myocardiograph, 149
- Myocardiographic tracings, action of, alcohol, 147
 brandy, 147
- Myocardiographic tracings, action of—Cont'd.
 whiskey, 147
 wine, 147
- Myotics, 273
- N
- Nails, 480
- Narcotine, action of, on bronchioles, 194, 203
- Needle holder, 50
- Needles, large, 195
- Nerve, cervical sympathetic, 142
 chain, sympathetic, 282, 384
 conductivity and irritability, 57
 depressor, in rabbit, 247
 erigens, 282, 384
 inferior laryngeal, 142
 muscle preparation, 243
 optic, 272, 319, 384
 phrenic, in a dog, 142, 193
 pudic, 282
 superior laryngeal, 139, 247
 vago-sympathetic, in dog, 142
 in frog, 133
 vagus, 142, 154, 166, 247
 vagus, in frog, 65
- Nerve supply to intestine, 336, 384
- Nerves, cardiac sympathetic, 142, 147, 154, 155
 intraocular, 318, 319, 394
 action of nicotine, pilocarpine, and atropine on, 318, 320
 of brachial plexus, 142
 of frog's heart, 65, 240
 thoracic sympathetic, 166
 to lachrymal gland, 265, 384
 to salivary glands, dog, 257
- Nervous system, involuntary, diagram of, 384
 sympathetic, diagram of 384
- Nicotine, action of, on blood-pressure, respiration, limb volume and intestinal contraction, 304, 305, 307, 309
 on heart and vagus nerves in frog, 300
 on heart and vagus nerves in turtle, 301, 337
 on intestinal segment, 334
 on intraocular pressure, 307, 308
 on pulmonary blood-pressure, 310-318
 on pupil, 306
 on turtle's lungs, 302, 303
 on uterine strip, 332, 333
 general action on frog, 300
- Nitrite, amyl, general action, 404
 of sodium, action of, on frog's blood-vessels, 458
 sodium, general action, 404

- Nitrites, action on bronchioles, 406
 Nitrogen, effect on anesthesia, 124
 Nitroglycerine, action of, on pulmonary blood-pressure, 415
 general action, 404
 Nitrous oxide, action of, in closed anesthesia, 121
 on frog, 113, 117, 118
 on guinea pig, 117, 118
 on kitten, 117
 on pup, 117
 on rat, 117
 on respiration, 126, 131
 apparatus for administering, 130
 method for making, 115
 some dogs do not take well, 357
 tank yoke, 115, 116
 Normal salt solution, 52
 Note book, permanent, 50
 Novocaine, local anesthetic action, 351
 spinal anesthesia, 356
 Nurling tool, 488
- O
- Oesophageal contractions, 137 (*see* Esophageal contractions)
 Oil can, 484
 Oncometer, 128, 129, 160
 brass, 422
 brass, for spleen, 421
 Edmund's 416
 for intestinal loop, 223
 kidney, 41, 162
 Roy's, 42
 spleen, 160, 161
 Oncometers, method for making, 491
 Opening of chest, 102, 108, 109
 Operating, table arranged for, 123
 Ophthalmoscope, 169-171
 Optic lobes, removal of, in frog, 56
 Optic nerve, dissection for, 272, 319
 Oxygen, action of, on frog, 113
 method for generating, 185
 Oxygen consumption, action of, β -tetrahydranaphthylamine on, 453
 cyanides on, 441
 morphine on, 228
 nicotine, pilocarpine and atropine on, 318
 recording rate of, 180, 181
 strychnine on, 226, 229
 Oxygen tanks, pressure in, 113
 yoke for, 115
- P
- Pancreas, dissection of, for ducts, 267, 276, 278
 Pancreas—Cont'd.
 dissection for, 128
 innervation of, 384
 Pancreatic ducts, insertion of cannula in, 276, 278
 Pancreatic ducts, 252, 276, 278
 Pancreatic secretion, action of atropine on, 270, 272
 Pantopon, action of, on bronchioles, 194, 200
 Paraldehyde, action of, on frog, 168
 dose of, for cat or rabbit, 254
 Passing catheter, 217
 Paul Bert's experiment, 120
 Pelvic (erigens) nerves, 282, 384
 Pelvic organs in dog, 216
 Penis muscle, retractor, innervation of, 282
 Peptone, action on temperature, 451
 Perfusion of excised kidney, 342
 apparatus for, 343
 Perfusion of frog's vessels, 458
 Perfusion of heart, Langendorff, 424, 425
 Pericardium, 110
 opening of, 166
 Permanent note book, 50
 Peronine, action of, on bronchioles, 194, 201
 Pharmacology and dissection of eye, 394
 Phases, two, of adrenaline action, 166
 Phenacetine, action on fever, 451
 Phenol, antidote for, 454, 456
 general action of, on dog, 454
 general action of, on frog, 454
 Phenylsalicylate, absorption and excretion, 452
 Phloridzin, glycosuria, 457
 Photography, 500
 Phrenic nerve, in dog, 193, 207, 268
 Phrenic nerves, dissection for, 110, 143
 Phrenic nerves, section of, 102
 Physostigmine, action of, on blood-pressure, respiration and bladder contractions, 346
 on blood-pressure, respiration, intestinal contractions, 339
 on frog's heart, 337
 on ring of frog's stomach, 337
 on the pupil, 350
 on turtle's heart, 338
 on turtle's lung, 338
 Pierotoxine, action of, on blood-pressure, 233
 on frog, 231, 232
 on respiration, 233

Pigeon, brain of, 173, 174
 semicircular canals of, 174
 Pilocarpine, action of, on adrenal glands, 278
 on bladder, 278
 on bronchioles, 287, 295
 on frog's heart and vagus nerves, 273
 on frog's retinal circulation, 274
 on intestinal contraction, blood-pressure and respiration, 283
 on intestinal segment, 334
 on pancreatic secretion, 275
 on pupil, 275
 on rate of oxygen consumption, 283
 on salivary secretion, 275
 on turtle lung, 274
 on uterine strip, 332, 333
 Pipe cutter, 487
 Pipe, gas, fittings, 485-487
 Pipe stock and dies, 485
 Pithing a dog or cat, method for, 291-294
 Pithing a frog, method of, 56
 Pituitrin, action of, on bronchioles and blood-pressure, 391
 on capillary circulation, 387
 on frog or turtle heart, 388
 on intestinal contractions, 392
 on lymph flow, 384
 on pulmonary blood-pressure, 384
 on turtle lung, 388
 on urine secretion, 392
 on uterine strip, 390
 on uterus in situ, 382, 389
 Planes, 484
 Plethysmograph, 398
 action of amylnitrite with, 397
 Plethysmograph for dog's hind limb, 304
 Pleura, parietal, 208, 209
 Plexus, Auerbach's, 336
 Meissner's, 336
 pelvic, 384
 vesical, 384
 Pliers, 479, 485
 Points, writing, adjustment of, 98
 Potassium chloride, action of, on heart, 424
 Potassium iodide, absorption, exertion, 457
 Preparation, (gastrocnemius) muscle and nerve, 243
 Pressure, air, negative, 474, 475
 positive, 474, 475

Pressure—Cont'd.
 intraocular, method of recording, 308
 of air for intratracheal insufflation, 132
 pulmonary, action of nicotine, adrenergic, barium on, 310-318
 method of recording, 310-314
 Pressure bottle, on pulley, 97
 Print, paper, blue, 510, 511
 Printing blue prints in sunlight, 511
 Printing frames for blue prints, 511
 Printing paper, 508
 Prints, blue, 51, 510
 bromide solution for, 509
 developer for, 508, 509
 developing, 509
 drying and mounting, 510
 fixer for, 509
 fixing, 510
 Print trimmer, 63
 Probe, dissecting, 49
 Prussic acid (hydrocyanic), 441
 Pudic nerve, 282
 Pulmonary artery, dissection for, 306, 312, 313, 314
 special cannulas for, 315
 Pulmonary blood-pressure, 415
 action of ergamine on, 369, 372
 Punch for metal, 485
 Puncturing spinal canal, 349, 356, 359
 Pupil, action of, adrenergic on, 272
 atropine on, 239
 cocaine on, 350
 nicotine on, 306
 physostigmine on, 350
 pilocarpine on, 275
 sympathetic on, 100
 Pupils, action of morphine on, 190
 Pyro developer, 503

Q

Quinine, action of, on fever, 451
 on frog or turtle heart, 447
 on white corpuscle, Binz's experiment, 447

R

Rabbit, action of, agurine on, 253
 diuretic on, 253
 caffeine, diuresis in, 247
 cervical nerves in, 247
 depressor nerves in, 247
 doses of urethane for, 247
 etherization of, 247
 uterine strip, 332, 333

- Rat, action of, carbon dioxide on, 117
 ethyl chloride on, 117
 increased atmospheric pressure on, 117
 nitrous oxide on, 117
 Rate of oxygen consumption, apparatus for, 180, 181
 Reaction time, action of, caffeine on, 244
 strychnine on, 230
 whiskey on, 144
 Recorder for drops of urine flow, 249
 Recording, bladder contractions, mercury bulb for, 188, 206
 bladder contractions, apparatus for, 207
 contractions of intestinal segment, 334
 convulsions in a frog, 218
 turtle lung tracings, 260-264
 uterine strip contractions, apparatus for, 333
 Records, apparatus arranged for several on drum, 165
 Rectum, innervation of, 384
 Reducing bath for slides or negatives, 505
 Reducing bodies, Fehling's test for, 176
 Reservoir for gas, 186
 Respiration, action of, carbon dioxide on, 117
 nitrous oxide on, 126
 Cheyne-Stokes, 176, 355
 recording, 97, 98
 recording, Cushny's method, 99
 Resuscitation of dog, 102, 140
 Retinal circulation, action of, chloral on, 169
 pilocarpine, arecoline and atropine on, 274
 seen with ophthalmoscope, 170, 171
 Retinal corpuscles, action of, amyl-nitrite on, 400
 Retinal vessels, action of, amyl-nitrite on, 401
 Retractor penis muscle, innervation of, 282
 Rhubarb, 466
 Ring of frog's stomach, 336
 Ringer's solution, 52
 Risus sardonius, 224
 Rods, brass, 480, 482
 Room for the shop, 470
 Rooster's comb, action of, ergot on, 360
 Rouge, 498
 Rubber dam, attaching to stethograph, 484
 attaching screw or tack to, method of, 484
 S
 Salivary ducts and nerves, 257, 266
 Salivary glands, action of, nicotine, pilocarpine, and atropine on, 318
 dissection to show, 274
 general plan of innervation, 274
 Salol, 452
 Salt solution, 52
 Saphenous nerve, 93
 Saw, hack, 479, 488
 hand, 479
 hand bandage, 108
 Scalpel, 49
 Sciatic nerve carries sweat nerves to foot, 271
 Sciatic nerve stimulation, effect on blood-pressure, 249
 effect on respiration, 249, 258
 Sciatic nerves, dissection for, 237
 stimulation of, 237
 Scissors, dissecting, 49
 Scopolamine, action of, on frog, 273
 Scratch awl, 485
 Screw, wood or metal (machine), 485
 Screw drivers, 479
 Secretion of pancreas, how controlled, 268
 action of atropine on, 270
 Secretion of salivary glands, action of atropine on, 270
 Section of the phrenic nerves, 179
 Sensation not prevented by curara, 258
 Serrefine, 48
 Shaper (planer), 488
 Shield, lung, 208, 209
 Shielded electrodes, 38
 Shock, action, vaso-constrictor center in, 166
 Shock, rabbit's ears in, 166
 Shop work, 470
 Signal magnet, Hale's, 35
 Harvard, 35
 manometer, 37
 Simple key, 145
 Simplex heater, 487
 Sinus, longitudinal, 105
 Skull of cat, mesial section of, 179
 upper surface of, 178
 Small electric heater, 487
 Small vise, 479
 Smoking drums, 61

- Snips, tinnors, 104, 479
- Sodium citrate solution, 53
 cyanide, general action, 404, 441-445
 hydroxide, 462
 nitrite, action of, on frog's blood-vessels, 458
 action of on perfused kidney, 342
 action of on ring of frog's stomach, 337
 orthovanadate, action of, on perfused kidney, 345
 sulphate, 454
 diuresis, 249, 251
 sulphide, 441
- Sodium-theobromine-acetate, 253
- Sodium-theobromine-salicylate, 253
- Soldering, 483, 489-492
 acid, 483, 489
 aluminum, 489
 tracheal cannula, 490
- Solution, Locke's, 52
 NaOH for closed anesthesia, 122
 normal salt, 52
 Ringer's, 52
 sodium citrate, 53
 Tyrode's, 52
- Solutions, injection of, 94
- Somnoform, 121
- Special apparatus, 52
 for obtaining bronchiole tracings, 288, 289
- Speed lathe, 488
- Sphygmograph, action of amylnitrite on, 400
 Dudgeon's, 399
- Spinal anesthesia, 356
- Spinal canal, puncture of, 349, 359
- Spinal dog, method of preparing, 194, 291-294
- Spinal ganglion, 349
- Spinning attachment for drum, 436
- Splanchnic nerves, dissection for, 166, 167
 functions of, 167
- Spleen, dissection for, 128
 innervation of, 384
 oncometer, 160, 161, 421
 method of applying, 161
 volume, action of nicotine on, 307, 309
- Squares, try and carpenter's, 485
- Staining lantern slides, 508
- Stand, copying, 501
- Stands, castings for, 496
 making, 496, 497
- Starch granules, injected into carotid artery, 197
- Stellate ganglion, 154
- Sterilization of hands, 358
- Stethograph drum, 41
- Stillson wrenches, 487
- Stimulation of motor areas, 104
- Stocks and dies, 485
- Stomach, innervation of, 384
- Stomach tube, passing in a dog, 234
- Straight cannula, glass, 107
- Strophanthin, action of, on perfused heart, 424, 425
 on pulmonary blood-pressure, 415
 general action, 420
- Strychnine, action of, on blood-pressure, 222
 on frog, 217
 on frog's cardio-inhibitory nerves, 220
 on frog's heart, 220
 on oxygen consumption, 226
 on reaction time, 230
 on respiration, 222
 on special senses, 231
 on turtle's heart, 220
 on vagus nerve in turtle's heart, 220, 222
 and curara, action of, on blood-pressure and respiration, 257
 gastrocnemius contraction records, 218, 219
- Subclavian ansa, 154
- Subclavian artery, dissection for, 143
- Subclavian vein, 142, 194
 dissection for, 143
- Substitute for membrane manometer, 141
- Superior cervical ganglion, 154, 245, 265, 274, 394
- Superior laryngeal nerve, 139
- Superior mesenteric ganglion, 384
- Supplies and equipment, dealers, 515
- Supplies of brass, 480
- Supplies of iron rod, etc., 487
- Sweat secretion, action of atropine on, 270
- Sympathetic, cervical nerves and ganglion, 142
 ganglion, inferior cervical, 154
 nerve, cervical, in rabbit, 246
 nerves, cardiac, in cat, 155
 cardiac, in frog, 66
 cardiac, in turtle, 75
 in neck of rabbit, 247, 248
 to frog's heart, 240
 to heart, 154
 nervous system, diagram of, 384
 thoracic trunks, 166
- System, electric wiring, 471

T

- Table, arranged for operating, 123
 laboratory, 79
 Tables, small supporting, 47
 Tambour, adjustable, 40, 483
 cheap form, 484
 Marcy, 40
 Tanks, carbon dioxide, 116
 nitrous oxide, 113
 oxygen, 113
 Tape worms, 230
 Tartar emetic, 462
 Taste organs, 351
 Technic for inserting bladder cannula, 188
 Telephone, for reaction time, 145, 146
 Temperature, rectal, 148
 Tetramethylammonium chloride, action of, before and after atropine, 329
 on blood-pressure, respiration, bladder and pupil, 325, 330, 331
 on bronchioles, 331
 Thebaine, action of, on bronchioles, 194, 377
 on frog, 173
 Thoracic duct, 356, 384, 386
 Thoracic sympathetic, 166
 Thyroid gland, 142
 Time clock, Harvard, 81
 Time recording metronome, 80
 Time recording watch, Lieb-Becker, 80
 Tincture of iodine, 358
 Tinner's snips, 479
 Trachea, dissection to expose, 86
 Tracheal cannula, attachment of ether bottle to, 89
 brass, 39
 insertion of, in dog, 89
 soldering, 490
 Tracing trimmer, 63
 Tracings from turtle's lungs, 260, 264
 Transverse scapular artery, 194
 Trepine, 105
 Trimethylamine, action of, on blood-pressure, respiration and intestinal contractions, 339, 340, 341.
 Tripoli, 498
 Trocar and cannula, 359
 Try square, 485
 Tube, stomach, passing in a dog, 234
 into larynx, 235
 to pass through chest, 196
 Tubing, brass, 480
 Turning attachments, 488
 Turning lathe, 477, 488
 motor driven, 488
 Turtle board, operating, 46
 Turtle lung tracings, method for making, 260-264
 Turtle's heart, 74
 action of, alcohol on, 135
 chloroform on, 76
 ether on, 71
 hydrastine on, 241
 and vagus nerves, action of atropine on, 269
 exposure of, circular saw for, 73
 method for recording heart tracings, 72, 73
 sympathetic nerves to, 77
 Turtles, list of dealers supplying, 515
 Turtle's lungs, action of, lobeline on, 323, 324
 nicotine on, 302, 303
 physostigmine on, 338
 dissection to show, 261
 Turtle's vagus nerve, 71, 73, 75
 Tyramine, 371
 action of, on blood-pressure, 370
 on capillaries, 363
 Tyrode's solution, 52
- U
- Ureter, innervation of, 384
 Ureteral cannula, glass, 225
 Ureters, dissection for, 226
 Urethane, action of, on frog, 168
 dose for cat, 254
 dose for rabbit, 247, 254
 Urine, action of curara on secretion of, 257
 collecting from bladder cannula, 188
 testing for glucose, 189, 248
 Urine flow, action of, caffeine on, 247, 249
 chloral on, 252
 Matthews' solution on, 254
 sodium iodide on, 255
 sodium sulphate on, 251
 urea on, 254
 drop recorder for, 249, 250
 normal rate of, 250
 Uterine contractions, Barbour's method of recording, 363, 364
 method of recording, 333
 method of recording in situ, 382
 Uterine strip, action of, lobeline, nicotine, and pilocarpine on, 332, 333

- Uterine strip,
 action of—Cont'd.
 pituiridin on, 390
 method of recording contractions
 of, 333, 380, 381
- Uterus, action of, barium on, 284
 ergamine and ergotoxine on,
 363, 366
 ergot on, 381
 dissection for, 230
 innervation of, 384
- V
- Vacuum pump, 473, 474
- Vagi, action of, on turtle's lung,
 260-264
 section of, effect on respiration,
 236
- Vago-sympathetic nerve in frog, 65,
 66, 133
- Vagus and sympathetic nerves in
 the turtle, 75
- Vagus and sympathetic nerves to
 the heart, 154
- Vagus nerve, dissection for, in dog,
 85, 90, 142, 194
 in frog, 65
 in turtle, heart, 71, 135
 method of stimulating in turtle,
 72, 75
- Vagus nerves, action of atropine on,
 269, 273
- Valves for artificial respiration ma-
 chines, 473-477
- Vanadium, action of, on pulmonary
 blood-pressure, 394
 general action, 462-465
- Varnish for tracings, 62
- Varnishing pan for varnishing long
 tracings, 63
- Varnishing rack and pan, 62
- Vein, external jugular, 91
 femoral, dissection for, 94
 left pulmonary, 112
 saphenous, 93
 insertion of cannula in, 93
 subclavian, 142, 143, 155, 194
- Veins, jugular, 142, 192, 194
 ligation of, 193
- Veratrine, action of, on blood-pres-
 sure, respiration and intes-
 tinal contractions, 437
- Veratrine,
 action of—Cont'd.
 on frog's skeletal muscle, 434
 on turtle's lung, 437, 438
 frog, general action, 433
 frog or turtle heart, action on,
 434, 435
 heart tracings and blood-pressure,
 440
- Vertebral artery, 193, 195
- Vessels, blood, of a frog, perfusion
 of, 458, 459
- Viesssenii, annulus of, 143
- Visceral organs, dissection of, dog,
 167
- Vise, large, 487
 small, 479
- Vision, action of amylnitrite on, 403
- Vitality of spinal dog, 205
- Vomiting, apomorphine, 440
 ipecac in, 440
 tartar emetic in, 462
- W
- Wharton's duct, 257, 259, 266, 274
 dissections for, 266, 274
- Wheel, emery, 487, 495
- Whiskey, action of, on blood-pres-
 sure and respiration, 136
- Wine, action of, on blood-pressure
 and respiration, 136
- Wire, copper, 484
- Wire gauge, 487
- Wiring system for electric current
 for laboratory, 471
- Wood former, 488
- Wood lathe, 488
- Work bench, 485
- Worms, tape, 230
- Woulff, ether bottle, three necked, 38
- Wrenches, 485
 Stillson, 487
- Writing points, adjustment of, 98
- Y
- Yeast, fermentation by, 157
- Yokes for gas tanks, 115, 116
- Z
- Zinc sulphate solution for boot elec-
 trodes, 59

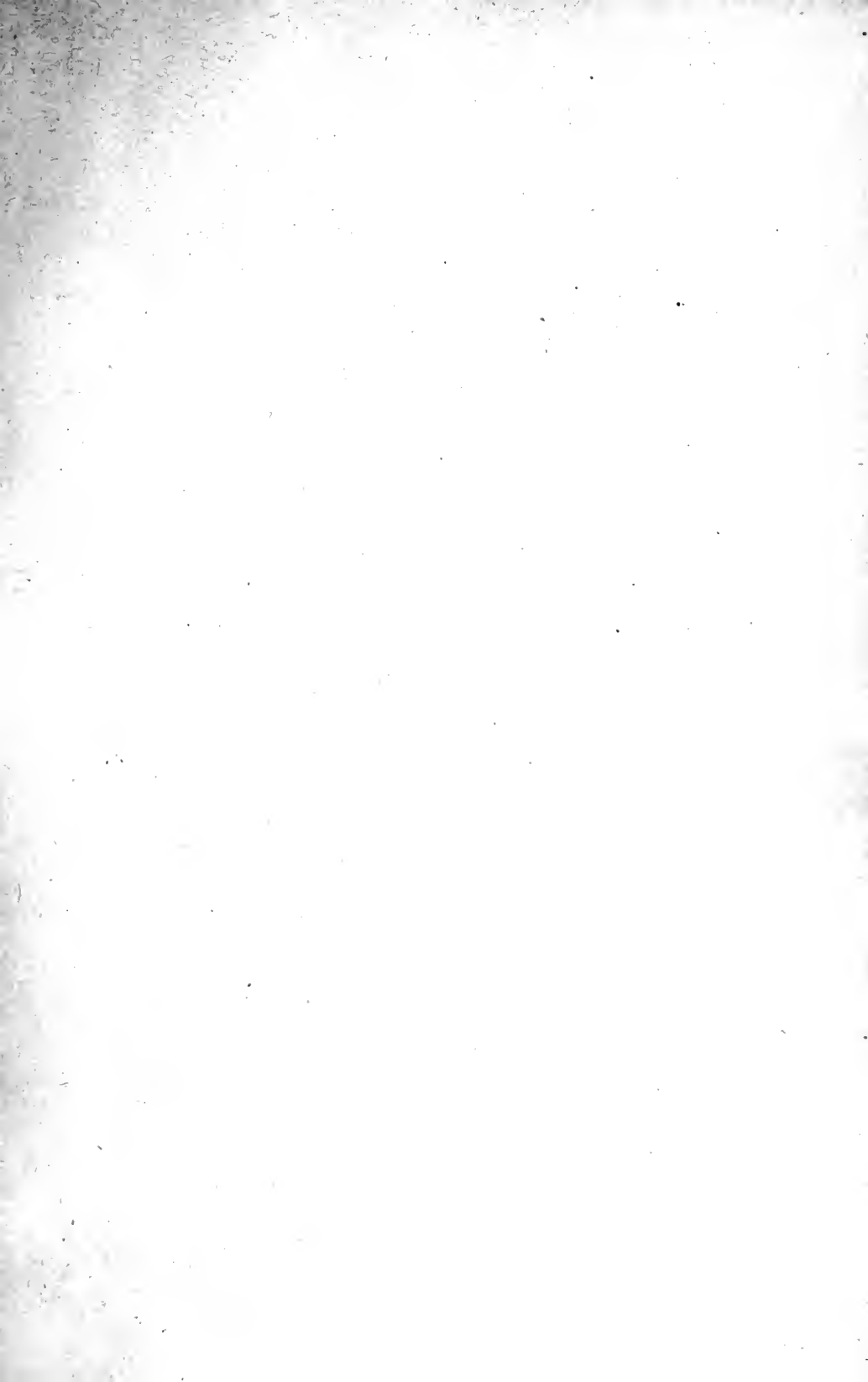

MTherap.

J.

A

145790

Author Jackson, Dennis Emerson

Title Experimental pharmacology.

University of Toronto
Library

DO NOT
REMOVE
THE
CARD
FROM
THIS
POCKET

MSA/acc 110

Acme Library Card Pocket

Under Pat. "Ref. Index File"

Made by LIBRARY BUREAU

