

1
A984 Mr
Cop. 4

EXPORTING LEATHERLEAF FERN TO EUROPE IN VAN CONTAINERS

U.S. DEPT. OF AGRICULTURE
NAT'L. AGRIC. LIBRARY
RECEIVED
JUN 7 1979
DEPARTMENT OF AGRICULTURE
OFFICE OF MARKET RESEARCH
WASHINGTON, D.C. 20250



UNITED STATES
DEPARTMENT OF
AGRICULTURE

MARKETING
RESEARCH
REPORT
NUMBER 1103

PREPARED BY
SCIENCE AND
EDUCATION
ADMINISTRATION

Historic, archived document

Do not assume content reflects current scientific knowledge, policies, or practices.

ABSTRACT

Miller, W. R., L. A. Risse, T. Moffitt, and A. J. Bongers. 1979.
Exporting leatherleaf fern to Europe in van containers. U.S. Department of
Agriculture, Marketing Research Report No. 1103, 18 pp.

This report details stowage and shipping procedures for exporting leatherleaf fern (Rumohra adiantiformis (G. Forst.) Ching) in van containers. Guidelines are recommended that will improve the arrival condition of fern in export markets. These recommendations were developed by studying product temperature profiles of 11 test loads in relation to thermostat settings of refrigeration units and loading patterns used to stow boxes in van containers.

Recommended product temperatures for storing and shipping leatherleaf fern are 34^o-40^o F (1.1^o-4.4^o C). When shipped in commercial van containers, it must be stowed in loading patterns that provide air channels through the load mass. Air channels allow free circulation of refrigerated air from the source of discharge to the return side of the refrigeration system. Discharge air temperature will fluctuate from the thermostat setting, especially during the first few days after loading. This is especially true when ferns are not precooled to recommended storage temperatures prior to loading in van containers. Thermostats must be properly calibrated to manufacturers' specifications prior to loading and set at 37^o ± 1^o F (2.8^o ± 0.6^o C).

KEYWORDS: Leatherleaf fern, export, van container, shipping, quality, stowage patterns.

ACKNOWLEDGMENTS

The following companies and organizations assisted in this research: Florida Leatherleaf and Plumosus Growers, Inc., Pierson, Fla.; Uniflora Florida, Yalaha, Fla.; Volusia Fern Co., Pierson, Fla.; Uniflora Europe, Hamburg, Germany; S. Zurel & Co., B.V., Aalsmeer, the Netherlands; Sea-Land Services, Inc., Elizabeth, N.J.; and U.S. Lines, New York, N.Y.

Science and Education Administration personnel who collected data at points of origin, destination, or both during this study included Roy McDonald and Ben Hillebrand, European Marketing Research Center, Rotterdam, the Netherlands, and Francis Marousky, Bradenton, and Randall Cubbedge, Orlando, Fla. Victor Chew (SEA), Gainesville, Fla., provided the computer science expertise for handling and plotting the temperature data for this project. The research was conducted under the general leadership of T. T. Hatton, SEA research leader, Orlando.

CONTENTS

	Page
Materials and methods-----	2
Results-----	9
Conclusions-----	14
Appendix-----	16

EXPORTING LEATHERLEAF FERN TO EUROPE IN VAN CONTAINERS

By W. R. Miller, 1/ L. A. Risse, 2/ T. Moffitt, 2/ and A. J. Bongers 1/

Leatherleaf fern (Rumohra adiantiformis (G. Forst.) Ching) is an important commercial horticultural commodity produced in central Florida. Total fern acreage in Florida for 1977 was estimated at 2,500. Approximately one-half of this acreage was in leatherleaf fern. During the 1977-78 reporting period, approximately 23 percent of the total fern shipments were exported; 3/ 45 percent of this volume was shipped by surface transport (ships) in van containers and the remainder by air. Leatherleaf ferns were exported primarily to the Netherlands and West Germany, where importers distributed the product to destinations throughout western Europe.

Several years ago, major U.S. shipping companies indicated that claims against their companies for fern were excessive. The major reported problems were either heating or freezing damage to the fern during transit that made the product unsalable. Some shippers and receivers indicated that they would stop exporting or importing fern if better product quality could not be maintained.

The recommended storage and shipping temperature for leatherleaf fern is 34°-40° F (1.1°-4.4° C), with 90-95 percent relative humidity. 4/ If ferns are maintained at these environmental conditions, they can be stored or transported to export markets and arrive with sufficient shelf life for successful marketing.

The purpose of this report is to provide growers, packer-shippers, carriers, and receivers of leatherleaf fern with recommended handling, stowage, and shipping procedures that will achieve the best possible arrival condition with minimum losses from damage during transit. To attain this purpose, several shipments of leatherleaf fern were monitored during transit to determine product temperatures relative to temperatures of refrigerated air, uniformity of temperatures relative to stacking patterns, and product condition on arrival.

1/ Agricultural marketing specialist and agricultural research specialist, respectively, European Marketing Research Center, Science and Education Administration, U.S. Department of Agriculture, Rotterdam, the Netherlands.

2/ Agricultural marketing specialist and industrial engineering technician, respectively, U.S. Horticultural Research Laboratory, Science and Education Administration, U.S. Department of Agriculture, Orlando, Fla. 32803.

3/ Florida Department of Agriculture and Consumer Services. Fresh flowers and ferns - summary 1977-78. 33 pp. Winter Park, Fla. 1978.

4/ Lutz, T. M., and Hardenburg, R. E. The commercial storage of fruit, vegetables and florist and nursery stocks. U.S. Dept. Agr. Agr. Handb. 66, 94 pp. 1977.

MATERIALS AND METHODS

During 1975-76, 11 refrigerated van containers of leatherleaf fern were evaluated and temperatures monitored en route from Florida to Europe (table 1).

Ferns were harvested from shaded ferneries, sized according to frond length, and tied together in bunches containing 25 fronds each. The bunches were transported to the packinghouse, dipped in a fungicide or moistened with water, and placed in polyethylene liners inside moisture-resistant, corrugated fiberboard boxes. Perforated polyethylene liners were used to completely encase the ferns inside the boxes. Twenty to forty-five bunches of fern were packed per box depending on the fern and box size. Boxes were closed with staples.

Ferns were packed in four box sizes. The outside dimensions (length by width by depth) were as follows:

<u>In</u>	<u>(Cm)</u>
30 x 21 x 11	(76.2 x 53.3 x 27.9)
30 x 21 x 6	(76.2 x 53.3 x 15.2)
27 x 15 x 15	(68.6 x 38.1 x 38.1)
30 x 14 x 9	(76.2 x 35.6 x 22.9)

All boxes were regular slotted containers constructed of single-wall, corrugated fiberboard. They were either wax coated or wax impregnated with a bursting strength of at least 275 pounds (124.7 kg) (Mullen test). After packing, boxes were placed in either refrigerated storage or unrefrigerated holding areas until they were loaded into the van container.

Specific stowage patterns used to stack boxes in the van containers depended on box size. The stowage patterns for box sizes tested were as follows:

<u>Stowage pattern</u>	<u>Box size</u>
	<u>In</u> <u>(Cm)</u>
5 x 3 modified bonded block-----	27 x 15 x 15 (68.6 x 38.1 x 38.1)
Parallel air channels-----	30 x 21 x 11 (76.2 x 53.3 x 27.9)
	30 x 21 x 6 (76.2 x 53.3 x 15.2)
	30 x 14 x 9 (76.2 x 35.6 x 22.9)
1 load tight stacked-----	30 x 21 x 11 (76.2 x 53.3 x 27.9)

Table 1.--Mean fern and discharge air range temperatures during transit from Florida to Europe at various intervals by test No., thermostat setting, and loading pattern

Test No.	Thermostat setting	Loading pattern 1/	Time in transit	Fern temperature at--												Discharge air range during 24-96 h
				Loading 2/		24 h		48 h		72 h		96 h				
				$\frac{^{\circ}\text{F}}{^{\circ}\text{C}}$	$\frac{^{\circ}\text{F}}{^{\circ}\text{C}}$	$\frac{^{\circ}\text{F}}{^{\circ}\text{C}}$	$\frac{^{\circ}\text{F}}{^{\circ}\text{C}}$	$\frac{^{\circ}\text{F}}{^{\circ}\text{C}}$	$\frac{^{\circ}\text{F}}{^{\circ}\text{C}}$	$\frac{^{\circ}\text{F}}{^{\circ}\text{C}}$	$\frac{^{\circ}\text{F}}{^{\circ}\text{C}}$	$\frac{^{\circ}\text{F}}{^{\circ}\text{C}}$	$\frac{^{\circ}\text{F}}{^{\circ}\text{C}}$	$\frac{^{\circ}\text{F}}{^{\circ}\text{C}}$		
1 A-----	38 (3.3)	A/ch 3, 6, 7	13	60 (15.6)	45 (7.2)	39 (3.9)	37 (2.8)	37 (2.8)	37 (2.8)	37 (2.8)	37 (2.8)	37 (2.8)	23-38	(-5.0-3.3)		
B-----	38 (3.3)	A/ch 3, 6, 7	13	45 (7.2)	38 (3.3)	36 (2.2)	36 (2.2)	36 (2.2)	36 (2.2)	36 (2.2)	36 (2.2)	36 (2.2)	27-37	(-2.8-2.8)		
2 A-----	36 (2.2)	5 x 3 MBB	10	66 (18.9)	49 (9.4)	41 (5.0)	39 (3.9)	39 (3.9)	39 (3.9)	38 (3.3)	38 (3.3)	38 (3.3)	28-38	(-2.2-3.3)		
B-----	36 (2.2)	A/ch 3, 5	10	53 (11.7)	43 (6.1)	39 (3.9)	38 (3.3)	38 (3.3)	38 (3.3)	38 (3.3)	38 (3.3)	30-38	(-1.1-3.3)			
3 A-----	40 (4.4)	A/ch 3, 5	16	50 (10.0)	40 (4.4)	37 (2.8)	36 (2.2)	36 (2.2)	36 (2.2)	36 (2.2)	36 (2.2)	36 (2.2)	17-39	(-8.3-3.9)		
B-----	38 (3.3)	A/ch 3, 5	16	52 (11.1)	46 (7.8)	45 (7.2)	45 (7.2)	45 (7.2)	45 (7.2)	44 (6.7)	44 (6.7)	44 (6.7)	17-49	(-8.3-9.4)		
4 A-----	40 (4.4)	A/ch 3, 5	23	49 (9.4)	45 (7.2)	45 (7.2)	44 (6.7)	44 (6.7)	44 (6.7)	44 (6.7)	44 (6.7)	44 (6.7)	33-45	(0.6-7.2)		
B-----	42 (5.6)	A/ch 3, 5	23	48 (8.9)	43 (6.1)	41 (5.0)	41 (5.0)	41 (5.0)	41 (5.0)	41 (5.0)	42 (5.6)	42 (5.6)	27-45	(-2.8-7.2)		
5 A-----	38 (3.3)	A/ch 3, 5	15	48 (8.9)	42 (5.6)	39 (3.9)	38 (3.3)	38 (3.3)	38 (3.3)	37 (2.8)	37 (2.8)	37 (2.8)	30-42	(-1.1-5.6)		
6 A-----	38 (3.3)	Tight stack	22	49 (9.4)	48 (8.9)	44 (6.7)	42 (5.6)	42 (5.6)	42 (5.6)	41 (5.0)	41 (5.0)	41 (5.0)	27-46	(-2.8-7.8)		
7 A-----	38 (3.3)	A/ch 3	20	54 (12.2)	48 (8.9)	37 (2.8)	35 (1.7)	35 (1.7)	35 (1.7)	34 (1.1)	34 (1.1)	34 (1.1)	31-42	(-0.6-5.6)		

1/ A/ch 3, 5, i.e., air channels in 3d and 5th layers; MBB, modified bonded block; tight stack, boxes stacked in block stowage.
 2/ Initial loading into van container.

Cargo air and product temperatures were recorded at 1-hour intervals from time of loading at shipping point until unloading at destination. All temperature measurements were recorded using automatic temperature instruments with thermistor-type sensing probes. Twenty-four temperature probes were used in each van container. Eighteen probes monitored temperature at selected locations and 6 probes monitored ceiling, floor, discharge, and return air temperature in the van container (fig. 1). All product temperature probes were

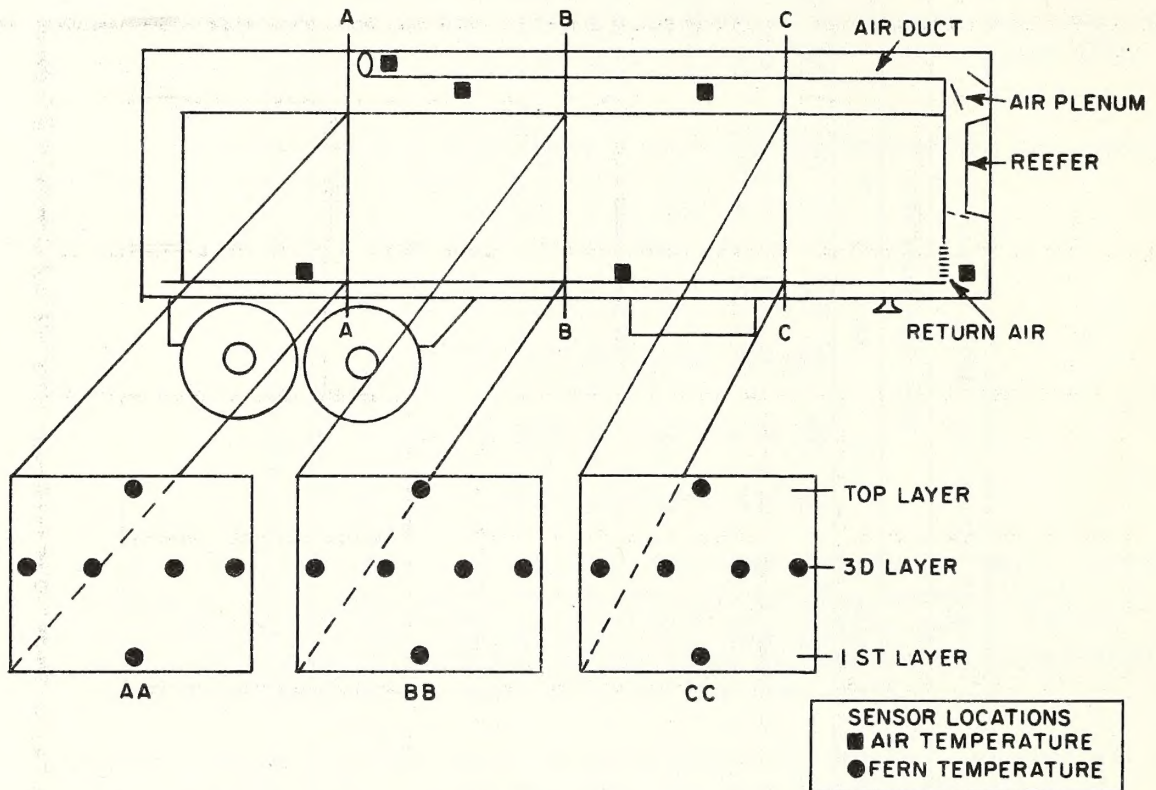

Figure 1.--Location of 6 cargo area air and 18 product temperature sensors in a typical test van container, showing end view through load.

placed in the center of a designated box in the center of a fern bunch. Temperatures were individually sensed and recorded by each probe and the data were processed and plotted by a computer.

Test shipments 1 and 2, consisting of four van containers, are selected for detailed discussion with temperature results depicted graphically. Major highlights are presented for test shipments 3-7. Test shipments 1-4 each consisted of van containers A and B, which were loaded by a single shipper and transported on the same voyage. Thus, both van containers A and B in each of the test shipments 1-4 were subjected to similar handling and environmental factors. The van containers in each particular test had similar refrigeration, insulation, and dimensional characteristics. The ferns in each van container were from several growers, but sample boxes used for observations were from

the same lot. Data collected in these shipments included the product temperatures relative to thermostat settings and loading patterns and the box and product condition on arrival.

In test shipment 1, boxes 30 x 21 x 11 and 30 x 21 x 6 inches (76.2 x 53.3 x 27.9 and 76.2 x 53.3 x 15.2 cm) were loaded in each van container. The 11-inch (27.9-cm) deep boxes were placed in the header stack (fig. 2) and the lower three layers of all remaining stacks (fig. 3). The

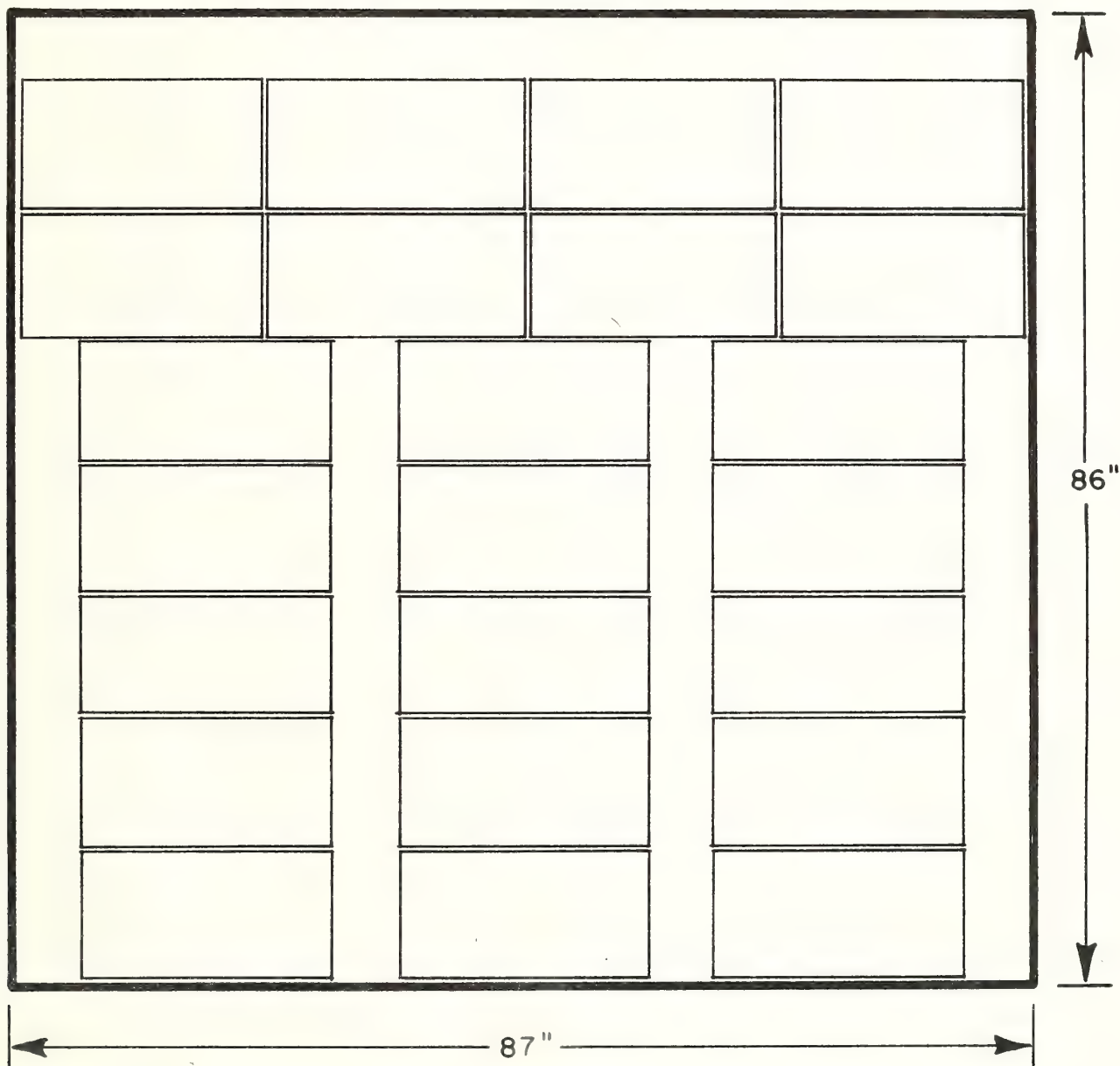

Figure 2.--End view of header stack (1st stack), with boxes 30 x 21 x 11 inches (76.2 x 53.3 x 27.9 cm) placed in van container.

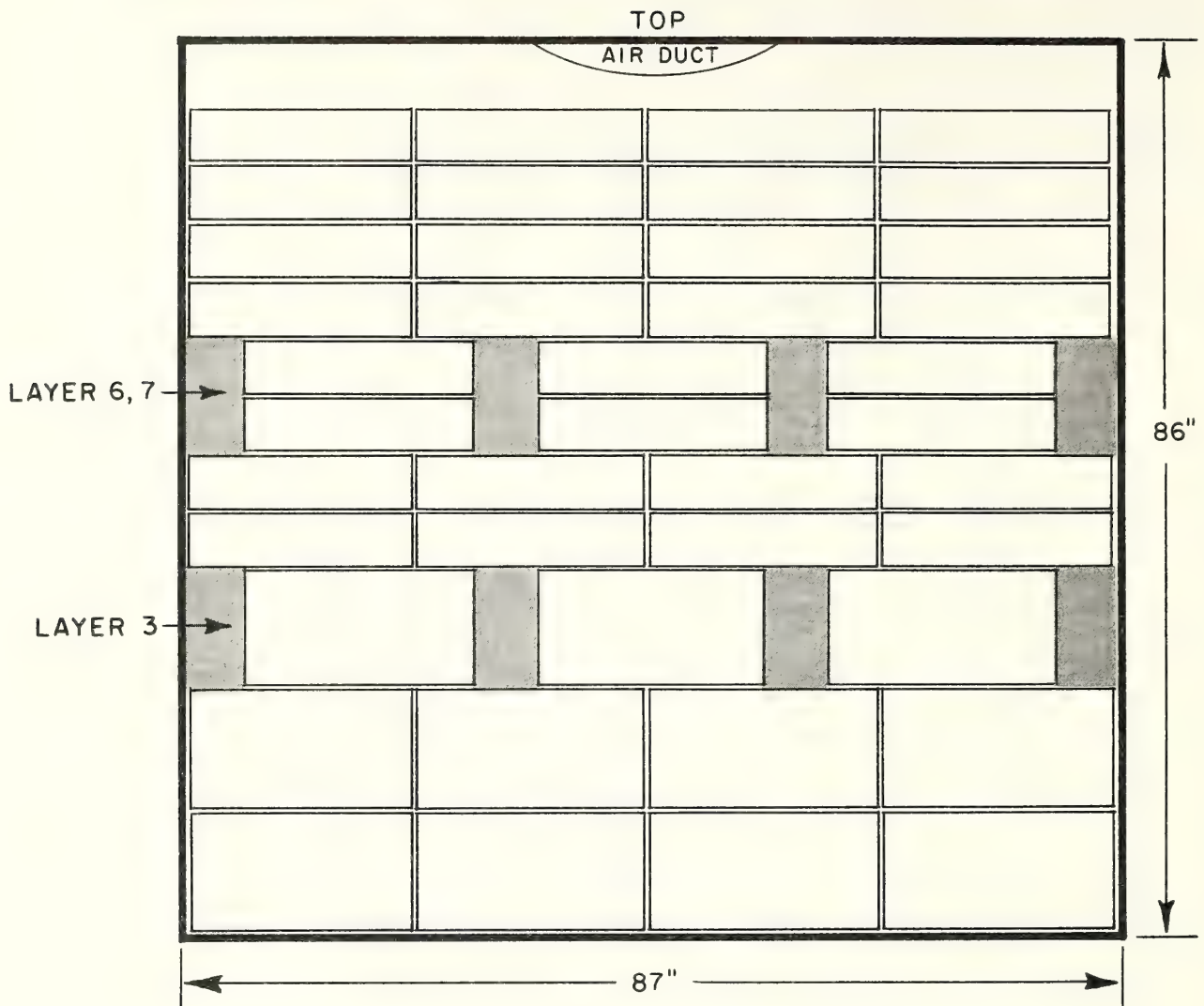

Figure 3.--Rear view of parallel air channel loading pattern used for boxes 30 x 21 x 11 and 30 x 21 x 6 inches (76.2 x 53.3 x 27.9 and 76.2 x 53.3 x 15.2 cm) in layers 3 and 6, 7. Air channels are shaded.

boxes were stowed so that nonrestricted parallel air channels were maintained the entire length of the load. In test shipment 2, van A, boxes 27 x 15 x 15 inches (68.6 x 38.1 x 38.1 cm) were stacked in a modified bonded-block pattern (fig. 4). In van container B of test 2, boxes 30 x 14 x 9 inches (76.2 x 35.6 x 22.9 cm) were stowed with parallel airflow channels in layers 3 and 6 (fig. 5).

Van containers used in test 1 measured 454 inches (11.53 m) long by 87 inches (2.21 m) wide and 86 inches (2.18 m) high (ID - internal dimensions). Refrigerated air was discharged through finger ducts at the ceiling and

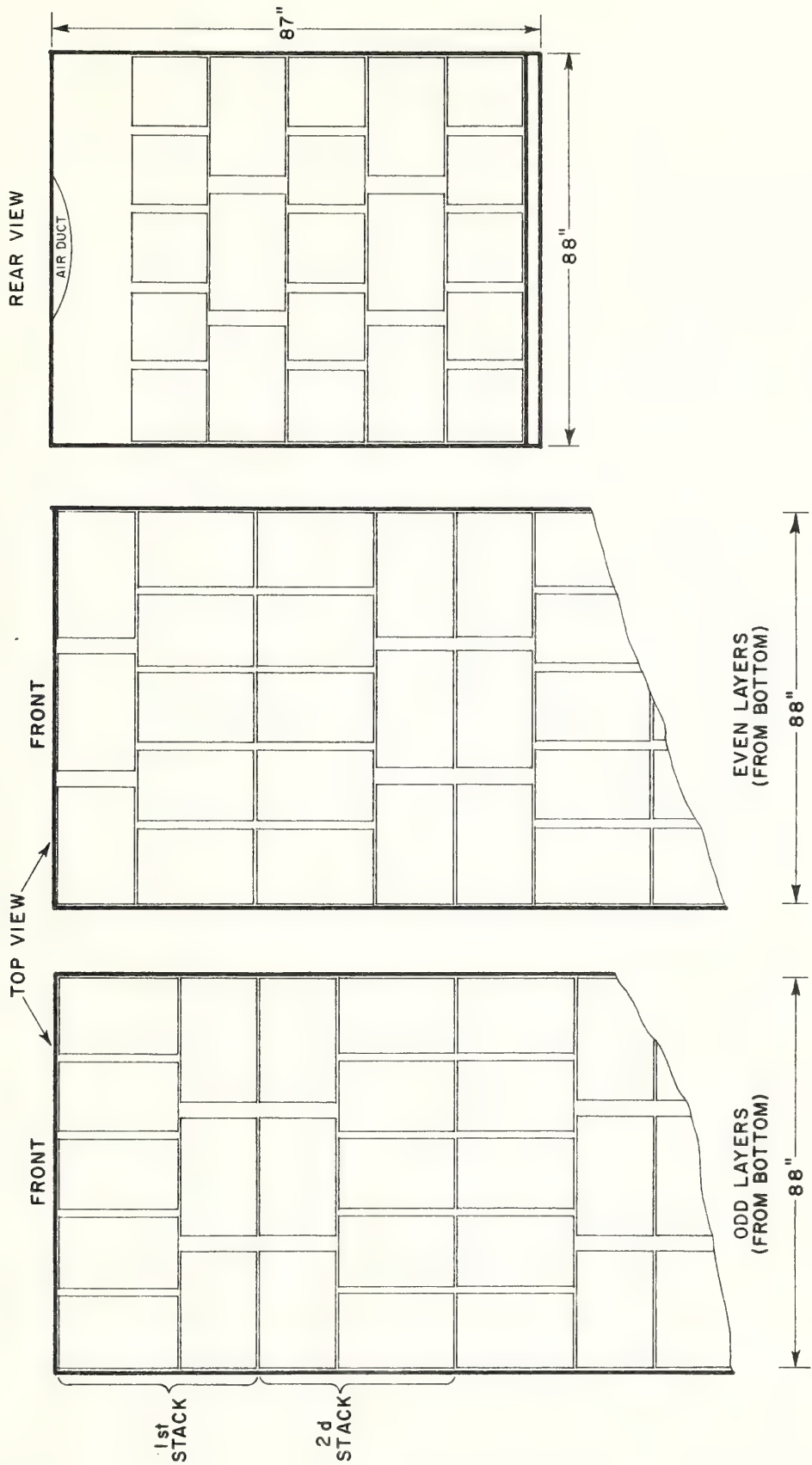

Figure 4.--Top and rear view of 5 x 3 modified bonded-block loading pattern used for boxes 27 x 15 x 15 inches (68.6 x 38.1 x 38.1 cm).

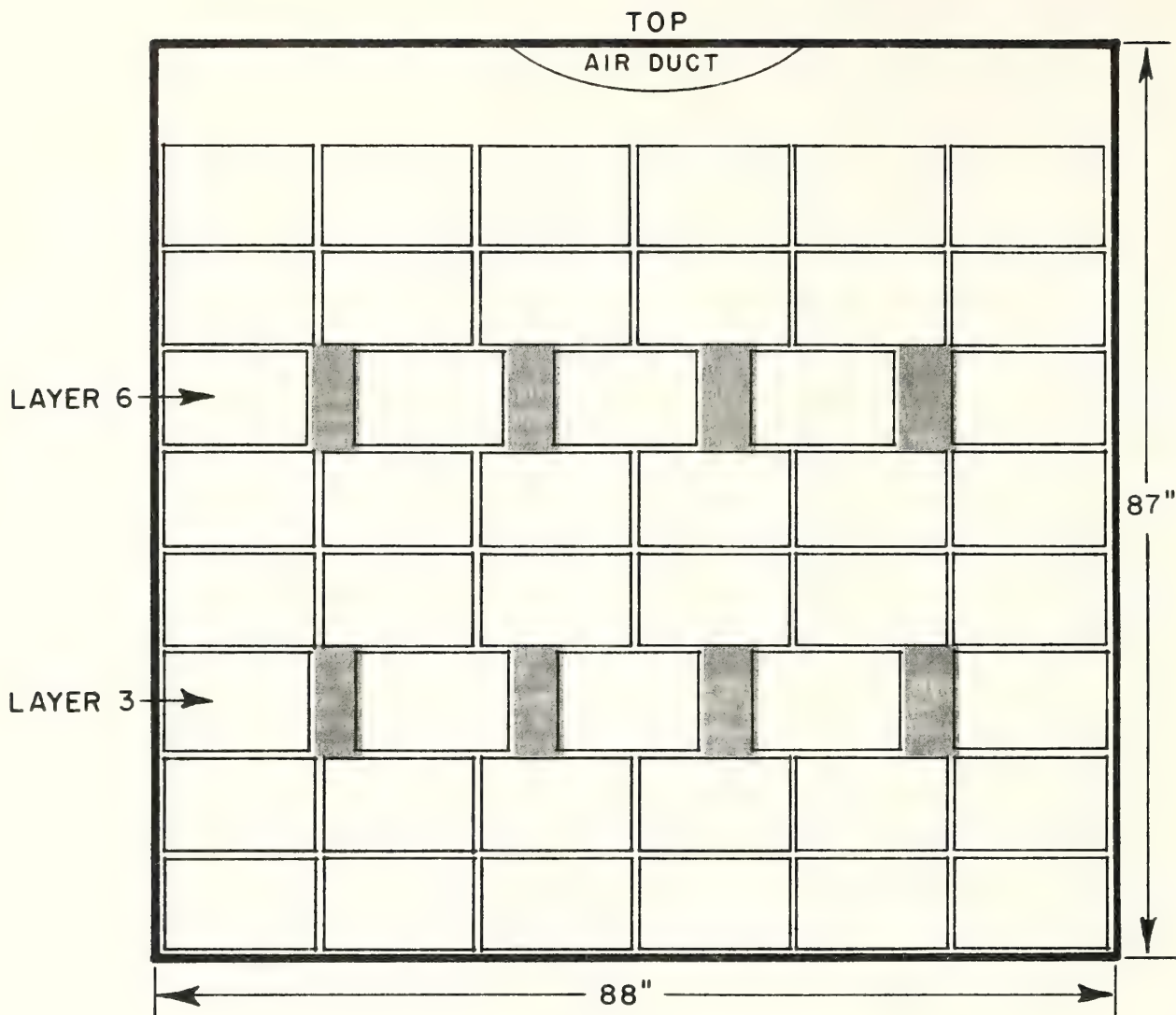

Figure 5.--Rear view of parallel air channel loading pattern used for boxes 30 x 14 x 9 inches (76.2 x 35.6 x 22.9 cm). Air channels in layers 3 and 6 are shaded.

returned to the refrigeration unit at the bottom of the forward bulkhead. Van containers used in test 2 measured 386 inches (9.80 m) long by 88 inches (2.23 m) wide and 87 inches (2.21 m) high (ID). Refrigerated air was discharged through a single duct extending approximately two-thirds the length of the van and returned to the refrigeration unit through 2-inch (5.1-cm) diameter holes in the lower half of the forward bulkhead and through an opening just forward of the "T" rails at the bottom of the forward bulkhead.

All shipments were destined for either the Netherlands or West Germany. Transit time varied from 10 to 23 days. The van containers were loaded at a cooperating shipper's warehouse in central Florida and trucked to the port of

Jacksonville, Fla. Van containers destined for the Netherlands were unloaded at the port of Rotterdam and trucked to the receiver's warehouse. Van containers destined for West Germany were discharged at either the port of Rotterdam, the Netherlands, or the port of Bremen, West Germany, and then trucked to the receiver's warehouse in Hamburg, West Germany.

Test shipments were loaded under the supervision of USDA researchers, who determined stowage patterns and thermostat settings and installed temperature monitoring instruments in the van containers. At destination, USDA researchers recovered the instruments and observed the condition of the ferns and the stability of boxes in the stowage pattern.

RESULTS

Temperatures recorded during all test loads include mean product temperatures at 24-hour intervals relative to the thermostat settings and loading patterns and the range of discharge air temperatures between 24 and 96 hours of transit time (table 1).

In test 1, thermostats on van containers A and B were set at 38° F (3.3° C). Mean fern, discharge, and return air temperatures for van containers A and B of test 1 are shown in figure 6. The automatic recorder monitoring temperatures in van container A malfunctioned after 148 hours. Initial mean fern temperature at loading in van A was approximately 60° (15.6°) compared with 45° (7.2°) in van container B. It stabilized near discharge air temperature in about 60 and 28 hours after loading in van containers A and B, respectively. Temperature of discharge air delivered by the refrigeration units in both van containers generally fluctuated between 30° and 38° (-1.1° and 3.3°). There was a greater difference between the extreme high and low product temperatures during the time product temperatures were decreasing in van container A as compared with van container B. This occurred because van container A had several lots of ferns that varied considerably in temperature prior to loading, whereas ferns in van container B were all the same temperature at loading. After product temperatures reached the recommended shipping temperature, they were rather uniform throughout the load mass, varying no more than 4° to 5° (2.2° to 2.8°). No freeze or heat damage of fern was observed in either van container in test 1.

In test 2, the thermostats on van containers A and B were set at 36° F (2.2° C) (fig. 7). Initial mean fern temperatures measured about 66° (18.9°) and 53° (11.7°) in van containers A and B, respectively. In both van containers, the large differences between the high and low product temperatures at loading were the result of mixed lots, some boxes precooled and others held prior to loading at ambient temperatures. In van containers A and B, approximately 60 and 48 hours, respectively, were required for mean fern temperatures to reach 40° (4.4°). After fern temperatures reached near the thermostat setting in both van containers A and B, they were relatively uniform throughout the load mass, varying no more than 4° (2.2°) during the remaining transit period. No freeze or heat damage was observed in either van container of this test. Since the corrugated boxes shipped in both tests 1 and 2 arrived in good condition and maintained excellent alignment during transit, the loading patterns performed satisfactorily.

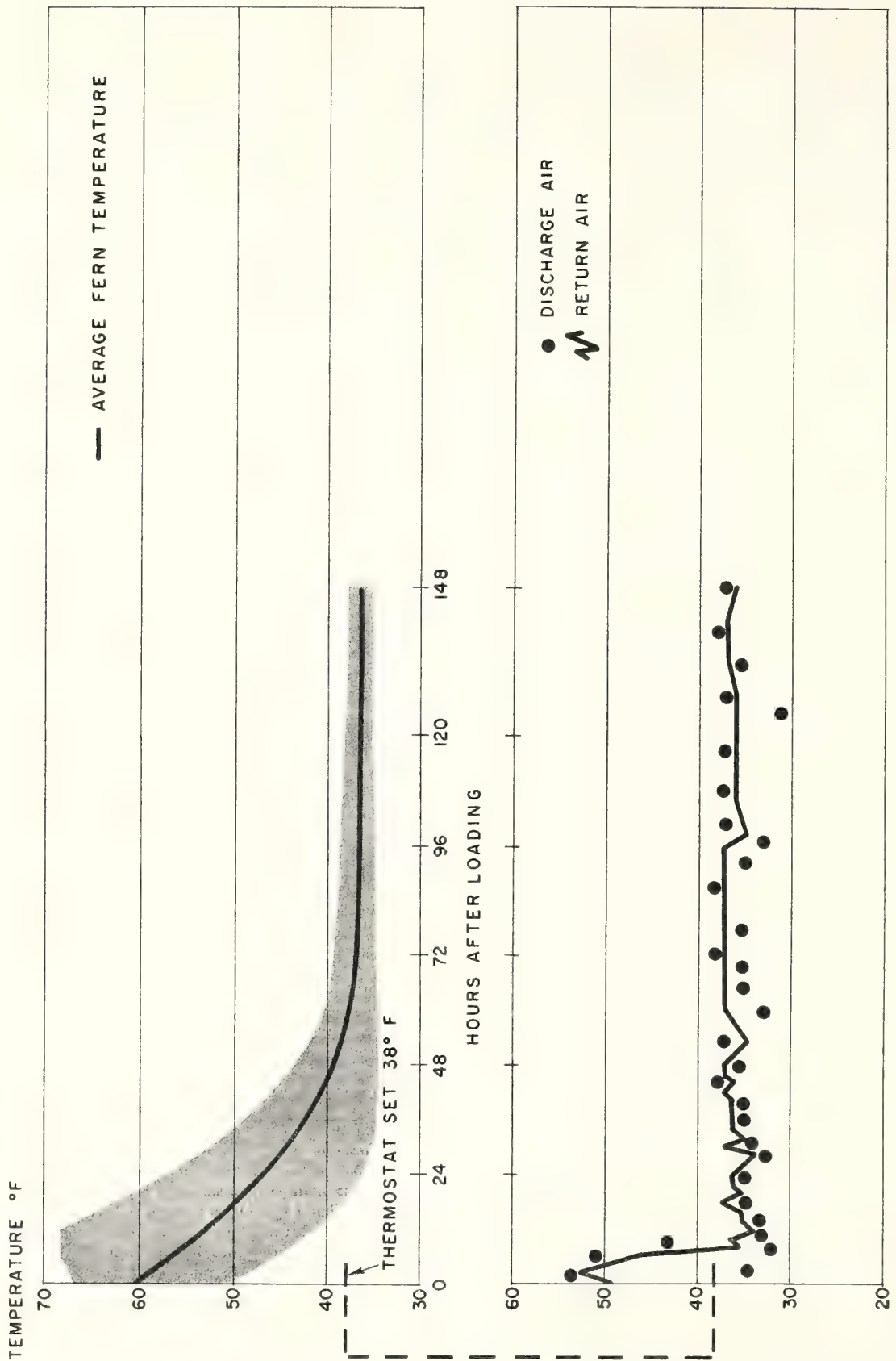

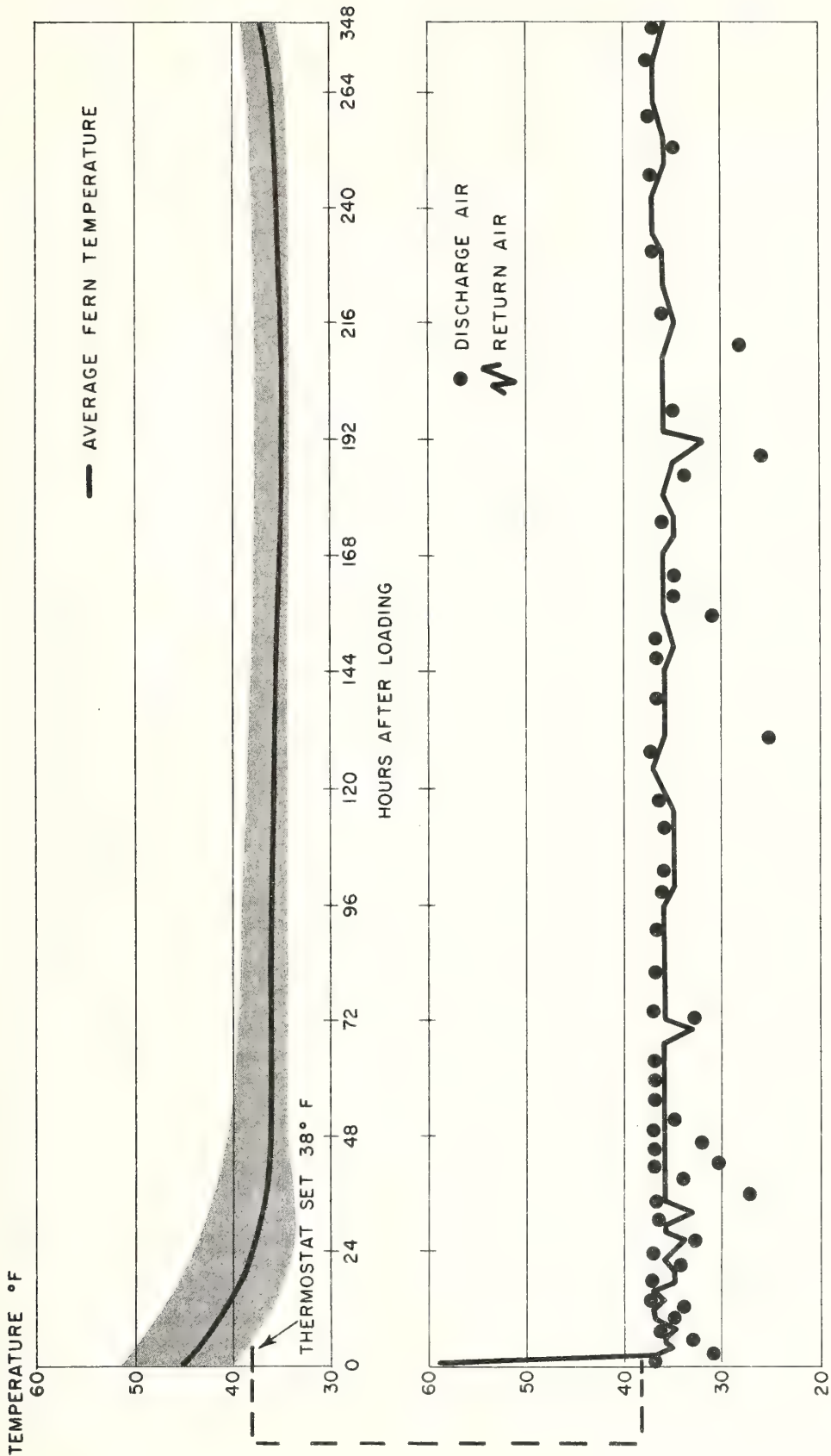
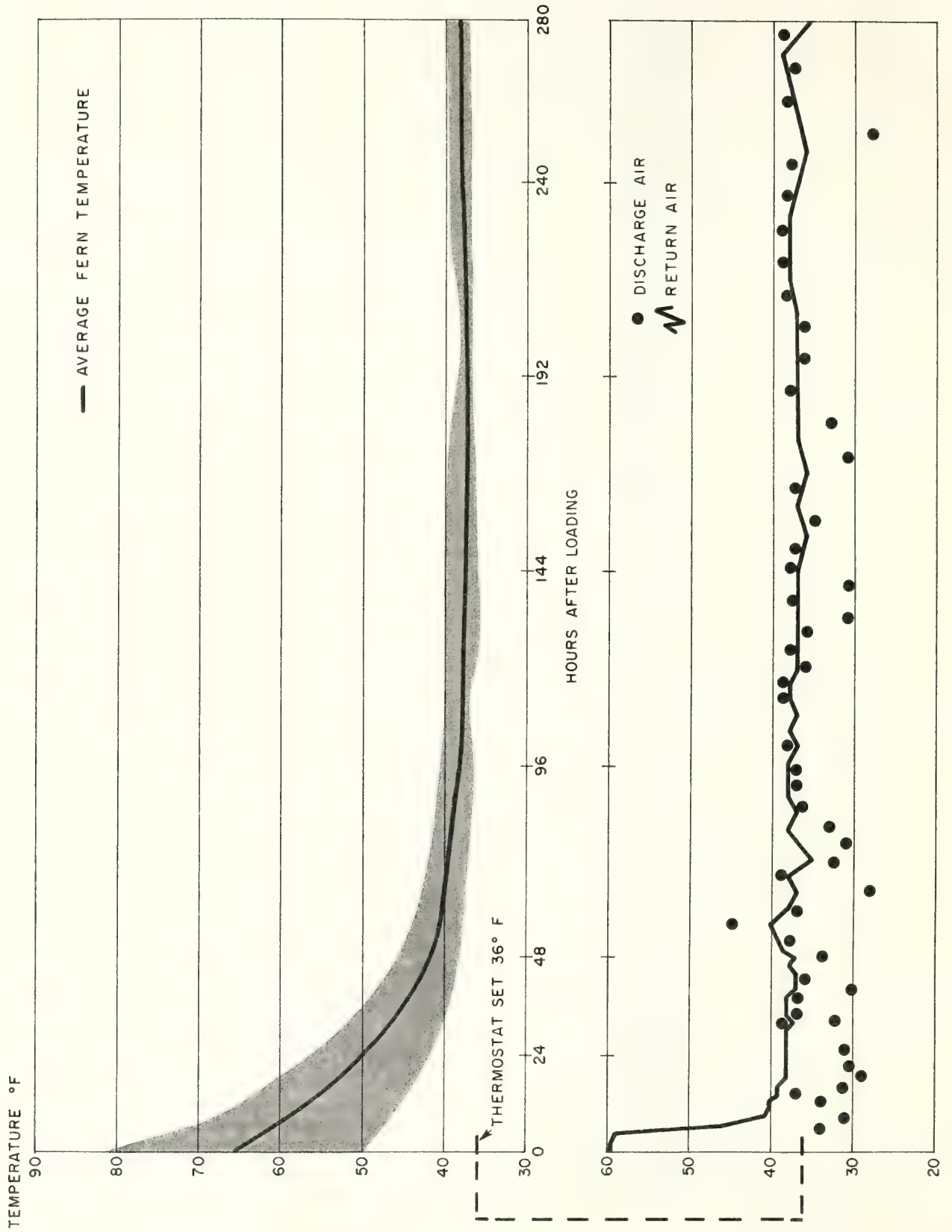

Figure 6.--Mean fern, discharge, and return air temperatures during transit in test 1 in van container A (above) and van container B (below). Shaded area encloses boundary for high and low temperature recordings.



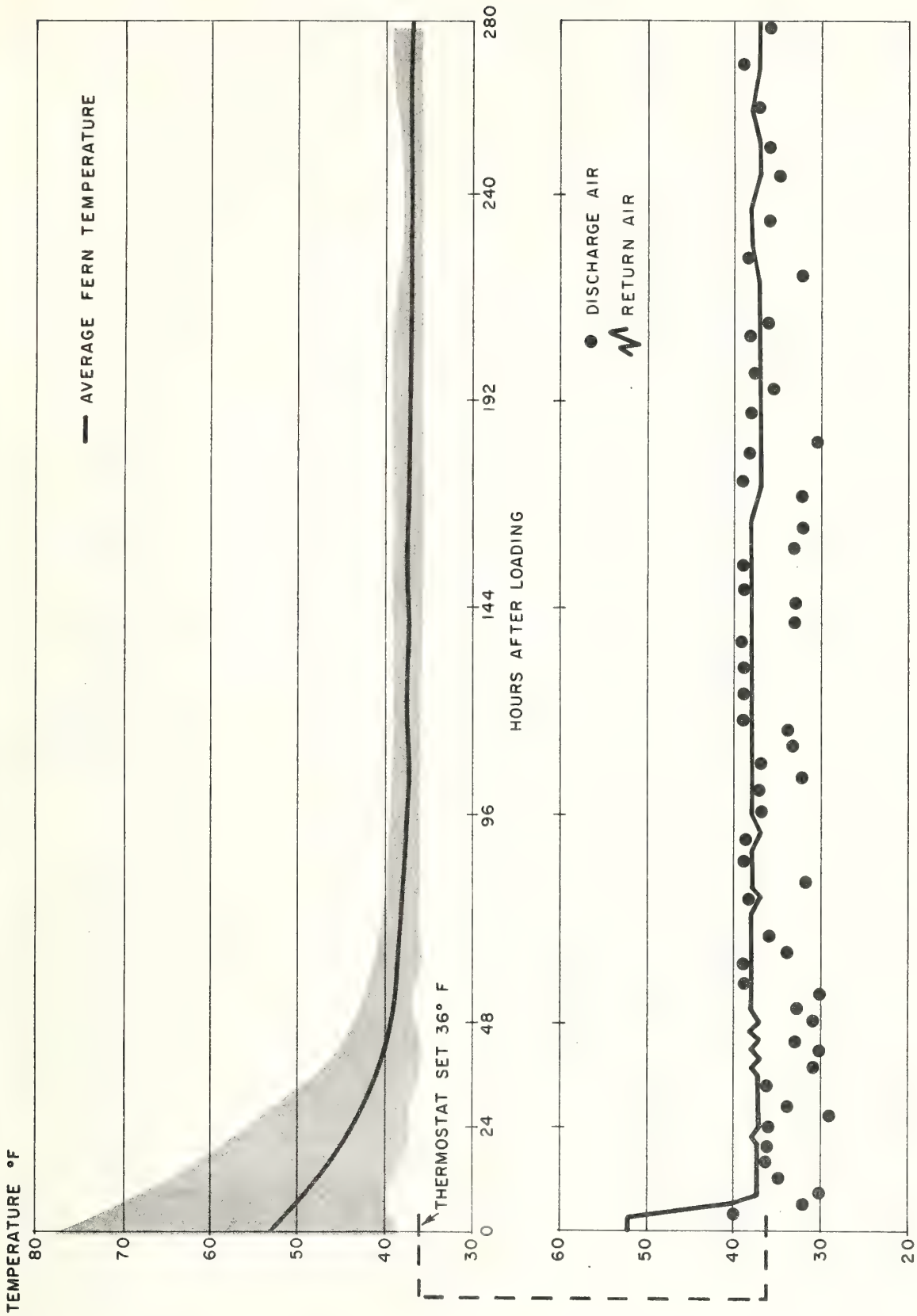

Figure 7.--Mean fern, discharge, and return air temperatures during transit in test 2 in van container A (above) and van container B (below). Shaded area encloses boundary for high and low temperature recordings.

In test 3, thermostats were set at 40° F (4.4° C) on van container A and at 38° (3.3°) on van container B. Discharge air temperatures fluctuated from 17° to 39° (-8.3° to 3.9°) in van container A and from 17° to 49° (-8.3° to 9.4°) in van container B. On arrival, some fern in boxes on the top layers of both loads had freeze damage. This indicated discharge air temperatures were too low for extended periods of time. The excessive low temperatures and range in discharge air temperature fluctuations indicate that in this particular test the thermostat sensing devices may not have been properly calibrated or that some other malfunction occurred. The boxes in both loads were stacked in parallel air patterns and box condition on arrival was excellent.

In test 4, thermostats on van containers A and B were set at 40° F (4.4° C) and 42° (5.6°), respectively. Initial fern temperatures at loading were relatively similar, 49° (9.4°) and 48° (8.9°). Discharge air temperatures ranged from 33° to 45° (0.6° to 7.2°) in van A and 27° to 45° (-2.8° to 7.2°) in van B. Boxes in both loads were stacked with parallel air channels in the third and fifth layers. The boxes arrived in excellent condition and maintained alinement during transit. No freeze or heat damage to ferns was observed.

Tests 5, 6, and 7 were of single van containers shipped at different times with thermostats set at 38° F (3.3° C). Boxes of fern shipped in each of these test van containers were stacked in different stowage patterns. Boxes were stacked in a parallel air channel (layers 3, 5), tight stack, and parallel air channel (layer 3) patterns in tests 5, 6, and 7, respectively. Mean temperature of fern in test 6 decreased more slowly during the first 48 hours than that in tests 5 and 7. This slower reduction can be related to the tight stack pattern, which restricts the free flow of air through the load mass. No freeze damage was observed to ferns shipped in these three tests. The boxes arrived in satisfactory condition and the loading patterns maintained excellent alinement.

CONCLUSIONS

The results of this study indicate that discharge air temperatures in commercially available van containers fluctuate considerably from thermostat settings. When relatively low thermostat settings are required (near but above 32° F (0° C) for chilled cargo, such as leatherleaf fern, a fluctuation below the freezing point of fern for a considerable time may cause freeze injury. Fluctuations in discharge air temperature are usually most extreme during the first hours after loading when product temperatures are stabilizing near the temperature of discharge air. Varying the thermostat setting as in these tests between 36° and 42° (2.2° and 5.6°) results in little degree difference in the spread of the temperature fluctuation of discharge air. The object then is to reduce the product temperature to recommended levels quickly and then maintain it at the recommended shipping levels of between 34° and 40° (1.1° and 4.4°) without freeze injury during transit. To accomplish this shippers must stow boxes in proper loading patterns, which will insure that refrigerated air is distributed throughout the load mass and returned unrestricted to the refrigeration unit. The thermostat should not be set below 36° (2.2°) or above 38° (3.3°). If a single thermostat setting will eliminate confusion for operators of equipment, we suggest 37° (2.8°).

This series of test shipments indicates that leatherleaf ferns can be transported to export markets in van containers and that they will arrive in excellent salable condition.

APPENDIX

The information in this appendix is provided as a quick reference of recommended handling and shipping practices that shippers should follow when exporting leatherleaf fern in van containers. This checklist was developed from the study described in this report and from previous research conducted with shipping perishable cargo. 5/ 6/

(1) Quality.--Ferns shipped to export markets should be free of injury, diseases, and pests. The fronds should be clean and free of soil and any debris. Each frond in a given bunch should be of uniform size and color and at the same relative stage of maturity. Most export markets utilize and prefer the large fronds, 18-21 inches (45.7-53.3 cm) in length, but some receivers request and use smaller fronds. It is important that frond size and quality be agreed upon between shipper and receiver prior to shipment.

(2) Pretransit Treatment.--After harvesting, ferns should be moistened with water and precooled to 34^o-40^o F (1.1^o-4.4^o C) as rapidly as possible. This can best be accomplished by placing bulk lots of ferns in cold storage for precooling before packaging. When fronds are dipped in a fungicide, this chemical must have clearance for entry into the importing country.

(3) Packaging.--Ferns should be packaged in moisture-resistant, corrugated fiberboard boxes, which should be either wax dipped or wax impregnated. These boxes should be constructed of at least 275-pound (124.7-kg) test weight material. Overfilled boxes result in damage to the ferns, and bulging causes severe misalignment of boxes during stowage. Boxes should be lined on all sides with perforated polyethylene that completely encloses the ferns. Perforated liners prevent excessive drying out and will allow improved air exchange and cooling.

(4) Van Containers.--Request newer model van containers that provide continuous air circulation because in some older units the fan only operates when the compressor is on.

(5) Pretransit Van Container Check.--The transport vehicle should be checked by the shipper or his agent for cleanliness, proper refrigeration operation, and other mechanical operations prior to dispatching the vehicle for

5/ Miller, W. R., Moffitt, T., Risse, L. A., and others. Importance of handling and shipping practices in exporting leatherleaf fern via van containers. South. Floral and Nurseryman Mag. 90 (1): 16, 17, 35-37. Mar. 1977.

6/ Miller, W. R., and Risse, L. A. Recommendations for handling and shipping cut leatherleaf ferns for European markets. Fla. Ornamental Growers Assoc. Newsletter 3, 8 pp. May 1978.

loading. This also applies to a second vehicle if the fern is transferred to another van for the ocean voyage. Specifically, the following items should be checked:

(a) The electrical generator unit and refrigeration system should be placed in operation and all functions checked, including the heating and defrost mechanisms.

(b) The thermostat should be set at the desired transit temperature of 36°-38° F (2.2°-3.3° C) and the unit allowed to operate until the set point is reached. Once the set point is reached, the unit should be observed through several on/off cycles, in which the thermostat controls the unit around the set point. If the indicating thermometer on the unit varies more than $\pm 3^\circ$ from the set point, the carrier should be notified so that repairs or adjustments can be made before the loading proceeds.

(c) All doors should close tightly and maintain an adequate seal.

(d) Ducts should be examined to be sure they are installed properly.

(e) The floor drains should be checked to make certain they are operable and not clogged with debris.

(f) The cleanliness of the van should be verified before loading.

(g) If any of these items are not met, the carrier should be notified and the deficiencies corrected before loading the vehicle.

(6) Transit Environment.--During transit, the recommended temperature for leatherleaf ferns is 34°-40° F (1.1°-4.4° C) and the relative humidity 90-95 percent. The thermostat setting of the transport vehicle should be based on the outcome of the pretransit vehicle check, but the thermostat generally must be set from 36° to 38° (2.2° to 3.3°) to avoid product freeze damage. Both the ferns and the transit vehicle should be precooled to the required shipping temperature before final loading.

(7) Loading Pattern.--The most important factor in loading van containers is to use stowage or stacking patterns that permit adequate air circulation and distribution through the load. In conventional van containers, air channels should be provided lengthwise through the load. This can be accomplished either by stacking the boxes in a modified bonded-block pattern or by providing parallel air channels in selected layers. In this way, product temperatures will equalize with the vehicle's refrigerated air temperature as quickly as possible and will permit fern temperatures to be uniformly maintained throughout the load.

(8) Bracing.--Boxes should not be stacked beyond the "T" rails at the aft end of the floor of van containers. If there is a void space between the rear vertical surface of the load and the inside of the rear doors, bracing should be used to keep the boxes at the rear from shifting back against the rear doors. Shifting may cause severe restriction of air circulation around the perimeter of the load, prevent air movement in the air channels, and thus

cause severe misalignment and crushing of the rear boxes. Bracing is a simple, inexpensive device and should be used when needed.

(9) Care of Ferns During Distribution and Marketing.--Cut ferns are highly perishable and must be handled properly during marketing. Proper handling assures that the ferns will arrive in optimum condition and will have a reasonable shelf life. Proper handling includes those factors previously described. On arrival, ferns should be kept in shipping containers and held under refrigeration during temporary storage and distribution to wholesale and retail markets. Temperatures during this period should be maintained at 34^o-40^o F (1.1^o-4.4^o C) and fronds should not be allowed to dry out.

**U.S. DEPARTMENT OF AGRICULTURE
SCIENCE AND EDUCATION ADMINISTRATION
WASHINGTON, D.C. 20250**

**OFFICIAL BUSINESS
PENALTY FOR PRIVATE USE, \$300**

**POSTAGE AND FEES PAID
U. S. DEPARTMENT OF
AGRICULTURE
AGR 101**

