

FARM SHOP WORK

BRACE AND MAYNE

UC-NRLF



B 3 135 358

GIFT OF

F. L. Griffin

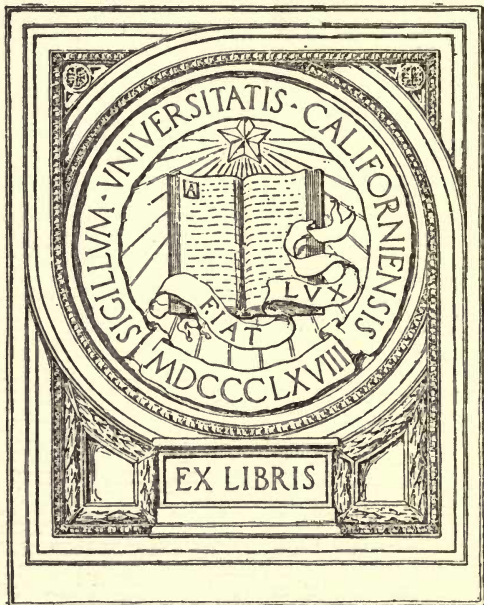

EX LIBRIS

FARM SHOP WORK

PRACTICAL MANUAL TRAINING

BY

GEORGE M. BRACE

DIRECTOR OF MANUAL TRAINING, CENTRAL HIGH SCHOOL
ST. PAUL, MINNESOTA

AND

D. D. MAYNE

PRINCIPAL OF SCHOOL OF AGRICULTURE AND PROFESSOR
OF AGRICULTURAL PEDAGOGICS, UNIVERSITY
OF MINNESOTA

WITH AN INTRODUCTION

BY

C. A. PRÖSSER

SECRETARY OF THE NATIONAL SOCIETY FOR
THE PROMOTION OF INDUSTRIAL EDUCATION



AMERICAN BOOK COMPANY

NEW YORK

CINCINNATI

CHICAGO

TT169
B7

Gift
F. L. Griffin

COPYRIGHT, 1915, BY
GEORGE M. BRACE AND D. D. MAYNE

FARM SHOP WORK
E. P. 2



AMERICAN BOOK COMPANY
NEW YORK

INTRODUCTION

By C. A. PROSSER

SECRETARY OF THE NATIONAL SOCIETY FOR THE PROMOTION
OF INDUSTRIAL EDUCATION

THIS book is written primarily for pupils taking agriculture in elementary and secondary schools, and for pupils in the practical arts work of schools in rural communities; but it also has suggestions of great merit for farmers and others who have to deal in any way with the varied repair and construction problems of farm and village life.

Not until the rural schools realize that their manual training and shop work must be entirely different from that of the city schools will they serve properly the vocational needs of the children who are to spend their lives on the farm or in the village.

The aim of the practical arts courses in agricultural communities should be to give the boy at least an elementary experience in every form of manual work required to make an independent and successful farmer on his home acres. Such training will make the farm more attractive. It will also equip the farmer for more successful work in agriculture, both because he is prepared to meet the everyday demands of his calling and because he is saved the time and expense of relying on the village mechanic for much that the school should prepare him to do.

In most of our thinking to-day on the subject of manual training or practical arts in the rural schools, we have stopped with the idea of woodwork. Too often this woodwork is taught with little reference to its connection with the home life and agricultural career of the boy. The courses and methods have been borrowed all too frequently from the work of the city schools.

The farm boy and man must work in wood: in the making of fences, in the repair of tools and machinery, and in the repair and construction of farm implements, conveniences, and buildings. It is far more important that he should know how to deal with wood in these things than that he should be highly skilled in the making of mission furniture. It is training in the work of the ordinary rough carpenter rather than in that of the finished furniture maker that will be most beneficial to the farmer. He needs to know how to handle all the ordinary tools of the carpenter and how to put wood together. His practice should be on farm things and should result in a usable output of farm things.

An outfit of ordinary farm implements of the simplest kind can be constructed for the use of the school. Pupils should be encouraged to bring from home articles that need to be repaired. They should also be encouraged to set up a workshop on the farm and to do more extensive and ambitious repair and construction jobs, as supplementary to the school instruction. It goes without saying that successful results can only be secured when the teacher in charge of this training is not only able to sense the demands of the farm home

by having actually experienced them, but is also able intelligently to direct the efforts of the boy.

The farmer must know how to shape iron for uses in all sorts of things. The school should be equipped with a small forge, and the boy be trained in the forging and tempering of iron, the cutting and soldering of sheet metal. He should be trained to think his problem through by making at least rough diagrams of his plans in dealing with material of all kinds.

He should be able to meet successfully emergency repairs on harness and belting. This means that the school should give him an elementary experience in the cutting, shaping, fitting, and sewing of leather, which can only result from training in actual repair problems.

The use of cement on the farm is increasing enormously. The ordinary farmer can now with some instruction use it successfully for most of the purposes for which it is employed in the country home. Hence it follows that the school should give the boy instruction in such things as the making of molds for cement work, the laying of foundations and the construction of posts, floors, and walks.

One of the most difficult questions confronting the work in industrial education to-day is the kind of industrial training which should be offered in villages and small towns. The diversified character of its industrial life, sometimes the entire absence of manufacturing, together with the certainty that only a small number of persons would care to be, or should be, trained for any one occupation, make it impossible for these small communities to undertake any program of industrial education which aims to give specific

preparation for any one industry or trade. This has, in many cases, prevented such places from undertaking any work whatever of this character.

The solution of the problem in my opinion lies in a course in the practical arts in the upper grades and in the high school, which will serve a double aim. It will give the village boy an experience in manual work from which he will derive all the customary values, and which will fit him to be a "jack of all trades," if he so elects. At the same time it will give the boy from the farm a training in a range of activities which will fit him to meet, as a "jack of all trades," the ordinary everyday demands of farm life.

This book has been written from such points of view as the foregoing, and will find its largest field of usefulness as a text or reference book in the hands of pupils of rural elementary and secondary schools. It offers a course of instruction in farm shop work which includes working the four fundamental materials used on the farm — wood, metal, leather, and cement. All the jobs undertaken by the pupil deal in a very practical way with the repair or construction of things which are used in the actual work of the farm. For example, the woodworking covers instruction in the making of the bench hook, level square, sawbuck, porch chair, clothesrack, clothes-tree, seed testing box, sheep feeding trough, trap nest, chicken feed box, wagon-jack, hammer handle, plank drag for roads, sewing horse, trussed ladder, combination ladder, farmer's level, corn rack, cattle rack, hog cot, wagon box, workbench, tool chest.

The treatment of each task which the pupil is to undertake is excellent from the standpoint of good

teaching. Throughout the language is simple and the explanations and directions clear. Each new article to be made is described and its use explained at the outset. Numerous illustrations illuminate the text.

From the outset, the pupil is engaged in the making of usable things. The assignment of work is by separate jobs or projects to individual pupils. The aim is to lead him to an understanding through practice rather than through either theory alone or through unapplied exercises. The realness and usefulness of the work performed will undoubtedly appeal to the interest of both the boy and his parent. The pupil is led gradually to rely more and more upon the text and less upon the teacher, which promotes self-help, an indispensable asset to the worker on the farm and in the farm shop. The book offers on every page excellent suggestions to the boy who has unoccupied time on his hands and makes possible school credit for shop work done at home. Practice and thinking about the practice, doing useful things while at the same time the work is directed and interpreted — this is the cardinal principle on which the treatment of practical arts work has been based throughout.

The farmer will find the book a mine of information as to all such things as the care and use of shop tools, the repair and construction of farm implements, devices and buildings of all kinds. School boys will have in it an admirable guide in undertaking to make either at home or at school useful things which have a definite and helpful place in country, village, and town life. It should give them a genuine interest in the repair and construction of new as well as familiar things and make

them self-reliant workers relieved from dependence on the specialist for much of the ordinary mechanical work of the country district.

The book carries a special message also to the teacher who is in any way engaged in the teaching of manual training, practical arts, or shop work in the rural, consolidated, or agricultural high school. Throughout, the vocational opportunities of practical arts work in its application to agricultural life are emphasized. Teachers are too often singularly lacking in a conception of the purpose and possibilities of farm shop work as it has been taught in the schools. When they have been trained in manual training classes dealing almost entirely with the problems of the work in cities or with more or less traditional courses, they find it difficult to adjust their courses and methods to meet rural conditions and requirements. They need, as all of us as teachers do, to have their work interpreted in terms of its use in the lives of their students, as the authors have done.

Even the unskilled teacher of the country school entirely without experience in handling the matter, will find in the book a wealth of suggestions as to what country boys might do, and how they can be helped to do it.

The authors have brought to their task a long, varied, and intimate experience in dealing with the farm and school problems of the great agricultural state of Minnesota. They have sensed a real need of the rural schools and have offered what in my opinion is the only sound basis for the solution of "prevocational," "practical arts," "manual training," or "industrial training" for the children of our small towns and rural districts.

PREFACE

THE purpose of this book is to provide a series of projects in woodworking, blacksmithing, cement and concrete work, and harness mending. These exercises will not only furnish valuable training in the practical arts, but will also result in the making of many things that are of great use on the farm.

In case the time devoted to industrial work is too short for the class to do all the regular exercises provided in this book, the teacher should select those that involve the uses of the most common tools and the description of the most important processes. If more time is allotted to industrial work than is necessary for the regular exercises, the supplementary projects may be undertaken. The making of furniture should not be commenced until the pupil has mastered the woodworking tools.

The pupil should be required to make in pencil a complete working drawing with full-size details of the project he is about to make. Plans for farm buildings should be required as supplementary work in drawing. The teacher should standardize his work by requiring a definite procedure to be followed in tool operations. After a standard of manipulation has been adopted, the work of the class should be held to that standard.

The authors are indebted to C. G. Schulz, Superintendent of Public Instruction, Minnesota, to A. V.

Storm, Professor of Agricultural Education, University of Minnesota, and to many teachers of manual training in the rural communities of Minnesota for their helpful suggestions in the preparation of the manuscript. Credit for the exercises given under the subject of Blacksmithing is due Mr. A. D. Johnston, Instructor in Forging, Agricultural College of Minnesota. Thanks are due the several publications which have granted permission to use the designs accredited to them in the text.

CONTENTS

WOODWORKING

LESSON	PAGE
I. BENCH HOOK	1
II. LEVEL SQUARE	10
III. SAWBUCK	20
IV. FOLDING SAWBUCK	27
V. PORCH CHAIR	31
VI. CLOTHES RACK	36
VII. CLOTHES TREE	39
VIII. SEED TESTING BOX	44
IX. SHEEP-FEEDING TROUGH	49
X. CHICKEN FEED BOX	56
XI. TRAP NEST	61
XII. WAGON JACK	66
XIII. HAMMER HANDLE	71
XIV. PLANK DRAG FOR ROADS	75
XV. SEWING HORSE	79
XVI. TRUSSED LADDER	85
XVII. COMBINATION LADDER	89
XVIII. FARMER'S LEVEL	96
XIX. LEVELING ROD	105
XX. THREE HORSE EVENER	109
XXI. FARM GATE	113
XXII. CORN RACK	118
XXIII. CATTLE RACK	122
XXIV. HOG COT	127
XXV. WAGON BOX	133
XXVI. WORK BENCH	138
XXVII. TOOL CHEST	146
XXVIII. TIMBER	159
XXIX. WOODWORKING TOOLS	165

LESSON	PAGE
XXX. USES OF THE STEEL SQUARE	177
XXXI. GLUE IN WOODWORKING	185
XXXII. FILING SAWS AND GRINDING EDGE TOOLS	189
 BLACKSMITHING 	
XXXIII. THE FORGE AND ANVIL	198
XXXIV. STAPLE	201
XXXV. GATE HOOK	204
XXXVI. BOLT	207
XXXVII. CHAIN AND HOOK	210
XXXVIII. SWIVEL	217
XXXIX. TONGS	221
XL. WRENCH	224
XLI. HARNESS HOOK	227
XLII. IRONS FOR WAGON JACK	229
XLIII. IRONS FOR THREE-HORSE EVENER	230
XLIV. IRONS FOR PLANK DRAG	234
XLV. IRONS FOR COMBINATION LADDER	235
XLVI. IRON FOR LEVELING ROD	237
XLVII. IRONS FOR FARM GATE	238
XLVIII. IRONS FOR CATTLE RACK AND CORN RACK	239
XLIX. IRONS FOR WAGON BOX	240
L. TOOL STEEL	242
 CEMENT AND CONCRETE WORK 	
LI. CEMENT AND CONCRETE	246
LII. SIDEWALKS AND FLOORS	252
LIII. FOUNDATION WALLS AND STEPS	256
LIV. CONCRETE TROUGHS	259
LV. FENCE POSTS	264
 LEATHER WORK 	
LVI. HARNESS MENDING	269
SUGGESTIONS FOR ADDITIONAL WORK	275
INDEX	287

WOODWORKING

LESSON I

BENCH HOOK

STOCK

- 1 pc. white pine $\frac{7}{8}'' \times 4\frac{1}{2}'' \times 8\frac{1}{2}''$ 4 screws $1\frac{1}{2}''$, No. 8, F. H. B.
1 pc. white pine $\frac{7}{8}'' \times 1\frac{3}{4}'' \times 4\frac{1}{2}''$ (F. H. B. = flat head, bright)
1 pc. white pine $\frac{7}{8}'' \times 1\frac{3}{4}'' \times 4''$

TOOLS

Rule	Marking gauge	Plane
Try-square	Saw	Brace and bit
		Screw driver

OPERATIONS

1. Laying out.
2. Surfacing one side.
3. Planing one edge.
4. Squaring one end.
5. Laying out length, width, thickness.
6. Planing to thickness.
7. Sawing to length.
8. Planing to length.
9. Sawing to width.
10. Planing to width.
11. Making blocks.
12. Laying out screw holes.
13. Boring screw holes.
14. Assembling.

In explaining this first exercise, it is assumed that

the pupil knows nothing about the operations. Even though he has performed some of them many times before, it will be to his advantage to follow directions as carefully as though it were the first time he ever

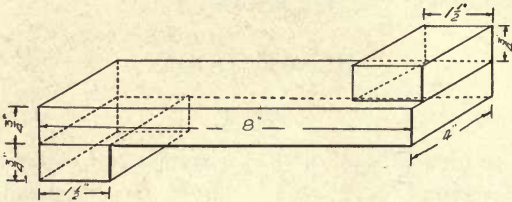

FIG. 1.—WORKING DRAWING OF BENCH HOOK.

held tools in his hands. Follow directions carefully. Do not hurry.

1. Lay out the dimensions on a piece of white pine board.

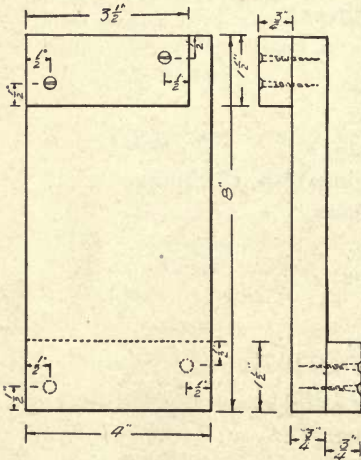

FIG. 2.—WORKING DRAWING OF BENCH HOOK, TOP AND SIDE VIEWS.

so the pieces should be laid out a little larger than the finished dimensions. (*Laying out* means marking the lines that represent the shape and sizes of the various pieces which, when cut out and put together, or assembled, make the exercise.) The first operation in laying out is to select an end nearly square with one edge of the board. If neither end is square, square a

line across one end with a try-square and saw on this line.

With the rule measure off $8\frac{1}{2}$ " from this end. In measuring with a rule, do not lay it flat down on the board; stand it on edge so that the marks on the rule meet the surface of the board. In this way the knife blade can touch the mark on the rule and the wood at the same time. (See Fig. 3.) If this method is followed always, there will be no excuse for making mistakes in measurements; if the rule is laid flat, the measurements will likely be inaccurate. When it is necessary to make

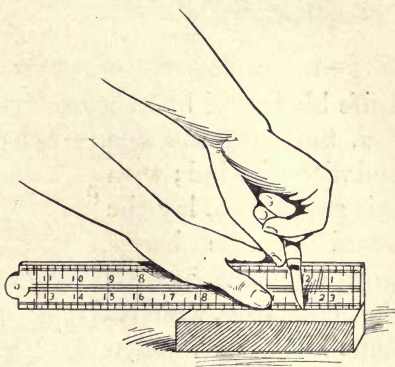

FIG. 3.—POSITION OF RULE IN MEASURING.

more than one measurement, if the rule is not raised from the work, the chance of making mistakes is thereby lessened. If the board is too wide, the width should be measured also.

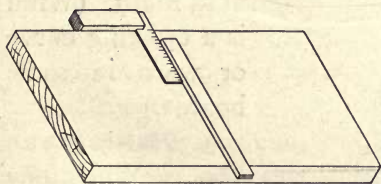

FIG. 4.—SQUARING ACROSS A WIDE BOARD.

With the try-square on the $8\frac{1}{2}$ " mark, line across the board. If the board is wider than the length of the blade of the try-square, use a carpenter's steel square, or extend the length of the blade as shown in Fig. 4, by placing a rule on

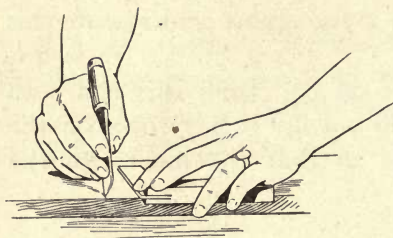

FIG. 5.—PLACING THE KNIFE BLADE ON POINT.

the board against the blade of the try-square, and lining across with this. In using the try-square place the knife blade on the point; move the blade of the

try-square up to the knife blade and line across. (Figs. 5 and 6.)

2. **Surfacing one side.**—Select a surface that is flat and without wind; with this surface up, lay the board on the bench with one end against the bench stop, which is some kind of a wooden or iron plug projecting from one end of the bench; and with the plane, plane the surface smooth and flat. Test the surface across the grain and with the grain by the try-square as in Fig. 7. (Wind is a twisting curve or warp in some boards.)

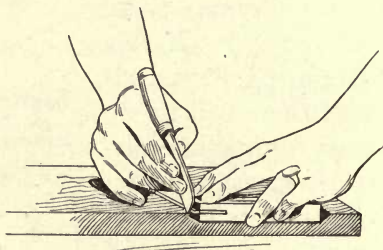

FIG. 6.—USING THE TRY-SQUARE.

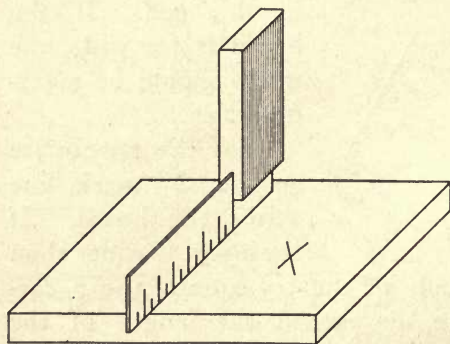

FIG. 7.—TESTING SURFACE OF BOARD.

3. **Planing one edge.**—When one surface is planed smooth and true, two witness marks (see Fig. 7) are made on this sur-

face. (Wind is a twisting curve or warp in some boards.)

face near one edge; this edge is next to be trued up square with the surface. Place the board in the vise

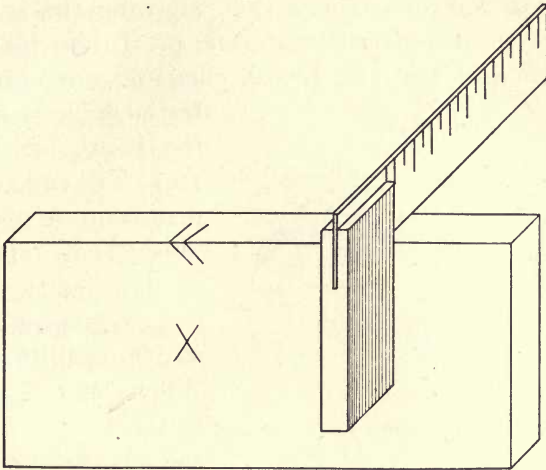

FIG. 8.—USING TRY-SQUARE TO TEST A SQUARE CORNER.

and plane until the edge is square with the surface just finished. Its truth can be tested by the try-square. (See Fig. 8.) When true, two more witness marks are drawn on the edge ending at the surface.

4. Squaring one end.

—In squaring up one end, place the board upright in the vise with the finished edge next

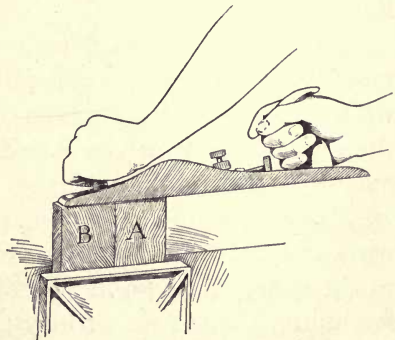

FIG. 9.—ONE METHOD OF PREVENTING SPLINTERING IN USING PLANE.

to the body; when planing across the grain, to prevent the blade from splintering off pieces from the farther

edge, either place a block of waste material back of the farther edge and on a level with the end of the board, *B*, Fig. 9, and plane across this, allowing the splinters to come from the waste material; or, if there is enough waste material in the board, chisel off one corner on

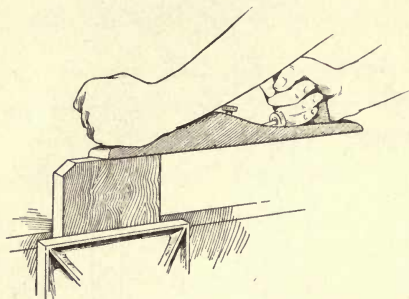

FIG. 10.—ANOTHER METHOD OF PREVENTING SPLINTERING IN USING PLANE.

the edge farthest from the body. (See Fig. 10.) The end must be made square with the finished edge, also with the finished surface.

5. **Laying out length, width, thickness.**—When one end is squared up, lay out the length by measur-

ing 8" from the squared end and square across with a knife and try-square, resting the beam against the finished edge.

Lay out the width with the marking gauge; set the guide of the gauge at the 4" mark on the beam and, with the guide resting against the finished edge, gauge the entire length of the board. The thickness is laid out with the marking gauge set at $\frac{3}{4}$ ". The proper way to set the guide of the marking gauge is to measure with the rule the distance required from the guide to the spur, as shown in Fig. 11. In holding the gauge for lining, Fig. 12 shows how the tool is grasped in the hand with the thumb in front of the spur and the first finger over the guide. Tip the beam so the spur just touches the wood. In laying out the thickness of the board, measure off $\frac{3}{4}$ ", and with the guide resting against

the finished surface gauge around on all four edges. The gauge should be used in laying out the width. Where large measurements are required, it is very difficult to hold the gauge so it will score accurately; and, besides, the beam is not long enough for very large measurements.

6. **Planing to thickness.** — When the thickness has been gauged, the board

should be planed to this thickness. The same care that was used on the other sides should be exercised in planing this surface.

7. **Sawing to length.** — When this work is done, the

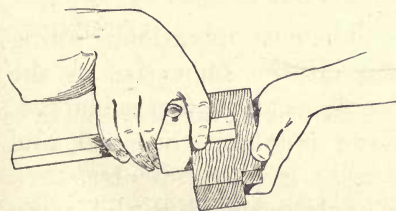

FIG. 12.—USING THE MARKING GAUGE.

piece should be sawed to length, sawing just outside the knife mark made in laying out the length. It is necessary to leave a little wood outside the line so it will be possible to plane

the end down smooth and square without making the board too short.

8. **Planing to length.** — The end should be planed after it is sawed and the same precautions should be observed as were indicated in Operation 4.

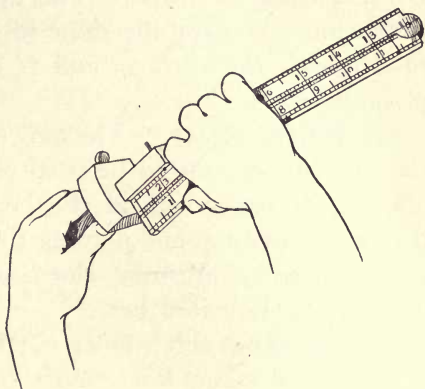

FIG. 11.—SETTING THE GUIDE OF THE MARKING GAUGE.

9. **Sawing to width.**—The next operation is to saw to width, sawing just outside the line.

10. **Planing to width.**—The operation of planing to width must be carefully done in order to get the edge square with the surface, and at the same time not to plane below the line.

11. **Making blocks.**—The next operation is laying out the two blocks, one to be used on the upper side and one on the lower side of the board. The method of laying out, sawing, and planing these pieces is the same as that used in finishing the board, so the directions will not be repeated here.

12. **Laying out screw holes.**—After the two blocks are finished, the screw holes must be located. With the

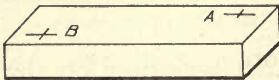

FIG. 13.—LOCATION OF SCREW HOLES.

ruler or try-square, measure in from each end $\frac{1}{2}$ " and mark; then set the gauge at $\frac{1}{2}$ " and line across these marks, gauging from the opposite edges at *A*

and *B*, Fig. 13.

13. **Boring screw holes.**—The next operation is boring the holes. Select a gimlet bit the same size as the screws and bore through the pieces at the places marked.

In boring, place the screw point on the mark and hold the brace so that the bit is perpendicular, then with the left hand on the knob and holding the sweep with the right hand, place the forehead on the left hand, pressing down so as to make the bit cut.

14. **Assembling.**—The last operation is assembling; this is putting together the various pieces, completing the project. Place the shorter piece on one end, as in Fig. 14, and clamp it in the vise with one edge flush,

or even, with one end of the board, and one end flush with the left-hand edge of the board. Put the screws in and screw them down with a screw driver until the head is flush with the surface of the wood. Turn the board over and fasten the other piece on the opposite side of the other end, with one edge flush with the end of the board.

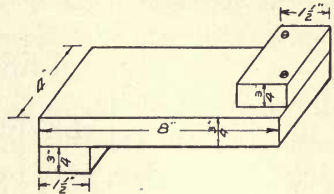

FIG. 14.—BENCH HOOK ASSEMBLED.

If the work has been done accurately, the pieces will fit nicely, and when placed in position will be square with the edges of the board, and the longer piece will just reach from edge to edge of the board. No holes are needed in the board for the screws, as the wood is soft white pine; but if it were to be made of hard wood, it would be necessary to bore holes in the board, a trifle smaller than the screws, and the holes in the pieces should be countersunk. (Countersinking is reaming out the edge of the bored hole to fit the head of a wood screw.)

QUESTIONS

1. Why does the gauge mark more easily when held at an angle than when held vertical?
2. Why should the point of the gauge be sharpened like a knife point rather than like a round point?
3. Why do you bore holes through the small pieces and not into the board?
4. Why are the screws placed on opposite edges of the small pieces instead of on the same edge?

LESSON II

LEVEL SQUARE

STOCK

1 pc. white pine $\frac{7}{8}'' \times 2\frac{1}{4}'' \times 25''$ Brads $\frac{3}{4}''$ Glue
1 pc. white pine $\frac{7}{8}'' \times 2\frac{1}{4}'' \times 13''$

TOOLS

Rule	Marking gauge	Plane
Try-square	Saw	Chisel

OPERATIONS

1. Laying out.
2. Surfacing one side.
3. Planing one edge.
4. Squaring one end.
5. Laying out length and width and thickness.
6. Planing to thickness.
7. Sawing to length.
8. Planing to length.
9. Sawing to width.
10. Planing to width.
11. Laying out halved joint.
12. Sawing halved joint.
13. Trimming halved joint.
14. Gluing.
15. Squaring up corners.
16. Laying out scale for plumb bob.

Requirements. — The pieces are to be of the exact length, width, and thickness called for in the drawing. The two ends halved are to be fitted together so the surfaces are flush with each other, and the outside and inside corners square.

When two pieces of wood of equal thickness are to be fitted together so that the surfaces are flush, the halved joint is commonly used. In making this joint, one half of the thickness is cut out of each of the pieces for a distance equal to the width of the pieces.

There are two methods commonly used; in one, the joint is laid out according to measurements, and in the other, the laying out is done by superimposing, which is laying one piece on the other and marking the width by lining along the edges. The latter method is not

so accurate, because when the pieces are cut along the lines marked out, the cut is too large, and the two parts make a poor fit. In order to prevent this, it is necessary to cut inside the lines with the saw and trim with the chisel. This makes a "cut and try" method, which is not recommended. If the work is laid out accurately, if all measurements are exact, and if the cuts are on the lines, the pieces will fit together with the pressure of the hands, requiring no forcing, neither will they be so loose as to fall apart.

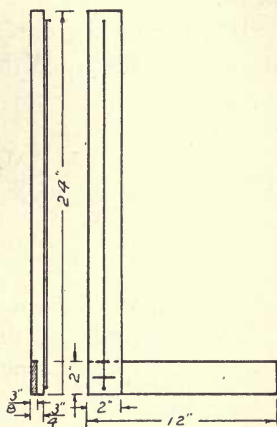

FIG. 15.—WORKING DRAWING OF LEVEL SQUARE.

1-10. First Ten Operations. — Lay out the pieces $\frac{7}{8}'' \times 2\frac{1}{4}'' \times 25''$ and $\frac{7}{8}'' \times 2\frac{1}{4}'' \times 13''$ so as to leave enough stock for planing, and follow in order the directions for the first ten operations given in Lesson I.

11. Laying out halved joint. — In laying out the halved joint, lay off 2'' from one end and square across one surface and two edges. Then set the gauge at $\frac{3}{8}''$ and gauge across the end and along both edges to the knife lines.

In gauging, be careful to keep the guide against the part to be removed in one piece and against the part remaining in the other piece.

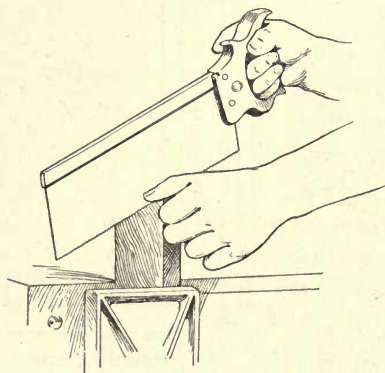

FIG. 16.—FIRST CUT IN MAKING HALVED JOINT.

It is necessary to take great care in making any joint, both in laying out and in cutting.

12. Sawing halved joint. — If the pupil feels confident that he can do careful and accurate work with the saw, he may follow the directions given under *a*. If

not quite sure, it will be wise to follow the directions given under *b*.

a. Hold the piece perpendicular in the vise, as in Fig. 16. Hold the thumb nail of the left hand in the groove made by the marking gauge and set the teeth of the rip saw so that they will just touch the thumb nail, and so will split the line.

Saw very carefully down to the line squared across

the edge. In this operation watch the back of the piece as carefully as the front.

Place the piece on the bench hook, and with the cross-cut saw split the line squared across the surface, making the shoulder down to the saw cut already made. Be sure that the saw cut, or kerf, is always made in the material to be removed.

(Fig. 17.)

If these sawing operations have been made carefully and accurately, the two pieces will fit together without any further trimming and fitting.

b. This operation is to be recommended unless the pupil is certain that he can do very accurate work in sawing. It is expected that the pupil, after a little practice, will be able to saw all joints where sawing is possible.

The advantages of the sawed joints are that glue holds the parts together better, and time and labor are saved in the extra operations. The work should be held just the same as in 12, *a*, but instead of splitting the lines, the saw should be held at such a distance from the lines that the teeth just miss touching it.

13. **Trimming halved joint.** — Remove with the chisel the stock left between the kerf and the line. Hold the piece on the bench hook or in the vise and with an inch chisel cut down through the scored line, taking

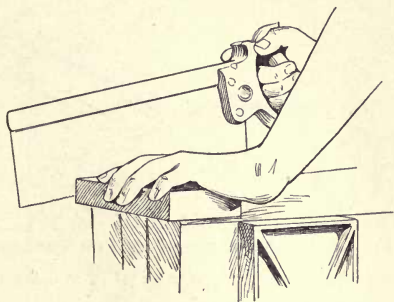

FIG. 17.—SECOND CUT IN MAKING HALVED JOINT.

care not to cut off the line. Test the squareness of the line with the try-square, as in Fig. 18. If this shoulder is not exactly square, it will be impossible to fit the

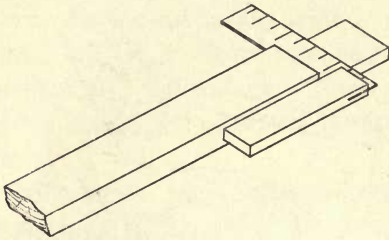

FIG. 18.—TESTING SQUARENESS OF SHOULDER.

two arms together so that they will be square. Do not use a narrow chisel, for it is more difficult to chisel a straight line with it than with a wide one.

After the shoulder is chiseled square, place the piece in the vise, and chisel the inside of the tongue down to the line. (See Fig. 19.) Square up this surface to see that it is flat in all directions.

If the grain of the wood is crooked so that it will split down below the line if chiseled in this way, then use the following method.

Place the piece edge-wise against a waste piece, and put both of them in the vise so that the piece will lie horizontally, and chisel across the grain of the wood, as in Fig. 20, down to the line.

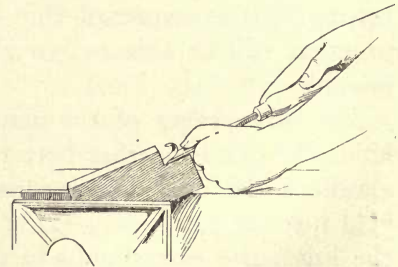

FIG. 19.—CHISELING INSIDE OF TONGUE.

14. Gluing. — Hold the two pieces of the halved joint in the vise and test both inside and outside angles with the try-square. In gluing this joint, rub the glue on to

the surface of one piece, and on the shoulders of both pieces. In forcing the pieces together, be sure to force the edges up against the two shoulders; then fasten securely with the $\frac{3}{4}$ " brads, leaving enough of the heads projecting so that the brads may be pulled out again after the glue has set. If hot glue is used, it will set in a few hours; but if cold fish glue is used, it will require 24 hours to set.

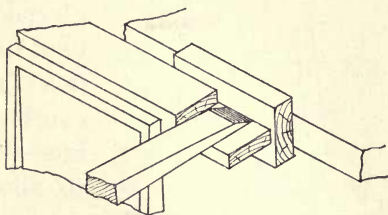

FIG. 20.—CHISELING ACROSS THE GRAIN.

15. **Squaring up corners.**—When the glue is set, remove the brads and trim off the surplus glue with a chisel, taking care not to cut the wood. Test the squareness of the corners and the flatness of the surfaces with the try-square.



FIG. 21.—PLUMB LINE AND BOB.

Take off a thin shaving with the plane to true up and make a neat appearance. Drive the brads back in place and clinch them.

16. **Laying out scale for plumb bob.**—Drive a brad in the free end of the longer arm of the square, and attach to this a fine silk thread as long as the arm; split a buckshot or BB shot and attach to the thread at a point so near the corner that it will just clear the bench top when placed as in Fig. 21.

In laying out the scale for the plumb bob, select a surface that is perfectly level by a spirit level, and standing the square on this make a mark under the

thread. A spirit level is a small straight piece of wood or iron in one edge of which is placed a glass tube containing alcohol or spirits, and this is used in determining horizontal surfaces. When a second tube is

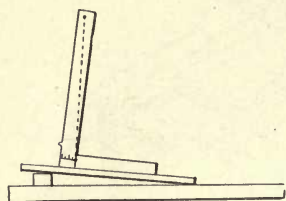

FIG. 22.—LAYING OUT SCALE FOR PLUMB BOB. • FIRST STEP.

placed across one end, it can be used in determining vertical surfaces also. If no level surface can be found, stand it on a surface that is slanted sufficiently to allow the thread to incline considerably towards one side and mark under the thread; then reverse the position of the shorter arm so the thread inclines the same distance in the opposite direction, and mark again. (Figs. 22 and 23.)

A point halfway between these two marks is the place at which the thread will be when the lower arm is level and the upright arm is plumb. To complete the scale several marks can be made equidistant from the center line.

Use of the chisel.—In using a chisel, never place either hand in front of the cutting edge, as a slip of the tool may cause a serious accident. The chisel must be kept very sharp; the method of sharpening will be given later. The action of the chisel in entering the wood is like that of a wedge, and unless the wood on one side gives way to the pressure, the fibers on each side will be forced back and crushed as in *A*, Fig. 24. If

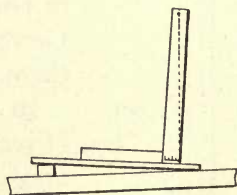

FIG. 23.—LAYING OUT SCALE FOR PLUMB BOB. SECOND STEP.

there is room for a shaving to be pushed to one side, as at *B*, then the fibers back of the chisel will bear the pressure without being crushed. Therefore, when it is necessary to take a heavy cut and to use the mallet, do not place the chisel on the line, for it will force the wood back over

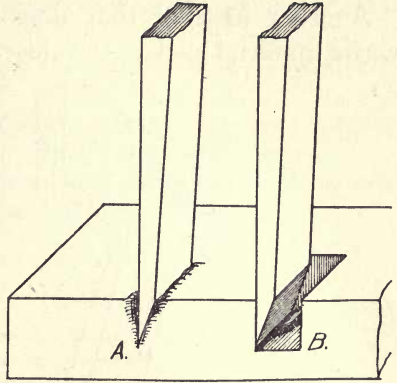

FIG. 24.—ACTION OF CHISEL IN ENTERING WOOD.

the line and make the work inaccurate; leave enough wood in front of the line so that a light paring cut can be made, trimming down to the line. In horizontal paring, the work should be placed in the vise so that the two hands are free to handle the tool.

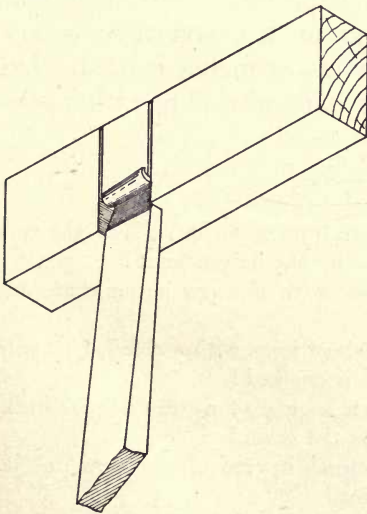

FIG. 25.—CHISELING FROM BOTH SIDES TOWARD THE MIDDLE.

Place a piece of waste material back of the piece to be pared, and take a light cut with the bevel or slanting surface of the tool up. If the waste piece were not placed there, the pressure of the chisel would splinter a piece off the farther edge, spoiling good work.

Another method that does not require a piece of waste material back of the chisel is to cut partly through from one side, then reverse the block and finish from the other side. (See Fig. 25.)

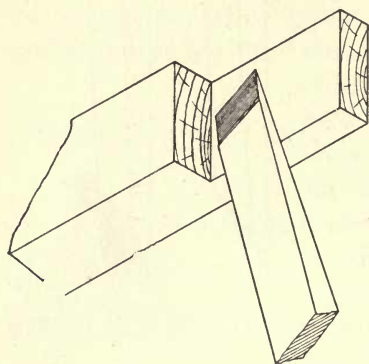

FIG. 26.—A SHEARING CUT WITH A CHISEL.

In taking the finishing cuts, turn the chisel a little to one side, giving a shearing cut, which insures a smooth surface, and also requires less force in pushing the tool. (See Fig. 26.) A shearing cut is made by moving

the chisel to one side while pushing it into the wood. In cutting across the end grain, it is almost necessary to use this shearing cut unless a mallet is used. Do not attempt a heavy cut on joint work, but rather several light cuts.

QUESTIONS

1. Why is it necessary to gauge from opposite sides of the two pieces when gauging the thickness for the halved joint?
2. Why is a halved joint made with the saw better than one made with the saw and chisel?
3. When about to trim the halved joint with a chisel, how will you determine whether the grain is crooked?
4. Why is it necessary to place a piece of waste material back of the piece when chiseling across the grain?
5. Why do you use a wide chisel instead of a narrow one in trimming the shoulder of the joint?
6. Why is the double angle at the edge of the chisel better than a single angle?

7. Why is a smaller angle at the chisel edge better for soft wood than for hard wood?

8. In gluing up stock, which is preferable, cold, warm, or hot glue, and why?

9. In gluing the end grain, why is it better to put on two coats of glue, allowing the first to dry before applying the second?

10. Would you use glue of the same consistency in gluing oak that you would in gluing maple? Why?

LESSON III

SAWBUCK

STOCK

4 pcs. red oak	$2'' \times 3\frac{1}{4}'' \times 36''$	12 screws 2'', No. 10,
2 pcs. red oak	$1'' \times 2\frac{1}{2}'' \times 25''$	F. H. B.
1 pc. red oak	$1'' \times 6'' \times 18''$	
1 pc. round hickory	$2'' \times 20''$	

TOOLS

Try-square	Chisel	Drawknife
Bevel square	Brace and bit	Spokeshave
Saw	Screw driver	Marking gauge
Carpenter's square		Rule

OPERATIONS

1. Laying out.
2. Surfacing one side.
3. Planing one edge.
4. Laying out length, width, thickness.
5. Planing to thickness.
6. Laying out angles at ends of legs.
7. Sawing the angles at the ends of the legs.
8. Planing to width.
9. Laying the angles of the halved joint.
10. Sawing the halved joint.
11. Chiseling the halved joint.
12. Fastening the legs together.
13. Laying out the holes for the crossbar.

14. Boring the holes for the crossbar.
15. Trimming the ends of the crossbar.
16. Wedging the ends of the crossbar.
17. Laying out the braces.
18. Sawing the braces.
19. Chiseling the braces.
20. Fastening the braces in place.

Follow the directions given in Lesson I for Operations 1 to 5 inclusive.

6. Laying out angles at ends of legs.—In this operation you will need a carpenter's steel square

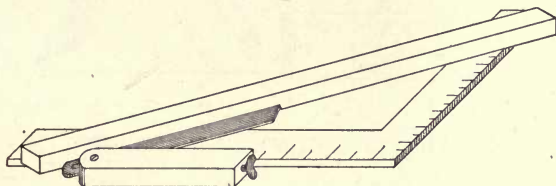

FIG. 27.—METHOD OF SETTING BEVEL.

and a bevel. Lay the carpenter's square on the bench, and place a straightedge (which is a straight stick of any kind) so that one edge touches the 15" mark on the longer arm, called the blade, and also the 9" mark on the shorter arm, called the tongue. These dimensions, as you can see by the drawing, represent the perpendicular height of the joint from the ground and half the distance between the legs.

Have some one hold the straightedge in place while you set the bevel square to this angle, holding the beam of the bevel against the carpenter's square, and adjust the blade to the straightedge; then fasten the blade by tightening the thumbscrew, as shown

in Fig. 27. Lay out the angles on one leg by lining across, as in Fig. 28; and placing the bevel on the opposite edge, lay out the angle on the other end. With the try-square line across the edges at the points where the bevel cuts the corner.

7. **Sawing the angles at the ends of the legs.** — When the angles have been laid out, they can be sawed, using a backsaw and bench hook. Care should be

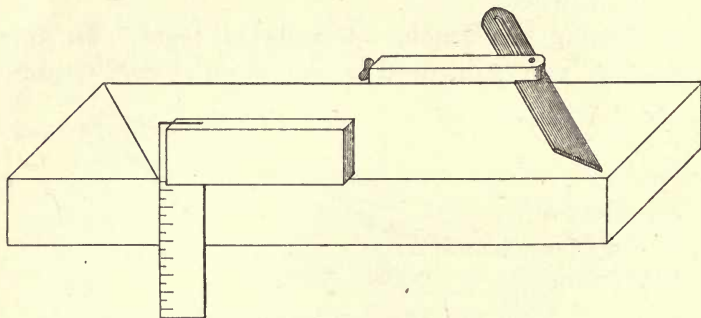

FIG. 28. — LAYING OUT ANGLES ON LEGS OF SAWBUCK.

taken in following both lines. The planing to width in Operation 8 is the same as in former lessons.

9. **Laying out the angles of the halved joint.** — Measure up from points *a, a*, Fig. 29, on each leg 17" to points *b, b*, and mark; now lay one leg over the other so the points *b, b* touch each other, and spread the lower ends until the points *a, a* are 18" apart; hold in this position and adjust the bevel square so the beam lies on one leg and the blade along the other leg. Tighten the set screw, and, removing the leg, line across at this point on both legs, but on opposite sides. In order to locate the other point it will be necessary to measure on a

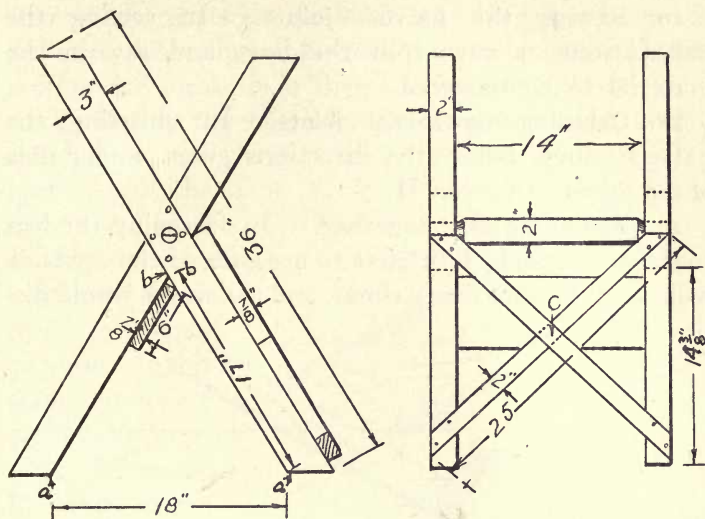

FIG. 29.—WORKING DRAWING OF SAWBUCK.

line perpendicular to the first line. Lay the end of the rule along the blade of the bevel, as in Fig. 30, and move the bevel down the leg until the 3" mark touches the mark already lined across. With the bevel, line across at this point, and repeat the operation on the other leg.

With the try-square, line halfway across the edges at the ends of the lines already drawn, as in Fig. 30. With the marking gauge set at one half the thickness of the legs, gauge on both edges of both legs between the lines; being sure to hold the gauge guide against opposite surfaces of the two legs so that the amount of wood to be removed from one leg will exactly equal the material that is left in the other leg. Repeat these operations on the other pair of legs.

10. **Sawing the halved joints.**—In sawing the halved joint, always split the lines and saw in the material to be removed.

11. **Chiseling the halved joints.**—In chiseling the halved joints, follow the directions given under **Use of the chisel** in Lesson II.

12. **Fastening legs together.**—In fastening the legs together, it would be useless to use glue, as the sawbuck will be in the rain many times, and the water would dis-

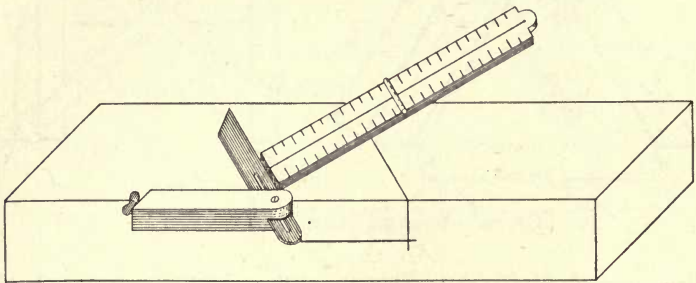

FIG. 30.—LAYING OUT WIDTH OF HALVED JOINT.

solve and wash out the glue in the joint. Therefore, it would be better to use screws.

It will not be necessary to lay out the screw holes by measurement; locate them with the eye as in the drawing, and, selecting a gimlet bit the size of the screws, bore through one leg. Place the screws in place, and, fitting the joint together, drive the screws into the other leg just far enough to mark their location. Selecting a bit about one half the size of the screws, bore into, or nearly through, the other leg at the marks made by the screws. Fasten together by screwing the screws into place, after countersinking the holes.

13. **Laying out the holes for the crossbar.**—All

that will be necessary to locate the hole for the crossbar is to draw diagonals from the four points of intersection and locate it at their intersection.

14. **Boring the holes for the crossbar.** — In boring these holes, use an expansion bit and set it at $1\frac{1}{2}$ ''; bore until the spur comes through, then reverse and finish from the opposite side. In this way you insure a clean-cut hole.

15. **Trimming the ends of the crossbar.** — The ends of the hickory crossbar should be rounded off for a distance of about 3'' from each end. (Fig. 32.) If the bar is considerably too large, it will

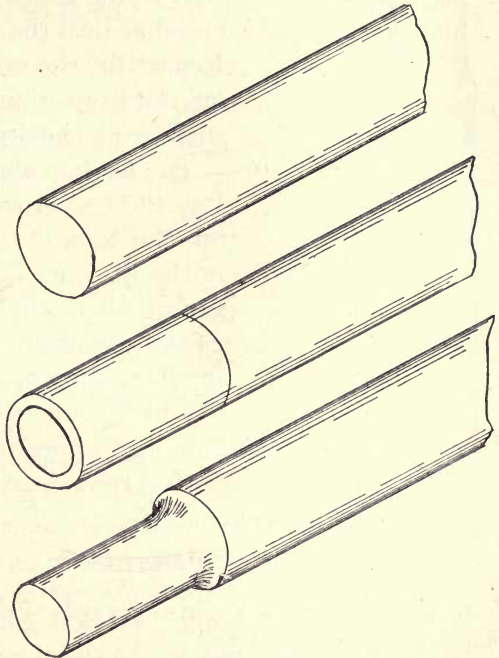

FIG. 31.—TRIMMING ENDS OF CROSSBAR.

be necessary to use the drawknife and spokeshave, but if only a little is to be removed, the spokeshave only need be used. First, with the compass set at $\frac{3}{4}$ '' , locate the center of the end by the eye, and lay out the circles $1\frac{1}{2}$ '' in diameter. Trim off the ends with the drawknife, and finish with the spokeshave.

16. **Wedging the ends of the crossbar.** — Saw slits in the end of the crossbar to a depth of about $2\frac{1}{2}$ "', as in Fig. 32, and make two wedges also of hickory similar to that shown in Fig. 32. Drive the crossbar into the hole and wedge. Repeat for the other end and saw off the projections flush with the surface of the legs.

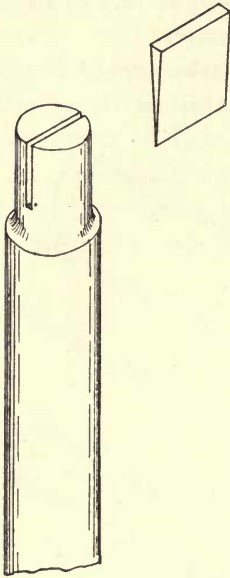

FIG. 32. — WEDGING ENDS OF CROSSBAR.

17. **Laying out the braces.** — Lay the two cross braces in place on the legs of the sawbuck, as in the drawing, and set the bevel square for the halved joint *c*, Fig. 29, following the directions given in Operations 9, 10, 11, 12. The 6" brace on the underside of the legs opposite is fastened on with screws as are the others.

QUESTIONS

1. In laying out the angles at the ends of the legs, why are the dimensions 9" and $14\frac{3}{8}$ " used?
2. In laying out the angles 30 and 60 degrees with the carpenter's square, where will you hold the beam in each case?
3. In laying out the halved joints for the legs and the cross braces, do you lay them out on the same or opposite sides of the members, and why?
4. In boring the holes for the screws, why do you select bits of different sizes for the two pieces?
5. In boring the holes for the crossbar, why do you use an expansion bit instead of an auger bit?

LESSON IV

FOLDING SAWBUCK

STOCK

- 4 pcs. maple or birch $2'' \times 3'' \times 36''$ 14 screws $2''$, No. 10,
2 pcs. maple or birch $2'' \times \frac{7}{8}'' \times 25''$ F. H. B.
1 pc. maple or birch $1'' \times 2'' \times 22''$
1 pc. round hickory $2'' \times 22''$
1 pc. round hickory $2'' \times 18''$

TOOLS

Same as in Lesson III.

OPERATIONS

1. Laying out.
2. Surfacing one side.
3. Planing one edge.
4. Laying out length, width, thickness.
5. Planing to thickness.
6. Sawing ends square.
7. Planing to width.
8. Laying out holes for crossbars.
9. Boring holes for crossbars.
10. Trimming ends of crossbars.
11. Wedging the legs to the crossbars.
12. Laying out braces.
13. Sawing braces.
14. Chiseling braces.
15. Fastening braces.
16. Attaching rope to cross pieces.

Follow the directions given in Lesson I for Operations 1-7.

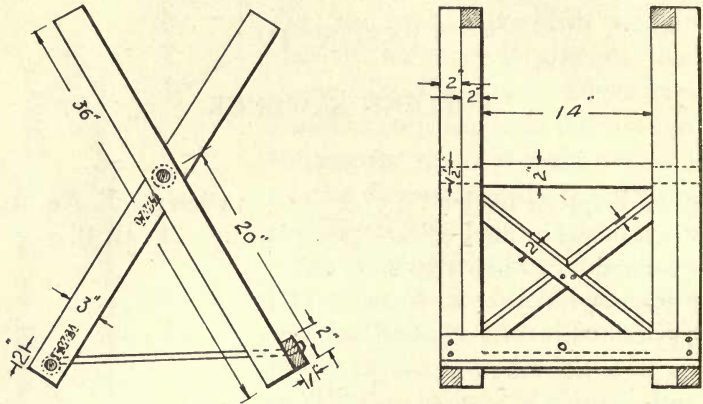

FIG. 33.—WORKING DRAWING OF FOLDING SAWBUCK.

8. In laying out the holes for the crossbars, measure up from one end of each leg 20'' for the upper crossbar, and for the lower crossbar measure up 2'' from the lower end of each of the inner legs. Square across at these points and find the middle of each line. With the compass, describe $1\frac{1}{2}$ '' circles at these points.

9. In boring the holes for the crossbars, follow the directions and remember the precautions given in the preceding lesson.

10. In trimming the ends of the lower crossbar, follow the directions given in the previous lesson; but in trimming the ends of the middle crossbar, draw a line around the bar 4'' from each end; lay out $1\frac{1}{2}$ '' circles at each end with the compass, and saw along the line to a depth of about $\frac{1}{4}$ '' clear around the bar.

Trim down to the circle at the end as in the previous

lesson and with a chisel trim up to the saw kerf, making a shoulder at this point. (See Fig. 35.) In this lesson more care must be taken in trimming the ends, for they must be perfectly cylindrical and smooth. It will be necessary to use sandpaper in smoothing up the work.

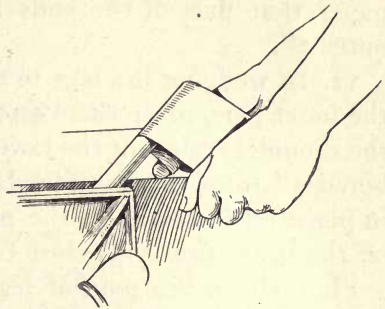

FIG. 34. — SANDPAPERING END OF CROSSBAR.

Hold the piece as shown in Fig. 34. The two outer legs are to be wedged in place as described in Lesson III. The two inner legs are to fit snug against the outer legs and inside against the shoulders cut in the upper crossbar. They must be free to rotate on the crossbar, and so it will be well to sand-

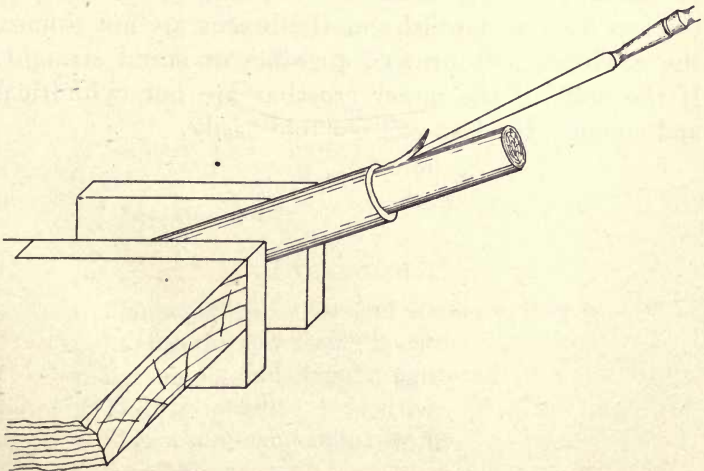

FIG. 35. — TRIMMING END OF CROSSBAR.

paper that part of the ends a trifle smaller than the outer 2".

11. In wedging the legs to the crossbars, begin with the inner pair, place them on the upper bar up against the shoulders; then fit the lower bar in place in the holes bored 2" from the lower end. Wedge this lower bar in place as described in the preceding lesson, and saw off the projecting ends close to the legs.

Place the other pair of legs on the upper crossbar snug up against the inner pair of legs, and wedge in place.

12, 13, 14, 15. In laying out the braces, in sawing, chiseling, and fastening to the legs, follow the directions given previously with the exception that the braces are attached to the legs in different places, as shown in Fig. 33.

16. Attach a small rope to the lower brace and bar of the legs to keep them from spreading too far. If the legs are not parallel and the braces are not square, the sawbuck will not fold together or stand straight. If the ends of the upper crossbar are not cylindrical and smooth, the legs will not fold easily.

LESSON V

PORCH CHAIR

STOCK

- 2 pcs. oak, maple, or birch $\frac{7}{8}'' \times 2'' \times 50''$
- 2 pcs. oak, maple, or birch $\frac{7}{8}'' \times 2'' \times 45''$
- 2 pcs. oak, maple, or birch $\frac{7}{8}'' \times 2'' \times 23''$
- 2 pcs. oak, maple, or birch $\frac{7}{8}'' \times 2'' \times 19''$
- 2 pcs. oak, maple, or birch $\frac{5}{8}'' \times 2'' \times 12''$
- 2 pcs. oak, maple, or birch $\frac{5}{8}'' \times 2'' \times 11''$
- 1 pc. oak, maple, or birch $1'' \times 6'' \times 28''$
- 1 strip canvas $2' \times 50''$
- 6 carriage bolts $\frac{1}{4}'' \times 2\frac{1}{2}''$
- 2 carriage bolts $\frac{1}{4}'' \times 3\frac{3}{4}''$
- 8 washers $\frac{1}{4}''$
- 4 screws $1''$, No. 6
- Large tacks

TOOLS

Try-square	Saw	Brace and bit
Bevel	Plane	Chisel
Marking gauge		Sandpaper

OPERATIONS

1. Planing strips to size and sawing to length.
2. Laying out and boring holes.
3. Laying out and chamfering ends.
4. Making rounds.
5. Shellacking and sandpapering.
6. Assembling.

FIG. 36. — DETAILS FOR PORCH CHAIR.
(Two pieces of each dimension.)

Permission of American Carpenter and Builder.

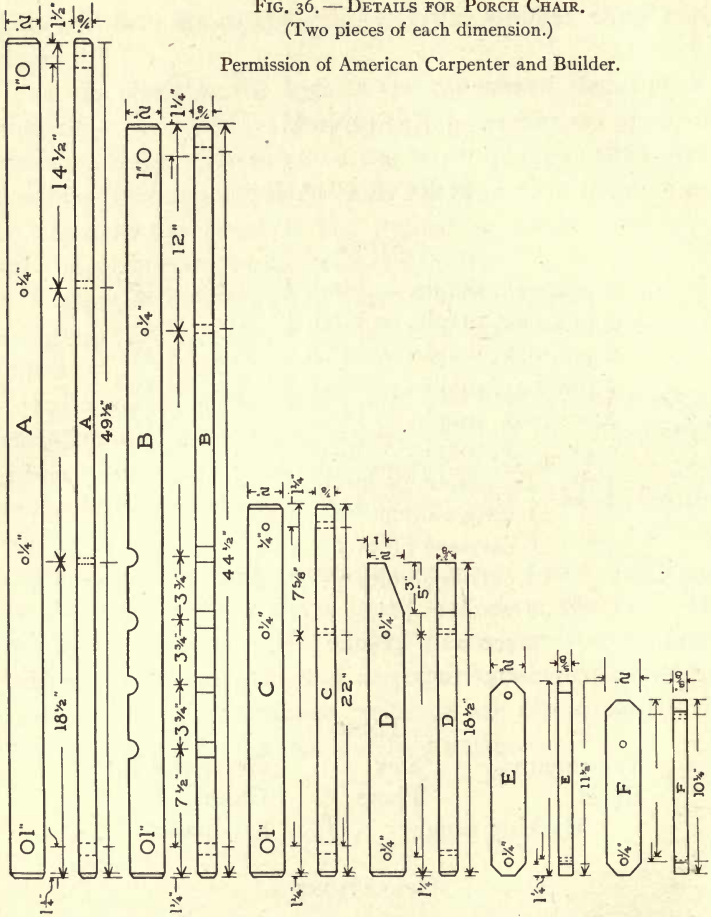

1. Planing all strips to size and sawing to length. — All strips are to be planed square and smooth. After squaring, strips *A*, *B*, *C*, and *D* are to be $\frac{7}{8}$ " thick and 2" wide, with the corners slightly rounded (Fig. 36).

Pieces *E* and *F* are $\frac{5}{8}$ " thick and 2" wide. Cutting

off two or three shavings from the corners prevents the possibility of splinters.

When planed to size, saw to the following lengths :

A, $49\frac{1}{2}''$

B, $44\frac{1}{2}''$

C, $22''$

D, $18\frac{1}{2}''$

E, $11\frac{1}{2}''$

F, $10\frac{1}{4}''$

2. **Laying out and boring holes.** — On each of pieces *A* lay out at one end a hole $1''$ in diameter, the centers of which are $1\frac{1}{4}''$ from the end. At the other end lay out a similar hole $1\frac{1}{2}''$ from the end. $18\frac{1}{2}''$ from the first end lay out a $\frac{1}{4}''$ hole, and $14\frac{1}{2}''$ from the other end lay out a $\frac{1}{4}''$ hole.

On each of pieces *B* lay out at both ends $1''$ holes, $1\frac{1}{4}''$ from the ends. $12''$ from one end lay out a $\frac{1}{4}''$ hole. $7\frac{1}{2}''$ from the other end lay out a $1''$ hole with the center on one edge. $3\frac{3}{4}''$ from this hole lay out a similar hole, and continue until 4 such holes have been laid out on this edge.

On each of pieces *C* lay out a $1''$ hole $1\frac{1}{4}''$ from one end, and a $\frac{1}{4}''$ hole the same distance from the other end. $7\frac{5}{8}''$ from this end lay out a $\frac{1}{4}''$ hole.

On each of pieces *D* lay out a $\frac{1}{4}''$ hole $1\frac{1}{4}''$ from one end and $5''$ from the other end lay out a $\frac{1}{4}''$ hole.

On pieces *E* lay out $\frac{1}{4}''$ holes $1\frac{1}{4}''$ from each end.

On pieces *F* lay out one hole $1\frac{1}{4}''$ from one end, and another hole $4''$ from the other end. These should be of the size to admit No. 6 screws.

In boring the half holes on pieces *B*, place the two

pieces together edgewise in the vise and bore with the screw of the bit in the crack between the pieces. To prevent splitting, all pieces should be held in the vise when boring the 1" holes.

3. **Laying out and chamfering the ends.** — Lay out $\frac{1}{4}$ " chamfers on both ends of pieces *A*, *B*, and *C*, and on one end of pieces *D*; on the other end of pieces *D* lay out a bevel 3" from the end down to 1" at the end.

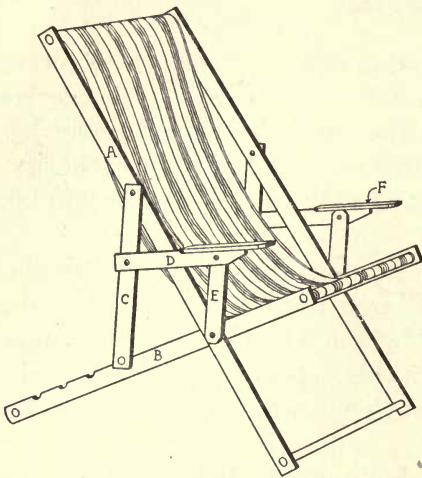

FIG. 37.—PORCH CHAIR ASSEMBLED.

Chisel the $\frac{1}{4}$ " chamfers. Saw, and chisel or plane the bevels larger than $\frac{1}{4}$ ".

4. **Making rounds.** — Make the five rounds from the board whose dimensions are 1" \times 6" \times 28", according to the directions given in the lesson on the Combination Ladder.

5. **Shellacking and sandpapering.** — Shellac over all pieces, sandpaper, and shellac again.

To chamfer, cut off the angles made where two surfaces meet. This cut is usually made at an angle of 45°. On pieces *E* lay out $\frac{3}{4}$ " bevels on the edges only of the two ends. These bevels will be at a 45-degree angle made with the bevel. On pieces *F* lay out 45-degree bevels of $\frac{1}{2}$ " on the edges only of the two ends.

6. **Assembling the pieces.** — (1) Fit and glue the rounds into *A* and *B* (Fig. 37). The distance between pieces *A* when fastened together should be 2' 3", inside measurements. The distance between pieces *B* should be 2' 3", outside measurements, as this pair must fit inside the first pair. (2) Fasten pieces *A*, *B*, and *E* together with the carriage bolts $3\frac{3}{4}$ " long, heads outside. (3) Fit round to pieces *C* so that they are 2' 3" apart, inside measurements. (4) Fasten the other ends of pieces *C* to *A* with carriage bolts $2\frac{1}{2}$ " long. (5) Fasten pieces *D* to pieces *C* with carriage bolts $2\frac{1}{2}$ " long. (6) Fasten pieces *E* to pieces *D* with carriage bolts $2\frac{1}{2}$ " long. (7) Fasten pieces *F* to pieces *D* with screws. (8) Fasten the canvas to the upper round of pieces *A* and *B* with heavy tacks, doubling under the canvas while tacking.

LESSON VI

CLOTHES RACK

STOCK

1 pc. oak $1\frac{1}{4}'' \times 1\frac{1}{4}'' \times 60''$	16 screws $1''$, No. 6 R. H. Bl.
2 pcs. oak $1'' \times 12'' \times 12''$	16 screws $\frac{3}{4}''$, No. 6 R. H. Bl.
16 pcs. poplar $\frac{3}{8}'' \times 1\frac{1}{4}'' \times 24''$	32 washers for screws
4 pcs. poplar $\frac{3}{8}'' \times 1\frac{1}{4}'' \times 60''$	8 screws $2''$, No. 8 R. H. Bl.

(R. H. Bl. means round head, blue.)

TOOLS

Rule	Plane	Turning saw
Try-square	Brace and bit	Cabinet file
Saw	Screwdriver	Sandpaper

OPERATIONS

1. Laying out and planing center post, uprights, and bars.
2. Boring holes for screws.
3. Laying out and cutting braces.
4. Shellacking.
5. Assembling.

1. **Laying out and planing center post, uprights, and bars.** — The center post should be of some hard wood, as oak, and should be planed $1\frac{1}{4}''$ square and $60''$ long; square up both ends with the block plane. The four

uprights should be of some soft wood, preferably poplar, but basswood will do (Fig. 38).

Plane up to size and square the ends. The bars are to be $\frac{3}{8}'' \times 1\frac{1}{4}'' \times 24''$, of the same wood as the uprights,

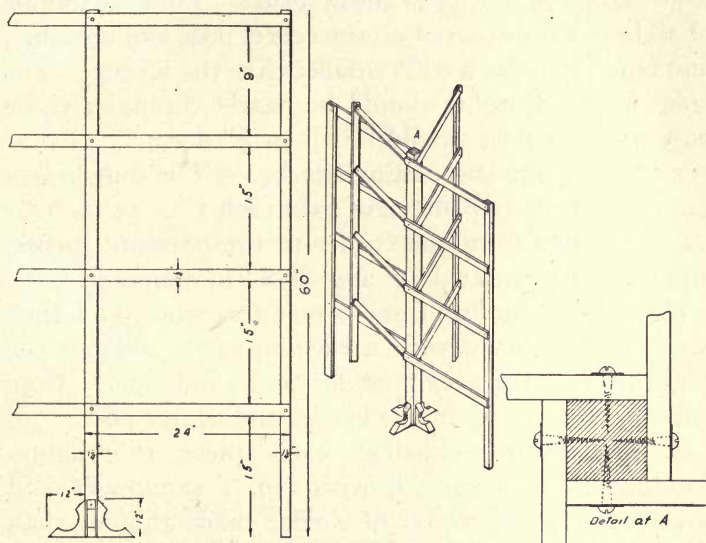

FIG. 38. — WORKING DRAWINGS OF CLOTHES RACK.

and planed square. Take pains to have all the bars of the same length.

2. **Boring holes for screws.** — Lay out the holes $\frac{5}{8}''$ from each end of the 16 bars; bore the holes the size of the screws. Locate the screw holes on the center post and uprights, by placing the bars in position with the ends flush with the edges of the center post and uprights, then drive the screws just hard enough to make a mark on these pieces.

Repeat these operations for all four bars on one up-

right and one side of the center post. Then placing the other three uprights beside the first one, square across them from each screw mark.

Square around the other three sides of the center post from the screw marks on the first side. Find the middle of all lines thus squared on the center post and uprights, and bore the holes a trifle smaller than the screws. The holes in the uprights should be nearly through; those on the center post should be about $\frac{1}{2}$ " deep.

3. **Laying out and cutting braces.** — The four braces can be cut from two pieces of oak, each $1'' \times 12'' \times 12''$. Lay off a line from one corner to the opposite corner, and from the center draw a circle 8" in diameter.

Saw along the line from corner to corner, and then saw out the curves with a turning saw. Smooth the edges down with a cabinet file and sandpaper. Bore holes for the screws in the braces and center post.

4. **Shellacking.** — Shellac each piece thoroughly. Sandpaper down smooth with No. 1 sandpaper, and cover with another coat of shellac made thinner than the first coat by the addition of some alcohol in about the proportion of one tablespoonful to a teacup of shellac. It is advisable to fasten the braces to the upright with screws before shellacking, and then remove them for sandpapering. This avoids covering the joints with shellac, which would prevent the glue from holding.

5. **Assembling.** — Assemble the rack by first fastening the braces to the center post with glue and screws; then fasten the bars to the center post with screws and washers; finally, fasten the bars to the uprights with screws and washers.

LESSON VII

CLOTHES TREE

STOCK

1 pc. oak $2\frac{1}{2}'' \times 2\frac{1}{2}'' \times 5' 2''$

2 pcs. oak $\frac{7}{8}'' \times 1' 3'' \times 1' 4''$

Glue, stain, filler, varnish, sandpaper

TOOLS

Rule	Plane	Chisel
Try-square	Turning saw	Spokeshave
Saw	Brace and bit	

OPERATIONS

1. Laying out and planing upright.
2. Cutting mortises and boring dowel holes.
3. Laying out, planing, and sawing legs.
4. Laying out, planing, and sawing hooks.
5. Staining, filling, and varnishing.
6. Assembling.

1. **Laying out and planing upright.** — The upright is a square piece tapering from $2\frac{1}{2}''$ at one end to $1\frac{1}{2}''$ at the other. Plane $2\frac{1}{2}''$ square from end to end; then at one end lay off a square $1\frac{1}{2}''$ on a side, and plane down to this square from the other end. The smaller end is beveled, as shown in Fig. 39.

2. **Cutting mortises and boring dowel holes.** — Mor-

tises are holes cut in wood to receive the tenons in a mortise and tenon joint. The tenon is the tongue of wood that fits into the mortise.

Dowel holes are holes bored in wood to receive the dowel pins in a doweled joint. The dowel pins are

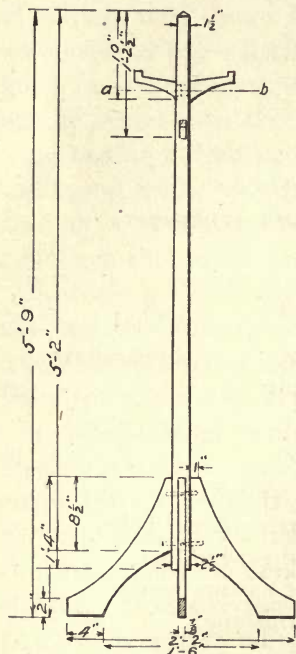

FIG. 39. — WORKING DRAWING OF CLOTHES TREE.

round pins of hardwood made to fit the dowel holes, and correspond to the tenons of a mortise and tenon joint. The first pair of mortises is cut 10'' from the top. By the section drawing (Fig. 40) you can see that the mortises are laid off center; that is, one mortise $\frac{3}{8}$ '' wide is $\frac{3}{8}$ '' from one edge and $\frac{3}{4}$ '' from the other edge. The mortise on the opposite side is laid off according to the same dimensions, but they are taken from opposite sides, so that when the tenons are introduced they will lap. The reason for lapping the tenons is to allow longer and consequently stronger tenons to be used; then, too, in this case the tenons are glued in place

and nailed together with brads, as shown in the section on *ab*, Fig. 40.

The second pair of hooks is placed 14 $\frac{1}{2}$ '' from the top. Cut the mortises in the same way as the first two, but on the other two sides, so there will be one hook on each of the four sides.

Two dowel holes are placed in each of the four sides of the post; the lower set of dowel holes is placed 3" from the lower end of the upright; bore them with a $\frac{3}{8}$ " bit and 1" deep. The second set of holes is 9" from the lower end and bored the same depth.

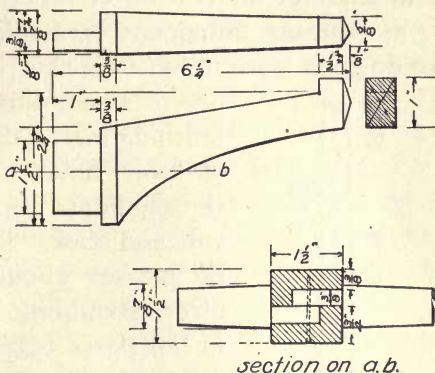

FIG. 40.—HOOKS OF CLOTHES TREE.

3. Laying out, planing, and sawing legs. — The dotted lines of Fig. 41 show how two legs may

be laid out on one piece $15'' \times 16''$ with the least waste of lumber. The curves are not arcs of circles and so must be laid out free hand, after locating the points as indicated in Fig. 41.

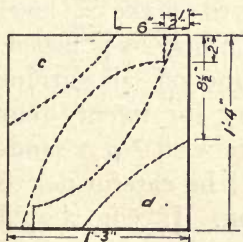

FIG. 41.—METHOD OF CUTTING OUT LEGS OF CLOTHES TREE.

In sawing the legs, use the turning saw or keyhole saw, and finish with the spokeshave and sandpaper.

4. Laying out, planing, and sawing hooks. — The hooks can be cut from the two corners left on each board after laying out the legs. Be careful that the grain of the wood runs lengthwise of the hooks.

Fig. 40 shows how the hooks are to be laid out. Two hooks are to be just like those in the drawing, and the other two are to be the same, except that the tenons will be on opposite surfaces. Be careful

not to make a mistake in this, or the work will be spoiled. Cut the tenons before the rest of the outline, and chamfer the ends after tapering from $\frac{7}{8}$ " to $\frac{5}{8}$ ".

5. Staining, filling, and varnishing. — It will be easier to do good work in finishing this piece, if it can be done

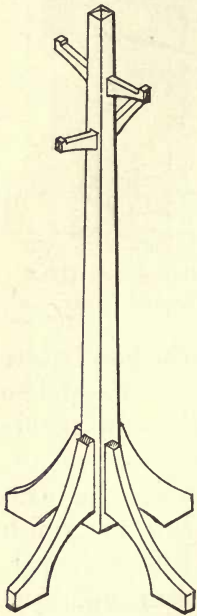

FIG. 42. — CLOTHES TREE ASSEMBLED.

before assembling; but if any of the finishing materials get into the mortises or dowel holes, or on the wood where the shoulders are to be glued, the glue will not stick. The pupil may do as he pleases about finishing before or after assembling. If done before, then fit all parts together and stain; then take the pieces apart, and wipe off all the stain that can be removed with a cloth.

Assemble the parts again and fill. — Filling consists of rubbing into the pores of the wood a pasty substance called wood filler, to make a level smooth surface which may be polished. Take apart and wipe off all surplus filler. Allow to dry for twenty-four hours, and sandpaper with No. 1 sandpaper until smooth; be careful not to

remove any stain in this operation. If you should sandpaper off some of the stain, go over the spots again with a rag moistened with the stain. Assemble the tree and cover with a coat of shellac; when this dries, which will be in about twelve hours, sandpaper smooth with No. 1 sandpaper moistened with oil to prevent gumming and sticking. Steel wool can be used

in this work to advantage, as it does not gum up or scratch. The final coat of shellac or varnish should be given after the clothes tree is assembled and glued.

6. **Assembling.** — In assembling the various parts and gluing them in place, it will be necessary to glue them on in pairs, using blocks of wood shaped so that you can get the pressure where you want it when clamping. The pressure must come along the line *ab*, Fig. 39, in the hooks so as to force the tenons in the mortises square, and the shoulders flush with the upright. The pressure on the legs must be such that the dowels will be forced in place with equal pressure, and the edges flush with the surface of the upright. Here is a chance for the pupil to exercise some ingenuity in cutting out the blocks.

QUESTIONS

1. Why are the hooks set in pairs at different heights on the upright?
2. Why are the tenons lapped?
3. Why are not the legs tenoned?
4. Why is the upright tapered?
5. Why is it better to square up the upright before tapering it?
6. Why are the hooks tapered?

LESSON VIII

SEED-TESTING BOX

A seed-testing box is used for the purpose of testing seed corn before planting. The bottom of the box is covered about 2" deep with wet sand. Over this is laid

a white cloth, also wet, on which have been drawn with a soft lead pencil, lines three inches apart, crossing each other at right angles. Each square is numbered, and six kernels of corn are taken from an ear and placed in a square, there being as many ears tested at once as there are squares on the cloth. The ear from which the kernels have been placed on square

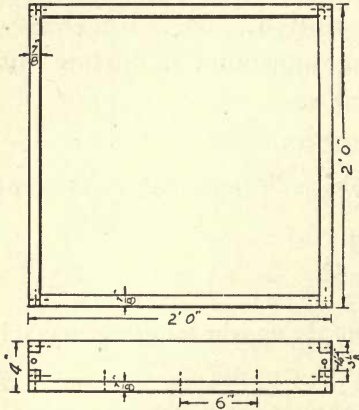

FIG. 43.—WORKING DRAWING OF SEED-TESTING BOX.

No. 1 is hung on a nail driven into a board or rack, and numbered 1, so that at any time the kernels can be identified with the ears from which they were taken.

Over the kernels is placed another wet cloth, and the seeds are allowed to germinate.

STOCK

4 pcs. white pine $1'' \times 3\frac{1}{2}'' \times 25''$ Screws 2'', No. 8 F. H. B.
 4 pcs. white pine $1'' \times 6\frac{1}{4}'' \times 25''$

TOOLS

Rule	Saw	Brace, bit, and countersink
Try-square	Plane	Screwdriver
Marking gauge	Chisel	Hammer

OPERATIONS

1. Laying out.
2. Surfacing one side.
3. Planing one edge.
4. Squaring one end.
5. Laying out length, width, thickness.
6. Planing to thickness.
7. Sawing to length.
8. Planing to length.
9. Sawing to width.
10. Planing to width.
11. Laying out halved joint.
12. Cutting halved joint.
13. Laying out screw holes.
14. Boring screw holes.
15. Assembling.
16. Trimming.

1-10. Operations 1-10 are similar to those given in Lesson I.

11. Laying out the halved joints. — In laying out the halved joints at the corners, set the marking gauge at $\frac{7}{8}''$ and gauge both ends of the four pieces, gauging from the two edges as at *a, b, c, d* (Fig. 44), then gauge across the ends as at *e, f, g*, being careful that both ends of each

piece are gauged alike and that the pieces are gauged in pairs. Gauge across the ends as well as on both surfaces. The material to be removed is marked x.

12. **Cutting halved joint.** — In cutting the halved joint it is best to saw down the gauge lines, bearing in mind the rule that the saw kerf must be in the material

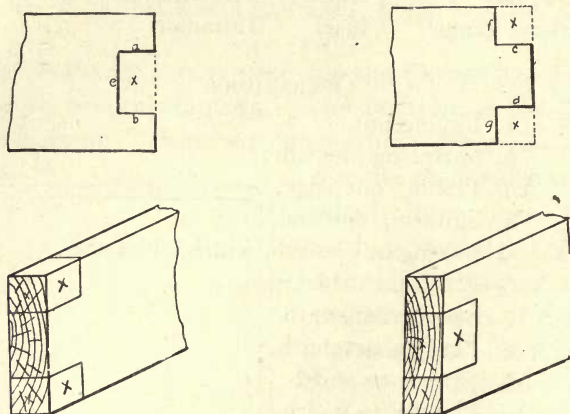

FIG. 44.—HALVED JOINTS OF SEED-TESTING BOX.

to be removed, which means in this case to saw along *a*, but on the x side of the line.

Also saw along *b*, but on the x side; then along *c*, *d*, *f*, *g*, on the x side of these lines. In cutting out the block x, it will be necessary to bore two holes, after sawing *a* and *b*, through the block so that the bit just touches the line *e*, and then chisel along the line *e* from both sides towards the center. (See Fig. 45.)

If the joints have been carefully cut, the tongues, or tenons, will fit tight into the mortises. If they do not fit, use the chisel in trimming down whichever piece is too large.

13. In laying out the screw holes, locate them by diagonals drawn from the four corners of the projecting tongues.

Lay out the holes for the bottom boards about 6" apart, but be sure that each board has at least two holes in each end.

14. Bore the screw holes with a gimlet bit just the size of the screws; it will be unnecessary to bore into the second piece, as the screws will hold better if forced into the soft wood without previous boring.

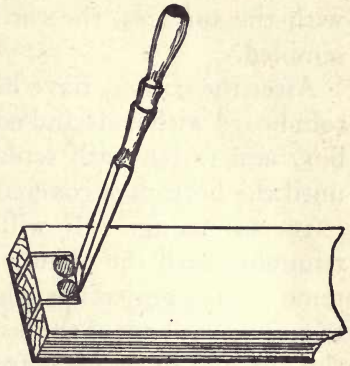

FIG. 45.—METHOD OF CUTTING MORTISE.

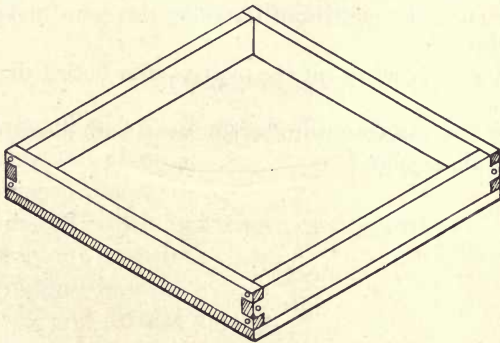

FIG. 46.—SEED-TESTING BOX ASSEMBLED.

15. In assembling, fit the four corners together tight, start the screws with the hammer, and finish with the screwdriver.

If the shoulders of the joints have been cut square

with the surfaces, the corners will be square when assembled.

After the corners have been fastened, lay on the bottom board with ends and edge flush with the sides of the box, and fasten with screws; continue this operation until the bottom is covered.

16. Trimming. — It will be necessary to do a little trimming with the plane after the box is assembled, to remove any projecting edges or tenons. Be careful in trimming the ends of the tenons, always to plane towards the box and never away from it, or you will splinter it.

QUESTIONS

1. Why should the seed be tested before planting?
2. Why do you select kernels from different parts of the ear?
3. Why should the sand and cloths be wet?
4. Why is it necessary to cut the shoulders of the joints square?
5. How does the method of fastening this joint make it one of the strongest?
6. Why is it easier to cut the mortise after boring than without boring?
7. Why is it unnecessary to bore holes in both pieces of wood in assembling these joints?

LESSON IX

SHEEP-FEEDING TROUGH

STOCK

13 board feet white pine $\frac{7}{8}$ " thick, s2s

$\frac{1}{2}$ lb. 8d nails

2 bolts $2\frac{1}{2}$ " \times $\frac{3}{8}$ " and washers

(s2s means "surface two sides," or planed on the two surfaces.)

TOOLS

Carpenter's square

Saw

Hammer

Try-square

Plane

Chisel

Gauge

Brace and bit

OPERATIONS

1. Laying off width and length of bottom, sides, and ends.
2. Sawing and planing.
3. Nailing in place.
4. Laying off width and length of supports.
5. Laying out mortises.
6. Laying out bases.
7. Sawing and planing to size.
8. Cutting mortises.
9. Nailing bases to uprights.
10. Laying off width and length of brace.
11. Laying out tenons.
12. Cutting tenons.
13. Laying off wedges to size.

14. Cutting to size.
15. Trimming holes for wedges.
16. Assembling.

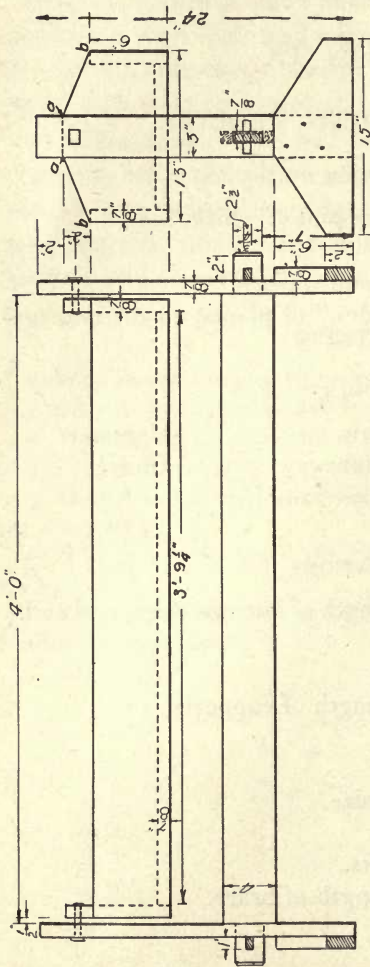

FIG. 47. — WORKING DRAWING OF SHEEP-FEEDING TROUGH.

1. Laying off width and length. — Lay off the width of the bottom $11\frac{1}{4}$ " and length $3' 9\frac{1}{4}$ ". Lay off the sides 6" wide and $3' 11$ " long. Lay out the ends 8" wide and 13" long; 2" from one edge of the ends, gauge a line from end to end; find the middle of the length and on the same edge lay off the middle line; $1\frac{1}{2}$ " on each side mark *a, a*, and draw lines to *b, b* on the ends (Fig. 47).

2. Sawing and planing. — Saw out the members just outside the lines, leaving enough material to plane the edges smooth and straight, and yet leave them full size.

3. Nailing in place. — Nail the two ends to

the bottom first, then nail the sides to the bottom and ends.

4. **Laying off supports.**—Lay off the supports, 3'' wide and 24'' long.

5. **Laying out mortises.**—Lay out the mortises in the supports as follows: 7'' from the lower ends square a line across; $2\frac{1}{2}$ '' from this line square another line across; but instead of measuring the $2\frac{1}{2}$ '' from the first line, a better way is to measure up from the lower end $9\frac{1}{2}$ '' and square across. The reason for preferring this method in measuring is that the liability of mistakes is reduced because mistakes are seldom repeated.

Find the middle of the supports by measuring $1\frac{1}{2}$ '' from each edge. As the brace is $\frac{7}{8}$ '' thick, you should make the mortise the same thickness; in laying it out, measure one half of this thickness on each side of the middle line; therefore measure $\frac{7}{16}$ '' on each side of the middle line and with the marking gauge scribe each side of the mortise. (To scribe means to mark with a knife or other sharp instrument.)

In gauging the first line, set it at $1\frac{1}{16}$ '', but in gauging the second line, *do not* gauge the same distance from the other edge. This would be all right if the supports were exactly the right width, but so seldom are all dimensions exact, that a better way is to gauge both sides of the mortise from one edge of the support; so for the second line, set the gauge at $1\frac{5}{16}$ '' and gauge from the same edge as before. Lay out the mortise on both surfaces.

6. **Laying out bases.**—Lay out the bases of the supports 6'' in width; rip along this line and plane. Square

one end and lay off 15'' for the length, square across and lay off the length of the second base. Gauge a line 2'' from one edge; find the middle of the length of each base and from this middle line measure off $1\frac{1}{2}$ '' on each side, and line to the 2'' mark on the ends, just as in laying off the ends of the box.

7. Saw and plane the members to line.

8. Cut the mortise by boring $\frac{5}{8}$ '' holes inside the lines; chisel from both sides, commencing with the ends, then trim down the sides. Be sure the edges of the mortise are square with the surfaces, and chisel from both sides towards the center. In testing the sides, or cheeks, of a mortise, use the try-square if it is possible to get the blade in the mortise; if not, lay the blade of a narrow chisel against the cheek of the mortise and test with a try-square.

9. Nail the bases to the uprights by starting the nails in the bases and locate them where they belong on the uprights; then drive one nail through, with the try-square or carpenter's square against the edge of the upright; square the bottom of the base with this and drive a second nail through, then the others, and clinch on the inside. This insures the bases being square with the supports. Be sure to stagger the nails.

10. Lay off the brace 4'' in width and $55\frac{1}{2}$ '' in length, saw, and plane.

11. Lay off the tenons by measuring in from each end $2\frac{7}{8}$ '' and square around on all four sides; then find the middle of the width, and from this line measure on each side $1\frac{1}{4}$ '' and gauge from the ends to the $2\frac{7}{8}$ '' line. In this case set the gauge at $\frac{3}{4}$ '' for the first line and at $3\frac{1}{4}$ '' for the second line. Lay out the holes in the tenons

before cutting the tenons. The line squared across $2\frac{7}{8}$ " from the end is called the shoulder; $\frac{7}{8}$ " from this shoulder, square a line across, and another, $1\frac{7}{8}$ " from the shoulder. Measure $\frac{3}{8}$ " on each side of the middle line, and gauge lines between the two cross lines just drawn, as in Fig. 48. Lay out on both surfaces.

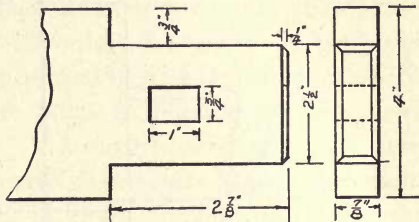
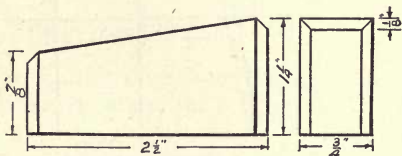

FIG. 48.—MORTISE AND TENON JOINT.

12. Cutting the tenons.—First, bore three $\frac{1}{4}$ " holes inside the lines marking the holes, and chisel out from both sides. The



hole is cut first, as the piece will not be so likely to split as it would be if the tenons were cut first. Second, saw from the edges along the shoulder from *a* to *b*, then rip from *c* to *b*; smooth up the edges with the chisel; gauge $\frac{1}{4}$ " from the edges of the ends, and chamfer with the plane (Fig. 49).

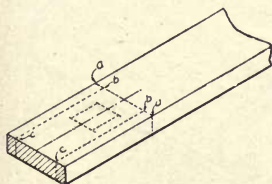

FIG. 49.—CUTTING THE TENON.

13. The wedges are laid off $2\frac{1}{2}$ " long and $\frac{3}{4}$ " thick and tapering from $1\frac{1}{4}$ " to $\frac{7}{8}$ ". Both ends are chamfered on three sides, as shown in the drawing.

14. Saw and plane on four sides.

15. Trimming holes for wedges.—Fit the tenon of the brace into the mortise of the upright support and drive

the wedge into place in the hole. The taper of the wedge will not allow it to fit into the hole because the

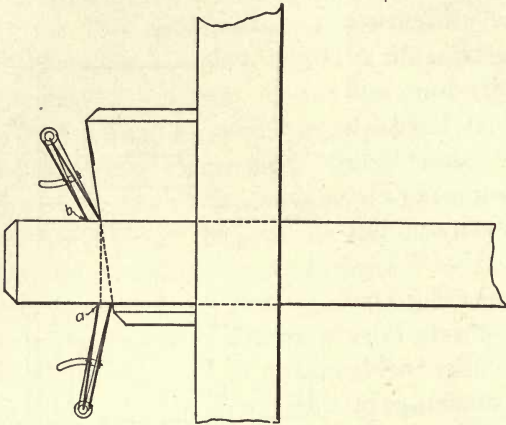

FIG. 50.—METHOD OF TRIMMING HOLE FOR WEDGE.

sides of the hole are square and one edge of the wedge tapers. The wedge binds on the side next the larger end of the wedge and there is a crack on the side opposite. With a pair of dividers, measure the width of the crack *a*, Fig. 50, then measure the same distance *b*; chisel down from this line inside, making a taper inside that will fit the taper of the wedge. If the hole is not slanted this way, the wedge will not fit tight and will not hold the supports firmly against the shoulder of the brace.

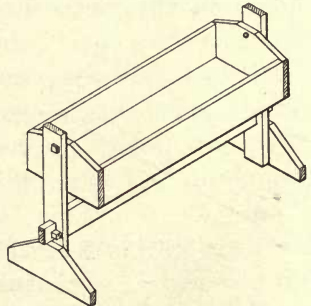

FIG. 51.—SHEEP FEED BOX ASSEMBLED.

16. **Assembling.** — Locate the holes for the bolts by measuring down from the top of the supports 3'' along the middle line; bore a $\frac{3}{8}$ '' hole.

Also 1'' down from the top of the ends of the box along the center line, bore a $\frac{3}{8}$ '' hole. Connect the supports by the brace which is mortised in and held in place with the wedges. Place the bolts in place, supporting the box, and screw on nut. Carriage bolts are used here because they have a square shank near the head, which, when driven into the wood, holds the bolt while the nut is being screwed on.

QUESTIONS

1. Why is the bottom fitted inside the sides and ends?
2. Why is the cross piece mortised into the uprights?
3. What advantage has a swinging trough over a fixed one?
4. How do you lay out a mortise for a wedge?

LESSON X

CHICKEN FEED BOX

STOCK

White pine 22 board feet, $\frac{7}{8}$ " thick, s2s.
 1 lb. 8d nails.
 1 pair hinges 2" butts.

TOOLS

Carpenter's square	Plane	Screwdriver
Bevel	Hammer	Chisel
Saw	Gauge	Try-square

OPERATIONS

1. Laying out two ends, three partitions, back, bottom, top, front, trough.
2. Making cleats.
3. Sawing and planing members.
4. Assembling.

1. The laying out of this exercise is the most important and difficult part of the operations. Care must

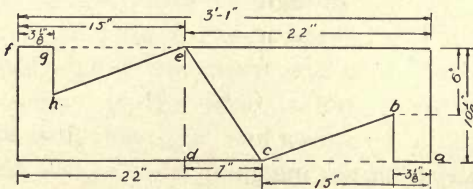

FIG. 52.—ENDS OF CHICKEN FEED BOX.

be taken to use no more lumber than is necessary.

For the two ends you need a board $10\frac{1}{4}$ "

wide and 3' 1" long. Beginning at *a*, Fig. 52, see if the end is square with the edges; if not, square it up. From *a* measure $3\frac{1}{8}$ " along one edge; square across about one half the width of the board; measure on this line $4\frac{1}{4}$ " to *b*. From *a* measure along the edge 15" to *c*, scribe a line from *b* to *c*. From *c* measure 7" to *d* and square across the board to *e*. Scribe a line from *c* to *e*. From *e* measure 15" to *f* and square across the board. Measure back from *f* $3\frac{3}{8}$ " to *g* and scribe a line about half-way across the board. From *g* measure on this line $4\frac{1}{4}$ " to *h* and scribe a line from *h* to *e*.

For the three partitions you need a board 4' 8" long and $10\frac{1}{4}$ " wide. Square up the end at *k*, Fig. 53, and measure on this line 5" to *l*. Along the edge measure 14" to *m*. Scribe a line from *l* to *m*. Square across the board to *n* and from this

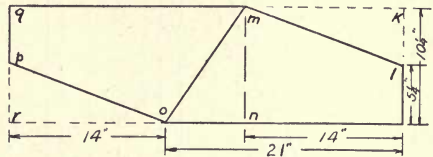

FIG. 53.—PARTITIONS OF CHICKEN FEED BOX.

point measure 7" to *o*. Scribe a line from *m* to *o*. Measure from *o* 14" to *r* and square across to *q*. On this line measure off 5" *r* to *p* and scribe a line from *o* to *p*. In the same way lay out the third partition from the remainder of the board.

You need for the back enough boards 24" long to make a width of $22\frac{1}{2}$ ". Square across one end of each board and accurately measure from these ends 24" and square across these ends. One edge of the top board is to be beveled. Scribe a line $\frac{1}{2}$ " down from the edge on one side with the marking gauge and then bevel.

You need for the bottom enough boards 24" long to

make a width of 12". Lay out by the same method that was used for the back, but do not bevel.

For the top you need enough boards 24" long to make a width of 15½". Lay out in the same way as the back and bottom are laid out, except that two bevels are to be laid out, each of ½", on opposite surfaces of the top.

For the front you need enough boards 24" long to

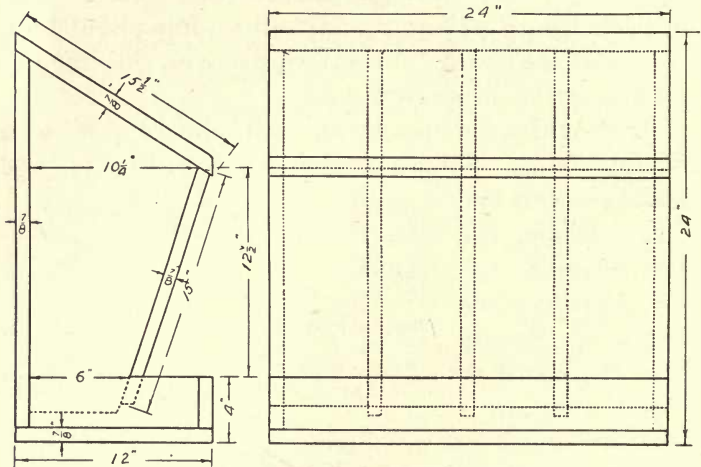

FIG. 54.—WORKING DRAWING OF CHICKEN FEED BOX.

make a width of 15". Lay out in the same way, except that there are two notches cut on the lower edge, each 2" deep and 7/8" wide. The top edge is also beveled 1/4" down from the edge.

The front of the trough consists of a board 24" long and 3 1/8" wide. Square up one end, measure 24", and square up the other end.

2. Making cleats.—The top is held together by two cleats 2" wide and 9" long. The thickness is the same

as the rest of the lumber. Gauge down $\frac{1}{4}$ " on the surface and edges, and plane down to these lines for the bevel, planing the edges first and the ends afterwards.

3. Saw outside all lines and leave the planing of outside edges until the box is assembled. Plane the edges square except where bevels are required.

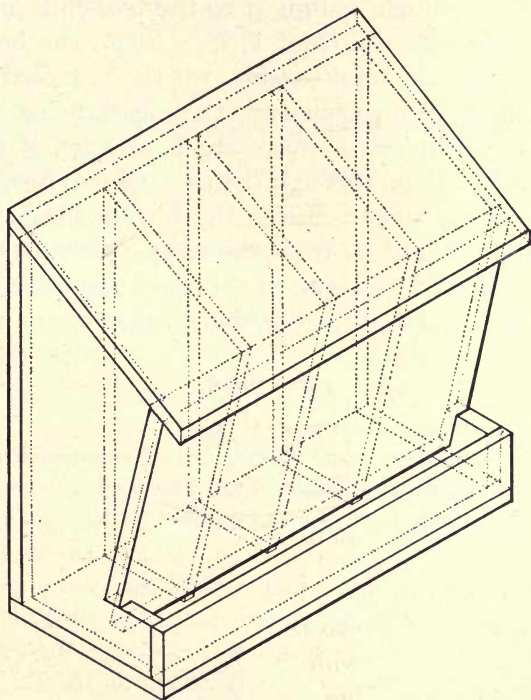

FIG. 55.—CHICKEN FEED BOX ASSEMBLED.

4. Assembling. — *First*, locate the three partitions by measuring on the back and squaring lines across at each point on both surfaces of the back. The inside line serves to locate the partitions and the outside line serves

to locate the nails which are to be driven in from the back into the partitions. *Second*, nail on the two ends in the same way. *Third*, nail the bottom to the two ends. *Fourth*, square lines across the front similar to the lines on the back and for the same purpose, and nail the front in place in the same way. *Fifth*, nail on the front strip of the trough, nailing it to the two ends and from the bottom into the front strip. *Sixth*, the boards of the top are held together by two cleats nailed on the underside 2" from each end, the cleats being 9" long and one end placed 2" from the back edge of the top. These nails will go through the top and can be clinched. *Seventh*, using screws, fasten the top on the back with two hinges placed 2" from the ends. Be sure to place the middle of the hinges on the crack between the top and back. Trim all projecting edges with the plane.

QUESTIONS

1. Why is the top made to slant down?
2. Why is the front made slanting instead of perpendicular?
3. Why does the top project over the trough?
4. Why does the front project into the trough?

LESSON XI

TRAP NEST

STOCK

- 12 board feet white pine $\frac{7}{8}$ " by 8" wide, s2s.
- 1 pair brass hinges 2" \times 1"
- $\frac{1}{2}$ lb. 8d nails
- $\frac{1}{4}$ lb. 6d nails
- 3 sq. ft. chicken wire
- Brads

TOOLS

Carpenter's square	Rule	Hammer	Chisel
Try-square	Saw	Plane	

OPERATIONS

1. Laying out and cutting bottom, sides, and end.
2. Laying out and cutting partition and nail in place.
3. Laying out and cutting cross piece.
4. Laying out and cutting blocks.
5. Laying out and cutting door, attaching strips.
6. Laying out and cutting brace.
7. Laying out and cutting strip.
8. Laying out and making frame for top.
9. Assembling.

1. Lay out the bottom 24" long by 15 $\frac{1}{4}$ " wide, the two sides 24" long by 11 $\frac{5}{8}$ " wide, and the end 15 $\frac{1}{4}$ " long by 10 $\frac{3}{4}$ " wide. These four pieces are sawed square on the

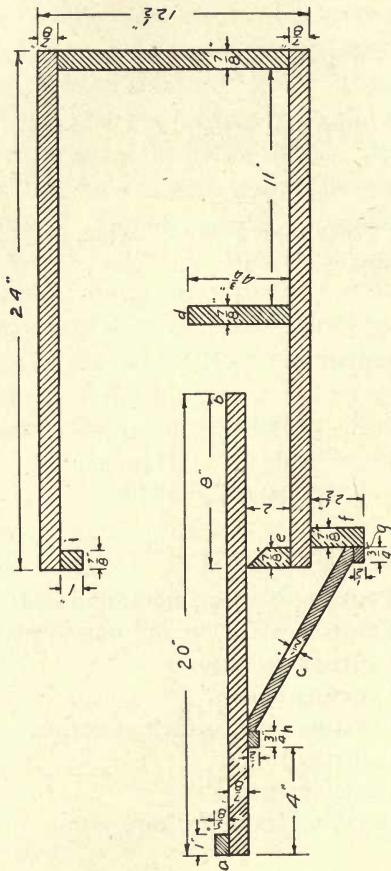

FIG. 56. — SECTION DRAWING OF TRAP NEST.

The trap nest allows a hen to enter the nest and keeps her there until she is released by hand. This is done in order to determine the laying hens. The hen lights at *a*, walks to *b*, her weight lifts *a*, and the brace *c* drops out. She hops to *d*, releasing *b*, which, on account of being lighter than *a*, flies up to *i*, closing the nest. The top is a frame filled in with chicken wire and is removable.

ends, and planed square on the edges, but the surfaces are left as they come from the mill.

2. Lay out the partition *d* $15\frac{1}{4}$ " long by $4\frac{3}{4}$ " wide. Fit this piece across the bottom 11" from the back, and nail in place on the bottom before the nest is assembled.

3. Lay out the crosspiece *e* $15\frac{1}{4}$ " long and 2" wide. Bevel the upper edge at an angle of 45 degrees. In laying out this bevel, either set the bevel at 45 degrees and mark the two ends, and then from the ends

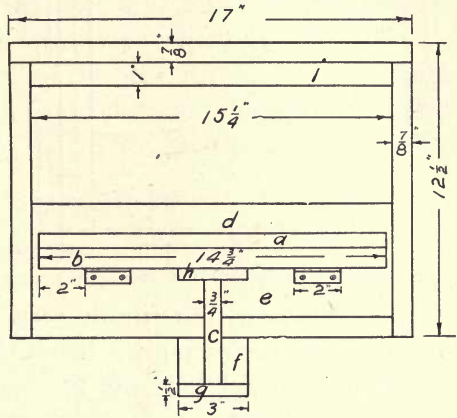

FIG. 57.—FRONT OF TRAP NEST.

scribe a line across one surface; or measure down from one edge a distance equal to the thickness of the piece and scribe across the surface.

4. Lay out the block *f* $2\frac{1}{2}$ " \times $\frac{7}{8}$ " \times 3", and the block *g* $\frac{1}{2}$ " \times $\frac{3}{4}$ " \times 3". Nail block *g* to the bottom of block *f*.

5. Lay out the door 20" long by $14\frac{3}{4}$ " wide. Across one end of the door, nail a strip *a* $\frac{5}{8}$ " \times 1" \times $14\frac{3}{4}$ ", flush with the edge, and underneath, in the middle of the width, nail another strip *h* $\frac{1}{2}$ " \times $\frac{3}{4}$ " \times 3". Place this 4" back from the edge.

6. Lay out the brace *c* $\frac{1}{2}$ " \times $\frac{3}{4}$ " \times $9\frac{1}{2}$ " and bevel the ends so that they will fit in the corners made by the blocks *h* and *g*. This brace, the block *g*, and the strip

h just laid out are the same thickness and width, and so can be laid out in one piece and afterwards cut to the

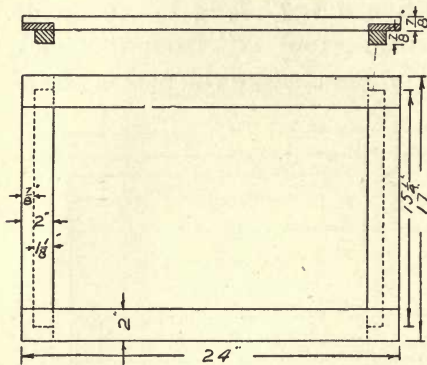

FIG. 58.—TOP OF TRAP NEST.

lengths required.

7. Lay out the strip *i* $\frac{3}{4}$ " \times 1" \times 15 $\frac{1}{4}$ " long. Saw out and fit between the sides flush with the top edges and the front edges.

8. Lay out the frame of the top, which is not fastened to the nest, but simply rests on top so it can be removed when releasing the hen and removing the eggs.

The frame is 24" long and 17" wide, outside measurements; the pieces are $\frac{7}{8}$ " thick and 2" wide, and are joined at the corners by halved joints glued and nailed with brads. Nail on two strips, as shown in Fig. 58.

9. **A s s e m b l i n g.** — First, nail the two sides

on the bottom with 8d nails. Second, nail the end in between the sides. Third, nail the strip *i* in front, flush with the upper edges and front edges. Fourth, nail the strip *e* in place between the sides and to

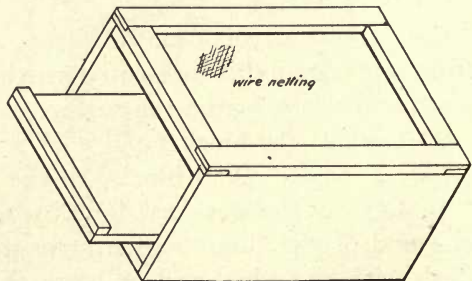

FIG. 59.—TRAP NEST ASSEMBLED.

the bottom flush with the front edges, and with the bevel sloping down and in. Fifth, fasten the door to the strip *e* with brass hinges placed 2'' from each end of the strip. The hinges can be screwed to the surface of the wood without letting in. (*Letting in* means to chisel a groove or recess to receive the hinges.) The top frame can be held in place by the two strips which are $\frac{7}{8}$ '' \times $\frac{7}{8}$ '' and as long as the width of the nest, inside measurements. Nail block *f* 1'' back from the front edge so that when the door drops down it will not hit the block *g*.

QUESTIONS

1. Why should one wish to use a trap nest?
2. If the end *b* of the door were heavier than the end *a*, how would you remedy it?
3. Why is the edge *e* beveled?
4. Of what use is the strip *a*?
5. Why is the wire netting on the top better than a board?

LESSON XII

WAGON JACK

STOCK

- 1 pc. hardwood, oak, hickory, or maple $5'' \times 2'' \times 3'$
- 1 pc. hardwood, oak, hickory, or maple $2'' \times 1'' \times 3'$
- 1 pc. hardwood, oak, hickory, or maple $1'' \times 2'' \times 12''$
- 1 hinge, 1 bolt, two iron straps

TOOLS

Rule	Saw	Screwdriver
Try-square	Chisel	Spokeshave
Bevel	Brace and bit	Plane
	Marking gauge	

OPERATIONS

1. Laying out, squaring, and planing pieces.
2. Making iron straps.
3. Assembling.

1. **Laying out, squaring, and planing.** — Plane *A*, Fig. 60, $5''$ wide, $2''$ thick, and $3'$ long. Set the gauge at $3''$ and gauge on both surfaces from one edge. $6''$ from one end, square a line across the gauged line. $4\frac{1}{4}''$ from this line, square another line. Repeat this operation until 5 lines have been drawn. These lines locate points *a*, *b*, *c*, *d*, and *e*. $1\frac{1}{2}''$ from the first line *a*, square another line, and at the same distance

from lines *b*, *c*, and *d*, square lines across; these lines locate points *f*, *g*, *h*, and *i*. Connect these points with *a*, *b*, *c*, *d*, *e*, and you will have the steps laid off. In sawing out this piece, begin at the upper end and rip down to *a*, then crosscut from *f* to *a*, saw from *f* to *b*, and so on until you have cut down to *e*, then rip from the lower end to *e*. With the compass, lay out both ends in a semicircle, and cut them with a chisel, finishing with sandpaper.

The steps and edges that have been sawed will have to be made as smooth as possible with the chisel. The block plane can be used with advantage on some of the longer edges. With a $\frac{3}{8}$ " bit, bore a hole through the upper end, nearer the lower edge than the upper, so as to give the piece as much strength as possible. The support of the jack is made of three pieces; two of them hinged together, and a handle fastened to the upper piece with screws. The handle projects over the end of the lower piece to prevent it from buckling or bending back and breaking the hinged joint.

Lay out the handle 1" thick, 2" wide, and 12" long. $7\frac{1}{2}$ " from one end square a line *ab* across one edge. Lay off a point *c* on the same end 1" from the edge; connect this point with the line squared across the edge. From *a*, square a line across the side (Fig. 60).

At the other end of the handle lay off a point 1" from the edge *d* and gauge a line from this point to *e* in the line squared across the side. Saw from *a* to *c* and from *d* nearly to *e*. Saw from *a* down to the line *de* on a slant so that the curve may be cut out with a chisel. Draw a free-hand curve at *e* and chisel down as close to the line as possible. Finish with a cabinet file and

sandpaper. Round off the handle with a spokeshave and sandpaper.

The line *ac* is cut on a slant because the handle is thus thrown out farther from the edge of the support and so does not pinch the fingers.

2. **Making iron straps.** — The iron straps are described under Blacksmithing.

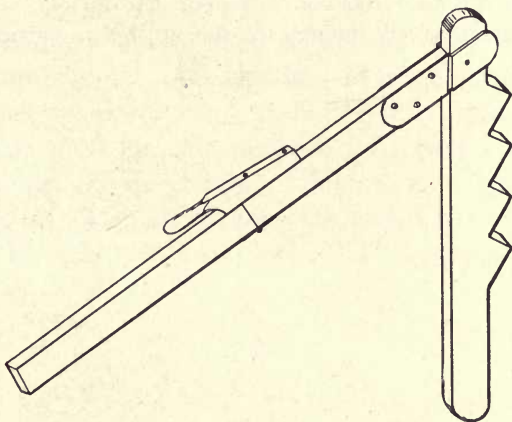

FIG. 61. — WAGON JACK ASSEMBLED.

3. **Assembling.** — *First*, saw nearly through the support 16" from one end with a fine saw. *Second*, fasten the hinge to the uncut edge of this support, taking pains to have the center of the hinge exactly over the line for the saw cut. *Third*, finish the saw cut down to the hinge. *Fourth*, fasten the iron straps in place on the upper end of the support. *Fifth*, fasten the handle in place with screws. *Sixth*, bolt the support to the leg of the jack.

To operate the jack, place it under the axle of the wagon, lifting the support with the handle; drop the

support to the ground in such a way that the support is bent at the hinge, and press down on the handle until the support straightens out, and raises the axle.

QUESTIONS

1. Why is the hole bored in the top off center ?
2. Why does the handle lap over the joint in closing ?
3. Why is the lower end of the support left square ?
4. Why saw nearly through the support before putting on the hinge ?

LESSON XIII

HAMMER HANDLE

The hammer handle must be made from some wood that is both strong and elastic. Maple is strong, but not elastic enough; birch is better than maple and is sometimes used for this purpose. Ironwood is tough enough, but is not elastic. Hickory makes an ideal wood for ax and hammer handles, and is the wood that should be selected if possible. The second growth hickory is the best.

STOCK

1 pc. hickory 1" \times 1 $\frac{1}{4}$ " \times 13 $\frac{1}{2}$ " Shellac

TOOLS

Rule	Plane	Spokeshave
Try-square	Saw	Sandpaper
Marking gauge	Chisel	Cabinet file

OPERATIONS

1. Laying out.
2. Surfacing one side.
3. Planing one edge.
4. Squaring one end.
5. Laying out length, width, thickness.
6. Planing to thickness.
7. Sawing to length.

8. Planing to width.
9. Laying out curves.
10. Cutting curves.
11. Chamfering corners.
12. Finishing.

1-8. Operations from 1 to 8, inclusive, are the same as those in the first lesson. Notice that two of the

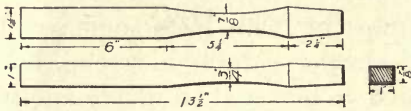

FIG. 62.—WORKING DRAWINGS OF HAMMER HANDLE.

operations have been omitted, viz., planing to length and sawing to width. They are unnecessary in this exercise.

9. Laying out curves. — In laying out the curves, draw a middle line on each surface and edge. Square a line across, $2\frac{1}{4}$ " from one end, which we will call the head end, as it is on this end that the head of the hammer will be fitted. Square another line across, 6" from the other end, which we will call the handle end. Draw these lines entirely around the piece. On the head end, gauge $\frac{1}{8}$ " in on the edges and $\frac{1}{16}$ " in from the two surfaces, making a parallelogram $1'' \times \frac{7}{8}''$. Draw lines from the $2\frac{1}{4}$ " line to meet the corners of this parallelogram produced to the edges. In laying out the curves, measure from the middle line $\frac{7}{16}$ " in each direction across the wider surfaces and $\frac{3}{8}$ " from the center line

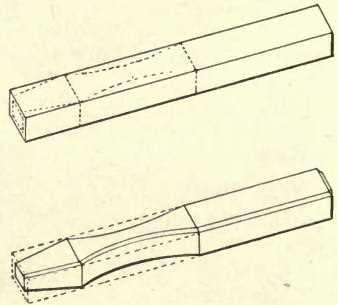

FIG. 63.—LAYING OUT CURVES ON HAMMER HANDLE.

across the narrow surfaces. Draw the curve free-hand, making it as nearly like that indicated by Fig. 63 as possible.

10. **Cutting curves.** — In cutting the curves, first saw down to the curves at the deepest point of the curve and chisel down from each end towards the saw cut, as illustrated in Fig. 64. Repeat this on all sides, chiseling as close to the line as possible without cutting it; then chisel down the head to the lines marked on the end.

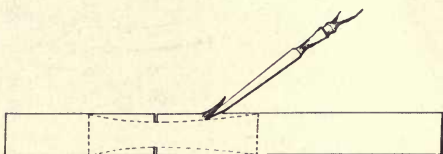

FIG. 64.—CUTTING CURVES IN HAMMER HANDLE.

11. **Chamfering.** — Chamfer off all corners, using the plane on all straight edges and the spokeshave on the curves.

All chamfers should be the same width if they are cut to the same depth. Work down the curved surfaces as smooth as possible with the spokeshave, and the flat surfaces with the plane.

When this operation is complete, the handle is ready for sandpapering. Hold it in the vise and sandpaper all over, as illustrated in Fig. 35, Lesson IV.

12. **Finishing.** — In finishing the hammer handle, give it a coat of orange shellac, let dry several hours, and sandpaper down to the wood. The shellac fills the pores of the wood and renders it impervious to water. If the handle is to be fitted to a head of a hammer, it will be necessary to trim down the head end to fit the opening in the head, then wedge it in place, as illustrated in Fig. 32, Lesson III.

QUESTIONS

1. Name the woods best suited for hammer handles, beginning with the best.
2. Why is it necessary to saw down to the lowest point of the curve before chiseling?
3. Why is the handle elliptical rather than round in section?
4. Why is the handle coated with shellac?
5. Why is the shellac sandpapered off afterwards?

LESSON XIV

PLANK DRAG FOR ROADS

STOCK

2 pcs. white pine or hemlock 2'' × 8'' × 7'	1 eyebolt $\frac{3}{4}$ '' × 5''
2 pcs. white pine or hemlock 2'' × 4'' × 7'	1 chain 2' 6''
1 pc. white pine or hemlock 2'' × 4'' × 4'	1 chain 4' 6''
2 bars 2'' round hickory	1 ring 3''
	1 lb. 20d spikes

TOOLS

Carpenter's square Saw Brace and bit Hammer

OPERATIONS

1. Laying out length.
2. Sawing to length.
3. Laying out holes.
4. Spiking planks together.
5. Boring holes.
6. Trimming ends of crosspieces and wedging in place.
7. Laying out brace, sawing, and nailing in place.
8. Boring hole for eyebolt.
9. Attaching chain.

1-2. **Laying out and sawing.** — The operations of laying out and sawing are very simple except those for the brace, and consist of simply laying off the length, squaring across one surface and one edge, and sawing to these lines. Do not lay out the brace until the planks are fastened together.

3. **Laying out holes.** — Lay out the holes in the 2" × 4" pieces before spiking them to the 2" × 8" pieces so that you will not drive a spike where a hole should be. Figure 65 indicates where the holes should be bored.

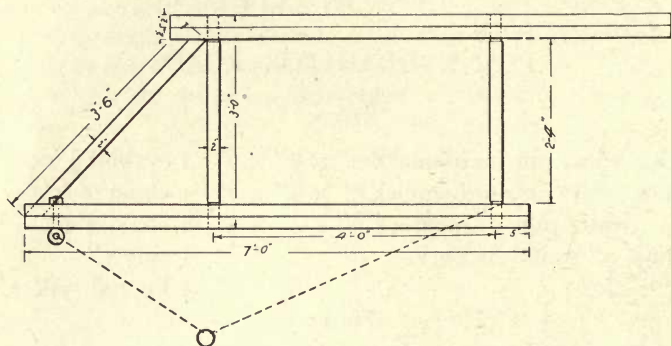

FIG. 65.—WORKING DRAWING OF PLANK DRAG.

4. **Spiking the planks.** — Spike the planks together from the 2" × 4" side, taking pains that the 2" × 4" are placed on the correct side of the larger planks.

5. **Bore the holes** with an expansion bit, taking the precautions referred to in Lesson III.

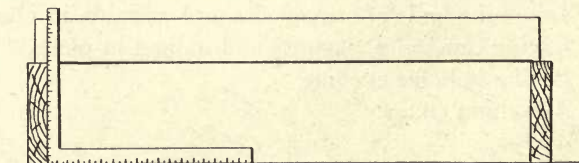

FIG. 66.—LAYING OUT BRACE. (FIRST STEP.)

6. **Trim ends of crosspieces** like those in the saw-buck and wedge them in the same way.

7. **Laying out brace, sawing, and nailing.** — Lay brace on top of the planks and at the proper angle

(Fig. 66). Scribe on the under edge; square across both surfaces at both ends and connect the ends of these lines to a line on opposite edge. This is the length

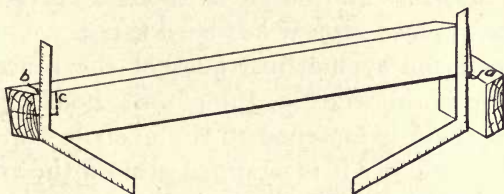

FIG. 67.—LAYING OUT BRACE. (SECOND STEP.)

the brace would be if it were placed flush with the top; or bottom; but as it is inclined from the top of the back plank to the middle of the front plank, it must be longer than this.

Lay one end of the brace on a block 4" high (Fig. 67), place the carpenter's square against it, touching the lower corner *a*, scribe along this edge, also repeat the operation at the other end, moving the square until the tongue touches the upper corner *b*, and scribe.

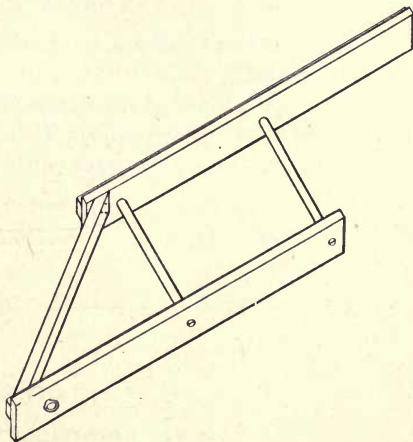

FIG. 68.—PLANK DRAG ASSEMBLED.

Repeat the scribing on the opposite surface and connect the ends of these lines with lines scribed across the two edges. This would be the layout if there were

no 2" \times 4" piece at *c*. This necessitates the cutting of a notch. Lay it out as in the drawing, measuring over 2" from the scribed line and draw lines parallel to those already drawn. The notch is about 2" deep. Spike the brace in place after it has been fitted.

8. Locate the eyebolt just back of the brace and in the middle of the width of the plank; bore a $\frac{3}{4}$ " hole.

9. The chain is fastened to the eyebolt and ring by split links, and at *e* it is wrapped around the crosspiece and fastened with a split link.

Sometimes the lower edge of the front plank is protected for one half of its length with a strip of steel, as that is the place where most of the wear comes.

QUESTIONS

1. With the ring located as it is in the drawing, how will the drag lie as it is pulled?
2. Why is the brace placed diagonally from the top of the back plank down to the bottom of the front plank?
3. Where is the greatest wear on this form of drag?

LESSON XV

SEWING HORSE

This sewing horse is not like those used by regular harness makers; but is a very simple design that will do on the farm, even though it is not so good as the other more complicated forms.

STOCK

1 pc. white pine	2" × 12" × 3'	1 pr. strap hinges 3"
1 pc. white pine	1" × 12" × 2' 8"	1 lb. 20d spikes
1 pc. white pine	1" × 12" × 3'	1 lb. 10d nails
2 pcs. white pine	2" × 4" × 3' 4"	1 doz. 1 $\frac{3}{4}$ " screws, F. H. B.
2 pcs. white pine	1" × 2" × 12"	

TOOLS

Steel square	Turning saw	Chisel
Try-square	Plane	Hammer
Bevel square	Drawshave	Screwdriver
Handsaw	Spokeshave	Brace and bit
	Keyhole saw	

OPERATIONS

1. Laying out and cutting bottom plank.
2. Laying out and cutting end board.
3. Laying out and cutting seat.
4. Laying out and cutting jaws.
5. Laying out and cutting cleats and boring screw holes.
6. Assembling.

1. **Laying out and cutting bottom plank.**—The bottom plank is to be 3' long, 12" wide, and 2" thick. Square up edges and ends. Locate the notches for the jaws by measuring 1' 3" and 1' 7" from one end, and squaring

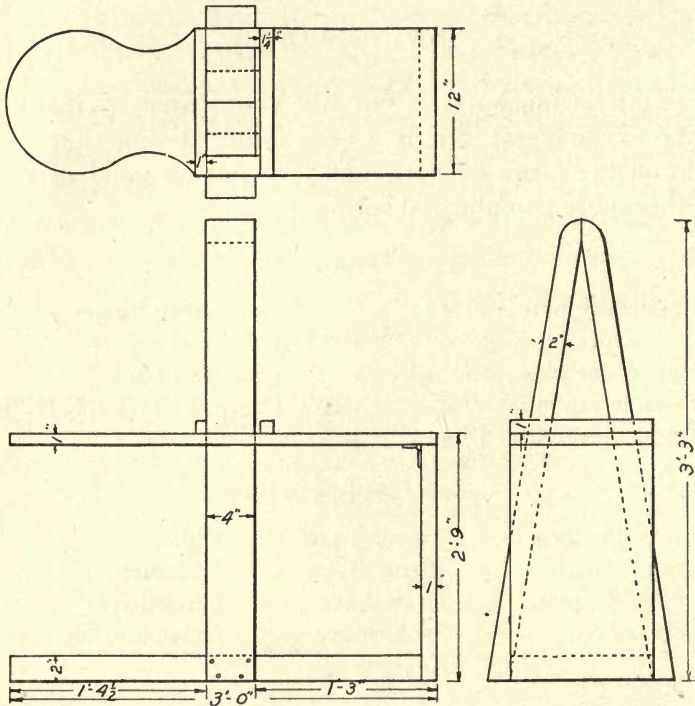

FIG. 69.—WORKING DRAWINGS OF SEWING HORSE.

lines across. If the jaws are wide enough to be full 4" after being planed smooth, then make the notches that wide; if not, make them as wide as the jaws will be, and no wider. In determining the angle at which the notches are to be cut, it will be necessary to lay out the

jaws on a piece of board half-size in the following manner. Measure 6'' along the end of the board, and from each end of this line draw a perpendicular line 1' 7½'' long; connect the upper ends of these lines with another line, which should be just 6'' long if the lines have been drawn correctly. Lay

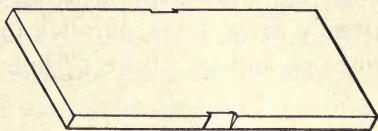

FIG. 70.—NOTCHES CUT IN BOTTOM PLANK.

off a point in the middle of the 6'' line and draw two lines from this point to the ends of the 6'' line on the end of the board. These lines represent the inner surfaces of the two jaws. Set the bevel, with the beam resting against the end of the board and the blade resting on one of the lines. Saw down one corner of the plank and chisel out, as shown in Fig. 70, testing the chiseled surface from time to time with the bevel.

2. **Laying out and cutting end board.** — The end board is laid out 1'' × 12'' × 2' 8'' long and squared up on the edges and ends.

3. **Laying out and cutting seat.** — Lay out the seat 1'' × 12'' × 3'.

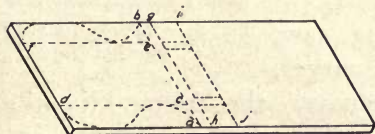

FIG. 71.—SEAT OF SEWING HORSE.

Square up the edges and the two ends, plane the upper surface smooth. Measure 1' 3'' from one end and square across the surface; then measure 1' 7'' from the same end, if the jaws

are full 4'' wide, and square across. Compare with the lay-out shown in Fig. 71. Measure in 2'' from each edge on line *ab* and from these points draw two lines

parallel with the edges *cd* and *ef*. Lay out the curve of the seat as indicated by the figure.

In laying out the holes, measure in from each edge $2\frac{3}{4}$ " and again 5" from each edge. At these four points draw lines parallel to the edges and between lines *gh* and *ij*. Bore 1" holes at the opposite corners

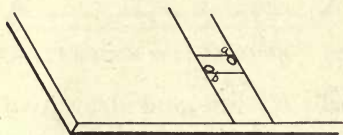

FIG. 72.—CUTTING HOLES IN SEAT.

a and *b*, Fig. 72. With the keyhole saw, saw along the adjacent sides.

When both holes have been sawed out, chisel out the inside edges until they are the same bevel as the notches in the bottom plank. A cross section through the holes is shown in Fig. 73. The sides of the two holes are beveled in the opposite directions.

In cutting out the curve of the seat either use a turning saw, cutting just outside the line and finishing down to the line with the spokeshave; or with the handsaw, saw down to the bottom of the concave curve and chisel from both sides down to this kerf, then finish with the spokeshave. Saw off the corners and with the drawshave cut down to the lines.

If you have a turning saw, use that in cutting all curves, turning the handles whenever the frame hits the board.



FIG. 73.—SECTION THROUGH SEAT, SHOWING HOLES.

The top of the curve is rounded with the spokeshave to make it more comfortable.

4. Laying out and cutting jaws.—The lower ends of the jaws will have to be beveled at the same angle as

the edges of the notches; so if you have the bevel still set at that angle, use it; but if not, then set it from the board you laid out, not from the angle of the notches. (Always take measurements and angles from some one pattern or measure. Never take measurements from each piece of work finished, or the last piece will be far different from the first piece or pattern.) Bevel the lower ends of the jaws, and also the upper ends at the same angle, but from opposite surfaces.

Then with the compass set at 2" strike a curve at the upper ends and chisel down to this curve; and finish with the block plane. Bore holes in the lower ends of the jaws for the 20d spikes so the ends will not split when the spikes are driven in.

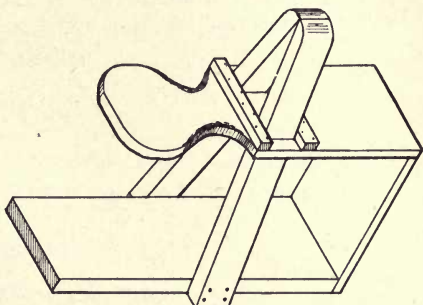

FIG. 74. — SEWING HORSE ASSEMBLED.

5. **Laying out and cutting cleats and boring screw holes.** — The cleats are laid out and planed 1" × 2" × 12". Square up and bore 6 holes for the screws, staggering the holes, as shown in the drawing.

6. **Assembling.** — *First*, nail the end board on to the plank. *Second*, screw the cleats to the top of the seat on each side of the holes, as shown in the drawing. *Third*, fasten the seat to the end board with the strap hinges on the under side. *Fourth*, place the jaws through the holes in the seat and nail the lower ends to the plank.

By lifting the seat, the jaws can be opened ; by sitting on the seat, the jaws can be closed with considerable force.

QUESTIONS

1. Why is a 2" plank better for the bottom than a 1" board ?
2. Why are cleats necessary across the top of the seat ?
3. Why are the tops of the jaws rounded ?

LESSON XVI

TRUSSED LADDER

STOCK

4 pcs. white oak 1" × 1" × 10'	12 carriage bolts $\frac{1}{4}$ " × 6"
10 pcs. white oak 1" × 5" × 12"	8 carriage bolts $\frac{1}{4}$ " × 4"
2 pcs. white oak 1" × 1" × 12"	4 carriage bolts $\frac{1}{4}$ " × 3"

Shellac

TOOLS

Rule S	Try-square	Keyhole saw	Marking gauge
Saw	Brace and bit	Spokeshave	Sandpaper

OPERATIONS

1. Squaring up side strips and cutting taper at ends.
2. Squaring up steps and cutting notches.
3. Making rungs.
4. Laying out and boring holes.
5. Assembling and shellacking.

1. Squaring up side strips and cutting taper at ends. — The side strips are planed 1" square and are then clamped to two blocks 3" wide, placed about 3' from each end. The ends are overlapped and

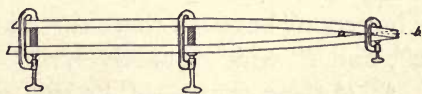

FIG. 75.—OVERLAPPING ENDS OF SIDE STRIPS.

held in place with clamps, as shown in Fig. 75. Then a line *ab* is drawn from where the pieces cross each other.

Saw the ends of the strips along this line and plane smooth.

2. **Squaring up steps and cutting notches.** — The steps are all squared up to the same size and planed smooth. After the ladder is assembled temporarily, some of the steps near the end will be found extending out beyond the strips. Cut six steps as shown in Fig. 76, with the

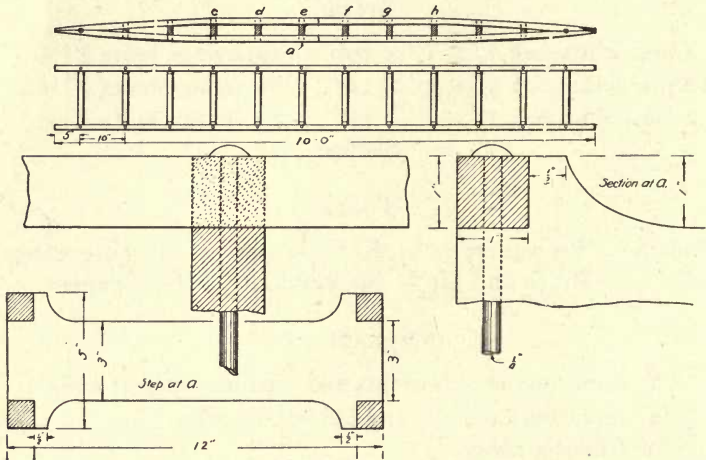

FIG. 76.—WORKING DRAWINGS OF TRUSSED LADDER.

1" × 1" notches cut at each corner. Two of the remaining four steps will be cut with the notches 1 1/2" deep, and the other two with the notches 2" deep. The tenons between these three kinds of notches are 3", 2", and 1" wide respectively.

3. **Making rungs.** — The two rungs, one for each end of the ladder, are made 1" in diameter and 12" long, by the method given in Lesson III.

4. **Laying out and boring holes.** — Locate the holes as

follows. 5" from one end square a line across the strips; 10" from this line square across another line, and repeat every 10". The last line will be 5" from the farther end of the strips. With the gauge set at $\frac{1}{2}$ ", gauge lines across each of the lines squared across; these locate the $\frac{1}{4}$ " holes that are to be bored for the bolts which will hold the strips together. Place the ends of two steps between the strips and clamp in place with carriage clamps, as in Fig. 75. Be sure that the steps are centered on the lines squared across, and that the shoulders of the steps are up tight against the strips. Bore a $\frac{1}{4}$ " hole through the strip and halfway through the step; reverse and bore from the opposite side, meeting the first hole in the center of the step. This insures a straight hole. As soon as the hole is bored, place a bolt in it, and screw on a nut and washer. Continue this until all steps are in place. The steps near the end will project beyond the strips. Mark them along the edge of the strips, so that they can be taken out and cut down to size. They are to be cut the same shape as the full-sized steps, but of course all dimensions should be reduced. When all the steps have been fitted, fasten the ends of the side strips together with large screws. Bore 1" holes for the rungs at the place marked out for them, and then bore $\frac{1}{4}$ " holes for the $\frac{1}{4}$ " bolts that hold the rungs in place. Fasten the rungs in place with $\frac{1}{4}$ " bolts.

5. **Assembling and shellacking.** — When the ladder has been fitted, screw all the nuts tight and give the whole a coat of shellac. Follow this with a sandpapering, and a second coat of shellac. Then the ladder is ready for use.

QUESTIONS

1. Why is it necessary to clamp the strips in place before laying out the taper for the ends?
2. Of what use are the notches in the ends of the steps?
3. How do you lay out an octagon in laying out the rungs?
4. Why not bore all the holes straight through the strips instead of boring them after the steps have been fitted in place?
5. Why is it necessary to fasten the ends with screws before boring the 1" hole for the rungs?

LESSON XVII

COMBINATION LADDER

A combination ladder is one which can be used as a step ladder and also changed into a longer ladder of the common type.

STOCK

2 side strips oak $\frac{3}{4}'' \times 4'' \times 5'$	1½ doz. screws $\frac{7}{8}''$, No. 8
2 side bars elm $1'' \times 2'' \times 4' 6''$	2 doz. screws $2''$, No. 10
5 steps oak $\frac{7}{8}'' \times 5'' \times 1' 5''$	1 bolt $\frac{3}{8}'' \times 1' 7''$
1 step oak $\frac{3}{4}'' \times 6'' \times 1' 10''$	2 bolts $\frac{3}{8}'' \times 2\frac{1}{2}''$
5 rungs oak $1''$ round $\times 1' 6''$	2 iron plates
	2 iron straps
Chain and screw eye	3 iron hooks

TOOLS

Steel square	Saw	Screwdriver
Try-square	Plane	Chisel
Bevel	Brace and bit	Marking gauge
Keyhole Saw	Sandpaper	

OPERATIONS

1. Laying out and cutting side pieces.
2. Laying out and boring side bars.
3. Laying out and cutting steps.
4. Laying out and making rungs.
5. Making iron plates and straps.
6. Cutting the curve in the ends of the side pieces.
7. Assembling and shellacking.

1. Laying out and cutting side pieces. — The side pieces are $\frac{3}{4}'' \times 4'' \times 5'$, made of oak or some other hardwood and planed smooth with the edges and ends squared. Lay out the bevel for the top and bottom and steps in the same way as in Lesson XV.

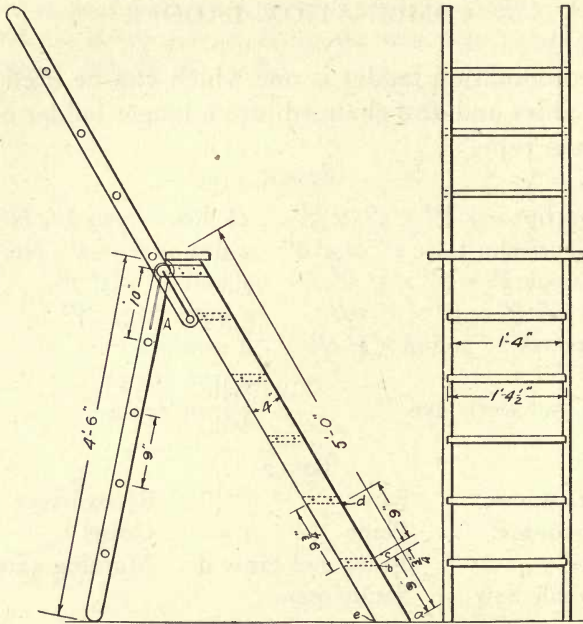

FIG. 77.—WORKING DRAWINGS OF COMBINATION LADDER.

Lay out, half size, a side piece on a board in the following manner. Measure along the edge of the board 2' 2" and from this point square in 1' 3" from the edge. Draw a line from the corner of the board to the point just located. This line represents the inclination of the side pieces when the ladder is standing.

Set the beam of the bevel against the end of the board and adjust the blade along the inclined line.

Beginning at *a*, Fig. 77, lay off the bevel *ae* and measure up from point *a* 9'' to *b*. Lay off another bevel, then measure $\frac{3}{4}$ '' to *c*, and lay off another bevel. Continue this operation until all steps are laid off. On the other side piece repeat the operation, but on the reverse side; that is, so that when both pieces are laid off and placed together, face to face, the lines will all coincide, or touch each other.

At the points where these bevel lines touch the edges, square across the edges with the try-square. With the marking gauge set at $\frac{1}{4}$ '', gauge between the lines along both edges, holding the guide against the inner surface of the piece. This means that the grooves are to be $\frac{3}{4}$ '' wide and $\frac{1}{4}$ '' deep. With the backsaw, saw very carefully inside the lines.

A method very often used when accurate work is desired is as follows: select a small strip of hardwood about 6'' long and 1'' square; lay this on the outside of the line with the edge just covering the line and fasten in place with two carriage clamps; hold the blade of the saw against the piece and saw down to the required depth, $\frac{1}{4}$ ''.

When all grooves have been cut, chisel out the grooves with a $\frac{1}{2}$ '' chisel. Chisel from both edges towards the middle so as not to get the groove too deep. Test the bottom of the groove from time to time by laying the edge of the chisel along the bottom.

2. **Laying out and boring side bars.** — The side bars are 1'' × 2'' × 4' 6''. Elm makes better side bars than any other wood because of its toughness. Plane,

square up the edges and sides. With the compass set at 1" radius, draw semicircles at each end of the bars. Saw along each semicircle with a keyhole saw.

Lay out the holes as follows: 1" from one end square a line across the surface; 10" from this line square another line across; 9" from this line square another line across, and so on every 9" until five holes have been located. This brings the last hole 13" from the end of the bar.

Set the marking gauge at 1" and gauge a short line cutting each of the five lines drawn. Repeat these operations on the other bar.

Set the gauge at $\frac{3}{4}$ " and gauge from both edges between the first two holes; this is for a slot which is to be cut $8\frac{1}{2}$ " long and $\frac{1}{2}$ " wide.

The slot begins at a point $\frac{1}{4}$ " from the edge of the first hole. You must lay this out accurately or the ladder will not work properly when you want to make the change from a step ladder to an extension ladder.

When the work is all laid out, bore the holes for the rungs, using a $\frac{7}{8}$ " bit and boring from both sides so as to insure clean holes.

For the slot, use a $\frac{3}{8}$ " bit and bore a row of holes inside the gauged lines as close together as possible; then chisel out the slot smooth, chiseling from both sides.

3. Laying out and cutting steps. — Surface the steps, square up the edges and the ends so that they are all exactly of the same dimensions, — $\frac{3}{4}$ " \times 5" \times 1' 4 $\frac{1}{2}$ ". As the grooves cut for the steps are only $\frac{3}{4}$ " wide, it will be necessary to plane the thickness a trifle over $\frac{3}{4}$ ", which we will call $\frac{3}{4}$ " full, so as to insure the steps fit-

ting tight enough to make it necessary to drive in with the mallet.

Some workmen advise planing down the ends of the steps until they fit the groove. This method is not advised, as it does not give strong joints where strength is needed; and it is a sort of cut-and-try method, which is not recommended in any work where it can be avoided.

If the steps are not all the same length, the longest will prevent the others from fitting properly. The top step is longer and wider than the others, being 1' 10" long and 6" wide.

4. Laying out and making rungs. — In making the rungs,

saw out the strips 1" square and 1' 6" long; square up on all four sides with the plane until the pieces are exactly 1" square. Lay off on each stick an octagon in the following manner. *First*, measure across the diagonal of the end of the stick. *Second*, set the gauge at one half this distance and gauge from all four sides in both directions, which will leave two lines on

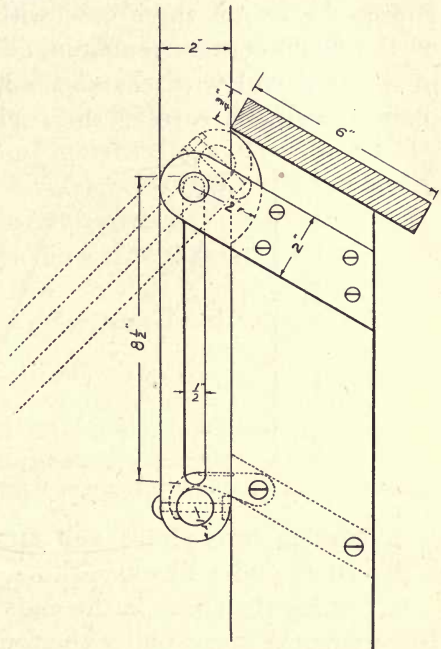

FIG. 78.—DETAIL AT TOP OF STEP LADDER.

each surface. *Third*, place the square piece in the board made for this purpose, which is shown in Fig. 125, page 155; plane each corner down to the gauged lines and you will have an octagon. *Fourth*, lay the octagonal pieces on the bench against the bench dog and make about three cuts with the plane on each of the eight corners remaining. *Fifth*, hold the stick in the vise and with coarse sandpaper cut off the remaining corners, turning the stick frequently so as to

insure even cutting. In this way it is possible to make a stick nearly as round as it would be if turned in a lathe. Trim down the ends to fit the holes and split them with a saw for the wedges.

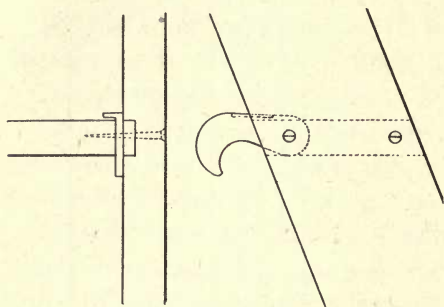

FIG. 79. — DETAIL SHOWING ATTACHMENT OF HOOK.

5. **Making iron plates and straps.** — The ironwork is described under Blacksmithing.

6. **Cutting the curve in the ends of the side pieces.** — In cutting the curve under the top step, lay a side piece on the bench and place a block against the edge near the acute angle of the top of the piece. Gauge a line 1" from the edge of the block that rests against the side piece and set the compass at 2"; scribe an arc similar to the one in the detailed drawing, Fig. 78. Saw this out with a keyhole saw and smooth with sandpaper.

7. **Assembling and shellacking.** — *First*, fit all steps in place and fasten with 2" screws; and fasten on the top

step. *Second*, drive the rungs in place so that the saw kerfs in the ends are perpendicular to the sides of the bars, otherwise driving in the wedges will be apt to split the bars. Then drive in the wedges. *Third*, put the iron straps and plates in place, and fasten the two parts of the ladder together with the bolt. *Fourth*, the hooks are to be fastened to the side bars where the next to the top step is located, as shown in the detailed drawing, Fig. 79. Take out the screw; saw a slit deep enough to admit the hook; and replace the screw through the eye of the hook. *Fifth*, fasten the chain and the screw eye in place so that the ladder can be spread the proper distance. *Sixth*, shellac and sandpaper.

QUESTIONS

1. Why are the steps let into the sides?
2. Why is the top of the support ironed?
3. Why do you bore holes from both sides?
4. How do you lay out an octagon?

LESSON XVIII

FARMER'S LEVEL

The farmer's level consists of a tripod and a turntable composed of a crosspiece holding two uprights, to which are fastened two glass tubes connected by a rubber tube. The turntable is fastened to the tripod head by a pivot screw, which enables it to rotate in any direction.

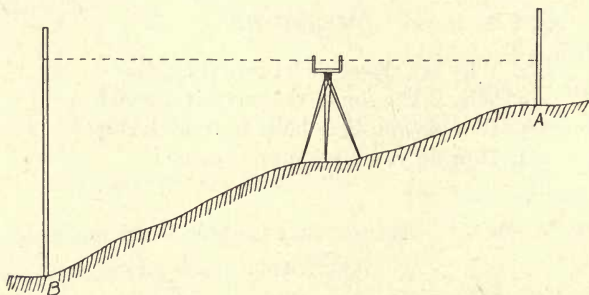

FIG. 80. — METHOD OF USING FARMER'S LEVEL.

Water is poured into the tubes until within an inch or so of the top. When the tripod is set up, one can be sure that the water in the tubes is at the same level, and so a line sighted across the water surfaces is horizontal or level. Suppose it were required to find the difference in level of two points *A* and *B*, Fig. 80. Set the level about midway between *A* and *B* and sight across to the leveling rod placed at *A*. When the target is raised

so it can be seen on a level with the water surface, then it is at the same level as the surface of the water. Note the height of the target above the ground at *A*. Place the rod at *B* and raise target until it is level with the surface of the water in the tubes. The difference between the height of the target when at *A* and when at *B* is the difference between the level of the ground at *A* and *B*. If the target at *A* stood at 2', and the one at *B* 6', then the point *B* is 4' lower than *A*. Without moving the level one can determine the heights of several points by turning the turntable in different directions.

STOCK

- 1 pc. white pine $\frac{7}{8}'' \times 8'' \times 4'$
- 1 pc. hard wood $\frac{7}{8}'' \times 6''$ square
- 2 glass tubes $6'' \times \frac{5}{8}''$ diameter
- 1 rubber tube to fit glass tubes
- 18 screws 1'', No. 38, F. H. B.
- 5 screws $1\frac{1}{2}''$, No. 38, F. H. B.
- 4 screws $\frac{1}{2}''$, No. 3, R. H. Bl.

TOOLS

Rule	Try-square	Marking gauge
Ripsaw	Plane	Brace and bit
Turning saw	Screwdriver	Gouge
Chisel	Cabinet file	Sandpaper
	Carpenter's square	

OPERATIONS

Legs of Tripod

1. Laying out the legs.
2. Ripping the legs.
3. Planing the edges of the legs.

4. Laying off the middle lines on the legs.
5. Squaring up the ends.
6. Locating and boring holes for hinges.
7. Pointing the smaller ends of the legs.

Tripod Head

1. Surfacing one side.
2. Gauging to thickness.
3. Surfacing other side.
4. Laying off the circle.
5. Cutting the circle.
6. Laying off and boring screw holes for hinges.
7. Boring hole for pivot.

Turntable

1. Surfacing one side.
2. Planing one edge.
3. Gauging to thickness.
4. Surfacing other side.
5. Planing other edge.
6. Laying out length.
7. Sawing to length.
8. Planing ends.
9. Boring the holes in the uprights.
10. Gouging the groove in the crosspiece.
11. Boring the screw holes and pivot hole.

All Parts

1. Assembling.

LEGS OF TRIPOD

1 and 2. Laying out and ripping the legs. — There are several methods of laying out the legs, but the one given here is economical in both material and labor;

and in making large or small pieces it is advisable to be as economical in lumber and time as possible.

Select a pine board that has been surfaced or planed

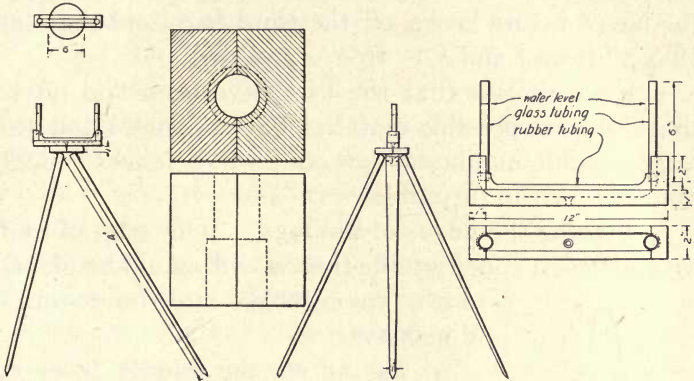

FIG. 81.—WORKING DRAWINGS OF FARMER'S LEVEL.

on both sides and is about $\frac{7}{8}$ " thick. Measure off 4' in length. (See Fig. 82.) From one corner *a* measure off 3" to *b*. From the other corner *c* measure off 1" to *d*. Draw a line between *b* and *d*.

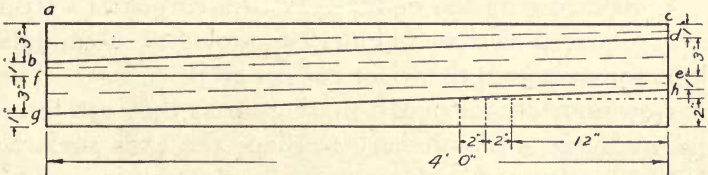

FIG. 82.—LAYING OFF LEGS OF TRIPOD.

Before laying off the other legs, this one should be ripped off; for the reason that if all the legs were laid off at once and then ripped, they would be too small. Therefore, lay off one leg and rip, being careful to saw

in the material to be removed. Plane the edge of the board just ripped before laying out the second leg; and lay off the second leg with the point *e* 3" from *c* and the point *f* 1" from *b*. Rip this off and plane the edge of the board before laying off the third leg; and then lay off *g* 3" from *f* and *h* 1" from *e* and rip.

You will notice that the legs have been laid off so that the least possible material has been used and the least possible number of saw cuts, which leaves enough material for the turntable.

3. **Planing the edges of the legs.** — One edge of each leg will be left rough by the rip saw and should be planed down smooth and to the required dimensions.

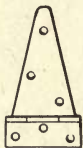

FIG. 83.—HINGE FOR FARMER'S LEVEL.

4. **Laying off the middle lines on the legs.** — It will be necessary to lay off middle lines on each leg before the ends can be squared up. Select a point midway between *a* and *b* and another midway between *c* and *d* and connect these points with a line.

5. **Squaring up the ends.** — With a carpenter's steel square placed so that its inner edge touches the middle line, square across the wider ends of all three legs. The narrow ends do not need squaring up as they are to be pointed. It is unnecessary to plane the ends smooth.

6. **Locating and boring screw holes for hinges.** — The hinges should be of the pattern indicated in Fig. 83. The strap leaf should extend along the leg, and the other leaf should be fastened to the tripod head. It is better not to fasten the hinges to the legs until the screw holes have been bored in the tripod head.

7. **Pointing the smaller ends of the legs.** — Measure up 1" from the smaller end of the legs and square around on four sides. From these marks, chisel towards the center line on the two surfaces and towards the middle from the two edges.

TRIPOD HEAD

1. **Surfacing one side.** — Select a hard wood, as maple, birch, or oak. It will be necessary to have a board at least 6" square and $\frac{7}{8}$ " thick. Surface one side.

2. **Gauging to thickness.** — Gauge to thickness on all edges.

3. **Surfacing other side.** — Surface the other side, planing down to the gauge lines.

4. **Laying off the circle.** — Draw

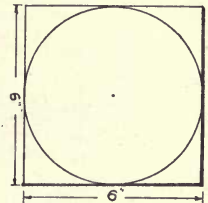

FIG. 84. — LAYING OFF CIRCLE.

diagonals from the four corners of the board. Locate the center and then draw the circle with the compass set at 3" radius. (See Fig. 84.)

5. **Cutting the circle.** —

There are two methods of cutting the circle. If you have a turning saw, use it and saw about $\frac{1}{16}$ " outside the line, holding the saw as illustrated in Fig. 85. Then it is necessary to smooth the edge

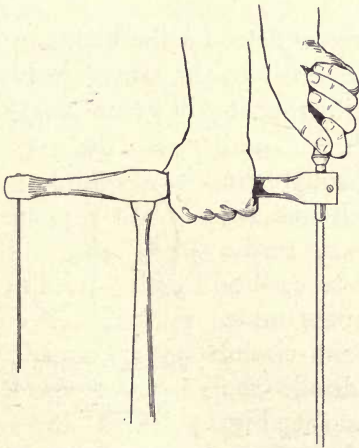

FIG. 85. — METHOD OF HOLDING A TURNING SAW.

down with a cabinet file and sandpaper. Take pains to keep the edge square with the surfaces. The second

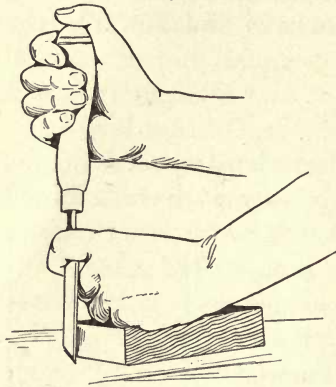

FIG. 86.—CUTTING OUT CIRCLE WITH A CHISEL.

method is to saw off the corners and chisel down to the line as in Fig. 86. This method can be followed when no turning saw is available. Be careful to place a board under the piece so as to prevent the chisel cutting the bench top. Always chisel in the direction of the grain and not in the crosswise direction, to avoid splitting the wood. Be sure the under

board is flat, or you will be apt to splinter the under side of the piece.

6. Laying off and boring screw holes for the hinges. — There are three legs to be fastened to the tripod head. In order to locate them equidistant it will be necessary to divide the circle into three equal parts. Draw a diameter through the center of the circle and with one leg of the compass at point *a*, scribe points *c* and *b*. The distance between the legs of the compass must be equal to the radius of the circle. These two points with *d* divide the circle into three equal parts. (See Fig. 87.) From points *c* and *b* draw lines to the center; on these lines locate the three hinges by placing the center

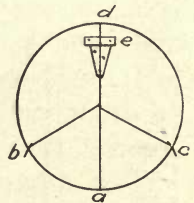

FIG. 87.—POINTS AT WHICH HINGES ARE ATTACHED.

of the hinges on the lines and the edges equidistant from the edge of the circle, as at *e*. Mark the screw holes and bore them with a gimlet bit a trifle smaller than the screws to be used.

7. Boring hole for pivot. — To bore the hole for the pivot screw, select a bit a trifle smaller than the screw and bore a hole in the center of the circle nearly through the board.

TURNTABLE

1-8. — For the turntable, use the fourth piece of pine cut off from the legs. The operations 1-8 are the same as those of Lesson I and need not be repeated here.

9. Boring the holes in the upright blocks. — When the two short blocks have been properly squared up, fasten them together in the vise, end grain uppermost. Lo-

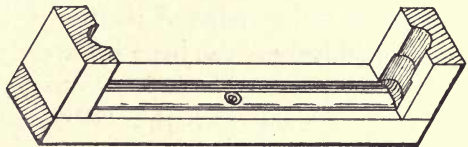

FIG. 88. — SUPPORT FOR GLASS TUBES.

cate the center by drawing diagonals from the corners, and bore the larger hole first, halfway through the block. Reverse the ends and bore the smaller hole the rest of the way, meeting the other hole in the center. (See Fig. 81.)

The smaller hole is the size of the glass tubes, and the larger hole the size of the rubber tubing after it has been attached to the glass tubes.

10. Gouging the groove in the crosspiece. — The part of the rubber tube that connects the glass tubes must have a groove in which to lie; so the crosspiece

must be grooved with a half-round gouge to a depth equal to one half the diameter of the rubber tubing.

11. **Boring the screw holes and pivot hole.** — The uprights are to be fastened to the crosspiece, as in Fig. 88, with screws from the under side, two screws in each end. In the center of the crosspiece and at the bottom of the groove bore a hole the size of the pivot screw, and countersink.

ALL PARTS

1. **Assembling.** — In assembling, first fasten the hinges to the under side of the tripod head; then fasten the legs on the hinges with screws. Next fasten the turntable to the tripod by a pivot screw through the center. Now fasten the tubes and rubber tubing to the uprights by strips of leather or tin held in place by small, round-headed, blue screws.

QUESTIONS

1. In laying out taper legs, why do you reverse every other piece?
2. Why do you plane down one edge before laying out the next leg?
3. Why is a middle line on each leg necessary?
4. Which method of cutting a circle do you prefer? Why?
5. Why is it best to have a groove in the crosspiece for the rubber tubing?

LESSON XIX

LEVELING ROD

STOCK

1 pc. pine $\frac{1}{2}'' \times 2'' \times 5'$	1 pc. brass, 16 gauge, $7'' \times 4''$
1 pc. pine $\frac{1}{4}'' \times 1\frac{1}{2}'' \times 5' 6''$	1 pc. spring brass $4'' \times 1''$
1 pc. pine $\frac{1}{4}'' \times 1\frac{1}{4}'' \times 5' 6''$	2 screws $\frac{3}{4}''$, No. 6
2 pcs. pine $\frac{1}{4}'' \times \frac{3}{8}'' \times 5' 6''$	4 screws $\frac{1}{4}''$, No. 8
2 pcs. pine $\frac{1}{4}'' \times \frac{1}{4}'' \times 5' 6''$	$\frac{1}{2}$ lb. $\frac{1}{2}''$ brads
1 pc. pine $\frac{1}{4}'' \times 6'' \times 6''$	$\frac{1}{2}$ lb. $1''$ brads

Glue and shellac

TOOLS

Rule	Try-square	Marking gauge
Plane	Hammer	Sandpaper
File		Drill

OPERATIONS

1. Gauging and planing stock to size.
2. Assembling all pieces and shellacking.
3. Laying off graduations.
4. Making the target.

1. Gauging and planing stock to size. — If the lumber comes in the rough, it should be a quarter over size to allow for surfacing. This exercise requires a considerable degree of accuracy in measuring and planing.

Plane up the piece *a*, Fig. 91, to size, following the directions given in previous lessons as to planing up

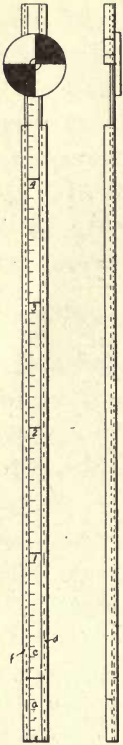

FIG. 89.—LEVELING ROD, FRONT AND SIDE VIEWS.

stock. The dimensions of this piece will be $\frac{1}{2}'' \times 2'' \times 5' 6''$. As it is a thin, narrow piece, it is apt to buckle and break in planing. To prevent this, fasten the two ends to a board, as shown in Fig. 90, by boring $\frac{3}{8}''$ holes through the piece and board and driving hardwood pegs in flush with the top of the piece to be planed. Very thin lumber can be surfaced this way, and all the pieces in this exercise can be planed on the same board with the same pegs and board. Each of strips *d*, *e*, *f*, and *g*, Fig. 91, are $\frac{1}{4}''$ thick and so can be planed in one strip and cut apart afterwards. In cutting apart the strips, some lumber will be wasted, as the edges must be planed, so it will be necessary to allow for this waste and make the piece from which they are cut $1\frac{1}{2}''$ wide, although the sum of the widths is only $1\frac{1}{4}''$.

It will be almost impossible to cut off the narrow strips with the saw, so the following method is recommended. File the spur of the marking gauge until it resembles the point of a knife, and set the gauge at a little over $\frac{1}{4}''$ and gauge on both surfaces as deeply as possible; the spur will cut nearly through, so that a jackknife drawn along the groove will easily cut them apart. Next plane up the two edges and cut the second strip the same width. Plane

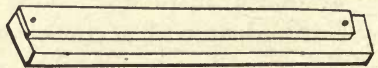

FIG. 90.—HOLDING A THIN STRIP FOR PLANING.

up the edges, set the gauge at $\frac{3}{8}$ " , and cut two more strips in the same way.

2. Assembling all pieces and shellacking. — Strip *c* should now be glued and nailed to strip *b* in the position shown in Fig. 91, end view.

Then strips *f* and *g* should be glued and nailed together and fastened to strip *a*; likewise strips *d* and *e*. Carefully wipe away all glue that squeezes out from the joints, as it would prevent the sliding of the strips if allowed to harden. The whole should be sandpapered smooth, shellacked, then sandpapered again. Be sure that *cb* is in position when you fasten *de* to *a*, or it will not fit; but be sure to withdraw it soon, or it will be glued by the excess glue that squeezes out from the joint.

3. Laying off graduations. — Lay off the graduations with waterproof India ink. Beginning at the bottom of strip *c*, lay off feet, inches, and half

inches up to 5'. On the bottom of the second strip *a* lay off the same graduations, but begin where the others left off, that is, at 5'. Shellac over the graduations. In using the leveling rod the height of the target is read directly from the scale on *a*. If the height is 7', the bottom of strip *c* rests on the 7' mark of strip *a*.

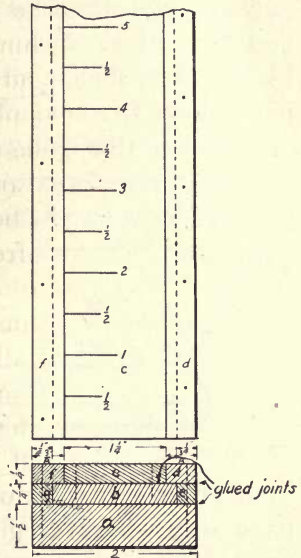

FIG. 91.—DETAILS OF LEVELING ROD.

4. **Making the target.** — Make the target round and 6" in diameter. Plane both surfaces smooth before cutting out the circle; then lay out the circle and chisel around, beginning with the grain of the wood and chiseling towards each end. Place a piece of coarse sandpaper on a block and smooth down to a perfect circle; then finish with No. 1 sandpaper.

Draw two diameters at right angles to each other, and with black shellac color alternate quarter circles black; then shellac all over with white shellac. Sandpaper down to a smooth finish. Bore a 1" hole in center of target so that you can see the graduations.

Make a brass stirrup so it will just fit over the leveling rod and have two flanges about $\frac{1}{4}$ " wide through which

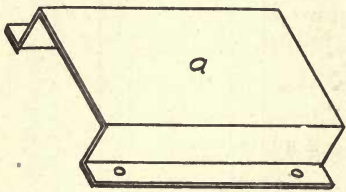

FIG. 92.—STIRRUP FOR LEVELING ROD.

screws can be driven to hold it to the target. (See Fig. 92.) Drill two holes in each flange large enough to fit the $\frac{1}{4}$ " screws. With the hammer, dent in the surface from the outside a

little at *a*; this will make it bind on the rod and cause it to stay wherever placed without holding. Saw off the top 6" of the part *adefg*, Fig. 91, and fasten to part *bc* with two screws.

QUESTIONS

1. What method do you prefer in planing up thin stock?
2. What method is best in splitting thin stock into strips?
3. How would you measure heights over 5 feet?

LESSON XX

THREE HORSE EVENER

With this form of an evener no horse can pull less than his share of the load.

STOCK

- 1 pc. hickory or white oak $2'' \times 6'' \times 4' 5\frac{1}{2}''$
- 1 pc. hickory or white oak $1\frac{1}{2}'' \times 4\frac{1}{2}'' \times 3' 1''$
- 3 pcs. hickory or white oak $1\frac{1}{2}'' \times 3'' \times 2' 6''$

TOOLS

Rule	Saw	Brace and bit
Try-square	Plane	Spokeshave
	Marking gauge	

OPERATIONS

1. Laying out evener.
2. Laying out doubletree.
3. Laying out singletrees.
4. Sawing and boring.
5. Chamfering.
6. Ironing.

1. Laying out evener. — Lay out point *c* $2''$ from point *f*, Fig. 94. Lay out point *d* $2''$ from point *g* at the other end. Square across both ends at these points. Lay out point *e* $18\frac{1}{2}''$ from *f* and square across one surface. $3''$ from *e* on either side locate

points *h* and *i* and square across the edge at these points. Locate the holes at *K* and by *L* measuring in from each end 2'' and up 3'' from the lower edge. On line squared across from *e* locate hole *M* 1'' from lower edge. Connect points *d* and *i* with a line on each surface; also connect points *c* and *h* with similar lines.

2. **Laying out doubletree.** — Lay out point *c* 1½'' from point *f*, Fig. 95. Lay out point *d* 1½'' from point *g* at the other end. Square across both ends at these points. Lay out point *e* 1' 6½'' from each end and square across one surface. From *e* lay out points *h* and *i* 2½'' on each side. Connect points *c* and *h* with lines on both surfaces, also points *d* and *i*. Locate holes at *K* and *L* by measuring in from both ends 2'' and up from the lower edge 2''. Locate hole at *M* 1'' up from the lower edge on line squared across from *e*.

3. **Laying out singletrees.** — Lay out *c* 1'' from *f*, Fig. 96, and *d* 1'' from *g*, and square across the ends at these points. Lay out *e* 1' 3'' from each end and square across one surface. 2'' on either side of *e* locate *h* and *i*. Connect *c* and *h* with lines on both surfaces; connect also *d* and *i*. Locate hole *M* by measuring up from lower edge 1'' on line squared across from *e*. If hooks as shown in Fig. 208, page 233, are desired, then locate the holes shown in the drawing. If hooks as shown in Fig. 209, page 234, are wanted, then the ends of the singletrees should be rounded to fit the same, or 1¾'' in diameter.

4. **Sawing and boring.** — Bore ¾'' holes at *K* and *L* and 1'' hole at *M* (Fig. 94). Bore ½'' holes at *K* and *L* and ¾'' hole at *M* (Fig. 95). Bore ½'' hole at *M* (Fig. 96).

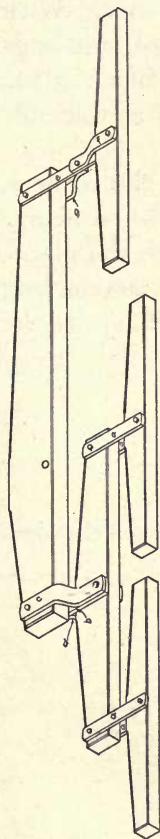

FIG. 93. — THREE HORSE EVENER WITH ALL PARTS ATTACHED.

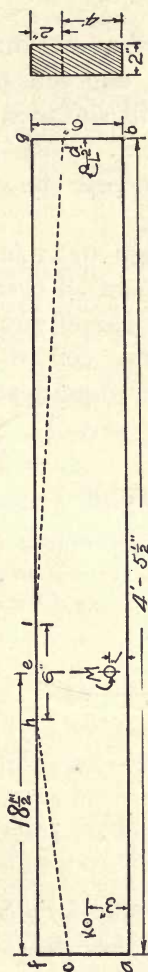

FIG. 94. — THREE HORSE EVENER.

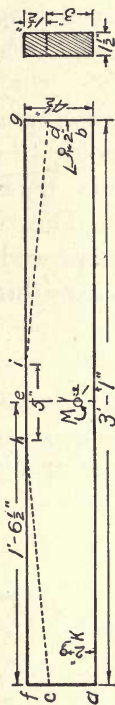

FIG. 95. — DOUBLETREE.



FIG. 96. — SINGLETREE.

Rip along the lines *ch* and *di* in Figs. 94, 95, 96, and plane smooth.

5. **Chamfering.** — With the marking gauge set at $\frac{3}{4}$ " gauge all surfaces, edges, and ends of evener. With the gauge set at $\frac{1}{4}$ " gauge all surfaces, edges, and ends of doubletree and singletrees. With the block plane chamfer down to the lines across the grain at the ends of all pieces.

With the spokeshave begin to chamfer the corners, beginning at points *h* and *i* in all cases; when nearly down to the lines, finish the chamfering with the plane.

6. **Ironing.** — The ironing consists of assembling the various parts with the irons described under the subject of Blacksmithing.

QUESTIONS

1. What are the advantages of this type of evener?
2. Can any doubletree be used on the shorter end?
3. Is there any advantage in tapering the members on the edges near the horses?

LESSON XXI

FARM GATE

STOCK

- 6 boards pine 1" × 6" × 12'
- 3 boards pine 1" × 6" × 5'
- 1 board pine 1" × 6" × 9'
- 1 pc. hard wood 1" × 3" × 4' 6"
- 1 pc. hickory 1" × 1" × 3' 3"
- 1 lb. 10d. nails
- 1 pair hinges
- 2 doz. screws 2", No. 10, F. H. B.

TOOLS

- | | |
|--------------|-------------|
| Steel square | Hammer |
| Saw | Screwdriver |

OPERATIONS

1. Sawing boards to length.
2. Nailing gate together.
3. Cutting bevel on brace.
4. Making catch, spring, and slot.
5. Hanging on hinges.

1. Sawing boards to length. — The gate is to be 12' long; so measure up and saw off six boards of that length. The three uprights are to be 5' long and the brace is to be 9' long. The brace should not be beveled until after the gate has been assembled.

2. **Nailing gate together.** — Lay five of the 12' boards 6'' apart on the floor. Lay the sixth board against the edge of the fifth. (See *A*, Fig. 97.) Lay one upright across each end; and drive one nail through the uprights into the end of each board properly spaced, with the end of the boards flush with the edge of the upright. An easy and satisfactory method

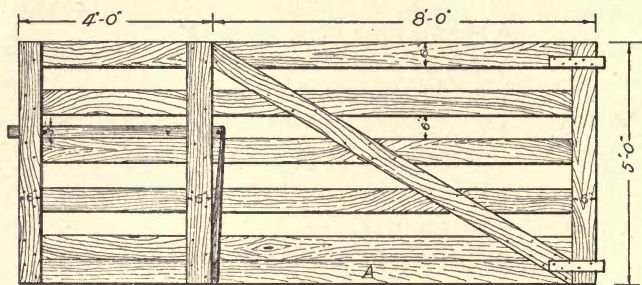

FIG. 97.— FARM GATE.

of spacing the boards is to take a block that has been cut from one of the boards and place it between the last board nailed and the next one to be nailed. When you have put one nail in each board, then square up the gate with the steel square and fasten in place by driving a second nail in each board. Four feet from one end square a line across the top and bottom board. This line locates the third crosspiece, which should be nailed in place.

3. **Cutting bevel on brace.** — To cut the bevel on the ends of the brace, lay it on the gate so that the ends are flush with the top of the upright at the end and with the bottom of the next upright. Place the steel square so that its edge is flush with the edge of the up-

right, line across the bevel, and saw along this line. Repeat at the other end.

The principle of this brace is one that is so commonly used on the farm, that it will be described at length. The entire weight of the gate is supported from one end. This causes the free end to sag, as shown in Fig. 98. The sag of the gate will increase the distance between *a* and *b* and decrease the distance between *c* and *d*. When the gate is held level, the distance *ab* is equal to the distance *cd*. To keep the gate level, some means of keeping the distances equal must be devised. If a board were nailed on between points *a* and *b*, it would hold the gate level, but a strong steel wire would do just as well, and perhaps better. This proves that the tendency to sag exerts a pull force, or, as it is called, a tension. Likewise anything that will keep the points *c* and *d* from coming together will keep the gate level. Evidently a wire connecting these points will not keep them the proper distance apart. A board nailed connecting points *c* and *d* will have the same tendency to keep the gate level as would a wire connecting points *a* and *b*. If both are used, a double effect is secured.

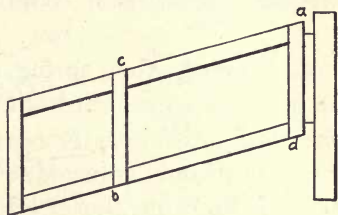

FIG. 98.—SAGGING OF A GATE DUE TO LACK OF BRACING.

Another fact to remember in bracing gates is that the more nearly perpendicular the compression or tension brace is, the stronger it is. If a gate were divided into three parts and each section braced, as in Fig. 99, it would be stronger than if it had only one brace, because

each brace would be nearer a perpendicular; but the gate would also be heavier and require more material, which would be disadvantageous.

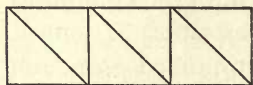

FIG. 99. — BRACING A LONG GATE.

If a gate were made longer than twelve feet, it would be advisable to have two such braces instead of one.

4. **Making catch, spring, and slot.** — The catch should be made of some hard wood $1'' \times 3'' \times 4' 6''$. $1''$ from one end a $\frac{1}{2}''$ hole is bored, $12''$ from the same end another $\frac{1}{2}''$ hole is bored, $9''$ from the other end another hole of the same size is bored. Hard wood pegs should be fitted in these holes. The one for the first hole needs to be about $3''$ long, while the other should be about $5''$ long so that it can be handled easily in pulling back the catch to open the gate (Fig. 100). The spring should be made of hickory $3' 3''$ long and about $1''$ square.

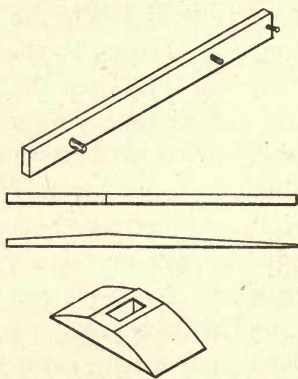

FIG. 100. — CATCH, SPRING, AND SLOT OF GATE.

The larger end of the spring is cut on a bevel so that the end will project about $2\frac{1}{2}''$ from the upright. Bore holes through the larger end of the spring so that it can be nailed to the upright and horizontal boards. When the catch is pulled back by the peg, the spring will force it back again into the slot in the post. The end of the catch that fits in the slot should be rounded so that it will slide easily up the beveled edges. The slot can be cut in the post, if the

post is large; otherwise one can be made from a block of hard wood, as shown in Fig. 100, and nailed to the post. Lay the catch where it belongs on the gate and nail over it two strips in line with the two uprights.

5. The hinges are described under Blacksmithing. They are fastened to the upright of the gate with the heavy wood screws.

QUESTIONS

1. What is meant by tension and compression?
2. What kind of stress does the brace exert?
3. What kind of stress does each hinge exert?
4. Why are there two boards on the bottom?

LESSON XXII

CORN RACK

STOCK

2 pcs. 4" × 6" × 20'	1 carriage bolt $\frac{3}{4}$ " × 7"
96 board feet pine 1" × 12"	1 long king bolt
22 linear feet 2" × 4"	2 stirrup bolts
1 pc. hardwood 2" × 6" × 10"	2 bolts $\frac{3}{4}$ " × 10"
	1 lb. 6od. spikes
	1 lb. 10d. nails

TOOLS

Steel square	Hammer
Saw	Brace and bit

OPERATIONS

1. Laying out the material.
2. Assembling the rack.

1. **Laying out the material.** — The two stringers are laid out 20' long. Lay out two uprights for the rear end from the 2" × 4" stock, each 4' long. Lay off and saw one end of each piece at an angle of 60 degrees. Lay out two uprights for the forward end 4' 3" long, and saw one end of each piece at an angle of 60 degrees. Lay out two braces for the ends 2' 6" long and saw the two ends of each at an angle of 60 degrees. Lay out two pieces 2" × 4" × 2' 9" and one piece 2" × 4" × 3' 10". The flooring is all cut 6' long.

2. **Assembling the rack.** — In assembling the corn rack, bolt the two front ends of the stringers together with two $\frac{3}{4}$ " bolts. Spread the other two ends 3' apart, inside measurements, and hold in place by tacking a piece of the flooring across the ends. The stringers will be curved slightly because of this springing apart of the ends. Straighten them out by tacking several pieces

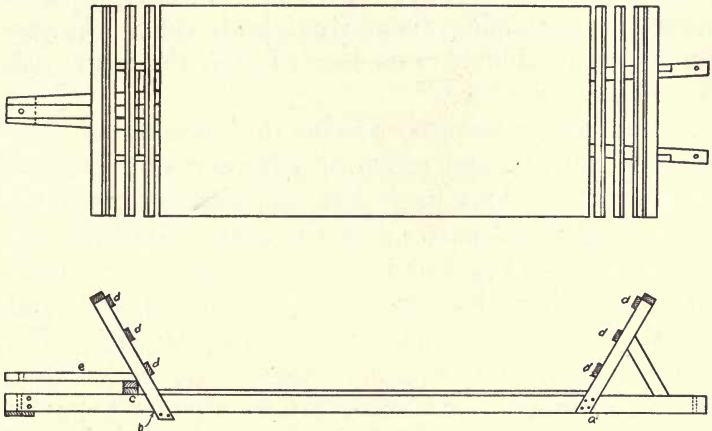

FIG. 101. — WORKING DRAWINGS OF CORN RACK.

of flooring on the under side of the stringers. At point *a*, 4' from the rear end, spike the two uprights to the stringers. On top of these two uprights, nail a piece $2'' \times 4'' \times 6'$ so that it projects equal distances beyond the uprights. Nail in place the two braces as shown in the drawing, spiking the lower ends to the upper edge of the stringers, and the upper ends to the uprights. At point *b*, 4' 3'' from the front end, spike a piece $2'' \times 4'' \times 2' 5''$ to the under side of the stringers with an equal length extending beyond each

stringer. To the ends of this piece nail the lower ends of the forward uprights. To the upper ends of the uprights nail a piece $2'' \times 4'' \times 6'$. At point *c* spike a piece $2'' \times 4'' \times 2' 9''$ across the stringers and on top of this, spike another similar piece in such a position that they will hold the front uprights in the same position as those in the rear; that is, at an angle of 60 degrees with the stringers. Spike the uprights to these pieces by toenailing them from both sides. To the middle of the double crosspiece *c* fasten the bar *e* with a carriage bolt $\frac{3}{4}'' \times 7''$.

The double crosspiece *c* is for the purposes of bracing the uprights, and to afford a fastening for one end of the bar *e*. This bar takes the place of the reach of the wagon and passes over the front hound and between the sand board and axle, being held in that position by the king bolt which passes through the sand board, reach, axle, and stringers successively. The wheels and hounds of some wagons are larger than those on others, and some truck wagons have no hounds; therefore it will be necessary to vary the distance between the ends of the stringers and the uprights according to the wagon to be fitted.

Across the edges of both sets of uprights at *d, d, d, d, d, d*, nail strips $1'' \times 4'' \times 6'$. Lay the flooring and remove the strips tacked to the under side of the stringers. To the under side of the front end of the stringers nail a piece of hardwood $2'' \times 6'' \times 10''$, and then through the middle of the piece and between the stringers bore a $1''$ hole for the king bolt. $6''$ from the other ends of the stringers bore a $\frac{3}{4}''$ hole for the stirrup bolts, which are to hook over the rear axle.

To fit this rack in place first remove the reach and the front bolster, then fasten the rear end of the stringers under the rear axle of the wagon with the hind hound resting on the stringers, next slip the front hound between the stringers and the bar (*e*), the latter passing into the hole intended for the reach. The rear ends of the stringers are held to the axle by two stirrup bolts and the front ends to the front axle by a long king bolt. These bolts are described under Blacksmithing.

QUESTIONS

1. Why are the stringers not laid parallel?
2. How will you determine where to place the racks at each end?
3. Why is the rack hung so low?

LESSON XXIII

CATTLE RACK

STOCK

2 pcs. pine or hemlock	1" × 6" × 12'	5 lb. 12d. wire nails
2 pcs. pine or hemlock	1" × 6" × 10'	2 lb. 6od. wire nails
2 pcs. pine or hemlock	1" × 6" × 2' 6"	
3 pcs. pine or hemlock	1" × 6" × 3'	
3 pcs. pine or hemlock	1" × 6" × 3 6 ¹ / ₂ "	
18 pcs. hardwood	1" × 3" × 3' 3"	
2 pcs. hardwood	1" × 3" × 2' 9"	
2 pcs. hardwood	1" × 2" × 1' 3"	
3 pcs. pine	2" × 4" × 3' 3"	
2 pcs. pine	2" × 4" × 5'	
2 pcs. pine	2" × 6" × 3'	
2 pcs. pine	2" × 4" × 4' 6"	
1 pc. pine	2" × 4" × 6' 9"	

TOOLS

Steel square	Saw
Hammer	Brace and bit

OPERATIONS

1. Laying out and sawing boards.
2. Ripping strips.
3. Nailing strips to boards.
4. Laying out and sawing timbers for stanchion.
5. Assembling stanchion.
6. Making iron hooks.

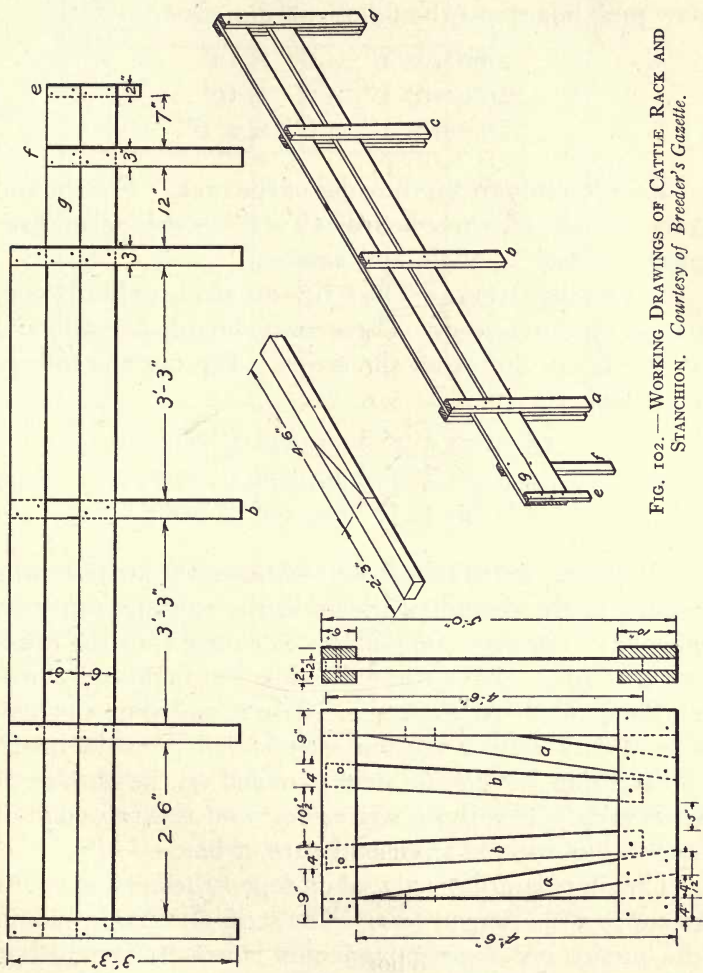

FIG. 102. — WORKING DRAWINGS OF CATTLE RACK AND STANCHION. Courtesy of Breeder's Gazette.

1. **Laying out and sawing boards.** — Measure off and saw pine boards to the following dimensions :

- 2 boards 1'' × 6'' × 12'
- 2 boards 1'' × 6'' × 10'
- 2 boards 1'' × 6'' × 2' 6''

These boards are for the sides of the rack. For the end gate measure off three boards 1'' × 6'' × 36½'', also three pieces 2'' × 4'' × 3' 3'', and saw.

2. **Ripping strips.** — The strips are made of hardwood, oak or elm preferred. Three 12-ft. boards 6'' wide and 1'' thick will do for all the strips. Rip out the following strips :

- 18 strips 3' 3'' long and 3'' wide
- 2 strips 2' 9'' long and 3'' wide
- 2 strips 1' 3'' long and 2'' wide

3. **Nailing strips to boards.** — Locate the strips on the boards at the distances shown in the working drawing, Fig. 102. Stagger the nails so as to not split the hardwood strips. Drive the nails clear through and clinch on the inside. At *e* one short strip is nailed on the outside of each side. At *f* one strip is nailed on the inside of each side. At *b* one strip is nailed on the outside of each rack. The short strip *e* rests on the top edge of wagon box to hold front end gate of box.

The short board *g* is placed on top of the bottom board to support the wagon seat. The strip *b* is single and on the outside because the stanchion is usually fastened at this place. The end gate is made according to Fig. 103, and is fastened in place with end-gate rods.

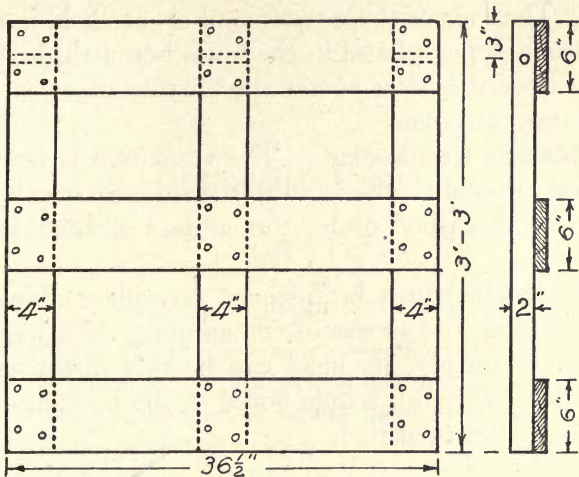

FIG. 103.—WORKING DRAWING OF END GATE OF CATTLE RACK.

(The holes for the lower end-gate rod are not shown. They should be bored at the proper height to admit the end-gate rod of the wagon box.)

4. Laying out and sawing timbers for stanchion. —

A stanchion is an arrangement of bars for fastening cattle in a stall by locking timbers around their necks so they cannot get away, and yet giving them considerable freedom of motion. In sawing the braces *a, a*, you can save considerable lumber by laying them out in one piece instead of using two pieces each 4' 6" long. In this way you save the difference between 6' 9" and 9'. The rest of the timbers are laid out as indicated. (See Fig. 102.)

5. In assembling the stanchion, first nail the two outside pieces to the top and bottom crosspieces. The two braces *a, a*, are spiked to the bottom planks and to the two uprights. The two movable timbers *b, b*, are fastened by spiking with one spike in the lower end of

each. The tops of these two members are held in place by a wooden peg placed in the holes bored through the tops. Bore the holes nearer the outside edges so as to make them stronger.

6. **Making iron hooks.** — The stanchion is fastened to the bottom of the box and to the sides by iron hooks, which are described under the subject of Blacksmithing.

The stanchion can be fastened any place along the box according to the size of the animal. If it happens to be very unruly, its head can be tied down with a rope passed through a hole bored in the bottom of the stanchion, and then tied.

QUESTIONS

1. Why is hardwood used for the strips instead of pine?
2. Why is a short strip used at *e*?
3. Why is a single strip used at *b* instead of a double one?
4. Why do you lay out the braces *a, a*, as shown, from one piece instead of from two pieces?
5. Why should you nail on the braces *a, a*, before the movable pieces?
6. Why do you bore the holes nearer the outside edges of the stanchions?

LESSON XXIV

HOG COT

STOCK

- 150 linear feet white pine or hemlock 2" × 4"
- 20 linear feet white pine or hemlock 2" × 6"
- 21 linear feet white pine or hemlock 2" × 8"
- 400 board feet sheathing
- 5 lb. 20d. nails
- 2 lb. 8d. nails
- 1 lb. 10d. nails
- 1 doz. screws 1½", No. 10, F. H. B.

TOOLS

Steel square	Try-square	Hammer	Screwdriver
Bevel	Saw	Block plane	

OPERATIONS

1. Laying out and sawing floor joists.
2. Laying out and sawing side pieces.
3. Spiking side pieces to floor joists.
4. Making the runners.
5. Laying out and sawing the rafters.
6. Nailing rafters in place.
7. Cutting and nailing purlins in place.
8. Laying out and nailing headers and trimmers.
9. Nailing on flooring and roofing.
10. Making the door.

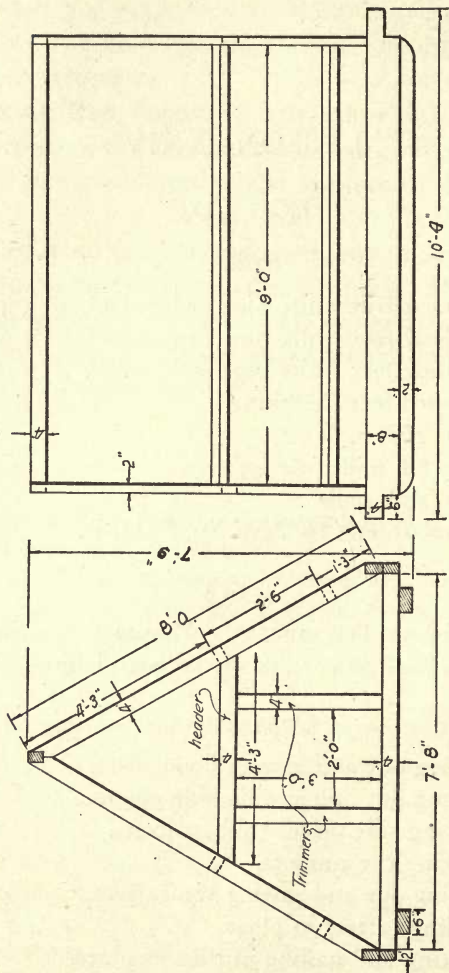

FIG. 104.—WORKING DRAWINGS OF HOG COT.

1. **Laying out and sawing floor joists.** — Lay out and saw six pieces $2'' \times 4'' \times 7' 8''$ for the floor joists. Saw the ends square.

2. **Laying out and sawing the side pieces.** — Lay out two pieces $2'' \times 8'' \times 10' 4''$ for the side pieces. Notch each end $4''$ down from the top and $6''$ in from each end, as shown in Fig. 104.

3. **Spiking the side pieces to the floor joists.** — As there are six joists and the cot is $9' 4''$ long, each space between the joists is $20''$. This gives a distance of $22''$ between the middle lines of the joists. Locate these spaces and spike through the side pieces into the ends of the floor joists with 20d. spikes.

Locate the lower edges of the joists flush with the lower edges of the side pieces.

4. **Making the runners.** — The runners are made of two pieces of $2'' \times 6'' \times 10' 4''$. The ends are rounded off by drawing an arc of a circle $2''$ in radius, holding the two planks as shown in Fig. 105, placing the point

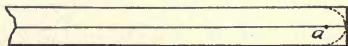

FIG. 105. — LAYING OUT ENDS OF RUNNERS.

of the compass at *a*. Repeat at the other end. Chisel down just outside the line, and finish with the block plane. Turn the floor upside down and spike the runners to the floor joists, locating them about $6''$ from each side piece.

5. **Laying out and sawing the rafters.** — The rafters slope at an angle of 60 degrees with the horizontal. The lower ends fit over the edge of the side pieces, and the ridgepole fits into the top. Figure 106 shows how the two ends of each rafter are cut. Lay out and saw.

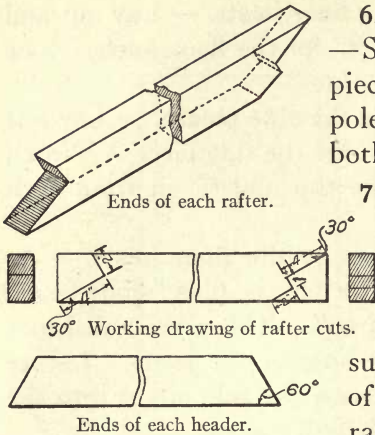

FIG. 106. — RAFTER AND HEADER.

8. Laying out and nailing headers and trimmers. — The ends of the headers are to be cut at an angle of 60 degrees, as shown in Fig. 106, so as to fit the rafters. There is one for each end of the cot. The two trimmers are placed at one end for the door.

9. Nailing on flooring and roofing. — The flooring is nailed across the floor joists. The roofing runs from the ridge down to the side pieces, being nailed to the ridge, purlin, and

6. Nailing rafters in place. — Spike the rafters to the side pieces. Then place the ridge-pole in place and spike from both sides.

7. Cutting and nailing purlins in place. — A purlin is a timber placed horizontally to support rafters. In the hog cot it supports roof boards instead of rafters, and is spiked to the rafters. The drawing shows where to locate the purlins.

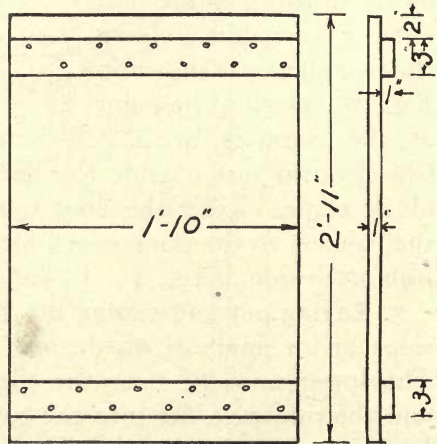

FIG. 107. — WORKING DRAWING OF DOOR OF HOG COT.

side pieces with 8d. nails. The roof is made water-tight by battens, which are 2" strips nailed over the cracks between the roof boards.

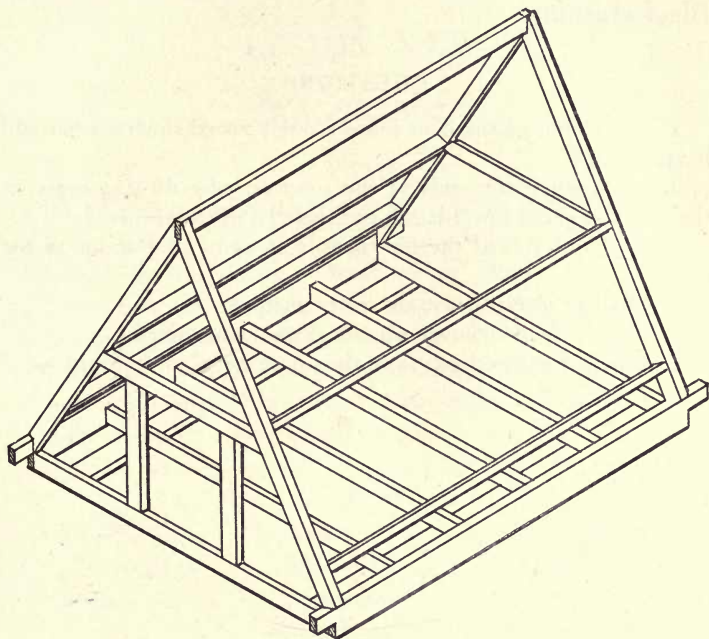

FIG. 108. — FRAMEWORK OF HOG COT.

Saw the battens from the same lumber used for the roof. Nail the sheathing on the two ends, leaving an opening 3' \times 2' at one end for the door.

10. **Making the door.** — The door opening is 3' high and 2' wide, but the door is to be 1" shorter and 2" narrower than the opening, so that it will swing in and out easily and allow the entry of air.

Saw the boards 3' long and fasten them together with cleats nailed and clinched about 2" from each end.

The door is hung by hinges at the top, so that the hog can go either in or out by simply pushing against the door. The making of the hinges is described under Blacksmithing.

QUESTIONS

1. If the ends of the floor joists are not sawed square, what will be the result?
2. In chiseling the ends of the runners, why do you begin at the side and chisel towards the end, instead of the reverse?
3. How will you fit the roof boards so as to shed water at the ridge?
4. Of what special use is the lower purlin?
5. Why is the door made smaller than the opening?
6. Why is the door hung from the top rather than from the side?

LESSON XXV

WAGON BOX

STOCK

- 35 board feet matched oak boards 4" wide and $\frac{7}{8}$ " thick
- 14 linear feet oak strips 2" wide and $\frac{7}{8}$ " thick
- 6 linear feet oak strips 4" wide and $\frac{7}{8}$ " thick
- 14 linear feet oak strips 2" wide and 2" thick
- 28 linear feet whitewood 14" wide and $\frac{7}{8}$ " thick
- 18 bolts $2\frac{1}{2}$ " long, $\frac{3}{8}$ " diameter, and washers (carriage)
- 16 bolts $2\frac{1}{4}$ " long, $\frac{3}{8}$ " diameter, and washers (carriage)
- 9 doz. screws 2", No. 10, F. H. B.

TOOLS

Steel square	Saw	Brace and bit
Try-square	Plane	Wrench
Rule	Screwdriver	Countersink

OPERATIONS

1. Laying out and sawing crosspieces.
2. Laying out and sawing flooring and fastening to crosspieces.
3. Boring holes in crosspieces.
4. Laying out, planing, and sawing side boards and end gates.
5. Laying out cleats, boring holes, and fastening to side boards and end gates.
6. Fastening side boards to flooring.
7. Fitting end-gate rods in place.
8. Fastening foot rest in place.

1. **Laying out and sawing crosspieces.**—There are four pieces under the floor of the wagon box. Each of the two end pieces is $2'' \times 2'' \times 3' 6''$, and the two middle crosspieces are $2'' \times 2'' \times 4'$.

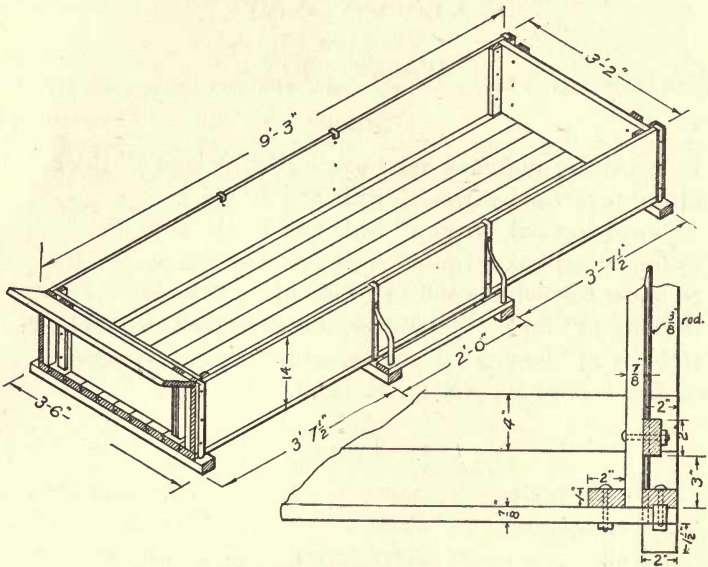

FIG. 109.—WORKING DRAWINGS OF WAGON BOX.

Unless the crosspieces come in the rough, it will be unnecessary to do any planing.

2. **Laying out flooring.**—The flooring consists of 4'' tongued and grooved oak boards $\frac{7}{8}''$ thick, and should be sawed $9' 3''$ long. When the boards have been sawed the proper length, they can be laid. Mark a center line on each crosspiece and $2''$ from this on one side square a line across each crosspiece. Lay the crosspieces the proper distance apart, as shown in the drawing. There will be one crosspiece at each end, and one

3' 7 $\frac{1}{2}$ " from each end. This places the two middle crosspieces 1' 8" apart, inside measurements. Lay the edge of the middle board against the marks on the crosspieces and fasten in place with one screw near its edge, having first bored and countersunk the holes.

When this has been done on all crosspieces, with the steel square, square up all crosspieces and put in the second screw in each crosspiece, staggering the screws, and placing them about $\frac{1}{2}$ " from the edges. The screw holes should be countersunk deep enough so that the screw heads sink about $\frac{1}{16}$ " below the surface of the flooring.

Place the second board in place and drive it up tight, using a waste piece of flooring to take the hammer blows and protect the edge of the tongue or groove. It may be necessary to use clamps to hold the flooring in place while it is being fastened to the crosspiece.

Continue this process until you come to the last board, which will extend out too far; draw it up in place, but do not fasten it.

Then proceed on the other side until you come to the last board. Measure from the center of the middle board 1' 7" to each edge at each end, and mark on the two outer boards. By means of a straightedge draw lines from end to end of the outer boards, showing where they are to be sawed and planed. When finished, fasten in place to the crosspieces.

3. **Boring holes in crosspieces.** — The side boards are fastened to the flooring by screws and iron strips. The iron strips have a round tang or bolt-like end threaded which passes through the crosspieces and is fastened by nuts and washers on the under side. The

holes are $\frac{3}{8}$ " and are bored close to the edge of the outer board of the floor. The foot boards are placed on the ends of the two middle crosspieces. They are 4" wide and are tacked in place with their outer edges flush with the ends of the crosspieces. The irons that go down through these holes are fastened by two nuts and washers, one above the foot board and one below the crosspiece, as shown in Fig. 110.

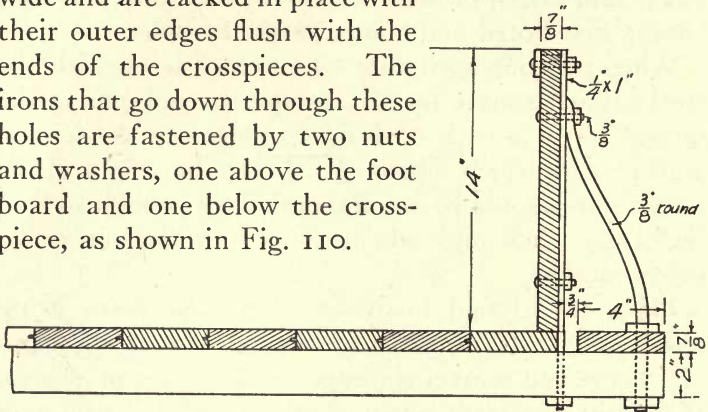

FIG. 110.—IRONS OF FOOT BOARD.

4. The side boards and end gates are made of white-wood and should be surfaced on both sides. The ends and edges should be planed square and straight.

5. The cleats are of oak and are fastened to the side boards and end gates by $\frac{3}{8}$ " carriage bolts, nuts, and washers.

The cleats are 14" long and 2" wide by $\frac{7}{8}$ " thick. At the ends they are held in place by carriage clamps while the holes are being bored and the bolts fastened in place. The bolts pass through the iron strips on the outside of the side boards. Other cleats are fastened 1" from the end cleats to hold the end gates in place. Square a line across the side boards 1" from the inner edge of the end cleats and lay these cleats along this line. Hold with clamps and bore the holes for the bolts.

These bolts do not pass through iron strips. 3" from the ends of the end gates, square lines across and fasten cleats as before.

6. Fastening side boards to flooring. — After fastening all irons in place, turn the box over and at intervals of 6" drive 2" screws down through the flooring into the edges of the side boards.

7. Fitting end-gate rods in place. — Fit the end gates in place and bore $\frac{3}{8}$ " holes for the end-gate rods which are used to hold the side boards together.

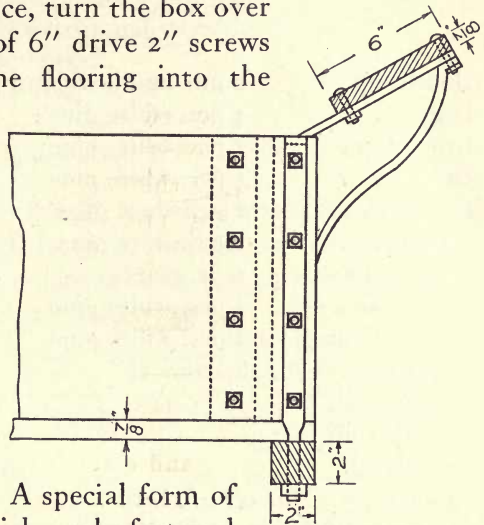

FIG. III.—FOOT REST OF WAGON BOX.

A special form of washer is made which can be fastened permanently to the side boards with small screws; one of them is thicker and is threaded to fit the end of the end-gate rod which screws into it.

8. Fastening the foot rest in place. — The iron braces for the foot rest can now be fastened in place with two of the bolts used on the cleats of the front end gate, and the 4" strip of oak bolted to these braces.

QUESTIONS

1. Why is the flooring laid from the center rather than from one side?
2. Of what use are the iron strips on the side boards?
3. Why should the screws in the flooring be countersunk?

LESSON XXVI

WORK BENCH

STOCK

Bench top	2 pcs. maple or hard pine	2" × 12" × 6'
Legs	4 pcs. white pine	2" × 4" × 32"
Crosspieces	2 pcs. white pine	2" × 4" × 23"
Braces	4 pcs. white pine	1" × 2" × 2' 6"
Long brace	1 pc. white pine	1" × 3" × 5'
Apron	1 pc. white pine	1" × 8" × 6'
Vise. — Jaw	1 pc. maple	2" × 6" × 24"
Braces	2 pcs. white pine	1" × 2" × 2' 6"
Crosspiece	2 pcs. white pine	1" × 2" × 18"
1 carpenter's bench screw 1 $\frac{1}{8}$ "		
8 nails 20d.		
10 nails 10d.		
30 nails 8d.		
8 screws 3", No. 14, F. H. B.		
4 screws 1", No. 8, F. H. B.		

TOOLS

Try-square	Saw	Screwdriver
Rule	Plane	Chisel
Bevel square	Brace and bit	Hammer
		Clamps

OPERATIONS

1. Laying out length of legs and crosspieces.
2. Sawing to length.
3. Laying out the mitered ends of braces.
4. Sawing the mitered ends.
5. Laying out the halved joints.

6. Cutting the halved joints.
7. Assembling the bench.
8. Laying out screw hole and mortises of vise.
9. Boring the screw hole.
10. Cutting the mortises of the vise.
11. Laying out braces and crosspieces.
12. Sawing the miters.
13. Assembling vise.
14. Fitting vise to bench.
15. Inserting bench stop.

1. Laying out length of legs and crosspieces. — The height of the bench is 36"; and as the top planks are 2" thick, and the crosspieces on top of the legs are 2" thick, the legs are 32" long.

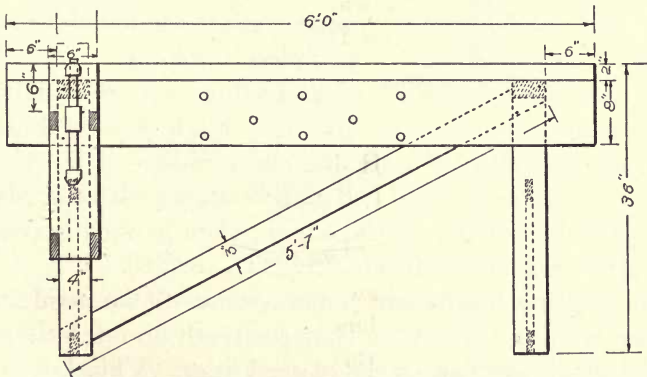

FIG. 112.—WORKING DRAWING OF WORK BENCH.

Square across the ends of the legs. Do the same with the two crosspieces, which should be 23" long, or 1" shorter than the bench is wide.

2. Sawing to length. — As there is no need of planing the stock that goes into the legs and crosspieces, it will be necessary to take pains in sawing the ends square.

3. **Laying out the mitered ends of braces.** — The braces between the legs are laid out at right angles to each other, and so the ends will fit on to the legs at an angle of 45 degrees. Set the bevel at 45 degrees by placing the beam against the edge of the carpenter's square, and set the blade at equal distances on the tongue and blade. Be sure that the four braces are the same length. Square down from the miter lines across the edges.

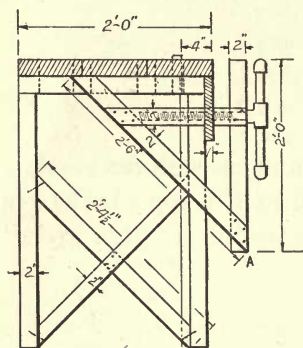

FIG. 113.—END VIEW OF WORK BENCH.

4. **Sawing the mitered ends.** — It is more difficult to saw down a miter than square across, so take particular pains to follow the lines.

5. **Laying out the halved joints.** — Each pair of braces should be halved together at the middle. The halved joint should be marked out at right angles with the edges and lined down across the edges; then gauged between these lines halfway from surface to surface.

6. **Cutting the halved joints.** — Saw down inside the lines, holding the saw so that the teeth on one side just split the line. Saw to the gauged lines. Chisel out the block as described in Lesson II.

7. **Assembling the bench.** — In assembling the bench nail the crosspieces on to the top of the legs with 20d. spikes. In nailing, be sure to stagger the nails, which means that they should not be placed parallel to the outer edges. Fig. 114 shows the correct and incorrect method. If the tops of the legs have been sawed

square, the crosspieces, when nailed in place, will make right angles with the legs, and the edge *B* will be flush with the edge *C*. The second step is to nail the braces in place. The braces are fitted together by the halved joint and fastened with two screws; they are then placed inside the legs and the ends nailed in place. The next step is to fasten the legs on to the top of the bench. Place the planks on the floor with the better side down; hold them together with two long clamps, one at each end. 6" from each end place the

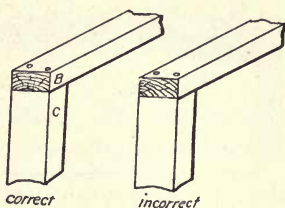

FIG. 114.—CORRECT AND INCORRECT METHOD OF PLACING THE NAILS.

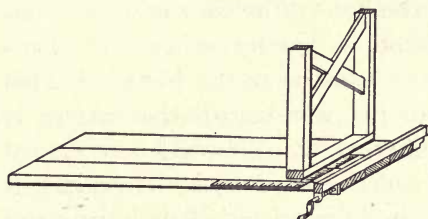

FIG. 115.—FASTENING LEGS TO BENCH TOP.

legs upside down, as in Fig. 115. The screw holes are then located and bored. Be sure to stagger the screws.

The vise should be planed smooth and squared up according to the directions given in Lesson I.

8. Laying out the screw hole and mortises of vise. — Place the better end at the top of the vise. 6" down from the top of the vise square a line across the surface, and 8" from the top square another line across. From the points where these lines meet the edges, square across the edges. As the crosspieces are to be let into these mortises, they should be gauged to a depth equal to the thickness of the crosspieces.

At the lower end of the jaw line, lay off an angle of 45 degrees from the corner *A*, Fig. 116, using the bevel.

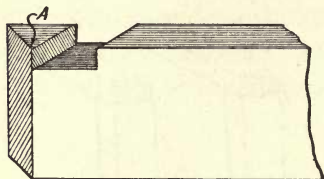

FIG. 116.—MORTISE CUT AT LOWER END OF VISE.

With the bevel still in place, measure perpendicularly 2" and draw another 45-degree line through this point parallel to the first. Square across the surface from the points where these two lines

meet the corner, and draw similar lines on the other edge.

As the braces that are to be let into these mortises are the same thickness as the crosspieces, these mortises should be gauged to the same depth as the others. The screw hole is laid out in the middle of the width of the jaw with the center of the hole 7" below the upper end.

9. Boring the screw hole. — The screw is $1\frac{1}{8}$ " in diameter and has a cast iron washer near the handle. This washer is to be let into the wood until the surface is flush with the surface of the jaw, so it will be necessary to bore a hole the size of the washer, and to a depth equal to the thickness of the washer before boring the hole for the screw. If the small hole were bored first, there would be no wood to hold the screw and guide the bit. (See Fig. 117.) Because of the spherical projection back of the washer, it will be necessary to gouge out a recess deep enough to let the washer down flush. In boring these large holes, use an expansion bit. When the cutter has been set at the proper



FIG. 117.—HOLE FOR BENCH SCREW.

distance, be sure that the set screw is tight, or the spur of the cutter will draw it out farther and farther, increasing the diameter of the hole as you go through.

When the washer is fitted to place, mark the screw holes and bore with a gimlet bit of the proper size.

10. Cutting the mortises of the vise. — In cutting the mortises follow the directions given in the first part of the lesson.

11. Laying out braces and crosspieces. — Lay off 2' 7" for the two braces and miter the ends in the same way as the miters of the cross braces of the legs were laid out, except that the 45-degree angle in these braces should be on the same edge of the piece rather than on the opposite edges. For the crosspieces, lay out 18" in length and miter one end only.

12. Sawing the miters. — Follow the directions given for sawing the miters of the cross braces of the legs.

13. Assembling the vise. — Fasten the braces in place on the vise and then the crosspieces. Then fasten the crosspieces to the braces. In order to fit the vise to the bench, it will be necessary to bore a hole through the leg at a height equal to the distance from the top of the vise jaw to the center of the screw. On the inner side of this leg over the hole fasten the nut that comes with the screw.

Two slots must be cut in the apron of the bench to accommodate the crosspieces. Measure 6" down from the top of the bench and locate one slot on each side of the leg. The slots are 1" wide and are cut up from the bottom edge of the apron a distance of 4".

14. Fitting vise to bench. — The vise can now be placed where it belongs in the bench.

15. **Inserting bench stop.** — A bench stop is an arrangement of metal or wood at the front of the bench, against which boards are placed for surfacing. In this case the stop is of wood, squared and about 4" long by 1" square,

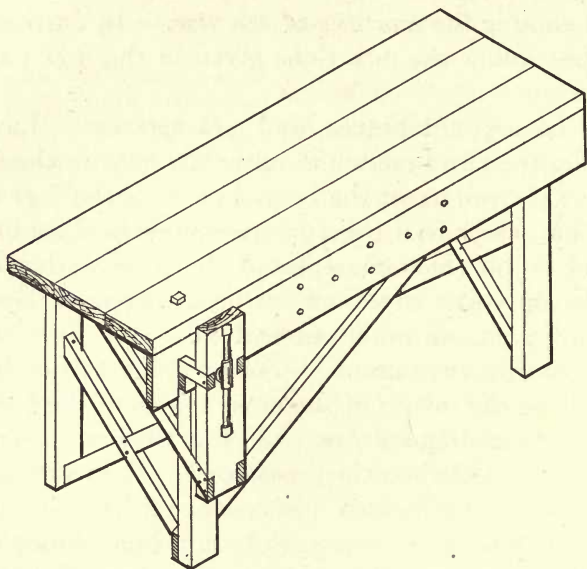

FIG. 118. — WORK BENCH ASSEMBLED.

made of some hard wood. Metal bench stops can be bought, but unless one uses the bench a great deal, the wooden stop will answer as well. Bore a hole with a 1" bit through the top of the bench 8" from the end and 4" from the side of the bench, and chisel it out square down through the top and crosspiece over the leg.

The stop must fit tight so that it will stay where it is wanted and yet can be driven up or down.

QUESTIONS

1. Why are the crosspieces cut 1" shorter than the width of the bench?
2. Why are the crosspieces spiked on top of the legs rather than the legs spiked to the ends of the crosspieces?
3. If the tops of the legs were not sawed square, how would it affect the bench?
4. What advantage is there in halving the braces at the middle over fastening them together without halving?
5. What advantage is there in staggering the nails?
6. Is there any advantage in fastening the braces inside the legs instead of fastening them to the edges of the legs?
7. Why are the legs fastened to the top from underneath by screws rather than from above?
8. Why is the larger hole in the vise bored before the smaller one?
9. Why is the bench stop of wood rather than of metal?

LESSON XXVII

TOOL CHEST

STOCK

- 30 board feet oak $\frac{7}{8}'' \times 6''$
- 8 board feet bass or pine $\frac{1}{2}'' \times 12''$
- 2 doz. screws $\frac{3}{4}''$, No. 6, F. H. B.
- 7 doz. screws $1\frac{1}{2}''$, No. 8, F. H. B.
- 3 butt hinges, iron, 3''
- 1 lb. brads $1\frac{1}{2}''$
- Stain, filler, and shellac

TOOLS

Carpenter's square	Bevel	Screwdriver
Try-square	Saw	Brace and bit
Sandpaper	Plane	Chisel

OPERATIONS

1. Laying out.
2. Squaring up and doweling.
3. Squaring and planing bottom, sides, ends.
4. Assembling the box.
5. Mitering strips for the bottom.
6. Cutting halved joints for the top.
7. Grooving the top.
8. Mitering strips for the top.
9. Attaching the top to the box.
10. Making trays.
11. Making slides.
12. Finishing.

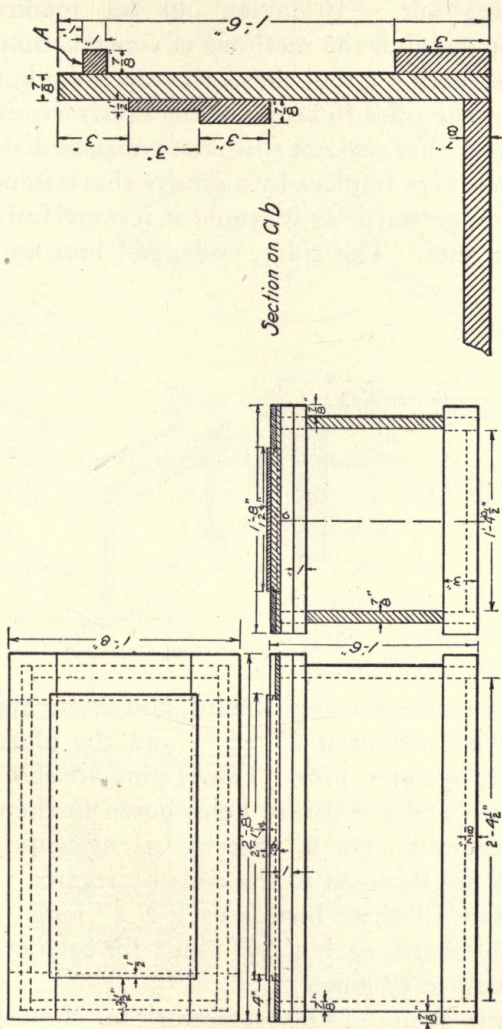

1. **Laying out.** — In laying out the material, one must keep in mind the methods of construction.

In constructing a tool chest, the top is made to come down over the sides to keep out the rain. It is made of a framework that will not shrink or warp, and the panel in the top is kept in place by a groove that will not allow it to check or warp, as it would if it were fastened by glue or screws. The sides, ends, and bottom, are too

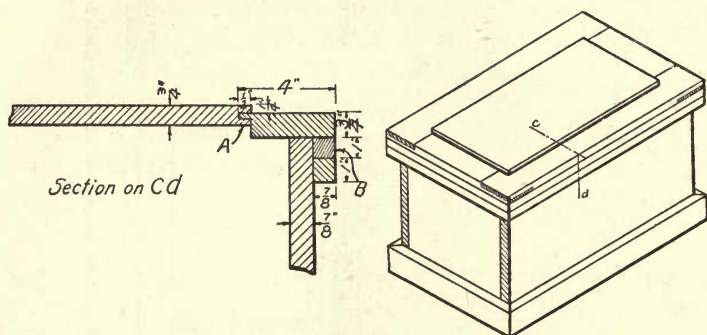

FIG. 120.—ASSEMBLED TOOL CHEST.

wide to be made of a single board, and so are made from glued-up boards, each 6" wide, and the glued joints reënforced by *dowel pins*. Dowel pins are short, round pegs driven and glued into holes bored in the edges of the pieces to be glued, thereby strengthening them. The sides are fastened to the ends by screws. For the bottom saw off three boards each 2' 5" long; for each side, three boards each 2' 6½" long; for each end, three boards each 1' 5" long.

The four strips of the framework for the top are $\frac{3}{4}$ " thick and 4" wide, with a rabbet cut on one edge.

The panel of the top is cut with a groove to fit the

tongue of the rabbet in the frame. The rabbet and groove are shown in Fig. 120 at *A*. The method of halving the pieces together after cutting the rabbet is shown in Fig. 121, which is an illustration of the pieces ready to assemble.

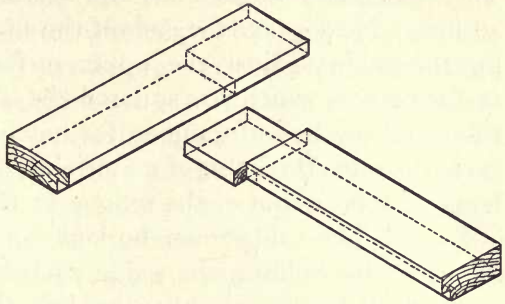

FIG. 121.—HALVING THE CORNERS OF THE TOP.

Figure 122 is a working drawing of the strips halved with the rabbet cut. It is difficult to lay out the strips for the top, and so attention is called to this in order that you may pay strict attention to the directions. *First*, Lay out the halved joints

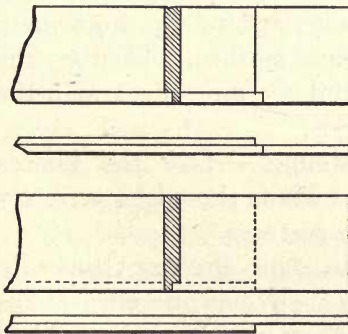

FIG. 122.—WORKING DRAWING OF STRIPS HALVED.

at the ends by squaring across the surface 4" from the ends on each of the four pieces. (It is expected that the pieces have first been cut the right length and width.) This surface will be the under surface of the longer strips, which are the side strips, and the upper surface of the shorter, or end strips.

Square across the edges from these lines. Set the gauge at one half the thickness of the strips, and gauge the edge of the longer strips

with the guide resting against the under surface, which is the surface across which was gauged the 4'' lines. Then gauge across the ends and down each edge to the 4'' line. Next gauge the ends of the shorter strips, holding the guide against the upper surface, which is the surface across which was squared the 4'' lines. This is the usual method of gauging for halved joints, and insures the same thickness of material to be removed in the longer strips as that of the tongue in the shorter strips.'

Second, The rabbet can be laid out with the gauge set at $\frac{1}{2}$ '' by holding the guide against the upper surfaces of all four strips, then holding the guide against the inner edges, and scribing along the under surfaces of the four strips.

Third, The panel must be glued up and doweled before it can be laid out. In laying out, square up one end and one edge, lay off the length, 2' 1'', and saw and plane square. Then lay off the width 12 $\frac{1}{2}$ '', and plane. Set the gauge at $\frac{1}{4}$ '' and gauge around the four edges with the guide against the upper surface. Then set the gauge at $\frac{5}{8}$ '' and gauge around the four edges with the guide against the same surface.

2. Squaring up and doweling. — Saw the boards for the bottom as laid out. Plane the edges perfectly straight and square with the surfaces.

Test the straightness of the edges, also test them with the try-square for squareness. When one edge is finished, place two witness marks on it to show this. Then plane one edge of the second board in the same way, and test it by placing it on the finished edge of the first board and look at the crack towards the light to see if there are any points where the light comes

through. If the edges fit perfectly, no light will come through, but generally there will be a crack at one or both ends, due to the fact that you have not been careful enough to hold the plane level in starting and finishing the stroke. You can prevent this trouble by pressing down hard on the knob of the plane in starting the stroke, and down on the handle in finishing the stroke. When the edges fit so far as their straightness is concerned, then test them for squareness. Place one on the other and test the surfaces with a straightedge or steel square. If the edges are square, the surfaces will be in line.

When the boards are squared up, then locate and bore the dowel holes. It does not matter just where they are located in the edge, but they must be located in exactly the same places with reference to each other. Hold the two edges that have been fitted in the vise, as in Fig. 123, and locate one hole 3" from each end and one in the center; square across the edges at these points, and with the gauge set at one half the thickness of the boards, gauge across the lines, holding the guide against the outer surface of each board; then the boards can be folded together so as to fit. In boring for the dowel pins, use a $\frac{3}{8}$ " bit, and bore all the holes the same depth. In order to do this it will be necessary to use some kind of a bit gauge or to count the number of turns of the brace it takes to

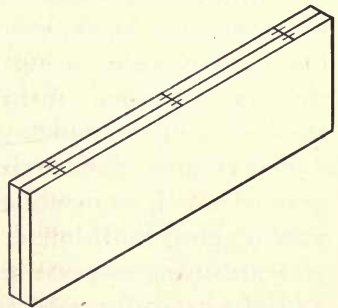

FIG. 123.—LOCATING DOWEL HOLES.

bore to the required depth. A bit gauge can be purchased or one can be made that will answer the purpose just as well unless a large number of holes of different depths are to be bored. Figure

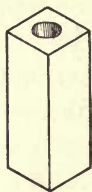

FIG. 124.—A BIT GAUGE.

124 illustrates one that can be used in this case. A square block of wood the length of the bit when in the brace is bored from end to end and cut off so as to expose just $1\frac{1}{8}$ " from the cutting lip of the bit to the lower end of the block. The dowel pin will extend 1" into each board, but the extra $\frac{1}{8}$ " is bored to allow plenty of room for the tight fit of the edges, and any surplus glue that cannot get out.

Be careful not to measure from the end of the screw or the spur, but from the cutting lip. Dowel bits are used when a good deal of doweling is done. They are shorter than the others and so are easier to operate, but they have no other advantages. The operations thus far described are to be repeated for the sides and the ends and top panel.

Dowel pins should always be of some hard, close-grained wood, as maple or birch, and can be purchased at a planing mill, but it is well to make them, unless you are using a great number. They should not fit so tight as to force all of the glue out of the sides of the holes. Those purchased are grooved along the sides for this purpose, but when made by hand, they can be left slightly irregular.

Rip a strip of maple or birch about 2' long and $\frac{1}{2}$ " square; plane down to $\frac{3}{8}$ " square, and then plane off the four corners, making it eight sided. As it will be

difficult to plane the corners of so small a strip, you can use a board that will hold the strip true while planing; such a board is shown in Fig. 125. Select two pieces of pine, and gauge down one edge and one adjacent surface $\frac{3}{8}$ " ; chamfer down to these lines with the plane. When these two chamfers are placed together, they form a right angle. Fasten the two pieces together with screws near the top, and bore a $\frac{3}{8}$ " hole near one end. Into this drive a hardwood dowel pin so that it comes flush with the top edges of the board.

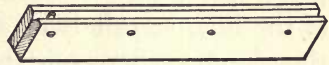

FIG. 125.—BOARD FOR HOLDING STRIP WHILE PLANING.

Hold this board in the vise and place the square strips in the groove when planing off the corners. The peg answers the purposes of the dog in the bench. It is not necessary or advisable to make the dowel pins perfectly round, but leave them eight sided and a trifle large for the holes, large enough so that they will have to be driven in place with a mallet. The eight corners will then fit the hole very tightly, and the eight sides will leave enough room for the glue to fasten the pin in the hole and for any surplus glue to escape.

When all the boards have been fitted with dowels, spread the glue on the edges of one board and into the dowel holes; drive the pins in place; spread the glue on the other edge and into the holes; and drive the second board up against the edge of the first by placing a block of waste lumber on one edge and driving with the mallet so as not to mar the edge. Then glue on the third board in like manner, and place in the long clamps. Before clamping up tight, place strips on upper and

under surfaces near the ends and hold in place with two carriage or wooden clamps at each end. Then draw the boards up tight with the long clamps. Be careful to place waste stock between the clamps and the edges of the boards, otherwise the edges would be marred by the clamps. Set aside for several hours to dry.

3. **Squaring and planing bottom, sides, and ends.** — When the bottom, sides, and ends are glued up and dry, they must be surfaced on both sides and squared up to the dimensions shown in the drawings. After surfacing both sides, finish the outside with sandpaper.

4. **Assembling the box.** — The assembling of the box will test your workmanship. If you have not been careful in the measuring and squaring up, it will be necessary to do some trimming in order to make the box square and a good fit. When the bottom, sides, and ends are finished, they should be assembled. Fasten the sides on to the ends with screws $1\frac{1}{2}$ " No. 8. Bore the holes and countersink according to directions given in previous lessons.

Next fit the bottom in place and fasten with screws.

5. **Mitering the strips for the bottom.** — The strips for the bottom cannot be laid out until the box is assembled, as the exact dimensions will not be known until then. Surface and square up the 3" strips. Then set the bevel square at 45 degrees and scribe one end of each of the four pieces; square across the inner surface from the point where the 45-degree line meets the inner surface; and saw so as to split the lines. Test the miter with the bevel square and trim with the block plane.

Lay the strip where it belongs on the box, and very carefully set the inside edge of the miter already cut on

the corner, and scribe the other corner so as to get the length of the piece accurately. From this line lay out the second miter and saw as before. Fasten this strip in place with screws, and lay out the strip on the opposite side in the same manner, and fasten it in place. The two remaining strips can be fitted in place more accurately than if they had been fitted around the box instead of in pairs.

6. **Cutting the halved joints for the top.** — The top has already been laid out and should now be sawed and planed according to the lay out.

Saw the halved joints, ripping down to the shoulder first and then crosscutting the shoulder. If the joints do not fit nicely, trim them down with a broad chisel and block plane, planing across the grain and chiseling the part next the shoulder that cannot be reached by the plane.

7. **Grooving the top.** — In cutting the groove or rabbet, workmen usually use a special form of plane called by various names according to the use it is intended for. But it is possible to cut the rabbet with nothing but the chisel and mallet. Chisel down nearly to the line, as shown in Fig. 126, and trim with a broad chisel down to the lines from both the edge and the surface. The groove extends $\frac{1}{2}$ " past the shoulder at each end. Glue the corner made by one side and one end, and fasten with $\frac{3}{4}$ " screws from the under side. Then glue the corner made by the other side and end, and fasten in the

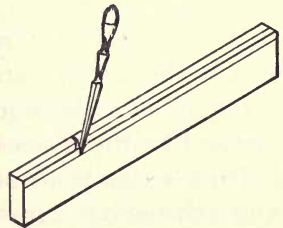

FIG. 126. — CUTTING RABBET WITH A CHISEL.

same way. Do not assemble all four pieces until the panel has been made and is ready to put in place. Groove the edges and ends of the panel with the chisel in the same way as the frame was grooved, but the groove in this case is in the middle of the edges instead of to one side. Cut the groove $\frac{1}{2}$ " and trim the sides, or cheeks, with a broad chisel.

Fit the panel into one corner, and then fit the other corner in place on the other side; when a good fit is assured, glue the two remaining halved joints in the same manner as the first pair, but holding them together tightly with the long clamps. Do not glue the panel in place, as its shrinking would cause it to crack. The tongue and groove will hold it securely from warping, allowing it to shrink and expand without cracking.

8. **Mitering the strips for the top.** — If the top has been made according to the dimensions on the drawings, it will extend over the sides of the box 1" on each side and over the ends the same distance. Four strips each 1" wide and $\frac{7}{8}$ " thick are to be fastened to the underside of this overhang of the top. These strips must be fitted so as to fit tight around the box, and are to be mitered at the corners. Lay out and cut just as the bottom strips were. Fasten to the top by screws put down through the top into the strips. (See *B*, Fig. 120.) Underneath these strips are four others the same size fastened to the box, and they act as a shoulder on which fall the top strips. (*A*, Fig. 119.)

The mitered corners should be fastened with two 2" brads from each side. These strips can be fastened on with round-head screws if desired. They are more

expensive than the flat ones, but they improve the appearance of the chest.

9. **Attaching the top.** — Fasten on the top with three butt hinges 3" long screwed on the top strips, and put a hasp on the front strips in the middle.

A chain should be fastened to the inside of the box and the underside of the cover, so the box can be opened and remain so without holding the cover.

10. **Making trays.** — The two trays are for the purpose of holding the smaller tools, such as bits, files, scrapers, and screwdrivers. They are partitioned off as shown in Fig. 127. The top tray should be 2' 4 $\frac{1}{2}$ " long and 8" wide, and 3" deep (outside measurements), and made of soft wood $\frac{1}{2}$ " thick. The lower tray should be 1" shorter and the same width and depth. Nail on the sides to the ends and the partitions, then nail on the bottom.

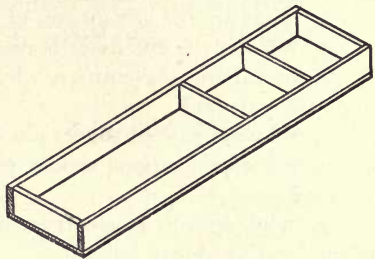

FIG. 127.—TRAY OF TOOL CHEST.

11. **Making slides.** — The slides on which the trays rest should be as long as the chest is wide (inside measurements), and made of two pieces of $\frac{1}{2}$ " pine, one piece 6" wide and the other 3" wide, as in Fig. 128. The 3" strip is nailed to the 6" strip with one edge flush, and the whole is screwed to the ends of the chest 3" down from the upper edge, as shown in *Section on ab*, Fig. 119.

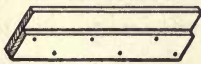

FIG. 128.—SLIDE ON WHICH TRAY RESTS.

12. **Finishing.** — The subject of wood finishing is

taken up in another part of the book, and the directions are not to be repeated here. The chest may be stained with some dark color and filled with a filler of the same color, then covered with a coat of orange shellac, which should be sanded down, and then finally covered with a coat or two of spar varnish.

Handles can be added if desired.

QUESTIONS

1. What are the requisites of a good tool chest?
2. What are the advantages of doweling a glued joint?
3. What is the difference between a rabbet and a groove?
4. In halving the corners, why do you rest the guide against opposite surfaces?
5. Why are witness marks placed on surfaces that are finished?
6. What precautions should you take in jointing up edges of boards?
7. Why do you gauge from opposite surfaces of the boards when locating dowel holes?
8. Why should dowel pins not fit the holes too tight?
9. How can you protect the edges of boards from being marred by the mallet or clamps?
10. What advantages do the mitered joints have over the butt joints? What disadvantages?
11. Why is the lower tray shorter than the upper tray?

LESSON XXVIII

TIMBER

Classes of trees. — Trees are divided into two classes, — broadleaf trees and needleleaf trees. Since most of the broadleaf trees have hard wood, this class is known quite generally as hardwoods ; and since most of the needleleaf trees have soft wood, this group is known as softwoods.

BROADLEAF TREES

Oak	Mahogany
Ash	Hickory
Butternut	Elm
Maple	Basswood
Birch	Yellow poplar
Beech	Cottonwood
Walnut	

NEEDLELEAF TREES

Pine
Hemlock
Cedar
Fir
Spruce
Tamarack

Manner of growth. — All trees, except the palms, add each year one layer of wood or annual ring to their trunks. Each annual ring consists of two parts, — an inner layer called spring wood and an outer layer called summer wood. The spring wood is more porous than the summer wood and is lighter in color and weight. Being more compact, the summer wood gives more strength to the tree than does the spring wood. Radiating from the center, and cutting across the annual rings at right angles, are thin plates of wood, called

medullary rays. In several species of trees the medullary rays are so thick that they may easily be seen in cross section as radial lines running across the annual rings.

Heartwood and sapwood. — As a tree grows in size, adding a layer each year just under the bark, the inner layers become denser and darker in color. These rings are called heartwood. The lighter, outer layers of wood through which the sap flows are the sapwood of a tree. Usually the heartwood is better for all purposes, because it is more compact and not so full of decomposable sap, though the sapwood of some trees, such as hickory and ash, is better than the heartwood.

Hardness of wood. — By hardness we mean the ability to resist pressure. It requires greater pressure to drive a chisel to a given depth in a hard wood than in a soft wood. The thickness of the cell walls and the smallness of the cell cavities determine the hardness. Soft woods hold glue much better than hard woods. Before gluing, hard woods should always be scratched or scored.

TABLE OF HARDNESS

VERY HARD	HARD	FAIRLY HARD	SOFT
Maple	Soft maple	Gum	Butternut
White oak	Red oak	Chestnut	Basswood
Osage orange	Ash	Poplar	Redwood
Rosewood	Elm	Hemlock	Cedar
Holly	Hickory	Norway pine	Cottonwood
Ebony	Cherry	Tamarack	White pine
Cocobola	Birch	Sycamore	Spruce
Lignum vitæ	Hard pine		

Strength of wood. — Strength is the ability to resist any kind of stress or strain. Some woods stand more strain of pulling and compressing than an equal weight of wrought iron. Thoroughly dry wood is much stronger than green wood.

Elasticity of wood. — Elasticity is the capacity of wood to regain its former shape after being bent and twisted out of shape. Hickory is the most elastic of woods. It is used in making ax handles, forks, hoes, bows, fishing-rod butts, and golf sticks.

Toughness of wood. — By toughness we mean strength and flexibility. Woods named in the order of their toughness are hickory, ironwood, rock elm, birch, oak, ash. Because of this quality, hickory is used for the spokes, and elm for the hubs of wheels.

Weight of wood. — The woody substance is heavier than water, so if timber were all woody substance it would sink in water. It floats because of the air spaces in the cells. The difference in weight of the species of wood is due to the proportion of air spaces to woody fiber. A cubic foot of white pine weighs 24 pounds, while the same volume of white oak weighs 50 pounds.

Shrinkage of wood. — When moisture evaporates from wood, the wood shrinks in size. As the wood is not uniform in structure, there will be more rapid shrinkage in some portions of it than in others, and warping results. Shrinkage is greatest in the direction of the rings, less in the radial direction, and least in the longitudinal direction. Thick-walled cells will shrink more than thin-walled cells; therefore, summer wood shrinks more than spring wood. The medullary rays shrink

very little in the radial direction; therefore, as the wood on each side shrinks, it pulls away from the medullary

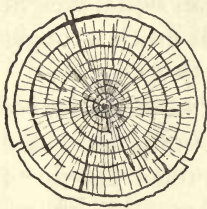

FIG. 129. — CHECKS AT THE END OF A LOG PARTLY DRY.

rays, causing checks and splits. The outside layers of a log will check because they dry out faster than the inner layers (Fig. 129). When the entire log is dry (Fig. 130), these checks close up somewhat. When a log is sawed into boards, the surfaces of all boards except the middle one will shrink unevenly, causing warping;

and those surfaces farthest from the center of the log will shrink most, causing the warping shown in Fig. 131. Notice that the concave sides of the boards are farthest from the center of the log. The center board shrinks evenly because the two surfaces are the same

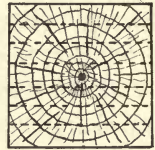

FIG. 130. — CHECKS AT END OF A DRY PIECE OF TIMBER.

distance from the center; but the edges of this board are thinner than

the center because there is more shrinkage there on account of its greater distance from the center of the log. Boards that are joined edge to edge, as in table tops, should be so joined that the warping of one board will be in the opposite direction from that of the board next to it. In order to accomplish this, join the boards with their annual rings curving in the opposite

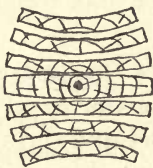

FIG. 131. — WARPING OF BOARDS SAWED FROM DIFFERENT PARTS OF A LOG.

direction, as in Fig. 132.

A shaky piece of timber is one that has cracks or splits

between the annual rings. Splits that run from the heart to the circumference perpendicular to the annular rings are called heart shakes. Rapid drying of wood is always harmful, as the surface dries more quickly



than the interior, and so pulls away from it, causing checks. Ordinary kiln-dried lumber is inferior to seasoned lumber for this reason.

FIG. 132.—METHOD OF JOINING BOARDS
EDGE TO EDGE.

In kilns, lumber is subjected to a dry heat for several days or weeks, which is not sufficient time to dry it thoroughly. Some kilns are managed by first injecting wet steam into the kiln to dissolve the chemicals in the pores; then adding dry heat for a long time, which drives out the moisture gradually, and so prevents checking.

In seasoning, lumber is piled under cover with strips between layers of boards, and allowed to remain there from two to four years. In this way it dries thoroughly and evenly. To prevent checking at the ends of thick planks, it is well to paint the ends before drying them. The hardwoods must be dried more slowly than the softwoods, or they will check and warp badly.

Coarse-grained and close-grained woods.—The wood of trees may be classified as coarse-grained or close-grained according to their texture:

COARSE-GRAINED

Chestnut	Mahogany
Elm	Rosewood
Ash	Hickory
Oak	
Butternut	
Walnut	

CLOSE-GRAINED

Soft pine	Boxwood.
Basswood	Cherry
Poplar	Gum
Maple	Cedar
Birch	Western hemlock
Beech	Spruce

Adaptation to special uses. — Each kind of wood possesses some characteristic which makes it valuable in certain lines of work and useless in others. The following tables give woods adapted to particular uses :

TIMBER FOR PLACING IN MOIST SITUATIONS	TIMBER FOR LIGHT FRAMING	TIMBER FOR HEAVY FRAMING
Chestnut	Spruce	Georgia pine
White cedar	Yellow pine	Oregon pine
Redwood	White pine	White oak
Cypress	Hemlock	Fir
Locust		Norway pine
Red cedar		
TIMBER FOR OUTSIDE FINISH	TIMBER FOR FLOORS	TIMBER FOR INTERIOR TRIM
White pine	Hard pine	Pine
Redwood	Oak	Birch
Cypress	Birch	Oak
Cedar	Maple	Butternut
Spruce		Mahogany
		Cherry

LESSON XXIX

WOODWORKING TOOLS

BEVEL

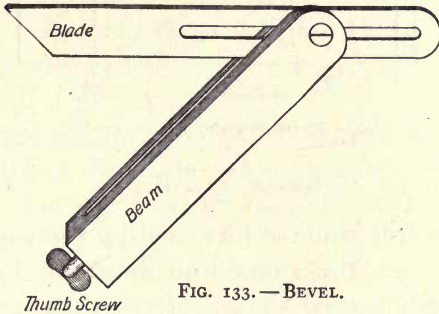

FIG. 133.—BEVEL.

The bevel has a movable blade that can be adjusted to any angle and held in that position by a thumbscrew. It is used for marking and testing any angle, as the try-square is used for right angles. The angles can be measured by means of a protractor, or a carpenter's square may be used for the most common angles. Fig. 134 shows what distances to take for the most common angles.

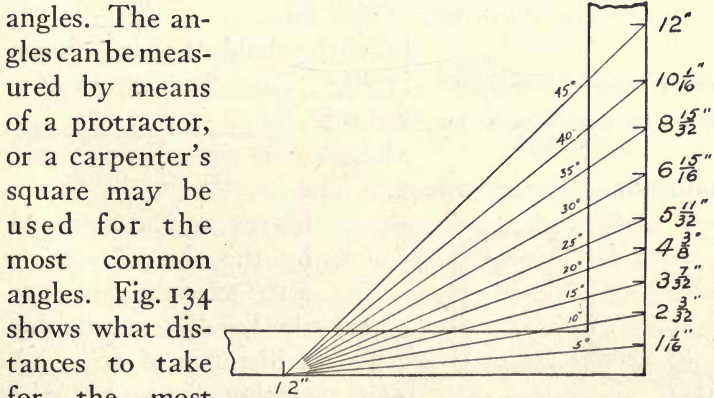

FIG. 134.—DISTANCES TO BE USED IN SETTING BEVEL AT THE MOST COMMON ANGLES.

Fig. 135 shows the method of setting the bevel at an angle of 30 degrees.

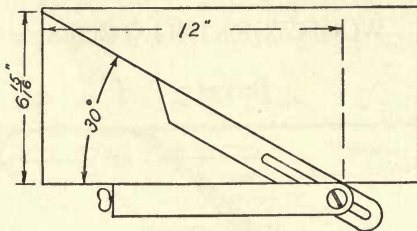

FIG. 135.—METHOD OF SETTING BEVEL AT ANGLE OF 30°.

BRACE AND BIT

Of the several kinds of bits used by the woodworker, the auger bit, shown in Fig. 136, is used more often than any other. The German center bit is shown in Fig. 137, and Steer's patent expansion



FIG. 136.—AUGER BIT.



FIG. 137.—GERMAN CENTER BIT.

bit in Fig. 138. Figure 139 shows a gimlet, or twist bit.



FIG. 138.—STEER'S PATENT EXPANSION BIT.



FIG. 139.—GIMLET.

The bit-brace that holds the bit is shown in Fig. 140. It consists of a knob, chuck, and handle, or sweep. The

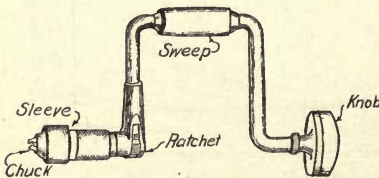

FIG. 140.—BITBRACE.

braces are designated by the size of sweep; a 10" sweep means that the handle extends out a distance of 10". A ratchet brace has the chuck set in a ratchet so

that it can be used in a corner where it is impossible to turn the handle all the way round. The expansion bit has a lip held in place by a set screw *a*, Fig. 138, which is pushed in and out by the set screw *b*, so it is possible to bore holes of various sizes with the one bit. The gimlet, used for boring small holes, is made of hardened steel, and will not be injured if it strikes a nail.

CHISEL

Chisels are cutting or edged tools, and are designated by the width of the blade. They range by eighths from $\frac{1}{8}$ " to 1", and by quarters from 1" to 2". Very few chisels are wider than 2".

The handles are fastened to the blades either by a socket or a tang. The socket is a hollow cone in one end of the blade, and the handle is turned down to fit this socket.



The tang is a sharp point with a shoulder, and is driven into the handle up to the shoulder. The handle of a tanged chisel has a metal ferrule to prevent splitting.

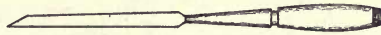

FIG. 141. — CHISELS.

The handle of a tanged chisel has a metal ferrule to prevent splitting.

Chisels are divided into three general classes according to their uses. The paring chisel has a light, thin blade intended to be used in the light work of paring, or taking thin shavings, and should never be driven by a mallet. The firmer chisel is heavier and intended for all ordinary work. The framing chisel is the heaviest and is used for cutting mortises in heavy timbers. The handle is in a socket, and it has a heavy iron ferrule

at the upper end to prevent splintering by blows of the mallet. Some chisels are bevel-edged, which have advantages over the other form in cutting dovetail joints, as the thin edge enables one to cut down close to the line without danger of splitting the sides of the mortise.

DRAWSHAVE AND SPOKESHAVE

The drawshave, Fig. 142, is a long chisel pulled by two hands, and is used in rather coarse work where con-

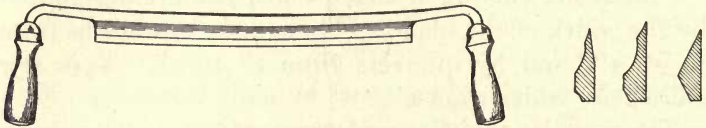

FIG. 142.—DRAWSHAVE.

siderable material is to be removed. The sections in this drawing show shapes of blades for different uses. The spokeshave, Fig. 143, is a small plane with a very

short sole, and so may be used on curved work.



FIG. 143.—SPOKESHAVE.

It is pulled or

pushed by the two handles at the side of the blade. The depth of cut may be regulated by the set screw on the blade.

GOUGE

The gouge is a chisel with curved blade. If the gouge is ground on the outside, or convex surface, it is called

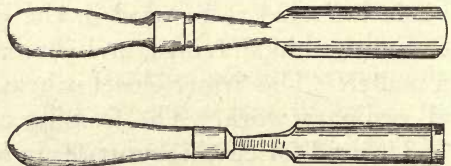

FIG. 144.—GOUGES.

outside ground; and if ground on the inside, or concave surface, it is called inside ground. The gouge is measured across from edge to edge, and is designated by this dimension. By its curvature, or sweep, it is designated as flat, middle, or full curved.

MARKING GAUGE

This tool consists of the beam, which is usually 8" or 10" long and nearly square, with a spur or steel point fastened in one end so that it projects about $\frac{1}{16}$ ". The head or guide is a block which slides on the beam, and is held in position by a thumbscrew. One side of the beam is graduated into inches and fractions of an inch. If the spur becomes bent, these graduations no longer indicate the correct distances.

PLANE

The plane consists of a blade set in a cast-iron or wooden stock. The front end of the stock is the toe, and the back end is the heel. The bottom is the sole, and the opening or slit in it is the mouth. The plane is held in both hands, by the knob in front and the handle behind. The blade, which is the cutting iron of the plane, is fastened to the stock by an iron clamp. Fastened to the upper side of the blade is a cap iron, or chip breaker. The iron clamp fastens the blade and cap iron to the frog. The slot in the blade allows the cap iron to be regulated at different distances from the edge of the blade; also the lower end of the lever fits into this slot and adjusts it from side to side. In the cap iron are three openings: At the upper end is a small slot, by which it is regulated up and down with the thumb-

screw. Below this is a small, round-threaded hole, through which passes a short machine screw which

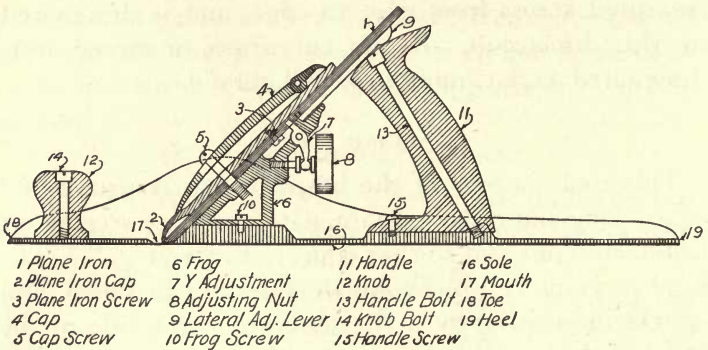

FIG. 145.—PLANE.

fastens the cap iron to the blade. Beneath this is a

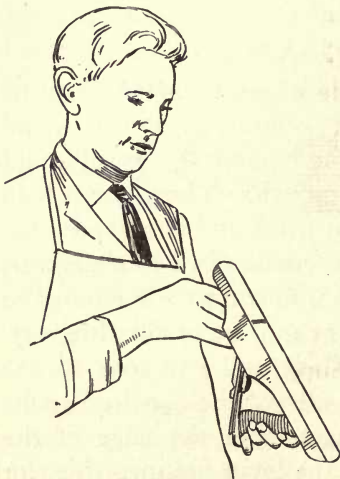

FIG. 146.—SETTING THE PLANE BLADE.

larger slot, through which passes the longer machine screw which is screwed into the frog, and by means of the clamp this screw holds the blade and cap iron to the frog. Back of the frog and in front of the handle is the thumbscrew, which engages a lever that fits into the upper slot of the cap iron and forces it up and down. This motion carries the edge of the blade in and out of the mouth and sets it for depth of cut.

While setting the plane blade, hold the plane as shown in Fig. 146 and sight along the sole of the stock,

as along a gun barrel, with one eye closed; and in this way you can see how much of the blade projects, and regulate it accordingly. The lever working in the slot of the blade regulates the blade from side to side.

There are several kinds of planes. Those most commonly used are the smoothing plane, used for surfacing lumber; and the jack plane, used for edging and for rough surfacing lumber when it is necessary to remove a quantity of stock to reduce the thickness. The jointer is a long jack plane which is used to true up the edges of boards preparatory to gluing them, or to make straight edges. The block plane has the blade set at a low angle and is used for planing across the grain of the ends of boards.

RULE

The rule ordinarily used by carpenters and cabinet makers is two feet long, made of boxwood, and bound with brass. On each of the four edges there are marks every 1", $\frac{1}{2}$ ", $\frac{1}{4}$ ", and $\frac{1}{8}$ "; and two of the edges also have marks every $\frac{1}{16}$ ". There are, in addition to these marks, others representing scales. Suppose the object we wish to draw is too large to be represented full size; as, for example, a barn. It would have to be drawn on a smaller scale of, say, $\frac{1}{4}$ " to the foot. We would use that part of the rule where a quarter of an inch is divided off into twelve parts, each representing an inch on the reduced scale. The scale marked 3 means that a space of 3"

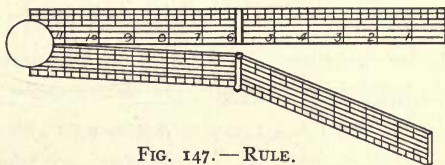

FIG. 147.—RULE.

is divided off into twelfths, each representing one inch.

If it is desired to find the middle of a board of such a width, that to measure one half of it would mean the use of fractions not found on the rule, for example, $3\frac{2}{3}$ "', the middle can be found easily by setting the rule diagonally on the surface, so that it measures an even number from edge to edge of the board; and then mark off the middle point of this division. In this way a board may be divided into any number of equal parts. If three parts are wanted, use a number of inches divisible by three.

SAW

Next to the hammer, the saw is the most important tool used by the woodworker. Saws are used for cutting lumber into smaller pieces, and when the cutting

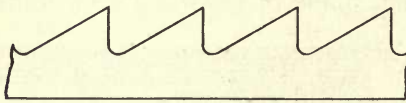

FIG. 148.—TEETH OF A RIPSAW.

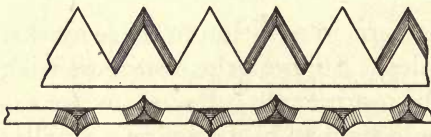

FIG. 149.—TEETH OF A CROSSCUT SAW.

is across the grain, the teeth must be so sharpened that they will cut just as the point of a knife cuts when drawn across the grain. Such saws are called crosscut saws. Saws used for cutting parallel with the grain have the teeth filed

like the edge of a narrow chisel, and are called rip saws. Fig. 148 shows the teeth of a rip saw. Fig. 149 shows the teeth of a crosscut saw.

The shape of the teeth also determines the use of the saw. Notice in the crosscut teeth that the sides make equal angles with the horizontal line while, one edge of the rip-saw teeth makes an angle of 90 degrees with this line, and the other side a variable angle. Saws for coarse work have large teeth, and consequently, in such saws there are fewer teeth to the inch than in saws intended for fine work. The size of the teeth is designated by so many points per inch. In a 6-point saw there are six teeth to the inch, and this number is stamped on the end of the blade next to the handle.

The bevel on the edges of a crosscut saw is called the fleam, and the wider this fleam, the sharper and weaker the teeth. The weak tooth will soon wear out on hardwood, and so a saw to be used on hardwood should have a narrow fleam. The angle at the front edge of the tooth affects the smoothness of the cut and the force necessary to push the saw through the wood. This can be illustrated by drawing the blade of a knife across the grain of a board, first with the blade held in a perpendicular position, and then held inclined at an angle less than 90 degrees. It has been found that the angle of 60 degrees in crosscut saws is the best for all-round work; and that in rip-saws, 90 degrees is best.

When a large board is to be sawed, it should be placed on sawhorses, and a large saw should be used. If the piece is small, it can be held in the vise or on a bench hook, and a small saw should be used. A back-saw is the name of a small saw with fine teeth and a thin blade, too thin to be used without a strip of metal on the back to prevent it buckling or bending. This saw is used in fine cabinet work.

Thick stuff should be lined on both sides and sawed from both sides to insure accurate work.

In using the saw, little or no pressure should be exerted in a line parallel with the edge, or it will be difficult to make the saw cut to the line. It is best to place the piece to be cut in a vertical or horizontal position. No steering of the saw should be necessary, but if the teeth are longer on one side than on the other, then the saw will run towards that side. The practice of changing sides will remedy this; however, the proper remedy is the careful filing and setting of the teeth. In starting the saw, set the heel on the mark and make the first stroke a pull to make a small groove in which the saw will travel more easily on the push stroke. If, in sawing wood full of resin, the saw gums up, a little kerosene will dissolve the gum.

TRY-SQUARE

The parts of a try-square are the beam and the blade, shown in Fig. 150.

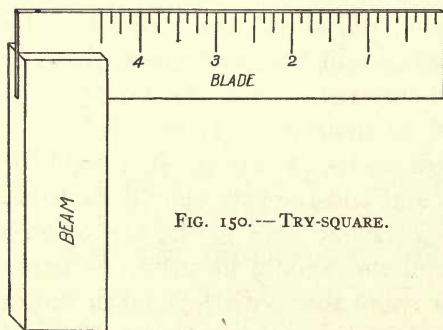

FIG. 150.—TRY-SQUARE.

The beam may be of wood or metal, the latter being better; and the blade should be of steel, marked off into inches and fractions of an inch. Try-squares should be tested with the

large carpenter's square before beginning work, to be sure that they are true.

TURNING SAW

The turning saw consists of a thin blade held in a frame very similar to a bucksaw. It is much smaller, however, and has the handles at each end of the blade. These handles can be turned at any angle so that the blade may be made to cut in any direction. The narrow blade makes it possible to turn the saw while cutting, and so it can be used in cutting curves.

Several sizes of blades can be used. The narrower the blade, the smaller the arc in which it can be turned. When cutting out fretwork, it is first necessary to bore a hole, then to take out the saw blade from one handle by loosening the turnbuckle on the back, next, insert it in the hole, then place it back in the frame and tighten the turnbuckle.

SANDPAPER

Sandpaper is a tough heavy paper, coated with glue on which sand has been sprinkled. It is called garnet paper, when the sand is dark red in color; and it is called glass paper, when ground glass is sprinkled on instead of sand. The sand is of various degrees of fineness and is numbered from 00 to 3, the 00 being the finest. Sandpaper is an abrasive tool that must not be used until all other tool work is completed, as the particles of sand become embedded in the pores of the wood, and will dull any edged tool used over it. Sandpaper blocks should

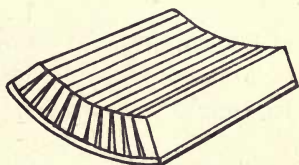

FIG. 151.—A SANDPAPER BLOCK FOR CURVED SURFACES.

be used except when sanding down shellac or varnish in wood finishing. A square block of wood is used for plain surfaces. A block as shown in Fig. 151 is useful on curved surfaces. It is made by gluing a strip of leather to the surface of a block, and, when dry, sawing grooves through the wood down to the leather, so that the block can be curved into a concave or convex shape, according to the kind of work to be done.

Never sandpaper across the grain, as it leaves scratches that become more ugly as the wood is stained or filled.

LESSON XXX

USES OF THE STEEL SQUARE

Frequently farmers wish to build a shed, or an addition to the barn, or even to construct the barn itself.

If a man happens to be handy with tools and understands the use of the steel square, he can plan and construct most of his buildings without hiring expert carpenters.

The steel square, also called the carpenter's square, or framing square, consists of two steel blades at right angles to each other. One, about 24" long and 2" wide, is called the blade; the other, about 16" long and 1½" wide, is called the tongue. Steel squares are graduated into sixteenths, eighths, quarters, and halves of an inch, and some into twelfths of an inch. The blade and tongue of the square are covered with graduations, the meaning of which will be given in the directions that are to follow.

Brace measure. — On one side of the tongue in the middle are figures, by means of which it is possible to obtain the length of braces used in framing. Take, for example, the numbers

$$\left. \begin{array}{l} 36 \\ 36 \end{array} \right\} 50.92$$

which means that if two timbers each 36" long are to be braced, the brace will be 50.92" long. The length

of the brace can also be obtained by geometry. The square of the hypotenuse of a right triangle is equal to the sum of the squares of the other two sides. In

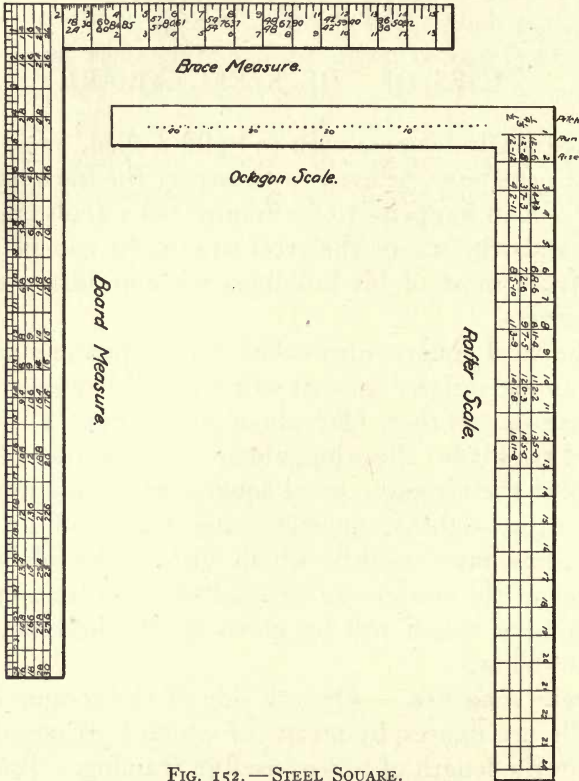

FIG. 152. — STEEL SQUARE.

this case the two timbers and the brace form a right triangle in which the brace forms the hypotenuse. The two sides are each 36'' long; and, as the square of 36 is 1296, the sum of the two squares equals 2592. The square root of 2592 is 50.92, which is the length of the

brace. Take another example; look on the square for the numbers

$$\left. \begin{array}{l} 18 \\ 24 \end{array} \right\} 30$$

which means that if two timbers are respectively 18" and 24" long, the brace connecting them will be 30" long. The square of 18 is 324 and the square of 24 is 576. The sum of these two is 900. The square root of 900 is 30, which is the length of the hypotenuse, or brace. By this rule of geometry you can determine the length of the brace for two timbers of any length not given on the square. Another method is to measure off two lines at right angles to each other, representing respectively the lengths of the timbers to be braced, then measure the distance between their ends.

The carpenter's method of finding the length of a brace and the bevel of the cuts at the ends is as follows. Suppose the two timbers are each 36" long; lay the

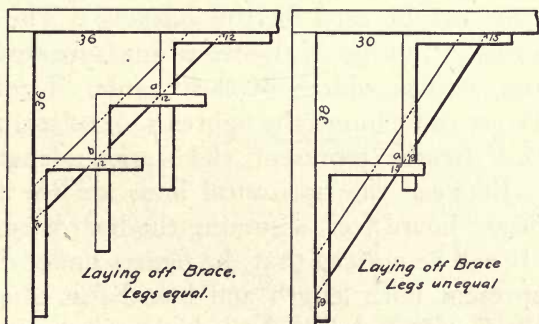

FIG. 153.—LAYING OFF BRACES.

square on the timber to be used for the brace so that the 12" mark on the tongue and blade are both on the

edge of the timber, Fig. 153. The tongue will give the bevel of the upper end of the brace. Mark the edge of the brace at *a* where the blade crosses it. Set the square again so that the 12" mark comes at *a* and the 12" mark on the blade crosses the edge of the timber at *b*. Again set the square in the same way and the blade will give the bevel of the lower end of the brace and the length of the brace at the same time.

Take another example in which the two timbers to be braced are 30" and 38" long. Set the square on the brace so that the 15" mark on the tongue and the 19" mark on the blade are on the edge, and mark at *a*; set again in the same way as before and you will have the length of the brace and the bevels of the upper and lower ends.

Board measure. — The unit of measurement in lumber is the board foot, which is a board 1" thick, 12" wide, and 12" long. It is often necessary to find the number of board feet in timbers of various sizes. The steel square can be used for this purpose. The large-sized figures at the top of the board measure scale represent the various widths of the boards. Under the 12" mark are to be found the figures 8, 9, 10, 11, 13, 14, 15. These figures represent the various lengths of boards. Between the horizontal lines are the figures that indicate board feet, assuming the boards to be 1" thick. It will be noticed that the figures under the 12" mark represent both length and board feet of boards that are 12" wide. A board 1" thick, 12" wide, and 8' long contains 8 board feet. Notice that the board feet of boards 10" wide, whose lengths are indicated by the figures under the 12" mark, are represented by

the figures under the 10'' mark. For example, a board 10'' wide and 8' long contains 6.8 board feet; and a board 10'' wide and 10' long contains 8.4 board feet. Notice the number of board feet in boards 18'' wide and whose lengths are 8', 9', 10', 11', 13', 14', and 15', respectively. By calculation verify the correctness of these numbers that indicate the board measure. You will notice that many of the numbers indicating board feet are correct only to the nearest tenth. Suppose a timber is 2'' thick, 14' long, and 8'' wide. Look under the 12'' mark for 14 and then along the line for the figure 8'', under which you will find the number 9.4. This indicates that there are 9.4 board feet in a board 1'' thick, 8'' wide, and 14' long; but our piece is 2'' thick, so it is necessary to multiply the 9.4 by 2, which gives 18.8, the number of board feet.

You will notice that there are no provisions made for a timber that is 12' long, because a timber that long has in it as many board feet as the number of inches in its width, if it is 1'' thick.

Octagon scale. — On one side of the tongue of some squares will be found small round dots, or short lines, and numbers on them, as 10, 20, 30, 40, etc. This constitutes the octagon scale which is used in laying off octagons on square timbers.

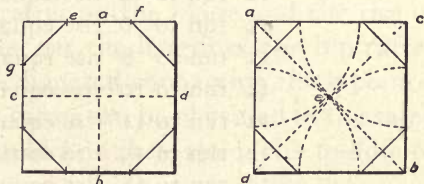

FIG. 154.—LAYING OFF AN OCTAGON.

Suppose the timber is 8'' \times 8''. Across the end of the timber draw two center lines, Fig. 154, *ab* and *cd*, at right angles to each other. Set a compass with

the points stretching across as many places on the scale as the timber is inches wide and thick. Placing one point of the compass at *a*, lay off points *e* and *f*. Likewise, lay off two points each from *b*, *c*, and *d*. Draw lines from these points and you have an octagon.

Another way is to draw diagonals *ab* and *cd*; and with the compass set at half the length of these diagonals scribe arcs as in the drawing, and then connect the ends of these arcs, thus completing an octagon.

Rafter tables. — Some squares are marked with rafter tables. These tables are under the edge of the

blade graduated into twelfths. The twelfths may mean twelfths of an inch or twelfths of a foot. The number

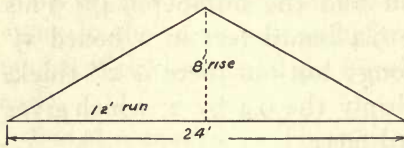

FIG. 155.—PITCH OF RAFTER.

above represents the run of the rafter. The run of a rafter is one half the width of the house. (See Fig. 155.)

The following table gives the pitch of a roof with the runs and rises most commonly used by carpenters :

12' run to	4' rise equals	$\frac{1}{3}$ pitch.
12' run to	6' rise equals	$\frac{1}{2}$ pitch.
12' run to	8' rise equals	$\frac{2}{3}$ pitch.
12' run to	10' rise equals	$\frac{5}{6}$ pitch.
12' run to	12' rise equals	1 pitch.
12' run to	15' rise equals	$\frac{5}{4}$ pitch.
12' run to	18' rise equals	$\frac{3}{2}$ pitch.

If the width of a building is 22' and the roof is $\frac{1}{2}$ pitch, the run is 11' and the rise is 11'. Following the rafter table under ruling $\frac{1}{2}$ pitch, under the graduation 10 you

will find the figures 14 1-8, which means that the rafter length is $14' 1\frac{8}{12}''$.

The rafters can also be laid off with the square, as the braces were. Take the run of the rafter on the blade and the rise on the tongue, and lay off the square on the timber as many times as the run on the square is contained in the run of the rafter. This method also gives the bevel cuts at the top and bottom of the rafters. Suppose the roof is $\frac{1}{4}$ pitch, which means that the run is 12' and the rise 6'. Lay the square on the rafter with the 12'' mark of the tongue and the 6'' mark of the blade touching the edge. Mark and repeat the operation as many times as 12'' is contained in 12', or 12 times. You then will have the bevel at the foot of the rafter.

Hip rafters. — A hip rafter is one that runs from the corner of a building to the ridgepole, striking the latter at a point as far from the end of the building as the ridge is from the side of the building.

In order to find the length of a hip rafter it is necessary first to find the run. If the roof is $\frac{1}{2}$ pitch, take half the width of the building on both blade and tongue. The diagonal between them is the run of the hip rafter. With the run of this rafter on the blade and the rise of the roof on the tongue, get the length of the hip rafter from the length of the diagonal connecting these points. The length of a valley rafter can be obtained in the same way. All lengths should be taken along the middle of the rafter.

Jack rafters. — A jack rafter is a rafter running from the plate to a hip or valley rafter; and is shorter than other rafters. To find the length of a jack rafter, first find its run. The run of the hip rafter is divided

into as many parts as there are spaces between the first full rafter and the corner of the building. The distance along the plate between the corner and the first full rafter is divided into the same number. Set the square so that this number taken on the blade coincides with the edge of the plate, and place the edge of the tongue on the first point of the run of the hip rafter. The distance on the tongue represents the run of the first jack rafter.

With this distance on the blade, divide the rise of the common rafter into as many divisions as there are spaces between the jack rafters, and the resulting number taken on the tongue gives for the length of the jack rafter the diagonal of these two points.

Stairs. — In finding the length of stringers for stairs, use the same methods as in finding the length of braces and rafters. Having found the length of the stringer by this means, lay off on it the square with a point on the tongue representing the riser of the stairs, and a point on the blade representing the run, or tread, of the stairs.

Repeat this until the required number of stairs has been laid out.

LESSON XXXI

GLUE IN WOODWORKING

Gluing up work. — In gluing up work it is necessary to have a number of suitable wooden clamps, as shown in Fig. 156, and a long wooden clamp, as in Fig. 157, or iron clamp, as in Fig. 158. In case there are not enough of the long clamps for the work, temporary clamps can be made like those in Fig. 159. For small joint work, iron carriage clamps, like

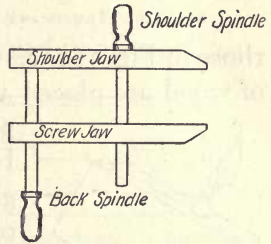

FIG. 156.—WOODEN CLAMP.

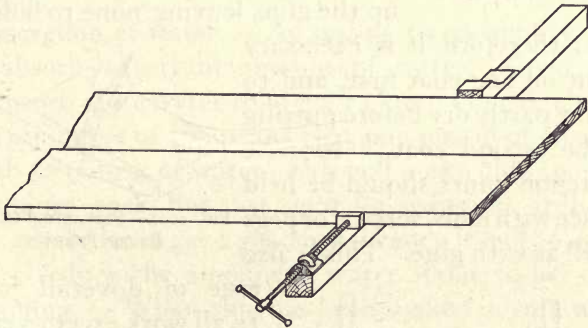

FIG. 157.—LONG WOODEN CLAMP.

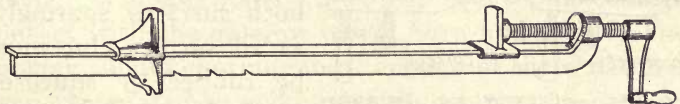

FIG. 158.—IRON CLAMP.

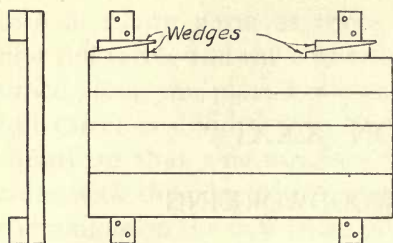

FIG. 159.—TEMPORARY CLAMPS.

those in Fig. 160, can be used if blocks of wood are placed under the jaws to prevent marring.

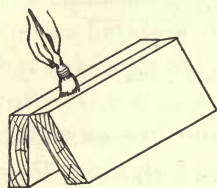

FIG. 161.—SPREADING GLUE ON EDGES.

In applying the glue to two edges to be joined, hold them as in Fig. 161. In gluing surfaces, hold them as in Fig. 162. The end grain, being more porous, soaks up the glue, leaving none to hold the

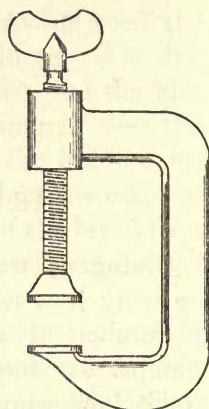

FIG. 160.—CARRIAGE CLAMP.

joint; therefore, it is necessary to put on one coat first, and to let that partly dry before putting on the second coat. Mortise and tenon joints should be held in place with nails, screws, or pegs as well as with glue. This is also

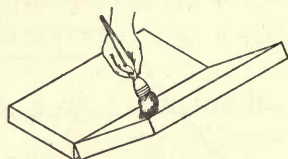

FIG. 162.—SPREADING GLUE ON BROAD SURFACES.

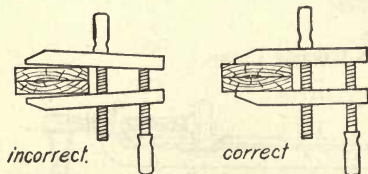

FIG. 163.—CORRECT AND INCORRECT METHODS OF CLAMPING GLUED SURFACES.

true of dovetail joints. In all work except veneer, glue should be applied to both surfaces sparingly, as all surplus glue must be rubbed or squeezed out before the joint sets.

An absolutely smooth surface does not glue so well as a rough one, as the glue does not enter the pores so readily; and for this reason, sawed mortise and tenon and halved joints are stronger than those trimmed with the chisel. On some kinds of wood, as birch, the glue will appear dark, thereby making the joint conspicuous. The only way to avoid this is to make the joint come in an inconspicuous place if possible.

After a glued joint has been clamped in place, all surplus glue that has been squeezed out should be wiped off with a cloth wet in warm water, as it is easier to remove it this way than after it has hardened. Do not wash it off, as the water would enter the joint and weaken the glue.

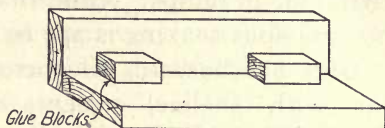

FIG. 164.—STRENGTHENING A JOINT BY MEANS OF GLUE BLOCKS.

Absorption of water. — According to its quality, glue will absorb a certain amount of water. Good glue will absorb more water than poor glue. Glue having an absorption test of 50, means that one pound of glue will absorb 50 ounces of water; this will make glue too thin for cabinet work, but just right for sizing or cardboard work. In order to get a good consistency it will be necessary to reduce the amount of water about 30 per cent.

Cooking. — When glue has been soaked in cold water over night, it is ready for cooking, which is done in a gluepot, or double boiler. No direct heat should come in contact with the glue, or it will burn and stick. The cooking should continue until enough of the water has been evaporated to make it of the proper consistency.

If the cooking is continued very long, the quality of the glue will deteriorate. New glue should be made for each day's work, if the best results are to be obtained. Old glue will hold, but not so well as fresh stock. Glue that is held to the cooking point for a half day will lose half of its holding power. Being soluble in water, glue will not hold if kept in a damp place or if frequently wet with water. Soaked glue will dissolve more readily than dry glue, and ground glue will dissolve more readily than glue in lumps. Glue that has been cooked without previous soaking is apt to have hard lumps in it.

Glue brushes are, of course, not fastened with glue, but with shellac, cement, or rubber. Rubber-set brushes are the best for all purposes, as they are not soluble in any of the solvents usually used, and so will not lose hairs, as the others do. In these brushes the bristles are set in liquid rubber and the rubber is then vulcanized, or made hard, by steam heat. The glue brush should be soaked in hot water some time before using, and should be taken from the gluepot and washed in hot water after using. In gluing large surfaces, use thinner glue than when gluing small joints; for if the surfaces are cold, the glue will chill before the pieces can be put in place, and a poor joint will result; and if the boards are too hot, they will cause the glue to dry before the joining can be done.

Purchasing glue. — The purchase of good glue is a matter of great importance. The average woodworker should purchase glue from professional woodworkers, to be sure of obtaining as good a grade as that supplied to the trade. Buy from a cabinet maker, pattern maker, or a planing mill, and you will get the best results.

LESSON XXXII

FILING SAWS AND GRINDING EDGE TOOLS

FILING SAWS*

Filing a saw is a very difficult operation, and the novice should read the directions very carefully before beginning, and in the first trial he should take a rather coarse saw, such as a bucksaw.

Remember that each tooth is a knife or a chisel, and if all teeth are of the same length, each will do an equal amount of work in cutting; but if one tooth is longer than the others, it will do more than its share of work and will be strained so that it is liable to break.

The space between two teeth is called the throat; it serves to carry out the sawdust as fast as made by the teeth. Different kinds of wood require teeth varying in size, shape, and style of filing. To get the best results, there should be a different kind of saw for each variety of work to be done; but as this is impracticable, it will be better to dress the saws in such a way as to make them do as great a variety of work as possible.



FIG. 165.—POSITION OF FILE IN FILING A SAW.

The blades of all saws filed should be held in a vise perpendicularly, and the file should be held horizontally, as in Fig. 165. If the front and back of the tooth are filed

straight across with the file held horizontally and at right angles to the edge of the blade, the filing will produce a perfect chisel edge. If all the teeth are filed from one side, a wire edge will be produced on the opposite side, which will cause the saw to run or saw crooked, so it will be better to file every alternate tooth from one side and the others from the opposite side.

Ripsaws.—The teeth of a rip saw are chisel-shaped, and each tooth cuts off a small piece of wood across the grain. They should be filed across the saw or at an angle of 90 degrees with the edge.

The front of a rip saw tooth is perpendicular and the back is inclined at an angle of 60 degrees from the perpendicular front of the tooth.

The teeth of a rip saw should be set slightly to insure easy and smooth work. Softwoods require larger teeth and more set to prevent binding.

Crosscut saws.—In crosscut saws, the teeth cut the fibers of the wood at right angles to their length, and therefore should be shaped like the point of a knife blade. Considerable care should be taken to give the tooth the most desirable shape. Remember that the sharper the tooth the weaker it is, the faster it will cut, and the faster it will become dull.

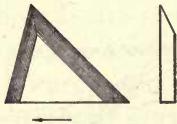

FIG. 166.—A SHARP TOOTH.

Therefore a tooth intended for very soft wood, as basswood, redwood, or butternut, should be very sharp; while that intended for white oak, hard maple, or osage orange should be blunt. A tooth shaped as in Fig. 166 will do very well for very soft woods. The bevel, or fleam, has a very wide front and

back, making a very sharp and weak tooth. It also has a greater rake, or angle, in front than in back, which insures fast cutting in soft-woods, but in hardwoods this rake causes the saw to buckle and hang up. A tooth like Fig. 167 will be suitable for moderately hard woods.



FIG. 167.—A MODERATELY SHARP TOOTH.

It has a moderate fleam in front and back, with the front and back rake equal and at 60 degrees. A tooth shaped like Fig. 168 will answer for very hard woods. It has a narrow fleam in front and no fleam on the back; and the rake behind is a trifle greater than that in front. This tooth will stay sharp when used on hard woods.



FIG. 168.—A BLUNT TOOTH.

Jointing. — Always joint the saw before setting or filing it. Jointing means filing the points down even. A good jointer is shown in Fig. 169.

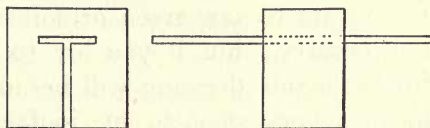

FIG. 169.—A SAW JOINTER.

It is a block of wood cut out so that a flat file can be inserted and the whole run over the edge of the saw.

Setting. — Setting is done by means of a saw set which turns the points of the teeth alternately right and left. This causes the saw to cut a kerf wider than the blade of the saw and thus enables it to move freely through the wood. A considerably larger set is required for saws to be used on soft green woods than for

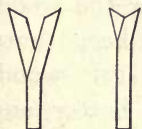

FIG. 170.—SETTING THE TEETH OF A SAW.

hard dry woods Do not try to set the entire tooth, but only the point. (Fig. 170.)

Filing.—When the saw has been jointed and set, then proceed to file it. In filing a crosscut saw, hold the file horizontally, and at an angle of 45 degrees with the edge of the blade, when filing a tooth represented by Fig. 166. For filing a tooth shown by Fig. 167, hold the file horizontally with the blade and at an angle greater than 45 degrees with the edge. For a tooth shown by Fig. 168, hold the file horizontally and at an angle of about 60 degrees for the front fleam, and at an angle of 90 degrees for the back of the tooth. Begin at the heel of the saw and file towards the point.

Side dressing.—When the saw has been filed, it should be side dressed by laying it flat on the bench and once or twice rubbing an oilstone over the teeth. If you are to saw green or soft wood, side dressing is unnecessary; but if you are to saw hard wood, considerable side dressing will be advantageous, as it will mean a very smooth cut, in fact, smoother than one can plane the end grain with the block plane.

GRINDING EDGE TOOLS

The plane bit and chisel should be sharpened for the kind of work they are to do. The harder the wood, the blunter must be the edge in order to keep sharp against the wear of the hard grain. On soft wood, a longer bevel can be used; this will cut better, and because of the softness of the wood will wear longer.

The chisel and plane bit should be sharpened in the same manner, and so directions given for one will

apply to the other. The angle at which these tools should be sharpened varies with mechanics from 20 to 30 degrees. We may take 23 degrees as satisfactory, and sharpen all tools at this angle. When it is necessary to use the tool on some hard wood, it can be honed on an oilstone to a greater angle with little trouble, and the necessity of grinding down to a new bevel over the entire thickness of the tool is avoided. The first step in sharpening these tools is to use the grindstone or emery wheel. Water should be used on either stone for two reasons: (1) it keeps the tool from getting so hot as to draw the temper; (2) it carries away the bits of steel and stone that are worn off, leaving a new surface for grinding. A soft stone is better than a hard one, because it wears away instead of glazing over, thus always presenting a new and sharp surface to the tool. The tool should be examined frequently, and some device should be used to insure replacing the tool on the stone at the same angle at which it was before it was lifted. Grind the edge down until it is square and sharp. Test for squareness with the try-square, and test for the desired angle by the use of a template ground at the proper angle. When the bevel has been properly ground, it should be honed on an oilstone.

The honing can be done in one of two ways, either by a forward and backward motion, or by a circular motion. Either method will wear down the oilstone unevenly at the ends if it is not a round stone.

The grinding and honing will leave a wire edge, which will drop off in time if the tool is reversed and honed on the flat side with the flat side flat on the stone.

Do not raise it, or a second bevel will be started on that side and it will be impossible to do good work when using the tool.

Test the sharpness of the tool by drawing it across the thick of the thumb, to see if it takes hold of the callus there. If not, then it is not sharp; but if sharp, it will take hold enough to catch the skin, and care must be taken or a deep cut will result. When the honing has been completed, draw the corners across the hone once or twice to round the square corners. This will prevent the corners making a score or mark on the surface of the wood when it is planed.

A gouge must be sharpened with slips, which are small oilstones tapering from edge to edge, and with the edges rounded instead of square.

Carving and turning tools are sharpened with slips in the same way as the gouges are.

Oilstones. — Oilstones are of two kinds, — natural and artificial. The most common natural stones are the Washita and the Arkansas, which are very fine and very hard. They are also very expensive, too much so for use in any ordinary work shop. These stones give a very fine edge on tools, but require a great deal of time and work in producing it.

Emery and corundum, which are nearly pure forms of alumina, have been extensively used as abrasives. They are extremely hard, but not so hard as the diamond, being 9 in the scale of hardness, while the diamond is 10. If the diamond were not so scarce, it would drive all other abrasives out of the market.

To prevent oilstones being broken, they should be mounted in a box made for that purpose. As the name

indicates, oil should be used on these stones when sharpening tools. Mineral oils are not recommended, but some light animal oil that will not gum should be used sparingly, and the surplus wiped off when through. Kerosene is useful after the stone has been used quite a time with other oils, and a mixture of equal parts glycerin and alcohol will make a stone take hold even after it seems to be glazed. Soaking in dilute sulphuric acid or lye will also clean out a stone and make it work after all other efforts have proved useless. It is almost impossible to wear down an oilstone evenly, for most of the wear comes in the middle, and it is difficult to use the extreme ends without the tool slipping off and thus injuring its edge.

Fig. 171 shows a method of making a box with two pieces of hard wood set upright at the ends, and the tops flush with the top of the oilstone.

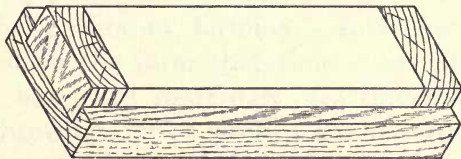

FIG. 171.—BOX TO HOLD OILSTONE.

With this arrangement, it is possible to use the stone clear to the ends, thus wearing it down evenly. Round stones have the advantage in this respect, for no part of them is subjected to more wear than any other part. Oilstones with an uneven surface can be trued up by rubbing them on sandpaper or on a smooth flat board over which has been sprinkled sand and water. Of the artificial stones the carborundum is the best be-

cause of its rapid cutting, its hardness, and nonglazing qualities.

Carborundum is cleaned by washing in dilute sulphuric acid. To make wheels, stones, etc., the carborundum is mixed with some binding material and placed in a hydraulic press and then vitrified. Carborundum will do work better and more quickly than emery or corundum; and because it saves time and labor, it is in great demand.

BLACKSMITHING

The farmer is called upon to exercise a great deal of ingenuity, and to adapt himself to meet emergencies perhaps more than a man in any other line of work. There are so many chances on the farm for small leaks in the income, so many trifling expenses connected with the upkeep of tools and appliances, that in the aggregate they amount to a good deal, and may mean the difference between a profit and a loss at the end of the year. The farmer must know something about a great many trades as well as a great deal about agriculture. Any information and skill he may acquire will increase his earning power and saving power, and so will increase the profits of farming. It is not generally considered on the farm that time is an all-important element; but when some part of a threshing machine breaks, throwing out of work a dozen men while it is taken to town to be mended by a blacksmith, the farmer is impressed with the fact that time is money. With a few tools and a little instruction and practice, any farmer can mend nearly any break that is likely to occur in the ordinary work of the farm. If careful records be kept of such items, it will soon be found that the saving in time will pay for the outlay for tools. Besides these economic considerations, it is a well known fact that blacksmithing has a peculiar fascination for boys.

LESSON XXXIII

THE FORGE AND ANVIL

The forge. — The blacksmith's forge consists of a bowl-shaped hearth with an opening in the middle of the bottom, called the tuyère. Through the tuyère comes the blast of air forced either with a bellows or rotary fan.

The tuyère should provide openings for the blast and at the same time should be protected in such a way as to prevent any quantity of cinders from falling into it, thus clogging and interfering with the blast. There should be an opening in the lower part of the pipe leading to the forge, so the cinders can be cleaned out from time to time.

A portable fan-blast forge of light construction is suitable for farm work. One in which the fan is operated by a crank and a train of gears is the most convenient. The farmer should have a tool house, or shop where all repair work can be done. In this place should be the work bench and tools, the sewing jack for the repair of harness, and the forge.

Coal. — The best soft coal should be used for forging. Good forge coal crumbles easily in the hands and produces very few clinkers when burned. Avoid coal that breaks into layers and is of a dull appearance, as that is steam coal and is not so good for blacksmithing

as the other. Coke and charcoal are sometimes used for forging, but not generally.

Coking. — Clean out the bowl of the forge and start a fire with shavings and chips of wood, and cover with some coke left over from the last fire.

If there is no coke, then cover with green coal and continue the blast until a good fire is burning. Next produce coke by covering the fire with green coal that has been wet with water, and pack the coal over the fire to prevent the blast from coming through.

In forming coke, the gases are driven out of the coal, leaving nothing but carbon and ash. The value of coke over coal lies in the fact that it can be brought to a higher degree of heat and it is free from smoke and flame. Coke is a nonconductor of heat and so confines the heat of the fire to a small area. During the forging, the fire should be banked around on all sides with wet green coal, which will gradually turn to coke. Keep the fire free from clinkers and supply fresh coke from time to time. When it is desired to keep a fire for any length of time, bank it with wet coal and it will keep, gradually changing the coal to coke.

Blast. — The amount of air forced into the fire has much to do with the work. Enough air must be forced in to cause the fire to burn with a great deal of heat, but if more air is forced in than can be used in burning the coke, the excess is a detriment to good forging, especially to good welding. This oversupply of air produces an oxidizing fire, which means that the excess of oxygen attacks the iron and causes it to scale or burn. A great deal of scale forming on the iron indicates that too much air is being used, and the iron is being

burned as well as heated. When brilliant scintillating sparks fly out of the fire, it means that the iron is burning very rapidly, and will in a short time be ruined.

The anvil. — The blacksmith's anvil is made of cast-iron or soft steel, on the upper surface of which has been welded a flat piece of tool steel which has been hardened and tempered. The pointed end is called the horn, and is left soft. A small flat surface between the horn and the hard surface is also left soft for the purpose of cutting off stock without injuring the edged tools. The anvil may be placed so that the horn points to the right or to the left, but it will be found more convenient to have it pointing toward the right.

LESSON XXXIV

STAPLE

STOCK

1 piece iron $\frac{1}{4}$ " round, 4" long

TOOLS

Hammer

Tongs

OPERATIONS

1. Drawing out.
2. Bending.

1. Drawing out.—Whenever iron is reduced in thickness, or lengthened, it is said to be drawn out. This piece of iron is to be drawn out to a point at both ends. The drawn part is to be left square. The piece when drawn out will be about 5" long. The only tools required are the hammer and tongs for this operation.

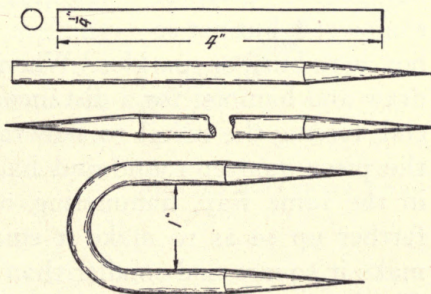

FIG. 172.—DRAWING OUT IRON FOR STAPLE.

The blacksmith will have use for several kinds and weights of hammers, but the one most commonly used is called the ball peen hammer (Fig. 173). This form of hammer may be had in various weights, but one weighing $1\frac{1}{2}$ pounds is right for most of the work.

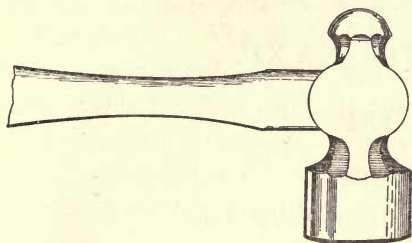

FIG. 173.—BALL PEEN HAMMER.

The tongs necessary for this exercise will be more commonly used than any other form. They are illustrated in Fig. 174, which gives a side view, and an end view of the jaws grooved for holding round stock.

In drawing out, first heat one end of the iron, holding it with the tongs in the center of the fire, and turn on the blast. Take it out from time to time to examine. It should be heated brighter than a red, but not so



FIG. 174.—TONGS FOR ROUND STOCK.

hot as to burn or sparkle. When sufficiently hot, withdraw and hammer for a distance of about 1" from the end, forcing the metal to flow toward the end. Turn the piece quarter round and hammer toward the end in the same way, hammering more at the end than farther up so as to make it smaller there. This will make it square and smaller than the original diameter. Continue the hammering toward the end until it becomes pointed. When drawing the end down to a fine point, it is necessary to hold the end at the edge of the

anvil so as not to strike the anvil (Fig. 175). If you strike the anvil instead of the iron, the hammer will rebound with considerable force and might strike your face, besides splintering off some chips from the edge of the hammer. Draw out the other end in the same

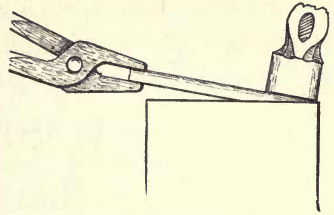

FIG. 175.—DRAWING OUT THE POINT OF THE STAPLE.

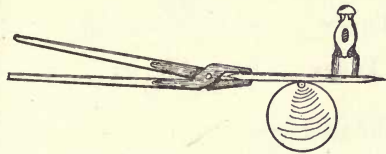

FIG. 176.—BENDING STAPLE AT MIDDLE POINT.

do. If the iron is not heated hot enough, it will also split.

2. **Bending.**—When both ends have been drawn out, heat the iron and bend it at the middle point, holding it as in Fig. 176, and striking not above the horn of the anvil, but just beyond it. As the iron bends, continue striking it, holding as in Fig. 177.

way. In drawing out, take as few heats as possible, but do not continue hammering after the iron has become black cold, for it will surely split if you

do. If the iron is not heated hot enough, it will also

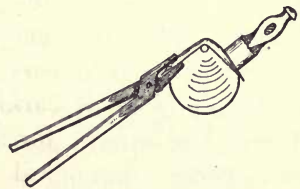

FIG. 177.—BENDING THE STAPLE OVER THE HORN OF THE ANVIL.

LESSON XXXV

GATE HOOK

STOCK

1 piece of iron $\frac{3}{8}$ " square, $9\frac{1}{2}$ " long

TOOLS

Hammer

Tongs

Flatter

OPERATIONS

1. Drawing out ends.
2. Forming shoulders.
3. Bending.
4. Twisting.

1. **Drawing out ends.** — Draw out the two ends $\frac{1}{4}$ " square, one of them $2\frac{3}{4}$ " long, the other 3" long, leaving $4\frac{1}{2}$ " in the middle full size.

Always draw out stock square before rounding off, so as to prevent the iron splitting. When the ends are drawn out square and to the size required, round off the corners, making as smooth as possible. The end drawn out 3" long should be pointed.

2. **Forming the shoulders.** — In forming the shoulders, heat the iron and place on the anvil at a point $2\frac{3}{4}$ " from one end. Place the flatter or set hammer directly over the edge of the anvil and hammer down approximately to size. Turn the iron one quarter round and repeat the operation. Treat the other end

in the same way. Hammer down the corners and make smooth and round, using the flatter with the hammer.

If you are not careful in placing the iron on the anvil

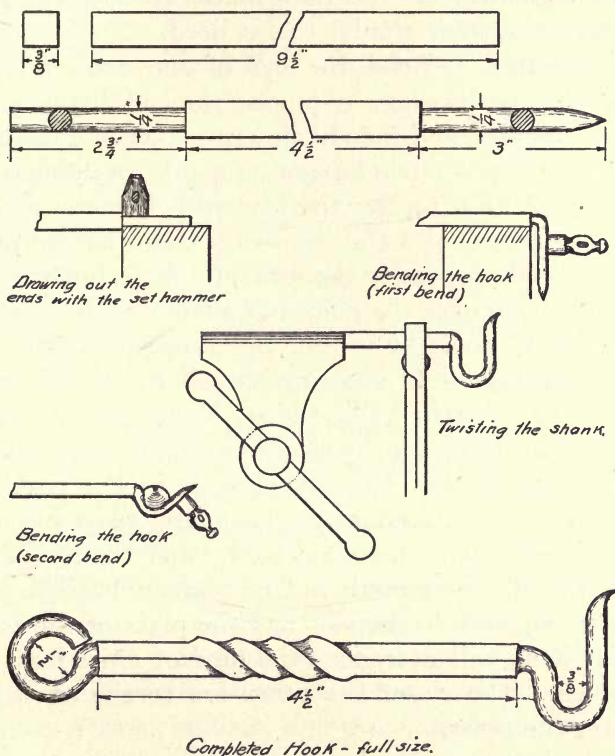

FIG. 178.—STEPS IN MAKING A GATE HOOK.

or the flatter directly over the edge of the anvil, you will not get a good shoulder. If you do not use the edge of the anvil as well as the flatter, the iron will be reduced only on one side, or will be off center.

The flatter, or set hammer, is not intended to be

used as a hammer, but is shaped somewhat like one; and is used where the hammer marks would mar the iron. It is impossible to hammer hot iron so carefully that no marks show, and when these marks are objectionable, the flatter or some similar tool is used.

3. **Bending.** — Bend the eye of the hook first, as shown in the drawing, by forcing the end down square at the shoulder, and then hammering it around the horn of the anvil to a circle having an eye $\frac{1}{2}$ " in diameter.

Be careful not to mar the iron with hammer marks. Next bend the hook in the same way except that the point is not brought around in the form of a circle, but straight up, and then curve the point out a trifle. The bending of the hook should be in the same direction as the eye.

4. **Twisting.** — In twisting the shank of the hook, heat it to a bright yellow heat, being careful not to burn it, as the smaller the piece of iron, the more quickly it heats and burns. Quickly place it in the vise, and with the tongs placed as in the figure, twist one half around and, taking a second hold, twist the rest of the way around. Straighten out on the anvil. The position of the hook in the vise and the place of the tongs on the hook will determine the kind of twist that will be given. The closer the tongs are to the anvil, the shorter the twist.

In case the iron for the gate hook must be cut from a piece two or three feet long, it will be necessary to determine what length of stock to cut off. To do this, take a piece of copper wire and bend it with the fingers the exact shape of the gate hook that is desired. Cut off the wire and straighten it out. This gives the length required.

LESSON XXXVI

BOLT

STOCK

1 piece iron $\frac{1}{2}$ " round, 7" long

TOOLS

Hammer

Tongs

Heading tool

OPERATIONS

1. Upsetting the head.
2. Heading on the heading tool.
3. Squaring the head.
4. Chamfering the corners.

1. **Upsetting the head.** — The size of the head of the bolt bears a definite relation to the diameter of the bolt. The formula is $H = 1\frac{1}{2} \times d + \frac{1}{8}$. H is the short diameter of the head, or, as it is called, the distance across the flats, d is the diameter of the bolt, $\frac{1}{2}$ " in this case. The formula in this case would read — $H = 1\frac{1}{2} \times \frac{1}{2}'' + \frac{1}{8} = \frac{7}{8}''$.

The thickness of the bolt head is always equal to the diameter of the bolt.

Upsetting is the process of shortening the length of a piece of iron and increasing its width, thickness, or diameter. Usually a piece is upset by holding firmly

in the tongs, with the ends of the tongs resting against the leg, and hammering on the hot end.

The hottest part of the iron will be upset most, and as the end is usually the hottest part, it will be upset the most, and too much sometimes. This can be guarded against by cooling the tip end by dipping in

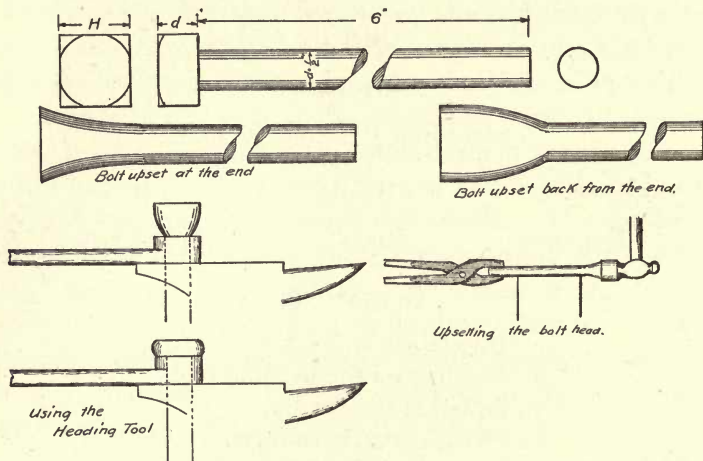

FIG. 179.—STEPS IN MAKING A BOLT.

water just before upsetting. This will cause the part still hot to be upset, but not the end. Several heats will be necessary, and the bar should be straightened between heats.

2. **Heading on the heading tool.** — After upsetting to a diameter of about 1'', place the bolt in the heading tool, which should be placed flat side down on the face of the anvil, allowing the bolt to extend down through the square hole in the end of the anvil. Hammer the head down to a thickness of $\frac{1}{2}''$ and smooth with the flatter.

3. **Squaring the head.** — In squaring up the head, heat to a white heat, and hammer alternately on the four sides, taking pains that each of the four sides is the same distance from the shank of the bolt, or you will likely have a bolt head that is off center, or lopsided. The metal will be forced out over the head, so it will be necessary to place it in the heading tool several times to hammer it back into shape.

Make the head the required size, $\frac{7}{8}$ " square and $\frac{1}{2}$ " thick.

4. **Chamfering the corners.** — The corners of the upper surface, if left as they are now, would catch the clothing, and cut and mar anything that happened to hit them. To prevent this as well as to make them more sightly, they should be chamfered off. Place in the heading tool and hammer down the corners slightly, being sure that you do not destroy the squareness of the head.

LESSON XXXVII

CHAIN AND HOOK

STOCK

1 pc. iron $\frac{3}{8}$ " round, 10" long, for link

1 pc. iron $\frac{3}{8}$ " \times 1", 7" long, for hook

1 pc. iron $\frac{3}{8}$ " round, 10" long, for ring

TOOLS

Hammer

Fullers

Punch

OPERATIONS

For Link

1. Measuring.
2. Bending.
3. Scarfing.
4. Welding.

For Ring

1. Measuring.
2. Scarfing.
3. Bending.
4. Welding.

For Hook

1. Measuring.
2. Fullering.
3. Punching eye.
4. Shaping hook.
5. Bending hook.

LINK

1. **Measuring.** — When the length of stock is given, as in this particular exercise, this operation is unnecessary. However, if the stock must be cut from a longer

bar of iron, it is necessary to determine what length of iron is necessary to make a link of the required size. Let Fig. 180 represent the link to be made. An inspection of this figure

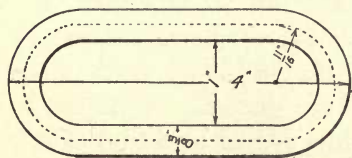

FIG. 180. — MEASURING THE LENGTH OF IRON NECESSARY FOR LINK.

shows that it consists of two semicircles, one at each end, and two straight pieces, one on each side. The outside dimensions of the link are $4'' \times 1\frac{3}{4}''$ and the stock is $\frac{3}{8}''$ round. We take all measurements along a center line, indicated by the broken line in Fig. 1. This line has a radius of $\frac{11}{16}''$ at the two ends and a length of $2\frac{1}{4}''$ along each of the two straight sides. The two semicircles make a complete circle with a diameter

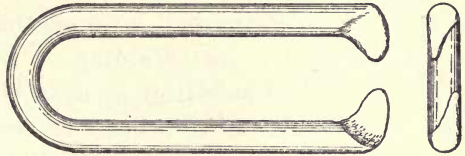

FIG. 181.—ENDS OF LINK SCARFED.

of $1\frac{3}{8}''$, and as the circumference of a circle equals 3.1416 times the diameter, the circumference of this circle along the middle line equals $4\frac{5}{16}''$. The length of the two sides equals 2 times $2\frac{1}{4}''$, or $4\frac{1}{2}''$. The total length is $8\frac{13}{16}''$. The length of stock required when we make allowance for welding is $10''$.

2. **Bending.**—The operation of bending is very simple. It has been explained in the lesson on the Staple.

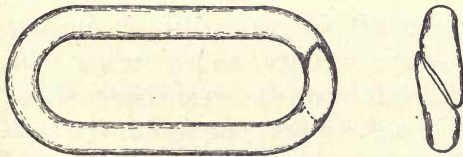

FIG. 182.—SCARFED ENDS OF LINK READY FOR WELDING.

3. **Scarfig.**—Scarfig the ends of the link to be welded consists of flattening out the ends with the ball peen of

the hammer or over the edge of the anvil so that when bent around, the ends will overlap for the weld.

Fig. 181 shows the two ends scarfed ready to be bent together, and Fig. 182 shows them overlapped.

Figure 183 shows the method of holding the link over the edge of the anvil in scarfing. Hammer the end at *a* down until it looks like the ends in Fig. 181, then reverse and scarf the other end on the opposite side in the same way. Figure 184 shows how to hold the link and hammer when scarfing with the ball peen on the face of the anvil.

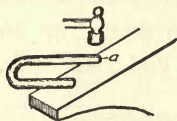

FIG. 183. — SCARFING ENDS OF LINK OVER EDGE OF ANVIL.

4. **Welding.** — In heating a piece of soft iron or mild steel, the metal gets

softer and softer until it becomes pasty and then melts; and if the heating is continued, the iron burns and becomes worthless. There is a point of temperature at which if two pieces are placed together, they will stick, or be welded so that they cannot be pulled apart when cold. *First*, then, it is necessary to heat the iron to a proper temperature, a welding heat. *Second*, it is necessary to force the pieces of iron together by hammering. *Third*, it is necessary to hammer the joint to the proper shape.

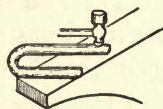

FIG. 184. — SCARFING ENDS OF LINK WITH BALL PEEN HAMMER.

If the iron is heated too rapidly, the surface comes to a welding heat before the interior, and a strong joint is impossible. If the iron is burned, a weld is impossible. If the iron is heated in a dirty fire, one full of slag and cinders, the particles of slag get into the weld and prevent a strong joint. If the edges of the scarf are too thin, they will cool so quickly as to get below the welding heat before the union can be made, and a weld will not be complete. If the scarfs have not been lapped far enough, the welded joint will be smaller than the

rest of the iron, and consequently the weakest part of the link. In view of these facts it is necessary to have the following :

(1) A clean fire of coke. Clean out all the cinders and pile the coke into a mound over the tuyère. Turn on the blast and place the ends of the link in the middle of the fire, just above the tuyère, but not too close to the latter, or the cold blast will prevent a welding heat.

(2) The iron must be raised to the proper temperature. If two pieces of the same size are to be welded, they will heat evenly; but if the two pieces are unequal in size, the larger will heat more slowly, hence it should be placed in the fire before the other.

(3) It is necessary to heat the iron clear through to a welding heat, and not merely on the surface. You can do this better with a slow fire than with one burning fiercely.

(4) The thin edges of the scarf must be welded down first, as they will cool most rapidly. After the edges are stuck, then the rest of the iron can be welded into a good strong joint.

(5) Lap the scarfs far enough so that the welded joint will be larger than the rest of the iron, then it can be drawn down to size; but if the weld is too small, it cannot be upset except with great difficulty.

In most welds, the ends to be welded should be upset before they are scarfed so as to insure the proper size; but in the case of the link, the upsetting will be unnecessary, as the lap will provide enough extra metal to insure a good size to the joint. If the weld has not been entirely successful, reheat the iron and finish it. Remember

that no amount of hammering will weld iron that is not at the welding heat, and that quick light strokes will weld just as surely as strong heavy blows and will not reduce the size of the iron so much. When the second link has been welded, and the third is ready for welding, place the two welded links on the third before welding it. Continue this until a chain of the proper length has been made. The length will be determined by the use to which the chain is to be put when completed.

RING

1. **Measuring.**—The inside diameter of the ring is 3"; and as the iron is $\frac{3}{8}$ " round, the diameter of the middle

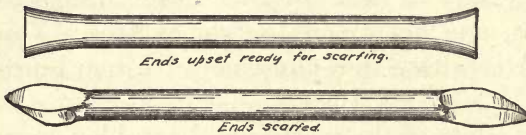

line is $3\frac{3}{8}$ ", which, when making allowance for the weld,

means a circumference of 10", the length of stock required.

2. **Scarfig.**—Upset the ends, and scarf them to a point, remembering to scarf them on opposite sides.

3, 4. **Bending and welding.**—Bend in the shape of a ring with the ends overlapping.

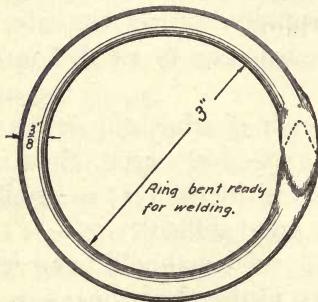

FIG. 185.—STEPS IN MAKING RING.

Before closing the ring, place the end link on the ring and weld. The process of bending and welding are the same as those given for the link.

Hook

1. **Measuring.** — The length over all is $3\frac{1}{2}''$ and the diameter of the middle line at the curve is $1''$. The point returns for a distance of $2''$. This makes a total length of $7''$ along the middle line.

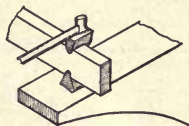

FIG. 186. — USING TOP AND BOTTOM FULLERS.

2. **Fullering.** — Fullers are used in

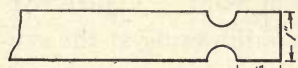

FIG. 187. — STOCK FULLERED.

rounding corners and making grooves. The top fuller is fitted with a handle, and the bottom fuller has a stem that fits into the square hardy hole in the end of the anvil. (See Fig. 186.)

Fig. 187 shows the piece when fullered to a depth of $\frac{5}{16}''$. Hammer down the end until flat and round and $\frac{3}{8}''$ thick (Figs. 188 and 189).

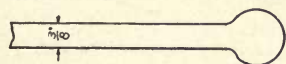

FIG. 189. — END DRAWN OUT.

Fig. 188 shows the piece when

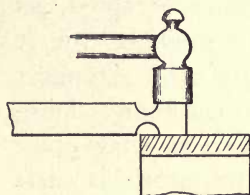

FIG. 188. — FLATTENING OUT THE FULLERED END.

Fig. 189 shows the piece when fullered to a depth of $\frac{5}{16}''$. Hammer down the end until flat and round and $\frac{3}{8}''$ thick (Figs. 188 and 189).

3. **Punching eye.** — With the punch placed in the center of the flattened head, punch one half through the hot iron (Fig. 190). Reverse the iron and punch from the other side. Drive the punch through from each side, enlarging the hole. (See Fig. 191.) The edges of the hole should be rounded on the horn of the

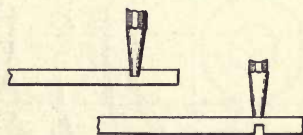

FIG. 190. — STEPS IN PUNCHING THE EYE.

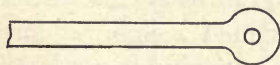

FIG. 191. — EYE PUNCHED IN END.

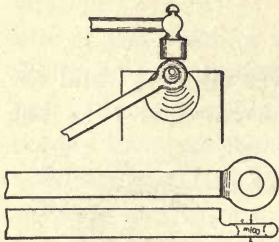

FIG. 192.—ENLARGING THE EYE OVER THE HORN.

anvil by holding it as shown in Fig. 192 and hammering around the outside edges, making a smooth round eye with the metal the same thickness all around.

4. Shaping the hook. — The hook should be shaped complete before being bent. Figure 193

shows the shape required. Begin hammering at the eye and work towards the tip. A hook has a tendency

to straighten out when strained, so to prevent this it must be strongest at the bend; therefore at that place the iron is left widest and thickest.

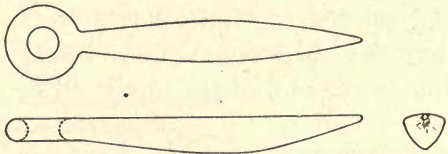

FIG. 193.—SHAPE OF HOOK BEFORE BENDING.

The end view in Fig. 193 shows the best way to taper the iron towards the back.

5. Bending the hook. — Bend the hook as in Fig. 194. Remember that the middle point of the bend must be opposite the eye of the hook.

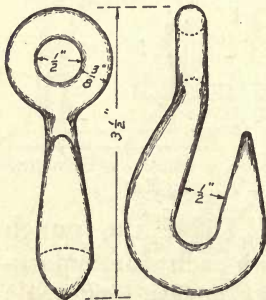

FIG. 194.—COMPLETED HOOK.

The opening in the hook should be $\frac{1}{2}$ " so as to easily accommodate the $\frac{3}{8}$ " links. This form of a hook is called a grab hook, because it will grab or hold a chain at any place, as the opening is not large enough for a link to slip through except flatways.

LESSON XXXVIII

SWIVEL

STOCK

1 pc. iron $\frac{7}{8}'' \times \frac{7}{8}'' \times 4''$

1 pc. iron $\frac{3}{8}''$ round, 6'' long

TOOLS

Hammer
Punch

Fullers
Swages

OPERATIONS

1. Fullering.
2. Drawing out.
3. Punching.
4. Swaging head.
5. Shaping ring and welding.
6. Upsetting pin in place.
7. Welding link.

1. Fullering. — The head of the swivel must be left full size; so on each side of the head, fuller down to within $\frac{1}{2}''$ of the bottom, leaving a block 1'' long, as in Fig. 196, in the middle of the bar. Fuller

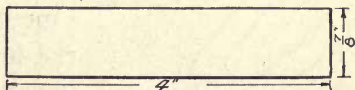

FIG. 195.—IRON FOR LINK OF SWIVEL.



FIG. 196.—IRON FULLERED.

on the top and two sides, but not on the bottom. In this first operation, use the top

fuller only, but when fullering the sides use both the top and bottom fullers.

2. **Drawing out.** — Draw out the two ends to $\frac{1}{2}$ " round; make them even the entire length, and smooth down with the top and bottom swage as in Fig. 197. A swage is a small tool with the face grooved. Most

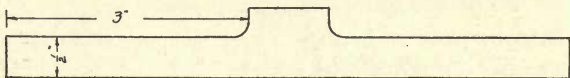

FIG. 197.—IRON DRAWN OUT.

swages have a semicircular groove, but some have angular grooves. They come in pairs and in different sizes. A top swage has a handle like a flatter and a top fuller, while the bottom swage has a stem that fits into the square hardy hole. These tools are generally used to give a finish to the work. (See Fig. 198.)

3. **Punching.** — The hole for the stem of the eye or ring can be punched with a small-sized punch and then enlarged by using larger punches. The hole must be perfectly round and straight in order that the swivel may work easily.

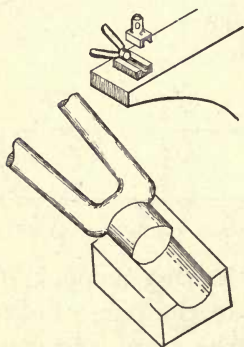

FIG. 198.—SWAGING TOOLS.

4. **Swaging the head.** — When the hole has been finished, fit into it a pin of $\frac{1}{2}$ " round iron or steel and hammer the head round, using the hammer at first, then the top and bottom swages to finish. (See Fig. 198.) This operation will be rather difficult, but by taking

pains one can make a good looking head. The pin must be kept in the hole during the operation to

prevent it from being hammered out of round and reduced in size.

5. **Shaping ring and welding.** — In shaping the ring, bend the two ends of the round piece of iron as shown in Fig. 199. Then bend

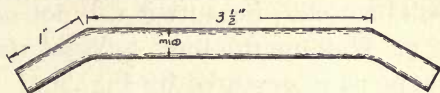

FIG. 199.—FIRST BENDS IN PIN OF SWIVEL.

the middle part into a ring over the horn of the anvil, weld the two parts of the stem together and draw down to a round stem $\frac{1}{2}''$ in diameter (Fig. 200). Use the top and bottom swages in finishing.

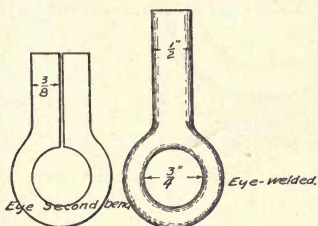

FIG. 200.—MAKING EYE IN PIN OF SWIVEL.

6. **Upsetting pin in place.** — Before upsetting the pin, bend the two arms of the link as in Fig. 201 and scarf the two ends for welding, but

leave them far enough apart so that the hammer can be used between them in upsetting the stem of the ring.

Heat the stem of the ring to almost a welding heat, and introduce it into the hole and upset, holding the tongs

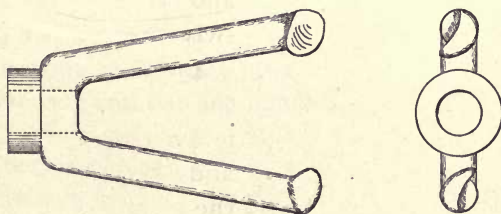

FIG. 201.—END SCARFED FOR WELDING.

against the leg for support. The upsetting should be done in one heat, as it will not do to heat the link and ring together or the head of the link will be hammered out of shape. Therefore, heat the stem to a high

temperature and work rapidly while the iron remains hot. The stem should not be upset too much or it will bind when the arms are welded together, and the swivel will be useless because it will not swivel.

7. **Welding the link.** — Weld the arms together and shape as represented by Fig. 202.

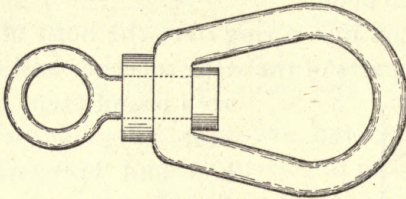

FIG. 202. — COMPLETED SWIVEL.

LESSON XXXIX

TONGS

There are a great variety of tongs used for various purposes, as bolt tongs used for holding bolts, pick-up tongs used in picking up small pieces of hot iron from the floor, tire tongs used in holding tires, etc.

STOCK

2 pcs. of iron $\frac{1}{2}'' \times 1'' \times 8\frac{1}{2}''$
1 pc. of iron $\frac{3}{8}''$ round, 2'' long

TOOLS

Hammer	Flatter
Tongs	Swages
Fuller	Punch

Sledge

OPERATIONS

1. Fullering.
2. Drawing and flattening jaws.
3. Drawing and swaging handles.
4. Grooving jaws.
5. Punching holes.
6. Riveting bolt.

1. Fullering. — Make a chalk mark $1\frac{3}{4}''$ from one end of one of the long pieces of iron, and fuller down to a depth of $\frac{1}{2}''$. The chunk of metal between the groove and end is to be drawn out for the jaw. (All operations given here are the same for the two jaws.)

$1\frac{1}{2}$ " from the groove just fullered, fuller another groove to the same depth, but on the opposite edge of the iron.

2. **Drawing and flattening jaws.** — Draw down the jaws until they are $\frac{3}{8}$ " thick at *a* and $\frac{1}{4}$ " thick at the end *b*. In drawing the jaw down to this thickness it will spread out sideways, and care must be taken that

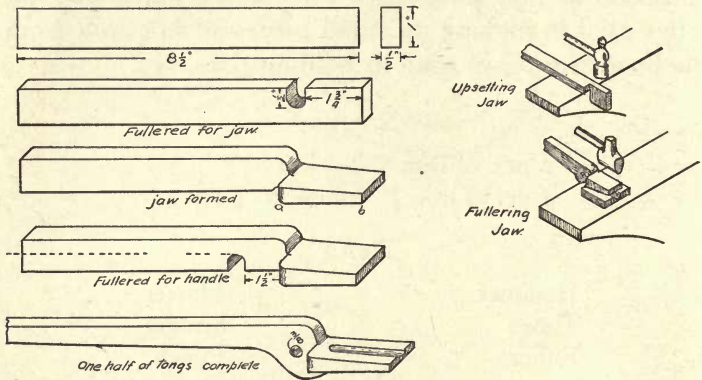

FIG. 203.—STEPS IN MAKING TONGS.

it spreads in one direction only. To secure this, lay it on the edge of the anvil and hammer the opposite edge flat and even with the side of the piece of iron. When the jaw has been drawn to the proper shape and size, shape it up smooth with the flatter or set hammer.

3. **Drawing and swaging handles.** — Draw out the handle from the fullered groove to the end, tapering from $\frac{1}{2}$ " square at the shoulder to $\frac{1}{4}$ " round at the end. This drawing will be rather heavy work for the hammer, so it will be better to have some one help by using the sledge, which is a heavy hammer with a longer handle and intended to be swung with two hands. One

must be careful in using the sledge not to strike too hard, as a heavy blow on the anvil will injure both the anvil and sledge. When the handle has been roughed out to size with the sledge, finish the work with the top and bottom swage.

4. **Grooving jaws.** — If the tongs are to be used in holding round stock, the jaws should be grooved with the top fuller and the bottom swage; but if the tongs are for flat work as well as round or square stock, they should be grooved slightly with the top fuller but not swaged. The drawing shows how to hold the jaw when grooving it for round stock. It is held in the same way for flat stock except that the jaw rests on the face of the anvil instead of on the swage.

5. **Punching holes.** — Punch a $\frac{3}{8}$ " hole in the joint, punching from both sides so as to get the sides of the hole straight and parallel. The jaws should be fitted together with the rivet in place, but not riveted, as it will probably be necessary to do some fitting and shaping before they will fit and work smoothly. If one is longer than the other, it can be upset, or the shorter one drawn out; and the joint must be very smooth and flat in order to have the tongs work well and close completely.

6. **Riveting the bolt.** — Upset one end of a piece of $\frac{3}{8}$ " round iron or steel, using a heading tool to make a rivet head; cut it off $1\frac{1}{4}$ " long and heat and drop in the hole; and then rivet the other end with the ball peen of the hammer, taking care that it is not riveted so tight that the jaws cannot be moved when the iron is cold. When a heavy pair of tongs is wanted, make the jaws out of heavy iron and the handles out of lighter stock so as to make the work of drawing down easier.

LESSON XL

WRENCH

STOCK

1 pc. iron $1\frac{1}{2}'' \times \frac{5}{8}'' \times 5''$

1 pc. iron $1\frac{1}{4}'' \times \frac{1}{2}'' \times 4''$

TOOLS

Hammer

Tongs

Punch

Hot chisel

Fullers

Flatter

OPERATIONS

1. Fullering.
2. Punching.
3. Shaping jaws.
4. Welding and shaping handle.

1. **Fullering.** — Instead of making this wrench from one bar, two pieces of different sizes are used so as to reduce the labor of drawing down so much stock for the smaller end of the wrench. Two inches from one end of the larger iron, fuller down each edge, and round this end up approximately circular.

2. **Punching.** — Punch a $\frac{1}{2}''$ hole in the center, and with a hot chisel cut a piece out of the end along the dotted lines (Fig. 204). A hot chisel is made for cutting hot iron, while a cold chisel is made for cutting cold iron. The hot chisel is tempered the same as the cold

chisel, but the blade is slimmer and the edge is not so blunt. The hot iron soon takes the temper out of it, so it must frequently be retempered. One should never be used for the other.

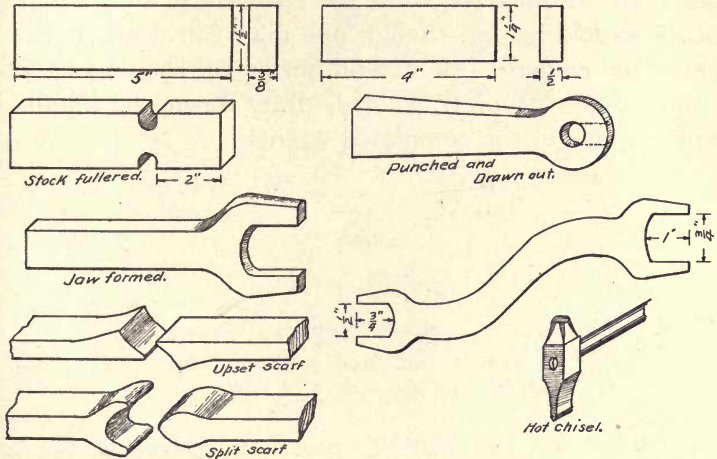

FIG. 204.—STEPS IN MAKING A WRENCH.

3. **Shaping the jaws.**—The jaws are shaped up over the horn of the anvil, and keeping in mind that the greatest strain will come at the shoulders, they should be kept as thick as possible at these points. Be sure that the inside edges are kept parallel, and that the end of the opening curves slightly so as to accommodate hexagonal nuts and heads.

The smaller end of the wrench is worked up the same way. Make the openings $\frac{3}{4}$ " and $\frac{1}{2}$ ".

4. **Welding and shaping handle.**—When the jaws are completed, the two pieces can be welded and the handle shaped. As the ends must be upset, two methods are given, either of which will make a strong

joint if properly done. In the ordinary lap weld, the ends are scarfed and then lapped and welded. In the split weld, one end is split and the other upset to fit into the split. One advantage of the split weld is that one man can make it, while the lap weld is more easily made with a helper, though one man can do it, if experienced enough. Be careful not to get the edges too thin. When properly welded, draw down the handle to the shape of the completed wrench.

LESSON XLI

HARNESS HOOK

STOCK

1 pc. iron $2'' \times 1\frac{1}{2}'' \times \frac{3}{8}''$

1 pc. iron $\frac{3}{4}''$ diameter, 6'' long

TOOLS

Hammer

Drill or punch

Tongs

Flatter

Swage

OPERATIONS

1. Drawing out hook.
2. Scarfing plate and hook.
3. Welding and punching holes.

1. **Drawing out hook.** — Draw out the iron for the hook in a straight piece, working from the large end toward the small end. If you were to reverse the direction, the small end would get so hot on account of its smaller size that it would burn before the larger part was hot enough to work.

Draw the piece approximately round the entire distance, and when straight and smooth, finish with the swages. As the sectional views in Fig. 205 indicate, the hook is not round the entire distance, but elliptical for a part of the way; so, with the flatter, flatten out slightly until it is of the dimensions given in the drawing. The tip should be upset slightly and rounded off into the form of a ball so as to prevent any cutting or scratching of the harness.

2. Scarfing the plate and hook. — The large end of the hook is upset and scarfed as for a lap weld. The plate is scarfed by hammering a depression in the surface along one side with the ball peen of the hammer. This will force some of the metal to bulge out beyond the edge. Do not let it get too thin. This is a difficult weld to make properly.

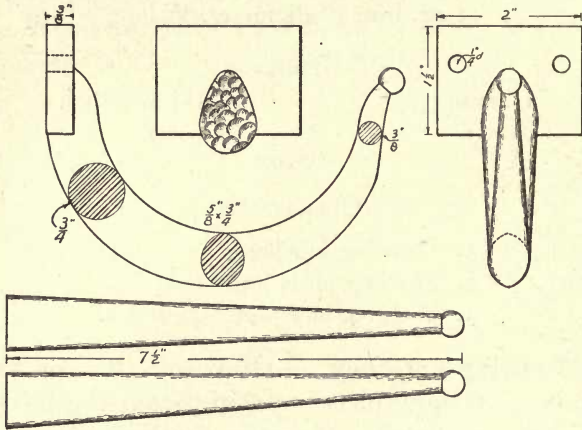

FIG. 205. — STEPS IN MAKING A HARNESS HOOK.

3. Welding and punching holes. — The two pieces cannot be held together and welded very easily by one man, so a helper will be needed. Heat both pieces to the welding heat, and place together quickly on the anvil.

Hammer down the tip of the hook first and then reverse and hammer down the scarf on the plate; afterwards weld the body together. It may take two heats for this weld. Unless it is a complete success, the hook will not be strong enough to hold any weight, as most of the strain comes on the weld. Drill or punch two holes for the screws, and bend up the hook to the proper shape.

LESSON XLII

IRONS FOR WAGON JACK

1. Take two pieces of iron of the dimensions given in Fig. 206, and lay off a distance of 4'' on each.

2. Bend at this point as shown in the drawing. (It is not necessary to have a square corner.)

3. On the shorter piece lay off a distance of $\frac{1}{2}$ '' from the corner. Heat and bend back at right angles, making the piece parallel with the longer piece.

4. Heat end *a* and lay it on the block of soft iron found between the horn and the face of the anvil. With a hot chisel and sledge, cut around an arc of a circle.

5. Punch or drill screw holes and hole for pin.

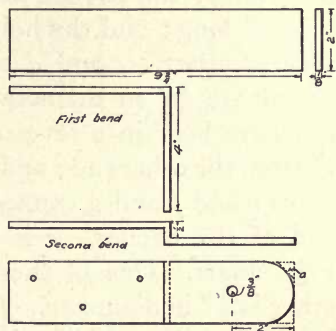

FIG. 206.—IRONS FOR WAGON JACK.

LESSON XLIII

IRONS FOR THREE-HORSE EVENER

1. The irons for the three-horse evener are $\frac{1}{4}$ " thick and 2" wide. Each of the four that connect the singletrees to the doubletree is represented by *a*, Fig. 207. They are 8" long. The holes, which are $\frac{1}{2}$ " in diameter, are 6" apart. The irons connecting the doubletree to one end of the evener are represented by *b*, *c*, and *d*. *b* is 9" long; and the holes, which are $\frac{3}{4}$ " in diameter, are $6\frac{1}{2}$ " apart. *c* and *d* are $11\frac{1}{2}$ " long; and the holes, which are $\frac{3}{4}$ " in diameter, are 9" apart. These two irons are bent in a reverse curve 4" from one end and 3" from the other end; and the amount of the offset is 2". Irons *e* and *f* and *g* connect one singletree to the other end of the evener. *e* is 15" long; and the holes are $12\frac{1}{2}$ " apart. One of them is $\frac{3}{4}$ " in diameter and the other is $\frac{1}{2}$ " in diameter. *f* is $11\frac{3}{8}$ " long; and the holes, both of which are $\frac{1}{2}$ " in diameter, are $9\frac{3}{8}$ " apart. This iron is bent in a reverse curve 2" from one end and 4" from the other end; and the offset is 2". *g* is $12\frac{1}{4}$ " long; and the holes, one of which is $\frac{3}{4}$ " in diameter and the other $\frac{1}{2}$ " in diameter, are $9\frac{3}{4}$ " apart. This is bent in a reverse curve $5\frac{1}{2}$ " from one end and $1\frac{3}{4}$ " from the other end; and offset is 2".

Make the following bolts and rivet: 3 bolts $\frac{3}{4}$ " \times 4" with a small hole $3\frac{1}{4}$ " from the head, for a cotter pin; 5 bolts $\frac{1}{2}$ " \times 3" with a small hole $2\frac{1}{4}$ " from the head, for a cotter pin; 1 rivet $\frac{1}{2}$ " \times 1" to rivet together pieces *e*, *f*, and *g*.

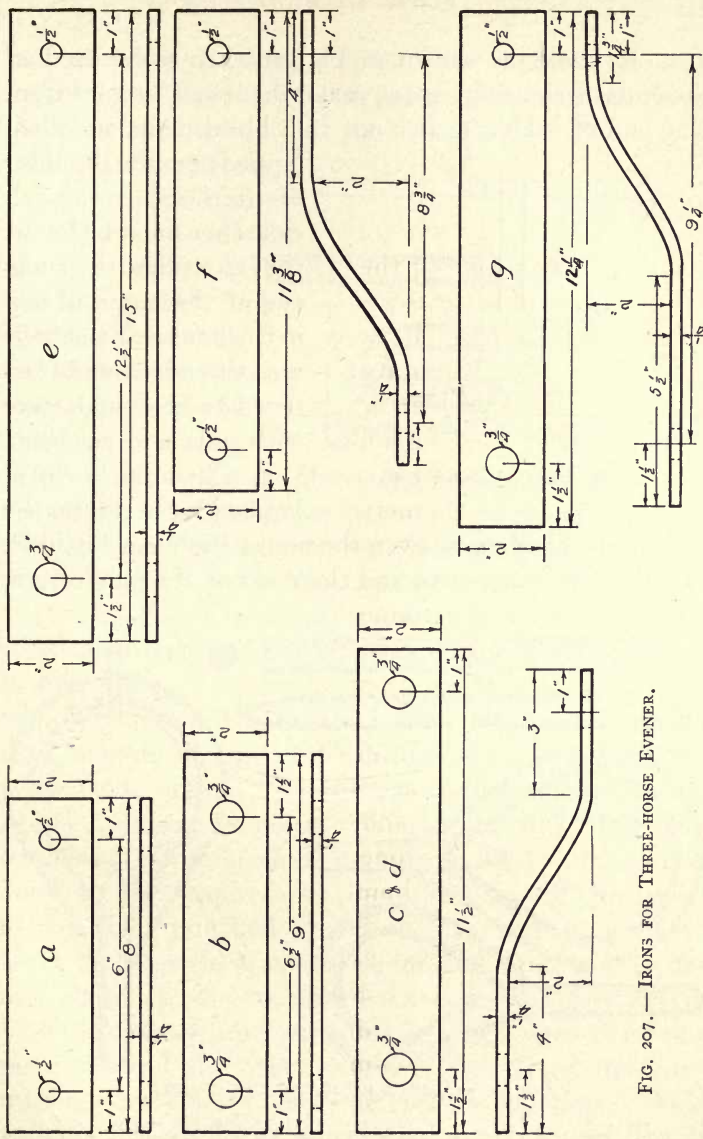

FIG. 207.—IRONS FOR THREE-HORSE EVENER.

2. If hooks as shown in Fig. 208 are to be used at the ends of the singletrees, make them of $\frac{1}{2}$ " round iron. One end of each is drawn out to a blunt point and then

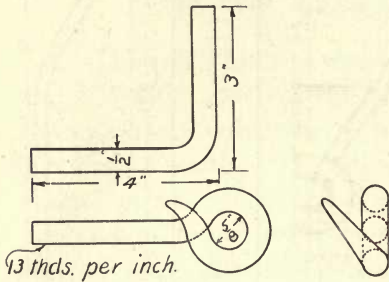

FIG. 208.—SINGLETREE HOOKS.

lapped over the shoulder of the hook. Enough clearance must be left at the lap so that the cock-eye of the tug will slip in the hook. The hooks are threaded and fastened to the singletrees with nuts and washers.

3. Clips as shown in Fig. 209 are better for the ends of the singletrees than the hooks shown in Fig. 208. For the flat rings covering the ends of the singletrees,

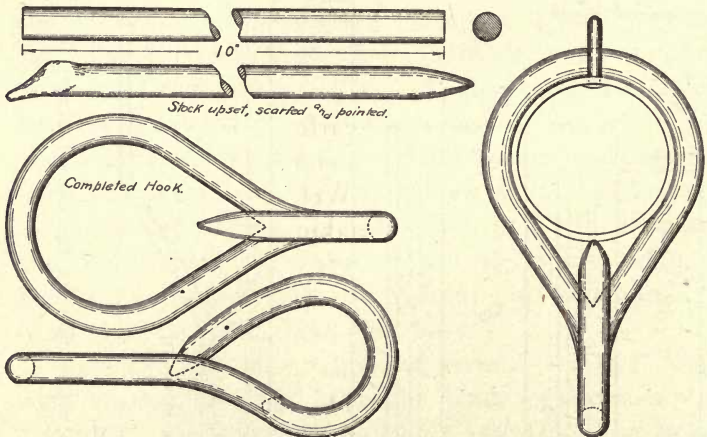

FIG. 209.—CLIPS FOR ENDS OF SINGLETREES.

it will be necessary to measure carefully the circum-

ference of the ends and calculate the amount of stock necessary to make a good fit, after allowance has been made for the split weld. The iron for this flat ring should be about 1" wide and $\frac{1}{8}$ " thick. It will be necessary to rivet into the middle of this piece a

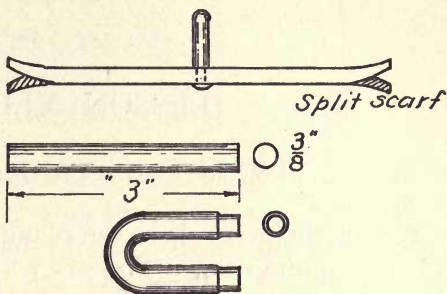

FIG. 210. — IRONS FOR RING AND STAPLE OF CLIP.

staple to keep the hook on the ring. When it is riveted in place, the hook must be inside the staple. Punch two holes 1" apart and in the middle of the length, then lay aside until the other two pieces are prepared. (Fig. 210.)

4. The staple is simply tapered at each end down to $\frac{1}{4}$ " diameter, but not to a point, and bent as shown in Fig. 210.

5. The round iron for the hook is $\frac{3}{8}$ " in diameter and is tapered at one end and scarfed at the other end for a lap weld. Bend the large end until it meets the iron again 3" from the point. Weld it at this place and bend the point around, making a hook. Place this hook in the staple, and rivet the ends of the staple in the holes punched for them. It will be well to make a split weld of the piece for the ring, as it is flat and thin. To do so, split each end for a distance of $\frac{1}{2}$ " and hammer down to a blunt edge; then bend one piece up and the other down. Then form the strip into a ring and fit the split scarfs together. Weld and finish smooth and round.

LESSON XLIV

IRONS FOR PLANK DRAG

1. For the eye bolt in the plank drag you will need 9'' of $\frac{1}{2}$ '' round iron. (Fig. 211.)
2. Scarf one end for a lap weld.

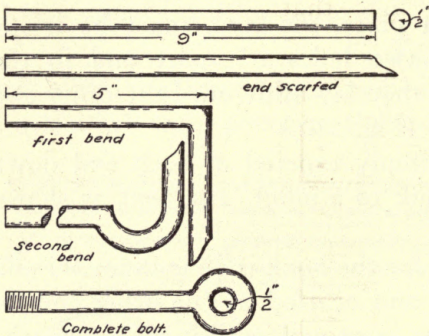

FIG. 211.-- BOLT FOR PLANK DRAG.

3. Five inches from the other end bend the rod at right angles, taking care that the scarf is on the outside so that when it is bent around it will fit on the rod.

4. Weld the eye and cut a thread on the other end

to which you can fit a nut. The chain can be attached to the eye with a split link or a clevis. The making of the chain and ring has already been described.

LESSON XLV

IRONS FOR COMBINATION LADDER

1. Each of the two side pieces that hold the ladder support is cut out of thin iron along the dotted lines shown in Fig. 212, and a hole is drilled for the bolt 1" from the round end *a*. The other holes are for the screws and should be countersunk. The end *b* should be cut at the same angle that the steps are placed with the stringers.

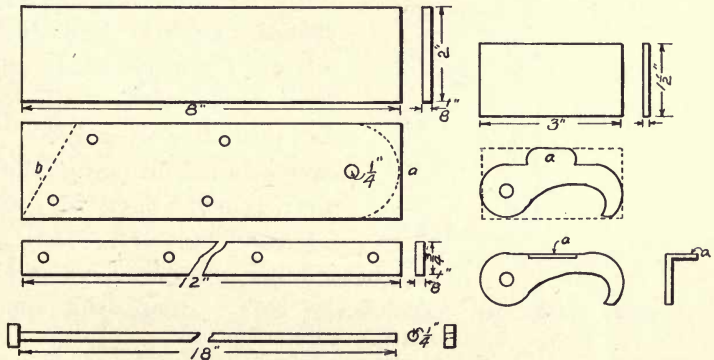

FIG. 212. — IRONS FOR COMBINATION LADDER.

2. Each of the narrow straps is drilled for screws and is fitted around the end of the support above the slot to strengthen it.

3. The iron hooks are laid out upon the plates with a soft pencil, and are then cut with a cold chisel on a cast-iron plate or on the soft spot of the anvil.

The whole should be filed up smooth. The lip *a* should be bent down at right angles, to the right on one hook and to the left on the other, to serve as a lift for the fingers when raising the hook from the rung of the ladder. It is quite necessary that these hooks fit nicely, so it will be well to try them before finally fitting them permanently in place.

4. The long bolt is made from $\frac{1}{4}$ " round iron, and should be long enough to connect the two broad iron straps.

LESSON XLVI

IRON FOR LEVELING ROD

1. A piece of strap iron or heavy soft brass, Fig. 213, can be used for this slide. It is laid out with a pencil; and a line $1\frac{1}{2}$ " from each end is drawn across the piece, leaving 2" in the middle. Two other lines $\frac{1}{2}$ " from each end complete the laying out. The two ends are bent down at right angles. At the lines $\frac{1}{2}$ " from each end the iron is bent out again. The screw holes are then drilled.

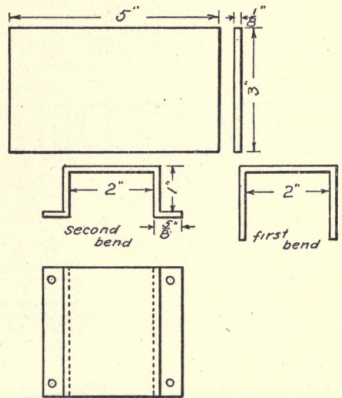

FIG. 213. — IRON FOR LEVELING ROD.

LESSON XLVII

IRONS FOR FARM GATE

1. For each hinge of the farm gate three pieces of iron are needed. The dimensions of each piece are given in Fig. 214. Bend the end of each flat piece around, making a lap weld so as to leave a $\frac{1}{2}$ " hole at

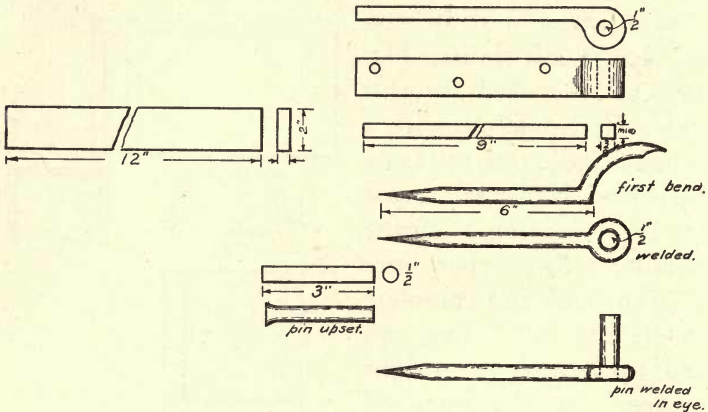

FIG. 214.—HINGE FOR FARM GATE.

the end. It will be well to run a $\frac{1}{2}$ " drill through this hole to smooth it out. Drill and countersink the screw holes.

2. Draw out one end of the spike to a sharp round point; scarf the other end, and weld into an eye with a $\frac{1}{2}$ " hole in the eye.

3. The pin is upset at one end, and placed in the eye of the spike and welded there.

LESSON XLVIII

IRONS FOR CATTLE RACK AND CORN RACK

No dimensions can be given for the irons for the corn rack, as they will depend upon the kind of wagon used.

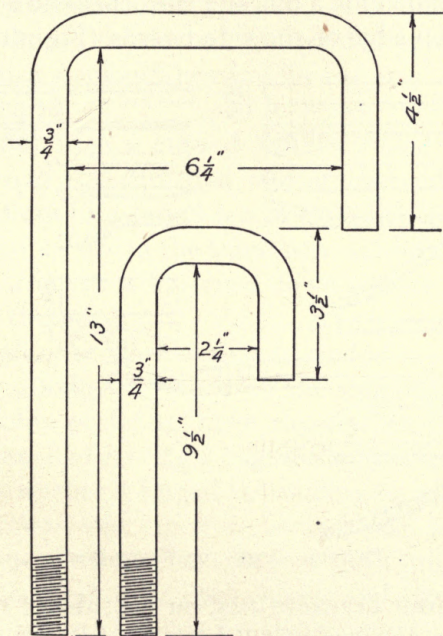

FIG. 215. — HOOKS FOR STANCHION OF CATTLE RACK. (Two of each size.)

The irons for the stanchion of the cattle rack are shown in Fig. 215.

LESSON XLIX

IRONS FOR WAGON BOX

1. Each of the 8 strips used to fasten the crosspieces on to the side boards, is rounded at one end for a distance of 3''; and is made $\frac{3}{8}$ '' in diameter. This rounded end is threaded for a nut and the other end is bent to fit over the top edge of the side boards (Fig. 216).

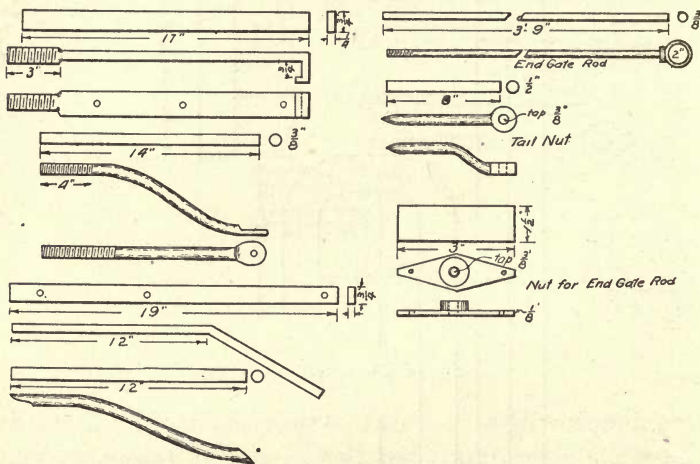

FIG. 216.—IRONS FOR WAGON BOX.

2. The four brackets used on the sides of the box are made from $\frac{3}{8}$ '' round iron bent in the shape shown in the drawing. The lower end of each is threaded for a distance of 4'' and the upper end flattened out and a bolt hole punched.

3. The two strips that hold up the foot rest in front are made of the same material as the strips for the sides. Seven inches from one end they are bent in the shape indicated. Both ends are flattened and bolt holes punched in them.

4. The two brackets for the foot rest are made of $\frac{3}{8}$ " round iron 12" long, bent in the shape shown in Fig. 216, flattened at the ends, and punched for the bolts.

5. The end gate rods are bent at one end into an eye 2" in diameter, and welded. A round button of $\frac{3}{8}$ " iron is slipped on the rod and welded up close to the eye to furnish a smooth bearing for the eye. The other end is threaded.

6. The nut with a curved handle, called a tail nut, is made to fit the threaded end of the end gate rod. It is forged out of a round bar of iron, the end of which is made into an eye in the same way as the spike of the gate hinge, the eye is flattened down smooth and a hole bored and threaded.

7. The plate or washer that is made for each end of the end gate rod, is fastened on the side boards by two screws. Some prefer to have the washer threaded at one end instead of having a tail nut, which is frequently lost. This washer is forged by welding on to its middle a piece of round iron cut from an inch bar, and drilling it the required size. The plate is then cut diamond-shaped with the hot or cold chisel; and the two holes are then bored in the ends for the screws.

LESSON L

TOOL STEEL

Wrought iron contains practically no carbon and cannot be used for tools because it cannot be hardened. Tool steel contains a small percentage of carbon and can be hardened and tempered; therefore it can be used in tool making. The amount of carbon in tool steel determines the degree of hardness it will attain when hardened. High carbon steel, or high temper steel, has a large percentage of carbon; and low carbon, or low temper steel, has a small percentage of carbon.

Low carbon steel can be welded, but with more difficulty than wrought iron. The more carbon steel contains, the more difficult it is to weld.

Tool steel must be treated differently from wrought iron in forging. It must not be heated so high or it will burn and crumble under the hammer. Heat to a red heat for all forging, and do not hammer cold.

Tempering. — Tempering tool steel consists of two processes: (1) hardening, and (2) drawing the temper. Heat a piece to a cherry red and dip it in water. The steel is now as hard as it can be made and a file will not cut it. It is also very brittle, and a blow of the hammer will shatter it; consequently, it is of little value for tools that have to be driven with the hammer or sledge. If the piece is slowly and carefully reheated, the hardness will gradually disappear, and if heated

long enough, it will be as soft as it was before hardening. In order to temper steel properly, it should be hardened "right out" and then the temper drawn until it is of the proper hardness and toughness for the work expected of it. Heat to a cherry red; and plunge the end in water for a short distance, leaving a portion above still hot. The heat from above will gradually soak down into the hardened point, softening it, and if the point is smooth and bright, different colors will appear on the bright surface. In order to get a bright surface on which the colors may be easily detected, after hardening, rub the surface with a piece of broken grindstone, emery wheel, smooth file, or sandpaper.

The first color to appear will be a pale yellow, or straw color, to be followed in order by dark straw color, brown, light purple, dark purple, pale blue, and finally dark blue. As soon as the proper color appears, the piece should be plunged all over in the water. Tools requiring steel of great hardness should be tempered to a straw color; tools of soft steel should be tempered at the dark blue color.

Punch. — Using a piece of round or octagon steel, forge it down to the shape of the punch shown in Fig. 217 and do not heat above a cherry red in forging. When hammered to shape, grind or file smooth and round. Then heat the tapered end to a cherry red and dip in water, holding the punch vertically. Dip to a distance of about one inch, and withdrawing, rub the surface hardened with something to brighten it; and then watch for the colors, as they will appear when the heat from above soaks down to the hardened part. When the purple color gets down to the point, plunge

in water all over. Test with a file, and if it is too soft, reheat and harden and temper over again. Unless you know just the amount of carbon in the steel, it will be necessary to experiment a little with different degrees

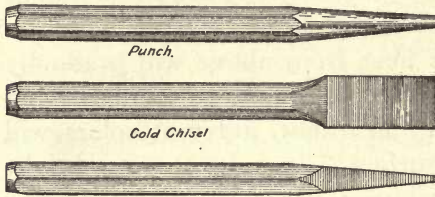

FIG. 217.—PUNCH AND COLD CHISEL.

of heat in hardening and tempering, until you can produce the desired results.

Cold chisel.— Forge a cold chisel like that shown in

Fig. 217, and harden and temper in the same way as the punch. Use the flatter in smoothing up the sides of the taper.

In grinding tools, take care not to heat them enough to draw the temper, or you will get them too soft.

Casehardening.— Casehardening is preparing wrought iron or steel of low carbon so that there is a coating of high carbon steel on the surface, while the interior remains soft and tough.

The thickness of this coating is determined by the length of time the process is carried on. It is similar to the old cementation process of making steel, which consisted in heating the iron in a box filled with chips of leather, horn, or charcoal, until the carbon had soaked into the iron, transforming it into steel. It will not be necessary to follow this method, for we do not need a very thick coating of carbon on the pieces that are usually casehardened. If the piece is heated red hot and plunged in a box of powdered cyanide of potassium, the carbon from this chemical will soak into

the iron for a distance depending on the length of time it is left there. When the piece is suddenly cooled by quenching in water, the surface is as hard as though it were tool steel all through. If a wearing surface is casehardened, it lasts longer and wears smoother. Ends of set screws and the faces of small hammers are casehardened, and sometimes bolts, when there is to be considerable wear on them. Cyanide of potassium is a very powerful poison, and if there are any sores or cuts on the hands, it will be well to wear gloves while using the cyanide, as very dangerous cases of poisoning have resulted from carelessness in its use.

CEMENT AND CONCRETE WORK

LESSON LI

CEMENT AND CONCRETE

Portland cement is made from clay and limestone pulverized and burned at a high temperature; the mass is then pulverized a second time and sifted, whereupon it is ready for use.

Natural cement is made from limestone that has about the same composition as the artificial cement. The process of manufacture is much the same as that by which Portland cement is made.

Concrete. — In making concrete for any purpose, sand and gravel or crushed rock are mixed with cement and water. The sand and gravel are used simply to fill up space and thus make it unnecessary to use so much cement, as the latter is very expensive. The cement binds the particles of sand and gravel together, making artificial stone. The sand should be clean and coarse. Experiments show that rounded grains of sand give as good results as sharp sand, and that as small a percentage of dirt as 5 per cent is objectionable. Sand of a varying degree of coarseness is better than that of uniform coarseness. The proper size of the crushed rock or gravel depends upon the use to be made of the concrete. Plain concrete can be made of coarser gravel than reënforced concrete.

A sieve with a 1" mesh for plain concrete and one with a $\frac{3}{4}$ " mesh for reënforced concrete has been found satisfactory. Gravel of varied sizes has been found better than that of uniform size.

Proportions. — The proportions of the various ingredients depend upon the use required.

A rich mixture used in water tanks, arches, and reënforced concrete floors subject to vibration, is made in the proportion of 1 : 2 : 4; that is, 1 part cement, 2 parts sand, and 4 parts gravel or rock; or 1 part cement and 4 parts sand. This is probably the best concrete used for any purpose.

An ordinary mixture of 1 : 3 : 6 can be used for cellar and barn floors, sidewalks, foundations, and abutments.

A lean mixture, 1 : 4 : 8, may be used in large heavy foundations for stationary loads, or for backing for masonry; richer mixtures are necessary for loaded columns, beams, arches, and foundations laid under water.

Mixing concrete. — Concrete can be mixed either by hand or by machinery. Whatever method is used in mixing the concrete, the following points must be looked after : (1) the exact amount of cement, sand, and stone must be measured out; (2) the mass must be thoroughly mixed; (3) the proper amount of water must be used; (4) the concrete must be thoroughly rammed.

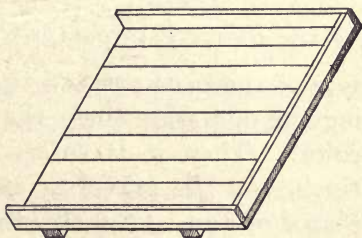

FIG. 218.—PLATFORM FOR MIXING CONCRETE.

Hand mixing. — A suitable platform may be con-

constructed of 1" planed boards, nailed to cleats or cross-pieces of 2" × 4". The size of this platform is determined by the amount of work to be done. One 10' × 12' will be large enough for all ordinary purposes, and one considerably smaller will do for small jobs and repair work.

The platform should be placed as near the work as possible and in such a position that the sand and gravel can be unloaded near it. It is well to nail a strip around the edges of the platform to prevent the cement from spilling.

A measuring box can be made of rough inch boards of a size that can be handled conveniently. It should

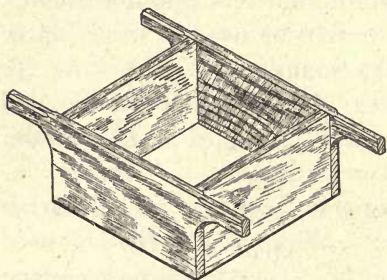

FIG. 210. — MEASURING BOX FOR CONCRETE.

be made with projecting handles and without bottom and top. The cement is measured and spread out on the platform with a rake, and the sand measured over it. The mass is thoroughly mixed by shoveling it over to one

side of the platform and then back again, and repeating the operation until the mixture shows a uniform color. Then it is spread out in a layer about 6" thick, and the gravel or crushed stone measured and placed on top. Over this the required amount of water is poured, and mixed thoroughly by shoveling the mass over two or three times.

A wet concrete is a mixture containing enough water to make the mass flow. This is simply poured into the

molds and allowed to harden. When the molds are complex or reënforcing rods are laid near the surface, the wet mixture is necessary to fill the mold properly.

A dry mixture is one which will not flow, and requires ramming in order to fill the mold properly. A dry mixture will just show water on the surface when properly rammed.

Ramming is unnecessary in wet mixtures; but in ordinary mixtures it is advisable and necessary to a strong piece of work. A ram can be made of a piece of 2" \times 4" timber nailed to a handle. For dry mixtures a larger ram made of iron should be used, and the concrete should be rammed until the water shows on the surface.

Spading. — The ramming will have the effect of forcing some of the stones against the surface of the molds, which, if allowed to remain there, would make an unsightly appearance. To overcome this, run a flat spade down between the forms and the concrete, pushing the stones back from the surface, and allowing the cement to flow into the space thus formed. Do not pry the concrete enough to spring the forms out of shape.

Bonding. — New cement can be bonded to old concrete so as to make water-tight joints if great care is taken in washing the joints with liquid cement made of equal parts of cement and sand. In construction work when all the concrete is not laid the same day, it is well to make a joint on top of the last concrete. Lay

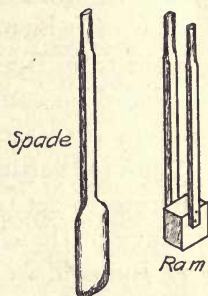

FIG. 220. — SPADE AND RAM FOR CONCRETE WORK.

a piece of timber 2" \times 4" or of any suitable dimensions in the top layer of concrete. Take it out before laying the new concrete, wash the joint thoroughly, and cover with rich cement, 1 : 1.

Freezing. — Sometimes the smooth surface of concrete will peel off, due to freezing, but otherwise it does not seem to be affected by freezing. In very cold weather the materials used in making concrete should be warmed to prevent freezing before setting. The addition of a small quantity of salt to the water used lowers the freezing point. About one pound of salt to a sack of cement will do no harm and may keep the cement from freezing until it has set. No load should be placed on concrete until the weather is warm enough to allow it to set properly.

Time for setting. — It takes from 12 to 48 hours for concrete to set, depending upon the weather, the consistency of the concrete, and the thickness of the work. Wet and cold weather will retard the setting of the concrete: Arch work requires a longer time for setting than walls. Dry concrete sets much more quickly than wet concrete.

Forms. — The lumber for concrete forms makes quite an item of expense, and therefore one should devise ways of getting results with the minimum amount of lumber. Green lumber is better than kiln-dried lumber, because the latter soaks up too much of the water from the concrete, and swells and warps too much. If the lumber is smooth on the inside of the forms, it produces better looking work; however, rough lumber may be used in most form work, and afterwards it may be used in framing buildings or for repair work.

Forms should be kept from the sun when not in use, and the insides should be coated with oil or soft soap just before using. Forms should be designed so that they can be taken apart and used again for the same work; and should be so well made that the water and cement cannot leak out through the joints.



Tongue and groove boards.



Beveled boards.

FIG. 221.—LUMBER FOR CONCRETE FORMS.

Tongued and grooved lumber makes the best forms, but beveled or even squared lumber will do, if well matched.

The thickness of the lumber used depends upon the distance between the studs, and the height of the green concrete. For ordinary work done on the farm, one-inch lumber reinforced by $2'' \times 4''$ studs every two feet has proved satisfactory. The forms should be so rigid that there is no bulging of the sides.

LESSON LII

SIDEWALKS AND FLOORS

Sidewalks. — The climate and the character of the soil very largely determine the method of laying the foundations for sidewalks. It is important to have a good foundation, for one that is poorly laid will cause the ruin of the best walk. It should be laid so as not to hold water, which, by freezing, might bulge and crack the cement; therefore, a porous soil will not require so thick a foundation as an impervious one. Likewise, in a mild climate, foundations need not be so thick as in a severe one. As a rule, foundations should be laid from 4" to 10" thick.

Suppose we wish to build a sidewalk consisting of a 4" layer of concrete resting upon a 6" foundation, with the surface of the walk 2" above the level of the ground. Excavate to a depth of 8". Fill in 6" of crushed rock, gravel, or cinders, tamping it thoroughly as it is being filled. Do not postpone the tamping until all the filling is done, but level off each load and tamp the successive layers so that the entire foundation may be firm, but porous. It is a good plan to wet down the foundation as it is being tamped, for in this way it can be made more compact.

The excavation should extend three or four inches on each side of the walk to allow for drainage. Place $2'' \times 4''$ stringers on each side on top of the foundation. These stringers must be perfectly straight, and the inside surfaces should be smooth.

Drive stakes down outside the stringers to hold them in place.

The proportion usually required for sidewalks is 1 : 2 : 4. Mix with sufficient water to make the concrete moderately wet, and tamp until water appears on the

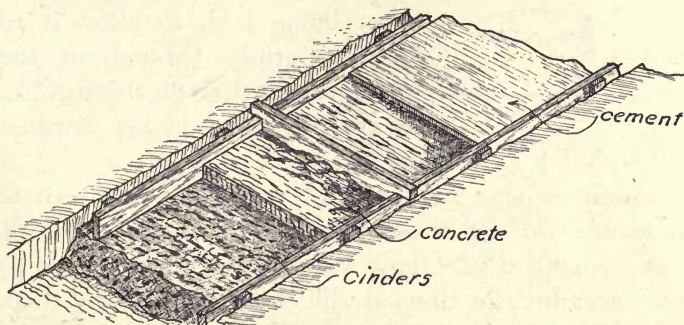
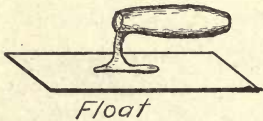
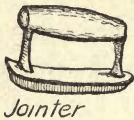

FIG. 222.—A CONCRETE SIDEWALK.

surface. The finishing coat is made of 1 : 1 mixture, which is spread on about $1''$ thick. A strong bond between the finishing coat and the concrete must be made or the cement will in time chip and peel off. To prevent this, coat the surface with pure cement before making the bond. It is sometimes spread on the concrete before the latter has set. The finishing coat is leveled off by drawing a straightedge over the edges of the stringers. After straightening out the surface, smooth with a float and groove with a jointer.

It is desirable to make a slight slope to the outside of the walk to drain off the water. The grooves are placed in the walk so that portions may be replaced or relaid without the difficulty of cutting out portions with a chisel. The jointer can be used to round the outer edges of the walk so that all four edges of the block will be rounded. If the surface of the cement is troweled too much, it will not wear well.



The walk must be kept covered and wet for two or three days after being laid, to allow it to dry uniformly throughout the mass, rather than on the surface. A good covering is wet sawdust or wet sand.

FIG. 223.—FLOAT AND JOINTER.

Sometimes the walk is laid out so that alternate blocks are laid and allowed to set; then the remaining blocks are filled in. This necessitates placing 2" \times 4" crosspieces for the alternate blocks and removing them when the remaining blocks are filled in.

Cellar floors.—These may be laid without any foundation because there is no danger of any frost getting under them.

The process of laying a floor is similar to that of laying a sidewalk, and the mixture is made in the same proportions. The size of the sections in the cellar floor may be made larger than those in a walk, and the stringers removed as soon as the cement has set.

Barn floors are laid in the same way as sidewalks, with the same kind of foundations, and with cement

of the same proportions. The surface should be left rough or grooved to prevent animals from slipping.

Expansion joints. — Concrete expands and contracts like iron, and in large areas such as barn floors it is necessary to make provision for this expansion, because of the wide range of temperature. The best method of preventing damage by expansion is to lay the floor in small sections or blocks. This produces many cracks which will take up the expansion.

LESSON LIII

FOUNDATION WALLS AND STEPS

Foundation walls.— Foundation walls for a house or a barn should be from 8" to 12" thick with a footing of from 16" to 20", according to the size and weight of

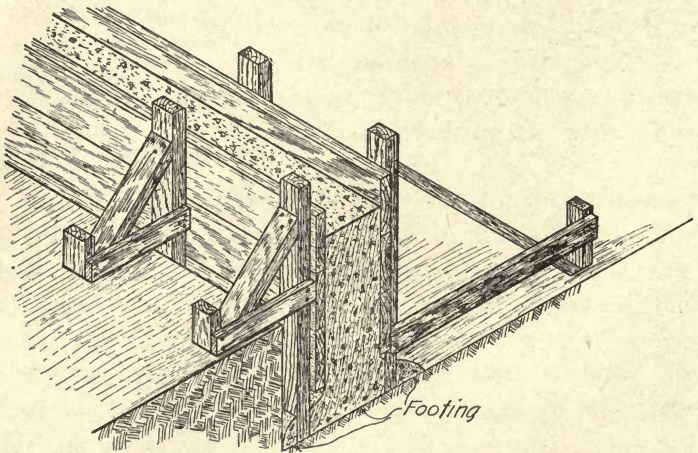

FIG. 224.— FOUNDATION WALL OF CONCRETE.

the building to be placed on them. Pieces 2" \times 4" should be driven in the ground every 2', and braced by pieces of the same dimension, as shown in the drawing. 1" boards are nailed to the inside of these pieces with the bottom board about 6" up from the bottom of the trench, allowing the concrete to flow out under it to form the footing.

If the walls are to be built up a considerable distance above the surface of the ground, the 2" × 4" pieces should extend above the last board, so that the forms that are to be placed on top can be fastened to them and so held in line. All forms should be carefully braced so as to keep them from bulging. The sides should be spaded and the concrete cast in layers and tamped carefully. Use concrete of the following proportion: 1 part cement, 2½ parts sand, 5 parts gravel or crushed stone.

Steps. — In making the steps of a porch or cellar, the riser, or vertical face, of a step should be propor-

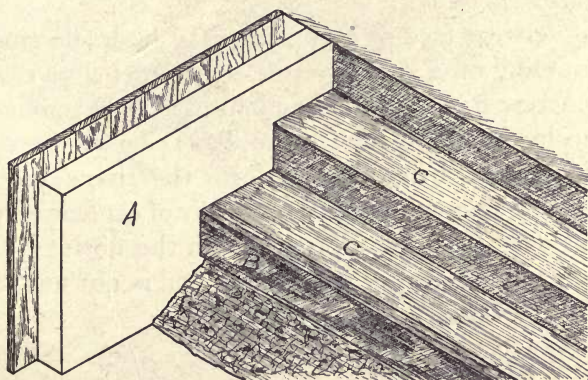

FIG. 225. — CONCRETE STEPS.

tioned to the tread, or horizontal surface, so that the sum of the two will equal 15. Therefore, a step with a 5" riser needs a 10" tread, and one with a 6" riser needs a 9" tread to make the two proportional.

In making concrete steps, the outside walls (*A*, Fig. 225) are laid either on a porous foundation that will drain water, or they are laid below the frost line.

Inside the walls gravel is packed at the same slope or angle that the steps are to be laid. Over this the concrete should be placed to a depth of four inches. In this concrete, reënforcing of woven wire should be placed. Beginning at the top, lay a plank upright and brace with stakes. The plank should be as wide as the rise of the steps. Fill the space between the board and the concrete slope with concrete to the level of the top edge of the plank and trowel off smooth. When the concrete has set, remove the plank and place it for the next step. Continue in this way until all the steps are complete. The steps should be the same width as the walk.

The vertical face of each step may be made smooth by troweling on a thin layer of rich cement, 1 : 1, after the concrete has set and the plank has been removed.

A nosing can be made for the front edge of the steps, if it is desired, by making a form the shape and size wanted and laying on a thin top layer of cement extending out over the edge of the step in the nosing. This requires a good deal of extra work and is not necessary in ordinary steps.

LESSON LIV

CONCRETE TROUGHS

Hog trough. — A concrete hog trough may be made by making a bottomless box from 4' to 6' long, 22'' wide, inside measurements, and 10'' deep. Make a V-

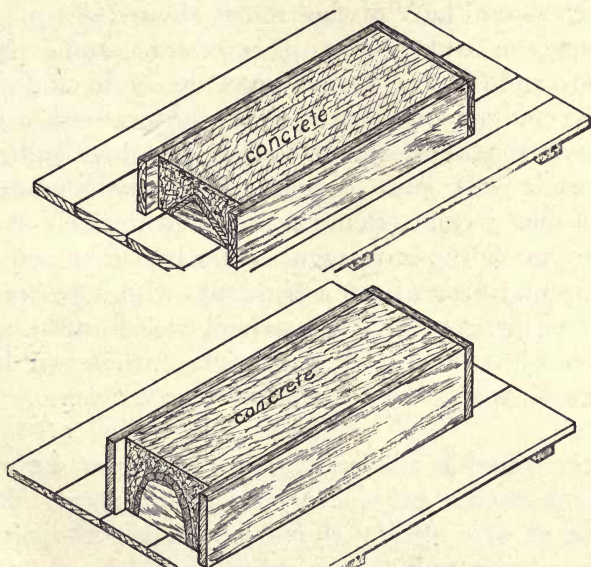

FIG. 226. — CONCRETE HOG TROUGHS. (Triangular and Semicircular Types.)

shaped trough 6'' shorter than the inside length of the box, with two boards, one of which is 13'' wide and the other 12'' wide, nailed together at right angles to each other, as shown in the upper part of Fig. 226. This

makes the two inner sides equal in width. Fit a triangular piece of 2" plank in the ends and nail in place. Bevel the edges of the two sides of the trough so that when laid upside down on a platform there will be no crack between the form and the platform. Lay the trough upside down on a platform of smooth matched boards, and place the bottomless box over it so that the two ends are equidistant from the ends of the trough, and the sides are also equidistant from the sides of the trough. The upper edges of the box should project above the V of the trough about $1\frac{1}{2}$ ".

Pour the concrete, 1 part cement and 3 parts coarse sand or fine gravel, into the mold and tamp lightly, and smooth off the upper surface with a float. Remove from the forms in four or five days and paint the inside with pure cement of creamy consistency.

If a semicircular trough is preferred to the V-shaped trough, make the form semicircular by cutting out two semicircular pieces from a 2" plank, with a $7\frac{1}{2}$ " radius. To these pieces nail narrow strips beveled on the edges, so that when they are nailed in place, there will be no cracks between the strips for the cement to leak through.

If the trough is a long one, several semicircular pieces of plank should be placed equidistant apart. Reënforcing of wire netting should be used in the casting, or several iron rods, $\frac{1}{4}$ " diameter, should be inserted in the four corners, about 1" from the surface.

Water trough. — The walls of a water trough should be at least 6" thick for those of ordinary size, and much thicker for large ones. If no reënforcing is used, make the walls twice as thick to prevent cracking.

To make it water-tight, the entire tank must be cast at one operation. A richer mixture of concrete must also be used than that used in other pieces of work, and the concrete must be quite wet.

Inlet and outlet pipes can be cast in the concrete during the pouring if desired; if not possible to cast them then, place greased plugs where they are to go, and insert the pipes afterwards.

Having decided upon the size of the trough desired, make a bottomless box of this size, having the sides slope in towards the top; that is, the top of the box should be about 2" narrower than the bottom.

For a small trough, excavate the surface of the ground down until hard firm soil is reached; and then tamp this down flat and level. For a large trough, it will be necessary to excavate about 12" and make a foundation similar to a concrete sidewalk. Lay down smooth an 8" layer of cinders or gravel and on this a 4" layer of concrete of the proportions used in building sidewalks. On the top of this foundation place the box in position and brace in place, as shown in Fig. 227. The number of braces needed will depend upon the size of the box. They should be about 2' apart. The inside of this form should be smooth and greased if you wish to remove it without breaking it up. The inside box has a bottom in it, and should be at least 12" narrower and 12" shorter than the outside box or form. This form should slant in the opposite direction from the outside form; that is, it should be narrower at the bottom than at the top so that it may be readily removed when the cement has set.

The outside of the inner form must be smooth and greased. It should be braced on the inside if the tank is over three feet long. The depth of the inner form must be 6" less than that of the outer form, so that when the two are in place with their upper edges on a level, the bottom of the inner form will be 6" from the

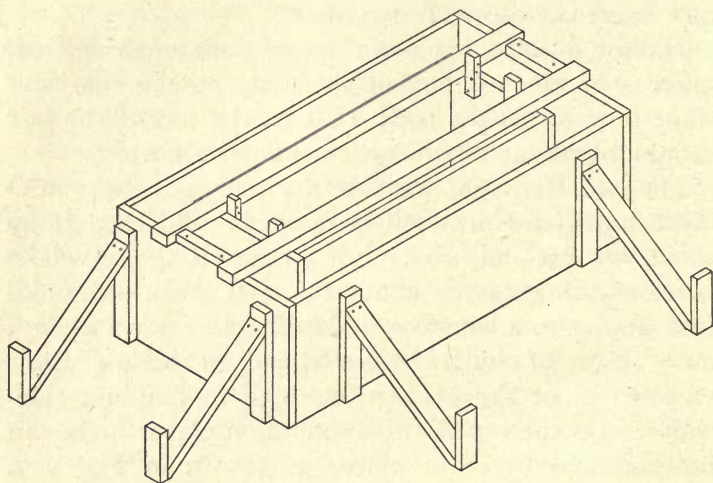

FIG. 227.—FORMS SET FOR CONCRETE WATER TROUGH.

foundation. The inner form should be supported by two pieces $2'' \times 4''$, nailed to it by strips and long enough to project over the ends of outer box. Place the forms in position so that the walls are everywhere equidistant, then nail on two cleats that are just long enough to fit in between the supports of the inner form. These cleats are for the purpose of keeping the inner form in the proper place and to prevent it from being moved by the tamping and spading of the cement.

The mixture of concrete must be rich in cement. Use 1 part cement, 1 part sand, 3 parts broken stone or gravel. If you use gravel as it comes from the bank, use 1 part cement and 3 parts gravel. Have the inner form all ready and greased before beginning the casting, and be sure to mix enough concrete for the entire trough before beginning the work. Spread concrete on the foundation, and on this lay the reënforcing of expanded metal or wire lath, bending it up on all four sides to within 2" of the top of the trough.

On top of the reënforcing, place 3" more of concrete, and then put the inner form in place and fasten the reënforcing of the sides so that it will be midway between the walls of the forms. Pour the concrete in place and spade it so that the larger stones are forced away from the surfaces. The inner form may be removed in two or three hours and the inside painted with pure cement of creamy consistency, using a brush. Do not remove the outer form for at least ten days. If the work is kept covered and wet during this time, the trough will then be ready for water. The outside may be painted with pure cement if desired. In that case, remove the outside form in two days and after wetting down the outside of the tank, paint with pure cement, using a brush.

LESSON LV

FENCE POSTS

Concrete fence posts are being used quite extensively, as they have many advantages over the wooden posts. In the first place, the concrete posts will last forever when properly reënforced; then, too, the cost is but a trifle more than for wooden posts of the best quality, if the labor is not counted in.

The posts, for ordinary purposes, should be 6'' square at the base, 4'' square at the top, and 7' long. If it is desired to place them below the frost line, for northern latitudes they should be made longer, but it is not necessary for them to be placed so deep.

The corners above the ground should be beveled, and they should be reënforced with wire or rods, hooked at the ends.

Molds. — Make a platform 8' long by 2' wide of planks or boards surfaced on one side and matched or tongued and grooved, and fastened together with several cleats 2'' \times 4''. Then prepare the form for casting three posts at once. Use the following pieces:

- 4 pieces 7' 2'' long, 6'' wide at one end and 4'' wide at the other, 1'' thick, (a)
- 1 piece 26'' long, 6'' wide, 1'' thick, (b)
- 1 piece 20'' long, 4'' wide, 1'' thick, (c)
- 3 pieces 6'' long, 6'' wide, 1'' thick, (d)
- 3 pieces 4'' long, 4'' wide, 1'' thick, (e)
- 2 pieces 6'' long, 2'' wide, 1'' thick, (f)
- 2 pieces 4'' long, 2'' wide, 1'' thick, (g)
- 6 pieces triangular in shape 4' long, (h)

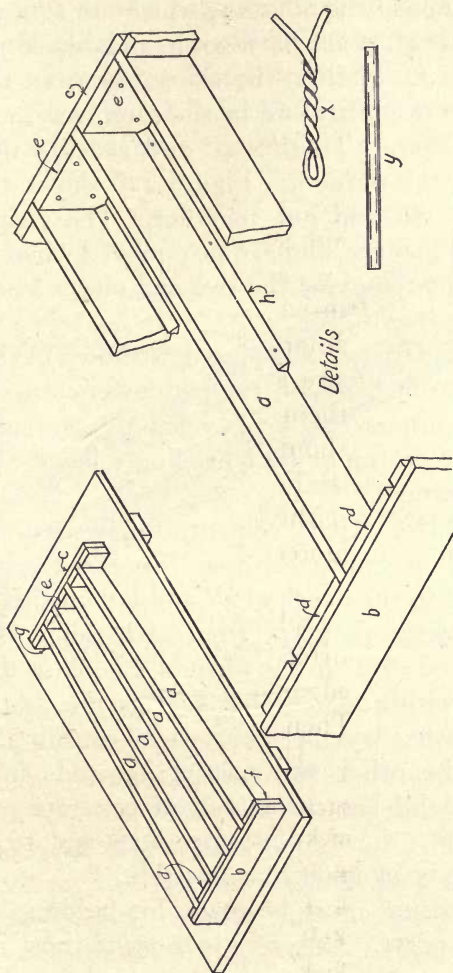

FIG. 228. — FORMS FOR FENCE POSTS. (Double Taper.)

Nail the 2" strip *f* in place at one end of the piece *b*, then nail on one of the blocks *d*, which are 1" × 6" × 6", with just enough space between it and block *f* for one of the pieces *a*. Nail on the other blocks in the same way. Make the other end in the same way, using the blocks which are 1" × 4" × 4" and spacing them the thickness of the strips *a*. Figure 228 shows the form when completed and put together. The strips *a* are not fastened in place, and can be removed when the concrete is set, by removing the two end pieces *b* and *c* and lifting the strips.

The triangular strip *h* is placed as shown in the detail drawing so as to bevel off the two lower corners. The two upper corners can be beveled by pressing down similar strips on top or by troweling a bevel along the two upper corners.

Casting.—Use 1 part cement, 2 parts sand, and 4 parts gravel or crushed stone. Spread the concrete in each mold to the depth of 1" and lay on this the two reënforcing wires about 1" from each side. Bend the ends of the rods over in the form of a hook so that they will come to within 2" of each end. (See Fig. 229.) Then pour on another layer of concrete to within 1" of the top, place the other two reënforcing rods in similar manner, and fill the molds full of concrete over this reënforcement. Spade the sides well and trowel the top to make it as smooth as possible.

Some provision must be made for holding the wire fence to the posts. One way is to twist short pieces of doubled copper wire No. 12 as shown by *x*, Fig. 228, and insert them in the wet concrete at the positions where the wires of the fence will come. Another way is

to insert greased iron rods (y, Fig. 228) $\frac{1}{2}$ " in diameter in the center of the posts, making a round hole clear through the post. These rods can be held in place by tacking a strip on top of the forms where the holes are to be, and boring $\frac{1}{2}$ " holes through this strip so that each hole will be over the middle of each post. An-

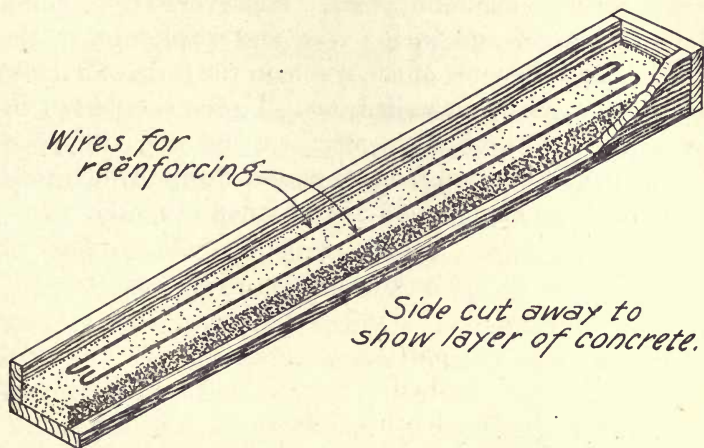

FIG. 229.—REËNFORCING WIRES IN FENCE POST.

other method is to cast in the post a round hardwood plug to which the wires may be nailed with common staples. Sometimes galvanized screw eyes are cast in the posts and the fence fastened to these by twisting short pieces of wire around both.

If necessary to brace the mold to keep the two outer sides from bulging, a strip may be tacked across the top about the middle of the mold. Corner posts should be made larger and longer than common posts.

As these posts are quite heavy, to save handling they ought to be cast where they are to be used. It is possi-

ble to cast braces to the corner posts at the same time the posts are cast, but the whole must be cast in an upright position; but as it requires a great deal of skill to make the forms as well as to pour the cement, it should not be attempted by the beginner.

Hitching and clothesline posts can be made in the same way as common posts. However, they should be made larger and with a ring and staple cast in the top. Bend the ends of the staple in the form of a hook, to prevent its being pulled out. Forms should not be removed for three days after casting and the posts ought not to be used for two weeks, during which time they must be kept wet so as to harden properly.

LEATHER WORK

LESSON LVI

HARNESS MENDING

Although the mending of harness is commonly considered to be within the province of the harness-maker, there is no good reason why the farmer should not make many of his own repairs. Harnesses can be kept in good repair at very little expense. Although many of the processes seem complicated, they are really not so, and can be mastered easily. The purpose of this lesson is to show how simple repairs can be neatly and strongly made.

Thread. — A good thread is necessary in making strong and lasting repairs. Good linen must be selected, and considerable care exercised in making the thread. Hold one end between the second and third fingers of the left hand; pass the thread around a nail or hook and bring back, catching between the thumb and finger of the same hand. With the right hand, roll the thread downward over the knee, as shown in Fig. 230, and pull it apart with a jerk. The rolling untwists the strands and

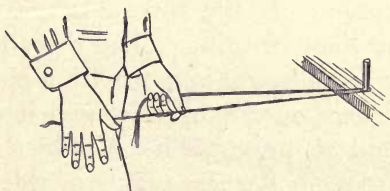

FIG. 230. — UNTWISTING THE STRANDS OF THREAD.

makes the thread easy to break. Never cut or break a thread without untwisting it, as that would produce a blunt end, while the untwisting leaves a fine tapering end. The process is repeated until enough strands have been broken to produce a thread of the required strength,—three for light work and five or six for heavy stitching. In putting the ends of the broken threads together, do not leave them exactly the same length. By leaving some shorter than others a pointed thread is made, fine enough to go into the eye of the needle. Draw the thread tight so there will be no loose strands, and wax the ends.

Holding the thread as shown in Fig. 230, twist it by rolling it with the right hand over the knee. It is kept from untwisting by catching it up with the thumb and finger of the left hand. The threads are not doubled before twisting.

Waxing. — When well twisted throughout the entire length, wax by rubbing well and quickly over the entire length. The ends should be waxed more than the rest of the thread so the needle can be attached more securely. If the thread is twisted too much, it is apt to knot in using. The thread may be smoothed after waxing by rubbing it with a piece of soft leather. Wax is used on the thread to give it strength and smoothness, and to preserve it. Cobbler's wax may be obtained from the harness-maker or the shoemaker. It is made of pitch and resin, in equal parts, heated and thoroughly mixed. To this is added a small quantity of tallow in hot weather and a larger quantity in cold weather. If the thread becomes sticky, smear some fat on the fingers and rub the entire length.

Threading the needle. — A single thread is used and a needle is attached to each end. The needle must be threaded securely

and in such a way that the thread

where it leaves the eye is not thicker than the needle. If it is larger, it will soon wear out or the needle will be broken in stitching. Pass about two inches of the

thread through the eye, twist the end around the thread and rub down smooth.



FIG. 232.—PRICKING WHEEL.

good work is required, mark out the line of stitching with the compass and run a pricking wheel over this line (Fig. 232). The

points on the wheel cut into the leather and make distinct marks where the holes are to be made with the awl (Fig. 235).

The sharp edges of the leather must be removed with an edging tool. To obtain an even thickness and a smooth surface the ends of the leather must be beveled before stitching. This is done by shaving the ends with a round knife (Fig. 233).

FIG. 231.—TWISTING THE END OF THE THREAD AFTER THREADING THE NEEDLE.



Edging Tool

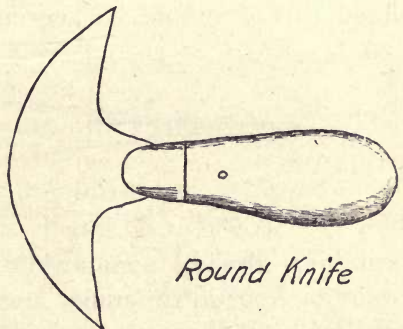

Round Knife

FIG. 233.—EDGING TOOL AND ROUND KNIFE.

The work while being stitched is held in a sewing horse. The awl is pushed through from the right side. When the first hole has been made, the needle is passed through from the left side and the thread drawn through

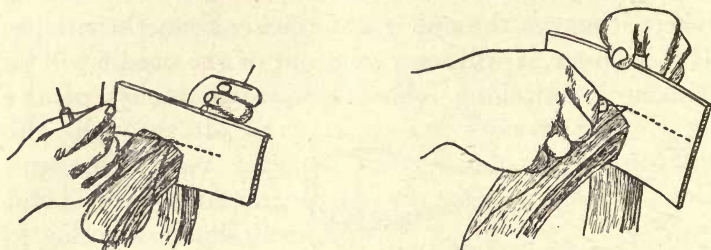

FIG. 234.—STITCHING WORK HELD IN SEWING HORSE.

until an equal length is on each side of the leather. The next hole is made with the awl and the left-hand needle brought through this. When the thread has been drawn through about three inches, the right-hand needle is passed through the same hole.

The awl makes a diamond-shaped hole and the left-hand thread should be kept in the angle nearest the

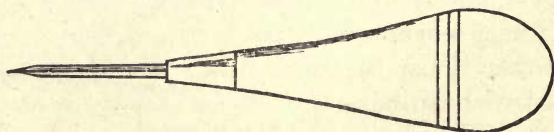

FIG. 235.—STITCHING AWL.

stitching already done, while the right-hand thread must be kept in the upper angle. This can be accomplished by pulling away a little from the body with the right hand and slightly towards the body with the left hand. Pull both threads firmly at the same time.

When the stitching is completed, the thread can be fastened by turning back one stitch. Cut it off flush with the surface of the leather.

To obtain good stitching, it is necessary :

- (1) That thread of a kind and strength suited to the nature of the work be selected.
- (2) That the thread be smooth, well twisted, and well waxed.
- (3) That the stitches all be drawn equally tight, and made firm without cutting the leather.
- (4) That the needles be used in the right way.
- (5) That the awls be correctly used.
- (6) That the stitches be of equal length.
- (7) That the holes be of equal size and angle.

Splicing. — In splicing, it is necessary to shave the two ends to be joined down to a thin edge, Fig. 236, with the round knife. Then stitch along each edge, fastening the threads at the ends. In mending a broken tug, if the break occurs at any place other than where the cockeye is fastened, it should be done by splicing, as shown in Fig. 236. If the

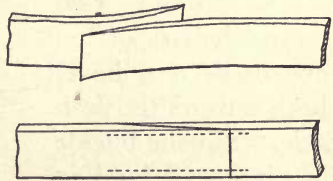

FIG. 236. — SPLICING A STRAP.

break occurs in the loop holding the cockeye, it can be repaired as shown in Fig. 237. The illustrations show the reverse, or inside, of the tug. First, a piece must be cut out of the inside layer and the outside piece beveled with the round knife. The inside piece must be beveled in the same way. Then a piece of new leather is beveled at one end on the

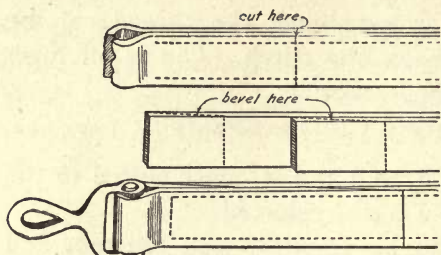

FIG. 237. — REPAIRING A BROKEN TUG.

flesh side and at the other end on the grain side. The strip is placed around the cockeye and the two ends are stitched with a seven-strand thread.

Fastening a buckle and loop. — In stitching on a buckle and loop, bevel one end of the strap with the round knife; then make the hole for the tongue of the buckle by punching two holes, as in Fig. 238, and cutting out the leather between with the points of the round knife. For the loop, cut a strap long enough to reach around two straps the size of the one used, and bevel both ends on the flesh side. Put the buckle in place and hold in the sewing horse with one end of the loop inserted in between the two edges to be stitched. Stitch as shown in the drawing.

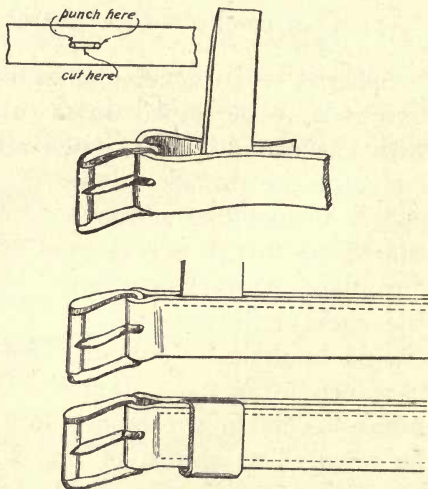

FIG. 238. — INSERTING A BUCKLE AND LOOP.

Turn the strap over and insert the other end of the loop so that the two ends meet in the middle between the straps, and stitch.

SUGGESTIONS FOR ADDITIONAL WORK

THE drawings on the following pages will suggest additional work which may be done by pupils who are more rapid in their work and more skillful in the use of tools than the other members of the class. The dimensions and other features of the things to be constructed may be modified as desired by teacher or pupils.

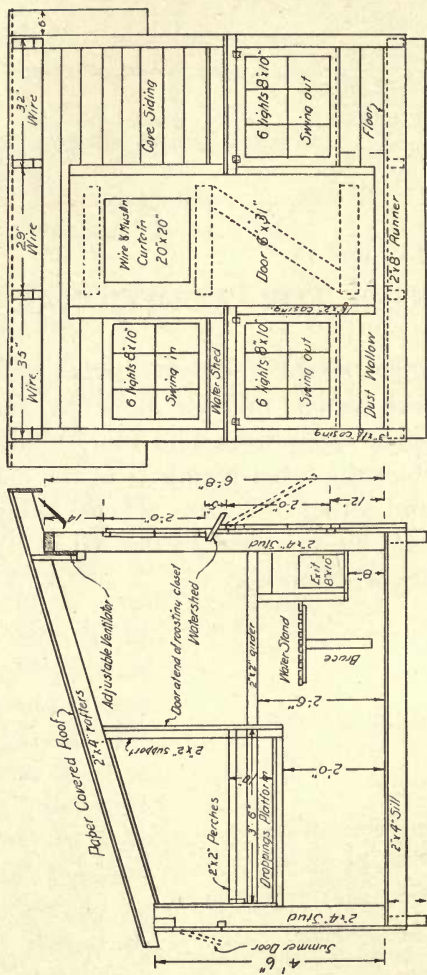

FIG. 239. — CHICKEN HOUSE. FRONT AND SIDE ELEVATION.
 (From a bulletin of the Minnesota Experiment Station.)

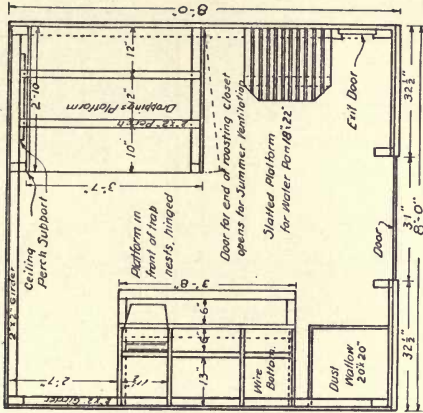

FIG. 241. — FLOOR PLAN OF CHICKEN HOUSE.

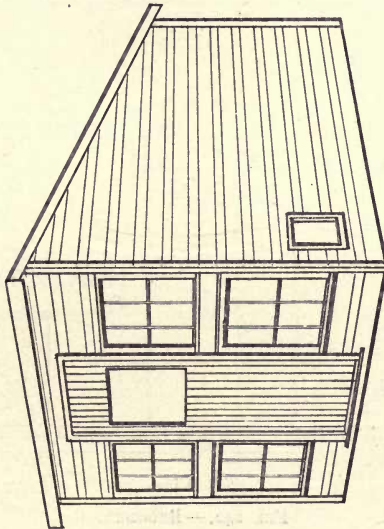
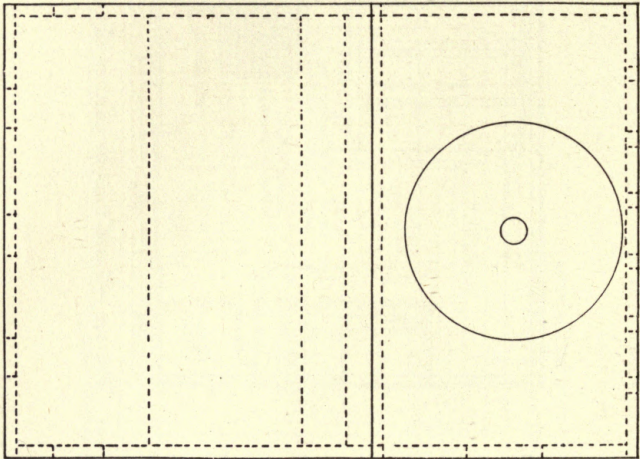
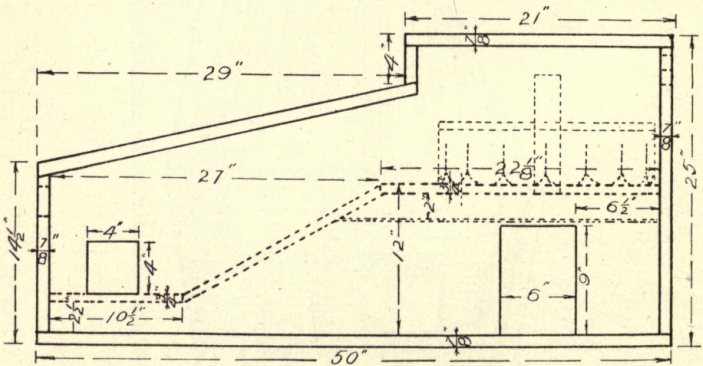

FIG. 240. — PERSPECTIVE OF CHICKEN HOUSE.



Top View



Side View

FIG. 242.—BROODER.

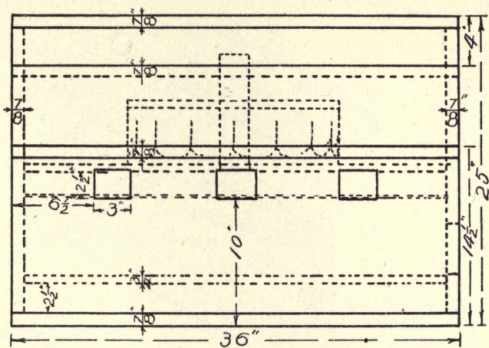
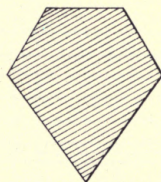
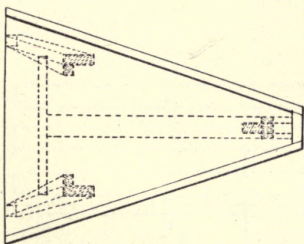

FIG. 243.—BROODER, END VIEW.



section on AB.

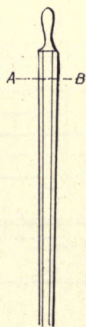
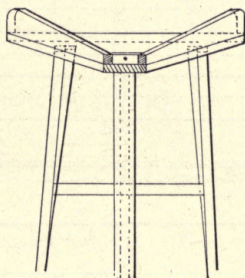
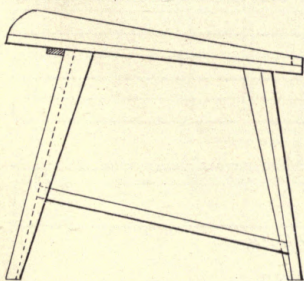

FIG. 244.—BUTTER WORKER.

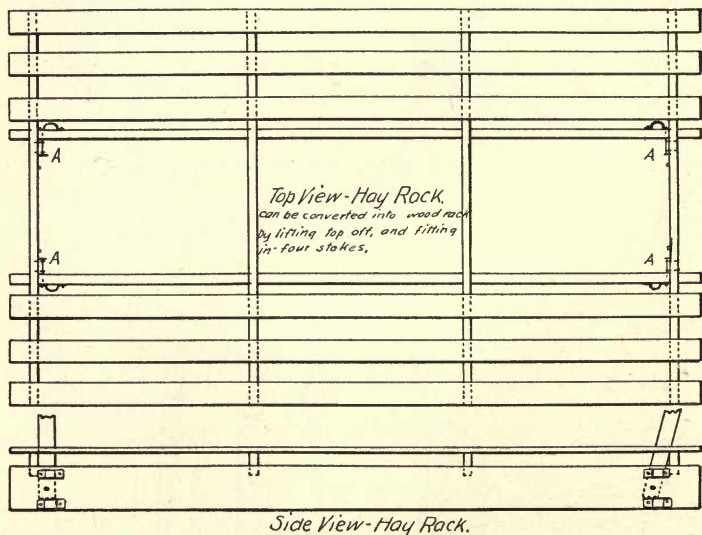
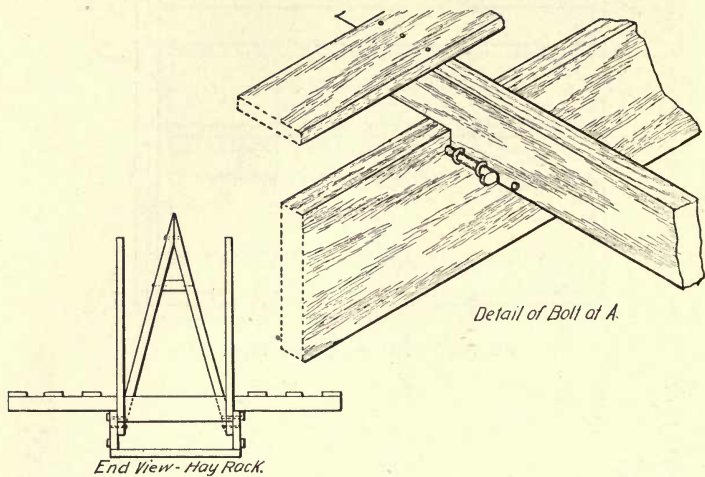

FIG. 245.—HAY RACK.

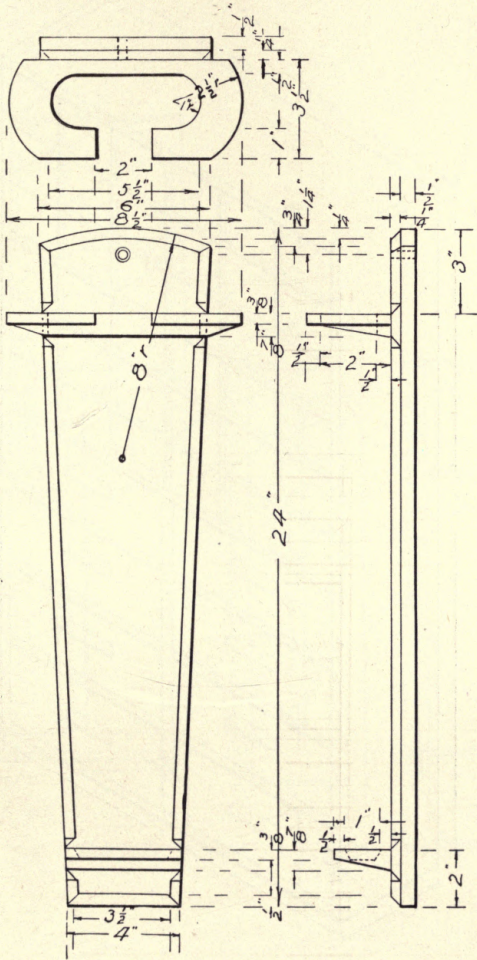

FIG. 246.—UMBRELLA RACK.

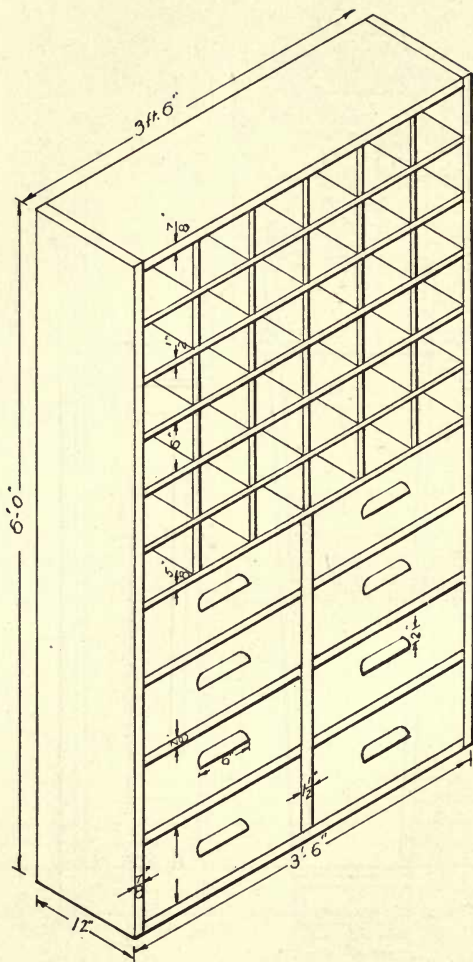

FIG. 247.—MUSEUM CABINET.

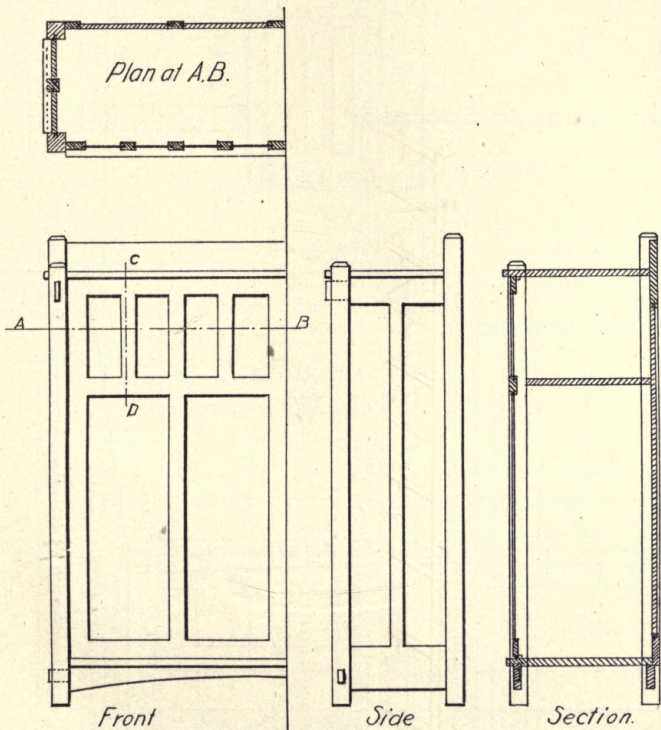

FIG. 248. — BOOKCASE. Scale, 1" = 1 ft. (From Craftsman design.)

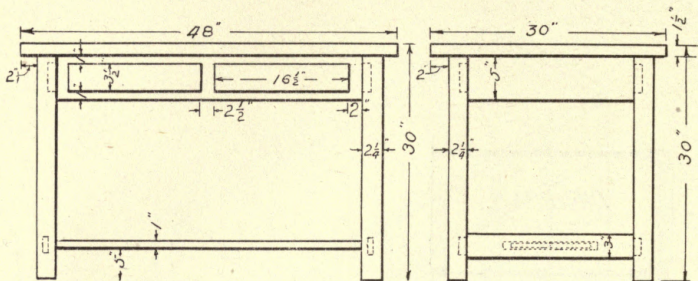

FIG. 249.—LIBRARY TABLE.

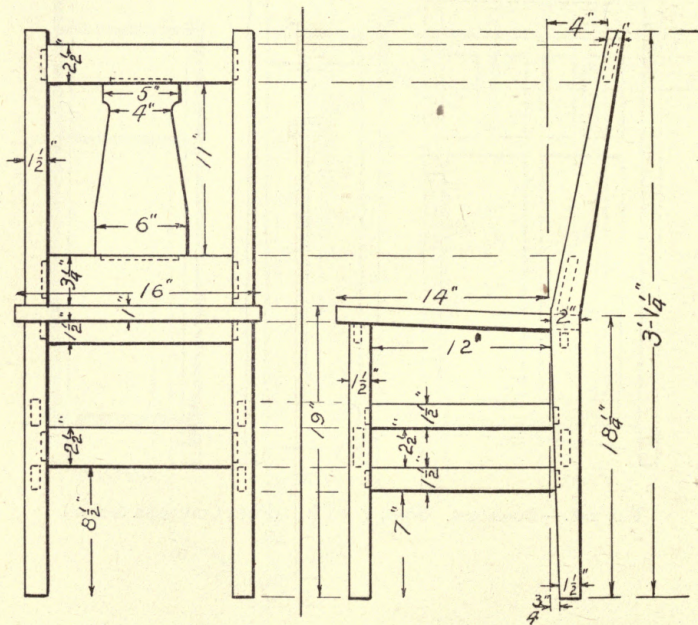

FIG. 250.—DINING ROOM CHAIR.

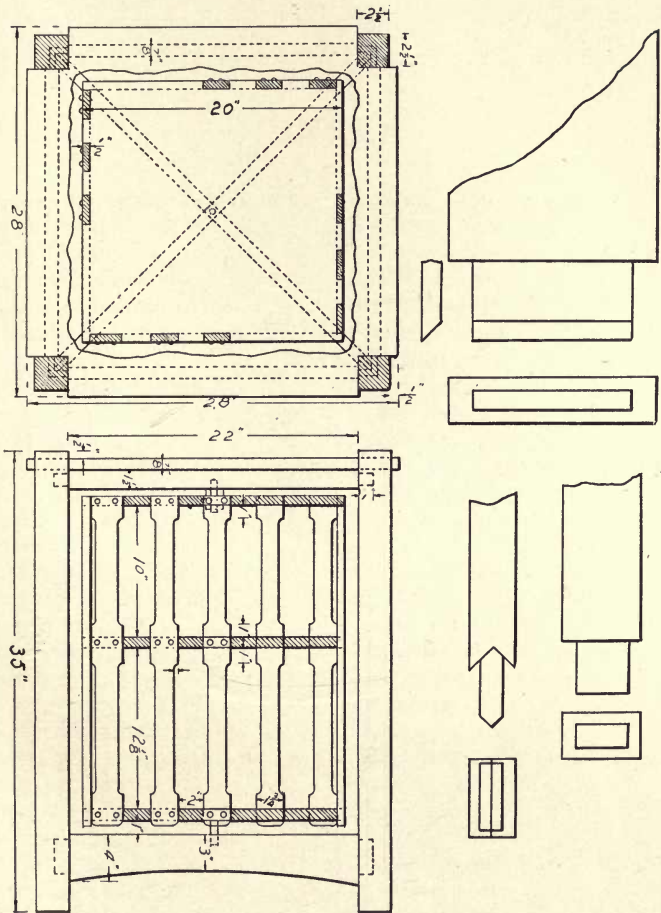
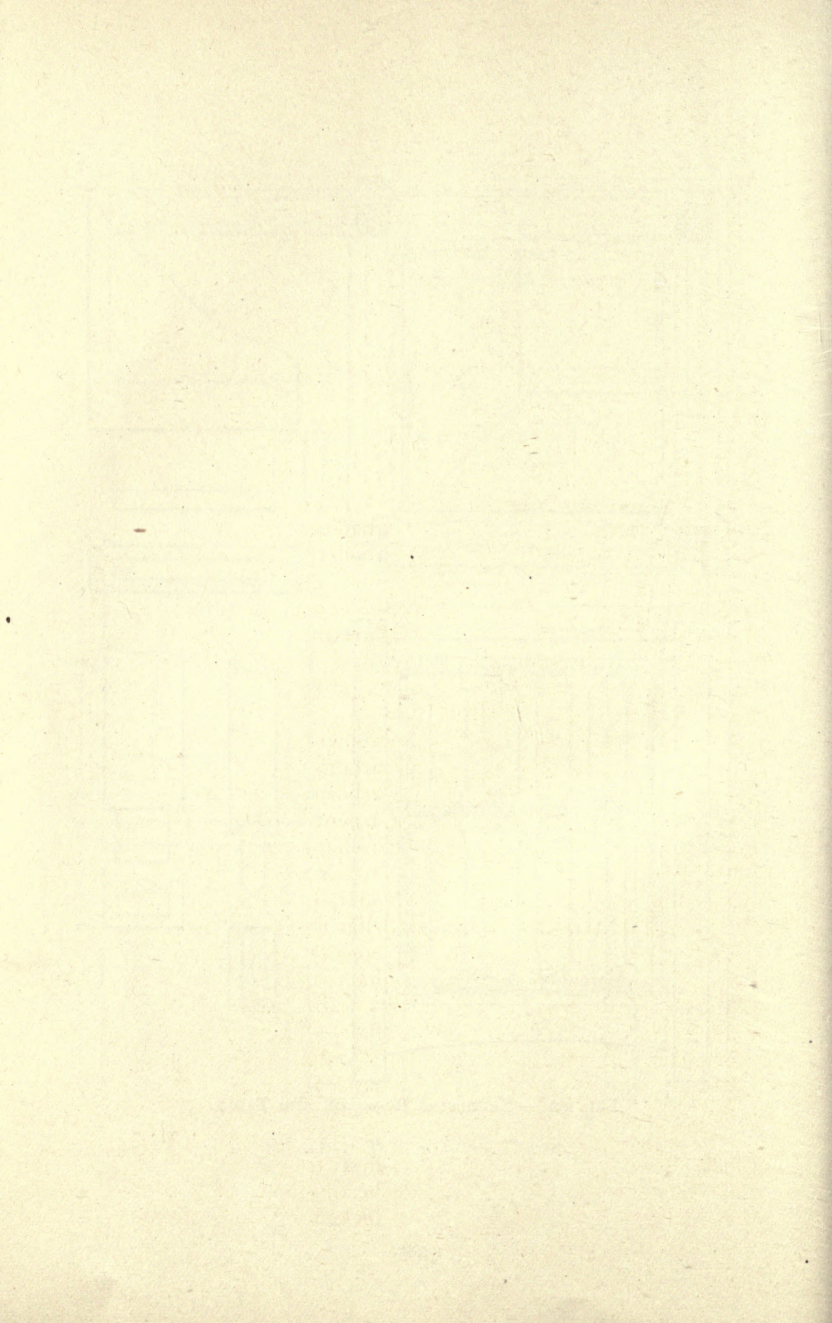

FIG. 251. — REVOLVING BOOKCASE AND TABLE.



INDEX

- Angles, for setting bevels, 165.
Annual rings, 159, 162, 163.
Anvil, 200.
Arkansas stone, 194.
Ash, 159, 160, 161, 163.
Assembling, definition of, 8.
Auger bits, 166.
Awl, stitching, 272.
- Backsaw, 173.
Ball peen hammer, 202.
Barn floors, concrete, 254, 255.
Basswood, 159, 160, 163.
Beam, of bevel, 165.
 of marking gauge, 7, 169.
 of try-square, 6, 174.
Beech, 159, 163.
Bench hook, 1-9.
Bench stop, 144.
Bevel, 21-24, 165.
Beveled boards, 251.
Birch, 71, 159, 160, 161, 163, 164.
Bitbrace, 166.
Bits, 166.
Blacksmithing, 197-245.
Blade, of bevel, 165.
 of plane, 169, 170.
 of saws, 173, 175.
 of steel square, 177.
 of try-square, 174.
Block plane, 171.
Board measure, 180, 181.
Bolt, making, 207-209.
- Bonding concrete, 249.
Bookcase, drawings only, 283,
 285.
Boxwood, 163.
Brace measure, 177-180.
Braces, 179, 180.
Broadleaf trees, 159.
Brooder, drawings only, 278, 279.
Brush, glue, 188.
Buckle and loop, harness, 274.
Butternut, 159, 160, 163, 164.
Butter worker, drawings only,
 279.
- Cabinet, museum, 282.
Carbon, in steel, 242.
Carborundum, 195, 196.
Carpenter's bench, 138-145.
Casehardening, 244, 245.
Cattle rack, 122-126.
Cedar, 159, 160, 163.
Cellar floors, concrete, 254.
Cement, 246-268.
Chain and hook, making, 210-
 216.
Chair, dining room, drawings
 only, 284.
Charcoal, 199.
Checks in lumber, 162, 163.
Cherry, 160, 163.
Chest, tool, 146-158.
Chestnut, 160, 163.
Chicken feed box, 56-60.

- Chicken house, drawings only, 276, 277.
 Chiseling, 16-18.
 Chisels, 167, 168.
 Circle, method of cutting, 101, 102.
 Clamps, 185, 186.
 Close-grained woods, 163.
 Clothes rack, 36-38.
 Clothes tree, 39-43.
 Coal, for forging, 198, 199.
 Coarse-grained woods, 163.
 Cobbler's wax, 270.
 Cockeye, harness, 273, 274.
 Cocobola, 160.
 Coke, 199.
 Cold chisel, making, 244.
 Combination ladder, 89-95.
 Compass, 25.
 Concrete, 246-268.
 mixing, 247.
 Cooking glue, 187.
 Corn rack, 118-121.
 Corundum, 194, 196.
 Cottonwood, 159, 160.
 Countersinking, 9.
 Crosscut saw, 172.
 Cyanide of potassium, 245.
 Cypress, 164.

 Dining room chair, drawings only, 284.
 Doubletree, 109-112.
 Dowel holes, 39, 40, 150-153.
 Dowel pins, 40, 150-153.
 Dowels, 39, 40, 150-153.
 Drawing out, iron, 203.
 Drawshave, 168.
 Dry mixture, concrete, 249.

 Ebony, 160, 163.
 Edging tool, for leather, 271.
- Elasticity, of woods, 161.
 Elm, 159, 160, 161, 163.
 Emery, 194, 196.
 Expansion joints in concrete, 255.
 Extension bit, 166.

 Farmer's level, 96-104.
 Farm gate, 113-117.
 Filing saws, 189-196.
 Filler, wood finishing, 42.
 Fir, 159, 164.
 Firmer chisel, 167.
 Flatter, 204-206.
 Fleam, of saw teeth, 173.
 Float, for concrete work, 254.
 Floors, concrete, 252-255.
 Folding sawbuck, 27-30.
 Foot board, wagon box, 136.
 Foot rest, wagon box, 137.
 Forge, 197-200.
 Forms for concrete, 250, 251.
 Foundation walls, concrete, 256.
 Framing chisel, 167.
 Framing square, 177-184.
 Freezing, effect on concrete, 250.
 Fullering, 215.
 Fullers, 215.

 Gate hook, making, 204-206.
 Gauge, marking, 7, 169.
 Gimlet, 167.
 Glue, in woodworking, 14, 15, 185-188.
 Glue brushes, 188.
 Gouge, 168, 169.
 Grain, of wood, 163.
 Gravel, 246, 247.
 Grinding edge tools, 192-196.
 Grindstone, 193.

- Halved joint, 12-14.
 Hammer, ball peen, 202.
 Hammer handle, making, 71-74.
 Hardness, of woods, 160.
 Hard pine, 160.
 Hardwoods, 159.
 Hardy hole, of anvil, 215.
 Harness hook, making, 227,
 228.
 Harness mending, 269-274.
 Hay rack, drawings only, 280.
 Header, 130, 131.
 Heading tool, 208.
 Heartwood, 160.
 Hemlock, 159, 160, 164.
 Hickory, 71, 159, 160, 161, 163.
 Hinges, for level, 100.
 for farm gate, 238.
 Hip rafter, 183.
 Hog cot, 127-132.
 Hog trough, concrete, 259, 260.
 Holly, 160.
 Horn, of anvil, 200.
 Hot chisel, 224.

 Iron, for leveling rod, 237.
 wrought, 242.
 Irons, for cattle rack and corn
 rack, 239.
 for combination ladder, 235,
 236.
 for farm gate, 238.
 for plank drag, 234.
 for three-horse evener, 230-
 233.
 for wagon box, 240, 241.
 for wagon jack, 229.
 Ironwood, 71, 161.

 Jack plane, 171.
 Jack rafter, 183.

 Jointer, saw, 191.
 for concrete work, 254.

 Kerf, 46.
 Kiln-dried lumber, 163.
 Knife, marking with, 3, 4.

 Lap weld, 212-214.
 Laying out, definition of, 2.
 Letting in, definition of, 65.
 Leveling rod, 105-108.
 Level square, 10-19.
 Library table, drawings only,
 284.
 Lignum vitæ, 160.

 Mahogany, 159, 163, 164.
 Maple, 71, 159, 160, 163, 164.
 Marking gauge, 6, 7, 169.
 Measure, brace, 177.
 board, 180, 181.
 Measuring box, for concrete,
 248.
 Medullary rays, 159, 160.
 Miters, 140, 154, 156.
 Mixing concrete, 247.
 Molds, for concrete, 259-263,
 264-268.
 Mortise, 39, 40.
 Mortise and tenon joint, 39, 40.
 Museum cabinet, drawing only,
 282.

 Natural cement, 246.
 Needleleaf trees, 159.
 Norway pine, 160, 164.
 Nosing, of steps, 258.

 Oak, 160, 161, 163, 164.
 Octagon scale, 181, 182.
 Oilstones, 194, 195.

- Osage orange, 160.
 Oxidizing fire, 199, 200.
- Palms, 159.
 Paring chisel, 167.
 Pine, 159, 164.
 Planes, 169-171.
 block, 171.
 jack, 171.
 smoothing, 171.
 Plank drag for roads, 75-78.
 Plumb bob, 15, 16.
 Poplar, 160, 163.
 Porch chair, 31-35.
 Portland cement, 246.
 Posts, concrete, 264-268.
 Pricking wheel, for leather, 271.
 Punch, making, 243, 244.
 Purlins, 130.
- Rabbet, 149, 150, 155.
 Rafters, 182, 183.
 Rafter tables, 182.
 Red oak, 160.
 Redwood, 160.
 Revolving bookcase and table,
 drawings only, 285.
 Ripsaw, 172.
 Rise, of rafters, 182, 183.
 Riser of steps, 184, 257.
 Rock elm, 161.
 Rosewood, 160.
 Round knife, for leather, 271.
 Rule, 171.
 Run, of rafters, 182, 183.
 of stairs, 184.
- Sand, 246, 247.
 Sandpaper, 175.
 Sandpaper block, 175, 176.
 Sapwood, 160.
- Sawbuck, 20-30.
 Saw jointer, 191.
 Saws, 172, 174, 175.
 Saw setting, 191, 192.
 Scarfing, 211.
 Scribing, 51.
 Set hammer, 204, 206.
 Sewing horse, 79-84.
 Sharpening, of chisels, 192, 193.
 of planes, 192, 193.
 of saws, 189-192.
 Sheep-feeding trough, 49-55.
 Shellacking, 34, 38, 42, 43, 158.
 Shrinkage, of wood, 161-163.
 Sidewalks, cement, 252-254.
 Singletrees, 109-112.
 Slips, 194.
 Soft maple, 160.
 Soft pine, 163.
 Softwoods, 159.
 Splicing, leather, 273.
 Split weld, 226.
 Spokeshave, 25, 168.
 Spring wood, 159.
 Spruce, 159, 160, 163, 164.
 Spur, of marking gauge, 7.
 Squaring, definition of, 3, 6.
 "Staggering" nails, 140, 141.
 Stains, 42, 43.
 Stairs, 184.
 Stanchion, of cattle rack, 122-
 126.
 Staple, making, 201-203.
 Steel square, 177-184.
 Stitching, harness, 271.
 Stitching awl, 272.
 Straightedge, 21.
 Strength, of woods, 161.
 Summer wood, 159.
 Surfacing, 4.
 Swaging, 218.

- Swaging tools, 218.
Swivel, making, 217-220.
Sycamore, 160.
- Target, for leveling rod, 108.
Tempering steel, 242, 243.
Thread, for harness mending,
269-273.
Three-horse evener, 109-112.
Tongs, making, 221, 223.
Tool chest, 146-158.
Tool steel, 242-245.
Toughness of wood, 161.
Trap nest, 61-65.
Tread, of stairs, 184, 257.
Trimmer, 130, 131.
Turntable, 96, 103, 104.
Tuyère, 198.
- Umbrella rack, drawings only,
281.
Upsetting, definition of, 207.
- Valley rafter, 183.
Varnish, 42.
Vise, of work bench, 141-143.
- Wagon box, 133-137.
Wagon jack, 66-70.
Walnut, 159, 163.
Warping, of lumber, 162, 163.
Washita stone, 194.
Weight, of wood, 161.
Welding, 212-214.
Western hemlock, 163.
White oak, 160, 161, 164.
White pine, 160, 161, 164.
Wind, definition of, 4.
Woodworking, 1-196.
Work bench, 138-145.
Wrench, making, 224-226.
Wrought iron, 242.
- Yellow pine, 164.
Yellow poplar, 159.

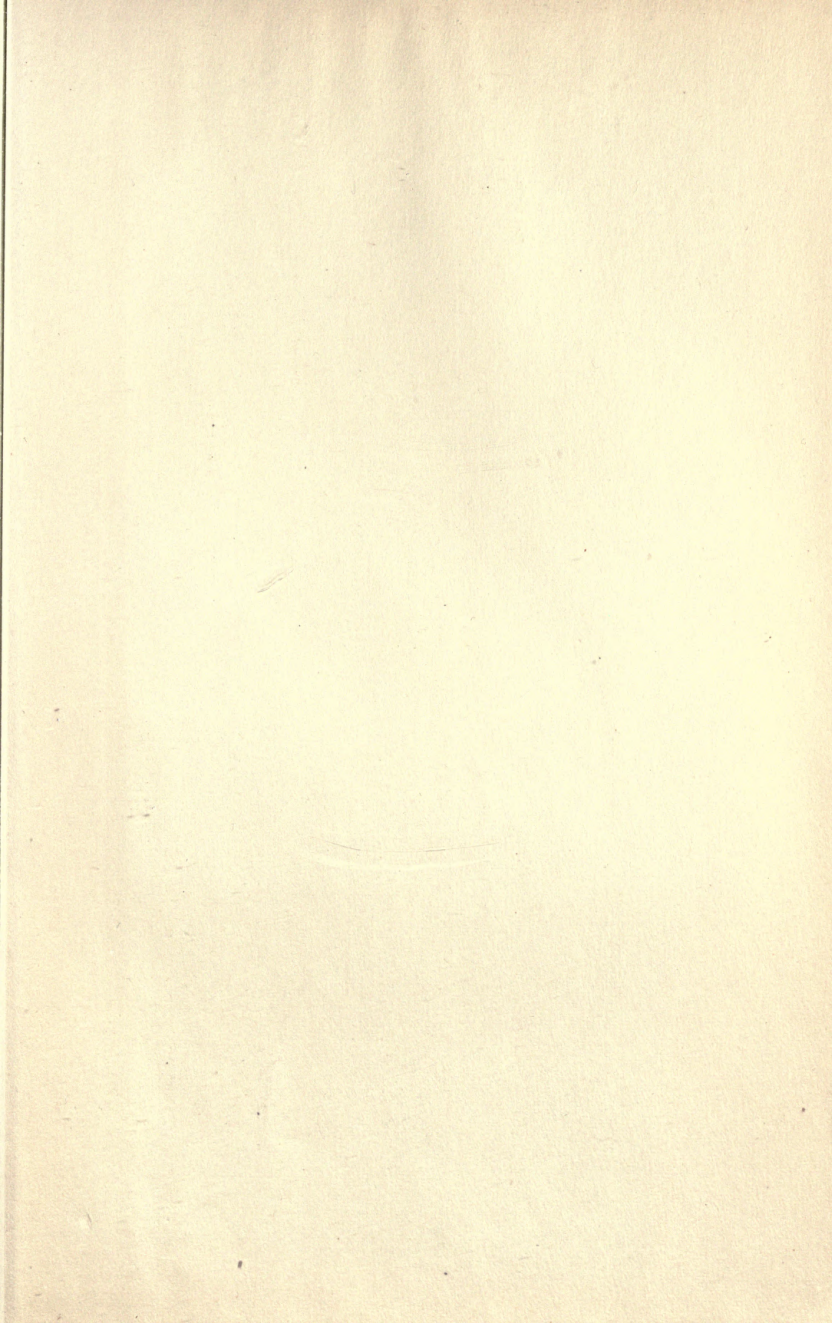

THIS BOOK IS DUE ON THE LAST DATE
STAMPED BELOW

AN INITIAL FINE OF 25 CENTS

WILL BE ASSESSED FOR FAILURE TO RETURN
THIS BOOK ON THE DATE DUE. THE PENALTY
WILL INCREASE TO 50 CENTS ON THE FOURTH
DAY AND TO \$1.00 ON THE SEVENTH DAY
OVERDUE.

MAR 29 1938

MAR 30 1938

AUG 28 1939

LD 21-95m-7,'37

TT169

445134

B7

UNIVERSITY OF CALIFORNIA LIBRARY

