

TT

185

.R72

FARM WOODWORK

L.M. ROEHL



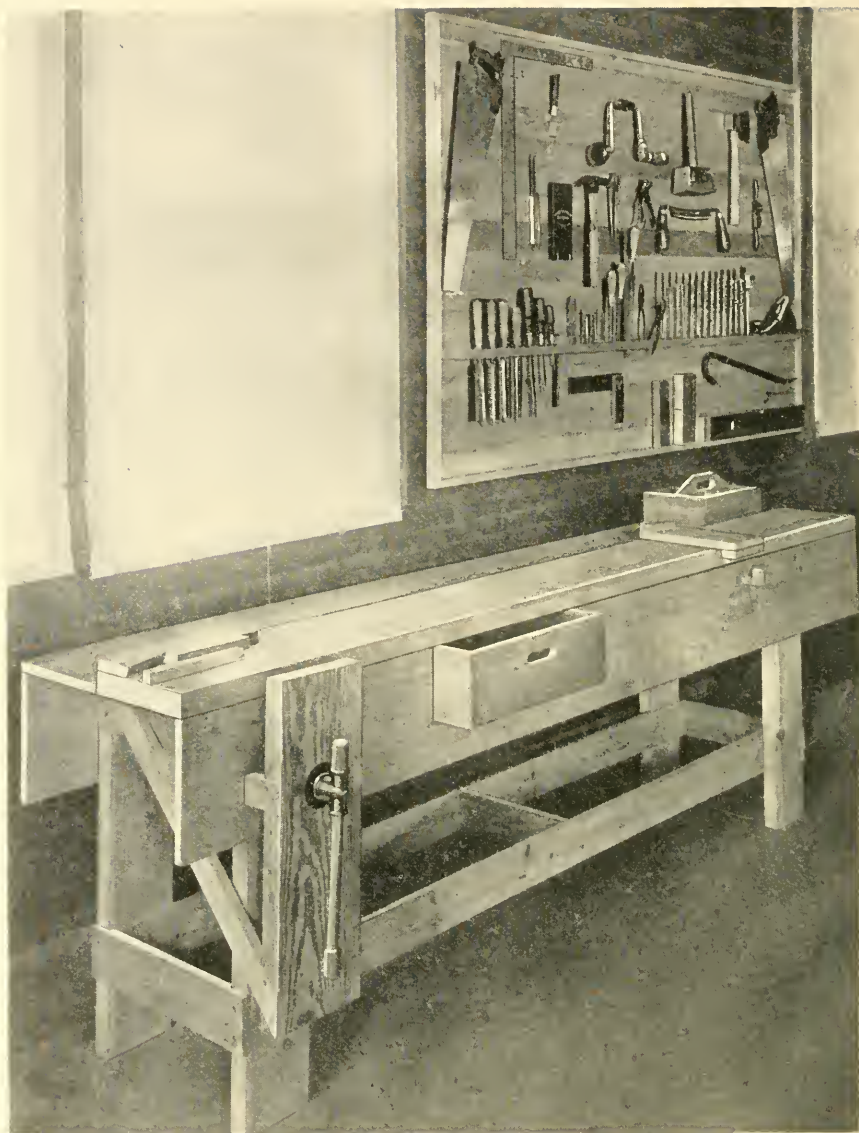


Class TT185

Book .R72

Copyright N^o _____

COPYRIGHT DEPOSIT.



Farm Shop Work Bench and Farm Woodworking Tools.

Farm Woodwork

by

Louis M. Roehl

Supervisor of Farm Shop Work, New York State College
of Agriculture at Cornell University,
Ithaca, N. Y.

With an Introduction by George A. Works, Head of the
Department of Rural Education, New York
State College of Agriculture.



The Bruce Publishing Company

Milwaukee, Wis.

TT 185
F 72

Copyright, 1919
The Bruce Publishing Company
Milwaukee, Wis.



1919-8 1919

19-1-1919 11

©1925710138

Introduction

This book is designed primarily for use as a text or reference book in connection with farm shop courses in agricultural schools or in the agricultural departments of rural high schools. The problems that this work presents are many and their seriousness is accentuated by the fact that commonly the farm shop instruction is offered by the teacher of agriculture. This arrangement has an advantage in the fact, that it makes possible a more intimate relationship between the shop work and the various phases of the agricultural work, but it presents serious teaching difficulties and makes necessary such assistance for the teacher as is to be found in this book.

This book and *Agricultural Woodworking* by the same author are in marked contrast with the early efforts that were made to organize courses in farm shop work. For the most part they consisted mainly of a bodily transposition of manual training and drawing courses from city schools to the schools of the rural community. Commonly there was little or no relationship between the drawing and construction work. Usually the drawing consisted of a segment of a drafting course and the wood work centered around "exercises," necktie holders, and Morris chairs. The authors of these attempts lost sight of the fact that the farmer is neither a draftsman nor a cabinet maker. His skill in the use of the hammer, saw, plane, and pencil should be developed in connection with problems of rough carpentry. He must be a "jack of all trades" in repair and simple construction work.

The error of this procedure has been realized by many who are now endeavoring to select construction problems adapted to farm conditions. As a result there has been a decided improvement in the character of the work done in the farm shop course but the movement has not gone far enough. The content of the high school course in farm crops is determined in a large measure by the crops raised in the immediate vicinity of the school. In a similar manner there should be a recognition of the influence of local farming conditions in the determination of the content of the farm shop course. The woodworking problems that are presented to the truck farmer are quite different from those that are presented to the dairyman, poultryman, or general farmer. The instruction offered in the farm shop course should reflect this difference to a much greater extent than is usually the case.

Since the farm shop course is quite commonly taught by the teacher of agriculture, it is especially desirable that he should have a large number of carefully prepared shop problems from which selections may be made so that the work will be adapted to local conditions. In the preparation of this book the author has borne this fact in mind. It is not offered as a course adapted to any community but rather as a book, which with the preceding volume, will form the basis of many courses for

schools situated in widely divergent farming conditions. It is expected that the teacher will supplement the problems he selects by repair work brought in by the pupils from their home farms.

The author's extensive farm experience, technical training, several years of experience as a teacher of shop work to farm boys and more recently his efforts in instructing prospective teachers of vocational agriculture in farm shop work have made an excellent background for such an undertaking as is represented by this volume. As a result he has prepared a book that contains practical problems, carefully analyzed and skillfully presented. Wise use of this volume is certain to result in a marked advance in the character of work done in farm shop courses in agricultural departments and schools.

GEORGE A. WORKS.

TABLE OF CONTENTS

	Page		Page
Adjustable Wagon Jack.....	40-41	Plane Table and Leveling Rod.....	127
Apple Box Press.....	106-107	Playground Swing.....	66-67
Bag Holder.....	65	Poultry Carrying Crate.....	78
Berry Stand for Six Boxes.....	116-117	Poultry Catching Hook.....	79
Bird Houses.....	63-64	Poultry Feed Box.....	74
Carpentry Apron.....	30-31	Poultry Feed Box.....	76-77
Contents of a Course in Farm Woodwork.....	8	Poultry Feed Hopper for 25 Birds.....	75-77
Dog House.....	56-57	Poultry Feed Hopper for 50 Birds.....	77
Double Deck Berry Stand for Twelve Boxes.....	116-117	Poultry Feeding Trough.....	72-73
Farm Carpentry Tools.....	9	Poultry Show Crate.....	78
Farm Shop Equipment for Schools.....	11	Poultry Sticking Knife.....	79
Wood Working Tools.....	11-12	Rafter Framing.....	128
Blacksmiths' Tools.....	12-13	Root Study Case.....	11-12
Pipe Fitting Tools.....	13	Rural School Work Bench.....	20-24
Tinning Tools.....	13	Saw Filing Clamp.....	46-47
Harness Repair Tools and Equipment.....	13-14	Saw Horse.....	44-45
Farm Shopwork Bench.....	16-19	Saws and Saw Fitting.....	130-131
Farm Tool Box.....	48-49	Seed Corn Rack.....	38-39
Folding Bench.....	34-35	Seed Corn Testing Box.....	38-39
Fruit Can Rack.....	52	Self Feeder for Hogs.....	90-91
Fruit Step Ladder.....	110-112	Sheep and Hog Shipping Crate	96-97
Handy Ladder.....	71	Sheep Feeding Rack.....	93
Harness Hook.....	105	Sled.....	70
Hay Rack.....	80-83	Soil Sieve.....	125
Introduction.....	5	Stitching Horse.....	98-104
Jointing, Setting and Filing a Cross Cut Saw.....	129	Stock Rack for Wagon Box... Support Racks for Soil Tubes.	88-89 124
Kitchen Table.....	54-55	Table of Bit Sizes for Wood Screws.....	136
List of Builders' Hardware....	133	Take-Down Horse.....	42-43
Lumber Measurement Table... Lumber Rack.....	134 28-29	Teeter-Totter.....	68-69
Milking Stool.....	58-61	Tool Cabinet for Wood Shop... Top, Wagon Box.....	25 86-87
Milk Test Bottle Holder.....	79	Vise and Bench Stop.....	22-24
Miter Box.....	36-37	Vise Handle.....	122-123
Nail and Staple Box.....	32-33	Wagon Box.....	84-85
Nails and Screws.....	135	Wall Sheep Feeding Rack.... Waste Basket.....	94 36-37
Orchard Ladder.....	108-109	Water Trough.....	126
Orchard Ladder.....	113-115	Wire Tightener.....	71
Packing Table for Barrel of Apples.....	120-121	Wood Basket.....	53
Packing Table for Box Apples.	118-119	Wood Box.....	50-51
		Wood Working Tool Rack....	26-27

A COURSE IN FARM WOODWORK

It should fulfill the following conditions:

- a. Each project must be useful on the farm when completed.
- b. The course must give practice in all of the carpentry tool operations.

Carpentry Tool Operations

- | | |
|------------------------------------|--------------------------|
| 1. Rip sawing | 15. Chiseling |
| 2. Cross grain sawing | a. With grain |
| 3. Leveling | b. Cross grain |
| 4. Plumbing | 16. Nailing |
| 5. Erecting | 17. Nail setting |
| 6. Tool sharpening | 18. Nail pulling |
| a. Saw filing | 19. Screw driving |
| b. Grinding | 20. Screw drawing |
| 7. Measuring | 21. Counter sinking |
| 8. Squaring a line at right angles | 22. Tapering |
| 9. Planing | 23. Scraping |
| 10. Laying out chamfer | 24. Sanding |
| 11. Laying out and cutting bevel. | 25. Round surface edging |
| 12. Boring | 26. Mortising |
| 13. Doweling | 27. Wood filing |
| 14. Mitering | |

FARM CARPENTRY TOOLS

The following is a complete list of farm carpentry tools. With these tools at hand it is possible to do the ordinary construction and repair work which require wood working tools on the farm.

As a means to aid in preventing the loss of tools and to conserve time oftentimes wasted in looking for tools which have been mislaid it is advisable to have a definite place for the tools in the farm shop, granary, implement shed or other convenient place and also to have a definite place on the wall for each tool. This place for each tool may be indicated by a silhouette of the tool being painted on the wall where the tool is to hang. The picture of the tool on the wall serves as a reminder that the tool is out.

It is far better to have the tools hang on the wall over the work bench where they may be placed and removed instantly than to have them thrown into a tool box where time is consumed and patience taxed digging around for what is desired.

Woodworking tools to work efficiently must be free from rust. This may be accomplished by having handy a dry rag or handful of waste and wiping the tools as they are brought in and then covering them with a coat of oil. The oiling may be accomplished quickly by wiping the saws and other tools with a rag or handful of waste soaked in oil. A thin coat of any oil will prevent rust.

Fig. 1 illustrates the wall of the farm shop over the work bench.

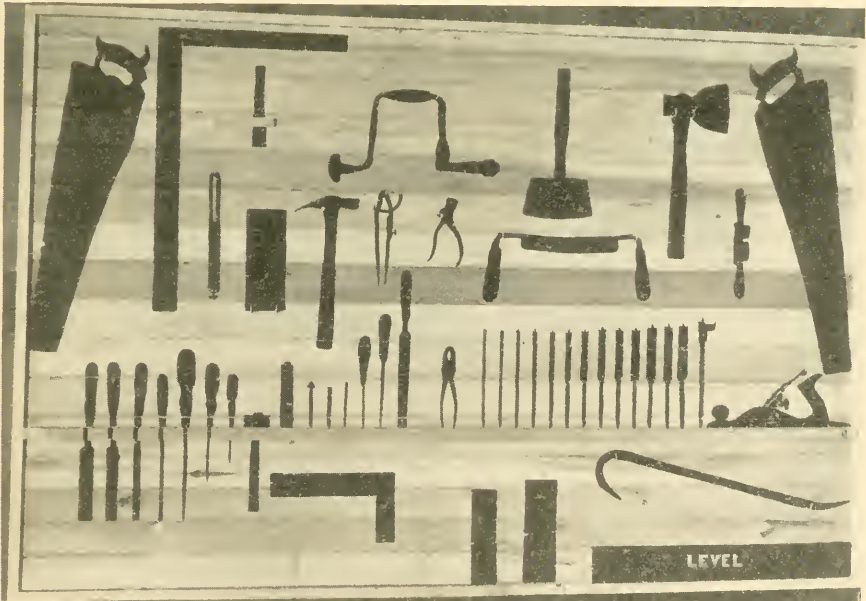


Fig. 1. Farm Shop Woodwork Tool Rack with Tools Removed.

FARM CARPENTRY TOOLS

- | | |
|---|--|
| 1—26" Cross Cut Saw | 1—8" Triangular file |
| 1—26" Rip Saw | 1—6" slim tapered triangular file |
| 1—Jack plane—14" with 2" cutter | 1—12" Half-round wood file |
| 1—Carpenter's draw knife | 1—8" Oblong carborundum oil stone |
| 1—Marking gauge | 1—16-oz. Straight claw hammer |
| 1—8" try square | 1—24" Carpenter's level |
| 1—Mallet | 1—Putty knife |
| 1—Saw set | 1—Nail set |
| 1—Set of Auger Bits, 4/16" to 16/16"
inclusive | 4—Socket firmer chisels, ¼", ½", 1"
1½" |
| 1—Expansion bit | 1—2-lb. 2-oz. Bench hatchet |
| 1—Ratchet Brace | 1—2-ft., four-fold boxwood rule |
| 2—Screwdrivers, 1 large, 1 small | 1—Cross cut saw tool |
| 1—Countersink | 1—Pinch bar |
| 1—Steel rafter framing square | 1—Spoke shave |
| 1—Pair pliers | 1—Screwdriver bit |
| 1—10" flat file | 1—Pair 8" winged dividers |
| 1—Auger bit file | |

FARM SHOP EQUIPMENT FOR SCHOOLS

Wood Working

Necessary Equipment

Amount	Item
1	—1½ inch brad awl
1	—Set bits ¼ inch, 5/16 inch, 3/8 inch, 7/16 inch, ½ inch, 5/8 inch ¾ inch 7/8 inch, 1 inch
1	—Countersink, Rose
2	—Screwdriver bits, 3/8 inch tip and 5/16 inch tip
2	—Bit braces, 8 inch sweep
12	—Chisels, socket, firmer, 2-¼ inch, 1-3/8 inch, 4-½ inch, 1-5/8 inch, 3-7/8 inch, 1-1 inch
4	—Dividers, 8 inch, loose leg, wing
1	—Set twist drills, 1/8, 3/8 by 32nds, square shank
1	—File, mill cut, 6 inch
1	—File, mill cut, 10 inch
6	—Files, slim taper, triangular, 6 inch
2	—Files, slim taper, 5 inch
1	—File, auger bit
1	—File card (cleaner)
6	—Gauges, marking, plain
1	—Glass cutter, turret head
1	—Grindstone, 2"x24", ball-bearing, mounted with foot pedal
1*	—Carpenter's hammers, equal number bell face, adze eye, curved claw; and plain face, straight claw
1	—Drawing knife, 8 inch
1	—Level and plumb, wood, 26 inch
1	—Level stand and sights
1	—Mallet (or more if home made)
3	—Nail sets (assorted)
1	—Oiler
1	—12 inch half round wood file
4	—Wood screws (adjustable) two 8 inch, two 12 inch
2	—4 ft. steel bar carpenter's clamps
1	—Oilstone, coarse and fine face carborundum
1	—Oilstone, round edge slip
1*	—Plane, jack, 14 inch iron, 2 inch cutter
3	—Pliers (assorted)
1	—Punch, center
1	—Putty knife
2	—Saws, cross cut, 22 inch, 10 point
3	—Saws, cross cut, 24 inch, 10 point
1	—Saw, cross cut, 26 inch, 8 point
2	—Saws, rip, 26 inch 5 point
1	—Saw, compass, 16 inch
2	—Saws, coping, metal handle

- 1 —Saw, hack, 10 inch, with one doz. blades.....
- 1 —Saw set
- 1 —Saw vise (home made).....
- 3 —Screwdrivers, 4 inch, 8 inch and 10 inch.....
- 3 —Sliding T bevels, two 6 inch, one 8 inch.....
- 2 —Squares, steel 18 inch x 24 inch, polished, (rafter framing).....
- 1*—Squares, try, 8-inch blades, wood handle.....
- 1 —Square, mitre (blade fixed at angle of 45°).....
- Tape in case—100 ft.....
- 1-inch iron bench screw for home made bench vise. (1 for each vise
 needed.)
- 1 —Blacksmith's vise, 3½-inch jaw.....
- 1*—Bench stops (home made).....
- 1 —10-inch monkey wrench.....
- 1*—Two-foot rules, four fold.....
- 1*—Bench hook (home made)

*Equipment needed in sets of one for each boy.

Additional Desirable Equipment

- 1 —1½-inch scratch awl.....
- 1 —Expansion bit ¾ inch, 3 inch.....
- 1 —Bit brace, 12-inch sweep (ratchet with jaws holding square shank
 drills)
- 1 —Chalk line with reel to fit scratch awl.....
- 1 —Carpenter's chalk
- 1 —File, bastard cut, 8 inch
- 1 —File, bastard cut, 12 inch.....
- 1 —File, round, 10 inch.....
- 1 —Gauge, mortise
- 1 —Gauge, ½ inch, inside firmer.....
- 1 —Hand axe
- 1 —Cross cut saw tool.....
- 1 —Cross cut set gauge
- 1 —Cross cut saw set.....
- 2 —Planes, block, 6 inch adjustable.....
- 1 —Plane, smooth, 9-inch iron, 2-inch cutter.....
- 1 —Plane, fore, 18-inch iron, 2-inch cutter.....
- 1 —Plumb bob
- 1 —Spoke shave, two cutters, 1 straight, 1 curved.....
- 1 —Floor brush

Blacksmith's Tools

Necessary Equipment

- 1 —Anvil, 80 or 100 lbs., steel with hardened face.....
- 1 —Hardie to fit anvil.....
- 6 —Cold chisels (assorted sizes ¾ inch to 5/8 inch).....
- 1 —Set of drills, 1/8 inch to 1/2 inch by 16ths, with square shank to fit bit
 stock

- 1 —Breast drill with chuck to take square shank fitting bit stock.....
- 1 —Forge, portable, with hood and tub.....
- 1 —Hammer, blacksmith's 2 lb.....
- 1 —Hammer, ball pein, 24 oz.....
- 1 —Hammer, riveting 10 oz.....
- 1 —Punch, center.....
- 1 —Tongs, 18-inch length, straight lip, 1/4-inch opening.....
- 1 —Tongs, bolt 3/8 inch, 1/2-inch opening.....
- 1 —Tongs, 18-inch length, fluted jaw, for 1/4 inch, 5/6-inch iron.....
- 1 —Emery or carborundum high-g geared grinder with 1 coarse and 1 medium grit wheel.....
- 1 —Steel square 8 inch x 12 inch.....
- 1 —Set, stock, dies and taps 3/16 inch, 26 threads, 1/4 inch, 20, 5/16 inch, 18, 7/16 inch, 1/2 inch, 14 for threading bolts and nuts.....

Desirable Equipment

- 1 —Drill, 5/8 inch, 1/2 inch shank.....
- 1 —Drill press, self feed, with chuck to take square shank twist drills...

Pipe Fitting (Desirable)

Necessary Equipment

- 1 —Cutter, 3 wheel, cutting 1/4 inch, 2 inch.....
- 1 —Stock and dies, Armstrong type, cutting 1/4 inch, 1/2 inch, 3/4 inch, 1 inch, 1 1/4 inch, 1 1/2 inch, and 2 inch threading pipe.....
- 1 —Pipe vise, capacity 1/2 inch, 2 inch.....
- 1 —Wrench, 18-inch Stillson pattern, iron handle.....
- 1 —Wrench, 12-inch Stillson pattern, iron handle.....

Tinning

Necessary Equipment

- 1 —Soldering scraper.....
- 1 —Blow torch.....
- 2 —Coppers, 2 lb.....
- 1 —Snips, 3 1/2-inch cut.....
- 1 —Bar solder, half and half.....
Muriatic acid and zine.....
- 1 —Sal ammoniac.....

Harness Repair

Necessary Equipment

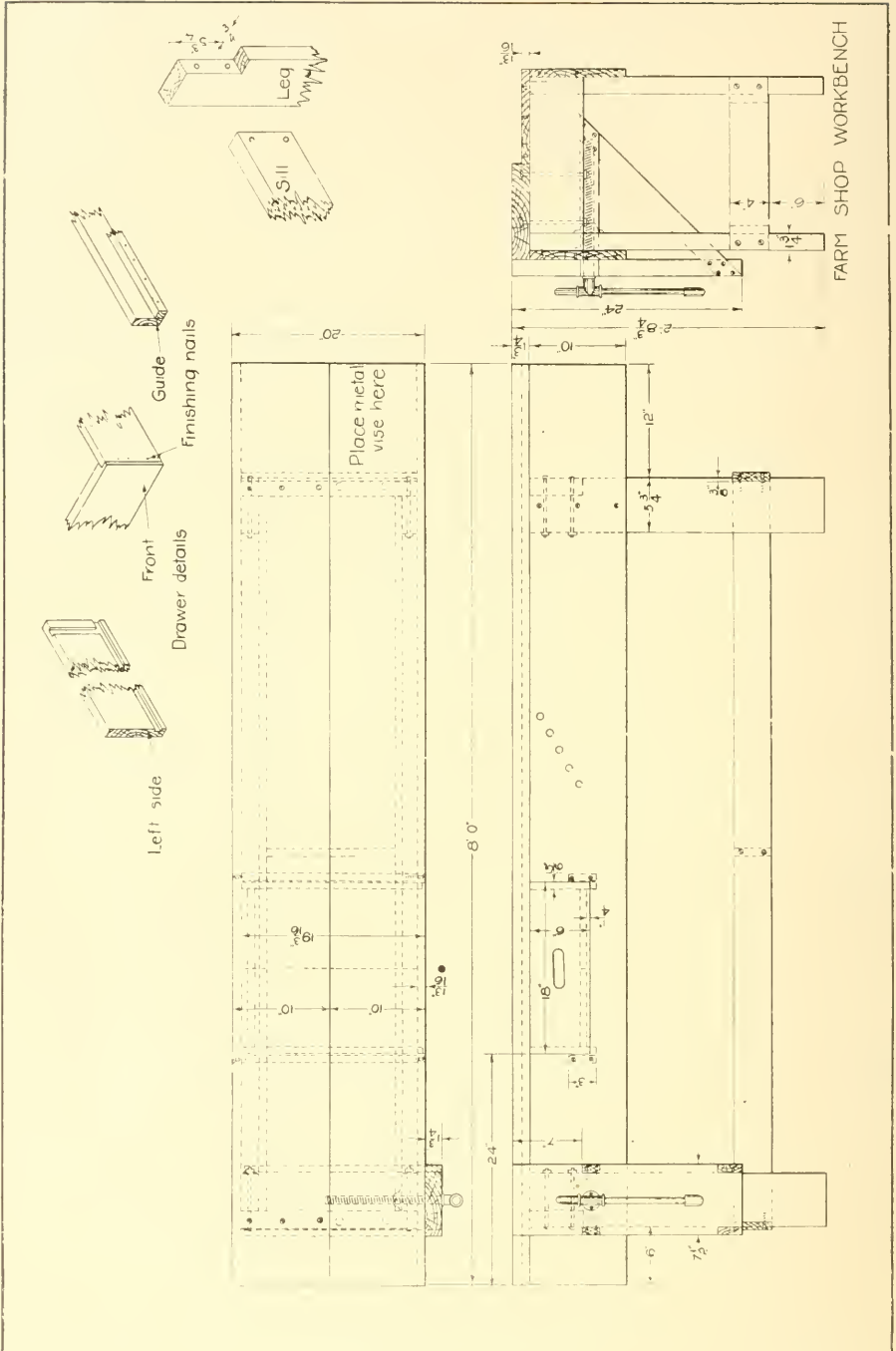
- 1 —Claw tool.....
- 1 —Pricking wheel.....
- 12—Sewing awls, assorted.....
- 6 —Awl hafts.....
- 1 —Knife, harness maker's straight.....
- 1 —Punch, revolving 4 tube.....
- 1/4—lb. Black shoemaker's wax.....
- 2 —Paper needles assorted sizes.....
- 6 —Balls harness thread No. 10 white.....
- 1 —Box 50 assorted split rivets.....

1	—Round knife, 5 inch.....
1	—Rex riveting machine.....
1	—Common edge tool.....
1	—Finishing wheel No. 40.....
1	—Single edge creaser.....
1	—Rivet set.....

Harness Repair Parts

	Harness oil.....
6	—1 inch sham roller buckles.....
6	—1 inch wire bent heel harness buckles.....
6	—Repair clips for end of hames.....
6	—Wrought iron $\frac{3}{8}$ inch hame clips.....
2	—Doz. $\frac{3}{8}$ inch hame staples with washers.....
6	—Bottom hame repair loops.....
4	—Common line rings and studs.....
4	—Pairs, hold back plates and rings.....
1	—lb $1\frac{1}{4}$ inch soft iron hame rivets.....
1	—Pair over top wood hames 20 inch.....
1	—Black, $\frac{3}{4}$ pound cake harness soap.....
4	—Boxes tubular harness rivets (assorted).....
2	—Doz. Conway loops assorted.....
1	—Box serew cockeyes $1\frac{3}{4}$ inch.....
$\frac{1}{2}$	—Doz. Wrot Concord Clips.....
1	—Box assorted repair dees.....
$\frac{1}{2}$	—Doz. 1 inch buckle shield No. 1.....
1	—Doz. repair roller buckles.....
1	—Doz. assorted snaps.....
$\frac{1}{2}$	—Doz. team trace splicers.....
1	—qt. Miller's edge ink.....
1	—Doz. hame buckles and loops.....
1	—Doz. 1 inch halter squares.....
1	—Doz. assorted rings $\frac{3}{4}$, $\frac{7}{8}$ inch, 1 inch (black).....
2	—Doz. assorted $\frac{3}{4}$, $\frac{7}{8}$, 1 inch leather slide loops.....
1	—Side harness leather for general work.....
1	—Package $\frac{1}{2}$ inch swede tacks.....
$\frac{1}{2}$	—lb. Soft iron rivets assorted $\frac{3}{8}$ inch to $\frac{7}{8}$ inch.....

FARM SHOP PROBLEMS



FARM SHOP WORK BENCH

Bill of Material

Lumber for bench:	Dimensions	Use
Pieces		
1	1 3/4" x 10" x 8' 0"	Top (Maple or other hard wood)
1	1 3/8" x 10" x 8' 0"	Top (soft wood)
4	1 3/4" x 5 3/4" x 2' 7"	Legs
2	1 3/4" x 5 3/4" x 18 3/8"	Sills
2	1 3/8" x 4" x 18 3/8"	End braces
2	1 3/8" x 4" x 6' 5 1/4"	Long braces
1	1 3/8" x 4" x 13 1/4"	Cross brace
2	1 3/8" x 10" x 8' 0"	Aprons
2	1 3/8" x 3" x 18 3/8"	Drawer guides
2	1 3/8" x 1 3/8" x 18 3/8"	Drawer guides
1	1 3/8" x 6" x 18"	Drawer front
2	1 3/8" x 6" x 19"	Drawer sides
1	1 3/8" x 4 1/8" x 17"	Drawer back
2	1 3/8" x 9 3/8" x 16 3/8"	Drawer bottom
Lumber for vise:		
1	1 3/4" x 7 1/2" x 24"	Jaw (oak, maple or other hardwood)
2	1 3/8" x 2" x 17"	Horizontal braces (oak, maple or other hardwood)
2	1 3/8" x 2" x 2' 7 1/2"	Diagonal braces (oak, maple or other hardwood)
Hardware for bench:		
	7 carriage bolts 3/8" x 6 1/2" with washers, for holding sills to legs.	
	1 carriage bolt 3/8" x 6" with washer, for holding sill to leg.	
	4 carriage bolts 3/8" x 7" with washers, for holding top to sills.	
	40 flat head bright wood screws, 1 3/4" No. 8 or 9 for fastening top board, aprons, braces, and drawer guides.	
	20 6d common nails for fastening long braces to legs.	
	1 doz. 4d. common nails for assembling drawer guides.	
	1/4 lb. 6d. finishing nails for assembling drawer.	
Hardware for vise:		
	1 iron bench screw 7/8" or 1" with handle.	
	4 flat head bright wood screws 1 1/2" No. 12 for fastening bench screw to jaw.	
	8 flat head bright wood screws 2" No. 12 for fastening braces to jaw.	
	8 flat head bright wood screws 3/4" No. 8 for fastening braces at joints.	

Directions

Dry lumber should be used for all parts of the bench and vise. Soft lumber may be used for all parts excepting the vise and top plank. Oak, maple, hard pine or other hard lumber should be used for these members. All lumber should be surfaced on two sides to the thicknesses called for in the drawing.

1. Cut the legs to length 2' 7", and lay out the mortises at one end of each leg to receive the ends of the sills as shown in the detail drawing 13 3/4" x 5 3/4" removing the stock with the cross cut and rip saws.

A 6 1/2" bolt at the top of the back leg at vise end would prevent the vise from closing. This is overcome by cutting 1/2" out of the edge of the leg at the top and using the 6" bolt.

2. Lay out the gains on the outside edges of the legs, 3/8" deep, 4" wide and 6" from the bottom ends to receive the cross braces.

3. Cut the sills to length, 18 3/4" and fasten them to the legs with two 3/8" x 6 1/2" carriage bolts at each joint. Use the square to assure right

angles between the legs and sills.

4. Fasten the cross braces to the legs using two $1\frac{3}{4}$ " No. 8 or 9 flat head screws at each joint.

5. Cut the long braces to dimensions and fasten them in place, using five 6d common nails at each joint. Make sure that the legs stand at right angle to the long braces.

6. Cut the middle cross brace to length $13\frac{1}{4}$ " and fasten to the two long braces with two $1\frac{3}{4}$ " No. 8 or 9 flat head screws at each end.

7. Cut an opening in the upper edge of the front apron 18" long and 6" deep, 24" from the front end of the board for the drawer.

8. Fasten the aprons to the legs, using three $1\frac{3}{4}$ " No. 8 or 9 flat head screws at each leg except the vise leg on which the middle screw is omitted because of the bench screw.

9. Lay out the mortises on the front apron for the horizontal braces of the vise so that the top of the mortises are 7" from the top of the bench or $5\frac{1}{4}$ " from the top of the apron, and so that the inside of the mortises fall flush with the sides of the legs. The mortises should be made slightly larger than the braces to provide a free working of the braces through the mortises.

10. Locate and bore a hole for the bench screw with a bit $1/16$ " larger than the bench screw thru the apron and legs on a center line of the leg $7\frac{1}{2}$ " from the top of the bench, or $5\frac{3}{4}$ " from the top of the apron.

11. Place the bench screw through the hole and fasten the screw washer in place on the inside of the leg with two $1\frac{3}{4}$ " No. 12 flat head wood screws.

12. The braces for the vise are assembled at the half lap joint and placed thru the apron from the inside and fastened to the jaw of the vise with two No. 12 flat head wood screws at each brace.

13. Assemble the drawer guides as shown in the detail drawing, using six 4d common nails for each guide, and fasten in position, using two $1\frac{3}{4}$ " No. 8 or 9 flat head screws at each end of each piece.

14. The methods of constructing a drawer depends somewhat upon the tools and machines at hand. If a grooving plane, buzz saw or dado saw are at hand, the method suggested in the detail drawings is to be preferred.

It will be noted that grooves are cut in the side pieces near the lower edge and also near the rear end to receive the bottom and end pieces. A groove is also cut in the drawer front at the inside near the bottom to receive the front end of the bottom. The drawer front should be constructed at both ends as shown in the detail drawings. If the above tools are not at hand this may be done with saw, chisel and mallet. Simple box construction where only butt joints are used makes a very substantial drawer if securely nailed. Six penny finishing nails may be used.

15. For a drawer pull in this place an opening 1" wide by 4" long

is preferable to a drawer pull which is fastened to the outside of the drawer, as it is out of the way.

16. Lay the top plank in place, clamp tightly, and draw lines across over the center of the cross sills.

17. On each line just drawn locate two points; one $1\frac{1}{2}$ " from the back edge and one $3\frac{1}{4}$ " from the front edge.

18. Bore holes $\frac{3}{4}$ " deep on points just located with $\frac{7}{8}$ " bit.

19. Continue holes thru planks and into sills with $\frac{3}{8}$ " bit.

20. Remove planks and continue holes thru sill.

21. Place planks in position and fasten with $\frac{3}{8}$ " x 7" carriage bolts, using one washer for each bolt.

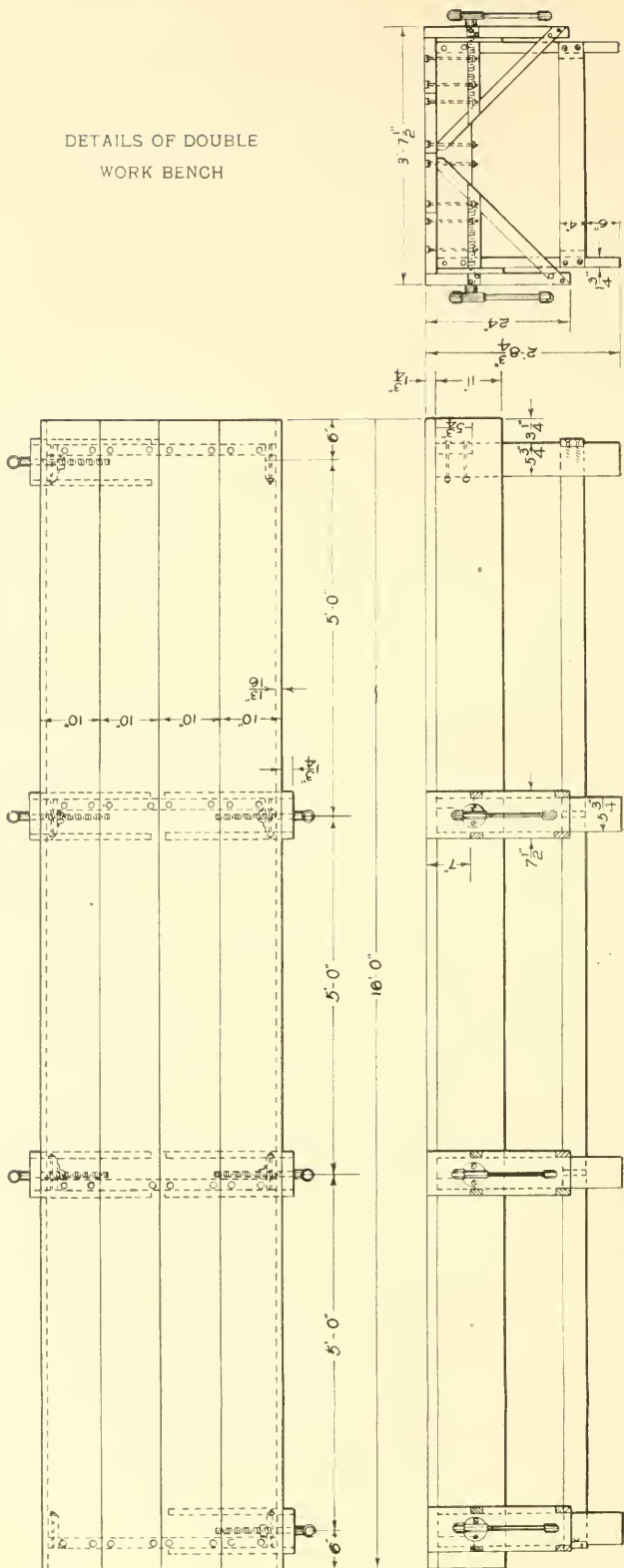
22. Plug the holes in the top of the plank.

23. Fasten the top board by using three $1\frac{3}{4}$ " No. 8 or 9 flat head screws thru the board into each sill.



Fig. 2. Another View of the Farm Shop Work Bench and Farm Woodworking Tools.

DETAILS OF DOUBLE
WORK BENCH



A SIX-STUDENT WORKBENCH FOR THE RURAL HIGH SCHOOL

A demand for a woodworking bench, at which a number of boys can work, caused the bench illustrated in Figs. 3 and 4 and described here to be designed and built. The bench has been made and used successfully in a number of rural high schools where space and funds will not allow the purchase and use of the familiar individual type of bench.

Bench Stop—Bill of Material

Pieces	Dimensions	Use	Material
1	¾"x1"x8"	Left side	Soft wood
1	¾"x4½"x8"	Wedge	Soft wood
1	¾"x4"x8"	Right side	Soft wood
5 flat head, bright wood screws 1½" No. 8 or 9.			

Vise—Bill of Material

Pieces	Dimensions	Use	Material
1	1¾"x7½"x24"	Jaw	Oak, maple or hard pine
2	1½"x2"x17"	Horizontal brace	Oak or maple
2	1½"x2"x2' 7½"	Diagonal brace	Oak or maple
1 iron bench screw ⅞", 1' or 1½".			
4 flat head, bright wood screws 1½", No. 12, for fastening vise to jaw.			
8 flat head, bright wood screws 2", No. 12, for fastening braces to jaw.			
8 flat head, bright wood screws ¾", No. 8, for fastening braces at joint.			

Workbench—Bill of Material

Pieces	Dimensions	Use	Material
4	1¾"x10"x16"x10"	Top	Hard wood
8	1¾"x5¾"x2' 7"	Legs	Soft wood
4	1¾"x5¾"x3' 2¾"	Sills	Soft wood
2	1½"x4"x3' 2¾"	End cross braces at bottom	Soft wood
2	1½"x4"x2' 10⅞"	Cross braces at bottom	Soft wood
2	1½"x4"x4' 11⅜"	Middle horizontal braces at bottom	Soft wood
2	1½"x4"x5' 1⅞"	Horizontal braces at bottom	Soft wood
2	1½"x11"x16' 0"	Aprons	

32 carriage bolts ⅝"x7" with washers for bolting top to sills.
 16 carriage bolts ⅝"x6½" with washers for bolting sills to legs.
 4½ dozen flat head, bright wood screws 1½", No. 8 or 9, for fastening braces and aprons to legs.
 16 8d finishing nails for toenailing the two middle cross braces to the legs.

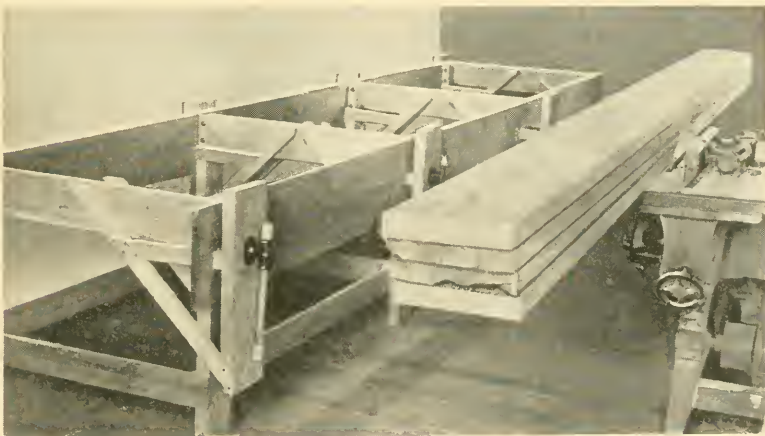
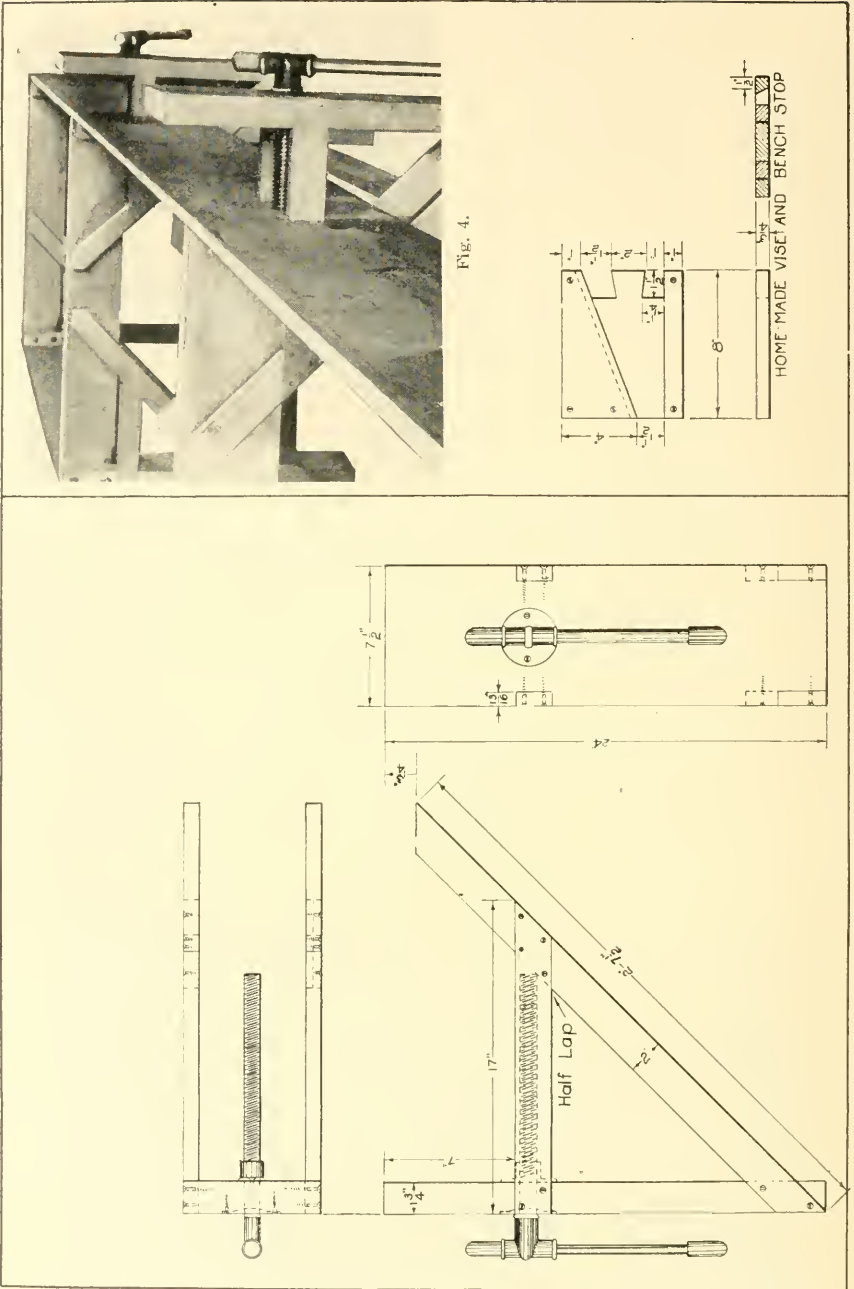


Fig. 3. Rural School Work Bench (Top Removed to Show Framing and Vises.)



DETAILS OF VISE AND BENCH STOP

Directions

All lumber for the bench should be thoroly dry. The top can best be made of hard pine planks which should be planed on both sides and jointed. If they are gotten out at a mill it is well to have them dressed to exactly ten inches in width and matched at the mill so that they will draw up to tight joints and make a top of exactly forty inches.

Pieces narrower than ten inches cannot be used for the top of a double bench where this kind of vise is used as the upper ends of the horizontal braces interfere with each other. It may be noted in the illustration that the points have been sawed off so as to prevent interference when opposite vises are closed at the same time.

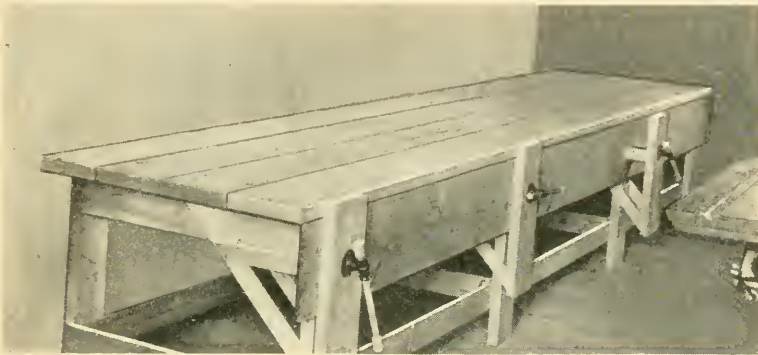


Fig. 5. Rural School Work Bench with Six Vises.

1. Cut the eight legs to exactly the same length, 2' 7" and lay out the mortises $1\frac{3}{4}$ " x $5\frac{3}{4}$ " on one edge at one end of each piece and cut the mortises with the cross-cut saw and rip saw. (Do not split out the wood for the mortises.)

2. Cut the four sills to exactly the same length, 3' $2\frac{3}{8}$ ", and fasten to the legs with two $\frac{3}{8}$ " x $6\frac{1}{2}$ " carriage bolts at each joint. It is well to measure the exact width of the four planks and the thickness of the two aprons and regulate the length of the sills accordingly. Any deviation from the widths called for in the drawing must be corrected here.

3. Measure and cut the two lower end cross braces to the same length as the sills, 3' $2\frac{3}{8}$ ", and fasten with two $1\frac{1}{2}$ " No. 8 or 9 flat head wood screws at each end of each piece.

4. Measure and cut the horizontal braces to the lengths called for in the above bill of material and fasten to the legs with three $1\frac{1}{2}$ " No. 8 or 9 flat head wood screws at each end of each piece. The two middle lower cross braces should be cut to their length, 4' $11\frac{3}{16}$ ", and placed in position at the same time as the lower horizontal braces as they butt against the legs between the horizontal braces. They should be fastened by toenailing with two 8d finishing nails from each side.

5. Fasten the aprons in the positions with three $1\frac{1}{2}$ " No. 8 or 9 flat head wood screws. Avoid placing a screw in the center where it will interfere with the bench screw.

6. Lay out the mortises in the apron for the horizontal braces of the vise so that the top of the mortises are 7" from the top of the bench or $5\frac{1}{4}$ " from the top of the apron and so that the inside of the mortises falls flush with the sides of the legs. The mortises should be made slightly larger than the braces so that the braces will work thru them freely.

7. Locate and bore a hole for the bench screws with a bit $\frac{1}{16}$ " larger than the bench screw thru the aprons and legs on a center line of the leg, $7\frac{1}{2}$ " from the top of the bench, or $5\frac{3}{4}$ " from the top of the apron.

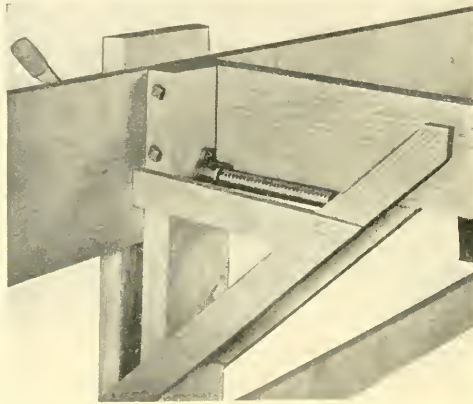


Fig. 6. Inside View of Vise.

8. Place the bench screw thru the hole and fasten the screw washer in place on the inside of the leg with two $1\frac{3}{4}$ " No. 12 flat head wood screws.

9. The braces for the vise are assembled at the half-lap joint and placed thru the apron from the inside and fastened to the jaw of the vise with two 2" No. 12 flat head wood screws at each brace.

10. Lay the top planks in place, clamp tightly, and draw lines across over the center of the cross sills.

11. Locate points on lines just drawn, $1\frac{1}{2}$ " from each edge of each plank, excepting the outside edge of the outside planks which are $3\frac{1}{4}$ ".

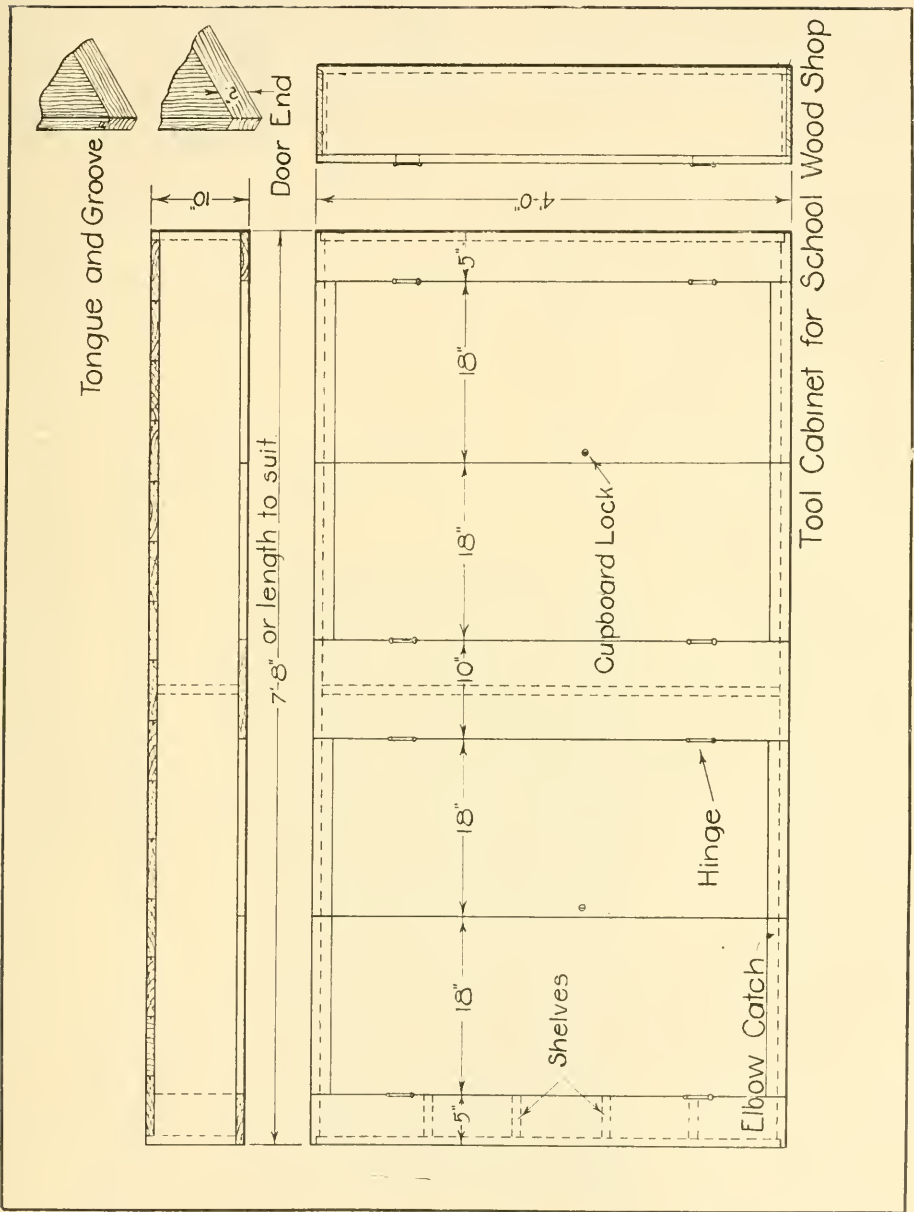
12. Bore holes $\frac{3}{4}$ " deep on points just located with $\frac{7}{8}$ " bit.

13. Continue holes thru planks and into sills with $\frac{3}{8}$ " bit.

14. Remove planks and continue holes thru sills.

15. Place planks in position and fasten with bolts, using one washer for each bolt.

16. Plug the holes in the top of the bench.



Tool Cabinet for School Wood Shop

<p>Saw Rack</p> <p>Length of rack determined by number of saws</p> <p>1/2" facing all along front</p> <p>Top member of saw rack</p> <p>Distance between members is determined by the length of saws</p> <p>Chamfer</p> <p>Saw kerf across stock</p> <p>Base member of saw rack</p>	<p>Rack for Chisels, Screwdrivers, Countersink, Wood Files & Nail Sets</p> <p>Length of rack and number of each kind of hole depends on number of tools of each kind</p> <p>1/2" holes for wood files and small screwdrivers</p> <p>5/8" holes for chisels and large screwdrivers</p> <p>Chisels</p>	<p>Twist Drill Case</p> <p>Screw hooks</p> <p>Case to be left on wall</p> <p>Try Square Bracket</p>
<p>Marking Gauge Rack</p> <p>1/2" facing all along front</p>	<p>Rack for Two-Foot, Four-Fold Rule</p> <p>1/2" holes squared at top for bits</p> <p>Rack for Bits</p> <p>Length determined by number of bits</p>	<p>Chamfer</p> <p>Saw kerfs</p> <p>Paint a silhouette of each tool on the wall</p>
<p>Planes may be placed on a shelf with the nose resting on a 1/4" wooden strip</p>	<p>To be hung on screw hooks:</p> <ul style="list-style-type: none"> T bevels Braces Mallets, with screw eye in end Dividers Coping saws Drawing knife Steel square 	<p>WOODWORKING TOOL RACKS</p>

It is recommended that the tool racks which are dimensioned on p. 26 be made of oak, maple or other hardwood. These racks are in use in the author's shop and not only hold the tools but hold them in such a way that they may be removed quickly and without loss of motion. It may be noted that the saw rack, Fig. 7, holds the saws in such a way that the workman may take a saw from the rack and use it without change of position of the hand.

As indicated by the silhouette of the draw shave on p. 26, it is very desirable to paint a silhouette of all tools where they are to hang. It encourages having a place for each tool and keeping it in that place when not in use.

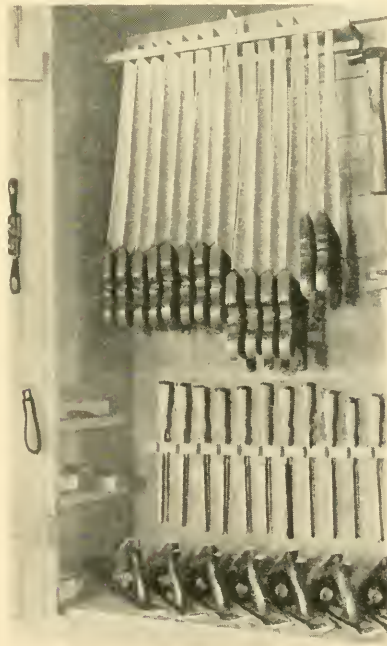
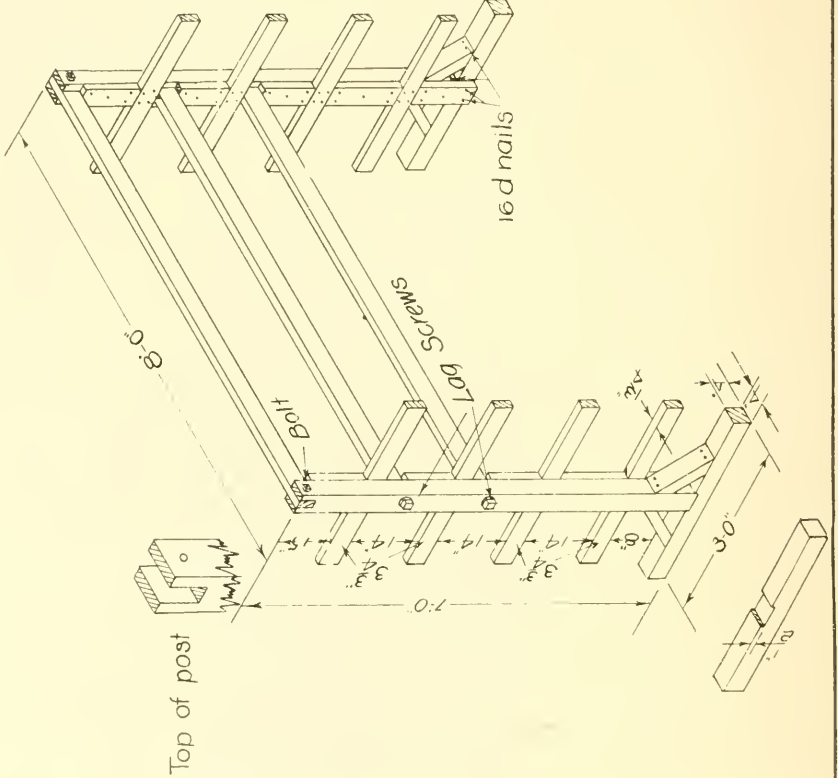


Fig. 7. Detail of Rack for Woodworking Tools.

Bill of Material

- 2 pieces 4"x4"x3'-0"
- 2 " 4"x4"x7'-0"
- 1 " $\frac{3}{4}$ "x $\frac{3}{4}$ "x8'-0"
- 2 " $\frac{3}{4}$ "x $\frac{3}{4}$ "x7'-4"
- 4 " $\frac{5}{8}$ "x $\frac{3}{4}$ "x11"-braces
- 8 " $\frac{3}{4}$ "x $\frac{3}{4}$ "x3'-0"
- 2 " $\frac{3}{4}$ "x $\frac{3}{4}$ "x12"
- 2 " $\frac{3}{4}$ "x $\frac{3}{4}$ "x14"
- 4 " $\frac{3}{4}$ "x $\frac{3}{4}$ "x10 $\frac{1}{4}$ "
- 2 " $\frac{3}{4}$ "x $\frac{3}{4}$ "x11 $\frac{1}{4}$ "
- 4-8" lag screws
- 3 lbs. 16d. common nails
- 2 carriage bolts $\frac{3}{8}$ "x4 $\frac{1}{2}$ "



LUMBER RACK

LUMBER RACK

In school shops and on the farms it is highly desirable that a place be provided for the storage of lumber and that this place be such as may be gotten at easily and so arranged that any piece of lumber may be taken from the stock on hand without moving large quantities.

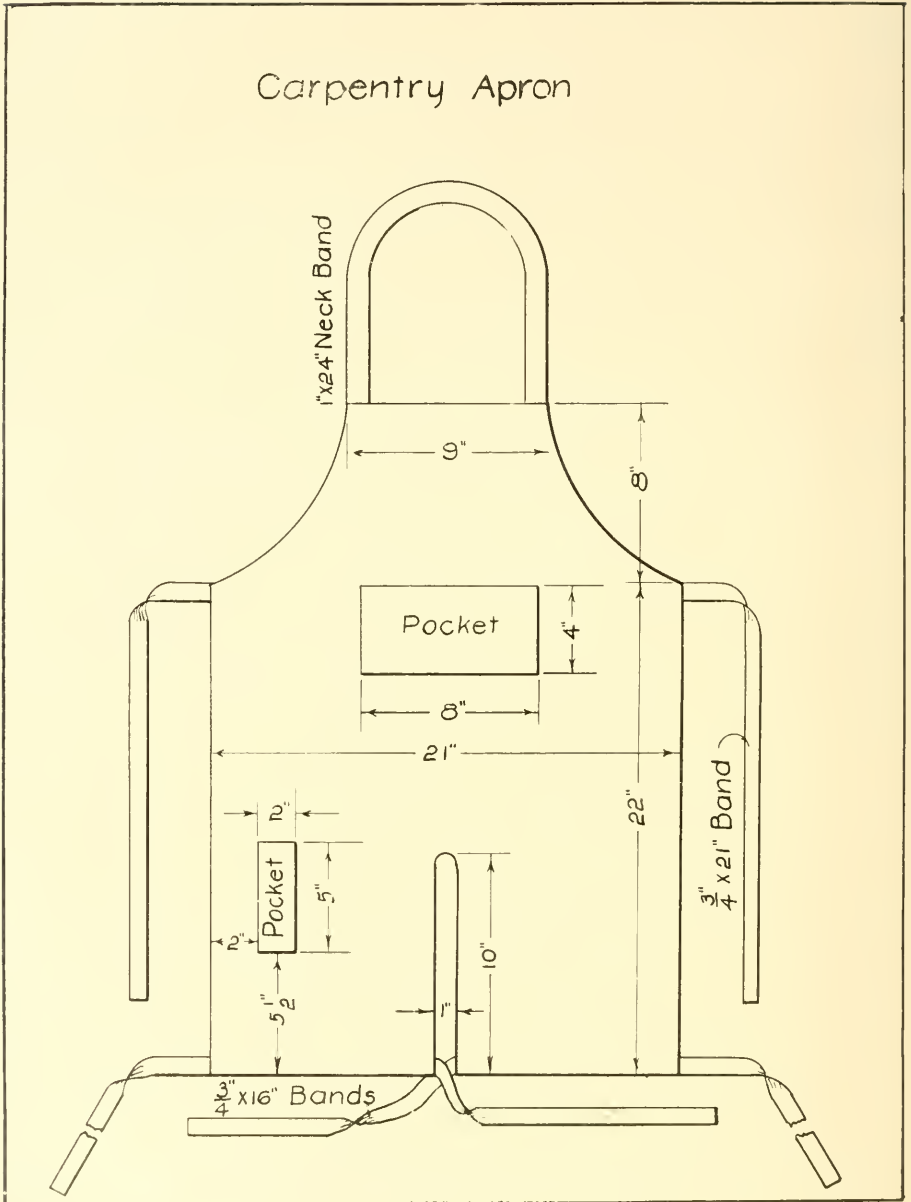
The particular arrangement of a shop makes a situation peculiar to that shop, due to space, light, windows, stairs, doors, benches, etc. and each farm presents a problem of its own. One farm may have space for lumber in the attic of the farm shop, while on another it may be required to store it in the implement shed, granary or elsewhere.

The drawing is one of a simple, yet serviceable, rack which may be placed in any of the above places. It is seldom that a large quantity of one kind of lumber need be kept on hand, but a variety is desirable. This rack, as may be noted, is provided with ten shelves to make this provision.

In some instances on farms, the 4" x 4" posts may be extended up and fastened to a joist, rafter or collar beam above and thus dispense with the long horizontal members.

It is difficult and often impossible to make a desirable finished article in farm wood work either in the school shop or home farm shop out of warped, weatherbeaten, knotty lumber or dry goods boxes. If it is desired in the school shop or home farm shops to make farm devices or appliances which will promote the mechanical end of farming it seems advisable to first obtain a quantity of such lumber, as a first-class carpenter would need to construct the desired articles and store it in a dry place on a lumber rack.

Carpentry Apron



CARPENTRY APRON

Denim or ticking is the material most commonly used. An apron of this size requires about $1\frac{1}{4}$ yards. No. 40 thread may be used, and the sewing machine should be set so as to make ten or twelve stitches to the inch.

Cut the apron to the measurements called for in the drawing. The measurements given in the drawing are for the finished apron and therefore $\frac{3}{8}$ " must be allowed on all edges to make a $\frac{1}{4}$ " hem.

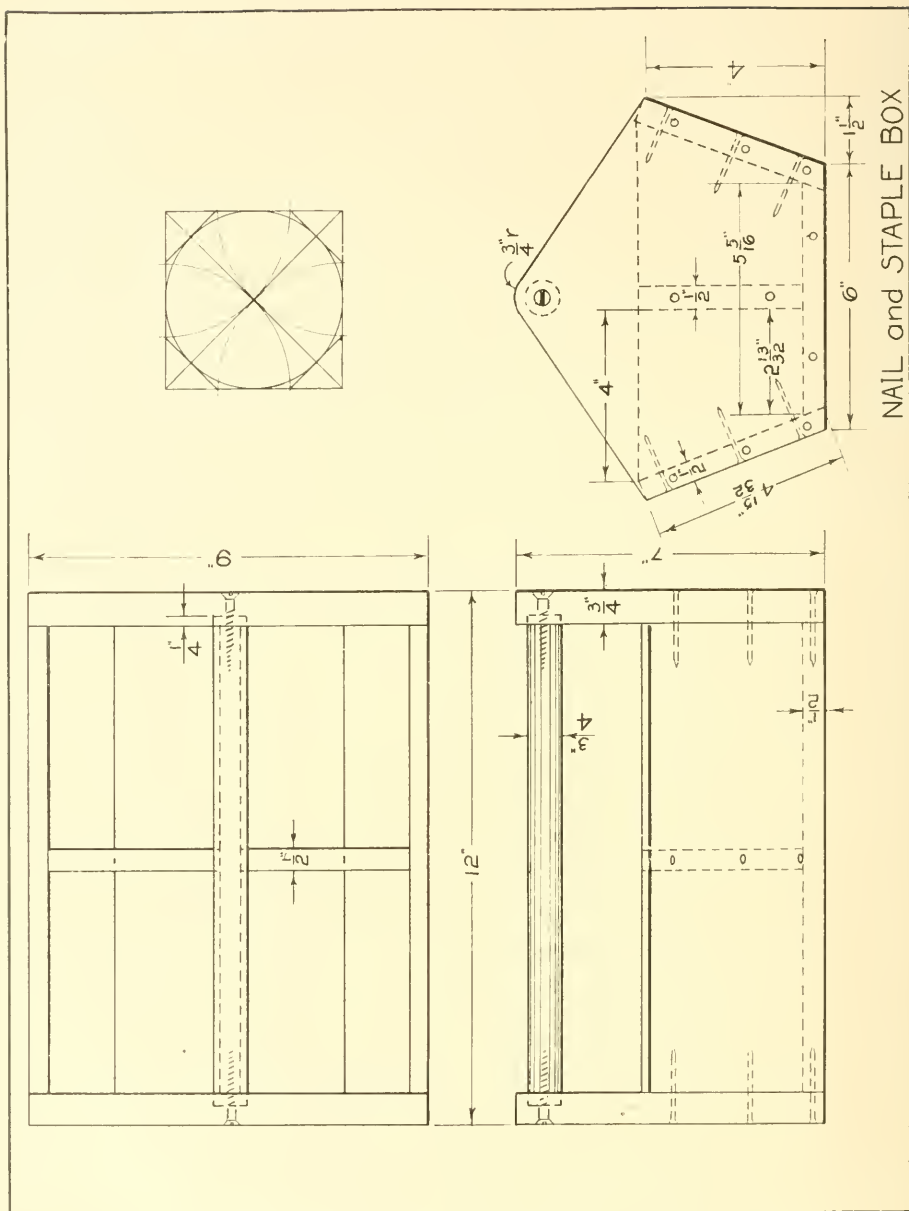
When dividing the apron at the bottom do not take a piece out, simply cut the slash the given length.

Turn and baste a $\frac{1}{4}$ " hem around the apron. As the hem is basted, slip the unfinished end of a strap under the hem at the correct place so that, when the hem is stitched, the strap is also stitched into place. Reinforce the corner of the slash at the bottom by facing it in a slight curve with a bias piece of material or by facing it with a shaped piece. Stitch the hem in place.

Bring the straps up at right angles to the edge of the apron and fasten them to the outer edge.

Press the apron.

Cut and hem the pockets. Crease a $\frac{1}{4}$ " turn around the unfinished edges. Press them and sew them in place.



NAIL AND STAPLE BOX

Material Required

- 1 piece of any soft wood 1"x9¼"x14½".
- 1 piece of any soft wood ½"x10"x26".
- 1 piece hard wood ⅞"x⅞"x11½".

Hardware

- 2 flat head bright wood screws 1¾" No. 10.
- 32 5d finishing nails.
- 2 1" No. 16 brads.

Stock Bill

Pieces	Dimensions	Use
2	¾"x9"x7"	Ends
2	½"x4-15/32"x10½"	Sides
1	½"x5 ⅞"x10½"	Bottom
1	½"x3 11/16"x10½"	Partition
2	½"x3 11/16"x3-25/32"	Cross Partitions
1	¾" round x11"	Handle

Directions

1. Reduce all pieces to finished dimensions.
2. Lay out an end piece by drawing a line across each edge 4" from the bottom end and two lines across the bottom end 1½" from edge. Connect lines across edges with lines across ends. Draw a center line lengthwise of stock on each side. At a point on center line on one side, ¾" from the top, bore a ¾" hole ¼" deep to receive handle. At a point on the centerline on the opposite side of the stock ¾" from end, swing an arc with a ¾" radius.

Draw lines on both sides of the stock from the lines across the edges tangent to the arc.

Remove stock to lines with the saw and smooth with the plane.

Smooth the rounding end of the stock with the chisel.

3. With the T bevel set at 12" on the beam and 4½" on the blade of the steel square lay out the bevels at the bottom edges of the sides, and both edges of the bottom and remove stock to line with plane.

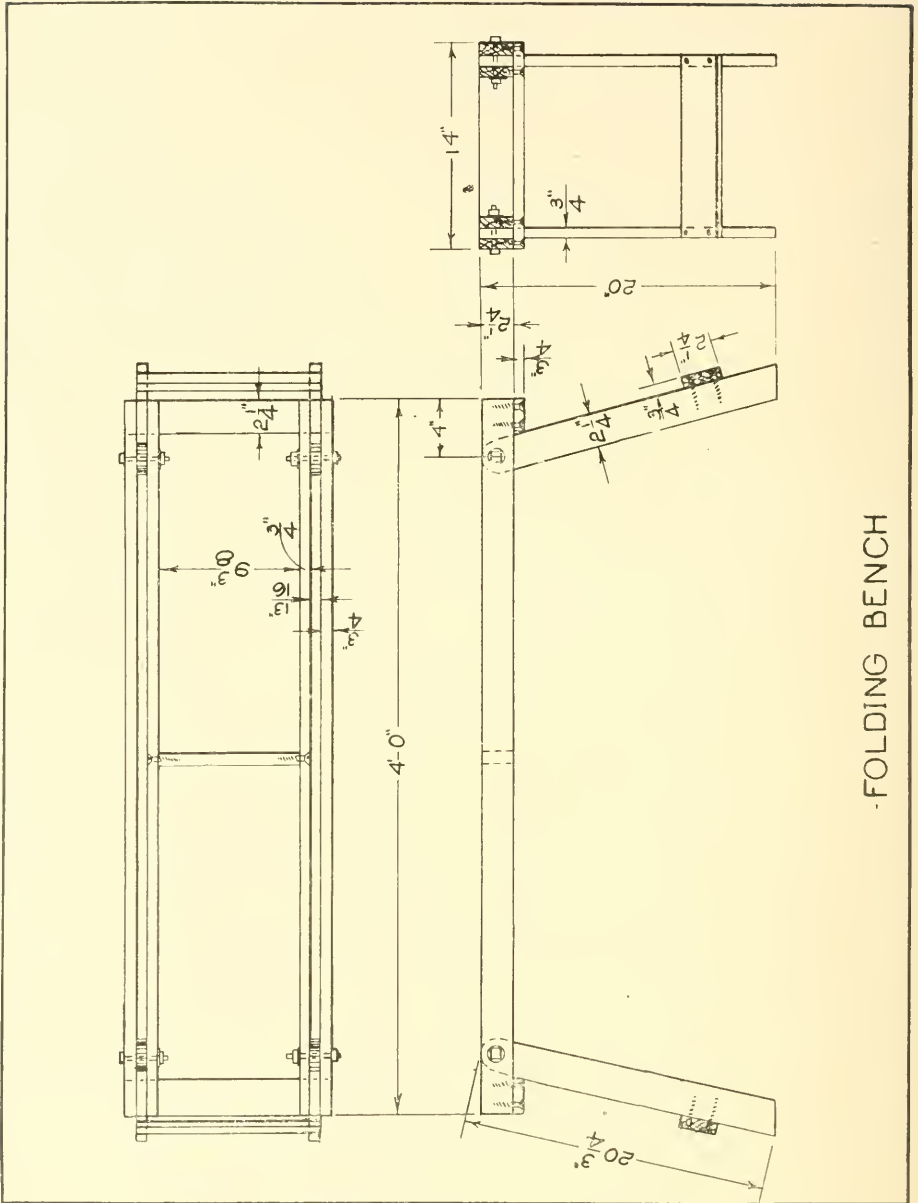
4. With the T bevel set as above, lay off the slant for the cross partitions and remove the stock with the saw.

5. Take the ¾" square piece of hardwood and at each end lay out an octagon as shown in the detail drawing, mark off the octagonal lines on the sides of the stock and remove the stock to lines with the plane. Continue rounding the stock by planing the corners.

6. Assemble the box by placing the handle in position and securing it with one 1¾" No. 10 flat head wood screw at each end and then fastening the sides to the ends by using three 5d finishing nails at each end of each piece spaced as shown in the drawing.

7. Place the box on the bench and lay the bottom in place, securing it with two 5d, finishing nails at each end.

8. On the centerlines which are at the ends of the end pieces, drive two 5d nails to hold the partition in place. Fasten the partition to the bottom by driving four nails into the partition from the bottom of the box.



9. The cross partitions are fastened by use of three nails thru the side of the box and one from the bottom. A 1" brad is used to toenail it to the long partition.

10. Finish by applying two coats of paint, allowing the first coat several days to dry before the second coat is applied.

FOLDING BENCH

Stock Bill

Pieces	Dimensions	Use
4	$\frac{3}{4}$ " x $2\frac{1}{4}$ " x 4' 0"	Platform
2	$\frac{3}{4}$ " x $2\frac{1}{4}$ " x 14"	Ends
4	$\frac{3}{4}$ " x $2\frac{1}{4}$ " x $20\frac{3}{4}$ "	Legs
2	$\frac{3}{4}$ " x $2\frac{1}{4}$ " x $12\frac{1}{2}$ "	Braces for legs
1	$\frac{3}{4}$ " x $2\frac{1}{4}$ " x $9\frac{3}{8}$ "	Center brace

Hardware: 28 flat head wood screws $2\frac{1}{2}$ " No. 10.

4 machine bolts $\frac{3}{8}$ " x 3" with two washers for each bolt.

Directions

Cypress lumber is desirable as it is not affected as much as most other soft woods by the constant drying and wetting which the bench is subjected to.

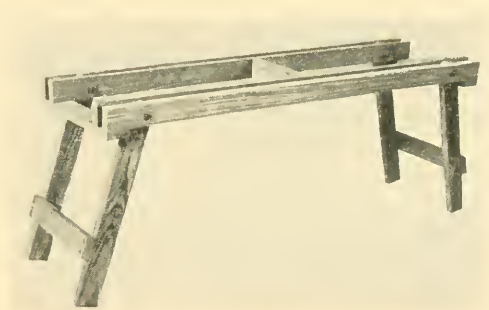


Fig. 8A. Folding Bench.

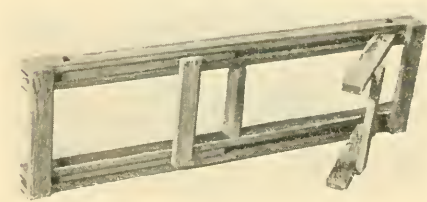
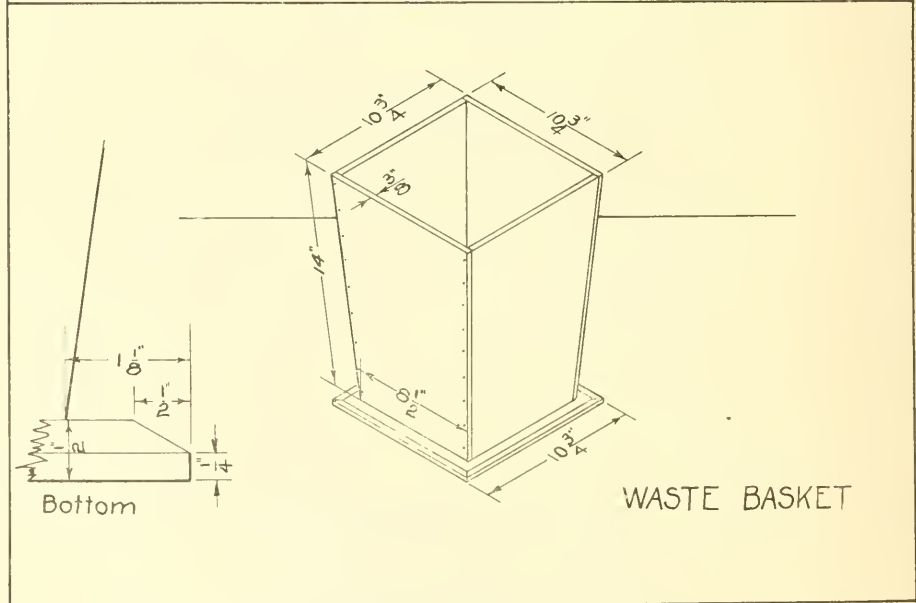
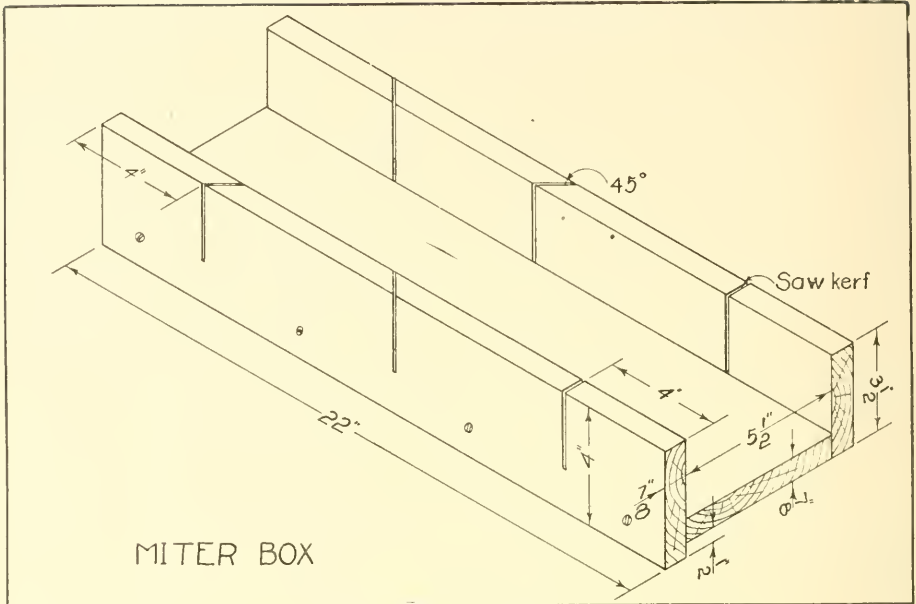


Fig. 8B. Bench Partly Folded.



MITER BOX

In farm woodwork it is in most instances unnecessary to plane the side of a board merely to remove the planer marks when the board is already of the required thickness. It is also unnecessary to plane the ends of a board if a good cut has been made with the saw. Much end planing indicates poor sawing, and it is suggested that one who cannot make an end cut on a board so that the end will be square with the side and edge, had better take a piece of scrap lumber and practice sawing until he can produce the desired result with the saw and not be required to fix it up with the plane. The result of each saw cut should be carefully analyzed and the error traced to its cause and overcome by direction thru the muscles of hand and arm.

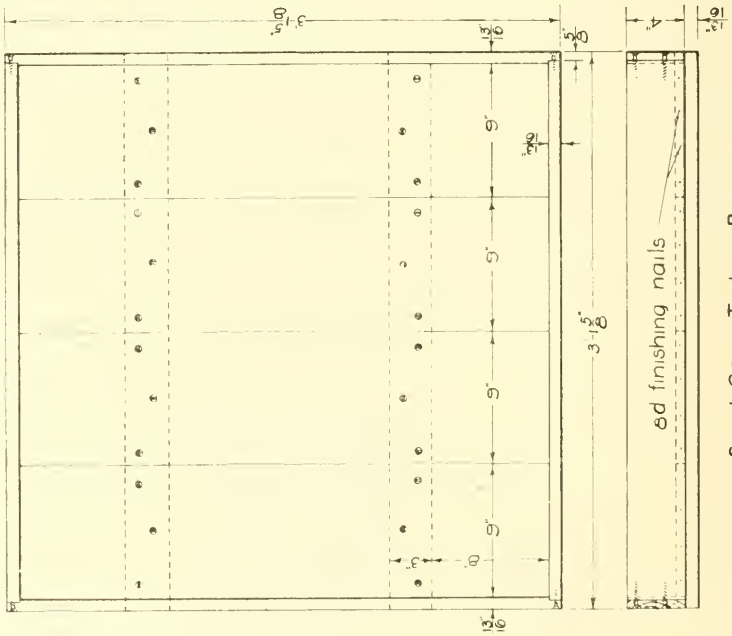
To do this requires skill, care and time. The miter box is a means of accomplishing the same result in less time, without skill or care. For the sake of time and convenience it is recommended that it be used only **after** one has acquired the skill to saw an end square at every attempt. If he does not acquire the skill but depends on the mitre box entirely, he will need to take the box with him wherever skill is required. It is easier to carry the skill.

WASTE BASKET

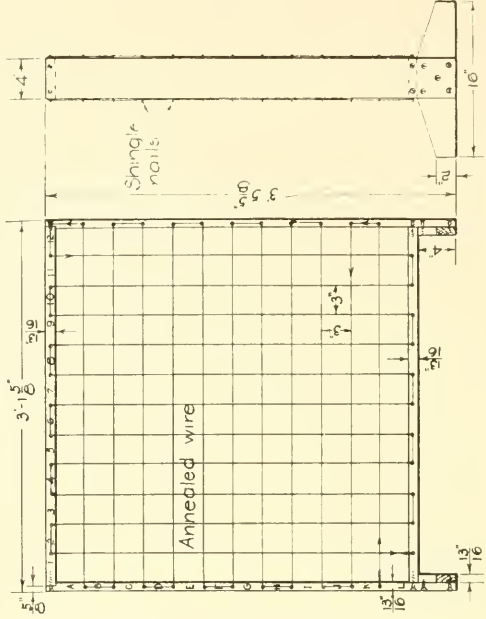
A waste basket with solid sides is to be preferred to one made of slats, as it is more likely to fulfill the purpose of the basket which is to hold waste. The bottom should project enough to reduce to a minimum the possibility of the basket tipping over. Stock $\frac{3}{8}$ " thick, if it is available, is heavy enough for the sides. Cypress, basswood or other soft wood free from knots, being lighter than the hardwood, is to be preferred. Both sides of the stock should be planed smooth and lightly sanded, drawing the sandpaper lengthwise of the grain of the wood only. The basket may be finished by applying two coats of shellac. Allow the first coat at least 24 hours to dry before the second coat is applied.



Fig. 9. Waste Basket of Wood.



Seed Corn Testing Box



Seed Corn Rack

SEED CORN TESTING BOX**Lumber Required**

Any softwood lumber may be used, though cypress is preferable as it is affected least by change of moisture content. Matched flooring is desirable for the bottom as it will hold the moisture better than unmatched lumber, but any lumber will do if the edges are jointed smooth.

Hardware Required

8 $1\frac{3}{4}$ " No. 9 flat head bright wood screws for corners.
 24 $1\frac{1}{2}$ " No. 8 flat head bright wood screws for floor.
 3 doz. 8d. finishing nails for assembling box.

Stock Bill

Pieces	Dimensions	Use
4	$1\frac{3}{8}$ "x9"x3' 0"	Floor
2	$1\frac{3}{8}$ "x3"x3' $1\frac{5}{8}$ "	Sills
2	$1\frac{3}{8}$ "x4"x3' $1\frac{5}{8}$ "	Sides
2	$1\frac{3}{8}$ "x4"x3' $\frac{3}{8}$ "	Ends

Directions

It is not necessary that boards exactly 9" wide be used for the floor. Any width of boards at hand will do just as well.

A cheaper method of fastening the floor to the sills is that of using 6d. common nails instead of the screws. These nails will need to be clinched as they are 2" long, which is $\frac{3}{8}$ " longer than the thickness of the sill and floor.

SEED CORN RACK**Stock Bill**

Pieces	Dimensions	Use
2	$1\frac{3}{8}$ "x4"x3' $5\frac{5}{8}$ "	Uprights
1	$1\frac{3}{8}$ "x4"x3' $\frac{3}{8}$ "	Top
1	$1\frac{3}{8}$ "x4"x3' 0"	Bottom
2	$1\frac{3}{8}$ "x4"x16"	Feet

Hardware: 50 yds. No. 18 annealed wire (3 coils of stove pipe wire).
 8 $1\frac{3}{4}$ " No. 9 flat head bright wood screws.
 10 $1\frac{1}{2}$ " No. 8 flat head bright wood screws.
 68 3d fine shingle nails.

Directions

It should be noted that the top is set into the upright at top 3' 16". This makes a shoulder for the top to rest on instead of being supported entirely by screws.

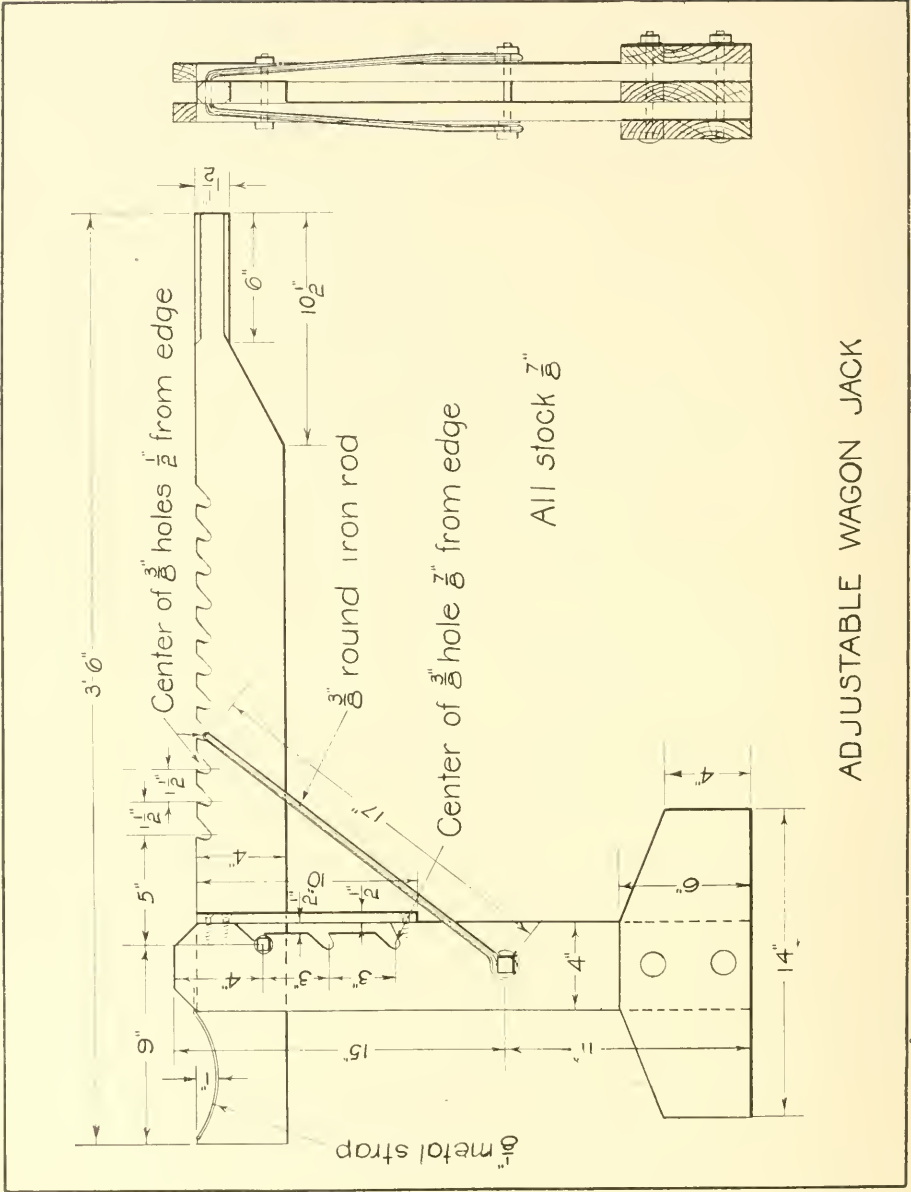
In fastening the wire, begin by fastening the wire securely to the nail at the lower corner and then draw the wire as indicated by the arrow points. Use the pliers and draw the wire tight. In placing the wire the opposite way it should be woven above and below the first wires, this will hold all wires more rigid.

Use of Rack and Testing Box

The rows are numbered at the top and lettered at the left so that any ear of corn in the rack may be specified as 1A, 1B, 2C, 3D, 8F, 12A etc.

Mark a cloth checkerboard fashion into 3" squares and number and letter the squares as on the rack.

Place about 2" of sawdust in the testing box, moisten it and cover it with the checkered cloth. Place six seeds from space 1A on the rack



ADJUSTABLE WAGON JACK

in square 1A in the box. Place six seeds from each ear in the corresponding square on the cloth in the box.

Cover the seeds with another cloth and spread 1" of damp sawdust over the top. This top covering is easier to handle if made into a sawdust pad 1" thick.

Poor ears may be located by this method and discarded.

ADJUSTABLE WAGON JACK

Stock Bill

Lumber: Oak, maple or other hardwood.

Pieces	Dimensions	Use
3	$7/8$ "x6"x14"	Base
2	$7/8$ "x4"x26"	Posts
1	$7/8$ "x4"x3' 6"	Lever
2	$1/2$ "x $7/8$ "x10"	Guides for lever bolt

2 carriage bolts $3/8$ "x5" with washers to bolt posts to base.

1 machine bolt $3/8$ "x3 $1/2$ " with two washers, fulcrum for lever.

1 machine bolt $1/2$ "x4 $1/2$ " with two washers for holding rod to posts.

1 piece of iron $1/8$ "x $7/8$ "x8" to place on top of lever at axle end.

1 piece of iron rod $3/8$ "x3' 4".

4 flat head wood screws $3/4$ " No. 7 to fasten iron at top of lever.

6 flat head wood screws 1 $1/2$ " No. 9 to fasten guides for lever bolt to posts.

A machine bolt $1/2$ "x3 $1/2$ " may be used as a fulcrum for the lever. In that event $1/2$ " holes must be made instead of $3/8$ ".

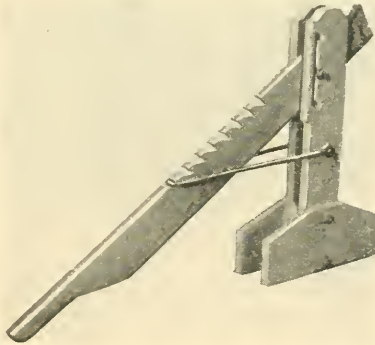
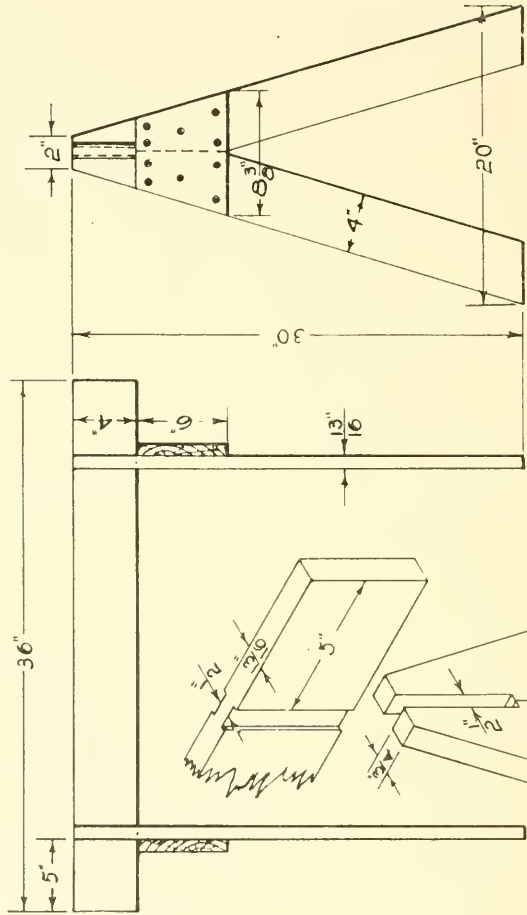


Fig. 10. Wagon Jack.



TAKE-DOWN HORSE for TABLES, CRATES, ETC.

TAKE-DOWN HORSE FOR TABLES, CRATES, ETC. Stock Bill

Pieces	Dimensions	Use
4	$1\frac{3}{8}$ "x4"x2' x7 $\frac{3}{4}$ "	Legs
1	$1\frac{3}{8}$ "x4"x3' 0"	Top
2	$1\frac{3}{8}$ "x6"x8 $\frac{3}{8}$ "	Aprons

20 flat head screws 1 $\frac{1}{2}$ " No. 8.

Directions

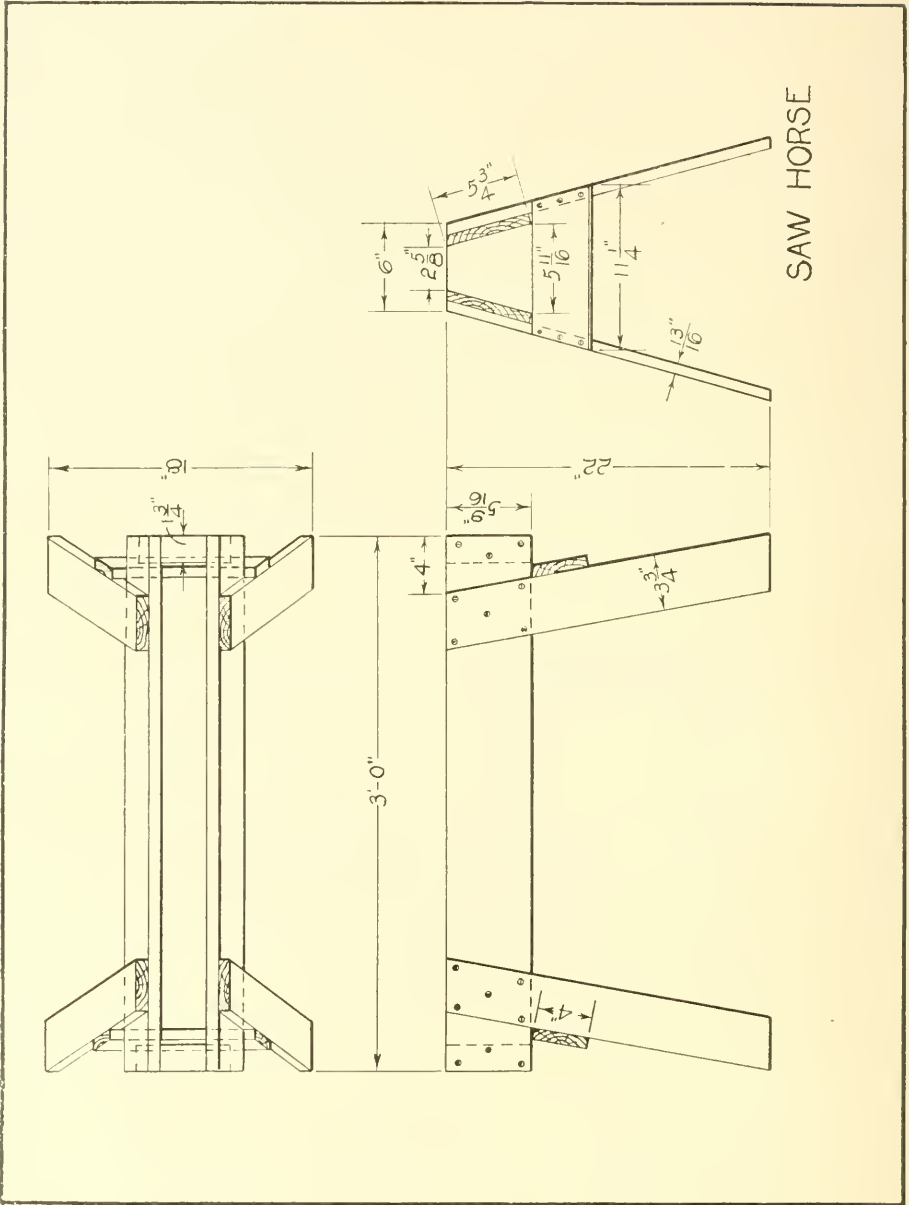
This take-down horse is planned to be used where supports are needed only temporarily, e. g., tables for picnics, church suppers, bazaars, fairs, etc. Its advantage over a solidly assembled horse is that it may be taken apart and stored in small space when not in use.

For laying off the slant at the ends of the legs the T bevel is set at 12° on the blade and 35 $\frac{1}{8}$ ° on the tongue of the steel square.

It may be noted in the detail drawings that notches are cut on both sides of the top member at points 5" from the ends so as to leave the top $\frac{1}{2}$ " thick at those points. After the legs are fastened together with the aprons, a slot is cut $\frac{1}{2}$ " wide and 4" deep at top of legs. This permits the top to slip into the slot and holds the horse rigid.



Fig. 11. Take Down Horse.



SAW HORSE

Stock Bill

Lumber: Pieces	Dimensions	Use
2	$1\frac{3}{8}" \times 5\frac{3}{4}" \times 3' 0"$	Sides
4	$1\frac{3}{8}" \times 3\frac{3}{4}" \times 24"$	Legs
2	$1\frac{3}{4}" \times 5\frac{9}{16}" \times 5\frac{11}{16}"$	Braces
2	$1\frac{3}{8}" \times 4" \times 11\frac{1}{4}"$	Aprons

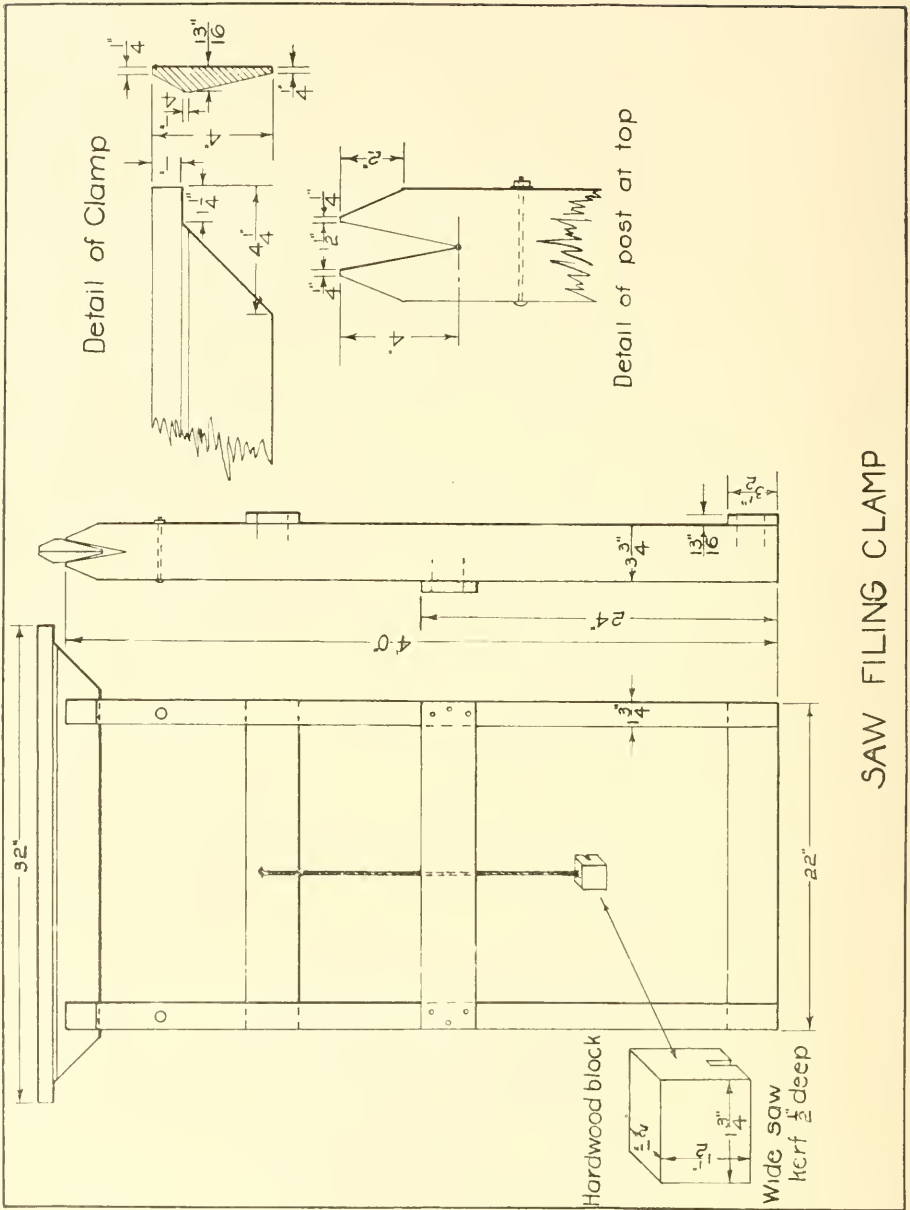
Hardware: 24 flat head bright wood screws $1\frac{3}{4}"$ No. 10.
 20 flat head bright wood screws $1\frac{1}{2}"$ No. 9.

Directions

1. Reduce all pieces to dimensions as called for in the stock bill.
2. For laying out the bevel at ends of the legs, set the T bevel at 6" on the blade and $1-1/16"$ on the tongue of the steel square and draw lines across the sides of the legs.
3. To lay out the slant at the ends of the legs set the T bevel at 6" on the blade and $1-9/16"$ on the tongue of the steel square and draw lines across the edges of the legs.
4. To make the aprons fit tight against the legs, bevel the outside edges of the legs with the T bevel set at 9" on the blade and $1/4"$ on the tongue of the steel square.
5. Fasten the sides to the braces with three $1\frac{3}{4}"$ No. 10 flat head screws at each end of each piece.
6. Fasten the legs to the sides with five $1\frac{1}{2}"$ No. 9 flat head screws in each leg.
7. Fasten the aprons by using three $1\frac{1}{2}"$ No. 9 flat head screws at each end of each piece.



Fig. 12. Saw Horse.



SAW FILING CLAMP

SAW FILING CLAMP

Stock Bill

2	1 3/4" x 3 3/4" x 4' 0"	Posts
3	1 3/8" x 3 1/2" x 22"	Braces
2	1 3/8" x 4" x 2' 8"	Clamps
1	1 1/2" x 1 1/2" x 1 3/4"	Hardwood block for tapping clamps in slot to hold saw.

18 6d common nails to fasten braces.

2 carriage bolts 1/4" x 4" to strengthen posts at top.

24" of a heavy cord to attach hardwood block.

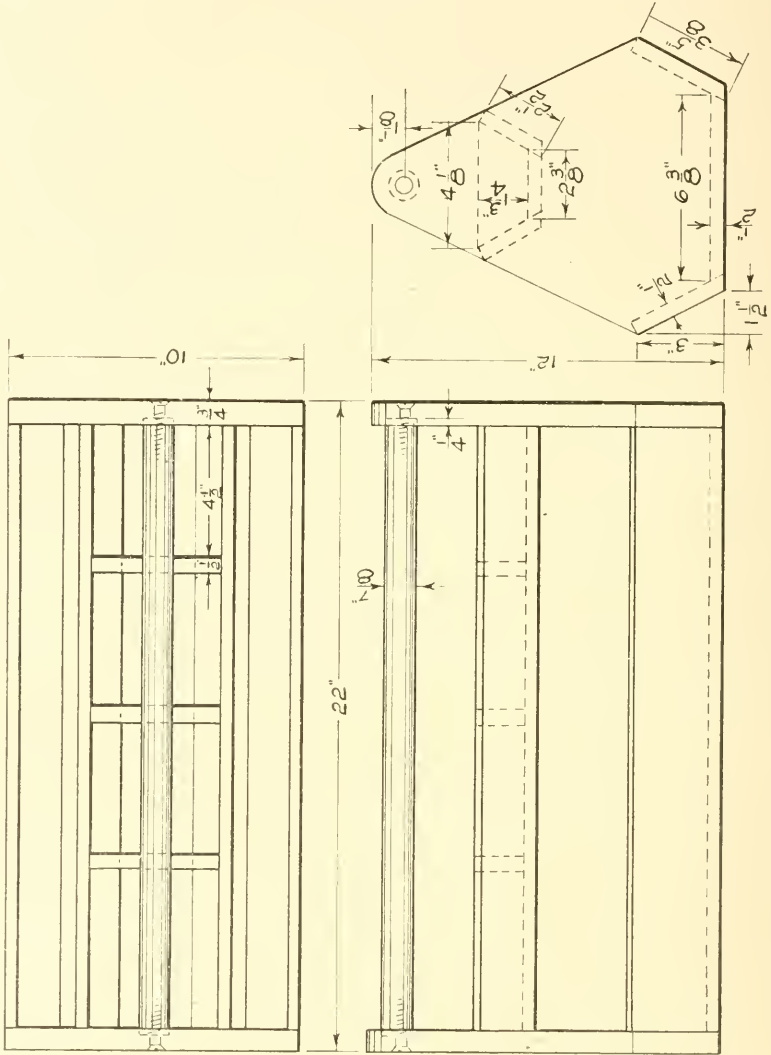
2 poultry netting staples to fasten cord to block and top brace.

Directions

The height of the posts, which is four feet, is a convenient size for a person of average size. It may be varied to suit the individual.

The clamps as called for in the drawing and stock bill are 32" long. This is a size suitable for the average handsaws. Longer clamps and deeper cuts at top of posts will be found more satisfactory for big cross-cut saws.

The hardwood block is a convenience for tapping the clamps in the notches when the saw is in place between the clamps. It is placed over the saw and clamps directly over the posts and tapped firmly with a hammer. By its use the saw is not hit with or the clamps marred by the hammer.



Farm Tool Box

FARM TOOL BOX

Bill of Material

Use hardwood for handle and any soft wood for rest of box.

Pieces	Dimensions	Use
2	$\frac{3}{4}$ "x10"x12"	Ends
1	$\frac{1}{2}$ "x6 $\frac{3}{8}$ "x20 $\frac{1}{2}$ "	Bottom of box
2	$\frac{1}{2}$ "x3 $\frac{5}{8}$ "x20 $\frac{1}{2}$ "	Sides of box
1	$\frac{1}{2}$ "x2 $\frac{3}{8}$ "x20 $\frac{1}{2}$ "	Bottom of nail tray
2	$\frac{1}{2}$ "x2 $\frac{1}{2}$ "x20 $\frac{1}{2}$ "	Sides of nail tray
3	$\frac{1}{2}$ "x1 $\frac{3}{4}$ "x4 $\frac{1}{8}$ "	Partitions in nail tray
1	$\frac{7}{8}$ " round x21" long	Handle

Hardware: 2 flat head bright wood screws 2" No. 10 for handle.

2 doz. 6d. finishing nails.

4 doz. 4d. finishing nails.

Directions

For fastening handle see direction on "Berry Stand."

For construction of handle see "Vise Handle."

The purpose of this tool box is to furnish a means of carrying a quantity of tools, nails, screws, staples, etc. to any point about the farm where work is to be done. For example, a repair and construction job may require the following: cross-cut saw, pinch bar, hand ax, claw hammer, staple puller, wire stretcher, nails and staples. These tools may all be placed in the box and carried conveniently as well as kept together.

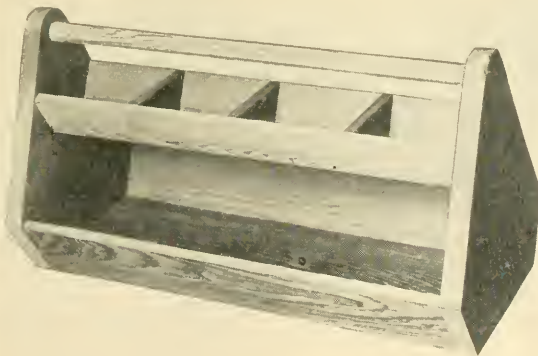
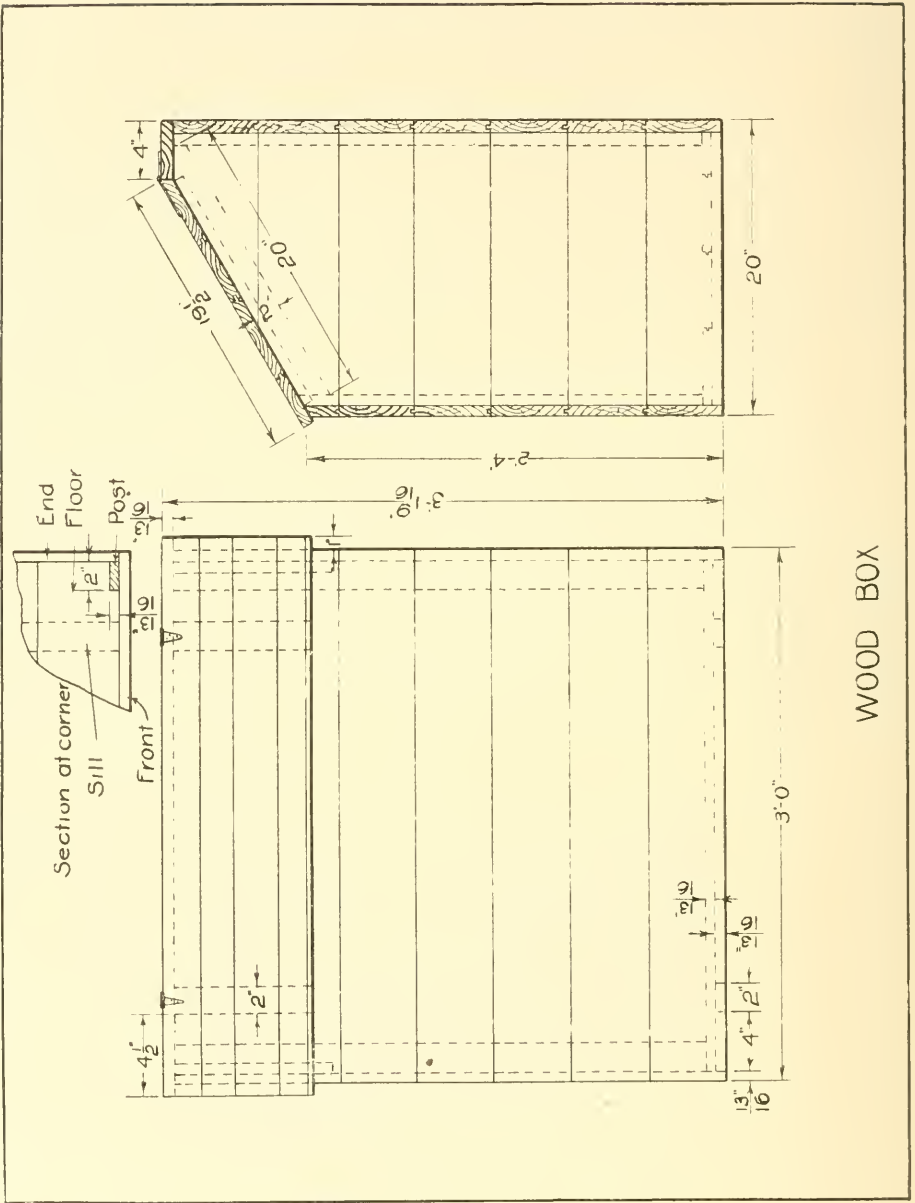


Fig. 13. Farm Tool Box.



WOOD BOX

Lumber Stock Bill

Lumber: (6" matched flooring).

Pieces	Dimensions	Use
2	$\frac{1}{8}$ " x 2" x 18 $\frac{3}{8}$ "	Sills
4	$\frac{1}{8}$ " x 5 $\frac{1}{4}$ " x 2' 10 $\frac{3}{8}$ "	Floor
6	$\frac{1}{8}$ " x 5 $\frac{1}{4}$ " x 3' 0"	Front
7	$\frac{1}{8}$ " x 5 $\frac{1}{4}$ " x 3' 0"	Back
13	$\frac{1}{8}$ " x 5 $\frac{1}{4}$ " x 18 $\frac{3}{8}$ "	Ends
2	$\frac{1}{8}$ " x 2" x 2' 2 $\frac{3}{8}$ "	Front posts
2	$\frac{1}{8}$ " x 2" x 2' 11 $\frac{1}{8}$ "	Back posts
4	$\frac{1}{8}$ " x 5 $\frac{1}{4}$ " x 3' 2"	Door
2	$\frac{1}{8}$ " x 2" x 17 $\frac{1}{2}$ "	Door straps
2	$\frac{1}{8}$ " x 2" x 20"	Cleats for ends at top
1	$\frac{1}{8}$ " x 4" x 3' 2"	Top

Hardware: 16 6d common nails for nailing floor to sills.

1 $\frac{1}{4}$ lb. 8d finishing nails for assembling box.

28 flat head bright wood screws 1 $\frac{1}{2}$ " No. 8 for fastening straps to door and cleats to ends.

2 light T hinges.

Directions

In assembling the box the floor boards are nailed to the sills with 6d common nails and the nails are clinched.

The bottom end boards are fastened to the floor with three 8d finishing nails into the end of each floor board. The end boards are fastened to the posts with three 8d finishing nails at each end of each board. The cleats at the top are fastened to the top end boards with three 1 $\frac{1}{2}$ " No. 8 flat head bright screws placed from the inside.

The front and back boards are secured by placing two 8d finishing nails at each end of each board into the ends of the end pieces and two into the post. Those in the post are clinched on the inside.

The top board is fastened in place with 8d finishing nails.

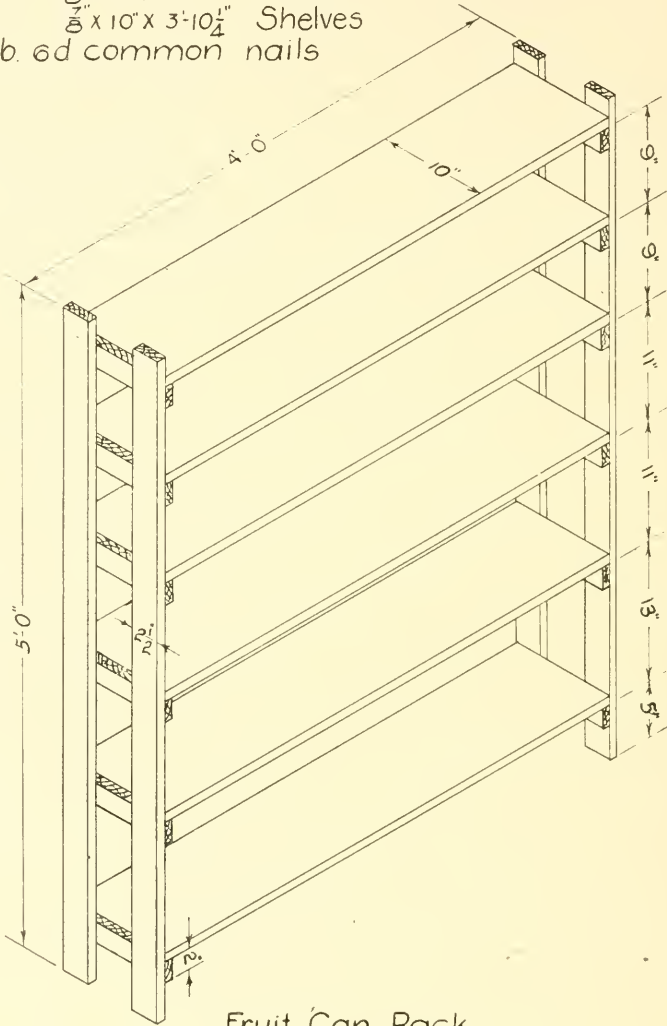
In assembling the door the boards should be drawn tightly together with clamps. The straps are then placed in position and fastened by placing two 1 $\frac{1}{2}$ " No. 8 flat head wood screws into each board at each strap, placing the screws from the inside of the door.

Bevel the top edge of the door and fasten the door in place.

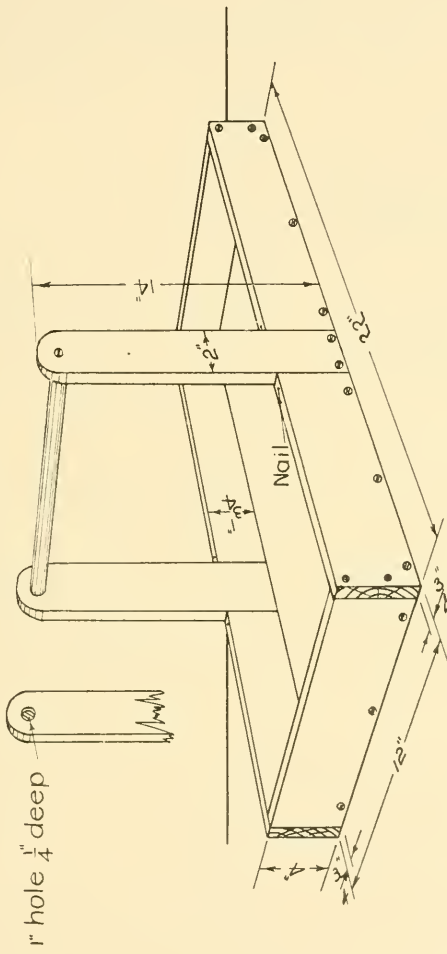
Set the nails with a nail set; putty the holes, and paint the box a color suitable for the room where it is to be placed.

Stock Bill

Pieces	Dimensions	Use
4	$2\frac{1}{2}$ " x 5'-0"	Posts
6	$2\frac{1}{2}$ " x 2" x 10"	Cleats
6	$3\frac{1}{2}$ " x 10" x $3\frac{1}{4}$ "	Shelves
$1\frac{3}{4}$ lb.	6d common	nails



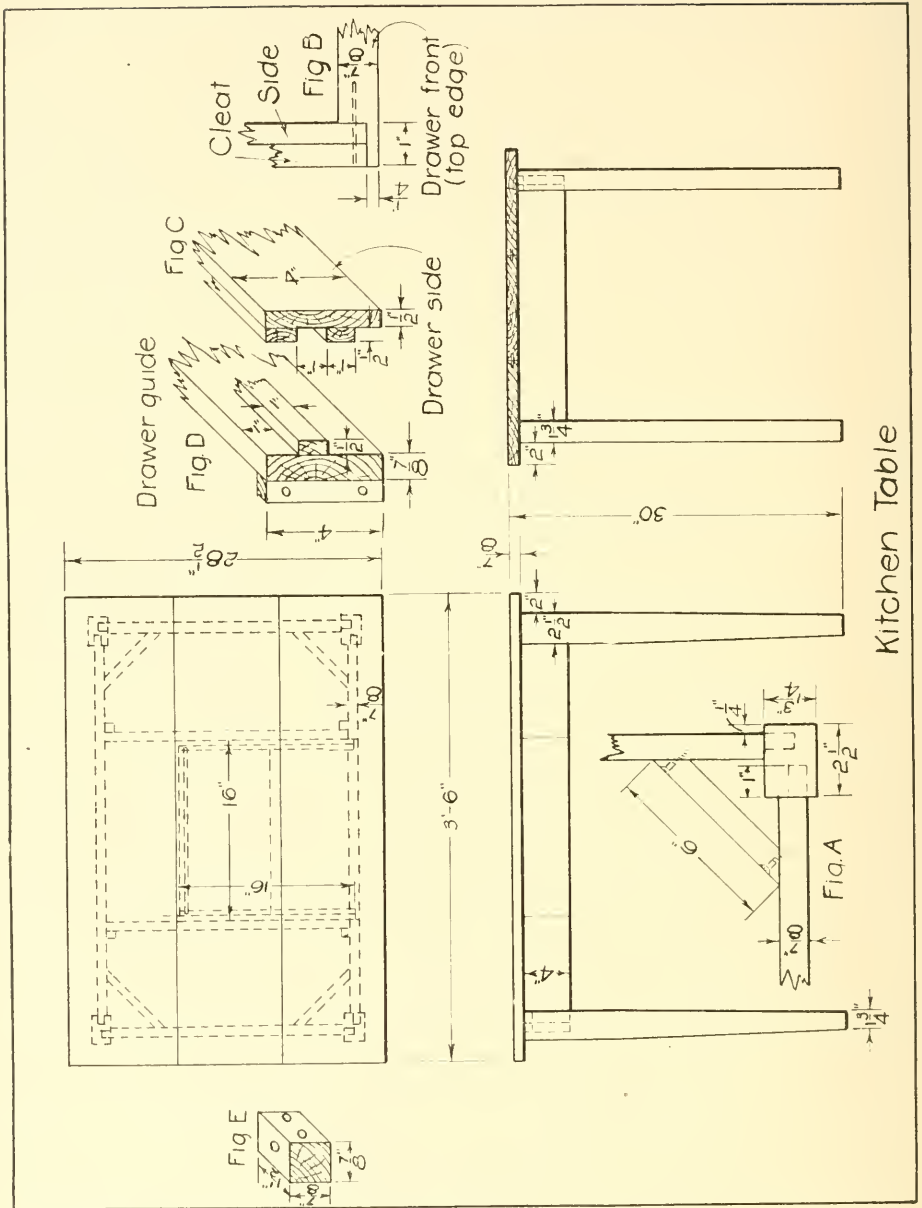
Fruit Can Rack



WOOD BASKET

Bill of Material

- 1 piece $\frac{3}{4}$ " x $10\frac{1}{2}$ " x $20\frac{1}{2}$ " - bottom
- 4 " $\frac{3}{4}$ " x 4" x 10" - sides
- 2 " $\frac{3}{4}$ " x 4" x $10\frac{1}{2}$ " - ends
- 2 " $\frac{3}{4}$ " x 2" x 14" - posts
- 1 " 1" round x 11" - handle
- 26-2" No. 10 flat head wood screws
- 4 - 8d finishing nails



Kitchen Table

KITCHEN TABLE

The frames of kitchen tables are usually made of hard wood, maple, birch or oak. Maple or birch make a very desirable top though basswood is used for this purpose extensively and is very satisfactory.

The legs of kitchen tables are frequently $2\frac{1}{4}$ " or $2\frac{1}{2}$ " square at top and tapered at bottom. The drawing calls for legs which are $1\frac{3}{4}$ " x $2\frac{1}{2}$ " at top and tapered on the two edges only so as to be $1\frac{3}{4}$ " square at the bottom. This has been done to make it possible to saw the legs out of an ordinary 2" plank.

The sides and ends are fastened to the legs with mortise and tenon joints, Fig. A. The joints should be glued with hot glue. The corners are further stiffened with braces as shown in the detail drawing, Fig. A. These braces should be fastened to the side and end pieces with at least three flat head wood screws at each end of each brace.

A piece 16" long is cut out of the front side piece for a drawer front. This piece is then shaped at the ends as shown in Fig. B.

The drawer sides are $\frac{1}{2}$ " x 4" x 16" and are provided with two $\frac{1}{2}$ " x 1" x 16" cleats fastened to the outside as shown in Fig. C. Quarter inch stock is used for the drawer bottom. If means are at hand for plowing a groove on the insides of the side pieces $\frac{1}{4}$ " wide and $\frac{1}{4}$ " from the bottom edge of the side pieces it is desirable to do so. Otherwise the bottom is merely nailed in place.

Two pieces of stock $\frac{7}{8}$ " x 4" are extended between sides at right and left of the drawer respectively. They are fastened to the sides of the table by use of blocks and screws as shown in Fig. D. A cleat $\frac{1}{2}$ " x 1" x 16" is fastened to the inside of the two guides. This cleat fits between the two cleats which are on the outside of the drawer and holds the drawer in place.

The drawer need not be provided with a draw pull as it is as easily opened by clasping it at the bottom.

The top may be constructed of three or more boards.

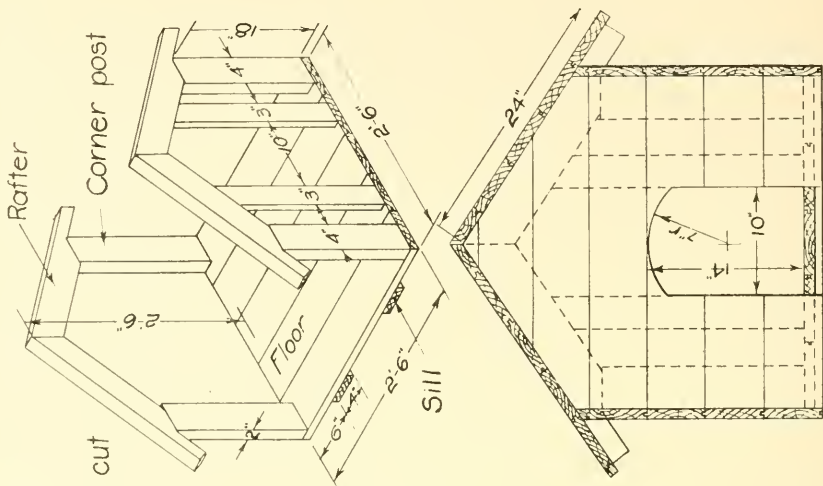
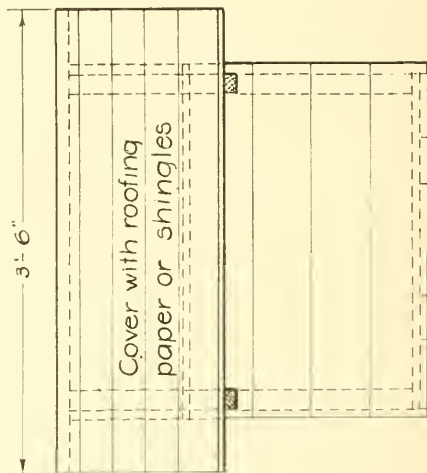
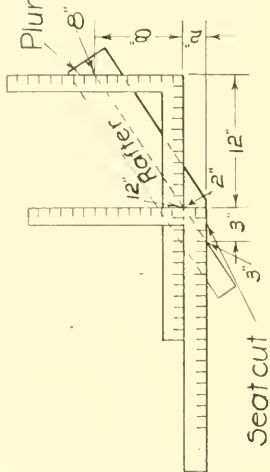
These boards are carefully jointed, held even with dowel pins and glued.

The top is held to the table by use of blocks as indicated in Fig. E. At least ten such blocks should be used—two at each end and three at each side.

When the table is assembled the legs, sides and ends should be scraped clean with a cabinet scraper and then sanded. The top should also be cleaned with sandpaper.

The top of the table is left white. The rest of the table may be finished with two coats of shellac, or one coat of shellac and a coat of varnish.

$\frac{3}{4}$ pitch, use 12" for run and 8" for rise



Dog House

DOG HOUSE

Material Required

Pieces	Dimensions	Use
2	$\frac{7}{8}$ " x 4" x 2' 6"	Sills
6	$\frac{7}{8}$ " x 5 $\frac{1}{4}$ " x 2' 6"	Floor
4	2" x 4" x 18"	Corner posts
4	2" x 4" x 24"	Rafters
9	$\frac{7}{8}$ " x 5 $\frac{1}{4}$ " x 2' 7 $\frac{3}{4}$ "	Sides
10	$\frac{7}{8}$ " x 5 $\frac{1}{4}$ " x 2' 6"	Ends
4	$\frac{7}{8}$ " x 5 $\frac{1}{4}$ " x 10"	Ends at front
2	$\frac{7}{8}$ " x 3" x 23"	Door posts
10	$\frac{7}{8}$ " x 5 $\frac{1}{4}$ " x 3' 6"	Roof boards

2 pieces of prepared roofing 3' 8" long or $\frac{1}{2}$ bundle of shingles.

If shingles are used two pieces of wood $\frac{7}{8}$ " x 4" x 3' 6" are required for a saddle board and also $\frac{1}{2}$ lb. of shingle nails.

1 lb. 6d common nails.

A quantity of outside paint.

Directions

Before starting the construction of the framework of the dog house it is suggested that the subject of rafter framing be studied. Obtain a piece of 2" x 4" or 2" x 6" x 10, 12, 14 or 16 ft. long. Select a building with any span of roof and decide on a pitch of roof. Lay out the rafter as shown in the plate on rafter framing. Do not cut the rafter unless you are actually going to use the piece in a building. In like manner lay off the rafter on the same piece for other pitches and spans.

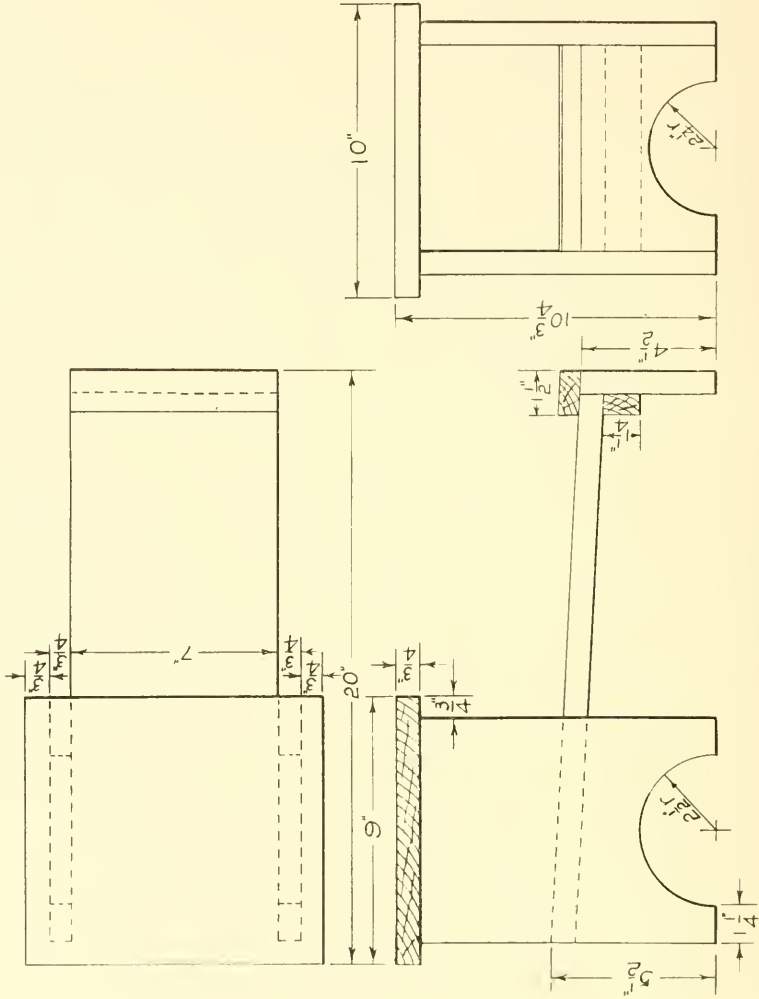
When thoroly familiar with the use of the steel square for laying out rafters, lay out the rafter for the dog house as indicated on the drawing of the dog house.

Matched lumber is preferable for the construction of a dog house. It may be noted that not all matched lumber is of the same width. If the lumber which is being used is other than $\frac{7}{8}$ " thick and 5 $\frac{1}{4}$ " face, as called for in the stock bill, it is suggested that a new stock bill be made out.

If shingles are used, a double layer is used for the first row at the eaves. They may project over the roof boards one inch at the bottom and also at the ends. They are laid 4" or 4 $\frac{1}{2}$ " to the weather and should break joints at least 1". The points projecting over the peak are sawed off and the peak finished with a saddle board.

If roofing paper is used it should be bent over the ends and edges of the roof and nailed with roofing nails spaced not more than 2" apart.

Finish the house by applying at least two coats of paint.



MILKING STOOL

MILKING STOOL

Stock Bill

Lumber: Any soft wood.

Pieces	Dimensions	Use
2	$\frac{3}{4}$ " x $7\frac{1}{2}$ " x 10"	Sides
1	$\frac{3}{4}$ " x 7" x $4\frac{1}{2}$ "	Front
1	$\frac{3}{4}$ " x 7" x $19\frac{1}{4}$ "	Platform
1	$\frac{3}{4}$ " x 9" x 10"	Seat
1	$\frac{3}{4}$ " x $1\frac{1}{2}$ " x 7"	Cleat at top
1	$\frac{3}{4}$ " x $1\frac{1}{4}$ " x 7"	Cleat underneath at front.

Hardware: 2 doz. $1\frac{1}{2}$ " No. 9 flat head bright wood screws.

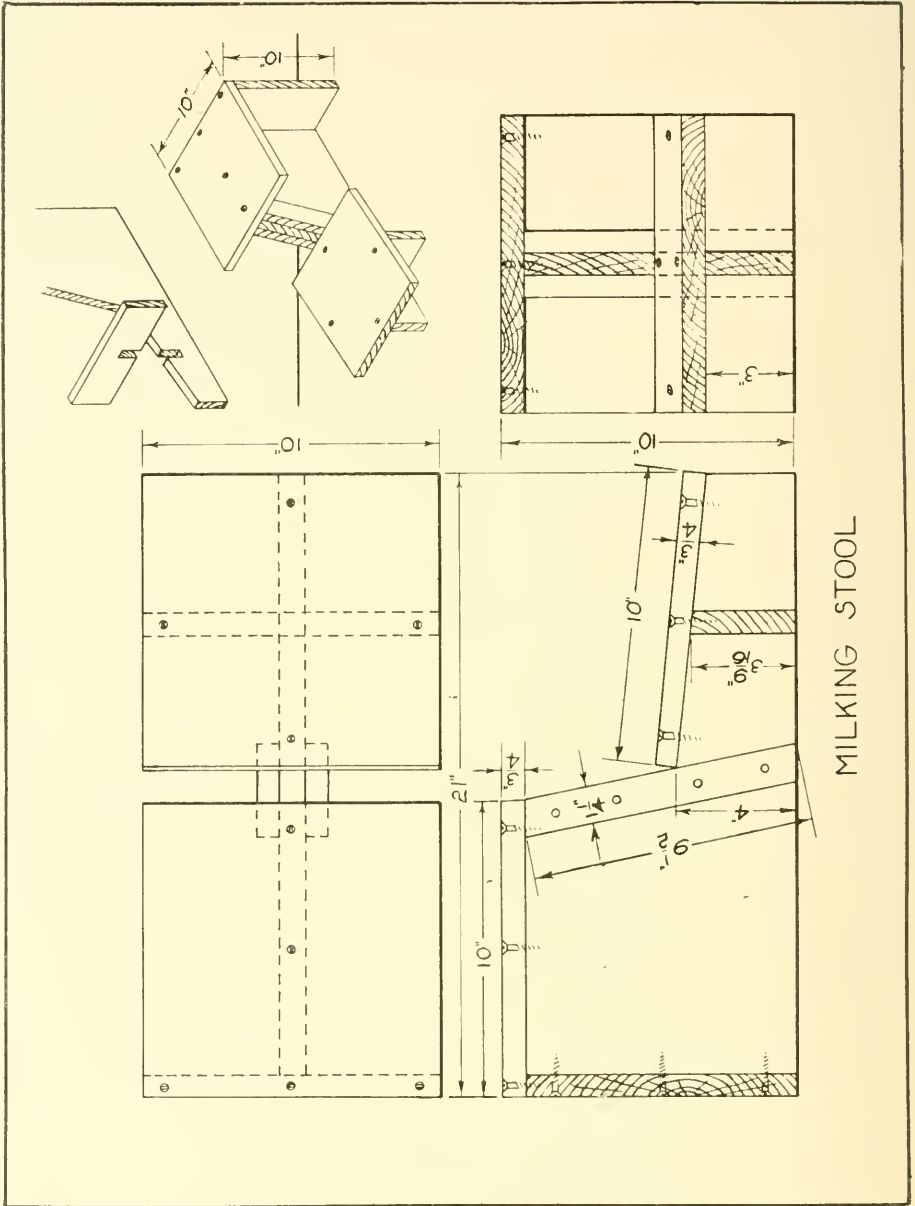
Directions

In getting out the sides get out a piece $\frac{3}{4}$ " x $7\frac{1}{2}$ " x 20"; draw a centerline lengthwise of the stock and at a point on the centerline equidistant from ends swing a circle with the compass set at $2\frac{1}{2}$ " radius. Draw a line across the stock thru the center of the circle. Cut the board in two on line just drawn. Saw arcs with turning saw, keyhole saw or coping saw.

In getting out the front piece be sure and cut it so that the grain of the wood runs vertically in the finished stool, i. e., 7" across the grain and $4\frac{1}{2}$ " lengthwise of the grain.

The ends of the platform are beveled. The T bevel is set at $19\frac{1}{2}$ " on the blade and 1" on the tongue of the steel square.

In assembling, three screws are placed thru the seat into the top of each side piece; three screws secure the sides to the platform and three are used to fasten the front to the front end of the platform. Five screws are used to fasten the top cleat at the front end—three into the front and two into the platform. Four screws are used to fasten the $1\frac{1}{4}$ " cleat to the front on the inside.



A MILKING STOOL

Material

- 1 piece of any soft wood, preferably white pine, $\frac{3}{4}$ "x10"x5' 1".
- 12 flat head bright wood screws $1\frac{3}{4}$ " No. 10.
- 8 flat head bright wood screws $1\frac{1}{2}$ " No. 8.

Tools

Plane, try square, cross cut and rip saws, chisel, 5 $\frac{32}$ " drill, brace, countersink, screwdriver, T bevel.

Stock

Pieces	Dimensions	Use
1	$\frac{3}{4}$ "x9 $\frac{1}{4}$ "x20 $\frac{1}{4}$ "	Main brace
1	$\frac{3}{4}$ "x9 $\frac{1}{4}$ "x10"	Back end
1	$\frac{3}{4}$ "x3 $\frac{9}{16}$ "x10"	Front cross brace
1	$\frac{3}{4}$ "x10"x10"	Pail platform
1	$\frac{3}{4}$ "x10"x10"	Seat
2	$\frac{3}{4}$ "x1 $\frac{1}{4}$ "x9 $\frac{1}{2}$ "	Braces

Directions

1. Reduce all pieces to finished dimensions.
2. Draw a line across the front end of the main brace 3" from the bottom edge; locate a point on each side 4" from the lower edge and 10" from the line across the end and connect the points just located with the line across the end.
3. Draw a line across the upper edge 9 $\frac{1}{4}$ " from the back end and connect the line with the points on the side of the board. Remove the stock to line with the rip and crosscut saws.
4. Lay out a cross half-lap joint in the upper edge of the front part of the main brace and the lower edge of the front cross brace as wide as the thickness of the stock and one-half the width of the stock as shown in the detail drawing and remove the stock with the cross-cut saw and chisel as shown in the detail drawing.
5. Set the T bevel at the angle which is made by the top and slant edge of the main brace, and lay out the ends of the braces. Remove the stock to line with the saw.
6. Bore holes for the screws with the $\frac{5}{16}$ " drill at positions shown in the drawings. countersink the holes and fasten all members in position.

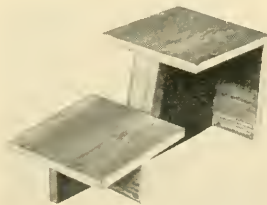
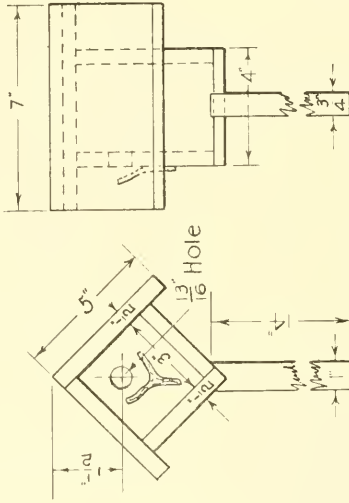
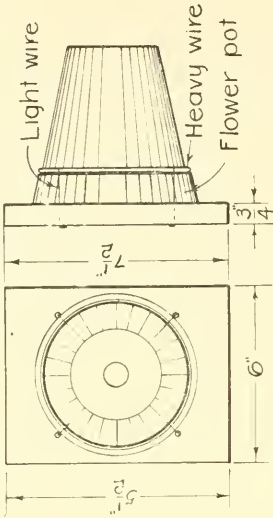


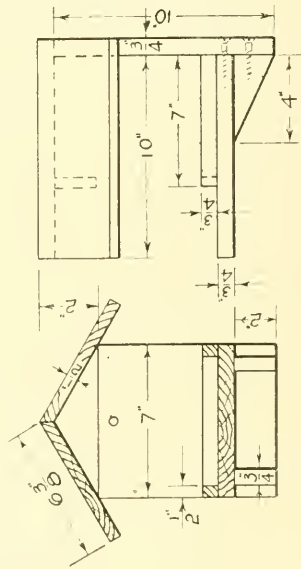
Fig. 14. Milking Stool.



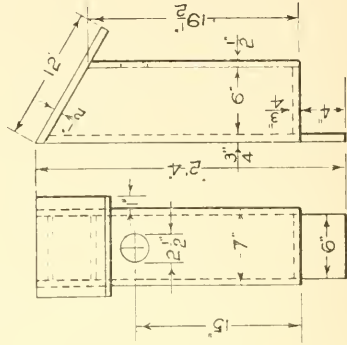
WREN HOUSE



WREN HOUSE



ROBIN NESTING SHED



FLICKER or WOODPECKER

BIRD HOUSES

Robin Nesting Shed

Material Required

- 1 piece of any soft wood $\frac{3}{4}$ "x5"x12".
 - 1 piece of any soft wood $\frac{1}{2}$ "x5 $\frac{1}{4}$ "x2' 6".
 - 2 flat head bright wood screws $1\frac{1}{2}$ " No. 7.
 - 2 doz. brads $1\frac{1}{2}$ " No. 18.
 - 1 round head blued wood screw, $1\frac{1}{2}$ " No. 10, for fastening to a tree or shed.
- Small quantity of outside paint.

Stock Bill

Pieces	Dimensions	Use
1	$\frac{3}{4}$ "x7"x10"	Back
2	$\frac{1}{2}$ "x6 $\frac{3}{8}$ "x10 $\frac{3}{4}$ "	Roof
1	$\frac{3}{4}$ "x7"x10"	Floor
2	$\frac{3}{4}$ "x2"x4"	Brackets
2	$\frac{1}{2}$ "x $\frac{3}{4}$ "x7"	Sides
1	$\frac{1}{2}$ "x $\frac{3}{4}$ "x6"	Front
1	$\frac{1}{2}$ "x2"x7"	Roof brace

WREN HOUSE

Material Required

- 1 piece of any soft wood $\frac{1}{2}$ "x5"x2' 6".
 - 1 piece of any soft wood $\frac{3}{4}$ "x1"x16".
 - 2 $\frac{3}{4}$ " brads for fastening perch.
 - 3 doz. $1\frac{1}{2}$ " No. 18 brads.
 - Twig for perch (optional).
- Small quantity paint.

Stock Bill

Pieces	Dimensions	Use
1	$\frac{1}{2}$ "x5"x7"	Roof
1	$\frac{1}{2}$ "x4 $\frac{1}{2}$ x7"	Roof
1	$\frac{1}{2}$ "x3 $\frac{1}{2}$ "x4"	Side
1	$\frac{1}{2}$ "x3"x4"	Side
2	$\frac{1}{2}$ "x3"x3"	Ends
1	$\frac{3}{4}$ "x1"x14"	Post

Directions

The opening for a wren should be the size of a twenty-five cent piece. If made larger, the house is apt to be used by English sparrows. A perch is not necessary, its value is only in adding to the ornamental appearance of the house. The house may be fastened to a tree or to the house or other buildings, preferably not too high from the ground.

WREN HOUSE

Material Required

- 1 5 $\frac{1}{2}$ " flower pot.
 - 1 piece of any kind of wood $\frac{3}{4}$ "x6"x7 $\frac{1}{2}$ ".
 - 1 piece heavy wire 18" long.
 - 4 pieces light wire 4" long.
 - 4 poultry netting staples.
- A small quantity of paint.

Directions

A house which wrens like especially well may be made by fastening a flower pot to a board and placing it in a secluded place.

The pot need not be exactly the same size as called for in this drawing. The hole in the bottom of the pot must be made the size of a twenty-five-cent piece which is $\frac{15}{16}$ of an inch. This may be done with a

$\frac{1}{4}$ " chisel and a mallet or hammer. The pot is fastened to the board by placing and clinching a heavy wire as shown in the side view of the drawing and drawing the pot tight against the board with the four pieces of light wire. Holes may be made thru the board with a 6d nail for wire to pass thru. The wire is drawn tightly so as to bring the pot snugly against the board and fastened with poultry netting staples as shown in the illustration.

FLICKER OR WOODPECKER HOUSE

Material Required

- 1 piece of any soft wood $\frac{3}{4}$ "x6"x2' 10".
- 1 piece of any soft wood $\frac{1}{2}$ "x7 $\frac{1}{2}$ "x6' 6".
- 4 doz. $\frac{1}{2}$ " No. 18 brads.
- A small quantity paint.

Stock Bill

1	$\frac{3}{4}$ "x6"x2' 3 $\frac{1}{4}$ "	Back
2	$\frac{1}{2}$ "x6 $\frac{3}{4}$ "x23 $\frac{1}{4}$ "	Sides
1	$\frac{1}{2}$ "x7"x19 $\frac{1}{2}$ "	Front
1	$\frac{1}{2}$ "x9"x12"	Roof

Directions

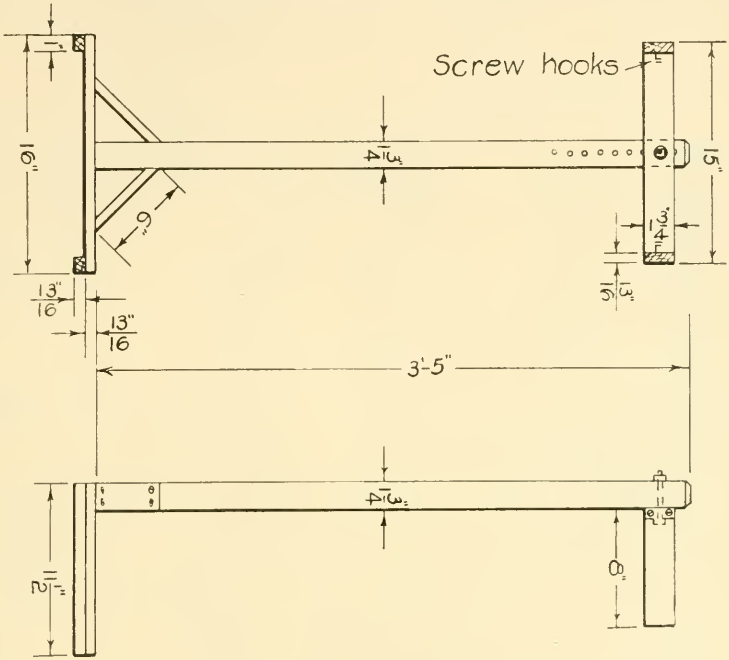
This house may be made for the flicker, red-headed, golden-fronted, hairy or downy woodpeckers, chickadees, nuthatches or titmice. The diameter of entrance for the various birds shall be as follows:

Flicker—2 $\frac{1}{2}$ "; Red-headed woodpecker—2" Golden fronted woodpecker—2"; Hairy woodpecker—1 $\frac{1}{2}$ "; Downy woodpecker—1 $\frac{1}{4}$ "; Chickadee—1 $\frac{1}{8}$ "; Nuthatch—1 $\frac{1}{8}$ "; Titmouse—1".

A color of paint should be used which closely resembles the color of the bark of a tree, so as to make the house as inconspicuous as possible. Lumber:

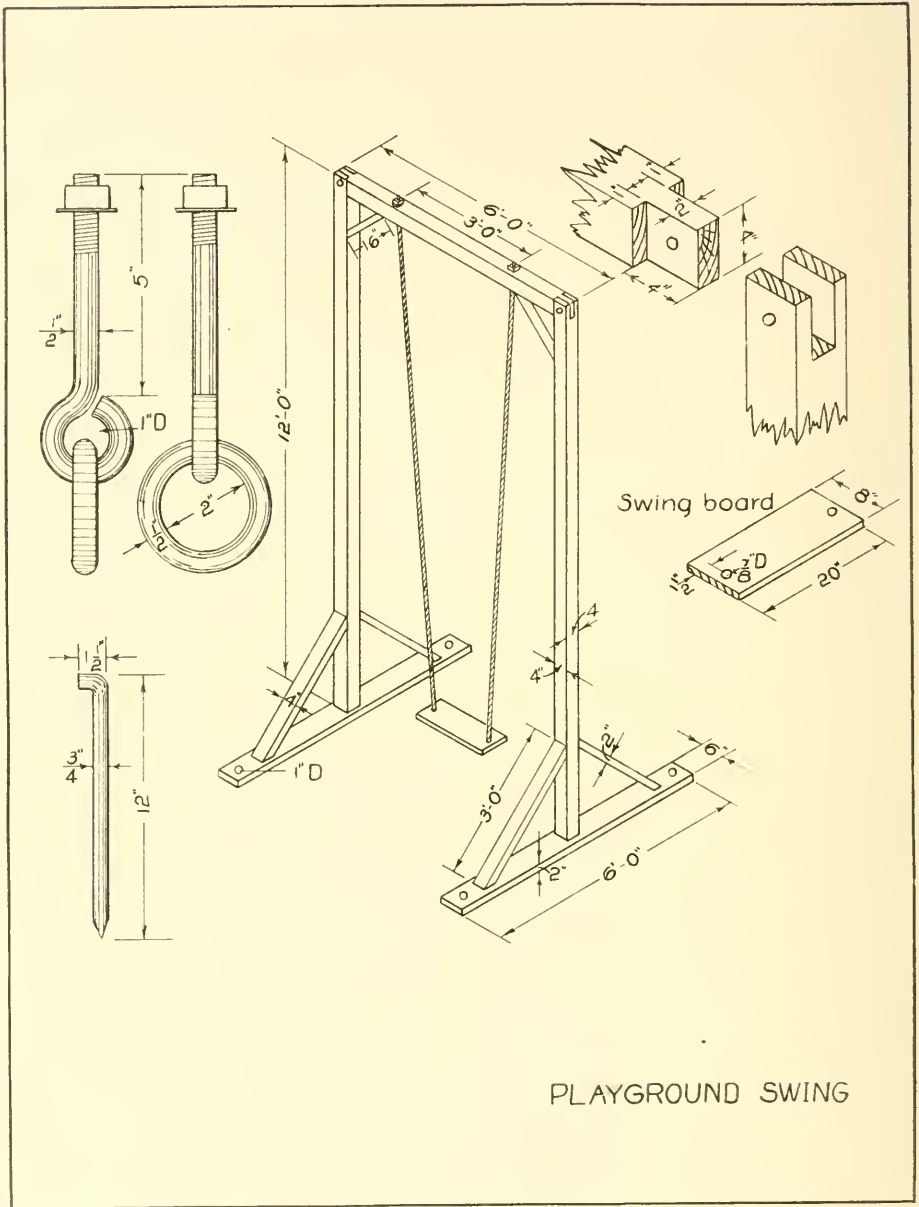


Fig. 15. Bag Holder.



BAG HOLDER

Pieces	Dimensions	Use
2	1 3/8" x 1" x 11 1/2"	Sills
1	" x 1 1/2" x 16"	Platform
2	" x 1 3/4" x 6"	Braces
1	" x 4" x 13 3/8"	Cross bar
2	" x " x 8"	Arms
1	1 3/4" x 1 1/4" x 3'-5"	Post
4	Screw hooks	
4	flat head screws	2" No. 10
16	" "	1 1/2" "



PLAYGROUND SWING

Bill of Material

Pieces	Dimensions	Use
2	2"x6"x6' 0"	Base
2	4"x4"x12' 0"	Posts
1	4"x4"x6' 0"	Beam
4	2"x4"x3' 0"	Lower braces
2	2"x4"x16"	Upper braces
1	1"x8"x20"	Swing board
52 16d common nails (refer to table on nails).		
2 carriage bolts $\frac{3}{8}$ "x4 $\frac{1}{2}$ " with washers.		
2 rings and eye bolts as shown in drawing.		
1 piece of $\frac{3}{4}$ " rope 24 ft. long.		

Directions

1. Reduce all pieces to finished dimensions called for in bill of material.

2. Lay out and cut a tenon at each end of the beam to the dimensions called for in the detail drawing.

3. Lay out an open mortise in the upper end of each post to receive the tenons at the ends of the beam as indicated in the detail drawing.

4. Fasten the posts to the sills by driving four 16d common nails thru the base at the center from bottom and up into the lower end of each post; also toenail the posts to the bases by using one 16d common nail on each side of each post.

5. Miter both ends of the lower braces and fasten the posts and bases by using two 16d common nails at each end of each brace.

6. Bore two $\frac{1}{2}$ " holes thru the beam from the upper edge 18" from ends and 3' apart.

7. Place the beam on the posts; bore $\frac{3}{8}$ " holes through the mortise and tenon joint, and fasten with one $\frac{3}{8}$ " x 4 $\frac{1}{2}$ " carriage bolt at each joint.

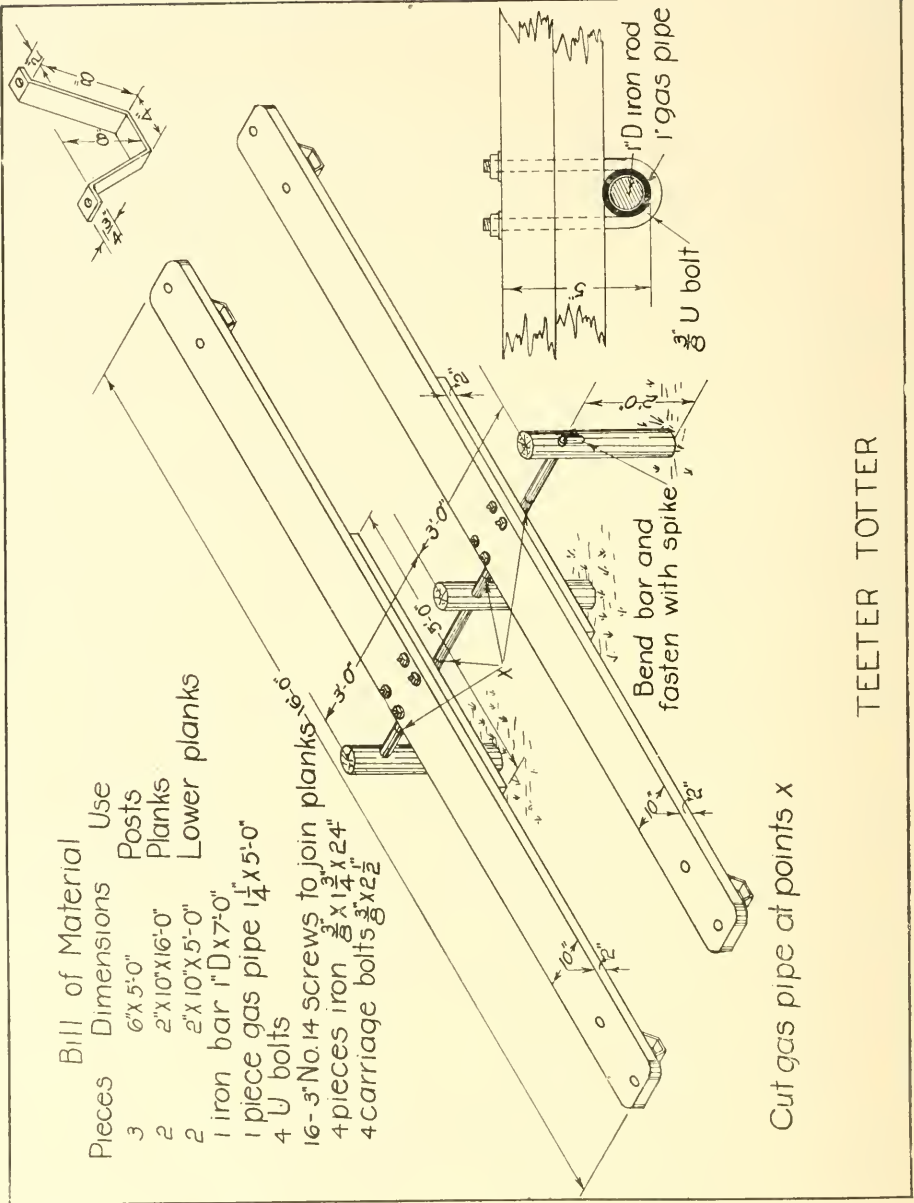
8. Miter the ends of the upper braces and fasten to posts and beam by using two 16d common nails at each end of each piece.

9. Draw a centerline lengthwise of the swing board and bore $\frac{7}{8}$ " holes 1 $\frac{1}{2}$ " from each end.

10. Fasten the eye bolts in place.

11. Tie one end of the rope to one ring; draw the rope down thru one hole in the board and up thru the other; then draw it up thru the second ring so as to bring the rope at a suitable distance from the ground, and tie it to the ring.

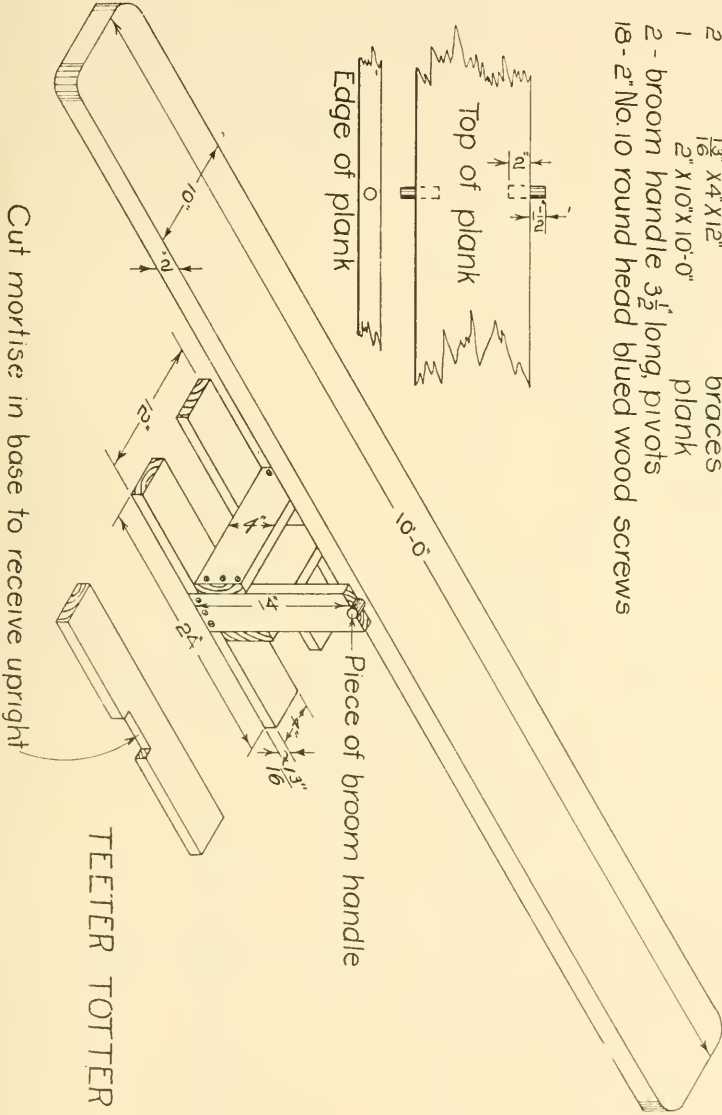
12. Bore 1" holes thru the base members so that the swing may be staked firmly to the ground by use of the iron pins as suggested in the drawing.



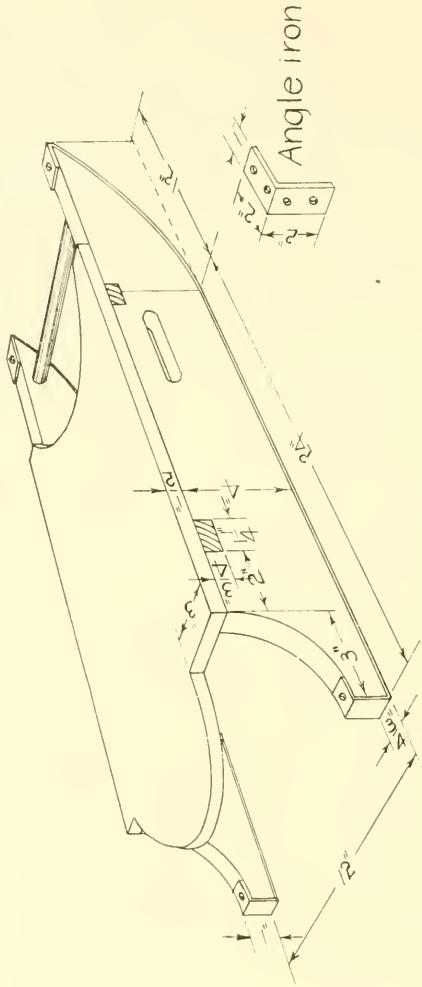
TEETER TOTTER

Bill of Material

Pieces	Dimensions	Use
2	$\frac{1}{2}$ " x 4" x 24"	base
2	$\frac{1}{2}$ " x 4" x 14"	uprights
2	$\frac{1}{2}$ " x 4" x 12"	braces
1	2" x 10" x 10'-0"	plank
2 - broom handle $3\frac{1}{2}$ ' long, pivots		
18 - 2" No. 10 round head blued wood screws		

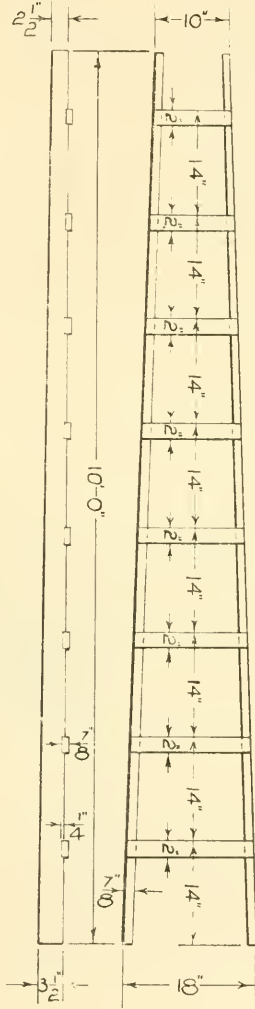


Sled

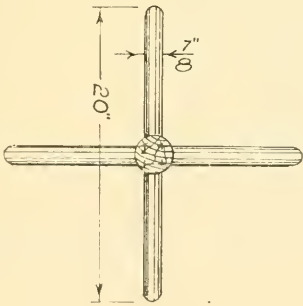
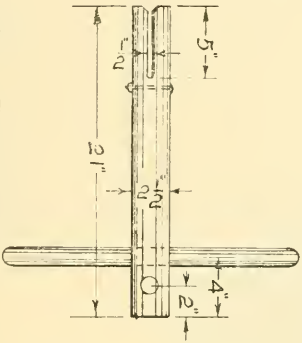
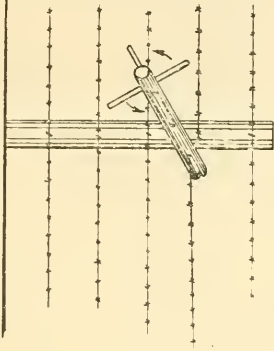


Bill of Material

2	pieces oak, maple or ash	3/4" x 4" x 2'-6"	Runners	2	pieces iron	1 1/2" x 3/4" x 3'-3"	Runners
2	"	"	"	2	"	5" x 1" x 4"	Angle irons
1	"	"	"	18	flat head wood screws	3/4"	No. 6 Runners
1	"	maple or pine	"	8	"	"	" 2" No. 9 Braces
				8	"	"	" 1 1/4" No. 7 Top
				16	"	"	" 3/4" No. 7 Angles

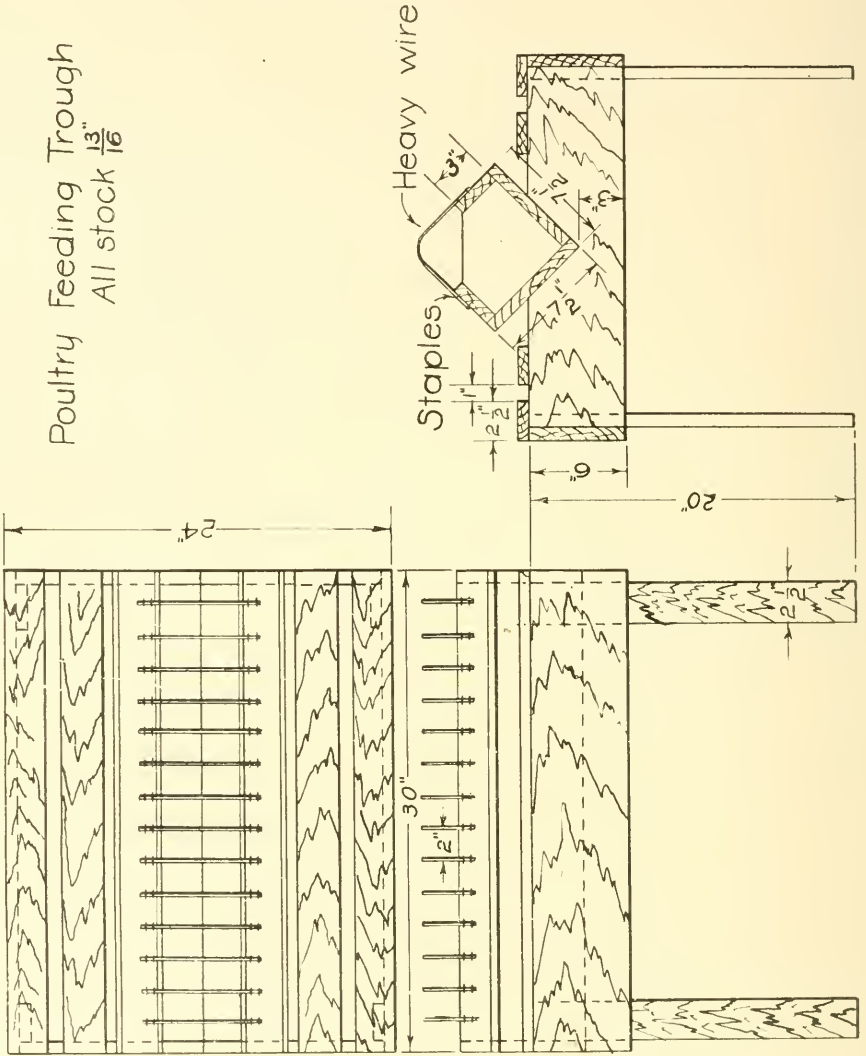


Handy Ladder
(Oak, ash, maple or other hardwood)



Wire Tightener
(Hickory or other tough wood)

Poultry Feeding Trough
All stock $\frac{13}{16}$ "



POULTRY FEEDING TROUGH Stock Bill

Pieces	Dimensions	Use
4	$1\frac{3}{8}$ " x $2\frac{1}{2}$ " x 20"	Legs
2	$1\frac{3}{8}$ " x 6" x 2' 6"	Sides
2	$1\frac{3}{8}$ " x 6" x $22\frac{3}{8}$ "	Ends
4	$1\frac{3}{8}$ " x $2\frac{1}{2}$ " x 2' 6"	Platform
1	$1\frac{3}{8}$ " x $7\frac{1}{2}$ " x 2' 6"	Box
1	$1\frac{3}{8}$ " x $6\frac{1}{8}$ " x 2' 6"	Box
2	$1\frac{3}{8}$ " x 3" x 2' 6"	Box
2	$1\frac{3}{8}$ " x $5\frac{7}{8}$ " x $5\frac{7}{8}$ "	Ends of box

Hardware: $\frac{1}{2}$ lb. 8d finishing nails.
56 poultry netting staples.
12 feet heavy wire.

Directions

The length of legs may be varied to suit the breed of hens.

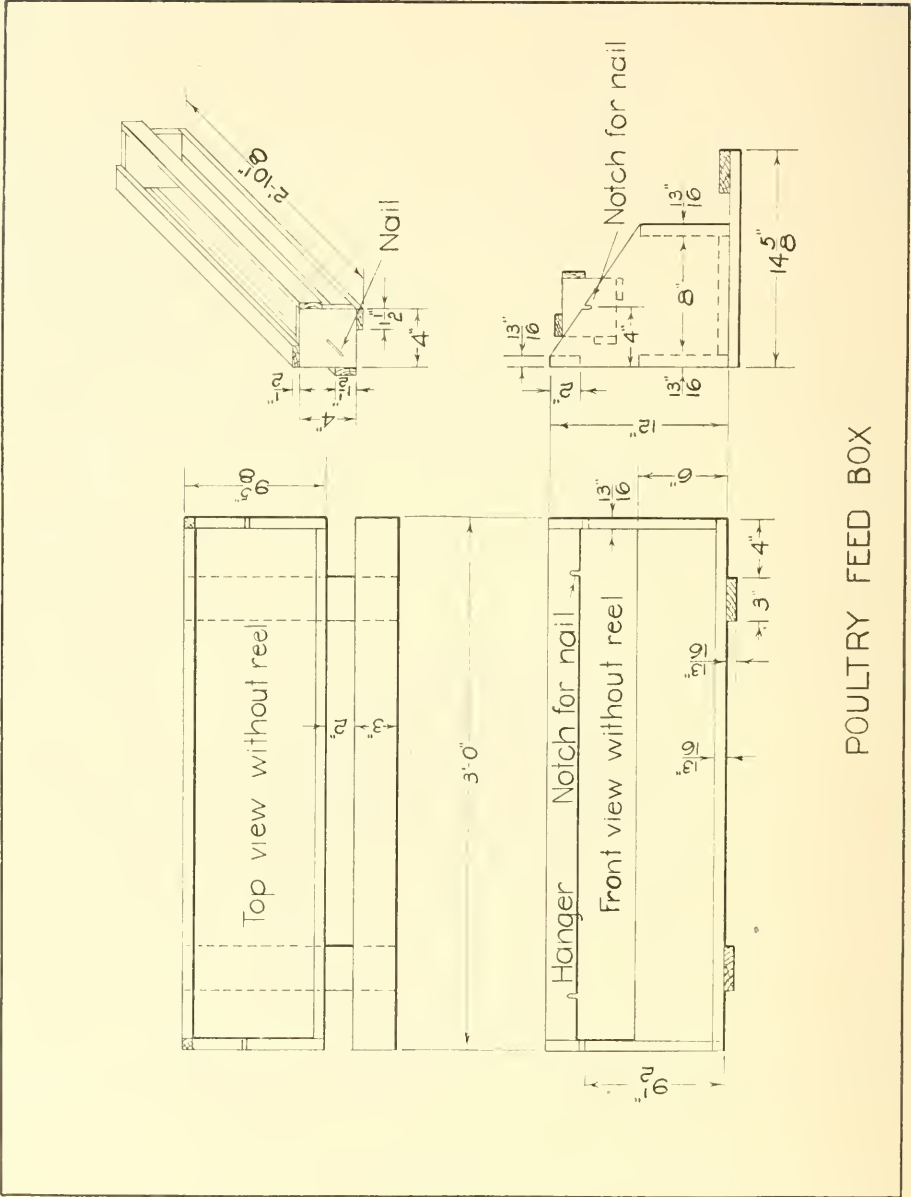
Braces for the legs near the bottom have purposely been omitted so that the space under the stand may be used for scratching and also to facilitate the use of tools under and around the stand.

Strips of wood may be nailed to the outside of the end members of the stand to prevent the trough from sliding lengthwise and off the platform.

It may be noted that the trough is not nailed to the platform but only set into the notches in the end pieces of the frame. This permits the removal of the trough for cleaning and filling.



Fig. 16. Poultry Feeding Trough.



POULTRY FEED BOX

POULTRY FEED HOPPER (FOR 25 BIRDS)

Bill of Material

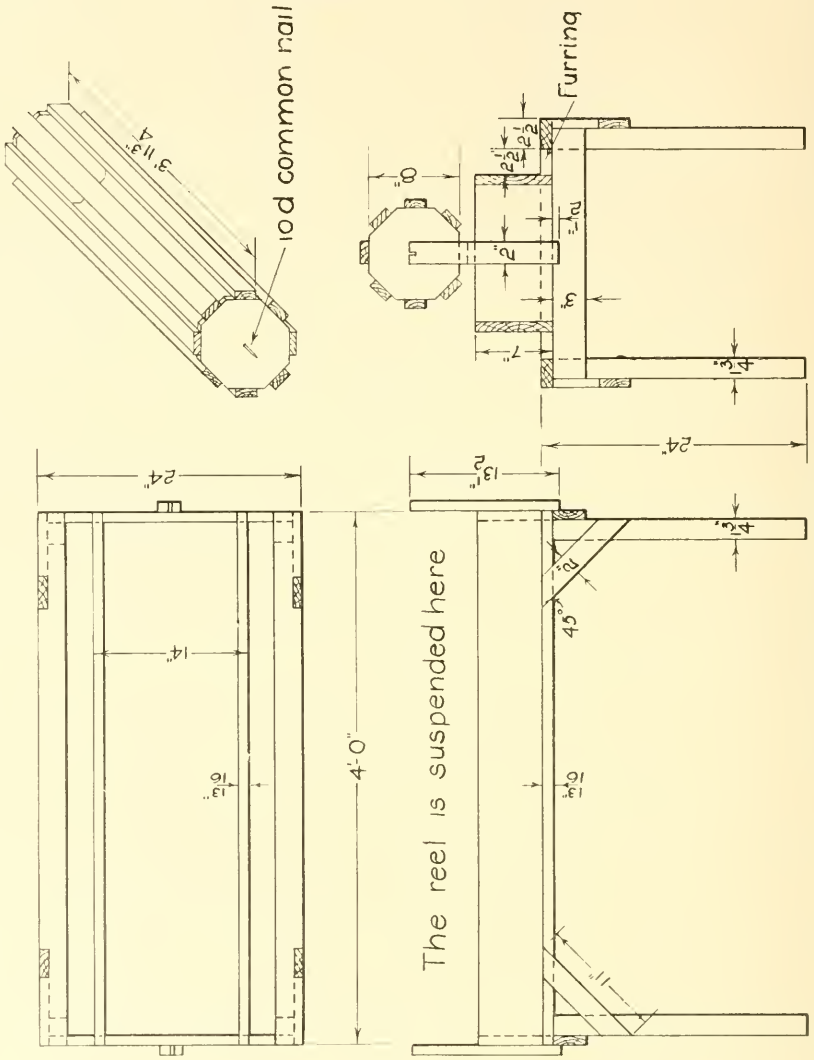
Pieces	Dimensions	Use
2	$1\frac{3}{8}$ "x3"x14 $\frac{5}{8}$ "	Sills
1	$1\frac{3}{8}$ "x6"x2' 10 $\frac{3}{8}$ "	Back
1	$1\frac{3}{8}$ "x6"x2' 10 $\frac{3}{8}$ "	Front
1	$1\frac{3}{8}$ "x8"x2' 10 $\frac{3}{8}$ "	Bottom
2	$1\frac{3}{8}$ "x9 $\frac{5}{8}$ "x12"	Ends
1	$1\frac{3}{8}$ "x2"x2' 10 $\frac{3}{8}$ "	Hanger
1	$1\frac{3}{8}$ "x3"x3' 0"	Landing board
2	$1\frac{3}{8}$ "x4"x4"	Ends of reel
4	$\frac{1}{2}$ "x1 $\frac{1}{2}$ "x2' 10 $\frac{1}{8}$ "	Slats for reel.
Hardware:	4 doz. 8d finishing nails for assembling box.	
	2 doz. 4d finishing nails for fastening slats of reel.	
	1 doz. 1 $\frac{1}{2}$ " No. 9 flat head wood screws for fastening landing board to sills and sills to box.	
	2 8d common nails for reel pivots.	
	1 piece 1" mesh wire, or $\frac{1}{2}$ " mesh hardware cloth, 6"x2' 10" to lay on feed.	

Directions

1. Reduce all pieces to length, width and thickness.
2. To lay out the slant on the end pieces, draw a line across the top end $13/16$ " from the back edge and a line across the front edge 6" from the bottom end; connect lines on edge and end with lines on the sides of the stock and remove stock to line with saw and plane.
3. Using a $1/4$ " bit and a cross-cut saw, bore a hole and cut notches in the end pieces for the reel nails as shown in the drawing. 4" from back edge and $9\frac{1}{2}$ " from the bottom end.
4. Assemble the box and hanger by using the 8d finishing nails.
5. Fasten the sills to the bottom with $1\frac{1}{2}$ " No. 9 flat head screws.
6. Fasten the landing board to the sills at front by using two $1\frac{1}{2}$ " No. 9 flat head wood screws for each sill.
7. Fasten the slats to the end pieces of the reel, using three 4d finishing nails at each end of each slat.
8. Bore a hole with the $1/8$ " bit thru each end piece at its center and drive an 8d common nail thru from the inside for the reel to turn on the ends of the box.
9. Cut notches for nails in the lower edge of the hanger. This may be done by boring a hole of the same diameter as the nails or spikes which are to be used for the box to hang on and sawing tangent to the holes from the bottom edge of the board.

The purpose of the reel is to keep the fowl from the top of the box or feed. The purpose of the 1" mesh wire is to prevent the fowl from wasting feed. By use of it they can get all that is in the box but cannot flip it out as is the habit of fowl.

By the suggested arrangement the reel may be lifted off when filling or cleaning the box. The box is suspended on the wall by hanging it over two nails or spikes.



POULTRY FEED BOX

It is understood that the box may be increased to any length to suit the size of flock.

POULTRY FEED HOPPER (FOR 50 BIRDS)

Bill of Material

Pieces	Dimensions	Use
4	$1\frac{3}{4}'' \times 1\frac{3}{4}'' \times 23\frac{3}{16}''$	Posts
2	$\frac{13}{16}'' \times 3'' \times 22\frac{3}{8}''$	Cross braces
2	$\frac{13}{16}'' \times 2\frac{1}{2}'' \times 4' 0''$	Landing boards
4	$\frac{13}{16}'' \times 2'' \times 11''$	Braces
2	$\frac{13}{16}'' \times 7'' \times 4' 0''$	Sides of box
2	$\frac{13}{16}'' \times 7'' \times 12\frac{3}{8}''$	Ends of box
2	$\frac{13}{16}'' \times 6\frac{3}{16}'' \times 3' 10\frac{3}{8}''$	Bottom of box
2	$\frac{13}{16}'' \times 2'' \times 13\frac{1}{2}''$	End posts
2	$\frac{13}{16}'' \times 8'' \times 8''$	Ends of wheel
8	$\frac{13}{16}'' \times 2'' \times 3' 11\frac{3}{4}''$	Slats for wheel
4	$\frac{13}{16}'' \times 1\frac{3}{16}'' \times 2\frac{1}{2}''$	Furring to hold box in place
Hardware:	$\frac{3}{4}$ lb. 8d finishing nails.	
	1 piece of 1" mesh wire screen or $\frac{1}{2}''$ mesh hardware cloth, 12" x 3' 10" to lay on feed.	

Directions

The purpose of the wheel is to keep the fowl from the top of the box. It has the additional advantage over a fixed top in that it is removable for filling and cleaning the box.

The box is removable and is held in place by the two end posts projecting down over the end cross braces on the outside. It is prevented from moving sidewise by the small pieces of furring which are nailed on the top edge of the end cross braces between the landing board and box.

There are numerous ways of preventing the waste of feed. Heavy wires may be nailed across the top of the box spaced 3" or 4" on center or a piece of quarter round may be nailed to the inside of the side boards of the box at the top edge.

The screen has the advantage of being removable, thus making it easier to fill and clean.

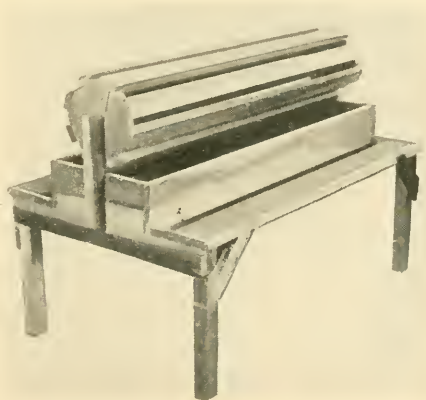
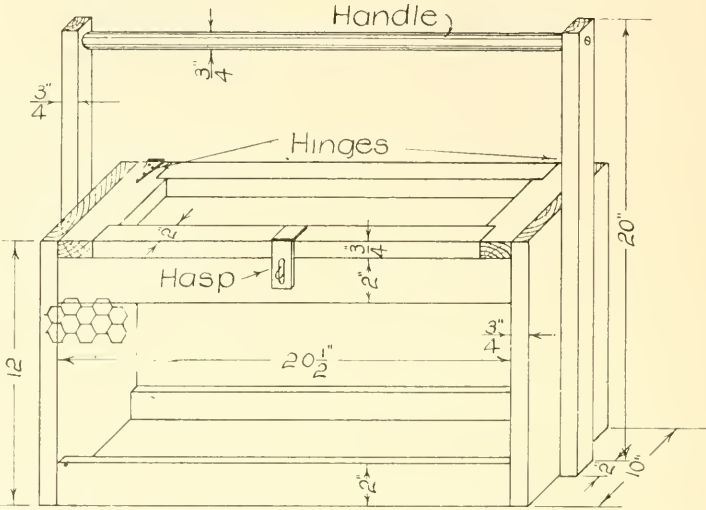


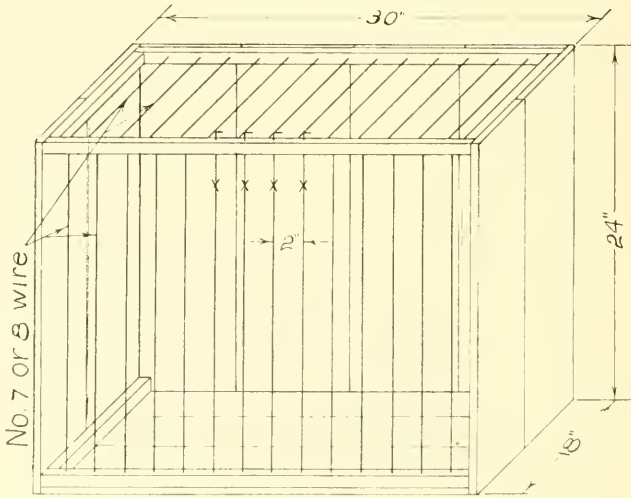
Fig. 17. Poultry Feeding Box.

Poultry netting for sides and door



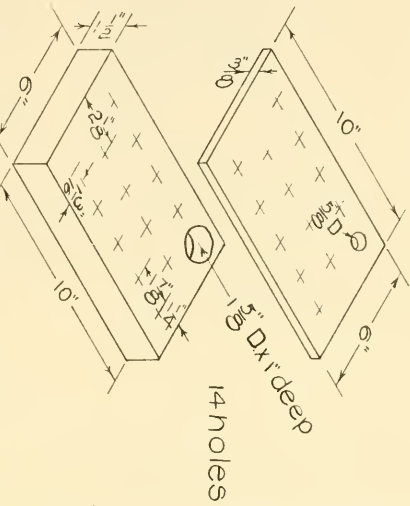
Poultry Carrying Crate

Raise wires "x" for door
Use lumber 3/4 x 3/4 for frame
Use 1/2 lumber for floor, sides & back



Poultry Show Crate

Milk Test Bottle Holder



The hook



Broom handle

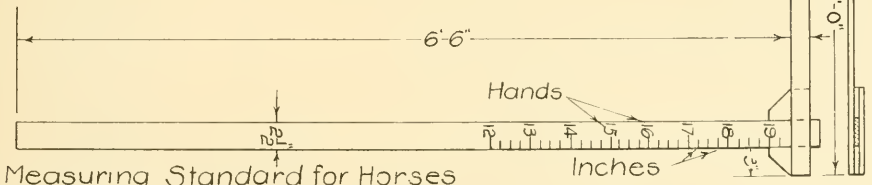
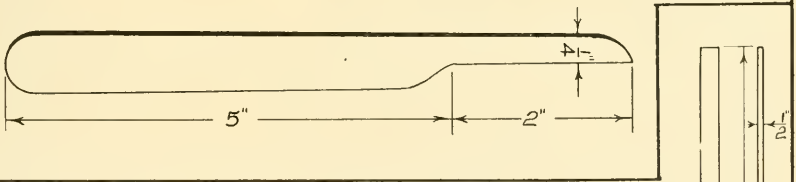
No. 9 or 10 steel wire 2 1/4" long

Poultry Catching Hook

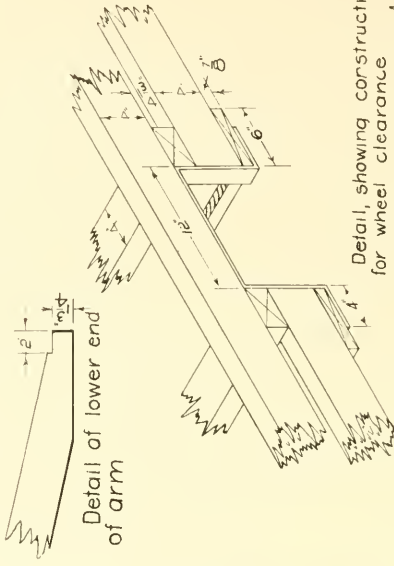
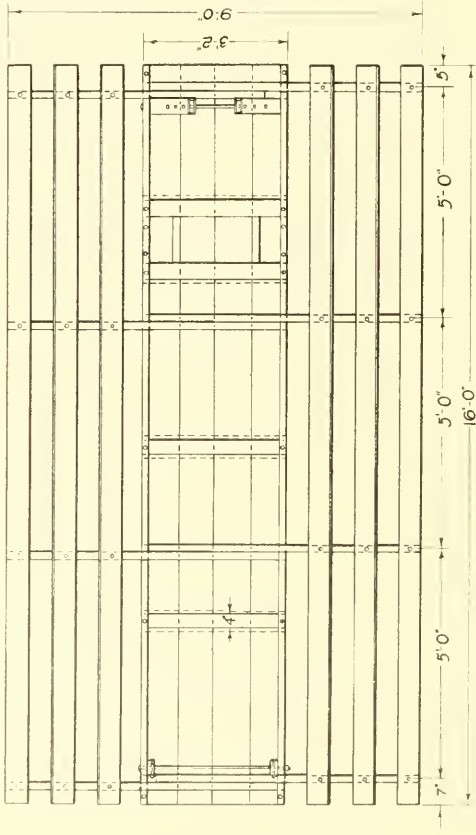


8" flat file

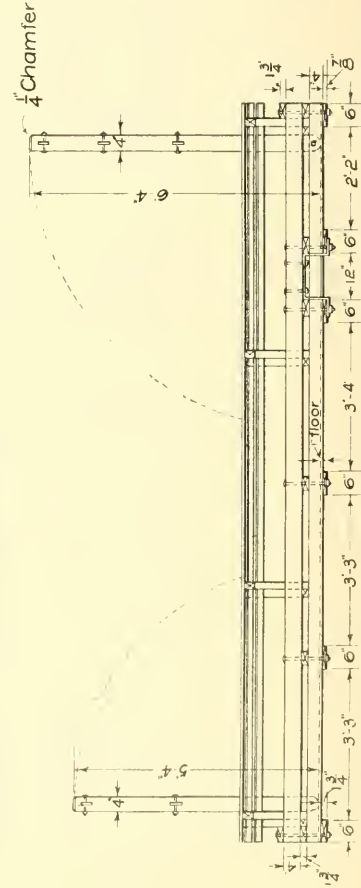
Poultry Sticking Knife



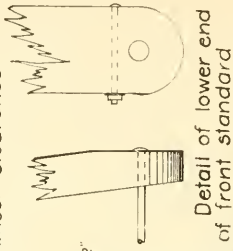
Measuring Standard for Horses



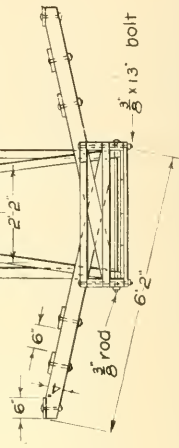
Detail, showing construction for wheel clearance



1/4 Chamfer



Detail of lower end of front standard



HAY RACK

Material Required

Pieces	Dimensions	Use
2	2"x4"x16' 0"	Upper stringers
2	2"x4"x11' 10"	Lower stringers
2	2"x4"x3' 2"	Lower stringers at front
8	1¾"x4"x3' 2"	Cross ties
1	1¾"x6"x3' 2"	Floor sill at rear
5	7⁄8"x6"x3' 2"	Floor sills
4	7⁄8"x9"x16' 0"	Floor
8	1¾"x4"x6' 2"	Arms
6	7⁄8"x6"x16' 0"	Top boards
2	1¾"x4"x6' 4"	Front standard
2	1¾"x4"x5' 4"	Rear standards
2	7⁄8"x3"x2' 11"	Rear standard cross bars
1	7⁄8"x3"x2' 2"	Front standard cross bar bottom
1	7⁄8"x3"x20½"	Front standard cross bar middle
1	7⁄8"x3"x16½"	Front standard cross bar top
2	1¾"x4"x6"	Furring

Hardware

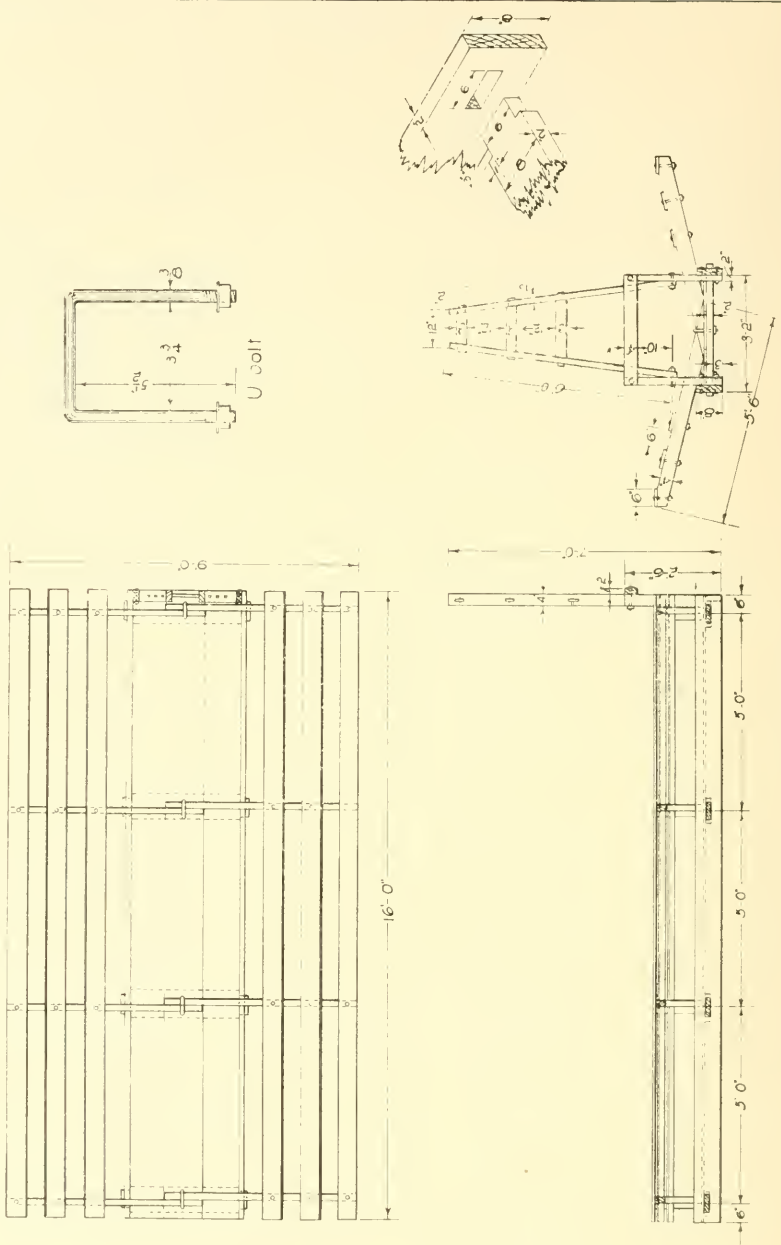
- 2 pieces of iron ¾"x1¾"x33¼" trusses (old wagon tire).
- 2 carriage bolts ¾"x13" front.
- 2 carriage bolts ¾"x13½" rear.
- 4 carriage bolts ¾"x11" cross ties.
- 4 carriage bolts ¾"x11½" cross ties and truss.
- 4 carriage bolts ¾"x5" truss.
- 24 carriage bolts ¼"x5½" boards to arms.
- 14 carriage bolts ¼"x4½" standards.
- 2 ¾"x3' 3" rods for standards at bottom.
- 72 6d common nails for floor.

Directions

In making the iron truss for the wheel, clearance space measurements should be made of the combined thickness of the floor sill and cross tie and width of stringers. Any deviation from the dimensions given on the drawing must be made in dimensions of the truss. If an old wagon tire is available it will serve as well as new iron.

Quarter inch bolts are placed thru the upright members of the standards at the lower ends to prevent their splitting.

Flat head wood screws may be used to fasten the floor boards to the floor sills instead of the 6d common nails.



HAY RACK

HAY RACK

Bill of Material

Pieces	Dimensions	Use
2	2"x8"x16' 0"	Stringers
4	2"x8"x3' 4"	Sills
8	2"x4"x5' 6"	Arms
3	1"x11 ³ / ₈ "x16' 0"	Floor
6	1"x6"x16' 0"	Top boards
2	2"x4"x2' 6"	Front posts
1	2"x4"x2' 10 ¹ / ₄ "	Cross bar at front posts
2	2"x4"x6' 0"	Front standards
1	1"x3"x1' 11"	Cross bar at front standard
1	1"x3"x1' 7"	Cross bar at front standard
1	1"x3"x1' 3"	Cross bar at front standard

Hardware

16 carriage bolts $\frac{3}{8}$ "x5" to fasten inside boards on arms.

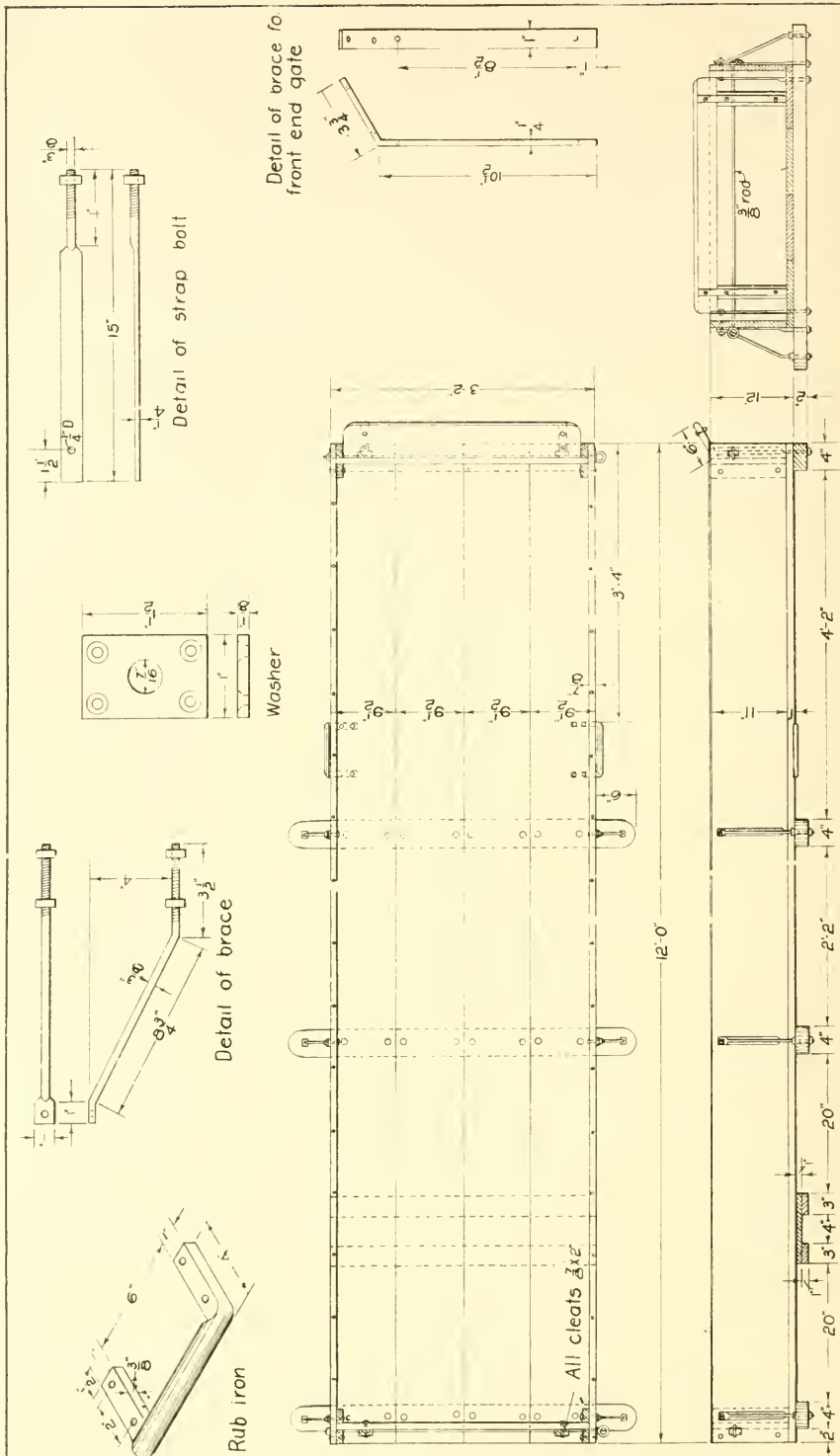
12 carriage bolts $\frac{3}{8}$ "x4¹/₂" to fasten outside boards on arms, posts to stringers and standards to posts.

4 carriage bolts $\frac{3}{8}$ "x6" to fasten cross bar to front standard.

6 8d common nails to fasten cross bars into front standard.

4 U bolts as shown in the detail drawing.

16 40d spikes to fasten sills to stringers.



WAGON BOX

WAGON BOX

Lumber: Poplar or basswood are desirable woods.

Stock Bill

Pieces	Dimensions	Use
3	2" x 4" x 4' 2"	Cross sills
1	2" x 4" x 3' 2"	Front cross sill
2	7/8" x 11" x 12' 0"	Sides
2	7/8" x 11" x 3' 1/4"	End gates
4	1" x 9 1/2" x 12' 0"	Floor
12	7/8" x 2" x 11"	Cleats
1	7/8" x 6" x 2' 10 1/2"	Foot board
1	1" x 10" x 3' 2" oak or other	Axle support
2	1" x 3" x 3' 2" hardwood	Axle guides

Hardware

- 32 wagon box rivets 1/4" x 3 1/2" for floor boards.
- 12 wagon box rivets 1/4" x 2" for rear end gate and side cleats.
- 16 wagon box rivets 1/4" x 1 1/2" for rub irons, braces and foot boards.
- 2 wagon box rivets 1/4" x 2 1/2" for rear end braces.
- 8 wagon box rivets 1/4" x 2 1/4" braces for front end gate and front side cleats.
- 6 braces as shown in detail drawing.
- 2 rub irons shown in detail drawing.
- 4 rectangular washers as shown in detail drawing.
- 8 wagon box strap irons as shown in detail drawing.
- 2 front end gate braces as shown in detail drawing.
- 2 wagon box rods.
- 4 doz. flat head wood screws for fastening axle support to box and axle guides to axle support.
- 31 ft. of beveled or half oval wagon box strap iron with screws.

Wagon boxes usually wear out at the part over the rear axle. This may be prevented by fastening a 10" board beneath the box where it rests on the axle.

To hold the box in place cleats are fastened beneath the 10" board so that one will be in front of and the other back of the axle. The distance between cleats is 3 1/2", 3 3/4" or 4" as determined by the width of the axle.



Fig. 18. Wagon Box.

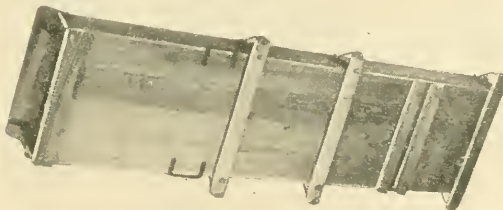
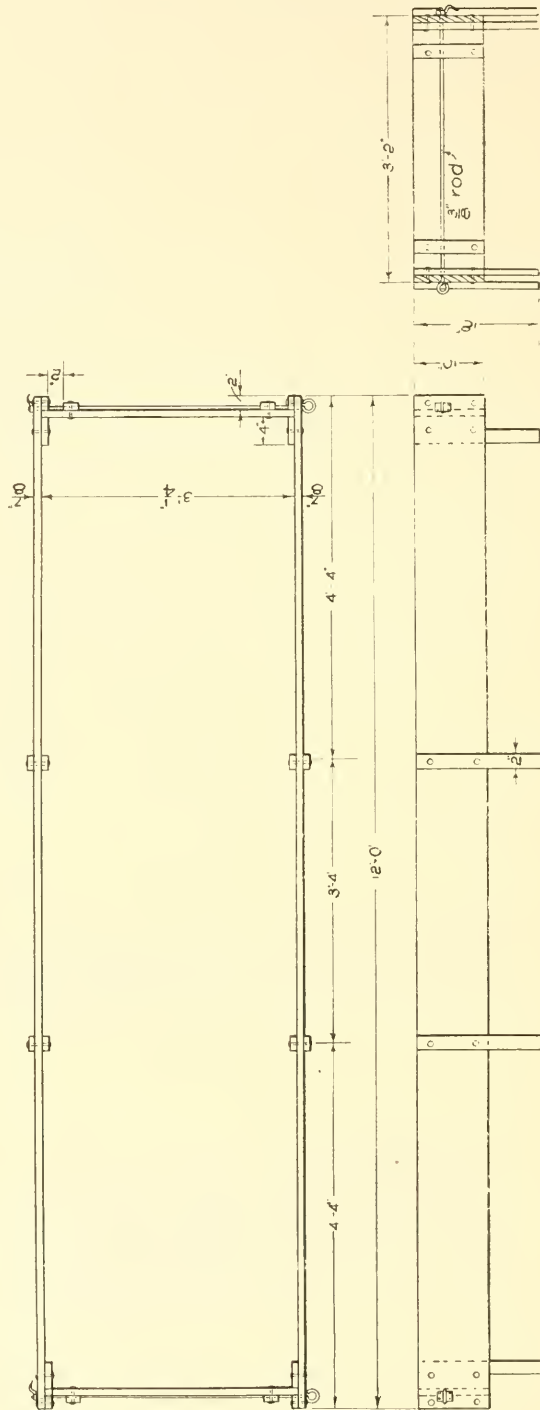


Fig. 19. Bottom of Wagon Box.



10' WAGON BOX

TOP WAGON BOX

Stock Bill

Pieces	Dimensions	Use
2	$7\frac{7}{8}$ "x10"x12' 0"	Sides
2	$7\frac{7}{8}$ "x10"x3' $\frac{1}{4}$ "	End gates
8	$7\frac{7}{8}$ "x2"x18"	Braces
8	$7\frac{7}{8}$ "x2"x10"	Cleats at ends outside and end gates
4	$7\frac{7}{8}$ "x4"x18"	Cleats at ends inside

Hardware

24 wagon box rivets $\frac{1}{4}$ "x2".

8 wagon box rivets $\frac{1}{4}$ "x2 $\frac{3}{4}$ ".

4 rectangular washers as for wagon box.

2 wagon box rods with winged nuts.

31 feet of half oval or beveled wagon box strap iron with screws for fastening.

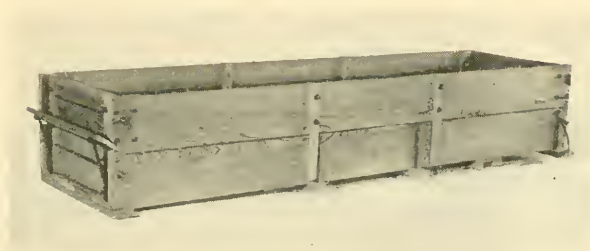
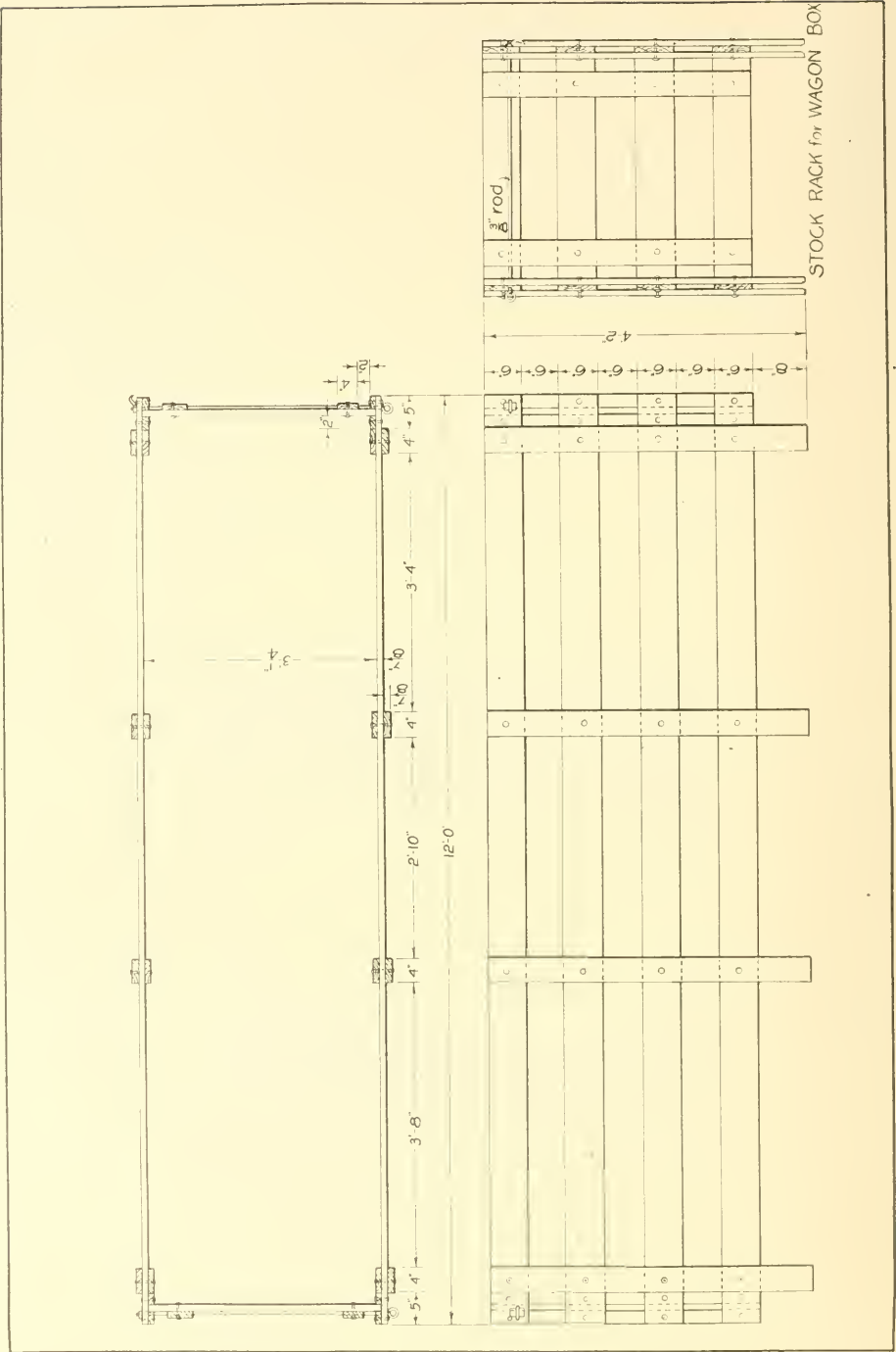


Fig. 20. Wagon Box with Top Box in Place.



Fig. 21. Top, Wagon Box.



STOCK RACK FOR WAGON BOX

Stock Bill

Pieces	Dimensions	Use
8	$\frac{7}{8}$ " x 6" x 12' 0"	Sides
8	$\frac{7}{8}$ " x 6" x 3' $\frac{1}{4}$ "	End gates
16	$\frac{7}{8}$ " x 4" x 4' 2"	Uprights for sides
4	$\frac{7}{8}$ " x 4" x 3' 6"	Uprights for end gates
8	$\frac{7}{8}$ " x 2" x 3' 2"	Cleats at ends of sides

Hardware

32 carriage bolts $\frac{5}{16}$ " x 3" for fastening uprights to sides.

48 carriage bolts $\frac{5}{16}$ " x 2 $\frac{1}{2}$ " for fastening end uprights and cleats at ends of sides.

4 rectangular washers as for wagon box.

2 wagon box rods with winged nuts.

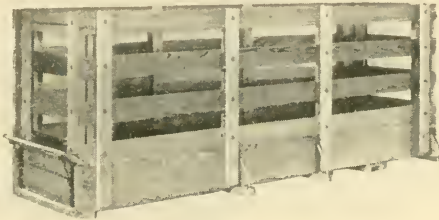


Fig. 22. Stock Rack and Wagon Box.

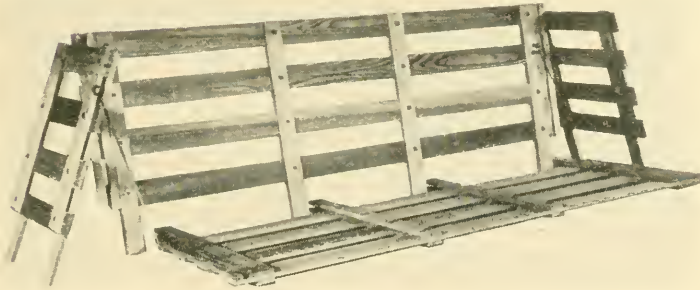


Fig. 23. Stock Rack Knocked Down.

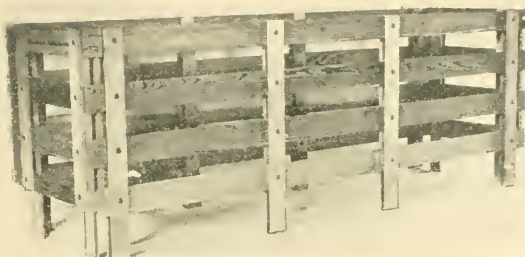
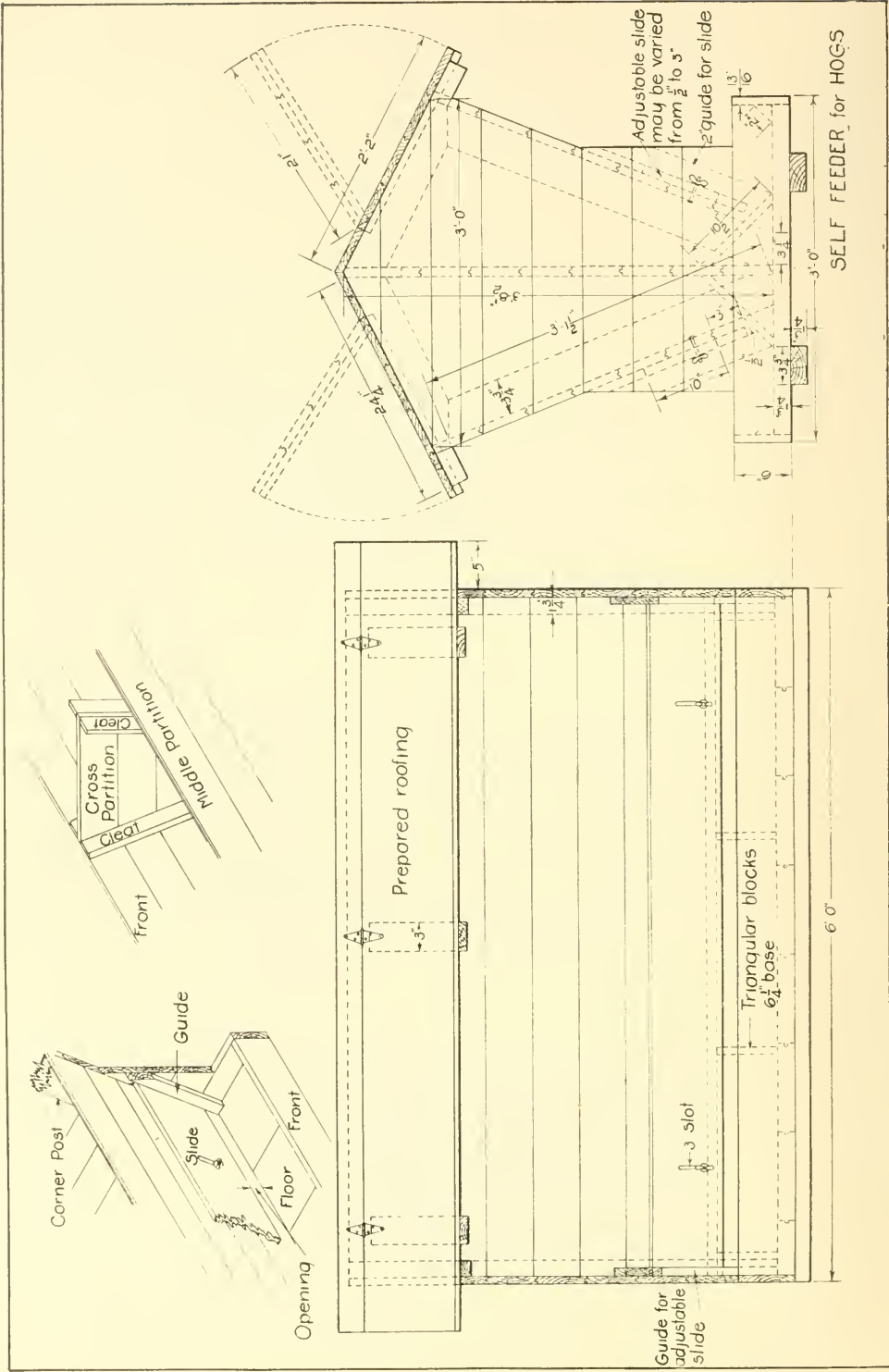


Fig. 24. Stock Rack for Wagon Box Assembled.



SELF FEEDER FOR HOGS

Many farmers claim distinct advantages in the self feeder for hogs. Among others the following points are raised: (a) Less labor is required than by the hand-feeding system. (b) A smaller amount of feed is used in making pork. (c) It allows the pigs to eat as often as they choose and gives them free choice regarding the proportions and amounts of the different feeds, consequently they are never hungry or gorged with feed.

The size of a self feeder can only be determined by the needs of the individual farmer.

Material Required

- 2 pieces 2"x10"x12' 0" matched flooring.
- 1 piece 2"x4"x12' 0" skids.
- 2 pieces 2"x4"x10' 0" rafters and studs.
- 1 piece 2"x4"x12' 0" for triangular strips in corners of troughs.
- 15 pieces 1"x6"x12' 0" matched flooring (actual measurements $1\frac{3}{8}$ "x5 $\frac{1}{4}$ "x12' 0").
- 5 pieces 1"x6"x14' 0" matched flooring for roof.
- 2 pieces 1"x6"x12' 0" unmatched lumber, ridge board, sides and ends.
- 2 pieces 1"x10"x12' 0" unmatched lumber for slides, triangular blocks, guides for slides, cleats for door.
- Lumber for desired cross partitions.
- 68 square feet of roofing paper.
- 6 heavy strap hinges.
- 1 lb. 10d. common nails.
- 2 $\frac{1}{2}$ lb. 6d. common nails.
- 4 2 $\frac{1}{2}$ " bolts with thumb nuts.

Directions

If it is so desired the skids may be cut from a piece of 2" x 4" x 14' 0" and allowed to project out at the ends of the feeder. By boring holes thru the skids near the ends means are provided for hitching a team of horses and dragging the feeder to any desired location.

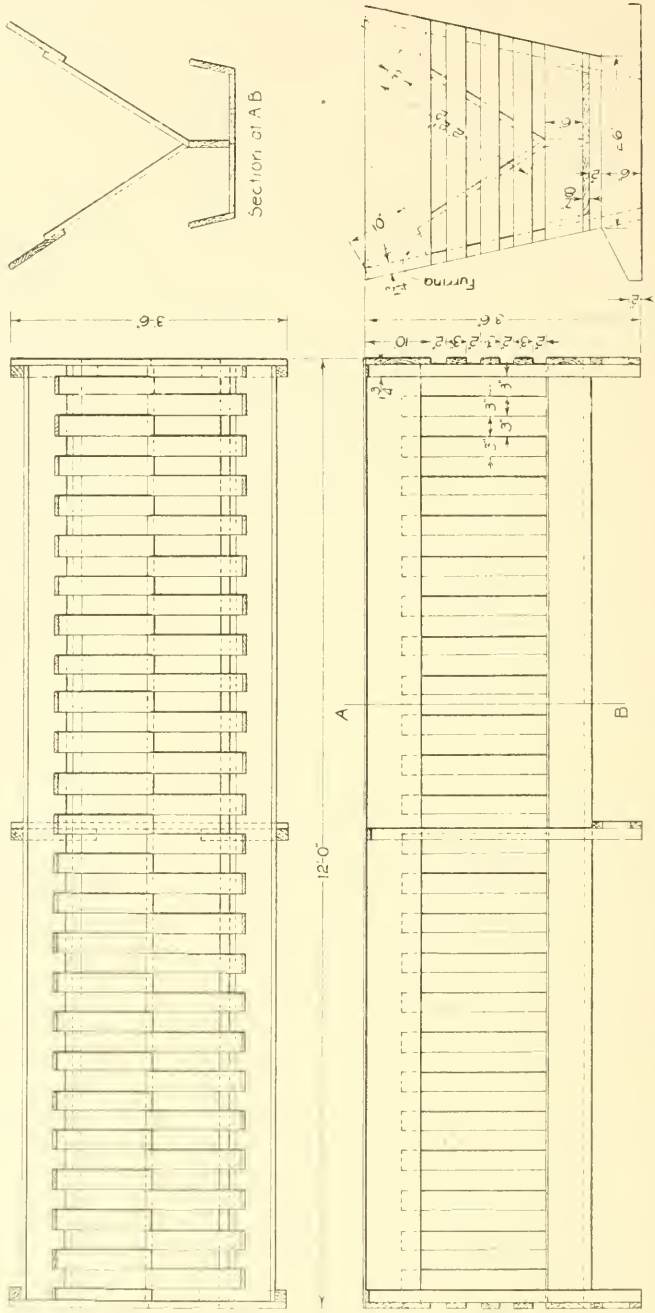
Matched lumber which is designated 1" x 6" varies in width of face. Some manufacturers make it 5 $\frac{1}{4}$ " face, others 5 $\frac{1}{2}$ ". The size, 5 $\frac{1}{4}$ " appears most frequently the dimension used and is the measurement used in the drawing.

Cross partitions have purposely been omitted from the drawing as the variety and amounts of the various feeds rest with the farmer. A method of constructing a cross partition is shown in the detail drawing.

The roofing should be placed over the hinges. A separate piece should be placed over each door and the piece at top should lap down onto the door from 1 $\frac{1}{2}$ " to 2".

The size of opening may be varied for different feeds from 1 $\frac{1}{2}$ " to 3" by use of the adjustable slides.

SHEEP FEEDING RACK



SHEEP FEEDING RACK

Bill of Material

Lumber: Pieces	Dimensions	Use
6	1 3/4" x 1 3/4" x 3' 7"	Posts
3	7/8" x 6" x 3' 6"	Bases
2	7/8" x 10" x 3' 6"	Ends
2	7/8" x 3" x 3' 0"	Ends
2	7/8" x 3" x 2' 10"	Ends
2	7/8" x 3" x 2' 8"	Ends
2	7/8" x 6" x 2' 6"	Ends of trough
3	7/8" x 2" x 2' 3"	Ends below trough
2	7/8" x 7" x 11' 10 1/4"	Sides of trough
1	7/8" x 6" x 11' 10 1/4"	Trough partition
2	7/8" x 10 1/4" x 12' 0"	Trough bottom
2	7/8" x 10" x 11' 10 1/4"	Top boards
46	7/8" x 3" x 2' 2 1/2"	Slats
6	1 3/4" x 3 1/2" tapered to a point x 10"	Furring to nail top boards
Hardware:	1 lb. 6d. common nails.	
	2 lbs. 8d common nails.	

Directions

Sheep respond more readily to good feed and care than any other livestock, and it is necessary that the flock be fed consistently and regularly to insure a wool clip of good weight and quality.

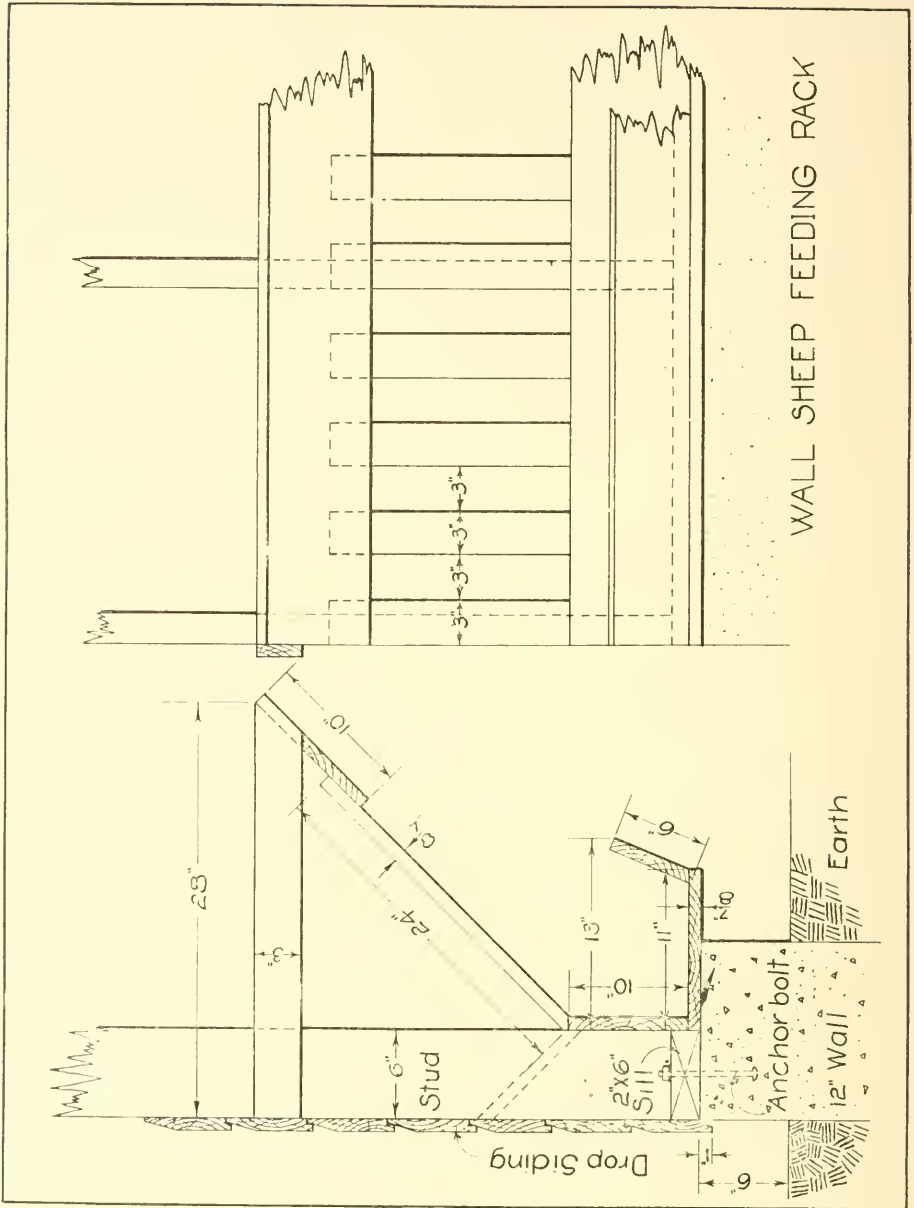
Good feeding is difficult without the use of a feeding rack for both hay and grains.

The hopper design of rack for feeding hay has the advantage over others by keeping the heads of the sheep out of the hay and thus preventing chaff, seeds, etc., from getting into the wool. The trough has the additional advantage of catching the leaves of alfalfa, clover or other hay so they may be consumed. Without a trough underneath the hay the leaves would drop onto the bedding and hence would be lost. The length of rack may be made longer or shorter to suit the needs of any size of flock. If made eight feet or less in length, the two middle posts and their cross ties may be omitted.

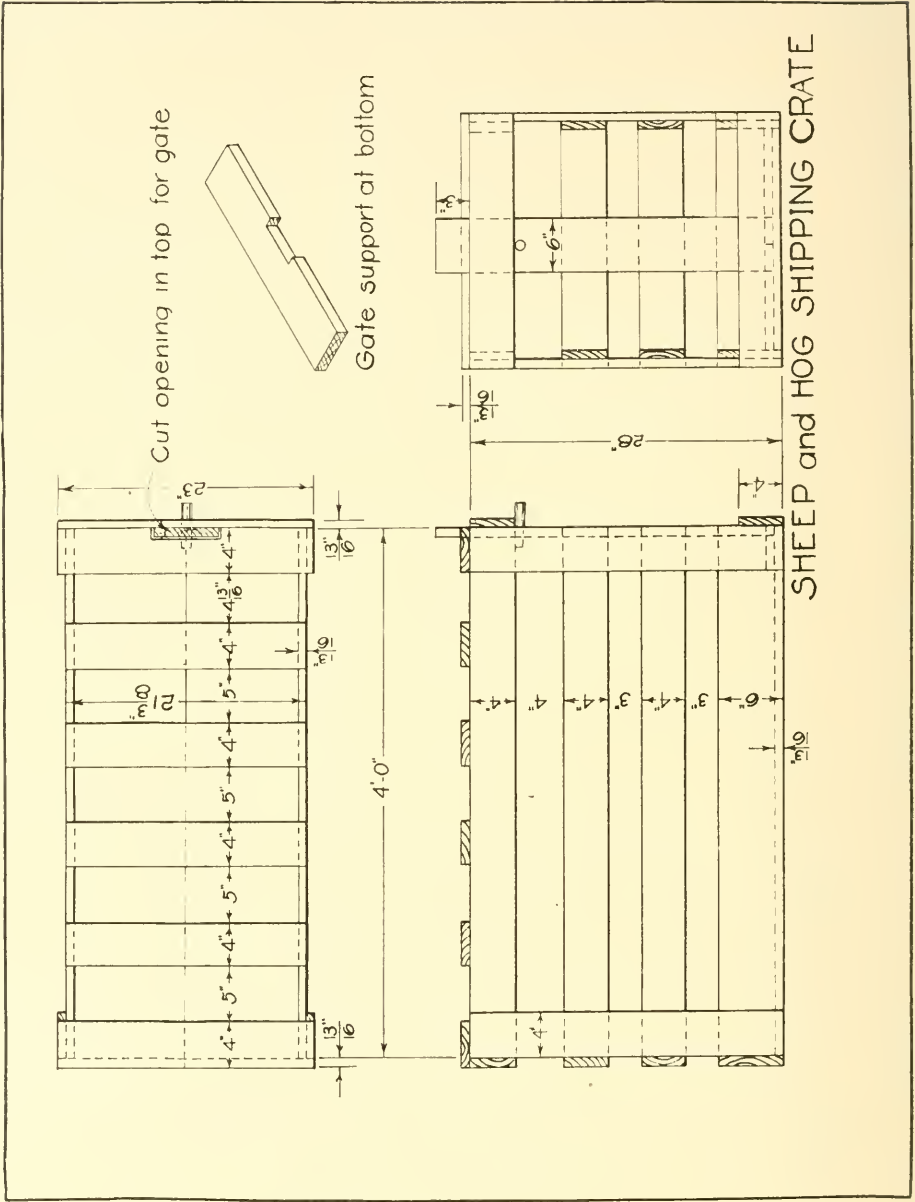
In assembling the 8d nails are used at places where nails are driven into the 1 3/4" pieces. The 6d nails are used at all other points. The lower ends of the slats are beveled as shown in the detail drawing and nailed to the top edge of the trough partition.

Those teachers of agricultural woodworking who are using the home project method may find the wall sheep feeding rack a suitable home project. It is understood that the length of rack and some of the details are in that case determined by the number of sheep, the place where the rack has to be placed, kind of wall to be fastened to, the thickness of wall, etc. The drawing can only serve to give general dimensions which, if followed, will make a serviceable rack.

It is felt that when a boy in the agricultural high school has obtained a general notion of how to go at the building of a rack of the



kinds shown and thru his school farm shop work has acquired the knowledge of tool manipulation to make it and thru his study of animal husbandry in the classroom has acquired a desire to build it, the agricultural high school has done much toward adding one valuable young farmer to the community's general worth.



SHEEP AND HOG SHIPPING CRATE

Bill of Material

Lumber:	Dimensions	Use
Pieces		
2	$\frac{1}{8}$ " x $9\frac{7}{8}$ " x 4' 0"	Bottom
1	$\frac{1}{8}$ " x 6" x 23"	Front end at bottom
7	$\frac{1}{8}$ " x 4" x 23"	Ends and top at ends
4	$\frac{1}{8}$ " x 4" x $21\frac{3}{8}$ "	Top
4	$\frac{1}{8}$ " x 4" x 2' 4"	Corner posts
2	$\frac{1}{8}$ " x 6" x 4' 0"	Sides at bottom
6	$\frac{1}{8}$ " x 4" x 4' 0"	Sides
1	$\frac{1}{8}$ " x 4" x $19\frac{3}{4}$ "	Gate support at bottom
1	$\frac{1}{8}$ " x 6" x 2' $6\frac{3}{8}$ "	Gate
1	$\frac{3}{4}$ " round x 4"	Pin to lock gate
Hardware:	1 pound of 6d common nails.	

STITCHING HORSE

Bill of Materials

Lumber: Oak, maple, beech, birch or other hardwood.

Pieces	Dimensions	Use
1	1 3/4" x 10 1/2" x 26"	Seat
4	1 1/4" x 1 1/4" x 24 1/4"	Legs
1	1 1/4" x 1 1/4" x 21 3/8"	Brace (left side)
1	3/4" x 3/4" x 23 3/4"	Brace (right side)
2	3/4" x 3/4" x 13 3/4"	Braces (end)
1	3/4" x 1 1/4" x 22"	Lever
1	1 1/2" x 5" x 20 3/4"	Post
1	1 1/2" x 5" x 16 3/4"	Clamp
1	1" x 1 3/4" x 5"	Key

Hardware

- 6 flat head bright wood screws 2 1/2" No. 12 for fastening legs to seat and brace to legs at left side.
- 6 flat head bright wood screws 1 3/4" No. 9 for fastening braces at ends and right side.
- 7 round head blued wood screws 1" No. 9 to fasten lock on leg and catch to lever.
- 2 machine bolts 5/8" x 3 1/2" to fasten clamp to post.
- 2 fast joint steel butts 1 1/2" x 1 1/2".
- 1 coil spring 1" x 3".
- 1 leather strap 1" x 44".
- 1-1" harness buckle.
- 3 lining nails to fasten end of strap to clamp.
- 1 piece of heavy wire 2 1/2" long to hold strap in place on lever.
- 1 piece of metal 1/4" x 1 1/2" x 5" for the lock.
- 1 piece of metal 1/4" x 1 1/2" x 2 1/2" for the catch.
- 1 piece of metal 1/4" x 1" x 5 1/2" for the U iron.
- 2 machine bolts 1/4" x 2" to hold the U iron to brace and lever in U iron.

Directions

1. Reduce all pieces to finished dimensions.

2. Draw a centerline lengthwise of the seat piece and also lines across the stock 5 1/4" from each end, and at the intersection of lines swing arcs with a 5 1/4" radius.

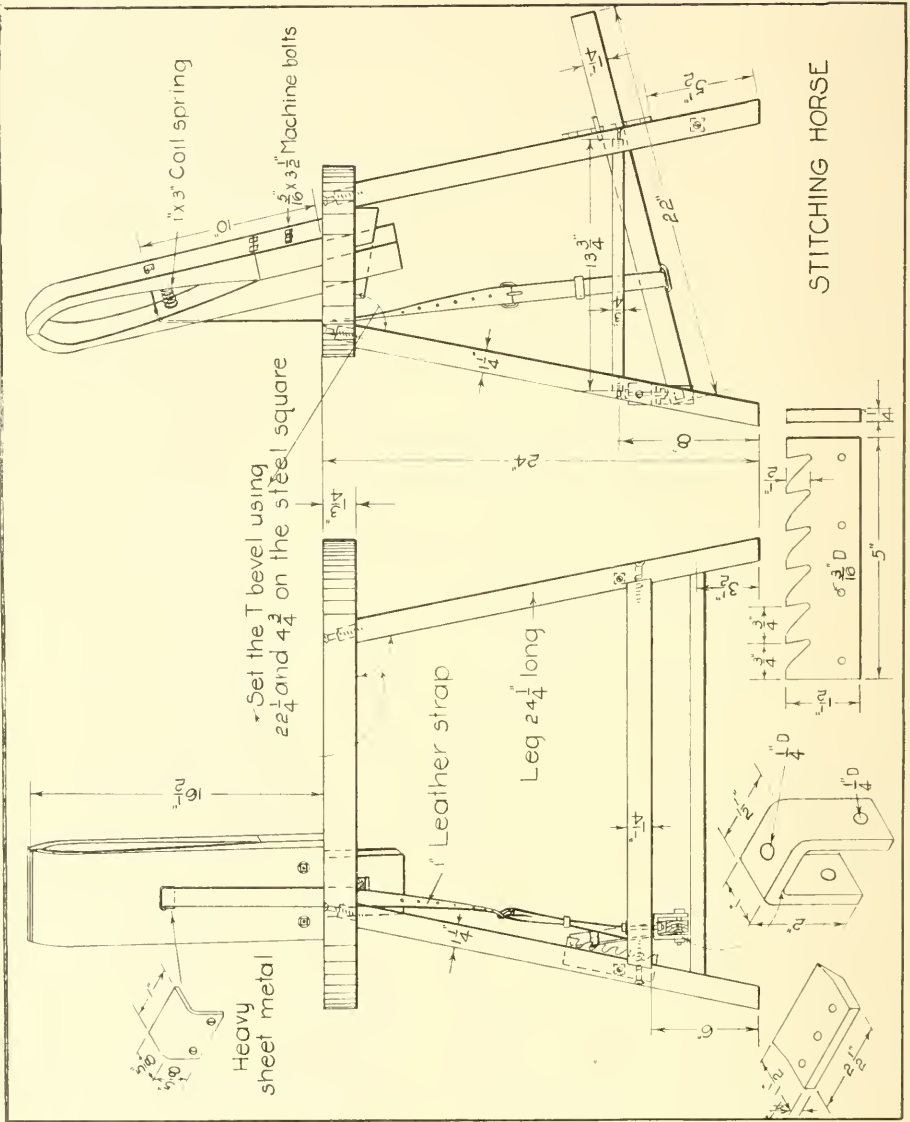
3. With the compass set at 9 3/4", swing an arc at each side tangent to the arcs at each end.

4. Remove stock to line with a turning saw, keyhole saw, or by making saw kerfs to the line and removing the stock with the draw shave. The edge may be smoothed with a wood file.

5. The stock on the upper side of the seat where the worker's legs rest on the seat may be further removed with the draw shave and smoothed with the wood file.



Fig. 23. Front View of Stitching Horse.



6. To lay out the mortise for the post on the seat locate a point on the line across the front end of the seat $\frac{1}{4}$ " from the centerline as shown in the detail drawing. Set the T bevel at $\frac{1}{8}$ pitch using the figures 12 and 3 or 4 and 1 on the steel square and draw lines for the sides of the mortise. The end lines of the mortise are at right angles to the sides. The mortise extends thru the seat at the above angle and the T bevel may be used as a guide in boring out the stock.

7. Remove the stock for the mortise with bit, chisel and mallet. It may be noted in the detail drawing that the mortise is $1\frac{5}{8}$ " x $3\frac{1}{2}$ ".

8. Set the T bevel at $22\frac{1}{4}$ " and $4\frac{3}{4}$ " on the steel square and lay out the cuts at both ends of the legs and left side brace. A shoulder is cut at the upper end of the legs 1" from the end so that the end will go into the $\frac{3}{4}$ " holes which are bored in the lower side of the seat.

9. At a point 6" from the lower end of the left legs and on the inside lay out gains $\frac{1}{4}$ " deep and $1\frac{1}{4}$ " wide across the stock to receive the ends of the left side brace. The stock may be removed with the saw and chisel, making the saw kerfs close together. Use the T bevel as set for the ends of the legs. This will place the top and bottom edge of the brace parallel to the floor when the horse is assembled.

10. Assemble the brace and left legs by the use of one $2\frac{1}{2}$ " No. 12 flat head bright wood screw at each joint. The holes for all flat head screws should be countersunk so as to place the screws slightly below the surface of the wood. In placing screws it is well to use two wood twist drills; one the diameter of the wire of the screw to bore a hole as deep as the screw up to the thread on the screw and another $\frac{1}{32}$ " smaller to bore the hole slightly deeper.

11. Locate points on the inside of all four legs on a centerline and 8" from the bottom end of the legs and bore $\frac{3}{4}$ " holes $\frac{3}{4}$ " deep for the ends of the end braces. The holes are bored at the same angle as is used for the ends of the legs. The ends of the braces are rounded so as to draw snugly into the $\frac{3}{4}$ " holes.

12. Locate points on the two right legs $3\frac{1}{2}$ " from the bottom ends and bore $\frac{3}{4}$ " holes for the right side brace.

13. Fasten the braces to the legs by using one $1\frac{3}{4}$ " No. 9 flat head bright wood screw at each joint.

14. Lay the seat on the bench with the bottom side up. Draw a centerline lengthwise of the stock and lines across the stock $5\frac{1}{4}$ " from each end. Locate two points on each line across the stock 4" from the centerline. At these points bore $\frac{3}{4}$ " holes 1" deep, using the T bevel set as for the ends of the legs for a guide.

15. With a twist drill of the size of $2\frac{1}{2}$ " No. 12 screws continue the holes thru the seat from the same side. Countersink the hole; from the upper side of the seat.

16. Place the legs in position and with a twist drill $\frac{1}{32}$ " smaller than the above bore a hole into the top end of each leg for the screws.

17. Fasten the seat to the legs using one $2\frac{1}{2}$ " No. 12 flat head screw at each joint.

18. By use of the T bevel as set for the mortise thru the seat lay out the lower end of the clamp and post and remove the stock with saws as shown in the detail drawing of clamp.

19. Lay out the mortise for the key thru the post at the dimensions shown in the detail drawing of the clamp. Remove the stock with bit, chisel and mallet.



Fig. 24. Side View of Stitching Horse.

20. To lay out the clearance space on the clamp and post, draw seven lines across the inside and both edges of each as shown in the detail drawing; the first $\frac{3}{4}$ " from the end and the others 2" apart. Locate points on the lines across the edges as shown in the detail drawing and lay out the curves free hand. The stock may be removed by making saw kerfs close together across the stock and removing the wood with the chisel and draw shave. The surface may be smoothed with a wood file.

21. Draw lines across the upper ends of the post and clamp $\frac{1}{4}$ " from the inside edge and a line across the outside of each $2\frac{3}{4}$ " from the end.

Lay out a curve free hand for rounding the corners and remove the stock with the draw shave. The surface may be smoothed with the wood file.

22. Draw a line across the outside of the clamp, 10" from the lower end, and on this line make an opening for the strap thru both clamp and post, using the $\frac{3}{8}$ " bit as shown in the detail drawing.

23. Bolt the clamp and post together with two 5 16" x 3 $\frac{1}{2}$ " machine bolts placed as indicated in the detail drawing.

24. Place the two steel butts as shown in the detail drawing 4" from the lower end of the clamp.

25. Remove the hinges and saw the clamps in two below the center of the hinges; then replace the hinges. If it were sawed first and then the hinges placed in position the clamp would drop down the thickness of the saw kerf and not match at the top with the post.

26. Shape the key as shown in the detail drawing of the key.

27. On a line drawn parallel to the side of the mortise and 2 $\frac{3}{4}$ " from the side of the seat and 6" from the front end of the seat, make a slot through the seat 5/16" wide and 1 $\frac{1}{8}$ " long for the strap to pass thru.

28. The coil spring is placed directly below the strap between the clamp and post. It may be held in place by bending about $\frac{3}{8}$ " of one end of a wire at a right angle to the length of the spring and forcing this bent end into a hole in the post.

29. Cut a piece of galvanized iron or other heavy sheet metal 1" x 1 $\frac{1}{4}$ " and bend to a right angle as shown in the detail drawing; place it in the strap opening in the post and fasten with two small flat head screws.

30. With the hack saw cut a piece of metal for the lock $\frac{1}{4}$ " x 1 $\frac{1}{2}$ " x 5". The notches are $\frac{1}{2}$ " deep and shaped as indicated in the detail drawing. They are cut with the hack saw and the corners are rounded with an iron file. Centerpunch for holes for the screws as shown and drill 3 16" holes, using the drill press or breast drill. Fasten the clamp to the right front leg with four 1" No. 9 round head blued screws so that the lower end is 5 $\frac{1}{2}$ " from the bottom of the leg.

31. By use of the hack saw cut a piece of metal for the catch 1 $\frac{1}{4}$ " x 1 $\frac{1}{2}$ " x 2 $\frac{1}{2}$ ", heat to a cherry red heat and forge to the form shown in the detail drawing. If a forge is not available it may be filed or ground to the form and bent slightly with hammer and vise. Centerpunch for three holes and drill $\frac{3}{16}$ " holes. Fasten to the top edge of the lever with three 1" No. 9 round head blued screws.

32. Cut a piece of metal with the hack saw $\frac{1}{4}$ " x 1 $\frac{1}{2}$ " x 5 $\frac{1}{2}$ ". Centerpunch for the holes and bore three $\frac{1}{4}$ " holes as indicated. Heat the metal to a cherry red heat and bent to a U form to the dimensions shown in the detail drawing.

33. Bore a $\frac{1}{4}$ " hole thru the left horizontal brace at a point 2" from the front end and fasten the U iron in place with a $\frac{1}{4}$ " x 2" machine bolt.

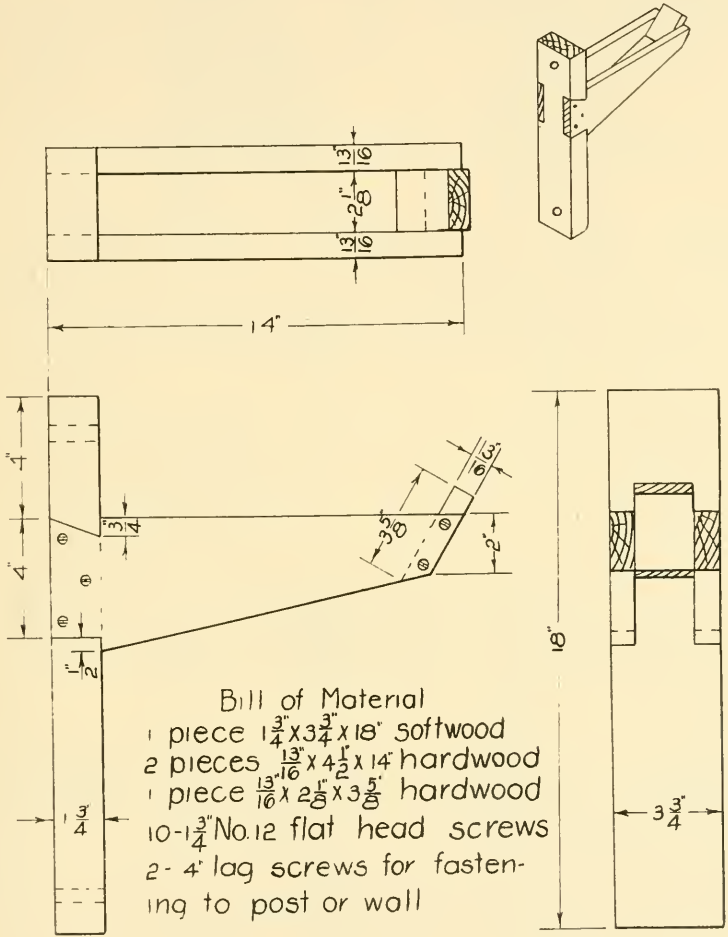
34. Bore a $\frac{1}{4}$ " hole thru the left end of the lever and fasten into the U iron with a $\frac{1}{4}$ " x 2" machine bolt.

35. File both ends of the $2\frac{1}{2}$ " heavy steel wire to a point; bend $\frac{1}{2}$ " of each end at a right angle. Drill holes and fasten to the lower edge of the lever so as to hold the strap at 7" from the lower end of the lever.

36. Fasten the buckle to the end of the strap; strip a leather loop on the strap; draw the strap around the lever thru the bent wire guide and again thru the leather loop and thru the buckle. Draw it up thru the slots in the seat, post and clamp and fasten to the outside of the clamp with three lining nails.

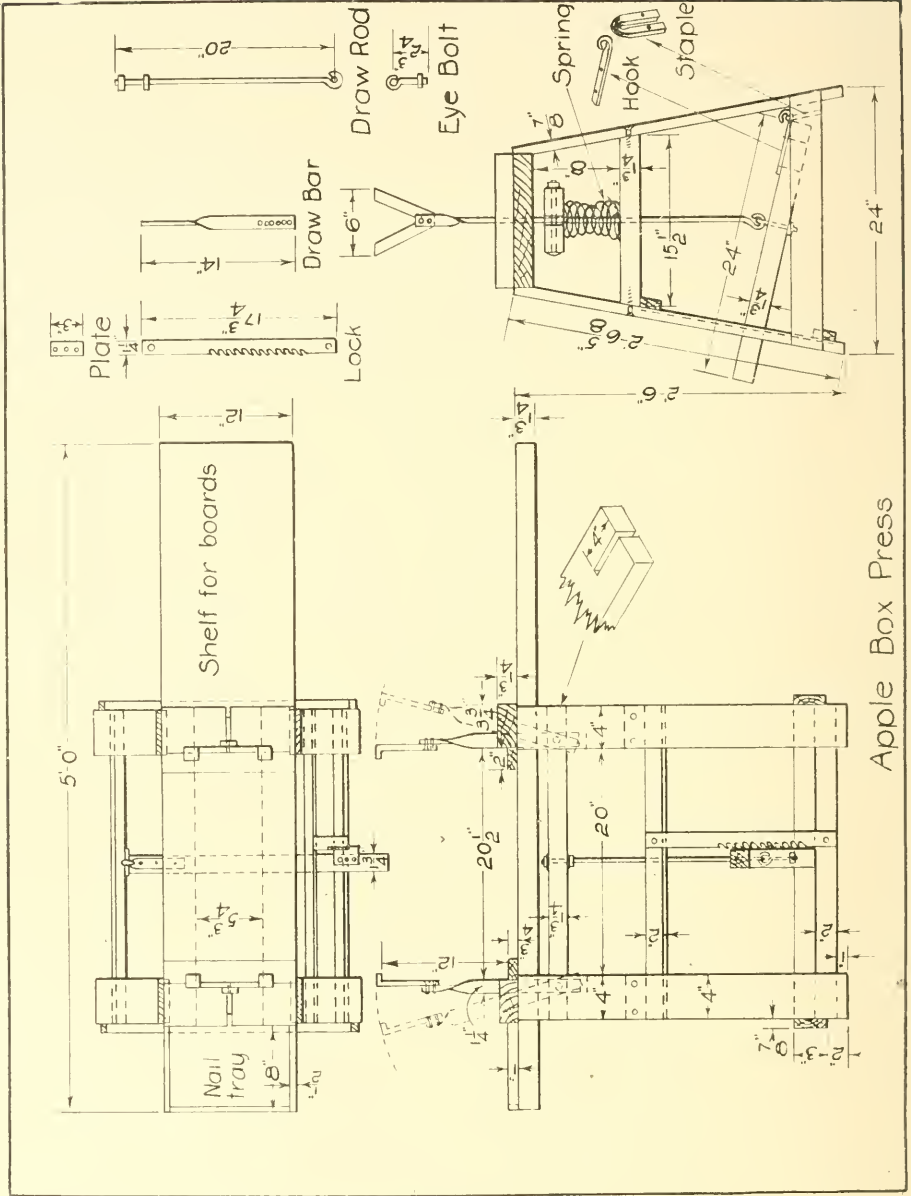
37. With the belt punch make holes in the strap 1" apart and draw the strap up so that the lever works the clamp and locks it.

38. Wood deteriorates in value and strength as it constantly increases and decreases in moisture content. This may be largely prevented by covering with a coat of paint or shellac. It is suggested that the stitching horse be finished with two coats of shellac.



Bill of Material
 1 piece $1\frac{3}{4} \times 3\frac{3}{4} \times 18$ " softwood
 2 pieces $1\frac{3}{10} \times 4\frac{1}{2} \times 14$ " hardwood
 1 piece $1\frac{3}{10} \times 2\frac{5}{8} \times 3\frac{5}{8}$ " hardwood
 10- $1\frac{3}{4}$ " No.12 flat head screws
 2- 4" lag screws for fasten-
 ing to post or wall

HARNESS HOOK



APPLE BOX PRESS

Bill of Material

Pieces	Dimensions	Use
1	1 3/4" x 12' x 5' 0"	Sill
4	7/8" x 4' x 2' 6 5/8"	Legs
2	7/8" x 3' x 2 3 1/4"	End leg braces at bottom
1	7/8" x 3' x 2' 4"	Leg brace, bottom at back
2	7/8" x 2' x 2' 4"	Leg braces at front
2	1 3/4" x 4' x 15 1/2"	Upper cross braces
1	1 3/4" x 1 3/4" x 24"	Lever
1	1 3/4" x 5 3/4" x 2' 4"	Upper lever
4	1 3/4" x 3 3/4" x 5 3/4"	Cross pieces at top
2	3/4" x 2' x 12"	Box rests at top
2	1/2" x 1' x 8"	Nail tray
1	1/2" x 1' x 11"	Nail tray

Hardware

- 3 ft. 5/8" round iron for draw rod, eyebolt, staple and hook.
- 6 ft. 4 in. rectangular iron 1/4" x 1 1/4" for draw bars, clamps, locks and plate.
- 3 5/8" nuts and washers for draw rod and eye bolt.
- 2 carriage bolts 1/4" x 6" to fasten lower end of draw bar to ends of upper lever.
- 2 machine bolts 1/4" x 2 1/2" to fasten hook to foot lever.
- 4 machine bolts 1/4" x 1 1/2" to fasten lock to front cross bars and staple to back leg brace.
- 4 iron rivets with counter sunk head to assemble draw bars and clamps.
- 3 7/8" No. 7 round head blued wood screws to fasten plate to top of foot lever at lock.
- 2 doz. flat head wood screws 2" No. 10 to fasten legs to sill and upper cross braces.
- 26 flat head wood screws 1 1/2" No. 9 for fastening all leg braces.
- 1 1/2 doz. 1 3/4" No. 16 brads to fasten pieces of the nail tray.
- 8 8d common nails to fasten cross pieces at top.
- 4 6d common nails to fasten box rests.
- 2 coil bed springs or heavy coil push springs.

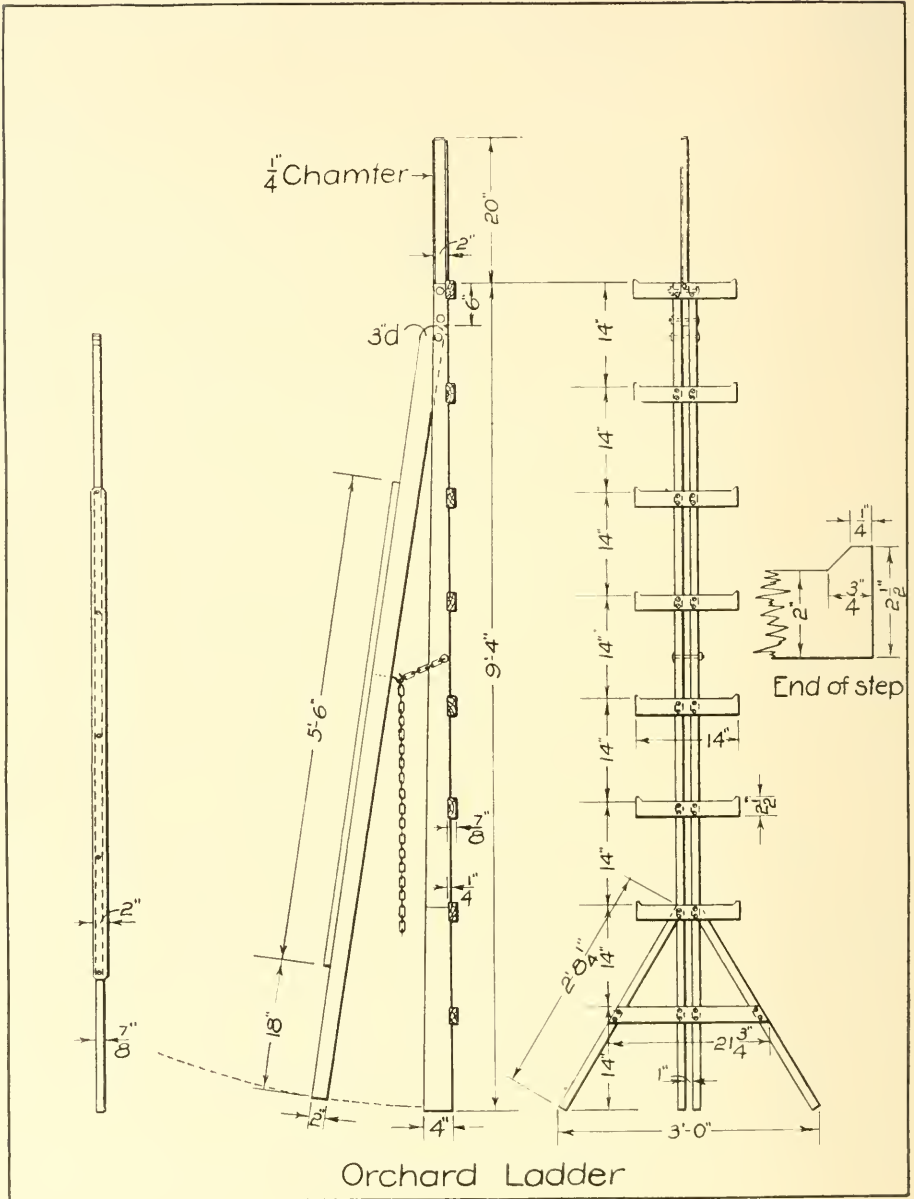
Directions

After the box has been packed it is placed on the box press. The box rests set the box up 3/4" from the sill and as the pressure is applied on the clamps the bulge in the box is distributed evenly between top and bottom of the box. If 20" boxes are used pieces narrower than 2" may be used for the rests.

The draw bar should be provided with several holes at the bottom end so as to provide for different sizes of boxes.

Oblong openings are cut thru the sill for the draw bar. These openings must be long enough to permit the clamps to fall away from the box when the pressure is removed.

The sill is purposely made long so as to provide a shelf where boards and cleats for the top may be conveniently placed.



ORCHARD LADDER

Material Required

Oak, ash, maple or other hardwood is recommended.

Pieces	Dimensions	Use
2	$\frac{7}{8}$ " x 4" tapered to 2" x 9' 4"	Main standards
1	$\frac{7}{8}$ " x 2" x 2' 2"	Point of ladder
2	$\frac{7}{8}$ " x 4" x 2' 8 $\frac{1}{4}$ "	Bottom braces
1	$\frac{7}{8}$ " x 2' x 21 $\frac{3}{4}$ "	Bottom step
7	$\frac{7}{8}$ " x 2 $\frac{1}{2}$ " x 14"	Steps
1	$\frac{7}{8}$ " x 3" tapered to 2" x 8' 10"	Back standard
1	$\frac{7}{8}$ " x 2" x 5' 6"	Top member of back standard

3 carriage bolts $\frac{1}{4}$ " x 3" to bolt point between main standard and to pivot top of back standard.

1 carriage bolt $\frac{1}{4}$ " x 3 $\frac{1}{2}$ " to fasten chain to main standards.

1 large screw hook.

40 flat head wood screws 2 $\frac{1}{2}$ " No. 12 for fastening steps and top member of back standard.

6 flat head wood screws 1 $\frac{1}{2}$ " No. 9 for fastening upper ends of bottom braces to main standards.

4' 6" of a substantial chain.

Directions

1. Reduce all pieces to the required dimensions.
2. Lay out and cut gains $\frac{1}{4}$ " deep and 2" wide for the steps in the upper edges of the main standards.
3. Shape the upper edge of all steps except the bottom one as shown in the detail drawing. This is a means of preventing the feet from slipping from the ends of the steps.
4. Place the point between the main standards at the upper end and fasten in place with two $\frac{1}{4}$ " x 3" carriage bolts.
5. Fasten all steps in place using two 2 $\frac{1}{2}$ " No. 12 flat head screws at each joint. The two main standards are left 1" apart at the bottom so that the back standard will drop between them freely.
6. Place the bottom braces in position and mark off the places for the gains for the first and second steps. Cut the gains for the steps and fasten the braces to the main standards with three 1 $\frac{1}{2}$ " No. 9 screws at the top and two 2 $\frac{1}{2}$ " No. 12 screws for the bottom step.
7. Place the top member of the back standard on the top edge of the back standard and fasten by using five 2 $\frac{1}{2}$ " No. 12 flat head wood screws.
8. Fold the back standard in between the main standards and bore a $\frac{1}{4}$ " hole at top for pivot. It will be noted that the hole for the bolt does not go thru the center. Fasten back standard in place.
9. With the back standard folded in bore a hole for the $\frac{1}{4}$ " bolt which is to hold the chain at a point half way between the fourth and fifth steps and $\frac{5}{8}$ " from the front edge of the standards. Fasten one end of the chain in place.
10. Fasten the large screw hook into the bottom edge of the back standard so that when the ladder is folded the hook will come between the fourth step and the chain bolt.
11. Finish the ladder by applying at least two coats of paint.

FRUIT STEP LADDER

Stock Bill

Pieces	Dimensions	Use
2	$\frac{13}{16}$ "x4"x2' 11"	Standards
1	$\frac{13}{16}$ "x2"x2' 7 $\frac{3}{4}$ "	Brace
1	$\frac{13}{16}$ "x8 $\frac{1}{2}$ "x18"	Top
1	$\frac{13}{16}$ "x5"x20 $\frac{3}{4}$ "	Bottom step
1	$\frac{13}{16}$ "x5"x18 $\frac{5}{8}$ "	Middle step
1	$\frac{13}{16}$ "x5"x16 $\frac{1}{2}$ "	Top step
2	$\frac{13}{16}$ "x2"x8 $\frac{1}{2}$ "	Braces

Hardware

- 1 iron rod $\frac{3}{8}$ "x15 $\frac{1}{4}$ " with two nuts.
- 2 metal braces $\frac{1}{8}$ "x1"x10" bent as shown in drawing.
- 1 stove bolt $\frac{1}{4}$ "x1 $\frac{1}{2}$ " to fasten metal braces.
- 1 piece of light chain 20" long.
- 2 carriage bolts $\frac{1}{4}$ "x1 $\frac{1}{2}$ " with washers larger than link of chain.
- 20 flat head wood screws 2" No. 10 for fastening steps and top.
- 6 flat head wood screws 1 $\frac{1}{2}$ " No. 8 for fastening braces to standards.

Directions



Fig. 25. Fruit Step Ladder.

The bevel across the sides of stock at ends of standards and in standards for steps is marked off with the T bevel, set at 6" on the blade and 3" on the tongue of the steel square.

The bevel at ends of standards and steps across the edge of stock is marked off with the T bevel set at 6" on the blade and 15/16" on the tongue of the steel square.

The steps are gained into the standards $\frac{1}{8}$ ".

Four 2" No. 10 wood screws are placed thru the top at each end, two into the brace and two into the standard.

The braces are held to the standards with three 1 $\frac{1}{2}$ " No. 8 wood screws.

The rods may be threaded and held with a nut at each end.

A $\frac{1}{4}$ " x 1 $\frac{1}{2}$ " carriage bolt is used to fasten the chain to the bottom of the middle step. The chain may pass around the brace and be fastened with staples or by placing a $\frac{1}{4}$ " bolt thru a link and thru the brace.

ORCHARD LADDER



Fig. 26. Orchard Ladder.

Many ladders of diversified design, are used for orchard purposes. For orchard purposes the common step-ladder has the disadvantage of four supports and narrow spread of standards which make it unstable on uneven ground. The painters' ladder needs to be supported at the upper end by leaning against the limbs of the tree which is often harmful to the tree and usually rather unstable.

The three-legged ladder with wide spread of standards has the advantage of stability on uneven ground as well as on the flat surface. It is also light and tall enough for most orchard purposes.

Bill of Material

Pieces	Dimensions	Use	Material
2	$1\frac{3}{8}$ "x4"x4' 2"	Standards	White pine,
2	$1\frac{3}{8}$ "x4"x2' 8"	Bottom standards	cypress, bass-
1	$1\frac{3}{8}$ "x8 $\frac{1}{2}$ "x15"	Top	wood, or
1	$1\frac{3}{8}$ "x4 $\frac{3}{4}$ "x24 $\frac{1}{2}$ "	Bottom step	other soft
4	$1\frac{3}{8}$ "x1 $\frac{3}{4}$ "x10 $\frac{5}{8}$ "	Steps	wood.
2	$1\frac{3}{8}$ "x3"x8"	Upper rod brace	
2	$1\frac{3}{8}$ "x2 $\frac{1}{2}$ "x8 $\frac{1}{4}$ "	Cleats	
1	$1\frac{3}{8}$ "x3" tapered to 2"x5' 2"	Brace	

Hardware

- 1 iron rod $\frac{3}{8}$ "x14 $\frac{1}{2}$ " with two nuts and two washers.
- 38 flat head bright wood screws $1\frac{3}{4}$ " No. 9 or 10.
- 18 flat head bright wood screws $1\frac{1}{2}$ " No. 8 or 9, for cleats and upper rod brace.
- 2 pieces flat iron $\frac{1}{4}$ "x1"x8" for braces.
- 1 machine or stove bolt $\frac{1}{4}$ "x1 $\frac{3}{4}$ ".
- 2 flat head stove bolts $1\frac{1}{4}$ ".
- 1 piece substantial chain $1\frac{1}{2}$ ", 20" long, or 1 piece canvas strap $1\frac{1}{2}$ ", 20" long.

Directions

1. Reduce all pieces to finished dimensions.
2. Set the T bevel at 1" on the blade and $3\frac{1}{8}$ " on the tongue of the steel square and lay out both ends of all standards, and remove the stock to line with the cross-cut saw.
3. With the T bevel set at the same angle as for the standards, lay out a dado $3/16$ " deep for each end of each step on the inside of each

main standard at the measurements shown on the drawing and remove the stock with a $5\frac{3}{8}$ " or $\frac{3}{4}$ " chisel.

4. Using the T bevel as set for the above lay out the ends of the cleats and remove the stock to line with the saw.

5. Lay off the upper end of the upper rod braces with the T bevel set as for the standards and remove stock to line with the saw.

5. Cut a slant to the lower ends of the upper rod braces as shown on the drawing so that they may be fastened to the standards with screws. Remove stock with saw and smooth with plane.

7. Round the upper end of the brace. To do this, draw a center line lengthwise of the stock on both sides and on this center line swing an arc with a $11\frac{1}{2}$ " radius $11\frac{1}{2}$ " from the end. Remove stock with saw and smooth with chisel.

8. Set the T bevel at 2" on the blade and $4\frac{1}{8}$ " on the tongue of the steel square and lay out the lower end of the brace. Remove the stock to line with the saw.

9. The cheek cut on the inside of the bottom standards at top is laid out by use of the steel square. Lay the square on an edge of the stock, using the figures 12" and $41\frac{1}{2}$ ". Place the figures 12" on the outside edge at the end and the figure $41\frac{1}{2}$ " on the same edge down on the stock and draw the line. Lay out on both edges. Remove the stock with the saw.

10. Bend the irons for the braces as shown in the drawing. They may be bent cold if securely held in a metal vise.

11. Centerpunch for the holes and bore $\frac{3}{8}$ " holes at upper ends and $\frac{1}{4}$ " holes at the lower ends of the braces, using the drill press or breast drill.

12. Bore a $\frac{3}{8}$ " hole thru the upper end of the brace at center to receive the rod.

13. The first parts to be assembled are the steps and main standards. Use two $1\frac{3}{4}$ " No. 9 or 10 flat head wood screws at each joint. Bore holes for the screws, using a twist drill, thru the standards and countersink the holes. Clamp the parts firmly in place and force the screws into the ends of the steps.

14. Fasten the bottom step to the lower ends of the front standards by use of two $1\frac{3}{4}$ " No. 9 or 10 wood screws.

15. Fasten the bottom standards to the ends of the bottom step by using two $1\frac{3}{4}$ " No. 9 or 10 wood screws for each joint and three similar screws to secure the upper ends of the bottom standards to the sides of the upper standard.

16. The top is fastened by using eight screws, four at each end, two thru the top and into the top end of the standards and two into the upper rod brace.

17. Fasten the cleats to the upper rod brace and standards by use of eight $1\frac{1}{2}$ " No. 8 or 9 wood screws as shown in the drawing.

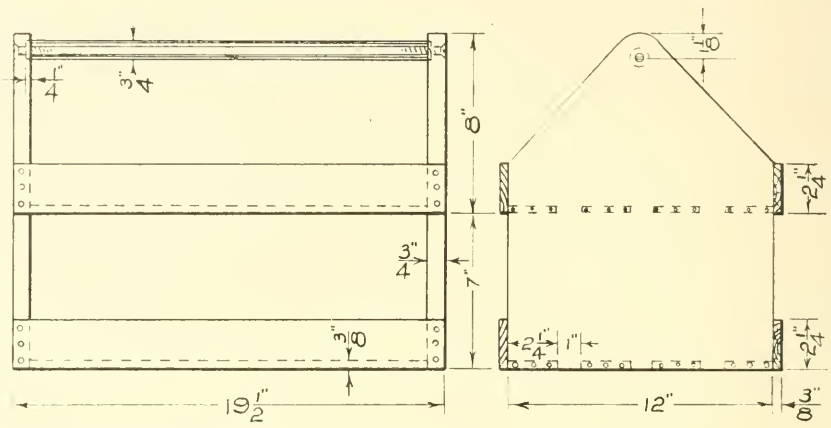
18. Bore a $\frac{3}{8}$ " hole thru the cleat and upper rod brace at each side at point shown in the drawing and assemble brace, iron braces and rod. It may be noted that the rod is threaded at both ends. This is easier to make than to forge a head on a rod and is quite as satisfactory.

19. Bore a $\frac{1}{4}$ " hole thru the brace and fasten the iron braces to brace with $\frac{1}{4}$ " x $1\frac{5}{8}$ " bolt.

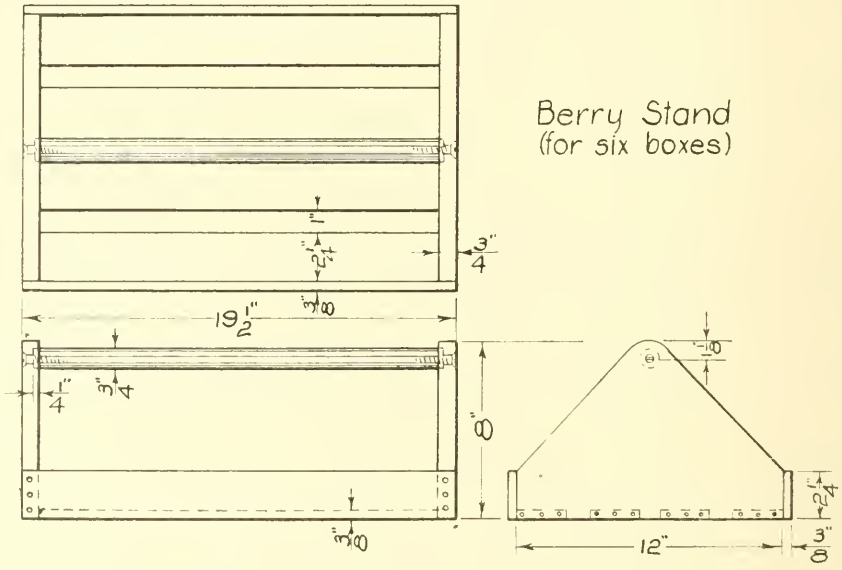
20. Stand the ladder in upright position with the top level, measure length of chain required for position indicated in the drawing and fasten to step and back standard with stove bolts.

21. Finish the ladder by applying two coats of exterior paint, allowing the first coat several days to become thoroly dry.

Double Deck Berry Stand
(for twelve boxes)



Berry Stand
(for six boxes)



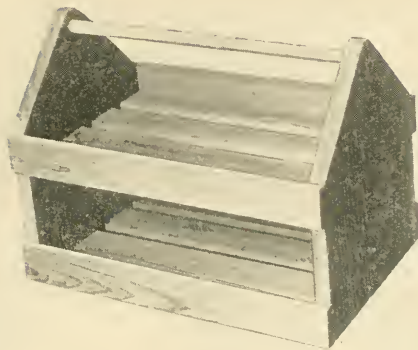


Fig. 27. Double Deck Berry Stand.

DOUBLE DECK BERRY STAND (For Twelve Boxes)

Bill of Material

Pieces	Dimensions	Use
2	$\frac{3}{4}$ " x 12" x 15"	Ends
4	$\frac{3}{8}$ " x 2 $\frac{1}{4}$ " x 19 $\frac{1}{2}$ "	Sides
8	$\frac{3}{8}$ " x 2 $\frac{1}{4}$ " x 18"	Bottom
1	$\frac{3}{4}$ " round 18 $\frac{1}{2}$ " long	Handle

An old broom handle makes an excellent handle.

Hardware: 2 flat head bright wood screws 2" No. 10 for fastening handle.
6 doz. 6d finishing nails.
Slats $\frac{1}{4}$ " instead of $\frac{3}{8}$ " may be used for sides and bottom.

BERRY STAND (For Six Boxes)

Bill of Material

Pieces	Dimensions	Use
2	$\frac{3}{4}$ " x 12" x 8"	Ends
2	$\frac{3}{8}$ " x 2 $\frac{1}{4}$ " x 19 $\frac{1}{2}$ "	Sides
4	$\frac{3}{8}$ " x 2 $\frac{1}{4}$ " x 18"	Bottom
1	$\frac{3}{4}$ " round x 18 $\frac{1}{2}$ " long	Handle

Hardware: 2 flat head bright wood screws 2" No. 10 for fastening handle.
3 doz. 6d finishing nails.
Slats $\frac{1}{4}$ " instead of $\frac{3}{8}$ " may be used sides and bottom.

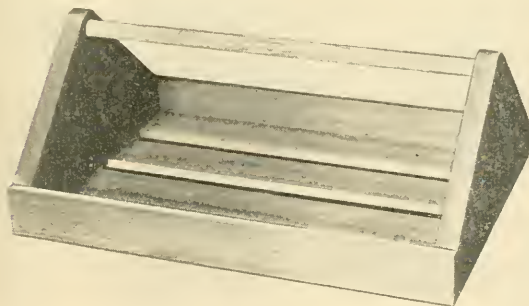
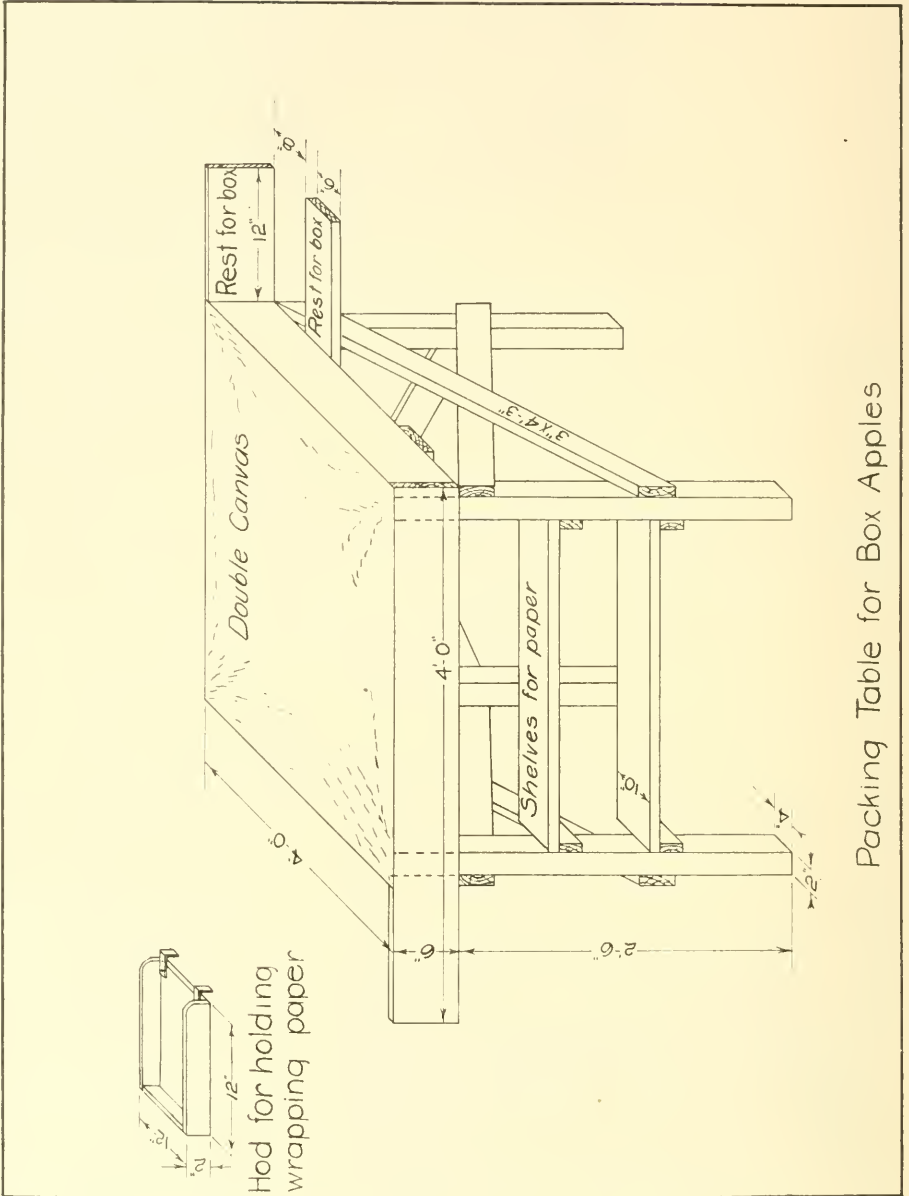


Fig. 28. Berry Stand.

To fasten the handle, bore $\frac{3}{4}$ " holes $\frac{1}{4}$ " deep on a centerline on the inside of the end pieces at a point 1" from the top; bore a hole for the screw from the same side of the stock using a twist drill as large as the screw; counter-sink for the head of the screw on the outside of the stock and fasten handle in place.



Packing Table for Box Apples

APPLE PACKING TABLE FOR BOX APPLES

Material Required

Lumber: Any soft wood.

Pieces	Dimensions	Use
4	2" x 4" x 3' 0"	Legs
6	7/8" x 3" x 4' 3"	Braces
2	7/8" x 6" x 4' 0"	Ends
2	7/8" x 6" x 3' 10 1/4"	Sides
2	7/8" x 6" x 1' 0"	Rests for box
4	7/8" x 2" x 10"	Shelf brackets
2	7/8" x 10" x 3' 6 3/4"	Shelves

2 pieces of canvas or ticking 3' 2" x 4' 2".

1/2 lb. 6d. common nails.

1 package tacks.

Directions

This apple packing table is one which has been found quite satisfactory where box packing of apples is done. It is designed for two packers; one at each side, with a box before him which rests in a tilting position on the two boards provided for that purpose.

Shelves are placed underneath at one end of the table where supplies of lining paper, layer paper and wrapping paper may be kept. More and wider shelves may be provided if desired.

The inside corners of the legs at the top are sawed off to prevent their bruising the apples.

The first layer of canvas is tacked securely all round the top edge of the table. The upper piece is tacked at one end only. This enables the packer to shake off quickly any dirt which may accumulate on the table.

The sizes of boxes are usually used:

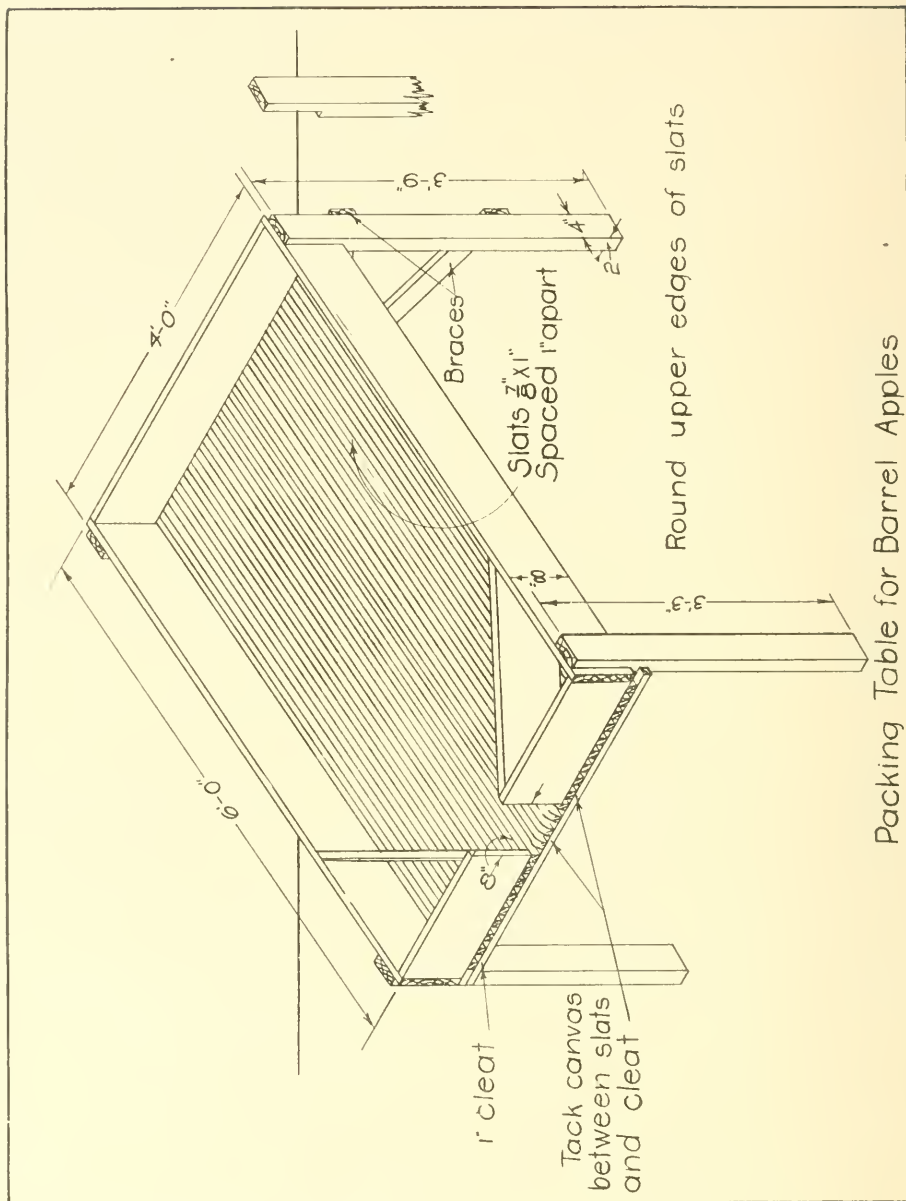
a. Standard, 10 1/2" x 11 1/2" x 18" inside measurement.

b. Special, 10" x 11" x 20" inside measurement.

The detail drawing shows a hod for holding the wrapping paper. The angle irons at the open end hook over the edge of the box and hold it in place.

The hod may be made of 1/2" or 3/8" material so as to make it light and facilitate its placing on and removal from the box.

This makes it convenient for the packer to pick up a sheet of wrapping paper with one hand while the other hand picks up an apple.



Packing Table for Barrel Apples

PACKING TABLE FOR BARREL APPLES

Bill of Material

Lumber: Any soft wood.

Pieces	Dimensions	Use
2	2" x 4" x 3' 3"	Legs at front
2	2" x 4" x 3' 9"	Legs at back
2	7/8" x 8" x 6' 0"	Sides
1	7/8" x 8" x 3' 10 1/4"	Back end
2	7/8" x 8" x 19 1/8"	Front end
2	7/8" x 8" x 2' 3"	Chute boards
22	7/8" x 1" x 6' 0"	Slats
2	7/8" x 1" x 4' 0"	Cleats
2	7/8" x 3" x 4' 8"	Braces
	5 doz. 6d. common nails.	
	6 doz. 10d. finishing nails.	

Directions

The size of the standard apple barrel has been regulated by Congress. The specifications are as follows:

Length of stave 28 1/2 inches.

Diameter of head 17 1/8 inches.

Distance between heads 26 inches.

Circumference of the bulge 64 inches outside measure.

All barrels not coming up to this standard shall be so marked.

The table shown in the drawing admits a standard barrel to be placed under it at the front end.

A piece of canvas, denim or ticking is fastened between the slats and cleat at the front end. A barrel is placed in position and the apron is placed over the top of the barrel.

The table is 6" higher at the rear end, causing the apples to roll toward the barrel. The chute boards guide them toward the opening where they can easily be inspected as they roll onto the apron. When a quantity of apples is on the apron it may be slowly lowered into the barrel without bruising the fruit.

In constructing the table it is suggested that the legs be cut at top as shown in the detail drawing so as to provide a resting surface for the box.

The finishing nails are used in fastening the corners and cleats and slats. One 10d nail is used for each slat.

The 6d common nails are used to fasten the legs, braces and chute boards.

Fig 1

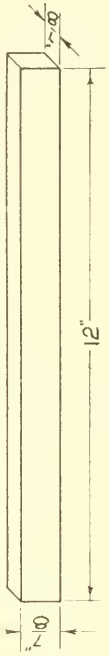


Fig 2



Fig 3



Fig 4



Fig 5



Fig 6

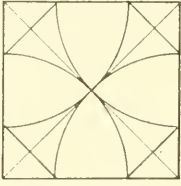


Fig 8

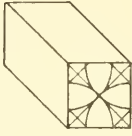


Fig 10

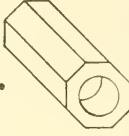


Fig 12

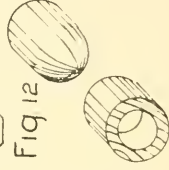


Fig 7

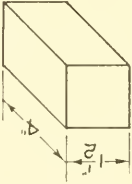


Fig 9

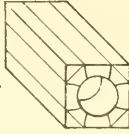
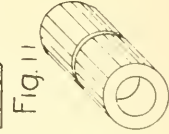


Fig 11



A Vise Handle

A VISE HANDLE

Material Required

- 1 piece of oak, maple, ash or other hardwood $\frac{7}{8}$ "x $\frac{7}{8}$ "x12".
- 1 piece of oak, maple, ash or other hardwood $1\frac{1}{2}$ "x $1\frac{1}{2}$ "x4".
- 2 flat head bright wood screws $\frac{3}{4}$ " No. 7.

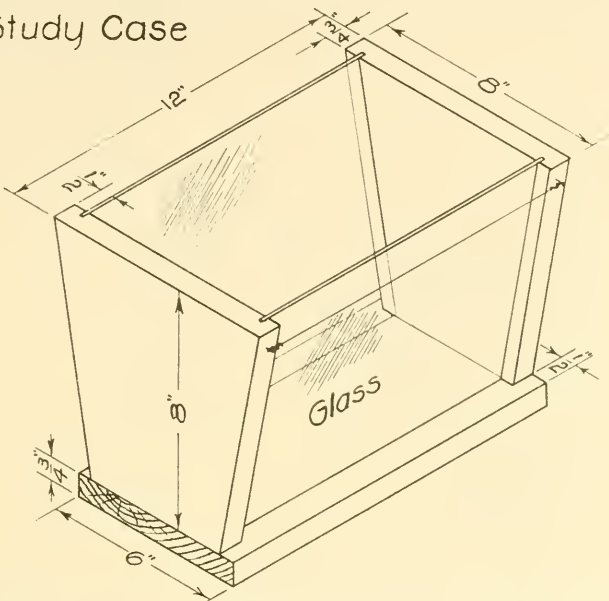
Directions for the Knobs

1. Reduce a piece of stock to the dimensions called for in Fig. 1.
2. Lay out an octagon at an end of the stock as shown in Fig. 6.
3. Draw lines on the sides of the stock as indicated in Fig. 2.
4. Remove the corners as shown in Fig. 3 using the plane; when the four corners are removed thus making an octagonal stick, plane off the new edges until the stick is round as shown in Fig. 4. The plane should be set fine for the last cuts.

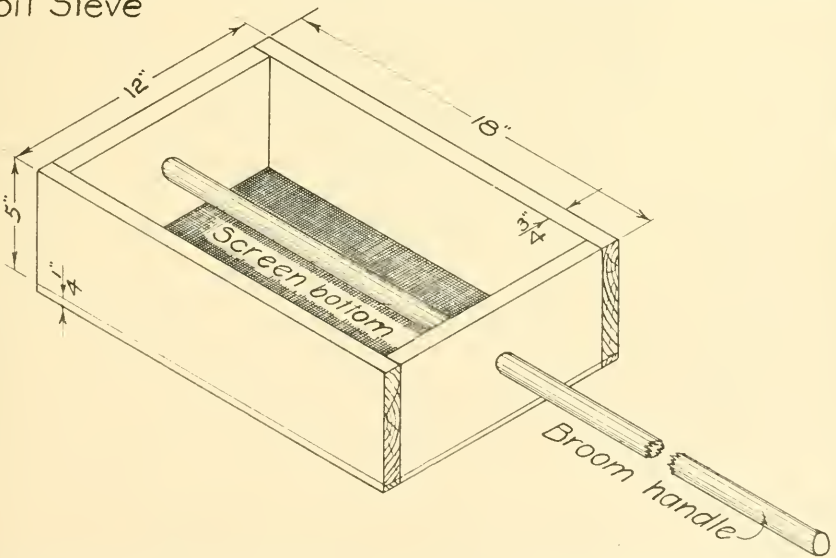
Directions for Handle

1. Reduce a piece of hardwood to the dimensions called for in Fig. 7.
 2. Lay out octagons at both ends as indicated in Fig. 8.
 3. Draw lines on sides of stock as shown in Fig. 9.
 4. Bore a $\frac{7}{8}$ " hole $\frac{3}{4}$ " deep in each end of the piece of stock as indicated in Fig. 9.
 5. Plane the corners so as to make the stock octagonal in shape Fig. 10 and continue planing the corners until the stock is round, Fig. 11.
 6. Saw the block in two in the center as shown in Fig. 11 and round the ends as indicated in Fig. 12.
 7. Place one knob on the stick and fasten with a $\frac{3}{4}$ " No. 7 flat head screw. Fig. 5.
 8. Place the handle on the vise and fasten the other knob in place.
- Since vises vary in diameter of handle required it is suggested that measurement be taken before starting the handle and the diameter of stick regulated accordingly.
- It is also suggested that this method be used wherever it is required to make a round stick of any size.

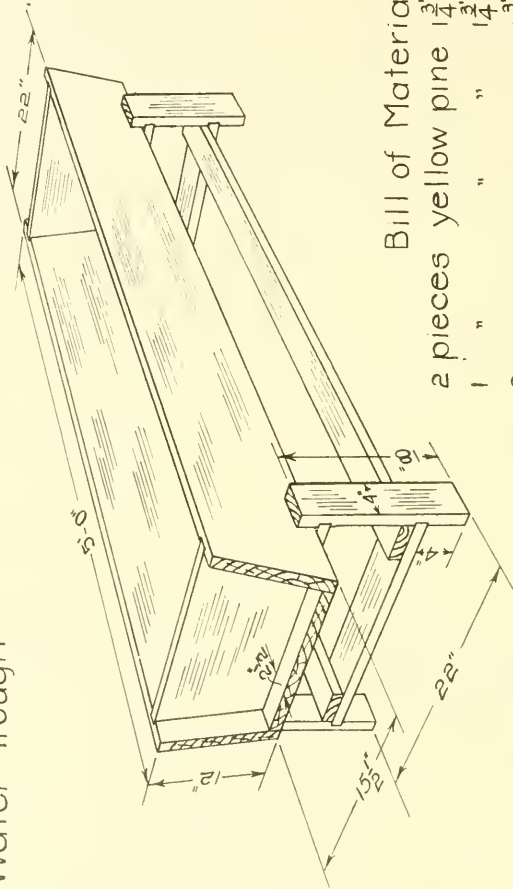
Root Study Case



Soil Sieve

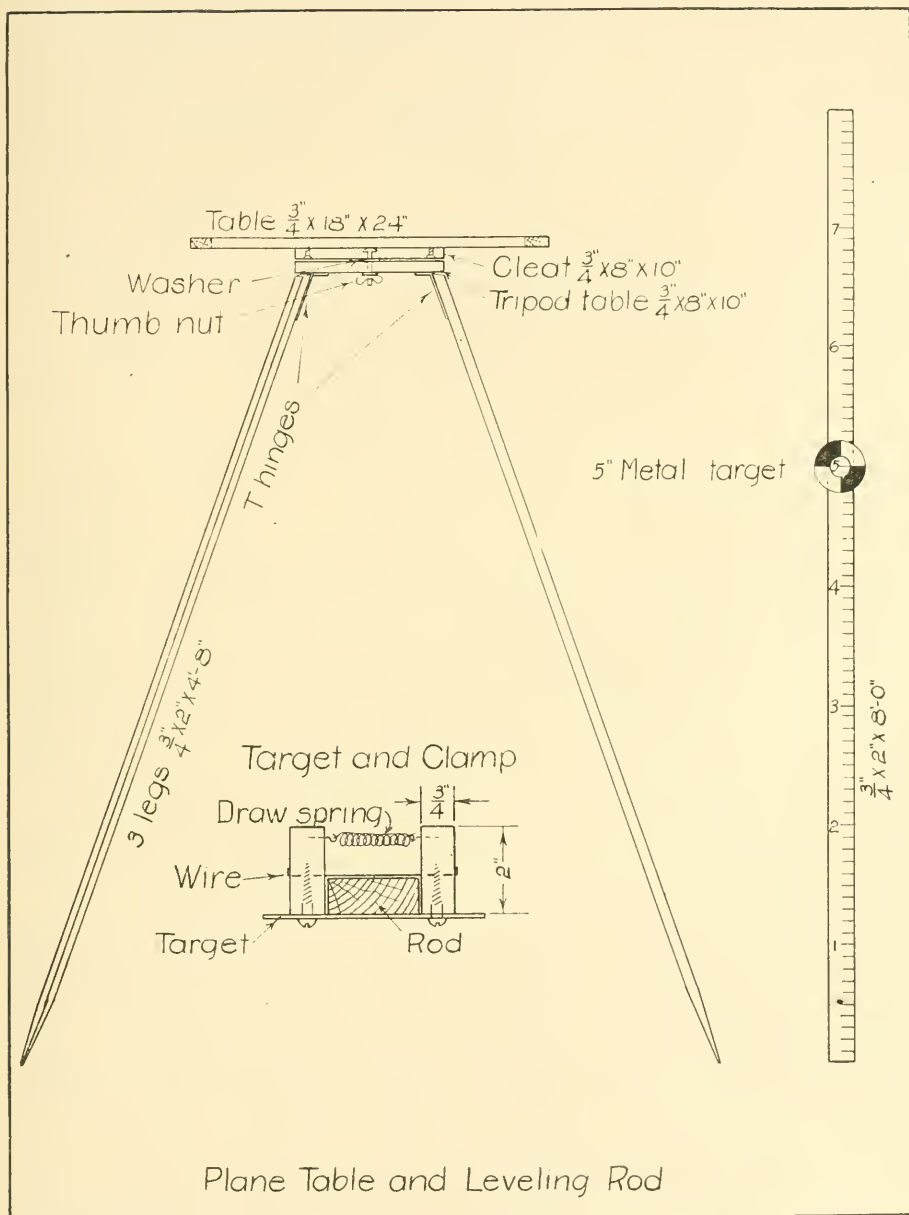


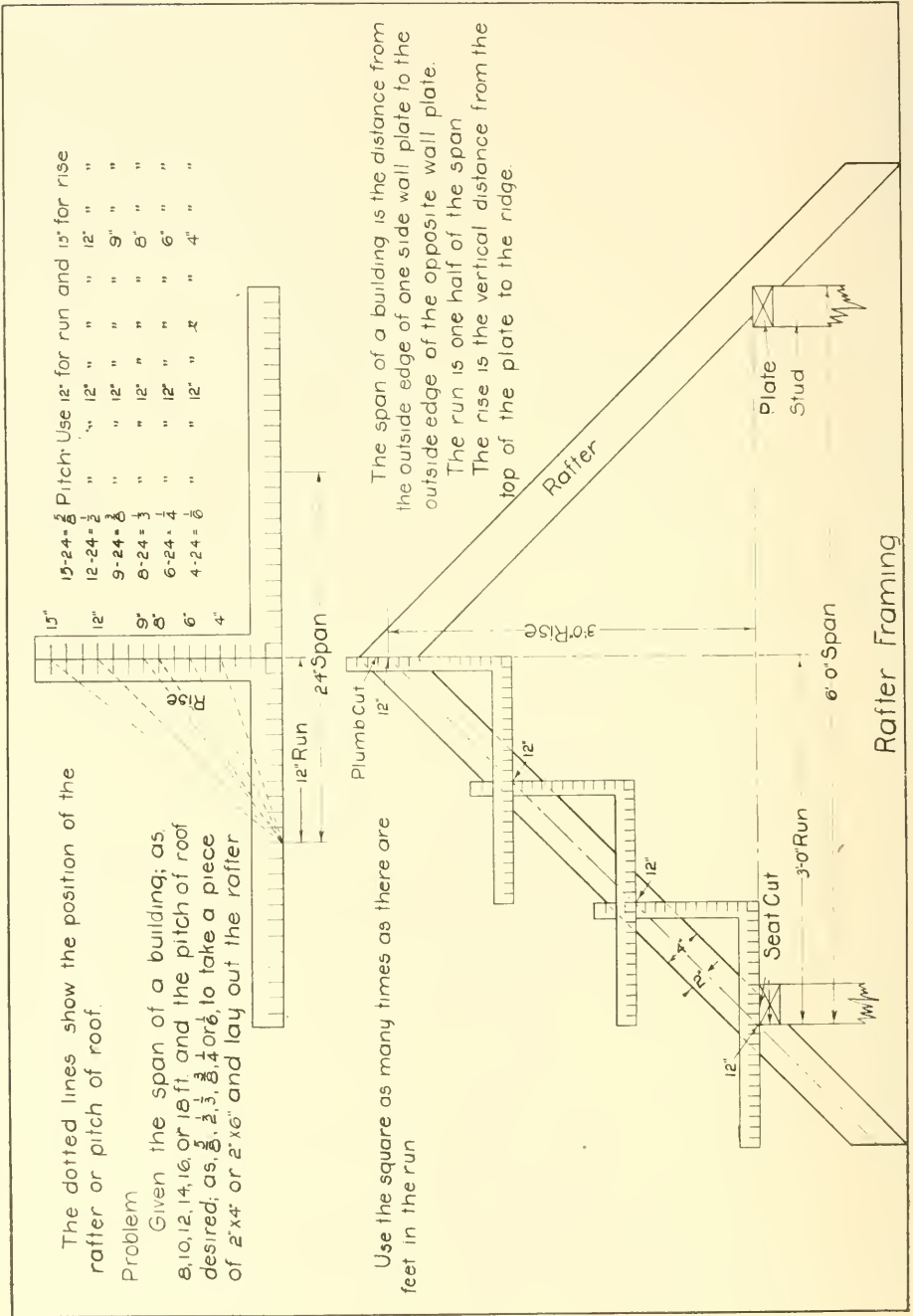
Water Trough



Bill of Material

- 2 pieces yellow pine 1 3/4" x 12" x 5'-0" Sides
 - 1 " " " 1 3/4" x 12" x 5'-0" Bottom
 - 2 " " " 1 3/4" x 10 1/2" x 19" Ends
 - 4 " " " 2" x 4" x 18" Legs
 - 4 " " " 2" x 4" x 19" Cross pcs.
 - 2 " " " 2" x 4" x 2" Braces
- 1 1/2 lbs. lead and 1 lb. 10d Common nails
 Small quantity white lead and paint





SAW FITTING

There are many cross cut saws of varying designs in use in the lumbering industry, but for general farm use selection may be made from the four illustrated in the drawing. Figures A, B, and C are of saws suited for general use. Fig. D shows a shape of tooth better suited for knotty lumber.

The tools required for cross-cut-saw fitting are as follows:

1 cross-cut-saw tool which consists of a jointer, a raker-tooth gauge and a tooth set gauge.

1 saw set.

Several flat files.

The essential features of a well fitted saw are:

1. All teeth must be of the same length and all points come to the same plane so that each tooth will do the same work as each other tooth.
2. All rakers must be not less than 1-100 nor more than 1-32 of an inch shorter than the cutting teeth and must be filed to sharp chisel-shaped edges.
3. All teeth must be filed to a sharp point.
4. All teeth must be uniformly set so that the saw draws freely thru the wood.

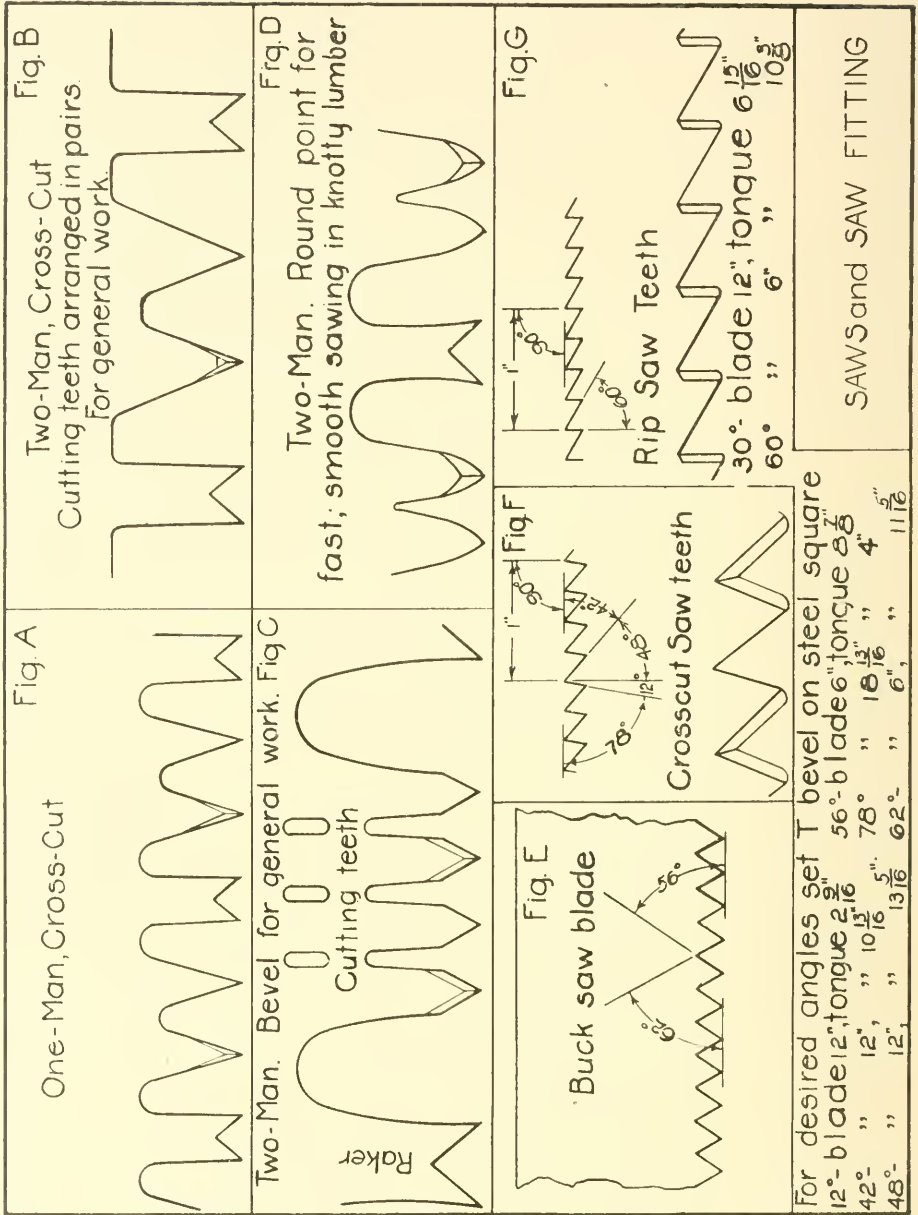
JOINTING, SETTING AND FILING A CROSS CUT SAW

There are four operations in bringing a cross cut saw to a good cutting condition: (1) jointing; (2) filing down the rakers; (3) setting the cutting teeth; (4) filing the rakers and cutting teeth.

A saw is jointed by holding the file in the saw tool as shown in Fig. 29 and, holding the file on the teeth and the saw tool tightly against the side of the saw, drawing the file lengthwise over the saw until all teeth and rakers have been touched.

To file down the rakers the saw tool is placed on the teeth so that a pair of rakers projects up thru the slot in the tool. Fig. 30. All that part of the rakers which projects up thru the slot is filed off so that the points of the rakers will be below the points of the cutting teeth. The distance which the rakers are below the points of the cutting teeth may be varied according to the kind of wood which the saw is to be used for. The rakers should be not less than 1-100 of an inch nor more than 1-32 of an inch shorter than the teeth. Soft woods may have a greater distance than hard woods. If the saw has a tendency to jump when in use the rakers are too long and need to be filed down and sharpened.

About $\frac{1}{4}$ " of the point of each tooth is set. This consists of placing the saw set on a tooth and pressing the tooth out so as to make the saw kerf wider than the blade of the saw. Begin at one end and set every other tooth to one side, then reverse the saw and set the other teeth in the opposite direction. The amount of set to give a saw is determined by the use that the saw is to have. Green and wet lumber require more set than dry lumber. The set of the saw is regulated by the set screw at the bottom of the saw set.



The rakers are filed to a chisel point. Effort should be made to keep all of the rakers the same shape and size and the filing regulated with this in mind. Since the purpose of the rakers is not to cut but to draw the cut particles of wood lengthwise of the saw kerf and out, they should be kept true and straight and may be filed from one side of the saw. The file is held straight across the saw. Great care must be taken not to bring either the rakers or the cutting teeth below the surface to which they have been jointed as that will render them out of cutting or raking service.

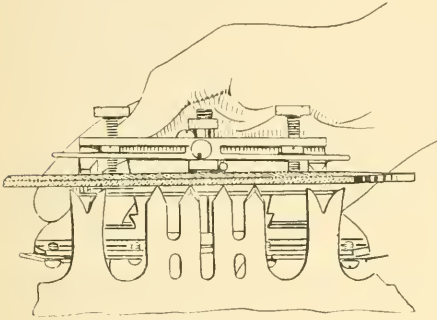


Fig. 29.

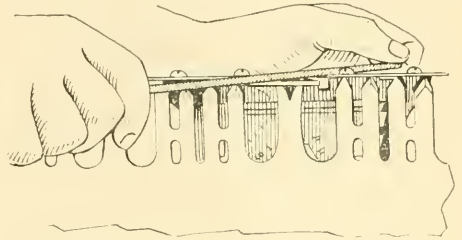


Fig. 30.

To file the teeth, the saw is placed low in the clamp so as to hold it firmly and minimize the vibration. All the teeth projecting away from the filer are filed from one side. Both edges of the tooth are filed the same because the saw is to cut both ways. The file is held at an angle as shown by the points of the cutting teeth in Fig. C, and by forward strokes of the file the tooth is brought to a point. When all the teeth projecting to one side have been filed the saw is reversed and the teeth projecting in the opposite direction are filed in the same way.

If a saw has been used extensively and filed so that the teeth are short it should be gummed. This consists of grinding a slot down into the blade between the teeth with a thin emery grinder.

When not in use, the blade of the saw should be covered with a coat of oil to prevent rusting. If a saw has become rusty it should **not** be cleaned with coarse emery cloth or coarse sand paper or other substance or preparation that will scratch the surface of the metal. No. 0 or 00 sand paper or 00 emery cloth or kerosene oil may be used.

FITTING HAND SAWS

The tools required for fitting hand saws are:

1 flat file.

Several slim taper triangular files—size determined by the fineness of saw.

1 saw set.

The first point to observe in fitting a saw is to make sure that the points of all teeth are in the same plane, so that no tooth projects out farther than any other. This is accomplished by running the side of a flat file lengthwise over the teeth and is called jointing the saw. The file is

run over the teeth enough times to file all teeth down to the same plane as that of the point of the lowest tooth. The file is held so that the side of the file stands at right angles to the side of the saw. The file is held in both hands with the thumbs and balls of the thumbs resting on the file and the index fingers closed and under the file. The saw fits up between the index fingers. By holding the saw in this way it is under the control of the operator.

The second point in fitting a hand saw is setting the saw. This should be done before filing it. All teeth must have an equal amount of set to make all do the same amount of work. The set should not go below half the length of the tooth. Soft and wet woods require more set than dry or hard woods. Setting a saw consists of bending the teeth outward, every alternate tooth to the same side. In cross cut saws the teeth are bent away from the bevel side of the teeth.

The third operation in fitting a hand saw is that of filing the teeth. Care should be taken when filing to keep the teeth of a uniform size and shape. This is accomplished by bringing the pressure of the file to bear on the large tooth and not on the small ones. In sharpening a cross cut saw the point of the file should point toward the handle of the saw and be held at an angle of about 45 degrees. The filer works against the front or cutting edge of the teeth. Every alternate tooth is filed the whole length of the saw, then the saw is reversed in the clamp and the alternate teeth are filed. Only forward strokes of the file are used.

The angle or pitch at which the teeth of a cross cut saw are filed depends on the use which is to be made of the saw. Fig. F in the drawing shows the angle best adapted for general work. Hardwoods require less pitch than softwoods.

The bevel of the teeth of a saw is determined by the use to be made of the saw. Hardwoods require less bevel than softwoods. The bevel is regulated by the position or angle at which the file is held across the saw. For a general purpose crosscut saw the file is held at an angle of about 45 degrees. This will result in a bevel as shown in Fig. F in the drawing.

Buck saws may be filed with the file at 80 degrees to the side of the blade. The angles of the teeth which are 56 and 62 degrees are illustrated in Fig. E in the drawing. These angles vary in different makes of saws.

As illustrated in Fig. G in the drawing the angles of the teeth of rip saws are 90 and 60 degrees. In filing, the file is held straight across the saw which makes a series of chisels of the saw points. The thrust of the saw in ripping should be at an angle of about 45 degrees.

Saws are designated by the length of blade and the number of teeth to the inch. Rip saws are to be had in 3, 3½, 4, 4½, 5 and 5½ points to the inch. For hardwoods, medium hardwoods, and for fine work the 5 or 5½ point rip saw is to be preferred.

It may be noted that the saws shown in Figs. F and G in the drawing are 5 point saws.

Cross cut saws are to be had in 4, 5, 6, 7, 8, 9, 10, 11 and 12 points to the inch. For general use a 7 or 8 point is to be preferred. For fine work a 10, 11 or 12 point gives better service.

LIST OF BUILDERS' HARDWARE EVERY BOY SHOULD KNOW

- | | |
|--|--|
| <p>Lock:</p> <ul style="list-style-type: none"> rim lock pad lock mortise lock rim door latch cupboard lock drawer lock screen door catches barn door latch gate latch thumb latch screen door latch screen hangers door button <p>Hasps and staples</p> <p>Safety gate hooks</p> <p>Barn door pulls</p> <p>Eye bolt</p> <p>Hitching ring</p> <p>Barn door bolt</p> <p>Barn door catch</p> <p>Barn door track</p> <p>Barn door rollers</p> <p>Barn door stay rollers</p> <p>Steel hay carrier track</p> <p>Hay carrier</p> <p>Rafter bracket for hanging hay carrier track</p> <p>Hay carrier track hanging tool</p> <p>Floor hook</p> <p>Swivel rope hitch</p> <p>Wood frame pulley</p> <p>Floor pulley</p> <p>Cast frame plain pulley</p> <p>Cast frame knot-passing pulley</p> | <ul style="list-style-type: none"> Windows, common sizes of glass and number of panes to window. Cellar window set, i. e., one pair butts; one hook and eye Sash cord Sash pulley Sash lifts Sash weights Wrought barrel bolts Carriage bolts Machine bolts Stove bolts Plow bolts Expansion shields Common nails Casing nails Finishing nails Round head blue wood screws Flat head bright wood screws Washers Lock washers Wagon box rivets Oval head rivets Set screws Spiral door spring with screen door set hook and eye Door pull Hinges: <ul style="list-style-type: none"> loose pin butts riveted pin butts heavy T hinges light T hinges heavy strap hinges light strap hinges strap hinges hook and eye hinges |
|--|--|

LUMBER MEASUREMENT TABLE

	4	6	8	10	12	14	16	18	20	22	24	26	28	30	32	34	36	38	40
2 x 4	3	4	5	7	8	9	11	12	13	15	16	17	19	20	21	23	24	25	27
2 x 6	4	6	8	10	12	14	16	18	20	22	24	26	28	30	32	34	36	38	40
2 x 8	5	8	11	13	16	19	21	24	27	29	32	35	37	40	43	45	48	51	53
2 x 10	7	10	13	17	20	23	27	30	33	37	40	43	47	50	53	57	60	63	67
2 x 12	8	12	16	20	24	28	32	36	40	44	48	52	56	60	64	68	72	76	80
2 x 14	9	14	19	23	28	33	37	42	47	51	56	61	65	70	75	79	84	89	93
2 x 16	11	16	21	27	32	37	43	48	53	59	64	69	75	80	85	91	96	101	107
3 x 4	4	6	8	10	12	14	16	18	20	22	24	26	28	30	32	34	36	38	40
3 x 6	6	9	12	15	18	21	24	27	30	33	36	39	42	45	48	51	54	57	60
3 x 8	8	12	16	20	24	28	32	36	40	44	48	52	56	60	64	68	72	76	80
3 x 10	10	15	20	25	30	35	40	45	50	55	60	65	70	75	80	85	90	95	100
3 x 12	12	18	24	30	36	42	48	54	60	66	72	78	84	90	96	102	108	114	120
3 x 14	14	21	28	35	42	49	56	63	70	77	84	91	98	105	112	119	126	133	140
3 x 16	16	24	32	40	48	56	64	72	80	88	96	104	112	120	128	136	144	152	160
4 x 4	5	8	11	13	16	19	21	24	27	29	32	35	37	40	43	45	48	51	53
4 x 6	8	12	16	20	24	28	32	36	40	44	48	52	56	60	64	68	72	76	80
4 x 8	11	16	21	27	32	37	43	48	53	59	64	69	75	80	85	91	96	101	107
6 x 6	12	18	24	30	36	42	48	54	60	66	72	78	84	90	96	102	108	114	120
6 x 8	16	24	32	40	48	56	64	72	80	88	96	104	112	120	128	136	144	152	160
6 x 10	20	30	40	50	60	70	80	90	100	110	120	130	140	150	160	170	180	190	200
8 x 8	21	32	43	53	64	75	85	96	107	117	128	139	149	160	171	181	192	203	213
8 x 10	27	40	53	67	80	93	107	120	133	147	160	173	187	200	213	227	240	253	267
8 x 12	32	48	64	80	96	112	128	144	160	176	192	208	224	240	256	272	288	304	320
10 x 10	33	50	67	83	100	117	133	150	167	183	200	217	233	250	267	283	300	317	333
10 x 12	40	60	80	100	120	140	160	180	200	220	240	260	280	300	320	340	360	380	400
12 x 12	48	72	96	120	144	168	192	216	240	264	288	312	336	360	384	408	432	456	480
12 x 14	56	84	112	140	168	196	224	252	280	308	336	364	392	420	448	476	504	532	560
14 x 14	65	98	131	163	196	229	261	294	327	359	392	425	457	490	523	555	588	621	653

The rules for finding the number of board feet in a piece of lumber is as follows: Multiply the thickness in inches by the width in inches by the length in feet and divide by twelve.

Example: How many board feet in a piece of lumber 2 in. thick, 6 in. wide and 12 ft. long?

$$\frac{2 \times 6 \times 12}{12} = 12 \text{ ft. Ans.}$$

All the numbers in the above table are derived in this way.

The table is a rapid way of figuring up bills of lumber and should be used as soon as the above rule is understood.

NAILS AND SCREWS

Wire nails is an ordinary name applied to common nails, casing nails, and brads, or finishing nails. They are made from steel wire. Common nails have flat heads and are used where the heads are to be left flush with the surface of the wood. Casing and finishing nails are used when it is desirable to have them as inconspicuous as possible, as for inside finish. They are sunk, or "set," into the wood and the holes are later filled with putty.

The size of a nail is specified by the term penny (d), prefixed by a number; as, 6d, 10d. This term had its origin in England, where it formerly represented the price per pound in terms of pence.

Number of Nails to the Pound

Size	Length	Number per pound		
		Common	Finishing	Casing
2d	1 in.	860	1,558	1,140
3d com.	1¼ in.	594	884	675
4d	1½ in.	339	767	567
5d	1¾ in.	230	491	396
6d	2 in.	205	359	260
7d	2¼ in.	135	317	239
8d	2½ in.	96	214	160
9d	2¾ in.	92	195	148
10d	3 in.	63	134	108
12d	3¼ in.	52	120	99
16d	3½ in.	38	91	69
20d	4 in.	30	61	50
30d	4½ in.	23		45
40d	5 in.	17		35
50d	5½ in.	13		
60d	6 in.	10		

Quantity of Nails per M Feet of Lumber

Sheathing, per M,	8d com.	20 lbs.
	10d com.	25 lbs.
Flooring, per M,	8d com.	30 lbs.
	10d com.	35 lbs.
Studding, per M,	10d com.	14 lbs.
	20d com.	10 lbs.
Furring, per M,	10d com.	10 lbs.
Finish Flooring, per M,	7/8" 8d fin.	20 lbs.
Finishing, 7/8" per M,	8d fin.	30 lbs.
Finishing, 1 1/8" per M,	10d fin.	40 lbs.
Beveled siding, per M,	6d com.	18 lbs.
Lath, per M,	3d com.	6 1/2 lbs.
Shingles, per M,	4d com.	4 lbs.

Sizes of Nails for Given Purposes

Balusters	.4d finishing
Baseboard	.8d finishing
Braces	16d common
Bridging	.8d common
Ceiling	.6d casing
Drip cap.	.8d casing
Door frame.	.8d common
Drawers	.6 and 4d casing
Doors	.6d common

Fascia	.8d casing
Framing	10d, 16d and 20d common
Frieze	10d casing
Finish floor	.8d casing
Handrail	.4d and 6d casing
Inside Casing	.6d and 8d finishing
Inside mouldings	.6d finishing
Lath	.3d fine
Lap siding	.6d casing and common
Newel post	.8d casing
Outside moulding	.8d and 6d casing
Outside casing	.8d and 10d casing
Plancher	.8d casing
Roof boards	.8d common
Rafters	10d and 16d spikes
Ridge board	.8d common
Rough flooring	.8d common
Risers	.8d common
Saddle board	.8d and 10d common
Shingles	.3d coarse galvanized
Sheathing	.8d common
Stair stringers	16d common
Treads	.8d casing
Wainscoting	.6d common
Window frame	.8d common
Water table	.8d common

Other fastenings which are most extensively used in carpentry work are dowels and flat and round-head screws. In timber framing, the joints are usually fastened with dowels made of hardwood, preferably maple. Flat-head bright screws are most commonly used. Hinges are usually fastened with screws of this kind, as the head of the screw sets flush with the surface. Round-head blued screws are used where it is not necessary to have the heads flush with the surface, and when the screws become a part of the decorative scheme.

TABLE OF BIT SIZES FOR WOOD SCREWS

Screw Gauge	Diam. in Decims.	Size of Hole for Wire	Twist Bit or Gimlet No.	Size of Hole for Thread	Twist Bit or Gimlet No.
5	.1236	$\frac{1}{8}$ "	4	$\frac{5}{64}$ "	3
6	.1368	$\frac{9}{64}$ "		$\frac{3}{32}$ "	3
7	.1500	$\frac{5}{32}$ "	5	$\frac{1}{8}$ " hardwood	4
				$\frac{3}{32}$ " softwood	3
10	.1894	$\frac{3}{16}$ "	6	$\frac{5}{32}$ " hardwood	5
				$\frac{1}{8}$ " softwood	4
12	.2158	$\frac{7}{32}$ "	7	$\frac{3}{16}$ " hardwood	6
				$\frac{5}{32}$ " softwood	5
14	.2421	$\frac{1}{4}$ "	8	$\frac{3}{16}$ " hardwood	6
				$\frac{5}{32}$ " softwood	5
16	.2684	$\frac{9}{32}$ "	9	$\frac{7}{32}$ " hardwood	7
				$\frac{3}{16}$ " softwood	6
18	.2947	$\frac{5}{16}$ "	10	$\frac{1}{4}$ " hardwood	8
				$\frac{7}{32}$ " softwood	7

LIBRARY OF CONGRESS



0 013 974 055 5

