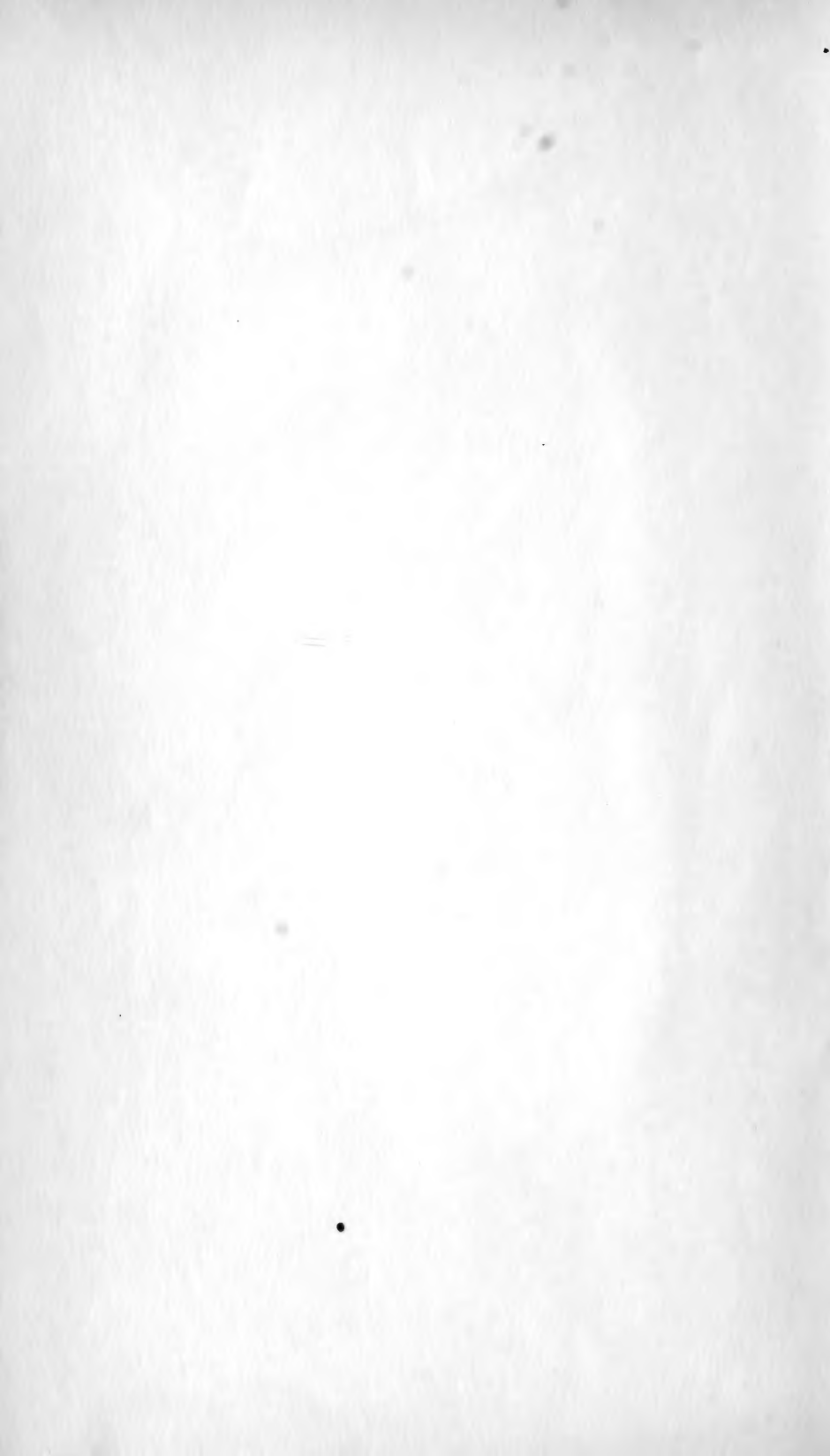


*The*  
THOMAS LINCOLN  
CASEY  
LIBRARY  
1925









761  
P3  
Ent,

51ST CONGRESS, } HOUSE OF REPRESENTATIVES. { MIS. DOC.  
1st Session. } { No. 269.

---

U. S. DEPARTMENT OF AGRICULTURE.

---

FIFTH REPORT

OF THE

UNITED STATES

ENTOMOLOGICAL COMMISSION,

BEING A REVISED AND ENLARGED EDITION OF  
BULLETIN No. 7,

ON

INSECTS INJURIOUS TO FOREST AND SHADE TREES.

BY

ALPHEUS S. PACKARD, M. D., PH. D.

---

WITH WOOD-CUTS AND 38 PLATES.

---

WASHINGTON:  
GOVERNMENT PRINTING OFFICE.  
1890.

JOINT RESOLUTION AUTHORIZING THE PRINTING OF TWO THOUSAND  
COPIES OF THE FIFTH REPORT OF THE UNITED STATES ENTOMO-  
LOGICAL COMMISSION.

The following resolution, originating in the House of Representa-  
tives, was concurred in by the Senate, July 6, 1882 :

*Resolved by the House of Representatives (the Senate concurring), That there be printed, for the use of the Department of Agriculture, with necessary illustrations, 2,000 copies of the fifth report of the United States Entomological Commission, being a special report on the insects affecting forest trees.—(See Congressional Record, July 7, 1882.)*





## TABLE OF CONTENTS.

	Page.
LETTER OF SUBMITTAL.....	VII
PREFACE .....	1
INTRODUCTION .....	5
<p>Literature of forest entomology, 5—Insects in general, 6—The beetles and borers, 7—Moths and butterflies, 7—Gall-flies, 10—Saw-flies, 12—Plant-lice, 13—Bark-lice, 14—Dipterous or two-winged gall-flies, 14—Insectivorous or parasitic insects, 14—Artificial breeding of parasitic and predaceous insects, 16—Coleopterous enemies of borers, 18—Influence of temperature on insect life, 19—Generations or broods, 19—Hibernation stage, 23—Diseases of trees produced by the attacks of insects, 24—The appearance of unusual new growths, 24—The origin of repaired parts from representative indefinite growths is very general, 25—Prevention and remedies against forest insects, 27—Borers in shade and ornamental trees, 27—Prevention and remedies against timber-beetles and bark-borers, 28—Insecticides and means of applying them to shade and forest trees, 31—Paris green and London purple, 31—Insecticides which act by contact, 34—Wood ashes and lime, 34—Coal ashes and coal dust, 35—Pyrethrum, hellebore, sulphur, 35—Alkaline washes, potash lye and soda lye, 35—Alkaline washes, soaps, 35—Petroleum products, kerosene, naphtha, 36—Kerosene emulsions, 36—Resin washes, 37—Fumigants, gases, 37—Hydrocyanic acid gas, 38—Insecticide apparatus, 38—Devices for applying powders, powder blowers, 38—The Woodason bellows, 39—The Leggett Brothers orchard gun, 39—Devices for applying liquids, 39—The pump, 39—Hose and bamboo extension rod, 42—Nozzles; the Riley or Cyclone nozzle, 44—The Nixon or Climax nozzle, 46.</p>	
<b>CHAPTER I.</b>	
<i>Insects injurious to the oak</i> .....	48
<p>Affecting the roots, 49—Affecting the trunk, 53—Affecting the limbs and twigs, 83—Feeding on the buds, 116—Injuring the leaves, 117—Injuring the seeds (acorns), 215—Insects either habitually or occasionally occurring on the oak, 217.</p>	
<b>CHAPTER II.</b>	
<i>Insects injurious to the elm</i> .....	224
<p>Affecting the trunk, 224—Affecting the leaves, 230—Insects occasionally preying upon the elm, 232.</p>	
<b>CHAPTER III.</b>	
<i>Insects injurious to the hickory</i> .....	285
<p>Injuring the trunk and branches, 285—Affecting the bark, 298—Affecting the leaves, 299—Affecting the fruit, 326—Other species occurring on the hickory, 328.</p>	
<i>Insects injurious to the black walnut</i> .....	329
<p>Affecting the trunk, 329—Other species occurring on the black walnut, 336.</p>	

	Page.
<i>Insects injurious to the butternut</i> .....	337
Affecting the trunk and limbs, 337—Affecting the leaves, 338—Other species living on the butternut, 342.	
<i>Insects injurious to the chestnut</i> .....	343
Affecting the trunk and limbs, 343—Affecting the leaves, 344—Affecting the fruit, 350—Other species preying on the chestnut, 353.	
CHAPTER IV.	
<i>Insects injurious to the locust tree</i> .....	355
Affecting the trunk, 355—Affecting the leaves, 361—Other insects feeding on the locust, 372.	
CHAPTER V.	
<i>Insects injurious to the different species of maple</i> .....	374
Affecting the trunk, 374—Boring in the twigs, 391—Affecting the leaf-buds, 392—Affecting the leaves, 392—Other insects occurring on the maple, 424.	
CHAPTER VI.	
<i>Insects injurious to the cottonwood</i> .....	426
Affecting the roots, 426—Affecting the trunk and branches, 426—Affecting the leaves, 428.	
<i>Insects injurious to the poplar</i> .....	435
Affecting the trunk, 435—Affecting the leaves, 445—Other insects feeding on the poplar, 472.	
<i>Insects injurious to the bass-wood or linden tree</i> .....	474
Affecting the trunk, 474—Affecting the leaves, 475—Other insects living on the linden, 480.	
CHAPTER VII.	
<i>Insects injurious to the birch</i> .....	483
Injuring the trunk, 483—Affecting the leaves, 486—Other species occurring on the birch, 514.	
CHAPTER VIII.	
<i>Insects injurious to the beech</i> .....	515
Affecting the trunk, 515—Affecting the leaves, 515—Other insects occurring on the beech, 519.	
CHAPTER IX.	
<i>Insects injurious to the wild cherry, wild plum, the thorn, crab-apple and mountain ash.</i>	521
Insects affecting the wild cherry: Affecting the trunk, 521—Affecting the leaves, 522—Other insects, 529.	
Insects affecting the wild plum: Feeding on the leaves, 530—Feeding on the fruit, 530—Other insects, 531.	
Insects affecting the service-berry or June berry, 531.	
Insects affecting the wild thorn: Affecting the leaves, 532—Other insects, 535.	
Insects injurious to the crab-apple: Affecting the leaves, 537.	
Insects injurious to the mountain ash: Affecting the leaves, 537—Other insects, 539.	
CHAPTER X.	
<i>Insects injurious to the ash</i> .....	540
Affecting the trunk and branches, 540—Affecting the leaves, 544—Other insects occurring on the ash, 555.	

TABLE OF CONTENTS.

V

CHAPTER XI.

	Page.
<i>Insects injurious to the willow</i> .....	557
Affecting the trunk, 557—Injuring the leaves, 559—Other insects occurring on the willow, 596.	

CHAPTER XII.

<i>Insects injurious to the hackberry</i> .....	601
Injuring the leaves, 602—Boring in the trunk, 610—Cecidomyioidous hackberry galls, 612—Hackberry <i>Psyllidæ</i> , 614.	

CHAPTER XIII.

<i>Insects preying upon the alder</i> .....	623
Boring in the trunk, 623—Injuring the leaves, 625—Other insects of the alder, 636.	
Insects injurious to the hazel: Feeding on the leaves, 637—Affecting the nuts, 641—Other insects, 641.	

CHAPTER XIV.

<i>Insects injurious to the sycamore, etc</i> .....	643
Boring in the trunk, 643—Eating the leaves, 644—Other insects also occurring on the sycamore, 646.	
Insects injurious to the hop-hornbeam, or iron-wood, 647.	
Insects infesting the water-beech, hornbeam, 650.	
Insects injurious to the sassafras, 650.	
Insects injuring the honey-locust: Affecting the leaves, 652—Other insects of the honey-locust, 653.	
Insects injuring the horse chestnut, or buckeye: Boring in the terminal twigs, 654—Affecting the leaves, 656.	
Insects of the sweet-gum, 657.	
Insects injurious to the sour-gum tree, 657.	
Insects injurious to the prickly ash: Affecting the trunk and limbs, 659—Eating the leaves, 661.	
Insects of the tulip tree, 663.	
Insects injurious to the sumach, 664.	
Insects injurious to the poison ivy, 665.	
Insects affecting the catalpa: Affecting the leaves, 666—Affecting the pods, 666.	
Insects injurious to the witch hazel, 668.	
Insects injurious to the magnolia, 669.	
Insects injurious to the papaw, 669.	
Insects injurious to the tree of heaven, 669.	
Insects injurious to the box elder, 669.	
Insects injurious to the mesquite, 670.	
Insects injurious to the persimmon, 671.	
Insects injurious to the California bay or laurel, 671.	
Insects affecting the China tree, 671.	
Insects injurious to the dogwood, 672.	
Insects injurious to the box, 672.	
Insects injurious to the black alder, 673.	
Insects injurious to the Kentucky coffee tree, 673.	

CHAPTER XV.

<i>Insects injurious to the pine</i> .....	674
Affecting the roots, 675—Affecting the trunk, 676—Affecting the twigs, 735—Affecting the leaves, 756—Other insects occurring on the pine, 809.	

CHAPTER XVI.		Page.
<i>Insects injurious to the spruce</i> .....		811
Affecting the trunk and branches, 811—Affecting the leaves, 830—Affecting the cones, 854—Other insects of the spruce, 856—Insects injurious to the Rocky Mountain spruce and Douglass spruce, 857.		
CHAPTER XVII.		
<i>Insects injurious to the fir tree</i> .....		861
Affecting the trunk, 861—Affecting the leaves, 862—Other insects of the fir, 869.		
CHAPTER XVIII.		
<i>Insects injurious to the hemlock and larch</i> .....		871
Injuring the trunk, 871—Affecting the leaves, 873.		
Insects injurious to the larch or tamarack: Affecting the leaves, 879—Other insects, 903.		
CHAPTER XIX.		
<i>Insects injurious to the juniper</i> .....		904
Affecting the trunk, 904—Affecting the leaves, 907.		
Insects injurious to the common juniper, 910.		
CHAPTER XX.		
<i>Insects injurious to the cedar and cypress</i> .....		917
Insects injurious to the cedar, 917.		
Insects injurious to the cypress, 921.		
Insects injurious to the <i>Sequoia gigantea</i> , 922.		
EXPLANATIONS TO PLATES .....		923
INDICES OF INSECTS, PLANTS, AND AUTHORS QUOTED .....		929, 947, 953

LETTER OF SUBMITTAL.

---

DEPARTMENT OF AGRICULTURE,  
DIVISION OF ENTOMOLOGY,  
*Washington, D. C., December 26, 1887.*

SIR: In accordance with the act of Congress approved March 3, 1881, which provided that the reports of the United States Entomological Commission be made to the Commissioner of Agriculture, I have the honor to submit for publication this the fifth and final report of said Commission. This report is on the insects affecting forest trees, by Dr. A. S. Packard, and has been in part written and completed since the termination of the work of the Commission, and while he has been connected with the Division as a special agent.

Respectfully,

C. V. RILEY,  
*Chief U. S. E. C.*

Hon. NORMAN J. COLMAN,  
*Commissioner of Agriculture.*

MEMBERS OF THE COMMISSION.

---

C. V. RILEY, *Chief.*

A. S. PACKARD, *Secretary.*

CYRUS THOMAS, *Disbursing Agent.*

# INSECTS INJURIOUS TO FOREST AND SHADE TREES.

---

## PREFACE.

The following report is an enlarged and revised edition of Bulletin 7 of the U. S. Entomological Commission on insects injurious to forest and shade trees, which was published in 1881.

The design of this report is to give to the public, especially those persons interested in forestry and the planting and cultivation of shade trees, a brief summary of what is up to this time known of the habits and appearance of such insects as are injurious to the more useful kinds of trees. It is hoped that such a compendium will be found useful, and lead the reader not only to refer to the works of Harris, Fitch, Walsh, Riley, Le Conte, Horn, LeBaron, Saunders, Lintner, Forbes, and others of our entomologists who have contributed to this neglected branch, but induce him to make careful observations on the habits of destructive forest insects and to carry on experiments as to the best remedies against their insidious attacks. The writer has added notes of observations made during the past twenty-five years in the forests of Maine, New Hampshire, New York, and the woods of Massachusetts, as well as in Colorado, Utah, Montana, Florida, and on the Pacific coast; also a number of original engravings. The aim has been both to present original matter and to bring together from numerous entomological works, reports, and journals all that is of most importance to the practical man. It is hoped that the work in its present form may serve as a convenient synopsis, a starting-point for future more detailed work, as well as a handy book of reference for the use of future observers, and that it will call the attention of the public to a neglected subject, stimulating entomologists, practical foresters, and gardeners to do what they can to add to our knowledge of this department of applied or economic entomology.

A volume could be written on the insects living on any single kind of tree, and hereafter it may be expected that the insect population of the oak, elm, poplar, pine, and other trees will be treated of monographically. Certainly there could be no more interesting and profitable work for the young entomologist.

The preservation of our forests and of old and valued shade trees in our cities and towns is a subject of pressing importance, and it is to be hoped that the Government will foster private work and research in this direction. Next to the wanton destruction of forests by unthinking settlers and shiftless land owners, as well as by fires caused by the sparks of locomotives, the attacks of injurious insects are most widespread and far-reaching. Our forest and shade trees are yearly growing more valuable and indispensable, and at the same time the ravages of insects are becoming more widespread and noticeable. The diffusion of a moderate amount of information upon the subject at the present time will attract the notice of the public and lead owners of land to pay a little attention to the subject and do something towards checking the ravages of noxious insects.

In France and Germany private persons, entomologists such as Perris in France, and especially Ratzeburg in Germany, have published beautifully illustrated general works of very great interest and value upon forest insects, and their books have done immense service in those countries, where an enlightened government and an intelligent people have felt the importance of building up schools of forestry and of making laws compelling due efforts towards repressing the more injurious forest insects.

Kaltenbach, in his work entitled "Die Pflanzenfeinde aus der Klasse der Insekten," or the Insect-enemies of Plants, has enumerated, in a closely-printed volume of 848 pages, the species of insects preying upon the different trees and plants, of all sorts, of central Europe. The number of insects found upon some kinds of forest trees is astonishing, though it is to be remembered that all kinds are not equally destructive, the most injurious and deadly forms being comparatively few.

Kaltenbach enumerates 537 species of insects injurious to the oak, and 107 obnoxious to the elm. The poplars afford a livelihood to 264 kinds of insects; the willows yield food to 396 species; the birches harbor 270 species; the alder, 119; the beech, 154; the hazelnut, 97, and the hornbeam, 88. Coming to the coniferous trees, as the pine, spruce, larch, firs, etc., the junipers supply 33 species, while upon the pines, larch, spruce, and firs, collectively, prey 299 species of insects. In France Perris has observed over one hundred species either injurious to, or living upon without being especially injurious to, the maritime pine. These are described in an octavo volume of 532 pages, with numerous plates.

The number as yet known to attack the different kinds of trees in the United States may be seen by reference to the following pages. It is sufficiently large to excite great fears for the future prosperity of our diminished forests, unless the Government interposes, and through the proper channels fosters entomological research in this direction. Our forests, moreover, are much richer in species of trees than those of Europe. We have, without doubt, on the trees corresponding to those of



Europe as many destructive species as in Europe. But we have many more shade and forest trees of importance in the eastern United States alone, and when we add to these the forest trees of the western Rocky Mountain plateau and of the Pacific coast, and when we look forward to the attention which must be given in the immediate future to the planting of shade and forest trees on the great plains and in California, the subject of forest entomology assumes still more importance.

The author has here arranged the forest trees in the order of their importance, beginning with the hard-wood or deciduous trees, the oak heading the list, and ending with the coniferous trees; and under each tree he has first described the habits of the insect on the whole most injurious, sometimes merely giving a list of those insects found to be regular parasites of the tree but not specially injurious, though it should be borne in mind that any species of insect may at certain seasons so abound as to prove destructive.

In preparing the original bulletin, the author was, for valuable information regarding the food-trees of a number of beetles hitherto unpublished, indebted to Mr. George Hunt, of Providence, R. I., and for aid in collecting specimens he acknowledged the assistance received from Mr. Edwin C. Calder, formerly assistant instructor in chemistry, Brown University, and from Prof. H. C. Bumpus, then a member of the sophomore class of Brown University.

While preparing the work in its present form the author has been for the last four years connected with the Division of Entomology as a special agent, and matter contained in his reports have been incorporated in this general work. And he takes pleasure in acknowledging the constant aid and sympathy in the work shown by Professor Riley, the United States Entomologist, not only in allowing free and unrestricted use of specimens, both in his private collection and that which he has generously presented to the Agricultural Department at Washington and to the National Museum, but for the privilege of describing the transformations of a number of species, represented by blown or alcoholic larvæ. Professor Riley has also freely made over to the author many hitherto unpublished notes of habits and transformations, which have been accumulating for the past twenty years—notes and observations which most persons would naturally prefer to keep or publish independently under their own names. These especially relate to oak and elm insects, besides others, and are acknowledged in the places where they appear. He also contributes an account of the insects of the *Celtis*.

Professor Riley has also allowed the use of some unpublished drawings and a few cuts prepared as Entomologist of the Department of Agriculture for future use.

Thanks are also due to the late S. Lowell Elliott, esq., of Brooklyn, Henry Edwards, esq., of New York, and Professor Riley, as well as to Dr. G. H. Horn, of Philadelphia; Dr. P. R. Uhler, of Baltimore; Dr. J. A. Lintner, State entomologist of New York, Mr. L. O. Howard and

Mr. E. A. Schwarz, assistant entomologists in the National Department of Agriculture, and Mr. D. W. Coquillett, of California, one of Professor Riley's field agents, for numerous favors in identifying insects, and other aid, and information.

For some of the colored drawings the author is indebted to Mr. Joseph Bridgham, Mr. H. H. Wilder, Prof. H. C. Bumpus, Miss Julia E. Sanders, Miss Emily A. Morton, and to the late Dr. J. L. Le Conte for a few colored drawings bequeathed by his father. These are specifically acknowledged in the explanations of the plates. Professor Riley has also had a number of original drawings made by Dr. George Marx, Mr. J. B. Smith, Miss Lillie Sullivan, all of Washington, and others have been made by Mr. Joseph Bridgham, of Providence, R. I. The artists' names are mentioned under the cuts in the text.

For aid in collecting specimens in Maine he is indebted to Mr. H. H. Wilder and Master Allen Howe, of Lewiston.

The author is well aware of the short-comings and imperfections in this report. A good deal of time has been expended in unsuccessful attempts at raising insects, which has not produced visible results. Upwards of two hundred descriptions of unidentified larvæ have been made; those of the oak appear in the appendix, and others are scattered through the report. It is hoped that future observations will enable us to complete these life-histories. It would have been desirable to have had more and, in some cases, better illustrations.

This report will be sent to all known to be specially interested in entomology, and they are respectfully asked to send the author corrections and additions, as undoubtedly a number of species have been omitted from the list of those peculiar to different trees. Such changes could be made in a second, revised edition, should it be called for by the public.

BROWN UNIVERSITY,  
*Providence, R. I., January 2, 1888.*

## INTRODUCTION.

The subject of Forest Insects is almost a distinct branch of economic entomology, and little special attention has been given to it as yet in this country, owing to the fact that our entomological students have been obliged to concentrate their efforts upon the more destructive garden and field insects.

The special works on this topic are, though few, notable for the extensive research and care with which they have been prepared; hence their permanent value. By far the most important are the voluminous works of Dr. J. T. C. Ratzeburg and those of Perris, Eichhoff, and Kaltenbach, while an excellent general work on forest insects is that of Judeich and Nitsche. The following list of works bearing directly on this topic, and indispensable, should be supplemented by the reports and articles of C. V. Riley, J. A. Lintner, J. H. Comstock, S. A. Forbes, and others:

- T. W. HARRIS *Treatise on some of the Insects injurious to Vegetation*. Third edition; illustrated. Boston, 1862.
- ASA FITCH. *Reports (1 to 14) on the noxious, beneficial, and other Insects of the State of New York*. Albany, 1856-'70.
- V. KOLLAR. *A Treatise on Insects injurious to Gardeners, Foresters, and Farmers*. Translated from the German by J. and M. Loudon. London, 1840.
- J. T. C. RATZEBURG. *Die Forstinsekten, etc.* (Forest Insects). Berlin, 1839, 1840, and 1844. 4 vols. 4to, with many plates.
- *Die Ichneumonien der Forstinsekten, etc.* (Ichneumons of Forest Insects). 3 parts. Berlin, 1844, 1848, and 1852. 4to. Plates.
- *Die Waldverderber und ihre Feinde* (Forest Destroyers and their Enemies). Berlin, 1841. 8vo. Sixth edition; 1869.
- *Die Waldverderbniss oder dauernder Schade, welcher durch Insektenfrass, Schälén, Schlagen, und Verbeissen an lebenden Waldbäumen entsteht* (Forest injury or losses inflicted by insect attacks, etc.). 4to. 2 parts. Berlin, 1866-'68, with many colored plates. (A magnificent and most useful work.)
- A. S. PACKARD. *Guide to the Study of Insects*. Ninth edition; 1888. 8vo. New York, H. Holt & Co.
- JUDEICH und NITSCHÉ. *Lehrbuch der Mittel-Europäischen Forstinsektenkunde*. Wien, Part I, 1885. Part II, 1889. 8vo.
- (Compare also the works of Perris, Taschenberg, Eichhoff, Kaltenbach, Altum, Nördlinger, Henschel, and others.)

While the reader is referred to the ordinary text books for the elements of entomology, the following facts may prove serviceable in connection with the subject of forest entomology:

*Insects in general.*—The term insect is applied to that class of jointed animals (*Arthropoda*) whose bodies are divided into three regions or sections, called the head, thorax, and hind-body or abdomen. They usually have three pairs of legs attached to the mid-body or thorax, and two pairs of wings. Most insects pass through a series of changes. In the butterfly, for example, after hatching from the egg as a caterpillar (*larva*), it transforms to a chrysalis (*pupa*), finally changing to the *imago* or winged insect. The insects form a class comprising about 200,000 known species.

They are divided into sixteen orders (not including those which are extinct), as may be seen by the following tabular view copied from the author's "Zoology," which briefly represents the more apparent, superficial differences between the groups. The list begins with the lowest, ending with the highest.

*Orders of insects now living.*

- |   |  |
|---|--|
| 1. Wingless, often with a spring .....                          | <i>Thysanura</i> : Spring-tails, etc.      |
| 2. Fore wings minute, elytra-like .....                         | <i>Dermaptera</i> : Earwig.                |
| 3. Wings net-veined; fore wings narrow; hind wings folded ..... | <i>Orthoptera</i> : Locusts, Grasshoppers. |
| 4. Four net-veined wings; mouth-parts adapted for biting .....  | <i>Platyptera</i> : White Ants, Bird-lice. |
| 5. Wings net-veined, equal .....                                | <i>Odonata</i> : Dragon-flies.             |
| 6. Wings net-veined, unequal .....                              | <i>Plectoptera</i> : May flies.            |
| 7. Mouth-parts beak-like, but with palpi .....                  | <i>Thysanoptera</i> : Thrips.              |
| 8. Mouth-parts forming a beak for sucking; no palpi .....       | <i>Hemiptera</i> : Bugs.                   |
| 9. Wings net-veined; metamorphosis complete .....               | <i>Neuroptera</i> : Lace-winged Fly, etc.  |
| 10. Wings long and narrow; body with a forceps .....            | <i>Mecoptera</i> : Panorpa.                |
| 11. Wings not net-veined .....                                  | <i>Trichoptera</i> : Caddis-fly.           |
| 12. Fore wings sheathing the hinder ones .....                  | <i>Coleoptera</i> : Beetles.               |
| 13. Wingless, parasitic .....                                   | <i>Siphonaptera</i> : Fleas.               |
| 14. One pair of wings .....                                     | <i>Diptera</i> : Flies.                    |
| 15. Four wings and body scaled .....                            | <i>Lepidoptera</i> : Butterflies.          |
| 16. Four clear wings; hinder pair small; a tongue .....         | <i>Hymenoptera</i> : Bees, Wasps, etc.     |

Allied to the insects are the myriopods, or centipedes and galley-worms, none of which are injurious to forest or shade-trees, although the smaller kinds of centipedes (*Lithobius*, etc.), occur under the bark of decayed trees. No spiders or allied forms, comprising the class *Arachnida*, are injurious to vegetation, except certain mites (*Acarina*) whose forms and gall-making habits are peculiar. Many spiders take up their abode in the leaves of shade and forest trees, but none are known to be injurious. The false-scorpions (*Chelifer*, etc.) often occur under the bark of decayed trees, but they are more useful than otherwise, as they probably devour the smaller wood-boring larvæ.

The bulk of our destructive forest insects belong to the orders comprising the beetles, the caterpillars, gall-flies, saw-fly larvæ, and the bugs. We will mention them in the order of their importance as destructive to shade and forest trees.

*The beetles and borers.*—The order *Coleoptera* comprises about 100,000 species of beetles, divided into a large number of families. The beetles are easily recognized by the hard, sheath-like fore wings which protect the hind wings; their jaws are stout and thick, more or less toothed, and adapted for biting.

The larvæ of beetles are called “grubs.” They have been thus characterized in the author’s “Guide to the Study of Insects:”

The larvæ, when active and not permanently inclosed (like the *Curculio*) in the substances which form their food, are elongated, flattened, worm-like, with a large head, well developed mouth parts, and with three pairs of thoracic feet, either horny or fleshy and retractile, while there is often a single terminal prop-leg on the terminal segment and a lateral horny spine. The larvæ of the *Cerambycidae* are white, soft, and more or less cylindrical, while those of the *Curculionidae* are footless, or nearly so, and resemble those of the gall-flies, both hymenopterous and dipterous.

The pupæ have free limbs, and are either inclosed in cocoons of earth or, if wood-borers, in rude cocoons of fine chips and dust, united by threads or a viscid matter supplied by the insect. \* \* \* Generally, however, the antennæ are folded on each side of the clypeus, and the mandibles, maxillæ, and labial palpi appear as elongated papillæ. The wing-pads being small, are shaped like those of the adult *Meloe*, and are laid upon the posterior femora, thus exposing the meso- and meta-thorax to view. The tarsal joints lie parallel on each side of the middle line of the body, the hinder pair not reaching to the tips of the abdomen, which ends in a pair of acute, prolonged, forked, incurved, horny hooks, which must aid the pupa in working its way to the surface when about to transform into the beetle.

Most of the destructive kinds belong to the following families :

Body of beetle, broad, flat, hard; antennæ short, serrated. Larva with head and first succeeding segment very broad and flat. .... *Buprestidæ*.  
 Body of beetle more or less cylindrical, with very long, slender antennæ; larvæ called “borers,” their bodies cylindrical, usually footless ..... *Cerambycidæ*.  
 Small cylindrical beetles, with no snout, called bark-borers; larvæ footless, thick, cylindrical, pointed at each end ..... *Scolytidæ*.  
 Hard-bodied beetles, called “weevils,” with a long beak or snout, with jaws at the end; larvæ grub like, footless, thick and fleshy ..... *Curculionidæ*.

*Moths and butterflies.*—While a few caterpillars (mostly of the family *Ægeriadæ* and the *Cossidæ*) bore into the trunk and branches of trees, the great bulk devour the leaves. Caterpillars are provided with stout, toothed jaws (mandibles) for cutting leaves. They are voracious feeders, as will be seen by the following extract from Mr. L. Trouvelot in Packard’s “Guide to the Study of Insects:”

Caterpillars grow very rapidly and consume a great quantity of food. Mr. Trouvelot gives us the following account of the gastronomical powers of the *Polyphemus* caterpillar: “It is astonishing how rapidly the larva grows, and one who has no experience in the matter could hardly believe what an amount of food is devoured by these little creatures. One experiment which I made can give some idea of it. When the young silk-worm hatches out it weighs one-twentieth of a grain; when ten days old it weighs half a grain, or ten times its original weight; twenty days old it weighs 3 grains, or sixty times its original weight; thirty days old it weighs 31 grains, or 620 times its original weight; forty days old it weighs 90 grains, or 1,800 times its original weight; fifty-six days old it weighs 207 grains, or 4,140 times its original weight.

When a worm is thirty days old it will have consumed about 90 grains of food; but when fifty-six days old it is fully grown and has consumed not less than one hundred

and thirty oak leaves weighing three-fourths of a pound; besides this it has drunk not less than one-half an ounce of water. So the food taken by a single silk-worm in fifty-six days equals in weight eighty-six thousand times the primitive weight of the worm. Of this, about one-fourth of a pound becomes excrementitious matter; 207 grains are assimilated and over 5 ounces have evaporated. What a destruction of leaves this single species of insect could make if only a one-hundredth part of the eggs laid came to maturity. A few years would be sufficient for the propagation of a number large enough to devour all the leaves of our forests." The Lepidoptera are almost without exception injurious to vegetation, and are among the chief enemies of the agriculturist.

In our descriptions of the larvæ of Lepidoptera the following points are noticed: Behind the head are twelve segments; the first or prothoracic is, in the small leaf-rolling and mining kinds, protected by a "cervical" or prothoracic shield; there are three thoracic segments, called the prothoracic, mesothoracic or metathoracic, or sometimes the first, second, and third thoracic segments; these correspond to the thorax of the imago or adult butterfly or moth. Behind these are nine distinct abdominal segments; on the eighth is often situated a dorsal hump. Many caterpillars are striped with a dorsal, subdorsal, and lateral lines or bands, moreover, the body in many is provided with warts or tubercles bearing a hair or spine; the "lateral ridge" is a broken swelling extending along the sides of the body. The abdominal feet are in certain leaf-miners wanting; or in the span or geometrid worms there are but two pairs; and the last or "anal legs" are often broad and large, the better adapted for seizing firm hold of a leaf or twig.

While a few butterflies live in the caterpillar state on trees, the following brief synopsis gives the most salient characteristics of the families of moths which especially abound on the leaves of shade and forest trees:

- Moths of large size; larvæ with a horn on the eighth abdominal segment.. *Sphingidæ*.  
 Moths with stout hairy bodies and small heads and broad wings; larvæ more or less hairy or with spines; usually spinning silken cocoons..... *Bombycidæ*.  
 Moths of moderate size; stout bodies; shining hind wings; larvæ with five pairs of abdominal legs; sometimes semi-loopers..... *Noctuidæ*.  
 Moths with slender bodies, broad wings, both pairs colored alike; larvæ with only two pairs of abdominal legs; span-worms or geometrids ..... *Phalænidæ*.  
 Small moths with narrow, straight fore-wings, the hind wings plain; larvæ glossy green or pale, the head spotted, and the body more or less striped.... *Pyralidæ*.  
 Still smaller moths, the fore-wings more or less oblong; the larvæ green, with dark heads and cervical shields; not striped; rolling leaves or eating buds.. *Tortricidæ*.  
 Minute moths with narrow, pointed wings; larvæ small, pale greenish, etc., with a darker head and cervical shield; often mining leaves, buds, etc..... *Tineidæ*.

Forest trees, and especially evergreen trees, support each year hordes of caterpillars, comprising species of different families. In beating the branches of any spruce, fir, larch, poplar, or maple, and especially the oak, a great number and variety of caterpillars are shaken down, and the question arises whether the innumerable host constantly and ordinarily at work from spring-time to the fall of the leaf in our forest trees are really injurious to the tree. It is not improbable that good

is done to the tree by these voracious beings. The process up to a certain limit may be one of natural and healthy pruning, but there is no certainty that the limit may not at any time be overstepped and destruction ensue. The tree is attacked in a multitude of ways by caterpillars alone. The buds are eaten by various leaf-rollers (Tortrices), the leaves are mined on the upper and under sides by various Tineids, while the leaves are rolled over in various ways and in various degrees to make shelter for the caterpillars, or they are folded on the edges, or gathered and sewed together by Tineid, Tortricid, and Pyralid larvæ. The entire leaves are devoured by multitudes of species of larger caterpillars, belonging especially to the Pyralid, Geometrid, Bombycid, and Sphingid moths; while certain species prey on the fruit, acorns, nuts, and seeds.

It is a singular fact that of the great family of Owlet or Noctuid moths, of which there are known to be 1,200 species in this country, very few feed on trees, the bulk of them occurring on herbaceous plants and grasses.

While the smaller caterpillars (*Microlepidoptera*) feed concealed between the leaves or in the rolls or folds in the leaf, or in the buds, the caterpillars of the larger species feed exposed on or among the leaves. Here they are subject to the attacks of birds and of Ichneumon and Tachina flies, which are constantly on the watch for them. And it is curious to see how nature has protected the caterpillars from observation. While the young of the smaller moths are usually green and of the same hue as the leaves among which they hide, or reddish and brownish if in spruce and fir buds, where they hide at the base of the needles next to the reddish or brownish shoots, the larger kinds are variously colored and assimilated to those of the leaves and twigs among which they feed. Were it not for this they would be snapped up by birds. Of course, the birds devour a good many, and the prying Ichneumons and Tachinæ lay their eggs in a large proportion, but those which do survive owe their safety to their protective coloration.

Of some twenty or more different species of Geometrid caterpillars which occur on the evergreen trees, some are green and so striped with white that when at rest stretched along a pine needle, they could with difficulty be detected; others resemble in various ways (being brown and warted) the small twigs of these trees; and one is like a dead red leaf of the fir or hemlock. There are several span-worms on the oak, which in color and markings, as well as in the tubercles and warts on the body, resemble the lighter or darker, larger or smaller knotty twigs; this resemblance, of course, is in keeping with the characteristic habit of these worms of holding themselves out stiff and motionless when not feeding.

In an entirely different way the various kinds of Notodontian caterpillars, which feed exposed on oak leaves, are protected from observation. They feed on the edges of the leaves, and their bodies are green,

with reddish brown patches, so that these irregular spots, when the caterpillar is at rest, are closely similar to the dead and sere blotches so frequent on oak leaves. The same may be said of other kinds feeding on the leaves of other forest trees.

While the bodies of those Noctuid caterpillars which feed on herbaceous plants are smooth, those of the tree-inhabiting *Catocala*, *Homoptera*, and *Pheocyma* are mottled with brown and ash like the bark of the tree, and provided with dorsal humps and warts assimilated in form and color to the knots and leaf scales on the twigs and smaller branches.

There is thus a close harmony in color, style of markings, shape, and size of the humps and other excrescences of tree-inhabiting caterpillars, and it is due to this cause that they are protected from the attacks of their enemies. Mr. Poulton has recently called attention to the fact that caterpillars are extremely liable to die from slight injuries, owing to their soft bodies and thin skins. They can not defend themselves when once discovered. The means of protection are of passive kinds, *i. e.*, such as render the delicately organized animal practically invisible on the part of its enemies, and these means vary with each kind of caterpillar. In this way different kinds of larvæ can live on different parts of the leaf, the upper or under side, or the edge; on different colored twigs, on those of different sizes, with different kinds of leaf scars, scales, or projections; and thus the tree is divided, so to speak, into so many provinces or sections, within whose limits a particular kind of worm may live with impunity, but beyond which it goes at the peril of its life.

To the *Hymenoptera* belong the gall-flies and saw-flies, besides bees and ants, and ichneumons.

*Gall-flies.*—These little creatures produce tumors or galls both in the trunk, branches, but more usually the smaller twigs and leaves of the oak, and rarely other trees. They belong to the family *Cynipidæ*, and are described as follows in the writer's "Guide to the Study of Insects:"

The gall-flies are closely allied to the parasitic Chalcids, but in their habits are plant-parasites, as they live in a gall or tumor formed by the abnormal growth of the vegetable cells, due to the irritation first excited when the egg is laid in the bark or substance of the leaf, as the case may be. The generation of the summer broods is also anomalous, but the parthenogenesis that occurs in these forms, by which immense numbers of females are produced, is necessary for the work they perform in the economy of nature. When we see a single oak hung with countless galls, the work of a single species, and learn how numerous are its natural enemies, it becomes evident that the demand for a great numerical increase must be met by extraordinary means, like the generation of the summer broods of the plant-lice.

The gall-flies are readily recognized by their resemblance to certain Chalcids, but the abdomen is much compressed and usually very short, while the second, or the second and third segments, are greatly developed, the remaining ones being imbricated, or covered one by the other, leaving the lined edges exposed. Concealed within these is the long, partially coiled, very slender ovipositor, which arises near the base of the abdomen. [See Plate xv, ovipositor of the gall-fly.] Among other distinguishing characters, are the straight (not being elbowed) thirteen to sixteen jointed antennæ, the labial palpi being from two to four jointed and the maxillary



palpi from four to six jointed. The maxillary lobes are broad and membranous, while the ligula is fleshy, and either rounded or square at the end. There is a complete costal cell, while the subcostal cells are incomplete. The egg is of large size, and increases in size as the embryo becomes more developed. The larva is a short, thick, fleshy, footless grub, with the segments of the body rather convex. When hatched they immediately attack the interior of the gall, which has already formed around them. Many species transform within the gall, while others enter the earth and there become pupæ.

Like the Aphides and certain other insects, the females often reproduce parthenogenetically, viz, they lay eggs without having paired with males, the latter not being at the time in existence. Thus the late B. D. Walsh \* discovered that the autumn brood of a gall-fly (*Cynips quercus-aciculata*) consisted entirely of females which laid eggs, producing the following spring both males and females which were originally referred to a supposed distinct species (*Cynips quercus-spongifica*). Hence, after several experiments Mr. Walsh declared that "the agamous autumnal female form of this *Cynips* (*C. q.-aciculata*) sooner or later reproduces the bisexual vernal form," and is thus "a mere dimorphous female form" of *C. q.-spongifica*. It was reserved for two other American students of the gall-flies to establish the fact that an alternation of generations takes place in these insects. The case is thus stated by Mr. L. O. Howard, in *Psyche* (III, 329, June 24, 1882).

America may justly claim the credit for the discovery of this most interesting fact of alternation of generations among Cynipids. Riley, in the interjected remarks in his article on "Controlling Sex in Butterflies" (*American Nat.*, Sept., 1873, v. 7, p. 519), was the first actually to establish the fact beyond all peradventure, as M. Lichtenstein points out; yet Bassett, four months previously (*Can. Entomologist*, May, 1873, vol. 5, p. 93) had stated, in the following words, the theory which Adler has so fully verified: "From all the above facts I infer that all our species that are found only in the female sex are represented in another generation by both sexes, and that the two broods are, owing to seasonable differences, produced from galls that are entirely distinct from each other." In this article Bassett has just missed the actual proof in two instances. With *Cynips q.-operator* he had observed the females of the vernal brood ovipositing in acorn cups and producing the gall *q.-operatola* of Riley's MS.; but he failed to rear the flies from these galls and so missed the complete proof. In the case of *C. q.-batatus* Bass., he had bred the sexual forms from leaf galls, and the agamic females from twig galls, but had not actually observed the females of the former in the act of ovipositing in the twigs; thus again missing the proof. Riley, however, as he tells us in his published note, succeeded in breeding the agamic females of *q.-operator* from the acorn galls; thus, in connection with Bassett's observation of the oviposition, completely establishing the fact of alternation. So the credit should be joint. It is, in fact, much like the well-known case of *Siredon* and *Amblystoma*, in which the credit should be divided between Baird and Dumeril. Dr. Adler very excusably overlooked this note of Riley's. Walsh, in his earlier articles, came no nearer the actual state of the case than to prove that two females, formerly described as distinct species, may belong to the same male.

Independently of and subsequently to the work done in the United States, Dr. Adler, of Germany, also discovered and satisfactorily

\* *American Entomologist*, ii, 330, October, 1870.

proved in an extensive and beautifully illustrated memoir\* the fact of alternation of generations in a number of European species.

In a notice of Adler's work in the *American Naturalist* for July, 1881, Professor Riley added that Mr. H. F. Bassett "has, following Adler's interesting experiments in Europe, suggested the probable dimorphic connection of several of our vernal galls which produce bisexual individuals, with autumnal forms which produce larger asexual flies. Dr. Adler gives a list of nineteen species of Cynipidæ in which the occurrence of dimorphic forms has been proved, giving the names of the agamic forms and the corresponding bisexual forms the latter of which, in all cases, were referred to distinct genera by previous observers.

In this connection should be mentioned the remarkable fact that in certain closely allied species (*Aphilotrix seminationis*, *marginalis*, *quadri-lineatus* and *albopunctatus*) no alternation of generations seems to occur.

*Saw-flies.*—These often seriously injure evergreen trees, while they occur on all other trees. There are a large number of species. Their larvæ resemble caterpillars in appearance and in voracity. The flies differ from wasps, etc., in the abdomen being broad at the base; the body is somewhat flattened, and the head is wide, while the antennæ are not elbowed, and as in *Lophyrus* are pectinated in the males, serrated in the females. In the end of the hind body of the female is situated the "saw" or ovipositor. This consists of two blades, the lower edge of the lower one of which is toothed like a saw, and fits in a groove in the under side of the upper blade; both blades being protected by sheath-

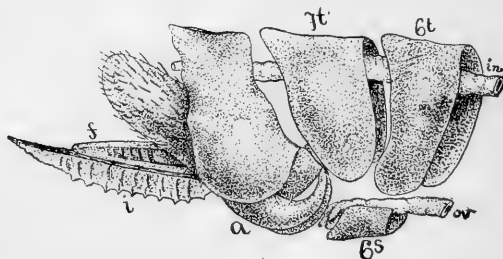


FIG. 1.—Saw of a saw-fly (*Hylotoma*): *a*, lateral scale; *i*, saw; *f*, gorget. After Lacaze-Duthiers.

like stylets. On pressing the end of the abdomen the saw is depressed; by this movement the saw, which both cuts and pierces, makes a gash in the soft part of the leaf, where it deposits its eggs. (Fig. 1.)

The *Lophyrus* of the pine makes a series of punctures on each side of a pine needle; the *Nematus* of the alder makes from twenty to forty pairs of semicircular punctures in the under side of the midrib of the leaf, while the larch saw-fly inserts her eggs in two alternating rows at the

\**Zeitschrift für Wissenschaftliche Zoologie*, xxxv, Feb. 1, 1881, pp. 151-246, Pls. x-xii. Dr. Adler's researches were commenced in 1875, and his first paper appeared in 1877. (*Deutsche Entomolog. Zeitschrift*, 1877, Heft 1.)

base of the fresh leaves of the new shoots. The punctures made in the willow by saw-flies of the genus *Euura* result in the formation of galls or tumors within which the larvæ live.

The larvæ strongly resemble caterpillars, hence they are sometimes called "false caterpillars;" but they have from six to eight pairs of abdominal legs, whereas caterpillars have only five pairs. Many kinds (*Nematus*, etc.) curl the hind body spirally when feeding or at rest. They are usually green, of the color of the leaves upon which they feed, with lines and markings of various colors. They usually molt four times, the last change being the most marked. Most of the larvæ secrete silk and spin a tough oval, cylindrical cocoon, in which they hibernate in the larva and often in the pupa state.

*Ants and bees.*—Ants have not been noticed in the United States to injure trees, but in the tropics species of *Cæcodoma*, or leaf-bearing ants, are very destructive to trees; it is possible that there are species in the Gulf States which may in part defoliate trees.

Bees are of great use in setting the fruit of trees; little has been observed on this point in this country, but without doubt the visits of innumerable bees to linden trees are of service in "setting" the seed of that tree.

Mr. Lugg<sup>\*</sup> mentions the fact that the seeds of the rock maple, so numerous in the grounds of the Smithsonian Institution, Washington, D. C., were in 1886 uniformly sterile. He attributed this phenomenon to the inclement weather prevailing during the flowering season, which prevented bees from visiting the flowers.

*Plant lice.*—While many *Hemiptera*, such as the bugs, destroy many caterpillars, particularly span-worms and leaf-rollers, some of the most annoying and destructive of our forest insects belong to this order. They all take their food by piercing the succulent leaves and stems, or twigs of trees, shrubs, or herbs, often causing them, as in the elm aphid, to crumple up. The species of *Psyllidæ* are very common on the leaves of hard-wood trees, either hopping over the surface or living in leaf-galls which are the results of their punctures.

The following account of Aphides or plant-lice is adapted from the writer's "Guide to the Study of Insects:"

The plant-lice have greenish, flask-shaped bodies, covered with a soft, powdery, bloom; their antennæ are five to seven-jointed, with a three-jointed beak, and legs with two-jointed tarsi. The males and females are winged, and also the last brood of asexual individuals, while the early summer brood are wingless. The abdomen is thick and rounded, and in *Aphis* and *Lachnus* provided with two "honey tubes" for the passage of a sweet fluid secreted from the stomach.

In the early autumn the colonies of plant-lice are composed of both male and female individuals; these pair, the males then die, and the females begin to deposit their eggs, after which they also die. Early in the spring, as soon as the leaves begin to unfold, the eggs are hatched, and the young lice begin to suck the sap, and soon begin to bring forth young, which develop by a budding process within the body of the

\* *Entomologica Americana*, ii, 89.

parent. A second generation of sexless individuals thus results, which is succeeded by a third, fourth, fifth, and even a ninth generation, the process being only terminated by the approach of cold weather, when a last brood of males and females appear. By this anomalous, asexual mode of reproduction, a single Aphis may become the parent of millions of young.

Certain plant-lice occur on the roots of plants, others on the stems or twigs; others puncture leaves, causing them to roll or crumple, or to form galls. Ants are fond of the sweet excretions from the "honey tubes," and often keep them captive in their nests like herds of cattle. The maggots of *Syrphus* flies, lady-birds (*Coccinella*), and the larvæ of the lace-winged fly, besides small ichneumons, destroy great numbers of them and keep them within due limits.

To the plant-lice family belong the species of *Adelges* and *Chermes* which produce cone-like swellings on the new-grown twigs of spruce; also of *Pemphigus*, which produce gall-like swellings on poplars, etc.

*Bark-lice.*—In the species of *Coccidæ*, the males alone are winged, having but a single pair, while the females are wingless, scale-like and do great damage by puncturing the bark of trees.

*Dipterous or two winged gall-flies.*—Maples, wild plums, poplars, and other trees have numerous leaf-galls of varied form made by little gnat-like flies belonging to the dipterous family *Cecidomyidæ*. These flies are minute, most of them smaller than a mosquito. The females lay their eggs in the stems, leaves, and buds of various plants and trees, thus producing galls, a common example being the willow dipterous gall-fly (*Cecidomyia strobiloides*). There are thirteen other species found by Mr. Walsh to raise galls on eight different kinds of willow, the different kinds of galls being readily distinguished, while the flies themselves and their maggots are closely similar. The maggots of the *Cecidomyians* are usually minute orange, pinkish, or yellowish worms without feet, and with the body pointed at each end.

*Insectivorous or parasitic insects.*—While the undue increase of forest insects is largely prevented by insectivorous birds, their numbers are especially reduced by the attacks of parasitic or carnivorous insects. Of these the most efficient are the ichneumon flies, which are wasp-like insects forming a large group of the order *Hymenoptera*, belonging to the families *Ichneumonidæ*, *Proctotrupidæ*, and *Chalcididæ*. Of the ichneumons there are probably from 4,000 to 5,000 species. Many of the species of *Proctotrupidæ* oviposit in the eggs of *Lepidoptera* and of dragon flies, etc. The largest species belong to the first-named family. They are recognized by their long, slender body and long, external ovipositor. The larva is like the maggot of a bee or wasp, being footless, soft, and white, and with a smaller head.

"When about to enter the pupa state the larva spins a cocoon, consisting in the larger species of an inner dense case and a looser, thinner outer covering, and escapes as a fly through the skin of the caterpillar. The cocoons of the smaller genera, such as *Cryptus* and *Microgaster*, may be found packed closely in considerable numbers, side by side, or sometimes placed upright within the body of caterpillars."\*

\* Packard's "Guide to the Study of Insects," p. 193.

Fig. 2 represents the mode of oviposition by an unknown ichneumon observed by us in Providence. The egg (*d*) was laid on the head, and the larva soon hatching, bored under the skin, entering the body so as finally to disappear out of sight.

The eggs are laid either within or on the outside of the body of the host, usually some caterpillar.

A special account of the mode of egg-laying of an European ichneumon (*Paniscus cephalotes*) is given by Mr. E. B. Poulton in the Transactions of the Entomological Society of London, 1886, page 162. It laid 14 eggs on the caterpillar it selected as its host, firmly attaching them to its skin, most of them in the sutures between the segments on the sides of the body.

"It is probable that an excess of ova is generally laid, for a small proportion do not develop, and the way in which they are attached in small groups insures that of those that do develop a large proportion of the larvæ are so crowded by the others that they die at an early stage, as has been also previously observed. If too large a number were laid and all developed, it is obvious that none could arrive at maturity; but this is obviated in the manner described above, and it is partly brought about by the limited space on the circumference of the larva attacked. This space, of course, varies with the size of the latter, and it is more quickly filled in the rapid development of the parasites upon small than upon large larvæ; so that, if they are too numerous, crowding ensues earlier, and with more fatal results in the former than in the latter case. Thus the smaller surface may compensate for the less amount of food, and may itself insure that the parasites reach maturity." The ichneumon lays a smaller number of eggs on small caterpillars than on large ones, and yet lays more than can develop in all cases, "the eggs being laid in such a way that crowding results if all or nearly all develop; so that the chance of the eggs being sterile is obviated on the one hand and of the parasitic larvæ dying immature on the other."

The larva of the ichneumon does not attack the solid or vital parts of its host, but absorbs the blood and other fluids of the body. Mr. Poulton thinks that the motive force which drives the blood from the body of the host into the digestive tract of the parasite is entirely supplied by the contracted body-walls of the former.

Many ichneumons are polyphagous, *i. e.*, live in insects of widely different species, and those of different orders.\* Others confine their attacks

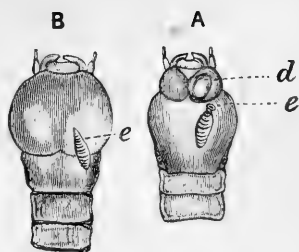


FIG. 2.—Head of a Noctuid caterpillar on the hickory, containing a freshly-hatched ichneumon larva. *A*, *d*, egg-shell of the ichneumon on the caterpillar's head, the larva (*e*) having bored into the prothoracic segment of its host. *B* as the host appears ten minutes later, the egg-shell having dropped off. The prothoracic segment has contracted and the head has become swollen, while the posterior part of the caterpillar's head has concealed the opening of the larval parasite seen at *A*, *e*. Gissler, *del.*

\* This and the following remarks on ichneumons are taken mainly from Judeich and Nitsche's Lehrbuch der Mittel-Europäischen Forstinsektenkunde.

to a single species. Most ichneumons have but a single generation; a few are double-brooded. In Germany, Ratzeburg observed a brood of *Microgaster globatus* early in May, and another early in August. Though there may be two broods of the hosts, there is, as a rule, but a single brood of ichneumons. Ratzeburg, indeed, found that certain ichneumons of saw-fly larvæ imitated the habit of the latter of living more than a year, *i. e.*, they did not develop until the greater number of saw-flies had issued from the belated cocoons. On the other hand *Pteromalus puparum* undergoes an extraordinarily rapid growth; it stings early in June the chrysalids of *Vanessa polychloros*, and by the middle of July the adults appear. *Teleas ovulorum* requires only four to six weeks to develop; it however flies somewhat later, so as to find the suitable objects on which to lay its eggs.

Ichneumons rarely develop in adult insects, but certain Braconids infest Coccinella beetles. The small Chalcids, *i. e.*, Pteromali, mostly inhabit the tender pupæ of bark-boring beetles and leaf-rollers.

Among the smaller ichneumons several females usually inhabit a single host, while from 600 to 700 individuals of *Pteromalus puparum* may inhabit a single chrysalid, and 1,200 *Apanteles* a Sphinx larva.

Most ichneumons develop within their hosts, but many species of Chalcids live on the outside and suck the blood of their host. The ichneumon larvæ living within their hosts often undergo the most remarkable transformation of their mouth-parts. In *Microgaster globatus* there are, at first, only the wart-like rudimentary sucking mouth-parts; but after the last molt the larvæ acquire ordinary biting mandibles, with which they can gnaw through the skin of their host. However, the food of the ichneumon larvæ is wholly fluid, their mouth-parts not allowing them to eat the fat-body of their host.

Other parasitic insects are the larvæ of the *Tachina* flies, a group closely allied to the common house-fly. The larvæ are true maggots, footless, and take their food by suction through the mouth, the mouth-parts being very rudimentary. The *Tachina* (*Senometopia*) *militaris* has been observed by Riley to lay from one to six eggs on the skin of the army-worm, "fastening them by an insoluble cement on the upper surface of the two or three first rings of the body." The young maggots in hatching penetrate within the body of the caterpillar, and lying among the internal organs absorb the blood of their unwilling host, causing it to weaken and die.

Other insectivorous insects are the Aphis-lions, the young of the lace-winged flies *Chrysopa* and *Hemerobius*, which are frequently found in trees among plant-lice; also Carabid beetles.

*Artificial breeding of parasitic and predaceous insects.*—Among the most important preventive measure against the wholesale ravages of insects is the artificial breeding of parasitic insects. We early advocated this in dealing with the Hessian-fly and wheat midge, suggesting the importation of the European parasites of the latter species in straw. Dr. Le Baron has experimented with the parasites of the apple bark-louse.

Professor Riley in his third and subsequent Missouri reports has shown how easily and practically certain parasites of the Plum Curculio and of various scale-insects may be artificially disseminated, and has successfully introduced the most common European parasite (*Apanteles glomeratus*) of the imported cabbage worm.\*

\* The most striking illustration of the good that may be accomplished by this means has, however, been furnished by Professor Riley since these pages were prepared for the printer, and as it refers to an insect very destructive to forest as well as fruit trees, we reproduce here the paper read by him at the Toronto (1889) meeting of the American Association for the Advancement of Science on "the artificial importation and colonization of parasites and predaceous enemies of injurious insects":

"The encouragement of the natural checks to the increase of insects injurious to vegetation may be of a two-fold nature. It frequently happens that an indigenous species is found to have certain parasites in only a portion of the country which it inhabits. In such cases, where it is practicable to transport the parasites, a great deal of good may be accomplished. Cases in point are not uncommon. \* \* \*

"But this intentional distribution of the parasites or natural enemies of an injurious insect from one part to another of its native country is by no means to be compared in importance with the introduction of such parasites or enemies from one country to another, in which the injurious species has obtained a foothold, without the corresponding natural enemies which serve to keep it in check in its original home.

"The object of the present note is to cite an illustration of artificial introduction on a large scale, which has already been productive of great good. A successful attempt of this kind had been made by me in the case of *Microgaster glomeratus*, which, after several futile efforts, was introduced from Europe and established in the United States in 1885, and which has now become so widely distributed as to raise the question of its previous existence there. This *Microgaster* is one of the commonest parasites of the European Cabbage Worm, *Pieris rapa*, which got a foothold in America, without its European enemies, about the year 1859, and which rapidly spread over the States and parts of Canada, with disastrous results to the cabbage crop.

"The case to which I would particularly allude is, however, far more important and satisfactory. Orange culture has become a very important industry in southern California. The orange groves there have suffered for some years from the attacks of several insects, but particularly of a very pernicious scale insect (*Icerya purchasi* Maskell). This is one of our largest coccids and, from its habits and characteristics, very difficult to overcome. It does a great deal of damage—not only to the orange and other citrus fruit-trees but to many other cultivated plants and to forest trees. The damage has become so serious during the past few years that many orange-growers have abandoned their groves, while the cost and trouble of protecting these by the use of insecticides have always been great, even where successful. After careful researches I ascertained that the insect was without much question a native of Australia and had been artificially introduced not only into southern California, but also into Cape Colony, in South Africa, and probably into New Zealand; also that in its native home it rarely did serious damage, being kept in check there by various natural enemies and parasites. Some attempt was made, through correspondence with Mr. Frazer S. Crawford, of Adelaide, to introduce one of the parasites by mail in 1887. Specimens were received alive and liberated at Los Angeles under confinement, but no positive evidence was obtained of multiplication or colonization. Special effort and introduction on a larger scale seemed necessary.

"Last autumn and winter in connection with the commission appointed to visit the Melbourne International Exposition and through the State Department I was able to send one of my field agents, Mr. Albert Koebele, to Australia with instructions to study these natural enemies and to send living specimens to California. The principal facts have been recorded in my last annual report as entomologist of the United States Department of Agriculture and in late numbers of "Insect Life," a monthly bulletin published under the auspices of the entomologist and his assistants. Without going into detail I may say that Mr. Koebele's mission has been eminently successful and that we have succeeded in introducing alive not only the most important of the parasites, an interesting Dipteron (*Lestophonus iceryæ* Williston), but also several predaceous species, and particularly certain ladybirds (Coccinellidæ.) These were brought over last winter and spring, have become well acclimated, and are now spreading and multiplying at a rapid rate. The latest reports which I have received from California are to the effect that one of the commoner ladybirds but recently described, namely, the *Vedalia cardinalis*, and another lately described by Dr. D. Sharp as *Scymnus res-titutor* are multiplying and spreading in a most satisfactory manner. The consign-

*Coleopterous enemies of borers.*—Besides woodpeckers and other birds which pick insects out of bark, and thus do great benefit to forestry, and besides ichneumon and Chalcid parasites of borers, there are many carnivorous grubs which prey upon the borers.

Among the external though less known enemies belonging to the order of beetles, which Perris enumerates from his extended observations on their habits, are a large number which live under the bark of trees. I quote his accounts of them, premising that we have similar insects with like habits in this country; and though the list of scientific names seems formidable, yet there are no common names for them. I use nearly his own words, with occasional interpolations of English names.

When one of the Scolytids injurious to pines (the *Bostrichus stenographus*) lays its eggs under the bark, the *Platysoma oblongum* introduces itself by the hole which has given entrance to the first named insect; it lays its eggs in the gallery of the *Bostrichus*, and from those eggs are born the carnivorous larvæ which devour those of the wood-eating beetles. Other beetles conduct themselves in the same manner in warring against other Scolyti. The larvæ or grubs of *Plegaderus discisus* destroy the young of *Crypturgus pusillus*; another wood-eating beetle, the *Aulonium sulcatum*, is the deadly enemy of *Scolytus destructor*, so formidable a foe to shade trees; *Aulonium bicolor* attacks *Bostrichus laricis*; *Colydium bicolor* preys upon the *Bostrichus* of the larch; *Colydium elongatum* on *Platypus cylindrus*; *Rhizophagus depressus* on *Blastophagus piniperda* and *B. minor*; *Læmophlæus hypobori* on *Hypoborus ficus*; *Hypophlæus pini* on *Bostrichus stenographus*; and finally *Hypophlæus linearis* on *Bostrichus bidens*. Who will not be struck by these antagonisms? Who will not admire this infallibility of instinct which causes these insects to discover the tree attacked, and perceive among the species which the tree conceals the victim which has been assigned to them?

Other beetles exhibit the same sagacity. The larvæ of several Elaterids (wire-worms) and those of *Clerus mutillarius* and *C. formicarius* make war on those of some longicorn beetles of the oak, the elm, alder bush, and the pine. The *Opilus mollis* and *O. domesticus* are the enemies of the borers which mine our floors and ceilings; the *Cylidrus albofasciatus* and the *Tillus unifasciatus* prey on *Sinoxylon sexdentatum* and on *Xylopertha sinuata*, which seek the diseased branches of the vine and those of several trees; the *Tarsostenus univittatus* attacks the *Lycus canaliculatus*, injuring our timber works; while the *Trogosita mauritanica* destroys the grain moth.

In an article in the *American Naturalist* (xvi, 823) on inquiline wood-borers, or those which usually take up their residence in mines or galleries made by true wood-borers, Mr. E. A. Schwarz finds that the common *Platypus compositus* may itself bore in the thick bark of pine

---

ments from Australia were received at Los Angeles by Dr. D. W. Coquillett, another of the agents of the division." \* \* \*

The people of California are enthusiastic over the grand success of this effort, and the Vedalia is spreading with remarkable rapidity and clearing the trees in its wake. Prof. W. A. Henry, director of the Wisconsin Experiment Station, in a recent report to the Department of Agriculture writes:

“A word in relation to the grand work of the Department in the introduction of this one predaceous insect. Without doubt it is the best stroke ever made by the Agricultural Department at Washington. Doubtless other efforts have been productive of greater good, but they were of such character that the people could not clearly see and appreciate the benefits, so that the Department did not receive the credit it deserved. Here is the finest illustration possible of the value of the Department to give people aid in time of distress. And the distress was very great indeed.”



stumps, but in hard wood, as oak, etc., associates with *Colyidium lineola* and *Sosylus costatus*, living in their mines. Professor Riley has discovered that the larva of *Hemirhipus fascicularis* is parasitic on *Cyllene picta*, living in its mines. *Strongylium tenuicolle* is not a true borer, but Mr. Schwarz has found it in the mines of longicorn borers, wherein it perhaps lays its eggs.

*Influence of temperature on insect life.*—The following statements are taken from Judeich and Nitsche's Lehrbuch, and will apply to insects in this country:

“The influence of temperature may either work injuriously on insect life from extremes of heat or cold, or from sudden and, at given times of the year, abnormal changes. High temperature does not directly in our climate, in the natural course of nature, affect insects. On the other hand, it is not unfrequently the case that insects, suddenly overcome by the frost, freeze to death in great numbers, since with the lowering of the temperature, benumbed by the cold, they can not reach crevices or holes out of the reach of the frost. As an example, we may refer to the winter of 1864-'65, in which, in the district of Mark and the province of Saxony, the caterpillars of pine silk worms and measuring worms remained unusually long on the trees, and the former froze in the middle of December,  $-12.5^{\circ}$  C., and the latter during the considerably greater cold in January. Hence the influence of even very great cold on the normal hibernating stages of our insects is not very great. In the summer of 1854 the ‘nun’ moth had very generally laid its eggs in eastern Prussia uncovered on the bark, and these did not freeze in the hard winter of 1854-'55, notwithstanding the expectation that they would, based on a temperature of 30 to  $35^{\circ}$  C.

“According to the observations of Regener, openly exposed caterpillars of the pine silk worm endured  $-12.5^{\circ}$  C. The other stages froze earlier, the pupa at  $-6^{\circ}$  C., the moth at  $-7.5^{\circ}$  C., the eggs at  $-10^{\circ}$  C. According to Duclaux (Comptes Rendus, 83, p. 1079) the eggs of the silk worm endure well remaining two months in a temperature of  $-8^{\circ}$  C.

“Great fluctuations of temperature during the winter produce an abnormal interruption of the winter's rest or hibernation, and thus cause the death of many insects.”

*Generations or broods.*—The length of time which any insect needs in order to complete a single developmental cycle from the time the egg is laid until the insect is mature and fit for reproduction is a generation; a generation then is the time from an egg to an egg. The length of time of a generation varies, of course, in different insects. Generally an insect requires twelve months for its development. In such a case we speak of an annual generation. On the other hand an insect which requires for its developmental cycle twenty-four, thirty-six, or forty-eight months has a biennial, triennial, or quadrennial generation. The European May beetle has, in northern Germany, a quadrennial generation; the seventeen-year locust has a generation of seventeen years.

On the other hand, there are insects which repeat their developmental

cycle two, three, or more times in a year; such insects are said to be double or treble-brooded. *Lophyrus abietis* and other species are double-brooded, while many butterflies are double or treble brooded, and the Aphides have from nine to fourteen generations in a season, *i. e.*, from spring to autumn. In all cases of seasonal dimorphism or of parthenogenesis there are several generations.

Judeich and Nitsche graphically represent as follows the generations of the European *Lophyrus pini*, with its double generations, which will also apply to our *L. abietis*: The egg is denoted by a point (.), the larva by a dash (—), the larva lying in a semi-pupa condition in the cocoon, thus (⊖); the pupa by the following mark (●), and the imago by a cross (+); the time during which the larva is eating, by a heavy dash (■■■■); lastly, the period of injury by the larva is placed under, the time of imaginal injury above, the mark for the stage under consideration.

	Jan.	Feb.	Mar.	Apr.	May.	June.	July.	Aug.	Sept.	Oct.	Nov.	Dec.
1880.				++ ..	--- ■■■■	---	●●++ ..	--- ■■■■	---	⊖⊖	⊖⊖	⊖⊖
1881.	⊖⊖⊖	⊖⊖⊖	⊖⊖●	●++ ..								

In the United States a butterfly or moth which is single-brooded in the New England or northern Central States may be three-brooded in the Southern or Gulf States. A generation or brood which appears and ends in the summer is shorter than that which hibernates.

Thus the summer generation of the species of pine saw-flies (*Lophyrus*) is about four months, the winter generation about eight months. Hence the length of the generation depends on the temperature and climate, as does also the number of broods or generations. "This influence of climate is, as is well known, so considerable that a species of insect which has a double generation in a certain locality, in another place with a colder climate is only single-brooded, while in a warmer climate it is three-brooded. An example is *Hylesinus piniperda*. Thus also a species of insect whose generations in a certain middle location is, for example, four-yearly, in a more southern situation is three-yearly. A proof of this is afforded by the May beetle, which north of the 'main line' is four, but south of it needs only three years to complete its development. A certain species of insect may moreover in the same locality in a warmer and more favorable year be double-brooded, while in the next harsher unfavorable year it is single-brooded. But if the checking influence of the harsh weather is less, then even in an unfavorable year a second generation may begin to develop, but does not complete its cycle by the end of twelve months. Hence there are in twenty-four months three generations, and then arises what Ratzeburg calls a 'one-and-a-half generation.' Of this *Tomicus bidentatus* not rarely affords an example.

“We have observed that certain species of insects and often individual insects may without any assignable reason remain a considerably longer time than usual in the pupa state. *Lyda stellata* usually has a single brood (one year generation) while it frequently happens that from the pupa beginning the first of May, the imago does not fly at the end of May or in June, as is the rule, but that the pupa state lasts over to the next May, when the adult flies. The pupal rest in this case lasts, instead of three weeks, more than a year. A similar case is that of *Cnethocampa pinivora*. This relation is connected with the fact that insects are cold-blooded, or better, poikilothermic, *i. e.*, changeably warm animals. We understand thereby such animals as those whose peculiar body heat, although constantly a little higher than that of the surrounding medium, the air, water or earth, *i. e.*, their habitat, yet varies with the changing temperature of this medium. In contrast with these are the warm-blooded, or, more exactly, the *homœothermal*, *i. e.*, animals with an even temperature which as long as they live steadily maintain their own normal temperature up to a height ranging at most 1° C. The blood-heat of a healthy man, although he may be exposed to a degree of cold of — 30° C. or a warmth of + 30° C., remains steadily at 38° C. (Judeich and Nitsche.)\*

The duration of development of a warm-blooded animal is definite. The development of an insect's eggs, however, is analogous to that of a fish. We best see this when at the beginning of spring the leafing out of the foliage is late and the caterpillars of *Clisiocampa* hatch correspondingly late. Exact series of observations of indubitable certainty are scarcely at hand, but, add our authors,† we will cite the positive statements of Regener‡ on the influence of temperature on the duration of development and of life of the pine *Bombyx* at different temperatures, though, indeed, they are somewhat inexact and incomplete.

Provisional tabular view of the life-history of the Pine spinner (*Gastropacha pini*) at different temperatures, after Regener.

Temperature, ° C.	Duration (in days) of—				
	Egg-stage, from laying to hatching.	Caterpillar, from hatching to spinning of cocoon.	Spinning of cocoon.	Preparations for pupa.	Pupal rest.
+ 4° to 5°	-----	-----	-----	-----	-----
+ 6°	-----	500	-----	-----	-----
+ 9° to 11°	36	196	-----	-----	-----
+ 11° to 14°	26	152	-----	15	-----
+ 15° to 19°	20	119	3	9	49
+ 18° to 21°	18	84	2½	5½	36
+ 20° to 24°	17	67	2	2½	26
+ 24° to 28°	16	56	½	2	21

\* Each degree of the Centigrade thermometer is equal to 1½° of Fahrenheit; and 0° is at the freezing point of water.

†Judeich and Nitsche, I, 116.

‡E. Regener. Erfahrungen über den Nahrungsverbrauch und über die Lebensweise, Lebensdauer und Verteilung der grossen Kiefernraupe. Leipzig: Emil Baensch's Verlag. 1865.

What combination of different climatic influences in reality causes that one and the same insect either in different years in the same locality, or in different localities in the same year, needs a time different in length for the completion of a generation, could not be determined in advance. Ratzeburg was inclined in this matter to follow the similar relations established by Boussingault as regards the duration of vegetation of plants. According to the views of this French observer each plant needs a definite amount of heat; *i. e.*, the sum of the mean daily temperature of its time of vegetation should be a constant one, while the duration of the time of vegetation may itself vary. It is also theoretically assumed that a plant needs heat amounting to  $2000^{\circ}$  C., so that it can develop in one hundred days, with an average mean temperature of  $20^{\circ}$  C.; also as well in one hundred and eleven with  $18^{\circ}$  C., and in ninety-one days with an average mean temperature of  $22^{\circ}$  C.

Ratzeburg\* applies this to the case of the May beetle. He says:

Interesting and important is, moreover, the behavior of the May beetle. In middle and northern Germany its generation is a quadrennial one, in southern Germany a triennial one. The reason of this plainly lies in the climatic features of those regions. In the south the season opens much earlier and closes later, which must exert some influence on animals of a pliable nature, such as the May beetle, as well as on plants. The grub there has, in three years, a start of at least three months, in comparison with those in the north; also, even in the third summer, its development may be ready, though we should consider that with us in the fourth summer, it is usually in July; it eats no more, and in August pupates. Erichson found that the pupation sometimes occurs even in May; it fails only a little of a three-years' generation. Finally, everything depends, as in plants, on the amount of heat in the soil and air which a genus or species needs for its development. If the May beetle does not find this in the third summer, it requires it in the fourth, and can shorten the time in an especially favorable year, but with us can never complete it in three years.

Should we, for example, add together the mean temperature of Berlin for twelve months it would amount to  $106^{\circ}$  C., and for four years  $4 \times 106^{\circ} = 424^{\circ}$ ; on the other hand Carlsruhe would in three years give  $375^{\circ}$ , and beyond the Alps there is fully  $424^{\circ}$ . Should we also take into account the temperature of the soil, the amount in the south would be still better for the May beetle. In north Germany in humous sandy soil (in the Waldschutten), the thermometer in the hibernation stage of the May beetle in one month, from the end of March to the end of April and beginning of May, rises from  $+6^{\circ}$  to  $+9^{\circ}$  C. How is it now in the south? All other insects which inhabit both the north and south must have a "heat surplus;" but since this lasts only one, but at the most two years, it follows that such results as in the case of the May beetle, which requires so long a time to develop, can not occur there.

Accurate researches on this problem are still very rare. Herr Uhlig in Tharand found by observations on the temperature made three times daily during a generation of *Tomicus typographus*, from May 30 to July 21, a heat-amount of  $145^{\circ}$  C., or divided, a daily amount of  $22.02^{\circ}$ ; during the second generation, from August 4 to October 3, an amount of  $1228.5^{\circ}$ , or divided, a daily amount of  $20.48^{\circ}$  (Thar. Tagebuch, 25 Bd., s. 256).

Ratzeburg's statement should also be noticed. A double brood of *Tomicus typographus* appears if, as is usual in central Germany, the

\*Die Waldverderber und ihre Feinde;  $8^{\circ}$ , p. 360.

mean temperature of the months reaches 13° C. in May, 17° C. in June, 19° C. in July, 17° C. in August, and 14° C. in September.

But it has now long been proved that plant physiology does not accept the simple heat-amount of Boussingault, and we have besides to consider the period of sunlight (duration of light) during which alone the chlorophyll-containing parts are assimilated, as well as the mean temperature reached in the sun—at best measured by an actinometer. However, in animals the transformation of tissue depends much less on the amount of light than in plants, hence simply the total heat-amount can scarcely be sufficient to explain the differences in the animal developmental processes, especially if we only take into account the temperature of the air. It would be much better to take into consideration the temperature of the soil throughout their larval life of insects living in the earth, and in insects living in wood the temperature of the tree, *i. e.*, the portion of the tree concerned. Compare the exact researches of Krutzsch.\* Such researches should determine what is the minimum temperature at which generally an advance in development would be possible. Also the optimum temperature, *i. e.*, the temperature which is most favorable to any process should be noted.

For example, these optima would require to be different for the different developmental stages in the insects, as would the temperature-minima supportable to the same. We also know, through the researches of Semper, † that as in the germination, growth, and flowering of plants, so also in animals; *i. e.*, in our common fresh water snails, the temperature-optima for the different function, *i. e.*, for the ripening of the sexual products and for growth, are different, a thesis which by Semper has been applied to a striking attempt at an explanation of the occurrence of wingless, larval-like, but still sexually developed Orthoptera in southern lands, *i. e.*, the so-called “stick insect” (Judeich and Nitsche).

*Hibernation stage.*—The developmental cycle of two species of insects with similar generations may, under similar climatic relations, produce a very different shape, namely, in the cases where they pass the winter in different stages of development, since the hibernation-stage is always the longest, and hibernation is possible in the egg, as in the larva, pupa, or imago, stage. But under normal relations a given species of insect always hibernates in the same stage, *i. e.*, many moths as pupæ, some butterflies as imagines.

It is not possible, then, to predicate in general for a single order of insects as to what stage they may hibernate in, since species of the same family differ in this respect. Thus, for example, according to an estimate

\*Untersuchungen über die Temperatur der Bäume im Vergleiche zur Luft und Boden-Temperatur. Forstwirthschaftliches Jahrbuch der Akademie Tharand, x, 1854, 214-270.

†Animal life as affected by the natural conditions of existence. The International Scientific Series. New York, 1881.

of Werneburg's\* of the German Macrolepidoptera 3.4 per cent. hibernated as egg, 66.9 per cent. as larvæ, 28.2 per cent. as pupæ, and 1.5 per cent. as imagines, while in considering a single family the result stood entirely different. Thus all the Zygænidæ hibernated as larvæ, most Sphingidæ as pupæ, and of the butterflies 9 per cent. in the egg, 54 per cent. in the larval, 28 per cent. in the pupal, and 9 per cent. in the imaginal state. Thus it appears that insects which, not to take too narrow a limitation of genera, belong to one and the same genus, may hibernate in wholly different stages.

Of many species of insects only the females hibernate after impregnation in autumn, *i. e.*, many gnats and our common paper wasp (*Vespa*), while the honey bees tolerate no drones in their hives, so that only the queen with the workers lives through the winter.

But abnormal meteorological phenomena may so effect such changes that a species of insect may hibernate in a different stage of development from what is customary. Indeed there are cases where an insect may, though rarely, live through the winter in another of the four stages of metamorphosis than the usual one, for it has been observed that the pine *Gastropacha* lives through the second winter as pupa. (*Ratzburg: Die Forstinsekten*, ii., 147, *Anm.*) On the other hand, it is very common for caterpillars, which seek winter quarters when half grown. This they have to do as very young animals. Thus the pine *Gastropacha* hibernates after the first molt, instead of, as usual, after the second.

Insects which have generations requiring several years must naturally hibernate several times. This may occur in the same or in different stages of metamorphosis; thus, for example, the one, two to three years' generation of the May fly remains as a larva in the water, while the May beetle passes three winters as a larva, but the fourth as an imago.†

For the following interesting remarks we are indebted to Judeich and Nitsche's work on Forest Entomology :

*Diseases of trees produced by the attacks of insects.*—Various deformities and alterations of the wood, branches, and leaves result from the attacks of borers and bud and leaf devourers. Before the tree completely heals there is a more or less long period during which the tree assumes an abnormal, morbid appearance. Such appearances in which the disease affects the growth of the wood are: 1. The appearance of unusual new structures, such as leaves, etc., both in form and dimensions. 2. The origin of repaired parts from representative growths or sleeping buds. 3. The diminution of growth.

*The appearance of unusual new growths.*—In general the changed sickly new growths are smaller and more sparse than the normal. A thinner foliage in the year after the damage is generally the result of

\*A. Werneburg. *Der Schmetterling und sein Leben*. 8°. Berlin: 1854.

†The foregoing remarks on insect-generations and hibernation have been translated from Judeich and Nitsche's valuable work on Central European Entomology.

stripping the trees bare. After injury by the nun caterpillar the trees seem to suffer most in the second year following the damage.

The new growth of the fir generally sends out only very short needles, which remain as brush shoots (Fig. 3.) In the pine there arises after defoliation from lateral buds "rosette shoots," *i. e.*, very short, persisting growths bearing dense, short, broad, and serrate (gesägte) single needles (Fig. 4). But on the other hand cases occur, when many buds are destroyed, where the remaining remnant of the entire sap-stream is used and the organs formed out of it, *i. e.*, needles or leaves become unusually large, as for example in the ordinary pine, in which case the leaves bear three needles.



Fig. 3. Lateral twig of a fireaten by nun caterpillars in 1856, which in 1858 only produced "brush needles." After Ratzeburg.



Fig. 4. Rosette shoot on the pine. After Ratzeburg.

Similar relations are observed in the helve oak attacked by *Orchestes*. Generally the first growth seems to grow straight on and resist the injury arising from the laying of the eggs by the female of this leaping weevil, and the injured leaves are crumpled, but such leaves on the *Johannis* growth (*Johannistriebe*) become unusually large and abnormally formed, while those situated on the summit entirely assume their normal shape.

*The origin of repaired parts from representative indefinite growths is very general.*—The clearest example is afforded by pines deprived by *Retinia buoliana* of their terminal shoots. In this case there grows out after a certain time a shoot of the uppermost branch (*Quirles*), which now becomes the terminal shoot, though in growing up there is a crumpling of the stem in the place under consideration.

For the formation of mostly abnormally shaped organs which have been replaced from sleeping buds, the pine affords the best example. From the usually dormant sheathing-buds on the point of origin of the short shoot occurring between every two pine needles, are developed

(in the course of the appearance of needles, and dwarfing the leading shoot) *sheathing shoots*, which, however, usually reach no great age, but are provisionally of much importance to the life of the tree.

The loss of increase in size resulting from disease is twofold. Sometimes the shoots suffer in decrease in length, at others in shrinking in size. The diminution of length is shown after the year succeeding that in which the injury took place; that in the terminal shoot of the branch, and especially the topmost shoot, the needles remain shorter. Not until later do they again assume their normal length. The fir also, whose topmost shoot is here represented (Fig. 5), after injury received in the year 1857 formed only short leading shoots, but in 1861 again formed a strong shoot.



Fig. 5. Terminal shoot of a fir defoliated by the nun-caterpillar in 1857, showing the different lengths of the year's growth. After Ratzeburg.

are smaller and feebler, and this may sometimes last over for many years. (Fig. 6.)

Nördlinger has repeatedly found signs of defoliation by the May beetle for three years on oaks, also on *Carya alba*, in southern Germany, indicated by very small annual rings. The counting of the annual rings to ascertain the age of the tree in the practically so important matter of discovering its rate of growth is rendered unsafe by the formation of double rings, which may result from the sudden leaving-out in summer on young shoots, or by the coalescence of two annual rings in one, and sometimes even by the total omission of a ring. The sharply-defined difference between the spring and autumn growth of wood as denoted by the color, "white and brown wood" of an annual ring, especially in the coniferous woods, enable them to be very easily counted, provided there is no interruption in the growth. In the deciduous trees the two layers of the annual rings are

The diminution of the growth in diameter is especially noticeable in the loss of the foliage or needles, which sometimes occurs in the year of injury, but more decidedly the following year.

After a greater loss of leaves the annual rings

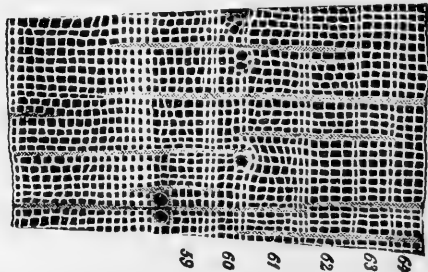


Fig. 6. The last seven rings of pine stem almost wholly defoliated in 1858, but not killed outright. After Ratzeburg.



less sharply distinguished; and it is only in the oaks, ashes, and elms, where the pores are arranged in rings ("ringporen") that the richly vascular spring wood sharply defines each new annual ring from the denser and more compact autumnal layer of the preceding ring.

Injuries in the production of the resin also arise from molds, which effect a transformation of the starch and of the cellulose into turpentine, and thus cause a morbid increase as well as outflow of the resin or pitch; *e. g.*, *Agaricus melleus*, *Accidium pini*, *Peziza Willkommii*. All insects which externally gnaw the bark or the wood of coniferous trees, *e. g.*, bark borers, wood wasps, *Grapholitha pactolana* and *G. coniferana*, *Dioryctria abietella*; different weevils (*Hylobius* and *Pissodes*), produce a more or less strong flow of pitch or resin. But also in the interior of the wood arise abnormal formations, as, for example, the so-called pitch-chains. We understand by these a morbid increase of the pitch canals of conifers into concentric chains which often coalesce; also the pitch canals in the last year's ring are completely omitted.

*Prevention and remedies against forest insects.*—Besides the insecticides for such insects as feed upon the leaves, and the means of applying them to single trees, to groves, or to more or less extensive forest areas, and which will be described farther on by Professor Riley, there are some suggestions which may be made as to the remedies against borers.

In the first place it should be borne in mind that dead stumps and decaying trees or logs left standing near groves or road-side trees, are a continual menace to healthy trees, since they afford an asylum or breeding-place to timber and bark borers. Such objects, large and small, should be cut down or pulled up and burnt. Forests should be kept free from standing dead trees and stumps, or if left standing should have the bark removed. It is well known that lumberers remove the bark of logs to prevent injury to the lumber of "sawyers," or the grubs of timber-beetles.

While in the virgin spruce forest on the eastern shores of Lake Kennebago, Maine, which had never been lumbered, my attention was forcibly called to the necessity of cutting down the dead and dying spruces so as to save the healthy trees. It is of course out of the question to burn such dead timber, but we question whether it would not in the long run pay the owners of lumber lands to send parties in to cut down the trees, remove the bark, and thus prevent the breeding of bark-borers, and hasten the decay of trees infested by timber and bark-borers.

Plantations and forests of limited extent can with comparative ease and slight expense be kept in neat, trim order by judicious thinning and removal of injured or infected branches, the latter being burnt.

*Borers in shade and ornamental trees.*—Our experience in detecting the gashes in the bark of the spruce and fir made by the female *Monohammus*, the parent-beetle of the "sawyer" or borer, and those made in rock-maples by the female beetle of the maple-tree borer, so destructive in parks and streets, has taught us that it is quite practicable during

August to find these gashes and to cut out the small grubs in the bark underneath, at a time when they have not descended deep into the tree. An observant and intelligent gardener could easily prevent further damage from such a cause.

One of the most formidable and deadly borers of the oak, from Maine to California and Texas, is the caterpillar of the Carpenter moth. In Europe a similar borer is dealt with in the following ways, according to different writers quoted by Miss Ormerod in her "Manual of Injurious Insects." A wire thrust into the "mine" or hole may destroy them. Paraffine injected by a sharp-nozzled syringe with as much force as possible into the holes where the caterpillars are working is a good remedy, also any oily or soapy mixture (kerosene injections might injure the tree more than the borer). The flames of sulphur blown into the hole might be of use. "Where a tree is much infested, it is the best plan to cut it down, split it, and destroy the caterpillars within. As many as sixty or more caterpillars may be taken from one tree, and when in this state it will never thoroughly recover, and it becomes a center to attract further attack, as well as one to spread infection."

As preventive measures, to prevent oviposition, the lower part of the trunk should be washed with whale-oil soap of the consistency of thick paint. This should be done at or about the time the moth lays her eggs, viz, as early as April and May in Texas, and in June and July in the Northern States.

These suggestions will also apply to the Sesiau borers of the maple, ash, etc.

*Prevention and remedies against Timber-beetles and Bark-borers.*—The family of bark-borers (*Scolytidæ*) include those which live in the bark and those which descend into the wood, the latter often being called timber-beetles. We have given in this work some of the known facts regarding their habits, which are very curious. Eichhoff's excellent work in German on European bark-beetles is replete with fresh observations on these beetles. We may here draw attention to what Eichhoff says concerning some causes of the undue increase of these insects, and their sudden appearance in places not before frequented by them.

The chief factors in the growth of bark-beetles are good weather and sufficient nourishment. An uninterrupted dry, and hence hot, summer checks the growth of the larva, and retards the speedy development and more often prevents a repetition of another brood, than an uninterrupted wet and cold spring and summer. Hence, on account of great heat and drought many trees survive which would otherwise be injured by the later brood of bark-beetles. The most favorable conditions for the increase of bark-beetles are doubtless a warm early spring and a warm summer, with frequent rains and a long, mild autumn.

Other circumstances, says Eichhoff, favorable to the increase of bark-beetles, are strong winds, snow, frosts, forest fires, the devastation wrought by caterpillars, whereby the trees are more or less decorti-

cated in places and otherwise wounded, so that the beetles can gnaw into the wood or inner bark, lay their eggs, and thus finally form brood-galleries.

Eichhoff asks the pertinent question: "How do great numbers of bark-beetles pass into regions where perhaps before they were scarcely known by name? For example, at the end of a period of fifty years, all at once *Tomicus curvidens* appeared in the Botanic Garden of the University of Vienna, and were very destructive to different exotic cedars, larches, etc., afterwards attacking white firs, which contained numbers of the beetles.

The bark-borers, especially *Tomicus typographus*, belong to those insects which sometimes produce extensive devastations by immigration from without. According to a German writer they doubtless migrate for short distances, since not seldom there result local destruction of groups of firs when previously no bark-borers were to be seen. It is also certain that forests previously entirely free from bark-beetles become infested by bark-beetles bred in wood and lumber yards. It is difficult and questionable how far such an immigration may extend. An example of an extensive emigration of *Tomicus typographus* is afforded by H. Tiedemann in the province of Nishny-Novgorod.

In the midst of an imperial forest of about 2,500 *ha* lying in the district Arsamass, and composed almost exclusively of hard-wood trees, occur two fir-growths of 50, perhaps 60, *ha* in extent. In both there was no windfalls, no burnt areas, but a good close growth in which no bark-borers had appeared. Suddenly in the year 1883 the bark-borers were so numerous that 2,000 fir trunks at once fell, and had to have the bark stripped off and burnt. The appearance of the bark-beetles is in this case only to be explained by their flying into this area. The nearest fir-growths are from 15 to 20 kilometers distant, and those of sufficient size to afford time for the infection of the fir-growths in question, about 50 kilometers distant.

Perhaps the best method of preventing or stopping the work of bark-beetles is that of a Frenchman, M. Robert, given in the Gardener's Chronicle and quoted by Miss Ormerod:

The best remedy appears to be that adopted with great success in France by M. Robert, after careful observation of the circumstances which stopped the operations of the female beetle when gnawing her gallery for egg-laying, or which disagreed with or destroyed the maggots, and is based in part on similar observations of the effect of flow of sap to those noticed in England by Dr. Chapman.

It appeared on examination that the grubs died if they were not well protected from the drying action of the air; on the other hand, if there was a very large amount of sap in the vegetable tissues that they fed on, this also killed them; and it was observed that when the female was boring through the bark, if a flow of sap took place she abandoned the spot and went elsewhere. It was also noticed that the attack (that is, the boring of the galleries which separates much of the bark from the wood) is usually under thick old bark, such as that of old elm trunks rather than under the thinner bark of the branches. Working on these observations, M. Robert had strips of about two inches wide cut out of the bark from the large boughs down the trunk to the ground, and it was found that where the young bark pressed forward to heal the wound and a vigorous flow of sap took place that many of the maggots near it were killed, the bark which had not been entirely undermined was consolidated, and the health of the tree was improved.

Working on from this, M. Robert tried the more extended treatment of paring off the outer bark, a practice much used in Normandy and sometimes in England for restoring vigor of growth to bark-bound apple trees, and noted by Andrew Knight as giving a great stimulus to vegetation. M. Robert had the whole of the rough outer bark removed from the elm (this may be done conveniently by a scraping-knife shaped like a spoke-shave). This operation caused a great flow of sap in the inner lining of the bark (the liber), and the grubs of the *Scolytus* beetle were found in almost all cases to perish shortly after. Whether this occurred from the altered sap disagreeing with them, or from the greater amount of moisture around them, or from the maggots being more exposed to atmospheric changes, or any other cause, was not ascertained, but the trees that were experimented on were cleared of the maggots. The treatment was applied on a large scale, and the barked trees were found, after examination by the Commissioners of the Institute at two different periods, to be in more vigorous health than the neighboring ones of which the bark was untouched. More than two thousand elms were thus treated.

This account is abridged from the leading article in the "Gardener's Chronicle and Agricultural Gazette," for April 29, 1848, and the method is well worth trying in our public and private parks. It is not expensive; the principle on which it acts as regards vegetable growth is a well-known one, and as regards insect health it is also well known that a sudden flow of the sap that they feed on, or a sudden increase of moisture around them, is very productive of unhealthiness or of fatal diarrhœa to vegetable feeding grubs.

A somewhat similar process was tried by the Botanic Society, in 1842, on trees infested by the *Scolytus destructor* in the belt of elms encircling their garden in the Regents' Park, London. "It consists in divesting the tree of its rough outer bark, being careful at the infested parts to go deep enough to destroy the young larvæ, and dressing with the usual mixture of lime and cow-dung." This operation was found very successful, and details with illustrations were given in a paper read in 1848 before the Botanic Society.

Various applications have been recommended, such as brushing the bark of infested trees with coal-tar or with whitewash, in order to keep off the beetle attack. Anything of this kind that would make the surface unpleasant to the beetle would certainly be of use so long as it was not of a nature to hurt the tree, and if previously the very rugged bark was partially smoothed it would make the application of whatever mixture might be chosen easier and more thorough.

Anything that would catch the beetles, either going into or out from the bark, like coal-tar, would be particularly useful, and probably strong-smelling and greasy mixtures, such as fish-oil soft soap, would do much good.

Washing down the trunks of attacked trees has not been suggested, but, looking at the dislike of the female beetle to moisture in her burrow, it would be worth while, in the case of single trees which it was an object to preserve, to drench the bark daily from a garden-engine for a short time when the beetles were seen (or known by the wood-dust thrown out) to be at work forming burrows for egg-laying.

The possibility of carrying out the important point of clearing away or treating infested standing trees depends, of course, on local circumstances; but, whatever care is exercised in other ways, it is very unlikely that much good will be done in lessening attack so long as the inexcusable practice continues of leaving the felled trunks of infested elms lying, *with their bark still on*, when containing myriads of these maggots, which are all getting ready shortly to change to perfect beetles, and to fly to the nearest growing elms.

Such neglected trunks may be seen in our parks and rural wood-yards all over the country, where, without difficulty, the hand may be run under the bark so as to detach feet and yards in length from the trunk all swarming with white *Scolytus* galleries in their narrow galleries.

This bark, with its contents, ought never to be permitted to remain. Where it is loose it may be cleared of many of the maggots by stripping it off and letting the

poultry have access to it; or, if still partly adhering, it may be ripped from the wood by barking tools and burnt; but it is a tangible and serious cause of injury, and if our landed proprietors were fully aware of the mischief thus caused to their own trees and those of the neighborhood they would quickly get rid of it.

#### INSECTICIDES AND MEANS OF APPLYING THEM TO SHADE AND FOREST TREES.\*

This subject may be divided into two parts, viz, (1) a discussion of insecticides and (2) a discussion of insecticide apparatus.

(1) **INSECTICIDES.**—Remedial measures against forest-tree insects are not different from those employed against the insect enemies of fruit-trees or farm and garden crops. The same species are frequently the culprits in both cases; and, in general, insects of the same orders and families, having similar habits and requiring similar treatment, attack wild-growing, woody plants and the cultivated sorts.

For convenience of treatment, the first part may be considered under the following heads: Insecticides which act through the food; insecticides which act by contact; fumigants and gases.

**INSECTICIDES WHICH ACT THROUGH THE FOOD.**—These insecticides are available against all mandibulate insects that feed externally on the leaves, such as the larvæ of Lepidoptera, larvæ and adults of leaf-feeding beetles, and saw-fly larvæ. Gall-insects, leaf-miners, and insects which burrow beneath the bark or in the wood cannot be controlled by these means.

It would be possible to enumerate under this heading a large number of substances depending for their effects on arsenic, strychnine, or other poisons, but I prefer to limit the discussion to the consideration of two substances which are now commonly used to the exclusion of nearly all others.

*Paris green and London purple.*—The arsenites of copper and calcium, Paris green and London purple, are so well known as not to need particular description here. The safety and efficiency with which they can be used and their slight cost fully satisfy all the demands of practical work.

As containing records of a general nature, together with full instructions for the use of these poisons, I can not do better than quote from Bulletin No. 10 of the division of entomology,† the conclusions being based on experiments under my direction, especially by the late Dr. W. S. Barnard.

The quotation refers particularly to work against the imported Elm leaf-beetle (*Galeruca xanthomelæna*) and deals with the treatment of elm trees only, but the results obtained may apply to other insects infesting various shade and forest trees. The recommendation given

\*Prepared, at the author's request, by Professor Riley.

†Our Shade Trees and Their Insect Defoliators, by C. V. Riley, Entomologist, Washington, 1887. Second revised edition, 1888.

will need to be modified to correspond with the varying conditions in habits and life-history of any particular species, as found detailed in the following pages of Dr. Packard's report:

*Effects of Arsenical Poisons on Insect and Plant.*—Species of elms are somewhat differently affected by the poison. When treated alike there is always manifest some difference in the susceptibility of different elms to the corrosive effects of the poison. Even individuals of the same species or variety are differently impaired. As a rule, those which suit the insect best are injured most by the poison, and those which resist the insect most withstand the poison best. The latter have coarser foliage with a darker green color and more vigorous general growth; the former have more delicate foliage, lighter in color and weight, apparently less succulent.

Certain elms of the species *U. campestris* and other species which were over-poisoned, and shed most of their leaves in consequence in the last of June, 1883, sent out a profuse new growth of leaves and twigs. The foliage fell gradually for three weeks, and this was somewhat promoted by the succeeding rains.

The larvæ move from place to place so seldom that, if the leaves are imperfectly poisoned from the mixture being weakly diluted or from its application only in large, scattered drops, which are much avoided by the larvæ, they are not killed off thoroughly for several days, and in all cases it requires considerable time to attain the full effect of the poison. This result appears on the plant and on the insect. After each rain the poison takes a new effect upon the plant and the pest, which indicates that the poison is absorbed more or is more active when wet, and that it acts by dehydrating thereafter. Where the tree is too strongly poisoned, each rain causes a new lot of leaves to become discolored by the poison or to fall. On some of the trees the discoloration appears in brown, dead blotches on the foliage, chiefly about the gnawed places and margins, while in other instances many of the leaves turn yellow, and others fall without change of color. The latter may not all drop from the effects of poison, but the coloration referred to is without doubt generally from the caustic action. The poison not only produces the local effects from contact action on the parts touched by it, but following this there appears a more general effect, manifest in that all the foliage appears to lose, to some extent, its freshness and vitality. This secondary influence is probably from poisoning of the sap in a moderate degree. When this is once observable, no leaf-eater thrives upon the foliage. Slight over-poisoning seems to have a tonic or invigorating effect on the tree.

*Preventive Effects of the Poison.*—In this grove the elms that were poisoned in 1882 were attacked in the spring of 1883 less severely than were those which were not poisoned the previous year. This would seem to imply that the insects deposit mostly on the trees nearest to where they develop, and are only partially migratory before ovipositing. The attack afterward became increased, probably by immigration and the new generation, so that later in the season the trees were mostly infested to the usual extent.

In the region of Washington a preventive application of poison should be made before the last of May or first of June, when the eggs are being deposited and before they hatch. This will prevent the worms from ever getting a start. By the preventive method the tree escapes two kinds of injury: first, that directly from the eating by the insect; second, that which follows indirectly from the deleterious effects of the poison on the plant, for its caustic effect is much greater where the leaves have been so gnawed that the poison comes in contact with the sap.

*Treatment with London Purple.*—Already early in June the insect appears plentiful. On June 7, 1882, it was at work on all the trees, and its clusters of eggs were numerous beneath the leaves. Some of the trees had half of the leaves considerably gnawed and perforated by larvæ of all sizes, and by the adults. At this date fifteen trees, constituting the south part of the grove, were treated.

*Preparation of the Poison.*—London purple (one-half pound), flour (3 quarts), and water (barrel, 40 gallons) were mixed as follows: A large galvanized iron funnel of

thirteen quarts capacity, and having a cross-septum of fine wire gauze, such as is used for sieves, also having vertical sides, and a rim to keep it from rocking on the barrel, was used. About three quarts of cheap flour were placed in the funnel and washed through the wire gauze by water poured in. The flour in passing through is finely divided, and will diffuse in the water without appearing in lumps. The flour is a suitable medium to make the poison adhesive. The London purple is then placed upon the gauze and washed in by the remainder of the water until the barrel is filled. In other tests the flour was mixed dry with the poison powder, and both were afterward washed through together with good results. It is thought that by mixing in this way less flour will suffice. Three-eighths of a pound of London purple to one barrel of water may be taken as a suitable percentage. Three-eighths of an ounce may be used as an equivalent in one bucketful of water. The amount of this poison was reduced to one-fourth of a pound to the barrel with good effect, but this seems to be the minimum quantity, and to be of value it must be applied in favorable weather and with unusual thoroughness. With one-half or three-fourths of a pound to the barrel, about the maximum strength allowable is attained, and this should be applied only as an extremely fine mist, without drenching the foliage.

*Effects of the Mixture.*—The flour seems to keep the poison from taking effect on the leaf, preventing to some extent the corrosive injury which otherwise obtains when the poison is coarsely sprinkled or too strong. It also renders the poison more permanent. On the leaves, especially on the under surfaces, the London purple and flour can be seen for several weeks after it has been applied, and the insect is not only destroyed, but is prevented from reappearing, at least for a long period. By poisoning again, a few weeks later, the insect is deterred with greater certainty for the entire season. By being careful to administer the poison before the insect has worked, and, above all, to diffuse the spray finely, but not in large drops, no harm worth mentioning will accrue to the plant from the proportion of poison recommended. The new growth, that developed after the first poisoning, was protected by one-fourth of a pound to the barrel in 1882. From midsummer until autumn the unpoisoned half of the grove remained denuded of foliage, while the poisoned half retained its verdure. The little damage then appearing in the protected part was mostly done before the first treatment. Eggs were laid abundantly throughout the season. Many of these seemed unhealthy and failed to develop, probably because they were poisoned. Many hatched, but the young larvæ soon died. The eggs were seldom deposited on the young leaves that were appearing after the poison was applied, but were attached to the developed leaves, and here the larvæ generally got the poison to prevent their attack upon the aftergrowth. Still the young leaves became perforated to some extent. The adults, which fly from tree to tree, appeared plentifully without much interruption throughout the season, and often several could be seen feeding on each tree. Possibly many of these may have become poisoned before depositing the eggs.

The efficiency of London purple being established, it will generally be preferred to other arsenicals, because of its cheapness, better diffusibility, visibility on the foliage, etc. As the effects of the poisons commonly do not appear decidedly for two or three days after their administration, the importance of the preventive method of poisoning in advance can not be too strongly urged. As the effect is slow in appearing, impatient parties will be apt to repositon on the second or third day, and thus put on enough to hurt the plant when the effect does come. Much depends on dryness or wetness of the weather; but good effects may be expected by the third or fourth day.

London purple seems to injure the plant less than Paris green.

*Treatment with Paris green.*—In 1883 the Paris green was first applied on the 29th of May, at which date the eggs were extremely abundant and hatching rapidly on the leaves. Paris green, flour, and water were mixed by the means previously employed with London purple and already described. The mixture was applied to the north part of the same grove of elms. Thus far experience shows that the Paris green is

effective against the insect, but that this poison injures the plant more than does the London purple.

Three-fourths of a pound of Paris green to a barrel (36 or 40 gallons) of water, with 3 quarts of flour, may be regarded as a poison mixture of medium or average strength for treating elms against these beetles, and the indications thus far are that the amount of Paris green should not be increased above one pound or be diminished much below one-half a pound in this mixture. To a bucketful of water three-fourths of an ounce of Paris green may be used. The action of this poison is slow but severe, and varies much with the weather. Thus far the results of tests have been varied so much by the weather and different modes of preparation and application that they will be repeated. When used strong enough to cauterize the leaves the poisonous action upon the plant may be observed to continue for several weeks.

The species of *Ulmus* are quite susceptible to the effects of poison, perhaps as much so as any common species of forest tree. But little can be added to the above quotation, as there are few experiments recorded concerning work of this kind on other forest trees. With fruit trees and vines there is a large experience, and the results indicate that either of these arsenicals can be safely used on the most tender plants in proportion of 1 pound to 100 gallons of water, if properly atomized. Strong, hardy plants readily stand a strength of 1 pound to 50 gallons of water, if applied with proper care. It is safe to conclude that between these two limits a strength suitable for all plants may be obtained.

A thoroughly atomized weak mixture will, under favorable conditions, prove as efficient as the stronger ones; but in wet, showery weather weak applications are more liable to be washed off.

Properly atomizing the liquid is of the greatest importance, for only by this means can all the foliage be reached. The even distribution thus obtained enables the leaves to retain a greater amount of the poison with less injury than when sprayed in coarse drops.

**INSECTICIDES WHICH ACT BY CONTACT.**—This class of remedies apply principally to non-masticating insects, *i. e.*, those which take their food through a sucking-tube or proboscis, such as the plant-bugs, aphids, and scale-insects. They may, however, often be successfully applied to soft-bodied mandibulate insects, in lieu of the poisonous mixtures.

There are a great variety of substances, such as alkaline washes and powders, and preparations of oils, and particularly the products of petroleum, which have been successfully used on insects affecting roots, trunks, branches, and foliage of trees. The experimental data concerning them have been mostly obtained from cultivated fruit trees and vines, but they will prove equally available against the similar enemies of forest trees.

**Wood Ashes and Lime.**—Of alkaline powders, wood ashes and slaked lime are commonly used either pure or in mixtures around the bases of trees or interred in the earth among the roots of plants to destroy root aphids or other insects affecting the roots. No definite instructions concerning their use can be given, as both substances vary as to strength,



and the conditions of application also vary greatly. Unleached wood ashes should not be applied too freely in contact with the body of the tree or the roots, since water leaching through them may contain potash enough to injure the plant. Lime in any reasonable quantity could hardly cause injury. The application of either of these is generally beneficial and tends to destroy and repel insects from the base and roots of trees. The ashes act beneficially as a fertilizer.

*Coal Ashes and coal Dust.*—Coal ashes and coal dust have been used for this purpose, but their effects could only be mechanical, and, while doubtless of value to the plant as a mulching, could have but little effect on insects. The beneficial effects of either of these used dusted on the plant are doubtful, except in cases of soft-bodied slugs (saw-fly larvæ), where their action is generally good.

*Pyrethrum, Hellebore, Sulphur.*—These well known insecticides may be used in powdered form or may be mixed with water and applied in a spray. While they can not be recommended for general forest work, cases will frequently arise warranting their use in a limited way against aphids and other soft-bodied insects. Hellebore is of especial value against saw-fly larvæ. Sulphur is a valuable agent against the red spider (*Tetranychus telarius*) and may be used alone or in connection with emulsion of kerosene.

*Alkaline Washes: potash Lye and soda Lye.*—Alkaline washes are solutions of crude soda or potash, or soap preparations of these substances. Concentrated soda or potash lye can be purchased at the stores, and are often used as washes for aphids and coccids with considerable success. Of these the potash lye is to be preferred, as its action on the tree is not so harmful as the soda lye. The best possible source of a caustic wash is the potash lye leached from wood ashes. Crude lye washes should be used with caution, since when too strong it injures both branches and foliage. Definite statements as to the strength to be used can not be made. The different brands of concentrated lye vary much in composition, so that it will always be advisable to make test applications before general work is attempted. In the preparation of washes, one can (1 pound) of lye is dissolved in from 3 to 5 gallons of water; the stronger solution is very injurious to tender plants, and even the weaker one is entirely too harsh for a safe wash; yet, if diluted much more, its effect on the insect will be impaired. The same quantity of lye used in the preparation of a soap will give better results, and its use will not then be attended with like danger to the plant.

*Alkaline Washes: Soaps.*—Soap preparations are made from either of the above lyes with grease or oils of any kind and in my experience are much preferable to the crude lyes.

Any soft or jelly soap makes a good wash for Aphides, and for this purpose need not be strong; for Coccids the strength should be greater. The preparation known as "whale-oil" soap has a more or less stand-

ard strength and has long been used as an insecticide wash. It is made from various fish-oils and fish-oil residue with caustic soda. Better success attends the use of jelly soaps made directly from fish-oil and concentrated lye, with water, using about three gallons of water, three pints of fish-oil, and one can of lye. Various preparations of this nature can easily be made. Coarse grease does not make so good a soap as oils.

The whale-oil soap sold in the stores is used in solutions of one pound in two to five gallons of water, experiment being necessary to determine what strength will be efficient. The jelly-soap made as mentioned above has been successfully used on Aphides, *when fresh*, in strength of 1 pound to 8 gallons of water. For most work, however, it would need to be stronger.

*Petroleum Products: Kerosene, Naphtha, etc.*—Among the washes of an insecticide nature which kill by contact there is probably nothing equal to the preparations from petroleum. Of these it is only necessary to notice those made from kerosene, as experience has fully demonstrated the value of this product for insecticide work. In most instances either the low or high grade can be used with equally good effect. Kerosene, naphtha and some of the lighter products of petroleum have been used pure.

Naphtha and the lighter products of petroleum can be used in this manner with safety to most plants, but the destructive effect on the insects is by no means satisfactory. The use of kerosene pure is, however, attended with danger and should never be undertaken except in a small way and with the utmost care. Finely *atomized*, I have employed it with some success, especially on oranges and certain conifers in years gone by, before the emulsions were discovered.

*Kerosene Emulsions.*—The ease and practicability of emulsifying and diluting kerosene to any desired strength have been so fully demonstrated in the course of the work of the division of entomology under my direction that there is no longer need of attempting its use pure.

The methods of emulsification have been so fully set forth elsewhere that it is unnecessary to undertake their discussion here more than in the nature of general instructions.

An emulsion, if properly made, always contains a greater per cent. of kerosene than of the other ingredients. This per cent. may vary from 60 per cent. to 90 per cent., but experiment has shown that 66 per cent kerosene will give the most satisfactory results.

The formula for the preparation of kerosene emulsion ordinarily recommended by me is the one originated by my former agent, Mr. H. G. Hubbard, in his work against orange insects. It is as follows:

Kerosene .....	2 gallons	= 67 per cent.
Common soap, or whale-oil soap.....	$\frac{1}{2}$ pound	} = 33 per cent.
Water .....	1 gallon	

Dissolve the soap in the water by heating and add the solution, boiling hot, to the kerosene and churn the mixture by means of a

force-pump and spray-nozzle for five minutes. The emulsion, if perfect, forms a cream which thickens on cooling and should adhere without oiliness to the surface of glass. Dilute, before using, one part of the emulsion with nine parts of cold water. The above formula makes 3 gallons of emulsion, and when diluted gives 30 gallons of wash.

*Resin Washes.*—Various compounds of resin and emulsions of resin with kerosene are now being extensively used in California against scale-insects and other enemies of the orange tree. Resin compounds were first used as an insecticide by one of my agents, Mr. Albert Koebele, and his experiments with this substance are given in full in my annual reports as United States Entomologist for 1886 and 1887, and additional experiments by Mr. Coquillett are given in the report for 1888.

Mr. Koebele had good success with the resin compound prepared as follows: Dissolve 3 pounds of sal-soda and 4 pounds of resin in 3 pints of water above fire; when properly dissolved, add water slowly, while boiling, to make 36 pints of compound. A very strong solution of this was used on pear trees without injury to the foliage, the solution consisting of 3 pints of the compound to 4 of water. Numerous successful experiments were made with one part of the compound and 8 parts of water, and this strength for most purposes will be sufficient.

Mr. Coquillett has found the following to be an excellent formula for the preparation of this compound:\*

Caustic soda .....	pound..	1
Resin .....	pounds..	8
Water to make .....	gallons..	32

Dissolve by boiling the caustic soda in a gallon of water; add the resin to one half the soda solution and dissolve it by boiling; add the remainder of the soda solution and boil over a hot fire, stirring constantly. When sufficiently cooked it will assimilate with water like milk, which it much resembles. Add water and strain through a fine sieve.

An emulsion of kerosene with resin compound was satisfactorily accomplished by taking equal parts of both substances and working them together for two minutes with a pump. This emulsion is not so stable as the emulsion with soap, but is eminently effective against scale-insects and Aphides. At my suggestion the addition of arsenic in the proportion of 1 pound to from 75 to 300 gallons of the resin, or resin and kerosene wash, was made, and this addition was found to greatly increase the efficiency of these insecticides.

The value of these insecticides for the protection of shade and ornamental trees, which, where scale-insects abound, are as liable to attack and injury as the various fruit trees, need not here be emphasized.

*FUMIGANTS—GASES.*—The destruction of hot-house pests by fumigation with sulphur, tobacco, or other noxious substances has long been practiced. The application of such methods to trees on a large scale is, however, of recent origin.

The experiments of the last few years conducted by my California agent, Mr. D. W. Coquillett, relating to the use of poisonous fumes or gases against the scale-insects of citrous trees have been attended with

\*See Rep. of the U. S. Entomologist for 1888, p. 130.

such good results that the value of this comparatively new method of combating out-of-door insects is now well established. It is not to be supposed that work of this kind can be carried on in the case of forest trees, except on a very limited scale, to protect cherished trees in lawns or parks. This treatment is also effective against Aphides and leaf-mites—and indeed is calculated to destroy any insects whatever.

*Hydrocyanic acid Gas.*—Of the several gases experimented with by Mr. Coquillett, of which full accounts are given in my annual reports as Entomologist for 1887 and 1888, the one named has given much the best results.

A number of methods of generating this gas have been devised, of which the most satisfactory is now known as the "dry-gas process."

The necessity of drying the gas was very evident from the first, for it was found that the injury to foliage was very serious when the gases were charged with any considerable amount of aqueous vapor. In the dry-gas process the cyanide is dissolved by boiling in water for a few minutes, using 1 gallon of water for each 5 pounds of cyanide. To generate the gas, sulphuric acid is caused to flow upon the cyanide solution in a fine stream, causing the gas to be rapidly given off in the form of a whitish fog. The moisture is taken up by passing the gas through sulphuric acid, which by reason of the water taken up becomes diluted, but may still be employed to generate fresh quantities of gas.

The gas is confined to the trees under treatment by means of a suitable canvas tent or fumigator, of which a number of styles have been patented. They are constructed so as to be lowered over the tree from above or to inclose it from the sides. Full details for the construction of these tents, together with figures, are given in the reports cited above, to which the reader is referred, also for a detailed account of the use of various gases.

**INSECTICIDE APPARATUS.**—The application of insecticides to fruit or forest trees may be successfully accomplished by the use of the same devices employed in the case of low-growing plants, except that more force will be required as a rule, and hence larger and stronger machinery. The treatment of young trees or application to the lower part of the trunk or to the base or roots of larger ones may easily be effected by hand, but in the case of the branches and foliage of large trees other means must be employed.

As has been already indicated, the principal insecticides are now used in the liquid form, and particularly in the case of work against the insect enemies of forest trees will this method prove the only practicable one. The use of insecticides in the form of powders will occasionally be desirable, however, and hence the treatment of the second part of the subject may be discussed under (1) devices for applying powders and (2) devices for applying liquids.

**DEVICES FOR APPLYING POWDERS.**—*Powder Blowers.*—The application of powders to trees may be successfully accomplished by the use of long-discharge-tube power-bellows.

*The Woodason Bellows.*—With one of the double-cone bellows manufactured by Thomas Woodason, Philadelphia, Pa., or other bellows of similar pattern, it is possible to reach branches eight or ten feet high quite readily, and by mounting into the tree, or by means of a ladder, quite effective work can be done on trees of moderate size.

*The Leggett Brothers' orchard Gun.*—Quite recently the Leggett Brothers, of New York City, have invented what they call an "orchard gun," a machine for the application of powders to foliage beyond the reach of the ordinary hand-bellows.

This device has been tested in the work of the Entomological Division and promises for certain kinds of work to be a very useful implement.

It is constructed of tin tubing  $1\frac{1}{2}$  inches in diameter made in sections so as to be easily adjusted to any length desired up to 16 feet. On the second section from the base of the device is arranged a small fan  $4\frac{1}{2}$  inches in diameter propelled by a crank and cog-gearing of such relative diameters that one revolution of the crank gives thirty of the fan. This delivers a strong blast into the distal portion of the tube or gun. Just above the fan is arranged on the upper side of the tube a can 8 inches long and 4 inches in diameter, from which the powder fed is into the tube when the crank is turned by the following contrivance:

Between the can and tube is a flat perforated surface its entire length, and along this surface plays a set of sliding arms attached to a piston-rod which is thrust forward and backward with each revolution of the crank. This sifts into the tube just the amount of powder necessary to supply a constant but extremely diffuse blast. The shortest working length of the gun is 5 feet, and in this length it serves for all ordinary work of applying powder. The weight of the implement when full length is 7 pounds. The length could be easily increased without impairing the efficiency of the implement, except that it would become too heavy and unwieldy.

**DEVICES FOR APPLYING LIQUIDS.**—For the application of liquids to trees the requisites are a good force-pump and a suitable nozzle, and of both of them there is no scarcity of styles manufactured in this country. In fact, the abundance of pumps, nozzles, and spraying devices tends to confuse the would-be purchaser and makes it the more necessary that the characteristics of a good apparatus should be carefully pointed out.

*The Pump.*—While secondary in importance to the nozzle, a suitable force-pump is very essential to successful work. As I have previously stated, the nature of the work under discussion precludes the use of any but the more powerful machines, except for comparatively limited operations, where any of the smaller hand pumps, aquapults, hydro-nettes, or syringes may be used.

In the case of tall trees in parks, such as elms, which frequently attain a height of 40 or 50 feet or more, I have recommended the use of fire engines, with which the liquid might be thrown to a considerable distance and, by the force of the discharge, caused to break up into an efficient spray.

The same end may be more easily attained, perhaps, by using, in connection with a good barrel or tank force-pump, long hose with suitable supports, so that the spray may be brought to bear on the upper portion of the tree. Devices for this purpose will be described later on.

Several forms of pumps are being manufactured in this country with which satisfactory work may be done, and in the list of manufacturers of insecticide apparatus appended to this article are given a number of addresses of reliable firms whose pumps I have used and can recommend.

I will content myself here with describing somewhat fully a force-pump which, in the work of the United States Entomological Commission and of the Division of Entomology, has proved itself well adapted to the purposes desired.

*The double Cylinder brass Pump.*—The special recommendation of this pump is the more freely given from the fact that at present no one holds a patent on it and various modifications embracing the essential features are largely manufactured in different parts of the country. Attention was directed to the advantages of this pump in the work of the commission, and it is illustrated in section and also in operation at plate XLVI of the fourth report. The pump, fitted in a barrel with stirrer attachment, there illustrated, was specially constructed by Dr. Barnard, and has been several times mentioned and illustrated in other official reports.

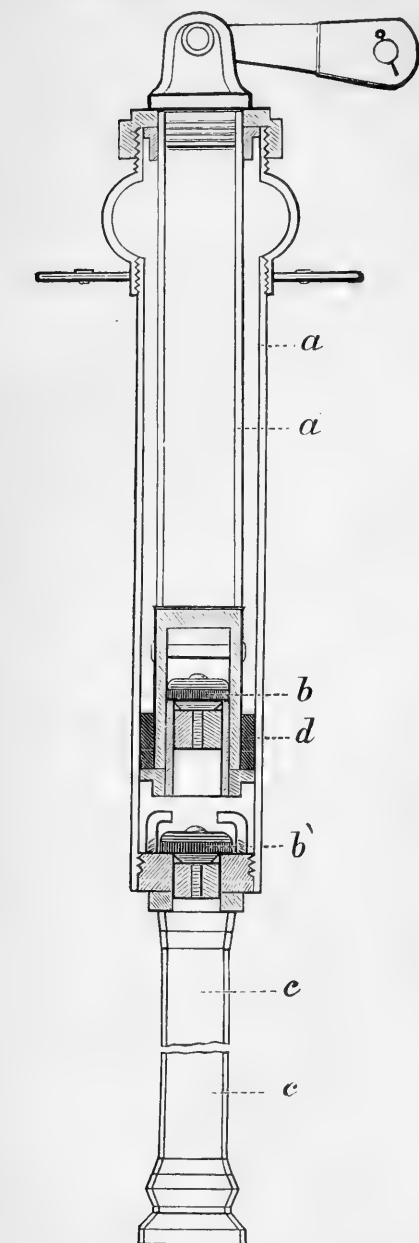


FIG. 7.—Double cylinder brass pump.

The appended illustration (Fig. 7) is a sectional view of a similar pump now in use by the Division.

The essential features of this pump are an outer cylinder *a* and an inner cylinder *a'*, which may be called the piston cylinder. This inner cylinder is provided with a valve, *b*, similar to the valve in the outer cyl-

inder  $b^1$  and above the valve  $b$  the inner cylinder is closed as shown in the cut. Thus it represents a displacement cylinder and its capacity bears such a relation to the outer cylinder that on the downward stroke it displaces a body of water equal to that taken up by the upward stroke of the piston, thus producing a constant pressure in a simple single-barreled pump.

The packing  $d$  is held in place by a metal follower and fits snugly to the inner surface of the outer cylinder. The pipe,  $c$ , is of rubber hose and made of any length desired to suit the depth of cask or tank and with a fine wire strainer on the bottom. The head of the pump is of cast iron and bulged to allow room for a considerable head of water; iron flanges extend out from its lower part and furnish support by which it is bolted to the tank. All of the working parts are brass. The packing burr and follower around the upper end of the piston cylinder are the same style as ordinarily used with steam machinery so as to withstand any reasonable pressure. The head to which is attached the compensating bar screws into the top of the piston cylinder. The outlet is tapped through the bulged cast-iron head, and the pressure is much better if a good-sized air chamber is attached to the discharge pipe just outside of the pump head.

The pump from which Fig. 7 was made has two discharge pipes, and one man easily supplies pressure for two ordinary streams of spray.



Fig. 8.—Single-discharge pump.

Fig. 8 shows a similar pump entire, fitted with a single discharge pipe.

This style of pump is especially convenient from the fact that it can readily be bolted on to a tank of almost any shape or dimensions.

The fulcrum post is not cast with the flange-plate, but bolts to it.

*The stirrer Pump.*—A barrel-tank, with pump similar to the one just described, attached, as used in the work of the commission in the cotton-fields, has already been referred to and is figured in the fourth report.

*Hose and Bamboo extension Rod.*—The hose commonly used on spray apparatus is half-inch in internal diameter, or even larger. This size is entirely unnecessary and entails extra labor upon the operator; it is, moreover, quite difficult to get a small extension-rod of any length sufficiently strong to carry such a hose. In the work of the Division of Entomology I have found that a good quality of quarter-inch cloth insertion rubber tubing is sufficiently strong for all ordinary work. No spray-nozzle used by hand power will require a stronger stream than this will carry. In some work it is convenient and necessary to have as much as 30 feet of discharge-pipe, and where this small tubing is used it can readily be handled.

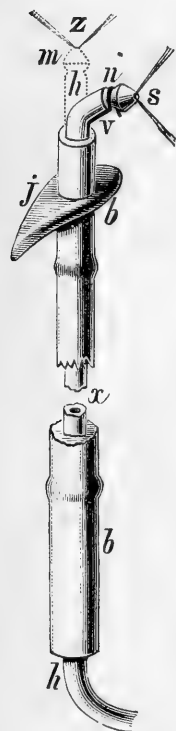


FIG. 9.—Parts of hose pole device for spraying trees: bamboo pole, *b b*; drip washer, *j*; hose *h x*; side hook, *v*; eddy chamber nozzle, *n m*; spray, *z s*.

For elevating the nozzle among the branches, a bamboo rod with the septa burned out so that the rubber tubing may be passed through, and made in sections to be adjusted to the desired length, is the most useful contrivance. If this is large enough to admit the tube to pass up the center, and is provided with a clamp at the top to hold the nozzle vertical or in any direction desired, it is superior to any other device which I have ever used. The smaller southern cane, so commonly used for fishing tackle, makes a very good supporting rod, but in such case the discharge-pipe must be fastened to the outside by means of suitable spring clasps.

FIG. 9 shows a section of an extension pole of the sort first mentioned above. A special feature of this pole is the washer *j*, which prevents the drip from trickling down the pole upon the operator. It is cut out of a heavy piece of sole leather and fitted snugly over the rod a few inches below the nozzle.

By means of this supporting pole, trees below 20 feet in height can readily be sprayed. For higher trees, I know of nothing better than a ladder mounted on wheels so as to be easily moved from tree to tree, such as has been used in California in the work against the Fluted scale. This ladder is supported so that it does not rest against the tree, and the operator can move up and down without being hindered by projecting branches.



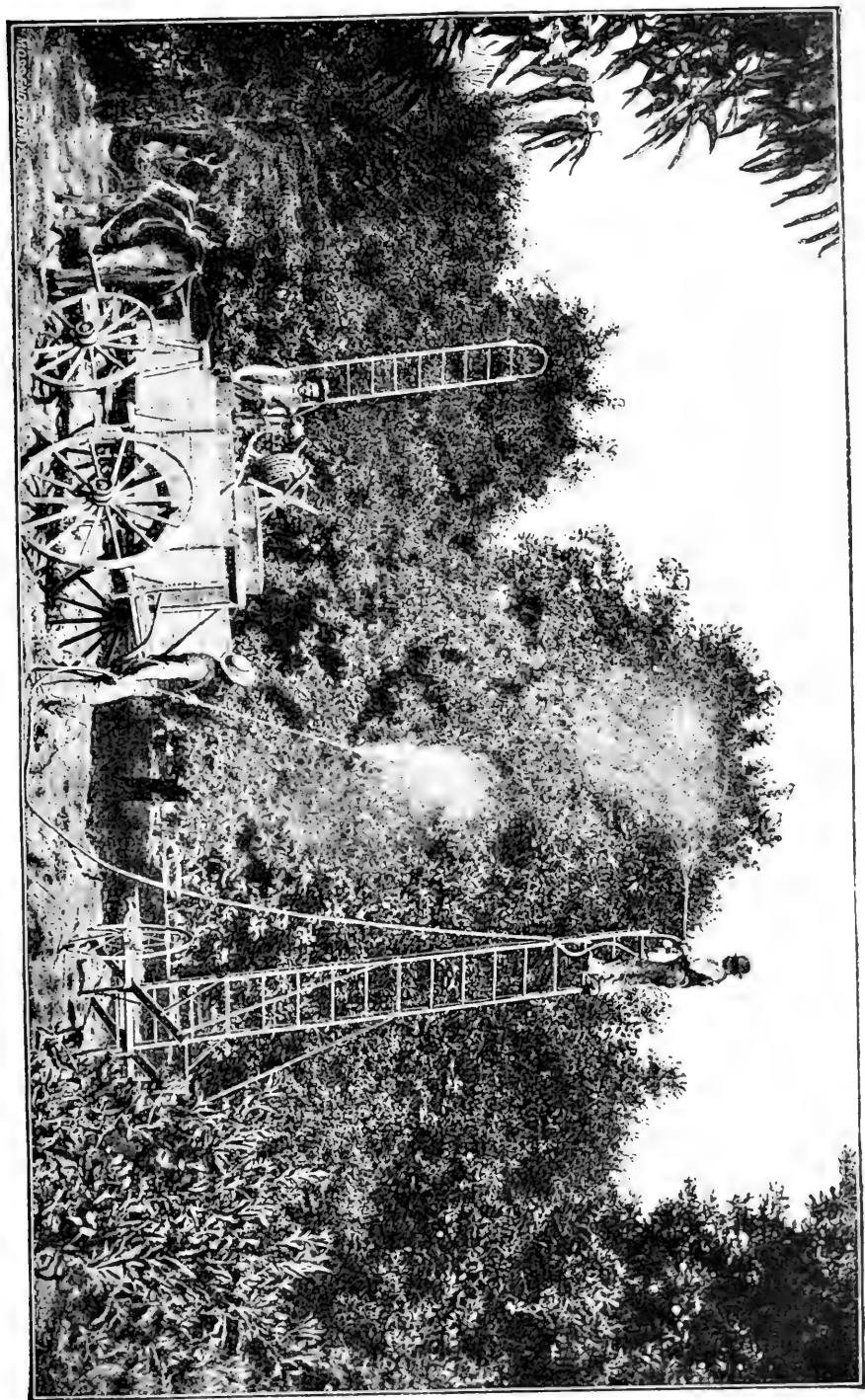


Fig. 10.—Spraying outfit in operation as used in orange groves.

Fig. 10 is taken from my annual report as United States Entomologist for 1886. It represents a spraying outfit in operation against the Fluted scale (*Icerya purchasi*), and indicates sufficiently well the use of the ladder just referred to, and also of the extension poles.

In *Garden and Forest* for June 19, 1889, Prof. J. B. Smith, entomologist of the New Jersey experimental station, reports the successful spraying of elm trees in the Rutgers College campus, some of which were over 50 feet high. A Seneca Falls force-pump, provided with some 50 feet of hose, was used. By removing the spraying attachment from the nozzle—a large-size Nixon—the liquid could be thrown in a small stream to a distance of 20 feet. A light ladder gave access to the center of the tree, from which point the extreme tips of the branches could be reached.

*Nozzles.*—In any device for applying liquid insecticides the nozzle is of prime importance, for on its efficiency will depend in large degree the success or failure of the work. The desiderata in a spray nozzle, as I have elsewhere stated, are “ready regulation of the volume to be thrown; greatest atomizing power with least tendency to clog; facility of cleansing, or ready separation of its component parts; cheapness; simplicity and adjustability to any angle.”

Without attempting a general discussion of the merits of different classes of nozzles, I shall content myself with a brief reference to a few styles, which, to a greater or less degree, answer the conditions just enumerated and which have stood the test of practical work.

*The Riley or cyclone Nozzle.*—This nozzle is now so widely known as hardly to require description. As there have been some erroneous statements as to its invention, I may take occasion here to reiterate what was recorded in the fourth report of the commission, viz: that it was a development and outgrowth of my work on the Cotton Worm, the first suggestion of the principle being my own and its development resulting

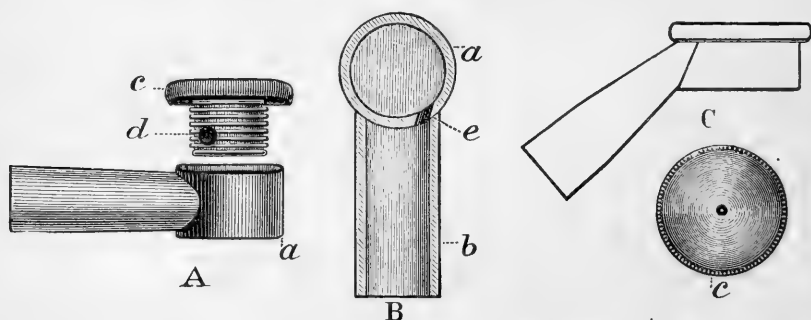


FIG. 11.—The Riley or cyclone Nozzle.

from two years' experimentation under my direction and chiefly through the assistance of the late Dr. W. S. Barnard. “Its principal feature consists in the inlet through which the liquid is forced being bored tangentially through its wall, so as to cause a rapid whirling or centrifugal

motion of the liquid, which issues in a funnel-shaped spray through a central outlet in the adjustable cap. The breadth or height, fineness or coarseness of the spray depend on certain details in the proportion of the parts, particularly of the central outlet."

FIG. 11 shows two styles of this nozzle, which I have adopted from a host of experimental forms as the best for all ordinary work. At A is shown the typical small-stemmed nozzle, with the screw cap removed to show the inlet orifice *d*. At B is shown a sectional view of the same again with the cap removed, showing the tangential entrance to the chamber *a* through the orifice *e*, which when the cap is inserted coincides with the orifice *d*. At C is shown a face view of the cap *c*, which should be countersunk about the orifice of exit on the exterior surface only; and also an outline drawing of a chamber placed at an angle of 45° with the stem—a form of advantage especially in overhead spraying.

The stem may be inserted into the discharge-pipe and fastened by wrapping tightly with copper wire, or a more convenient form is made with a female screw of a size to fit a three-eighth inch nipple. The nipple is inserted into the discharge-pipe and fastened in the ordinary manner, and allows an easy interchange of nozzles of different sizes or patterns. A discharge orifice of about one-sixty-fourth of an inch may be used for a very fine spray; for coarser and heavier work a one-sixteenth-inch orifice will be preferable.

The value of rotating the liquid to break it up into a suitable spray and to prevent clogging, which are the essential features of the Riley nozzle, has been universally recognized.

In this country, owing to the fact that this nozzle has not been patented and is not pushed by interested parties as are patented contrivances, it has not come into such general use as its merits warrant or as has accompanied the introduction of patented modifications of it in other countries. It is now, however, being quite extensively manufactured and offered by the trade, and a number of modifications of this nozzle have appeared in France, which, while adding certain new features, have not departed from the valuable principle of the typical form, viz: that of the centrifugal motion of the liquid. These nozzles are employed in France, Germany, and other European countries almost to the exclusion of all other forms, and in this country they are also extensively used. More recently a valuable modification has appeared in this country, the Universal Spray Tip, and in New Zealand a compound form is manufactured, known as the New Zealand Triplet, and fashioned after one which I used and described in California in 1887.

A full description of the important modifications of the Riley nozzle that have appeared in this and in foreign countries is given by me in *Insect Life*, Vol. I, Nos. 8 and 9, to which the reader is referred for fuller details.

In this country, these nozzles are manufactured under contract, for dealers, by Thomas Somerville & Son, Washington, D. C., and by

Woodin & Little, 509 and 511, Market street, San Francisco, Cal. The universal spray tip, the only valuable modification of the Riley nozzle that has appeared in this country, is the invention of and is manufactured by J. Crofton and L. D. Green, Walnut Grove, Cal.

The addresses of the manufacturers of the foreign modifications of the Riley nozzle are as follows:

*The Noël nozzle*, by the firm of Noël, Paris.

*The Vermorel nozzle*, by V. Vermorel, Villefranche (Rhône), France.

Two modifications of the Vermorel nozzle are:

*The Japy nozzle*, by Japy Frères & Cie, Beaucourt, France, and

*The Albrand nozzle*, by M. C. Albrand, 87 rue de la République, Marseilles, France.

*The Marseilles nozzle*, by L'Avenir Viticole, Marseilles, France.

In New Zealand the Riley nozzle is manufactured by Kutzner Bros., of Masterton, who call it the American cyclone nozzle and make it single and in triplets.

I will call attention here to but one of the most successful of these modifications, which is shown in figure 12. It is known as the Vermorel nozzle, and was devised by a gentleman of that name in France. The

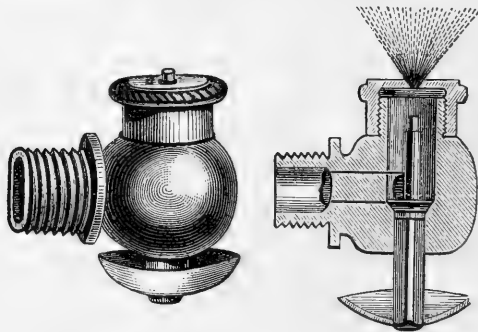


FIG. 12.—The Vermorel Nozzle—natural size (original).

important feature of this nozzle is the pin inserted through its base, bearing on its upper end a point sufficiently small to enter the discharge orifice when thrust upward from below. This enables the operator to clean the discharge, when it becomes clogged, and is a great convenience, especially for spraying heavy suspension liquids.

*The Nixon or Climax Nozzle.*—This is the invention of Mr. A. H. Nixon, of Dayton, Ohio. Its work is so satisfactory, especially where considerable force is required, as will be generally the case in forest work, that I notice it here. A nipple screws on the distal end of a discharge-pipe, and on its outer end is screwed a brass tube varying in length and diameter according to size of nozzle. The discharge orifice through the nipple regulates the quantity of spray, and nipples with different sized discharge orifices are interchangeable. The stream projected through this nipple strikes a brass screen at the outer end of the tube and is cut into a perfect spray.

*Cost of a spraying Outfit.*—In the foregoing I have presented briefly, yet in sufficient detail, the essential requisites of a good spray apparatus. An entire outfit, embracing the best materials mentioned above, can be gotten together by an ingenious person for a sum not exceeding \$20. Outfits may be purchased from manufacturers at prices ranging from \$20 to \$50, according to sizes or styles.

A list of responsible firms with whom the Division of Entomology has had business relations is here appended :

W. & B. Douglass, Middletown, Conn.; Rumsey & Co., Seneca Falls, N. Y.; Field Force-Pump Company, Lockport, N. Y.; Robert T. Deakin & Co., Philadelphia, Pa.; Nixon Nozzle and Machine Company, Dayton, Ohio; Woodin & Little, San Francisco, Cal.; The Gould's Manufacturing Company, Seneca Falls, N. Y.; Thomas Woodason, 451 East Cambria street, Philadelphia, Pa.; Leggett & Brother, New York.

## CHAPTER I.

### INSECTS INJURIOUS TO THE OAK.

#### Various species of *Quercus*.

The oak perhaps affords our most valuable lumber, whether ship-timber, carriage wood, or when used for carved work, floors, or furniture. As a shade tree it will always be in demand, while groves of oaks are among the chief ornaments of parks. The oak can be easily planted, and it is one of the trees most available in the renewal of our forests.

Unfortunately the oak is preyed upon by a larger number of kinds of insects than perhaps all the other hard-wood forest trees mentioned in this work put together. From the roots to the extremity of the smallest twigs, including the buds and acorns, there are assemblages of insects which divide the arboreal territory among themselves, not often encroaching on each other's domain. In this way the work of destruction often becomes thoroughly well done. Yet, considering the number of species of insects which prey upon this devoted tree, particularly when isolated from its fellows, it is a wonder how evenly preserved is the balance of nature. Undoubtedly, as in all other trees and most vegetable growths, a certain amount of natural, healthy pruning is accomplished by insects. But were there not a complicated system of checks, particularly those due to parasitic insects and to unfavorable climatic changes, the tide of insect life would sweep away every tree and shrub from the face of the earth.

In his work on "Plant-Enemies of the Class of Insects," Kaltenbach enumerates five hundred and thirty-seven species of insects of all orders which in Germany prey upon the oaks of that empire.

It is probable that nearly if not quite as many will be found in a region of the same extent in this country, especially since the species of oaks are more numerous in the eastern United States than in central Europe, the number of species in the latter region being but two or three to twenty in the United States, east of the Rocky Mountains.

The number of determined species of oak insects recorded in the following pages is over 400, while the number of undetermined species would carry the number up to over 500, or about as many as Kaltenbach

records for Germany. It is not improbable that ultimately the number of species for the United States will be between 600 and 800 or even 1,000.

We will now briefly indicate those species of insects which are habitually more or less destructive to the oak.

The roots of the live and probably the water oak are infested by the great longicorn borer, *Mallophon melanopus*, the trees being permanently dwarfed and their growth arrested.

Of the borers in the trunk, the caterpillar of the Carpenter moth (*Prionoxystus robiniae*) probably does more damage than all other borers combined. Next to this borer, come the flat-head borers, and the bark-borers, with the oak-pruner (*Elaphidion villosum*), while the seventeen-year Cicada periodically prunes or destroys many of the twigs.

The leaves suffer most from the attacks of the forest tent-caterpillar (*Clisiocampa disstria*) and the large black-and-red-striped spiny caterpillar of the senatorial moth (*Anisota senatoria*). These two caterpillars in the Atlantic and Central States as a rule do more harm to oak forests than perhaps all the other species combined.

Finally, many acorns are worm-eaten, the intruder being the grub of the long-snouted weevil (*Balaninus*). We have, so far as practicable, described the habits and appearance of the most destructive species first.

#### AFFECTING THE ROOTS.

The roots of various species of oak are, without much doubt, more or less injured by the attacks of the seventeen-year Cicada while in its preparatory state, as it is known that this insect, so abundant in the central and southern States of the Union, remains for over sixteen years attached by its beak to the rootlets of the oak and probably other forest trees, where it sucks the sap, thus in a greater or less degree injuring the health of the tree. Observations as to the subterranean life of the seventeen-year locust are few and obscure, and it is quite uncertain how much injury is really done to trees by this habit. They have sometimes been found sucking the sap of forest trees, notably the oak, and also of fruit trees, such as the pear and apple. According to Riley (First Report, p. 24), the larvæ are frequently found at great depth, sometimes as much as 10 feet below the surface. It has been claimed by Miss Margaretta H. Morris, in an account published in 1846, that pear trees have been killed by the larvæ sucking the roots. This has been denied by the late Dr. Smith, of Baltimore, who says:

The larva obtains its food from the small vegetable radicles that everywhere pervade the fertile earth. It takes its food from the surface of these roots, consisting of the moist exudation (like animal perspiration), for which purpose its rostrum or snout is provided with three exceedingly delicate capillaries or hairs, which project from the tube of the snout and sweep over the surface, gathering up the minute drops of moisture. This is its only food. The mode of taking it can be seen by a good glass.—Prairie Farmer, December, 1851.

Dr. Riley adds that Dr. Hall, of Alton, Ill., has often found them firmly attached to different roots by the legs, but never found the beaks inserted. He remarks as follows :

The fact that they will rise from land which has been cleaned of timber, cultivated, and even built upon for over a dozen years, certainly contravenes Miss Morris's statement, while their long subterranean existence precludes the necessity of rapid suction. It is also quite certain that if they thus killed trees we should oftener hear of it, and I have captured a gigantic but unnamed species of Cicada on the plains of Colorado, 50 miles from any tree other than a few scattering willows.

We would add that in June, in Idaho Territory, we have seen numerous Cicadæ which had just appeared above the surface of the earth in a desert region with scattered sage bushes, upon whose roots, which it is known descend to a great depth, the young may feed. While, then, the Cicada may seldom do marked injury to the oak, the reader is referred to a subsequent page for a further notice of the injury done by this insect to the twigs and smaller branches of the oak and other trees.

In Europe the roots of oaks are affected by a small wingless gall-fly, which punctures the root and inserts an egg into the hole. The irritation set up by the presence of the larva causes the root to swell until a tumor or gall is formed, in the center of which lies the white footless larva or maggot of the fly.

Fitch has found similar wingless flies in this country, but they will always remain objects rather of a scientific than economic interest. He has described them under the names of *Biorhizanigra*, *Philonix fulvicollis* and *nigricollis*. They are wingless, and occur in forests in November and December, often walking on the snow in company with other snow insects, such as *Boreus* and *Chionea*. There is also a root gall, of which Professor Riley has detected a species. The known species of root-galls are enumerated in Mr. Ashmead's catalogue of Cynipidæ, reprinted further on in this chapter, at the end of the section on insects infesting oak twigs.

### 1. THE LIVE-OAK ROOT-BORER.

*Mallodon melanopus* Linn. (Larva. Pl. xxxv, Fig. 1.)

Boring under ground in the roots of the live-oak and dwarfing the young trees in Florida and the Gulf States; a very large white grub, transforming to a large brown longicorn beetle.

While in Florida, at Crescent City, I had an opportunity, owing to the kindness of Mr. H. G. Hubbard, of collecting the grubs (described below) and seeing the injury done by this borer to the live oaks.

The following account is taken from Professor Riley's report for 1884 :

This beetle is one of our largest insects, being about two inches long and very broad and heavy. Its larva is a cylindrical grub, or "sawyer," about an inch in thickness and over three inches in length.

In Texas Mr. Schwarz found the larva of this *Mallodon* excavating its galleries in the heart-wood of the Hackberry (*Celtis*), a tree of the largest size. In Florida and elsewhere it feeds upon the live-oak, and it would seem that so large and powerful a borer was well chosen to be the destroyer of this giant among trees.



In point of fact, however, in its connection with this tree the beetle shows a surprising modification of its recorded habits. Its larva is found, not in the stem of the mature tree so justly celebrated for its strength and toughness, but always in the root of infant trees, and usually in degenerate highland varieties of *Quercus virens*, or of its relatives, *Q. aquatica* and *Q. catesbæi*.

The mother beetle selects small saplings as a place of deposit for her eggs, which are laid in the foot, or collar, of the tree, just below the surface of the ground. How long a larval existence the insect has is not known, but it must extend over several years, since the roots occupied by these larvæ grow to a large size, while at the same time they show an entirely abnormal development and become a tangle of vegetable knots. In fact, the entire root in its growth accommodates itself to the requirements of the borer within. Very few new roots are formed, but the old roots excavated by the larva are constantly receiving additions of woody layers, which are in turn eaten away and huge flattened galleries are formed, which are for the most part tightly packed with sawdust.

The beetle thus becomes, not the destroyer, but the parasite of the tree, and lives in a domicile, which may not improperly be termed a gigantic root-gall. The effect on the tree is to kill the original sapling, which becomes replaced by a cluster of insignificant and straggling suckers, forming perhaps a small clump of underbrush. In many cases the branches and leaves are barely sufficient to supply the materials for sluggish growth, and the entire strength of the plant goes toward the formation of a root plexus, out of all proportion to the growth above ground, and plainly designed to repair the ravages of the borer.

The Mallodon borers are very abundant in South Georgia and Florida, and as a result of their attacks, vast tracks which might otherwise have become forests, enriching the ground with annual deposits of leaves, are reduced to comparatively barren scrub, in which the scattered oak bushes barely suffice to cover the surface of the sand.

Many a new settler, seeing his sandy hill-side covered only by insignificant oak bushes, and anticipating easy work in converting the wilderness into a blooming garden of orange-trees, has been grievously disappointed to find before him no light task in clearing from the soil these gnarled and tangled roots. In fact the great strength and weight of the southern grubbing-hoe appears no longer a mystery when one contemplates the astonishing pile of "grub roots" which in vigorous hands it will extract from a few square rods of apparently unoccupied soil.

The results of the work of this beetle are very plainly visible around Savannah, and especially on Tybee Island, where Mr. George Noble first drew our attention to it; while Mr. Hubbard has carefully studied its work, as here recorded, in Florida. (*Riley's report*, 1884.)

The genus *Mallodon* contains species of large size with the sides of the prothorax armed with numerous small teeth. The head is comparatively large, the eyes strongly granulated, distant, transverse, feebly emarginate. The antennæ are slender, not exceeding half the length of the body in the male and shorter in the female. The sexual differences are worthy of note. The prothorax in the male is nearly quadrate, densely punctured, with smooth separate facets, while in the female it is narrowed in front, more coarsely punctured towards the sides, and uneven on the disk.

The present species is distinguished by the decidedly serrate prothorax, while the tibiæ are densely ciliated on the lower edge. It is dark brown, almost black. Length, 45 to 55<sup>mm</sup>, (1.75 to 2.25 inches). It inhabits Florida, Arkansas and Texas.—(*Horn*.)

*Larva*.—Body as large and thick as one's forefinger. It closely resembles the larva of *Orthosoma brunneum*\* in general appearance and proportions, but considerably thicker. Shape of the prothoracic segment and size of the head and shape of the

\* I have no larva of *Prionus laticollis* with which to compare it, and which it may more closely resemble than *Orthosoma*.

mouth-parts much as in *Orthosoma*. Dorsal prothoracic plate and the segment beneath as in *Orthosoma*, but on each side in front of and above the prothoracic feet is a large hairy tubercle of which *Orthosoma* has no traces. The remaining segments of the body above and beneath are almost identical in form and markings with those of *Orthosoma*. The callosities on the upper side of the abdominal segments differ slightly in having the transverse areas not divided by a median impressed line, as they are in *Orthosoma* (see Pl. xxxv, Fig. 1). The thoracic feet as in *Orthosoma*, but the spiracles are much larger in proportion.

Head as in *Orthosoma*, except that the front edge of the epicranium next to the clypeus is smooth and straight, not dentate, as in *Orthosoma* (Pl. xxxv, Fig. 1a). Clypeus and labrum identical in form with those of *Orthosoma*, but the stiff bristles on the front edge of the labrum are considerably longer. Antennæ three-jointed and as in *Orthosoma*, as is the shape of the labium with its two-jointed palpi; the latter, however, much stouter, though not reaching beyond the end of the labrum. Maxillæ as in *Orthosoma*, but the four-jointed palpi are a little stouter. Length of body, 87<sup>mm</sup> (3 $\frac{2}{8}$  inches); breadth of prothoracic segment, 20<sup>mm</sup>.

## 2. THE BROAD-NECKED PRIONUS.

*Prionus laticollis* (Drury).

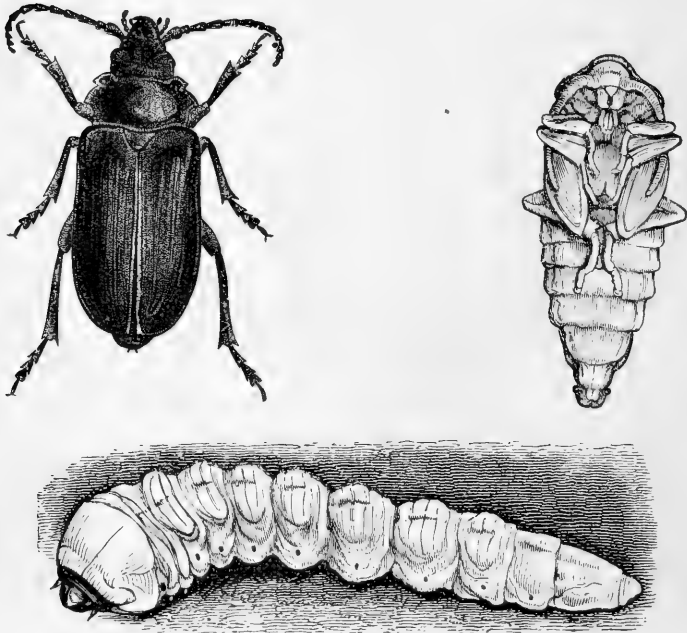


FIG. 13.—Broad-necked *Prionus*, its larva and pupa. After Riley.

Though usually living in the roots and trunks of the poplar and balm-of-Gilead, Mr. F. Clarkson states that at Oak Hill, Columbia County, N. Y., this borer infests the black oak, the beetle emerging at twilight during the first two weeks in July.

Their presence is quickly realized by the odor of the female, which is very powerful, and can readily be detected 20 feet distant. I placed a female immediately after emergence in an uncovered jar, and wherever I positioned it, on the piazza or elsewhere, the males were attracted from every direction. I captured twenty males

in a very few minutes. Oak Hill can not boast of a balm-of-Gilead or a Lombardy poplar, but it is famous for its oaks, and while it is admitted that the former trees, as mentioned by Harris, serve as food for the larvæ, my observations indisputably prove that they feed also upon the roots of the oak. (Can. Ent., xvi, 95.)

#### AFFECTING THE TRUNK.

#### 3. THE OAK CARPENTER WORM.

*Prionoxystus robinie* (Peck).

Order LEPIDOPTERA; Family COSSIDÆ.

Boring large holes and galleries in the trunk; a large, livid, reddish caterpillar, nearly three inches long, greenish beneath, and the head shining black; the body somewhat flattened, and with scattered long, fine hairs. The chrysalis also in the burrow, and transforming to a large, thick-bodied moth in June and July.

In different parts of New England, from Maine to Rhode Island, and southward to Texas, oak lumber and cord-wood is commonly seen to be often honeycombed by the large black burrows of this common and destructive borer. It is the most directly injurious of all the insects preying on this noble tree, since it sinks its tunnels deep in towards the heart of the tree in the living wood, and is a difficult insect to discover until after the injury is done. It may be found in the autumn and winter months, of different sizes, showing that at least there is an interval of one year between the smaller and larger sizes, and that consequently the moth is two, and probably three years in attaining maturity.

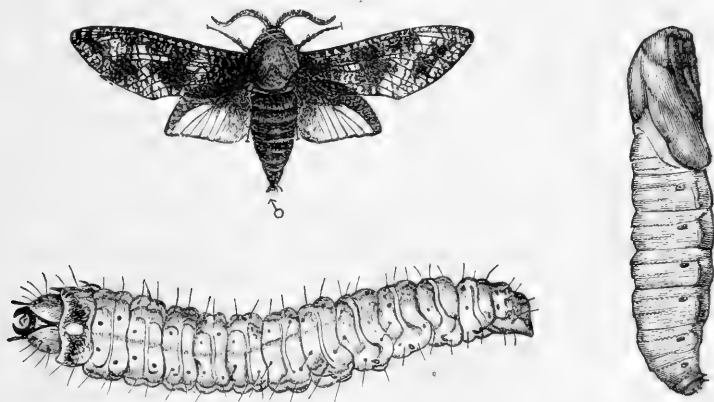


FIG. 14.—Larva and pupa of female, and male imago of Oak Carpenter Worm—all natural size. After Riley.

The female moth, without doubt, lays her eggs in the cracks and interstices of the bark of the oak or locust, in the latitude of Boston, about the middle of July.

I have taken the larva and chrysalis from the red oak in Maine, and the insect occurs westward to the Mississippi Valley and southward to Bosque County, central Texas. At Houston, Tex., I have found a dozen

or more of the cast chrysalid skins projecting from the stumps of the pin oak; one pupa was alive early in April. It is said by Fitch to be more common in the Southern and Southwestern States than in the Northern. It is also an inhabitant of California, and may be found to occur in nearly all the United States wherever the black, red, and white oak or locust trees grow. The habits and metamorphoses of the moth were first discovered by Peck,\* who bred it from caterpillars found in the locust, but Harris afterward discovered that it "perforates the trunks of the red oak." Bailey states that it also feeds on the willow. (Bull. No. 3, Div. Ent., U. S. Dept. Ag., p. 54).

Riley states that the male caterpillar is only half as large as the female. He adds that with her extensile ovipositor the moth deposits her eggs in the deep notches and dark bottoms of crevices. "The young worms which hatch from them are dark brown with large heads; they are active and commence spinning as soon as they are born" (Amer. Ent., II, 127). He finds it more partial in the West to the locust than to the oak.

The following account of its habits and transformations is copied from Fitch:

Of all the wood-boring insects in our land this is by far the most pernicious, wounding the trees the most cruelly. The stateliest oaks in our forests are ruined, probably in every instance where one of these borers obtains a lodgment in their trunks. It perforates a hole the size of a half-inch auger, or large enough to admit the little finger, and requiring three or four years for the bark to close together over it. This hole running inward to the heart of the tree, and admitting the water thereto from every shower that passes, causes a decay in the wood to commence, and the tree never regains its previous soundness.†

This is also a most prolific insect. The abdomen of the female is so filled and distended with eggs that it becomes unwieldy and inert, falling from side to side as its position is shifted. A specimen which I once obtained extruded upwards of three hundred eggs within a few hours after its capture, its abdomen becoming diminished hereby to nearly half its previous bulk; and in the analogous European species more than a thousand eggs have been found on dissection. It hence appears that a single one of these insects is capable of ruining a whole forest of oak trees. This calamity, however, is prevented, probably by most of the eggs being destroyed, either by birds or by other insects, for these borers are by no means so common in our trees as the fecundity of their parents would lead us to expect.

Our moth comes abroad, as already stated, in June and the forepart of July. It flies only in the night time, remaining at rest during the day, clinging to the trunks of trees, its gray color being so similar to that of the bark that it usually escapes notice. In repose its wings are held together in the shape of a roof, covering the hind body. From observing her motions in confinement, I think the female does not insert her eggs into the bark, but merely drops them into the cracks and crevices upon its outer surface. They are coated with a glutinous matter which immediately dries and hardens on exposure to the air, whereby they adhere to the spot where they touch; and if the short two-jointed ovipositor be not fully exerted as the egg is passed

\* Mass. Agr. Report and Journal, Vol. v, p. 67, with a plate, 1818.

† We have observed that the old burrows are lined by a dark layer, consisting of a mealy débris about as thick as pasteboard; this detritus is probably composed of the castings of the larva, which form a paste that in drying strongly adheres to the sides of the gallery.—A. S. P.

through it, so as to carry the egg beyond the hair-like scales with which the body is clothed, some of these touching adhere to it, their attachment to the body being so slight.

The eggs are of a broad oval form, and about half the size of a grain of wheat, being the tenth of an inch in length and three-fourths as thick, of a dirty whitish color with one of the ends black. When highly magnified their surface is seen to be reticulated or occupied by numerous slightly impressed dots arranged in rows like the meshes in a net. From the fact that several worms of the same size are sometimes met with in a single tree, indicating them all to be the progeny of one parent, it appears that the female drops a number of eggs upon each tree that she visits, and probably disposes of her whole supply upon a very few trees. The size of the eggs doubtless renders them a favorite article of food to some of our smaller birds. And a bird in discovering some of these eggs will be incited thereby to search for others in the same vicinity, which search being successful, will be perseveringly continued so long as an egg can be found upon that or any of the adjacent trees. Thus it may be that of the whole stock of eggs which a female deposits, scarcely one escapes being picked up and devoured. This appears the most probable cause of so few of these worms being met with, although the females are so prolific.

The worm on hatching from the egg sinks itself inward and feeds at first on the soft inner bark, till its jaws acquiring more strength it penetrates to the harder sap-wood and finally resorts to the solid heart-wood, residing mostly in and around the center of the trunk, boring the wood here usually in a longitudinal direction, and moving backwards and forth in its burrow, enlarging it by gnawing its walls as it increases in size, whereby the excavation comes to present nearly the same diameter through its whole length. In an oak in which I met with two worms fully grown and several others but half grown, the whole of the central part of the trunk had been extensively mined by preceding generations of this insect and was in a state of incipient decay; and I thus had an opportunity to notice the fact that none of the worms were lying in the decaying wood, all being outside of this, where the wood was still sound. Hence it is evident that it is living healthy trees which this insect prefers, and not those which are sickly and decaying, which latter are preferred by the European *Cossus*, some authors say, though perhaps their observations have not been exact upon this point, for in the instance here alluded to it would have been said on a first glance that these worms preferred decaying wood, since the diseased heart of the tree was everywhere traversed with their burrows, and the sound wood showed few of them; and thus no doubt in many other cases we mistake the cause for the effect, and on seeing semi-putrid wood filled with worm-holes, we suppose the worms have preferred wood of this character, when in truth it is these holes which have caused the decay of the wood.

These worms are probably three years in obtaining their growth. They cast off their skin several times, and after the last of these moltings their color becomes different from what it has previously been.

The larva previous to the last change of its skin is of a rose-red or a pale cherry-red color, often with a faint yellowish stripe along the middle of its back, on all except the three anterior rings. It is of a cylindrical form, slightly broadest anteriorly and a little flattened beneath. It is divided by transverse constrictions resembling broad shallow grooves into twelve rings, which are twice as broad as long. On each of these rings are a few pimples of a deep purple color, regularly placed, each giving out a pale-brown bristle. Four of these pimples are on the back, placed at the angles of an imaginary square or a trapezoid having its hind side the longest, the two hinder pimples being larger. Small white dots confluent into broken lines may also be perceived, forming a transverse square in which the two anterior pimples are inclosed, and other dots less regularly placed surrounding the two hind pimples except upon their hind side. Above the breathing pores on each side is also a large pimple, which, upon the four rings bearing the prolegs, has a white dot in its lower edge, which dot does not appear in the corresponding pimples of the other rings. A

minute pimple is also seen forward of the upper end of each breathing pore, below which all the under side of the worm is greenish white. The breathing pores are oval and light yellow, with a rusty brown oval spot in their center and a dark purple ring around their outer edge. Below them the skin bulges out, forming a longitudinal ridge, or rather two parallel ridges divided by a deep intervening furrow. Upon the upper one of these ridges near the middle of each ring is a round cherry-red spot in which are two small pimples, and on the lower ridge is a single one, placed farther back, whilst four others equally minute may be seen farther down and around the anterior base of the prolegs. The second and third rings are shorter, each with fourteen pimples of different sizes, the larger ones forming a single transverse row. The first ring or neck is polished and of a dark tawny brown color on its upper side, with a white line in its middle disappearing anteriorly in a black two-lobed cloud. The head is but half as broad as the body, and is of a shining black color, tinged more or less with chestnut brown in its middle, with scattered punctures from which arise fine hairs. The antennæ are chestnut brown, conical and three-jointed, the last joint minute, with a bristle beside it given out from the apex of the second joint. The palpi are similar, with two small processes from the summit of their second joint, the outer one of which ends in a minute fourth joint. Of the eight pairs of legs, the three anterior are conical and end in a single chestnut-colored claw. The others are short, thick, and retractile, with their soles surrounded by a blackish fringe-like ring composed of a multitude of minute hooks, the last pair, however, having these hooks only around the anterior and outer half of their soles. Placed in a glass or tin vessel, this worm is perfectly helpless, being unable to cling with these hooks to a hard smooth surface.

With the last change of its skin it loses its bright-red color and is then white, tinged with green at the sutures, and with a pale-green stripe along the middle of its back, which disappears at the sutures. The pimples are of a pale tawny yellow color with black centers. The head is light tawny yellow varied in its middle with greenish white, its anterior edge blackish and the jaws deep black.\*

As the moth into which this worm changes possesses no jaws or other implements by which it is possible for it to perforate the wood, it is necessary for the worm to prepare a way for its future escape from the tree; and the provisions which it makes for this end are truly interesting, indicating that the worm has a clear perception of what its future condition and requirements will be, both in its pupa and its perfect state. This is the more surprising when we recur to the fact that since its infancy this creature has been lying deeply bedded in the interior of the tree, the only act of its life having been to crawl lazily around in its cell and gnaw the wood there when impelled by hunger. How does it now come to do anything different from what it has been doing for months and years before? But, having got its growth and the time drawing near to have it change into a pupa or chrysalis, we see it engaging in a new work. It now bores a passage from the upper end of its cell outward through the wood and bark till only a thin scale of the brittle dead outer bark remains. It is usually at the bottom of one of the large cracks or furrows in the bark that this passage ends,

---

\* Received full grown larvæ from F. G. Mygatt, Richmond, Ill., February 26, 1868, found boring in a large black-oak tree, forming their cocoons soon after the receipt. The male larvæ have generally broken bands of reddish brown across the middle of each segment. The female larvæ are perfectly fulvous or of the color of ordinary yellow butter; subcylindrical; thoracic segments broadest, tapering thence to anus. Segment 1 flatter than the rest; head polished brown and fulvous; piliferous spots variable in size, being more distinct when young, and often connected by transverse bands of brown; stigmata brown, large, and distinct; feet and legs same as venter, the former with brown extremities, the latter fringed with brown; anal segment more glaucous than the rest. Others were received from J. M. Shaffer, January, 1870, found boring in black locust, and were exactly like the oak-feeding specimens. (Riley's unpublished notes.)

whereby the hole inside is less liable to be discovered by birds. The worm then diligently lines the walls of this hole with silken threads interspersed with its chips and forming a rough surface resembling felt, as it withdraws itself backward for a distance of about three inches, thus placing itself beyond the reach of any bird or other enemy outside of the tree, should its retreat be discovered; and it here incloses itself in a cocoon which it spins of silk, of a long oval form, having the end towards the outer opening much thinner and its threads more loosely woven. In this cocoon it throws off its larva skin and then appears in its nymph or pupa form.

The pupa is an inch and three-quarters long and half an inch thick, of a dull chestnut color, the rings of its abdomen paler, and on the back near the anterior edge of each ring is a row of angular teeth, resembling those of a saw, of a dark brown color and all of them inclining backward, these rows of teeth extending downwards upon each side below the breathing pores or about two-thirds of the distance around the body. On the middle of each ring is also a much shorter row of little tubercular points. Finally, upon the under side of the last segment are about four stouter conical teeth, the tips of which are drawn out into sharp points which are curved forward, so that when this last segment, which is tapering and smaller than the others, is bent downwards these curved points will catch and hold the body from moving forward.

The pupa lies perfectly dormant in its cocoon probably a fortnight or longer. It then awakes from its slumbers and begins to writhe and bend itself from side to side. By this motion the rows of little teeth upon the rings of its abdomen, which incline backward as above described, catch in the threads of the cocoon, first upon one side and then upon the other, and thus move the body forward, whereby its head presses upon the loosely woven end of the cocoon, more and more firmly, until it forces its way through it, and the pupa works itself forward out of its cocoon. And the same writhing motion being continued, the teeth now catch in the threads with which the sides of the hole are lined, and thus, though destitute of feet, the pupa moves itself along till it reaches and breaks through the thin scale of bark which hitherto has closed the mouth of its burrow, and pushes itself onward till about three-fourths of its length protrude from the tree, when by curving the tip of its body downward the four little hooks thereon catch in some of the threads and hold it from advancing further and falling to the ground. By so much motion of the pupa the connections of the inclosed insect with its shell become sundered and the sutures of the shell are probably cracked open, so that the moth readily presses them apart and crawls out therefrom, leaving the empty and now lifeless shell projecting out from the mouth of the hole, with a small mass of worm-dust surrounding it.

The male moth is of a gray color from white scales intermixed with black ones. The head is furnished upon the crown, or vertex, with longer or hair-like scales. The antennæ are tapering and many-jointed, their basal joint thickest and covered with black and gray scales, the remaining joints being naked, shining, coal-black, each joint bearing two branches on its front side, forming two rows of coarse teeth like those of a comb, the teeth being six or more times as long as thick, and all of the same length except at the base and tip, where they become shorter, all of them ciliated with fine hairs. The feelers are appressed to the face and reach as high as to the middle of the eyes, and are cylindric, clothed with short appressed scales, the separation of the terminal joint being slightly perceptible. The thorax has the shoulder-covers black, forming a stripe of this color along each side, which anteriorly curves downwards and is continued backward upon the upper side of the breast. Its base is clothed with larger scales, forming tufts upon each side. The abdomen is conic and equals the tips of the wings in its length, and is but slightly covered with scales except along each side, where they form a broad stripe, the under side being entirely denuded; it is black and shining, with the sutures dull yellowish. At its tip are three appendages, longer than the last rings of the abdomen. The two lower ones are broad, thick, flattened processes of a dull brownish yellow color, with their tips rounded and slightly bent inwards towards each other. The upper one is a slender, black, shining hook or claw of the same length, its tip sharp-pointed and curved downward. Above

these appendages and hiding them from view is a brush of black hairs, forming a conical tuft at the end of the abdomen, blunt at its apex. The *legs* are more or less denuded of scales, black and shining, with the hind shanks thicker toward their tips and with two pairs of spurs, the forward shanks having only a single spine, which is placed on the middle of their inner sides, the same as in other moths; and the feet are compressed and five-jointed, with the basal joint longest and the following ones successively shorter. The *fore wings* are black, with groups of whitish scales forming gray spots or clouds which are netted with black lines, varying greatly in different individuals. Often a transverse gray spot is situated towards the base and another on the anal angle, the outer and hind margins being gray alternated with black. The *hind wings* are black, with their posterior half of a rich marigold yellow color bordered with a black line upon the hind margin, the yellow color being irregularly notched on its anterior side and narrowed to the inner angle, and not extended to the outer angle, the two outer cells being black. The outer or anterior margin, except at its base and tip, is usually gray alternated with transverse black streaks and blotches, and inside of this is a large ash-gray spot occupying the outer anterior part of the disk. The under sides of both wings are similar to their upper surface.

The *female* would not be supposed to pertain to the same species with the male, her size is so much larger, her colors so much paler gray, and her hind wings being wholly destitute of the bright yellow coloring which forms so conspicuous a mark in the other sex. The branches of her antennæ are also shorter, being but about four times as long as thick. The ground color of her fore wings is gray, variously netted with black lines dividing the gray in places into small roundish spots and into rings having black centers. The black color usually forms a broad irregular band across the middle of the wings parallel with the hind margin, and another between this and the hind edge, chiefly on the outer half of the wing, the hind edge and fringe being whitish alternated with black spots placed on the tips of the veins. The hind wings are dusky gray and towards their bases blackish, their posterior half being freely transparent and faintly netted with darker lines. The body is densely coated with gray scales, its under side hoary white; and the legs are gray, with black bands on the shanks, and black feet, with gray rings at their articulations.

*Remedies.*—We have but a single suggestion to make upon the subject of remedies against this truly formidable though fortunately rare enemy. It is probable that soft soap applied the fore part of June to the bodies of trees will be equally efficacious against this and other borers as it is against that of the apple tree. This remedy may well be resorted to, to protect the locusts and oaks which we value as ornamental trees; and scarce and valuable as timber is becoming in all the older settled sections of our country, I doubt not it will be found to be good economy to bestow similar attention upon the more valuable trees standing in our forests.

It should also be observed that whenever a hole made by a borer is discovered in the trunk of a tree, it should be immediately closed by inserting a plug therein, to exclude the wet which will otherwise be admitted hereby to the interior of the tree and produce a decay of the surrounding wood.—(Fitch's Fifth Report, pp. 4-10.)

#### 4. THE LESSER OAK CARPENTER WORM.

*Prionoxystus querciperda* (Fitch).

Order LEPIDOPTERA; Family COSSIDÆ.

(Pl. II, Figs. 4, 5.)

Another and rather smaller Cossid, but belonging to a closely allied species, was found by Mr. J. A. Lintner resting upon the trunk of an oak tree in Schoharie, N. Y. It probably ranges all over the Eastern States and Mississippi Valley, since a species, either this or closely allied, is reported to us by Mr. G. W. Belfrage to inhabit central Texas. Dr.



Fitch thinks it probable that it bores into the oak. He describes it as a moth smaller in size than *P. robinia*, with thin and slight transparent wings, which are crossed by numerous black lines, the outer margin only of the forward pair being opaque and of a gray color; the hind wings of the male are colorless, with the inner margin broadly blackish and the hind edge coal-black.

Mr. Lintner has found the larva burrowing in the black oak. The moth appeared April 29th. The male is about half as large as the female.

"This species is smaller than *robinia*, the female expanding 46<sup>mm</sup> or 47<sup>mm</sup>, the male about 10<sup>mm</sup> less. The male hind wings seem translucent, but on holding them obliquely in certain lights the yellow tint may be seen plainly. This smaller and rarer species occurs also in Texas. It is freer from reticulations and more transparent than any other form." (Bailey, Bull. No. 3, Div. Ent., Dept. Ag., 55.)

*Larva*.—Length an inch and a half. Pale green, with a darker green dorsal stripe, bordered faintly with yellow. Head flat, subtriangular, dark brown clouded with black. First segment with two brown spots extending across it, narrowed laterally, and of nearly the length of the segment medially, where they unite to inclose on the dorsal line an elongate-elliptical green spot. The anterior segments are flattened, and broader than the following, which gradually diminish in breadth toward the posterior end. The segments are marked dorsally with four rose-colored elevated points, the trapezoidal spots of Guenée; on the 10th and 11th segments they form a square. A similar spot is present above each stigma, a smaller one below, and another in front—each of these bearing a short brown hair. The stigmata are oval, orange-colored, centered with dark brown. The legs are tipped with chestnut brown, and the prolegs armed with brown plantæ.—(Lintner, Ent. Contributions, iv, 135.)

##### 5. *Cossula magnifica* Bailey.

(Pl. II, figs. 1-3.)

An account of this fine moth and its transformations is published in *Papilio* (ii, 93) by Dr. J. S. Bailey. The larvæ were found by Mr. Koebele boring in species of oak and hickory near Tallahassee, Fla. A single live-oak was observed standing in an open field containing many larvæ, their debris, resembling saw-dust, being distributed over the ground around the roots of the tree more than six inches in depth. "At the period of pupation the larvæ, as is customary with the Cossidæ, takes its position near the surface of the bark. The tunneling is usually conducted near the surface, from one-quarter to one inch beneath the bark. After the imagines emerge their pupa cases are left protruding through the bark."

*Pupa*.—The long testaceous pupa-case is provided with an irregular series of five tuberculations on each side of the anus. (Bailey.)

*Moth*.—Size small; male antennæ bipectinate to the tips, the inner series one-third the length of the outer pectinations; hind tibiæ pilose; wings broad, the front pair rounded at the apices, costa with dark dots; fuscous gray, smooth, with indistinct fragmentary reticulations. A light brown patch covers the outer edge; before the patch is a light gray subterminal shade. Hind wings blackish brown; front yellowish; thorax light gray; abdomen dark gray; expanse of wings, 36<sup>mm</sup>. (1.44 inches). (Bailey.)

6. *Cossus reticulatus* Lintner.

This moth was described by Mr. J. A. Lintner, from a single female in the collection of Mr. Neumogen, collected in Texas, on the Rio Grande. Mrs. Slosson has observed it riddling live oaks in Florida.

Allied to *C. robinia* in shape of wings and markings, having the stronger scales and reticulated ornamentation of that species, in which it differs from the minute and sparse scales and transverse lines of *C. querciperda* and *C. centerensis*.

Primaries reticulated with black on a pale ash ground, the wings lighter than in *C. robinia*, from the absence of the conspicuous intranervular black spots and streaks which characterize that species, and are well represented in fig. 205, p. 413, of Harris' *Insects Injurious to Vegetation*. In this species, only between the internal, submedian and 1st median venule (veins 1a, 1b, and 2), at the outer third of the wings, do the reticulations coalesce so as almost to form spots. In the terminal and subterminal portions of the wing, the small ash spots (sometimes ocellated with a black dot or line) for the greater part rest upon the veins; between 2 and 5, there are other spots intermediate to these venular ones; elsewhere, with a few exceptions, the spots are venular, forming two intranervular rows. The costal region is pale ash, traversed by black lines rather than reticulated. The median portion of the wing is imperfectly reticulated. The terminal margin and the unicolorous fringe are conspicuously marked with a black spot on each vein.

Secondaries thinly clothed with fuscous hairs, permitting the reticulations of the lower surface to be seen in transparency, except between the margin and costal nerve, where it is seated in pale ash, as the primaries. Terminal margin and the pale fringe, black spotted as the primaries.—(Lintner, Ent. Contributions, iv, 130, 1878.)

## 7. THE TOOTHED-LEGGED BUPRESTIS.

*Chrysobothris dentipes* Germar.

Order COLEOPTERA; Family BUPRESTIDÆ.

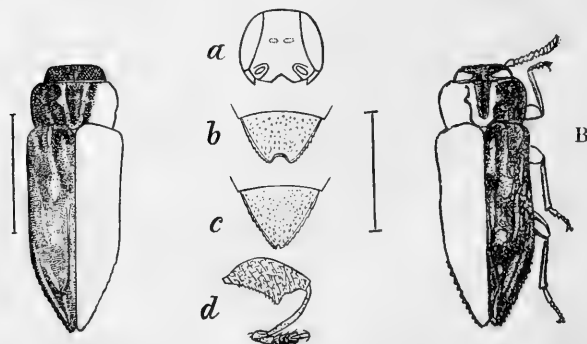


FIG. 15.—*Chrysobothris dentipes*: a, head, front view; b, last male ventral segment; c, last female ventral segment; d, first leg of male. After Horn. B. The same, after Smith.

Eating a slender, winding, broad, shallow burrow between the bark and sap-wood of newly felled oak trees; a white, footless grub, with the fore part of the body enormously large, circular, and flattened, inclosing the small head in front.

This singularly shaped borer is often found under the bark of newly felled oaks, or those which have been prostrate for a longer time. We have found it in its mine under the bark of the red oak at Salem, Mass., early in May, in company with more numerous individuals of *Magdalis olyra*.

It will be seen by the form of this singular borer that it is adapted for a life under or next to the bark of diseased trees, as it is quite unfitted, by reason of the enormously swollen front rings of the body, for boring very far into the living fresh wood, as is the case with the oak-boring caterpillar of *Prionoxystus robinia*, or the oak pruner (*Elaphidion villosum*). With its short, powerful jaws it can eat its way on either side in front of it, after hatching from the egg, which is probably laid by the parent beetle in some crack in the bark. Its head is rather small and partly sunken within the segment next behind the head. This segment, destined to be the prothorax of the beetle, is remarkably broad, nearly three times as much so as the hinder segments, and fully as broad again as it is long, while the surface above is flat and more or less rough or pitted in the middle. With this unusual form it can eat its way in a serpentine course under the bark, deriving its nourishment from the sap-wood next to the bark. Owing to the form of its body in front, the burrow is shallow and broad, in transverse outline oval cylindrical. The body of this as well as most other borers is provided with fine, delicate, scattered hairs, projecting on each side of each segment. Judging by analogy, these hairs are probably provided each with a fine nerve (though this remains to be proved), and probably are endowed with a delicate sense of touch, useful to the insect as it moves to and fro in its gallery. The Buprestid larvæ are blind, without simple eyes, since living as they do in total darkness and never coming to the light they do not need even the simple eyes present in many other larvæ, and which are probably chiefly of use in enabling the insect to distinguish light from darkness.

The larvæ of the *Buprestidæ* and the breeding habits of the beetles have not as yet been carefully studied in America, and for any exact knowledge we have to go to French and German authors.

According to Perris, the Buprestids couple in the usual manner, the male mounting upon the back of the female, the act of copulation not being of long duration.

The form of the eggs and their size in our species are unknown, or have not been stated in print. It is most probable that the female lays them in the bottom of cracks in the bark, or under the partly loosened bark at least, where the larva upon hatching may find itself next to or immediately in contact with the bast or the sap-wood, which probably forms the greater part of its food, though Ratzeburg has found that the "frass" or excrement is colored by the bark, which indicates that the larvæ feed both on the bast and bark. As to the number of eggs laid by the female we have no information. The eggs are deposited in fissures or cracks by means of the extensile end of the body. As Westwood states, "The abdomen appears to be composed of only five segments; the remainder are, however, internal, and constitute in the female a retractile, corneous, conical plate, employed for depositing the eggs in the chinks of the bark of trees within which the larvæ feed." Perris, however, says that "the

eggs are deposited in the interior of the bark, the outer layers of which the ovipositor of the female penetrates."

It has been claimed by Ratzeburg and also by Reifsig\* that the European larvæ of Buprestis and the numerous allied genera, such as *Chrysobothris*, *Chalcophora*, etc., attain their full size in two years; but according to Perris the time required for their transformations is but a single year, as may be seen by the extracts from his work further on.

As regards the habits of the larvæ we have no direct observations on the young of this family in this country, though much needed in connection with the use of remedial measures.

Mr. E. Perris, in his invaluable work, entitled "*Insectes du Pin maritime*," says of the larva of the European *Ancylocheira flavomaculata* :

The larva of the *A. flavomaculata* lives in the wood of old pines recently dead, and especially in the larger branches and the large twigs (*pieux*). It is, indeed, under these two last conditions that they oftenest occur. It does not stop in the bark, because it is in the interior of the bark that the female lays its eggs, by means of its oviduct, and after its birth it plunges into the wood to the depth of about a centimeter [nearly two-fifths of an inch]. It follows the longitudinal fibers of the sap-wood while making a gallery elliptical in section, which it leaves behind it completely filled and packed with excrement and detritus. When the time of its metamorphosis approaches it goes towards the surface of the sap-wood, perforates it to the bark, sometimes makes a small incision into the latter, stops up the gallery with a plug made entirely of small, compacted chips; then it retires backward a little into a cell scooped out in the wood, and this is where it transforms into a pupa.

The following extract from Perris refers to the habits of *Chrysobothris solieri*, which also lives in the maritime pine in France. The habits of our *C. dentipes* of the oak, and *C. femorata* of the oak and different fruit trees, and *C. harrisii* of the white pine are probably quite similar.

According to my observations the *Chrysobothris* only lays its eggs on the trunks of pines from five to fifteen centimeters in diameter at the base, and on the branches of old trees. I have never found it on an old trunk, and when a large prostrate pine is deprived of its branches it is on them that it lives, and not on the trunk. I have already said that the larva lives at first under the bark; it there busies itself, sometimes attacking very plainly the sap-wood, sometimes boring a sinuous gallery, which it leaves behind it filled with white chips and excrements of a brownish red; but at the approach of winter it burrows into the wood, where it gouges out a gallery elliptical in section, the dimensions of which increase as its body grows larger. When the moment of transformation has arrived it returns into its gallery, and undergoes its metamorphosis sometimes more than two centimeters from the surface, because I have found some pupæ and perfect insects at this depth.

Perris calls attention to the fact that though the Buprestid beetles stand quite high in the Coleopterous series, yet their larvæ have an organization inferior to that of all other Coleopterous larvæ known. Thus, they have neither feet nor eyes, and there are no other Coleopterous larvæ which, as in the Buprestids, have very rudimentary labial palpi, and which consist of less than two joints.

---

\* Ratzeburg's *Die Waldverderbniss*, etc., ii, p. 360.

The burrows of the Buprestid larvæ may nearly always be distinguished, says Perris, by their tortuous course, and by the fact that the excrement and detritus, instead of being accumulated in the gallery without order, are there disposed in small layers forming concentric arcs, whose opening is turned away from the larvæ, and of a regularity not less remarkable than characteristic.

This symmetrical arrangement has as its primary cause the dimensions of the gallery, which are out of proportion with the abdomen of the larva. The latter, because of the size of the anterior portion of its body, is obliged to give to its gallery a size sufficient for the posterior part to execute freely movements of advance and retreat, which have as their natural result the disposition *en arc* of the rejected material behind. On the other hand, the larva, in consequence of the dimensions of its gallery, in order to have points of support is obliged to bend the posterior part of the body on itself. It is, indeed, ordinarily found in this attitude, which allows it to press against the walls, so as to push itself ahead; but in this condition the abdomen forms an arc which, propping itself from the convex side on the detritus, causes the concavity of the successive beds. \* \* \*

We have seen that some Buprestid larvæ undergo their metamorphoses in the interior of the bark, others in the thickness of the wood. It is, moreover, in this that the wisdom of nature is revealed, for it is not capriciously and without motive that things happen as I have described. We know, indeed, that if those larvæ which do not attack the young trees, as those of *Ancylocheira 8-guttata*, of *Chrysobothris solieri*, and of *Anthaxia morio*, and of several species of *Agrilus*, should live under the bark they would not be sufficiently protected, because the bark is not thick enough and would easily separate from the wood. When, however, on the contrary, they live under the hard and thick bark of old trees, as *Melanophila tarda*, *Chrysobothris affinis*, *Agrilus biguttatus*, and *4-guttatus*, and others, they do not hesitate to take refuge in the bark, because they are there well sheltered, and because they save the beetle from making a long and difficult journey in order to make its exit. \* \* \*

What is the duration of the life of the larvæ of the *Buprestidæ*? Ratzeburg is inclined to believe that it is two years. M. Levaillant, whose observations are reproduced by M. Lucas in his notice of *Chalcophora*, is also disposed to think that those of this insect pass two years in the wood. The reason which he gives, and which is drawn from the size of the larvæ found from December to August, does not seem to me conclusive, because the female of *Chalcophora* is capable of laying eggs during almost the entire year. As to M. Ratzeburg, he has not, apparently, made careful observations in this respect.

As to myself, numerous facts authorize me to say that, in general, these larvæ only live one year. For example, some pines, poplars, and willows which I have cut down in the spring time, with the design of obtaining Buprestids, have afforded me often very numerous perfect insects in May and June of the year following.

Some logs of oak, cut in January, 1847, and which lay during a whole year in the open air, furnished me in June and July, 1848, more than three hundred *Chrysobothris affinis*. The trunks of some large, very rigorous pines, cut down at the beginning of one year, contained pupæ of *Ancylocheira* in the following May. Finally, as regards all the species that I have here described, and for a number of others, I have, from my own experience, the certainty that the larvæ live only one year.

I admit that, without doubt, among these larvæ there are some which, not placed in conditions sufficiently favorable to complete during this period all the phases of their existence, from one cause or another, may be retarded some months, for a year even. I moreover accept the more willingly this fact, because I have had good occasions for observing this in larvæ which I have raised in my cabinet; but this is the exception, and the rule is that a single year suffices, in our country, for the development of the larvæ of the *Buprestidæ*.

The Buprestids in the perfect state love the daylight and sunshine. Before storms, when the air is calm and heavy and the sun is hot, they have an extraordinary activity; and when the weather gradually becomes cloudy and the wind rises they disappear from our sight. We know but little as to the nature of their food. *Chalcophora mariana* devours the young shoots of pines, *Anthaxia morio* and *chevrierii* eat, the first the petals of buttercups, the second those of *Cissus alyssoides*. Other *Anthaxiæ* also, as well as *Trachys*, frequent different flowers. *Aphanisticus emarginatus* occurs on rushes (*joncs*), and I have sometimes taken *Acmeodera tæniata* on the flowers of carrots. All these facts lead me to think that the Buprestids are phytophagous; but it appears that certain species are, accidentally at least, carnivorous. This appears from a communication made by M. Léon Fairmaire to the Société Entomologique, in its session of January 10, 1849, relative to the subject of *Chrysobothris solieri*.

Regarding our oak-borer (*C. dentipes*), Harris states that it completes its transformations and comes out of the trees between the end of May and the first of July. This applies to Maine and Massachusetts. In New York, according to Dr. Fitch, the beetles are "often found basking in the sunshine on the bark of the trees in June and July."

*The beetle.*—This insect is so named from the little tooth on the under side of the thick fore legs. It is oblong, oval, and flattened, of a bronzed brownish or purplish-black color above, copper-colored beneath, and rough-like shagreen, with numerous punctures; the thorax is not so wide as the hinder part of the body; its hinder margin is hollowed on both sides to receive the rounded base of each wing-cover, and there are two smooth elevated lines on the middle; on each wing-cover there are three irregular, smooth, elevated lines, which are divided and interrupted by large, thickly punctured, impressed spots, two of which are oblique; the tips are rounded. Length from  $\frac{1}{2}$  to  $\frac{6}{10}$  of an inch. (Harris.)

#### 7. THE FLAT-HEADED BORER.

*Chrysobothris femorata* Fabricius.

Order COLEOPTERA; Family BUPRESTIDÆ.

Boring under the bark and in the sap-wood of the white oak, and in the Gulf States, the pin oak; a pale-yellow flat-headed grub, closely resembling the preceding species.

This pernicious borer of the apple tree, as stated both by Harris and Fitch, originally infested the white oak, but since the settlement of the country has abounded in the apple and sometimes in the peach, but may still be found to injure the white oak. Riley has also found it in the soft maple and weeping willow. Riley has reared this beetle from the oak, apple, mountain ash, box elder, peach, and pear, and has found the larva in the mountain ash, linden, beech, cherry, and peach (7th Rt. Ins. Mo., 72).

Fig. 18 will fairly represent the "mine" or gallery made under the bark of a stump of the white oak, as it occurred at Providence, R. I. The worm soon after hatching made the mine as is seen on the right of

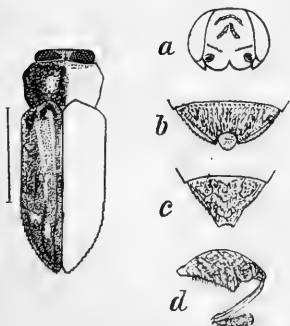


FIG. 16.—*Chrysobothris femorata*: a, head; b, last ventral segment of male; c, last ventral segment of female; d, first leg of male.—After Horn.

the figure, where after a sinuous course it opens into a broad, shallow cell, and then after pursuing an irregular direction dilates on the left into a broad, shallow cell two-thirds of an inch wide; the oval, black spot in the upper corner representing the hole made by the larva for the exit of the beetle. In this hole the beetle was found. The large cell is for the repose of the pupa.

At Houston, Tex., I found the larva and pupa in abundance, April 2, 1881, under the bark of large pin oak stumps and of dead trees. The burrows were like those represented in Fig. 18, being irregular winding, shallow burrows, not nearly so definite in outline as those made by longicorn borers. The mine is about  $\frac{1}{2}$  inch wide, and terminates in a broad, irregular, oval cell  $1\frac{1}{2}$  inches long and  $\frac{1}{4}$  to  $\frac{2}{3}$  inch wide. In this cell the pupa spends the winter and early spring. One end of this cell lies toward the outer side of the bark so that even if there is not a clearly defined oval opening, as in Fig. 18, the beetle on emerging from the pupa state can with little difficulty extricate itself from its cell and make its way out of doors by pushing aside a thin barrier of bark. In the case of one in the pin oak there was a quite irregular, oval cell built up by the larva between the wood and the bark, the partition consisting of a composition of firm bark dust, thus forming a rude cocoon. The insect occurred at Providence in the larva, pupa, and beetle states May 20, though the larvæ were the most abundant.

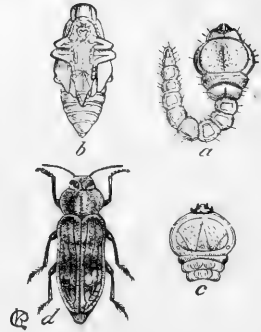


FIG. 17.—Transformation of *Chrysobothris femorata*.—*a*, larva; *b*, pupa; *c*, under side of the head and thorax segments; *d*, beetle. After Riley.

Harris says of it from his observations in eastern Massachusetts :

Its time of appearance is from the end of May to the middle of July, during which it may often be seen, in the middle of the day, resting upon or flying round the trunks of white-oak trees and recently-cut timber of the same kind of wood. I have repeatedly taken it upon and under the bark of peach trees also. The grubs or larvæ bore into the trunks of these trees.

Mr. Ricksecker remarks that on the Pacific coast it “attacks young fruit trees that have been scorched by the sun, but its natural food is the oak, for I have seen dozens of them in the branches of a small live oak that had been cut down less than an hour.” (Ent. Amer., i, 97.)

The following extracts from Dr. Fitch’s first report will further serve to characterize the habits and appearance of this formidable pest of our most valuable forest, shade, and fruit trees. It will appear that Dr. Fitch has been the first to discover an ichneumon parasite in the larva of this beetle, no European Buprestid beetle being, so far as we know, infested by internal parasites:

Another insect, which has not heretofore been noticed in our country as a borer in the apple tree, pertains to the family *Buprestidae*, or the brilliant snapping beetles.

Mr. P. Barry, of the Mount Hope nurseries, Rochester, has forwarded to us sections of the body of some young apple trees, which were sent to him from a correspondent in Hillsborough, in southern Ohio, who states that in that vicinity the borer, which is contained in the specimens sent, is doing great damage to the apple trees, and that he has had peach trees also killed by this same worm. From an examination of these specimens, it appears that this insect is quite similar to the common apple-tree borer in its habits. The parent insect deposits its eggs on the bark, from which a worm hatches, which passes through the bark and during the first periods of its life consumes the soft sap-wood immediately under the bark. But when the worm approaches maturity and has become stronger and more robust, it gnaws into the more solid heart-wood, forming a flattish, and not a cylindrical hole such as is formed by most other borers, the burrow which it excavates being twice as broad as it is high, the height measuring the tenth of an inch or slightly over. It is the latter part of summer when these worms thus sink themselves into the solid heart-wood of the tree, their burrow extending upwards from the spot under the bark where they had previously dwelt. On laying open one of these burrows I find it is more than an inch in length, and all its lower part is filled and blocked up with the fine sawdust-like castings of the worm. Thus, when the worm is destined to lay torpid and inactive during the long months of winter, it has the forethought, so to speak, to place itself in a safe and secure retreat, within the solid wood of the tree, with the hole leading to its cell plugged up so as effectually to prevent any enemy from gaining admission to it.

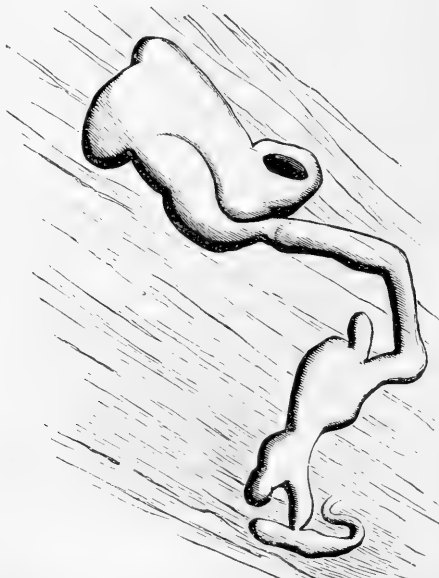


FIG. 18.—Mine or burrow made by the apple flat-headed borer (*C. femorata*) in the white oak, nat. size.—Packard del.

Still, this worm is not able to secure itself entirely from those parasitic insects which are the destroyers of so many other species of its race, and which, as is currently remarked, appear to have been created for the express purpose of preying upon those species, in order to prevent their becoming excessively multiplied. We should expect that this and other borers, lying as they do beneath the bark or within the wood of trees, were so securely shielded that it would be impossible for any insect enemy to discover and gain access to them, to molest or destroy them. But among the specimens sent me by Mr. Barry is one where the worm has been entirely devoured, nothing but its shriveled skin remaining, within and upon



which are several minute maggots or footless little grubs, soft, dull white, shining, of a long egg shaped form, pointed at the tip and blunt in front, their bodies divided into segments by very fine transverse impressed lines or sutures. They are about one-tenth of an inch long and 0.035 broad at the widest part. These are evidently the larvæ of some small Hymenopterous or bee-like insect, pertaining, there can be little doubt, to the family Chalcididæ, the female of which has the instinct to discover these borers, probably in the earlier periods of their life when they are lying directly beneath the bark, and piercing through the bark with her ovipositor, and puncturing the skin of the borer, drops her eggs therein, which subsequently hatch and subsist upon the borer, eventually destroying it. These minute larvæ were forwarded to me under the supposition that they were injurious to the apple tree, whereas, by destroying these pernicious borers, it is evident they must be regarded as our best friends. This fact illustrates how important it is for us to be acquainted with our insects in the different stages of their lives, that we may be able to discriminate friends from foes, and know which to destroy and which to cherish. (Fitch.)

*Larva.*—Prothorax very broad, being broader and flatter and the abdominal segments smaller in proportion than any other borer of this family known to us. Head retracted within the prothorax. The disk finely shagreened with raised dots. A narrow inverted V-shaped smooth impressed line in the middle of the disk, the apex becoming prolonged towards but finally becoming obsolete at the front edge of the disk; the arms of the V behind not reaching very near the posterior edge of the disk. Beneath, is a similar roughened disk, but more regularly rounded-oval than above, and with a single straight median swollen impressed line, which is a little over one-half as long as the disk, but which reaches a little nearer the front than the hind edge.

Second thoracic (mesothoracic) segment very short, considerably shorter and wider than the third, with an oval, slightly rough, area on each side of the median line, the similar area on the third thoracic segment being larger and united over the median line.

The ten abdominal segments of uniform width, being a little shorter than broad, except the small tenth segment, which is about two-thirds as wide as the ninth. A pair of irregular, rather long patches on each abdominal segment above, and a pair of curvilinear impressed lines beneath.

One pair of mesothoracic and eight pairs of abdominal spiracles.

Head a little narrower than the thoracic disk. Clypeus corneous, square in front—very short and broad. Labrum square, a little longer than wide, front edge moderately rounded, densely hirsute. Antennæ 3-jointed; first joint short, membranous, second considerably narrower, third minute, rounded at tip, considerably slenderer than second. Mandibles entirely black. Maxillary lobe short, projecting slightly beyond the edge of labium. Maxillary palpus 2-jointed, second joint not so long as the first is wide, one-third as thick, and extending a little beyond the maxillary lobe. Labium entire, the front edge not being excavated.

Length, 22<sup>mm</sup>; breadth of prothoracic segment, 7<sup>mm</sup>; length, 4<sup>mm</sup>; width of sixth abdominal segment, 3<sup>mm</sup>.

*Pupa.* Body flattened, and of the general shape of the imago. The antennæ seen from above extend to a little behind the outer hinder angle of the prothorax. The elytra reach to the middle of the fourth abdominal segment. The wings extend as far as the hinder edge of the same segment. The third pair of tarsi reach to near the middle of the sixth abdominal segment. Six pairs of abdominal spiracles. Length, 15<sup>mm</sup>; breadth, 7<sup>mm</sup>.

In transforming, the eyes, the front of the head, the prothorax, the femora, and tibiæ and portions of the sternum and under side of the abdominal segments turn dark first.

The foregoing descriptions have been drawn up from specimens obtained by us in Texas and in Rhode Island.

*The beetle.*—Like other species of its family, the thick-legged Buprestis is variable in size, measuring from four to five tenths of an inch in length and about two-thirds in width. It is of a black or greenish-black color, polished and shining, with the surface rough and uneven. The head, and sometimes the thorax, and the depressed portions of the elytra are of a dull coppery color. The head is sunk into the thorax to the eyes, is densely punctured, and is clothed in front with fine white hairs, which are directed downwards. Upon the middle of the top of the head is a smooth raised black line with a narrow impressed line through its middle, a mark which serves to distinguish this from some of the other species which are closely related to it. The thorax is much more broad than long, and is widest forward of the middle. Its surface is covered with dense, coarsish punctures, which run into each other in a somewhat transverse direction. It is also somewhat uneven, with slight elevations and hollows, but has not two smooth raised lines on its middle and anterior part, which are met with in another species very similar to this, the tooth-legged snapping-beetle (*Chrysobothris dentipes* Germar). The elytra or wing-covers present a much more rough and unequal surface than any other part of the insect. Three smooth and polished raised lines extend lengthwise of each wing-cover, and the intervals between them are in places occupied by smaller raised lines, which form a kind of net-work, and two impressed transverse spots may also be discerned, more or less distinctly, dividing each wing-cover into three nearly equal portions. These spots reach from the inner one of the three raised lines nearly to the outer margin, crossing the two other raised lines and interrupting them more or less. They are commonly of a cupreous tinge, and densely punctured, but are smoother than the other portions of the surface. A smaller and more deeply impressed spot may commonly be found in the space next to the suture and forward of the anterior spot, of which it is, as it were, a continuation. The wing-covers are rounded at their tips, so as to present a slight notch at the suture when they are closed, and the outer margin towards the tip has several very minute projecting teeth. When the wing-covers are parted the back is discovered to be of a brilliant bluish-green color and thickly punctured, with a row of large impressed spots along the middle, one on each segment, and half way between these and the outer margin is another row of smaller impressed dots, having their centers black. The underside of the body and the legs are brilliant coppery, the feet being deep shining green, their last joint and the hooks at its end black. Here also the surface is everywhere thickly punctured, the punctures on the venter or hind part of the body opening backwards. The last segment has an elevated line in the middle at its base, and its apex is cut off by a straight line, in the middle of which is commonly a small projecting tooth. The anterior thighs are remarkably large, from which circumstance this species has received its name, and they have an angular projection on their inner sides, beyond the middle. The tibiae, or shanks, of these legs are slightly curved. (Fitch.)

**REMEDIES.**—Under this head we extract the following suggestions from Fitch:

The remedies for destroying this borer must necessarily be much the same with those already stated for the common borer or striped Saperda. They consist essentially of three measures: First, coating or impregnating the bark with some substance repulsive to the insect; second, destroying the beetle by hand-picking; and, third, destroying the larva by cutting into and extracting it from its burrow.

As it is during the month of June and forepart of July that the beetle frequents the trees for the purpose of depositing its eggs in the bark, it is probable that white-washing the trunk and large limbs or rubbing them over with soft soap early in June will secure them from molestation from this enemy. And in districts where this borer is known to infest the apple trees the trees should be repeatedly inspected during this part of the year, and any of these beetles that are found upon them should be captured and destroyed. It is at midday of warm, sunshiny days that the search

for them will be most successful, as they are then most active and show themselves abroad. The larvæ, when young, appear to have the same habit with most other borers, of keeping their burrow clean by throwing their castings out of it through a small orifice in the bark. They can, therefore, be discovered probably by the new sawdust-like powder which will be found adhering to the outer surface of the bark. In August or September, while the worms are yet young and before they have penetrated the heart-wood, the trees should be carefully examined for these worms. Wherever, from any particles of the sawdust-like powder appearing externally upon the bark, one of these worms is suspected, it will be easy, at least in young trees, where the bark is thin and smooth, to ascertain by puncturing it with a stiff pin whether there is any hollow cavity beneath, and if one is discovered, the bark should be cut away with a knife until the worm is found and destroyed. After it has penetrated the solid wood it ceases to eject its castings, and, consequently, we are then left without any clew by which to discover it. Hence the importance of searching for it seasonably.

The following ichneumon parasites are said by Riley to keep the numbers of the larvæ in check, besides a chalcid fly: *Bracon charus* Riley and *Cryptus* or *Labena grillator* Say.

#### 8. THE GREEN-HEADED CHRYSOBOTHRIS.

*Chrysobothris chlorocephala* (Gory).

Order COLEOPTERA; Family BUPRESTIDÆ.

Probably boring under the bark of the white-oak, with habits similar to those of other flat-headed borers of the oak; a Buprestid beetle.

#### 9. THE NORTHERN BRENTHIAN.

*Eupsalis minuta* (Drury).

Order COLEOPTERA; Family BRENTHIDÆ.

Boring into the solid wood of the white oak, forming a cylindrical passage, a slender grub  $\frac{3}{4}$  inch long and not quite 0.05 inch thick, changing to a weevil with a large, very thick snout.

The habits and transformations of this beetle were first described by Dr. Riley, the original account given by Dr. Harris proving erroneous, his larva being that of a Tenebrionid beetle, as stated by Riley. This interesting weevil may be found on the trunk and under the bark of the white oak in June and July in New England, or in May and June in New York and Missouri, having then assumed the imago or beetle condition. Riley states that it is equally common on the black, red, and post oaks; that it bores in all directions through the heart-wood, and is found most commonly in stumps or in felled trees the year after they are cut.

The beetle differs from other weevils in that the snout projects straight out in front, not being curved downwards as in weevils in general. In the male the snout is much broader and flatter than in the female, but



FIG. 19.—*Chrysobothris chlorocephala*.—Smith, del.

varies considerably, especially in the males, both in length and breadth. It is of a mahogany brown, the thorax smooth and highly polished, and the wing-covers strongly furrowed, shaded with deeper brown, and marked with narrow tawny-yellow spots. It is from one-fourth to a little over one-half an inch in length. The males are, contrary to the general rule in insects, almost invariably the larger. The males of the Brenthians are known to fight desperately for the female, and, as has been remarked by Mr. A. R. Wallace,\* it is interesting,

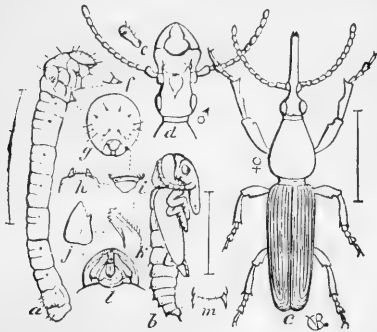


FIG. 20.—Northern Brenthian; a, larva; b, pupa; c, beetle, female; d, head of male; e, 4th antennal joint; f, leg; g-l, parts of larval head.—After Riley.

“as bearing on the question of sexual selection, that in this case, as in the stag beetles, when the males fight together, they should be not only better armed, but also much larger than the females.” (Riley.)

According to Riley, in Missouri the eggs are deposited during the months of May and June. The female bores a cylindrical hole in the bark with her slender snout and pushes an egg to the bottom of the hole.

“It requires about a day to make a puncture and deposit the egg. During the time the puncture is being made the male stands guard, occasionally assisting the female in extracting her beak; this he does by stationing himself at a right angle with her body, and by pressing his heavy prosternum against the tip of her abdomen; her stout forelegs serving as a fulcrum and her long body as a lever. When the beak is extracted, the female uses her antennæ for freeing the pincers or jaws of bits of wood or dust, the antennæ being furnished with stiff hairs and forming an excellent brush. Should a strange male approach, a heavy contest at once ensues, and continues until one or the other is thrown from the tree. The successful party then takes his station as guard.” (W. R. Howard, in Riley’s Sixth Report.)

Riley thinks that the larva lives but a single year, although larvæ of different sizes occur in midwinter with the beetles.

*The larva.*—Length, 0.55–0.75 inch; diameter in middle of body, 0.05 inch. Body almost straight, cylindrical, 12-jointed, with a few faint hairs only on prothorax and around anus; thoracic joints short, bent a little forward, swollen and broadly and deeply wrinkled, with two especially prominent swellings on top of joints 2 and 3, converging towards head, and having each a granulated rufous spot; the other joints with about three dorsal transverse wrinkles; joints 5–9 subequal, as long as 1–3 together, twice as long as 4; 10–12 diminishing in length, slightly swollen, the anus

\* The Malay Archipelago, p. 482. The line by the side of the insect in this and other cuts indicates the length of the insect, most of the sketches being enlarged views.

retracted; 6 very small 3-jointed thoracic legs, the terminal joint being a mere bristle; stigmata quite distinct and brown, the first pair much the largest, between the fold of joints 2 and 3; the others on anterior fifth of joints 4-11, the last pair more dorsal than the rest. Head pale yellow, darker around mouth; rounded, more or less bent over the breast, with sparse, stiff, pale hairs springing from elevated points; ocelli, none; antennæ not visible, unless a dusky prominence lying close between mandibles and maxillæ be called such; labium small, with two depressions and other inequalities, the margins slightly angular, allowing the jaws to closely fit around it; jaws stout, triangular, the inner margin produced at middle into a larger and smaller tooth, and with a slight excavation near tip; maxillæ long, with but a short, horny cardinal piece; the palpi apparently 2-jointed and with difficulty resolved, on account of three or four other prominences around them; garnished on the inside with a close row of stiff hairs and on the outside with two stouter hairs; labium large, oboval, the palpi placed in front and 2-jointed.

*Pupa*.—Average length 0.40 inch, with the antennæ curled back over the thorax, the seven or eight terminal joints each with a more or less distinct, forwardly-directed, brown thorn; the snout lying on the breast and varying according to sex; abdominal joints with a more or less distinct row of small thorns on the posterior dorsal edge, the last joint with a more prominent thorn directed backwards in a line with the body. (Riley.)

#### 10. THE GRAY-SIDED OAK WEEVIL.

*Pandeletius hilaris* (Herbst).

Order COLEOPTERA; Family CURCULIONIDÆ.

Making a smaller burrow than that of the Northern Brentian, a worm like that of the plum weevil and changing to a gray weevil, found on the leaves from May to September.

Beyond the fact stated by Harris that the larva lives in the trunks of white oaks, on which the beetles occur from late in May to September, we know nothing of this insect.

*The beetle*.—A little pale-brown beetle, variegated with gray upon the sides. Its snout is short, broad, and slightly furrowed in the middle; there are three blackish stripes on the thorax, between which are two of a light-gray color; the wing-covers have a broad stripe of light gray on the outer side, edged within by a slender blackish line, and sending two short oblique branches almost across each wing-cover; and the fore legs are larger than the others. Length from one-eighth to one-fifth of an inch. (Harris.)



FIG. 21.—*Pandeletius hilaris*.  
Smith, del.

#### 11. THE QUERCITRON BARK-BORER.

*Graphisurus fasciatus* (De Geer).

Order COLEOPTERA; Family CERAMBYCIDÆ.

Feeding upon and destroying the quercitron bark of newly-felled trees, forming large tracks filled with worm-dust, a white, footless grub about 0.60 inch long, and with a transverse oval tawny-yellow spot on the middle of each wing above and below; in June transforming to a long-horned beetle about one-half an inch long, of an ash-gray color sprinkled with blackish spots and punctures, and back of the middle of its wing-covers an irregular oblique black band; the female with a straight awl-like ovipositor nearly one-quarter of an inch in length. (Fitch.)

Prof. Riley found this insect boring in the wood of a rotten oak-stump in May, 1872, at St. Louis, Mo.

The bark called quercitron, of the *Quercus tinctoria*, is highly valued as a dye, and is much worm-eaten by this insect.

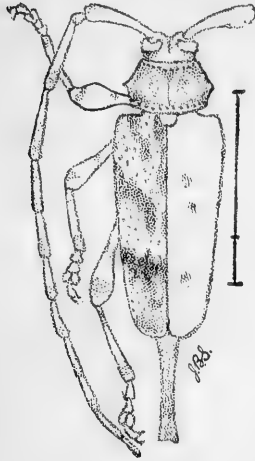


FIG. 22.—*Graphisurus fasciatus*, female. Smith, del.

The parent of the worm differs remarkably from all the other beetles of this group in that the female is furnished with a straight awl-like ovipositor nearly a quarter of an inch in length, projecting horizontally backwards from the end of her body. The importance of this implement becomes manifest when we observe the thickness of the bark of the black oak, with its outer layers so dry and hard that they form, as it were, a coat of mail, protecting the trunk of the tree against the attacks of its enemies. Equipped as she is, however, the female of this beetle is able to perforate this hard outer bark and sink her eggs through it, placing them where her young will find themselves surrounded with their appropriate food. The worms from these eggs mine their burrows mostly lengthwise of the grain or fibers of the bark, and the channels which they excavate are so numerous and so filled with worm-dust of the same color with the bark that it is difficult to trace them.

The eggs are deposited the latter part of June, and the worms grow to their full size by the close of the season, and will be found during the winter and spring, lying in the inner layers of the bark, in a small oval flattened cavity about an inch in length, which is usually at the larger end of the track they have traveled.

The larva is divided by transverse constrictions into twelve rings, the last one being double. The head is small and retracted more or less into the neck, its base white and shining, and its anterior part deep tawny yellow, and along each side black. The neck or first ring is much longer as well as thicker than any of the others, the two rings next to it being shortest. From the neck the body of the worm is slightly tapered backwards to the middle, from whence it has nearly the same diameter to the tip, where it is bluntly rounded. Upon the upper side of the neck, occupying the basal half of this ring, is a large transverse tawny-yellow spot, rounded upon its forward side; but no corresponding spot appears on the under side of this ring. On the middle of all the other rings, except the two last, both above and below, is an elevated, rough, transverse, oval spot of a tawny-yellow color.

The beetle, like other species of the family to which it pertains, varies greatly in its size, specimens before me being of all lengths, from 0.35 to 0.58. It is of an ash-gray color from short incumbent hairs or scales, which have a faint tinge of tawny yellow except along the suture of the wing-covers. It is also bearded with fine erect blackish hairs which arise from coarsish black punctures which are sprinkled over the thorax and wing-covers, several of which punctures are in the centre of small black dots, which in places are confluent into small irregular spots. The head is of the same width as the anterior end of the thorax, and has a deep narrow furrow along its middle its whole length, and on the crown is an oval blackish spot on each side of this furrow. The face is dark gray, and the antennæ are black with an ash-gray band occupying the basal half of each of the joints. The thorax is narrower than the wing-covers, more broad than long, and thickest across its middle. Upon each side slightly back of the middle is an angular projection or short broad spine, blunt at its tip. On the middle of the back, between the centre and the base, is a short impressed line, and on each side of this, extending the whole length of the thorax, is a wavy blackish stripe, which is suddenly widened towards its hind end, and is some-

times interrupted in its middle. Often, also, there is a blackish spot between the anterior ends of these stripes, extending from the centre of the thorax to its forward end. The scutel is ash-gray in its middle and black upon each side. The wing-covers almost always show a large oblique and irregular triangular spot of black on their outer side forward of the middle, and always behind the middle is an irregular black *oblique band*, which seldom reaches to the suture, and which has a notch in the middle of its anterior side, and opposite to this on its hind side a large angular projection extending backward. Immediately back of this band is an irregular spot of a paler black color, which is sometimes confluent with the band; and there is also a small blackish spot on the outer side of the tips. The tips are cut off, sometimes transversely in a straight line, but usually concavely, and sometimes presenting a slight tooth-like projection on each side. The legs are ash-gray, the thighs with two black spots on their upper side, and the shanks with a black band at their base and another at their tip, these bands being more broad on the hind pair.

On elevating the loose bark of fallen trees the forepart of June, these insects will be found therein, lying in the cavities already mentioned, some of them being still in their pupa state, while others are changed to their perfect form, ready with the stout jaws and sharp teeth with which they are furnished to gnaw their way through the bark and come abroad.

This species occurs throughout the United States and Canada. Different specimens of it, however, vary greatly in their aspect. Even when newly born, among the individuals in the bark of the same tree, considerable diversities in size and markings may be noticed. And the beetles found in this situation have their colors so much brighter and their spots and bands so much more distinct and clearly defined that I supposed them to be a different species from *fasciatus* for several years and until specimens came to hand showing a gradual transition from these to the older individuals which we usually capture abroad, and meet with preserved in cabinets, in which the colors have become faded and dim and the marks obscure and partially obliterated. In the shape of some of its parts, also, different specimens are liable to vary. (Fitch.)

## 12. THE OAK LIOPUS.

*Liopus querci* Fitch.

Order COLEOPTERA; Family CERAMBYCIDÆ.

Probably boring in the red and white oak, the beetle occurring on the leaves early in July.

A very small, long-horned beetle, which I am unable to refer to any of the described species, I am assured lives at the expense of the red and white oak, from meeting with it upon those trees standing apart from others in fields. As the larvæ of kindred species burrow in the bark of trees, this will probably be found in the same situation in oaks. The beetle is met with upon the leaves of these trees early in July. It is very closely related to the Facetious *Liopus*. (Fitch.)

*The beetle.*—It is 0.20 inch long, and black, with ash-gray wing-covers, which are punctured and marked with a large black spot on the base of their suture in the form of a cross, and a broad black band slightly back of their middle, which is angulated, somewhat resembling an inverted letter **W**, this band often having a small ash-gray spot placed in it near its outer ends. Forward of this band are two black dots or short lines on each wing-cover, and sometimes a third dot back of it. There is also a dusky spot, usually on the tips of the wing covers, and their deflected outer margin is black. The wing-covers are rounded at their tips. The thorax sometimes shows three faint gray stripes above. It is narrowed anteriorly, and on each side slightly forward of the

base is a short, broad, sharp-pointed spine, from the tip of which, forward, the sides are straight. The long, thread-like antennæ are dull yellow, with a slight duskiuess at the end of each joint. The legs are blackish, with the bases of the thighs, and frequently of the shanks also, pale dull yellow, the hind thighs being less thickened towards their tips than the four forward ones. (Fitch.)

### 13. THE THUNDERBOLT BEETLE.

*Arhopalus fulminans* (Fabr.).

Order COLEOPTERA; Family CERAMBYCIDÆ.

Excavating a burrow in the soft sap-wood, about three inches long and 0.20 inch in diameter, a worm like the apple-tree borer, which changes to a long-horned beetle.

This beetle is said by Fitch to infest the oak, excavating a burrow in the soft sap-wood about three inches long and 0.20 inch in diameter, this burrow having the shape of a much bent bow or a letter **U**. It changes to a pupa in the same cell, the beetle appearing in July. We have also found that it bores in the chestnut, and for a description and figure of the beetle would refer the reader to the account of insects infesting the chestnut.

### 14. THE WHITE-OAK PHYMATODES.

*Phymatodes variabilis* (Linn.).

Order COLEOPTERA; Family CERAMBYCIDÆ.

Boring the trunk and branches of the white oak, a narrow longicorn larva, changing to a reddish-yellow thick-bodied longicorn beetle, more or less marked with blue.

Several specimens of this beetle were taken by Mr. Alfred Poor from a white-oak stick, June 20. It was collected on a pile of oak cordwood, May 30, by Mr. Calder; and I have a specimen of it from Salt Lake City, Utah, identified by Dr. Horn. It is undoubtedly closely similar in its habits and in the form of the larva to the grape *Phymatodes* figured in our first report on the injurious insects of Massachusetts, and is one of our more common species of the genus.



FIG. 23.—*Phymatodes variabilis*.—  
Smith, del.

*Beetle*.—It is closely allied to *P. amarus*, but is larger and less coarsely punctured, while the antennæ are more reddish; the scutellum is concolorous with the wing-covers. The body, legs (except the femora, which are blackish in the middle), and antennæ are reddish, the tips of the joints of the latter dark, and on the back of the prothorax are two black spots, often confluent. The head is black. The wing-covers are Prussian blue, smooth, finely punctured, with rather thick, fine, black hairs, bent downwards. Specimens recently changed from the pupa state are brown, and the species is exposed to considerable variation, as its name indicates. The male is just half an inch long, the female .60 inch.

The foregoing description is taken from our second report on the injurious insects of Massachusetts. The pupa of this beetle was also



found at Providence, May 30, 1862, by Mr. George Hunt, under the bark of the oak (not the white oak); the beetle appeared June 8. We add the following description of the larva of a closely allied species, *P. amœnus*, Fig. 24, which injures the trunk of the grape:

*The larva of the Grape Phymatodes.*—Several years ago I received from Dr. Shimer, of Illinois, specimens of the larva, pupa, and adult of this pretty insect (*Callidium amœnum* of Say), which is not uncommon in our own State. So much alike are all the borers of this family of long-horned beetles that long and prolix descriptions and carefully drawn figures of the mouth parts (wherein most of the differences lie) are absolutely necessary for their identification.

The larva (Fig. 24, *b*, head seen from above; *c*, seen from beneath) has a small head, which is a little more than half as wide as the prothoracic segment. This latter, be-

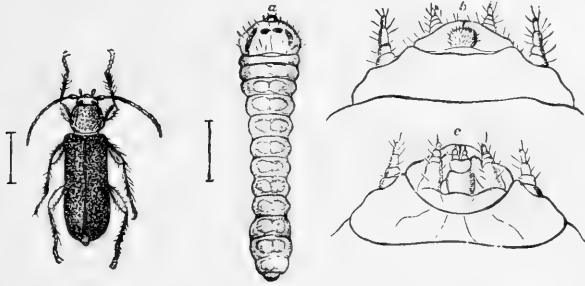


FIG. 24.—Grape Phymatodes: *a*, larva; *b*, upper side; *c*, under side, of head of larva much enlarged.—From Packard.

ing the segment immediately succeeding the head, is half as long as broad, with a distinct median suture and four chitinous patches; the two middle ones transverse and irregularly oblong, being about twice as broad as long, the outer spots being longitudinal to the segment, and oblong in form, or about twice as long as broad. The three segments succeeding are of nearly equal length and width, being about half as long as the prothoracic segment, and not much narrower. The body decreases in width towards the posterior half, which is of equal width throughout, the end suddenly rounding off; the terminal three segments are indicated by very slightly-marked sutures, and together form a straight cylindrical portion nearly as long as the three segments in advance of it taken collectively. The body is slightly hairy, with a few fine, pale hairs on the top of the segment next behind the head. The basal portion of the head (epicranium) is broad and smooth, with a few hairs on the edge. The eyes are two small black dots, each situated a little behind the base of the antennæ, and in a line with them. The frontal piece (clypeus) is very small, about three times as broad as long, while the minute upper lip (labrum) is two-thirds as long as broad; they together form a somewhat triangular portion resting on the inner edge of the mandibles, which are broad and short, the ends broad and square, and blackish in color. The antennæ are not quite so large or as long as the maxillary palpi; they are four-jointed, the first joint being thick, the second joint a third shorter than the third, while the fourth joint is filiform and about as long as the second joint. The under side of the head is chitinous, with a mesial subtriangular fleshy area. The chin (mentum) is square, not much longer than broad. The under lip (labium) is one-half as long as broad. The labial palpi are three-jointed, the basal joint being one-half as long as the second; the third joint is minute, short, and hairy. The maxillary palpi are four-jointed, the first joint being twice as thick as the third, the second and third are of nearly equal length, while the fourth is slender and nearly as long as the second or third. The maxillary lobe is large and broad,

reaching out to the labial palpi and as far as the end of third joint of the maxillary palpi; there are a few hairs on the end of it.

On the upper side of the segments behind the prothoracic is a faint, transverse impressed line, with two or three short creases radiating from each end. On the eighth, ninth, and tenth rings these creases become much longer and are parallel to the median line of the body, while the transverse crease disappears.

There are nine pairs of stigmata, one pair on the mesothorax, the remainder on the first eight abdominal segments. There are three pairs of rudimentary thoracic feet, represented by very minute two-jointed tubercles, the basal joint consisting of a simple chitinous ring. The under side of the body is more hairy than above. On the under side of the prothoracic segment is a pair of round, smooth, very slightly chitinous spots, which are succeeded on each of the other rings by a pair of short, impressed oblique lines.

It is nearly half an inch (.45) in length.

It may be readily recognized by the four chitinous patches on the prothorax and by the very minute clypeus and labrum. The upper side of the prothorax is inclined downward towards the head, but not so much as in *Clytus*.

*The pupa.*—It is white, with the wing-covers reaching to the end of the second abdominal segment. The antennæ are not much curved, reaching to the end of the third abdominal segment, and resting above the legs. The prothorax is swollen just behind the middle and is just as long as broad. The maxillary palpi are long, reaching nearly to the end of the coxæ. The labial palpi reach a little beyond the middle of the maxillary palpi. The two anterior pairs of legs are folded at right angles to the body, the third pair obliquely. The first pair of tarsi reach to the base of the second tarsi; the second pair of tarsi reach to the coxæ of the third pair of legs. It is a third of an inch (.33) in length.

*The beetle.*—*Ph. amœnus* has a reddish body, with Prussian-blue wing-covers. The prothorax is just as long as broad, with the sides moderately convex, and broadest just behind the middle. The antennæ and tibiæ are blackish brown, the tarsi being dull red, the hind pair being darker than the others, and the femora are reddish. The prothorax is distinctly punctured, while the elytra are very coarsely punctured. The scutellum is pale reddish. It is a quarter of an inch in length. A single specimen received from Illinois.

#### 15. THE WHITE-BANDED PHYMÁTODES.

*Phymatodes varius* (Fabricius).

Order COLEOPTERA; Family CERAMBYCIDÆ.

Several specimens of this beetle were met with a few years since, the last of May, on the trunk of a black oak, in which, it is probable, their younger state had been passed. It is closely related to the black varieties of *P. varius* Fab., but is a third smaller, with the white bands much more slender, and the surface of the wing-covers is perceptibly more rough than in my specimens of that insect, notwithstanding their smaller size. Its thorax is densely punctured, with a short smooth stripe between the center and the base. One of the specimens varies in having the posterior white band wholly wanting. (Fitch.)



FIG. 25.—*Phymatodes varius*.—Smith, del.

I have found near Providence several of these pretty little beetles, of both sexes, running in

and out of a pile of oak cord-wood in the forest, May 30, under such circumstances as convinced me they prey upon the white oak. They were identified by Dr. Horn.

*Beetle*.—Black, 0.25 in length or slightly less, and about a third as broad, somewhat flattened, clothed with fine erect gray hairs; its wing-covers with two distinct slender white bands which do not reach the suture, the anterior one more slender than the hind one and curved; the antennæ and slender portions of the legs usually chestnut colored.

#### 16. THE COMMON OAK CLYTUS.

*Xylotrechus colonus* (Fabr.).

Order COLEOPTERA; Family CERAMBYCIDÆ.

LARVA, WITH DETAILS. PLATE XXII, FIGS. 2, 2a.

Mining between the bark and the wood of the oak, up and down the trunk, and making a broad, shallow, irregular groove about 5<sup>mm</sup> wide; the larva, pupa, and beetle occurring late in May and early in June.

I have found, in company with Mr. Calder, the larvæ of this pretty beetle in abundance mining under the bark of a fallen (probably white)

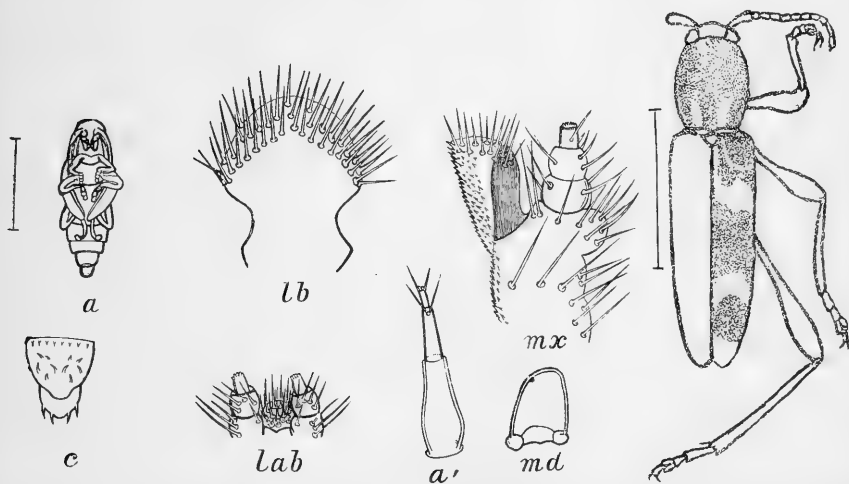


FIG. 26.—*Xylotrechus colonus*: *a*, pupa; *c*, end of body, enlarged; the other figures represent details *lab*, of the larva, all enlarged; *a'*, antenna; *lb*, labrum; *md*, mandible; *mx*, maxilla with the palpus; labium.—Gissler, *del.*

oak, near Providence, May 26; several pupæ were also found, one transforming to a beetle May 27. The mine extends up and down the trunk, and is of the usual form of longicorn mines, being a broad, shallow, irregularly sinuous burrow, and extending part of the way around the trunk, the diameter near the end of the burrow being 5<sup>mm</sup>.\*

\* Larvæ of this insect were found February 25, 1882, boring in dry wood of white oak at Washington, D. C. The color of the larvæ is pale yellowish or whitish. A yellowish band crosses the posterior part of the cervical shield and is beset with short, glistening, backward-directed hairs. The beetles commenced issuing July 3, 1882. (Riley's unpublished notes.)

Mr. George Hunt has found the beetle under the bark of an old sugar maple tree in northern New York, among the Adirondacks.

*Larva*.—Body of the usual shape, near that of Phymatodes. Prothorax less than one-half as long as wide; disk exactly one-half as long as wide; the disk is smooth on the posterior half, irregular on the front edge, with a broad, irregular median lobe in front; the front edge of this smooth space is often tinged with dark. In front of this smooth area is a clear, pale, hairy space, and still beyond (anteriorly) are two irregularly oval spaces which are hairy and irregularly spotted, and often tinted dark. The under side of the prothoracic segment is quite hairy, with minute oval patches among the hairs, and with two conspicuous small, dark, diverging patches on the middle of the segment, but situated rather far apart. Mesothoracic segment a little narrower than the prothoracic and shorter than the metathoracic segment, the latter a little shorter and but very slightly wider than the mesothoracic segment.

Body contracted on the sixth abdominal segment, which is considerably narrower than the succeeding part of the abdomen, the seventh abdominal segment being wider than the sixth and of the same width as the eighth; the ninth much shorter and two-thirds as wide as the eighth. The tenth segment small, one-half as wide, but nearly as long as the ninth. Abdominal segments two to seven with transversely oval, raised, smooth callosities, those on the sixth and seventh being round instead of oval; beneath are similar callosities.

Head a little over one-half as wide as the prothoracic segment; antennæ three-jointed; second joint one-half to two-thirds as long as the first and one-half as thick. Third minute, about one-third as long as the second joint is thick. Maxilla with the lobe as wide as the basal joint of the palpus and reaching to the end of the second palpal joint; the maxillary palpi four-jointed, the second joint one-half as wide as the first; the third just two-thirds as wide as the second; the fourth as long but one-half as thick as the third.

Labium with the ligula small and rounded, not more than one-third wider than the basal joint of the labial palpus, the latter two-jointed, the second joint nearly as long and about two-thirds as thick as the first. Mentum deeply cleft, one-half as long as the submentum.

Labrum small, rounded, not so long as round; surface convex, with dense hairs. Mandibles obtuse, rounded, not toothed.

Thoracic spiracles in the middle of the mesothoracic segment, with the usual eight pairs of abdominal ones. Length of body, 17<sup>mm</sup>; width of prothoracic segment, 4.5<sup>mm</sup>; length, 2<sup>mm</sup>; width of seventh abdominal segment, 3<sup>mm</sup>.

*Pupa*.—Prothorax well rounded, as in *Clytus* beetles; antennæ slender, curving backward and reaching to the distal end of the middle femora. Femora much swollen, but the legs beyond slender, as in the beetle. (It will not be difficult to distinguish the genus, from the peculiar form of the thorax, the swollen femora, and the slender legs and antennæ.) Abdomen short, end of hind femora extending to the third segment from the end of the abdomen. Length, 12 to 13<sup>mm</sup>.

The end of the body terminates in a pair of incurved hooks on each side, the inner pair a little smaller than the outer. Six large recurved spines on the penultimate abdominal segment, the other abdominal segment with about two irregular rows of minute stout spines adapted for progression.

*Beetle*.—Body rather long and narrow, not so broad and thick, nor the prothorax so spherical as in *X. undulatus*; prothorax with the sides regularly arcuate, two ashen spots on each side in front and behind, and a curvilinear spot just behind the middle. Wing-covers with three broad, irregular, waved pale bands, the first a little in front of the middle, the second much behind the middle, and the third situated on the tips. Antennæ and legs dark-brown; reddish-pitchy in immature specimens. A large, round yellow spot on the side between the middle and hind legs, succeeded by vertical linear spots on the hinder edge of the abdominal segments. Length, 8 to 16<sup>mm</sup>.

"The markings are very variable, but the yellow, wavy line running from the suture and forming the included mark seems to be constant and peculiar to the species. (Leng.)

17. *SMODICUM CUCUJIFORME* (Say).

Order COLEOPTERA; Family CERAMBYCIDÆ.

This insect bores in the larval stage under the dry bark of the live-oak (Florida), of the beech in Michigan, and of the hackberry in Texas. (E. A. Schwarz.)

18. THE HORN-TAILED BORER, OR PIGEON TREMEX.

*Tremex columba* Linn.

Order HYMENOPTERA; Family UROCIDÆ.

This insect is known to infest the oak, but oftener bores into the maple, under which head the insect will be described.

19. *MALLODON DASYSTOMUS* (Say).

Order COLEOPTERA; Family CERAMBYCIDÆ.

This insect bores in the live-oak, hackberry, pecan; attacking trees in healthy condition, and often greatly injuring them, but preferring trees which have already suffered from some cause. The beetle issues from April till August in Florida and Texas. (E. A. Schwarz.)



FIG. 27.—*Mallodon dasystomus*. After Horn.



FIG. 28.—*Typocerus zebratus*. Smith, del.

*Beetle*.—Mandibles nearly horizontal, prolonged in the male; sutural angle of elytra spiniform in both sexes; the metathoracic episterna, with the inner outline straight; the genæ emarginate. Length, 30 to 50<sup>mm</sup> (1.25 to 2 inches). (Horn.)

20. *Tylocerus zebratus* Fabr.

This pretty beetle mines the white-oak. by the accompanying figure. The body is black-brown, with reddish antennæ and legs, and four yellow cross-bars on each wing cover; that on the base much curved, while the fourth is straight.—Length, 12 to 14<sup>mm</sup>.

It may be easily recognized

## 21. THE OAK-BARK WEEVIL.

*Magdalis olyra* (Herbst).

Order COLEOPTERA; Family CURCULIONIDÆ.

Boring under the bark of the oak, probably after it has been loosened by the flat-headed borers, a curved, fat, footless grub, with the head freer from the body than in the larval pine weevil; occurring in all stages under the bark in May, and possibly producing a radiating track, as in Fig. 30; transforming into a black weevil, with the surface of the body punctured, the thorax with a lateral sharp tubercle on the front edge, while the tarsi are reddish brown, with whitish hairs.

Fig. 30 represents the mines possibly made by this weevil.\* The original specimen of the bark was taken from the same

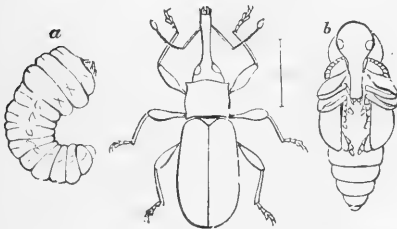


FIG. 29.—a, larva; b, pupa, and adult of the oak-bark weevil. After Emerton.

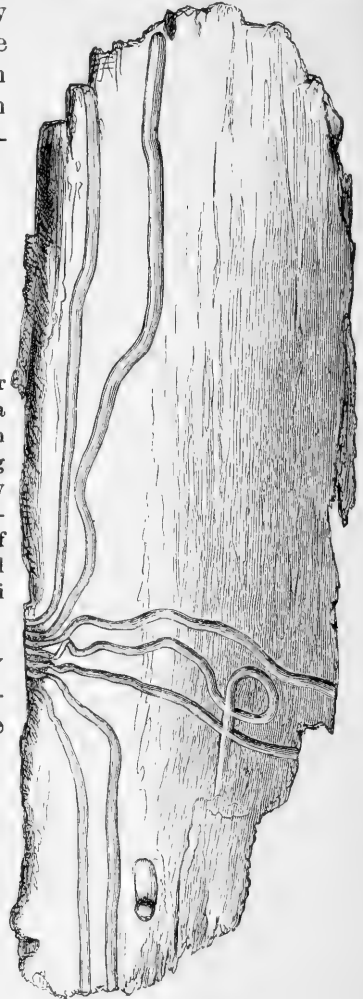


FIG. 30.—Track made by *Magdalis olyra*, or a longicorn? After Emerton.

tree, as numerous individuals of the beetle occurred in different stages of growth and no other weevils or Scolytidæ were present. The beetle which makes the burrow may have been a weevil from the shape of the burrow, which is long, narrow, and deep, being about four inches long. It will be seen by reference to the illustration that the parent beetle laid at least seven eggs in an opening in the bark; when the larvæ hatched

\* Mr. F. H. Chittenden writes that it may be the mine of another beetle.

they mined the bark and scored the wood in directions radiating on one side of the place of oviposition ; in one case a mine went directly across the one next to it. The specimen figured was found at Salem, Mass.

*Beetle*.—Of the form indicated by the figure ; prothorax square, angulated on each side in front, with a short spine on each wing-cover, with eleven well-marked ridges. Color, dark brown, with paler, stiff, short, hirsuties. Base and tips of femora and rest of the legs, including the antennæ, pitchy reddish. Length, 6 to 8<sup>mm</sup>.

#### 22. THE SILKY TIMBER-BEETLE.

*Lymexylon sericeum* (Harris).

Order COLEOPTERA ; Family LYMEXYLIDÆ.

Boring small long cylindrical burrows in the wood of the oak, probably, and other trees ; a slender, odd-looking worm, with six legs placed on its breast, a prominent hump upon its neck, and a leaf-like fleshy appendage at the end of its back ; changing into a long, narrow chestnut-brown beetle, 0.50 long, bearded with short, shining, yellowish hairs, giving it a silky luster ; its eyes large and almost meeting together above and below, and its wing-covers tapering and shorter than the body. See Harris's Treatise, p. 51. (Fitch.)

#### 23. THE AMERICAN TIMBER-BEETLE.

*Hylecoëtus americanus* (Harris).

Order COLEOPTERA ; Family LYMEXYLIDÆ.

A worm very similar to the preceding, but with a straight, sharp-pointed horn at the end of its back in place of a leaf-like appendage ; changing into a pale brownish red beetle, 0.40 long ; its wing-covers, except at their base and its breast, black, its eyes small, and a glassy dot on the middle of its forehead resembling a small eyelet. (See Harris's Treatise, p. 51.)

This and the preceding are very rare insects, and their larvæ have never been detected, but are inferred by Dr. Harris to inhabit oaks and to have the singular forms above indicated, from the analogy of the perfect insects to two European species. Foreign writers, I see, are misled by Dr. Harris's account into supposing that it is authentically ascertained that our insects coincide in their larva state with the European species. (Fitch.)

*Beetle*.—Its head, thorax, abdomen, and legs are light brownish red ; the wing-covers, except at the base, where they are also red, and the breast, between the middle and hindmost legs, are black. Head not bowed down under the prothorax ; eyes small and black ; on the middle of the forehead is one small reddish eyelet ; antennæ like those of *Lymexylon sericeum*, but shorter ; thorax nearly square, but wider than long ; and in each wing-cover are three slightly elevated ribs. Length, 10<sup>mm</sup> ( $\frac{1}{10}$  inch). (Harris.)

*Microclytus gazellula* (Haldeman).

This beetle has been found in the oak in early May at Buffalo, N. Y., by Messrs. Reinecke and Zesch. (Bull. Brooklyn Ent. Soc., VI, 36.)

## 24. THE FEEBLE OAK-BORER.

*Goes debilis* (Leconte).

Order COLEOPTERA; Family CERAMBYCIDÆ.

A cylindrical long-horned beetle, which has recently been described by Dr. Leconte under the above name, is so uniformly found upon white-oak trees in July and August that I doubt not its larva is a borer in the trunks of these trees, perforating the wood, probably, in a manner similar to that of the marked pine borer, and the worm resembling that in its appearance. This beetle is half an inch long and scarcely a third as broad, of a black color, its wing-covers chestnut red, its surface having a marbled appearance, produced by short prostrate hairs of a dull ochre-yellow color, except on the anterior half of the wing-covers, where they are gray, and are here followed by a tawny-brown spot destitute of these paler hairs. (Fitch.) For a figure and further mention the reader is referred to Hickory Insects.

25. *Goes tigrinus* (De Geer).

This species, according to Adams Tolman (Insect Life, i, 343), "is commonly taken on the oak in Philadelphia." Mr. Tolman, however, does not specifically state that this borer lives *in* the oak; but we insert it under oak-borers, as it may yet be found to infest the oak. It is figured and noticed under Hickory Insects.

## 26. THE BROWN PRIONUS.

*Orthosoma brunneum* (Forster).

Order COLEOPTERA; Family CERAMBYCIDÆ.

The larvæ of this beetle have been found in rotten oak and walnut stumps by Mr. George Hunt, near Providence, but as it is more commonly met with in pine logs the reader is referred to the account of it given under pine insects.

## 27. UNKNOWN LONGICORN BORER FROM AN OAK LOG.

(Pl. XXI, Fig. 3.)

*Larva*.—Body of large size, gradually tapering to the penultimate segment, with three pairs of thoracic legs of moderate size.

Head small and much rounded. Labrum small and unusually narrow, well rounded on the front edge. Antennæ conspicuous, unusually long; second joint very long and slender, longer than the basal one is thick; third joint minute and acute at tip. Labium very small, squarish; submentum and mentum both rectangular, broader than long; the ligula narrow, much rounded in front; labial palpi three-jointed; third joint obtuse, as long as the second. Maxillary lobe very broad and rather short, not reaching beyond the end of the second palpal joint. Maxillary palpi three-jointed; first joint very short and broad, second one-half as thick as the first, the third slender and a little longer than the second. Mandibles much rounded and entire at tip.



The callosities on the segments, as figured in the cut, are prominent, more or less rounded tubercles with the surface divided irregularly by impressed lines.

Length, 35<sup>mm</sup>; width of prothoracic segment, 8<sup>mm</sup>; length, 3<sup>mm</sup>; length of a leg with terminal claw, 0.4<sup>mm</sup>; length from base of labrum to posterior edge of meta-thoracic segment, 5<sup>mm</sup>; length of first and second abdominal segment, each, 2<sup>mm</sup>; length from base of third abdominal segment to end of body, 28<sup>mm</sup>; width of each of segments 2 to 6, 6<sup>mm</sup>; the seventh and eighth segments are slightly wider.

Found in an oak log at Providence, R. I., May 20, 1831.

Compare also pl. xvii, Fig. 2; xix, Fig. 2; xx, Fig. 3.

#### AFFECTING THE LIMBS AND TWIGS.

##### 28. THE OAK PRUNER.

*Elaphidion villosum* (Fabr.).

Order COLEOPTERA; Family CERAMBYCIDÆ.

Cutting off the branches of the white and black oak, which fall late in summer to the ground, containing the larva, which becomes a beetle in the next midsummer and lays its eggs near the axilla of a leaf stalk or small stem.

In walking under oak trees in the autumn one's attention is often directed to the large number of oak limbs and twigs lying on the ground. Upon examination they will be found to have been partially gnawed off

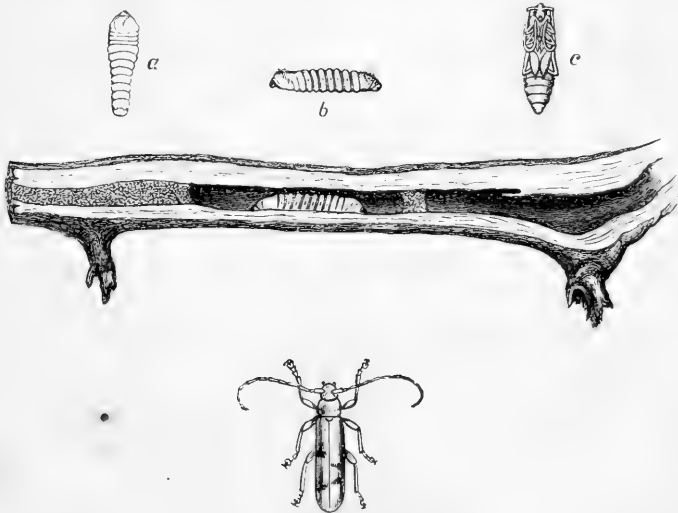


FIG. 31.—Oak pruner: a, larva; b, side view of the same; c, pupa.—From Packard.

by worms, the wind having further broken them off. This is the work of the grub of the oak pruner. The insect's purpose in cutting off the limb, whether conscious or not of any design in the matter, is probably, as Peck first suggested, to afford the insect a sufficiently moist retreat to live in during the winter. He supposed that the limb thus wounded would become too dry for the maintenance of the soft-bodied larva, hence it must be felled to the ground, where in the wet and under the

snows of winter it would remain sufficiently moist for the existence of the insect, which completes its transformation within.

Mr. C. A. Walker has brought us the insect in its different stages cut out of oak branches, which occurred in abundance at Chelsea, Mass. Late in August, 1888, this borer was reported to be especially abundant in Warwick, R. I., so that the ground was said to be strewn with the smaller branches of oak and locust trees. We are indebted to Dr. Fitch for the most detailed information regarding this curious longicorn :

The severed limbs are usually but eighteen inches or two feet in length, but Professor Peck states that limbs an inch in thickness and five feet in length are sometimes found. I have seen a limb cut off by this insect which was ten feet in length and an inch and a tenth in thickness, and have repeatedly met with them seven and eight feet long and usually an inch, but in one instance an inch and a quarter, in thickness.

The parent beetle seems aware that her progeny in their infancy will be too feeble to masticate the hard woody fibers of the limb. She, therefore, selects one of the small twigs which branch off from it, which is not thicker than a goose quill, with its base composed of soft wood, the growth of the last year, all the remainder of the twig being the green succulent growth of the present year. She places her egg near the tip of this twig, in the angle where one of the leaf-stalks branches off from it. The young worm which hatches therefrom sinks himself into the center of the twig and feeds upon the soft pulpy tissue around him until it is all consumed, leaving only the green outer bark, which is so thin and tender that it withers and dries up, and ere long becomes broken. By the time this green tender end of the twig is consumed the worm has acquired sufficient size and strength to attack the more solid woody portion forming its lower end. He accordingly eats his way downward in the center of the twig, consuming the pith, to its base, and onward into the main limb from which this twig grows, extending his burrow obliquely downward to the center of the limb, to a distance of half an inch or an inch below the point where the lateral twig is given off.

The worm, being about half grown, is now ready to cut the limb asunder. But this is a most nice and critical operation, requiring much skill and calculation; for the limb must not break and fall while he is in the act of gnawing it apart, or he will be crushed by being at the point where it bends and tears asunder, or will fall from the cavity there when it breaks open and separates. To avoid such casualties, therefore, he must after severing it have time to withdraw himself back into his hole in the limb and plug the opening behind him before the limb breaks and falls. And this little creature accordingly appears to be so much of a philosopher as to understand the force of the winds and their action upon the limbs of the tree, so that he can bring them into his service. He accordingly severs the limb so far that it will remain in its position until a strong gust of wind strikes it, whereupon it will break off and fall.

But the most astonishing part of this feat remains to be noticed. The limb which he cuts off is sometimes only a foot in length and is consequently quite light; sometimes ten feet long, loaded with leaves, and very heavy. A man by carefully inspecting the length of the limb, the size of its branches, and the amount of foliage growing upon them could judge how far it should be severed to insure its being afterwards broken by the winds. But this worm is imprisoned in a dark cell only an inch or two long in the interior of the limb. How is it possible for this creature, therefore, to know the length and weight of the limb and how far it should be cut asunder? A man; moreover, on cutting a number of limbs of different lengths so far that they will be broken by the winds, will find that he has often miscalculated, and that several of the limbs do not break off as he designed they should. This little worm, however, never makes a mistake of this kind. If the limb be short it severs all the woody fibers, leaving it hanging only by the outer bark. If it be longer a few of the woody fibers on its upper side are left uncut in addition to the bark. If it be very long and heavy

not more than three-fourths of the wood will be severed. The annexed figures\* represent the several ends of limbs of different sizes, the coarsely dotted parts of the two first indicating the ragged broken ends of the woody fibers, the remainder being the smooth surface cut by the worms, and the large black dot representing the perforation leading up the limb to where the worm lies. The first of these figures was taken from the limb already spoken of as ten feet in length, and here it will be noticed that a portion of the stouter wood towards the center of the limb was preserved, as though the worm had been aware that the weaker sappy fibers outside next to the bark could not be relied upon for sustaining a limb of this size, as they are where the limb is smaller. With such consummate skill and seemingly superterrestrial intelligence does this philosophical little carpenter vary his proceedings to meet the circumstances of his situation in each particular case! But by tracing the next stage of his life we shall be able to see how it is that he probably performs these feats which appear so much beyond his sphere.

Having cut the limb asunder so far that he supposes it will break with the next wind which arises, the worm withdraws himself into his burrow, and that he may not be stunned and drop therefrom should the limb strike the earth with violence when it falls, he closes the opening behind him by inserting therein a wad formed of elastic fibers of wood. He now feeds at his leisure upon the pith of the main limb, hereby extending his burrow up this limb six or twelve inches or more, until he attains his full growth—quietly awaiting the fall of the limb and his descent therein to the ground. It is quite probable that he does not always sever the limb sufficiently, in the first instance, for it to break and fall. Having cut it so much as he deems prudent, he withdraws and commences feeding upon the pith of the limb above the place where it is partially severed, until a high wind occurs. If the limb is not hereby broken, as soon as the weather becomes calm he very probably returns and gnaws off an additional portion of the wood, repeating this act again and again, it may be, until a wind comes which accomplishes the desired result. And this serves to explain to us why it is that the worm severs the limbs at such an early period of his life. For the formidable undertaking of cutting asunder such an extent of hard woody substance, we should expect he would await till he was almost grown and had attained his full strength and vigor. But by entering upon this task when he is but half grown he has ample opportunity to watch the result, and to return and perfect the work if he discovers his first essay fails to accomplish the end he has in view.

Thus the first part of the life of this worm is passed in a small twig branching off from the main limb. This is so slender and delicate that on being mined as it is by the worm and all its green outer end consumed, it dies and becomes so decayed and brittle that it is usually broken off when the limb falls, whereby it has escaped the notice of writers hitherto. The remainder of his larva life is passed in the main limb, first cutting off this limb sufficiently for it to break with the force of the winds, and then excavating a burrow upwards in the center of the limb, both before and after it has fallen to the ground, feeding hereon until he has grown to his full size.

It is most frequently the limbs of the red and the black oak that I have met with severed by the oak pruner, though it is not rare to find those of the scarlet oak (*Q. coccinea*) and of the white oak lopped off in the same manner. Limbs of the beech and chestnut not unfrequently and those of the birch, the apple, and probably of other trees, are sometimes similarly severed. Mr. P. Weter, of Tirade, Walworth County, Wis., informs me that the peach in his vicinity suffers in a similar manner, and to such an extent some years that the severed limbs, varying from a few inches to two feet in length, are seen lying under almost every tree. We have in our country several species of beetles very closely related to the oak pruner, but no attempts have yet been made to ascertain their mode of life. It is very probable that they all have this same habit of cutting off the limbs of trees, one perhaps preferring the wood of one kind of tree, another, another. This is the more probable, since

\* The figures have not been reproduced.—A. S. P.

there is considerable diversity in their operations, as shown by an examination of the fallen limbs. Thus the scarlet oak, instead of having a hole bored in the severed end of its limbs, commonly has half the wood eaten away on one side of the limb for the length of an inch or more, with the cavity thus formed under the bark packed with worm dust, and a cylindrical burrow from the upper end of this cavity running upwards in the center of the limb, the same as in other cases.

It further appears that the female, when ready to drop an egg, is not always able to find a small twig with a green succulent end adapted to her wants. She then consigns her progeny to the bark of the main limb, and the young worm subsists on the soft pulpy matter between the bark and the wood, excavating a shallow irregular cavity which is packed with worm dust, till it has acquired sufficient strength to gnaw the wood, when it cuts off the limb as in other cases. It may, however, be a different species from the common oak pruner, which cradles its young thus beneath the bark instead of in a lateral twig. It is usually in the fallen limbs of the beech, though sometimes in those of the oaks also, that I have met with these worm tracks under the bark.

The bark of the beech, it will be recollected, is quite thin and very brittle, so that it will ill serve to hold the limb in its place if the wood underneath is cut off in the usual manner. And accordingly a remarkable modification of this operation will be noticed in the amputated limbs of this tree. The worm eats its way down the limb beneath the bark until it has acquired sufficient strength to sever the woody fibers. It then passes transversely around the limb beneath the bark, girdling it by cutting off all the softer outer fibers and leaving the harder ones in the middle of the limb uncut, whereby the limb is sustained until the wind strikes it. How surprising that these little creatures have such intelligence given them as enables them to vary their operations to such an extent, according to the circumstances of their situation in each particular case! I should be inclined to think the beech pruner a different species from that of the oak, as it dwells beneath the bark instead of in a lateral twig, and cuts off the outer instead of the inner wood of the limb; but the worm is identical with that of the oak in its external appearance, and one of these worms which I placed in a cage, falling from its fractured burrow in the beech limb, forsook this wood and commenced boring into an oak limb lying beside it.

Not only the limbs, but small young trees, at least of the white oak, are sometimes felled by these insects; in which cases the worm, instead of cutting the wood off transversely, severs it in a slanting or oblique direction, as though it were aware the winds would prostrate a perpendicular shoot more readily by its being cut in this manner.

*The larva* grows to a length of 0.60, and is then 0.15 thick across its neck, where it is broadest. It tapers slightly from its neck backwards, the hind part of its body being nearly cylindrical. It is a soft or fleshy grub, somewhat shining and of a white color, often slightly tinged with yellow, its head, which is small and retracted into the neck, being black in front. It is divided, into twelve rings by very deep, wide, transverse grooves. The neck or first ring is much the largest, and shows two very pale tawny yellow bands on its upper side, the anterior one slightly broken asunder in its middle, and on each side beyond the ends of these bands is a spot of the same color. The two or three rings next to the neck are shorter than the others, and less widely separated from each other. A faint stripe of a darker color may be discerned along the middle of the back, widely broken apart at each of the sutures. The last ring is much narrower and more shining than the others, and is cut across by a fine transverse line, dividing it into two parts, of which the hinder one or tip is bearded with small blackish hairs, and a few fine hairs are perceptible upon the other rings. The last two rings are retracted into the ring which precedes them, at the pleasure of the animal, whereby this ring becomes humped and swollen; and it appears to be chiefly by thus enlarging the end of its body that the worm holds and moves itself about in its cell, its feet being so weak and minute that they are scarcely perceptible and can

be of little service. It has three pairs of soft, conical-jointed feet, resembling its antennæ in their size and shape. The first pair is placed on an elevated wrinkle of the skin in the suture between the first and second segments of the thorax, more distant from each other than are those of the second and third pairs, which are situated on the middle of the elevation of the second and third segments.

Some of the worms enter their pupa state the last of autumn, and others not till the following spring. Hence in examining the fallen limbs in the winter, a larva may be found in one, a pupa in another. Preparatory to entering its pupa state, the larva places a small wad of woody fibers, sometimes intermingled with worm-dust, below it, in its burrow, and sometimes another wad above it if the burrow runs far up the limb, thus partitioning off a room one or two inches in length in which to lie during its pupa state. The shriveled cast skin of the larva will be found at the upper end of this cell, after it has changed to a pupa.

Usually those insects which undergo a complete metamorphosis remain at rest, lying dormant and motionless during their pupa state. The oak pruner, however, is a remarkable exception to this. Whenever its cell is opened it will be seen moving from one end of it to the other with quite as much agility as it shows in its larva state. The sutures of its abdomen have the same deep transverse grooves as in the larvæ, admitting the same amount of motion to this part of its body that it previously had. And, lying on its back, it uses the tip of its abdomen as though it were furnished with a proleg, the little sharp points with which it is covered being pressed against the rough walls of the cell and the body pushed forward or drawn backward hereby, step after step, at the will of the animal.

*The pupa* is of much the same size with the larva and of a yellowish-white color. Its eyes are sometimes white, sometimes blackish-brown. The antenna-sheaths arise in the notch upon the inner side of the eyes and, passing directly across the surface of these organs, extend down along each side of the back above the sheath of the fore and middle pairs of legs, then curving inward they pass back to the eye along the inner side of the same legs, their ends being placed upon the eye slightly inside of their origin. The knees of the hind legs protrude far out from under the upper sides of the wing-sheaths forward of their tips, whilst the feet of these legs occupy the space between the tips of the wing-sheaths. The back of the abdomen shows a distinct, pale-brown stripe along the middle, on each side of which the surface of the segments is furnished with numerous small, erect, sharp points of a dark brown color, those on the apical segment being double the length of the others.

*The beetle*.—They are usually from 0.50 to 0.55 in length and 0.12 broad, of a slender, cylindrical form, of a dull black color, tinged more or less with brown on the wing-covers, more evidently so towards their tips, whilst the antennæ are paler brown, and the under side and legs chestnut colored, sometimes bright, sometimes dark and blackish. The surface is everywhere clothed with shortish, prostrate gray hairs, and on the wing-covers these are in places more dense, forming small gray spots, and on each side of the thorax, in the middle, is a whitish dot, formed in the same manner. Sometimes also on the base of the thorax, on each side of its middle, a short gray stripe formed by these hairs is very obvious, whilst in other individuals no traces of these stripes can be discerned.

The scutel also is densely covered and gray from these hairs. The surface, above, is occupied by numerous coarse, round punctures, those on the thorax being of the same size with those on the wing-covers, but more crowded, many of them running into each other. Towards the tips of the wing-covers these punctures become perceptibly smaller.

In at least three-fourths of the fallen limbs no worm is to be found; and an examination of them shows that the insect perished at the time the limb was severed, and before it had excavated any burrow upward in its center, no perforation being present, except that leading into the lateral twig. It is probable that in many of these instances the limb broke when the worm was in the act of gnawing it asunder, either from its own weight or from a wind arising whilst the work was in progress. And

even though the worm may have withdrawn into its hole and plugged the opening behind it, it is frequently discovered here, probably, and devoured by birds. After a violent wind in the summer season, some of our insect-eating birds may always be noticed actively in search of limbs and trees that have thereby been broken, their instinct teaching them that this breakage usually occurs from the wood being weakened by the mining operations of worms therein, whose lurking places are now opened to them. And they will be seen industriously occupied in picking around the fractured ends of the wood, and feasting upon the grubs which they there find. Numbers of our wood-boring larvæ are thus destroyed, and the oak pruner, notwithstanding the precautions it takes to secrete itself, doubtless frequently falls a prey to these sagacious foragers.

*Remedies.*—These insects will undoubtedly at times occur in such numbers as to render it important that they be destroyed, at least where they resort to the peach or other valuable trees. And this may readily be effected by gathering and burning the fallen limbs in the winter or the early part of spring. (Fitch's Fifth Report, pp. 17-24.)

We have preferred to quote in full Dr. Fitch's account of this insect, although somewhat prolix, and though he ascribes too much intelligence to the larva. The following criticisms and observations are also quoted in full from an article by Dr. John Hamilton, published in the Canadian Entomologist, August, 1887:\*

Divested of all romance and imagination, and descending to facts, the observations of Professors Peck, Fitch, and Harris may be reduced to this: In the month of July the parent lays the eggs on the limbs or in the axil of a leaf near the end of the twigs of that year's growth of various species of oak, and perhaps other trees. After hatching, the young larva (in the latter case) penetrates to the pith and devours it downwards till the woody base is reached, and so onward to the center of the main limb; here it eats away a considerable portion of the inside of the limb and then, plugging the end of the burrow, which it excavates towards the distal end, eventually falls to the ground with the limb, which, being weakened, is broken off by the high autumnal winds. They exist here either as larvæ or pupæ till spring and emerge in June as perfect beetles. Time, one year, though not so stated in words.

The account given in detail below is so different from the above that were the identity of the individuals established by actual comparison and by recognized authority, it might well be asserted I had given an account of some other *Elaphidion*.

April, 1883, I procured a barrel of hickory limbs from a tree girdled early in 1882. The limbs were from one-half to 1 inch in diameter. Very few things developed from them that season, but the next (1884) quite a number of species came forth—*Clytanthus ruricola* and *albofasciatus*, *Neoclytus luscus*, and *erythrocephalus*, *Stenosphenus notatus*, etc. Many larvæ of some Cerambycidae continued to work on under the bark. Late in the fall I observed that most of these had penetrated the wood, but some remained under the bark till April and May of the next year (1885). The most of the beetles appeared during the first two weeks of June, though individuals occurred occasionally till September. A few larvæ were still found at work, but by October they likewise had bored into the wood and appeared as beetles the next June (1886). The normal period of metamorphosis is therefore three years, but in individuals it may be retarded to four or more years.

At the present writing (June 5) these beetles are issuing in great numbers from a barrel of hickory limbs obtained in April, 1885, from a tree deadened in January, 1884, thus verifying the first observation.

How the larvæ get under the bark could not be ascertained. When first examined,

\*Also reprinted in the Eighteenth Annual Report of the Entomological Society of Ontario, 1887, pp. 38-40.

in April, they were from 4 to 5<sup>mm</sup> long. They ate the wood under the bark, following its grain, and packed their burrows solidly with their dust. The growth and progress were both slow, for by the next April they had scarcely more than doubled in length and had not traveled more than from 4 to 6 inches during the year; but after July they developed an enormous appetite and consumed the wood for at least an inch in length and often entirely around the limb, ejecting their castings through holes made in the bark. When full fed they bore obliquely an oval hole into the wood, penetrating it from 4 to 10 inches. The larva then packs the opening with fine castings and enlarges a couple of inches of the interior of the burrow by gnawing off its sides a quantity of coarse fiber, in which it lies, after turning its head to the entrance. When about to become pupa (I witnessed the process) the skin ruptures on the dorsum of three or four segments next the head; the head of the pupa appears, and after about half an hour's wriggling the whole body is divested of its covering. To the observer the pupa appears to crawl out of the skin, but in fact the skin with the large mandibles is forced backwards by the alternate extension and contraction of the segments, assisted materially by the fiber that surrounds it. After its soft body hardens the same movements free it from the fiber, some being shoved in advance of the head, and some posteriorly, the exuviae being often found at the distal end of the hole. The time spent in the pupal state is indefinite and does not seem to concern greatly the time of the appearance of the beetle. Sticks split open at different periods from December till March contained larvæ and pupæ about equally, but no developed beetles. A larva that I observed go into the wood in April appeared as a beetle among the first of such as had presumably pupated in the fall.

The number of these beetles obtained that and the present season was great and afforded a good opportunity to observe individual variations, and they do differ greatly. In length from 8 to 18<sup>mm</sup>; in pubescence, some being nearly naked and unicolorous, others having it longer and condensed into spots or almost vittate; some being quite slender and elongate, while others are short and broad. The surface of the elytra is mostly uniform, but in some, especially such as are narrow and elongated, one or two costæ are more or less evident.

Now, although this account differs so widely from that given by Mr. Fitch, still the beetles are the same. Unfortunately, I have never been able to find any pruned oak limbs from which to obtain the insects myself, but I have a good set from Mr. Blanchard, of Massachusetts, presumably from the oak, which are identical. Through the kindness of Mr. F. Clarkson, I have a set of those described by him in the Can. Ent., vol. 17, p. 188, from oak limbs, and which became imagoes in November, and there is no perceptible difference. Dr. George H. Horn says, "They are the same." To identify *Elaphidion parallelum* had always been a puzzle to me, and I once thought I had a real set; I obtained it about a dozen times by exchange, but could never be satisfied that the specimens received were not pauperized or peculiar individuals of *E. villosum*. On comparing my hickory insects with all the descriptions of *E. villosum* and *parallelum* and their several synonyms, as far as I possess them, it was easy to pick out sets that would answer satisfactorily all their requirements, and I became satisfied that *E. parallelum* could not be separated.

#### 29. *Elaphidion parallelum* Newman.

(Larva, Pl. xvii, Fig. 1.)

This borer, according to Riley, infests the oak, and Mr. Tyler Townsend, of Washington, D. C., has found it to be the common oak pruner of the vicinity of Constantine, Mich., while it also is common in hickory.\*

\* Dr. Horn has, in a letter to Dr. Hamilton (Can. Ent., Aug., 1887), stated that *Elaphidion villosum* and *parallelum* "are inseparable." It is, however, too late, since this note is added in the galley proof, to combine the accounts of the latter so-called species with that of *E. villosum*.

It becomes a pupa either in the autumn or spring. (Can. Ent., xviii, 13, 1886.) In the absence of the larva of any other species of this or an allied genus, for comparison, we have compared the larva with that of *Xylotrechus colonus*.

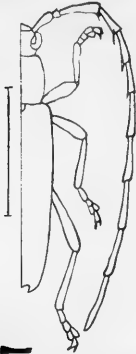


FIG. 32.—*Elaphidion parallelum*.  
(After Smith.)

*Beetle*.—Brown, punctured, covered with an ashy woolly pubescence; elongated linear; antennæ scarcely shorter than the body; second and third joints with a terminal spine; elytra parallel, truncated at the apex and armed with a spine at each angle, the outer spine rather long and incurved. Length .55 inch. (Le Conte.)

*Larva*.—The body very closely resembles *X. colonus*, but is larger and broader, especially on segments 7 to 9, but in general appearance is closely similar. Pro-

thoracic segment scarcely wider than the mesothoracic, but not so much swollen as in *Xylotrechus*. The disk is regularly transversely oblong, the sides not convex but straight, the edges in front and on the sides brown. The disk is one-half as long as broad; posterior half free from hairs, not so distinctly marked as in *X. colonus*, but the longitudinal irregular pale streaks are present. The mesothoracic and metathoracic segments are as wide as the prothoracic, but the mesothoracic is a little shorter than the metathoracic. The mesothoracic segment is divided into two lateral portions by a scutel-like, very short and broad callosity which is narrow, lanceolate-oval. The metathoracic segment has a similar callosity, but a transverse fleshy ridge is present, not found on the mesothoracic segment. Beneath is a callous brown spot incised in the middle, longer and narrower than those on the six succeeding segments. That on the prothoracic is much shorter and narrower than on the mesothoracic, the latter not divided mesially, where those on the metathoracic and three succeeding segments are partly divided by the median line of the body, forming two irregular oval patches touching the median line of the body, and with the outer, hinder edge produced a little posteriorly. On the first abdominal segment is a transverse, short but very wide crescent-shaped callosity with swollen margins; on the succeeding segments these become longer and narrower, until on the fourth segment they become one-half as long as broad; on the hinder segments (5 to 7) they become still longer and transversely oblong-oval, with irregular broad thickened patches. Beneath, on the segments behind the fourth, the callosities disappear, but there are raised smooth oval areas. A pair of thoracic feet on each of the three segments; they are three-jointed, basal joint membranous; second joint about three-fourths as long as wide; third joint about two-thirds as wide as the second, and slightly longer. The ninth abdominal segment but little narrower than the eighth; the tenth about one-third as wide as the ninth. A pair of mesothoracic spiracles and eight abdominal pairs.

Head not quite so large in proportion as in *X. colonus*. Labrum small, not quite so broad as in *X. colonus*, convex and well rounded in front, and very hairy. Mandibles black.

Antennæ four-jointed, first joint apparently divided into two subsegments; third a little longer and narrower than the second; the fourth minute, obtuse, one-half as long as the third is wide. Maxillæ with the lobe rather small, reaching to near the end of the third joint of the palpus. Maxillary palpi four-jointed, second joint slightly shorter and narrower than the first; fourth half as thick as the third and pointed at the tip. Labium with the mentum nearly square, narrower than the submentum. The ligula, which is very small in *X. colonus*, is here entirely wanting.



30. *Elaphidion atomarium* (Drury).

According to Mr. Schwarz, this species and *E mucronatum* bore in dry twigs of *Quercus virens* in Florida. (Riley in American Entomologist, iii, 239.)

*Beetle*.—Head brownish black, covered with short yellowish-gray pile. Thorax dirty black, covered with yellow-gray pile; cylindrical, and without any spines or eminences. Antennæ dusky brown; having a spine on each joint, except that next the head, and about the length of the insect. Scutellum very small. Elytra black, mottled with yellow-gray, being margined at the sides and suture and not reaching or covering the anus, each having two spines at the extremity. Abdomen and breast grayish brown, as are the legs, each of which is furnished with a spine at the tip of the tibiæ.

31. *Elaphidion mucronatum* (Say).

This species was found in company with the preceding by Mr. Schwarz.

*Beetle*.—Brown, with ashy hairs; antennæ three or four spined; thighs mucronate; elytra bidentate; body reddish brown, partially covered with short, prostrate cinereous hairs, unequally distributed. Antennæ longer than the body; joints 3 to 6, ending in a spine; scutellum white, with dense hair divided into two lobes; elytra punctured; the hairs so disposed as to give the surface an irregularly spotted appearance; tip bispinose; intermediate and posterior thighs bimucronate, the inner spine longest. Length seven-twentieths of an inch. (Say.)

32. *Acanthoderes 4-gibbus* Say.

In this longicorn, which according to Mr. Schwarz bores in the twigs, the scape of the antennæ becomes thicker towards the tip, and is shorter than the third joint; the prothorax is armed with dorsal tubercles, with a large lateral spine. The eyes are less coarsely granulated than in the other species. "Body dark brownish; antennæ hardly longer than the body, blackish; head before sparingly punctured; labrum dull honey-yellow; thorax with distant punctures; four tubercles nearly in a transverse line, and a longitudinal, elevated line; elytra quadrigibbous at base; inner gibbosity extended with a longitudinal elevated line; numerous distant deep punctures; a dilated, waved ashen spot before the middle; a sutural series of alternate square small brown and cinereous spots nearly opposite; tip emarginate; thighs clavate. Length less than three-fifths of an inch." (Say.)

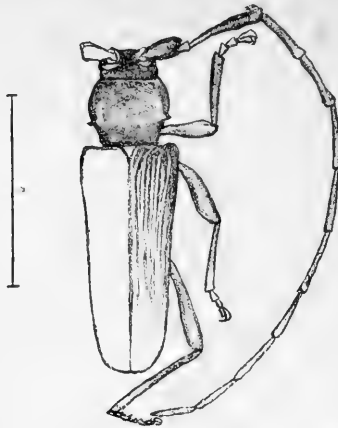
33. *Leptura zebra* Olivier.

The larva and pupa inhabit the black oak. (Dr. Horn.)

34. *Tragidion fulvipenne* Say.

According to Riley, this longicorn bores in the oak. (Am. Ent., iii, 239.)

*Beetle*.—Body deep black, covered with dense black hair; antennæ rather longer than the body, somewhat hairy; palpi glabrous, deep reddish brown; thorax above, with four obsolete tubercles and an intermediate, abbreviated, glabrous, longitudinal line; a slightly prominent lateral spine; scutel hairy, black; elytra yellowish-fulvous, covered with dense, very short prostrate hair; four longitudinal slightly elevated lines. Length three-fifths inch. (Say.)

FIG. 33.—*Tragidion fulvipenne*.—Smith and Marx del.35. *Bostrichus bicornis* Weber.

Order COLEOPTERA; Family PTINIDÆ.

Mr. A. S. McBride records finding this beetle under the dead bark of white oak posts in August, and he thinks the larva bores in the wood. (Can. Ent., xii, 107, June, 1880.)

*Beetle*.—Body blackish-brown varied with cinereous; with robust, scale-like hairs; head equal; eyes prominent, reddish brown; antennæ and palpi ferruginous; labrum fulvous; thorax declivous before and behind; anterior half and lateral margin armed with numerous short spines; anterior angles projected over the head in the form of parallel horns; posterior angles elongated backward in the form of tubercles; two hardly elevated tubercles on the middle of the base; scutel rounded, cinereous; elytra, each with two elevated lines, of which the inner one is the more prominent and acute, with the blackish-brown and cinereous colors somewhat alternate; tip near the sutural termination mucronate or only angulated; beneath dark reddish-brown.

Length, two-fifths of an inch. (Say.)

FIG. 34.—*Bostrichus bicornis*.—Smith del.36. *Xyleborus celsus* Eichhoff.

Order COLEOPTERA; Family SCOLYTIDÆ.

This species belongs to that section of the genus, according to Le Conte, in which the body is elongate, cylindrical; the declivity of the elytra oblique, frequently retuse or excavated; the funicle of the antennæ with five distinct joints; tibiæ rounded at tip and usually finely serrate.

*Beetle*.—Two lines long. Ferruginous, clothed with yellow hair; elytra obliquely sloping behind, perfectly flat, smooth, with two larger acute, pointed, tubercles each side near the suture, and near the edge of the declivity, with many smaller acute elevations. It differs from *X. pyri* by its much more elongate form, the prothorax being about one-half longer than wide, with the sides parallel behind the middle and the elytra much more than one-half longer than the thorax. (Le Conte.)

37. *Xyleborus fuscatus* Eichhorn.

*Beetle*.—Length, 1 to 1½ lines. Ferruginous brown, or yellow, thinly clothed with gray hair, with the same form and sculpture as *X. monographus*, but somewhat smaller, and distinguished by the oblique declivity of the elytra being marked by only a single, large, acute tubercle, while the suture itself is also distinctly elevated. (Le Conte.)

38. *Xyleborus retusicollis* Zimmermann.

*Beetle*.—Length, 1 line. Rust-yellow; front smooth, with a deep longitudinal impression; prothorax longer than wide, a little broader than the elytra, punctured in front; thinly pubescent and very deeply excavated; the front margin rising into an acute point; behind nearly glabrous and smooth. Elytra short, punctured without order, thinly pubescent, obliquely declivous behind, and somewhat impressed along the suture. Maryland, found under oak-bark. (Le Conte.)

39. *Pityophthorus pubipennis* Lec.

Order COLEOPTERA; Family SCOLYTIDÆ.

Mr. Ricksecker remarks concerning the habits of this bark borer on the Pacific coast:

I have seen great swarms of *Pityophthorus pubipennis* Lec. in the branches of newly felled live oaks, and have taken the same or an allied species from sticks of oak that had previously been peeled for tan-bark. (Ent. Amer., i, 97.)

*Beetle*.—Club of antennæ distinctly annulated and pubescent on both sides, not fringed with long hair. Fore tibiæ moderately serrate; fore tarsi with joints 1 to 3 stout, fifth longer than the others united.

Male head deeply concave; edge of the concavity fringed with long silky hairs. Female head shining, sparsely hairy, punctured with an interocular tubercle; the longer hairs of the elytra (which are finely punctulate) are arranged in rows. (Le Conte and Horn.)

40. *Pityophthorus querciperda* Schwarz.

Mr. Schwarz has observed the habits of this Scolytid beetle, and also described the beetle in the Proceedings of the Entomological Society of Washington (i, 56), stating that it occurs from New York to Florida. On page 162 of the same Proceedings Mr. John D. Sherman records finding some sixty or seventy specimens under the bark of a felled oak tree at Peekskill, N. Y.

The galleries, which are partly in the bark and partly in the outermost layer of the wood, are the primary galleries—i. e., those made by the parent beetle—and exhibited a feature hitherto not observed in any other Scolytid. The female beetle bores straight through the bark; then follows a very short gallery vertically downward, and this is crossed immediately below the entrance hole by an extremely long transverse gallery. The novelty consists in the short vertical gallery, which, evidently, is constructed only for the purpose of enabling the beetle to turn around without getting on the outside of the tree. The larval galleries, if there be any, are not yet known. (Schwarz.)

*Beetle*.—This new species belongs to Le Conte's group B, and may be called *Pityophthorus querciperda*. It is closely allied to *P. minutissimus*, with which it agrees in size, form, and coloration, but from which it differs in the sculpture and pubescence of the elytra. In *minutissimus* the elytra are finely and rather indistinctly punctulate; the pubescence is fine, very sparse or nearly absent on the basal portion of the elytra and denser on the declivity, but always hair-like. In *querciperda* the elytra are quite distinctly rugosely punctulate, and, therefore, less shining. The pubescence

is stout, moderately dense on the anterior part of the elytra and still denser and scale-like on the declivity. In the two Californian species of the same group the pubescence consists of long and short hair intermixed. *P. querciperda* occurs from New York to Florida. (Schwarz.)

41. *Monarthrum mali* (Fitch).

Mr. Schwarz has observed this Scolytid while at work in pieces of the red oak at Washington, D. C. It was first observed by Fitch attacking the apple tree in New York. It ranges from Lake Superior to Florida. (Le Conte.)

The parent beetle bores through the bark straight into the wood to a distance of from 5 to 7<sup>mm</sup>. Then follows a transverse gallery and, in most cases, a second transverse gallery immediately behind the first; in several instances there is still a third gallery. The secondary burrows, in which the larvæ undergo their transformations, and which, in all probability, are made by the larvæ, start rectangularly upward or downward from the transverse galleries and are but little longer than the beetle. Oviposition in this species has not yet been observed, and it remains, also, uncertain whether only one or several beetles have been at work when there are two or three transverse galleries present. (Schwarz, Proc. Ent. Soc. Wash., i, 44, 48.)

*Beetle*.—In this genus the body is long and cylindrical; the scape of the antennæ long and slender; the funicle of but one short joint, the others being absorbed in the club, which is rounded and very much compressed; elytra elongate, nearly perpendicularly declivous behind, and pubescent on the declivity; feebly punctured in rows. *M. mali* is small brown, elytra not hairy at tip.

*Male*: Club of antennæ with a long apical spine and a few hairs; declivity of elytra oblique, not retuse at the sides, acutely margined only at the apex and for a short distance behind; face of declivity with a slight reniform elevation rising into two cusps near the suture, which is deeply impressed and excavated at that place; head flat, opaque, not fringed with hair.

*Female*: Club of antennæ without apical spine; declivity of elytra as in male, but with the reniform elevation and its two cusps much stronger; head slightly convex, subopaque, feebly punctured.

Lake Superior to Florida; depredates on apple trees. Length, 2<sup>mm</sup> (.08 inch). (Le Conte.)

42. *Ithycerus noveboracensis* (Forster).

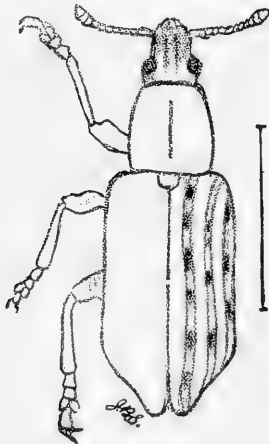


FIG. 35. *Ithycerus noveboracensis*. Smith del.

According to Riley this weevil infests the oak, having been seen boring into the twigs of the burr-oak; the larva is of the usual curculioniform appearance. The female first makes a small longitudinal excavation with her jaws, eating upward toward the end of the branch, then turns round and thrusts her egg into it. She was observed in the act by Mr. Charles Peabody. (Riley's unpublished notes.)

*Beetle*.—This is our largest species of weevil, and may be recognized by its great size, by its broad, large snout, its ash color, and by the eight pale lines on the wing-covers, interrupted by four or five distinct black squarish spots. Length, 12<sup>mm</sup>.

interrupted by four or five distinct black squarish spots. Length, 12<sup>mm</sup>.

## 43. THE SEVENTEEN-YEAR CICADA.

*Cicada septendecim* Linn.

Order HEMIPTERA; Family CICADARLE.

Stinging the terminal twigs of the oak and other forest trees and of various fruit trees, the seventeen-year locust, which deposits its long slender eggs in a broken line along the twig.

Without attempting to recapitulate the history of this famous insect, we would only say that the eggs are deposited from the end of May through June (Fig. 36, *d*, *e*) in pairs in the terminal twigs of the oak, etc. The larvæ (Fig. 36, *f*) hatch out in about six weeks after they are deposited, and drop to the ground, in which they live, sucking the roots of trees, etc., for nearly seventeen years, the pupa state (Fig. 36, *a*, *b*) lasting but a few days.

The following remarks on the habits of this insect are taken from our Third Report on the Injurious Insects of Massachusetts:

As regards the kinds of trees stung by the Cicada, I may quote from a communication from William Kite, in the American Naturalist, vol. ii, p. 442, as confirming and adding somewhat to Dr. Harris's statements: "Seeing in the July number of the Naturalist a request for twigs of oak which had been stung by the so-called seventeen-year locust, I take the liberty of sending you twigs from eleven different varieties of trees in which the females have deposited their eggs. I do this to show that the insect seems indifferent to the kind of wood made use of as a depository for her eggs. These were gathered July 1, in about an hour's time, on the south hills of the 'Great Chester Valley,' Chester County, Pa. No doubt the number of trees and bushes might be much increased. The female, in depositing her eggs, seems to prefer well-matured wood, rejecting the growing branch of this year, and using the last year's wood and frequently that of the year before, as some of the twigs inclosed will show. An orchard which I visited was so badly 'stung' that the apple trees will be seriously injured and the peach trees will hardly survive their treatment. Instinct did not seem to caution the animal against using improper depositories, as I found many cherry trees had been used by them, the gum exuding from the wounds, in that case sealing the eggs in beyond escape.

"The males have begun to die, and are found in numbers under the trees; the females are yet busy with their peculiar office. The length of wood perforated on each branch varied from one to two and a half feet, averaging probably eighteen inches; these seemed to be the work of one insect on each twig, showing a wonderful fecundity.

"The recurrence of three 'locust years' is well remembered in this locality—1834, 1851, and 1868. There has been no variation from the usual time, establishing the regularity of their periodical appearance."

As regards the time and mode of hatching, Mr. S. S. Rathvon, of Lancaster, Pa., contributes to the same journal some new and valuable facts, which we quote: "With reference to the eggs and young of the seventeen-year Cicada, your correspondent from Haverford College, Philadelphia, is not the only one who has failed to produce the young by keeping branches containing eggs in their studios. I so failed in 1834 and 1851, and indeed I have never heard that any one has succeeded in that way who has kept them for any great length of time. In the brood of 1868 the first Cicadas appeared here in a body, on the evening of the second day of June. The first pair *in coitu* I observed on the 21st, and the first female depositing on the 26th of the same month. The first young were excluded on the 5th of August. All these dates are some ten days later than corresponding observations made by myself and others in former years.

On the 15th of July, I cut off some apple, pear, and chestnut twigs containing eggs, and stuck the ends into a bottle containing water, and set it in a broad, shallow dish also filled with water, the whole remaining out of doors exposed to the weather, whatever it might be. The young continued to drop out on the water in the dish for a full week, after the date above mentioned. I could breed no Cicadas from branches that were dead and on which the leaves were withered, nor from those that from any cause had fallen to the ground, and this was also the case with Mr. Vincent Bernard, of Kennet Square, Chester County, Pa. After the precise time was known, fresh branches were obtained, and then the young Cicadas were seen coming forth in great numbers by half a dozen observers in this county. As the fruitful eggs were at least a third larger than they were when first deposited, I infer that they require the moisture contained in living wood to preserve their vitality. When the proper time arrives and the proper conditions are preserved, they are easily bred, and indeed I have seen them evolve on the palm of my hand. The eyes of the young Cicadas are seen through the egg-skin before it is broken."

Mr. Riley, in an interesting account of this Cicada in his First Annual Report on Noxious, Beneficial, and Other Insects of Missouri for 1869, has shown that in the Southern States thirteen-year broods of this insect are found. He remarks: "It was my good fortune to observe that besides the seventeen-year broods, the appearance of one of which was recorded as long ago as 1633, there are also thirteen-year broods, and that, though both sometimes occur in the same States, yet, in general terms, the seventeen-year broods may be said to belong to the Northern and the thirteen year broods to the Southern States, the dividing line being about latitude 38°, though in some places the seventeen-year brood extends below this line, while in Illinois the thirteen-year brood runs up considerably beyond it. It was also exceedingly gratifying to find, four months after I had published this fact, that the same discovery had been made years before by Dr. Smith, though it had never been given to the world."

Mr. Riley predicts that in southern New England a brood will appear in 1877 and 1885. Probably the Plymouth brood, which appeared in 1872, will not appear again for seventeen years, namely, in 1889, the two broods noticed by Riley appearing west of this town. As regards its appearance in Plymouth, Mass., Harris states that it appeared there in 1633. The next date given is 1804, "but, if the exact period of seventeen years had been observed, they should have returned in 1803."

Mr. B. M. Watson informs me, from his personal observation, that it also appeared in 1838, 1855, and 1872. In Sandwich it appeared in 1787, 1804, and 1821. In Fall River it appeared in 1834, in Hadley in 1818, in Bristol County in 1784, so that, as remarked by Harris and others, it appears at different years in places not far from each other. Thus, while in Plymouth and Sandwich we may look for its re-appearance in 1889, in Fall River it will come in 1885, or four years earlier.

There are three species of Cicada in the Northern States, and, in order that they may not be confounded in studying the times of appearance of the different broods of the seventeen-year species, I add a short description of each form, so that they may be readily recognized in the winged and immature states.

The two larger species are the seventeen-year locust (*Cicada septendecim*) and the dog-day cicada (*C. pruinosa*). Fig. 36, copied from Riley's report, gives a good idea of the former species: *a* represents the pupa, *b* the same after the adult has escaped through the rent in the back, *c* the winged fly, *d* the holes in which the eggs, *e*, are inserted. Fig. 36, *f* represents the larva as soon as hatched. The adult may be known by its rather narrow head, the black body, and bright red veins of the wings. The wings expand from two and a half to three and a quarter inches.

The pupa is long and narrow, and compared with that of *C. pruinosa* the head is longer and narrower, the antennæ considerably longer, the separate joints being longer than those of the dog-day locust. The anterior thighs (femora) are very large and swollen, smaller than in *C. pruinosa*, though not quite so thick, with the basal

spine shorter than in that species, while the snag or supplementary tooth is larger and nearer the end; the next spine, the basal one of the series of five, is three times as large as the next one, while in *C. pruinosa* it is of the same size, or, if anything, smaller. The toe joint (tarsus) projects over two-thirds of the length beyond the end of the shank (tibia), while in the other species it only projects half its length. The terminal segment of the body is rather larger than in *C. pruinosa*. The body is shining gum-color or honey-yellow, with the hinder edge of the abdominal segments thickened, but no darker than the rest of the body. Length, one inch (.90 to 1.00); width, about a third of an inch (.35), being rather smaller than that of *C. pruinosa* and much larger than that of *C. rimosa*.

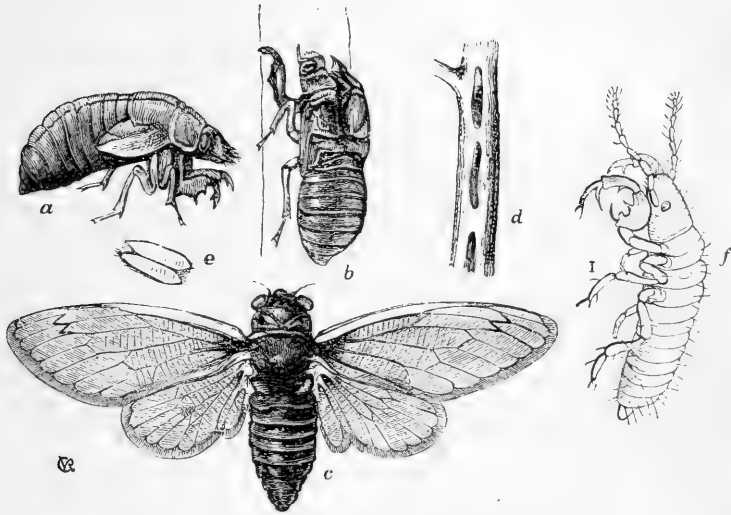


FIG. 36.—The seventeen-year Cicada (*c*) and pupa (*a*, *b*); *d*, position of eggs (*e*); *f*, larva. (After Riley.)

For a further account of this Cicada the reader is referred to Prof. Riley's report of the U. S. Entomologist for 1885, and to Bulletin No. 8, of the Division of Entomology, which contain full information regarding the different broods which appear in different years. From his observations it appears that the development of the larva is extremely slow, and when six years old it hardly attains one-fourth its full size. Moulting also takes place more than once a year, so that there are probably twenty-five or thirty changes of skin in all. Riley, also, has rarely found it more than two feet below the surface during the first six or seven years of its life, and almost invariably in an oval cell, and more often away from roots than near them. Yet it can descend to great depths, one writer stating that he had found it 20 feet below the surface. "As the time approaches for the issuing of the pupa it gradually rises nearer and nearer to the surface, and, for a year or two before the appearance of any given brood, this pupa may be dug up within one or two feet of the surface."

## 44. THE WHITE-LINED TREE HOPPER.

*Thelia univittata* Harris.

Order HEMIPTERA; family MEMBRACIDÆ.

Common upon oak limbs and twigs, puncturing them and sucking their juices.

This tree hopper is found on the oak in July. It is about four-tenths of an inch in length; the thorax is brown, has a short, obtuse horn extending obliquely upwards from in front, and there is a white line on the back extending from the top of the horn to the hinder extremity. (Harris.)

## 45. THE OAK BLIGHT.

*Eriosoma querci* Fitch.

Order HEMIPTERA; family APHIDIDÆ.

A species of blight, or a woolly aphid upon oak limbs, puncturing them and exhausting them of their sap.

This blight is very like a similar insect upon the basswood. The winged individuals are black throughout, and slightly dusted over with an ash-gray powder resembling mold. The fore wings are clear and glassy, with their stigma-spot dusky and feebly transparent, their rib-vein black, and their third oblique vein abortive nearly or quite to the fork. It is .16 long to the tips of its wings. (Fitch.)

## 46. THE WHITE OAK SCALE-INSECT.

*Lecanium quercifex* Fitch.

Order HEMIPTERA; family COCCIDÆ.

Adhering to the smooth bark of the limbs of the white oak, in June, an oval, convex, brownish-black scale, about .30 inch long and .18 wide, its margin paler and dull yellowish. (Fitch.)

## 47. THE QUERCITRON SCALE-INSECT.

*Lecanium quercitronis* Fitch.

Order HEMIPTERA; family COCCIDÆ.

On the small limbs of the black oak; a scale like the preceding but smaller, and of a nearly hemispherical form; its color varying from brownish-black to dull reddish and pale, dull yellow, with a more or less distinct stripe of paler yellow along the middle of its back, and the paler individuals usually mottled with black spots or stripes. Length, .20; width, .16 inch. (Fitch.)

These scales are parasitized by *Platygaster lecanii* (Fitch)

## 48. THE BLACK SCALE OF CALIFORNIA.

*Lecanium oleæ* Bernard.

The black scale is stated by Signoret to be properly in France an olive scale, sometimes, however, becoming so common as to occur on all neighboring plants also. In California we find it infesting the greatest variety of plants and becoming a very serious enemy to orange and other citrus trees. I have found it at Los Angeles on orange and all



other citrus plants, on olive, pear, apricot, plum, pomegranate, Oregon ash, bitter-sweet, apple, eucalyptus, sabal palm, California coffee, rose, cape jessamine, *Habrothmus elegans*; and elsewhere upon an Australian plant known as *Brachæton*, and also upon a heath. It preferably attacks the smaller twigs of these plants, and the young usually settle upon the leaves.

The development of this species is very slow, and it seems probable that there is only one brood in a year. Specimens observed by Mr. Alexander Craw at Los Angeles, which hatched in June or July, began to show the characteristic ridges only in November. Mr. Craw has seen the lice, even when quite well grown, move from twigs which had become dry and take up their quarters on fresh ones.

Although carefully looked for, the males, like those of so many other Lecanides, have never been found.

A dark-brown bark-louse has been sent me from Florida, on live oak, holly, oleander, orange, and one or two unknown plants, by Dr. R. S. Turner, of Fort George, which appears to be identical with *Lecanium oleæ*. It is, however, by no means as abundant or injurious in that State as in California.

Enormous quantities of the eggs of the black scales are destroyed by the chalcid parasite *Tomocera californica*,\* described on p. 368 of this report. Particulars as to the work of this parasite are given at the same place. Upon one occasion (August 25, 1880), I found within the body of a full-grown female a lepidopterous larva, which was very similar in appearance to the larvæ of the species of *Dakruma* described in my last report as destroying bark-lice. The specimen, however, was lost, and no more have been found since.

A number of beetles of the genus *Latridius* were found under scales which had been punctured by the *Tomocera*, but probably would not destroy the live insect. Many mites were found feeding upon the eggs and young. The infested trees were also swarming with the different species of lady-bugs (*Coccinellidæ*). (Comstock.)

*Adult female*.—Dark brown, nearly black in color; nearly hemispherical in form, often, however, quite a little longer than broad; average length from 4<sup>mm</sup> to 5<sup>mm</sup>—average height, 3<sup>mm</sup>. Dorsum with a median longitudinal carina and two transverse carinæ, the latter dividing the body into three subequal portions; frequently the longitudinal ridge is more prominent between the transverse ridges than elsewhere, thus forming with them a raised surface of the form of a capital H. The body is slightly margined; outer part of the disk with many (18 to 30) small ridges which extend from the margin half-way up to center of dorsum. Viewed with the microscope, the skin is seen to be filled with oval or round cells, each with a clear nucleus, the average size of the cells being from .05<sup>mm</sup> to .06<sup>mm</sup> in length, while the nuclei average .02<sup>mm</sup> in diameter. The antennæ are long and 8-jointed, the two basal joints short; joint 3 longest, joints 4 and 5 equal and shorter, joints 6 and 7 equal and still shorter, joint 8 with a notched margin and almost as long as joint 3. Legs rather

\* This parasite is now known as *Dilophogaster californica* Howard, Mr. Howard having changed the name *Tomocera* on account of its similarity to *Tomocerus* in Thysanura.

long and stout, the tibiæ being about one-fifth longer than the tarsi. The anal ring seems to bear six long hairs.

*The egg*.—Long oval in shape, .4<sup>mm</sup> in length, yellowish in color.

*Newly hatched larvæ*.—There is nothing very characteristic about the young larvæ; they are flat and their antennæ are only 6-jointed. (Comstock's Report for 1880, p. 336.)

#### 49. THE OAK CHERMES.

*Chermes* sp.

(Plate XXVIII, Fig. 1.)

The following characterization of this genus is taken from Signoret :

Body perfectly globular or with a slight incision for insertion on the twig or branch. On an external examination no trace of antennæ, legs, or even mouth parts is to be observed, and the insect presents precisely the appearance of a gall.

In the larvæ, however, the true characters of the Coccinæ are seen—multiarticulate lower lip and the absence of the anal plates. The larval characters are the ones which have been principally used in the description of species, as they are easy to find. They (the larvæ) are long, oval, the abdomen plainly segmented and deeply cleft at the extremity, except in *C. vermilio* and *C. ballotæ*. Upon each segment there are several spines at the lateral edge and several hairs upon each disk. The lateral lobes have each a bundle of spines and a very long hair. Antennæ 6-jointed, joint 3 longest. With all the legs the tibiæ are shorter than the tarsi. With the adult the antennæ and legs appear natural; but in very old individuals, which have secreted the horny covering, the antennæ are still present, but deformed; so also with the legs, but the latter are sometimes entirely wanting.

The males resemble those of other Coccinæ, and are inclosed in a little white felt-like sac. Head globular, with four eyes and six ocelli in *C. bauhinii* (the only species observed by Signoret). The antennæ are very long, joint 3 longest, joint 10 shortest, and carrying several hairs with buttoned tips. Wings long. Abdomen long, with a short genital armature and two long bristles each side. Legs long, the tibiæ longer than the tarsi, the latter with a long claw and the four ordinary digitules.

There are in the collection of the Department several species belonging to this genus, which we have collected in Florida, Alabama, Louisiana, California, New York, and District of Columbia. For want of time I am unable to characterize these now. The species represented on Plate XXVIII, fig. 1, occurs on *Quercus* in California. The only North American species which has been described is *Kermes galliformis* Riley, described in the American Naturalist, vol. xv, p. 482 (June, 1881). (Comstock, U. S. Agricultural Report, 1880, 337.)

#### 50. *Chermes galliformis* Riley.

“Received from H. H. Rusby, Silver City, N. Mex., the almost globular scales of a coccid from the same oak as the preceding (*Quercus emoryi*). They are shining, very indirectly sculptured, white, beautifully variegated with yellowish-gray and black. The white ground-color is especially noticeable in longitudinal stripes. These scales occur either singly or in clusters—the largest containing about eight—around the twig. They contained nothing but eggshells when received.

These scales were infested with the larva of a Lepidopteron apparently belonging to *Dakruma*, which issued in April, 1881.” (Riley's unpublished notes.)

## 51. THE OBSCURE SCALE INSECT.

*Aspidiotus obscurus* Comstock.

This scale insect was found by Professor Comstock on the leaves of the willow oak. The following account is copied from his report in the U. S. Agricultural Report for 1880:

*Scale of female.*—The scale of the female is very dark gray, agreeing in color with the bark to which it is attached; and as it is only slightly convex, its presence is difficult to detect. It is somewhat irregular in outline, but nearly circular. The exuviae are between the center and one side; their position is indicated by a nipple-like prominence, which is marked, as in many other species, with a white dot and concentric ring of the same color. The ventral scale consists of a delicate film of white excretion, and the lower half of the exuviae attached to the bark. Diameter of scale, 3<sup>mm</sup> (.12 inch).

*Female.*—The body of the full-grown female is reniform, being only four-fifths as long as wide and having the lobes of the penultimate segment extending back nearly as far as the end of the body. The segmentation of the body is very indistinct; the color is a yellowish brown. The last segment presents the following characters (Plate XII, Fig. 4):

There are five groups of *spinnerets*; the median consists of about six, the superior lateral of about twelve, and the inferior lateral of about eight. The oval pores opening on the dorsal side of the body are to be seen very distinctly from below.

There are three pairs of well developed *lobes*. The first lobe of each side is conical, tapering anteriorly, and with the distal margin rounded; there is often a small notch on the lateral side. The distal margins of the second and third lobes are serrate.

The thickened part of the *lateral margin* of the segment becomes narrower anteriorly until near the penultimate segment it is a mere line. It is irregularly notched and is terminated posteriorly by a prominent lobe.

There are seven short club-shaped *thickenings* of the body wall upon each side of the meson. Each thickening is rounded anteriorly and tapers posteriorly. They are situated as follows: one terminating near the lateral margin of the first lobe, one at each side of second lobe, one midway between second and third lobes, one at each side of third lobe, and one near the posterior end of the thickened lateral margin. This one is often obsolete. Those terminating at the median sides of the second and third lobes are narrower and shorter, and have their anterior ends directed laterad more than the others. The remaining thickenings are of about the same length as the median lobes.

The *plates* are inconspicuous, and in no case extend as far as the lobes. There is one between the median lobes, one between the first and second lobe of each side, two between the second and third lobes, and two between the third lobe and the posterior end of the thickened lateral margin. The last two are unequally bifid, the other four are simple and truncate.

On the ventral side the first pair of *spines* is obsolete, the second and third pores are situated at the base of the lateral margins of their respective lobes, the fourth pair is just laterad of the lobe of the lateral margin, and a fifth pair is situated about one-third the distance from this lobe to the penultimate segment. On the dorsal side the first pair is also obsolete; each member of the other four pairs is situated in little mesad of the corresponding spine on the ventral surface.

*Egg.*—The eggs have not been observed, and several specimens of females in the collection indicate that the species is viviparous.

*Scale of male.*—The scale of the male is oval in outline with the protuberance cov-

ering the larval skin near the anterior end. This scale is of the same color as that of the female.

Length, a little more than 1<sup>mm</sup> (.04 inch); breadth nearly  $\frac{1}{2}$ <sup>mm</sup> (.02 inch).

*Habitat*.—On the bark of the limbs of willow oak (*Quercus phellos*) at Washington, D. C.

Described from forty females and very many scales of each sex.

The scale of this species resembles very much that of *Aspidiotus tenebricosus* which occurs on red maple. That scale, however, is much more convex than this one, and its diameter is only one-half as great.

52. *Asterodiaspis quercicola* (Bouché).

(Plate XXVIII, Fig. 4.)

The females of this genus resemble those of *Asterolecanium* Targ.-Tozz. Around the lateral edge and upon the dorsum are *spinnerets*, which secrete a fringe which persists upon the sides but which upon the back melts down and forms a continuous whole, which constitutes in the old individuals a hard and consistent shield, slightly iridescent, which covers the whole insect. When the females have deposited their eggs the body shrinks up into the cephalic end of the covering so that there appears to be only a sac inclosing the eggs, which one would naturally take to be the body of the female. The male scale is of a long oval, with a weak median carina, and showing under the microscope an elegant fringe around the edge similar to that of the female scale. (Comstock, 1880.)

*Adult female*.—Of a dark brown or a clear yellow color, nearly round in outline, furnished at the anal extremity with a rounded lobule and above with transverse striæ, which represent the abdominal segmentation. Diameter from 1<sup>mm</sup> to 2<sup>mm</sup>.

The skin is covered with quite a large number of tubular *spinnerets*. The circumference of the body is ciliated with a fine radiating fringe secreted by openings upon the edge of the body. This fringe is double, formed of a row of large tubes joined together two by two, secreted by double openings, and another row, smaller, secreted by smaller openings placed below the others.

These insects are very closely applied to the bark, forming for themselves, in fact slight depressions, so that it is very difficult to lift them. Occasionally, however, one of the yellow scales (in which the body of the insect has shrunken up to the end) is slightly elevated at one side, perhaps to allow for the exit of the young. On lifting one of the scales there remain upon the bark floury marks corresponding to the stigmata.

*Male*.—The male scale is of a long oval, 1<sup>mm</sup> in length by .6<sup>mm</sup> in width; of a clear brilliant yellow with a weak median carina, and with a fringe similar to that of the female.

The male is brownish yellow upon the head and thorax, and of a clearer yellow upon the abdomen, the base of which is a little darker; the antennæ and legs almost black, the prothorax and mesothorax darker than the rest, the transverse band of the metathorax perfectly black, as well as the eyes. The wings are large and of a transparent whitish gray. The abdomen is large and rounded; the stylet is dark yellow and .35<sup>mm</sup> long.

*Habitat*.—Upon the imported oaks on the Department of Agriculture grounds at Washington. Only the females were found and the male description is taken from Signoret. The species is not a common one in Europe, but is occasionally quite destructive to an individual tree. (Comstock, 1880.)

53. *Rhizococcus quercus* Comst.

(Plate XXIX, Fig. 2.)

The following account of this scale insect is by Professor Comstock (Agricultural Report, 1880):

*Female*.—The tubular spinnerets are more numerous than in *R. araucariæ*, and are not confined to the margin of the body, but are distributed irregularly over the dorsum. They vary much in size and are curved and acuminate (Fig. 2*a*). Tarsi less than one-half as long as tibiæ. Hair on trochanter nearly as long as femur.

*Male*.—I have only one specimen, which is much shriveled; this resembles *R. araucariæ*, except that the ocelli are placed farther caudad of the eyes than in that species.

Described from 17 females, 1 male, and very many larvæ, all mounted in balsam.

*Habitat*.—On scrub oak at Rock Ledge, Fla.; upon gall-berry, oak, and grass at Fort George, Fla. (Dr. R. S. Turner). The sacs (Fig. 2) of this species, of which I have very many specimens, very closely resemble those of *R. araucariæ*. The sacs of the female are all large, indicating that the species is naked till full grown.

The following observations are from Prof. Riley's MS. notes:

Specimens of this coccid were received March 29, 1882, from A. Koebele, Archer, Fla., infesting both the trunk and twigs of live oak. Males were just issuing in considerable numbers when received. Their color is reddish, eyes black, antennæ and legs paler red, thoracic band black. Wings faintly yellowish, somewhat iridescent, with the veins slightly darker. The whole insect is covered with a delicate whitish layer of a mealy excretion. The white anal filaments are longer than the whole insect, including the antennæ. The young females are dull greenish yellow. The old females are purplish, and the eggs pale purplish. Some of the scales were infested by *Dakruma coccidivora*, and others by the larvæ of a *Seymnus* which were feeding on the eggs.

The following observations, which relate to this or an allied species, are also copied from Prof. Riley's MS. notes:

March 1, 1880, received from Dr. J. H. Mellichamp, of Bluffton, S. C., some twigs of *Quercus myrtifolia* infested by a coccid. The scales are white and have a silky appearance; they are mostly oblong-oval in form, but sometimes shorter. The eggs under these scales are regularly oval, whitish pink in color, opaque, semi-transparent, without visible sculpture, and held together by short, interwoven threads that somewhat resemble cotton batting. The scales are found in clusters at the base of the more slender twigs, others single, while a few stray to the leaves. One cluster of these scales was infested by a lepidopterous larva about two-thirds of an inch in length and of a dirty greenish-gray color. This larva kept concealed under the scales and wherever it pierced them it closed up the holes with a delicate web. It spun for itself a silken cocoon, March 3, at the bottom of the jar and issued on April 19. The eggs of the coccid hatched from the 6th to 20th of March. All died.

54. *Chionaspis quercus* Comstock.

(Plate XXVIII, Fig. 3.)

This scale insect, according to Professor Comstock (Ag. Rep. 1880), lives on white oak (*Quercus lobata*) in San Fernando Valley, California.

The females occur on the bark of the small limbs; the males upon the leaves.

*Scale of female.*—The scale of the female is long, narrow at the anterior end, much widened posteriorly, and quite convex. The exuviae are brownish yellow; the secretion, of which the remainder of the scale is composed, is white; but all of my specimens appear dark gray, being more or less covered with the hairs of the stem to which the scale was attached, and with dust. Length of scale 2<sup>mm</sup> (.08 inch).

*Female.*—The last segment of the female presents the following characters:

The anterior group of *spinnerets* consists of about ten; the anterior laterals of seventeen to twenty, and the posterior laterals of ten to eighteen.

This species differs from all *Diaspinæ* known to me in having a single undivided lobe on the meson; this lobe is large and rounded distally. The second and third lobes of each side are very small and are laterad of small incisions in the margin of the segment. In each case there is a reniform thickening of the body wall bounding each incision anteriorly. There is also a similar incision with a rudimentary lobe and reniform thickening of the body wall about midway between third lobe and penultimate segment.

The *plates* are inconspicuous and spine-like; there are usually one or two laterad of second ventral spine, two or three between third and fourth lobe, and usually five between fourth lobe and penultimate segment. The penultimate and antepenultimate segments bear six each; those on the latter are much expanded at the base.

The *spines* are long and conspicuous; those on the dorsal surface are situated as follows: One on each side at the base of the lateral margin of median lobe, one laterad of each of the second and third lobes, and a fourth one near the center of the anterior group of plates. Those on the ventral surface are as follows: A short one nearly ventrad of the first dorsal spine, a large one laterad of each of the second and third dorsal spines, and a fourth one a little cephalad of the fourth dorsal spine.

*Scale of the male.*—The scale of the male is snowy white, with the larval skin very light yellow. The texture of the scale is quite loose and the carinae prominent; length, 1.25<sup>mm</sup> (.05 inch).

*Male.*—The adult male is as yet unknown; many pupæ were collected August 17, 1880. Specimens of these mounted in balsam are bright yellow in color, with eyes purplish black. Fully grown male larvæ in balsam are yellowish brown.

Described from four scales of the female, four females, hundreds of scales of the male, and many male pupæ and larvæ.

Mr. W. H. Ashmead has kindly allowed me to reprint, with his additions and corrections, the following:

CATALOGUE OF NORTH AMERICAN CYNIPIDÆ LIVING ON THE OAK.

CYNIPIDÆ.

Division I.—PSENIDÆ, or True Gall-makers.

**BELONOCNEMA**, Mayr.

55. *treatæ*, Mayr. Die Gen. d. Gallenbw. Cynip. p. 16.

**AMPHIBOLIPS**, Reinhard.

56. *spongifica*, O. S. (*Cynips*) Proc. Ent. Soc. Phil. ii p. 244.  
 57. *cocciniæ*, O. S. l. c. p. 242.  
 58. *nubilipennis*, Harris (*Cynips*) Ins. Inj. Veg. p. 434; Fitch Rep. 2nd, No. 318.

**AMPHIBOLIPS**, Beinhard—Continued.

59. *inanis*, O. S. (*Cynips*) l. c. ante i, p. 61.
60. *cœlebs*, O. S. (*Cynips*) l. c. p. 61.
61. *ilicifoliæ*, Bass. (*Cynips*) l. c. iii, p. 682.
62. *formosa*, Bass. (*Cynips*) l. c. p. 679.
63. *sculpta*, Bass. (*Cynips*) l. c. ii, p. 324.
64. *phellos*, O. S. (*Cynips*) l. c. i, p. 70.
65. *cinerea*, Ashm. (*Cynips*) Proc. Ent. Soc. 1881, p. xix.
66. *racemaria*, Ashm. (*Cynips*) l. c. p. xxvi.
67. *citriformis*, Ashm. (*Cynips*) l. c. p. xxviii.
68. *fuliginosa*, Ashm. (*Cynips*) l. c. 1885, p. vii.
69. *melanocera*, Ashm. Trans. Am. Ent. Soc. xii, p. 299.
70. *prunus*, Walsh (*Cynips*) Am. Ent. i, p. 104.

**ANDRICUS**, Hartig.

S. G. *CALLIRHYTIS* Förster.

71. *agrifoliæ*, Bass. (*Cynips*) Can. Ent. vol. xiii, p. 53.
72. *suttoni*, Bass. (*Cynips*) l. c. p. 54.
73. *californicus*, Bass. (*Cynips*) l. c. p. 51.
74. *capsula*, Bass. (*Cynips*) l. c. p. 101.
75. *conigerus*, O. S. (*Cynips*) Proc. Ent. Soc. Phil. ii, p. 251, vol. v, p. 358.
76. *seminator*, Harris (*Cynips*) Ins. Inj. Veg. p. 548; Fitch, Rep. 2d N. Y. State Agr. Soc. p. 315.
77. *similis*, Bass. (*Cynips*) Proc. Ent. Soc. Phil. iii, p. 685.
78. *futilis*, O. S. (*Cynips*) l. c. pp. 63-64.
79. *tumifica*, O. S. (*Cynips*) l. c. v, p. 683.
80. *scitula*, Bass. (*Cynips*) l. c. iii, p. 683.
81. *clavula*, Bass. (*Cynips*) l. c. p. 685.
82. *operator*, O. S. (*Cynips*) l. c. ii, pp. 256-257.
83. *palustris*, O. S. (*Cynips*) l. c. i, p. 63.
84. *nigræ*, O. S. (*Cynips*) l. c. i, p. 66.
85. *tuber*, Fitch (*Cynips*) Rep. 2d N. Y. State Agr. Soc. p. 309; Bassett. Proc. Ent. Soc. Phil. iii, p. 685.
86. *modesta*, O. S. (*Cynips*) l. c. i, p. 66.
87. *notha*, O. S. (*Cynips*) l. c. p. 58.
88. *podagræ*, Walsh (*Cynips*) Proc. Ent. Soc. iii, p. 492.
89. *futilis*, O. S. (*Cynips*) l. c. i, pp. 63-64.
90. *papillatus*, O. S. (*Cynips*) l. c. p. 64.
91. *quercifoliæ*, Ashm. Trans. Am. Ent. Soc. xii, p. 299.

S. G. *ANDRICUS*, Hartig.

92. *tubicola*, O. S. (*Cynips*) Proc. Ent. Soc. i, p. 60.
93. *singularis*, Bass. (*Cynips*) l. c. ii, p. 326; Walsh, vol. ii, p. 485.
94. *osten sackenii*, Bass. (*Cynips*) l. c. p. 327.
95. *ventricosus*, Bass. (*Cynips*) l. c. iii, p. 681.
96. *iana*, Fitch (*Cynips*) Fifth Report, No. 316.
97. *confluens*, Harris (*Cynips*) Ins. Inj. Veg. p. 433; O. S. Proc. Ent. Soc. i, p. 57.
98. *petiolicola*, Bass. (*Cynips*) Proc. ii, p. 325.
99. *fusififormis*, O. S. (*Cynips*) l. c. i, p. 61.
100. *floci*, Walsh (*Cynips*) l. c. vol. iv, p. 482.
101. *ignotus*, Bass. (*Cynips*) Can. Ent. vol. xiii, p. 106.
102. *cinerosus*, Bass. (*Cynips*) l. c. p. 110.
103. *utriculus*, Bass. (*Cynips*) l. c. p. 78.
104. *californicus*, Bass. (*Cynips*) l. c. p. 51.
105. *pomiformis*, Bass. (*Cynips*) l. c. p. 74.

**ANDRICUS**, Hartig—Continued.S. G. *ANDRICUS*, Hartig—Continued.

106. *Pattoni*, Bass. (*Cynips*) l. c. p. 98.
107. *coxii*, Bass. (*Cynips*) l. c. p. 112.
108. *papula*, Bass. (*Cynips*) l. c. p. 107.
109. *bataoides*, Ashm. (*Cynips*) Proc. Ent. Soc. 1881, p. xi.
110. *foliatus*, Ashm. (*Cynips*) l. c. p. xiii.
111. *lanigera*, Ashm. (*Cynips*) l. c. p. xiii.
112. *catesbæi*, Ashm. (*Cynips*) l. c. p. xv.
113. *turnerii*, Ashm. (*Cynips*) l. c. p. xvi.
114. *rugosus*, Ashm. (*Cynips*) l. c. p. xviii.
115. *medullæ*, Ashm. (*Cynips*) l. c. 1885, p. viii.
116. *gemmarius*, Ashm. (*Cynips*) l. c. 1885, p. ix.
117. *capsualus*, Ashm. (*Cynips*) l. c. 1885, p. ix.
118. *virens*, Ashm. (*Cynips*) l. c. 1881, p. x.
119. *succinipes*, Ashm. (*Cynips*) l. c. p. xi.
120. *clavigerus*, Ashm. (*Cynips*) l. c. p. xxvii.
121. *omnivorus*, Ashm. (*Cynips*) l. c. 1885, p. vi.
122. *gibbosus*, Prov. Le Nat. Can. vol. xii, p. 232.
123. *quinqueseptum*, n. sp.

**CYNIPS**, Linn.

124. *strobilana*, O. S. Proc. Ent. Soc. Phil. ii, p. 254; Bassett, l. c. vi, p. 690.
125. *echinus*, O. S. Trans. Am. Ent. Soc. 1870, p. 56.

**ACRASPIS**, Mayr.

126. *pezomachoides*, O. S. (*Teras*) l. c. ii, p. 250.
127. *erinacei*, Walsh (*Teras*) l. c. ii, p. 483.

**BIORHIZA**, Westw.

128. *forticornis*, Walsh (*Cynips*) l. c. iii, p. 490; (*Teras*) O. S. l. c. iv, p. 379.
129. *hirta*, Bass. (*Cynips*) l. c. iii, p. 688; (*Teras*) O. S. l. c. iv, p. 379.
130. *fulvicollis*, Fitch (*Philonix*) Rep. No. 291; (*Teras*) O. S. l. c. p. 379.
131. *nigricollis*, Fitch (*Philonix*) l. c. No. 292; (*Teras*) O. S. l. c. iv, p. 379.
132. *nigra*, Fitch, Fifth Rep. No. 290.
133. *loxaulis*, Mayr, *mammula*, Bass. (*Cynips*) Can. Ent. xiii, p. 76.

**HOLCASPIS**, Mayr.

134. *globulus*, Fitch (*Callaspidia*) Fifth Rep. No. 313; (*Cynips*) O. S. l. c. ante vol. i, p. 67; Bassett, l. c. vol. ii, p. 328.
135. *centricola*, O. S. (*Cynips*) l. c. vol. i, p. 58.
136. *tenuicornis*, Bass. (*Cynips*) Can. Ent. vol. xiii, p. 92.
137. *ficula*, Bass. (*Cynips*) l. c. xii, p. 75.
138. *ficigera*, Ashm. (*Cynips*) Proc. Ent. Soc. 1885, p. vi.

**DRYOPHANTA**, Förster.

139. *gemma*, Bass. (*Cynips*) Can. Ent. vol. xiii, p. 104.
140. *nubila*, Bass. (*Cynips*) l. c. p. 56.
141. *bella*, Bass. (*Cynips*) l. c. p. 56.
142. *polita*, Bass. (*Cynips*) l. c. p. 56.
143. *aquaticæ*, Ashm. (*Cynips*) Proc. Ent. Soc. 1881, p. xvi.
144. *laurifoliæ*, Ashm. (*Cynips*) l. c. p. xvii.



**NEUROTERUS**, Hartig.

145. *batata*, Bass. (*Cynips*) Proc. Ent. Soc. Phil. iii, p. 684; Fitch, Fifth Rep. No. 311.  
 146. *noxiosus*, Bass. (*Cynips*) Can. Ent. xiii, p. 108.  
 147. *vesiculosus*, Bass. (*Cynips*) Proc. Ent. Soc. Phil. iii, p. 683.  
 148. *irregularis*, O. S. (*Cynips*) l. c. i, p. 65.  
 149. *verrucarum*, O. S. (*Cynips*) l. c. p. 62.  
 150. *minutus*, Bass. (*Cynips*) Can. Ent. vol. xiii, p. 96.  
 151. *floccosus*, Bass. (*Cynips*) l. c. p. 111.  
 152. *affinis*, Bass. (*Cynips*) l. c. p. 103.  
 153. *piger*, Bass. (*Cynips*) l. c. p. 105.  
 154. *corrugis*, Bass. (*Cynips*) l. c. p. 109.  
 155. *majalis*, Bass. (*Cynips*) Proc. Ent. Soc. Phila. iii, p. 683.  
 156. *rileyi*, Bass. (*Cynips*) Am. Nat. 1881, p. 149; Am. Ent. vol. iii, p. 153 (figure of gall).  
 157. *crassitelus*, Prov. Le Nat. Can. vol. xii, p. 232.  
 158. *minutissimus*, Ashm. (*Cynips*) Proc. Ent. Soc. 1885, p. vii.  
 159. *confusus*, Ashm. (*Cynips*) l. c. 1881, p. xviii.  
 160. *coniferus*, Ashm. (*Cynips*) l. c. p. xxvii.

The following species were characterized from the galls alone and their generic position is uncertain :

161. *Cynips pilulæ*, Walsh Proc. Ent. Soc. Phila. vol. iii, p. 481.  
 162. *Cynips juglans*, Osten Sacken l. c. vol. ii, p. 256.  
 163. *Cynips cicatricula*, Bassett, Can. Ent. vol. xii, p. 105.

## Division II.—INQUILINÆ, or Guest Gall-flies.\*

**PERICLISTIS**, Förster.

- sylvestris*, O. S. (*Aulax*) Proc. Ent. Soc. Phila. vol. iii, p. 37.  
*pirata*, O. S. (*Aulax*) l. c. vol. i, p. 64.  
*futilis*, O. S. (*Aulax*) l. c. vol. i, p. 64.  
*semipiceus*, Harris (*Cynips*) Ins. Inj. Veg. p. 549.

**CEROPTRES**, Hartig.

- ficus*, Fitch (*Cynips*) Fifth Rep. No. 314.  
*petiolicola*, O. S. (*Amblynotus*) l. c. vol. i, p. 67; vol. v, p. 380.  
*Amblynotus ensiger* Walsh, l. c. vol. ii, p. 496.  
*inermis*, Walsh (*Amblynotus*) l. c. vol. ii, p. 598; (*Ceroptres*) l. c. vol. v, p. 330.  
*arbus*, Fitch (*Cynips*) Fifth Rep. No. 310.  
*tuber*, Fitch (*Cynips*) l. c. No. 309.  
*obtusilobæ*, Ashm. Trans. Am. Ent. Soc. xii, p. 301.  
*citriformis*, Ashm. l. c. p. 300.  
*pomiformis*, Ashm. l. c. p. 300.  
*virentis*, Ashm. l. c. p. 300.  
*succinipedis*, Ashm. l. c. p. 300.  
*lanigeræ*, Ashm. l. c. p. 301.  
*minutissimi*, Ashm. l. c. p. 301.  
*catesbæi*, Ashm. l. c. 301.

**SYNERGUS**, Hartig.

- lignicola*, O. S. Proc. Ent. Soc. vol. ii, p. 252; *rhoditiformis* Walsh l. c. p. 499.  
*oneratus*, Harris (*Cynips*) Ins. Inj. Veg. 3d ed. p. 548; Fitch Second Rep. No. 313; (*Synergus*) Osten Sacken l. c. ante vol. v, p. 380.

\*As these are parasites on the other gall-flies, they are not numbered as injurious to the oak.

**SYNERGUS**, Hartig—Continued.

- læviventris*, O. S. (*Synophrus*) l. c. vol. i, p. 54; Walsh vol. ii, p. 494; (*Synergus*) O. S. l. c. vol. v, p. 380.  
*campanula*, O. S. l. c. vol. v, p. 376.  
*dimorphus*, O. S. l. c. vol. v, p. 376.  
*albipes*, Walsh (*Synophrus*) l. c. vol. ii, p. 496.  
*medax*, Walsh l. c. vol. iv, p. 498.  
*ficigeræ*, Ashm. Trans. Am. Ent. Soc. xii, p. 301.  
*coniferæ*, Ashm. l. c. p. 301.  
*batatoides*, Ashm. l. c. p. 301.  
*bicolor*, Ashm. l. c. p. 302.  
*medullæ*, Ashm. l. c. p. 302.

**SAPHOLYTUS**, Förster.

- gemmaræ*, Ashm. l. c. p. 302.

## Division III.—FIGITINÆ, or the Parasites.

**ANACHARIS**, Dalman.

- subcompressa*, Prov. (*Eucoila*) l. c. (ante) vol. xii, p. 237.

**ONYCHIA**, Dalman.

- quinquelineata*, Say (*Diplolepis*) Le Conte's Ed. Say's Works vol. ii, p. 716; (*Figites*) Prov. Le Nat. Can. xii, p. 237.  
*armata*, Say (*Diplolepis*) l. c. ii, p. 716; (*Figites*) Prov. l. c. xii, 238.

**EUCOILA**, Westwood.

- stigmata*, Say (*Figites*) l. c. ii, p. 718.  
*Kleidotoma maculipennis*, Prov. l. c. xii, 237.  
*impatiens*, Say (*Diplolepis*) l. c. ii, p. 716.  
*Kleidotoma cupulifera*, Prov. l. c. xii, 238.  
*pedata*, Say (*Diplolepis*) l. c. ii, p. 717.  
*mellipes*, Say (*Figites*) l. c. ii, p. 718.  
*Kleidotoma minima*, Prov. l. c. xii, p. 238.

**KLEIDOTOMA**, Westwood.

- vagabunda*, Ashm. Trans. Am. Ent. Soc. xii, p. 302.

**FIGITES**, Latreille.

- impatiens*, Say l. c. ii, p. 718.  
 ? *chinquapin*, Fitch Fifth Rep. No. 320.

**ÆGILIPS**, Halliday.

- ? *aciculatus*, Prov. l. c. (ante) vol. xii, p. 239.  
 ? *obtusilobæ*, O. S. Proc. Ent. Soc. Phila. vol. i, p. 68.

**IBALIA**, Latreille.

- ensiger*, Norton l. c. vol. i, p. 200.  
*anceps*, Say, Le Conte's Ed. Say's Works, vol. i, p. 218.  
*maculipennis*, Hald. Proc. Acad. Nat. Sci. vol. iii, p. 127.  
*rufipes*, Cress. Proc. Ent. Sec. A. N. S. 1879, p. xvii.  
*montana*, Cress. l. c. 1879, p. xvii.

Mr. W. H. Ashmead has published in the Transactions of the American Entomological Society for 1886, pp. 303-304, the following list of the species of oak on which the North American CYNIPIDÆ are found, with a list of the described species (129 in number) inhabiting each kind of oak. Mr. Ashmead has kindly revised and added to the list, bringing it down to 1888.

THE OAKS (*Cupuliferæ*).

## ENCENO OAK.

*(Quercus agrifolia.)**Andricus pomiformis*, Bassett.*Callirhytis agrifoliae*, B.*Cynips echinus*, O. S.

## WHITE OAK.

*(Quercus alba.)**Acraspis pezomachoides*, O. S.*forticornis*, Walsh.*Andricus fusiformis*, O. S.*lana*, Fitch.*utriculus*, B.*flocchi*, W.*Callirhytis clavula*, B.*tuber*, F.*futilis*, O. S.*seminator*, Harris.*Cynips juglans*, O. S.*cicatricula*, B.*pisum*, F.*Dryophanta carolina*.*Holcaspis globulus*, F.*Loxaulis mammula*, B.*Neuroterus batatus*, B.*majalis*, B.*minutus*, B.*vesiculus*, B.

## WATER OAK.

*(Quercus aquatica.)**Dryophanta aquatica*, Ashm.*Andricus turnerii*, A.*Amphibolips melanocera*, A.*Callirhytis aquatica*, A.

## SWAMP WHITE OAK.

*(Quercus bicolor.)**Andricus ignotus*, B.*Acraspis lanæ-globuli*, A.*echini*, A.*Callirhytis capsulus*, B.*Cynips strobilana*, O. S.*Neuroterus noxiosus*, B.*flucosus*, B.

## BLACK JACK, OR SCRUB OAK.

*(Quercus Catesbæi.)**Andricus catesbæi*, A.*omnivorus*, A.*capsulus*, A.*infuscatus*, A.*cryptus*, A.

## UPLAND WILLOW, OR BLUE JACK OAK.

*(Quercus cinerea.)**Amphibolips cinerea*, A.*Andricus omnivorus*, A.*medullæ*, A.*gemmarius*, A.*capsulus*, A.*saltatus*, A.*difficilis*, A.*blastophagus*, A.*Dryophanta cinerea*, A.

## SCARLET OAK.

*(Quercus coccinea.)**Amphibolips coccinea*, O. S.*nanus*, O. S.*Andricus osten-sackenii*, B.

## SWAMP CHESTNUT OAK.

*(Quercus prinus.)**Andricus papillatus*, B.*Callirhytis seminator*, H.*Holcaspis rugosa*, B.*Neuroterus majalis*, B.

## LAUREL OAK.

*(Quercus laurifolia.)**Amphibolips racemaria*, A.*citriformis*, A.*spinosa*, A.*Andricus rugosus*, A.*clavigerus*, A.*calycicola*, A.*femoratus*, A.*Callirhytis callæ*, A.*Eumayria floridana*, A.*Holcaspis fuliginosa*, A.*Neuroterus confusus*, A.*coniferus*, A.*longipennis*, A.*laurifoliae*, A.

## BURR OAK, OVERCUP OAK.

*(Quercus ficula)**Holcaspis ficula*, B.

## LIVE OAK.

*(Quercus virens)**Andricus foliatus*, A.*lanigerus*, A.*virens*, A.*Belonocnema treatae* Mayr.*Holcaspis omnivora*, A.*ficigera*, A.*Neuroterus minutissimus*, A.

## BLACK-JACK OAK, BARREN OAK.

*(Quercus nigra.)*

- Callirhytis nigra*, O. S.  
*operator*, O. S.  
*podagræ*, W.

## PIN OAK, SWAMP SPANISH OAK.

*(Quercus palustris.)*

- Callirhytis cornigera*, O. S.  
*palustris*, O. S.  
*notha*, O. S.

## WILLOW OAK.

*(Quercus phellos.)*

- Amphibolips phellos*, O. S.

## CHESTNUT OAK.

*(Quercus castanea.)*

- Neuroterus rileyi*, B.

## HINDS'S OAK.

*(Quercus hindsii.)*

- Andricus californicus*, B.

## MOUNTAIN CHESTNUT OAK.

*(Quercus montana.)*

- Andricus petiolicola*, B.  
*Biorhiza fulvicollis*, F.  
*hirta*, B.

## OAK.

*(Quercus prinoides?)*

- Dryophanta gemmula*, B.  
*Holcaspis rugosa*, B.  
*Neuroterus affinis*, B.  
*corrugis*, B.

## RED OAK.

*(Quercus rubra.)*

- Amphibolips nubilipennis*, H.  
*cælebs*, O. S.  
*formosa*, B.  
*sculpta*, B.  
*Andricus singularis*, B.  
*confluens*, B.  
*papulus*, B.  
*Callirhytis modesta*, O. S.  
*punctata*, B.  
*Cynips pilulæ*, W.

## POST OAK.

*(Quercus obtusiloba.)*

- Andricus tubicola*, O. S.  
*pattoni*, B.  
*omnivorus*, A.  
*floridanus* Ashm.  
*topiarius*, A.  
*stropus*, A.  
*cinnamomeus*, A.  
*Acraspis vaccinii*, A.  
*Biorhiza mellea*, A.  
*Callimytis parvifolia*, A.  
*Dryophanta polita*, B.  
*Holcaspis centricola*, O. S.  
*ficula*, B.  
*Loxaulis mammula*, B.  
*Neuroterus verrucarum*, O. S.  
*irregularis*, O. S.  
*pattoni*, B.

## BLACK OAK, YELLOW-BARKED OAK.

*(Quercus tinctoria.)*

- Amphibolips spongifica*, O. S.  
*Andricus papulus*, B.  
*Callirhytis tumifica*, O. S.  
*podagræ*, W.  
*scitula*, B.  
*Neuroterus piger*, B.

## OAK.

*(Quercus ilicifolia.)*

- Amphibolips ilicifolia*, B.  
*Andricus osten-sackenii*, B.  
*ventricosus*, B.  
*conigerus*, O. S.  
*Callirhytis similis*, B.  
*palustris*, O. S.

## ON UNKNOWN OAKS.

- Andricus cinerosus*, B.  
*coxii*, B.  
*Callirhytis suttonii*, B.  
*Dryophanta nubila*, B.  
*bella*, B.  
*texana*, A.  
*Holcaspis tenuicornis*, B.

The following species of Cynipidæ are not arranged systematically or by their modern genera, but so far as practicable by the species of oak on which they live.

THE OAK-FIG GALL-FLY.

*Cynips quercus-ficus* Fitch.

Order HYMENOPTERA; family CYNIPIDÆ.

Surrounding the twigs of white oaks in a dense cluster, resembling preserved figs packed in boxes, each molded to the shape of those pressing against its sides, hollow bladder-like galls of the pale dull yellow color of a faded oak leaf, each gall producing a small black fly with the lower half of its head, its antennæ, and legs pale dull yellow, its hind shanks dusky, and its abdomen beneath reddish-brown, its antennæ with fifteen and in the female thirteen joints. Length .06, females .10, and to the end of their wings .14. (Fitch.)

Galls which apparently belong to the above species were received June 10, 1882, from Miss Kath. Parsons, South Lancashire, Mass., who found them on the oak at Breakheart Hill, Saugus, Mass., and several of the gall-flies were bred from them between July 1 and July 13.

Apparently the same kind of galls were found July 20, 1883, in Virginia on *Q. alba*. From these issued, from August 16, 1883, to April 21, 1884, numerous parasites, belonging to the genera *Torymus*, *Ormyrus*, *Decatoma*, and a *Cecidomyid*.

The *Cynips*, which are wingless, differ from those from Miss Parsons in that they were winged. They commenced to issue January 30, 1884, and kept on issuing through the whole of February.

From a few galls, received March 19, 1883, two specimens, also wingless, issued February 9, 1884, and large numbers of wingless insects issued from a lot of galls collected by Mr. Koebele at Meredith Village, N. H., in September, 1883, in the same month. Among these last was also one winged specimen of probably a different species. (Riley's unpublished notes.)

THE OAK-POTATO GALL-FLY.

*Cynips quercus-batatus* Fitch.

Order HYMENOPTERA; family CYNIPIDÆ.

A large, hard, uneven swelling, three-fourths of an inch thick and twice or thrice as long, resembling a potato in its shape, growing on white-oak twigs more distant from their ends than the oak-tumor; producing a small black gall-fly with the basal joints of its antennæ and its legs dull pale yellow, its thighs and hind shanks black, and its middle shanks often dusky, the antennæ in the female with thirteen joints, and the length of this sex .09. (Fitch.)

THE OAK-BULLET GALL-FLY.

*Callaspidia quercus-globulus* Fitch and *Cynips oneratus* Harris.

Order HYMENOPTERA; family CYNIPIDÆ.

Smooth, globular galls the size of a bullet, growing singly, or two, three, or more in a cluster, upon white-oak twigs, internally of a corky texture, each containing in its center a single worm, lying in an oval whitish shell resembling a little egg .15 in

length; producing sometimes a black gall-fly with tawny-red legs and the second veinlet of its wings elbowed or angularly bent backwards, its length .15; sometimes a smaller fly (*C. oeratus*) of a clear pale yellow color, almost white, with a broad black stripe the whole length of its back, which color in the males is more extended, reaching down upon the sides, its length .12. (Fitch.)

These species are parasitized by two chalcid flies, *Macroglenes querciglobuli* Fitch and *Pteromalus oerati* Fitch.

#### THE WOOL-SOWER GALL-FLY.

*Cynips seminator* Harris.

#### Order HYMENOPTERA; family CYNIPIDÆ.

A round mass resembling wool, from the size of a walnut to that of a goose egg, growing on the side of or surrounding white-oak twigs in June, of a pure white color, or tinged or speckled with rose-red, and in autumn the color of sponge; producing small shining black gall-flies with bright tawny yellow legs and antennæ, and in the female the head and thorax cinnamon-red; their antennæ of fifteen and fourteen joints; length .08, and females .11 inch. (Fitch.)

#### THE OAK-TUMOR GALL-FLY.

*Cynips quercus-tuber* Fitch.

#### Order HYMENOPTERA; Family CYNIPIDÆ.

On or near the ends of the small limbs and twigs of the white oak, hard irregular swellings thrice as thick as the twig below them, the bark upon them of a brighter cherry-red color than elsewhere, and their substance internally corky and woody; produced by the stings of a small black gall-fly, with dull pale yellow antennæ, mouth, and legs, its hind shanks and its antennæ towards their tips being dusky, its length .08 and to the tips of its wings .13. (Fitch.)

#### THE OAK-TREE GALL-FLY.

*Cynips quercus-arbos* Fitch.

#### Order HYMENOPTERA; family CYNIPIDÆ.

Swellings similar to those above described, growing on the tips of the limbs of aged and large white-oak trees; producing a small black gall-fly having all its legs and antennæ of a bright pale yellow color, and one more joint in the latter organs than in the preceding species in the males, which sex is .06 in length, and to the tips of its wings .10. (Fitch.)

The following observations are from Professor Riley's unpublished notes:

*Cynips quercus-seminator* Harris.

Galls of this species were found on twigs of *Q. alba* in May and June in Virginia, and the flies and several species of Chalcidians issued from them.

The Cynipids are the true sexes, and were issuing June 13, and the parasites, among which was also a Cecidomyid, issuing from June till November 12.

Many of the galls were placed with a small tree of *Q. alba* and covered with gauze for observation, but notwithstanding the great number of flies, not a single gall was produced on leaves or twigs.

*C. q.-batatus* Bassett.

Found in Virginia June 13, 1883, numerous galls on a small shrub of *Q. alba*, which apparently belong to the above species. On some of the large branches all the young twigs were deformed. Most of the Cynipids seem to have issued, as only a single specimen was bred June 14.

Between June 14 and July 3 four different species of Chalcidians were bred.

*Cynips q.-strobilana* Osten Sacken.

Dr. Engelmann found this gall on *Q. bicolor* February 10, 1872, containing at this date fully formed larvæ.

The same gall on *Q. alba* was also received from G. W. Lettermann, Allenton, Mo., November 10, 1873. Nothing was bred from any of them, but when opened in 1881 they were found to contain the perfect fly and pupæ.

*C. q.-pezomachoides* Osten Sacken.

On *Q. alba*. Received November 10, 1873, from G. W. Lettermann, Allenton, Mo.

*Cynips quercus-clavula* Bassett.

Collected in the middle of April, 1870, at St. Louis, Mo., a lot of these galls on *Q. alba*. Received also some of the same galls from E. Michener, New Garden, Pa. At this date the galls are almost all empty; some of them contain, however, different parasites, among which are Antigaster and a trogositidous beetle and also the dead Cynips.

Galls collected in July contain the larva of parasites. The gall-flies are issuing by the 20th of July.

*Cynips q.-glandulus* Riley.

Gall formed on cups of acorns on *Q. bicolor*, in Chester County, Pa., producing a very curious swelling of the cupule terminating in a bunch of curly woolly fibers, the swelling being hard and woody like the acorn and containing in a cavity a kernel.

It is a gall something after the fashion of *C. q.-frondosa*, and the kernel has the same crinkled appearance, but is more elongate. It is greenish with a distinct bright yellowish-brown crown with a point sunken in the middle. In the more perfect galls the acorn is entirely absorbed.

*Cynips q.-duricaria* Bass.

Forming small woolly galls on the laurel-leaved oak in Missouri. Galls on both upper and under surface on the midrib.

*Cynips q.-duricaria* ?

Received from G. W. Lettermann, Allenton, Mo., November 10, 1873, galls on *Q. alba* which probably belong to the above species. Flies are just issuing at this date.

*C. q.-globulus* Fitch.

Found at St. Louis, Mo., on burr oak and swamp oak. Pupæ are found in September, the flies issuing in November.

*Cynips quercus-palustris* O. S.

May 19, 1869. A globular gall, .45 of an inch in diameter, on the leaves of the pin oak. Usually situated on the midrib and penetrating the leaf both above and below; sometimes on a side vein; tolerably smooth; partly translucent; containing a

small kernel, usually of an oval form and .08 of an inch long; this kernel perfectly free and containing the larva. Color of outer gall pale-green, with usually a pale rosy cheek, and having pale yellowish blotches. Color of inner gall fulvous. The galls had completed their growth, though the leaves had not been out more than a week. Flavor subacid. Flies issued during middle of May.

*Cynips (Neuroterus) rileyi* Bassett.

Received April 25, 1880, from John A. Warder, North Bend, Ohio, some twigs of *Quercus castanea* thickly covered with the galls of this insect. Others were received March 5, 1883, from J. G. Barlow, Cadet, Mo. Cynipids issue during April and early May. They are preyed upon by a species of Chalcid.

*C. q.-sculpta* Bass.

A translucent gall on *Q. imbricaria*. This is Bassett's *C. q. sculpta*, which he gets from *Q. rubra*. The fly has cloudy wings and is probably *nubilipennis* Harr. Harris probably described the gall, but not correctly.

*Cynips q.-cornigera* O. S.

Found on *Q. imbricaria*, St. Louis, Mo. Galls of the same species were also obtained at Ridgewood, N. J., on *Q. palustris*, and the flies were issuing for two weeks after September 8, 1871. They are the true sexes and were very active.

*Cynips q.-pedunculata*.

Received May 22, 1883, from J. G. Barlow, Cadet, Mo., one of these galls, found growing on the margin of *Q. obtusiloba*. Several were also found May 23 at Washington, D. C., on leaves of *Q. prinus*; a large number of them were, however, destroyed by birds which had eaten them, leaving only the petiole.

The flies were issuing from May 26 to June 5. Some were confined to some leaves and twigs on the same oak, covered with gauze, but no galls were formed.

On the 6th of May, 1884, the galls were found to be already fully formed.

*C. q.-ventricosa* Bass. ?

In May, 1870, it was observed that a week before the 8th of that month there was no trace yet of any galls, while on the 8th they were almost fully grown. Large clusters of these galls up to fourteen and more aggregate around a twig, each appressed to one another and terminating in a prominent nipple. Color, green with a roseate tint and thickly covered with bluish-white hairy pubescence. Inside dense and spongy, becoming harder towards the cell. Flavor pleasantly subacid or rather insipid. Larval cell at base close to twig. Larva quite small at this date.

By July 31 a very different growth has formed around the twigs of the same trees, caused by several spherical growths around the axis, which, as they enlarge, become closely confluent.

Their outside is green and roughened with a number of fulvous blotches, very much like the green bark. Flesh tough, yellowish, insipid and leathery, becoming whiter and more leathery towards the twig. It does not look like a fungus, and yet has no trace of insects, though in the more woody center there are pellucid spots which would indicate it to be a gall.

Similar galls were found by Mr. Bassett in October, 1871, on red oak and on *Q. ilicifolia*.

It was found also on *Q. imbricaria*, May 20, 1873, at St. Louis, Mo.

Some old galls which were opened contained the dead gall-flies and three different parasites.



*Cynips suttonii* Bass.

Received September 21, 1882, from William Sutton, San Francisco, three very large galls belonging to above species, found on twigs of *Q. lobata*. Several of the gall-flies issued November 8, 1882, and another one January 2, 1883. Chalcidians issued from January 2 to 13, 1883.

*Cynips q.-floccicola* Riley.

Producing a fuzzy gall on underside of leaves of swamp oak.

*C. q.-decidua* Bass.

Received November 10, 1873, from G. W. Lettermann, Allenton, Mo., apparently the same or a very similar gall to *C. q. flocci*, on twig of white oak. The insects were, however, in the larva state July 8, 1874. Nothing was bred.

A lot of galls, which also resemble those of *flocci*, were received February 14, 1879, from E. A. Schwarz, Jackson, Miss., but a fly which had issued on the way appears to be identical with *C. q. decidua*. Some of the galls contained Chalcidian larvæ.

*C. q.-flocci* W.

Found galls on white oak September 27, 1870, at St. Louis, Mo. Found apparently the same galls also on black oak, burr oak and red oak.

*C. lanæ* Fitch is perhaps synonymous.

Basset has another gall with totally different kernel.

I have insects and the gall of his *flocci*.

Flies from galls on post oak issued January 20, 1872.

*Cynips q.-prunus* Walsh.

One gall of the above species was received June 11, 1882, from D. S. Sheldon, Griswold College, Davenport, Iowa, and some dry galls from J. G. Barlow, Cadet, Mo., March 18, 1883.

*Cynips q.-tubicola* O. S.

Galls of this insect were received December 31, 1878, from W. B. Flippier, of Tellville, Ark. They were found on the leaves of post oak. Others galls were also received from Dr. J. W. Sparkman, Plantersville, S. C. The flies issued during the months of January and February, 1879. There also issued quite a number of a greenish-black chalcid fly. Prof. W. S. Barnard also collected the gall at Atlanta, Ga., in November, 1880, from which the cynipids and a chalcid which is very likely identical with those referred to above, issued during January and February, 1881.

*Cynips caducus* W. (?)

Round galls in clusters on the midrib on underside of leaf of *Quercus undulata*, of the size of a very small pea. Collected October 10, 1874, and examined December 16, 1876, when one cynipid was found. This gall looks much like 159<sup>x</sup>. October 1, 1880, received the same gall from J. Schenck, of Mt. Carmel, Ills., found on *Q. muhlenbergii*. The larvæ were only just hatching; gall tasteless, a pale circle around the larva. It is evidently *caducus* W.

*Cynips q.-spongifica* O. S.

May 19, 1870. Galls are found to contain pupæ at this date. Flies issued May 31.

## FEEDING ON THE BUDS.

160. *Mamestra detracta* Walk.

The following observations have been recorded by Professor Riley:\*

Larvæ of this species were noticed, April 30, 1884, near Rock Creek, Washington, D. C., feeding at night on the buds of oak, and others were seen resting on the twigs of different kinds of trees and shrubs.

They transformed to pupæ by the 2d of May, and the moths commenced issuing by the 23d of the same month. The pupa is quite active, and if placed on a table is able to crawl readily, on account of the spines along its sides.

*Moth.*—Dark gray. Hind wings black. Expanse of wings, 1.20 inches.

161. *Agrotis alternata* Grt.

The larvæ of the above species were observed, during April, 1884, to climb all kinds of trees and shrubs and to feed on the buds, especially those of the oak and hickory. They seemed to prefer, however, the hickory, as on some of the smaller bushes almost every bud had a hole, sometimes even two or three, and the worms may often be observed when feeding to have penetrated so far that only about one-half of their body projects from the bud. On one small oak shrub six of these larvæ were found at work. Numbers of these larvæ were also noticed at night to feed on the liquid which was placed on the trunk of oak trees for the purpose of capturing moths. They would feed in confinement on almost any kind of leaves from trees and shrubs and also on grass. By the 1st of May numbers of them were noticed every evening, as soon as it became dark, to ascend the trunks of the trees and shrubs.

Some begin at this date to enter the ground for transformation, and the moths issue from the 6th to about the end of June. (Riley.)

*Moth.*—Color reddish brown, sprinkled with dark brown atoms. Lines obliterated. No white along the costa. Subterminal space darker than the rest. The wings tinged with grayish; no ante-apical spot. Expanse of wings, 1.50 inches. (French.)

162. *Scopelosoma sidus* Guen.

This (writes Prof. Riley) is one of the earliest noctuids of the season. Specimens which were captured March 24, 1884, at sugar, commenced to deposit their eggs the following day, the larvae hatching therefrom in about fifteen days. Not finding any leaves they commenced at once to attack the leaf-buds of oak, wild cherry, apple, peach, and perhaps other trees and shrubs, into which they bore.

The larvæ commence entering the ground by about the 10th of May, and the moths emerge from the last of September to the early part of November, many, however, remaining as pupæ till the next spring.

Larvæ of the species were found in May at St. Louis, Mo., feeding on blackberry, the moth issuing in October.

*Eggs.*—Globular, with numerous fine ridges, of a yellowish-white, which gradually changes into a light brownish color.

The newly hatched larvæ are whitish with black head and dusky thoracic plate and legs. The first molt takes place about seven days after hatching, and with it there is quite a change in coloration. The thoracic segments, a broad lateral stripe, and the anal segment are reddish. The warts are prominent, black, bearing a short, fine hair.

\* For this habit of low-plant feeders eating the buds of trees in early spring, see Weismann's Studies in the Theory of Descent, i, 271.

After four to six days the second skin is cast and the color has become still darker. Head honey yellow. Cervical shield polished black. Thoracic and first abdominal segment brownish. Dorsal space light green or whitish, with the medial line and subdorsal stripe white, a brown line above stigmata and broad white lateral line. Venter light green. Piliferous warts white, furnished with a fine, short, pale hair.

Four or five days later the fourth and fifth molts take place. (Riley's unpublished notes.)

#### INJURING THE LEAVES.

##### 163. THE FOREST TENT-CATERPILLAR.

*Clisiocampa disstria* Hübner; (*Clisiocampa sylvatica* Harris).

Order LEPIDOPTERA; family BOMBYCIDÆ.

A caterpillar like the apple-tree tent-caterpillar, but differing from it in having a row of oval white spots instead of a white stripe along its back; the colony spinning a cobweb-like nest against the side of the tree; spinning a whitish cocoon, the moth appearing early in July.

The nests of this caterpillar, unlike the prominent tents of *C. americana*, so abundant in wild-cherry trees and neglected orchards, are seldom seen, as they are of so slight a texture and are so much less conspicuous objects than the tent-like whitish nests of *C. americana*; but the caterpillars are not infrequently met with. After spinning, about the middle of June in the Northern States, a dense, oblong cocoon, the caterpillar lies in it about twenty days, the moth appearing the early part of July. It occurs in the Atlantic and Southern States. Fitch states that it also occurs on the apple and cherry, the walnut, and other trees. Dr. Riley informs me that this is as destructive as any caterpillar to the foliage of the oak in the Southern States, being far more injurious than stated by Fitch, who quotes with disapproval Abbot's statement (Insects of Georgia, p. 117) that they are "sometimes so plentiful in Virginia as to strip the oak trees bare."

Boisduval states that this species occurs rarely in California, but Mr. Stretch states that "the occurrence of this species in California, or even on the Pacific coast of North America, is unknown" to him. (Papilio, I, 68.)

Mr. James Fletcher\* reports that this tent-caterpillar was very injurious in 1884 in parts of Nova Scotia and New Brunswick, "entirely defoliating large tracts of hard-wood bush."

"It feeds on leaves of different kinds of trees, such as the different kinds of oak, but seems to do best on the black oak (*Quercus tinctoria*) and laurel oak (*Q. imbricaria*), though it will feed also on post oak (*Q. obtusiloba*) and other species. Found also feeding on hickory, locust, plum, cherry, apple, and peach." (Riley's unpublished notes.)

*The caterpillar.*—Pale blue, sprinkled over with black points and dots. Along the middle of the back is a row of ten or eleven oval or diamond-shaped white spots; behind each of these spots is a much smaller white spot, occupying the middle of each

\* Report of the Entomologist, 1885. Ottawa.

segment. On the hinder part of each wing are three crinkled and more or less pale, orange-yellow lines, which are edged with black. On each side also is a continuous and some what broader stripe of the same yellow color, similarly edged on each side with black. Lower down on each side of the body is a paler yellow or cream-colored stripe, the edges of which are more jagged and irregular than those of the one above it. Length 1.50 inches. (Fitch.)

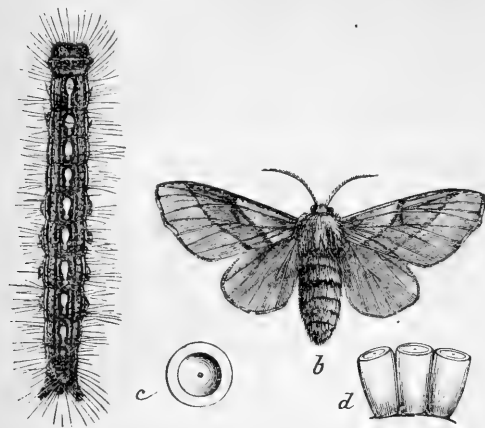


FIG. 37.—Forest tent-caterpillar; b, female moth; c, d, eggs of the forest tent-caterpillar. (After Riley.)

The male moth usually measures 1.20 across its spread wings. Its thorax is densely coated with soft hairs of a nankin-yellow color. Its abdomen is covered with shorter hairs, which are light umber or cinnamon brown on the back and tip and paler or nankin-yellow on the sides. The antennæ are gray, freckled with brown scales, and their branches are very dark brown. The face is brown with the tips of the feelers pale gray. The fore wings are gray, varied more or less with nankin yellow, and they are divided into three nearly equal portions by two straight, dark-brown lines, which cross them obliquely, parallel with each other and with the hind margin. The space between these lines is usually brownish and darker than the rest of the wing, being quite often of the same dark-brown color as the lines, whereby they become wholly lost. Sometimes the hind stripe is perceptibly margined on its hind side by a pale-yellowish line. The fringe is of the same dark-brown color with the oblique lines, with two whitish alternations toward its outer end. But sometimes it is of the same color with the wings and edged along its tips with whitish. The hind wings are of a uniform pale umber or cinnamon brown, sometimes broadly grayish on the outer margin, and across their middle a faint darker brown band is usually perceptible, its edges on each side indefinite. The fringe is of the same color with the wings or slightly darker and is tipped with whitish. The under side is paler umber brown, the hind wings often gray, and both pairs are sometimes crossed by a narrow dark-brown band, which on the hind wings are curved outside of the middle. All back of this band on both wings is often paler, and more so near the band.

The female is 1.75 in width, and, in addition to the shortness of the branches of her antennæ, differs from the male in her fore wings, which are proportionally narrower and longer, with their hind margin cut off more obliquely and slightly wavy along its edge. Hence, also, the dark-brown lines cross the wings more obliquely, the hind one in particular forming a much more acute angle with the outer margin. And all the wing back of this line is sometimes paler or of a brownish-ashy color. And the fringe of these wings has not the two whitish alternations which are often so conspicuous in the male. The head and forepart of the thorax is cinnamon brown. The abdomen is black, clothed with brown hairs, though very thinly so on the anterior part of each segment, where these hairs are intermingled with silvery gray scales. (Fitch.)\*

\* The following references are copied from Mrs. A. K. Dimmock's *Insects of Betula*, in *Psyche*, iv, 275:

*Climacampa sylvatica* Harris (Rept. Ins. Injur. Veg., 1841, pp. 271-272) [= *C. disstria* Hübn.]. Harris (*op. cit.*, p. 272) describes the larva of this species, giving as food-plants *Quercus*, *Juglans*, and apple; later (Treatise on Ins. Injur. Veg., 1862, pp. 375-376, pl. 7, figs. 18, 19) he repeats the description and adds a colored figure of the larva and imago, adding wild cherry to the food-plants; again he describes (Entom.

## 164. THE CALIFORNIAN TENT-CATERPILLAR.

*Clisiocampa californica* Packard.

Feeding on the scrubby oak, in abundance near San Francisco, a tent-caterpillar with a black head and a double rusty reddish dorsal line, often inclosing a long pale blue median dash, one to each segment; and with two lateral pale blue irregular spots; appearing from the middle of March till the middle of April.

I extract the following notice of its habits by Mr. Henry Edwards:

The moth lays its eggs in June, and they must remain unhatched until the following spring. Just when the young shoots of the oaks (*Quercus agrifolia* Nee) begin to appear, the larvæ make their appearance also, spinning thin and irregular webs over the branches of the trees. In these webs they house mostly during the heat of the day, but sally forth in the evening and at night for food. In this way they will soon strip a tree of its leaves, though it is well to say that the oaks do not seem to be permanently affected, as they soon send forth fresh shoots, and toward the time that the caterpillars undergo their change to the chrysalis they are green and gay again. The larvæ retain the shelter of their web until after the third molt, when they wander away singly, are found everywhere, becoming sometimes a complete nuisance in gardens and fields. They feed in their more mature stages upon many plants besides the oak, eating with avidity willows, ash, *Aesculus californica*, *Phatnia arbutifolia*, *Arbutus menziesii*, as well as apple and pear trees. Toward the end of May they spin their cocoons, seeming to have no choice of locality, but fixing themselves wherever they may chance to be, either on walls, palings, trunks or branches of trees, stems of grapes, or among the leaves of herbaceous plants. The time in the chrysalis state is about eighteen to twenty-one days, so that the moths emerge and are in the greatest abundance about the middle of June.

"This species," says Mr. Stretch (in *Papilio*, vol. i, No. 5), "is exceedingly abundant in the neighborhood of San Francisco, and is probably widely distributed." Near San Francisco its favorite food-plant is a species of scrubby oak, *Q. agrifolia*, but it is sometimes found on the blackberry (*Rubus*) and other shrubby plants. Its depredations have lately, Professor Rivers writes me, extended to the orchards. The nests, according to Mr. Stretch, may be seen in warm localities as early as the middle of March, while in those more exposed they are not seen till the middle of April; but both these dates are sufficiently early to protect the orchards. The larvæ pupate in about six weeks from the egg, and the imago appears in about a fortnight.

The following notes have been received from Professor Riley:

Received April 20, 1877, from Mr. E. W. Hilgard, Berkeley County, Cal., several larvæ and pupæ of above insect.

---

Corresp., 1869, p. 292) the larva. Morris (*Synop. Lepid. N. A.*, 1862, p. 326) quotes Harris's descriptions (1841) of the larva and imago. Riley (*Amer. Entom.*, July-Aug., 1870, v. 2, pp. 261-265, and 3d Rept. State Entom. Mo., 1871, pp. 121-127) describes eggs and egg-mass, larva and imago, giving, in addition to the food-plants mentioned above, *Fraxinus*, *Tilia*, *Rosa*, *Carya*, plum, and peach. Saunders (*Can. Entom.*, July, 1872, v. 4, p. 134) repeats Riley's figures and (*op. cit.*, Aug., 1877, v. 9, p. 159), gives another figure of the larva, adding *Acer*, *Crataegus*, and *Fagus* to the food-plants; later Saunders (*op. cit.*, Feb., 1878, v. 10, pp. 21-23) gives notes on the eggs of this species and of *C. americana*, and on the destruction of these eggs by mites. The larva of this species eats leaves of *Betula alba*.

The larvæ are about 2 inches long, of a velvety, blackish-brown color, and are covered with quite long yellowish-brown hairs. They are feeding on oak.

The larvæ changed to pupæ April 21, and the moths issued May 16.

Larvæ, pupæ and eggs were also received in July, 1884, from H. Bliss, Salt Lake City, Utah, who reports them to be extremely injurious to all kinds of fruit-trees and other vegetation. (Riley's unpublished notes.)

*Larva*.—Head black, legs black; abdominal feet pale testaceous. Body black, faintly dusted with rusty, which forms an exceedingly broken and indistinct lateral line and a more complete double dorsal line. Each segment carries a lateral, transverse, very faint linear dot above the lateral line, a dorsal pale blue median stripe, and on the side two irregular pale blue patches separated by a deep black space. The dorsal and lateral hairs are all tawny. The general appearance of the larva is tawny brown. Length about 1.40 inches.

*Cocoon*.—Constructed in the crevices of bark or in the angles of masonry, where accessible, and consisting of a loose, white web, in which is suspended the long ovate cocoon of dense papery consistency, thickened with a yellowish powdery gum. (Stretch.)

*Moth*.—Cinnamon brown, with two transverse pale lines curved outward just before ending on the costa. Base of the fore wings within the inner line lighter than without. Hind wings darker than the fore pair. Fringe of both pairs of wings broadly interrupted with pale brown. The female is lighter colored than the male, with two dark-brown lines, the other one continuing straight on to the costa. Beneath, in both sexes, uniformly darker than above. Expanse of wings, male, 1 inch; female, 1.20 inch.

The caterpillar of a species of *Clisiocampa*, which I have now little doubt is that of *C. californica*, which I have bred from eggs received from Miss Emily L. Morton, to whom they were sent from Colorado by Mr. Nash, was abundant at Virginia City and Helena, Mont., on the leaves of the wild rose so common near those towns, its conspicuous tents readily attracting the eye. A half-grown larva, found June 16 at Virginia City, measuring .75 inch in length, had a blue-black head. The body was blue on the sides, with dark spots; a black subdorsal spot rudely resembling a St. George's cross occurred on each side of each ring. The median dorsal line was pale blue, interrupted by the sutures between the segments. On each side of the line was a brown ocherous patch. The hairs are ocherous brown; the long ones paler. When fully grown it is about the size of the eastern tent-caterpillar (*C. americana*), *i. e.*, an inch and a half. The mature larva found at Helena, June 21, was described from life in my notes as follows:

"Head grayish brown; body pale, grayish-blue on the sides, speckled with black, with a large black squarish patch extending above into the subdorsal broad longitudinal band, which is mottled with bright ocherous brown, short wavy lines. A pale bluish distinct longitudinal broad median dorsal stripe interrupted by the sutures between the segments. Hairs long, pale brown. Body blackish beneath."

At this date the caterpillars had begun to be full-fed, and one caterpillar had spun a cocoon under a stone.

This caterpillar differs from that of *C. americana* in having a broad blue dorsal stripe instead of a white one, and there is no broad longitudinal black stripe, as in the eastern caterpillar. It also differs decidedly from the caterpillar of *C. constricta* Stretch, the dorsal stripe being blue instead of forming a series of black and ocherous red spots. The blue dorsal interrupted stripe varies in distinctness and may be nearly or quite absent. In fact, this caterpillar is exposed to much variation, and it would be easy to make several species out of this widely diffused one, which in Colorado feeds on the aspen. A blown specimen received from Prof. J. J. Rivers "from the mountains of Nevada that may be *C. fragilis*," is unquestionably a very distinctly marked larva of *C. californica*. My Montana specimens closely resemble it. In Mr. Rivers' Nevada examples the row of long dorsal pale-blue, almost whitish

blue, spots are very distinct. This dorsal row is flanked on each side by two large distinct irregular spots of the same pale blue color, the space between them being conspicuously deep black. In this specimen also the numerous close, broken, fine dorsal alternating black and ochereous lines so characteristic of *C. californica* are present.

Whether the larva received from Professor Rivers, and referred by him with doubt to *C. fragilis* Stretch, is that species is quite another question. I have not seen either the larva or imago of Stretch's *fragilis*.

## 165. THE PACIFIC OAK TENT-CATERPILLAR.

*Clisiocampa constricta* Stretch.

Feeding on the leaves of the Sonoma oak of California, a tent-caterpillar, with a broken dorsal row of large rust-red spots, and transforming at the end of May, the moth appearing late in June.

Prof. J. J. Rivers writes me regarding this species: "I have never found *C. constricta* but upon oak. This species can not be confused with any of the others that I am acquainted with, because the male is always pale and the female always dark, the male being a cream color and the female a little like red cedar color with a warm tone."

From an excellent blown larva kindly loaned me by Professor Rivers I find that it differs from all the other Californian species in the large, conspicuous ochereous-red dorsal patches which give rise to peculiar wedge-shaped ochereous tufts of short hairs; also by the lateral row of short white tufts, while the body in general is much more hairy than in the other species. No eastern species has such a characteristic and peculiar arrangement of spots and hairs.

The following descriptions of larva, chrysalis, and cocoon of this moth are copied from Mr. Henry Edwards's account in the Proceedings of the California Academy of Sciences, vol. v, 1874, p. 368:

*Larva*.—Head slate-gray, with black spots; mouth parts black, tipped with dull yellow. Body slate-gray, covered laterally with fine black speckles. Along the middle of the dorsal region is an irregular black stripe, marked on its sides with waved orange lines, and surmounted at the union of the segments by a double tuft of chestnut-brown hairs. On the second and third segments, in the middle of the notched black line, is a stripe of dull white. From the base of the orange-brown tufts spring a few scattered black hairs, longest anteriorly, and from the forepart of each segment arise lateral tufts of white hairs. The stigmata are orange, with black central points. Above the base of the feet is a black interrupted line, out of which spring other white hairs, irregularly disposed. Under side dull velvety black, with the anterior portion of each segment whitish. Feet and prolegs black, yellow at their tips. Length 1.85 inches. Food-plant, *Quercus sonomensis* Benth.

The larva is frequently attacked by a species of ichneumon, the eggs of which are visible on the head and anterior segments.

*Chrysalis*.—Chestnut brown, with few hairs along the base of each segment.

*Cocoon*.—Ovo-lanceolate, very silky, yellowish white, with some portions glued in compact mass and whiter than the remainder. Chrysalis only imperfectly seen through the web. Larva May 22, changed to chrysalis May 29. Imago, June 16.

*Moth*.—Of the size and general appearance of *C. americana*, but the outer line, instead of being directed outward on the costa, is more sinuous than in the eastern species, and decidedly curved inwards upon the costa.

## 166. THE AMERICAN LAPPET-MOTH.

*Gastropacha americana* Harris.

Order LEPIDOPTERA; family BOMBYCIDÆ.

The interesting larva of this moth rarely occurs on the oak.

*Larva*.—Body broad, somewhat flattened; the lateral ridge produced on each segment into a pair of hairy lappets, white, edged with gray, and fringed with long radiating hairs. On the eighth abdominal segment is a round black hump ringed with white. The body is white and gray, mottled so as to resemble the pale bark of the ash or poplar. When creeping two transverse bright scarlet bands are disclosed in the sutures just behind the second and third thoracic segments. On each segment are two dorsal, curved spindle-shaped dark gray spots; the sides are clouded with dark gray. Length 55–60<sup>mm</sup>.

## 167. THE CALIFORNIAN PHRYGANIDIA.

*Phryganidia californica* Pack.

Order LEPIDOPTERA; family ZYGÆNIDÆ.

Very destructive to young oaks, a naked, yellowish-white caterpillar, striped with black and white, with a large head, wandering incessantly over the bushes and feeding very rapidly; spinning no cocoon, but the chrysalis, yellowish and black, attached by the tail to fences, &c.

This is, by its numbers and familiar habits, one of the best known and most destructive insects of California. The following account has been furnished me for Hayden's Report by Mr. Henry Edwards:\*

"This insect is also very destructive to our young oaks, the caterpillars, which are naked perfectly and with the head almost monstrous in size, making their appearance about the same time as those of *Clisiocampa*. They are restless little creatures, wandering incessantly over the trees and feeding very rapidly. They spin no cocoon, but hang by the tail, like the larva of *Vanessa*, etc. The change to the chrysalis is undergone in April and May, and the moths appear in about fifteen or sixteen days. There is a second brood of these insects, the imagos of the latter appearing in September and October. Indeed, fresh specimens are now upon the wing, though the second brood is by no means so abundant as the first. I have

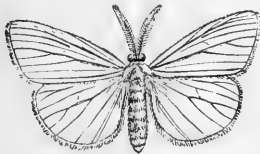


FIG. 38.—Californian Phryganidia.—From Packard, after Emerton.

observed that *Phryganidia* and *Clisiocampa* never associate upon the same tree, and I think that the former has always the mastery. This is perhaps owing to some excretion from its body which is unpleasant to the *Clisiocampa*, but of course I do not speak with certainty as to this fact. It is, however, sure that they are never found in large quantities on the same tree. I am inclined to think that *Phryganidia* is more destructive to the oaks than the other species, as it feeds solely upon *Quercus*, while the other, as I have said, is not so particular in the choice of its food. I inclose my published description of the eggs of *Phryganidia*." I quote Mr. Edwards's description of the egg and larva:

"The egg is spherical, a little flattened above, shining, yellowish-white at exclusion, attached in clusters of about ten or twelve to the upper sides of the leaves. The third day the apex of the egg assumes a dull orange hue, afterwards changing to a bright reddish-purple and gradually to a duller shade as the young larvæ emerge. The eggs were laid by a female in my possession on July 5. In the young larva the head is very large, almost monstrous, pale olive-brown, with a narrow black line at base; body pale canary-yellow, with four rows of black spots arranged longitudinally in lines.

\* A. S. Packard, jr., Report on the Rocky Mountain Locust, &c. Hayden's Report U. S. Geological Survey of the Territories for 1875.



"The larva is slender, with the head prominent, globose; last segment but one humped; head pale brown; body black above, dirty green below, with a broad dorsal line of dirty greenish, divided by three narrow black lines, and the sutures faintly marked with same color. There is also a narrow, broken, stigmal line of dirty greenish, and a similar line above each of the abdominal legs. Tip of the last segment horny, the segment not being used to assist in progression, but usually slightly elevated; body smooth, transversely wrinkled. Younger specimens chiefly differ in the disproportionate size of the head. Length .90 to 1 inch." (H. Edwards.)

*Pupa*, naked, suspended by the tail, greenish white, with black markings; all the sutures of the head, thorax, legs, and antennæ lined with black. The mesothorax has a central black line; the abdomen has a dorsal row of black points on the front edge of each segment, and a lateral row blending into each other towards the anal segment, which is black; below with two sublateral series of black transverse spots nearly blending into two longitudinal bands. Length 0.75 inch. (Stretch.)

*Moth*.—Sable brown, partially transparent; antennæ and veins darker; fore wings with the costa straight and apex obtuse, subrectangular. The hind wings of the female scarcely reach to the end of the abdomen. Expanse of wings, 1.22 to 1.47 inches.

Mr. Behrens, of San Francisco, writes me that three generations of the *Phryganidia* appear in a year. "In 1875 it, with the larva of the *Clisiocampa californica*, ate our ever-green oaks to broomsticks. You could hear the caterpillars eat and their manure drop, the latter covering everything; it could be swept together by the bushful. In the wake of both followed ichneumon parasites."

This singular insect was originally, from a study of the moth alone, referred by me to the Psychinæ, but Mr. R. H. Stretch, with a knowledge of its transformations, has shown that I was in error, and has placed it very properly in the Zygaenidæ, in his valuable work entitled *Illustrations of the Zygaenidæ and Bombycidæ of North America* (1873). Having recently received specimens of the larvæ and pupæ

from Mr. James Behrens, it was at once evident on a cursory examination that the early stages show all the characteristic features of the Zygaenidæ. The venation of the moth is, however, unusual, and this, together with the dull-brown coloration and semi-hyaline wings, misled me into placing it near Psyche. Mr. A. G. Butler, of the British Museum, regards it as closely allied to *Diophtis*.

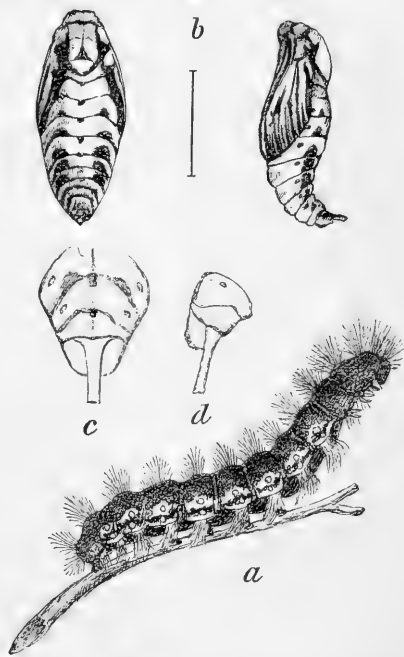


FIG. 39.—a, larva of *Phryganidia californica*, after Stretch; b, pupa; c, d, end of pupa. Bridg-ham, del.

## 168. THE ORANGE-STRIPED OAK-WORM.\*

*Anisota senatoria* Hübner.

Order LEPIDOPTERA; family BOMBYCIDÆ.

In August, sometimes stripping the trees, a spiny black caterpillar, with four orange-yellow stripes on the back and two along each side, with two black prickles above and two on each side, changing the following June to a large ocher-yellow moth, with a large white dot on the fore wings.

These prickly caterpillars, during certain years, as I have noticed at Amherst, Mass., and at Providence, as well as in Maine, so abound as to nearly strip large oak branches of their leaves, and is perhaps the most destructive of all our caterpillars to the foliage of the oak. The spines, if they happen to penetrate the skin, as Fitch and others have observed, sting like nettles. This species, Mr. Riley informs me, is the more injurious in the Northern States, while *A. stigma* is most destructive in the Southern. According to Riley, Mr. Bassett has bred a small ichneumon fly (*Limneria* [*Banchus*] *fugitiva* Say) from this caterpillar. Riley has also bred it from the larva of *Anisota stigma*, *Olisiocampa sylvatica*, as well as other caterpillars.

Mr. Lintner states that "the larvæ occur so abundantly at Center as wholly to defoliate numbers of the smaller oaks. On the 7th of July the female moths were seen to have commenced the deposition of their eggs on the under side of oak leaves in patches often nearly covering the entire surface. On the 11th of July some newly hatched larvæ were observed." (Ent. Contr., I, 58, foot-note 1.)

In 1882 this caterpillar was very destructive to oak forests in Pennsylvania. Professor Claypole writes to the Canadian Entomologist (xv, 38):

I have seen hillsides that looked as if fire had passed over them in consequence of the destruction of the foliage by millions of this species. In the woods they could be found crawling over almost every square foot of ground and lying dead by dozens in every pool of water. The sound of their falling "frass," too, was like a slight shower of rain. Farmers tell me they have never known them to be so abundant before within their recollection. Harris says this species lives on the white and red oaks in

\* *Anisota senatoria* Abb. & Smith (Nat. Hist. Lepid. Ins. Ga., 1797, v. 2, p. 113, pl. 57). Harris (Rept. Ins. Injur. Veg., 1841, p. 291-292) describes the larva, pupa, and imago of this species; the larva, he states, feeds upon white and red oaks [*Quercus* sp.]. Morris (Synop. Lepid. N. A., 1862, p. 231) describes the larva and imago. Harris (Treatise on Ins. Injur. Veg., 1862, p. 405-406) figures and describes larva, pupa, and imago, and (Entom. Corresp., 1869, p. 298, pl. 2, fig. 9, and pl. 4, fig. 12) gives a colored figure of the larva and a black one of the pupa. Riley [?] (Amer. Entom., Sept.-Oct., 1869, v. 2, p. 26) states that the larva eats raspberry [*Rubus* sp.]. Lintner (Entom. Contrib., No. 2, 1872, p. 51-52) describes the early stages of the larva, which, he writes, has four molts (five stages), and feeds on *Quercus prinoides*. Packard (Bull. 7, U. S. Entom. Comm., 1881, p. 45) briefly describes the larva, and gives a few notes upon its habits. The larva feeds on *Betula alba*. (Mrs. Dimmock, *Psyche*, iv, 275.)

Massachusetts. Here the white oaks were untouched and the red oak is not abundant. The food of the caterpillars was almost exclusively the foliage of the black oak (*Q. tinctoria*), the scarlet oak (*Q. coccinea*), and the bear or scrub oak (*Q. ilicifolia*). (See also American Naturalist, xvi, 914.)

It was also abundant in September of the same year in Sagadahock and Cumberland Counties, Maine, and in Rhode Island.

The following notes on the egg and freshly-hatched larva are contributed by Professor Riley:

August 1, 1869, received of F. A. Gates, Massillon, Cedar County, Iowa, a ribbed female of *Dryocampa senatoria* with a batch of over 300 eggs on the underside of a raspberry leaf. These eggs are almost round in outline, depressed, being about half as high as wide, the width across being .04 of an inch. The shell is so very transparent that it makes a very good object for watching the development of the embryo. The egg is when first laid yellow, with a darker brownish ring above.

*The larva when first hatched* is pale yellow, with a large black head, black thoracic legs and two stiff black horns springing with an anterior slant from the top of segment 2, each of which horns terminate in two finer bristles. The rest of the body is covered with pale bristles. (Riley's unpublished notes.)

*Larva.*—Head large, fully as wide as the body; jet black. Body uniformly thick, cylindrical. On mesothoracic segment a pair of long and slender, stiff, black spines, blunt at the end, nearly as long as the body is thick. They stand erect, diverging a little, and arise from swollen bases, connected by a slight transverse ridge. On each succeeding segment there is a transverse series of four small, sharp, simple spines, one or two sometimes ending in two spines; and low down on each side, below the spiracles, are three large and a fourth minute short acute spine.

There are on the hinder part of the back of most of the segments two small black spines. The spines become larger on the last three, especially the penultimate segment. Supra anal plate large and flat, rather rough, ending in two acute spines, with four smaller spines on each side. Abdominal legs larger and broad, with stiff short hairs on the hinder and lower edge.

Prothorax unarmed, but with a thickened conical plate. Body jet-black, with a double dorsal ocher-yellow-brown line, a narrow subdorsal line, and two wavy lateral lines of the same color. A median ventral ochre-brown band. Length, 42<sup>mm</sup>.

*Moth.*—Male antennæ broadly pectinated on basal two-thirds; yellowish-brown; base, costa, and outer edges bathed in faint purplish; the hind wings of the male well rounded; fore wings slightly spotted with dark brown; a clear large round white discal spot; an outer oblique distinct brownish line extending from a little beyond the middle of the inner edge to the costa just before the apex. Expanse of wings of male, 42<sup>mm</sup>; female, 57<sup>mm</sup>.

#### 169. THE SPINY OAK-WORM.

*Anisota stigma* Hübner.

Eating the leaves in September, in the Southern States especially, a worm like the preceding, but of a bright tawny or orange color, with a dusky stripe along the back and dusky bands along the sides, and with its prickles lengthened into thorn-like points.

This worm is said by Dr. Riley to be nearly as destructive in the Southern States as *A. senatoria* is in the Northern.

According to Abbot and Smith, in Georgia the caterpillar goes into the ground to pupate September 20 and comes forth by the middle of June

following. The young at first keep together and as they grow larger disperse.

The following quotations are from Riley's unpublished notes :

"Found feeding on oak and hazel at St. Louis, Mo., by Professor Riley, on hazel in Illinois, by Mr. Muhlemann, and on both oak and hazel by Mr. Saunders, London, Ont. Moths issue from middle of May to middle of June. Eggs were noticed to hatch July 10. Went through the first two molts till July 20, and through third molt July 27. The first larva entered the ground August 4, and the last one August 22, 1870. These are specimens from Canada, but around Kirkwood, Mo., there are some found which are not yet full grown at this date.

"Mr. Saunders says, November 21, 1870, that he has noticed a second brood.

"According to Abbot and Smith this is the more spotted moth, and their larva agrees with mine, but is colored too yellow. Their larva of *pellucida* seems to differ principally in having two pink longitudinal vittæ, each side. The male and female of *A. stigma* are almost alike, whilst in *A. pellucida* they are unlike. Both are sometimes found on the same tree.

"Dr. Asa Fitch states that his little daughter was stung badly by a larva which he had feeding under a glass; but, notwithstanding that a slight stinging sensation is discernible, it can not be likened to that of the true stinging larvæ and is not more irritating than the prickly spines of *Vanessa interrogationis*.

"*Young larva*.—August 24, 1876, found a lot of caterpillars feeding on *Quercus bicolor*? They are .63 of an inch in length, and of a dark greenish-gray color, with a broad dorsal line a shade darker; on each segment there are six black thorns tipped with white; two on the dorsal line, one on each side, and one on the margin of each side; those on the sides are very small and more like tubercles; thorns on the back and sides nearly equal in length, getting a little longer on the last segments; on the second segment are two very long horns, resembling very much antennæ, the point of which is divided into two; they are directed forwards and curved a little backwards. Head, brick-red, not very glossy; feet black. Destroyed by parasites.

"*Full grown larva*.—Average length, 50<sup>mm</sup>. General color pale tawny-red, inclining to orange. The whole surface covered with bright yellow, almost white papillæ of different sizes, giving a speckled appearance; the usual medio-dorsal narrow line; a broad subdorsal longitudinal stripe of a paler color and having a dingy carneous hue; a narrower substigmatal stripe of the same hue. Horns and spines black and marked with white papillæ, and with a tendency to branch, especially towards the tips; the longer horns on joint 2 being blunt-pointed, and also with white papillæ at the base. Head uniformly gamboge-yellow; cervical shield, anal plate, and plates on anal prolegs of the same yellowish color as head. A pale medio-ventral line; the thoracic legs pale, the prolegs with pale papillæ outside on a dark ground.

"The species is at once distinguished from the other species of the genus by the longer spines, their tendency to furcation and being speckled with white papillæ, and by the less distinct striping." (Riley's unpublished notes.)

*Moth*.—This is closely allied to *A. senatoria*, but in both sexes the wings are rather darker and more spotted with blackish; the cross-line on the hind wings is heavier and more distinct, and the white discal spot is apt to be less perfectly round than in *senatoria*. Expanse of wings, male, 45<sup>mm</sup>; female, 53 to 55<sup>mm</sup>.

## 170. THE ROSY-STRIPED OAK-WORM.

*Anisota pellucida* Hübner.

Order LEPIDOPTERA; family BOMBYCIDÆ.

Eating the leaves in July, in New York, a two-horned prickly worm of an obscure gray or greenish color, with dull brownish-yellow or rosy stripes, and its skin rough from white granules.

This species has been said by Fitch to have been common for many years in Salem, N. Y., where *A. stigma* has seldom been seen. The worms mostly enter the ground to transform into the pupa early in August, though some remain on the trees as late as the middle of September.

The following description is copied from Prof. G. H. French's Report of the Curator of the Museum of the Southern Illinois Normal University, 1880. They occurred on different species of oak during the middle and last of September, most of them pupating by October 2 in the soil.

*Larva*.—Length about 1.25 inches. General color pale dull green, striped with fine red substigmatal, subdorsal, and dorsal stripes, the last very pale, so as to be almost obsolete. Head with a slightly yellowish tinge. On each segment there are six short black thorns or sharp points, the two on the back of the second segment behind the head being about one-fourth inch long, but the rest much shorter.

We add also the following description furnished by Dr. Riley, who has compared it with the caterpillar of *Anisota stigma*:

*A. pellucida* comes nearest to *A. stigma* in general appearance, but the spines are shorter, more pointed, uniformly black; the color is darker, being almost black, so that the papillæ, which are rather denser, give the dark portion a bluish cast; the subdorsal and stigmatal lines are of a more intense red, inclining to pink, and the stigmatal line is rather broader than the subdorsal. The average length is somewhat less and the larva more slender than in *stigma*; the shorter, blacker spines, deeper colors, and stronger contrast between the lines at once separating it from *stigma*.\*

Specimens, without much doubt belonging to this species, though we have not found the moth in Maine, occurred on the red oak at Brunswick, Me., August 28. The body was greenish, with dark dorsal and lateral, not "reddish," bands.

*Moth*.—Besides being smaller, the male differs from those of *A. stigma* and *senatoria* in the hind wings being distinctly triangular, the outer edge being straight and the hind angle somewhat produced; the fore wings are also decidedly narrower, while the white discal spot is considerably larger, and the wings are throughout considerably darker and free from dark spots. Expanse of wings of male, 40<sup>mm</sup>.

\* Found on different kinds of oak, October 2, 1873, many larvæ looking like *A. stigma*. The form is the same, but they differ considerably from them in color and markings. It is to be distinguished from *A. stigma* in its smaller size, in the ground color of the dark parts being blacker, the papillæ being yellow instead of white, and in the paler vittæ being of a deep pink or lake-red. The head and anal shield are more olivaceous and the spines are shorter and stouter. The whole larva is more brightly and distinctly marked. Moths issued April 22, 1874.

Some of the dried larva skins were brought from Loudoun County, Va., in July, 1881. (Riley's unpublished notes).

The caterpillars of the following species of Lepidoptera are not known to be especially injurious, but occur more or less frequently on the leaves:

171. *Basilarchia astyanax* (Fabr. *Limenitis ursula* Fabr.).

In New England a caterpillar occurred on leaves of the scrub oak as early as June 1; by June 7 it pupated, the chrysalis suspended vertically by the tail, while the butterfly emerged June 18. Harris also observed a pupa July 8, the butterfly appearing July 20. It also feeds on the willow, wild cherry, *Carpinus americana*, and various shrubs. It ranges from the Atlantic coast to Kansas.

*Larva*.—Larva found feeding on leaves of scrub oak, June 1; head tinged with pale purple, two white stripes down the center of the face, lip brownish; vertex bifid, tuberculated, tubercles pale green. Body elongated, cylindrical, a pair of tubercles on each segment, those on the second being much elongated, linear, with short, blunt spines; first and second segments pale reddish-yellow, tubercles dirty green; third segment whitish or reddish white, veined with pale green above, tubercles pale; fourth segment green above, tinged with ochereous, especially at sides; fifth segment pale olive green above, darker at sides; tubercles whitish, transverse elevated line at sides whitish, as it is in all the following segments; sixth segment olive green, with two longitudinal white lines above; seventh segment olive green at sides, reddish white or clay colored behind, and on the top two white lines with a clay-colored patch between, a small blackish spot near the stigma; eighth segment clay colored, slightly green at sides behind; ninth segment greenish at sides, with a small black spot, clay colored above, before with two white lines; tenth and eleventh segments dark olive green, tubercles paler; twelfth segment dark green above, tubercles four, ochereous. Feet ochereous; prolegs greenish bordered with ochereous. Body beneath whitish varied with green. Length, 1.3 inches. (Lintner.)

*Pupa*.—Like that of *B. archippus* in form and color.

*Butterfly*.—Expanse of wings, 3 inches. Upper surface black, tinged with bluish or greenish, and a little with fulvous at the apex of the fore wings. Along the outer margin are two rows of blue or green spots, the outer in the form of crescents, the inner, lunules. Under side brownish-black, the outer border repeated, preceded by a row of black and a row of fulvous spots, some of the latter obsolete near the posterior angle. There are two fulvous spots in the cell of the fore wings, three near the base of the hind wings, and some on the costæ of both wings near the base. (French.)

172. *Basilarchia archippus* (Cram. *Limenitis disippus* Godt.).

According to Scudder, French, and others, this butterfly occasionally feeds on the oak, and the accompanying figure was drawn from a caterpillar found on the oak. (See Poplar Insects.)



FIG. 40.—Larva of *Basilarchia archippus* (*Limenitis disippus*). Emerton del.

### 173. THE LIVE-OAK THECLA.

*Thecla favonius* Abbot and Smith.

The green, slug-like caterpillars of this beautiful butterfly were observed on the live oak at Enterprise, Fla., April 7 and 8, also a few days afterwards at Crescent City, and again on the scrub live oaks on Anastasia Island, St. Augustine. They pupated April 13, 14; the chrysalis in general appearance closely resembling that of *Thecla calanus*, found about Providence. They breed easily in confinement, my specimens having been placed in a small pocket tin box. After my return to Providence the butterflies emerged from April 30 to May 2. It is the most common species in the Southern States, and is said by Abbot and Smith to feed on *Quercus rubra* and other oaks.

*Larva*.—Closely resembling in general appearance that of *Thecla calanus*. Body straw-yellowish green, with fine yellowish papillæ and dense, short hairs. Head pale horn color, small and narrow. Length, 17<sup>mm</sup>.

*Pupa*.—Of the same size and shape as that of *Thecla calanus*, the hirsuties the same, though not quite so coarse. In color rather pale horn, not so much mottled with black. It differs from *T. calanus* in the distinct lateral row of black dots. Length, 10<sup>mm</sup>.

*Imago*.—Wings of the usual form and color in the genus. Fore wings of male with a blackish sex-mark below the costa; a tawny patch in the first and a larger, more distinct one in the second median cell. Hind wings with a large deep orange patch near the inner angle, with a minute one on each side; orange spots on the inner angle. "The points of the W formed by the inner line on the under side of the hind wings touching the outer line." (French.) Expanse of wings, 23<sup>mm</sup>.

174. *Thecla autolyceus* Edwards.

This butterfly ranges from Missouri to Texas. The following account is given us by Professor Riley :

Found May 8, 1872, under an oak tree, beneath stone and bricks, a rather curious conchiliform larva.

*Larva*.—Head and first joint retractile. Color dull straw-yellow, variegated with pale fulvous and olive green. Minutely granulated with black spots, each giving rise to a short stiff hair. Dorsum narrow, flattened; sides sloping roof-fashion. Venter glaucous, with full complement of legs well developed. Stigmata large, but so concolorous with body that they are seen with difficulty. Before transforming to pupa the distinctive characters are lost and it becomes pinkish, more rounded, and the black dots are all pale.

*Pupa*.—Of the normal rounded form; of a dull dirty yellowish-brown, speckled with black, and pubescent with short pale blunt bristles. The head is produced into a hood with flattened frontal edge, and the characteristic feature is a white narrow transverse egg-like elevated spot in place of the first spiracle on suture between head and thorax—looking as though they might be eyes. Head parts not distinguishable. Imago issued May 25. (Unpublished notes.)

*Butterfly*.—Differs from *Thecla favonius* in the points of the W not touching the outer line. Expanse of wings, 1.05 to 1.1 inches. (French.)

175. *Thecla edwardsii* Saunders.

The following note on this butterfly, which ranges from Maine to Nebraska and Colorado, has been contributed by Professor Riley :

July 2, 1875, found two larvæ of a *Thecla* on oak. They are dark velvety green; changed to pupa July 4, and the imago issued on the 13th. (Unpublished notes.)

*Butterfly*.—Upper surface pale wood-brown; the male with the usual subcostal sex-mark, hind wings with one short tail and an angle in place of the second tail; two faint blackish spots on the hind wings, one between the tail and the angle and the other towards the anal angle, with faint orange crescents before each.

Under side paler than the upper, two rows of spots across each wing, as in the lines of *Thecla acadica* Edwards; they are shorter, with spaces between. The spots of the inner row, except the last two on the hind wings, are oblong and oval, each surrounded with white, the last two longer than the others. The outer row is a series of blackish crescents, edged on the inner side with white, on the outside with orange, fading out towards the apex of the fore wings, more prominent at the anal portion of the hind wings; the usual blue patch between the next to the last and the margin, and the two black spots of the other species. At the end of the discal cell a spot similar to the spots of the inner row. Maine to Nebraska, Colorado. Expanse of wings, 1.1 inches. (French.)

176. *Thecla calanus* (Huebner).

According to Scudder (Butterflies of the Eastern United States) this butterfly feeds on *Quercus rubra* and *Q. falcata*, but prefers the walnut and hickory. (See Walnut Insects.)



## 177. JUVENAL'S SKIPPER.

*Thanaos juvenalis* Westwood.

The larva of this butterfly is not uncommon on the white oak from early in September until towards the middle of October in Providence. We observed one caterpillar which (October 8) curled a leaf over its body and spun a thin floss of silk in which to transform.

*Thanaos ennius* was originally regarded as the northern representative of *Thanaos juvenalis* Westwood, but Mr. Scudder now writes me that he regards *ennisus* as a synonym of *T. juvenalis*. In New England this skipper is seen in meadows in May and again in August.

*Larva*.—Body somewhat flattened, tapering towards both ends; dull pea-green, the skin granulated with distinct white pimples. A lateral white line. Head wider than the prothoracic segment, bilobed, somewhat flattened in front, dark dull reddish-brown, with each lobe of the vertex touched slightly with red-brown, and an orange-red spot on the inside of each set of eyes. A dark median dorsal stripe and a lateral yellow line; the lateral ridge whitish. Length, 26<sup>mm</sup>.

*Butterfly*.—Smoky brown on both sides; fore wings variegated above with gray, with transverse rows of dusky spots, and six or seven small semi-transparent white spots near the tips; six of these spots are disposed in a transverse row, but the two hindmost are separated from the others by a considerable interval, and the seventh spot, which is sometimes wanting, is placed nearer the middle of the wing. Hind wings with a row of blackish spots near the hind margin. Expanse of wings, 1.6 inches. (Harris.)

178. *Thanaos brizo* Bois. and Le C.

Besides feeding on a leguminous plant (*Galactia glabella*) the larva of this skipper occurs on *Quercus ilicifolia*. (Scudder.)

179. *Smerinthus excecatus* (Abbot and Smith).

The larva of this sphingid moth has been found on *Quercus imbricarius* and *Q. obtusiloba* by Professor Riley, who has communicated the following description:

*Larva*.—Normal form. Uniform pea-green. The papillæ cream-colored and regularly arranged in about eight annulets. A bluish vesicular medio-dorsal mark. Yellowish-green oblique lines extending length of two joints, the last brighter yellow and extending up the caudal horn, which is also papillated. The thoracic joints have a longitudinal yellow subdorsal line. The head is triangular, but bluntly so; the front flattened, more polished, and deeper green, with less distinct papillæ and separated from the hinder part, which is like the body, by a pale  $\wedge$  relieved behind by darker shade. Abdominal and thoracic legs rosy outside. Stigmata white with heavy black annulations.—(Unpublished notes.)

180. *Daremma undulosa* Walker.

This sphingid feeds occasionally on the white and red oak. (W. J. Holland, Can. Ent., June, 1886. See Ash Insects.)



FIG. 41.—Larva (a) and pupa of *Thanaos juvenalis*, natural size.—After Scudder.

181. *Nola ovilla* Grote.

(Larva. Plate XXXV, Fig. 2.)

One of the most interesting forms whose life-history we have made out is that of a species of *Nola*. The position of the genus *Nola* has long been an uncertain one. By some of the older authors, notably Hübner, the species were placed among the Pyralidæ, and Stainton in his Manual of British Butterflies and Moths regards the genus as forming "Family IX, Nolidæ" under the Pyralites, though he says: "One little group, the Nolidæ, is by many recent authors, and perhaps with reason, referred to the Bombycina, being placed with family Lithosidæ."

The genus is now generally placed among the Lithosians. In our Synopsis of Bombycidæ we omitted to mention it, partly on account of want of specimens and partly perhaps from supposing it not to be a true Bombycid. Mr. Grote was the first American author to enumerate it in his New Check List of North American Moths, 1884, and to include it among the Lithosiæ.

Having reared *Nola ovilla*, my attention has again been drawn to its systematic position, which seems without much doubt to be properly among the Lithosiæ and near Clemensia.

I have found the larva frequently on the oak in September both in Maine and Rhode Island. Its habit is unmistakably Lithosian; it differs, however, from Arctian and Lithosian larvæ in having one less pair of abdominal legs, having but four pairs, whereas the caterpillars of the Lithosiæ and Arctians have, like most caterpillars, an additional pair, *i. e.*, ten abdominal legs in all.

When I first discovered the larva of *Nola ovilla* I supposed it to be near *Crocota*. It was found to be common on the leaves of the oak in Maine, September 6.

September 14 to 16 the caterpillars made singular boat-shaped, flattened, oval-cylindrical cocoons closely attached to the surface of the leaves; they were spun with silk, but covered closely on the inside with bits of oak leaves. The pupa appeared as soon as the cocoon was completed, September 15. The moths appeared May 31 and June 1 of the following year.

*Larva*.—The body is broad and much flattened, rather short, with four pairs of well developed abdominal feet, the first pair being situated on the fourth abdominal segment. The head is not very large, three-fourths as wide as the body; black, with a few paler irregular lines. The body is dirty-whitish, with a dark linear dorsal line, a dark dorsal discoloration behind the head, another in the middle of the body, and a third near the end.

The body is hairy, though not densely so; on each segment are four dorsal tubercles from which radiate short dusky hairs; on the side is a larger and longer tubercle from which arise lateral very long hairs, being as long as the body is broad; some black hairs are mixed with the dirty-whitish ones. The larger and most of the shorter hairs are simple, not barbed, but the shortest, smallest hairs are finely though

slightly barbed, the barbules short. The tubercles are dirty-white, concolorous with the rest of the body. Length, 13<sup>mm</sup>.

*Moth*.—A small frail form, with ciliate antennæ, no ocelli, and long dependent palpi, their second joint thickly scaled. Fore wings grayish-white, with the inner line black, fine, angulated. Outer line denticulate, followed by a pure white shade. A pure white shade in the place of the subterminal. Hind wings dusty white. Beneath, the fore wings are pale fuscous, immaculate; hind wings whitish, with a discal dot. Expanse of wings, 16<sup>mm</sup>. (Grote, Can. Ent., VII, 221.)

182. *Seirarctia echo* (Abbot and Smith).

This is a southern moth, whose caterpillar lives on the ground oak, persimmon, and several other kinds of trees. "It formed its web May 31; one came out the 23d of August, but the rest remained in chrysalis till the 14th of April. It is a rare species." (Abbot.)

The moth is white, the veins edged with black, while the abdomen is spotted with yellowish and black.

183. THE OAK TUSSOCK CATERPILLAR.

*Halesidota maculata* Harris.

Order LEPIDOPTERA; family BOMBYCIDÆ.

It may be found feeding in September, being a black, very hairy caterpillar, with yellow and black tufts and yellow on the sides of the body. The worm spins late in September a yellowish-gray oval cocoon, constructed of silk, with the hairs of the caterpillar interwoven. The moth appears the first week in June.

Found feeding on oak, London, Ont., July, 1870. Body black, thickly covered with bright yellow and black hairs. There is a dorsal row of black tufts from the fifth to the twelfth segment. Those on the fifth, eleventh, and twelfth are largest. Segments 5 and 12 have an extra substigmatal one each side.

The same insect was found August 19, 1875, feeding on willow, at Detroit, Mich. (Riley's unpublished notes.)

*The larva*.—Cylindrical; 1.30 inch long. Head large, slightly bilobed; black, with a faint white streak down the front as far as the middle, where it becomes forked. Body above black, thickly covered with tufts of bright yellow and black hairs. On the second, third, and fourth segments the hairs are mixed, yellow and black, those of the second and third segments overhanging the head. From the fourth to the eleventh segments, inclusive, is a dorsal row of black tufts, the largest of which are on the tenth and eleventh segments; the fourth and eleventh segments have also a black tuft on each side near the base. The hairs on the sides of the body, from the fifth to the tenth segments, inclusive, are all bright yellow, while those on the sides of the twelfth and thirteenth are mixed with black. On the third, fourth, eleventh, and twelfth segments are a few long, spreading yellow hairs, much longer than those elsewhere. (Saunders.)

*The moth*.—Light ochr-yellow, with large irregular light-brown spots on the fore wings, arranged almost in transverse bands. It expands nearly an inch and three-quarters. (Harris.)

184. *Halesidota edwardsii* Packard.

A Californian species; the caterpillar is abundant on various species of oaks, in the neighborhood of San Francisco. The larva, says Mr.

Stretch, is nocturnal in its habits, and in the day-time may be found crowded into holes and cavities (generally in families), and often in places where it seems scarcely possible for them to penetrate. It is full-fed about the end of June, and the imago is disclosed during the latter part of July. The cocoon is composed chiefly of the hairs of the larva, and, although of considerable density, is but slightly bound together with silk.

*Larva*.—Head dark brown, very large; thoracic legs reddish brown, abdominal legs tawny. Body stout, depressed, densely clothed with moderately long rich-brown hairs of uniform length, giving the larva a brush-like appearance. The sides of the body, as well as the head and anal segment, have long silky scattered hairs of a tawny yellow. Length, 1.50 inches. (Stretch.)

*Moth*.—Bicolorous, buff-yellow and vermilion. Fore wings with five subhyaline smoky, transverse bands, margined with black, less oblique than usual. The basal band consists of a small costal spot and an outer median large round spot. Second band regularly curved, third hardly oblique, waved. The outer ones nearly parallel with the outer margin. Hind wings transparent except on the pilose inner margin, which is tinged with vermilion. Abdomen above, including the base of the anal tuft, vermilion. Beneath, pale buff, the costal spot re-appearing. On the costa of the hind wings near the apex are two dusky square spots, which do not appear on the upper side. Legs ringed on the femora and tibiae. One ring on the end of the tibiae, and each tarsus annulated on the basal half with smoky pale brown. Femora vermilion beneath. Expanse of wings, 2.20 inches.

185. *Halesidota tessellata* (Abbot and Smith).

Found August 29, 1872, on laurel oak, a yellow, white tufted *Halesidota* larva. Others that were found on hickory are probably of the same species. Both, when full grown, are mouse gray, with a darker dorsal ridge. Two long black pencils near posterior end and four near the head, on joints one and two, and six shorter and thinner white ones. (Riley's unpublished notes.)

186. *Orygia gulosa* Hy. Edwards.

The moth closely resembles the Californian *O. vetusta*. *O. gulosa* is always much smaller than *O. vetusta*; the white spot near the inner angle is less distinct and the lines on the fore wings are invariably more clouded and confused. Expanse of wings, .75 inch. The caterpillar feeds on the oak in California, while *O. vetusta* feeds on the lupine. (H. Edwards.)

*The larva*.—Ground color, as in *O. vetusta*, velvety black; head jet black, without the yellow frontal line, and with the mouth-parts dull yellow; second segment with the usual complex series of black hairs. Between them are two dark, brick-red tubercles; third has two orange central tubercles and two brick-red ones on the sides; fourth has a black central tuft, with two brick-red ones on the sides of it; the fifth, sixth, and seventh have each a white central tuft, with two brick-red tubercles on each side; the eighth, ninth, and tenth each with six brick-red tubercles; the eleventh has a central tuft of black hairs, directed posteriorly, with two brick-red tubercles. Anal segment black. From the base of all the red tubercles arise bundles of black and white hairs, almost wholly white on the sides. Between the seventh and eighth segments are some bright orange dashes, which marks are also indistinctly seen on the anterior segments. Food plant, *Quercus*, of various species. (H. Edwards.)

187. *Orgyia definita* Packard.

Mr. R. Thaxter informs me that this species feeds on the oak. Mr. Otto Seifert has also bred the insect in all its stages, but as far as I am aware has not published his description.

*Moth*.—Female. Umber-brown. Head, thorax, base, and inner margin of primaries more testaceous. A faint, basal, dark, straight, transverse line. Beyond and near the linear lunate discal spot, which is surrounded by the testaceous brown, is an indistinct nearly straight line. An outer very distinct curved line, being straight from the costa to where it is angulated on the fifth subcostal nervule, and again half way between the discal spot and internal margin. Beyond this line on the costa is an oblong, dark, well-defined spot, succeeded by a submarginal row of dots, ending in a white spot near the internal margin. Beneath, lighter. Lines faintly seen beneath, the outer one extending faintly on to the secondaries, which have a discal dot.

The markings are much more distinct in this species than in *O. leucostigma*, while the outer line is angulated nearer the middle. Length of body, ♀, 0.60; exp. wings, 1.20 inches.

188. *Parorgyia achatina* (Abbot and Smith).

In their great work on the Lepidoptera of Georgia, Abbot and Smith state that this caterpillar feeds on various species of oak as well as on the hickory. "It spun on the 3d of May and the moth came out on the 20th." The moths of both this and the next species are very rare in our collections, though the caterpillars may be more commonly met with.

189. *Parorgyia parallela* Grote and Rob.

(Larva in hibernation stage. Plate xxxv, Fig. 3.)

Although I am strongly inclined to consider this species as a synonym of *P. achatina* Abbot and Smith, yet until we have more specimens in all stages from the Southern States, the present specific name may be retained. I have a single small female from Florida, which differs somewhat from Abbot's figure of *P. achatina*, and yet seems to belong to that species and to agree in many respects with a series of females of *P. parallela* in my collection.

Our northern specimens have been bred by Mr. Otto Seifert,\* of New York, and I have received some from Rev. G. D. Hulst, the latter of which have been pronounced to be *P. parallela* by him, by Mr. Graef, and also by Mr. Roland Thaxter. I have also raised the larva from eggs received both from Miss Morton, of Newburgh, N. Y., and from a lot of eggs received from Mr. Thaxter and kindly sent by him from Aiken, S. C.

The males of what I take to be *P. parallela* (? = *P. achatina*) and *P. clintonii* (= *P. leucophæa*), are difficult to separate, while the females are readily separable.

In the male of *P. parallela* the outer or extradiscal line curves outward before reaching the costa, and then bends inward on the costa;

\* See Entomologica Americana, iii, 93.

also the dark blotch between this line and the apex is narrower and much less distinct than in the male of *P. clintonii* (*leucophœa*).

The females are readily separated from those of *P. leucophœa*, as they lack the large brown patch near the apex of the fore wings.



FIG. 42.—*Parorgyia parallela*, male  
(from photographs).



FIG. 43.—*Parorgyia parallela*, female  
(from a photograph).

2d. They hatched in Maine, August 9th to 11th and molted for the second time August 26th.

It appears that the larvæ before the last molt contract in length and hibernate; spin a cocoon the following July, the moths appearing in the end of July in New York, and sometimes not until late in August.

*Larva*—1st stage. July 28th. Length 2.5<sup>mm</sup>. Head rounded, not very large, black, retracted within the very wide prothoracic segment, which has on each side a large black tubercle, larger than those on the abdominal segments; between the two tubercles is a median dark patch. On the two succeeding thoracic segments the tubercles are small. On each abdominal segment are two dorsal and two lateral black tubercles on each side. From the tubercles arise loose tufts of tawny brown and pale hairs, of unequal length, some twice as long as the body, so that the larva looks somewhat like an arctian or a young *Clisiocampa* or *Gastropacha*, and quite different from a young *Orgyia*. On the 5th abdominal segment is a clear pale dorsal space, the tubercles being absent. The thoracic legs are dark, while the abdominal legs are long, pale, like the body. August 3d and 4th, shortly before the first molt, the body became rather wider and flatter, and the hairs not so dense. Length, 3-4<sup>mm</sup>.

2d stage.—Aug. 6th first molt. Length 4-5<sup>mm</sup>. The generic characters, *i. e.*, those peculiar to the final stage of the caterpillar, now begin to reveal themselves. The hairs arising from the prothoracic segment extend out horizontally over the head and are very long and finely parted, so as to be feathery, some of them being nearly as long as the body; those arising from the end of the body are as long as those in front. The lateral outstretched hairs have fine long barbs so as to be beautifully feathery, as on the upright dorsal ones. There is a large, dark, irregular dorsal tuft on the second and third abdominal segments, and a smaller, but still large and dense, one on the eighth segment.

On the 6th and 7th abdominal segments is a single median white tubercle, situated on a dark ground. These two tubercles are *highly retractile*, and appear to be homologous with the coral-red retractile tubercles of *Orgyia*. They are each situated slightly in advance of the two dorsal tubercles of the same segments. The prothoracic

segment is still wide in front, as before. Each of the two black conspicuous tubercles gets rise to a small, black, slender pencil of hairs.

*3d stage.*—After 2d molt, Aug. 10-12. Length 7<sup>mm</sup>. The distinctive characters of the fully grown larva are now apparent. The head is entirely concealed by the overarching hairs arising from the prothoracic segment. All the hairs are now ash-gray in hue, except those on a large dark area forming the thoracic tuft and a naked area on the posterior third of the body, which bears the two whitish retractile papillæ. There is a large, black, low, dense tuft on the 8th abdominal segment. It is now a wonderfully beautiful larva, the hairs are so long, soft, and feathery.

*4th stage.*—After the 3d molt, Aug. 25. Length 12-14<sup>mm</sup>, not including the prothoracic pencils, which are now one-half as long as the body. It differs in this stage chiefly in the longer and larger, more distinct black pencils arising from just behind the head.

In this stage, represented by Fig. 3 of Plate xxxv, the body contracted in length and the larva ceased feeding in Maine (the eggs having been mostly laid in Aiken, S. C.), and most of them died. It evidently hibernates in this stage, not probably completing its transformations until the following midsummer in the Northern States. In the Southern States it is probably double-brooded.\*

*5th and last stage.*—Length of body, without the pencils, 35<sup>mm</sup>. From a colored sketch by Mr. Bridgman of a larva found wandering at Providence July 29, a pair of long, blackish pencils, but little shorter than those in front, arises from the 9th abdominal segment.

Professor Riley, in some notes on the eversible glands in larvæ of *Orgyia* and *Parorgyia*, and on the synonymy of the species (Proc. Ent. Soc., Washington, vol. I, p. 88), remarks:

"I also exhibit blown larvæ of a *Parorgyia*, which, from the bred specimens, I believe to be *P. leucophæa* Smith & Abbott. I have bred one male of this from the larva feeding on Persimmon. In an endeavor to determine my bred material in this genus, I have concluded that there are fewer species than have been made by Lepidopterists. The imagos vary considerably in details of coloration and markings, and it is quite probable that *obliquata* will prove to be synonymous with *leucophæa*. The larva, as figured by Smith and Abbott, is probably misleading, in having the dorsal tufts too conspicuously shown on joints 8, 9, and 10, for in my specimens they have been, as in other species of this genus, large and conspicuous on joints 4, 5, 6, and 7, inclusive, but far less so on the other joints.

"I also exhibit various blown larvæ of *Parorgyia clintonii* Gr. These vary in the color of the tufts according to state of growth, and there is also individual variation. My original specimens were found feeding on honey locust, but I have also found it on various other plants, as wild plum, elm, etc. Both these *Parorgyia* larvæ show the same eversible glands, though they are less conspicuous than in *Orgyia*, on account of the greater density of the hairs surrounding them. As to the synonymy of this species, my experience with the adolescent states leaves little doubt that *clintonii* is a synonym of *achatina* Sm. & Abb., and I question whether, with more complete knowledge, *parallela* and *basisflava* and even *cinnamomea* will not prove synonymous with the same species."

190. *Parorgyia leucophæa* (Abbot and Smith).

According to Abbot and Smith, the caterpillar feeds on the live oak and other species of oaks. "It spun a thin pale-brown web April 20, in Georgia, and came forth on the wing the 9th of May."

In the male of this species, of which I now regard *P. clintonii* G. and

\* Compare Dr. Lintner's statements in Entomological Contributions, III, 129.

Rob. as undoubtedly a synonym, the extradiscal line is nearly straight near and on the costa; and there can be seen the same dark brown streaks in the brown subapical patch, which are so marked and distinctive in the female. I can recognize this patch, with the points sent outward from it, in Grote and Robinson's excellent colored figure, as well as in one of my specimens. The females of *P. leucophava* (and *clintonii*), of which I have a small one from Florida, are at once distinguished from those of *P. achatina* by the outer line ending more obliquely on the costa. Just beyond this line and extending towards the apex are three dark brown longitudinal patches, with the spaces between filled up with brown, the whole forming a large, conspicuous dark brown patch, with ragged edges or points extending towards the outer margin of the wing. I have a male of *P. clintonii* which has been compared with one in Mr. Thaxter's collection, named for him by Mr. Grote; also one so labeled given me by Mrs. C. H. Fernald; also one so named raised by Mrs. A. T. Slosson from a larva found at Franconia, N. H., feeding on Hamamelis the second week in June. It remained, she kindly informs me, nineteen days in the cocoon, the moth appearing from June 27 to 30. It seems probable to me that *P. basiflava* Pack., *P. obliquata* G. and R., and *P. cinnamomea* G. and R. are synonyms of *P. clintonii*, and that the latter is the same as *P. leucophæa* of Abbot and Smith. Unfortunately we do not know the appearance of the larva of this species except from Abbot's drawings, as it has not since his time been described and figured.

## 191. THE EUROPEAN GIPSY MOTH.

*Ocneria dispar* (Linn.).

Plate XXXVII.

This insect, originally introduced from Europe through an accident by Mr. L. Trouvelot while living in Medford, Mass., about the year 1868 or 1869, has become acclimated, and during the summer of 1889 caused "very great alarm," being "very destructive" to fruit and shade trees, including the "linden, elm, birch, beech, oak, poplar, willow, hornbeam, ash, hazel-nut, larch, fir," etc. It is a destructive insect in Europe. The information here given is taken from an illustrated pamphlet published in 1889 by Prof. C. H. Fernald, entomologist of the Hatch Experiment Station at Amherst, Mass., who recommends showering the trees with Paris green in water (1 lb. to 150 gallons) soon after the hatching of the eggs in spring.

*Eggs.*—Globular, about  $\frac{1}{8}$ -inch in diameter, salmon colored, smooth, and laid often to the number of 400 or 500, early in July, on the under side of the branches or on the trunks, or on fences and on the sides of buildings. They do not hatch until the following spring.

*Larva.*—Length, 1.75 inches. Body very dark brown, or black, finely reticulated with pale yellow. There is a pale yellow line along the middle of the back, and a similar one along each side. On the first six segments behind the head there is a bluish tubercle armed with several black spines on each side of the dorsal line, and on the remaining segments these tubercles are dark crimson red. On the middle of



the 10th and 11th segments there is a smaller red tubercle notched at the top. The whole surface of the body is somewhat hairy, but along each side the hairs are long and form quite dense clusters.

*Pupa*.—From  $\frac{3}{4}$  to 1 inch long, varying in color from chocolate to reddish brown.

*Moths*.—The male is very much smaller than the female and with broadly pectinated antennæ. It is of a yellowish-brown color, with two dark brown lines crossing the fore-wings, one at the basal third, the other on the outer third, somewhat curved, and with teeth pointing outwards on the veins. The outer end of all the wings is dark brown. A curved dark brown spot (*reniform*) rests a little above the middle of the wing, and a small round spot of the same color (*orbicular*) is situated between this and the base of the wing, just outside of the inner cross line. A similar spot rests near the middle of the base of the wing. The fringes on the fore-wings are dull yellowish, and broken by eight brown spots. The antennæ are strongly bipectinated, or feather-like. The fore-wings expand about an inch and a half.

The female is pale yellowish white, with dark brown cross-lines and spots similar to those of the males. The cross-lines in both sexes are much darker and more prominent on the forward edge of the wings (*costa*) than elsewhere. In some specimens there is a faint stripe of brown across the middle of the wing (*median shade*), and a toothed line across the wing near the outer edge (*subterminal line*). The fringes of the fore-wings have eight dark spots between the ends of the veins, as in the males, and similar but fainter spots often occur in the fringes of the hind wings. The body is much stouter than in the males, and the antennæ are not so heavily feathered. The expanse of the wings is from  $1\frac{1}{2}$  to  $2\frac{1}{2}$  inches.

#### 192. *Lagoa crispata* Pack.

Although this caterpillar has been raised from the raspberry by the late Mr. C. A. Shurtleff, near Boston, we have found it common on the scrub oak in Providence as late as October 1, some specimens before the last molt occurring September 20 to 27. This curious woolly caterpillar will attract attention from its peculiar appearance.

As we have elsewhere stated, the cocoon is rather long, cylindrical; its texture is dense, being formed of the hairs of the larva, closely woven with silk. When the pupa, which is very thin, is about to transform it escapes from the cocoon, as the cast skin is found with the tip of the abdomen remaining in the cocoon. In this respect the moth is a connecting link between the groups represented by *Orgyia* and *Limacodes*.

*Full-grown larva*.—Body short, broad, and flat, head deep honey-yellow; jaws darker; the head very retractile within the large prothoracic segment, which is large and fleshy, produced down around the face like a hood, so as to entirely envelop the head, so that it is not seen while eating, with a large V-shaped incision in front. The body densely covered with hairs, so that the caterpillar appears about one-half as broad as long, rounded at each end, the hairs very long and curly; those on the thoracic segments mouse-gray; all the rest behind a uniform pale fawn-brown, sometimes above a dark, rich orange-ocherous; a slight dorsal broad crest, a subdorsal broad ridge, and the hairs spread out on the side, but everywhere so long and dense as to entirely conceal the head and body. The sides are mouse-gray as above, but the lateral hairs are not to be seen from above. The body is pale whitish yellow, the thoracic and abdominal legs also pale dull yellowish white. The first pair of thoracic legs are smaller and nearer together than the others, while there is a pair of rudimentary abdominal legs on the second and seventh abdominal segments. Length, 20–32<sup>mm</sup>; breadth, 10–15<sup>mm</sup>; height, 7<sup>mm</sup>.

*Larva before last molt.*—Body as in the adult. but smaller, and the hairs are thinner and looser and about twice as long and very much finer. The body can be seen through them and the fine cottony hairs can be seen to arise in dense verticils from small mammillæ, which are soft and white like the rest of the body, or pale tawny ochereous, while all the thoracic segments bear slate-colored hairs above. Behind each spiracle is an erect long conical acute fleshy projection, concealed by the hairs; the eighth segment has no such projection; the prothoracic spiracles are on the suture very near the mesothoracic segment, which have a similar but rounded and slightly chitinous projection in front of them. Length, 20<sup>mm</sup>; breadth, 16<sup>mm</sup>; height, 10<sup>mm</sup>. (Compare also the full account of the transformations of this moth by Dr. Lintner, Ent. Centr., ii, 138.)

193. *Lagoa opercularis* (Abbot and Smith.)FIG. 44.—*Lagoa opercularis*, larva.—After Riley.FIG. 45.—*Lagoa opercularis*, cocoon.—After Hubbard.FIG. 46.—*Lagoa opercularis*, moth, natural size.—After Hubbard.

The following account of this interesting insect is taken from Mr. Hubbard's Report on Orange Insects:

The caterpillars of this moth are covered with long, silky hairs, underneath which are concealed shorter, stiff hairs, exceedingly sharp at the points and powerfully nettling when they penetrate the flesh. Upon some persons the invisible wounds made by these hairs produce swellings and an amount of irritation equivalent to a sting; the larvæ are, in consequence, popularly supposed to be very poisonous. When young the caterpillars are white and resemble a flock of cotton wool. They undergo six molts, at one of the last of which they become darker, the color varying in individuals from red-brown to light-clay color.

The cocoon is placed in a crotch of the tree or upon a branch of considerable size; it is 20<sup>mm</sup> (eight-tenths inch) long, oval, convex, flattened on the side next the tree, and fastened very firmly to the bark. The upper end is abruptly truncate, and fitted with a hinged trap-door, which is readily pushed open from within by the escaping moth, but does not yield to pressure from without, and is so accurately fitted that no tell-tale crack can be discerned. Upon the back of the cocoon is an elevation formed by the meeting of several folds and ridges, forming a marvelously exact imitation of a winter bud. The ends of a lock of hair from the body of the caterpillar counterfeit the down which in nature protects the dormant bud. The substance of which the cocoon is made is a tough parchment, composed of agglutinated silk, in which is felt the long, hairy covering of the larva. Its color is a neutral brown, closely approximating to that of the bark upon which it is placed. The entire arrangement is a most successful representation of the stump of a small branch broken off near its junction with the main stem, and upon which is plainly shown the swelling of a bud.

*Life-history.*—The larva is a very general feeder, and although the oak appears to be its principal food plant, it is occasionally injurious to the orange. It never injures the bark or tender shoots, but subsists only on the mature leaves.

There are two broods, one in early summer and the other in the fall. The larvæ of the second brood form their cocoons in November or December, and in them pass the

winter, not changing to pupa until the following March or April, or about two weeks before the moths appear.

The same parasites have been bred from Lagoa as from the Orange Dog. *Tachina* flies have issued in June from a cocoon found on the orange in March. The hymenopterous parasite *Chalcis robusta* issued September 15 from a cocoon collected August 27.

*Larva*.—The larva presents the singular appearance of a lock of hair possessing sluggish life and a gliding, snail-like motion. It is  $1\frac{1}{2}$  inches long, bluntly rounded in front and diminishing rapidly to a point behind. The hair rises in a sharp ridge upon the back, and forms several tufts of rust-red color.

*Moth*.—Body very woolly, pale yellow, tinged with brown. The fore-wings are umber-brown at the base, fading to pale yellow outwardly; the surface is marked with fine wavy lines of silver gray, and the fore margins are nearly black. The legs are yellow, with dusky feet. The wings of the male moth spread about one inch; those of the female an inch and a half.

194. *Lacosoma chirodota* Grote.

The following account of this insect is copied from Professor Riley's notes. It is very rare and of curious habits, and like the succeeding species never likely to abound sufficiently to be injurious.

Larvæ of this insect were found in Virginia in September, feeding on the oak. It is a true case-bearer, resembling very much *Perophora melsheimerii*, differing, however, principally in the absence of the long antennæ-like horns. Its general color is yellowish-green; the head is brown, with yellow markings, and is coarsely rugose and punctured. Each side of the thoracic segments are two more or less confluent, brown, subdorsal lines, and on the last segment are some rather indistinct pale-brownish markings. Thoracic legs reddish-yellow. Stigmata black, with pale center. The case is constructed of a single leaf, which is bent longitudinally, the edges turned upward and held in place by a strong white web. This case is suspended by some threads and fastened to the surrounding leaves, and the larva issues partly when feeding, but retreats suddenly when disturbed. The case is open at both ends, so that the larva can turn and feed from which end it pleases.

Since the last of November they have ceased feeding, but did not transform to the pupa till the 28th of the following January, when they were noticed to change the position of their case and to suspend it in another place. The moth issued the 10th of February. The same insect was also received from Miss M. Murtfeldt, Kirkwood, Mo.

It is interesting to compare this larva with that of *Perophora*, and the following description, in addition to that given above, I have drawn up from Professor Riley's alcoholic specimen :

*Larva*.—Head large, about as wide as the prothoracic segment, but not so wide as the body, which is thickest in the middle. Head brown, slightly marbled with a paler hue. Prothoracic segment with a lateral reddish-brown stripe, which is continued upon the succeeding segment, but becomes more diffuse; below are two short unequal reddish lines; there are no markings on the rest of the body. Body moderately long and obtuse at the end; the supra-anal plate unusually large, broad and rounded, with six long marginal hairs. All the abdominal legs short and thick. Spiracles very distinct and visible from above. Antennæ minute, of the usual size, not elongated as in *Perophora*; otherwise the larvæ of the two insects are very similar. Length, 23<sup>mm</sup>.

*Moth*.—This moth seems to connect the true Psychidæ with *Perophora*. It resembles this last named genus in its broad head, the broadly pectinated antennæ, the general form of the subfalcate wings, and in its coloration. As in *Perophora*, it has but a

single outer line common to both wings, and a discal dot upon each wing. Wings and body dark yellowish-brown; fore wings with two undulating blackish median bands, the outer the broader and more distinct, both extending across the hind wings; a round black discal dot. Expanse of wings, 25 to 30<sup>mm</sup>.

## 195. MELSHEIMER'S SACK-BEARER.

*Perophora melsheimerii* Harris.

This rather singular insect ranges from Massachusetts to Missouri and southward to Georgia, as I possess a colored drawing of it made in that State by the elder Le Conte. I have observed it in Providence early in October. It has been figured in its larval and adult state by Harris, who has given an extended and interesting account of it. The following additional notes are copied from Riley:

August 28, a larva of this moth was found feeding on oak in Missouri; others were taken in southern Illinois. The larva is very active and savage when disturbed, turning with great ease in its case and attacking the intruder. Moth from larva received in fall of 1874 issued February 25, 1875, and laid eggs. The eggs are bright yellow, quite large for the insect, and very slightly glued to the sides and cover of the cage in which the moth was confined. At first the eggs are very soft, but in a few days become very tough. They were unfertilized. (Riley's unpublished notes.)

*Larva*.—Head with long, slender clavate appendages, bulbous at the end; the head is large, full, rounded, as wide as the prothoracic segment. Body thicker than usual, somewhat sack-like, thickest a little behind the middle, and truncated at the end; the unusually large supra-anal plate is rounded and convex on the dorsal surface. Spiracles so situated as to be visible from above, large and distinct; five pairs of short, almost rudimentary, abdominal feet; much shorter than in *Lacosoma*. Head dark brown, as is the prothoracic segment, the two hinder segments paler; a diffuse lateral stripe along the thoracic segments; rest of the body pale brown.

*Pupa*.—Very stout and thick, of the usual shape, but with no cremaster, this being represented by two short, flattened projections; across the abdominal segment a double dorsal row of spines. Length, 21<sup>mm</sup>.

*Moth*.—Rather large, in shape and size like the Chinese silk-worm; male with broadly feathered antennæ; reddish-gray, finely sprinkled with black dots; hinder edge of hind wings and the under side of the fore wings tinged with tawny red. A small black dot near the middle of the fore wings, and both the fore and hind wings crossed by a narrow blackish band, beginning with an angle on the front edge of the former and passing obliquely backward, ending a little beyond the middle of the inner edge of the hind wings. It expands about 2 inches.

## 196. THE CYLINDRICAL BASKET WORM.

*Psyche confederata* Grote and Robinson?

The following notes on this insect have been given us by Professor Riley. We append the original description of the moth.

A rather curious bag worm, carrying its case almost perpendicular, was found on the oak, June 14. Fastened to cover of breeding-case preparatory to transforming June 24, and emerged as moth July 16.

The case differs from that of *Platoeceticus gloverii* Pack. of Florida, in being cylindrical, not oval. (See Glover's figures, in Packard's Guide

to the Study of Insects, on which our description was based.) From specimens of *P. gloverii* it seems to differ in the hind wings being less rounded, more produced towards the apex. They appear to be of nearly the same size.

*Moth.*—Male entirely deep smoky black. Antennæ plumose. Wings ample, closely scaled, rounded and full. Neuration of primaries: costal nervure simple; slight, joining the costa before the apex; 3. c. nervure throwing off first and second s. c. nervules from its upper side on to the costal margin; third s. c. nervule at the upper extremity of the discal cell furcate, throwing off the fourth s. c. nervule from its lower side on to the apex; fifth simple, thrown off from a short transverse stem on to the external margin; discal cell equilateral, longitudinally cordate, not closed by a true vein, but by a vein-like fold depressedly medially angulated; a slight crease in the membrane divides the cell into two equal parts, running from the point of angulation of the fold, closing the cell to the base of the wing; median nervure four branched, first median thrown off upon external margin from a point opposite the fifth s. c. nervule; internal nervure sending off an angulated nervule from its upper side, at about its center, to internal angle; the nervure itself joins the margin before the angle, and is straight. The male cocoonet with agglutinated fragments of coniferous plants, and with the extruded skin of the chrysalis after the escape of the male moth, accompanied a number of specimens of this species received from the South. Expanse of wings, male 19<sup>mm</sup>. Length of body, 7<sup>mm</sup>. (Grote and Rob.)



FIG. 47.—Case of *Psyche confederata* (after Grote).

#### 197. THE EIGHT-FLAPPED SLUG-WORM.

*Phobetrum pithecius* (Abbot and Smith).

Order LEPIDOPTERA; Family BOMBYCIDÆ.

A singular dark-brown short, broad, ovate, flattened caterpillar, with eight long tongue-like, slender, fleshy lateral appendages, sometimes feeding on the oak.

This singular caterpillar, usually found on the plum, cherry, and apple, changes to a brown moth with very narrow wings. In the male the antennæ are very broadly pectinated, and the remarkably long narrow fore wings are partly transparent. Mr. Lintner has bred it from the oak, and Mr. S. Lowell Elliott tells me that it is almost exclusively an oak-feeder, though occurring on the wild cherry and chestnut. The following account is copied from Mr. Hubbard's "Orange Inse ts."

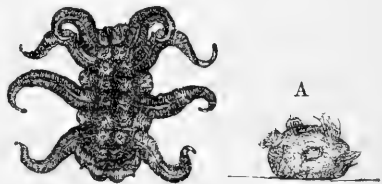


FIG. 48.—*P. pithecius* (after Riley); A, cocoon—natural size (after Hubbard).

This insect receives its name from the curious hairy appendages which cover the back and project from the sides of the larva, and have a backward twist, like locks of disheveled hair. These are, in fact, fleshy hooks, covered with feathery, brown hairs, among which are longer, black, stinging hairs. The cocoon is almost spherical, like that of the Saddle-back caterpillar, and is defended by the hairy appendages which the larva in some way contrives to leave upon the outside. These tufts give to the bullet-shaped cocoon a very nondescript appearance, and the stinging hairs afford a very perfect protection against birds and other insectivorous animals.

Unlike the preceding species, the Hag-moth larvæ do not seek to hide away their cocoons, but attach them to leaves and twigs fully exposed to view, with, however, such artful management as to surroundings and harmonizing colors that they are of all the group the most difficult to discover. A device to which this insect frequently resorts exhibits the extreme of instinctive sagacity. If the caterpillar can not find at hand a suitable place in which to weave its cocoon it frequently makes for itself more satisfactory surroundings by killing the leaves, upon which, after they have become dry and brown in color, it places its cocoon.

Several of these caterpillars unite together, and selecting a long and vigorous immature shoot or leader of the orange tree they kill it by cutting into its base until it wilts and bends over.

The leaves of a young shoot, in drying, turn a light tan-color, which harmonizes most perfectly with the hairy locks of the caterpillar covering the cocoon. The latter is, consequently, not easily detected, even when placed upon the exposed and upturned surface of the leaf.

*Larva.*—The larva is 15<sup>mm</sup> (six-tenths inch) long and has an oval body, over which, however, the flattened and closely applied appendages form a nearly square shield.

*Moth.*—The moth has body and legs of purple-brown, with ochereous patches on the back and a light yellow tuft on the middle pair of legs. The abdomen is sable, ending in a tuft of ochereous scales. The fore wings have the colors of the thorax finely mingled, as in graining. The hind wings are sable, bordered with ochereous in the female. The fore wings of the male are long and narrow, the hind wings short and very triangular. Both pairs are, in this sex, partly transparent.

The spread of wings varies in this moth from 20 to 24<sup>mm</sup> (eight-tenths inch to ninety-six hundredths inch. Hubbard).

198. *Euclea querceti* (Herrich-Schaeffer). (*Limacodes cippus* Harris).

This is said by Abbot to feed on the oak, the dog-wood, and other trees. It makes its cocoon in September, the moth appearing the next July.

*Larva.*—Body oblong-oval, with a broad dorsal flat ridge, bearing on the edge in front four large, and near the end of the body the same number of large, spinulated, fleshy, long conical green tubercles, and between them four pairs of short ones. Between them are four black square spots, giving a checkered appearance to the ridge. The sides of the ridge, the surface of which is not hollowed, fall away rapidly to the lateral row of eleven fleshy tubercles. At the end of the body are four stout black subconical dense tufts of dark brown spinulated hairs. Body of a peculiar pale glaucous green; between the two rows of tubercles is a row of nine roundish polygonal contiguous spots of the same hue as the rest of the body, but edged with blackish. Length, 15<sup>mm</sup>.

*Moth.*—Cinnamon brown; upon and beneath the median vein are two confluent green spots margined with a row of white and brown scales; between them is a large notch filled in with rust-red. These two spots are contiguous to three subapical spots, the middle one of which is triangular and largest, and beyond it is a rather narrow rust-red blotch. Discal dot very distinct, ovate, brown.

199. *Parasa chloris* (Herrich-Schaeffer).

The larva of this fine moth was first found by Reakirt on the chestnut in September. According to Andrews (*Psyche*, ii, 271), it feeds on the oak (*Quercus*), on the pear tree, on wild cherry (*Prunus*), and on the wax myrtle (*Myrica cerifera*) in September. Mr. Elliott has reared it from the elm, and Mr. Wetherby mentions the following as its food plants: Oak, pear, cherry, and tartarean honeysuckle. The moth appears in May and June, according to latitude.

*Larva*.—Onisciform, 19<sup>mm</sup> long. Head purplish-brown. Four purple and three white lines drawn very close together form a dorsal band running the length of the body. Subdorsal line bright red, from which arise six red spines (longest on central segments) studded with yellowish-red spinelets; between the spines and on the fifth, sixth, eighth, and ninth segments are reddish spiny warts. The spines and warts are on elevated ridges. Beneath the subdorsal line are two pairs of purple longitudinal lines on a yellowish ground; the pairs divided by a red line. The breathers [spiracles] are on a similar red line, and are guarded or ornamented by spiny warts, like those mentioned above. Legs of a sort of yellowish-olive color, prolegs, or rather tubercles, and under side of body of a reddish tinge. Varies considerably; one very beautiful variety has all the red of the typical larva replaced by brimstone yellow. (W. V. Andrews.)

FIG. 49.—*Parasa chloris*.

*Cocoon*.—About half an inch long, spun on the midrib of a leaf, oval, shining brownish-black.

*Moth*.—In general shape like *Euclea*, but yet quite distinct from it. The species may be known by its grass-green thorax and the broad grass-green band which separates the brown margin of the wing from its base. Ground color pale cinnamon-brown. A broad, short, vertical tuft between the bases of the antennæ. Thorax above, grass-green. Middle green band on the fore wings straight on the outer edge; within it is slightly excavated and follows the inner edge to the base of the wing. The hind wings are concolorous with the body, and above are a little paler within the outer edge. Expanse of wings, .94 inch.

#### 200. *Parasa fraterna* Grote.

This interesting species, according to MS. notes by the elder Le Conte, feeds in Georgia on the oak, chestnut, and wild cherry.

*Larva*.—Length, 16<sup>mm</sup>; September 3 and 4. The body is oblong-square, and seen in section subtrapezoidal, the dorsal surface being in general flattened, though still somewhat convex; the dorsal area being from one-half to two-thirds as wide as the creeping disk or underside of the body. The body ends in a long, slender, fleshy projection or tail, which is somewhat spinose and slightly forked at the end. Along each side of the dorsal surface is a row of short, thick, retractile tubercles, bearing peculiar stout spines, which are whitish tipped with brown at the end. The third pair from the head is situated apparently on the second abdominal segment, and is twice as large as the others; those on the eighth abdominal segment are much larger than the other abdominal tubercles, which are minute; the short spines on this pair are whiter than those on the other tubercles. A brown line externally washed with a paler hue bounds the sides of the back. There is a lateral row of small spine-bearing tubercles around the edge, the middle of each tubercle being raised or convex. The spiracles are minute, white, somewhat elevated, and situated on a darker round area. Low down between the two rows of tubercles is a row of smooth kidney-shaped depressed spots. The head is of a chestnut color, the labrum paler. The under side, or disk, is pale flesh color, edged above with a reddish stripe, which becomes reddish-brown above. The body still higher up is of a rich velvety, dark flesh-red brown, some individuals being much darker than others. The under side of the "tail" is carneous, becoming reddish above, and dorsally of a rich brown, with the spinules blackish, or pale at the base and brown-black at the tips.

*Moth*.—*P. fraterna* differs from *P. chloris* in being smaller, while the prolongation of the broad green band in the fore wings along the inner margin to the base of the wing is very much, at least two-thirds, narrower. The larva, judging by several

specimens belonging to the two last stages, differs remarkably from that of *chloris*, having almost nothing in common; as regards the larvæ alone, the two species would seem to be generically separated.

The preceding description was drawn up from specimens kindly sent by Miss Morton.

THE SADDLE-BACK CATERPILLAR.

201. *Empretia stimulea* Clemens.

While the singular caterpillar of this moth feeds on a variety of trees, it has been found by Mr. S. L. Elliott to occur on the oak, though it is nowhere a particularly common insect.

According to Clemens, it feeds on a great variety of plants; *i. e.*, fruit-trees, the rose, Indian corn, etc.

The caterpillar is of strange form, being short and thick, with two large spiny tubercles in front and two behind. On the back is a large square green patch like a saddle-cloth, while the saddle is represented by an oval purplish-brown spot. The hairs fringing the sides of the body sting severely. Clemens, who describes this insect (*Proc. Acad. Nat. Sci. Phila.*), says that the caterpillars "produce an exceedingly painful sensation when they come in contact with the back of the hand, or any portion of the body on which the skin is thin." The larvæ do not seem to seek cover, and are probably distasteful to birds on account of their nettling hairs.



FIG. 50.—*Empretia stimulea*: a, moth (after Hubbard); b, larva (after Riley) (all natural size).

"The cocoons are short, oval, almost globular, flattened against the branch to which they are attached, and are of the same tough, parchment-like material and brown color as in *Lagoa*. They are usually placed in concealment, often against the main trunk of the tree, at or near the surface of the ground. The larva before pupating cuts a circular flap at the end, making an opening nearly equal to the entire diameter of the cocoon, through which the moth makes its escape by pushing open the door from within." (*Hubbard's Orange Insects.*)

*Larva.*—Very short and broad, about an inch long and one-third as broad; with a pair of short tubercles on two of the thoracic segments, and four short ones at the end of the body; a pair of very large, fleshy tubercles like horns on the first and eighth abdominal segments, which are longer before the last molt than afterwards. Body brown, but green above between the two pairs of large tubercles, enclosing a central purplish or reddish-brown spot, bordered with white, the latter edged with a black line.



*Moth*.—The shape of body and wings are well represented by Fig. 50. The general color is a rich, dark, velvety reddish-brown. The only markings on the fore wings are two twin golden dots, nearly united to form a short line near the apex of the female, while in the male there are two more near the base of the wing beneath the median vein. Hind wings pale reddish-brown; expanse of wings, 36<sup>mm</sup>.

## 202. THE SKIFF CATERPILLAR.

*Limacodes scapha* Harris.

This is a singular boat-shaped triangular caterpillar, green, spotted above with brown, pale beneath, the sides raised and the dorsal surface flattened; forming in the autumn a tough rounded oval cocoon, covered by an outer thin envelope; the moth appears in June. It also occurs on the hickory and wild cherry.

*Larva*.—Ground-color pale apple green. The segments extended laterally in the middle of the body, and raised into an elevated ridge, sharp and angular at the edges. The flattened portion, which includes the dorsal region, is chestnut brown, darker on the margins. There is also a darker dorsal stripe. The segments are arranged like the plates of a tortoise. The latter region is of a pale yellowish-green, with an oval white spot on segments 9 and 10. Spiracles pale brown, mouth-parts also brown. In some specimens the brown color of the back is reduced to small patches, and occasionally a yellow dorsal line is present, the ground color (pale green) then prevailing. Length, 0.85; width, 0.25 inch. Food-plant, wild cherry. (H. Edwards and Elliott.)

*Moth*.—It is light cinnamon brown; on the fore wings the costo-median region is filled in with a large tan-brown triangular spot, ending on the tip of the wing, and is lined externally with silver. Expanse of wings, 26 to 28<sup>mm</sup>.



FIG. 51.—*Limacodes scapha*.  
Nat. size.

203. *Limacodes biguttata* Packard.

We have bred this species from a larva found upon the oak, October 7, at Providence, R. I. The caterpillar agreed with Harris' description and figure of *L. scapha* in his Correspondence, and I referred it to that species, but the moth, which appeared June 1, proved to be the present species. There also occurred on the oak at Brunswick, Me., a larva like that of *L. scapha*, but the elevated ridges were white; the body was green, with no other color. It spun a cocoon August 27, but afterwards died.

*Moth*.—A little smaller than *L. scapha*; of a soft velvety buff-brown; a whitish line reaches from the middle of the internal margin across and outward to the middle lobe. A short corresponding one from near the costa goes to the middle of the outer margin, thus making an inverted broad  $\lambda$ , inclosing at the internal angle a roundish red spot; apex red. Hind wings and under side of the hind body uniform obscure buff brown. It is a soft, woolly species with thick scales concealing the veins. Expanse of wings, 25<sup>mm</sup>.

204. *Sisyrosea inornata* Grote.

This singular and beautiful slug-worm was first described and figured in Harris' Correspondence (Pl. II, fig. 7; III, fig. 6). It also occurred at Providence on *Quercus alba*, October 7-9; October 10 it spun a round,

dense cocoon, but afterwards died. Another was bred, the moth appearing June 18. It was a female, and when at rest sat with its tail in the air, as if standing on its head.

Mr. S. Lowell Elliott assures me that he has bred the moth, which he has kindly shown me, from this larva.\* He tells me that it feeds not only on the oak, but also on the wild plum and cherry, and that it is a low feeder.

The following notes on this species have been given by Professor Riley, who has bred it:

October 24, 1882: Found to-day in Maryland three couchiipod larvæ feeding on oak and agreeing with figure in Harris' Correspondence (ii, 7). November 2, 1882: Found several of these larvæ, while sugaring at night, feeding on various plants. June 30, 1883: One of the moths issued to-day. July 16, 1883: One more issued. October 4, 1883: Found two larvæ in Virginia feeding on *Q. alba*. October 5, 1883: Several more were found on *Q. alba*, *Q. rubra*, and *Alnus incana*. October 10, 1883: Two of the larvæ have spun up. Found a few more on oak. There is but little variation in the color of this larva, only in the red spots on the dorsal space; some of them are very pale and sometimes the posterior one is absent. From one of the larvæ a Gordius issued. September 29, 1885: Found one of the larvæ on oak; it was parasitized by a tachinid, which pupated October 11, 1885, the fly issuing October 16, 1886. (Unpublished notes.)

*Larva*.—Body broad and flat, the prothoracic overhung by the mesothoracic segment; the V-shaped incision so broad as to be almost obsolete, the body being very broad; head pale green, a rather narrow median dorsal ridge, contracting in the middle and widening a little towards each end; it is hollow in the middle, and along the sides are ten small, narrow, flattened acute conical flaps, edged with green sharp spinules. The first pair are short, blunt and red; of the other nine pairs the anterior ones are the larger. The front edge of the body is thickened, somewhat revolute, and tinged with red. Along the side of the body, on the thin projecting edge, is a row of ten flat, fleshy, triangular flaps, the edges with white, uneven hairs. From in front of the base of each flap an oblique sinuous transverse ridge passes to the submedian dorsal ridge. There are two rows of scar-like round spots in the depressions between the lateral ridges, two scars in each depression. The spiracles are not visible seen sideways; the larva has to be turned over to discover them; they are slightly marked and situated under the projecting ridges of the side of the body. Behind the middle of the dorsal ridge are two red conical tubercles, whose sharp points nearly touch each other in the median line of the body. Another but smaller pair of red warts is situated half way between the first pair and the end of the body. The body is pea-green—a little brighter green than the glaucous under side of the oak leaf on which it feeds—and a little paler beneath than above. Length, 15<sup>mm</sup>; width, 7<sup>mm</sup>, not including the projections; height, 3.5<sup>mm</sup>. Described from a larva found in Providence, R. I.

*Moth*.—Body rather stout; fore wings with transverse waves or creases due to the arrangement of the scales, but with no markings; dull, pale, cinnamon-brown, the hind wings slightly darker; the fore wings are not so wide as in *Limacodes*, and they are very slightly subfalcate. Expanse, .90 to 1.20 inches.

---

\* This and other *Limacodes* larvæ, most of them colored conspicuously, suffer little from the attacks of birds, since they are protected by their nettling hairs, rendering them distasteful. Others, like *Lithacodes fasciola*, which feed on the under side of leaves and are entirely green, escape the observation of their enemies. *Phobetron pithecium*, on the other hand, mimics a brown, irregular dead patch of a leaf. Another aid to or means of safety in the smooth-bodied species is their slow gliding motion, which renders them less liable to be observed by passing birds.

205. *Adoneta spinuloides* (Herrich-Schaeffer).

(Larva, Plate III, Fig. 7.)

This insect in its larval state is a general feeder, as Mr. Elliott informs me, occurring on the oak, wild plum, cherry, and birch, while Dr. Clemens reared it from a larva found in September on the apricot. Miss Morton has found it feeding on the oak, chestnut, English, and probably, wild cherry.

I am indebted to Miss Emily L. Morton, of Newburgh, N. Y., for the use of the colored figure of the larva.

*Larva*.—Body semi-cylindrical, tapering posteriorly, and rounded obtusely in front. Nearly smooth, but with a subvascular row of small, fleshy, minutely spined papulæ on each side of the vascular lines, three of which placed anteriorly are separated and distinct, and three approximated on the last rings; the intermediate ones are minute. The outline of the body above the ventral surface is furnished with a row of minutely spined papulæ.

Bright green, with a broad dorsal yellow band, containing a reddish purple one, which is constricted opposite the second and third pairs of anterior papulæ and dilated into an elliptical patch in the middle of the body. This is almost separated from a smaller elliptical patch which is constricted opposite the third pair of posterior papulæ and ends in a small round patch. The anterior and posterior papulæ are crimson and the intermediate ones green. The superventral row of spined papulæ are green. (Clemens.)

*Moth*.—Reddish-brown, somewhat paler in the female than in the male. Fore wings with a dingy yellow streak along the base of the inner margin, extending toward the disk above the middle of the wing, and on this portion are two or three blackish dots. On the hind portion of the disk is a short black streak. In the male there is another short black streak along the median nervure and its last branch, with a curved row of three black, submarginal spots. The lower streak and the spots are as distinct in the female as in the male. In both sexes there is a subapical dingy yellow patch, lightly bordered behind with whitish. Hind margin spotted with black. Hind wing pale reddish brown. (Clemens.)

206. *Packardia nigripunctata* Goodell.

The caterpillar of this moth was found on the oak by Mr. L. W. Goodell, of Amherst, Mass. According to his recollection it was oval or boat-shaped in form, green, with several longitudinal rows of minute white papillæ or spots. The cocoon was round and hard, and the moth emerged June 20. (Can. Ent. XIII, 30.)

*The moth*.—Female: Fore wings light bronzy brown; a narrow, oblique, nearly straight, dark brown band runs from near the inner margin outward to a little beyond the middle of the costa, where it is joined at a right angle by another band, which is short and curved, terminating at about one-third of the distance from the costa to the inner angle. Between the end of the short band, and a little outward and above the internal angle, is a curved row of three roundish black dots, of which the marginal one is three times larger than the inner, and twice as large as the intermediate one. The bands and spots form a distinct inverted V. Within the area thus formed and parallel with the inner is a brown line, which extends from the inner margin to the discal end of the short curved band. This line is a shade lighter in color than the bands, and is edged outwardly with very pale or whitish brown. There is a band of the same pale brown or whitish color, which included the black dots and

extends outside of the short curved band to the costa. It is constricted near the inner dot, widening rapidly towards the costa, along which it extends towards the base to a little beyond the middle. Hind wings paler, the apex and outer margin concolorous with the fore wings, fringe of all the wings pale silky brown, interlined near the base with darker brown, and with a black spot on the apex of the fore wings. Fore wings beneath uniformly a little darker than above. Hind wings beneath much as above, but the darker shade of the exterior margin and apex is not so distinct. The wings above and beneath have the peculiar silken luster common to the genus. Head, thorax, and abdomen ochereous brown. Legs grayish brown, the tarsi a little paler. Length of body, 7<sup>mm</sup>; expanse of wings, 20<sup>mm</sup>. The wings are not so broad as in *P. geminata* and *albipunctata*. (Goodell.)

207. *Kronæa minuta* Reakirt.

According to Reakirt the caterpillar feeds on the oak and chestnut in August and September, the moth appearing in June at Philadelphia. The caterpillar is closely related to the European slug-worm *Limacodes asellus*.

*Egg*.—Length,  $\frac{1}{2}$  line, pale green, a black ring near one end, oblong.

*Larva*.—Length, 2 to 2 $\frac{1}{2}$  lines; basal outline elliptical; a flattened ridge, widened in the center, extends from head to tail, curving over vertical elevations at the sides, which gradually diminish before and behind, and terminate at both ends in a rounded margin. Around the base a row of small, densely spined papulæ, two of which, on the head, are the most prominent, and colored yellow. The body is smooth, but the ridge is thrown into thick, fleshy folds; it is thickest in the middle, whence it diminishes anteriorly and posteriorly. Green; two bright red lines, of equal length, cross each other at right angles on the central portion of the upper ridge.

*Moth*.—Male and female are alike in color, the last being the largest. Fore wings lustrous, brownish-yellow; hind wings blackish-brown. Below, testaceous, with a black shade, and roseate along the costa of primaries. Antennæ, thorax, abdomen, and legs ochereous-yellow. Expanse: Male, 5 lines; female, 5 $\frac{1}{2}$  lines. (Reakirt.)

208. *Datana integerrima* Grote and Robinson.

This insect, says Riley in his unpublished notes, like several other species of *Datana*, is not confined in its attacks to any one food-plant, but is injurious to a variety of trees, *i. e.*, the willow, honey-locust, thorn, and apple.

*The larva*.—Length 1.8 to 2 inches and very similar in appearance to *D. angusii*. The general color is dull black, of the appearance of India rubber. Sparsely covered with soft dirty white hair. Four thin sulphur-yellow lines along each side, the lower one, which is just under the stigmata, being somewhat indistinct on the latter half of the body, and all being more or less so on the last segment. Venter same color as above, with three yellow lines, the middle one uninterrupted, except by the prolegs; the outer ones interrupted in the middle of each segment by a rust-yellow spot, largest on the feet-bearing segments. Head rather larger than first segment, polished coal-black, with a suture down the middle and a V-shaped indentation in the center of the front. The first segment (which is the most striking feature) is of a gamboge or wax-yellow color, the cervical shield being darker and more shiny. The black between the second and third yellow lines extends about half way on this segment; that between third and fourth more than half, and under the fourth is a black line. Caudal plate almost round and shiny black like the head. Thoracic legs black, with gamboge or wax-yellow base; abdominal prolegs same color, with a shiny black spot

on the outside; anal inferior and of little use to the worm, small, thin, and shiny black.

When young the larvæ are brown or tawny yellow, with white stripes and more hair.

The larvæ go into the ground the latter part of August, and in less than thirty hours change to a chrysalis.

*Pupa*.—Eight-tenths of an inch and upwards in length, of the same form and appearance as that of *D. angusii*, but neither so dark nor so thickly punctured, and the four spines at the end are smaller in proportion. (Riley's unpublished notes.)

*Moth*.—Dark reddish-brown. Anterior wings entire along external margin, thickly and evenly covered with fine scattered irrorations, with a bright shade extending along costa centrally and above apical streak. Five transverse dark-brown lines. The first moderately arcuate, margined within by a paler shade. A central discal dot. The space between the first and second transverse lines darker. The second line covers the outer discal dot and is margined outwardly by paler scales, as are the third, fourth, and fifth lines. The position of all these lines is subject to variation. The fourth is, as usual, fainter than the rest and very contiguous to the fifth. Posterior wings very pale, crossed by a rather broad, pale, median shade. Under surface paler than upper, deepening in color towards external margin; fringes dark. The scales which clothe the head and form the thoracic patch are dark tawny-brown, deepening in color towards the edges of the thorax. The metathoracic and lateral hairs are very pale. Abdomen pale, testaceous; and segment concolorous with the rest. Expanse, male and female, 1.80 to 2.30 inches. Length of body, 0.78 to 1.10 inches. (Grote and Robinson.)

209. *Datana contracta* Walker.

Mr. James Angus has bred this species, which is confined to various species of oak, not feeding on other kinds of trees.

*Larva*.—Head black, shining. Body black, with four lateral broad yellowish-white stripes; a fifth is interrupted centrally by the legs, as in *D. ministra*, but in this latter species the stripes are darker and slightly narrow, while the larva is larger than that of *D. contracta*. The body is clothed with longer hair and is of a deeper black than in *D. ministra*. The dorsal swelled portion of the prothoracic ring is similarly colored, but less prominent and exerted than in its congener. (Angus.)\*

*Moth*.—Luteous tawny. Anterior wings entire, with a brighter shade extending along the costa centrally and above the apical streak. Profusely and distinctly irrorate with dark brown scales. Five transverse brown lines. The first oblique, very slightly arcuate, and margined inwardly with lighter scales. A central discal dot. The second line curved outwardly at costa, thence running inversely obliquely to internal margin. This line, which is margined outwardly with paler scales, joins the first at internal margin in a single specimen before us. A second discal spot. The third line slightly arcuate at costa, thence running parallel with fourth and fifth lines to internal margin. The third and fifth distinctly margined outwardly with paler scales. The fourth, which is quite contiguous to the fifth, is indistinct, and, in some instances, almost obsolete. Apical streak obsolete superiorly, indistinct. Fringes bright reddish-brown, the same with the thoracic patch. Posterior wings very pale, with a paler median shade. Under surface paler than upper, shading to reddish-brown towards external margin on anterior wings. The scales which clothe

\* The exact references to the place of publication of descriptions (published before 1889) of this and nearly all the other caterpillars noticed in this report may be found by the reader in Mr. Henry Edwards' useful Bibliographical Catalogue of the described Transformations of North American Lepidoptera, forming Bulletin No. 35 of the U. S. National Museum, Washington, 18-9.

the head and form the thoracic patch are bright tawny-brown, becoming darker towards the edges on the thorax. Metathoracic and lateral hairs concolorous with posterior wings. Abdomen pale tawny, anal segment darker. Expanse, male and female, 1.85 inches. (Grote and Robinson.)

210. *Edema albifrons* (Abbot and Smith).

This is perhaps the most common notodontian caterpillar to be found on the oak. At first the caterpillars are gregarious, but after the first or second molt they begin to scatter over the tree. In Georgia, according to Smith and Abbot, the caterpillar "spun itself up in a thin white web between the leaves October 28, and came out on the wing the 18th of February. Others spun on the 29th of March, and came out on the 2d of May. The whole brood feeds together, especially when small."

Mr. James Fletcher reports that in 1884 the caterpillars appeared in great numbers and were most injurious to both oaks and maples at Ottawa, Canada. (Rep., 32.)

It is common on white oaks in Rhode Island and Maine late in August and through September; those observed at Providence spinning a thin cocoon between the leaves early in October and until October 20-28. October 5 I found some small larvæ (probably next to the last molt) with the stripes straw-yellow instead of orange. The moth appears in June in the Northern States.

*Larva*.—Head large, orange-red, swollen, raised towards the apex; wider than the thoracic segments, the body increasing in width towards the end, which has a large swollen orange-red hump on the eighth segment. The body smooth and shining,

with no hairs; a pair of broad subdorsal yellow lines inclosing five median black lines on a pale lilac ground. Below the yellow line are three black lines, with a second yellowish spiracular line. Anal legs pale orange-red; all the legs pale orange.

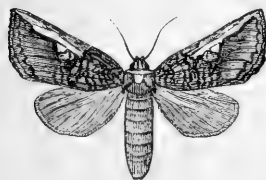


FIG. 52.—*Edema albifrons* (from Packard).

*Pupa*.—Of the usual form; the cremaster is very characteristic; it is flattened from above, deeply cleft, with tubercles from which arise three or four curved setæ on each side. Length, 0.78 inch.

*Moth*.—It is easily recognized by its whitish ash color, the square apex of the fore wings and the broad white costal margin on the outer two-thirds of the wings; this white band sends a tooth backwards, bounding the upper and outer side of the discal brown ring, and there is an obtuse tooth between that and the apex; the inner brown line is curved and sinuous; there is a faint deeply-toothed outer line and a distinct narrow deeply-scalloped, rich, deep-brown marginal line, the scallop filled in with whitish ash scales. Base of the wing inside of the middle line whitish ash; hind wing and abdomen uniform ash-slate color; wings beneath of the same color; costal edge slightly bathed with whitish, with traces of a curved submarginal band, broadest on the costa and broken up behind. Expanse of the wings, 47<sup>mm</sup>.

While in Florida in April I collected at Crescent City on the live or water oak a fully grown caterpillar which I supposed to be *Edema albifrons*. Bringing it to Providence in a tin box, it spun a slight cocoon between the leaves late in April, but the moth did not emerge until September 30. Although the summer was a warm one, and the room in which it was kept had a warm exposure, the moth was evidently re-

tarded in its appearance by a change to a cooler climate. Unfortunately I did not make a description of the larva.

The moth seems to represent a southern or local variety of this species. It differs from several specimens of *E. albifrons* slightly but distinctly; it is smaller and the white costal band is a little shorter and broader; inside of the discal spot it is not oblique, but straight, and the tooth bounding the outer, costal side of the discal spot is larger, rounder, and fuller, less conical than in *E. albifrons*. The submarginal scallops are less curved, and the space in front of the discal spot is filled in more densely with reddish brown. Expanse of wings. 35<sup>mm</sup>.

The pupa differs in the cremaster being consolidated, not forked, and the setæ are well developed. Length, 18<sup>mm</sup>. In a Providence pupa, however, the cremaster is partly consolidated, only forked at the end, and the six setæ are well developed.

The following notes on the early stages of the caterpillar are from Professor Riley's notes:

When young the larvæ feed in a phalanx, as it were, lying parallel on the leaf and as close together as they can.

Found at Woodstock, September 19, 1867, on the burr oak (*Q. macrocarpa*) some full grown and others just undergoing the third molt. When full grown, 1.45 inch in length, the body being larger on the abdominal than thoracic segments. Ground color white with a very slight corneous tint, which with the highly polished surface gives it the appearance of delicate porcelain. A subdorsal and stigmatal chrome-yellow band on each about .03 diameter. The subdorsal lines are not only thicker but wider apart on the abdominal than the thoracic segments, and between them, *i. e.*, along dorsum, are five polished black longitudinal lines, interrupted, however, at the sutures and merging into but three on the anterior five segments. Between the two yellow bands laterally are three other finer polished black lines and below the stigmatal yellow band several other longitudinal black marks, and one each side of venter. Stigmata in the yellow band, but being concolorous with it are scarcely noticed. Venter of the same dull shiny white as the ground color, but a little more glaucous. Legs and prolegs immaculate and also of the same color, the abdominals being large and swollen above, while the anal legs are small. Head larger than segment one, free, perpendicular, immaculate, glassy, and of a mixture of coral and yellow.

*Distinguishing feature.*—Segment eleven with a transverse ridge above, of the ground color with a band of the same color as the head, with a slight corneous mixture running transversely along its middle.

*Before the last moult* it has lost the polished appearance; the abdominal segments are not noticeably larger than the thoracic; the ground color is pure white, while dorsal and stigmatal bands are sulphur-yellow, and the ridge on segment eleven is more elevated dorsally and entirely corneous.

Entered the ground during the latter part of September and transformed to chrysalids, appearing as moths the following April.

#### 211. *Nadata gibbosa* Walker.

(Larva, Plate XI, Fig. 6.)

The caterpillar is not uncommonly found on the oak. By the middle or last of September, in New England (Maine and Rhode Island), it begins to pupate, not spinning a cocoon, and probably entering the ground before assuming the chrysalis state. In Providence it occurred on the white, in Maine on the red oak. In Georgia, according to Smith and Abbot, it "feeds on the chestnut oak, and other oaks. It went into the ground October 10 and came out March 15. Another went in June

1 and came out the 19th of the same month." It is therefore double brooded in the Gulf States and single brooded in the North. The following notes on its habits have been given by Professor Riley:

A pair of this moth were taken May 2, 1882, from the eggs of which larvæ hatched on the 9th. They went through their first moult May 15; second, May 22; third, May 26, and fourth, May 31. Pupated June 12 to 14. The moths issued from June 26 to July 10. Several larvæ of this moth were found by beating on oak June 26, July 10, 1882. This larva is now very plentiful and of all sizes, on several oaks. (Riley's unpublished notes.)

Dr. Lintner has bred the moth from a larva found feeding on the maple in New York. The figure on Plate XI was kindly loaned by him, and is probably the original of the wood-cut in his *Ent. Contr.*, iii, 150.

*Larva*.—Body green, large, head very large, full, rounded, high towards the vertex, as wide as the body, deep pea-green; the labrum whitish green; mandibles bright yellow, tipped with black, making them very conspicuous. Body glaucous pea-green, thick, full, soft, tapering towards the end, and the surface with minute raised, flattened, more or less confluent granulations. A lateral yellow line formed of coarse yellow, raised, flattened areas. Spiracles deep red. Supra-anal plate conical, flattened, apex much rounded, the edge colored bright yellow. Thoracic and abdominal feet pale pea-green; all concolorous. Length, 33<sup>mm</sup>, thickness, 6<sup>mm</sup>.

*Moth*.—Fore wings broad, apex pointed; male antennæ pectinated to the end. Body and wings reddish, reddish yellow-brown; thorax with a high, large, loose crest. Fore wings with two white twin discal dots, rather widely separated. An inner and outer narrow, oblique reddish-brown line; the outer parallel with the outer margin of the wing, which is slightly scalloped. Fringe dark, the scallops filled in with white. Hind wings whitish, with a faint outer line. Beneath, uniformly whitish; a faint outer line common to both wings; the costal edge dusted with reddish-brown. Abdomen yellowish-brown. Expanse of wings, 48<sup>mm</sup>.

212. *Lophodonta angulosa* (Abbot and Smith.)

It occurred on *Quercus alba* October 7, at Providence, when it began to pupate, the moth appearing the following June. Abbot and Smith remark that in Georgia it "feeds on the over cup oak and other kinds of the same genus. Some went into the ground May 30, and came out the 15th of June. Others that went in the 16th of October remained till the 20th of April." From this it appears that in the Southern States this species is double brooded.

*Larvæ*.—Somewhat like *Nadata gibbosa*, but the head is smaller, and it has no such supra-anal plate, while the body is smooth, not granulated. Head nearly as wide as the prothoracic segment, but not so wide as the body; full and rounded; though a little flattened above, deep pea-green, but concolorous with the body. On the side a pink line edged above with white extending to base of the antennæ. Mandibles green at base with an orange-red line along upper edge; tips black. A short black line above at base of antennæ. Body noctuiform, tapering towards the anal legs, which are short and small, no larger than the other abdominal legs, supra-anal plate small, rounded at the end, not large and conspicuous as in *Nadata gibbosa*. Segments not convex, but the sutures distinct. A faint double median, whitish, somewhat broken line, the two lines converging and forming one on the middle of the supra-anal plate and tinged slightly with pink. A distinct lateral pink line begins on the side of the head and extends to the end of the body along the edge of the supra-anal plate. The line is somewhat finely bordered with brown, and is edged below with white.



The whole body and legs pea-green, slightly darker below than along the back. Thoracic feet greenish-amber, spotted externally with black. Length, .40<sup>mm</sup>.

*Pupa*.—Body full and plump; of the usual form and color; the end of the abdomen very much rounded and obtuse, with no rudiment of a cremaster (as it goes into the ground, not spinning a web), only a rounded knob. Length, 18<sup>mm</sup>.

*Moth*.—Thorax and body dark grayish-brown; thorax with a round black spot on the hinder edge, encircled by a yellowish-brown line; abdomen yellowish brown. Fore wings rounded at the apex, of a quite uniform umber brown; basal line with a sharp distinct angle in the median space, the line reddish-brown, broadly shaded externally with much paler tawny brown; on the costa the line is straight, with a broad external whitish gray shade. Middle line sharply scalloped, becoming straight on the costa, with a sharp tooth on the discal fold and a sharp tooth occupying the entire submedian space; the last scallop short, indistinct, ending in a dark-brown tuft on the middle of the hinder edge of the wing. Outer line wavy but indistinct. A marginal wavy line. A broad whitish patch exterior to the middle line extending from the costa to the median vein. Hind wings sable brown, with a marginal shade and a dark broken band at the base of the fringe. Expanse of wings 40<sup>mm</sup>.

213. *Schizura ipomeæ* Doubleday (*Coelodasys biguttatus* Pack.).

The following notes and descriptions are based on an examination of the material in Professor Riley's collection. The larva occurred on the oak September 24. In Virginia one was found by Mr. Koebele, on the birch, September 14, and it has also been bred from the blackberry. The larva makes an earthen cocoon, regularly oval in shape, covering it with sand on the outside, so that it closely resembles that of *Janassa lignicola*. *C. unicornis* spins a silken cocoon, with débris collected and adhering to the exterior. It is evident that *C. cinereofrons* Pack. is only a variety of *biguttata*, there being a series of connecting forms in Riley's collection. The moth occurred at Cambridge, Mass., June 16, and in July and August. (Harris.)

Larvæ of this species are found from May to October at St. Louis, Mo., feeding on the different kinds of oak and on maple. The moths issued in April and August. The coloration of the larvæ is quite variable, though the most uniform marking is as follows: Color, green speckled with purple. A faint substigmatal sulphur yellow line, most distinct on thoracic joints. A broad pale subdorsal line, between which the dorsum is pale lilaceous, but thickly mottled with rich purple brown and ferruginous, leaving a narrow dorsal line distinctly marked. Two elevated ferruginous warts on top of joints 4 and 11. Head large, pale green, with a distinct lateral black and white stripe. (Unpublished notes.)

*Larva*.—Differs from *C. unicornis* in the head being purple and having four dark narrow lines extending from the base of the jaws to the vertex; the dorsal spine on the first abdominal segment is nearly three times as large and high as in *C. unicornis*, and ends in a deep fork, each tine of which bears a stiff truncated spine. A pair of dorsal, rounded, small tubercles on each abdominal segment 1-8, those on the 5th and 8th segments being much larger than the others and coral red in color. Coloration much as in *C. unicornis*, but the branches of the V in front of the tubercle on the 8th segment are wider and inclose a broken red line. Meso- and meta-thoracic segments green; body brick-reddish, slashed with pale lines, with a broad dorsal band forked on the prothoracic segment and extending upon the horn on the 1st abdominal segment; behind the horn are four dorsal oval light patches, each inclosing three red lines. Length 33<sup>mm</sup>.

*Pupa*.—Moderately stout; end of abdomen obtuse. The cremaster deeply cleft, each spine well developed, rather long, not much flattened, ending in a point and throwing off near the end a short branch which nearly meets its fellow with opposite spine. Length 21<sup>mm</sup>.

*Moth*.—Head gray, vertical tuft above black. Thorax reddish-brown, patagia blackish above. No distinct line on the prothorax. Primaries reddish-brown, nervules black. Base of the costa dark, beyond cinereous with brown scales along the edge, which become indistinct waved lines continued across the wing and are more oblique beyond the discal dot. The linear reddish discal dot is surrounded by gray, and below and beyond is a dark rather broad discoloration curved around it. Beyond this the black nervules are interrupted by gray scales. There are two obscure series of reddish dots near the margin in the interspaces. Opposite the outer series of these spots the fringe, otherwise ferruginous, is of a dirty-white. Secondaries white, discolored with smoky at inner angle. The large tuft beneath the head is lilac-ashen. Beneath, the fore-wings are white, smoky in the middle. Costo-apical dots distinct. Fringe white, black at the ends of the nervules, at the base are white dots in the interspace. Secondaries entirely white, except the dusky spot on the inner angle. Legs ashen, ends of the scales dark, tarsi broadly annulated with dark. Abdomen slender, whitish, a narrow mesial line beneath. In the female the markings are more distinct. The two series of ferruginous waved lines on each side of the median region are more distinct. The submarginal ferruginous region is more broken up by ashen scales. The secondaries and abdomen above smoky. There are faint traces of a slight mesial fascia across the wing. Beneath, both wings are dark smoky. A light ferruginous line on the abdomen, which is itself larger than in the other species. Length of body, male, 90; female, 95; expanse of wings, male, 1.60; female, 1.80 inch.

*Coelodasy cinereofrons* Pack., as stated by Grote, is undoubtedly a variety of this species now to be referred to the genus *Schizura*. The following notes on the larva of this variety have been received from Professor Riley:

June 20, found on oak two very small larvæ which entered the ground July 8 and emerged as moths July 30. Color of larva as follows: Second and third segments grass green; the horn of the fourth segment is two-forked and the tips blood red, also the tips of the two smaller horns on joints 8 and 11. The rest of the body and head, reddish brown. (Unpublished notes.)

214. *Hyparparæ aurora* (Abbot and Smith).

Larva, Plate III, fig. 6, 6a.

“The caterpillar was taken on the timber white oak, but feeds also on other species of oak. It went into the ground and inclosed itself in a thin case of dirt July 15, appearing on the wing August 7. Sometimes this species also buries itself in autumn, and remains till the spring, at which season the moth may now and then be observed sitting on the oak branches.” (Abbot and Smith.)

In New England it is single-brooded. The caterpillar, according to Abbot and Smith's figure, has a double red hump on the first abdominal segment, with a very broad dorsal green band between this and the tubercle on the eighth segment; the anal legs are elevated much as in *Schizura unicornis*. The moth has broad yellow fore-wings, in the female pink at base and on the outer margin.

I am indebted to Miss E. L. Morton for the colored sketches of this rather rare larva.

215. *Janassa lignicolor* Walk.

(Larva, Pl. III, fig. 5.)

The caterpillar of this moth occurred on the oak at Providence from the middle to the last of September. It has been bred by Professor Riley. This species is *Xylinodes virgata* of Packard. The larva is very characteristic and allied to those of Schizura. In Professor Riley's collection are the regularly oval thick earthen cocoons lined with silk, and about three fourths of an inch in length, the caterpillar transforming on the surface or within the earth.

*Larva*.—Head not very large, not so wide as the prothoracic segment; pale, almost whitish ash-gray; an irregular dark ash band on each side in front passing up from the mandibles and meeting on the vertex, where a branch is sent out at right angles, uniting with its fellow in the median line of the head; no median line above the apex of the vertex, but two spurs are sent out above the vertex from each side, which nearly reach the median line of the head, and inclose a clear round space. Prothoracic segment pea-green on each side above the spiracle. Meso- and meta-thoracic segments bright deep pea-green, bordered with reddish below; a long narrow triangular dorsal light-brown band, slightly forked on the prothoracic segment, extends from the head to near the base of the large dorsal tubercle on first abdominal segment; this tubercle is sensitive and retractile as in the other species of this genus; it is large but not forked, the end being very slightly cleft, blackish in the middle and each small terminal wart has a dark hair which is bent downward and forward. First to third abdominal segments pale gray and reddish-brown, the first less marbled and watered with gray than the second and third; the back of the fourth to ninth segments clear deep pea-green, with a round sinus in front on the fourth segment, and on the sixth and front edge of seventh inclosing a watered gray elongated irregular patch. On the eighth segment a small dorsal tubercle tinted with brown; the eighth spiracle much larger and more conspicuous than the others; around the seventh pair of spiracles are clear white patches. The abdominal legs 1 to 4 are thick and fleshy, with a reddish-brown circular line incomplete above; anal legs small and slender, about one-third as large as the others. Length 35<sup>mm</sup>.

*Pupa*.—Body short and thick; tip of abdomen unusually blunt; cremaster partly rudimentary, not projecting beyond the tip, and consisting of two widely separate flattened squarish spines, terminating in two small spines. Length 18<sup>mm</sup>.

*Moth*.—Pale cinereous. Pronotal pieces discolored with ligneous brown. A broad, median thoracic dusky line, succeeded on the abdomen by a dark spot. Primaries light ashen with brown scales arranged in streaks, which on the costa proceed obliquely towards the outer margin, ending upon the subcostal nervure. Towards the apex are two distinct brown streaks, which are parallel to the costa; between and below the second streak are two whitish streaks. A dark-brown discal dot is placed upon the lower discal nervule, and beyond it is a brown streak. In the middle of the discal space is a light line which passes over the discal dot and continues along the lowest subcostal interspace to near the outer margin. Below the median vein the wing is slightly tinged with ochreous. Just below the basal portion of the median nervure is a brown streak, and the internal border is mottled and streaked with dark cinereous. The tuft is dark-brown, and the outer edge of the wings is also darker than the discal portion. There are no transverse streaks. Secondaries white, the costa disclosed slightly with cinereous. Abdomen nearly concolorous, being a shade darker than the hind wings. Beneath cinereous, with a distinct median black line. Tarsi broadly annulated with dark. Length of body, .85; expanse of wings, 1.75 inch. Cambridge, female, Lansing, Mich.; Seekonk, R. I.

216. *Lochmaeus manteo* Doubleday (*Heterocampa subalbicans* Grote).

This species ranges from Maine to Texas. During 1880 a great amount of damage was done to the foliage of oak forests in at least two counties of Arkansas by this worm, which appeared in immense numbers in January. The following account is taken from Professor Comstock's report (Agricultural Report, 1880):

There are probably two broods of the variable caterpillar in the course of the season, although but one, the fall brood, seems to have been noticed. The moths appear in the latter part of April or in early May, and between that time and late September, when the principal damage is done by the worms, there is abundant time for two broods of caterpillars.

In the District of Columbia for the last two years these larvæ have been noticed very abundantly upon oak, hawthorn, and basswood, and doubtless feed upon other plants. In late September they had reached their full size and entered the ground, where, as we gather from Mrs. Thomas's letter, they lie most of the winter before transforming.

The most obvious remedy for the injuries of this insect is the destruction of the larvæ by burning the leaves upon the ground in the latter part of September, just as the larvæ are dropping from the trees. This could probably be done in most places without danger to the forest and without injury to the mast.

Should the damage done by the worms be sufficiently great to warrant the expense of trap lanterns to be used in May to destroy the moths, undoubtedly their numbers could be greatly lessened. For description of trap lanterns, with remarks upon their use, see page 330 of the report for 1879 (Comstock).

Professor Riley sends us the following notes on its habits and food plants:

Two larvæ of a *Notodonta* were found feeding on oak and persimmon in Virginia, June 18, 1882. Another one was found June 20, also in Virginia, feeding on walnut; and two more July 19, feeding on oak. (It also feeds on the white, post, and laurel oak, and linden). One of the first found larvæ spun up between leaves July 19, and another one pupated on the surface of the ground July 21. The first moth issued August 5 and the other one August 12.

Larvæ of a second brood were again found August 30 feeding on apple and black birch, and another full grown one September 3, feeding on persimmon.

October 14, 1870: S. S. Rathvon describes it as injurious to the linden trees, stripping them and going from one tree to another in the village of Lititz, near Lancaster, Pa. They went into the ground about the 1st of September. The specimen he sent had fifteen large *Tachina*-fly eggs attached transversely across the end and third joints. The white margin to the black stripe was missing, and the dark purple dorsal band extends to stigmata on joints 6 and 9 and to subdorsum on 4 and 11 (box 3, No. 29), also a variety in box 3, No. 53.

October 17, 1870: Bolter found 2 under oak leaves, both of them like that I found on oak October 2, 1870.

April 30, 1871, one has issued from an exotic oak in Shaw's gardens. The markings are much more diffused, with a large whitish discal spot on primaries. That marked 45\* from burr oak—Muhleman, issued May 25, 1871. It is a variety and perfectly deceptive like *N. unicornis*, taking the same tubular position.

Very abundant in 1873. October 12, leaves falling, obtained many from post oak. Three most persistent forms blown *a* (4 in cage 12) *b* (11 in cage 11) *c* (1 in cage 10).

July 6, 1874: The imagines have been issuing very irregularly. To-day I sieved the cages and especially 17, in which there were a number of all three forms. They now are all alike, and the head is the only characteristic part. All the color is gone from the body, which is now of a uniform Paris green more or less mottled

with a pale and dark shade, the vascular line dark and broken. Many of these are now crawling about quite actively, while others are in the pupa state and others issuing. They were all in a very slight elastic silken cocoon.

September 20, 1874: A number of all sizes on oak, separated into three lots—*a* in cage 12; *b* in cage 10; *c* in cage 5. They are very variable and there are specimens intermediate between these three forms. Some have the colors very bright and distinct, and others less so. A lot found on linden, but afterwards feeding well on oak, are all of the light form *a* in cage 13.

November 21, 1874: In sieving the cages containing forms *a*, *b*, and *c*, they were found still in the larval state, some having made a tough silken cocoon, others one made only of a few threads, while some had no cocoons at all but had made a smooth cavity in the earth. In cage 5 were found two large *Tachina* larvæ, certainly from form *c*, one of which is preserved in box 7-40. April 10, 1875, one *Tachina* fly issued marked 359°. One moth issued April 16, 1875, the larva of which was found on linden, but fed also on oak in cage 13, where there are many more in the ground. Braconid parasite bred October, 1874. October 26, 1875: Nine from oak all near form *b*. (Unpublished notes.)

*Full-grown larva—Variety a.*—Length, 40<sup>mm</sup> (1.50 inches), rather slender, subcylindrical. Head pale green with a deep purplish lateral line bordered below with a pure white line; dorsum of abdomen bluish-green with a narrow white dorsal line; the green dorsum is bordered each side by a narrow, scarcely noticeable yellow line running from the head to the fourth segment, from which point it is purple to the end of the body; this line is bordered below by a very distinct pure white subdorsal band; the sides are bluish with dark purplish spots; stigmata orange; below the stigmata a faint interrupted yellow band; the dorsal and lateral piliferous warts are yellowish; subdorsal whitish. The first thoracic segment has two yellow dorsal tubercular spots; segments 2 and 3 have each a yellow dorsal double wart, and the first abdominal segment has two quite conspicuous red piliferous tubercles; the penultimate segment is somewhat gibbous above and bears two small reddish piliferous tubercles.

*Variety b.*—Head dark yellow; dorsum of body purplish with paler mottlings; dorsal line white; the subdorsal white line interrupted on abdominal segments 3 and 6; the sides rather browner than the dorsum; lateral line yellow and more distinct than in variety *a*. Stigmata orange; the first thoracic segment has the yellow tubercle, but segments 2 and 3 have only the lower one of the double tubercles yellow. In other points it resembles variety *a*.

*Variety c.*—Head very pale yellow; dorsum pale grayish; dorsal white line bordered each side by a narrow purplish line. The subdorsal band consists of a narrow purple line, an indistinct yellow line, and a broad white band; the subdorsal lines approximate on the thoracic segments as in other varieties; the lateral line is yellow, distinct, and uninterrupted; sides slightly darker than the dorsum and specked with purplish spots. (Comstock, U. S. Ag. Report for 1880.)

#### 217. *Heterocampa pulverea* Grote and Robinson.

Order LEPIDOPTERA; family BOMBYCIDÆ.

Professor French has reared this caterpillar, which occurred in Union County, Ill., June 30; July 6 it went into the dirt of the breeding-cage to pupate, the moth appearing August 6.

*The caterpillar.*—Length, 1.25 inches [in shape tapering slightly from the middle forward, but more rapidly from that point backward, the body deeper than broad.] General color bright green, head gray, first segment behind the head with two dark purplish-black dorsal warts; from these a purplish-brown line extends backward. This purplish-brown color extends over the back part of the sixth segment, the whole of the seventh, and most of the eighth. On the third segment begins a dorsal orange-patch, which reaches back to the sixth segment, filling the space between the purple lines. On the ninth segment is another orange-patch. The tenth segment has no

purple and only a little orange below the stigmata. There is also a faint yellowish dorsal line. The eleventh segment has purple-brown subdorsal lines with orange on the back. These lines unite on the twelfth segment and form a broad dorsal line. Feet and legs purple. (French.)

*Mo h.*—Fore wings olive-ash, a distinct, dark olive subdorsal space; median space paler, olivaceous; transverse anterior line black, geminate, dentate; the space included is stained in the middle with brown. A narrow, distinct, discal lunate streak, preceded by a blackish zigzag median shade line most distinct in the costa. Beyond the discal streak the wing is clear and whitish, forming an oblique pyriform space, limited outwardly by the subterminal line and below by a dark shade below the third median vein, somewhat as in *H. obliqua*. It is closely related to *H. cinerea* Pack.

The following notes by Professor Riley throw more light on the habits of this insect:

Found July 9, 1882, at Hyattsville, Md., quite a number of larvæ of a Notodonta feeding on oak, hickory, walnut, birch, and *Carpinus americana*.

Larvæ entered the ground July 19 and 20, and the moths issued from July 27 to August 7. (Unpublished notes.)

#### 218. THE OAK FORKED TAIL.

*Heterocampa marthesia* (Cram.) (*Lochmæus tessella* Pack.).

The caterpillar of this moth is one of the most interesting among the Notodontians since it connects *Cerura* with the other genera, by reason of its two long caudal filaments, so much like those of *Cerura*. These appendages are simply modified anal legs, and seem to be tactile and repellant organs. This caterpillar is also interesting from its power when touched of forcing out a dense cloud of fine spray from a gland in the under side of the prothoracic segment, near the head. It is very common on the oak, both red and white, from Maine southward, in August and through September, and occurs as far south as Georgia.

The young before the last molt have much higher prothoracic dorsal tubercles and much longer anal filaments than in the adult, and they are tinged with reddish. The cocoon is of silk, not very thick, spun between the leaves, and in confinement the moths issued in November, though ordinarily not due until June.

Professor Riley has observed it on the oak at St. Louis, Mo., June 22, and in July. He sends the following notes:

The larva, if disturbed, thrusts from the anal appendages a fine red thread. The moths issued March 11 and 18.

Many of the larvæ are infected by parasites, among which were a Tachinid and a *Cryptus*. (Unpublished notes.)

*Larva.*—It is a large-bodied, pale green caterpillar, thickest in the middle, being somewhat spindle-shaped. The head is moderately large, flat in front, subconical, with the vertex high and conical, pale green, edged very irregularly with roseate on the sides. A small double reddish tubercle on the top of the prothoracic segment, from which a median white or yellow dorsal stripe, here and there marked with roseate spots, runs to the supra-anal plate. The anal legs are represented by two slender filaments held outstretched, which are nearly as long as the body is thick. There are seven pairs of oblique lateral faint yellowish slender stripes, the last pair extending to the sides of the anal filaments. All the legs are pale green and concolorous with the body. Length 40<sup>mm</sup>, including the filaments.

*Moth.*—This species is rather above the medium size, and may be known by being nearer in form of antennæ, body, and wings to *Cerura* than any other species of *Loch-*

*mæus* or *Heterocampa*; by the pale ashen bleached fore wings, the basal third of which is very dark cinereous; also by the linear obscure discal line, succeeded on the costa by a white zigzag spot, and more especially by the square black spot near the internal angle, which is isolated from the submargino-apical dusky line, of which it forms a part. Length of body, female, .90; expanse of wings, 2.15 inches.

#### 219. THE AMERICAN SILK-WORM.

*Telea polyphemus* Hübner.

Feeding on the leaves in August and September, a large, fat, pale-green worm, as large as one's finger, with pearly red warts, with an oblique white line between the two lowermost warts; the head and feet brown, and a brown V-shaped line on the tail.

The American silk-worm, not uncommonly met with on the oak, may be artificially reared in great abundance on the leaves of this tree, and the silk, reeled from the cocoons, can make a durable and useful cloth. The large, thick, oval cocoons are attached to the leaves and fall with them to the ground in autumn. The eggs are laid in June, when the moths may be seen flying at night. It is one of our largest moths, expanding from five to six inches, and is dull ochereous-yellow, with a large

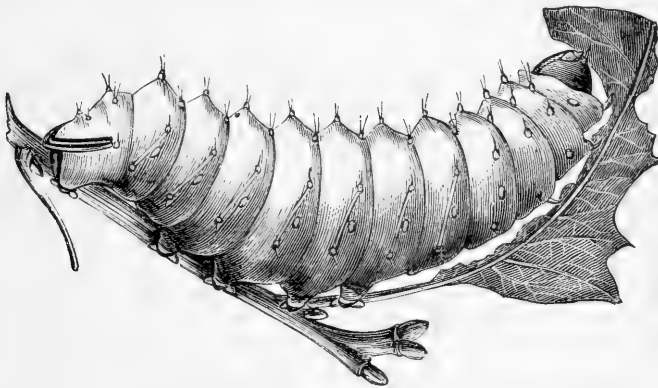


FIG. 53.—American silk worm, natural size.—From Packard, after Trouvelot.

transparent eye-like spot in the middle of each wing. It is not common enough to be destructive.



FIG. 54.—Cocoon.—After Trouvelot.

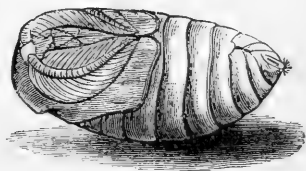


FIG. 55.—Pupa.—After Trouvelot.

According to Abbot and Smith, in Georgia the caterpillar feeds on the black-jack and other oaks. "It buried itself July 12, and the moth appeared the 26th. Another went into the ground August 9, and came out the 24th. It likewise comes forth early in the spring, for I

have taken this species of moth on the 16th of May." It thus appears to be double-brooded in the Gulf States.

*Larva*.—Body very thick and fleshy, skin thin, segments short and convex, somewhat swollen and angulated. The head large, rounded, full above and retractile in the prothoracic segment, which is considerably wider than the head, but much narrower than the one succeeding. The head is pale rust-red, and rather hairy in front. The body is of a soft rich pea-green, much paler than the upper side of an oak leaf and even than the under side. The front edge of the prothoracic segment is straw-yellow and on its anterior edge are four widely separated yellow warts, each bearing a black hair. Two dorsal rows on second (meso) to tenth segment behind the head of prominent spherical mammillæ, bearing two to three pale yellowish hairs; those on the first four segments rich yellow, those behind tinged with orange-red and glistening with silver. Two lateral rows of similar tubercles in color and form, reddish behind the fourth segment. The two rows are very wide apart, the lower row next to bases of abdominal and thoracic feet. The spiracles are slightly nearer the lower than upper lateral row of mammillæ. They are bright brick-red. A faint straight oblique pale yellow band connects the upper and lower tubercles on each segment, there being six such bands.

Supra-anal plate forming almost an equilateral triangle, subacute, the edge thickened and broadly marked with a bright varnish brown, forming a distinct brown **V**, the hind edge of the broad anal legs also of the same hue of brown. Thoracic feet rust-red. Abdominal feet concolorous with the body. Along the lateral ridge are numerous short hairs. Length 65 mm; thickness 13 mm.

#### 220. THE BUCK MOTH OR MAIA MOTH.

##### *Hemileuca maia* (Drury).

This fine insect feeds on the oak, as Harris says, in company when small, but dispersing when becoming larger; the caterpillar eats the leaves of various kinds of oaks and stings very sharply when handled. In the New England States the moth flies in July and early in August, but is usually rarely seen so far to the northeast. In Illinois and Missouri, according to Riley (fifth Missouri report), it is more abundant, and in Illinois is called the buck moth or deer moth, because seen flying late in autumn when the deer run. The species under its ordinary form ranges from Maine to Georgia and westward to Kansas; it has also been rarely found west of the Rocky Mountains at Dayton, Nev., flying about willows in August (var. *nevadensis* Stretch). I possess a male from Colorado which has still wider white bands on both wings than figured by Stretch. It also inhabits California (*californica* Stretch). The Californian moth apparently agrees, as Riley states, with Dr. Lintner's variety bred in New York; the fore wings having no pale markings. It thus appears to range from Maine to California; southward throughout the Gulf State and to Nevada.

Riley states that the leaves of our different oaks afford the usual food, and that "the black masses of the prickly larvæ are sometimes quite abundant on the young post, black, and red oaks along the Iron Mountain region." He has also found them abundantly



FIG. 56.—*H. maia*, eggs natural size.—  
After Riley.



on the scrub willow (*Salix humilis*) in northern Illinois, and on a rose bush, and states that they also occur on the common hazel, while Glover records them as living on the wild black cherry.

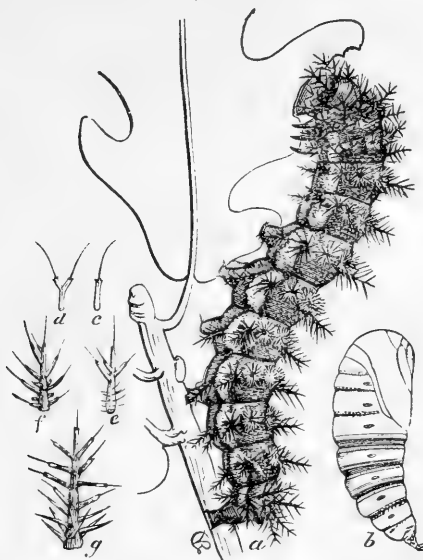


Fig. 57.—*H. maia*; a, larva fully grown; b, pupa—natural size; c, abdominal, d, thoracic spine, of newly-hatched larva; e, spine of larva after first molt; f, g, spine of larva after third and fourth molts—enlarged.—After Riley.

In the Central and Eastern States the moths begin to issue from the ground late in September and early in October, “the males almost always appearing first” (Riley). Both Lintner and Riley record cases where the moths were retarded a whole year. “From a batch of larvæ, which had all entered the ground before July 1, 1871, one moth did not issue till October 8, 1872.” (Riley.)

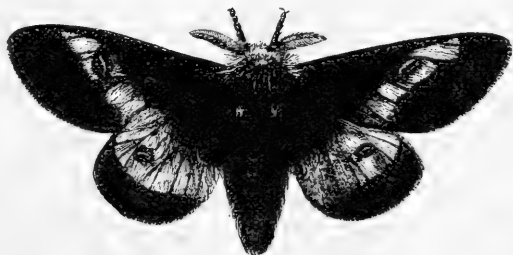


FIG. 58.—*Hemileuca maia*, male buck moth.—After Riley.

The eggs are deposited to the number of from one hundred to two hundred in naked belts, the smallest number of eggs in a mass being seventy. Riley thus describes the process of egg-laying:

Holding firmly by all her feet, the female stations herself upon a twig, with her head usually toward its end. She then stretches her abdomen to its fullest extent and fastens the first egg; another is then attached by its side, and so on, the body reaching round the twig without letting go the feet. In this manner, governed by

the thickness of the twig, an irregular, somewhat spiral ring is formed and others added, until toward the last the abdomen is raised and the ovipositor brought up between the legs. The lower or first deposited ones incline so as to almost lie on their sides. (5th Mo. Rt., p. 128.)

Mr. Joseph A. Stuart has communicated to me the following notes on this moth observed by him at Dracut, Mass :

September 25, 1876 : Marked cluster of eggs laid by *maia* around the stems of *Spiræa salicifolia* in a cranberry swamp. May 25, 1877 : Waded into my meadow to the marked cluster of eggs, and found the larvæ hatched and one-quarter of an inch long, feeding upon the plant on which the empty egg-shells still remained. June 3 : Plenty of broods to be found in the meadow. June 10 : Those in the meadow began to scatter ; at this time commencing to show the two rows of dull-yellow warts upon the back, otherwise black in color with red head and legs. June 17 : In the meadow they were from three-quarters of an inch to one and one-quarter inches long, and the branching spines showed plainly. Rarely more than one to be found on a plant. June 24 : Show the yellow dots between the warts and spines and the yellow " crescents " above the prop-legs. They are getting more scarce. Have found two specimens on the rough-leaved hardhack, but not a single specimen on the dog rose, though in one case found a dog rose growing intertwined with an infested hardhack, neither have I found them near a cranberry vine. In former years while picking cranberries from September 15 to 25 have found freshly-emerged moths on a spear of grass and an empty naked chrysalis in the peat moss three to four inches deep. Have never seen them on upland in either State.

The spines are poisonous, as in most spinose silk-worms, especially those on the back. Notwithstanding its armature, it is preyed upon by two parasites *Limneria fugitiva* (Say) and a species of *Microgaster*.

Dr. J. A. Lintner states that the freshly-hatched caterpillars are attacked by a bug, *Arma modesta*, which destroys whole broods at a time. Dr. Lintner has given the most detailed account of the transformations of this fine moth, but for convenience we copy the more condensed account of the larval changes as given by Riley :

*Egg*.—Length, .05 to .06 inch ; obovate ; compressed on the sides and at the apex ; reddish-brown above, below yellowish-white.

*Larva before first molt*.—Length, .15 inch. It is black and granulated above, reddish-brown and smooth below, with a row of spots along the middle joints. The prolegs are brown ; head with a few scattering hairs ; spines placed in the normal position, namely, 6 (in longitudinal rows) on all joints except 11, where two dorsal ones are replaced by a single medio-dorsal one, an additional subventral one each side on joints 1, 2, 3, 4, 5, and 10, and an additional medio-dorsal one on joint 12. They consist of a thickened, sub-cylindrical, polished black stem, nearly as long as the diameter of the body, truncated at tip, which is coronated with three or four short points, and emits a long black bristle, which, under high magnifying power, appears barbed. On the thoracic joints the stem of the six superior rows is forked near its tip.

*After first molt*.—The body remains the same, but the spines, which are now longest on thoracic joints, are more branched, with more hairs from the main stem, and the bristles from blunt ends comparatively short.

*After second molt*.—The dorsal spines are still more branched, and often less truncated, so that the bristle is less distinctly separated and forms more nearly part of the tapering spine. The bristles also, especially on the lateral spines, are longer and paler. During the latter part of this stage the characteristics of the mature larva are indicated.

*After third molt.*—The two dorsal rows of spines on joints 3 to 10, and the mesial one on joint 11, are reduced to subconical tubercles or warts, fascicled with short, stout, simple spines of a pale fulvous color, tipped with black; those on joints 1 and 2 remain much as before, but there is generally a fascicle of similarly fulvous spines at the base of the latter. The other spines are somewhat stouter, with the blunt tips from which the bristles spring more or less white. Characters of mature larva more patent.

*After fourth molt.*—The granulations assume the form of whitish transverse-oval papillæ, each emitting from the center a minute dark bristle. These papillæ are mostly confluent around the stigmata, and, together with some irregular, pale yellow markings, produce a broad and pale stigmatal stripe. They are most sparse along the subdorsal region, just above stigmata, where, in consequence, the body appears darkest.

*Mature larva.*—Average length, nearly 2 inches; color, brown-black; head, cervical shield, anal plate, and legs polished chestnut-brown, the prolegs lighter, and inclining to Venetian-red, with hooks more dusky and the true legs darker, inclining to black at tips. The dorsal fascicled spines, with the exception of a few short black ones in the center of each bunch, are pale rust-yellow, translucent, the tips mucronate and black; the other compound spines are black, with the blunt ends more or less distinctly white and translucent (but frequently crowned with minute black points, as in the first stage), and the sharp-pointed spinules arising from them dusky. They are generally enlarged and reddish at base, and an approach to the dorsal fascicles is made in the increased number and yellow color of the basal branches, especially in the subdorsal rows. Stigmata sunken, pale, elongate-oval; venter yellowish along the middle, the legs connected with red, and a reddish spot on the legless joints.

*Pupa.*—The larva, to transform, almost always enters the ground, and there, in a simple, ovoid cell, the prickly skin is shed, and the pupa state assumed. It is now of a deep brown-black color, heavy and rounded anteriorly, minutely shagreened or roughened, except at the sutures of legs and wing-sheaths, where it is smooth and polished. The margins of the three abdominal sutures next the thorax, and of that between the last two stigmata-bearing joints, are more or less crimped or plaited, while the three which intervene, and which are the only ones movable, are deep and transversely aciculate (as if scratched with the point of a needle) on the hind, and longitudinally and minutely striated on the front side. The body ends in a triangular, flattened, ventrally concave tubercle, tipped with a few curled, blunt, rufous bristles.

*Moth.*—The wings are so lightly covered with scales that they are semi-transparent and look like delicate black crape. The bands across them are cream-white, and broadest on the hind wings. The female antennæ below, the hair on the thighs, and two small tufts behind the thorax, are brick-red, and the male differs from the female in having broader, black antennæ and a smaller abdomen, tipped with a large tuft of brick-red hair. The color is cream-white, and the black hairs of the body more or less sprinkled with hairs of the same pale color.

221. *Tolype velleda* (Stål).

The caterpillar of this remarkable moth was found by Abbot in Georgia to feed on the willow oak (*Quercus phellos*) and the persimmon, spinning its cocoon August 10, the moth appearing September 22. In the northern States, where it has only been observed on the apple and would be mistaken for a swelling of the bark, it spins its cocoon also early in August, appearing as a moth forty days later.

*Larva.*—Body  $2\frac{1}{2}$  inches long; much like that of *G. americana*, the color, however, pale sea-green, marked with ash, blended into white, and beneath of a brilliant

orange, spotted with vivid black. When in motion a rich, velvet-black stripe appears two-thirds of an inch from the head. (Harris.)

*Cocoon*.—Like soft, brown-gray paper in texture; one and one-half inches long and half an inch wide; bordered on all sides by a loose web; oval; convex above and perfectly flat and very thin beneath.

*Moth*.—A large stout-bodied moth, white with a large, high tuft of long, metallic, brown scales along the thorax; wings short and broad, rounded at the apex with two basal bands and a broad, slightly curved submarginal dusky band, interrupted by the white veins; hind wings gray with a white border on which are two interrupted gray lines. Males with broadly feathered antennæ, and expanding  $1\frac{1}{2}$  to  $1\frac{3}{4}$  inches, while the females are much larger, the wings expanding  $2\frac{1}{4}$  to  $2\frac{3}{4}$  inches.

The following species of Noctuidæ are found on oaks of different species:

222. *Charadra deridens* (Guen.).

This white hairy caterpillar occurred on the oak August 28. It was first reared by Dr. Lintner (Contr. iii, 157), in New York, and September 16 made a thin cocoon between the leaves.

The caterpillar also inhabits the elm and birch and spins a cocoon late in August in a case between two leaves; the eggs were, as observed by Mr. Thaxter, laid July 4, singly or in rows on the under side of a leaf, the caterpillar hatching July 11, molting six times, the last time August 6.

*Egg*.—Flattened, ribbed, whitish.

*Larva*.—When hatched, light green, on segments 2, 3, 4, 5, 6, respectively, a large, roundish, red sub-dorsal spot. Head large, tinged with brown; body tapering considerably posteriorly, and sparingly clothed with long colorless hairs. Length 2.5<sup>mm</sup>. (Thaxter, *Papilio* iii, 11.)

*Larva before last molt*.—Head white, rounded, a broad jet-black transverse patch on the front above the apex of the clypeus; the latter edged with black, forming a black triangle connecting below with a black stripe on each side of base of labrum; the latter black-brown, body cylindrical, rather short and thick; sutures deep; head not so wide as the prothorax, the latter rather full and large, longer but not so wide as the meso-segment, and with a yellowish-white tinge like the head. Rest of the body white, with a very slight greenish tinge, with small tubercles concolorous with the body, from which radiate fascicles of long white fine hairs of unequal length half as long as the body. Length 21<sup>mm</sup>; thickness 5 to 6<sup>mm</sup>.

*Full-fed larva*.—After the last molt the head is jet black in front, except along back of vertex, which is white, and sends a median line between the two large black patches. In front are three triangular whitish patches, one on the clypeus, and a longer one on each side. In front black, face black, labrum white. Body dull white, tinged with pale glaucous-green, with very long white hairs arising from small white warts. Length 38<sup>mm</sup>.

*Moth*.—Fore wings broad, subtriangular, a little prolonged at the apex, of an ashy white washed with yellow, with several waved blackish lines; those of the middle of the wing more marked, one from the costa passing backward, forming a great U and containing in its middle a round dot pupilled with brown; the other contiguous and opposed to that of the internal border, containing in the middle the base of the median shade, and having the external side formed at the expense of the angulated line. This last lunulated, followed by a similar line near the submarginal. At the end of the discoidal cell is a blackish spot, and under the costa, before the upper U a mark of the same color. Hind wings rounded, white on the edges, with marginal lunules; antennæ short, well feathered. Palpi short, externally brown, with the last joint white. Expanse of wings 40<sup>mm</sup>. (Guenée.)

223. *Charadra propinquilinea* Grote.

The larva is said by Mr. Thaxter to feed in Maine on the birch, walnut, and maple, as well as the oak.

*Larva*.—Black, with a dorsal white band, and a lateral white band edged below with black beneath white. The long tufts in segment 2 were clear black instead of red as normally. Specimens on walnut were mottled and black. (Thaxter.)

*Moth*.—Differs from *C. deridens* by the median lines being much nearer together and not joined at the center of the wings. Orbicular spot round, distinct, whitish, with a central dark dot. Reniform spot contiguous to the outer line; median line apparent in front and behind the orbicular spot. Submarginal line distinct on the costal point behind, scalloped. An interrupted marginal line. Hind wings smoky, dark along the external margin. Head and thorax whitish. Tegulae with black marks. Expanse of wings 40<sup>mm</sup>. (Grote.)

224. *Pseudothyatira cymatophoroides* (Guenée).

Mr. R. Thaxter has collected on the red oak the caterpillar, which lives in cases between leaves, such as are made by *Charadra*. When at rest the body is bent, the head approaching the posterior segments. One spun a slight cocoon in moss September 20 to 25, the moth emerging on June 9 following.

*Larva*.—Rich yellow-brown, varying in shade, mottled by fine dark lines. A contrasting white spot just above the stigmata of segment 4, roundish and varying in size, sometimes altogether wanting. A fine, continuous, black dorsal line. Head protruded and darker brown than the body. Stigmata black-brown, slender. Length 42<sup>mm</sup> (1.68 inches). (Thaxter.)

*Moth*.—Fore wings straight and at the internal angle with a tooth, the fringe of which is reddish, and next to a large black spot. At the base of the wing is a grayish-black spot, then succeeds a wavy band composed of two or three black lines, the first of which is the extrabasilar, and which goes from the costa to the inner edge of the wing. The other lines are indistinct; the submarginal is very much toothed, oblique, not bent. The whole wing is of a silky gray, tinted with rose, with the median space dusted with black scales. Hind wings ashy with a small central line and yellowish fringe; beneath clear yellow. On each side of the abdomen is a tuft of dark-gray scales. The female differs much from the male in having no black spots at the base of the fore wings nor at the internal angle, and the broad band of the male is reduced to the extrabasilar alone, which is fine and edged with white. Abdomen not tufted on the sides. (Guenée.)

## 225. THE WESTERN DAGGER-MOTH.

*Apatela occidentalis* Grote and Robinson.

The caterpillar of this moth has been reared from the oak in Massachusetts by Mr. Roland Thaxter (*Psyche* ii, 35). The moth is of common occurrence from June to July in the New England and Middle States. The caterpillar also feeds on the elm and apple and is seen in September. It began to spin a cocoon September 23, the moth appearing early in the following summer. It was identified for us by Mr. Grote.

*Larva*.—Body cylindrical, hairy, with a black hump on the eighth segment, and a broad black longitudinal band. The general color of the body is a livid leaden hue.

*Pupa*.—Of the usual shape; tip of the abdomen obtuse, with eight long, even, stiff

chitinous setæ which are incurved at the end. The basal abdominal suture is well marked, being very deep. Length 20<sup>mm</sup>.

*Moth*.—This species is the American analogue of the European *A. psi*. It constantly differs from its ally by the paler color of the fore wings, which are more sparsely covered with scales, and by their somewhat squarer shape. The reniform spot on the disc shows a bright testaceous tinge, and the ordinary spots are less approximate than in *A. psi*. The secondaries are dark gray, nearly unicolorous, a little paler in the male, and darker in either sex than its European analogue. Expanse of wings 1.40 inches. (G. and R.)

226. *Apatela tobelia* (Guenée.)

This caterpillar was found by Mr. Coquillett on the burr oak in Illinois, June 6; it spun a cocoon June 22, the moth appearing July 14.

*Larva*.—Body bluish-gray, the dorsal space tinged with yellow; a dorsal and subdorsal pale yellowish line extending only to segment 11, which is humped, the top bluish, and on it are four quite large piliferous spots; the top of segment 4 bluish, interrupting the dorsal line; piliferous spots whitish, prominent, each bearing a black hair; sides of the body quite thickly covered with whitish hairs; spiracles white, encircled with black; body beneath greenish white. Head gray, dotted with black, and marked on the top with two blood-red spots. Length 1.50 inches. (Coquillett, *Papilio*, i, 6.)

*Moth*.—Fore wings oblong, somewhat square, of a clear ash, finely speckled, with a thick basal line, the transverse inferior line thick, and the superior one more feeble and black, ordinary lines quite well marked. The spots not distinct, joined together by a thick black spot; the orbicular spot relatively small. Fringe plainly spotted with black. Hind wings dirty white, a little irised, with the veins and the edge broadly washed with blackish; beneath white, with a basal dash, a large triangular spot, an interrupted transverse line and distinct terminal black dashes. Female with the fore wings relatively rather large, the hind wings more obscure, with the line on the under side more entire. Expanse of wings 55<sup>mm</sup> (2.20 inches). (Guenée.)

227. *Apatela afflicta* Grote.

Several caterpillars were observed feeding on the red oak by Mr. Thaxter. They spun stout, elongated cocoons September 17 to 25, and the moths appeared in June and July of the following year.

*Larva*.—Light yellow-brown, tinged with green, darker above. A few lateral whitish hairs. Stigmata white, ringed with black. A whitish stigmatal line; a distinct, continuous black dorsal line. A subdorsal row of stiff club-shaped hairs, such as are found in the larva of *A. funeralis*, but much smaller and not noticeable. These are easily broken and in the specimens before me are present only on segments 4, 5, 6, and 11, though in more perfect specimens they may occur on all the segments. One specimen found was rich yellow-green, and all vary considerably in shade. Head stout, flattened behind, yellow-brown, lighter externally, sparsely clothed with whitish hairs. It rests with the head touching the posterior segments, selecting a withered or discolored leaf on which it is well concealed. (R. Thaxter in *Papilio*, iii, 17.)

*Moth*.—Fore wings dark gray, shaded with black. The basal and transverse anterior lines are black, geminate, undulate. The median space dark gray, lighter on the costa and along internal margin, and traversed by the median shade-line, which is black, dentate, crosses the reniform spot, and is composed of three distinct black bands, which are obscured in the center of the wing, and only apparent on the costa and internal margin. Discal space occupied by a deep, blackish shade, showing a somewhat greenish reflection, and which occupies all the subterminal space. The ordinary spots are of the normal shape; the orbicular spot distinct, whitish with black center;

the reniform spot broad, but slightly excavated externally, obscured by the greenish discal shade, ringed with black and with a central streak. Transverse posterior line intensely black, geminate, minutely dentate. Subterminal and terminal lines white, interrupted, dentate between the veins; fringes whitish, broadly interrupted with black at the extremities of the veins; costa with some whitish marks. Hind wings gray; darker along the veins. Disc of thorax whitish gray, with two central blackish spots. Tegulae and collar blackish, the latter with a black line and grayish above. Expanse of wings, 1.60 inches. (Grote.)

228. *Apatela brumosa* (Guenée).

According to Coquillett, the caterpillar of this moth feeds on the plum and hazel; it spins a thin tough cocoon. In Illinois two caterpillars assumed the chrysalis state in September, the moths appearing in the last week in April and first week in May of the following year.

*Larva*.—Body black, marked with a broad yellowish-brown stigmatal stripe; hairs in spreading clusters from warts, those upon each end of the body being yellow, the rest white; sixteen legs; head black; length 38 mm.

Guenée says it lives on the oak and is entirely clear yellow, with a fine continuous blackish dorsal line, and the head of a pale red. The piliferous points in a trapezoid, somewhat warty, very small, pale red, and emitting but a single hair. The stigmata is circled with blackish.

*Moth*.—A little larger than the European *A. rumicis*, which it somewhat resembles. Wings of a little less fuliginous gray, with all the lines and the visible spots black; the orbicular spot quite large, clear, and marked with a central point; the reniform spot very large, and stained in the middle with black. A broad blackish shade, more marked even than in *A. rumicis*, starts from the base of the wing and ends almost on the terminal border, being interrupted behind the reniform spot. The fringe is distinctly checkered. The small white lunule which we see on the inner margin in *rumicis*, does not here exist. Hind wings of a very clear yellowish-gray, somewhat transparent, with the veins more distinct. A feeble cellular lunule, and the fringe checkered, outer edge brownish, in the female. (Guenée.)

229. *Apatela ovata* Grote.

This is a very common caterpillar, feeding on the red and white oak, and ranges from Maine to Georgia. It is a peculiar caterpillar, eating patches while clinging to the under side of the leaf. It varies much in color, some being reddish orange, and pinkish in tint; others dirty whitish yellow. In the pinkish specimens the dorsal line of dark diamond-shaped spots is obsolete. One was yellowish with dorsal brown spots; another caterpillar was brown, with ten pairs of bright straw-yellow dorsal spots. This singular larva, which differs from most of its congeners in being nearly naked, is probably protected from its enemies, as it lies curled up on the leaf, by its resemblance to a withered patch or blotch on an oak-leaf. It pupated September 19 to 25, not spinning a cocoon, and undoubtedly entering the ground.

We have also found it on *Betula populifolia*; and two specimens occurred on the chestnut; one of a straw-yellow, the other of a reddish tint. The moth was identified for us by Mr. John B. Smith.

The flattened body, very large head, the dorsal row of short diamond-

shaped spots on a straw-yellow ground, and the reddish-orange mamillæ giving rise to pale hairs will distinguish this singular larva.

*Larva*.—Head very large, full, bilobed, the lobe full and rounded, much wider than the body, pale, marbled with lilac. Five pairs of abdominal feet. Body short and thick, somewhat flattened, tapering somewhat toward the tail; straw-yellowish, with a row of dark broad, diamond-shaped, brown spots along the back, the spots connected and centered with yellowish. Four setiferous dorsal reddish rounded warts arranged in a trapezoid, with another wart on the side above each stigma. Body beneath paler. Length, 20<sup>mm</sup>.

*Moth*.—Of the general shape of *A. hamamelis*, but very different in color and with distinct sagittate marks. Gray with a bright tinge, shaded with testaceous. A black basal dash extends to the twice strongly angulated t. a. line, which is geminate, the inner more distinct line composed of raised scales. Above the basal dash the humeral space is pale beyond the geminate basal half-line. Median space wide superiorly, owing to the superior wide projection of the distinct and regularly denticulated t. p. line. Orbicular rather large, pale, and vague, with clouded center. Costal black marks evident. Median shade apparent by raised darker scales. Reniform vague, bisannulate, stained with deep testaceous. A very narrow black distinct dash at internal angle, broken at the pale continued s. t. line. A third black dash, indicated within s. t. line, opposite the disk. Secondaries fuscous, with the distinct black discal spot and dentate line of the paler under surface reflected. Expanse of wings, 1.45 inch. (Grote.)

230. *Scopelosoma morrisoni* Grote.

Order LEPIDOPTERA; family NOCTUIDÆ

The larvæ of five species of this genus have, according to Mr. R. Thaxter, the same form and habit; are omnivorous, and live in a case between two leaves, or within the folds of a single leaf; when young making a silk-covered burrow between two ribs or eating out a cavity in a bud somewhat after the manner of a Tortricid. When fully matured and somewhat soiled, it is hardly possible to separate the species. *S. morrisoni* and *walkeri* are the most difficult to separate, but the more even and richer color of the subdorsal and dorsal regions, together with the obliteration of the dorsal and subdorsal lines, and the clear white lateral line, render the latter species sufficiently recognizable when fresh. The lateral lines are substigmatal, the stigmata black, the body sparsely covered with minute tubercles bearing short colorless hairs in all the species. Form cylindrical, tapering very slightly, head moderate. The eggs of the present species were laid on oak twigs April 22. It molts five times.

*Egg*.—Stone color changing to reddish; flattened inferiorly, a central superior depression from which radiate beaded ridges. Transverse diameter about 6<sup>mm</sup>.

*First larval stage*.—When just hatched, color livid yellowish green with blackish superior and anterior blotches. Head large, jet black. Thoracic and abdominal legs black. A frontal semi-circular black plate on segment 1. After feeding and when nearly grown, indications of a dorsal, subdorsal, and lateral streak. Color light green. Length 2 to 3<sup>mm</sup>.

*Second stage*.—A dorsal, two subdorsal, and a substigmatal whitish line, the two subdorsal ones less clearly marked, especially the inferior. Setiferous tubercles, which bear short colorless minute hairs, blackish, indistinctly ringed.



*In third stage.*—Much as before, but the markings more distinct.

*In fourth stage.*—Color above and below on segments, one-third dull purple, tinged with green dorsally. Below light greenish; a patch of purplish in the substigmatal region of each segment. Dorsal line with a bluish tinge. Head light brown. Length 16<sup>mm</sup>.

*Fifth stage.*—Marked as before but less distinctly. Colors duller and darker. Length 25<sup>mm</sup>.

*Sixth stage, mature larva.*—Dull blackish with a slight bluish-green tinge and lateral dull purplish shades, obscurely mottled. Dorsal streak indistinct, bluish white, somewhat irregular. Subdorsal lines broken, but tolerably distinct, the superior edged with blackish. Lateral streak white with a bluish tinge. Stigmata black. Setiferous tubercles minute, black, ringed with bluish white; those below the lateral line more distinct. The superior subdorsal line cuts the frontal plate of segment 1 very clearly, and is there tinged with yellowish. Rather stout, slightly tapering. Length 35<sup>mm</sup>. (Thaxter.)

*Moth.*—This species is of the color of *S. walkeri*, but differs at once by the *even*, pale shaded distinct median lines on the fore wings, which latter are of a rusty olivaceous ochreous. The reniform appears merely as a pale luniform mark, looking of a piece with the t. p. line. This latter in *S. walkeri* is dark, single, narrow, irregular or wavy, or a little interspaceally notched over the median nervules. Hind wings blackish, with fringes like the fore wings and thorax in color. Beneath like the fore wings above, irrorate with black scales, with distinct blackish discal spot and median band, the latter centrally more deeply indented than usual. Costal edge of primaries straight. Expanse of wings, 38<sup>mm</sup>. (Grote.)

231. *Amphipyra pyramidoides* Guen.

Professor Riley found, May 28, 1873, the larva of this common moth almost full-grown on the oak. It entered the ground June 5, and issued as an imago June 25. He states that it feeds on oak, poplar, grape, *Cercis canadensis*, persimmon, and hazel.

Saunders states that it also occurs on the thorn, and that when full-grown the caterpillar descends to the ground, and, drawing together some loose fallen leaves or other rubbish, spins a slight cocoon within which it changes to a dark-brown chrysalis, from which the perfect insect escapes in the latter part of July.

*Larva.*—Nearly an inch and a half long, the body tapering towards the front, and thickened behind. The head is rather small, of a whitish-green color, with the mandibles tipped with black; the body whitish-green, a little darker on the sides, with a white stripe down the back, a little broken between the segments or rings, and widening behind. There is a bright-yellow stripe on each side close to the under surface, which is most distinct on the hinder segments, and a second one of the same color, but fainter, half-way between this and the dorsal line; this latter is more distinct on the posterior portion of the body, and follows the peculiar prominence on the twelfth segment. The under side of the body is pale green. (Saunders.)

*Moth.*—The fore wings are dark brown shaded with paler brown and with dots and wavy lines of dull white; the hind wings are reddish with a coppery luster,

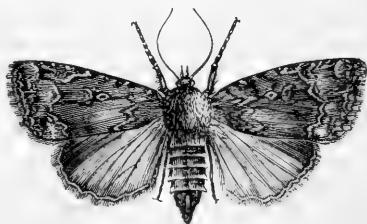


FIG. 59.—Imago of *Amphipyra pyramidoides*.—After Riley.

becoming brown on the outer angle of the front edge of the wing and paler toward the hinder and inner angle. The under surface of the wings is much paler than the upper. The body is dark brown; its hinder portion banded with lines of a paler hue. Expanse of wings, 1½ inches. (Saunders.)

232. *Taniocampa incerta* Hufn. (*Orthosia instabilis* Fitch).

Professor Riley has found, feeding on the oak, small whitish larvæ, with a yellow-brown head and a row of red spots on each side of the body. One folded a leaf within which it spun a loose, white silken web, open at both ends. It transformed within this, but deserted it and entered the ground August 14. It also feeds on the hickory and sassafras. (Unpublished notes.)

233. *Jodia rufago* Hübn.

Professor Riley states that this is one of the early Noctuids, specimens of which were collected on sugar at Washington April 15, 1884, and commenced to deposit their eggs the following day. The eggs are yellowish-white, globular, and finely ribbed. They hatch in about seven days, and the young larvæ commence to feed at once on the leaves of cherry and oak. They are yellowish-white, with a pale yellow head and black piliferous warts. They molt at intervals of three to four days, the last stage lasting about ten days, when, by the end of May, all enter the ground for transformation, apparently not appearing as moths before the following spring. (Unpublished notes.)

234. *Panopoda carneicosta* Guen.

Larvæ of this species were found August 25, 1884, in Virginia, feeding on the oak, and a moth issued September 23. The same species was also found at Atlanta, Ga.

*Larva*.—The full-grown larva is about 42<sup>mm</sup> in length, rather slender, of a dark green color, with orange-yellow subdorsal line, and an oblique, fine, yellow line each side of each segment. (Riley's unpublished notes.)

*Moth*.—Wings rounded, entire; of a violet-ash color, with the outer margin washed with brown, and an indistinct submarginal series of white points, shaded with blackish or reddish. Fore wings with three distinct brown lines; the extrabasilar straight; the extradiscal sinuous, curved, and the median diffuse line straight, passing beyond the reniform dot, which is black, very distinct, L-shaped, the lower branch of which is prolonged to a point under the orbicular, which is reduced to a black dot. Hind wings with a scarcely visible extradiscal line. Wings beneath gray, powdered with reddish, not spotted or banded. Prothorax reddish brown. Expanse of wings 46<sup>mm</sup>. (Guenée.)

235. *Panopoda rufimargo* Hübn.

This moth has been bred from the oak by Mr. R. Thaxter (*Psyche* ii, 35).

*Moth*.—Wings gray powdered with dark brown; the fore wings with two median lines very rambling (*écartées*), almost parallel, very wavy, but not toothed, fine and continuous, rust-red, lined with a yellow thread. The hind wings with a single similar line, starting from the anal angle, but disappearing two-thirds across the wings. Fore wings with the costa rust-red and the orbicular spot reduced to a dot, the reniform being larger and tear-like. Expanse of wings 45<sup>mm</sup>.

Var. *roseicosta* Guen., with the wings of a clear yellow ocher, with the red lines more widely edged with yellow. The reniform is divided into two dots, and the orbicular is divided into two spots. Both pairs of wings bear a subterminal line of yellow spots. The female differs in having the costa tinted with clear rose, and there are no subterminal dots. (Guenée.)

236. *Cosmia orina* Guen.

Order LEPIDOPTERA; family NOCTUIDÆ.

Mr. W. Saunders, of London, Canada, has bred this moth from the oak. One specimen, which entered the chrysalis state on the 24th of June, produced the imago on the 18th of July. (Saunders.)

*Larva*.—A smooth yellowish green larva nine-tenths of an inch long, body cylindrical, above pale yellowish-green, with a dorsal line of yellow, less distinct on the anterior segments, and covered with fine dots and short streaks of yellow, less numerous on the second and terminal segments. Head rather smooth, flattened in front, slightly bilobed, pale whitish-green.

*Moth*.—Fore wings somewhat oblong, and rather rectangular than triangular; of a fleshy gray mixed with blackish scales, and powdered on the veins with black scales; with two fine median white lines disposed in a trapezium more open at the base than in *trapezina*; median spots encircled with white; the orbicular spot punctured with blackish; the reniform spot straight, constricted in the middle; punctured with black at each end. Hind wings whitish, grayish on their outer half, with a discal dot, plainer beneath. Male abdomen very slender and ended by a very large tuft of hairs. (Guenée.)

## 237. CLIMBING CUT-WORMS.

*Agrotis saucia*, etc.

Order LEPIDOPTERA; family NOCTUIDÆ.

Climbing cut-worms were a prominent feature of the entomological developments of the spring of 1886. These attacked the oaks, elms, and other shade trees, as well as apple, pear, and cherry trees and a variety of vines and shrubs. Among the species detected in their work of destruction were *Agrotis saucia*, *A. scandens*, *A. alternata*, and *Homohadena badistriga*. The grass under shade and fruit trees would often in the morning be thickly strewn with leaves and buds that had been severed during the night. This was especially noticeable under the various oaks and sweet cherries. On a large, isolated specimen of the latter, up which a trumpet vine had climbed, I took early in May a great number of the larvæ of *Agrotis alternata*. These mottled gray worms were found during the day extended longitudinally on the trunk, closely appressed to the stems of the trumpet vine, where, protected by their imitative coloring, it would be impossible for an unpracticed eye to detect them and where even birds failed to find them. When ready to transform they descended to the earth and inclosed themselves in an ample, tough, dingy-white cocoon, under any slight protection that might be convenient. I also took this species from crevices of oak-bark and occasionally found one feeding in a rose. (Miss Murfeldt, Bull. Div. Ent., xiii, p. 60.)

238. *Catocala amica* (Hübner).

Mr. Coquillett found two caterpillars of this moth (*C. androphila* Guen.) in Illinois on a burr oak tree June 5. They spun cocoons about disclosing the moths July 24. Abbot also figured in manuscript the July 3, caterpillar, which he found on the oak.

*Larva*.—Body slender, dull greenish yellow, a light dorsal stripe, on each side of which is a darker stripe on which is a row of black piliferous spots; a stigmal row of black piliferous spots; on top of segment 8 is a slight prominence; under side of body greenish white, with a row of black spots in the middle, one spot to each segment; the two anterior pairs of abdominal legs smaller than the two posterior pairs. Head gray, with two white spots on the upper part of the face. Length, 1½ inches. (Coquillett).

*Moth*.—Fore wings pale gray, the lines fine, not very evident, the transverse anterior line the heavier marked. A distinct black median shade on costa above the reniform and continued beneath it, running upward to external margin below apex. A brown shade fills the space left by the exerted portion of the transverse posterior line beyond the reniform. This black median shade is marked on costa, but else sub-obsolete in all the males I have before me, and the brown shading very faint. The transverse posterior line minutely dentate without prominent teeth. Subreniform small, pale, and both spots inconspicuous and often incompletely ringed. The serrated subterminal white shade is tolerably distinct; fringes dark. Hind wings bright yellow; a broad thick terminal band is squarely discontinued and appears as a black dot at anal angle. Fringes dark except at apex, where is a small yellow patch. Beneath the marginal band is brokenly and narrowly continued to anal angle, and the median band is indicated by tolerably large spots or fragments. A specimen from Texas differs by its dirty, ochreous gray primaries much shaded with deep black, and may be a distinct species. Expanse 40 to 45<sup>mm</sup>. (Grote.)

239. *Catocala micronympha* Guenée (*C. fratercula* G. & R.)

Order LEPIDOPTERA; family NOCTUIDÆ.

The caterpillar lives on the live oak in early spring in Florida, the insect remaining in the pupa state two weeks (A. Koebele, Bull. Brooklyn Ent. Soc. i, p. 44. It also feeds on the burr oak in Illinois.

According to Coquillett it spun its cocoon June 1, disclosing the moth June 28 (*Papilio*, i, 7).

*Larva*.—Body ashen gray, the dorsal space dark gray, and on its outer edge is a row of black piliferous spots; on top of segment 8 is a conical dark-gray projection, tipped with whitish; posterior part of segment 8 blackish; body beneath pale greenish white, with a row of black spots in the middle, one spot to each segment; the two anterior pairs of abdominal legs are much smaller than the two posterior pairs; head light gray, bordered on the top and sides with black. Length, 1½ inches.

*Moth*.—Of moderate size, varying in the distinctness of the median black shade, which ascends as usual to the external margin. The median space is sometimes shaded with whitish before the reniform spot. There is no sinus to the transverse posterior line. The shape of the median band varies in being more or less acutely produced opposite the anal constriction of the hind border. The fore wings vary in depth of color. Expanse of wings, 42 to 46<sup>mm</sup>. Rhode Island to West Virginia. (Grote.)

This moth is very variable; var. *atarah* is slightly lighter than the type form; var. *jaquetta* has olivaceous fore wings with indistinct lines, and a dark shading toward

the apex; var. *timandra* has sordid white fore wings, with distinct lines, hind wings with the median band narrow; var. *hero* has the fore wings with a large white spot at base; and in var. *gisela* the fore wings are black to the transverse posterior line. (Hulst.)

240. *Catocala similis* Edwards.

The transformations of this moth were first described by Abbot and Smith, who named it *C. amasia*. Its food-plant is the oak.

*Larva*.—Probably nearly the same as in *C. amasia*, thus deceiving Abbot in the identity of the two species. His figure makes it greenish gray, with protuberances on each segment, and with dorsal, subdorsal, and stigmatal dark lines; also an oblique dark line on each segment. (Hulst.)

*Moth*.—Fore wings gray, clouded with brown and black; lines distinct; transverse anterior line edged inwardly; transverse posterior line edged outwardly with brown, and angulated with an angle beyond the reniform spot in place of the M-shaped part of the line, then nearly straight to the sinus, which is very small; reniform spot pyriform, light; subreniform annulate; triangular light patch at apex, along costa; hind wings bright yellow; median band curved, nearly even, short, border broken. Expands 45 to 55<sup>mm</sup>. From East and South.

Var. *aholah* has the fore wings clear silver gray, with a large black patch beyond the reniform extending to the apex.

Var. *isabella* has dirty white fore wings, lines distinct; transverse posterior line edged with cinnamon brown. (Hulst.)

241. *Catocala chelidonia* Grote.

According to Mr. Doll the food-tree of this Arizona species is the scrub oak.

*Moth*.—Fore wings even dark gray, somewhat hoary; reniform spot shaded with gray; subreniform spot stained with brown; lines indistinct, having the same course as *C. similis*. Hind wings like those of *C. similis*, but with the median band generally narrower. Probably representing *C. similis* in Arizona. Expands 40 to 50<sup>mm</sup>.

242. *Catocala amasia* (Abbot and Smith).

The caterpillar is said by Hulst to be probably similar to that of *C. similis* and to feed on the oak or pride of India.

*Moth*.—Fore wings sordid white; basal half line very distinct; transverse anterior and posterior lines nearly obsolete, the latter, when evident, scalloped, not angulated; median space sordid white; reniform spot blackish; transverse posterior line edged outwardly with cinnamon brown; subterminal line evenly dentate. Hind wings yellow; median band often hooked; the border generally interrupted. Expands 50 to 55<sup>mm</sup>. Eastern and Southeastern United States. (Hulst.)

243. *Catocala delilah* Strecker.

According to Mr. Hulst, the caterpillar of this moth feeds upon the oak, but no description of it has yet been published. The larva of var. *desdemonia*, which inhabits Arizona, was reared by Mr. Doll from the scrub oak.

*Moth*.—Fore wings rich velvety yellow-brown; basal dash present; transverse anterior line very heavy and dark; transverse posterior line dark and distinct; teeth prominent and broad; subterminal space somewhat lighter; subterminal line fine,

strongly dentate. Hind wings bright yellow, median band rather narrow, generally rectangular at bend towards inner margin; marginal band broad, broken or unbroken. Expands 70 to 80<sup>mm</sup>. Habitat, Nebraska to Illinois, and southward, west to Arizona. Var. *desdemona* Hy. Edw. Wood brown with lighter shades; reniform spot brown; subreniform lighter. Hind wings rich orange. Var. *calphurnia* Hy. Edw. Fore wings with a greenish tint, lines faint. Hind wings wholly black, with the exception of a central cloud, a broad marginal band, and a central narrow band, which are orange. Hulst adds that the species is a very variable one, the median band showing a tendency common to all the *Catocalæ*, as it narrows, to become rectangular at the bend near the anal margin.

244. *Catocala verrilliana* Grote.

This species extends from California to Texas, its food-plant being the scrub oak. (Hulst.)

*Moth*.—Fore wings gray, shaded with blackish; a diffuse black basal dash; transverse anterior line densely shaded with black; reniform dot small, yellowish, more or less distinctly double-ringed; transverse posterior line much as in *C. blandula*. Hind wings bright red, median black band narrow, quite even, not reaching the anal margin; marginal band narrow. Expands 50 to 60<sup>mm</sup>. *C. ophelia* Hy. Edw. differs only in having somewhat heavier lines on the fore wings. *C. verrilliana* is always described with bright red hind wings. *C. violeata* Hy. Edw. is somewhat larger and has more black. Var. *votria* Hulst has clear yellow hind wings, and inhabits Arizona.

245. *Catocala ultronia* (Hübner).

The caterpillar, first described in Packard's "Guide to the study of Insects" (p. 317, pl. 8, fig. 4), is said to feed on the wild cherry, plum, dogwood, and live oak. Mr. Saunders has bred it in Canada from the plum, finding it usually less than half grown in June. One caterpillar pupated June 21; it remained in this state for twenty-four days, the moth appearing July 15. The larva we reared in Maine pupated July 15 in an earthen cocoon, the moth appearing August 2. As Mr. Saunders's description of the caterpillar is more detailed than ours, we quote it below:

*Larva*.—Head medium sized, flattened in front, slightly bilobed, dull bluish gray, with the front flattened portion margined with a purplish-black stripe. Under a lens the surface appears thickly dotted with pale and dark-colored dots and streaks, with a few short, pale, scattered hairs. Body above dark, dull, grayish brown, appearing under a magnifying power thickly studded with brownish dots on a paler ground. Second segment a little paler than the others. A subdorsal row of dull reddish tubercles, one on each segment from second to fourth inclusive, but behind this there are two on each ring to the twelfth segment inclusive, the anterior one being the smallest, while the posterior and largest tubercle is more decidedly red, all encircled with a slight ring of black at their base. On the ninth segment above there is a prominent, nearly upright, stout, fleshy horn, about one-twelfth inch long, pointed, and similar in color to the body, but with an irregular grayish patch at each side. On the twelfth segment the two hinder tubercles are somewhat increased in size and united by a low ridge, tinted behind with deep reddish brown; there is also an oblique stripe of the same color extending forward from the base of the tubercles to near the spiracle on this segment. The terminal segment is flattened and has a number of small, pale reddish and blackish tubercles scattered over its surface. In front of each of the smaller subdorsal tubercles, from fifth to twelfth

segments inclusive, there is a dull white dot, and one also of a similar character in front of each of the spiracles along the middle segments of the body; from each of the tubercles throughout there arises a single dark short hair. Spiracles large, oval, dull grayish, faintly encircled with black. Along the sides of the body, close to the under surface, is a thick fringe of short, fleshy-looking hairs, of a delicate pink color. Under surface of a delicate pink, of a deeper shade along the middle, becoming bluish towards the margins, with a central row of nearly round, velvety black spots, which are largest from the seventh to eleventh segments inclusive. Anterior segments greenish white, tinted with rosy pink along the middle, with a dull reddish spot at the base and behind each pair of feet. Thoracic feet pale greenish, spotted outside and tipped with black; abdominal legs dull grayish brown, margined with black. Length 1.60 inches. (Saunders, *Can. Ent.*, vi, 148.)

*Moth*.—Fore wings light-gray fawn, dark, almost black, along the inner margin; a basal dash and one at sinus present; a subapical dark shading; outer line fine, strongly denticated to sinus. Hind wings bright red, median band broad, rather even, reaching the anal margin. Expands 60 to 70<sup>mm</sup>. Habitat, east of the great plains and Texas.

Var. *celia* Hy. Edw. median band of hind wings linear. Florida.

Var. *mopsa* Hy. Edw. Fore wings nearly uniform brown.

Var. *adriana* Hy. Edw. Fore wings nearly uniform fawn drab.

Var. *herodias* Streck. Fore wings uniform dark smoky gray; denticulations of outer line very strong, and thus continued to inner margin. (Hulst.)

#### 246. *Catocala ilia* (Cramer).

The caterpillar of this moth has been reared by Messrs. Koebele, Caulfield, French, and by Thaxter, in Massachusetts, from various species of oak. The moth is said by Grote to be an exceedingly common and very variable species. It is found from Canada, Maryland, and Virginia southward to the West Indies. Mr. Caulfield states that the caterpillar was fully grown by June 15 at Montreal; it spun up in a leaf June 18 and the moth emerged the latter end of July. Prof. G. H. French gives a detailed account of its early stages in the *Canadian Entomologist* for January, 1884.

*Larva*.—Head heart-shaped, strongly bilobed, pale green, with white blotches, twelve short, black hairs in front, and near the top of the head there are four small tubercles of a white color, each of which is tipped with a black hair; head surrounded with a broken border of dark streaks. Body with the upper surface greenish gray, with an interrupted dorsal band of delicate blue-gray spots, the whole minutely spotted with black. On the second segment are twelve small, white hairs, four on fourth, fifth and sixth segments, six on the seventh, four on the eighth to twelfth, six on the thirteenth. The sides delicate blue-gray, marbled with spots of green and black, with a broken lateral band of a green color; spiracles yellowish white, with a black ring; behind each is a large wart, tipped with a black hair. A fringe of short, white, fleshy filaments close to the under surface. Body beneath pink, with a row of transverse black spots, larger and darker on the middle segments. Feet and prolegs grayish white, spotted with green and black. Length  $2\frac{1}{2}$  to  $3\frac{1}{2}$ <sup>mm</sup> (Caulfield in part). Koebele states that there is a subdorsal line of slight protuberances, one on each segment from the third segment back. There is also a dark lunule with the horns formed on the eleventh segment.

*Moth*.—Fore wings dark cinereous, powdered with glaucous scales and shaded with black. A basal ray. Transverse anterior line geminate. Reniform spot whitish, with a small, black internal ring. Subreniform pale, subquadrate, connected usually

with the transverse posterior line. Beyond the spots the median space is shaded with black. Sometimes the whole wing is shaded with blackish to the transverse posterior line, leaving the reniform as a large white blotch without the annulus. Again, the wing wants the glaucous scales and the reniform is concolorous or merely shows a few white scales. Hind wings orange-red, with an irregular black median band tapering to the margin. Basal hairs fuscous. Average expanse of wings 75<sup>mm</sup>. Maryland and Virginia. (Grote.)

Mr. Hulst remarks that in var. *uxor* Guenée the fore wings are brown-gray, the reniform spot white; in the Californian var. *zoe* Behr, the hind wings are lighter orange; in the var. *osculata* Hulst, from Arizona, the hind wings are clear yellow. *C. ilia*, he adds, is the most variable of all our species. In some cases the fore wings are strongly mixed with blue.

247. *Catocala epione* (Drury).

The caterpillar is said by Guenée, on the authority of Abbot's manuscript drawings, to feed on the oak.

*Larva*.—Body reddish gray, marbled with bluish gray; a subdorsal black line interrupted at the middle of each segment; a paler lateral band; no protuberances; head gray, with two red points.

*Moth*.—Fore wings very dark gray; lines heavy; transverse posterior line not strongly angulated, and almost without a sinus; the reniform spot reddish; a reddish band beyond the transverse posterior line, then lighter, often almost white, serrated outwardly. Hind wings black; fringes pure white.

248. *Catocala vidua* (Abbot and Smith).

According to Abbot this species feeds on the willow, locust, and other species of oaks; Mr. Angus has bred it from the hickory and Mr. Koebele from the walnut.

*Larva*.—Greenish gray, with many black lines; whiter laterally; slight protuberances on each segment; head gray, edged behind with black.

*Moth*.—Fore wings with the color of *C. resecta* and markings of *luctuosa*, though these are in the present species heavier and more decided; transverse anterior line heavily geminate, connecting half way with the heavy black basal dash; apical and sinus shading heavy; transverse posterior line with **M** very much produced. Hind wings black, slightly gray at base; deep white fringe; in some specimens there is near the anterior margin a faint indication of a white median band. Expands 80 to 90<sup>mm</sup>. Middle, Western, and Southern States. (Hulst.)

249. *Catocala lachrymosa* Guenée.

Said by Mr. Hulst to probably feed on the oak and walnut.

*Moth*.—Fore wings light cinereous, heavily and quite uniformly powdered with black atoms; slight basal dash present; lines fairly strong, but often lost in the black powdering; transverse anterior line often confused and broken; transverse anterior line with teeth medium; reniform spot brownish; a brownish band beyond the transverse posterior line. Hind wings black, fringe white, black at end of veins. Expands 75 to 85<sup>mm</sup>. Lower Middle and Western States and southward. Var. *Ululume* differs in being less strongly powdered with black, and in having [both] the lines more distinct. Var. *zelica* French has a transverse anterior line inwardly and transverse anterior line outwardly, having a black band across the wing. Var. *paulina* Hy. Edw., fore wings black to the transverse posterior line.



250. *Catocala polygama* Guenée.

This species has been bred from the oak by Professor Riley, and the following description has been drawn from the blown specimen in his collection. The caterpillar pupates in a loose cocoon among leaves.

"May 7, 1872. About full-grown; found under shelter at foot of black jack oak. Color preserves well. Some paler than others. They lie very flat on the twigs.

"It prepared for pupation May 10, and changed to pupa May 16, the moth issuing June 6." (Riley's unpublished notes.)

*Larva*.—Body of the usual shape, with no spines or large tubercles. Head as usual, black on the sides of the front and vertex. Body ash brown, lineated, with two broad dark dorsal stripes, succeeded below by a narrower but similar stripe. Sides of the body above the base of the legs dark ash. On each abdominal segment are four light, distinct, small tubercles, and four on each side arranged in a rhomboid. A row of large black ventral patches edged with orange on each segment, becoming largest between the first and second pair of abdominal legs. Length 65<sup>mm</sup>.

*Pupa*.—Of the usual form, the body frosted over with a whitish powder. Length 25<sup>mm</sup>.

*Moth*.—The four wings slightly greenish gray, powdered with dark ferruginous scales, especially beyond the outer line, where this shade forms a dentate submarginal line. The outer or extradiscal line is more finely waved, and above the submedian vein it passes into a black spot bordered with rust-red. The edge of the hind wings are indented with yellow at the outer angle.

251. *Catocala coccinata* Grote.

The caterpillar of this moth has been bred from the oak by Mr. D. W. Coquillett, of Illinois. His specimen spun its cocoon June 6, producing the imago the 30th of the same month.

*Larva*.—Body dark gray, a curved fleshy projection on top of segment 8; segment 11 slightly raised, with two tubercles on the top; a row of small prickles on the dorsal space, sixteen legs, a black spot beneath each of the segments which bear the four pairs of abdominal legs; head gray, bordered with black. Length 62<sup>mm</sup>. (Coquillett.)

*Moth*.—A little smaller than *C. parta*; clear cinereous; before the reniform, which is smaller and paler than in *C. parta*, the wing is whitish and occasionally allows the crimson underface to be reflected. Subreniform spot whitish and large. Hind wings bright crimson. (Grote.)

The following species are geometrids, or species of the lepidopterous family *Phalænidae*:

252. *Eutrapala clemataria* Hübner.

The caterpillar of this moth occurred on the live oak at Crescent City, Fla., in April. My specimens were left to be bred in the office of the U. S. Entomologist, at Washington, but died. The following notes were copied for me by Mr. Pergande.

The larva had not eaten anything for some days when received, and drank greedily some water when placed near some drops, and soon after commenced feeding on leaves of white and other oaks. It cast a skin two or three days after and became quite dark brownish. It died April 27 of diarrhea.

June 27 one larva of the same species was found on oak near the fair ground, District of Columbia. It measures  $2\frac{1}{2}$  inches in length and is of a dark grayish-brown color, the dorsum being more brown whilst its sides and venter are dark gray. Warts and stigmata are of the same color as in the smaller larva from Florida. The minute oval spots are replaced by a rather indistinct marmoration, which on the dorsum is somewhat orange and on the sides and venter more olive. The moth issued July 23, 1886.

One larva of the same species was found by Koebele in Virginia, June 12, 1882, feeding on hickory.

The larva is long and slender, of nearly even width throughout; the head flattened in front; mesothoracic segments with lateral and dorsal tubercles which are very rough; on the fourth abdominal segment are two conical dark dorsal tubercles; there are two minute dark tubercles on the fifth, and two slightly larger ones nearer together on the eighth.

Abbot states that it feeds on *Clematis rosea*, and in his manuscript drawings that it feeds on *Pyrrhopappus carolinianus*.

*Larva*.—Its length is  $1\frac{3}{4}$  inches. Color gray with a slight yellowish tinge, and the whole surface closely marked with minute, transversely oval, blackish or pale dusky spots. Head small, quite flat, and closely spotted with darker gray. Prothorax small, scarcely broader than the head, with a broad, somewhat paler median and narrow subdorsal line. Its posterior margin is provided with a transverse row of four small black tubercles. The mesothorax is much larger and very abrupt in front; the small anterior wrinkles are somewhat yellowish, whilst the large posterior swelling is of the color of the body, being ornamented anteriorly by four transversely oval, conspicuous black spots, annulated with a brownish-yellow ring. The four black warts on the metathorax are only externally bordered with brownish yellow. The two dorsal rows of warts on abdominal segments 1 to 7, are arranged as usual, are small, black, and also with brownish-yellow border externally. The posterior pair of dorsal spots on the fourth abdominal segment is replaced by two prominent, somewhat transversely oval, black tubercles with rounded tip, and orange-yellow external margin at base. The eighth segment is also somewhat swollen above, is marked with two large black median spots, an orange annular with black center each side, and a transverse orange spot with black center behind the swelling. Stigmata orange with black annulus. The three warts which surround the first abdominal stigma differ somewhat from those of the other segments. The lower anterior wart is placed farther in front of the stigma than that of the other segments, whilst the upper wart is placed just above the stigma and largest. The two anterior warts of the other stigmata, however, are both placed in front, the upper one farthest apart. The anterior wart of the first stigma is black, with orange tips, and all other warts orange with black tip. There is a somewhat lunate, deep black superior margin at base of the wart above the first stigma and a short blackish dash above all other warts. The venter is of a paler gray with three large blackish spots on the fourth and fifth segments. (Riley.)

*Pupa*.—Body unusually thick, rather short; surface rough and corrugated, spotted with black; spiracles large and black. Pale dull reddish ash, dark towards and at the tip of the abdomen; legs somewhat streaked with black. The tip very peculiar, being short and blunt; the last segment corrugated with longitudinal ridges which are swollen at the anterior edge at the suture. Cremaster broad and conical, somewhat flattened, the surface rough, coarsely pitted; a large smooth terminal curved spine, with three pairs of lateral rather large setæ, all arising near together at the base of the single terminal one. Length,  $20^{\text{mm}}$ .

*Moth*.—Wings very falcate, especially in the female, where they are produced into a long point. Body and wings fawn color, with scattered black dots; front of head

reddish brown; vertex white. Fore wings, with two inner reddish-brown diffuse lines, the inner situated half-way between the base of the wing and discal dot, curved and more or less scalloped, the outer curved, situated just beyond the discal dot, and joining the third outer line on the second median venule; it is broader and still more diffuse than the basal line. Outer line straight, bent back at a very acute angle on to the costa, the line above the bend being more or less angularly curved and dilated on the costa; an oblique white line extends from the bend to the costa just below the apex, which is white above and blackish below, with a large reddish-brown patch extending from below the apex to the second median venule. Discal dots in both wings black; scales flattened as usual. Hind wings with a single slightly curved line just beyond the middle of the wing. Expanse of wings, 2.20 inches.

253. *Eutrapela transversata* (Drury).

This rather common caterpillar was first found by Abbot feeding on *Clethra alnifolia*. In the Northern States it feeds on the maple (Goodell) and currant (Emerton), and we have found the moth just emerged resting on the leaves of the red maple. In Florida, however, we have found it at Crescent City in April feeding on the live oak. It was reared by the U. S. Entomologist at Washington, where on May 6 it spun a rather dense cocoon between the leaves, the moth emerging May 31. The larva occurred in Virginia June 26, where it feeds on the oak (Koebele); in Massachusetts the caterpillar occurs in June; thus it is apparently double-brooded in Florida and the cotton States, but single-brooded in the Northern States.

*Larva*.—It is about 1 inch in length and quite uniformly dark gray, with a paler gray, elongated spot each side of the first abdominal segment. The lateral margin forms a flattened carina, on which the stigmata are situated. Both edges of this carina are purplish, and the small stigmata white with black annulus. Piliferous warts small and black. There is a large, prominent, transverse, bilobed projection of a blackish color on the fourth abdominal segment, which is bordered in front by a whitish triangle. Behind this projection, and parallel with its lateral angles, run two whitish dorsal lines to the anal plate. There are also two small black conical tubercles on the last segment. Head concolorous with the body, the face marked with a dull black semicircular spot, the angles of which end near the base of the mandibles.

The smaller larva, which measured about three-fourths of an inch in length, is dark purple, with the head entirely dull black. The projection on the fourth abdominal segment is in this specimen still divided into two oval and rather prominent tubercles which are orange externally. (Riley.)

*Pupa*.—Large and long, not very stout and short compared with that of *E. clemataria*; acutely pointed at the end of the abdomen. In color slightly pale ash-mahogany. The last segment much corrugated longitudinally at the base of the cremaster, but the ridges are not swollen anteriorly as in *E. clemataria*. Cremaster flattened, conical, not discolored with black, with two terminal excurved thick setæ, and only one pair of minute subdorsal-lateral setæ. Length, 21<sup>mm</sup>.

*The moth*.—It may be recognized by its large size, the very falcate wings, the obtusely bent outer line on the fore wings, and by the submarginal shade or row of spots on both wings; the hind wings extend farther than usual behind the tip of the abdomen. Fawn color, varying to ochereous; head chocolate brown in front, the vertex white. Fore wings with the inner line usually present, curved, consisting of two large scallops meeting on the median vein and pointing inward. Outer line straight, more or less distinctly bent near the apex, turning at right angles into the

costa. From the angle extends a more or less distinct slightly curved series of irregular diffuse dark spots to the inner angle; this is usually represented by a faint shade. Discal dots alike in each wing, being small and black. Hind wings with the single line in the middle of the wing straight, with the outer series of diffuse spots as on the fore wings. Expanse of wings, 2 to 2.10 inches.

254. *Metanema quercivoraria* Guenée.

(Larva, Pl. III, fig. 8.)

Feeding on the oak, a pale green span worm, marked with red, changing to a brownish-gray chrysalis, from which a beautiful sickle-winged moth comes.

In Georgia it was observed by Abbot on the oak and poplar in April; it pupates at the beginning of May, and the moth appears at the end of the same month. We have raised this from the oak, the moth issuing on May 3.

*Larva*.—Pale green, with the sutures and sides reddish, a double angle bordered with reddish on the second segment behind the head; another more salient on the sixth, and finally another on the tenth; the fifth segment has on each side a small pointed tubercle. Head and feet concolorous.

*Pupa*.—Reddish horn-brown, with the abdominal sutures reddish; caudal spine acute, large and flat. Length 13<sup>mm</sup>.

*Moth*.—Body and wings pale whitish ash. Wings thickly covered with fine speckles. Fore wings with three lines, the usual inner and outer lines, and a third wavy submarginal hair-line. The two inner lines distinct, of even width, a little oblique, not waved; the innermost line situated exactly on the inner third, the outer line on the outer third of the wing. Costal edge stained with reddish on the end of the outer line. Submarginal hair-line wavy, sinuate, reddish, situated half-way between the outer line and the edge of the wing, and disappearing below the second median venule, scalloped between each venule, much more distinct below than above. On the hind wings a single brown line, and traces of a submarginal wavy line. Beneath paler than above, with the lines reproduced beneath and dull colored; the third submarginal line on both wings partially obsolete, but clearer than above; fringe reddish. Expanse of wings 1.50 inches. It ranges from Maine southward.

255. *Nematocampa filamentaria* (Guenée).

The singular caterpillar of this species is found on the oak, maple, as well as the currant and strawberry, in June, becoming a chrysalis in New England by the 20th of the month, the moth appearing early in July and flying about through the summer. Its habits in Missouri have been thus described by Professor Riley:

June 1, 1870.—Larvæ were found at St. Louis, Mo., on thorn and laurel oak. One changed to pupa June 4, hanging between a few threads on a twig. The moth issued June 12. One larva was also received June 26, 1883, from J. H. Clark, of New York, which he found feeding on a rose-bush. It changed to pupa in a slight web of thread June 27, and the moth issued July 5, 1883.

Some larvæ of this insect are infested by Tachinids, the eggs of which were deposited at the side between the fourth and fifth segments. (Unpublished notes.)

*Larva*.—Body cylindrical; head large, with two unequal pairs of long, slender, fleshy filaments situated on the third and fifth abdominal segments, the posterior pair shorter than the others, curled at the end and finely tuberculated. Head pale rust-red, full, slightly bilobed, flattened in front; marbled with a still paler hue.

Half-way between the metathoracic legs and the first pair of filaments are two sub-acute tubercles, which are rust-red; when the four filaments are uncurled they are as long as from the head to the tubercles. The anterior pair of filaments are pale rust-red beneath at base, brown above, but tipped with white. A distinct dorsal line from the prothorax to the second pair of filaments; a pair of small tubercles next to the last segment, tipped with pale rust-red. Body wood-colored above and beneath; thoracic segments greenish above, succeeded by pale rust-red between the

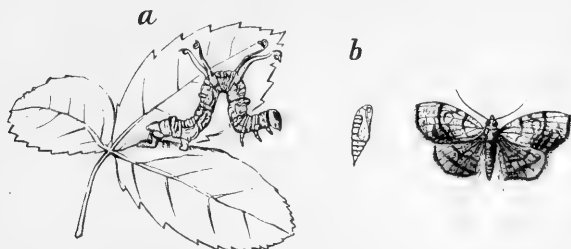


FIG. 60.—*Nematocampa filamentaria*; a larva, b pupa. Nat. size.—  
Emerton, del.

tubercles and first pair of filaments; behind these variously marked with light and dark brown. An oval dark spot behind the last pair of tubercles and extending into the anal plate. Anal legs rusty, lined above with a whitish line. Length 18<sup>mm</sup>.

*Pupa*.—Body rather thick, conical, pale horn-brown, slashed and speckled with dark-brown.

*Moth*.—Fore wings unusually short and broad; apex rectangular, outer edge bent in the middle, deeply excavated in the female on each side of the angles; hind wings rounded at the apex, with a distinct angle in the middle, reaching as far as the end of the abdomen. Pale ochreous, with brown veins and transverse dots; a brown inner line, much curved. An outer sinuate line, with a supplementary line just inside, touching the outer line on the submedian vein and in the extradiscal space, and forming a large circle, one side of which touches the outer line. Beyond the line the border of the wing is dull brown, with the apical region clear. Hind wings streaked transversely, as on the fore wing, with the outer third brown, the apex included. Expanse of wings 25<sup>mm</sup> (1 inch).

256. *Endropia bilinearia* Packard.

The geometric caterpillar of this species was found by Mr. W. Saunders, of London, Canada, feeding on the oak; unfortunately it was not described; it became a chrysalis early in July, emerging as a moth two weeks later.

*The moth*.—Clear fawn-brown; wings much darker and less spotted than in the other species of *Endropia*. Body and wings concolorous; front edge of the fore wings paler than the rest of the wing and spotted finely, especially on the edge, with brown specks. Two brown hair-lines, the inner situated on the basal, and the outer on the outer third of the wing; the inner line bent on the front edge of the wing. Outer line a little curved outward in the middle of the wing. Half-way between this line and the outer edge of the wing is a diffuse, interrupted, faint grayish band with a few dark scales, often wanting, and connecting with an oblique apical patch, also concolorous with the front edge of the wing. Outer edge of the wing deeply notched, the eight acute points (including the apex, which is very acute) tipped with a few black scales, the fringe being whitish between. Beneath, body and wings ocher-yellow, especially in the middle of the wings. Both wings marked alike with

a basal, diffuse, broad brown line, and an outer much curved brown hair-line. An outer row of dark patches forming a faint broken line. An apical, oblique, whitish patch. Hind edge of fore wings with darker spots and patches than elsewhere. Expanse of wings, 1.30 to 1.65 inches. This fine moth occurs all over the United States and on the Pacific coast from California to Oregon.

257. *Endropia pectinaria* Guenée.

Living on the oak and other trees, a large gray measuring worm, transforming to a large *Endropia*, with three sharp teeth in the hind wings.

The transformations of this moth have been observed by Abbot in Georgia, who found it living on the oak and poplar in April. It changes to a chrysalis at the beginning of May, and the moth appears at the end of the same month.

*Larva*.—Pale green, with the sutures and sides reddish, a double angle bordered with reddish on the second segment, another more salient on the sixth, and finally another on the tenth; the fifth has on each side a small pointed tubercle. Head and feet concolorous.

*Moth*.—The hind wings with a large tail and toothed; the fore wings angular, sickle-shaped. Body and wings pale whitish-ash. Wings thickly covered with fine speckles. Fore wings with three lines, the usual inner and outer line, and a third wavy submarginal hair-line. The two inner lines distinct, of even width, a little oblique, not waved; the innermost line situated exactly on the inner third, the outer line on the outer third of the wing. Front edge of the fore wings stained with reddish on the end of the outer line. Submarginal hair-line wavy, sinuate, reddish, situated half-way between the outer line and the edge of the wing and disappearing below the second median venule, scalloped between each venule, much more distinct below than above. On the hind wings a single brown line, and traces of a submarginal wavy line. Beneath, paler than above, with the lines reproduced beneath, and dull colored; the third submarginal line on both wings partly obsolete, but clearer than above; fringe reddish. Expanse of wings, 1.50 inches. Ranges from Maine to Missouri and Kansas.

The parent of this caterpillar, which is found in the United States, north and south, and west as far as Kansas, may be known by the three well-marked teeth on the apical half of the hind wings, by the clear border of the wings, and by the dark clear lines on the under side.

The caterpillar lives in Georgia on the oak and other trees, according to notes left after his death by Abbot, and is of a pale yellowish gray, with a dorsal lozenge-like mark. The fourth segment is darker, and on the back of the eighth, ninth, and tenth are also two obscure marks bifid anteriorly on the first, and carrying a blackish angle on each extremity of the second. The head and feet are concolorous. It is found in Georgia in May and June, and the moth is disclosed towards the end of this last month. A second generation enters the chrysalis state towards the middle of July to appear as moths in the beginning of August. In the Northern States the species is undoubtedly only single-brooded.

Besides these geometric caterpillars, that of *Metrocampa perlaria* Guenée should be looked for on the oak, as its closely allied European congener (*M. margaritata*) feeds on the elm, hornbeam, birch, and oak.

258. *Endropia textrinarum* Grote and Rob.

The caterpillar was found on the white oak at Providence, October 7. October 10 it began to spin a thin slight web at the bottom of the breeding box, and the pupa appeared October 12. The moth appeared in the breeding box in May. I have captured the moths in the Adirondacks at the end of June, where no oak trees were perceived.

*Larva*.—The body is rather slender, the head wider than the segment behind, rounded, rather deeply bilobed, swollen on each side of the apex of the clypeus; the latter edged with dark brown, forming a V-shaped line on the front of the head. The prothoracic segment is normal, while the mesothoracic segment is much swollen on each side, the rounded swellings connected by a dorsal curved ridge. On the metathoracic segment is a small transverse ridge, next to that on the meso-segment. On the hinder part of the third abdominal segment is a large double dorsal dark knob-like hump. On the sixth is a conspicuous dark transverse rounded ridge, enlarged and higher at each end. The eighth segment has large warts, and there are also large warts on the sides of segments 7 to 10. The supra-anal plate is triangular but short, with four hair-bearing warts above and four at the end. Anal legs large and broad. The short penultimate segment has a transverse row of eight large warts; these warts are obsolete on the front half of the body.

The body is of exactly the color of an oak twig, being dark gray shaded with light, and of the same color beneath as above; while the knotted appearance of the segments behind the head and in the middle of the body assist in the deception, the caterpillar being remarkably like a bit of oak twig. The anal conical dorsal tubercles are large and distinct.

*Moth*.—In this species the hind wings are distinctly "tailed," not merely sinuated, as in *E. madusaria*, while the fore wings are distinctly excavated, but not dentate below the apex, and they are shorter and broader than usual. Fore wings densely mottled and strigated with ochereous-brown; an inner, curved, pale-brown line, bent outward on the submedian vein, and meeting the outer line, which either runs very near, or if remote, throws out a connecting streak, in the former case forming an oval, with the end resting on the inner margin of the wing. Outer line dusky fawn-brown, oblique, curved outward above and below inward to meet the inner. Beyond, the wing is shaded with ochereous-brown; this shade sometimes extends to the border of the wing, interrupted by a submarginal row of irregular pale patches proceeding from the broad, apical, diffuse, pale patch. Discal dots black, distinct in both wings. Hind wings like the front pair, the outer line situated in the middle of the wing and nearer the discal dot than usual. Expanse of wings, 1.50 inches.

259. *Paraphia unipunctaria* (Haworth).

Order LEPIDOPTERA; family PHALENIDÆ.

Eating the leaves early in June, a gray span worm 1.40 inch long, sprinkled with blackish dots and short lines, its head and neck a little thicker than the body, each ring with a small squarish white spot above on its hind edge and with two blackish parallel lines on each side of this spot.

This moth ranges from New England to Texas; it is said by Fitch to feed on the oak, and by Abbot (in Guenée) to live on the "elm, oak, *cournouiller*," etc. The *Amilapis triplipunctata* of Fitch is undoubtedly synonymous with Haworth's species, originally described as an English species.

*The moth.*—Of a uniform clear fawn-color, without the usual spots and speckles present in other species of the genus; a basal, brown hair-line bent outward acutely on the median vein; a broad, diffuse, dark median band common to both wings. The extradiscal line is dark, finely scalloped, curved outward below the costa, and sweeping inward below the first median venule; beyond this line both wings are deeper fawn-color. At a little distance below the costa, and nearer the extradiscal line than the outer edge of the wing, is a conspicuous angular, clear, white spot. Fringe dark, the scallops filled with whitish scales. Hind wings like the anterior pair, though the extradiscal line is not sinuous, but curved regularly outward. Beneath, paler than above; the median band is distinct, and the extradiscal line more or less so; the tints are much as above. The wings expand 1.40 inches.

260. *Therina fervidaria* Hübner.

This moth was bred by Abbot in Georgia from the silver-bell tree (*Halesia diptera*), but Dr. Riley has reared it from the live oak in Florida. This is our most common species of the genus in the Eastern United States. It is at once known by the much-speckled wings and the ocherous-bordered, blackish lines. It varies greatly in the distance apart of the two lines, which in the fore wing are in some twice as wide apart as in others. The species is exceedingly variable.

At Esquimalt, Vancouver Is., "all the oaks were stripped by the larvæ of *Therina fervidaria*, and their trunks and branches were paved with the handsome Geometrid moths in September." (James J. Walker, Ent. Month. Mag., Aug., 1888, p. 65.)

*Larva.*—Head scarcely as wide as the prothoracic segment, the latter not so wide as the body behind. Body of uniform thickness, with no tubercles. Head smooth, slightly divided above, rounded and smooth; pale, with seven black dots on each side. Body and head pale yellowish ash; with two dorso-lateral blackish longitudinal stripes, and another stripe below on each side; the body elsewhere with fine, more or less interrupted, black lines, and some deep ocherous ones. Between the two dorso-lateral lines are four more or less interrupted fine lines. Length 38 to 40<sup>mm</sup>.

*Pupa.*—Rather slender, whitish, slashed and spotted with brown. (Described from Abbot's manuscript drawing.)

*Moth.*—Pale ocherous; head and front of the thorax with the antennæ deep ocherous. Wings densely speckled with smoky spots; well angulated, the angle on the fore wings often acute, on the hind wings forming a slight tail. Outer line dark brown, bordered externally with ocherous. Inner line a little curved, and situated either on or a little within the inner third of the wing. Discal dot dark, distinct, sometimes wanting on the hind wings. Outer line sinuate or zigzag, varying greatly, the angle on the first median venule being slight or very marked on both wings. On the hind wings a single line only. Beneath, much paler; the lines re-appear, but are diffuse and smoky. Expanse of wings 1.50 inches.

261. *Therina endropiaria* (Grote and Rob.).

This moth has been raised from caterpillars found feeding on the oak at Amherst, Mass., by Mr. L. W. Goodell. It pupated September 4, just beneath the surface, and the moth emerged May 19 following (Can. Ent., xi, 194). It has also been bred by the U. S. Entomologist from specimens which I collected in April at Crescent City, Fla., from the live oak. The larva spun a slight cocoon between leaves at Washington April 27, and the moth emerged May 19.



*Larva*.—Its length is  $1\frac{3}{8}$  inches. Ground color whitish. Head white, marked with large, round spots, similar to those of *Aletia*, and numerous minute spots and faintly brown mottlings. Cervical plate white with four small black spots along the anterior margin and two behind them. Median line slightly reddish, bordered by a fine black zigzag line. Abdomen with three pale brown, somewhat interrupted, rather broad dorsal stripes, each of which is also bordered with a very fine black zigzag line. There is also a subsorsal row of narrow, elongated, orange spots, one to each segment. Suprastigmatal band broad and purplish, divided along its whole length by an interrupted white line. Substigmatal band orange, bordered below by a broader, pale purplish stripe. Venter whitish or yellowish, divided longitudinally by four very narrow black lines. Stigmata black. Thoracic legs white, their claws blackish. (Riley's unpublished notes.)

*Pupa*.—Body moderately stout, whitish, very pale, spotted distinctly with black; about sixteen black dots on the prothoracic segment. A curved black line on each side of the head. Cremaster flattened, conical, ending in two long, twin, decurved bristles, the outer bristles either minute or wanting. Length  $15^{\text{mm}}$ .

*Moth*.—Male and female. Head and thorax, including the antennæ and legs, pale ochereous, extending to the costæ of the fore wings, especially the under side. Wings pale whitish, with a slight ochereous tint, with indistinct cinereous speckles, especially marked toward the outer edge; two parallel lines, the inner a perfectly straight, pale-brown hair-line, situated just before the forking of the median vein, and the outer narrow, cinereous, slightly oblique, but not curved; on the hind wings, which are concolorous with the fore wings, is a single line, very slightly curved in the middle; no discal dot on either wing; outer edge distinctly bent; the tail on the hind wings well developed, but a little less so than in *E. flagitiana*, and the wings are broader and shorter, while the anterior pair are not produced so much at the apex. Beneath, the costal edge is ochereous, but the rest of the wing is whitish-ochereous. The wings are very transparent, so that the lines distinctly appear through. The ochereous head and thorax, including the antennæ, in distinction from the pale transparent wings, the pale brown, parallel lines, the inner perfectly straight and the outer one slightly curved, will separate this species from its allies. Expanse of wings, 1.50 inches.

## 262. THE LARGE SCALLOPED-WINGED GEOMETER MOTH.

### *Stenotrachelys approximaria* Guenée.

In the Southern States feeding on the oak a large geometer whose body is ash gray, washed with brown, with a dorsal series of white lozenges, lined with black and traversed in their middle by a twin, interrupted black vascular line. Found in March and April, the moth remaining in the chrysalis.

This caterpillar, according to Abbot (in Guenée), lives in Georgia on *Smilax rotundifolia* and *laurifolia*, and, according to Abbot (MS.), on *Quercus*. This species is known to inhabit North Carolina as well as Georgia. In April I found the larvæ on the live oak at Crescent City, Fla., leaving it at the office of the U. S. Entomologist to be reared. The larvæ then in confinement entered the ground to pupate, and of two bred moths one emerged November 2 and the other November 11. One proved to be a fine male, the first one I have met with, the female alone having been described in my monograph of this family. It has plumose antennæ and is smaller than the female, but has the same shape of the wings and similar markings.

*Larva*.—April 22, 1886.—Three larvæ of this species were brought to-day by Dr. A. S. Packard, from Florida; found feeding on above oak. The smallest one of the three is about 1 inch in length, uniformly dark purplish-brown, with the exception

of a broad, lighter brown shading along each side of the median line of the meso- and meta-thorax and first abdominal segment. Ptiliferous warts small, black and projecting. Stigmata yellow, with narrow black annulus. Behind the two first abdominal stigmata there is a dull black patch, that behind the second being largest. The vertex of the head is bilobed and the lobes rounded at tip. Color of the head dark cherry-brown, the tip of the lobes lighter. The lower margin of the head and of the clypeus somewhat whitish. Its surface is quite smooth, though there are some very delicate transverse wrinkles.

The second larva measures  $1\frac{1}{4}$  inches in length, and is quite pale gray, with more or less distinct, irregular blackish lines and spots. A very fine black line borders each side of the two posterior thoracic and first abdominal segments, whilst on the other segments this line borders a more or less elongated, lozenge-shaped, paler gray, medio-dorsal space. The piliferous warts are of the color of the body, with black tips. Stigmata whitish, with black annulus. The dull black patch is only present behind the second stigma. Head concolorous with body; the two lobes are marked in front with a transverse, dark cherry-brown band.

The third larva is about  $1\frac{3}{8}$  inches in length, and very similar to the second one in coloration, though the color of the middle of the body is somewhat more purplish. On each of the two posterior thoracic and first abdominal segments is a paler gray triangular spot, a somewhat squarish, gray spot on the fifth and sixth abdominal segments, and on each side of the median line on the eighth segments is an oblique blackish line, both of which meet posteriorly on the median line. The purplish stripes of the lobes of the head are present. (Riley's unpublished notes.)

*Pupa*.—Pale mahogany-brown; cremaster very long and sharp, straight, with no lateral setæ. (Described from a broken specimen).

*Moth*.—It may be recognized by the deeply scalloped wings, and the large head, which is rather swollen in front. It is whitish gray, the wings clear, not bordered with brown. The fore wings with two distinct, heavy, black lines, the inner very near the base of the wing, regularly curved, a little pointed on the costa. Outer line bent at right angles on the basal third of the first median vein, the line thence going straight to the costa, though zigzag in its course; from the rectangular bend, the line follows a course subparallel to the median line, where it again turns rectangularly, ending on the middle of the inner edge of the wing. An inner reddish-brown line is parallel and near it below the median vein, and above passes just within the faint discal dot. Beyond this line the wing is speckled with transverse short, linear spots. A scalloped marginal, distinct black line. Expanse of wings, 1.80 to 1.90 inches.

#### 263. *Eubyja quernaria* (Abbot and Smith).

Guenée states on the authority of Abbot's drawing that the caterpillar of this moth lives in April and May, in Georgia, on a species of *Quercus*. In the manuscript drawing of Abbot's in the library of the Boston Society of Natural History the food-plant drawn is *Cratægus australis* T. and G.

*Larva*.—Body stouter and shorter than in the larva of *Amphidasis cognataria*. Head angular; prothoracic segments swollen; a tubercle on the back of the third, the lower part of the side of the first, and on the back of the penultimate segment. The body is, in the painting, colored slate-gray, with irregular dark spots and longitudinal slashes.

*Moth*.—Female. Body stout, abdomen thick, with a dorsal row of four large tufts, the fourth white, the others dark. Antennæ black. Head in front and palpi black-brown; vertex white, rounded behind by a black thread-line; thorax white, with two black spots in the center, and spotted with black posteriorly. Abdomen white on the outer third, with a white interrupted line on each segment, spotted thickly

on the under side with white. Fore wings long, outer edge very oblique, snow-white as a ground color; basal third white, mottled with deep brown, especially on the costa. The middle third of the wing brown, bordered with the black basal and extradiscal lines. The basal line is deeply and regularly curved outward; the extradiscal line is irregularly and deeply scalloped; it runs straight from the costa to the great angle on the median line through two deep scallops; the angle is jagged and sharp, and below the line forms a great curve, sending a point outward on the internal vein. Beyond this line the wing is white, with scattered dark specks, and with a ferruginous patch just below the sixth submedian, and a larger one extending from the second median venule to the inner edge of the wing near the angle. Hind wings white, more or less densely mottled with brown on the inner two-thirds; the extradiscal line is zigzag, with a large angle in the middle of the wing. Beyond this the markings repeat those of the fore wings. Expanse of wings 5.5<sup>mm</sup>.

264. *Aplodes mimosaria* Guenée.

This has been bred from the oak by Mr. Walsh in Illinois, while Riley has found it feeding on the oak at St. Louis, Mo., July 31. It is common in the New England and Central States.

*Larva*.—Larva ten-footed, cylindrical, its dorsum with curved lateral appendages covered with short velvety hairs, and similar to those of *Limacodes* ? *hyalinus* Walsh, except that they are much shorter and none of them abruptly longer than the others. Of a dingy-brown color, and, including the appendages, about one-fourth of an inch in diameter. (Walsh.)

*Pupa*.—The pupa is of a pale ochereous-brown color, varied with reddish-brown, with many fuscous dots, especially along the nervures of the wing-cases, and with the caudal spine simple. It measures 0.43 inch, including the spine. (Walsh.)

*Moth*.—Four males and females. A rather large species, with the antennæ moderately well pectinated. Apex of fore wings square, outer edge not very convex. Hind wings well rounded, less angulated than usual; anal angle square. Body and wings of the usual pale-green color; head and antennæ white, front bright rose-colored except on front border. Palpi white; end of second joint and under side of third joint roseate. Both pairs of wings crossed by linear, slightly waved, white lines. Inner line on fore wing, very near the base of wing, regularly curved; outer line straight, waved, parallel with outer edge. Costa narrowly edged with white. Fringe white on both wings. Hind wings with the inner line nearer the base of wing than on fore wings, curved regularly. Outer line bent outward in the middle, the line not so wavy as on fore wing. Beneath both lines faintly reproduced (not "*avec une seule ligne blanche*," as Guenée says). Hind wings and posterior two-thirds of fore wings whitish-green. Outer side of fore femora green, of tibiæ dull red; two posterior pairs white. Abdomen white, green at base above, with a conspicuous white spot at base. Expanse of wings 1½ inches. Length of body, male 0.45, female 0.40.

265. *Petrophora diversilineata* Hübner.

Professor Riley found, May 10, at St. Louis, Mo., larvæ of this species feeding on laurel-oak and elm. Others were found on pear, apple, cherry, and rose. They are of a deep, rich brown above, sulphur-yellow at sides, and pale beneath. All had entered the ground by June 5. The moths issued November 9. (Unpublished notes.)

*Egg*.—Cylindrical, much rounded, and fuller at the posterior than at the anterior end, which is truncated and contracted, with a swollen vein; white, with the surface granulated.

*Larva*.—The body above is dark brown, with a slightly reddish tint, and patches of a darker shade along the dorsal region, being the color of the twigs of its food-plant. It remains in the pupa state about a week.

*Pupa*.—Body rather stout, wing-covers reaching to the seventh abdominal ring, counting from the end; the tip is acutely conical; anal spine large, acute, much flattened from above downward: bearing two large, curved spines, with two much smaller, curved basal spines; abdomen with scattered, acute spinules arising from minute black tubercles; pale ash, minutely speckled with darker fine points, with a dark dorsal line extending from the head to the end of the anal spine. Length 0.55 inch.

*Moth*.—Thirty males and ten females. Palpi long. Fore wings foliate; outer edge almost angular. Hind wings slightly scalloped. Body and wings of a uniform ochereous-yellow; palpi dark in front of the head, tipped with dark brown. Fore wings uniformly ochereous; a curved, basal, rust-brown line, denticulated on the veins; beyond, two parallel, more distinct, concolorous lines, the inner a little wavy, directed obliquely to the inner edge; the outer makes a right angle in the submedian space, crosses the inner line, forming a broad triangular inclosure on the inner edge of the wing; beyond is a broad space just beyond the middle of the wing, usually filled in with a purplish-brown tint, disappearing before reaching the costal space; sometimes there are two central lines in this space, converging a little below the median vein and forming large ringlets; this mesial space is bounded externally by a dark rust-brown line, which ends at the same distance from the base of the wing, both on the costa and inner edge; in the first median space it forms a large, sharp projection; beyond is another concolorous line, which curves inward to where it is usually (not always) interrupted by the projection of the other line, and thence goes straight, though zigzag in its course, to the inner edge of the wing; a similarly colored, more or less zigzag, oblique, apical line extends to the middle of the wing, opposite the projection; the edge beyond the lines either clear yellow or filled in with lilac-brown; a small discal dot. Hind wings clear, a little paler than the fore wings, with a faint discal dot, sometimes absent; in the outer third of the wing an angulated, faint, violet-brown line, edged externally with silver, a heavier, diffuse, shorter, submarginal, dark brown, zigzag line, with a slight violet tinge; the space between this and the wing suffused with violet-brown, extending only toward the middle of the wing, or sometimes passing beyond the apex. Beneath the wings are yellow ochereous, speckled, especially on the hind pair, with coarse, violet-brown specks. Fore wings clear when covering the hind ones, with three costal spots, the third in the middle of the costa; beyond the angulated outer line is reproduced; apical oblique line distinct, with a violet-brown cloud below. Hind wings with three regularly scalloped lines; the margin of the wing broadly clouded with violet-brown. Legs yellow; joints tipped with violet-brown. Abdomen yellow, tinged above with rust-brown. Expanse of wings, male 1.30 to 2.10, female 1.35 inches.

266. *Eupithecia miserulata* Grote.

June 3, 1876.—Found two larvæ feeding on oak. Length about 0.63 of an inch, of a yellowish color, with brown markings on the back much like arrow-heads with the points directed towards the head; a brown line over the whole length of the back and a short brown line each side just behind the head, ending where the last pair of thoracic legs commence. The larva changed to pupa June 12, without constructing a cocoon, suspending itself by the point of the abdomen; it is also of a yellowish color. The moth issued June 23. (Riley's unpublished notes.)

The caterpillars of this widespread geometrid were common on the live oak at Crescent City, Fla., April 9 to 14. The larvæ spun a slight cocoon and pupated April 15, the moth emerging at Washington April 20. Another moth emerged in Providence April 30. In shape, the

body resembles *E. luteata*, being somewhat flattened. These caterpillars differed from those bred from the bush juniper at Salem, Mass., in wanting the lateral white line. The specimen bred was compared with those from different States in the National Museum by Mr. John B. Smith and myself. It seems to feed on evergreens northward and in Florida on oak, and may be a general feeder.

*Larva*.—Pale green; body covered with fine papillæ. Prothoracic segment much swollen transversely; no marking except a brownish linear dorsal line. This was the young of the moth which issued April 20.

Another larva, whose moth emerged April 30, was more typical. Body somewhat flattened, with a dorsal series of sharply pointed dark-brown patches, the points extending into the narrow linear brown dorsal line. On the thoracic segments a lateral broken heavy dark line, each becoming a pale narrow thread on the abdominal segments. Length, 18<sup>mm</sup>.

*Pupa*.—(?).

*Moth*.—This is our most common pug-moth, and may be distinguished by the pointed fore wings, with the numerous transverse lines bent sharply outward, the extradiscal line forming a sharp angle opposite the discal dot, and notched inward on the subcostal vein; by the distinct submarginal wavy white line, ending in a large white twin spot at the inner angle; by the fine dark lines on the hind wings, and by the heavy black costal spots and marginal lines on the under side. The fore wings expand 20<sup>mm</sup>.

#### 267. THE OAK-LEAF ROLLER.

*Tortrix quercifoliaria* Fitch.

In the early part of June, says Fitch, the sides of particular leaves may be found to be curved upward and drawn slightly together by silken threads, beneath which lies a slender, grass-green leaf-roller, which finally pupates in the end of the leaf, the moth appearing in New York about the 1st of July.

While at St. Augustine, Fla., early in April, I noticed a pale green leaf-roller on the live oaks on Anastasia Island. April 14 it spun a slight cocoon, within which the worm changed to a pupa April 16 or 17; the moth appeared April 30, after my return to Providence.

*Larva*.—Grass-green throughout, body tapering slightly posteriorly, but less so towards the head. Head round, slightly flattened, and "as thick as the neck into which it is sunken." Length 19<sup>mm</sup> (0.75 inch).

*Pupa*.—Body pale and slender, the cast skin thin and unusually so for a *Tortrix*. Cremaster or terminal abdominal spine peculiar in being long and narrow, as wide at the tip as at the base; the surface above and beneath with fine longitudinal ridges; a pair of short dorsal setæ near the end; edge of the extreme tip curvilinear, with four curved setæ of nearly equal length. Each abdominal segment with two rows of fine teeth. Length, 10<sup>mm</sup>.

*Moth*.—Pale tawny yellow, with yellowish brown darker scales and dots and darker brown lines. Head pale, tawny brown on the vertex, with a small spot in the middle of the front. Palpi dark, externally pale above and at tip of second joint. Fore wings pale whitish tawny yellow, densely speckled with darker scales; on the inner third of the wing an oblique, dark brown, narrow line beginning on the inner third of the costa and ending in the middle of the hind margin. An outer parallel line, which is forked on the costa and ends on the internal angle; from near the middle

the line sends off a spur to the apex, but before reaching the apex a spur is sent to the costa, also a 3-forked line to the outer edge of the wing. Hind wings, abdomen and legs almost white. Expanse of wings, 20<sup>mm</sup>. (Identified by Prof. Fernald.)

268. *Tortrix flaccidana* Robinson.

The habits of another leaf-roller have been observed and related by Miss Emma A. Smith in Thomas' second report on the injurious insects of Illinois (p. 114). It injures the black, red, burr, white, and pin oaks. The species has been found in Texas as well as Illinois.

*Moth.*—Palpi, head and thorax pale ochereous. Anterior wings shining pale yellow, almost entirely covered with pale olivaceous scales, so that the yellow ground color is only evident just below costa at base, in two small costal spots at and beyond the middle, and in a similar elongate spot on the disk below the two last mentioned. There are three brown dots on the costa near the apex, which is also tinged with brown. Posterior wings fuscous above, tinged apically with ferruginous; beneath tinged with fuscous internally, pale testaceous beyond. Fringes whitish. Under surface of anterior wings fuscous except the costa, which is pale testaceous. Expanse, male, 20<sup>mm</sup>. (Robinson.)

## 269. THE V-MARKED CACÆCIA.

*Cacæcia argyrospila* Walker.

The moth of this species is not uncommon, entering our houses at night during July in Maine and Massachusetts. My specimens have been kindly determined by Prof. C. H. Fernald.

This widespread species was first described in this country by Mr. C. T. Robinson, in 1869, under the name of *Tortrix furvana*; at nearly the same time or soon after I described it in the Massachusetts Agricultural Report for 1870 under the name of the V-marked Tortrix (*T. v-signatana*), and remarked that Mr. F. W. Putnam had raised it in abundance from the cherry. In his account of this species Lord Walsingham\* remarks that in California it occurred near San Francisco, May 19, 1871. "The species also occurred about Mendocino in the middle of June, and as far north as Mount Shasta in August. One specimen emerged on the 21st of June from a pupa found a few days previously between united leaves of *Æsculus californica* (Nutt.), the Californian horse-chestnut.

In his Synonymical Catalogue of the Described *Tortricidæ*, Prof. C. H. Fernald states:

Professor Riley wrote me that he bred it on rose, apple, hickory, oak, soft maple, elm, and wild cherry.

It thus appears to be a general feeder on our shade trees, living between the united leaves. It ranges from Maine, where it is common, to Georgia, Texas, and Missouri, while it is not uncommon on the Pacific coast.

\* Illustrations of Typical Specimens of *Lepidoptera Heterocera* in the Collection of the British Museum, part iv, London, 1879, p. 9.

It feeds on the oak early in June, as one caterpillar occurred June 11, when it became a chrysalis, the moth appearing June 23. Hence without much doubt there are two broods, the caterpillar occurring late in summer turning to chrysalides, and hibernating as such, the moth flying about in the spring and laying its eggs on the shoots, so that the larva may hatch when the leaves are unfolding and find its food ready and at hand. The first brood of caterpillars is found early in June, and the second in August and early in September. The moth is of the size and general shape of the common apple-leaf roller (*Cacæcia rosana*) and the cherry-leaf roller (*C. cerasivorana*), differing in the particulars stated below; but the caterpillar is more like that of *C. rosana* than *C. cerasivorana*.

According to Professor Riley's unpublished notes this was found May 15, 1869, on the I. M. R. R. rolling in perfect tubes the leaves of the common oak. May 26 it pupated, and June 3 three moths issued.

*Larva*.—Color delicate glass green, with a darker dorsal vesicular line. Not polished. Piliferous spots polished. Head brown. Cervical shield polished, glass-like, and scarcely darker than body; anterior edge lighter. Thoracic legs pale.

*Pupa*.—May 26 one changed to chrysalis with the abdomen yellowish, the dorsum roseate and wing-sheaths green; with two transverse rows of minute teeth on dorsum of largest abdominal segments, and also a few long hairs pointing posteriorly. Six, sometimes seven, tolerably long, curved hooks at extremity, four springing from the extreme point and two from the sides. Length scarcely 0.50 of an inch. Legs do not reach as far as the wing sheaths. (Riley's unpublished notes.)

Of the usual form and color, but rather stout; the end of the abdomen has an unusually large, sharp spine, with two lateral and two terminal large, stout, curved setæ or stiff hairs. Length, 12<sup>mm</sup>.

*Moth*.—Head, palpi, and thorax rust-red; fore wings bright rust-red; a broad, median, rust-red, oblique band bent downward in the middle of the wing; on each side are two yellowish-white costal blotches, the outer one usually triangular and oblique, sending a narrow line to the inner edge of the wing; a similar line on the inside of the band. Outer margin of the wing yellowish white, with two fine, rust-red lines, the outer one at the base of the fringe, which is whitish yellow. Hind wings pale yellowish slate color, as is the abdomen.

269. *Cacæcia fervidana* (Clemens).

The caterpillar was found by Professor Riley September 1, 1867, feeding on the oak, covering and inclosing numbers of the leaves by a white glistening web; also fastening the brown grains of excrement together with the silk so that it sometimes forms quite a large mass. They were quite numerous in various portions of Illinois, Iowa, and Missouri.

The worm also generally resides in a sort of silken case. It devours all the pulpy portions of the leaf. They are found on the burr oak, though they will eat the leaves of half a dozen varieties that I have given them. (Riley.)

There are probably three broods annually of this insect, as in Illinois it first appears in the middle of May, according to Miss Emma A. Smith,

of Peoria.\* Professor Riley adds that the eggs, hatched about the 1st of July and last of June, had become moths by the 1st of August; and then again those found September 1 must have been of a third brood, which winters over in the chrysalis. The eggs, according to Riley, are placed in clusters on the leaf.

Miss Smith's paper gives quite a full account of the habits and ravages of this insect in her vicinity. This is the *Tortrix paludana* of Robinson. It is attacked by *Calosoma scrutator* Fabr., *Podisus spinosus* Dall., also by *Diplodus luridus* Stål, and by *Pimpla conquisitor* Say.

*Larva*.—When full grown, .80 to .85 of an inch. Color dull brownish buff. Form subcylindrical, being flat below; tapers slightly posteriorly but not anteriorly. Dorsum light. A subdorsal darker band, edged above and below with a black line, the upper one being thickest. Wrinkled transversely, one indenture especially in the middle of each segment. Thoracic segments somewhat largest. Head as wide as No. 1 and carried nearly horizontally. It is dark brown, mottled with white. Venter, feet, and legs of same color as subdorsal band. Covered with fine sparse hairs. This worm is not very active, but when touched wriggles and lets itself down by a thread. It is quite variable in the depth of shading, some being very light, while others are quite dark, and some even have a greenish tinge. (Riley's unpublished notes.)

*Moth*.—Palpi reddish brown, short, the third joint extending beyond the head. Head and thorax reddish brown above. Anterior wings reddish brown, much clouded with fuscous beyond the middle. A dark brown patch on the middle of costa and a smaller one on the disk below it indicate the central fascia. A large dark brown subapical patch is continued as a broad fuscous shade to internal angle. Fringes pale. Posterior wings very dark, fuscous above; pale testaceous beneath, tinged with fuscous internally. Fringes pale testaceous. Abdomen fuscous above, pale testaceous beneath. Under surface of anterior wings entirely clouded with fuscous, giving in some lights a purple reflection. Expanse, male, 20<sup>mm</sup>; female, 23<sup>mm</sup>. (Robinson).

#### 270. *Cenopsis quercana* (Fernald.)

The caterpillar has been found by Professor Comstock feeding on the oak, and by Miss Murtfeldt on the cultivated cherry.

*Moth*.—Thorax and fore wings dull rust-red. Basal patch, median and subapical bands lighter in the males and inclining to yellowish on the costa, with strong greenish reflections when seen in an oblique light, showing most strongly in the females. Expanse of wings, 14 to 16<sup>mm</sup>. (Fernald).

#### 271. *Cenopsis reticulatana* (Clemens).

Besides the oak the caterpillar is said by Miss Murtfeldt to feed on the osage orange, maple, persimmon, and pear.

*Moth*.—Fore wings yellow, finely reticulated with orange; costa at base tinged with purple. Central fascia purple, commencing in a spot on the costa before the middle and ending in the apex of a large triangular spot of the same hue on the inner edge. The large purple costal spot throws out a line, which is forked just below it, one branch running obliquely inward to the triangular spot on the inner margin, the other outwardly to before the inner angle. Hind wings and fringes very pale yellow. Expanse of wings, 17 to 22<sup>mm</sup>. (Robinson).

\* Paper read before the Northern Horticultural Society at Franklin Grove, and published in the *Prairie Farmer* January 9, 1878.



272. *Cenopsis pettitana* (Robinson).

The caterpillar of this variable species is said by Miss Murtfeldt to feed on the oak, hickory, and rose.

Professor Riley found at the same time (May 15, 1869) as *Cacœcia argyrospila*, a large grass-green oak roller with a black head and a pale brown cervical shield and bluish dorsal line, with the thoracic legs black. June 3, 1869, five moths issued.

Zeller (November 20, 1871) says it is near the European *Xanthosetia hamana*, but differs.

Several of them entered the chrysalis state May 26, 1869.

October 9, 1872, received from Manhattan, Kans., a larva feeding on oak, which possesses several of the characteristics of *Perophora mel-sheimerii*. (Riley's unpublished notes.)

*Larva*.—Length, .625 of an inch; diameter about .10 across the head, which is the broadest part. Pale yellowish green, somewhat flattened, fine, medio-dorsal line, piliferous spots on dorsum very minute, sides somewhat tuberculated, with conspicuous longitudinal row of long, stiff brown hairs arising from brown plates. Head large, dark brown, not polished, horizontal. First segment horny, pale brown, constricted behind, roughened like the head with dense minute punctures. Anal plate orbicular, large, horny, with a glistening whitish punctured surface, with two conspicuous purple-brown spots and a dark longitudinal dorsal line. Larva forms a case of web-work on the leaf or between two leaves. Moths issued in early May.

*Pupa*.—Differs materially from that of *Cacœcia argyrospila*. It is .55 of an inch in length. The antennæ and legs reach exactly as far as wing sheaths. The color is very dark brown, and after the moth has left the posterior third behind last row of teeth is of a lighter reddish brown in contrast. Two rows of teeth on principal abdominal segments, as in *Cacœcia argyrospila*. The extremity is blunt with scarcely any hooks visible, though occasionally a very fine one may be seen. (Riley's unpublished notes.)

*Moth*.—Fore wings very pale yellow. Costa in the male with two patches of brownish ochreous scales at the basal and apical third. Expanse of wings, 22 to 28<sup>mm</sup>. (Robinson).

## 273. THE RED-BANDED LEAF ROLLER.

*Lophoderus triferanus* (Walk.).

Order LEPIDOPTERA; family TORTRICIDÆ.

Probably originally feeding on the oak, elm, and maple, as well as the cranberry. The caterpillar occasionally damages clover, corn, strawberry, bean, etc. The following notes are copied from Forbes' 3d Rep. Ins. Illinois:

This species occurs somewhat rarely in Illinois, and has not been reported throughout its wide range to do any injury except to the cranberry in Massachusetts, where its larva is locally known as one of the cranberry worms. We bred it, however, during this past season from pale-green leaf-rollers in young corn, and consequently may regard it as worthy of brief mention, especially as its local abundance in cranberry plantations in Massachusetts would indicate a capacity for excessive multiplication which makes it a possible source of danger in the great corn-fields of the Mississippi Valley.

The presence of this larva and of that of the sulphur leaf-roller, just treated, is indicated in corn-fields by the folding lengthwise or rolling of the leaves in May and

June. If these leaves be opened, a green wriggling larva will be found inclosed in a web within.

The moth hatching from these folded leaves in June, if *Lophoderus triferanus*, may be recognized as an insignificant brown species, about a half inch across the spread wings. The fore wings are reddish brown except on the terminal fourth, which is gray speckled with black, as is also the basal half of the posterior edge of the same wings.

The species was first described by Walker in 1863 as *Cacocia triferana*, and again by Clemens in 1865, in the proceedings of the Entomological Society of Philadelphia, under the name of *Tortrix incertana*. A better description of the moth, with figures of male and female, is given by Robinson in Volume II of the Transactions of the American Entomological Society, under the same specific name.

As an injurious insect it is mentioned by Dr. Packard in the Massachusetts Agricultural Report for 1870, and in the Tenth Report of the Geological and Geographical Survey of Colorado and Adjacent Territory, 1876. By Miss Murtfeldt it is reported as injurious to the rose, in the third volume of the American Entomologist (1880). and by Professor Lintner as a clover insect in the Annual Report of the New York Agricultural Society for the same year.

This species has been collected from Maine and New York to Illinois and Texas, and has been found feeding on the cranberry, elm, soft maple, oak, apple, rose, beans, *Gnaphalium polycephalum*, clover, strawberry, and corn. Our specimens, collected on May 29, emerged June 30.

In all the foregoing articles except the first this species is treated under Clemens's specific name, but in Fernald's Catalogue of the Tortricidæ of North America (1882) this is reduced to a synonym of Walker's *triferanus*. The larva was not distinguished in our breeding cages from that of the preceding species (*Dichelia sulphureana*), consequently I am unable to give a detailed description of it. Clemens's description of the imago is as follows:

*Moth*.—Palpi ocherous or brownish ocherous except the minute third joint, which is blackish. Head and thorax ocherous or brownish ocherous. Anterior wings pure pale reddish brown within the central fascia, except on internal margin, which is broadly covered at base with blackish brown scales, forming a rather prominent irregular spot followed by an aggregation of intermediate pale ocherous and blackish scales to the fascia. Central fascia broad, distinctly dark brown, sometimes reddish brown. The subapical costal spot is dark brown and separated from the central fascia by a reddish brown shade. The remaining outer portion of the wing pale ocherous except a testaceous brown spot above the anal angle. Fringes dark ocherous. Posterior wings fuscous above, testaceous beneath. Fringes pale testaceous, much clouded centrally with dark fuscous. Expanse, male 15, female 19<sup>mm</sup>.

#### 274. *Lophoderus velutinana* Walk.

This species is said by Miss Murtfeldt to feed on the laurel-oak, balsam-fir, and maple.

*Moth*.—Fore wings pale ocherous, darker on costa at base; a large dark-brown basal patch, not quite reaching the costa. Middle band dark brown to the middle of the wing, reddish brown beyond, throwing out a hooklet inwardly below the cell, which curving upwardly nearly incloses a pale ocherous spot. Subapical costal spot dark brown, semilunate, connected by a paler streak with internal angle. Expanse of wings, 17<sup>mm</sup>.

#### 275. *Phoxopterus murtfeldtiana* Riley.

Three specimens were bred from oak, May 19, by Miss Murtfeldt, in Missouri.

From *Ph. spireæfoliana*, which Dr. Clemens bred from larvæ found feeding on the leaves of *Spiræa opulifolia*, this oak-feeding species dif-

fers in the oblique central fascia extending to form a sharp angle towards the apex of wing, in the angulated portion containing two black streaks, and in this fascia extending, as a faint band, to the inner margin and beneath the ocellated patch.

*Ph. burgessiana* Zell., which may not be distinct from *pulchellana* Clem., and *Ph. laciniana* Zell., which, also, may not be distinct from *dubiana* Clem., are closely allied to *murtfeldtiana*, but the basal patch is darker than in those species, thus resembling *spireæfoliana*. (Riley.)

*Moth.*—Male: Expanse, 10<sup>mm</sup>. White, the primaries with a dark-brown patch on basal half of inner margin and with an oblique fascia extending from the middle of costa. Head reddish brown; palpi white, tinged with brown at base. Thorax white, becoming embrowned on the disk; primaries white, the apical half shaded with ferruginous, with a broad blackish-brown patch on the basal half of the inner margin, the patch rounded on its costal border and having a very indistinct coppery reflection from some of the scales in particular lights; from the middle of the costa an oblique reddish-brown fascia extending to form a sharp angle just before the apex of wing (these inclosing two black streaks), and retreating suddenly to curve around the ocellated patch, into which it sometimes sends a slight angle, and to attain the inner margin of the wing; this fascia much paler on its inner half than on its costal half, bounded exteriorly from costa to inner margin by a white line, and shading off on the inner half of its basal border into the white ground color; costa beyond the fascia to the apex streaked with white and ferruginous, the apex ferruginous; just below the apex two white streaks; ocellated patch white, generally containing a black streak; posterior margin ferruginous; fringes tinged with ferruginous, pale at base, darker at apical angle; secondaries gray; under surfaces gray; primaries shaded with fuscous; legs white, with the usual fuscous shadings on tarsi. Abdomen gray, silvery beneath. (Riley.)

#### 276. THE OAK-LEAF CRYPTOLECHIA.

*Cryptolechia schlagenella* Zeller.

Order LEPIDOPTERA; family TINEIDÆ.

This is a remarkable insect, both as a caterpillar and moth. It is not uncommon in the larval state on the oak, where we have seen it in Maine and Rhode Island in September. Professor Riley found, October 22, 1882, in Virginia, several larvæ of this Tineid feeding on oak. One moth issued June 2, 1883. It feeds between the leaves, drawing them together with silk threads. When about to pupate, it turns over a portion of the leaf nearly an inch long, lines the interior of the cell thus made with silk, and the moth appears the following spring. We have compared the moth with a type specimen sent to us several years ago by the late Prof. P. C. Zeller, and now in the Museum of Comparative Zoology, Cambridge, Mass., and it is undoubtedly that species, though the row of blackish dots so distinct in the fresh specimen reared by us are not to be seen in the type specimen; otherwise it agrees exactly with the latter. It is a not uncommon insect, but, so far as known, more curious than destructive, though it may at times disfigure the leaves of valuable shade trees. It is the largest Tineid larva we have met with.

*Larva*.—Head large, broad, and flat; as broad as the prothoracic segment; pale horn or whitish color, surface rough; in front crossed by two dark reddish-brown broad lines which form two large shallow scallops; the front line extends along the sides, including the eyes and the front edge of the clypeus; the other is broader, forming two scallops and crossing the apex of the clypeus. On each side of the head below the front line is a short, nearly straight brown-black line not reaching as far as the eyes. The median suture of the head is rather deeply impressed; the vertex on each side is a little swollen and marked with eight or nine dark reddish-brown more or less confluent spots. The posterior edge of the head is edged with black brown. The body is somewhat flattened, pale pea green, a little paler than the under side of the leaf. Prothoracic segment without a shield, but broad, flat, and green like the rest of the body. On the sides of the three thoracic segments is a dark tubercle tinged with reddish between, forming a lateral thoracic line. No dorsal tubercle, but pale hairs as long as the body arise from minute points, which are obscurely indicated. Length, 23<sup>mm</sup>.

*Pupa*.—Body very thick and stout; the head broad, and the abdomen short and thick, the end of the body very blunt, the tip broad and obtuse, somewhat tuberculated, not spined. The wings reach to the end of the fifth abdominal segment; and on the under side of the sixth and seventh segments are two dark ventral small callosities; the tip is broad, truncated, rough and dark. Length, 10<sup>mm</sup>; thickness, 3.5<sup>mm</sup>.

*Moth*.—A very large species for the family to which it belongs. Head with the scales between the antennæ and on the vertex loose and thick, not smooth as in *Gelechia*. Palpi long and slender, smooth, the third joint very long and slender, over one-half as long as the second. It is so large and the fore wings so broad and oblong, that at first it might be mistaken for a *Tortrix*. Body and wings snow white. Fore wings snow white, with two smoky trim dots at the base of the wing near the costa; two smoky spots inside of the middle of the wing on the internal edge. Beyond the middle of the wing are five or six indistinct, pearly, smoky spots, the central one apparently forming the discal dot. Two faint, curved, smoky lines parallel with each other and to the outer edge, neither of them reaching the costal edge of the wing, and the inner less than one-half as wide as the outer. On the outer edge of the wing, on the white fringe, is a row of about five conspicuous dark-brown spots; the base of the fringe is smoky, forming a faint line. Body, hind wings, abdomen, and legs snow-white; antennæ light brown. On hinder part of the thorax very distinct when the wings are closed, is a large prominent tuft of broad brown scales, which send off different metallic colors, especially steel-blue. Length of body, 9 to 10<sup>mm</sup>; of fore wing, 11<sup>mm</sup>; expanse of wings, 24<sup>mm</sup>.

#### 277. THE BROWN CRYPTOLECHIA.

##### *Cryptolechia quercicella* Clemens.

The leaves of the oak and, as we have found the past season, the aspen, are often bound together by a rather large flattened Tineid caterpillar, larger in size than most larvæ of the family to which it belongs. It is of about the size of the caterpillar of *C. schlagennella*.

The larva of the present species (originally described by Clemens as *Psilocosis quercicella*) was said by that author\* to bind the leaves of oaks together in August and September (in Pennsylvania) and to pick out the parenchyma between the network of veins; to weave a slight cocoon between two leaves, appearing as a moth in March and April.

\*Proc. Acad. Nat. Sciences, Phil., June, 1860. See also Clemens's Tineina of North America, edited by H. T. Stainton, p. 149.

Our observations confirm the accuracy of Clemens's statements. In 1884 we reared it from the oak in Providence, the moths in confinement appearing May 3 to 13 of the following spring.

During the season of 1886 we found the larvæ both on the oak and on the aspen at Brunswick, Me., during the last week in August (the 25th to 31st). It disfigures these trees by binding the leaves together, where it occupies a gallery in the mass of excrement filling the space. It weaves a slight, but quite consistent, oval, flat cocoon between the somewhat crumpled leaves; the moths appeared in the breeding cages from May 15 to 20; at first sight the moth resembles a Tortrix, the wings being wide and broad at the end, and the markings plain; it is very different in appearance from the moth of the other species we have mentioned, which is white, with longer, narrower wings. The abdominal spine of the chrysalis is also very peculiar in shape.

*Larva*.—Body flattened. Head wide, slightly narrower than the prothoracic segment; dark brown; prothoracic shield dark brown, slightly paler than the head. Body behind pale livid greenish flesh-colored; no dorsal setiferous warts, but on each side of each segment are two dark warts of unequal size giving rise to long hairs: below them are two smaller, paler, less conspicuous warts. Supra-anal plate large, broad, rounded, blackish, with five setiferous warts around the edges of the plate. All the legs concolorous with the body. Length, 12<sup>mm</sup>.

*Pupa*.—Of the shape of the Tortricidæ, being unusually stout and of a mahogany brown color. Abdominal segments peculiar in having a single, finely crenulated ridge passing dorsally and laterally around the front edge of the segment; there are no teeth or spines, but a rough surface on the ridge with confluent granulations. The tip is peculiar, the last segment being conical, with a stout spine (cremaster), which is rounded, a little flattened, and ending in two forks, from the sides and ends of which arise in all 6 to 8 long bristles, which stick into the silken lining of the rather slight cocoon in which it transforms. Length, 7<sup>mm</sup>.

*Moth*.—Recognized by its large size, broad square wings, and long slender palpi, curving backwards high over the head. Head, thorax, and fore wings tawny gray, with a line of fine dark scales on the base of the antennæ and on the upper and under side of the last joint of the palpi. Fore wings uniform tawny gray, mottled with fine blackish scales; no distinct markings except a dark diffuse discal dot. Fringe gray. Hind wings and abdomen as well as the legs shining pale tawny gray, much lighter than the fore wings; beneath of the same color, except that the fore wings are somewhat dusky except on the outer edge and outer half of the costal margin. Expanse of wings, 20<sup>mm</sup>.

#### 278. THE WHITE BLOTCH OAK-LEAF MINER.

*Lithocolletis hamadryadella* Clemens.

Order LEPIDOPTERA; family TINEIDÆ.

This miner makes a whitish blotch-like mine upon the upper surface of the leaves of different oaks. It is a minute, flat, horny, footless, active, brownish-yellow larva, which transforms within the mine in a delicate disk-like cocoon.

Several species of oak are injured by this leaf-miner, which ranges from New York to Washington. Sometimes each leaf will contain on an average four or five miners, and young shade trees are thus weak-

ened by their attacks in June. There are in Washington five or six broods of moths. The best remedy is to collect and burn the fallen leaves in the spring, since they contain the worms in their final stage before transforming. (Comstock.)



FIG. 61.—Oak leaf, with blotch-mine of *Lithocolletis hamadryadella*.

I have noticed the larva and its mines in abundance at Providence in September and October.

The following notes have been furnished by Professor Riley:

Received July 5, 1884, from N. H. Bishop (Griswold collection), Davenport, Iowa, a lot of leaves of different kinds of oak, badly infested with larvæ of the above insect. On some of the large leaves the entire upper surface was undermined. The same insect is also very common on all kinds of oak on the Agricultural grounds at Washington, D. C. The moths commenced to issue July 12 to July 18, and at the same time quite a number of four different species of parasites issued. (Unpublished notes.)

The moth has white front wings, with three broad irregular bronze bands across each one, each band being bordered with black on its inner side. The hind wings are silvery. The wings expand .23 inch. (Comstock.)

219. *Lithocolletis tubiferella* Clemens.

The mine of this insect is represented at A in Fig. 62, which has been identified by Mr. W. Beutenmüller, who thinks that the other mine (at C) is the work of a *Nepticula*.

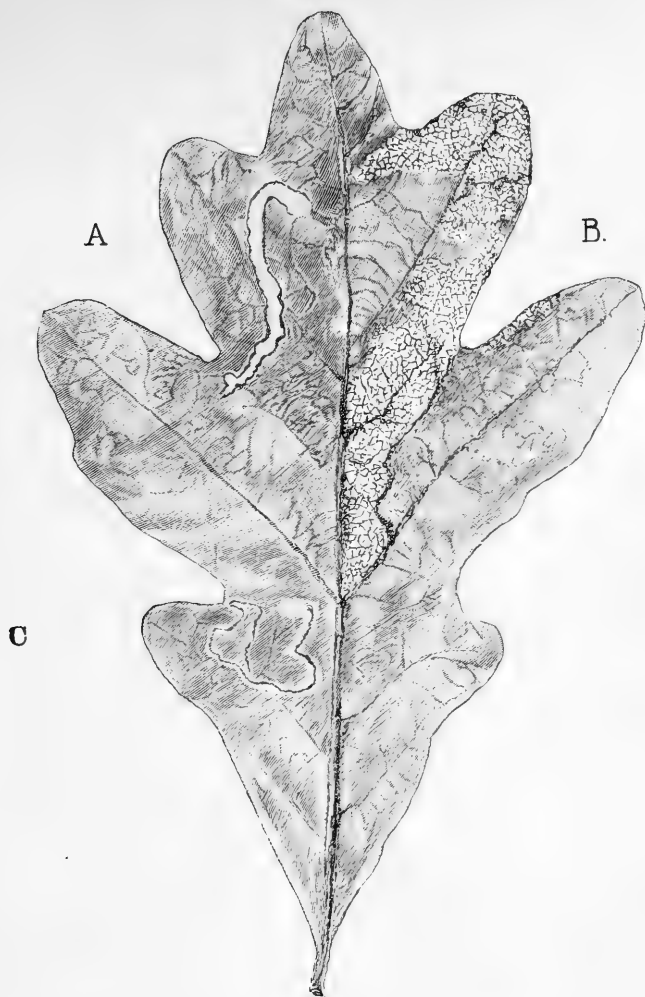


FIG. 62.—A, mine of *Lithocolletis tubiferella*.—Bridgham, del.

280. FITCH'S OAK-LEAF MINER.

*Lithocolletis fitchella* Clemens.

Order LEPIDOPTERA ; family TINEIDÆ.

This species forms a tent-like mine on the under surface of the leaves of different species of oaks. It is a minute, nearly cylindrical, white larva. The mine is visible on both sides of the leaf, while that of *L. hamadryadella* is to be seen only on the upper side. The insect hibernates in the pupa state within the leaves, so that the same general remedy of gathering and burning the leaves will apply to this as to the preceding leaf-miner. (Comstock.)

This is a very common species on all kinds of oak at Washington,

D. C. Specimens were also received from Miss M. Murtfeldt, Kirkwood, Mo. (Riley's unpublished notes.)

The moth has pale reddish saffron fore wings, with a slight brassy hue. Along the front edge (costa) are five silvery-white costal streaks; on the inner margin are two conspicuous silvery dorsal streaks, while the hind wings are grayish fuscous. (Comstock.)

281. *Ypsolophus quercipomonella* Chambers.

The following account of this Tineid has been furnished us by Professor Riley:

At Glenwood, Mo., folding up the leaves of the black oak in little tubes. June 2, 1868, one changed to chrysalis. The chrysalis is formed within the leaf, the caterpillar first lining it with a little white silk. The first moth issued June 15, and others up to the 22nd. Zeller says it is the same as a variable, often lighter brown spotted species, which he has often received from Ohio. (Unpublished notes.)

*Larva*.—Length, .60 inch. A striped white and black worm with a red-brown head and cervical shield. Considering the ground color as white, there is a black dorsal line somewhat restricted at the joints, and on each side of the dorsum another somewhat wavy line, separated from a lateral broader one only by a fine white line. Outer edge along stigmata white, and all underneath it black glaucous. Piliferous spots above quite large and black with a white annulation, two of them situated in a black wavy line and one on lateral black line just above stigmata. Stigmata small, with a smaller piliferous spot just below it, and others on venter. Segment 1 dark below cervical shield. Segment 2 darker than the others, with a white anterior edge. Last two segments almost entirely black above, being sharply separated from anus and anal prolegs, which are of a very light yellow. Feet black. Abdominal prolegs same as venter. Single white bristle from each spot. (Riley.)

*Pupa*.—The chrysalis averages .38 inch in length, with the abdomen comparatively narrow and small compared with the width of the anterior half, the extremity tapering to a single point; of the normal color, but characterized especially by having about six pairs of little elevations on the dorsum, immediately behind the thorax, and three others each side of them along the upper edge of wing-sheaths. It is quite active, and whirls its body around at a great rate when disturbed. (Unpublished notes.)

282. THE OAK SACK-BEARER.

*Coleophora*, species not determined.

Order LEPIDOPTERA; family TINEIDÆ.

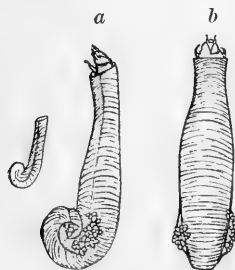


FIG. 63.—*Coleophora*, or oak sack-bearer, natural size: a, side view; b, dorsal view, enlarged.—Gissler, del.

We have found this interesting sack bearer on oak leaves at Providence, R. I., June 16. It apparently belongs to the genus *Coleophora*, which inhabits tubular cases, either straight or more or less coiled at the end, which the caterpillar drags about with it, suddenly withdrawing in it when disturbed. The little circular masses on each side of the coil are the pellets of excrement.

283. *Odontota rubra* Web.

Order COLEOPTERA; family CHRYSOMELIDÆ.

Professor Riley found, November 4, 1876, three larvæ of this beetle mining in the leaves of the white oak, near River des Peres. (Unpublished notes.)



## 284. THE LEAF-ROLLING WEEVIL.

*Attelabus bipustulatus* Fabr.

Order COLEOPTERA; family CURCULIONIDÆ.

Rolling up the leaves of the red, post, and laurel oak (*Q. imbricaria*), late in April, forming compact, cylindrical cases containing a single egg; the case dropping to the ground, the larva after hatching feeding on the food around it, and finally transforming into a long-snouted weevil. A second brood of larvæ in July. (Murtfeldt.)

This beetle has the curious habit of rolling up a leaf, trimming and tucking in the lower ends with her beak. The egg is first deposited near the tip of the leaf, and a little to one side; the blade of the leaf is then cut through on both sides of the midrib, about an inch and a half below; a row of punctures is made on each side of the midrib of the severed portion, which facilitates folding the leaf together, upper surface inside, after which the folded leaf is tightly rolled up from the apex to the transverse cut, bringing the egg in the center; the concluding operation is the tucking in and trimming off the irregularities of the ends. A few days after completion the cases, first observed the latter part of April, drop to the ground; by May 15 several larvæ hatched and fed on the dry substance of their nest, and by the end of May they pupated within the nest; this state lasted from five to seven days, the first beetles issuing by June 2, while a second brood of larvæ may be found early in July. (Murtfeldt.)

“On the leaves of the laurel oak, in the neighborhood of St. Louis, Mo., are often found in May little thimble-shaped cases, which are the work of the above insect. The tips of the leaves are folded and rolled up into that peculiar shape after the egg has been deposited.

“The egg is almost globular, slightly ovoid, tender, pale yellowish, and translucent. It is deposited near the tip on the under side of the leaf. The leaf is then cut transversely near its middle, punctured a short distance each side of midrib, which causes it to fold with its lower side out, then curled round, and the outer edges tucked in.” (Riley’s unpublished notes.)

*The larva.*—Average dorsal length, 0.22 inch; diameter on abdominal segments, 0.06 inch, tapering anteriorly from fourth segment. Yellowish white; thoracic segments slightly depressed on the back and smaller beneath; abdominal segments convex above and flat beneath, each one divided into three irregular shallow transverse folds, lateral surfaces with a double row of smooth polished oval tubercles, most symmetrical in form and position from segments 4 to 11 inclusive; above the tubercles on each segment is a deep depression. Head horizontal, rounded, small, about half the diameter of segment next behind, into which it retreats; white, the mandibles and other mouth parts reddish brown, surrounded by long hairs.



FIG. 64.—*Attelabus bipustulatus*.—Smith del.

*The pupa* is cream white, 0.12 inch long; abdominal segments sharply ridged; posterior extremity terminates in a pair of bristly points, white, tipped with brown.

*The beetle* is a small, highly polished black weevil, with two large orange-red spots at bases of the wing-cover. (Miss Murtfeldt.)

I have also found, May 30, on the leaves of the oak near Providence, the rolls made by the same species of *Attelabus*, apparently, but they were slenderer than those of the *Attelabus* found upon the alder.

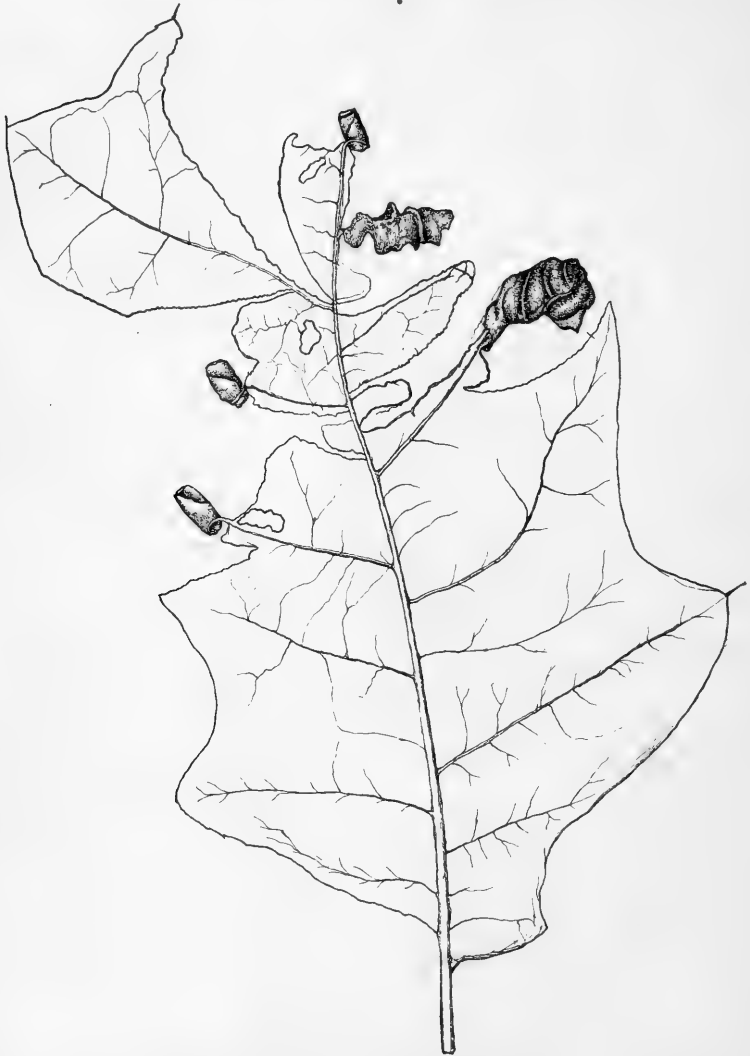


FIG. 65.—Rolls on oak leaf made by *Attelabus bipustulatus*.—Gissler del.

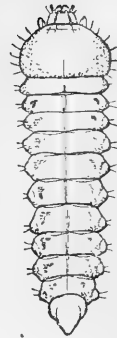
I have also found on the leaves of the oak at the end of May, near Providence, *Cryptorhynchus bisignatus* Say. It may prove to live at the expense of this tree.

284. *Brachys ærosa* Melsheimer.

Order COLEOPTERA; family BUPRESTIDÆ.

I have found this small Buprestid upon the leaves of the oak early in summer in Maine, and late in May near Providence, R. I. It most probably mines the leaves of the oak, but its habits are not yet known. The late Mr. V. T. Chambers once wrote me that he had often found in Kentucky "a *Brachys* larva (scarcely, if at all distinguishable from that of *B. æruginosa*) mining the leaves of oaks, but have never bred the beetle."

We introduce a cut of *B. æruginosa*, much enlarged, to illustrate a larva of this genus.

FIG. 66. Larva of *Brachys æruginosa*.—Packard.285. *Brachys ovata* Web.

On laurel oak; the imago issues the latter part of April and early May. (Riley's unpublished notes.) Mr. C. P. Gillette reports rearing the beetle from a larva mining a leaf of either the red or black oak. (Can. Ent. XIX, 139, 1887.)

286. *Chlamys plicata* Fabr.

We have given some account of this pretty beetle in our "Guide to the Study of Insects," p. 510. It was reared by Mr. S. H. Scudder from the sweet fern.

"August 24, 1876, found on *Quercus bicolor* curious little coleopterous case-bearers. The abdomen of the larvæ, as far as it can be seen, is yellow with a transverse black patch on first segment just behind the head. Head black; legs long; yellow, with last joint black; the case is dark-brown, nearly black, of the shape of the shell of some kind of snail or like a little horn." (Riley's unpublished notes.)

FIG. 67.—*Chlamys plicata*: a, larva taken from its case.—From Packard; Emerton del.287. *Selandria quercus-alba* Norton.

A species of slug-worm like that of the pear (*S. cerasi*) has been observed by Mr. Edward Norton living abundantly on the white oak, and also in abundance on the English oak (*Q. robur*), at Farmington, Conn.

"They feed in companies when young, sometimes twelve on a leaf, head outward, devouring the epidermis of the under side of the leaf, and not eating holes through. The eggs are not laid in the ribs of the leaf, but in the smooth surface between the upper and lower skin near the tip of the leaf, where whitish, irregular blotches are soon formed, visible only beneath, from the center of which the larva comes forth. I

have bred many specimens, coming forth in twelve or fourteen days." (Norton.)

*Larva*.—They are naked, slimy slugs, like those of *S. cerasi*, 22-footed; color pale green, at times almost white, enlarged near head. Head white, the six anterior legs amethystine brown, tail segment constricted, rather sharp. (Norton.)

*Saw-fly*.—Male and female: Shining black, short and compressed; antennæ slightly enlarged in middle, third joint nearly as long as fourth and fifth; head polished; lower ocellus in an oval basin, with three pits beneath; body wholly black; legs black, the two anterior pairs clear white below the middle of femora; tips of their tibiæ waxen; the basal two-thirds of posterior tibiæ and of first tarsal joint white; tarsi fuscous, apical joint of all the tarsi waxen-white; inner tooth of claws minute, beneath the middle. Wings hyaline, iridescent, nervures blackish, first submarginal cell rounded at base. (Norton.)

287. *Selandria diluta* Cress.

Order HYMENOPTERA; family TENTHREDINIDÆ.

The following account of this saw-fly has been furnished by Prof. Riley:

Spring larvæ feeding on the under side of the leaves of the post-oak, often several together during the latter part of May. Just previous to entering the ground the larva sheds its spring skin; enters ground the last of May or early in June. Flies emerge about the first of May following. (Unpublished notes.)

*Larva*.—Length of full-grown larva,  $\frac{5}{8}$  inch. Color, pale translucent green, purplish on dorsum; head, green, with two large black spots near the top, and four minute black dots below them, just above the jaws. Dorsum and sides quite thickly covered with spiny tubercles, those on dorsum bifid, while the lateral ones are single. Thoracic legs yellowish, prolegs of the same color as the general surface. (Riley.)

288. *Cecidomyia q.-pilulæ* Walsh.

Order DIPTERA; family CECIDOMYIIDÆ.



FIG. 68. Galls of *Cecidomyia q.-pilulæ*. After Riley.

The following notes on this Dipterous gall-fly have been copied from Professor Riley's notes. I have found it common on the oak in October, at Providence:

Found in abundance on the laurel-leaved oak, the gall always on the upper surface with the nipple on the under surface of the leaf (October 25, 1869). I find in every

well-developed gall two larvæ, the two cells sometimes separated, but more generally running into one. The larva is of the usual orange color, but appears to be somewhat shorter and thicker than those I have before noticed. Length, when not crawling, .14 of an inch. Head quite pointed, and the first few segments doubly wrinkled. Two appendages at head, and two brown spots near it superiorly. Breast-bone brown and clove-shaped. Terminal segment with two acute prominences.

October 29, 1869. Upon opening several galls to-day, I found one which contained four larvæ, two in each cell.

January 1, 1870. Many of the larvæ are on top of the ground, though most of them are yet in the galls. Some of the galls have become softer, and have peeled open; and it is from these, I think, that the larvæ have escaped.

April 3. I examined them to-day and find that, though some of them are empty, the great majority of them contain either pupæ or larvæ. The larva works and loosens a passage, pushing the débris to the surface. It then lines its cell with a delicate silken lining, and transforms to a pupa of the exact color of the larva; the head being furnished behind the antennæ with two thorns; the wing-sheaths reaching to the third abdominal joint, and the hind legs, which are free from the body, to the fifth.

Many of the galls contain a white parasitic maggot with a conspicuous black pointed head, divided longitudinally with a lighter line and with two brown spots behind it.

May 2, 1870. Many of the flies have issued, but all so far seem to be females. The antennæ are 14-jointed (double jointed + 12) and are scarcely at all verticillate, and only the slightest restriction on basal one; no pedicels; length of joints very gradually decreasing from 3 to 14. Nervules of wings as in true *Cecidomyia*. On opening many galls to-day I find most of the larvæ within cells. A great number of parasites have issued within the past few days, and on opening the galls I find the perfect parasite within a cell between two others occupied by *Cecidomyia* larvæ. So many of the galls are empty, that I greatly incline to believe some of the larvæ left them and entered the ground, the more so that the pupal integuments were all on the ground.

July 22, 1870. Larva just hatched and barely visible. Gall itself fully formed and golden yellow. (MSS. notes. Also see Amer. Ent., Vol. II, p. 29.)

289. *Cecidomyia quercus-majalis* Osten Sacken.

Blister-like gall of *Cecidomyia* on young leaves of the pin-oak (*Quercus palustris*). Generally these galls occur on the principal ribs of the leaf; sometimes between the ribs. They are oblong, blister-like, the hollow surface somewhat uneven, wrinkled, walls thin; color pale green or reddish. They bulge out on one side of the leaf and have a longitudinal slit on the other. Galls projecting on the under side of the leaf and having the slit on the upper side seem to be somewhat more common than those of the opposite description. The slit can be opened without injuring the gall by gently pulling at the sides. Such galls which grow upon a rib show a trace of it on their longitudinal diameter. The larva, which can be taken out of the slit without lacerating the gall, is rather larger than the majority of the larvæ of *Cecidomyia* (about 0.2 of an inch long), and not reddish, as usual, but white, smooth; the breast-bone is hardly visible, as its front part only is horny, having the appearance of a transverse, reddish-brown wavy line. The last abdominal segment has several minute, fleshy, pointed projections. The larva drops to the ground through the slit at a certain period of its development; hence, empty galls are often found. Found in consid-

erable numbers in the Central Park, New York, in May, 1869. (Osten Sacken, Trans. Amer. Ent. Soc. iii, 53.)

290. *Corythuca arcuata* (Say). (*Tingis arcuata* Say.)

Order HEMIPTERA; family TINGITIDÆ.

The following notice of this bug is copied from Professor Riley's MS. notes:

June 26, 1876, found in Ofallon Park, on the under side of leaves of white oak, the eggs, newly hatched larvæ, and others in various stages of development, as well as a few mature insects. Eggs laid in patches, but not close together, being set irregularly; they are pointed at both ends and attached by one end, and are of a dull black color. (See also Lintner, 4th Rep. p. 108, Figs. 42, 43.)

291. THE OAK-LEAF PHYLLOXERA.

*Phylloxera rileyi* Lichtenstein.

This insect forms a yellow circular spot on the under side of the leaf, but showing plainly above, of the white and post oak; the species is of small size and unusually slender, and with long tubercles in the pupa. A full account has been published by Riley in Seventh Mo. Rept., pp. 118-121.

292. *Lachnus quercicolens* Ashmead.

This plant louse was found by Ashmead early in February in Florida, feeding on the under surface of the leaves of the live oak (*Quercus virens*); winged specimens, however, were not taken until April.

*Wingless female*.—Length, .05 inch, ovate; reddish, becoming brown with age. Vertex of head brown; beak reaching to the middle coxæ, reddish at the base, yellowish in the middle and brown at tip; antennæ 7-jointed, reaching to the honey tubes, whitish, basal joint reddish; joints annulated at tip with black; apical joint short, black; honey tubes almost obsolete, as wide as long, whitish; style hardly visible, whitish, pubescent, legs pubescent, posterior pair dark brown or black, middle and anterior pair reddish-yellow, feet infuscated.

*Winged individual*.—Length, .05 inch. Same as apterous female, excepting that the abdomen is lighter in color; the middle femora and coxæ dark brown, and wings hyaline, with the stigma and veins green. (Ashmead, Can. Ent, XIII, 155.)

293. *Phyllaphis niger* Ashmead.

This in some respects anomalous *Aphis* was detected feeding on a tender shoot of the willow oak (*Quercus phellos*, variety *laurifolia*). No winged specimens were found. The broad head, slightly pubescent abdomen, and other characters exclude it from the genus *Lachnus*.

*Wingless female*.—Length .05 inch, ovate and of a shining black color; head broad, nearly as long as wide, slightly arcuate in front and with two longitudinal depressions on the vertex; beak long, reaching beyond hind coxæ, black at base, but becoming reddish towards tip and slightly pubescent, antennæ 7-jointed, situated very widely apart and not on tubercles, brownish in color, with the terminal joint very minute; metathorax a broad, smooth, shining, convex plate; abdomen wider than long, and sides flattened to honey tubes, slightly pubescent; honey tubes black, almost obsolete, as wide as long; style not visible, anus pubescent; legs dark brown, approaching black, pubescent, posterior pair long. (Ashmead.)

294. *Drepanosiphum? quercifolii* (Walsh).

*Larva*.—Pale greenish. Incisures of the antennæ dusky. Upper surface of the body, except the scutel, dusky; honey tubes long, robust, dusky at tip; legs long, with the terminal three-fourths of the femora, the extreme tips of the tibiæ, and the tarsi obfuscated.

*Imago*.—Blackish; prothorax and anterior part of the thorax sometimes varied with greenish; scutellum pale greenish; honey tubes two-thirds as long as the femora. Legs very long; basal half of femora pale greenish. Wings hyaline; veins brown; third discoidal vein hyaline at its origin; stigma and subcostal veins pale yellowish brown; extreme tip of the front wings slightly fumose; length of the wings scarcely .2 inch. "The antennæ attain the extreme tips of the wings when the wings are expanded, and the stigma is four times as long as wide and very acute at each end. On oak leaves." (Thomas.)

Although it is impossible to state positively from this description the genus to which this species belongs, yet I think it is almost certain that it should be placed in the genus to which I have assigned it. It is certainly not an *Aphis*, in the restricted sense, and the plant it infests would indicate that it is not a *Siphonophora*. (Thomas, Third Report.)

295. *Myzocallis bella* (Walsh).

"*Aphis bella*.—Oak leaves? Bright yellow, eyes black; antennæ with the tips of joints 3 to 6 black. Prothorax as long as the head, with a lateral black vitta; thorax with a black vitta extending from its anterior angle to the base of the front wing. Honey tubes scarcely as long as the tarsi, generally immaculate, sometimes tinged with fuscous. Legs long, black except the base of the femora and the coxæ. Wings hyaline; front wings with the entire costa as well as its nervures black to the tip of the stigmas, whence there extends a marginal dusky vitta, as wide as the costa at base and middle but tapering at tip, nearly as far as the middle branch of the third discoidal vein; this vitta covers the entire length of the fourth or stigmatal vein, which terminates half way between the tip of the stigma and the apex of the wing, is slightly and gradually curved, and incloses a marginal cell not wider than the costa; hind wings with a costal dusky vitta extending to the tip of the wing, the subcostal vein sometimes black; remaining veins of both wings slender and pale dusky, narrowly bordered with subhyaline where they traverse the terminal dusky vitta of the front wing. Length to tip of wings .15 inch.

"The antennæ attain the middle of the stigma when the wings are expanded, and the stigma is rather more than three times as long as wide, not very acute at each end." (Walsh.)

"The 22d of May, 1878, I discovered, at Carbondale, Ills., on the leaves of the burr oak (*Quercus macrocarpa*), plant lice, which I am inclined to believe belong to the species just described. In order that the reader may be in possession of all the facts concerning the species, I add here a description of these specimens:

"*Winged individuals* (the only kind seen).—Rather slender, of medium size; the body and all the parts except the wings a pretty creamy yellow color; the wings thin but clouded with fuscous, which is very distinct in the living insect, while the wings stand erect above the abdomen; these fuscous or cloudy spots appear to fall chiefly into two irregular oblique bands, one rather in advance of, and the other behind the stigma, but when a single wing is examined this arrangement will scarcely be observed. Costal and subcostal veins of the front wings close together, and parallel throughout; second discoidal vein decidedly sinuate and much nearer to the third

than to the first; third obsolete at the immediate base, curving somewhat strongly outward as it approaches the origin of the first fork; second fork rather nearer to the apex of the wing than to the third vein, but difference slight; fourth vein very sharply curved throughout, so that its middle portion approaches much nearer the first fork than its ends. Antennæ longer than the body, slender; third joint longest; fourth a little shorter than the third; fifth a little shorter than the fourth; sixth about half the length of the fifth or less; seventh, in the only complete antennæ obtained, about as long as the fifth.

“On most of the specimens I was unable to observe any honey-tubes; but in one specimen found on the same leaves, and which appears to belong to this species, these were apparent but very short, their length scarcely exceeding their diameter. This specimen was of the same delicate yellowish color, but the wings were perfectly pellucid. It is impossible to decide in reference to the honey-tubes from the mounted specimens, which are imperfect. On one of these specimens I found a species of mite fastened to the metathorax or base of the abdomen, so as not to interfere with the flight of the Aphis. It is probably a species of *Trombidium*, but as it is evidently in its larval state it is difficult to assign it to its proper position. It is probably the young of Dr. Packard's *T. bulbipes*, but it differs from that species in not having the tarsi enlarged. It also has the tarsi furnished with two strongly curved claws. It is possible that this is Dr. Fitch's *Lachnus quercifolice*, but it is impossible to identify the two from his very brief description. It approaches very nearly to *Aphis quercus* Kalt., which Koch has placed in *Callipterus*, and I would have identified it with that species but for the clouded wings. It will fall in *Myzocallis* as I have given the characters of that genus, and is probably a variety of the species under which I place it.” (Thomas.)

296. *Callipterus discolor* Monell.

Prof. Riley found, November 12, 1884, at Washington, D. C., on the lower side of leaves of *Q. prinus*, numerous specimens of the apterous oviparous females, larvæ, and the winged males of the above species.

The male is of a more or less dark rose color, though the fourth, fifth and last abdominal segments are yellowish, with a roseate tinge at sides. Head black. Ocelli clear, colorless. Eyes red. Antennal joints 3 and 4 whitish with blackish tips, the others black. Thorax black. There are two roseate stripes on prothorax and the sides of the mesothorax at insertion of the wings are dusky. There are two dorsal rows of black spots on the abdomen, of which the pair in front of the nectaries is confluent. A row of large, black, roundish, lateral spots and some smaller ones of different sizes between these and the dorsal rows. There is also a narrow, transverse band on the eighth segment. Nectaries short, black. Claspers blackish. Legs colorless, the tarsi pale dusky. Sternum black. On the venter are some large, transverse, and some smaller black spots. (Unpublished notes.)

297. *Callipterus punctatus* Monell.

Professor Riley found, May 19, 1883, at Washington, D. C., numerous specimens on the lower side of leaves of *Q. prinus* of an Aphis which



agrees with the above species. There were many winged specimens which already had deposited numbers of larvæ. (Unpublished notes.)

298. *Callipterus quercifolii* Thomas.

*Winged specimen.*—Antennæ nearly as long as the body, seven jointed; first joint quite large and very prominent, nearly twice the length and twice the diameter of the second joint, which is rather small, and of the usual suborbicular form; the third joint longest, but it exceeds the fourth very little, fifth very little shorter than the fourth; sixth not more than one-third the length of the fifth; seventh a little shorter than the sixth.

The wings as usual; third discoidal vein of the front pair twice-forked; the hind pair with two discoidal or branch veins; all the veins and branches are bordered with dark brown, giving them the appearance, when seen through a pocket magnifier, of broad black veins; the bordering does not expand at the tops of the veins, but retains its uniform width throughout. Stigma opaque, brown, with a posterior bordering of brown, fusiform in shape, being very acutely pointed at the apex, with no internal angle at the point where the fourth vein arises.

Costal vein very distinct, and rather prominent, it and the subcostal vein are remarkably parallel, the distance apart scarcely varying in the smallest degree from the base to the stigma. Distance between the insertion of the first and second, and second and third veins about equal; the second fork about equally distant from the apex and first fork. Fourth vein nearly straight at its base, curving regularly but not sharply towards its apex, runs very nearly with the first fork of the third vein.

The front of the mesothorax distinctly broader than the prothorax, the offset forming a distinct shoulder, the abdomen terminating suddenly and bluntly; no tail apparent. Honey-tubes very short and thick, slightly enlarged at the base, the length greater than but not twice the diameter.

When seen through a pocket lens, these (alcoholic) specimens appear dark brown; the antennæ annulated alternately with dark brown, or fuscous and white; the legs brownish or dusky with the base of the femora and tips of the tibiæ pale; the wings transparent with the broad dark brown or fuscous veins previously described. The body dark brown except the tip of the abdomen, which is pale and shows traces of transverse dark bands. (Thomas.)

*Wingless specimen.*—Somewhat regularly ovate, but subtruncate at the posterior extremity, or, at least, rounded very suddenly and bluntly to the tip. Antennæ not quite as long as the body, showing the light and dark annulations very distinctly. Eyes of this as well as the winged specimens reddish-brown. The ground color of the body of the alcoholic specimens is a pale, dirty yellow, but the dorsal surface is chiefly occupied by broad transverse brown or fuscous bands which extend to the somewhat broad, depressed portion of the lateral margins; there is one band on each segment; a pale line runs along the middle of the back from the head to the tail. Legs as in the winged specimens. Scattered over the body are stiff, spine like black hairs; it is also more or less covered with small tubercles. Honey-tubes as in the winged specimens—pale yellow.

Length of winged specimen to the tip of the abdomen (which is somewhat shrunken), .06 inch; to the tip of the wings, .15 inch.

Professor Bundy, of Sauk City, Wis., from whom the specimens were received, makes the following statement in reference to them:

Abdomen of the female light green below; black above, with four greenish spots; honey-tubes and tip of the abdomen white; head and thorax black, shining above. Eyes black: antennæ light, banded with black; wings with widened veins and tinged with purple (reflection).

On red oak (*Quercus rubra*) leaves in June, Sauk City, Wis. On both sides of the leaves, along the veins. Leaves becoming viscid from their secretions.

This is evidently distinct from the *Callipterus quercus* of Kaltenbach, which is of a pale ocher color throughout and nearly smooth, and has the veins of the wings unmargined. It approaches somewhat closely to *C. juglandis* Fisch., which is found on walnut. In that species the markings of the abdomen are almost exactly as in this, but the abdomen is much more drawn out and tapering; it is more than probable, however, that the shrinkage caused by the alcohol has caused this to present the blunt appearance. (Thomas.)

## 299. THE "OAK BLIGHT," OR WOOLY APHIS OF THE OAK.

*Schizoneura querci* Fitch.

This species is found in the northern part of Illinois upon oak limbs. Fitch says it is very similar to another species found on the basswood.

The winged individuals are black throughout, slightly dusted over with an ash-gray powder.

The fore wings are clear and transparent; the stigma is dusky, the rib-veins black, and the third discoidal vein with the basal portion abortive nearly or quite to the fork. The length to the tip of the wings is (0.16) a little over one-eighth of an inch. (Thomas.)

300. *Callipterus* (?) *quercicola* Thomas.

*Winged form*.—Antennæ about half as long as the body; not mounted on frontal tubercles; remote at base: third, fourth, and fifth joints equal in length; transition from the sixth to the seventh joint exceedingly gradual; seventh joint about half as long as the preceding. Rostrum short, not reaching the second coxæ; apical joint very acute. Nectaries reduced to mere openings. Style none. Wings with the veins bordered with brown. Stigma rather short, and blunt at apex, the cubital vein arising from its base. Stigmatal vein not so much curved as usual in this genus; not hyaline; distance between the base of the cubitus and that of the stigmatal vein equal to the distance between the furcals, and less than the distance between the base of the cubitus and that of the second discoidal. Second discoidal not sinuous. Body rather elongate. Length, 1.77<sup>mm</sup>; to tip of wings, 2.79<sup>mm</sup>.

It is with considerable doubt that I place this species in the genus *Callipterus*. It is very probable that it should be placed under *Asiphum*; but the only description of this genus which has been published is that given by Koch, and, like the other generic descriptions which were made from memory, after the loss of his eye-sight, is somewhat unsatisfactory. The following is a translation of the salient points in his description:

*Asiphum* Koch.—Beak short. Antennæ rather short; the third, fourth, and fifth joints subequal; the apical joint very small, scarcely perceptible.

Of this interesting species I have only seen two winged specimens, mounted on a slide, which were communicated by a correspondent with the information that they occurred at St. Louis, on oak. (Thomas.)

301. *Chaitophorus quercicola* Thomas.

*Apterous individuals*.—Dorsum greenish, with four rows of short tubercles, all of which, except a few in the side rows, are black; their apical circumference with from three to five bristles; the two middle rows of tubercles stop at the head,

but the two lateral rows are continued by smaller tubercles until near the base of the labrum. Rostrum reaching the second coxæ. Nectaries yellow, about as long as the tarsi, slightly enlarged at base, the mouth conspicuously flaring. Style not perceptible.

*Winged individuals*.—Antennæ very slightly pilose; fourth joint subequal to the fifth and two-thirds as long as the third joint; sixth about half as long as the preceding, and very little longer than the seventh wings, with the stigma and veins much as in *Ch. populicola*, the veins lying in narrow dusky bands. Length of apterous individuals 1.52–2.02 mm.; length of wing 2.54 mm.

On the under side of the leaf near the midrib. *Quercus prinus* May to June, Peoria, Ill.

Of this interesting species I have seen a number of apterous individuals, but only a single winged specimen, which was mounted on a slide, kindly communicated by Miss E. A. Smith, of Peoria, Ill. The dorsum of the winged individual is probably not tubercular, but this can not be decided with certainty on account of the manner in which the specimen is mounted.

Though the antennæ of this species are not sufficiently pilose to justify its being placed in *Chaitophorus*, its general appearance seems to point to this as its rightful position. (Thomas).

### 302. *Chaitophorus spinosus* Oestlund.

Mr. Oestlund has found this aphid on the under side of the leaves of the oak, confining itself to the higher parts of the tree.

*Wingless oviparous female*.—Head subquadrate in outline, straight in front, pale red or orange colored, with blackish spines in front and above like those on the abdomen. Antennæ very remote at base, about one half the length of the body; joints 1 and 2 as usual, 3 longest, 4 a little shorter, 5 a little shorter than 4, 6 hardly one-half of 5, 7 not longer than 6 or shorter, basal joints pale, apical black, with long white hairs as usual in this genus. Eyes large and round, with a distinct tubercle; the facets are reddish-brown, the space between them whitish, giving the eye the appearance of a ripe raspberry just picked with the bloom still on; no ocelli in this form. Beak not more than reaching second coxæ, stout and hairy, pale except at tip; second joint widest. Abdomen widest in the middle, tapering into a very long ovipositor behind, strongly convex above. Color pale yellow; last segments sometimes reddish as the head; above with grass-green markings, generally in the shape of a ring, leaving a large irregular white-like patch in the middle of the same color as the abdomen. Honey-tubes short and thick. Style short and thick. Length 2 to 3 mm. (Oestlund's Synopsis of the Aphididae of Minnesota).

### 303. BURR-OAK GALL MITE.

*Phytoptus quercii* Garman.

Class ARACHNIDA; order ACARINA.

Produces galls on the leaves of the burr-oak, *Quercus macrocarpa* Michx.

The mite is long and slender, and in a specimen seen among washings from a cecidium, there appeared to be an abrupt descent in the outline of the back from the abdomen to the cephalothorax. Length .005 inch.

The gall is large, greenish-yellow, entirely open below and slightly convex above. The hollow is densely filled with brown pubescence. The form is variable but the outline usually regular. The surface is smooth, or slightly roughened by the veinlets. Some of these galls grow downward instead of upward and form brown velvety buttons on the under side of the leaves. Specimens measured were from .1 inch to .4 inch in diameter. Thirty galls have been counted on one leaf. This is a common gall in northern Illinois and Indiana, and has been found occasionally in central part of Illinois. (H. Garman in Forbes 1st Rep. Ins. Illinois.)

The following notes have been supplied by Professor Riley :

Found August 8, 1878, on the upper side of the leaves of chestnut oak large irregular swellings which on the under side are entirely open and closely covered with fine brownish hairs. Upon examination quite a number of white mites were observed actively running about in these hairy depressions.

Some oak leaves were received from H. G. Hubbard, Crescent City, Fla., upon which were the blister like gall of some mite. Some of these galls are round, while others are irregularly oval, swelling on upper side of leaf—deeply depressed or concave beneath the concavity filled with long pink-colored hairs. (Unpublished notes.)

#### 304. THE POST OAK LOCUST.

*Dendrotettix quercus.* Riley MS.

The following account of this locust is taken bodily from Lawrence Bruner's report on locusts in Texas during the spring of 1886, Bull. No. 13, Div. of Entomology, Dept. of Agr., 1887, p. 17-19 :

In addition to the several species of locust that have been mentioned in the preceding pages, last summer for the first time another species of locust was noticed in vast numbers among the post-oak timber lying between the towns of Washington and Brenham, in Washington County. These were so numerous in one locality that they completely defoliated the trees of the forest, even to the very topmost twigs. The region occupied by this insect, although not over a mile and a half in width by 7 or 8 miles in length, is sufficiently large for the propagation of swarms capable of devastating a much larger area during the present spring and summer, and by another year to spread over several of the adjoining counties.

Although there is at present no apparent injury to the trees thus defoliated last year, and now in progress again this year, there can be no question as to the final result if these attacks are continued for several years longer. The trees will eventually die. While up to the present time this locust has shown a decided arboreal habit, it may, and undoubtedly will be, obliged to seek food in the adjoining fields when compelled to do so through lack of its present diet, which is rapidly disappearing before the hungry myriads of young locusts.

Notwithstanding the great numbers of the foregoing described species which together have combined in injuring the cotton and corn crops throughout this and adjoining counties, it is my opinion that the present species is more to be feared in the future than they, on account of its arboreal nature and the difficulty of getting at it in order to destroy it. To kill these locusts either while feeding among the foliage or "roosting" upon the topmost boughs of the tall trees would be next to impossible. On the other hand, the other species are easily to be gotten at and destroyed, as just shown.

The habits of this locust, as nearly as I was able to learn through inquiry from others, and by personal observation, are briefly as follows :

The egg-pods are deposited in the ground about the bases of trees or indifferently scattered about the surface among the decaying leaves, etc., like those of all other

ground-laying species. The young commence hatching about the middle of March, and continue to appear until into April. After molting the first time and becoming a little hardened they immediately climb up the trunks of the trees and bushes of all kinds and commence feeding upon the new and tender foliage. They molt at least five or six times, if we may take the variation in size and difference in the development of the rudiments of wings as a criterion. The imago or mature stage is reached by the last of May or during the first part of June.

The species is very active and shy in all its stages of growth after leaving the egg. The larva and pupa run up the trunks and along the limbs of trees with considerable speed, and in this respect differ considerably from all other species of locusts with which I am acquainted. I am informed that the mature insects are also equally wild and fly like birds. They feed both by day and night; and I am told by those who have passed through the woods after night when all else was quiet, that the noise produced by the grinding of their jaws was not unlike the greedy feeding of swine.

Aside from its arboreal nature there is but a single instance mentioned of its preference for growing crops. This was a small field of either cotton or corn, or perhaps both. If the nature of the crop was told me at the time I have forgotten. At any rate the crop of one or the other of these two staples grew in a small clearing in the very midst of the most thickly visited area. The mature insects alone were the offenders in this instance. During the day-time they would leave the trees in swarms and alight upon the growing crop and feed until evening, when they would return to the trees. If during the day they were disturbed, they immediately took wing and left for the tops of the surrounding trees, to return shortly afterwards.

The exact classification of this locust has not yet been fully ascertained, since no mature specimens were to be obtained, or, to my knowledge, are contained in any of our American collections. The larvæ and pupæ collected, however, would indicate a relationship to both the genera *Melanoplus* and *Acridium*. It appears to be congeneric with an undescribed short-winged form, thus far only taken in Missouri, which lives among and feeds upon the oaks only of that region. The present species is also evidently undescribed, unless the mature insect should differ widely from the preparatory stages herewith presented. It is popularly known in that region as the "Red-legged hopper" of the post oaks.

The larvæ and pupæ are of rather bright color, giving them a gaudy appearance. The ground color of the body is dark wood brown deepening into black along the sides of the pronotum and the apex of the posterior femora. The head for the most part is of a bright lemon yellow, while the pronotum is of the same, varied by streaks and blotches of the brown. The antennæ and posterior femora are red internally, dimly banded with yellow and brown on the external face, through which the red color of the inner side can be plainly seen. The feet and tarsi are also dark. The pupæ average almost an inch in length and are rather robust in form, with short broad heads and powerful jaws.

#### INJURING THE SEED (ACORNS).

##### 305. THE ACORN WORM.

*Balaninus rectus* Say.

Order COLEOPTERA; family CURCULIONIDÆ.

The grub is like the chestnut borer, boring into the acorns and transforming into a similar beetle, which is "easily distinguished from *B. nasiceus* by the finer, more rectilinear rostrum, and it always differs from *B. nasiceus* in having no bands or *vittæ*, the elytra being uniformly

spotted, as in *sparsus* Schoen. This is the species I breed from acorns, and I believe it also infests hazel-nuts." (Riley.)

Mr. F. Blanchard states that Dr. G. M. Lette has bred this weevil from acorns gathered in summer, and brought from Arizona. (Bull. Brooklyn Ent. Soc., vii, 107.)

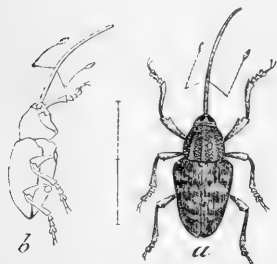


FIG. 69.—Acorn weevil, *Balanus rectus*.—After Riley.

*Beetle*.—First joint of antennæ longer than second; metasternum of male with a small, rounded, condensed patch of yellow scales each side of the median line. Femoral tooth small, the entering angle rounded.

206. *Balaninus nasicus* Say.

Professor Riley received from H. K. Morrison, Fort Grant, Ariz., July 26, 1882, a lot of acorns of *Q. grisea* infested by larvæ of the above insect, each containing apparently only one larva. The larvæ left the acorns as soon as received and entered the ground. They are yellow, head reddish brown, mandibles dark brown. The beetles issued from April 28 to May 21, 1883. (Unpublished notes.)

### 307. THE ACORN MOTH.

*Holocera glandulella* Riley.

Order LEPIDOPTERA; family TINEIDÆ.

The larva occupies the deserted holes of the acorn weevil. The imago is a narrow-winged moth which drops an egg in the hole, from which hatches a slender grayish white or yellowish worm with 16 legs and blue-black dorsal marks, with a light brown conical shield and dusky anal plate.

*Moth*.—With silvery-gray fore wings, marked with dull reddish; two distinct dark discal spots; a pale transverse stripe across the basal third of wing, slightly bent inwards at the middle; this stripe is well relieved behind by a dark shade, which

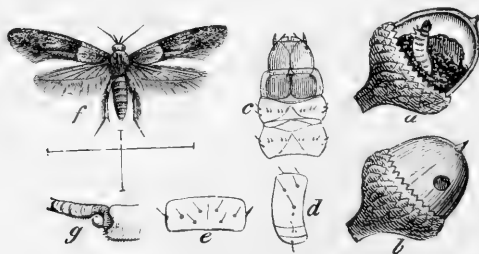


FIG. 70.—Acorn moth (f); a, b, acorns containing the worm; c, front end of the worm; d and e, side and top view of a segment.—After Riley.

generally extends from the bend to the costa above the discal spots, forming a more or less distinct triangular shade in the anterior middle portion of the wing. Hind wings brownish gray. Expanse of wings, 0.50-0.80 inch. (Riley.)

The following species of insects either habitually or occasionally occur on the oak.

## LEPIDOPTERA.

*Papilionidæ.*

308. *Basilarchia astyanax* (Fabr.).  
 309. *Basilarchia archippus* (Cramer).  
 310. *Papilio turnus* Linn. Larva found on the oak in Maine, August 18.  
 See, also, Scudder, Can. Ent., i, 74.  
 311. *Papilio glaucus* Linn. (Scudder).  
 312. *Thecla calanus* (Hübner). See hickory insects.  
 313. *Thecla liparops*. (Scudder).  
 314. *Thecla strigosa* Harris. (Coquillet in litt.), (Scudder).  
 315. *Thanaos brizo* Boisd. and Lec.

*Sphingidæ.*

316. *Smerinthus excæcatus* (Abb. and Sm.). Feeds on the oak (Riley's unpublished notes). See elm and willow insects.  
 317. *Daremma undulosa* Walker. Occasionally feeds on the white and red oak (Holland, Can. Ent., xviii, 102).

*Sesiidæ.*

318. *Sesia querci* (H. Edwards). From galls of live oak, Arizona (H. Edwards, Papilio, ii, 98).  
 319. *Sesia hospes* Walsh. Proc. Ent. Soc. Phil., vi, 1866, 270. Red by Walsh from a rough, black, woody polythalamous twig-gall occurring sparingly on black and red oaks.

*Hepialidæ.*

320. *Hepialus argenteomaculatus* Harris (Smith, Can. Ent. xx, 12, 233).

*Bombycidæ.*

321. *Callimorpha clymene* Esper. (Riley, 3d Rt. Ins. Mo., 134. "Larva found full-grown on oak, though whether it fed on oak I did not ascertain").  
 322. *Spilosoma virginica* (Fabr.), (Riley's notes). See butternut insects.  
 323. *Hyphantria textor* Harris. Abundant on the red oak. See elm insects.  
 324. *Halesidota tessellaris* (Hübner.) (Riley's notes.)  
 325. *Halesidota caryæ* Harris. (Beutenmüller, Ent. Amer., vi, 16, 1890.)  
 326. *Orgyia leucostigma*. On oak runners and other oaks (Abbot and Smith).  
 327. *Orgyia inornata* Beutenmüller. See cypress insects.  
 328. *Lithacodia fasciola* (Clem.). Found on the oak by Mr. Elliott. See maple insects.  
 329. *Thyridopteryx ephemeraformis* (Haworth). On oaks, willows, etc., Florida (Ashmead, Can. Ent., xviii, 97). See cedar insects.

330. *Datana angusii* G. and R. Occasionally feeds on the oak (Elliott).  
See hickory insects.
331. *Datana ministra* (Drury). Feeds on the oak (Riley, notes; also,  
Beutenmüller, Can. Ent., xx, 17). See hickory insects.
332. *Schizura unicornis* (Abbot and Smith), (Riley). See elm insects.
333. *Edemasia concinna* (Abbot and Smith), (Riley). See hickory in-  
sects.
334. *Heterocampa* (*Cecrita*) *guttivitta* Walk. On white oak, Providence,  
October 9. (Plate VI, fig. 1, 1a, 1b.)
335. *Platysamia cecropia* (Linn.). Feeds on the white oak (W. Brodie).  
See maple insects.
336. *Eacles imperialis* Hübner. Feeds on white, red, scarlet, burr, and  
pin oak (Beutenmüller). See pine insects.
337. *Hyperchiria io* (Fabr.). (L. W. Goodell, Can. Ent. ix, 180.)

#### *Noctuidæ.*

338. *Apatela americana* Harris (Coquillett, Papilio, i, 6). See maple in-  
sects. Also, Thaxter, Papilio, iii, 17.
339. *Apatela luteicoma* (Thaxter, Papilio, iii, 16).
340. *Apatela hamamelis* (Thaxter, Papilio, iii, 17; no descr.).
341. *Apatela lobeliæ* Guen. (Coquillett, in letter.)
342. *Scolecocampa liburna* Geyer. (Coquillett, in letter.)
343. *Catocala grynea* Cramer. (Coquillett, in letter.)
344. *Ingura* sp. indet. Most nearly resembling *I. delineata* (Riley in  
letter). Found in April on the live oak at St. Augustine, Fla.

#### *Pyralidæ.*

345. *Zanclognatha minivalis* Grt. Found July 23, 1882, in Virginia,  
several larvæ of a noctuid feeding on dead leaves of oak and  
maple. They commenced changing to pupæ July 26, and the  
moths issued from August 4-16, 1882. (Riley's unpublished  
notes.)
346. *Palthis asopialis* Guen. Found in Virginia, July 23, 1882, three  
larvæ of this Deltoid, feeding on dead leaves of oak. One larva  
spun up July 26 and the moth issued August 7, 1882. (Riley's  
unpublished notes.)
347. *Dakruma pallida* Comstock.
348. *Homoptera lunata* (Drury). (Lintner, Rep. iv, 58.)

#### *Phalænidæ.*

349. *Hibernia tiliaria* Harris. (Coquillett in letter.)

#### *Tortricidæ.*

350. *Tortrix rosaceana* Harr. Feeds on the leaves of apple, pear, and  
oak; also on black locust. (Riley's unpublished notes.)
351. *Cacæcia grisea* (Robinson). White oak (Miss Murtfeldt).



352. *Pandemis limitata* (Rob.). Oak, sassafras (Miss Murtfeldt).  
 353. *Tortrix albicomana* (Clem.). Oak (Miss Murtfeldt).  
 354. *Eccopsis inornatana* (Clem.). Leaves of white oak (Fernald).  
 355. *Lophoderus mariana* (Fern.). Oak ? (Fernald).  
 356. *Tmetocera ocellana* (Scniff.). Laurel oak (Miss Murtfeldt).  
 357. *Meliopus latiferreana* (Walsingham). Bred from acorns; either a genuine acorn-borer or inquiline. (Riley, Trans. St. Louis Acad. iv, 322.)

*Tineidæ.*

358. *Psilocorsis quercicella* Clemens's Tineidæ. Binds together the leaves.  
 359. *Blastobasis coccivorella* Chambers.  
 360. *Lithocolletis cratægella*. Oak-leaf roller; issued in April. (Riley's note-book vii, 358.)

The following species are said by Clemens and by Chambers to live on the leaves of various species of oak.

*Leaf-miners of the upper surface.*

361. *Lithocolletis cincinnatiella* Chamb. Yellowish blotch mine.  
 362. *Lithocolletis tubiferella* Clem. } Mines so as to form somewhat like  
 363. *Lithocolletis bifasciella* Chamb. } the track made by a drop of water.  
 364. *Lithocolletis bicolorella* Chamb. Yellowish blotch mine like that of *L. ulmella* in elm.  
 365. *Lithocolletis unifasciella* Chamb. } Irregular, yellowish blotch  
 366. *Lithocolletis bethuneella* Chamb. } mines, smaller than that of  
 367. *Lithocolletis castaneæella* Chamb. } *cincinnatiella*, and usually in red or black oaks.  
 368. *Tischeria zelleriella* Clem.  
 369. *Tischeria pruinosella* Chamb.  
 370. *Tischeria castaneæella* Chamb.  
 371. *Tischeria badiiella* Chamb. Bred from the oak. (Riley's unpublished notes.)  
 372. *Tischeria quercivorella* Chamb.  
 373. *Tischeria quercitella* Clem.  
 374. *Tischeria citrinipennella* Clem.  
 375. *Tischeria complanoides* Frey & Boll. (Doubtful species.)  
 376. *Tischeria concolor* Zeller. (Food plant uncertain.)  
 377. *Tischeria tinctoriella* Chamb.  
 378. *Nepticula platea* Clem. } Imago unknown. Larvæ of both in  
 379. *Nepticula anguinella*. } crooked, linear mines.  
 380. *Nepticula quercipulchella* Chamb. }  
 381. *Nepticula quercicastanella* Chamb. } Larvæ in crooked, linear mines.  
 382. *Nepticula saginella* Clem. }  
 383. *Coriscium* sp. Imago unknown.

384. *Coleophora querciella* Clem. Imago unknown. Larva lives in a case, which it attaches to the leaves.  
 385. *Coleophora discostrata* Walsingham, California.  
 386. *Catastega timidella* Clem. Imago unknown.  
 387. *Gelechia rubensella* Chambers. Feeds externally on the leaves. (Chambers in letter.)

*Leaf-miners of the under surface.*

- |   |                    |
|---|--------------------|
| 388. <i>Lithocolletis quercitorum</i> Frey & Boll. }                    | } Tentiform mines. |
| 389. <i>Lithocolletis fitchella</i> Clem.                               |                    |
| 390. <i>Lithocolletis basistrigella</i> Clem.                           |                    |
| 391. <i>Lithocolletis æriferella</i> Clem.                              |                    |
| 392. <i>Lithocolletis quercipulchella</i> Chamb.                        |                    |
| 393. <i>Lithocolletis quercialbella</i> Chamb.                          |                    |
| 394. <i>Lithocolletis fuscocostella</i> Chamb.                          |                    |
| 395. <i>Lithocolletis albanotella</i> Chamb.                            |                    |
| 396. <i>Lithocolletis obstrictella</i> Clem.                            |                    |
| 397. <i>Lithocolletis hageni</i> Frey & Boll.                           |                    |
| 398. <i>Lithocolletis argentifimbriella</i> Clem. }                     |                    |
| 399. <i>Lithocolletis intermedia</i> Frey & Boll. Doubtful species.     |                    |
| 400. <i>Lithocolletis mirifica</i> Frey & Boll. Doubtful species.       |                    |
| 401. <i>Ornix quercifoliella</i> Chamb. Under edge of leaf turned down. |                    |
| 402. <i>Coriscium albanotella</i> Chamb. Large tentiform mine.          |                    |

The following species either roll, fold, or sew the leaves together :

403. *Ypsolophus querciella* Chamb.  
 404. *Gelechia querciella* Chamb.  
 405. *Gelechia quercinigrælla* Chamb.  
 406. *Gelechia quercivorella* Chamb.  
 407. *Gelechia quercifoliella* Chamb.  
 408. *Cryptolechia quercicella* Clem.  
 409. *Machimia tentoriferella* Clem. Larva in a web.

The following species feed in galls :

410. *Gelechia gallægenitella* Clem.  
 411. *Ypsolophus quercipomonella* Chamb.  
 412. *Hamadryas bassettella* Clem.

COLEOPTERA.

413. *Artipus floridanus* Horn. Found commonly at Haulover Canal, Florida, feeding on leaves of oak and juniper. (Schwarz, Proc. Ent. Soc., Wash., i, 169.)  
 414. *Balaninus quercus* Horn. For an account, by J. Hamilton, of the habits, with description of the species, see Canadian Entomologist, Jan., 1890, 1-8.  
 415. *Balaninus nasiceus* Say. (*Ibid.*)  
 416. *Balaninus uniformis* Lec. (*Ibid.*)

417. *Hypothenemus dissimilis* Zimm. Boring, with the succeeding species, which may be the other sex, in oak twigs. (J. B. Smith, Ent., Amer., March, 1890, 54.)
418. *Hypothenemus erectus* Lec.
419. *Dicerca asperata* Lap. and Gory. (Chittenden, Ent. Amer., v, 218.)
420. *Prionus* (?) sp. Received January 20, 1881, from H. H. Rusby, a coleopterous larva found boring in a stick of oak at Silver City, N. Mex. The larva is evidently that of a species of *Prionus*. (Riley's unpublished notes.)
421. *Prionus californicus* (?). Received January 14, 1881, from Mrs. A. E. Bush, San José, Cal., the larva of some Longicorn found in "white oak," which in all probability is that of the above insect. Two others were received from the same person and locality in April. Not bred. (Riley's unpublished notes.)
422. *Pityophthorus minutissimus* Zimm. February 7, 1882. This insect was found at this date in large numbers, both in the imago and larva state, under the bark of a dry piece of oak wood. Their mines, as a rule, run parallel with the wood; rarely transversely. (Riley's unpublished notes.)
423. *Lachnosterna quercina* Knoch. Beetle devours the leaves of various trees at night. This beetle entirely denuded the pin and post oaks on W. C. Flag's place at Alton, this year. (Riley's unpublished notes.)
424. *Fidia* sp. June 25, found many *Fidia* beetles on oak and hickory eating large holes in their leaves. (Riley's unpublished notes.)
425. *Cryptocephalus notata*, Fabr. Feeding on oak, sassafras and elm. (Riley's unpublished notes.)
426. *Coscinoptera dominicana* Fabr. June 11, 1873, Riley records the beetles as found in copulation on young oak. The larva feeds, however, on dry leaves, and he has published a full account of the species. (6th Rep. Ins., Mo., pp. 127-132.)
427. *Centronopus calcaratus* Fabr. "Inhabits black oak stumps. It remains in pupa two weeks." (Horn.)
428. *Centronopus anthracinus* Knoch. May be taken in company with the preceding species. (Horn.)
429. *Acanthoderes 4-gibbus* Say. Bores in dead twigs of oak. (Schwarz.)
430. *Tragidion fulvipenne* Say. Bores in oak. (Riley.) The mode of egg-laying is described by Popenoe in *Insect Life*, ii, 192.
431. *Arhopalus fulminans* Fabr. Red oak. (Fitch & Hodge, also Riley.\*) See chestnut insects.
432. *Ataxia crypta* Say. Found by myself under the bark of the oak at Chattanooga, Tenn. (Identified by Dr. Horn.)

---

\* Numerous larvæ of this insect were found January 10, 1882, Washington, D. C., boring in dry red-oak wood. All the younger larvæ were working under the bark, the fully grown specimens, however, gnawed a channel into the solid wood for the purpose of pupation. By the 7th of February pupæ were found; the beetles commenced issuing the 13th of March. (Unpublished notes.)

433. *Agrius bilineatus* Say. At Providence, May 30, I found the pupæ under the bark of an oak trunk; the beetles were common on the leaves. Professor Riley found three pupæ in the bark of an oak stump. One of them transformed to the beetle May 18, and the second one May 31.
434. *Oncideres cingulatus* Say. Bores in the oak. (Hubbard.) See hickory insects.
435. *Neoptochus adspersus* Boh. This weevil feeds on oak. (Riley, Amer. Nat., November, 1882, 916.)
436. *Pachnæus distans* Horn. Feeds on oak and pine. (Riley, Amer. Nat., November, 1882, 916.)
437. *Systema blanda* Melsh. Lintner's Fourth Report, 155.

## ORTHOPTERA.

438. *Phaneroptera curvicauda*. Very common on the oak. (Riley's unpublished notes.)
439. *Diapheromera femorata* Say. See hickory insects. (Riley, Ann. Rept. Entom. Dept. Agric., 1879, pp. 241-245.)
440. *Œcanthus* sp. Larva on oak at St. Louis, July 1; pupated July 29. (Riley's unpublished notes.)

## HEMIPTERA.

441. *Lachnus quercifolia* Fitch.
442. *Callipterus hyalinus* Monell. On *Quercus imbricaria*.

NOTE.—Of undetermined species of insects living at the expense of the oaks, I have notes on 40 species of lepidopterous larvæ, whose transformations have not yet been worked out, and on 3 species of saw-fly larvæ, in addition to those mentioned in the previous pages.

Professor Riley also has reference to or notes on 40 species, viz: 10 species of Bombycidæ, 10 of Noctuidæ, 6 of Geometridæ, 2 Pyralidæ, 1 Tortricidæ, 7 Tineidæ, and 4 species of undetermined families; also 4 species of saw-fly larvæ, 10 species of Hemiptera, with notes of 140 undetermined species of Cynipidæ (some of which may already have been enumerated), carrying the number of species of oak insects known up to the end of 1889 to between 500 and 600 species.

## BEETLES LIVING IN ROTTEN WOOD, STUMPS, GALLS, ETC., NOT KNOWN TO BE INJURIOUS.

- Synchroa punctata* Newman. "They live in rotten oak stumps, thriving best in the white. The pupa requires about one week to perfect itself." (Horn.) The beetle is brown, sparsely covered with gray hairs; regularly punctured over the body, the punctures of medium size, distinct, not confluent, length, .5 inch; breadth, .1 inch. (Newman.)
- Ozognathus cornutus* Lec. Lives in oak galls. (Riley, notes.)

- Dendroides canadensis* Latr. Under bark of stumps and felled trees. (Riley, also Chittenden.)
- Cucujus clavipes* Fabr. Under bark of stumps and felled trees.
- Strongylium terminatum* Say. Larvæ of this insect were found January 12, 1882, at Washington, D. C., feeding in rotten oak wood. The full grown larva measures about 1 inch in length. They are polished, yellowish white, and cylindrical, the two last segments brownish yellow. Tip of last segment truncate, with two black, upward-curved horns. There is also on the dorsum of this segment a blackish transverse ridge divided at the middle, and each half beset with five or six short, sharp teeth. The beetle issued the 12th of June. (Riley's unpublished notes; see also, Schwarz, Amer. Nat., October, 1882, 823.)
- Mordella 8-punctata* Fabr. Larva found in old oak stumps. Color: Head yellowish white with three distinct yellowish lines above. Legs short. Tail pointed, horny and blackish brown. (Riley's unpublished notes.)
- Hymenorus communis* Lec. Found in Maryland, February 22, 1884, numbers of larvæ of above beetle boring in a rotten oak stump, the largest of which measured about 11<sup>mm</sup> in length. They are highly polished and pale yellow, the head and posterior margin of the thoracic and first three abdominal segments somewhat darker. A large squarish spot on the eighth and the greater anterior part of the last segment quite dark yellow; labrum brown; tip of body rounded. The first beetle issued May 1. (Riley's unpublished notes.)
- Pelidnota punctata* Linn. Lamellicorn larva in rotten oak stump. Riley has published a full account (3rd Rep. Ins., Mo., p. 319).
- Dinoderus punctatus* (Say). Boring in an oak stump; abundant; appears to be parasitized. (F. L. Chittenden in letter).
- Parandra brunnea* Fabr. Under bark. (Chittenden.)
- Ceruchus piceus* (Weber). In decaying oak wood. (Chittenden.)
- Nyctobates pensylvanicus* (De Geer). Under bark. (Chittenden.)
- Hypulus simulator* (Newman). In decaying wood. (Chittenden.)
- Osmoderma scabra* Beauv. In decaying oak wood. (Beutenmüller, Psyche v, 281, 1889.)
- Osmoderma eremicola* Knoch. (Coquillett in letter.)
- Athous cucullatus* Say. (Coquillett in letter.)
- Androchirus fuscipes* Mels. (Coquillett in letter.)
- Elater nigricollis* Herbst. (Coquillett in letter.)
- Lycus striatus* Melsh.
- Trogoxylon paralleopipedum* (Melsh.) The two latter species probably bore in dry oak wood, injuring furniture, etc. (Riley, Scientific American, Dec. 21, 1889.)

## CHAPTER II.

### INSECTS INJURIOUS TO THE ELM.

No shade tree is held in higher estimation than the elm. It is the pride of New England and New York towns and villages, as well as those of the northern, central, and middle Atlantic States. Kaltenbach enumerates 107 species of insects which in Germany live at the expense of the elm, while in this country we have about 80 species, the elm not occurring in the Rocky Mountains or on the Pacific coast.

The species which are the most abundant and persistent in their attacks are the common elm-tree borer, the canker-worm, and a plant-louse which disfigures the leaves by crumpling and discoloring them.

#### AFFECTING THE TRUNK.

##### 1. THE COMMON ELM-TREE BORER.

*Saperda tridentata* Olivier.

Order COLEOPTERA ; Family CERAMBYCIDÆ.

Perforating and loosening the bark and furrowing the surface of the wood with their irregular tracks, flat white longicorn borers, changing to beetles in June and July; the beetles flat, dark brown, with a longitudinal three-toothed red stripe on the outer edge of each wing-cover.

This is the most destructive borer of the elm in the Northern and Eastern States, often killing the trees by the wholesale. Great numbers of the larvæ of different sizes have been found boring in the inner bark and also furrowing with their irregular tracks the surface of the wood, the latter being, as it were, tattooed with sinuous grooves, and the tree completely girdled by them in some places. The elms on Boston Common have in former years been killed by this borer, and valuable trees, we have been informed, have been killed by them in Morristown, N. J. It has been found in all stages in the elm at Detroit, Mich., by Mr. H. G. Hubbard.

Fitch remarks that it consumes the inner bark of the slippery elm (*Ulmus fulva*), especially in dead and decaying trees. According to him, "the beetle deposits its eggs upon the bark in June, and the young larvæ therefrom nearly complete their growth before winter, and soon after warm weather arrives the following spring they pass into their pupa state." We have found the larvæ in abundance in the early spring in Providence in old dead elms.

More recently the ravages of this borer have been observed by Professor Forbes, whose notes we copy from his third report on the injurious insects of Illinois.

For several years past my attention has been attracted by the gradual decay and death of the rows of white elms (*Ulmus americana*) in the towns of Normal, Bloomington, and Champaign. The difficulty with the trees commonly commences to declare itself from the middle of summer to autumn, when the leaves, first upon the terminal twigs and then upon the larger branches, are seen to stop their growth, change their color, and ultimately to fall. This loss is naturally followed speedily by the death of the branches themselves, as is clearly evident the following spring, when these remain black and lifeless while the rest of the tree is putting on its foliage. Usually the higher branches of the tree are those first affected, but the whole top soon seems to blight, and in a year or two the tree perishes utterly. This difficulty, commencing here and there, extends slowly from tree to tree along the rows, finally inevitably destroying every tree of this species in the immediate vicinity.

In autumn of 1883, I directed an assistant, Mr. Webster, to dig up a tree which had nearly died in this manner during the summer, and to carefully examine the larger roots, the trunk, and all the branches, with a view to ascertaining, if practicable, the cause of the difficulty. The roots were found unaffected, but on peeling the bark from the trunk, about half-grown larvæ of *Saperda tridentata* appeared in considerable numbers in the still living parts of the wood, and those of *Magdalis armicollis* were abundant where the bark and wood were already dead. The manner in which the bark had been mined and burrowed by the Saperdas gave sufficient evidence of the cause of the death of the tree, the borers having again and again completely girdled the trunk.

Both the trunk and branches of this tree were cut up in lengths and boxed for the purpose of determining the details of the life history of the species. The specimens were boxed August 8, the cracks of the boxes being closed by pasting over them strips of paper, and each having left a glass-covered opening in the top, to which it was assumed that the insects emerging would be attracted. Later, this cover was removed, and a glass jar was inverted over the opening.

Nothing emerged until the following spring, except a single parasite taken September 14. On the 9th of April, living larvæ of *Saperda* were found still within the wood, but no imago had appeared in the boxes, neither were any pupæ discovered. On the 17th of that month, both larvæ and pupæ were detected, and on the 2d of May the first imago appeared, three in number. On the 3d another imago emerged, on the 5th five more, and on the 7th eighteen, on the 8th eleven, and on the 12th twenty-three, this being the largest number taken from the boxes at once. Beetles continued, however, to emerge at frequent intervals until the 22d of June, at which time the last appeared, one hundred and eighteen in all having been taken alive. On the 15th of September the boxes were opened finally, thoroughly searched, and fifty-three more dead *Saperdas* were found. The boxes in which these specimens transformed had been kept under cover, but at the natural temperature of the air.

Although the elm borer has evidently been for several years both numerous and increasing in the neighborhood where this tree was destroyed, the amount of parasitism developed by the experiments was quite insignificant, only eight parasitic insects, belonging to three species, appearing in the boxes as against the one hundred and seventy-one examples of the adult borer; and indeed, as the same pieces of wood contained a great host of the larvæ of *Magdalis armicollis*, from which multitudes of imago of this species emerged during this spring, it is impossible to say that some or most of this small number of parasites may not have escaped from the latter species.

From the present appearance of the elms throughout the towns of Central Illinois where I have had an opportunity to examine their condition, and from the rapid progress which this pest has made among them during the last two or three years, it seems extremely likely that it will totally exterminate the trees unless it be promptly

arrested by general action. The only remedy available is unquestionably the destruction of affected trees in autumn and winter before the beetles have a chance to emerge from the trunks. In towns this measure should usually be taken by the authorities, since individual action could not be depended on to more than palliate the difficulty. If every elm which is in the unhealthy condition above described, and which, upon examination, is found to harbor these borers beneath the bark, were cut down in autumn and burned before spring, the multiplication of the borer might be effectually checked; but if the destruction of the trees be postponed until as late as May, a part of all of the beetles maturing each year would escape to carry the mischief elsewhere. (Forbes).

*The larva.*—White, subcylindrical, a little flattened, with the lateral fold of the body rather prominent; end of the body flattened, obtuse, and nearly as wide as the

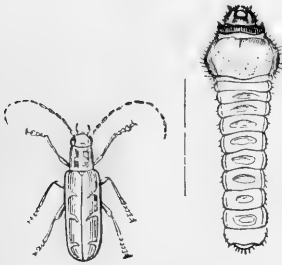


FIG. 71. Larva (from life) and adult of the elm-tree borer.—From Packard.

end as at the first abdominal ring. The head is one-half as wide as the prothoracic ring, being rather large. The prothoracic segment, or that next to the head, is transversely oblong, being about twice as broad as long; there is a pale dorsal corneous transversely oblong shield, being about two-thirds as long as wide, and nearly as long as the four succeeding segments; this plate is smooth, except on the posterior half, which is rough, with the front edge irregular, and not extending far down the sides. Fine hairs arise from the front edge and side of the plate, and similar hairs are scattered over the body and especially around the end. On the upper side of each segment is a transversely oblong ovate roughened

area, with the front edge slightly convex, and behind slightly arcuate. On the under side of each segment are similar rough horny plates, but arcuate in front, with the hinder edge straight.

It differs from the larva of *Saperda vestita* Say in the shorter body, which is broader, more hairy, with the tip of the abdomen flatter and more hairy. The prothoracic segment is broader and flatter, and the rough portion of the dorsal plates is larger and less transversely ovate. The structure of the head shows that its generic distinctness from *Saperda*, originally insisted on by Mulsant, may be well founded, as the head is smaller and flatter, the clypeus being twice as large, and the labrum broad and short, while in *Saperda vestita* it is longer than broad. The mandibles are much longer and slenderer, and the antennae are much smaller than in *Saperda vestita*.

*Beetle.*—A rather flat-bodied, dark-brown beetle, with a rusty-red curved line behind the eyes, two stripes on the thorax, and with a long red stripe on the outer edge of each wing-cover, with three long points projecting inwards; 0.50 inch in length.

## 2. THE RED-EDGED SAPERDA.

*Saperda lateralis* Fabricius.

Order COLEOPTERA; family CERAMBYCIDÆ.

Mining the inner bark of dead trees and logs of the common elm, a grub very similar to the foregoing, and about the 1st of June producing a similar beetle, but differing in wanting the transverse teeth or points arising from the marginal stripe on the wing-covers. (Fitch.)

## 3. *Saperda vestita*.

Found on the elm. This borer is destroyed by the larva of *Bracon charus* Riley, a specimen of which was taken from a larva found on the above-named tree. (Riley's unpublished notes.) See linden insects.



## 4. THE SIX-BANDED DRYOBIUS.

*Dryobius sex-fasciatus* Say.

Order COLEOPTERA; family CERAMBYCIDÆ.

A similar but larger grub than that of *Saperda tridentata*, but found with it, producing a black beetle of nearly similar form, with the edge of the thorax yellow, and also its scutel, with four yellow equidistant oblique bands on its wing-covers, the last one situated at the tip. Length 0.70 inch. (Fitch.) It also occurs on the beech, according to C. G. Siewers.

## 5. THE DARK ELM BARK-BORER.

*Hylesinus opaculus* Leconte.

Order COLEOPTERA; family SCOLYTIDÆ.

Making small perforations like pinholes, appearing in the bark, especially of diseased elms, from which, in August and September, issues a minute cylindrical bark-beetle of a dark-brown color; its wing-covers with deeply impressed punctured furrows and short hairs; its thorax also punctured. Length 0.10 or less. (Harris.)

We have not observed this bark-borer, but Mr. Wm. L. Devereaux, of Clyde, N. Y., writes as follows regarding the true name of the beetle:

I think Harris mistaken about the occurrence of *P. liminaris* on elm. It must have been *H. opaculus*; at least I never have found *liminaris* under or on the bark.\*

This is a stout pitchy-black timber-beetle, living under the dry bark of the elm and ash trees. (Riley.)

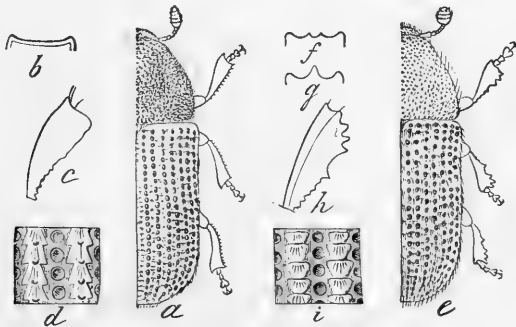


FIG. 72 a-d.—The dark elm bark-borer.—After Riley.

*The beetle.*—Stout, opaque, when mature of a uniform piceous-black color. Head punctulate, not narrow in front, without transverse impressions in front of the eyes. Epistoma (Fig. 72b) truncate or very slightly and broadly emarginate. Labrum visible. Antennal club very large, oblong-oval, the first two joints shining and pubescent only at apex. Thorax wider than long, very densely punctate; pubescence moderately thick and short. Elytral striae (Fig. 72d) evidently impressed and regularly, coarsely punctate; interstices very distinct, each with a regular row of small tubercles, which become more acute toward the apex and the sides. Pubescence very coarse and short. Tibiae (Fig. 72e) hardly dentate. (Riley's Rep. Ent. Dep. Ag. 1879, p. 45. The other figures illustrate *H. trifolii*.)

\* See also Mr. Schwarz's note in Proc. Ent. Soc. Wash., i, 149.

## 6. THE SHORT-LINED DULARIUS.

*Dularius brevilineus* Say.

Order COLEOPTERA; family CERAMBYCIDÆ.

FIG. 73.—*Dularius brevilineus*.—From Packard.

Boring in partly dead or dry elms, the larva of a pretty longicorn, with deep purplish-blue wing-covers bearing three short white lines in the middle.

This beetle was first bred from the dry wood of the elm by Riley, the larvæ occurring in Ohio; the beetle appearing in May and June. It was also known, by the late Mr. G. D. Smith, to inhabit this tree, probably in the vicinity of Boston; it was noticed in our second Massachusetts Report, page 18. Mr. George Hunt has observed this beetle on the bark of an elm at Plymouth, N. H., in the middle of July, inserting its eggs in the crevices of the bark.

*The beetle.*—It is a singular-looking beetle, with a round, flattened prothorax, and wing-covers contracted in the middle, and not covering the tip of the abdomen, while the thighs are unusually swollen. The antennæ are about two-thirds the length of the body, flattened towards the end, and somewhat serrate. The body above is velvety black, and brown-black beneath. The head is black and coarsely punctured, and the prothorax is covered with short, dense, black hairs, like velvet. The wing-covers are Prussian blue in color, bent, corrugated, with an interrupted ridge just outside of the middle of each cover. They are covered with fine black hairs, bent over. There is a pair of parallel, short honey-yellow lines in the middle of each wing-cover, with a third one a little in front, making in all six streaks. The legs and feet are black. It is a little over eight-tenths of an inch in length.

7. *Neoclytus erythrocephalus* Fabricius.

Order COLEOPTERA; family CERAMBYCIDÆ.

This insect was found in company with *Magdalis armicollis* under the bark of a dead elm at Detroit, Mich., by H. G. Hubbard; and also has been raised from hickory-wood by Dr. Horn.

8. *Neoclytus capræ* Say.

This insect was found in all stages in the fall of 1875 in felled trunks of elm and hickory by George Waite, of Emporia, Kans. (Riley's MS. notes.)

9. *Magdalis armicollis* Say.

Order COLEOPTERA; family CURCULIONIDÆ.

According to LeBaron (Fourth Rep. Ins. Illinois, 139) this weevil, which is allied to the *Magdalinus* of the oak (Fig. 29), inhabits the elm, living under the bark. Mr. H. G. Hubbard has also found it boring in the elm, and has bred from the larvæ four species of parasites. (*Psyche* ii, 40.)

The burrows were about an inch and a half long, running generally with the grain, and in the cambium layer throughout their entire length. From the cell at the end an exit pierced the bark as far as the thin outer layer. The beetles usually attacked the upper branches, but several small elms were found with the bark of the trunk undermined nearly to the ground. Occasional specimens were found associated with *Saperda tridentata* and *Synchroa punctata* in the thick bark of full-grown trunks. Of the three parasites the more common one was a Chalcid, probably belonging to the genus *Storthygacerus* of Ratzburg, which preys upon the larvæ of *Magdalinus*, completing its transformations in advance of the beetle.

*The beetle.*—Body reddish, punctured; head punctured, an obsolete impression between the eyes; a dilated, impressed, abbreviated line over the insertion of the antennæ, sometimes obsolete or wanting; thorax with much dilated confluent punctures; a polished longitudinal line near the middle; anterior angles with small, erect spines, of which the anterior one is largest; posterior angles slightly excurved, anterior and lateral margins dull rufous; elytra light rufous, profoundly striated; striæ with approximate punctures; thighs, with a robust spine beneath, near the tips. Length from the eyes to tip of the wing-covers one-fifth of an inch. Var. a. Thorax and beneath, excepting the feet, black. (Say.)

10. *Buprestis (Anthaxia) viridicornis* Say.

Order COLEOPTERA; family BUPRESTIDÆ.

This buprestid is reported by Mr. H. G. Hubbard as infesting the elm. (*Psyche*, ii, 40.)

*The beetle.*—Head and thorax coppery red; antennæ green; eyes rather large; thorax transversely indented each side behind the middle; reddish coppery, surface reticulated; posterior edge rectilinear; scutel triangular; wing-covers obscure or slightly brassy, slightly rugose, destitute of striæ, rounded at tip, entire or obsoletely serrated; beneath dark, brassy, brilliant; tail rounded, entire. Length rather more than one-fifth of an inch. (Say.)



FIG. 74.—*Anthaxia viridicornis* Smith and Marx del.

11. *Synchroa punctata* Newman.

Order COLEOPTERA; family MELANDRYIDÆ.

This insect has been found "exceedingly abundant" by Mr. H. G. Hubbard in the bark of the elm. (*Psyche*, ii, 40.)

*The beetle.*—The form is elongate, like an Elaterid of the genus *Melanotus*, coarsely punctured and pubescent; the head is prominent and horizontal; the maxillary palpi are moderate in length and but slightly dilated; the antennæ are long, slender, and feebly serrate, and the third joint is not longer than the fourth; the anterior coxæ are oval and separated by the prosternum, which is also slightly prolonged; the middle coxæ are equally separated; the hind coxæ are less distant; the tarsi are filiform and the claws simple; the tibial spurs are long. (Leconte.) It is brown, and five-tenths of an inch in length.

12. THE TREE-CRICKET.

*Ecanthus niveus* Serville.

Order ORTHOPTERA; family GRYLLIDÆ.

Boring into the corky bark of the elm in the Southern States, inserting its eggs irregularly, not in regular series as when it oviposits in the stems of the blackberry, raspberry, grape, etc.; a slender pale-green cricket, with white wings and a large ovipositor; the males shrilling loudly.

The eggs of the tree-cricket begin to develop as soon as they are laid in the early autumn, and the embryo partially develops, so that the rudimentary limbs may be seen, as well as the mouthparts; the insect completes its development in the early part of the following summer, appearing early in August.

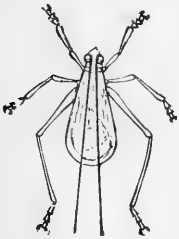


FIG. 75. Male tree-cricket.—After Harris.



FIG. 76. Female tree-cricket, natural size.—After Harris.

AFFECTING THE LEAVES.

13. THE SPRING CANKER WORM.

*Paleacrita vernata* (Peck).

Order LEPIDOPTERA; family PHALENIDÆ.

Very injurious to the elm in the Eastern States, stripping the trees; a dark-striped measuring worm varying in color to pale green, transforming from the middle to the last of June in the earth to a pupa, some appearing in the autumn, but most abundantly in March; the female grub-like, the male winged.

Originally confined, as an injurious insect, to New England, it is now destructive in the Western States (Illinois and Missouri) and must originally have occurred all over the United States east of the Mississippi, as I have received it from Texas.

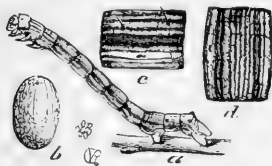


FIG. 77. Spring Canker worm; b, eggs; c, side; d, back of a segment.—After Riley.



FIG. 78. a, female Spring canker-worm moth; b, male; c, antennæ joints of female; d, one of female abdominal segments; e, ovipositor.—After Riley.

About the 1st of May, at the time when the leaves of the apple are unfolding, the young canker worms break through the eggs, which have

been laid earlier in the season, in March and April, in patches on the bark of the trunk and limbs. They may be soon found clustering on the terminal buds and partly unfolded leaves, and are then about a line in length, and not much thicker than a bit of thick thread. Fortunately, owing to the want of wings, the female is exceedingly sedentary, and year after year the apple and elm trees of particular orchards and towns are defoliated and turned brown, while adjoining orchards and towns scarcely suffer. By the 20th of June, in Essex County, Mass., the orchards or shade elms infested by them look as if a fire had run through them. At that date the worms are fully fed, and they then descend to the ground, letting themselves down by a silken thread. At this time I have destroyed thousands by jarring the tree and collecting those which fall down. I have watched old and young robins busily engaged in eating them, and from the number of toads in my garden, gathered under the trees, I feel confident that they eat multitudes of them.

The worms at once enter the ground, change to chrysalids several inches below the surface, near the trunk of the tree, and there remain until the early days of March and April, when the wingless females ascend the trees, and the winged males may be seen fluttering about.

I took pains one spring, in the middle of April, to count the number of these moths on my apple trees, fourteen in number, averaging from six to seven inches in thickness, besides three elms. They were more abundant on the apple trees than on the elms. But on those seventeen trees there were counted, adhering mostly to the tarred paper, one thousand males and two hundred females. The spring of 1875 was cold and backward and few moths were seen before this date. From these data we can ascertain approximately the relative numerical proportions between the sexes, which seems to approximate five males to one female.

The species I have referred to is the spring moth, the *Paleacrita vernata* of Peck, but not of Harris. *A. pometaria* is much less abundant in the adult condition, and only appears in the autumn. The wings are thicker than those of *vernata*, and the caterpillar has an additional pair of prop-legs, though so short as to be useless. I find that most of the damage is done by the caterpillars of *vernata*. On June 15, 1875, I collected five hundred and fifty-seven caterpillars from the apple trees in my garden. Of these, five hundred and twenty were *vernata*, and twenty-seven were the young of the autumn species. Peck, in his account published in 1795, states that *vernata* does the principal damage.\*

*Remedies.*—The use of printer's ink laid on tarred paper is the cheapest, though the ink should be applied every day or two. The use of tin troughs of oil surrounding the tree is almost sure to stop the ascent of the females, while wooden troughs of oil built around the bottom of the

\*It is probably this species which I have found feeding on the leaves May 30 and June 1, at Providence. It is a reddish-green obscurely striped larva, much like the canker-worm in form and size, but a little stouter.

trunk are almost equally efficacious. Care and attention, and, above all, co-operation among those suffering from these worms, will enable us to check their ravages.

#### 14. THE ELM SPAN-WORM.

*Eugonia subsignaria* (Hübner).

Order LEPIDOPTERA; Family PHALENIDÆ.

Hatching from the eggs as soon as the leaves unfold and living unobserved for a week or two on young shoots in the tree tops, measuring or span worms, resembling the twigs of the elm in color, with a large red head, and the terminal ring of the body bright red; pupating towards the end of June, and during July and August transforming into a snow-white moth.

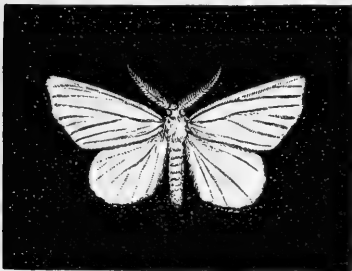


FIG. 79.—Elm span-worm moth, natural size.—After Emerton, from Packard.



FIG. 80.—Elm span-worm, natural size.—After Emerton, from Packard.

This insect is widely spread. I have observed it in the forests of northern Maine in August, and it is common in the Middle States. It is very destructive to the elms in New York City, Brooklyn, and Philadelphia, though not known to be destructive in the country. The moth may at once be recognized by the snow-white body and wings, the anterior pair being angular and the hinder pair slightly notched. It is, according to Fitch, still more destructive to the linden than to the elm.

From a pamphlet by H. A. Graef and Edw. Wiebe, entitled "The measure-worm, a description of the insect, in all its metamorphoses, etc." (Brooklyn, 1862), we quote the following facts:

The eggs are deposited by the female moth toward the beginning of July, not only on trunks and branches of early-leaving trees, but also on numerous other objects, to the number of from 20 to 250, in irregular clusters. During this period they are about the size of a small pin's head, conical in form, and somewhat compressed at their points; first of a yellowish, then of a light olive green, and later of a dark brown. They are covered with a thick, sticky glutinous matter and adhere strongly to the object on which they are deposited. They are usually found on the under side of branches, and almost always below the connecting points of the same, apparently for their better protection and with the design of opening several avenues for the young brood to find subsistence. The number of eggs generally decreases from the base of the branches towards their extremities.

In this state the eggs remain unaffected by rain or frost, seemingly unchanged, until the time when our shade trees unfold their first leaflets, which (subject to the weather) is usually between the 15th of April and the 15th of May.

Little caterpillars then creep from these eggs, eagerly enjoying the rays of the sun on warm days, and carefully hiding themselves under the young foliage for protection on cold and stormy days. Here we find them crowding together in countless numbers; until after a very brief period they engage in their work of destruction. The young caterpillars always creep towards the extremities of the branches, led by

their instinct to find there, first of all, the means for their subsistence, and make a retrograde movement only if they meet with any obstacle. They then devour the young foliage as quickly as it develops, so much so that often a fortnight suffices to render a tree entirely leafless.

For their perfect development the caterpillars need from five to six weeks, during which period they sometimes eat daily more than ten times their own weight. It is then that they are most troublesome to us, partly, and chiefly, by their destruction among our shade trees; partly by the considerable amount of an unpleasant matter which they drop; and last, but not least, by the terror which, in their state of suspension, or dropping from the trees, they are apt to create among our ladies.

After the caterpillar is fully developed, and has, in the mean time, accomplished its work of destruction, it enters its chrysalis state. When ready to be metamorphosed it selects a safe place of refuge, either in the leaf remnants or on the trunks and branches of the trees, on fences, railings, lamp-posts, or almost anything it happens to reach.

*Larva*.—The caterpillar closely resembles the twigs of the elm trees, on the leaves of which it lives, the body being brown, while the large head and terminal segment of the body are bright red.

*Remedies*.—Messrs. Graef and Wiebe removed from a single small maple tree in Brooklyn 60,000 fertilized eggs, and it is obvious that their suggestion to carefully scrape shade and ornamental elms in the winter months, if thoroughly carried out, would materially diminish the number of this great pest. Besides this, tarring, *i. e.*, rings of tarred paper, smeared over with printer's ink, should be placed around the trunks and larger branches as early as the middle of April. When the leaves are much infested they should be sprayed in the manner indicated in the introduction to this report.

#### 15. THE NOVEMBER MOTH.

*Epirrita dilutata* (Hübner).

Order LEPIDOPTERA; Family PHALENIDÆ.

Feeding on the leaves in spring; a dirty-green measure-worm, beneath paler bluish white, its breathing pores forming a row of orange-red dots along each side, where is sometimes also a yellow line; entering the ground in summer, the moth appearing in November. (Fitch.)

In our monograph of the *Phalenidæ* we had overlooked the fact that Fitch had observed this moth in New York, flying slowly in forests in November. It appears to be more abundant in sub-arctic regions than in New England, as we have received numerous specimens of it from Newfoundland, and it has also been obtained in Labrador. It is probable that it will rarely occur in injurious numbers on elm trees in New England. In Europe, according to Newman, "it feeds on white-thorn, black-thorn, horn-beam, sloe, oak, and almost every forest tree, and is full-fed in June." Our species in British America, probably like *E. cambricaria*, will be found feeding on the mountain ash, a common tree in Labrador and Newfoundland.

*Moth*.—A much larger species than *E. cambricaria*, which is more common, and which also occurs in Northern Europe. It may always be distinguished from the other species of the genus by the simple not pectinated male antennæ. The body and wings are pale ash-gray; fore wings with eight well-defined sinuous or scalloped blackish lines, most distinct on the costa and veins; the basal line is heavy, and bent rectangularly between the subcostal and median veins; the next line, rather remote

from the basal, curves inward on the subcostal vein, and outward on the median space; the two lines beyond are approximate, but less sinuous; the fourth line from the base of the wings is broad, diffuse, twice as broad on the costa as the three others; beyond this line is a clear median space, in the middle of which is the distinct discal dot; beyond are four more or less distinct lines, of which the outer (or submarginal) is most distinct and regularly scalloped; a marginal row of twin black dots; fringe whitish. Hind wings with traces of four scalloped lines, the marginal one the heaviest. Expanse of wings, 1.60 inches.

## 16. THE IMPORTED ELM-LEAF BEETLE.

*Galeruca xanthomelana* Schrank.

Order COLEOPTERA; Family CHRYSOMELIDÆ.



FIG. 81.—*Galeruca xanthomelana*: a, eggs; b, larva; c, adults; e, eggs (enlarged); f, sculpture of eggs; g, larva (enlarged); h, side view of greatly enlarged segment of larva; i, dorsal view of same; j, pupa (enlarged); l, portion of elytron of beetle (greatly enlarged).—After Riley.

The following account of this pest is taken from Professor Riley's pamphlet forming Bulletin 6 of the U. S. Department of Agriculture. It contains a full account of the imported elm-leaf beetle, and of the best means of attacking it, which will be welcome, as for several years past the elms of many towns and cities in the Middle Atlantic States have been ravaged by this pest.

According to Glover this beetle was imported from Europe as early as 1837. It somewhat resembles the striped cucumber beetle (*Diabrotica vittata*) in size and markings. The grub or larva is long, almost cylindri-



cal, yellowish black, with black spots, and a wide yellow line along the back and sides.

The worm is destructive to the foliage from May until August, skeletonizing the leaves. When fully grown it descends to the ground, and changes to a chrysalis, under leaves, etc., near the base of the tree. While the beetle, of which there are three to four broods, also injures the leaves, it is by no means so destructive as its young :

*Remedies.*—Glover suggested the use of oil and tar gutters, and other barriers, surrounding the base or the body of the tree, devices similar to those used against the canker worm and codling moth. He recommended that there be placed around each tree small, tight, square boxes or frames a foot or eighteen inches in height, sunk in the ground, the earth within the inclosure to be covered with cement, and the top edge of each frame to be covered with broad, projecting pieces of tin, like the eaves of a house or the letter T, or painted with some adhesive or repellent substance, as tar, etc. The worms, descending the tree, being unable to climb over the inclosure, would change into helpless chrysalids within the box, where they could daily be destroyed by thousands. Those hiding within the crevices of the bark of the trunk could easily be syringed from their hiding places.

“I found that the quickest and most satisfactory way of destroying the insect, which has nearly the same habits as the Colorado potato beetle, except that it does not propagate in the ground, is to syringe the trees with Paris green and water, though London purple may prove just as effectual and cheaper.

“The syringing can not be done from the ground except on very young trees, though a good fountain pump will throw a spray nearly 30 feet high. Larger trees will have to be ascended by means of a ladder, and the liquid sprinkled or atomized through one of the portable atomizers, like Peck’s, which is fastened to the body, and contains three gallons of the liquid.

“The mode of pupation of the insect under the tree, on the surface of the ground, beneath whatever shelter it can find, or in the crevices between the earth and the trunk, enables us to kill vast numbers of the pupæ and transforming larvæ by pouring hot water over them. We found that even Paris green water poured over them also killed. If the trees stand on the sidewalks of the streets the larvæ will go for pupation in the cracks between the bricks or at the base of the tree, where they can also be killed in the same way. This mode of destruction is, take it all in all, the next most satisfactory one we know of, though it must be frequently repeated.

“We have largely experimented with a view of intercepting and destroying the larvæ in their descent from the tree. Troughs, such as are used for canker-worms, tarred paper, felt bands saturated with oil, are all good, and the means of destroying large numbers. Care must be taken, however, that the oil does not come in contact with the trees, as it will soon kill them, and when felt bandages are used there should be a strip of tin or zinc beneath them. The trouble with all these intercepting devices, however, is that many larvæ let themselves drop down direct from the tree, and thus escape destruction.”

The London purple (one-half pound), flour (three quarts), and water (a barrel, forty gallons), were mixed as follows: A large galvanized iron funnel, of thirteen quarts capacity, and having a cross septum of fine wire gauze, such as is used for sieves, also having vertical sides and a rim to keep it from rocking on the barrel, was used. About three quarts of cheap flour were placed in the funnel and washed through the wire gauze by water poured in. The flour, in passing through, is finely divided, and will diffuse in the water without appearing in lumps. The flour is a suitable medium to make the poison adhesive. The London purple is then placed upon the gauze and washed in by the remainder of the water, until the barrel is filled. Three-eighths of a pound of London purple to one barrel of water may be taken as a suitable percentage. Three-eighths of an ounce may be used as an equivalent in one bucketful of water.

Paris green injures the tree more than the London purple. Three-fourths of a pound of Paris green to a barrel (thirty-six or forty gallons) of water, with three quarts of flour or three-quarters of an ounce of Paris green to a bucket of water, may be regarded as a poison mixture of medium or average strength for treating elms affected by these beetles.

When many trees are to be sprayed a cart or wagon may be used to haul the poison in a large barrel provided with a stirrer, force pump, skid, etc. The force pump was described and figured in the annual report of the entomologist for 1882. It is double-acting and very powerful, giving strong pressure to disperse the liquid far and finely, and about a pailful of poisoned water was sprayed upon each tree. When only two or three were to be treated an aquapult or other bucket pump was used to force the poison from a bucket carried by hand. Connected with either pump is a long flexible pipe, with its distal part stiff, and serving as a long handle whereby to hold its terminal nozzle beneath the branches or very high up at a comfortable distance from the person managing it. To the hose is attached a bamboo pole, the partitions of which may be burned out with a hot iron rod. With this apparatus a tree can be quickly sprayed, and a large grove or row of trees along a street treated in a short time. It is equally adapted for forestry use in general, and for orchards, when the trees are not in fruit.

*The egg.*—In each group (Fig. 81 *e*, magnified), and so firmly fastened to the leaf that they can only be detached with great care without breaking the thin and brittle shell. The number of eggs in each group varies from four or five to twenty or more. Very rarely only three eggs are seen in one group, but we never found less than that number. The egg itself is oblong oval, obtusely, but not abruptly, pointed at tip, of straw yellow color, its surface being opaque and beautifully and evenly reticulated, each mesh forming a regular hexagon, as shown, highly magnified, in Fig. 81 *f*. The form of the eggs is not quite constant, some of them, especially those in the middle of a large group, being much narrower than others. The duration of the egg state is about one week.

*Larva.*—The general shape of the larva is very elongate, almost cylindrical, and distinctly tapering posteriorly in the early stages, but less convex and of nearly equal width when mature. The general color of the young larva is yellowish-black, with the black markings comparatively larger and more conspicuous, and with the hairs arising from these markings much longer and stiffer than in the full-grown larva. With each consecutive molt the yellow color becomes more marked, the black markings of less extent and of less intense color, and the hairs much shorter, sparser, and lighter in color. A nearly full-grown larva is represented in Fig. 80 *g*, and in this the yellow color occupies a wide dorsal stripe and a lateral stripe each side. The head (excepting the mouth-parts and anterior margin of the front), the legs (excepting a ring around the trochanters), and the posterior portion of the anal segment are always black. The first thoracic segment has two large black spots on the disk, of varying extent, and often confluent. The following segments (excepting the anal segment) are dorsally divided by a shallow transverse impression into two halves, and the black markings on these halves are arranged as follows: two transverse dorsal markings, usually confluent, as shown in our figure; two round and sublateral spots; the tips of the lateral tubercles are also black. The abdominal joints of the ventral surface have each a transverse medial mark, and two round sublateral spots of black color. Stigmata visible as small umbilicate spots between outer sublateral series of dorsal markings and lateral tubercles. The yellow parts of the upper side are opaque, but those of the under side shining. The black markings are polished, piliferous, and raised above the remaining portions of the body.

*Pupa.*—Of brighter color than the larva, oval in shape, and strongly convex dorsally. It is sparsely covered with moderately long but very conspicuous black bristles, irregularly arranged on head and thorax, but in a transverse row on each following segment. The pupa state lasts from about six to ten days.

*The beetle.*—(Fig. 81 c, natural size ; k, magnified). Resembles somewhat in appearance the well-known striped cucumber-beetle (*Diabrotica vittata*), but is at once distinguished by the elytra not being striate punctate, but simply rugose, the sculpture under a high magnifying power being represented in Fig. 81 l. The color of the upper side is pale yellow or yellowish-brown, with the following parts black: on the head a frontal (often wanting) and a vertical spot; three spots on the thorax; on the elytra a narrow stripe along the suture, a short, often indistinct scutellar stria each side, and a wider humeral stripe not reaching the tip. Under side black, pro- and meso-sternum and legs yellow; femora with a black apical spot. Upper and under side covered with very fine, short, silky hairs. In newly-hatched individuals the black markings have a greenish tint; the humeral stripe varies in extent. (Riley).

## 18. THE ELM GALERUCA.

*Galeruca californiensis* (Linnæus).

Order COLEOPTERA ; Family CHRYSOMELIDÆ.

Thick, cylindrical, blackish, six-footed grubs, often wholly defoliating the trees, and changing into an oblong oval beetle a quarter of an inch long, of a grayish yellow color, with three small black spots on the prothorax, a broad black stripe on the outer edge of its wing-covers, and a small oblong spot near their base. (Fitch.)

This insect has been observed by Riley to be extremely abundant on the elm at Washington, D. C. I have observed it commonly at Brunswick, Me.

FIG. 82.—*Galeruca californiensis*.  
Smith del.19. *Haltica (Graptodera) chalybea* (Illiger).

Order COLEOPTERA ; Family CHRYSOMELIDÆ.

Occasionally eating holes in the leaves; a steel-blue flea beetle, varying much in color; the body oblong, oval, and the hinder part of the thorax marked with a transverse furrow; a little over .15 inch (4<sup>mm</sup>) in length.

## 20. THE LADDER CHRYSOMELA.

*Chrysomela scalaris* (Le Conte).

Order COLEOPTERA ; Family CHRYSOMELIDÆ.

Feeding on the leaves throughout the season, a shining, hemispherical, bottle-green beetle, with silvery-white wing-covers, on which are several bottle-green spots, and a broad jagged stripe on their suture; its wings rose-red and its antennæ and legs rusty yellow. Length, 0.30 to 0.40. More common on willows, and especially the alder. The larva is thick and fleshy, with a row of black spiracles along the side of the body and a dark prothoracic shield.

## 21. THE AMERICAN CIMBEX SAW-FLY.

*Cimbex americana* (Leach).

Order HYMENOPTERA ; Family TENTHREDINIDÆ.

A cylindrical, glaucous, yellowish-white worm, coiled and marked like a snail's shell, having a broad black line along the back; when disturbed ejecting a watery fluid from pores situated above the spiracles; transforming into the largest species of saw-fly we have, with stoutly-knobbed antennæ; appearing early in summer; also feeds on the birch, linden, and willow. (See willow insects.)

## 22. THE ANTIOPA BUTTERFLY.

*Vanessa antiopa* (Linnaeus).

Order LEPIDOPTERA ; Family PAPILIONIDÆ.

Sometimes occurring on the elm, but more common on the willow ; a stoutly-spined caterpillar, with a black body spotted minutely with white, with a row of eight dark brick-red spots on the back ; changing to a dark brown chrysalis, with large tawny spots around the tubercles on the back. The butterfly purplish brown above, with a broad buff-yellow border in which is a row of pale blue spots. Flying from March till June, and again from the middle of August until late autumn.

Its food plants are : elm, white birch, poplar, silver poplar, willow. It is two-brooded, and many of the late emerging specimens hibernate and may often be seen on warm days in January or February flitting about. The larvæ are often attacked by Tachinids and many pupæ are destroyed by *Pteromalus vanessa*, which watches her chance during pupation. They are also destroyed by *Podisus spinosus*. (Riley's MS. notes.)

## 23. THE GREAT ELM-LEAF BEETLE.

*Monocesta coryli* (Say).

Order COLEOPTERA ; Family CHRYSOMELIDÆ.

Occasionally destructive to the red or slippery elm in the Middle States ; a pale yellowish beetle more than half an inch long, with the wing-covers twice spotted with blue ; laying its yellow eggs in a cluster on the under side of the leaf in June, the grub appearing a week later, being brown or yellowish-brown, and eating the leaves into rags ; towards the end of July or early in August entering the ground, forming an oval cavity a few inches below the surface ; assuming the pupa state a week before they appear as beetles in June. (Riley.)

In his report as U. S. Entomologist for 1878, Professor Riley calls attention to a much larger beetle than the imported elm-leaf beetle, but having very similar habits, and which has proved extremely destructive to the red or slippery elm in Missouri during the past few years :

The sudden appearance of this insect in such excessive numbers as to absolutely strip all the elms of this species through the woods for many miles must be looked upon as phenomenal ; for while J. F. Melsheimer reported the beetle many years ago as sufficiently numerous in some parts of Virginia to completely defoliate in a short time the hazel (*Corylus americanus*),\* the species is generally considered a rarity in entomological cabinets. Nor can I find that anything has been recorded of its adolescent stages. The beetle was first described by Say (*loc. cit.*) as *Galeruca coryli*, and is the only North American species of the genus *Monocesta* to which it is now referred, the genus being more fully represented in Central and South America. The color is pale clay-yellow, with two dark, bluish spots on each wing-cover. These spots are variable in size, and sometimes entirely wanting.

My attention was first called to the injuries of this larva some three years ago by Mr. George W. Letterman, of Allentown, Mo., and I have since been able to trace the full natural history of the species as it is given below.

The parent beetles (Fig. 83, *jj*) make their first appearance during the month of June, when they may usually be found pairing on the tree first mentioned. The

\*Auctore Say, Journ. Ac. Nat. Sc., Phil., III, 1824.

eggs (Fig. 83, *a*) are laid on the under side of the leaf in a compact, more or less globose, gamboge-yellow cluster, each egg surrounded and the whole mass firmly held together by a glutinous substance. There are, on an average, about 125 eggs in each mass, the eggs being laid in layers. In general appearance the

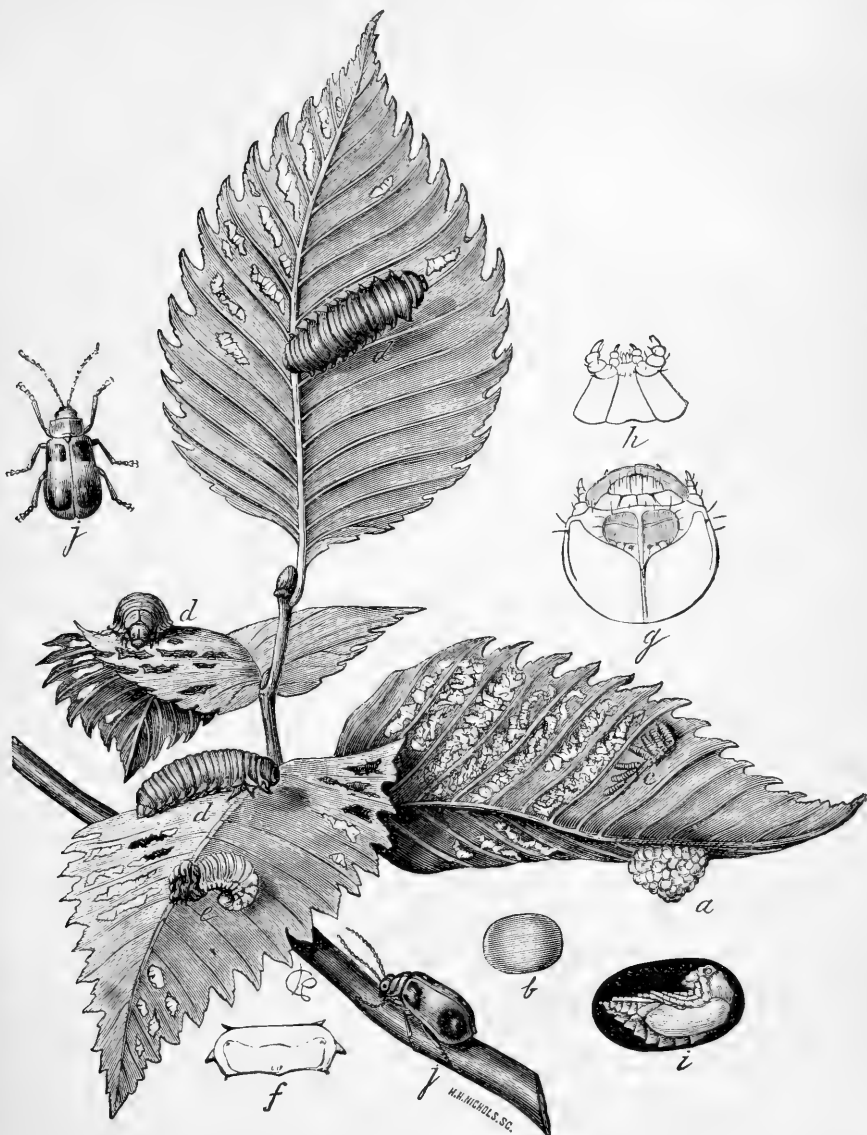


FIG. 83.—The great elm-leaf beetle, *a*, *b*, eggs; *d*, larva; *g*, *h*, head and mouth parts of the same; *i*, pupa; *j*, beetle.—After Riley.

mass bears a resemblance to a yellow raspberry. Each egg (Fig. 83, *b*), when examined separately, is seen to be subspherical in form and highly polished.

The young larvæ (Fig. 83, *c*) hatch in about a week after the eggs are laid, and at first congregate around the empty egg-shells, which they nibble and feed

upon. For about two days they remain close to their birthplace, eating only the parenchyma of the leaf, and showing so little inclination to travel that, should the leaf by accident be detached, they perish rather than search for another. They have at this stage of growth the curious habit, when disturbed, of raising the abdomen to a nearly perpendicular position, holding on to the leaf very firmly with their jaws. They are at this time of a glossy yellow color, and generally shed the first skin two days after birth, the empty skin adhering tightly to the leaf.

In the second stage, the color of the worms becomes more brownish, and they are more active, but still remain clustered together upon a single leaf or branch, scattering but slightly in proportion as they skeletonize one leaf after another. They yet, for the most part, feed upon the under side of the leaf, not touching the upper skin, and giving to the leaves a brownish, speckled, and seared appearance, as if covered by patches of some brown fungus. The excrement is voided in long, bead-like strings, which cover the ground or hang down from the branches and leaves of the infested trees. In another week, or when the larvæ are about half grown, a second molt takes place, they preparing for it in the usual manner by firmly attaching the anal joints to the leaf. (Fig. 83, e.) In the beginning of the third stage they feed indiscriminately on either side of the leaf, but still refuse to touch the epidermis of the opposite side. The gnawings on the upper side at this stage of growth are peculiar, being in the form of crescent lines with narrow strips of epidermis between them; whereas on the under side there is no such regularity, and all is eaten but the stronger cross veins. I have been unable to trace any further molts. This third stage lasts from two to three weeks, the larvæ scattering more thoroughly and the general color becoming quite brown or yellowish-brown. As the worms reach full growth (Fig. 83, ddd) the fleshy part of the leaves is entirely eaten so that little remains but the principal ribs, and the leaves thus present a very ragged appearance.

Toward the end of July and early in August the worms cease feeding and descend into the ground, burrowing therein and forming a simple oval cavity a few inches below the surface. They lie dormant therein through the fall, winter, and early spring months, assuming the pupa state (Fig. 83, i) but about a week before the beetles issue.

*Remedies.*—Experiments made upon the larva of the imported elm-leaf beetle shows that Paris-green water is very effective in destroying it, in both the larva and beetle states; and, while I have had no opportunity of making such experiments with the species in question, I have no doubt that it would here prove equally destructive. The larvæ are, throughout their existence, quite sluggish and drop to the ground on slight disturbance. A good shaking of an infested tree, therefore, will bring most of them to the ground, and experience shows that they have little or no capacity for mounting the tree again. This remedy will be applicable to cultivated trees, especially before they get too large.

#### 24. THE INTERROGATION—MARK BUTTERFLY.

##### *Grapta interrogationis* (Fabricius).

Injuring the foliage of the elm as well as linden tree and hop-vine, a caterpillar, with reddish black, bilobed head, and black body covered thickly with streaks and dots of yellowish white, transforming into our largest species of *Grapta*, and marked on the under side of the dull hind wings with a golden semicolon.

I am informed by H. L. Clark, esq., that in 1887 the elms in Providence were much eaten and disfigured by these caterpillars, and that the chrysalids were everywhere to be seen attached to fences, walls, etc.

*Larva.*—An inch and a quarter long. The head is reddish black, flat in front and somewhat bilobed, each lobe tipped with a tubercle emitting five single black pointed spines. It is covered with many small white and several blackish tubercles. The

body is cylindrical, black, thickly covered with streaks and dots of yellowish white; the second segment is without spines, but with a row of yellowish tubercles in their place; the third segment has four branching spines, all black, with a spot of dark yellow at their base; and on the fourth segment are four spines, as there are on all the others, excepting the terminal, which has two pairs, one posterior to the other. The spines are yellow, with blackish branches, excepting the terminal pair, which is black; and there is a row of reddish ones on each side. The under surface is yellowish gray, darker on the anterior segments, with a central line of blackish, and many small, black dots. (Saunders.)

The *chrysalis* is ash brown, with the head deeply notched; and there are eight silvery spots on the back. The *chrysalis* state lasts from twelve to fourteen days.

#### 25. THE PROGNE GRAPTA.

##### *Grapta progne* (Cramer).

Late in June, eating the leaves, a more common spiny caterpillar than the preceding, being white mottled with gray, the butterfly smaller than the foregoing and marked with a reversed silver C or comma in the middle of the hinder wings; but one brood of butterflies appearing in July.

Regarding the number of broods, Mr. D. S. Harris writes us from Cuba, Ill.:

On page 66 of Bulletin on Forest Insects, you state that *Grapta progne* (Cramer) is single brooded. I have quite a number of the caterpillars about ready to change into chrysalids. I also have butterflies of this species which emerged from the chrysalis during the month of September, showing that they are double brooded in this State. They are quite destructive this year.

The *larva* is gray, mottled with whitish; head white, with two black prickles. The two upper long-branched prickles upon the second ring black; no spines on the prothoracic segments; those on the succeeding rings white, tipped with black; their branches white, toward the forward end of the body becoming more and more tipped with black. (Fitch.)

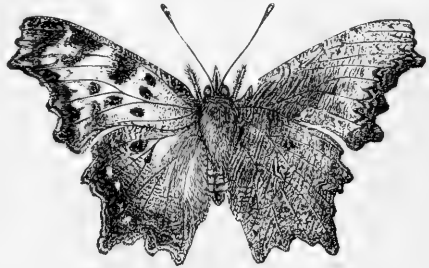


FIG. 84.—*Grapta progne*.—From Packard.

#### 26. THE COMMA BUTTERFLY.

##### *Grapta comma* (Harris).

Another caterpillar closely resembling that of *G. progne*, but different in being of a brownish-red color in front and white or pale yellow behind.

The *half-grown larva* is black, with a yellowish stripe along the side from the third segment to the tail, and with yellow stripes across the back, and spots of the same color at the base of the dorsal spines, which are yellow, tipped with black. The mature caterpillar is white, mottled or striped with gray or ashen, and with red spiracles (W. H. Edwards). It differs from the larva of *G. progne* in its brownish-red face, and in being more yellowish on the abdominal segments.

The *chrysalis* is brownish-gray or white, variegated with pale brown and ornamented with gold on the tubercles.

The *butterfly* differs from the Progne in the hind wings having a black spot on their center, as well as two others toward their base, and on their under side a central silvery curved mark like the letter C. Expanse of wings about two inches. It appears in May, and a second brood in July, August, and September. This caterpillar is more common on the currant and hop.

27. *Limenitis arthemis* (Drury).

Gosse, in his "Canadian Naturalist" (220), gives a figure of the larva, pupa, and under side of the butterfly of this species.\* The butterfly appears about the 1st of July. In the first week in July we have seen this butterfly in great numbers in the White Mountains.

## 28. THE FOUR-HORNED SPHINX.

*Ceratonia amyntor* (Hübner.)

(Larva, Pl. XI, fig. 1.)

The caterpillar, as observed by Harris (under the name of *Ceratonia quadricornis*), in one case hatched July 31. A record of its occurrence on the white birch is mentioned in "Psyche," 363, 1882. Professor Riley states that Boll found the caterpillar on the osage orange. Mr. Pilate has also observed the caterpillar on the linden in Ohio. A young larva found August 20, and 35<sup>mm</sup> in length, was green with 7 paler green lateral oblique stripes, the four thoracic horns being very prominent.

This worm not unusually occurs from Maine southward on the elm, becoming fully fed early in September, when it descends into the ground and pupates, the moth appearing the following May and June. I have taken it in Maine as early as May 24. The moth is a large broad-winged sphinx, with gray or ashen body and wings, the anterior pair with a large white dot near the front edge.

*Egg*.—Nearly of a compressed spheroidal shape, green, and with very fine reticulations. (Harris' Corr., p. 82.)

*Larva before first molt*.—Yellowish green, with a darker dorsal line, a long red caudal horn, and a very large, green head, with the dorsal denticulations and tubercles obsolete. A newly hatched larva is about one-fifth of an inch long, pale green, with a straight caudal horn about half the length of the body, dotted and tipped with brown. There is a pair of minute thoracic horns on the top of the third segment and another pair on the top of the fourth, and there is a row of minute fleshy teeth along the middle of the back, which are scarcely visible. Before the first molt the larva has nearly doubled its size and has a white vascular line, a faint line on each side of the middle of the back and seven oblique stripes on each side of the body, all of the same color. The head is smooth and the thoracic horns are barely visible. They molt their skins in about five days after they hatch, after which the head and caudal horn are granulated, the thoracic horns prominent, the fleshy teeth along the middle of the back with the stripe on each side of it; the oblique stripes on the sides and the thoracic lines are plainly visible.

*The second molt* is made in from five to eight days after the first, when the row of teeth along the middle of the back is prominent, the lateral oblique stripes are granulated, and the caudal horn is pale yellow with granulations in front and behind.

*The third molt* is made in from six to eight days after the second, when the larva is light green with the teeth along the back and the granulations on the side of a whitish color. The caudal horn is now curved, of a yellowish-green color, and cov-

\* See also Scudder's "Butterflies of the Eastern United States," 1889.



ered with brown granulations on the forward side. The thoracic horns are tipped with yellowish.

*The fourth and last molt* is made in from six to eight days, and in six days more they reach maturity, leave their food plant, descend to the ground which they enter for the purpose of spending the winter and reaching their final transformation.

*The mature larva* is from two and three-fourths to three and one-fourth inches long, pale green or reddish brown, head and body strongly granulated, a dorsal row of fleshy teeth, one on each wrinkle, tipped with whitish or pink, extends from the fourth segment to the caudal horn. There is a pair of short, straight, tuberculated horns on the top of the third segment and a similar pair on the fourth. A line of granulations connects the thoracic horns. Seven oblique stripes of whitish granulations occur on each side, each of which crosses one segment and a part of the one before and the one following. The last stripe extends to the caudal horn. (Fernald.)

*Pupa*.—Thick, not elongated before; tail ending with a conical projection, tipped with two little divaricating spines; tongue-case buried and soldered to the breast. (Harris' Corr.)

*Moth*.—The fore wings are broader than in most sphinges, with a large distinct round discal spot. The wings are light brown, variegated with dark brown and white, while along the hind body extend five longitudinal dark-brown lines. It expands 5 inches.

29. *Smerinthus excæcatus* Abbot and Smith.

(Larva, Pl. XI, fig 3, 3 a.)

The caterpillar of this moth, which usually feeds on the apple and plum, has been found on the elm by Mr. W. H. Edwards. Mr. Beutenmüller records it as feeding on American elm, the slippery or red elm, the whahoo or winged elm, and *Ulmus suberosa*. (Ent. Amer., i, 196.)

*Larva*.—Head apple-green, granulated, flattened, triangular, the apex rising somewhat above the first segment, with bright yellow, straight, lateral lines, in which are rounded granulations, increasing in size as they approach the apex. Body with thoracic segments tapering, light-green, studded with pointed white granulations. Lateral bands yellow, each occupying three-eighths, the whole, and six-eighths of three segments, respectively—on the central segment straight, on the following one curved posteriorly, not angulated at the incisure—having within them a granulation on each annulation (eight to the segment) larger than those elsewhere on the body. Subdorsal thoracic line yellow, granulated as in the bands, commencing on the anterior of the first segment, diverging from the dorsum as it proceeds and uniting at the sixth annulation of the fourth segment with the first lateral band. Caudal horn nearly straight, .25 inch long, acutely granulated, rose-colored, yellow laterally, and often yellow-tipped. Legs at tips reddish-brown. Stigmata brown bordered.

*Pupa*.—One-twentieth of an inch long; .40 inch broad. Dark brown. Head-case, darker brown, rounded, corrugated, with an impressed transverse line bordering it posteriorly, and a medial line impressed inferiorly and carinated superiorly. Tongue-case buried, short, not separating the leg and wing cases. Antennal cases in male terminating very near to tips of the middle leg-cases—in female, opposite tips of the anterior leg-cases. First stigma quite open. The three anterior segments shagreened with a moderately elevated medial line. Third segment without plates, but with a medial carination. The other segments, each with a subdorsal linear impression and also lateral ones, and with confluent punctulations, except posteriorly, where they are smooth, not shining, and under a lens delicately shagreened. Terminal segment subrectangular, with a short triangular rugose spine, more prominent in the male. One male, two females. (Fernald.)

## 30. THE FALL WEB-WORM.

*Hyphantria cunea* Drury. (*H. texor* Harris.)

(Ravages, Plate XXXVI.)

Passing the winter in the pupa state. The cocoons found during the winter principally at the surface of the ground, mixed with dirt and rubbish, or in cracks and crevices of tree-boxes, in fences, and under door-steps and basement walls. The first moths issue from these cocoons in May, and laying their eggs in flat batches on the under side of the leaves. The young worms feeding preferably in company, webbing first one and then several leaves together, and gradually extending their sphere of action until a large part of the tree becomes involved. The worms becoming full-grown in July, and spinning cocoons from which a second generation of moths issues early in August and lays eggs, from which the worms hatch, so they are once more in force by the latter part of August. The parent moth white, with a varying number of spots; winged in both sexes; the female preferring to oviposit on box-elder (*Negundo aceroides*), the poplars, cottonwoods, ashes, and willows.

The following account is copied from Professor Riley's "Our Shade Trees and their Insect Defoliators," as it contains the results of the latest investigations:

This insect has from time to time attracted general attention by its great injury to both fruit and shade trees. Many authors have written about it, and consequently it has received quite a number of different names. The popular name "Fall Web-worm," first given to it by Harris, in his "Insects injurious to Vegetation," is sufficiently appropriate as indicating the season when the webs are most numerous. The term is, however, most expressive for the New England and other northern States, where the insect is single-brooded, appearing there during August and September, while in more southern regions it is double-brooded. In our Third Missouri Report we have first called attention to its double-broodedness at St. Louis, and we find that it is invariably two-brooded at Baltimore and Washington. Except in seasons of extreme increase, however, the first brood does no widespread damage, while the fall brood nearly always attracts attention.

*Limitation of broods.*—At Washington we may say in general that the first brood appears soon after the leaves have fully developed, and numerous webs can be found about the first of June, while the second brood appears from the middle of July on through August and September. In Massachusetts and other northern States the first moths issue in June and July; the caterpillars hatch from the last of June until the middle of August, reach full growth and wander about seeking places for transformation from the end of August to the end of September.

The species invariably hibernates in the chrysalis state within its cocoon, and the issuing of the first brood of moths is, as a consequence, tolerably regular as to time, *i. e.*, they will be found issuing and flying slowly about during the evening, and more particularly at night, during the whole month of May, the bulk of them early or late in the month, according as the season may be early or late. They couple and oviposit very soon after issuing, and in ordinary seasons we may safely count on the bulk of the eggs being laid by the end of May. During the month of June the moths become scarcer and the bulk of them have perished by the middle of that month, while the webs of the caterpillars become more and more conspicuous. The second brood of moths begins to appear in July, and its occurrence extends over a longer period than is the case with the first or spring brood. The second brood of caterpillars may be found from the end of July to the end of September, hatching most extensively, however, about the first of August.

In Massachusetts and other northern States the first moths issue in June and July; the caterpillars hatch from the last of June until the middle of August, reach full

growth and wander about seeking places for transformation from the end of August to the end of September.

The following general remarks upon the different stages refer to Washington and localities where the same conditions hold:

*The eggs* (Fig. 85, b).—The female moth deposits her eggs in a cluster on a leaf, sometimes upon the upper and sometimes on the lower side, usually near the end of a branch. Each cluster consists of a great many eggs, which are deposited close together and in regular rows, if the surface of the leaf permits it. In three instances those deposited by a single female were counted. The result was 394, 427, and 502, or on an average 441 eggs. But in addition to such large clusters, each female will deposit eggs in smaller and less regular patches, so that at least 500 eggs may be considered as the real number produced by a single individual. The egg, measuring  $0.4\text{mm}$ , is of a bright golden-yellow color, quite globular, and ornamented by numerous regular pits, which give it under a magnifying lens the appearance of a beautiful golden thimble. As the eggs approach the time of hatching this color disappears and gives place to a dull leaden hue.

The interval between the time of depositing and hatching of the eggs for the first brood varies considerably, and the latter may be greatly retarded by inclement weather. Usually, however, not more than ten days are consumed in maturing the embryo within. The eggs of the summer brood seldom require more than one week to hatch.

Without check the offspring of the one female moth might in a single season (assuming one-half of her progeny to be female and barring all checks) number 125,000 caterpillars in early fall—enough to ruin the shade trees of many a fine street.

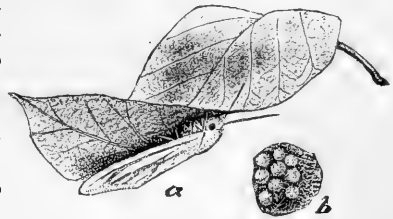


FIG. 85.—*Hyphantria cunea*: a, moth in position on leaf laying eggs, side view; b, eggs enlarged.

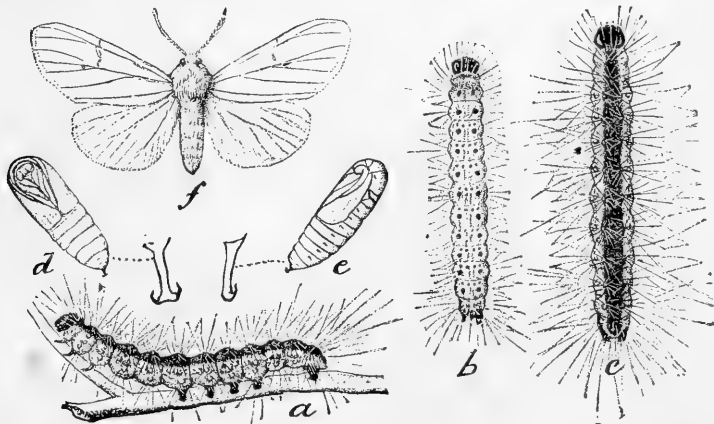


FIG. 86.—*Hyphantria cunea*: a, dark larva, seen from side; b, light larva from above; c, dark larva from above; d, pupa from below; e, pupa from side; f, moth.

*The larva* (Fig. 86, a, b, and c).—The caterpillars just born are pale yellow with two rows of black marks along the body, a black head, and with quite sparse hairs. When full-grown they generally appear pale yellowish or greenish, with a broad dusky stripe along the back and a yellow stripe along the sides; they are covered with whitish hairs, which spring from black and orange-yellow warts. The caterpillar is, however, very variable both as to depth of coloring and as to markings. Close observations have failed to show that different food produces changes in the

coloration; in fact nearly all the various color varieties may be found upon the same tree. The fall generation is, however, on the whole, darker, with browner hairs than the spring generation.

As soon as the young caterpillars hatch they immediately go to work to spin a small silken web for themselves, which by their united efforts soon grows large enough to be noticed upon the trees. Under this protecting shelter they feed in company, at first devouring only the green upper portions of the leaf and leaving the veins and lower skin unmolested. As they increase in size they enlarge their web by connecting it with the adjoining leaves and twigs; thus as they gradually work downwards their web becomes quite bulky, and, as it is filled with brown and skeletonized leaves and other discolored matter, as well as with their old skins, it becomes quite an unpleasant feature in our public thoroughfares and parks. The caterpillars always feed underneath these webs; but as soon as they approach maturity, which requires about one month, they commence to scatter about, searching for suitable places in which to spin their cocoons. If very numerous upon the same tree the food supply gives out, and they are forced by hunger to leave their sheltering homes before the usual time.

When the young caterpillars are forced to leave their webs they do not drop suddenly to the ground, but suspend themselves by a fine silken thread, by means of which they easily recover the tree. Grown caterpillars, which measure 1.11 inches in length, do not spin such a thread. Both old and young ones drop themselves to the ground without spinning when disturbed or sorely pressed by hunger.

*Pupa and cocoon.*—Favorite recesses selected for pupation are the crevices in bark and similar shelters above ground; in some cases even the empty cocoons of other moths.\* The angles of tree-boxes, the rubbish collected around the base of trees and other like shelters are employed for this purpose, while the second brood prefer to bury themselves just under the surface of the ground, provided that the earth be soft enough for that purpose. The cocoon itself is thin and almost transparent, and is composed of a slight web of silk intermixed with a few hairs, or mixed with sand if made in the soil.

The *pupa* (Fig. 86, *d* and *e*) is of a very dark-brown color, smooth and polished, and faintly punctate; it is characterized by a swelling or bulging about the middle. It is 0.60 inch long and 0.23 inch broad in the middle of its body, or where it bulges a little all round.

The *moth* (Fig. 86, *f*).—The moths vary greatly, both in size and coloration. They

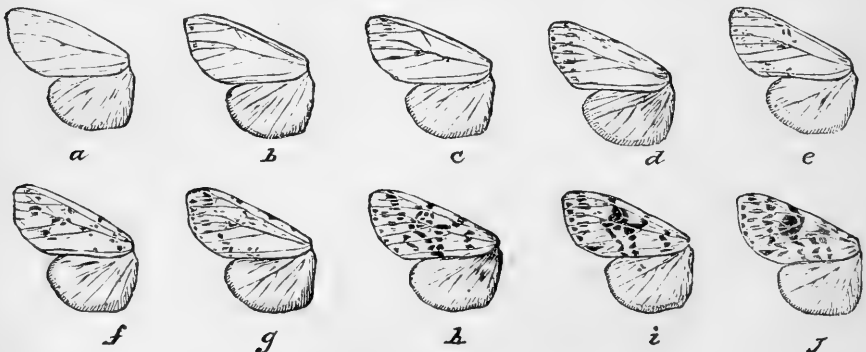


FIG. 87.—*Hyphantria cunea*: *a-j*, wings of a series of moths, showing the variations from the pure white form to one profusely dotted with black and brown.

have, in consequence of such variation received many names, such as *cunea* Drury, *textor* Harr., *punctata* Fitch, *punctatissima* Smith (Fig. 87). But there is no doubt, as proven from frequent breeding of specimens, that all of these names apply to the

\* We have known the substantial cocoon of *Cerura tobe* used for this purpose.

very same insect, or at most to slight varieties, and that Drury's name *gunea*, having priority, must be used for the species.

The most frequent form observed in the vicinity of Washington is white, with a very slight fulvous shade; it has immaculate wings, tawny-yellow front thighs, and blackish feet; in some specimens the tawny thighs have a large black spot, while the shanks on the upper surface are rufous. In many all the thighs are tawny yellow, while in others they have scarcely any color. Some specimens (often reared from the same lot of larvæ) have two tolerably distinct spots on each front wing—one at base of fork on the costal nerve and one just within the second furcation of the median nerve. Other specimens, again, have their wings spotted all over and approach the form *punctatissima*, described as the "Many-spotted Ermine-moth" of the Southern States. The wings of the moths expand from  $1\frac{1}{4}$  inches to  $1\frac{3}{8}$  inches. The male moth, which is usually a little smaller, has its antennæ doubly feathered beneath, and those of the female possess instead two rows of minute teeth.

The pupa state lasts from six to eight days for the summer brood, while the hibernating brood, however, requires as many months, according to the latitude in which they occur.

*Injury done in 1836.*—During the past year the city of Washington, as well as its vicinity, was entirely overrun by the caterpillars. With the exception of trees and plants the foliage of which was not agreeable to the taste of this insect, all vegetation suffered greatly. The appended list of trees, shrubs, and other plants, shows that comparatively few kinds escaped entirely. The fine rows of shade trees which grace all the streets and avenues appeared leafless, and covered with throngs of the hairy worms. Excepting on the very tall trees, in which the highest branches showed a few leaves too high for the caterpillars to reach, not a vestige of foliage could be seen. The trees were not alone bare, but were still more disfigured by old and new webs made by the caterpillars, in which bits of leaves and leaf-stems, as well as the dried frass, had collected, producing a very unpleasant sight. The pavements were also constantly covered with this unsightly frass, and the empty skins of the various molts the caterpillars had to undergo were drifted about with every wind, and collected in masses in corners and tree-boxes. The parks fared a little better. Because of the great variety of trees planted there some escaped entirely, while others showed the effect of the united efforts of so many hungry caterpillars, only in a more or less severe degree. The grassy spots surrounding the different groups of trees had also a protective influence, since the caterpillars do not like to travel over grass, except when prompted by a too ravenous hunger. The rapid increase of this insect is materially assisted by the peculiar method of selecting shade trees for the city. Each street has, in many cases, but one kind of shade tree; rows of them extend for miles, and the trees are planted so close together that their branches almost interlace. Thus there is no obstacle at all for the rapid increase and distribution of the caterpillars. If different kinds of trees had been planted, so as to alternate, less trouble might be experienced. Plate xxxvi shows a view of Fourteenth street, taken in late September, which illustrates this point; the poplars on the west side being completely defoliated as far as the eye can reach, while the maples on the east are almost untouched.

As long as the caterpillars were young, and still small, the different communities remained under cover of their webs, and only offended the eye. But as soon as they reached maturity, and commenced to scatter—prompted by the desire to find suitable places to spin their cocoons and transform to pupæ—matters became more unpleasant, and complaints were heard from all those who had to pass such infested trees. In many localities no one could walk without stepping upon caterpillars; they dropped upon every one and every thing; they entered flower and vegetable gardens, porches and verandas, and the house itself, and became, in fact, a general nuisance.

The chief damage done to vegetation was confined to the city itself, although the caterpillars extended some distance into the surrounding country. There, however,

they were more local, and almost entirely confined to certain trees, and mainly so to the white poplar and the cottonwood. Along the Baltimore and Potomac Railroad tracks these trees were defoliated as far as 5 miles from the Capitol. In Georgetown the caterpillars were equally noxious, but in the adjoining forests but very few webs could be seen.

The proportionate injury to any given species of tree is to some extent a matter of chance, and in some respects a year of great injury, as 1886, is not a good year to study the preferences of a species, because when hard pressed for food the caterpillars will feed upon almost any plant, though it is questionable whether they can mature and transform on those which they take to only under the influence of such absolute necessity. Again, the preference shown for particular trees is more the result of the preference of the parent moth than of its progeny in a case of so general a feeder as the Fall Web-worm. We had a very good illustration of this in Atlantic City last autumn. The caterpillars were exceedingly abundant during autumn along this portion of the Atlantic coast, especially on the trees above named. We studied particularly their ways upon one tree that was totally defoliated by September 11. The bulk of the caterpillars were then just through their last molt, though others were of all ages illustrating different hatchings. There was an instinctive migration of these larvæ of all sizes, and the strength of their food habits once acquired from birth upon a particular tree was well illustrated. At first the worms passed over various adjacent plants, like honeysuckles, roses, etc., the leaves of which they freely devour if hatched upon them, but as the migrating swarm became pressed with hunger they finally fell upon these, and even upon plants like the peach, and ailanthus, which ordinarily are passed over. They would pounce upon any food, and a rotten apple placed in their way was soon literally swarming with them and sucked dry.

In a general way it may be stated that conifers, grapes, and most herbaceous plants are free from their attacks, and it is very doubtful whether the species can mature upon them.

The list of plants which follows is arranged according to the relative damage to the foliage in the city of Washington. The three first named are most subject to attack, and, in fact, are almost always defoliated.

*Proportionate injury to different plants and shade trees.*—The damage done in the city of Washington was exceptional, but so was also the general damage throughout the New England States, if not throughout the country. In New England the greater predilection which the species showed for poplar, cottonwood, and the ranker growing willows was everywhere manifest, and so much was this the case that the destruction of the first brood on these trees would have substantially lessened the damage to other trees.

Plants marked 1 have lost from 75 to 100 per cent. of their foliage.

Plants marked 2 have lost from 50 to 45 per cent. of their foliage.

Plants marked 3 have lost from 25 to 50 per cent. of their foliage.

Plants marked 4 have lost from 0 to 25 per cent. of their foliage.

Plants marked with two figures have shown the relative immunity or injury indicated by both, the variation being in individual trees.

1. <i>Negundo aceroides</i> Mœnch. (Box Elder.)	1-2. <i>Fraxinus americana</i> L. (White Ash.)
1. <i>Populus alba</i> L. (European White Poplar.)	1-2. <i>Fraxinus excelsior</i> L. (European Ash.)
1. <i>Populus monilifera</i> Aiton. (Cottonwood.)	1-2. <i>Sambucus canadensis</i> L. (Elder.)
1-2. <i>Populus balsamifera</i> L. (Balsam Poplar.)	1-2. <i>Pyrus</i> species. (Cultivated Pear and Apple.)
1-2. <i>Populus tremuloides</i> Mich'x. (American Aspen.)	1-2. <i>Prunus avium</i> and <i>cerasus</i> L. (Cherries.)
	1-4. <i>Syringa vulgaris</i> L. (Lilac.)
	1-4. <i>Ilex spec.</i> (Holly.)

2. *Platanus occidentalis* L. (Sycamore.)  
 2. *Salix* species. (Willow.)  
 2. *Tilia americana* L. (American Linden.)  
 2. *Tilia europæa* L. (European Linden.)  
 2. *Populus dilatata* Aiton. (Lombardy Poplar.)  
 2. *Ulmus americana* L. (American White Elm.)  
 2-3. *Ulmus fulva* Mich'x. (Slippery Elm.)  
 2-3. *Prunus armeniaca* L. (Apricot.)  
 2-3. *Alnus maritima* Muhl. (Alder.)  
 2-3. *Betula alba* L. (White Birch.)  
 2-3. *Lonicera* species. (Haw or Sloe.)  
 2-3. *Lonicera* species. (Honeysuckles.)  
 2-3. *Prunus americana* Marsh. (Wild Red Plum.)  
 2-3. *Celtis occidentalis* L. (Hackberry.)  
 2-3. *Rosa* species. (Rose.)  
 2-3. *Gossypium album* Ham. (Cotton.)  
 2-3. *Cephalanthus occidentalis* L. (Button Bush.)  
 2-4. *Convolvulus* spec. (Morning Glory.)  
 2-4. *Acer saccharinum* Wang. (Sugar Maple.)  
 2-4. *Geranium* species. (Geranium.)  
 3. *Betula nigra* L. (Red Birch.)  
 3. *Tecoma radicans* Juss. (Trumpet Creeper.)  
 3. *Symphoricarpos racemosus*. Mich'x. (Snowberry.)  
 3. *Larix europæa*, Del. (European Larch.)  
 2. *Corylus americana* Walt. (Hazel-nut.)  
 3. *Quercus alba* L. (White Oak.)  
 3. *Diospyros virginiana* L. (Persimmon.)  
 3. *Carya* species. (Hickory.)  
 3. *Juglans* species. (Walnut.)  
 3. *Wistaria sinensis* Del. (Chinese Wistaria.)  
 3. *Wistaria frutescens* DC. (Native Wistaria.)  
 3. *Amelanchier canadensis* T. & G. (Shad-bush.)  
 3. *Cratægus* species. (Haw.)  
 3. *Rubus* species. (Blackberry.)  
 3. *Spiræa* species. (Spiræa.)  
 3. *Ribes* species. (Currant and Gooseberry.)  
 3. *Staphylea trifolia* L. (Bladder Nut.)  
 3-4. *Cydonia vulgaris* Pers. (Quince.)  
 3-4. *Asimina triloba* Dun. (Papaw.)  
 3-4. *Berberis canadensis* Pursh. (Barberry.)  
 3-4. *Catalpa bignonioides* Walt. (Indian bean.)  
 3-4. *Catalpa speciosa* Ward. (Bignonia.)  
 3-4. *Euonymus atropurpureus* Jaeg. (Burning Bush.)  
 3-4. *Cupressus thyoides* L. (White Cedar.)  
 3-4. *Juniperus virginiana* L. (Red Cedar.)  
 3-3. *Cornus florida* L. (Flowering Dogwood.)  
 3-4. *Cornus alternifolia* L. (Alternate-leaved Dogwood.)  
 3-4. *Carpinus americana* Mich'x. (Hornbeam.)  
 3-4. *Castanea americana* Mich'x. (American Chestnut.)  
 3-4. *Castanea pumila* Mich'x. (Chinquapin.)  
 3-4. *Ostrya virginica* Willd. (Hop Hornbeam.)  
 3-4. *Quercus coccinea* Wang. (Scarlet Oak.)  
 3-4. *Quercus phellos* L. (Willow Oak.)  
 3-4. *Quercus prinus* L. (Chestnut Oak.)  
 3-4. *Quercus rubra* L. (Red Oak.)  
 3-4. *Diospyros kaki* L. (Japan Persimmon.)  
 3-4. *Buzus sempervirens* L. (Common Box.)  
 3-4. *Hamamelis virginica* L. (Witch Hazel.)  
 3-4. *Sassafras officinale* Ness. (Sassafras.)  
 3-4. *Cercis canadensis* L. (Red Bud.)  
 3-4. *Hibiscus syriacus* L. (Tree Hibiscus.)  
 3-4. *Rhamnus alnifolius* L'Her. (Alder-leaved Buckthorn.)  
 3-4. *Prunus virginiana* L. (Choke-cherry.)  
 3-4. *Persica vulgaris* Mill. (Peach.)  
 3-4. *Æsculus hippocastanum* L. (Horse Chestnut.)  
 3-4. *Paulownia imperialis* Seeb. (Cigar Tree.)  
 3-4. *Ailanthus glandulosus* Daf. (Tree of Heaven.)  
 3-4. *Maclura aurantiaca* Nutt. (Osage Orange.)  
 3-4. *Ampelopsis quinquefolia*. (Virginia Creeper.)  
 3-4. *Clematis* species. (Clematis.)  
 3-4. *Trifolium* spec. (Clover.)  
 3-4. *Helianthus* spec. (Sunflower.)  
 3-4. *Jasminum* spec. (Jessamine.)

- |  |  |
|--|--|
| 3-4. <i>Ficus carica</i> L. (Fig.)                               | 4. <i>Liriodendron tulipifera</i> L. (Tulip Tree.)       |
| 4. <i>Rhus cotinus</i> L. (Smoke Tree.)                          | 4. <i>Magnolia</i> spec. (Magnolia.)                     |
| 4. <i>Pinus</i> spec. (Pine.)                                    | 4. <i>Chionanthus virginicus</i> L. (Fringe Tree.)       |
| 4. <i>Taxus</i> spec. (Yew.)                                     | 4. <i>Ligustrum vulgare</i> L. (Privet.)                 |
| 4. <i>Nyssa multiflora</i> Wang. (Sour Gum.)                     | 4. <i>Æsculus flava</i> , Ait. (Sweet Buckeye.)          |
| 4. <i>Fagus ferruginea</i> Ait. (Beech.)                         | 4. <i>Æsculus glabra</i> Willd. (Ohio Buckeye.)          |
| 4. <i>Kalmia</i> spec. (Laurel.)                                 | 4. <i>Morus rubra</i> L. (Red Mulberry.)                 |
| 4. <i>Rhododendron</i> spec. (Rhododendron.)                     | 4. <i>Zanthoxylum americanum</i> M. (Prickly Ash.)       |
| 4. <i>Ricinus communis</i> L. (Castor-oil Plant.)                | 4. <i>Acer dasycarpum</i> Ehrh. (White or Silver Maple.) |
| 4. <i>Liquidambar styraciflua</i> L. (Sweet Gum.)                | 4. <i>Acer rubrum</i> Wang. (Red Maple.)                 |
| 4. <i>Gleditsia triacanthos</i> L. (Honey Locust.)               |  |
| 4. <i>Gymnocladus canadensis</i> , Lamb. (Kentucky Coffee Tree.) |  |
| 4. <i>Robinia pseudacacia</i> L. (Locust.)                       |  |

Trees in the vicinity of the white poplar and cottonwood suffered most. Even trees usually not injured, as, for instance, the sugar maple, are often badly defoliated when in such contiguity.

This list contains a number of plants not usually injured by these caterpillars. In some cases the injury was due to the fact that twigs containing the web, with its occupants, had been pruned from the tree and thrown near plants, instead of being at once burned or otherwise destroyed.

In other cases the injury is due to the peculiar position of the plant injured, *i. e.*, under a tree infested by the caterpillars. These when fully grown commence to scatter, and dropping upon the plants underneath the tree so defoliate it without actually making their home upon it. The great number thus dropping from a large tree will soon defoliate any smaller plant, even if each caterpillar takes but a mouthful by way of trial. Thus holly, a plant not usually eaten by these insects, soon becomes denuded. Other plants unpalatable or even obnoxious to the caterpillars are sometimes destroyed by the multitudes in their search for more suitable food.

Hungry caterpillars leaving a denuded tree in search of food wander in a straight line to the next tree, sometimes a distance of 25 feet, showing that they possess some keen sense to guide them. If such a tree offers unsuitable food, they still explore it for a long time before deserting it. In this manner two columns of wandering caterpillars are formed, which frequently move in opposite directions.

*Peculiar effect of defoliation upon some plants.*—During the early part of October many trees, mainly apple and pear, which had been entirely denuded of their foliage by the caterpillars, showed renewed activity of growth. Some had a few scattered flowers upon them, others had one or two branches clothed with flowers, while in some few cases the whole tree appeared white. It looked as if the trees were covered with snow, since they lacked the green foliage usually seen with the blossoms in spring. Some few flowers were also observed upon badly defoliated cherry-trees. Even as late as the middle of November, owing perhaps also to the pleasantly warm weather, some few flowers could be observed upon some imported plants belonging to the genus *Spiræa* and upon the Chinese red-apple. All these plants usually blossom early in spring. The caterpillars having entirely defoliated the trees produced thus an artificial period of rest, or winter, which was followed by unseasonable budding and flowering. Such a result often follows summer denudation by any insect, and we have referred to some remarkable cases in our previous writings.\*

*Enemies of the Web-Worm other than insects.*—The caterpillars have comparatively few enemies belonging to the vertebrate animals. This is not owing to any offensive odor or to any other means of defense, but is entirely due to their hairiness.

\* See Eighth Report on the Insects of Missouri, p. 121.



Chickens, and even the omniverous ducks, do not eat them; if offered to the former they pick at these morsels, but do not swallow them.

The English sparrow has, in this case at least, not proven of any assistance whatever. Indeed, as before stated, its introduction and multiplication has greatly favored the increase of the worms.

The "pellets" of a Screech-owl (*Scops asio*) found in the vicinity of Baltimore, Md., and examined by Mr. Luggar, consisted apparently almost entirely of the hairs of these caterpillars, proving that this useful bird has done good service.

Perhaps the statement may be of interest, that this little owl is getting much more common in the vicinity of such cities in which the English sparrow has become numerous, and that the imported birds will find in this owl as bold an enemy as the Sparrow-hawk is to them in Europe, and even more dangerous, since its attacks are made towards dusk, at a time when the sparrow has retired for the night and is not as wide awake for ways and means to escape.

If our two cuckoos, the black billed as well as the yellow-billed species, could be induced to build their nests within the city limits or in our parks, we should gain in them two very useful friends, since they feed upon hairy caterpillars.

The common toad (*Bufo americana*) has eaten great numbers of these caterpillars, as shown by dissections made by Mr. Luggar, and it should be carefully protected instead of being tormented or killed by boys or even grown people. The toad is always a useful animal and ought to be introduced in all gardens and parks.

The following species of spiders were observed to eat the caterpillars, viz, *Marpessa undata* Koch and *Attus (Phydippus) tripunctatus*. Neither species builds a web, but obtains its prey by boldly leaping upon it; they are, in consequence of such habits, frequently called tiger-spiders. The former was exceedingly common last year, more so than for many previous years, thus plainly indicating that the species did not suffer for lack of food. This species is usually found upon the trunks of trees, and is there well protected by its color, which is like that of the bark. It hides in depressions and cracks of the bark, and, jumping upon the passing game, or, cat-like, approaching it from behind, it thrusts its poisonous fangs into the victim, which soon dies and is sucked dry. The *Attus* has similar habits, but is still more cautious; it usually hides under loose bark. Both spiders are wonderfully active, and kill large numbers of caterpillars. Their large flat egg-masses can be found during the winter under dead bark and in cracks. Both species hibernate in silken nests in similar localities.

*Predaceous insect enemies.*—The caterpillars of this moth have quite a number of external enemies, which slay large numbers of them. The well-known Rear-horse (*Mantis carolina*, see Fig. 89) seems to be very fond of the caterpillars. The Wheel-bug, *Prionidus cristatus* (Fig. 104), has proved to be one of our best friends in reducing the numbers of the caterpillars. This insect was formerly by no means very common in cities, but of late years it has greatly increased in numbers, and is now a well-known feature in all our public parks and such streets as possess shade-trees. Outside of the city it is rarely met with; nor does it extend much farther north than Washington. It is, like the Mantis, in all its stages a voracious feeder upon insects, slaying alike beneficial and noxious ones. The bright red larvæ and pupæ, also carnivorous, are seen in numbers during the summer; they usually remain together until hunger forces them to scatter. They assist each other in killing larger game, and are to this extent social. The Wheel-bug could be observed almost anywhere last summer, usually motionless, stationed upon the trunk of trees, waiting for the approach of an insect. If one comes near, it quite leisurely inserts its very poisonous beak, and sucks the life-blood of its victim. When this becomes empty it is hoisted up in the air, as if to facilitate the flow of blood, until eventually it is thrown away as a mere shriveled skin. The appetite of the Wheel-bug is remarkable, whenever chances offer to appease it to the fullest extent. Frequently, however, times go hard with it, and notwithstanding it is very loath to change a posi-

tion once taken, it is sometimes forced to seek better hunting grounds, and takes to its wings. The Wheel-bug has been observed to remain for days in the same ill-chosen position, for instance upon the walls of a building, waiting patiently for something to turn up. It is slow in all its motions, but withal very observant of

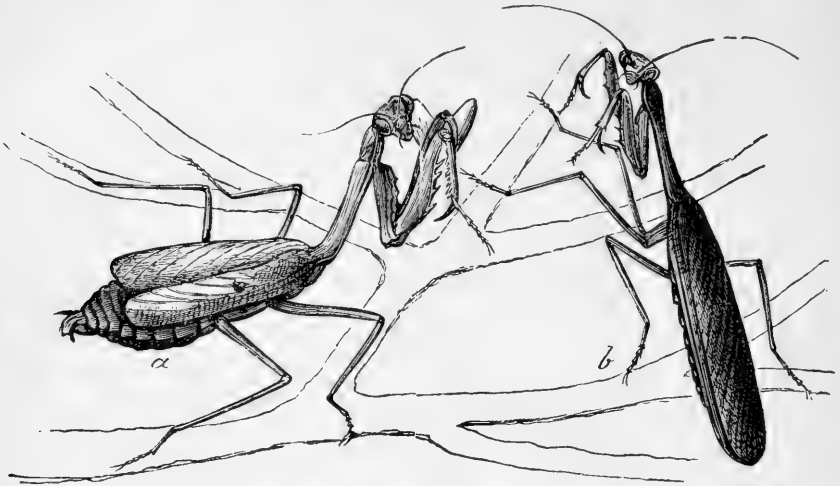


FIG. 89.—*Mantis carolina*: a, female; b, male.

everything occurring in its neighborhood, proving without doubt great acuteness of senses. It does not seem to possess any enemies itself, and a glance at its armor will indicate the reason for this unusual exemption.\* During warm weather this bug possesses a good deal of very searching curiosity, and a thrust with its beak, filled with poison, is very painful indeed. Boys call it the Blood-sucker, a misnomer, since it does not suck human blood. The eggs are laid during the autumn in various places, but chiefly upon smooth surfaces of the bark of tree-trunks, and frequently in such a position as to be somewhat protected against rain by a projecting branch. The female bug always selects places the color of which is like that of the eggs, so they are not easy to see, notwithstanding their large size.

*Euschistus servus* Say is another hemipterous insect that preys upon the caterpillar of *H. cunea*, and in a similar manner to the Wheel-bug. It is a much smaller, but is also a very useful insect.

*Podisus spinosus* Dall. (Fig. 90), in all its stages, was quite numerous during the caterpillar plague. Its brightly-colored larvæ and pupæ (Fig. 91) were usually

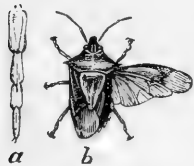


FIG. 90.—*Podisus spinosus*: a, enlarged beak; b, bug, with right wings expanded.

found in small numbers together; but as they grew older they become more solitary in their habits. All stages of this insect frequent the trunk and branches of trees, and are here actively engaged in feeding upon various insects. As soon as one of the more mature larvæ or a pupa has impaled its prey, the smaller ones crowd about to obtain their share. But the lucky captor is by no means willing to divide with the others, and he will frequently project his

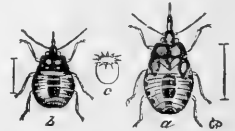


FIG. 91.—*Podisus spinosus*: a, pupa; b, larva, c, egg. After Riley.

beak forward, thus elevating the caterpillar into the air away from the others. The habit of carrying their food in such a difficult position has perhaps been acquired

\* The eggs of the Wheel-bug are pierced, however, by a little egg-parasite—*Eupelmus redivii* Howard.

simply to prevent others from sharing it. A wonderful strength is necessary to perform such a feat, since the caterpillar is sometimes many times as heavy as the bug itself. The greediness of this bug was well illustrated in the following observations: A pupa of *P. spinosus* had impaled a caterpillar, and was actively engaged in sucking it dry; meanwhile a Wheel-bug utilized a favorable opportunity and impaled the pupa, without forcing the same to let go the caterpillar. The elasticity of the beak (Fig. 90a) of these bugs must be very great; they can bend it in any direction, and yet keep it in sucking operation. The poison contained in the beak must act very rapidly, since caterpillars impaled by it squirm but for a very short time, and then become quiet.

*True parasites of the Web-worm.*—*Telenomus bifidus* Riley: A single egg of the moth of *H. texor* is a very small affair, yet it is large enough to be a world for a little parasite (Fig. 92), which undergoes all its transformations within it, and finds there all

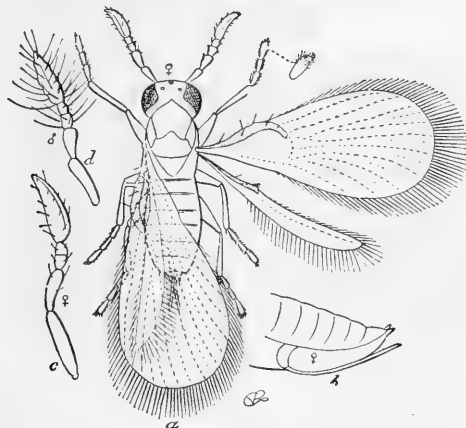


FIG. 92.—An egg-parasite: a, female; b, tip of female abdomen; c, female antenna; d, male antenna (all greatly enlarged). After Riley.

the food and lodgment required for the short period of its life. In several instances batches of eggs of this moth were parasitized, and instead of producing young caterpillars they brought forth the tiny insects of this species. The batches of parasitized eggs were found July 27 upon the leaves of sunflower, and August 18 upon leaves of willow; judging from these dates it was the second brood of moths that had deposited them. There can be no doubt, however, that eggs produced by moths emerging from their cocoons in early spring had been parasitized as well. The female *Telenomus* was also observed, August 2, busily engaged in forcing its ovipositor into the eggs, and depositing therein. The female insect is so very intent upon its work that it is not easily disturbed, and one can pluck a leaf and apply a lens without scaring it away. The eggs soon hatch inside the large egg of the moth, and the larvæ produced soon consume the contents. This egg-parasite is a very useful friend, nipping the evil in the bud, so to speak.

*Meteorus hyphantriæ* Riley.—This parasite (Fig. 93) has performed very good services during the caterpillar plague, and has done much to check any further increase of the Web-worm. During the earlier part of the summer this insect was not very numerous, but sufficient proofs, in the form of empty cocoons, were observed to indicate at least one earlier brood. Towards the end of September, and as late as the 15th of October, very numerous cocoons of a second brood were formed; they could be found in all situations to which the caterpillar itself had access. But the great majority of them were suspended from the trunks and branches of trees, and chiefly from near the base of the trunk. Each cocoon represents the death of one nearly full-grown caterpillar, since the latter harbors but one larva of the parasite.\* A

\* In only one instance the cocoon of this parasite was found inside of its host.

careful watch was kept to see how such a suspended cocoon was formed, but in vain. Once a larva had just started to make a cocoon, but it was prevented from finishing it by a secondary parasite, and it died. Another larva had already spun the rough outside cocoon, but became detached and dropped out of the lower orifice, and commenced a new one. The larva, suspended by the mandibles, evidently spins at first loose, irregular, horizontal loops around its body, until a loose cradle is formed. The silk secreted for this purpose hardens very rapidly when exposed to the air. When secure inside this cradle it lets go its hold with the mandibles, and finishes the soft.

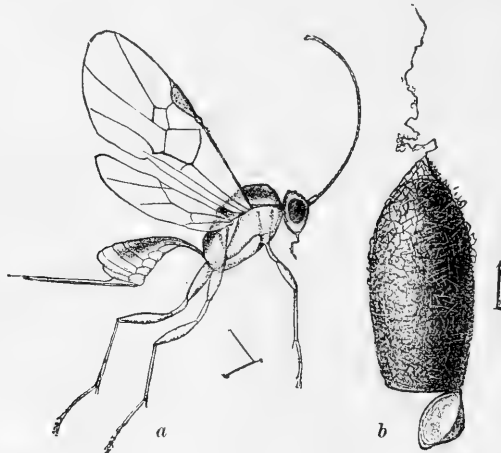


FIG. 93.—*Meteorus hyphantriae*: a, female; b, cocoon (enlarged). After Riley.

inside cocoon in the usual manner. If the larva has dropped to the ground it still makes an outer loose cocoon, but the silken threads are thicker and much more irregular. In cocoons made during a high wind the threads that suspend them are much longer, reaching sometimes the length of 4 inches; the more normal length varies from  $1\frac{1}{2}$  to 2 inches.

To find out the length of time which this insect occupies in maturing inside the cocoon, forty-four freshly-made cocoons were put in a glass jar. With a remarkable regularity but ten days were consumed by the insect in changing from the larval to the winged form. The winged *Meteorus* issues through a perfectly round hole at the lower end of the cocoon by gnawing off and detaching a snugly-fitting cap. There are several secondary parasites of the *Meteorus* which we may mention later, and they always leave the cocoon of their host by smaller holes cut through the sides. Most of the adults had issued by the 1st of November, but it is possible that some may remain in their cocoons until spring.

In order to obtain the proportion between the *Meteorus* raised from cocoons and its parasites, *i. e.* secondary parasites of *Hyphantria*, 450 cocoons were confined in a glass jar the latter part of September. Up to the first week in November only 70 specimens of *Meteorus* were bred from these cocoons, the rest giving out secondary parasites, which continued to issue up to date of writing (December 20, 1886). Thus only 16 per cent. of the cocoons produced the primary, while 84 per cent. produced secondary parasites.

*Apanteles hyphantriae* Riley (Fig. 94).—This insect was about as numerous as the *Perilitus communis*, and did equally good service in preventing a further increase of the caterpillars. It appeared somewhat earlier in the season, and killed only half-grown caterpillars. From the numerous old and empty cocoons in early summer it was plainly seen that a first brood had been quite numerous, and that from these cocoons mainly *Apanteles* had been bred, and not, as during the autumn, mostly

secondary parasites. The white silky cocoon is formed almost under the middle of a half-grown caterpillar, and is fastened securely to the object its host happened to rest upon, and but slightly to the host itself, which is readily carried to the ground by wind and rain, and can therefore only be found in position in the more sheltered places, such as cracks and fissures of the bark of trees. But one *Apanteles* is found in a caterpillar, so that each white cocoon indicates, like a tombstone, the death of a victim. In some places, and notably upon the trunks of poplars, these cocoons were so numerous as to attract attention; it seemed as if the trunk had been sprinkled with whitewash. But notwithstanding such vast numbers, but two specimens of the architects of these neat cocoons were raised; all the rest had been parasitized by secondary parasites. It is barely possible, however, that some specimens may hibernate in their cocoons, since numbers of them have as yet (December 20, 1886)

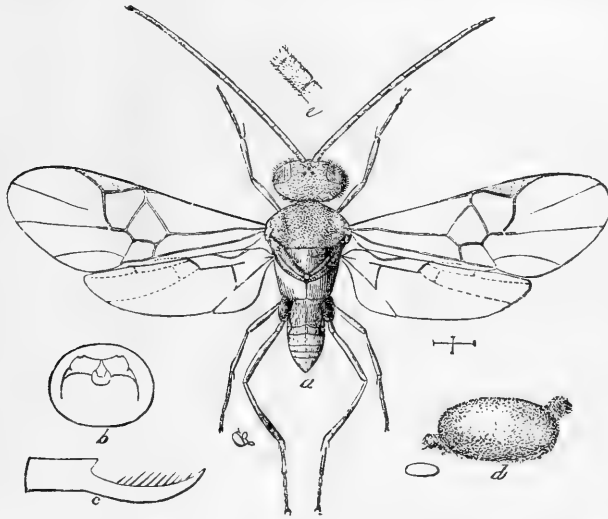


FIG. 94.—An *Apanteles*: a, female fly; b, outline of head of larva in position to show the chitinized parts of the mouth, the mandibles not visible, being withdrawn; c, one of its mandibles as seen within the head of a mounted specimen; d, cocoon; e, joint of antenna—all enlarged: natural size of a and d in hair-line. After Riley.

not revealed any insects. The winged *Apanteles* leaves the cocoon by a perfectly round orifice in the front by cutting off a little lid, which falls to the ground. Its parasites, however, leave by small holes cut through the sides. These secondary parasites were very common late in September and early in October, and busily engaged in inserting their ovipositors through the tough cocoon into their victim within. It seems as if the cocoons formed early in the season were on an average a little smaller than those formed later.

The cocoons of this *Apanteles* are of a uniform white color, but exceptionally a distinctly yellowish cocoon is found. From these yellow cocoons nothing has so far been bred, but since, as we have elsewhere shown,\* the color of the cocoon may vary in the same species, it is probable that the variation here referred to is not specific.

Not quite one-half of 1 per cent. produced parasites of various kinds.

*Limneria pallipes* Provaucher.—In addition to the two Hymenopterous parasites treated of, a third one has been very numerous, and has done much good in reducing the numbers of caterpillars. This, an Ichneumonid and a much larger insect, does not form an exposed cocoon like that of the other parasites described. Yet a little

\* Notes on North American Microgasters, p. 7 (author's edition).

attention will soon reveal large numbers of them. Upon the trunks of various trees, but chiefly upon those of the poplars and sugar maples, small colonies of caterpillars, varying in numbers from four to twelve, could be observed, which did not show any sign of life. When removed from the tree they appeared contracted, all of the same size, and pale or almost white. A closer inspection would reveal the fact that the posterior portion of the caterpillar had shrunk away to almost nothing, whilst the rest was somewhat inflated and covered with an unchanged but bleached skin, retaining all the hairs in their normal position. Opening one of these inflated skins, a long cylindrical, brown cocoon would be exposed; this is the cocoon of the *Limneria* under consideration. As numbers of such inflated skins would always occur together, it was clearly seen that the same parent *Limneria* had oviposited in all of them. Most of the cocoons were found in depressions of the rough bark or other protected places. Single ones were but rarely met with. The *Hyphantria* larva in dying had very securely fastened all its legs into the crevices of the bark, so that neither wind nor rain could easily dislodge them. Only half-grown caterpillars had thus been killed. Many of these inflated skins showed in the early part of October a large hole of exit in their posterior and dorsal ends, from which the ichneumons had escaped. Trying to obtain winged specimens of this parasite one hundred and forty of these cocoons—and only such as were not perforated in any way—were collected and put in a glass jar. Only a single female was produced from all up to the time of writing, whilst very large numbers of secondary parasites, issued from October 11 till the 20th of November, and doubtless others will appear during the spring of 1887, because some of these inflated skins show as yet no holes of exit.

*Tachina* sp. (Fig. 95.)—The parasites of *H. cunea* described so far all belong to the order Hymenoptera, which furnishes the greatest number of them. But the fly now to be described is fully as useful as any of the others.

*Tachina*-flies are very easily overlooked, because they resemble large house-flies both in appearance and in flight, and their presence out of doors is not usually noticed on that account. Yet they play a very important role, living as they do in their larval state entirely in insects. During the caterpillar plague such flies were often seen to dart repeatedly at an intended victim, buzz about it, and quickly disappear. If the caterpillar thus attacked was investigated, from one to four yellowish-white, ovoid, polished, and tough eggs would be found, usually fastened upon its neck, or some spot where they could not readily be reached. These eggs are glued so tightly to the skin of the caterpillar that they can not easily be removed. Sometimes as many as seven eggs could be counted upon a single caterpillar, showing a faulty instinct

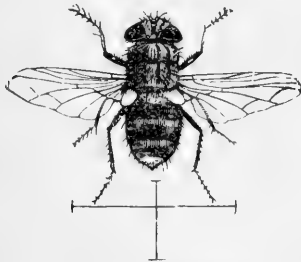


FIG. 95.—A *Tachina*-fly.

of the fly or flies, because the victim is not large enough to furnish food for so many voracious maggots. If the victim happens to be near a molt, it casts its skin with the eggs and escapes a slow but sure death. But usually the eggs hatch so soon that the small maggots have time to enter the body of the caterpillar where they soon reach their full growth, after which they force their way through the skin and drop to the ground, into which they enter to shrink into a brown, tun-like object (known technically as the coarctate pupa), which contains the true pupa. The caterpillar, tormented by enemies feeding within it, stops feeding and wanders about for a long time until it dies. As a rule, not more than two maggots of this fly mature in their host, and generally but one. The caterpillar attacked by a *Tachina*-fly is always either fully grown or nearly so.

*Tachina*-flies abounded during the whole term of the prevalence of the caterpillars. But it is impossible to state positively whether they were all bred from them or not,

since the many species of this genus of flies resemble each other so closely that a very scrutinizing investigation would have been necessary to settle such a question. But there is no doubt that they were very numerous during the summer. Some maggots obtained from caterpillars kept for this purpose in breeding jars changed to the fly in six days; others appeared in twenty three days, and still others, obtained at about the same time, are still under ground, where they will hibernate. The maggots of these flies do not, however, always enter the ground, as some were found inside cocoons made by caterpillars among rubbish above ground.

31. *Deiopeia bella* (Linn).

This caterpillar is said by Messrs. H. Edwards and Elliott to feed on the elm, as well as *Prunus*, *Lespedeza*, *Myrica*, and pods of *Crocalaria*.

*Larva*.—Head chestnut brown, smooth, shining. Ground color of the body deep buff, without orange tint. Each segment has a black transverse mark, deeply notched before and behind, and edged broadly with white, having rather long hairs, those of the dorsal region black, of the lateral white, mouth parts white, abdominal legs orange, banded with black and white. The thoracic legs wholly black. Length 30<sup>mm</sup> (.120 inch).

32. *Smerinthus geminatus* Say.

Besides occurring on the elm, this insect also feeds on the leaves of the ash and willow, as well as the apple and plum.

*Eggs*.—Globose, somewhat flattened, of a pale green color, about one-fifteenth of an inch in diameter; they hatch in seven days.

*Larva*.—When first hatched it is about one-fifth of an inch long, of a pale green color, and the caudal horn is fuscous. The mature larva is about two inches and one-fourth long, of an apple-green color, somewhat lighter above, with pale green or whitish granulations over the surface. The head has a yellow stripe on each side, and there are seven oblique stripes on each side of the body, of a pale yellow color, except the last, which is bright yellow. There is also a stripe on the side of the forward segments. The anal shield and plates are granulated, and of a darker green than the rest of the upper surface, but of the same color as the under surface. The caudal horn is slightly curved, of a violet color and granulated. (Fernald.)

*Moth*.—Expense of wings, two and a half inches. The head and thorax are pale gray, the latter with a rich dark brown triangular spot on the middle, which is rounded in front and widened out behind. The abdomen and under side of the body are brownish gray. The fore wings are gray with a faint rosy tint in some specimens. The discal spot is whitish and bordered with dark brown, and a dark brown line edged on the inside with whitish starts from the basal third of the costa at right angles with it, and runs about half way across the wing where it forms nearly a right angle, and then runs across to the hinder margin. The lower part of this line is wider and shades off on the outer side. A broad, dark brown, oblique stripe, starting from this line, occupies the space between veins 2 and 3, and ends at a narrow, somewhat wavy, pale band, which crosses the outer part of the wing, within which is a darker shade band with a straight but still darker inner edge. Outside of the pale band there are several indistinct, sinuous lines crossing the wing, a dark brown spot just inside of the anal angle, a lunulate spot of the same color edged on the inside with white at the apex, and the outer border has a wide, dark brown shade from the lunulate spot down to near the anal angle.

The hind wings are rosy red with gray costal and outer borders. There is a large black spot with two blue spots on it near the anal angle, and connected with it by a narrow black stripe. Occasionally a third blue spot appears, on the black, and sometimes there is but a single one, giving the variety *jamaicensis*, Drury, which Rev. G. D. Hulst has bred from eggs laid by *geminatus*. The under side of the fore

wings has the basal half rosy red, the entire costa and outer half gray, with the markings of the upper side faintly reproduced. The under side of the hind wings is gray and crossed by alternate bands of brown and whitish. The males have the antennæ strongly bipectinate. (Fernald.)

## 33. THE BAG-WORM.

*Thyridopteryx ephemeraformis* (Haw.).

The following account is taken from Professor Riley's bulletin on shade-tree pests (No. 10, Div. of Ent., U. S. Dept., Agr.):

Although this species was not particularly destructive to our shade-trees in 1886, and in numbers greatly inferior to the Fall Web-worm and the Tussock-moth, yet in 1879 it was much more formidable, and at irregular intervals becomes a great pest where not properly dealt with, especially in more southern States. For the past two or three years it has been on the increase in special localities in Washington, and should be carefully looked after.

*The eggs.*—During winter-time the dependent sacs or bags of this species may be seen hanging on the twigs of almost every kind of tree. If they happen to be on coniferous trees, and they are usually more abundant on these than on deciduous trees, they are not infrequently mistaken for the cones. In reality they are the coverings spun by our worm, and they serve not only as a protection to it, but also to the eggs. Upon cutting open the larger of these bags in winter-time they will be found to contain the shell of a chrysalis (technically called the pupa), which is filled with numerous small, yellow eggs (Fig. 96 e). Each of these is a little over 1 millimeter in length, obovate in form, and surrounded by a delicate, fawn-colored, silky down. In this condition the eggs remain from fall throughout the winter and early spring.

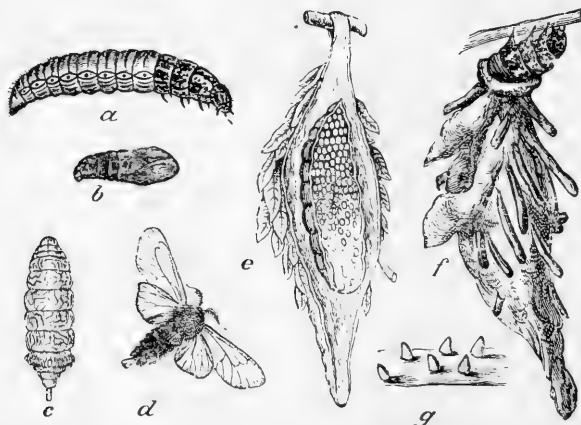


FIG. 96.—*Thyridopteryx ephemeraformis*: a, larva; b, male chrysalis; c, female moth; d, male moth; e, follicle and pupa cut open to show eggs; f, full grown larva with bag; g, young larvae with their conical upright coverings; all natural size. After Riley.

*The larva and its bag.*—About the middle of May in this latitude the eggs hatch into small but active larvæ, which at once commence to construct a portable case or bag in which to live. The way in which this bag is prepared is curious (Fig. 97). The young larva crawls on a leaf and, gnawing little bits from the surface, fastens these together with fine silk spun from its mouth. Continually adding to the mass, the larva finally produces a narrow, elongate band, which is then fastened at both ends onto the surface of the leaf by silky threads. Having secured itself from falling down by some threads, it now straddles this band and, bending its head down-



ward (Fig. 97 *b*), makes a dive under it, turns a complete somersault and lies on its back, held down by the band (Fig. 97 *c*). By a quick turning movement the larva regains its feet, the band now extending across its neck (Fig. 97 *d*). It then adds to the band at each end until the two ends meet, and they are then fastened together so as to form a kind of narrow collar which encircles the neck of the worm. Far from resting, it now busies itself by adding row after row to the anterior or lower end of the collar, which thus rapidly grows in girth and is pushed further and further over the maker (Fig. 97 *e*). The inside of this bag is now carefully lined with an additional layer of silk, and the larva now marches off, carrying the bag in an upright position (Fig. 96 *g* and Fig. 97 *f*). When in motion or when feeding, the head and thoracic segments protrude from the lower end of the bag, the rest of the body being bent upward and held in this position by the bag. As the worms grow they continue to increase the bags from the lower end and they gradually begin to use

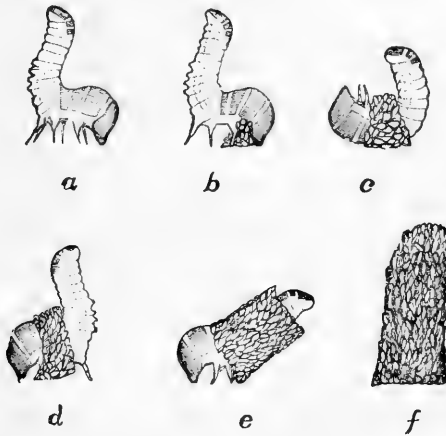


FIG. 97.—*Thyridopteryx ephemeraeformis*. How the young larva prepares its bag. After Riley

larger pieces of leaves, or bits of twigs, or any other small objects for ornamenting the outside. Thus the bags will differ according to the different kind of tree or shrub upon which the larva happens to feed; those found on coniferous trees being ornamented with the filiform pine leaves, usually arranged lengthwise on the bag, while those on the various deciduous trees are more or less densely and irregularly covered with bits of leaves interspersed with pieces of twigs. When kept in captivity the worms are very fond of using bits of cork, straw, or paper, if such are offered to them. When the bags, with the growth of the larva, get large and heavy, they are no longer carried, but allowed to hang down (Fig. 96 *f*). The worms undergo four molts, and at each of these periods they close up the mouth of their bags to remain within until they have cast their skin and recovered from this effort. The old skin, as well as the excrement, is pushed out through a passage which is kept open by the worms at the extremity of the bag.

The young larva is of a nearly uniform brown color, but when more full-grown that portion of the body which is covered by the bag is soft, of light-brown color and reddish on the sides, while the head and the thoracic joints are horny and mottled with dark-brown and white (Fig. 96 *a*). The numerous hooks with which the small, fleshy prolegs on the middle and posterior part of the body are furnished enable the worm to firmly cling to the silken lining of the bag, so that it can with difficulty be pulled out.

The bag of the full-grown worm (Fig. 96 *f*) is elongate-oval in shape, its outlines being more or less irregular on account of the irregularities in the ornamentation

above described. The silk itself is extremely tough and with difficulty pulled asunder.

The larvæ are poor travelers during growth, and though, when in great numbers, they must often wander from one branch to another, they rarely leave the tree upon which they were born unless compelled to do so by hunger through the defoliation of the tree. When full-grown, however, they develop a greater activity, especially when very numerous, and, letting themselves down by a fine silken thread, travel fast enough across sidewalks or streets and often for a considerable distance until they reach another tree, which they ascend. This migratory desire is instinctive; for should the worms remain on the same tree they would become so numerous as to necessarily perish for want of food.

*Pupation.*—The bags of the worms which are to produce male moths attain rather more than an inch in length, while those which produce females attain nearly double this size. When ready to transform, the larvæ firmly secures the anterior end of the bags to a twig or branch, and instinct leads it to reject for this purpose any deciduous leaf or leaf-stem with which it would be blown down by the winds. The inside of the bag is then strengthened with an additional lining of silk, and the change to chrysalis is made with their heads always downward. The chrysalis is of a dark-brown color, that of the male (Fig. 96, *b*) being only half the size of that of the female (Fig. 96, *e* and Fig. 99, *a*).

*The imago or perfect insect.*—After a lapse of about three weeks from pupation a still greater difference between the two sexes becomes apparant. The male chrysalis works its way to the lower end of the bag and half way out of the opening at the extremity.

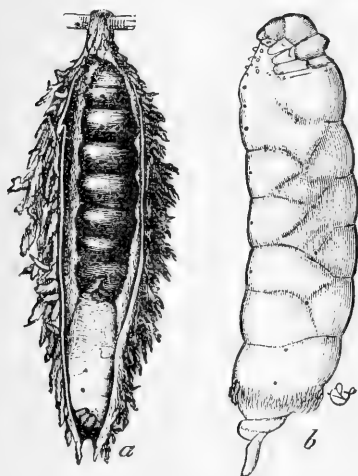


FIG. 98.—*Thyridopteryx ephemeraeformis*: *a*, Follicle cut open to show the manner in which the female works from her puparium and reaches the end of the bag, natural size; *b*, female extracted from her case, enlarged. (After Riley).

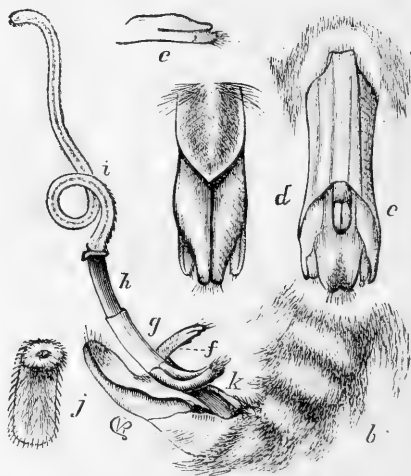


FIG. 99.—*Thyridopteryx ephemeraeformis*: *b*, The end of male abdomen from the side, showing genitalia extended; *c*, genitalia in repose, ventral view; *d*, do., dorsal view enlarged. (After Riley)

Then its skin bursts and the imago appears as a winged moth with a black, hairy body and glassy wings (Fig. 96, *d*). It is swift of flight, and owing to its small size and transparent wings, is rarely observed in nature. The life-duration of this sex is also very short. The female imago is naked (save a ring of pubescence near the end of the body of yellowish-white color), and entirely destitute of legs and wings (Fig. 96, *c*, and Fig. 98, *b*). She pushes her way partly out of the chrysalis, her head reaching to the lower end of the bag, where, without leaving the same, she awaits the approach of the male. The manner in which the chrysalis shell is elongated and reaches to the end of the bag is shown in Fig. 98, *a*, and an enlarged side view of the female showing

the details of structure is shown at *b*, in the same figure. The extensibility of the male genitalia, which permits him to reach the female within her bag, is set forth in the foregoing Fig. 99, where the parts are shown at rest, *c* and *d*, and in action *b*. Fertilization being accomplished, the female works her way back within the chrysalis skin and fills it with eggs, receding as she does so toward the lower end of the bag, where, having completed the work of oviposition, she forces, with a last effort, her shrunken body out of the opening, drops exhausted to the ground, and perishes. When the female has withdrawn, the slit at the head of the puparium and the elastic opening of the bag close again, and the eggs thus remain securely protected till they are ready to hatch the ensuing spring.

*Geographical distribution.*—The Bag-worm occurs most frequently in the more southern portion of the Middle States and in the Southern States, but seems to be absent from the Peninsula of Florida. Within these limits it extends from the Atlantic to Texas, and reaches the less timbered region west of the Mississippi. Northward, it is occasionally found in New York and even Massachusetts, but so rarely and locally restricted that neither Dr. Harris nor Dr. Fitch mention it in their publications on economic entomology. Wherever it occurs it prefers the gardens and parks within or near the cities, being much less abundant in the woods remote from cities.

*Food plants.*—The Bag-worm is known to feed on a large number of trees and shrubs, but has a predilection for certain kinds of coniferous trees, notably the red cedar and arbor vitæ, and as these evergreens are much less able to stand the loss of their foliage than the deciduous trees, the worms are much more dangerous to the former than to the latter. The hard maples are, as a rule, avoided by the worms, and it is also quite noticeable that they are not particularly fond of oak leaves and those of the Paulonias. The alanthus trees are also generally exempt from their attacks, either on account of the unpleasant taste of the leaves, or perhaps on account of the compound nature of the leaves, the worms fastening their bags to the leaf stems which fall to the ground in fall. With these exceptions,\* the worms, when sufficiently numerous, do great damage to most other kinds of trees used in our cities as shade and park trees.

*Remedies.*—In the case of the Thyrideropteryx, effective preventative work can be done during the winter-time or when the trees are bare. The bags which contain the hibernating eggs, and which are very easily detected, may then be gathered or pruned and burned. This work may be so easily done that there is no excuse for the increase of this species. Where intelligent action is possible the bags were better collected and heaped together in some open inclosure away from trees, rather than burned. By this means most of the parasites will in time escape, while the young Bag-worms, which will in time hatch and which have feeble traveling power, must needs perish from inability to reach proper food.

*Enemies.*—The Bag-worm is so well protected in all its stages that no insectivorous bird nor predaceous insect is known to attack it. In spite of the absence of predaceous enemies, the Bag-worm suffers from the attacks of at least six true parasites, while two others, which may be primary but are probably secondary, are reared from the bags. Three of these are Ichneumonids, viz: (1) *Pimpla conquisitor* Say (Fig. 100); (2) *Pimpla inquisitor* Say, and (3) *Hemiteles thyrideropterygis* Riley (Fig. 101). Of these, the last-named is most abundantly bred, and we have always considered it as the most important parasite of the Bag-worm. The past season, however, we have ascertained that three species of the genus *Hemiteles*, viz: *H. utilis*, and two undescribed species, are unquestionably secondary parasites, and this renders it quite likely that *H. thyrideropterygis* may also be secondary, or, in other words, a parasite of one of the true parasites of the Bag-worm. It is a question, however, which only the most careful study, with abundant material, can decide, as the law of unity of habit in the same genus finds many exceptions in insect life. The other parasites are as follows: (4) *Chalcis ovata* Say. This parasite is a very general feeder on Lepi-

\*The China trees of our Southern cities are entirely exempt from the worms.

dopterous larvæ, and we have bred it from seven widely different species. (5) *Spilochalcis maria* (Riley). This species, while parasitic on Thyridopteryx, is more partial to the large silk-spinning caterpillars, as we have reared it from the cocoons of all of our large native Silk-worms. (6) *Pteromalus* sp. This undescribed Chalcid is

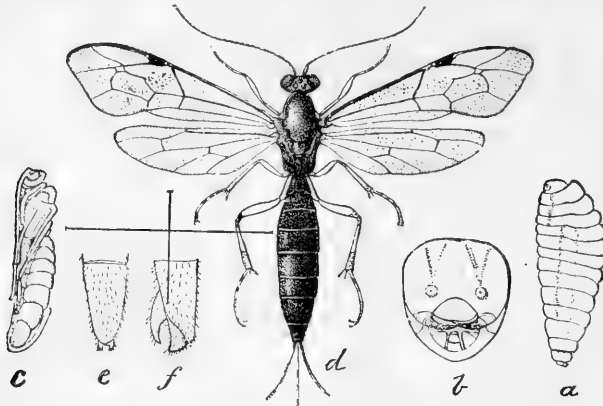


FIG. 100.—*Pimpla conquisitor*: a, larva; b, head of do. from front; c, pupa; d, adult female (hair line indicating natural size); e, end of male abdomen from above; f, same from the side—all enlarged. (After Riley.)

found very abundantly in the Bags, but may be a secondary parasite. (7) *Dinocarsis thyridopterygis* Ashmead.\* This parasite was bred from the bags in Florida by Mr. William H. Ashmead, who believes it to be parasitic on the eggs. (8) *Tachina* sp.

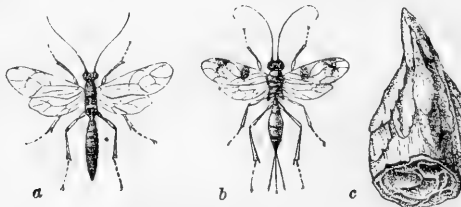


FIG. 101.—*Hemiteles thyridopterygis*: a, male; b, female; c, sack of bag-worm cut open, showing cocoons of parasite, natural size. (After Riley.)

We have bred a large bluish Tachinid from the bags. Its eggs are commonly attached to the bags externally, near the neck, and the young larvæ, on hatching, work their way into the case. They frequently fail, however, to reach the Bag-worm.

#### 34. THE WHITE-SPOTTED TUSSOCK-MOTH.

*Orgyia leucostigma* (Abbot and Smith).

The caterpillar of this moth is now and has been for some time a most grievous pest in our cities. We have observed it on Boston Common, where for years, as stated by the late Dr. Brewer, it has been injurious to the elms, as well as the maples. Though the species extends from Maine and Canada to the Southern States, it is most abundant in the New England and Middle States, and more common in

\* Mr. Ashmead's description (Canadian Entomologist, XVIII, No. 5, p. 97, May (1886), shows that this species can not belong to *Dinocarsis*, as limited by Mayr.

towns, parks, gardens, and orchards than in forests. As this insect has recently been studied by Professor Riley and his assistants, I reproduce their results:

*The eggs.*—During the month of June, and more especially late in fall and throughout the winter, glistening white objects may be seen on the trunks and the larger branches of trees, or in the corners of the fences near by, or on bunches of dead leaves hanging on the tree (see Fig. 102 *a*). Upon examination these masses will be found to be glued on to a cocoon of dirty gray color, and to consist of numerous perfectly round, cream-white eggs, which are partly covered by a glistening white froth or

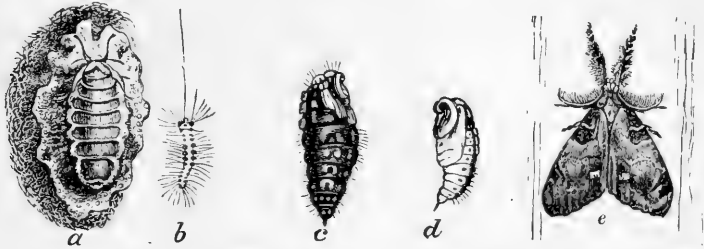


FIG. 102.—*Orgyia leucostigma*: *a*, female on cocoon; *b*, larva; *c*, female pupa; *d*, male pupa; *e*, male. Riley del.

spittle-like matter. In one of these egg-masses which we received from Kansas we have counted as many as 786 eggs, while from another mass we obtained upward of 400 young caterpillars.

The young caterpillars scatter all over the tree soon after hatching. When disturbed they make free use of a fine silken thread, which they spin, and by which they let themselves down. The full-grown larvæ are often seen to change quarters and travel from one branch to another or from one tree to another. Their rather quiet way of moving contrasts strongly with the nervous movements of the Fall Web-worm.

In the latitude of St. Louis, Mo., and Washington, the eggs begin to hatch about the middle of May, and the newly-born caterpillar, not quite 3 millimeters in length, is of dull whitish-gray color, with the under side paler, the upper side being covered with rather long hairs and tufts of a dark-brown color. In two days from hatching small orange spots begin to appear along the back, and on the seventh day the first

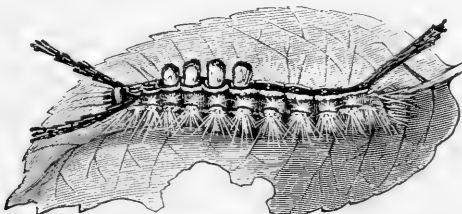


FIG. 103.—*Orgyia leucostigma*: female caterpillar. Riley del.

molt takes place, to be followed at intervals of six days each by the second and third molts. The changes that take place during this time in the appearance of the caterpillar are remarkable, and after the third molt it is a beautiful object and of striking appearance (Fig. 103).

*Larva.*—The head and two little elevated spots situated on joints 9 and 10 are bright vermilion red; the back is velvety black with two bright yellow subdorsal lines, and another yellow line each side along the lower sides. The whole body is thinly clothed with long pale-yellow hairs, originating from small wart-like elevations. Four cream-colored or white dense brushes of hair are in a row on the middle

of the fourth, fifth, sixth, and seventh dorsal joints, while from each side of the head arises a long plume-like tuft of black hair projecting forward and outward. A similar plume projects upwards from the last dorsal joint. The hairs composing these plumes are coarse, barbed, knobbed, and arranged in sets of unequal length, thus giving the plumes a turbinate appearance.

*Pupation.*—Six days after the third molt a portion of the larvæ spin up; all these produce male moths. The female caterpillars, which up to this time have been undistinguishable from the male caterpillars, undergo a fourth (and, as it appears from more recent experience, in some instances even a fifth) molt and acquire twice the size of the male caterpillar. This last, when full grown, measures about twenty millimeters in length. The cocoon spun by the male caterpillar is of whitish or yellowish color and sufficiently thin to show the insect within. It consists of two layers, the hairs of the tufts and brushes of the caterpillar being interwoven with the outer layer. The female cocoon is correspondingly larger, of gray color, and much more solid and denser than the male cocoon. The male chrysalis (Fig. 13 *d*), which is soon formed within the cocoon, is of brownish color, sometimes whitish on the ventral side, and covered on the back and sides with fine white hairs. The female chrysalis (Fig. 102 *c*) is much larger than the male, and otherwise differs, especially in lacking the wing-sheaths and in having on the three first segments after the head transverse flattened protuberances composed of scales, which are much less visible in the male. The duration of the pupa state is less than a fortnight.

*The imago.*—The male (Fig. 102 *e*) is a winged moth with feathery antennæ and very hairy forelegs. The general color is ash-gray, the front wings being crossed by undulated bands of darker shade, with two black markings on the outer edge near the tip and a white spot on the inner edge also near the tip. He may frequently be seen sitting on the trunks of trees or on the shady side of houses, etc., as he rests during the day and flies only after dusk, often being attracted by light. The female (Fig. 102 *a*) is totally different from the male in appearance and resembles a hairy worm rather than a moth, since she possesses the merest rudiments of wings. She is of a pale gray color, the antennæ being short and not feathered, the legs rather slender and not covered with long hairs. She has consequently no power of flight, and is barely able to walk. After working her way out of the chrysalis and cocoon she takes her place on the outside of the latter, and patiently awaits the approach of the male. Here she also deposits and protects her eggs in the manner already mentioned, after which she drops exhausted to the ground and perishes. The white mass covering the eggs is at first viscous, but soon dries, becoming brittle, and is impervious to water.

*Hibernation.*—The species hibernates normally in the egg state, but occasionally a living chrysalis may be found in winter-time. On January 30, 1874, we received from Mr. Hunter Nicholson, from Knoxville, Tenn., a newly-hatched female, and this had, no doubt, prematurely issued from a hibernating chrysalis. This is, however, quite exceptional, and the different climatic conditions to which the species is subjected in its wide distribution do not seem to alter the normal mode of hibernation.

*Number of annual generations.*—In the latitude of Washington the species is two-brooded, the imagos of the first generation appearing in the first part of June, those of the second generation in September and October. On several occasions we have found, however, that a portion of the caterpillars from one and the same batch of eggs would be feeding while the rest had already transformed to imagos. The result of this retardation and irregularity in development is that caterpillars may be found continuously throughout the season from June till October, and that there is, consequently, no distinct dividing line between the two generations. In the more northern States the species is single-brooded, the caterpillars appearing in the months of July and August.

*Natural enemies and parasites.*—The fact that the caterpillar makes no effort to conceal itself shows that it enjoys immunity from enemies, and notably from birds.

In fact, the American Yellow-billed Cuckoo, the Baltimore Oriole, and the Robin are the only birds which have been observed to feed upon the larvæ. Predaceous insects are also not particularly fond of this hairy caterpillar, the well-known Wheel-bug (*Prionidus cristatus*, Fig. 104) and a few other Soldier-bugs being the only species which occasionally suck its juices. Nocturnal birds, and especially bats, will, no doubt, devour many of the male moths flying about after dusk, but the destruction

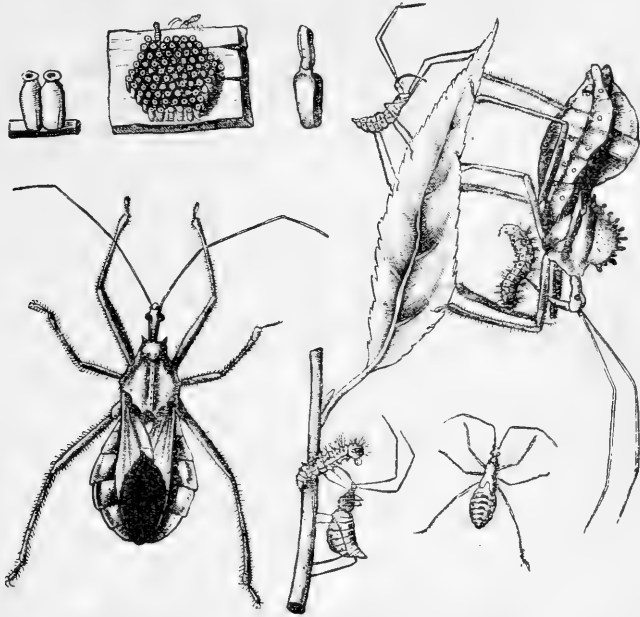


FIG. 104.—*Prionidus cristatus*: eggs, larvæ, and full-grown specimens. (After Glover).

of a portion of the males has no appreciable influence on the decrease of the worms of the next generation. The egg-masses appear to be effectually protected by the froth-like covering, as neither bird nor predaceous insect has been observed to destroy them.

While the list of enemies that devour the species is thus small, that of the parasites is fortunately quite large, and it is due to their influence that the caterpillars are not permanently injurious. There are several true parasites of this insect. Fitch described one species which he bred in considerable numbers from the larva, as *Trichogramma? orgyia*, but a perusal of his account indicates plainly that this parasite is an *Eulophus*. He also described a closely-related insect as *Trichogramma? fraterna* and gave it as a very probable parasite of *Orgyia*. There is, however, not the slightest evidence of such parasitism and this insect must in future be excluded from the list of parasites of the *Orgyia* larvæ. We have reared from this insect *Pimpla inquisitor*, and an undetermined Tachinid fly, and have had from the larva the cocoons of a *Microgaster* which has not been reared to the imago. We have also bred a true egg-parasite of the genus *Telenomus*, two distinct species of the genus *Pteromalus* from the larvæ, and Mr. Lintner has sent us a specimen of a species of *Tetrastichus*, which is probably parasitic upon one of the *Pteromali*.

### 35. *Halesidota tessellaris* Hb.

This beautiful insect, whether we consider the caterpillar or the moth, is said by Harris to be very common throughout the United States on

the buttonwood or sycamore, but as it also occurs on the elm, oak, and other forest trees, it may as well be described here.

I have found it on the sycamore at Providence, R. I., September 20 to 30. It spun a cocoon the 26th, but died in confinement. The cocoon is oblong-oval, composed of the hairs interwoven with a very little silk, and usually spun in crevices in fences, and under stones, etc. The moth appears in New England after the middle of June. The moth has an enormous geographical range, extending from Maine and Canada to Brazil and Paraguay, Mr. Neumogen having specimens from the latter country in his collection.

"Larvæ of this species were found at St. Louis, Mo., September 14, 1870, feeding on oak and elm; also on elm at Springfield, Ill.; on swamp oak at Selma, Ala., early in October. It is also found, according to Smith and Abbot, feeding on leaves of beech, hornbeam, and plane.

"The general color of some larvæ is quite yellow, but they become dark after molting. By the 6th of October they generally commence forming their cocoons, which as a rule are formed on the surface, though occasionally they go into the ground to the depth of an inch.

"The moth issues from about the last of April to the latter part of June.

"Some of the larvæ are infested by Tachinids and numerous specimens of a *Microgaster*.

"Two larvæ of this moth were found by E. A. Schwarz on swamp oak at Selma, Ala. From one of these larvæ a *Tachina* emerged early in October."—(Riley's unpublished notes.)

*Larva*.—Body of the shape usual in this genus; the hairs delicate buff-yellow; four dorsal pencils in front, of light sienna brown, with two pairs of shorter lateral white tufts; a pair of whitish tufts near the end of the body; head yellowish brown; a row of lateral black spots above the base of the abdominal legs; length 30<sup>mm</sup>.

*Moth*.—Pale buff-yellow; the fore wings more pointed than in most of the other species, translucent and crossed by five broad irregular, slightly darker bands, edged with fine dark lines; the third band is dislocated and only reaches from the costal edge of the wing to the median vein, and includes a long sinuous discal line. The large shoulder tippets are edged with bluish green, and the abdomen is ochereous-yellow. Expanse of wings 1½ to 2 inches.

### 36. *Datana contracta* Walker.

The following notes are contributed by Professor Riley:

This insect has been found from the middle of August to October at St. Louis, Mo., feeding on the elm and oak. Those found on the oak appear to have generally paler stripes than the elm-feeding form. The larvæ enter the ground by the first of October and commence issuing towards the end of June of the following year.—(Unpublished notes. See also p. 151.)

*Larva*.—The general color is shiny black, with four yellow, longitudinal lines running on each side the whole length of the body. The ventral region is also black, with three yellow longitudinal lines running its length, interrupted only by the prolegs; head as large as body and shiny black; cervical shield, feet, and abdominal prolegs light brown, the latter having black extremities. The anal prolegs are very



small and black. It is sparsely covered with fine white hairs, which are longest near the head and spiracles. When disturbed it throws up the head and tail, resting on the prolegs. They are gregarious when young. Length,  $2\frac{1}{4}$  inches.

37. *Nerice bidentata* Walker.

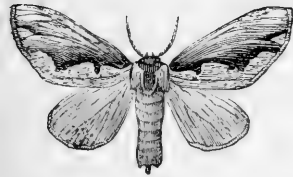


FIG. 105. *Nerice bidentata*, from Packard.

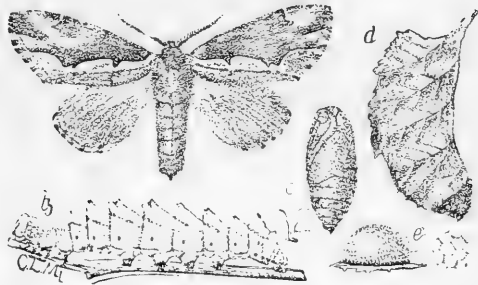


FIG. 106. *Nerice bidentata*: a, moth; b, larva; c, pupa; d, folded leaf inclosing the cocoon, all natural size; e, the egg, enlarged, with outline of the surface pattern, much magnified. C. L. Marlatt del.

I once found the larva on the elm at Providence fully grown September 3, but failed to describe it; it pupated September 6, and the moth appeared in May of the following year. The pupa is rather thick, the cremaster very blunt, with a long, slender, acute point bearing very short curled setæ, and divided at the end into two minute forks. Length, 18<sup>mm</sup>.

We are indebted for the following notes and description of the larva to Professor Riley :

Found September 16, 1869, at Bellville, on the common elm, a most singular caterpillar.

September 26, 1869, they all descended to the ground and formed their cocoons in the same corner of the breeding cage. The cocoon is formed on the surface of the earth, and consists of loose, yielding silk and earth.

It issued the following May 4, 1870. From a larva found feeding on the elm August 26 the moth issued September 21. (Unpublished notes.)

*Larva*.—Length, 1.25 inches. General color, polished bluish green. Head narrower above than below, and larger than segment 1; head of the same polished green hue as the body, with four perpendicular silvery-green lines, the two outer ones running parallel to the triangular piece and then taking its V-shaped form. A row—four to six—of minute black eye-spots at base of palpi. Three thoracic segments pale silvery green above, interrupted, however, by a straight dorsal and wavy subdorsal line of the dark bluish-green general color. Segments 4 to 11, inclusive, each with a large anteriorly directed prominence ending in a bifid ridge, the incision being transverse, the anterior portion being curved backwards and larger than the posterior part, the two looking very much like the bill of an eagle and susceptible of being opened and closed. Segments from 1 to 6 gradually increasing; 6 to 9 about of a size, or showing but a very slight decrease; 10 and 11 somewhat smaller and of a size, though the prominence on 11 is more pointed and higher than that on 10. Steep decline from 11 to anus, with but a very slight prominence on 12. The upper half of the body, including prominences, is silvery-green, with the dark lines already mentioned on thoracic segments, and an oblique dark line running on the other segments from anterior base of prominence to the posterior portion of the following segment.

Summits of prominences yellowish, with extreme edges brown. Spiracles yellowish with a lilaceous annulation. Thoracic segments with a lilaceous line, bordered above with yellow immediately above the legs; segments 4 and 5 with a distinct, and the rest of the segments each with an indistinct patch of the same two colors in a line with it, frequently becoming confluent and forming another line from 10 to anal legs.

Since this report was sent to the printer Mr. C. L. Marlatt has published in the Transactions of the twentieth and twenty-first annual meetings of the Kansas Academy of Science (1887-'88) an account of the habits and transformations, with the above figures,\* of this singular Notodontian. It appears to be double brooded, as the moths appeared in Kansas from May to June, and the females deposited their eggs at that time; a second brood of moths probably appearing about the first of August, as the caterpillars become fully grown September 14-21. They spin cocoons of stout, brownish silk within folded leaves (Fig. 106 *d*) or under some slight protection at the surface of the soil, concealed by particles of earth.

*Egg*.— $.9 \times .55$ mm. Shape hemispherical, with a broad flattened base, irregularly encircled by a whitish cement, fastening it to the leaf. Surface shining, apparently smooth, but when highly magnified is found to be covered with raised lines inclosing minute polygonal, usually six-sided areas. Color, honey-yellow; after hatching, nearly white. (Marlatt.)

### 38. *Seirodonta bilineata* (Packard).

This insect was known by Dr. Harris to inhabit the elm as early as 1837, and as his descriptions were from life I reproduce them below. The caterpillar is found from August until October. Professor French has also described the larva found on the elm. (Can. Ent., xviii, 49.) The larva which Harris (Ent. Corr., 302) found under a sycamore and reared on sycamore leaves is evidently the young of *Heterocampa unicolor*; September 16 it secured itself in a leaf, doubled and fastened with bands of silk.

*Larva*.—Body green like the following,† with a lateral white line approximating on the fourth, third, second, and first segments and distant on the others; dorsal line and tubercles as in the following. On the sides of the sixth and ninth segments a triangular, claret-red spot. This caterpillar varies in having also a semi-circular red spot on the top of the fourth segment, and sometimes the entire back between the white lateral lines is claret red and angulated downwards on the sixth and ninth segments.

A young specimen found September 10, 1841, had the whole back deep claret red, bounded on each side by an irregular, whitish line. The claret color was angularly dilated on the sixth and ninth segments, and the tubercles on the fourth and eleventh segments were also deep claret red. Length, three-fourths of an inch.

*Moth*.—Cinereous. Upper side of the palpi and end of the patagia dark. Fore wings crossed by basal and outer waved and angulated lines, margined on each side with blackish. The basal line is angular inwards on the internal nervure, is rounded outwards across to the subcostal and acutely angulated on that nervure. Outer line angulated outward on the internal, and waved and angulated to the costa. Between

\* I am indebted to Prof. E. A. Popenoe for the use of this cut.

† The "following" species is *Notodonta (Gluphisia?) ulmi* Harris MSS. Pl. II, figs. 2 and 3. These, however, appear to represent *Lochmæus manteo* (*Het. subalbicans*).

this line and the outer margin is a faint band. Between the two principal lines are some black scales; a few black scales mark the obsolete discal spot. Towards the apex on the costa are four dark spots. Hind wings smoky, a little discolored at the internal angle, beneath concolorous. The female wants the few black scales between the two principal lines. Length of body, male, .70; female, .75; expanse of wings, male, 1.50; female, 1.50 inch.

## THE UNICORN WORM.

39. *Schizura unicornis* (Abbot and Smith).

The caterpillar of this moth, more commonly met with on the apple tree, we have found September 6 on the elm at Brunswick, Me. At about this date, Harris says, it makes its cocoon, which is thin and almost transparent, resembling parchment in texture, and covered generally with bits of leaves on the outside. The caterpillars remain in their cocoons a long time previous to changing to chrysalids, and the moth appears the following May and June.

This and the other species of the genus are doubtless protected from the attacks of birds by their close resemblance to a dead, dry portion or blotch on the edge of the leaf, as they usually feed on the edge.

The following observations have been made by Professor Riley :

The larva of the above species is found feeding on quite a number of different plants, such as oak, elm, plum, apple, dogwood, alder, winterberry, rose, and blackberry, also on hickory.

It is a very singularly shaped caterpillar. General color in sound specimens, rich reddish-brown, in others grayish-brown, shaded with very minute spots of a darker color, which give it a shagreened appearance. A faint line of a darker color runs along each side from the third segment. It is variegated on the back with a lighter color, somewhat in the shape of a letter **W** as one looks from the head, and two lines forming a **V** start.

Larvæ found on blackberry were mostly very pale, with the white **V** mark on joints 9 and 10 very plain, with much glaucous color about the back, and with the other shades of purple-brown, flesh-brown, olive and pale green, which are found on the withering blackberry bushes, all present. The glaucous and brown colors are especially noticed on the canes of this plant.

The insect is evidently two-brooded, those of the first brood spinning up at the commencement of July, while larvæ of a second brood, often only about one-fourth grown, are found as late as October 10.

The cocoon is very thin and looks much like parchment. It frequently draws a few leaves together for this purpose, and changes to a chrysalis in about four days, which is at first of the same color as was the caterpillar, the green segments being distinctly visible, but soon changes to a shiny brown, with two points at the tail, and one blunter one at the head. There are also slight elevations on the under part of the abdomen where the prolegs of the caterpillar were.

The mimicry of the larva when on the blackberry, either stem or leaf, is perfect, and the imitative resemblance of the moth, when at rest, to the bark of a tree is still more striking. The moth always rests head downwards with the legs all drawn together and its wings folded round the body, which is stretched out at an angle of about 45 degrees, the dull gray coloring of the wings with the lichen-green and flesh color giving the whole such a perfect appearance to a piece of rough bark that the deception is perfect.

Some of the larvæ are, however, infested with Tachinids and with *Ophion purgator* Say. (Riley's unpublished notes.)

*Larva*.—Body much compressed; head not so wide as the body, compressed, flattened in front, elevated towards the vertex, cleft, ending in two rounded conical tubercles; pale rust-red, densely marbled with a fine net-work of darker lines. Body pale rust-red, with a pale pea-green patch on the side of the second and third thoracic segments, not reaching to the anterior spiracle. First abdominal segment with a large high acute conical tubercle, bearing at tip two very slender spreading brown cylindrical tubercles. On fifth a slight hump, bearing two small warts; eighth segment bearing a rather large dorsal hump, supporting two dark warts; in front is a broken V-shaped silver mark, the apex directed forward. Anal legs brown, held out, with end of body, horizontally. Three lateral obscure oblique lines connecting with a dark obscure lateral straight line placed some distance above the spiracles. Feet all rust-reddish, thoracic feet paler. Length 20<sup>mm</sup>.

*Moth*.—Fore wings light brown, with patches of greenish white and with wavy dark brown lines, two of which inclose a small whitish space near the shoulders; a short blackish mark near the middle; the tip and outer hind margin whitish, tinged with red in the males; and near the outer hind angle there are one small white and two black dashes; the hind wings of the male are dirty white, with a dusky spot on the inner hind angle; those of the female are sometimes entirely dusky; the body is brownish, and there are two narrow black bands across the fore part of the thorax. The wings expand from one inch and a quarter to one inch and a half, or nearly. (Harris.) It differs from the other species of the genus in having on the thorax dark transverse lines before and behind, with the internal angle of the hind wings dark. In this genus the antennæ are pectinated to the tip, the palpi are short; fore wings rather broad, square at the apex, the outer margin hardly oblique, and the anal tuft is bifid.

40. *Lochmaeus* sp.

A notodontian described below occurred on the elm August 22. I tried in vain to rear it; it began to make its cocoon September 20, but died.

*Larva*.—Young. Body rather slender, somewhat compressed. Head rather large, produced toward the apex, but not conical, green; on each side a white straight line edged in front with black. On first abdominal segment a pair of bright red dorsal tubercles, third segment from the end of the body humped, the hump ending in two rounded bead-like, reddish tubercles. Anal legs rather large, oblique, but not strikingly so, and not held out straight as in *N. unicornis*. Body pale green, color of the under side of the elm leaf. Three yellow dorsal lines, the median the narrowest, on the abdomen. On thoracic segments a broad single white line, containing two parallel dark distinct purple thread-like lines; 2 to 4 small yellow warts on each segment. Anal legs with a dark external line. Length 12<sup>mm</sup>.

41. *Gluphisia trilineata* Pack.

We have but a single eastern species of this genus to which possibly the *Gluphisia? ulmi* of Harris' Correspondence (p. 302) belongs. It is represented on his Pl. II, Figs. 2-3. He states that the caterpillar inhabits the American elm, occurring in August, September, and October. We add his description of the caterpillar, which, however, may possibly be that of *Lochmaeus manteo*, as Harris' figure very closely represents that caterpillar, though he undoubtedly bred this *Gluphisia* from the elm.

*Larva*.—Green, back paler. Head with a white lateral stripe edged before with vermilion and black; a reversed black V on the front; side of the body with minute black points and very short longitudinal lines. A white lateral line converging on the fourth

segment before and diverging behind, and extending on each side to the tips of the twelfth segment; on the fourth segment, between two orange-colored tubercles, begins a white dorsal line, edged with green, which also extends to the tip of the twelfth segment. The lateral lines on the first three segments are edged within or above with pink or purple, and sometimes a narrow purple edge borders the lateral line above to the end. On the eleventh segment are two very minute orange tubercles, and a few very small yellow ones on the sides of the body. A yellow lateral line just above the feet on the first three or four segments. Spiracles orange. The minute tubercles on the fourth and eleventh segments emit each a black hair, and the other tubercles small whitish hairs. Twelfth segment with the prolegs elevated when the insect is at rest. (Harris.)

*Moth*.—Light cinereous, fore wings lighter than the thorax. Two transverse darker lines, inclosing an obscure yellowish band. The first line straight, the second oblique, with two large teeth pointing in ward, on the submedian interspace, and on the fourth subcostal veinlet. A submarginal line twice bent, obtusely angulated in the second median interspace, and on the subapical space. Wings dark at the base and at the ends of the venules. Hind wings nearly white, not discolored. Beneath uniformly pale ash. Expanse of wings 1.10 to 1.25 inches. This moth can be distinguished from other Notodontians by the uniform cinereous tinge, the three transverse lines on the fore wings, the yellowish band limited within by the straight line, without by the oblique waved line; also by the plain outer half of the wing, interrupted near the margin by the rather obscure twice waved darker line, and by the plain hind wings.

#### 42. DEILEPHILA LINEATA (Fabr.).

Plate III, fig. 3, larva.

The larva of this species occurred on the elm, according to Mr. Joseph Bridgman, of Providence, who kindly presented me with the excellent colored sketch on plate III. It also feeds on the leaves of the apple, grape, plum, currant, gooseberry, buckwheat, turnip, watermelon, chickweed (*Stellaria*), bitter dock (*Rumex obtusifolius*), evening primrose (*Oenothera biennis*), common purslane (*Portulaca oleracea*). From this it will be seen that the larva, which is to be found in July, is a general feeder. The moth appears in September. It ranges from Maine and Canada to Mexico and the West Indies. The caterpillar is infested by a tachina fly.

*Larva*.—About 3 inches long and quite variable. The most common form is of a yellowish green color, with a row of prominent spots along each side, each spot consisting of two curved black lines inclosing a crimson patch above and a pale yellow line below, the whole being connected by a pale yellow stripe edged with black. In some instances these spots are disconnected, and the space between the black crescents is of a uniform cream color. The other form of the larva is black, with a yellow line along the middle of the back and a double series of yellow spots and dots along the side. Caudal horn, yellowish orange towards the extremity, and rough.

*Pupa*.—The pupa is light brown, the head-case compressed laterally and prominent; tongue-case not apparent. (Clemens.)

*Moth*.—Body and fore wings olive brown, with three parallel white stripes along each side of the thorax; fore wings with a buff stripe reaching from the base of the hinder edge to the apex; the hinder edge of the wing narrowly edged with white, and the veins marked with white; hind wings black, with a central reddish band inclosing a whitish spot near the hinder margin; the outer margin is narrowly edged with brownish, tinged with reddish; wings white; expanse of wings nearly 3½ inches.

43. *Apatela grisea* (Walker).

The caterpillar has been reared by Mr. Elliot from the elm.

*Larva after third molt.*—Pale apple green, the dorsal region elevated into a ridge and marked with a broken brown dorsal line, broadest on segments 2, 3, 8, 9, and 10; the brown patch on 2 with cream-colored edges; head pale green in center, brownish on the sides, with paler marblings. Segments 3, 4, 5, 6, 7, and 12 have small raised tubercles bearing spines, and on second segment bunches of long hairs. Lateral region wholly pale green with whitish irrorations. Spiracles cream color, edged with black. Thoracic and abdominal legs concolorous. Length 15<sup>mm</sup> (.60 inch).

*Full-grown larva.*—Head dull chestnut brown, with some darker markings; body wholly yellowish green with a slight brownish tint. On segments 7 and 8 is a broad brown triangular patch, the mark being continued, slightly reduced in size, to the anal segment. Each of the segments bears brownish tubercles, with short, spinous hairs; those of No. 5 have six tubercles, those of 8 and 9 three each, and the rest only two; there is a faint subdorsal brownish line broken up into patches; the spiracles are brown, with redder brown patches above and below them. When at rest segments 3, 4, 5, and 6 are very much elevated into a hump. All the tubercles bear short, sharp hairs, and there is also a series along the lower lateral region. Length, when at rest, 25<sup>mm</sup>; when feeding, 32<sup>mm</sup> (1.28 inches). (Hy. Edwards & Elliott.)

*Moth.*—Cinereous; abdomen and hind wings white. Fore wings rather short and broad, hardly oblique along the exterior border, with two irregular black discal ringlets, with a widely interrupted black stripe, and with two black bands, each of which forms a distinct X, where it traverses the stripe; interior band undulating, interrupted; exterior band zigzag; expanse of wings 14 to 16 lines. (Walker.)

44. *Apatela morula* Grote & Robinson.

Mr. R. Thaxter has found the eggs of this moth on the elm. They hatched July 12. The larva molts six times, the sixth time August 2. With the last molt there is a change of color and with this a change of habits, for the caterpillar instead of resting on the upper surface of the leaves, on which it spins a slight web, as in the preceding stages, betakes itself to the crevices of the bark, where it becomes almost invisible.

The cocoon is spun under loose bark or in the crevices, and can often be found on the trunks of old elms, though the moth is somewhat rare. The present brood began to spin August 9, producing a single imago in confinement September 7; the moth usually appears in June and July. A larva also occurred on the linden September 15. "In their early stages the larvæ of *A. morula*, *furcifera*, *radcliffii*, and *clarescens* can hardly be distinguished at a glance, and all except the last species produce striking changes of color after the last molt." (Papilio, iii, 13.)

*Eggs.*—Very small, much flattened, whitish.

*Young larva.*—Dirty greenish white, without marks; a few white hairs, a subdorsal row black, head tinged with brown.

*After first molt.*—July 15. Light green; legs and setiferous tubercles white; a subdorsal white band; a few anterior and posterior hairs very long. Head light green with a few longitudinal dark streaks. Length, 2.5<sup>mm</sup>.

*After second molt.*—July 19. Brighter green. Subdorsal band more distinct, interrupted on segments 1 and 10. A transverse median dorsal red band on segments 4, 7, 11. Form more tapering abruptly anteriorly and gradually posteriorly from segments 3 and 4. Length, 6<sup>mm</sup>.

*After third molt.*—July 22. Clear light pea-green. A subdorsal yellow band growing faint on segments 9 and 10. A conspicuous mottled, dark red brown dorsal patch on segments 4, 7, 11, edged posteriorly and externally with yellow. A fine lateral white line. Two small dorsal reddish patches on segment 1. Setiferous tubercles yellowish, bearing a few long whitish hairs. Head green anteriorly, mottled reddish posteriorly. Legs and prolegs green. Length, 10<sup>mm</sup>.

*After fourth molt.*—July 26. Dark yellow green above, blue green below; colors brighter than in the preceding stage. Lateral line broken and inconspicuous; otherwise as in the preceding stage. Length, 18<sup>mm</sup>.

*After fifth molt.*—Colors more intense, the yellow and red of the dorsal spots contrasting strongly. In a few specimens segment 8 has in all the above stages a dorsal spot less conspicuous than the rest; otherwise as in fifth stage. Larva, 30<sup>mm</sup>.

*After sixth molt, larva full fed.*—General color mottled-brown and greenish like the bark. A dorsal black band contracted between each segment, containing a central dorsal white line. On segments 4, 7, 8 this band forms a transverse dorsal hump, edged with deep black and set with a few short white hairs. Above and below the stigmata are white setiferous tubercles bearing whitish hairs. Segments, 1, 2, and 3 are set with tubercles bearing longer hairs than the others, which are directed anteriorly. A diagonal black mark suffused on segments 1, 2, 3 runs superiorly and posteriorly just above the stigmata. The latter black ringed with white. Head black anteriorly, dull carmine or orange posteriorly, with a central, arrow-shaped light-brownish mark, and with several lateral whitish streaks. Legs greenish; prolegs black. Beneath dirty greenish. Length, 50<sup>mm</sup> (2.00 inches). (Thaxter).

*Moth.*—Fore wings pale gray, the marks and lines with olivaceous shadings. An elongate narrow black streak along the median nervure, extending to the outer line of the transverse anterior and heavily shaded beneath with olivaceous. Transverse anterior line geminate, the lines wide apart on the costa, olivaceous, the inner marked with black scales along its middle. Orbicular spot small olivaceous. Reniform spot greenish ochereous. Hind wings smoky gray. Expanse of wings 44<sup>mm</sup> (1.76 inch). A little smaller than *A. lobeliae* and paler colored. Easily distinguished by its ochereous olivaceous shadings, and by the absence of the black dash on the disk which connects the ordinary spots in *A. lobeliae*. (Grote.)

45. *Apatela vinnula* Grote.

According to Mr. Thaxter this species feeds on the elm.

46. *Apatela ulmi* Harris.

This species was reared by Dr. Harris. It becomes fully fed by the middle of September in northern New England, and spins a tough cocoon, the moth appearing the second week in June (Harris's Corr.). We have found it on the elm September 15, in Maine.

*Larva.*—Head large, as wide as the body; black, with a deep red patch on each side of the vertex above; clypeus with a V-shaped white spot; between the forks of the V a white line leading to the white labrum; basal joint of antennæ white, rest jet black. Body thick, with three fleshy, black, conspicuous transverse dorsal humps, one on first, sixth, and eighth segments. From the eighth segment a black median dorsal line extends to end of body; in front a white-gray median line extends to head, and is edged broadly with black; four unequal whitish warts on each side of each segment; from them stand out on each side long white hairs, nearly as long as the body is thick. From each uppermost tubercle only short hairs radiate. The top and sides of the body also rough with short white thick hairs. Thoracic feet black; abdominal ones, pale flesh-colored. Anal legs striped slightly and irregularly on the outside. Behind the head on thoracic segments and on the tail a few erect long white hairs. Length, 32<sup>mm</sup>.

47. *Geometrid caterpillar.*

This span worm, which exactly resembles a small twig of the elm, occurred at Brunswick, Me., August 20. It did not complete its transformations, as a small Ichneumon came out of the end of the body.

*Larva.*—Body cylindrical, smooth, slightly wrinkled. Head cleft, but the lateral tubercles are not very high, subacute, quite regularly conical. Prothoracic segment slightly wider than the head; square in front, edge touched with light dull white. Fifth abdominal segment with two conspicuous rounded conical tubercles concolorous with the body, which is reddish brown—just the tint of a small elm twig. Penultimate segment a little humped and rough and dark. Supra-anal plate triangular, rather acute; surface rather rough, a little granulated. Anal legs very broad and rather short and with the dorsal spines rather broad; hind edge of legs and spines edged with fine setæ like a fringe. Front part of each abdominal segment lighter, being marbled or speckled with dark on a somewhat lilac ground, but these patches are scarcely well enough marked to give the body a checkered appearance. Full-fed, August 20 to 25. Length, 25<sup>mm</sup>.

## 48. THE GOLDSMITH BEETLE.

*Cotalpa lanigera* Linn.

Order COLEOPTERA; family SCARABÆIDÆ.

This beetle is nearly an inch in length, bright yellow above, with a golden metallic luster on the head and thorax, while the under side of the body is copper-colored, and densely covered with white hairs.

Dr. Harris says that it is very common, remarking that it begins to appear in Massachusetts about the middle of May, and continues generally till the 20th of June. "In the morning and evening twilight they come forth from their retreats, and fly about with a humming

and rustling sound among the branches of trees, the tender leaves of which they devour. Pear trees are particularly subject to their attacks, but the elm, hickory, poplar, oak, and probably also other kinds of trees, are frequented and injured by them." Dr. Lockwood has found it on the white poplar of Europe, the sweet-gum, and has seen it eating the Law-

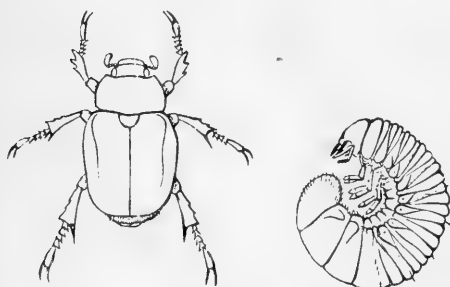


Fig. 107.—The Goldsmith beetle and larva.

ton blackberry. He adds that the larvæ of these insects are not known; probably they live in the ground upon the roots of plants.

It has remained for the Rev. Dr. S. Lockwood to discover that the grub or larva of this pretty beetle in New Jersey devastates strawberry beds, the larva feeding upon the roots, in the same manner as the May beetle. His account was first published in the American



Naturalist (vol. ii, pp. 186, 441). He says that in the month of May in the ordinary culture of his garden the spade has turned up this beetle generally in company with the May beetle. He found that some of the larvæ, as in the case of the May beetle, assume the adult beetle state in October and remain under ground for seven months before appearing in the spring.

*Larva.*—The larvæ (fig. 107) he describes as “whitish grubs, about one inch and three-quarters long and over half an inch thick, with a yellowish-brown scale on the part corresponding to the thorax.” I may add that it so nearly resembles the young of the May beetle that it requires a close examination to tell them apart. The proportions of the two are much the same; if anything the Cotalpa is slightly shorter and thicker, and its body is covered with short, stiff hair, especially at the end, while in the May beetle the hairs are much finer, sparse, and the skin is consequently shiny. They also differ in the head being fuller, more rounded in Cotalpa, the clypeus shorter and very convex, while in the May beetle it is flattened. The upper lip (labrum) is in Cotalpa longer, more rounded in front and narrower at the base, and full convex on the surface, while in the young May beetle it is flat. The antennæ are longer and larger in the goldsmith beetle, the second joint a little over half as long as the third, while in the May beetle grub it is nearly three-quarters as long; the third joint is much longer than in the latter grub, while the fourth and fifth are of the same relative length as in the May beetle, but much thicker. The jaws (mandibles) are much alike in both, but not quite so acute in the Cotalpa as in the other, nor are the inner teeth so prominent. The maxilla is much longer and with stouter spines, and the palpi are longer and slenderer in the grub of Cotalpa than in the other, though the joints have the same relative proportion in each; the basal joint is nearly twice as long as in the May beetle. The under lip (labium) is throughout much longer, and the palpi, though two-jointed in each, are much longer and slenderer in the grub of Cotalpa than in that of the May beetle. The feet are much larger and more hairy in the Cotalpa. Both larvæ are about an inch and a half long, and a third (.35) of an inch thick at the widest part.

As regards the number of years in the life of this insect, Dr. Lockwood remarks:

When collecting the larvæ in May I often observed in the same places grubs of the *Cotalpa* of at least four distinct ages, each representing a year in the life of the insect, judging from Renny's figures of the larvæ of the English cockchafer, or dor-beetle (*Melolontha vulgaris*). But the cockchafer becomes an imago in January or February, and comes forth into active life in May, just four years from the deposit of the egg. Supposing our *Cotalpa* to take on the imago form in autumn, and to spend its life from that time to the next May in the ground, it would be five years old when it makes its début as an arboreal insect.

It is possible that Dr. Lockwood may be in error regarding the age of this beetle, as M. T. Reiset says in France this insect is three years in arriving at its perfect beetle state. The following remarks on the habits of the European chafer may aid observers in this country in studying the habits of our native species. M. Reiset says (see “Cosmos” as translated in the American Naturalist, vol. ii, p. 209):

This beetle in the spring of 1865 defoliated the oaks and other trees, while immense numbers of their larvæ in the succeeding year, 1866, devoured to a fearful extent the roots of garden vegetables, etc., at a loss to the department of the lower Seine of over five millions of dollars. This insect is three years in arriving at its perfect beetle state. The larvæ, hatched from eggs laid by the beetles which appeared in

such numbers in 1865, passed a second winter, that of 1867, at a mean depth in the soil of forty-one hundredths of a meter, or nearly a foot and a half. The thermometer placed in the ground (which was covered with snow), at this mean depth, never rose to 32° F. as minimum. Thus the larvæ survived after being perfectly frozen (probably most subterranean larvæ are thus frozen, and thaw out in the spring at the approach of warm weather). In June, 1867, the grubs having become full fed, made their way upwards to a mean distance of about thirteen inches below the surface, where, in less than two months, they all changed to the pupa state, and in October and November the perfect beetle appeared. The beetles, however, hibernate, remaining below the surface for a period of five or six months and appearing in April and May. The immature larvæ, warned by the approaching cold, began to migrate deep down in the soil in October, when the temperature of the earth was ten degrees above zero. As soon as the snow melted they gradually rose towards the surface.

As regards the time and mode of laying the eggs, we quote from Dr. Lockwood as follows :

On the evening of the 13th June last we caught in the drug store, Keyport, whither they were attracted by the profusion of light, four *Cotalpas*, representing both sexes. These were taken home and well cared for. On the 16th a pair coupled. A jar of earth was at once provided and the beetles placed on top of the dirt. In the evening the female burrowed and disappeared. Near midnight she had not returned to the surface; next morning she had re-appeared. The earth was then very carefully taken from the jar, and, as removed, was inspected with a glass of wide field but low power. Fourteen eggs were found, not laid (as we expected) in one spot or group, but singly and at different depths. I was surprised at their great size. Laid lengthwise, end touching end, two eggs measured very nearly three-sixteenths of an inch. They were like white wax, semi-translucent; in form, long-ovoid and perfectly symmetrical. On the 13th of July one had hatched; the grub was well formed and very lively. Its dimensions were about five-sixteenths of an inch in length and about three-thirtieths of an inch in thickness. It was a dull white, the head plate precisely that dull yellow seen in the adult grub, the legs the same color, and the extremity of the abdomen lead color, the skin being transparent. For food a sod of white clover (*Trifolium repens*) was given them, roots downward, knowing that the young larvæ would come upward to eat. They were then left undisturbed until August 19, when the sod was removed, and it was found that the grubs had eaten into it, thus making little oval chambers, which were enlarged as the eating went on. They were carefully picked out and a fresh sod of grass and clover supplied. They had now grown five-eighths of an inch in length, preserving the same colors.

It is quite possible that a few of the eggs escaped me in the search. I am of opinion, however, that from fifteen to twenty is the average number laid by one beetle. In short, the insect lays her eggs in the night, probably not more than twenty. The hatching of these required in the present instance twenty-seven days. It must be remembered that a large portion of this time was remarkably cold and wet. It is almost certain that with favorable thermal conditions this might be lessened fully seven days.

#### 49. *Graptodera carinata* (Germ.).

Regarding the habits of this beetle, Mr. W. L. Devereaux writes us as follows :

I do not remember taking any of *Graptodera chalybea* on the elm except when the tree was a supporter of a grapevine or else in close proximity to one. There is a *Graptodera* occurring quite plentifully on elm foliage, however. It is of a greenish hue. I deem it *G. carinata*.

## 50. THE COCK'S-COMB ELM GALL-LOUSE.

*Colopha ulmicola* (Fitch).

Order HEMIPTERA ; family APHID.E.

The following account is taken from Professor Riley's Notes on the Aphididæ of the United States, published in Vol. V of the Bull. U. S. Geol. and Geog. Survey :

Forming cock's-comb-like galls on the upper surface of the leaves of *Ulmus americana*, the galls appearing with the opening of the leaves, and turning brown and black in late summer. A very common gall, which may be called the Cock's-comb Elm Gall, being found on the White Elm, and particularly on young trees. It was well described by Fitch as an "excrecence or follicle like a cock's comb, arising abruptly on the upper side of the leaves, usually 1 inch long and one-fourth of an inch high, compressed, its sides wrinkled perpendicularly and its summit irregularly gashed and toothed ; of a paler green color than the leaf and more or less red on the side exposed to the sun ; opening on the under side of the leaf by a long slit-like orifice ; inside wrinkled perpendicularly into deep plates." There are several generations and the sexual individuals are mouthless. I have not been able to prove absolutely that there are two broods of the gall-making female, and my observations all tend to the conclusion that no galls are formed except by the stem-mother that hatches from the impregnated egg. There is a link wanting between the third generation and the mouthless sexual individuals, but I am inclined to think that the third generation will be found to have a different habit, possibly feeding upon some other part of the tree, without forming galls, and producing in time the true sexual individuals.

## 51. THE WOOLY ELM-TREE LOUSE.

*Schizoneura rileyi* Thomas ; *Eriosoma ulmi* (Riley).

Order HEMIPTERA ; family APHID.E.

Clustering on the limbs and trunks of the white elm, causing a knotty unnatural growth of the wood ; small aphides covered with an intense white wool-like substance, the limbs at a distance appearing like snow. (Riley).

In Illinois and Missouri, late in May and in June, the white elms in the larger cities are apt to become infested with these conspicuous and curious insects. Riley finds that by washing with a weak solution of cresylic acid soap they will be instantly killed.

*The adult* is dark blue, the wings clear, three times as long as wide, and more pointed at the ends than in *E. pyri*. Costal and subcostal veins, and that bounding the stigma behind, robust and black. Discoidal veins, together with the third forked and stigmal veins, all slender and black, the forked vein being as distinct at its base as are the others, with the fork but one-third as long as the vein itself and curved in an opposite direction to the stigmal vein. Antennæ 6-jointed and of the same color as the body ; joints 1, 2, 4, 5, and 6 of about equal length ; joint 3 thrice as long as either. Legs of the same color as the body. Length to tip of closed wings, exclusive of antennæ, .12 inch.

The young lice are narrower and usually lighter colored than the adults, varying from flesh to various shades of blue and purple.

52. *Pulvinaria innumerabilis* Rathvon.

Mr. B. P. Mann reports (*Pysche* iv, 224) that he received from Auburn, N. Y., twigs of the elm bearing several mature specimens, with

fully developed nests, from which the larvæ have since hatched in great numbers. It had previously been found on the elm by Professor Riley.

"Finding an elm at Normal seriously infested by this louse, and apparently upon the point of death from the effects upon its foliage, I tried the experiment of applying pyrethrum for the destruction of the insect. A large branch was dusted with a mixture of one part of pyrethrum to ten of flour, at 9.30 a. m., July 4, and soon after the lice began falling from the twigs. At 6 p. m. only a few remained, and by 8 a. m. of the second day thereafter all had fallen off and were lying dead upon the table. Spraying the foliage of these trees with water in which pyrethrum was suspended in the proportion of about a table-spoonful to a gallon of water would, consequently, in all probability, destroy the lice, or at least so effectually check their multiplication as to prevent injury to the trees." (Forbes).

#### 53. CALLIPTERUS ULMIFOLII THOS.

Occurring on the under side of the leaves of the American elm in May and June in Illinois. Closely allied to the European *C. quercus*, which has also four dorsal tubercles.

*Apterous individuals*.—Tubercular, with capitate hairs, which disappear when the insect becomes winged.

*Winged individuals*.—Antennæ as long as the body; third, fourth, and sometimes the fifth joint slightly dusky at apex; apical joint a very little longer or shorter than the sixth. Wings hyaline, all of the veins, and especially the stigmal vein, subhyaline. Dorsum with four long spine-like tubercles on its basal portion, and with various shorter tubercles on the apical portion. Length, 1.77<sup>mm</sup>; to tip of wings, 3.04<sup>mm</sup>. (Thomas, 3d Rep. Ins. Illinois.)

#### 54. THE ELM CALLIPTERUS.

##### *Callipterus ulmicola* Thos.

*Winged specimen*.—Wings exceedingly delicate and transparent, appearing as a mere film, even the veins scarcely visible with a common pocket magnifier. When seen through a strong microscope the latter are pale transparent yellowish; the subcostal much the largest and nearly parallel with the costa, bending slightly inward at the insertion of the first branch vein, which is farther from the base of the wing and nearer the stigma than usual; it also makes a sharp curve forward toward the costa at the base of the stigma; the second vein rises about the base of the stigma; it and the first vein both curve somewhat strongly outward (toward the apex of the wing) at base; third vein, which is twice forked, arises apparently from the stigma, but is obsolete or nearly so at the immediate base. The fourth vein is nearly obsolete. When seen under a strong microscope it is represented by a series of points; it curves regularly but not sharply. Stigma rather broad, somewhat hatchet-shaped, widening towards the apex, with a distinct angle at the point where the fourth vein arises. The second fork of the third vein about equally distant from the apex and third vein. Posterior wings with two branch veins. Antennæ not on a tubercle; about as long as the body; third joint long; fourth about three-fourths the length of the third; fifth fully as long as the fourth, and about twice the length of the sixth, which is a little longer than the seventh. The whole antenna is quite slender. Honey tubes imperfect in all the winged specimens, but they appear to be very short, length not exceeding the diameter.

*Wingless specimen.*—Front of the head rather obtusely advanced in the middle. Honey tubes very short; length less than the diameter; tip of the abdomen extending or drawn out to a point, but no true tail was observed. Along the lateral margins of the abdomen, in front of and behind, the honey tubes are minute tubercles, each giving rise to a hair; these tubercles are quite distinct and about one to each segment. (Thomas.) On the elm in June in Wisconsin. (Bundy).

55. *Schizoneura americana* Riley.

Curling and gnarling the leaves of the White Elm (*Ulmus americana*), forming thereby a sort of pseudo-gall. The curl made by a single stem-mother in the spring takes the pretty constant form of a rather wrinkled roll of one side of the young leaf; but, according as there is more than one stem-mother, or as several contiguous leaves are affected, the deformation assumes various distorted shapes, sometimes involving quite large masses of the leaves.

Professor Riley has given the full life history of this species in his Notes on the Aphididæ of the United States, published in Bull. U. S. Geol. and Geog. Survey, from which the following is extracted:

This species is very closely allied to the European *S. ulmi* (Linn.), and until I was able to compare it with actual specimens, I was in doubt whether to look upon it as a mere variety or a distinct species. Judging from Kessler's figure and description of the European leaf-curl, and by a figure sent me by Mr. Buckton, it differs from ours, 1st, in bending upward, *i. e.*, the stem-mother settles on the upper instead of the under side of the leaf; 2d, in having a number of small, rounded or verrucose swellings. These differences in their dwellings are strongly presumptive of structural differences in the insects themselves; and the fact that *S. americana* does not attack the European Elms, either in Shaw's Botanical Gardens at Saint Louis, or in the grounds of the Department of Agriculture, points in the same direction. Differences are indeed easily enough made out if we take the more or less imperfect descriptions and figures of *ulmi*,\* but are less apparent when the actual specimens are compared.

The following are the more important differences, least subject to variation, between the winged females of *ulmi* as compared with those of *americana*: *ulmi* is a longer-winged species, averaging 7.3<sup>mm</sup> in expanse; the abdomen, wing-veins, and stigma are darker; the terminal distance between 1st and 2d discoidals slightly greater; the 3d joint of antennæ is relatively longer; the annulations are less deep and more numerous (those on 3d joint averaging 30); joints 5 and 6 are smoother, *i. e.*, without annulations, but they are more setous; joint 5 is shorter than 4; the apical, narrowed part of 6th joint is relatively longer and more pointed; the subcostal vein of hind wings is less straight; the cubital vein is often continuous to very near the subcostal, while I have not found any tendency of the kind in *americana*, the tendency being in the opposite direction, or to become shorter; the 2d discoidal of hind wings shows a tendency to fork; the hooklets on costa of hind wings are 3 in number, while in *americana* there are normally 4; \* the legs are more setous.

Among the more prominent of the natural enemies of this species, I have noticed, of Coleoptera, *Coccinella 9-notata*, *Coccinella sanguinea (munda)* Say, *Hippodamia convergens*, and several species of *Scymnus*. I also found feeding upon them the perfect beetle of *Podabrus modestus*, and the Hemipterous *Cyllocoris scutellatus*, Uhler, and *Capsus linearis*, Beauv. A Lepidopterous inquiline, namely, the larva of *Semasia prunivora*, Walsh, is also quite common within the curled leaves, feeding both on the lice and on the substance of the leaf. A large green *Syrphus* larva and several *Chrysopa* larvæ also prey upon them.

\* Koch's figure (evidently copied by Kessler) is faulty in several respects, and fails to indicate the hook-angle of hind wings, or the corresponding thickening of front wings, a fault that is, however, common to most of Koch's figures.

56. *Mytilaspis pomorum* Bouché?

The following account is from Professor Riley's notes :

February 3, 1879, on the Department grounds, a small purple-leaved elm badly infested by a scale insect, resembling very closely the oyster-shell bark louse of the apple tree, and which may be that insect. Upon examination it was ascertained that the scales contained nothing but eggs and dead females. The eggs are very coarsely faceted and perfectly white. This scale insect was also found on the elm in Professor Riley's yard, June 11, 1883. Some twigs that he brought were badly infested with it. All the old scales were dead and the young ones were casting their last skin. The male scales contained either larvæ in their last stage or pupæ. The pupæ are considerably elongated, pale purple, with the anterior median line of abdomen whitish; eyes dark purple, members colorless. Males issued on the 14th and 15th. Color of prothorax and abdomen pale purple; the lateral lobes of mesothorax, the anterior margin and the posterior band of metathorax yellowish; the middle field of mesothorax and metathorax purplish; band between wings brownish; eyes black; antennæ and legs purplish with yellowish tinge; style yellowish. Wings slightly brownish.

## 57. ELM BARK LOUSE.

(*Lecanium* sp.)

Order HEMIPTERA; family COCCIDÆ.

The following account is taken from Mr. Forbes' third report :

On the twigs of the white elm, at Normal, we found, this last season, a large brown bark louse, very similar in size, shape, and general appearance to the maple *Pulvinaria* previous to the appearance of the cottony egg-mass beneath the body of the female, but differing especially in the fact that the eggs were not inclosed in the waxy filamentous masses or nests characteristic of *Pulvinaria*.

As we obtained only the adult female, we had not the material for determining or describing the species. The matured scales are nearly circular, 5<sup>mm</sup> in diameter, vaulted, emarginate before and behind, the upper surface more or less shining, dark brown, irregularly pitted on the central area (where, however, it is nearly smooth), and deeply and irregularly punctured on the sides; below the punctures irregularly rugose. The eggs are oval .099<sup>mm</sup> in length by .048<sup>mm</sup> in transverse diameter. Beneath females obtained July 2 were eggs in various stages of development, young which had just hatched, and those which had just passed the first molt.

58. *Hapithus agitator* Uhler.

Order ORTHOPTERA; family GRYLLIDÆ.

Concerning this insect Professor Riley remarks :

The eggs from which this insect was bred were found by Miss Murtfeldt, of Kirkwood, Mo. They were thrust between the bark from the sides of the cracks, and on some occasions were found in great numbers. The female appears to prefer the corky bark of the elm and hackberry in preference to that of other trees in which to deposit her eggs, though they are also frequently found running about on the trunks and branches of other trees, in the bark of which they also may deposit. The young become fully fledged by the latter part of August, and egg-laying commences about the middle of September and continues until cold weather sets in. The larvæ, as well as the mature insects, are chiefly arboreal as well as nocturnal in their habits and like their allies, *Ceanthus* and *Orocharis*, are lovers of dense foliage. (Unpublished notes.)

59. *Pæciloptera pruinosa* Say.

Order HEMIPTERA; suborder HOMOPTERA; family FULGORIDÆ.

The following notes are from Professor Riley :

Numerous larvæ of this insect were noticed to infest the twigs and leaves of elm and Celtis, June 20, 1883, on the Agricultural grounds at Washington, D. C. They are also stationed on the lower side of both leaves and twigs, generally in larger or smaller colonies. They are white or pale greenish, with pale-brown eyes and black or brown claws. They are covered with a white, thread-like excretion, which at the end of the body forms a compact tuft. This excretion adheres only slightly to the insect, and is readily displaced if the insect is touched or is moving about. By the 3d of July they become fully grown, and vary considerably in color, some remaining white, whilst others acquire a pale grayish-blue color. The same insect was also noticed to feed on maple, red clover, *Erigeron canadense*, and quite a number of other low plants and shrubs. It is attacked by a species of *Gonatopus*, which feeds on them externally, and is generally attached in the region of the wing pads. Before preparing for pupation they cast their skin, which remains in position on their host, and form underneath it, on the leaf or branch, a circular, very low, convex, semi-transparent cocoon, which is covered with the white excretion of their host, rendering thereby their detection rather difficult. The perfect insect issues in July. A second external parasite is a small red mite which appears to be the young form of a *Trombidium*. One of these mites was noticed to have settled on the eye of one of the larvæ. It has only six legs, a free, small head, with stout three-jointed palpi, and a very curious sucking mouth; it is circular, apparently concave on its lower side, and its margin closely beset with lancet-shaped spines. (Unpublished notes.)

## 60. THE THREE-BANDED LEAF HOPPER.

*Typhlocyba tricincta* (Fitch).

Order HEMIPTERA; family CERCOPIDÆ.

About the middle of June, this pale-yellow leaf hopper, distinguished by two transverse dusky bands (one across the middle and one at the tips of the wing-covers) and a dusky cloud upon the scutellum, was abundant enough upon the leaves of the white elm at Normal to do considerable damage. This species, described by Fitch in his third report as State entomologist of New York (p. 74), was originally found by him in abundance on raspberry and currant bushes, and on grape-vines. (Forbes' Third Report.)

## 61. THE ELM GALL-MITE.

*Phytoptus ulmi* Garman.

Mr. H. Garman describes this species (Forbes' First Report Insects of Illinois) as follows:

Produces galls on the leaves of the white elm, *Ulmus americana* Linn.

A slender species, with from 67 to 70 striæ. Prongs of the feather-like tarsal appendage, three. Length of specimens preserved in alcohol .17<sup>mm</sup>.

In general form this gall resembles that found on the leaves of the soft maple, but it is smaller, more slender, and contracts less abruptly to the neck. It is from .077 to

.09 inch high, and .055 to .06 inch in diameter. It differs from the gall on *Acer dasycarpum* further in having scattered unicellular hairs growing from the outer surface. There is a tuft of pubescence over the opening beneath. The walls are rather thick, with numerous folds projecting into the cavity. The color is at times of the same dark hue as the leaves or it may be light yellowish-green. The gall occurs sparingly on shade trees at Normal, Ill., and young forest trees in the neighborhood of Bloomington are sometimes badly galled. The egg, young, and adult of the mite have been found in the galls in June and July.

The following insects also occasionally prey upon the elm :

#### LEPIDOPTERA.

62. *Parorgyia clintonii* G. and R. "Found by dozens on the elm." (Fernald.)
63. *Parasa chloris* H. S. (Elliot and Edwards. *Papilio*, iii, p. 128.)
64. *Halesidota caryæ* (Harris.) (Beutenmüller. *Ent. Amer.*, vi, p. 16.)
65. *Ichthyura americana* (Harris.) Ohio. (Pilate, *Papilio*, ii, p. 67.)
66. *Datana ministra* Riley. Ohio. (Pilate, *Papilio* ii, 67.) See Hickory insects.
67. *Edema albifrons* (Abb. Sm.) On elms in Canada. (Reed, *Can. Ent.*, xv, p. 204.) See p. 152.
68. *Schizura ipomeæ* Doubl. (Elliot.)
69. *Platysamia cecropia* (Linn.) Riley.
70. *Telea polyphemus* Hübner. See p. 161.
71. *Tolype vellea* (Stoll). See p. 165.
72. *Apatela occidentalis* G. and R. (Faxon, *Psyche*, ii, p. 35.)
73. *Eacles imperialis* (Drury.)
74. *Hyperchiria io* (Fabr.)
75. *Zeuzera aesculi* (Linn.) Boring in the trunk. (J. B. Smith in *Garden and Forest*, Jan. 15, 1890.)
76. *Charada deridens* Guen. See p. 166.
77. *Paraphia unipunctaria* (Haworth.) See p. 185.
78. *Hibernia tiliaria* Harris. Female moth issued in December (Riley MS. notes). See Linden insects.
79. *Metanema quercivoraria* Guenée. See p. 182.
80. *Petrophora diversilineata* Hübner. (Riley MS. Notes). See Oak insects, p. 189.
81. *Nephoptyx undulatella* Clemens.
82. *Nephoptyx? ulmi-arrosorrella* Clemens.
83. *Lophoderus triferanus* (Walk.) See p. 195.
84. *Bactra? argutana* Clem. (also on sumach, witch-hazel, and black-thorn.)
85. *Lithocolletis argentinetella* Clem. Larva makes a tentiform mine in the under side of the leaves; rarely in the upper side. (Chambers.)
86. *Lithocolletis ulmella* Chamb. Larva makes a flat mine in the upper side of the leaf. (Chambers.)



87. *Argyresthia austerella* Zeller. This moth, "I am convinced, feeds in some way on it; and in latter May and in June the imago may be found about the trees." (Chambers.)
88. *Coleophora* sp. "A *Coleophora* larva in its case feeds on the leaves in autumn and early spring. I have not bred it." (Chambers in letter.)

## HYMENOPTERA.

89. The horn-tail borer, *Tremex columba* (Linn.).

## PLATYPTERA.

90. *Termes flavipes* Kollar. We have observed white ants injuring a wounded elm tree near the common at Salem, Mass.

## HEMIPTERA-HOMOPTERA.

91. *Tetraneura ulmi* (Linn.) (Oestlund.)
92. *Pemphigus ulmifusus* (Walsh.) (Oestlund.)

Besides the determined species of insects found on the elm, Professor Riley has kindly furnished me with notes upon forty-two species additional, but not yet determined. This carries the number of elm insects up to the neighborhood of one hundred and twenty-five species. The undetermined species belong to the following groups: *Lepidoptera*, 11; *Tenthredinidæ*, 1; *Cecidomyiidæ*, 16; *Coccidæ*, 5; *Aphis*, 2; *Pemphiginæ*, 4; *Acarina* (*Phytoptus*), 3; total, 42 species.

## FEEDING ON THE DEAD WOOD.

*Osmoderma eremicola* Knoch.

Larvæ and beetles of this insect were found July 18, 1874, at St. Louis, Mo., at the base of the hollow trunk of a large elm, and several more of the larvæ were found at the same place. All were about full grown and were feeding on the decaying wood, reducing it to a tan-bark red, excrementitious powder, of which there were bushels filling the base of the cavity. Their pellets of excrement which were noticed are flattened-oval and compact. Eggs were also found in abundance. They are perfectly spherical, about 3<sup>mm</sup> in diameter, opaque-white, and with tolerably tough skin. The young larvæ differ in no respect from the mature, except in being more hirsute, or the hairs being longer. The mature larva, before changing, forms a large egg-shaped ball of excrement and loose earth. (See Schaupp, description of larva of *Osmoderma scabra*, Bull. Brooklyn Ent. Soc., vol. ii, p. 98.) (Riley's unpublished notes.)

Mr. W. L. Devereaux writes me that *Osmoderma scabra* and *eremicola* in the larva state channel up the heart of large trees and often enter into close proximity with the live wood. "None of our large trees, as a rule,

are exempt from their burrows, having them either at the lower part or else at the large fork or top. I have seen enormous trees in full leaf and blossom, in a still day, suddenly break off midway of trunk, fall to the earth with a crash, startling and mysterious enough to any hearer in such a day of reigning quiet. Where the fracture most often occurs no decay of the heart is present, but it is completely filled with the burrows of the *Osmoderma*."

*Alaus oculatus* (Linn.)

*Stenoscelis brevis* (Boh.) (Chittenden in letter.)

*Phlæophagus minor* (Horn.) (Chittenden in letter.)

## CHAPTER III.

### INSECTS INJURIOUS TO THE HICKORY.

*Carya alba, porcina, and tomentosa.*

Of the 170 species of insects which live at the expense of the hickory, the most annoying and common borer is the *Cyllene picta*, or common hickory borer, and the twig-girdler (*Oncideres cingulatus*). The most destructive bark-borer appears to be *Scolytus 4-spinosus*. No caterpillar is specially injurious, though the tree harbors a large number of species of different families. The buds, before unfolding, are preyed upon by a little Phycid miner (*Phycis rubrifasciella*), while the nuts are often despoiled and worm-eaten by the hickory-nut weevil (*Balaninus nasicus*). The different kinds of hickory are usually infested by the same species of insect.

Of walnut insects, of which thus far 44 species are recorded, there are also none specially injurious to the tree, which is therefore much favored. The same can be said of the butternut, on which 29 species subsist, and of the chestnut, which affords a livelihood to about 65 species of different orders, none of which overstep the normal limits or take unfair advantage of the provision afforded them by the generous and beautiful foliage of this noble tree, unless we except the chestnut borer (*Arhopalus fulminans*) and the chestnut weevil.

#### INJURING THE TRUNK AND BRANCHES.

##### 1. THE COMMON HICKORY BORER.

*Goes tigrinus* (De Geer).

Order COLEOPTERA; family CERAMBYCIDÆ.

Boring large holes lengthwise in the solid wood, a cream-colored grub, with the first segment behind the head flattened, pale tawny-yellowish, changing to a pupa in its burrow, and in summer appearing as a long-horned brown beetle an inch long, covered with a coarse gray pubescence, the wing covers with a broad dark brown band beyond their middle and another on their base, the thorax with an erect blunt spine on each side; the antennæ pale yellowish, with their first joint dark brown. (Fitch).

This is perhaps the most common borer in the hickory and walnut in the Northern States. According to Fitch the young worm lives at first upon the soft outer layers of the sap-wood, mining a shallow cavity all around the orifice in the bark, and the bark dies and turns black as far as this burrow extends. Its jaws having at length become sufficiently strong, it gnaws its way into the solid wood from the upper part of its burrow under the bark, boring obliquely inward and upward, all the lower part of its burrow being commonly packed with its sawdust-like chips. Finally, having completed its growth, it extends the upper end of its burrow outward again to the bark.

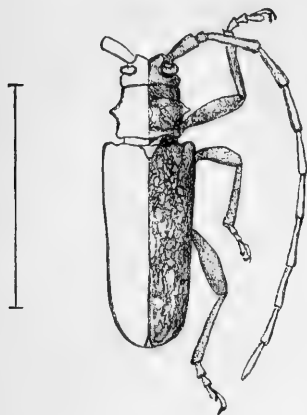


FIG. 108.—*Goes tigrinus* (Smith del.).

## 2. THE BEAUTIFUL HICKORY BORER.

*Goes pulchra* (Haldeman).

Similar to the preceding. "Scarce, but a few are found every season in the shagbark and pignut hickory, June and July." (Dr. T. Hadge, Buffalo, N. Y., Amer. Ent. III, p. 270.)

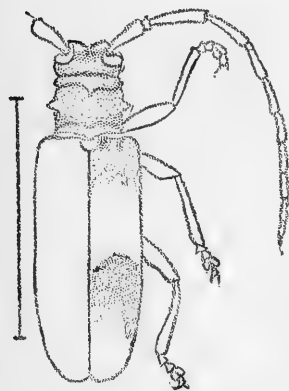


FIG. 109.—*Goes pulchra* (Smith del.).

Another but much smaller species is *Goes oculatus* Lec. "The beetle is rare, and I have only taken two specimens. There were a pair captured on hickory in the end of June, and which were copulating when taken. They are hardly half an inch long, and are black, densely covered beneath with short white hairs. The pubescence above is more sparse and scattered, and the coarse puncturing of the elytra gives them a mottled appearance. There is a black spot on each elytron just behind the middle, and the presence of these spots gives to the beetle its distinctive name of "*oculatus* or eyed." (W. H. Harrington, Rep. Ent. Soc. Ontario for 1883, p. 48.)

## 3. *Goes oculatus* Lec.

Another but much smaller species is *Goes oculatus* Lec. "The beetle is rare, and I have only taken two specimens. There were a pair captured on hickory in the end of June, and which were copulating when taken. They are hardly half an inch long, and are black, densely covered

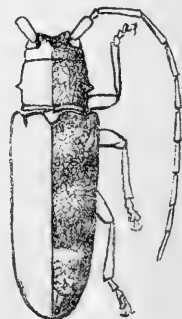


FIG. 110.—*Goes debilis* (Smith del.).

## 4. *Goes debilis* Lec.

Like the foregoing species of *Goes*, this is known to inhabit hickory trees, but its larva has not been yet identified with certainty, and its habits need to be studied.

5. THE BELTED CHION.

*Chion cinctus* (Drury).

Order COLEOPTERA; Family CERAMBYCIDÆ.

This worm, like the preceding and with probably similar habits, forms long galleries in the trunk in the direction of the fibers of the wood, producing a more flattened long-horned beetle from two-thirds to a little over an inch long, of a hazel-brown color, with a short dull straw-yellow band placed obliquely forward of the middle of each wing cover, and with a small sharp spine on each side of the prothorax, and two slender ones on the tips of each wing-cover; the antennæ of the males are more than twice the length of the body. (Harris.)



Fig. 111.—The belted Chion.

6. THE DISCOIDAL SAPERDA.

*Saperda discoidea* (Fabricius).

Order COLEOPTERA; family CERAMBYCIDÆ.

Not only did Dr. Fitch report this beetle as boring in hickory, but Drs. Le Conte and Riley have also bred it from this tree.

This grub is a similar but much smaller worm than the foregoing, changing to a cylindrical long-horned beetle of a black or blackish-brown color, clothed with ash-gray pubescence which is less dense above and commonly forms three gray stripes upon the thorax, and a band or crescent upon the middle of the wing-covers, its legs yellow or reddish. Length .40 to .60 inch. (Fitch.)

7. THE HICKORY BORER.

*Cyllene picta* (Drury).

Boring in the trunk of the hickory, a whitish worm, one-half an inch long, the beetle appearing in June. (See Locust tree borer.)

We have received this insect in all its stages from Mr. H. Gillman, of Detroit, who several years ago found a few of them in a hickory log March 10. From these living specimens the following description was drawn up:

*Larva*.—Body thick; mouth-parts black; head reddish behind the antennæ. Prothoracic segment (first behind the head) large and broad, being one-half as long as broad; flat and broad above, the upper surface being lower than that of the succeeding segment; the anterior edge thickened, being slightly corneous; a mesial deeply impressed line, especially on the hinder two-thirds, where it becomes a broad, deep, angular furrow, dividing the tergum into two quadrant-shaped halves; the outer edge of the segment rises above the flattened

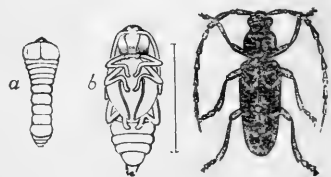


FIG. 112.—Common hickory borer; male. nat. size; a, larva; b, pupa.—From Packard.

the outer edge of the segment rises above the flattened

tergal portion, which is sparsely covered with hairs, the latter thicker along the sides of the body. The body contracts in width behind the fourth abdominal segment; the upper side of each of the first six abdominal segments (corresponding to those segments in the beetle) is raised into blister-like swelling, especially on the fifth and sixth segments, which are much narrower than the four preceding segments. These dorsal swellings are smooth and free from fine hairs. Abdominal segments seven to nine convex above, not swollen, and the abdomen is narrowest between the fifth and sixth segments. A pair of large spiracles on the mesothoracic segment, and a pair on each of the first eight abdominal segments.

Antennæ three-jointed; the two basal joints being of the same length; the basal one being one-third stouter than the second; the third joint filiform, and one-half as long as the second joint, and ending in two or three hairs. The thin membranous labrum is divided into two parts, the basal solid, the terminal portion forming a movable flap, overlapping and reaching nearly to the end of the mandibles when closed; the basal portion is shorter than broad, being broadly trapezoidal and smooth; the outer division is broader than long, the edges being rounded so that it is almost broadly ovate (transversely) and smooth, covered with long hairs. It is pale membranous with a testaceous hue. Mandibles black, very thick and stout, with obtuse, rounded edges; they are almost as long as the base is broad. Maxillæ membranous, flattened, maxillary palpi two-jointed. Labium membranous, with a transverse chitinous band near the insertion of the two-jointed palpi; both joints short; second one-half as thick as the first; edge hairy, the hairs reaching to the ends of the palpi. Length of body .50 inch; breadth of prothoracic segment, 4.2<sup>mm</sup>; breadth of head, 3.2<sup>mm</sup>.

#### 8. *Stenosphenus notatus* (Olivier).

This beetle is allied to *Cyllene*, but the punctures are sparse and coarse, the pubescence scanty, and the body is slenderer. It is said by Riley (Amer. Ent., iii, 239) to have been cut from hickory wood in March.

*The beetle*.—Head small, narrow, with the front short and nearly vertical. It differs from *Cyllene picta* in the elytra being truncated at the tip and ending in two spines. The thorax is rounded without spines or tubercles. The female antennæ are about as long as the body; those of the male longer; the legs are rather short.

#### 9. THE HICKORY-TWIG GIRDLER.

##### *Oncideres cingulatus* (Say).

Order COLEOPTERA; family CERAMBYCIDÆ.

Girdling and occasionally cutting off the twigs and branches, a thick-bodied long-horn, dark gray beetle 0.60 inch long, with its wing-covers sprinkled over with faint tawny yellow dots.

This singular beetle, which inhabits the eastern United States, appears in Pennsylvania from the middle of August until the middle of September. Fig. 113 represents the beetle and the incision it makes, and Fig. 114, from a drawing sent us by the late Professor Haldeman, shows how the beetle may injure several adjoining twigs. The editors of the *American Entomologist* (I, p. 76) state that they have counted in a persimmon branch, not more than two feet long, as many as eight eggs, placed one under each successive side-shoot, while they have found seven eggs all crowded together in a

small hickory branch only three inches long. Professor Haldeman states that "both sexes are rather rare, particularly the male, which is rather smaller than the female, but with longer antennæ. The female makes perforations (Fig. 113, *b*) in the branches of the tree upon which she lives, which are from half an inch to a quarter of an inch thick, in which she deposits her eggs (one of which is represented of the natural size at Fig. 113, *e*). She then proceeds to gnaw a groove, of about a tenth of an inch wide and deep, around the branch and below the place where the eggs are deposited, so that the exterior portion dies and the larva feeds upon the dead wood." In the case noticed by Professor Haldeman, the tree attacked was the shag-bark hickory (*Carya alba*) and the incisions were so shallow as not to break off until after the larva had matured within it, or nearly a year after the girdling. But in most of the cases observed by Messrs. Walsh and Riley upon pear and persimmon trees, the "twig was girdled so deeply that it



FIG. 113.—Hickory twig girdler.—After Riley.

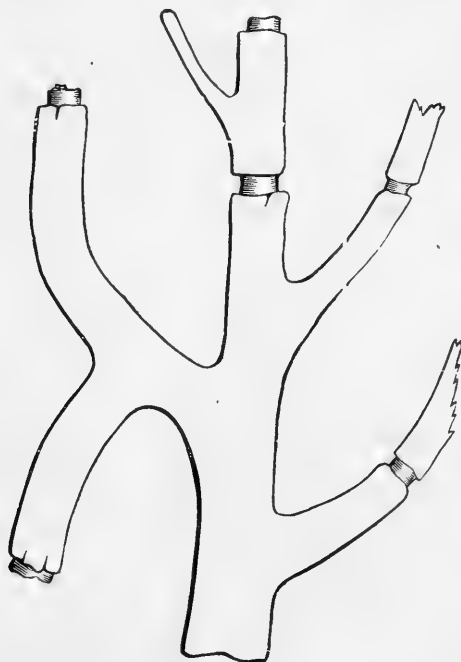


FIG. 114.—Tree cut by the twig girdler.—Haldeman *dcl.*

broke off and fell to the ground with the first wind, and while the eggs that had been laid in it by the mother-beetle were still unhatched. Even in a girdled hickory twig 0.35 inch in diameter, which we have now lying before us, but a third part of its diameter is left in the mid-

dle ungnawed away, so that in spite of the superior toughness of this timber the twig could scarcely have stood a high wind without breaking off and falling to the ground."

#### 10. THE COMMON ORANGE SAWYER.

*Elaphidion inerme* Newman.

In his report on Orange Insects, Mr. H. G. Hubbard says that "the larvæ of this beetle are more properly scavengers or pruners, feeding by preference upon dead branches, not only of orange, but also of hickory and other hard-wood trees, and confining themselves to the dry and lifeless wood, unless compelled by hunger to enter the living portions of the plant." The female deposits one or two eggs in the dead stubs of orange trees, and presumably of hickory trees.



FIG. 115.—*Elaphidion inerme*.—After Hubbard.

*Larva*.—Body cylindrical, whitish, with rudimentary legs, length 1 inch.

*The beetle*.—Body long, cylindrical, with a rather roughly pitted surface; dark brown, dusted densely beneath, but irregularly above, with fine ash-gray hairs; the antennæ are not longer than the body. Length 11–15<sup>mm</sup>. (Hubbard.)

#### 11. THE LURID DICERCA.

*Dicerca lurida* (Fabricius).

Order COLEOPTERA; family BUPRESTIDÆ.

Boring in the trunks and limbs of the pig-nut hickory, a flat-headed grub of a yellowish-white color, changing to a flattened, hard-shelled beetle with short slender antennæ, of a lurid dull brassy color above, and bright copper beneath, with the wing-covers lengthened into diverging obtuse points.

*Larva*.—Of a yellowish-white color, very long, narrow, and depressed in form but abruptly widened near the anterior extremity. The head is brownish, small, and sunk in the forepart of the first segment; the upper jaws are provided with three teeth, and are of a black color; and the antennæ are very short. The segment which receives the head is short and transverse; next to it is a large oval segment, broader than long, and depressed or flattened above and beneath. Behind this, the segments are very much narrowed and become gradually longer; but are still flattened, to the last, which is terminated by a rounded tubercle or wart. There are no legs, nor



FIG 116 — *Dicerca lurida*.  
Smith del.



any apparatus which can serve as such, except two small warts on the under side of the second segment from the thorax. (Harris.)

*The beetle.*—Of a lurid or dull brassy color above, bright copper beneath, and thickly punctured all over; there are numerous irregular impressed lines, and several narrow elevated black spots on the wing-covers, the tips of each of which end with two little points. Length 0.60–0.80 inch.

#### 12. THE SLENDER-FOOTED DYSPHAGA.

*Dysphaga tenuipes* (Haldeman).

A small grub, in the dead limbs and twigs, producing in May a small black longicorn beetle with rough wing-covers but half as long as the abdomen and tinged with paler yellowish at their bases, its head having a furrow in the middle and its thorax cylindrical. Length 0.25 inch. (Fitch.)

#### 13. *Chrysobothris femorata* Lec.

This Buprestid has been found by Mr. W. H. Harrington “very abundantly on dead hickories from June to September, and the fact that the larvæ live upon this tree was established by finding a beetle in its burrow under the bark. (Rep. Ent. Soc. Ontario for 1883, 44.)

#### 14. *Agrilus egenus* Gory.

Stated by Dr. Le Conte to live in the trunks and branches of *Carya tomentosa*.

#### 15. *Agrilus* sp.

This species, said by Le Conte to be “probably new,” he has bred from the branches of *Carya tomentosa*.

#### 16. *Acanthoderes quadrigibbus* (Say).

While Dr. Le Conte bred this longicorn beetle from branches and twigs of hickory, Mr. Schwarz has found it boring in the dead twigs of the oak, beech, and hackberry.

*The beetle.*—It is broader and flatter than the species of Goes; the prothorax in addition to two lateral spines has two more above, whence the name *quadrigibbus* or 4-horned. The legs are nearly of a uniform length, and the thighs are much enlarged. The general color is a mottled gray, due to pubescence, and there is a moderately broad transverse band of white in front of the middle. (Harrington.)



Fig. 117.—*Acanthoderes 4-gibbus*.—Smith del.

#### 17. *Liopus cinereus* LeConte.

This longicorn has been bred from hickory twigs by Dr. LeConte. It is allied to the *L. alpha* Say, which bores in dead apple twigs, the beetle occurring in July. *L. cinereus* is closely similar to *L. alpha*, but differs in the coarser punctures of the wing-covers. The latter species is also thought by Mr. Harrington to live at the expense of the hickory.

*Lepturges querci* (Fitch) has not been proved as yet to live either in the oak or hickory, but Mr. Harrington has captured specimens on the hickory "either on the bark of felled trees, or among the foliage of living ones." Another doubtful hickory species is *Hyperplatys aspersus* (Say) which bores in the poplar, but is not uncommon at Ottawa upon the bitter hickory.

18. *Ecyrus dasycerus* (Say).

This beetle has been bred from hickory twigs by Dr. LeConte.

*The beetle* is nearly of the same size and shape as the *Leptostylus macula*. The prothorax has slightly rounded sides, without any spines or tubercles. The pubescence is close and coarse, the body of brown or grayish brown, somewhat mottled. The antennæ are as long, or a little longer, than the body.

19. *Eupogonius vestitus* (Say.)

Professor Riley has bred this longicorn beetle from the hickory.

*The beetle*.—Chestnut-red, mottled with short yellowish pubescence, and clothed above with longer dark hairs arising from punctures in the surface. Head and thorax darker and more closely punctured than the elytra. The legs and antennæ are also hairy, the latter being as long as the body. Length 8-9mm.

20. *Clytanthus albofasciatus* Lap.

According to Dr. John Hamilton of Allegheny, Pa., this beetle has been raised both from grape-vines and from hickory limbs. "There are two color-forms, produced indiscriminately, that are so different in appearance that judged by color alone they would form two species. The one is entirely black, with the usual anterior and posterior white bands on the elytra; the other is black with the antennæ brown; the part of the elytra anterior to the posterior white band, the femora, the coxal part of the prosternum, the mesosternum and metasternum, rufous. This is exactly the color of the more plentiful form of *Cyrtophorus verrucosus*, and it is not difficult to confuse them. They may be readily distinguished by the compressed thorax and the spines of the antennal joints of the latter, as pointed out to me by Dr. Horn. The same color variation occurs in *Psenocerus supernotatus*, a few specimens of which, taken on the wild gooseberry, were entirely black, except the usual white markings on the elytra, and so different is the appearance that it required close attention to other characters to be convinced that they were the same species." (Hamilton.)

21. *Anthaxia viridifrons* Gory.

This handsome little beetle, says Mr. Harrington, was bred from hickory twigs by Dr. Le Conte, "and has very frequently been found by me upon the trees in summer." (Rep. Ent. Soc. Ontario for 1883, p. 45.) Mr. F. H. Chittenden has also bred it from a pupa taken from a dead branch of shag-bark hickory. (Ent. Amer., v, 219.)

*The beetle*.—Brown, with a bronze luster. The front of the head in the males is of a vivid green. Length, .2 inch.

22. *Anthaxia viridicornis* (Say).

This beetle has also been found by Mr. Harrington in abundance on this tree. It is a slightly larger species, he says, than the preceding, but closely resembles it, except that the wing-covers are of a bluish-black color. It is also found very commonly, he adds, on the elm. (See p. 229, fig. 74.)

23. *Eburia quadrigemina* Say.

This longicorn beetle has been observed by Mr. McBride commonly issuing from hickory trees in July.

*The beetle.*—Body pale yellowish brown; on the thorax are two black tubercles above, placed transversely, with a short spine on each side. On each wing-cover are two double short lines of a yellow color and slightly elevated; the tip is two-spined, the outer spine being the longer. Length .9 inch.

24. *Heterachthes quadrimaculatus* Newman.

This longicorn was bred from hickory branches by Dr. Le Conte.

25. *Molorchus bimaculatus* Say.

This longicorn is very frequently, says Mr. Harrington, found on flowering shrubs during June and July, and differs from nearly all our Cerambycidæ in having the wing-covers only half as long as the abdomen. It was bred by Dr. Le Conte from hickory twigs and branches.

*The beetle.*—Body slender; black, with the head and thorax coarsely punctured; the short elytra have each a yellowish dash almost parallel with the inner margin; the antennæ and legs are brownish. Length, one-third of an inch.

26. *Neoclytus erythrocephalus* (Fabricius).

Order COLEOPTERA; family CERAMBYCIDÆ.

This beetle has been raised from hickory wood by Dr. G. H. Horn (Proceedings of the Entomological Society of Philadelphia, vol. 1, p.29) and also by Dr. Le Conte. (Amer. Ent., iii, 236.) It has also been found boring in a dead elm by Mr. H. G. Hubbard, of Detroit, Mich., and a gravid female was found near the root of a rosebush in Washington, D. C. (Riley.)

27. *Dorcaschema nigrum* (Say).

Order COLEOPTERA; family CERAMBYCIDÆ.

This longicorn bores in the hickory, according to Dr. F. Hodge, Buffalo, N. Y.

28. *Thysanoes fimbriicornis* Le Conte.

Order COLEOPTERA; family SCOLYTIDÆ.

Mr. Harrington, of Ottawa, has "found the beetles issuing from dead trees in June, and they are abundant during that and the following month, both on dead and felled wood and on the trunks and foliage of living trees."

*The beetle.*—Velvety black; thorax cylindrical, not constricted at the head and but slightly behind. The wing-covers widen slightly toward the tips, which are

rounded, and they are coarsely punctured. The under side of the body and legs are covered with short white hairs. The antennæ are long and slender. Length, 12-13mm.

29. *Phyton pallidum* (Say).

Order COLEOPTERA ; family CERAMBYCIDÆ.

This longicorn has been bred by Dr. LeConte from branches of the hickory (*C. tomentosa*).

30. *Tillomorpha geminata* (Haldeman).

Order COLEOPTERA ; family CERAMBYCIDÆ.

This beetle has also been reared by Dr. Le Conte from the hickory in company with the preceding species.

31. THE HICKORY BARK-BORER.

*Scolytus 4-spinosus* (Say).

Order COLEOPTERA ; family SCOLYTIDÆ.

Undermining the bark and making long slender tracks radiating from a primary larger vertical chamber; a white footless grub becoming a small cylindrical weevil-like beetle.

This very destructive bark-borer affects the bitter-nut, shell-bark, pig-nut hickory, and probably the pecan (*Carya olivæformis*). Accord-

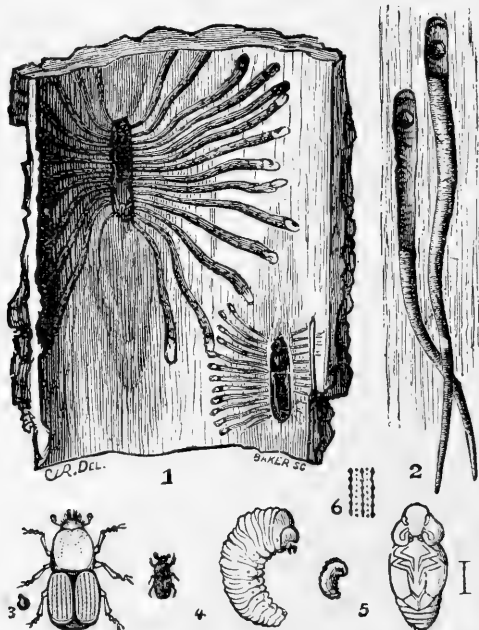


FIG. 118. Hickory bark-borer; 1, 2, its "mine;" 3, the beetle; 4, larva; 5, pupa.—After Riley.

ing to Riley the beetle issues the latter part of June and early part of July. "Both sexes bore into the tree—the male for food, and the

female mostly for the purpose of laying her eggs. In thus entering the tree they bore slantingly and upward, and do not confine themselves to the trunk, but penetrate the small branches and even the twigs. The entrance to the twig is usually made at the axil of a bud or leaf, and the channel often causes the leaf to wither and drop, or the twigs die or break off.

“The female in depositing, confines herself to the trunk or larger limbs, placing her eggs each side of a vertical chamber, as described by Mr. Bryant.\* Here she frequently dies, and her remains may be found long after her progeny have commenced working. The larvæ bore their cylindrical channels, at first, transversely and diverging (Fig. 118<sup>1</sup>), but afterwards lengthwise along the bark (Fig. 118<sup>2</sup>), always crowding the widening burrows with their powdery excrement, which is of the same color as the bark. The full-grown larva (Fig. 118<sup>4</sup>), natural size and enlarged) is soft, yellowish and without traces of legs. The head is slightly darker, with brown jaws, and the stigmata so pale that they are with difficulty discerned. It remains torpid in the winter, and transforms to the pupa state about the end of the following May. The pupa (Fig. 118<sup>5</sup>) is smooth and unarmed, and shows no sexual differences. The perfect beetle issues through a hole made direct from the sap-wood, and a badly infested tree looks as though it had been peppered with No. 8 shot. The sexes differ widely from each other, the male having spines on the truncated portion of the abdomen, not possessed by the female. The eggs are deposited during the months of August and September, and the transformations are effected within one year, as no larvæ will be found remaining in the tree the latter part of July.

Two ichneumon parasites, according to Riley, prey upon this insect, and after killing the grub spin little pale cocoons. They are *Spathius trifasciatus* Riley, and *Bracon scolytivorus* Cresson.

*The beetle.*—Male entirely black, or black with brown wing-covers; the head above flat, concave towards tip; thorax very little longer than wide, and narrowing in front but slightly. Elytra with about 10 striæ confusæ at the sides, but regular above, and composed of small, deep, approximate punctures; interstitial spaces with a single row of minute and nearly obsolete punctures; The female differs in having the head rather shorter, more rounded, less hairy, and the venter unarmed. Length 0.15–0.20 inch. (Riley.)

---

\* The mode of operation appears to be as follows: Boring through the bark, the insect forms a vertical chamber next to the wood, from half an inch to an inch in length, on each side of which it deposits its eggs, varying in number from twenty to forty or fifty in all. The larvæ, when hatched, feed on the inner bark, each one following a separate track, which is marked distinctly on the wood. Some trees contain them in such numbers that the bark is almost entirely separated from the wood. In many cases the upper part of the tree is killed a year or two before the lower part is attacked. (Riley's Fifth Annual Report Inj. Ins. Missouri, p. 104.)

32. *Scolytus* sp. (probably undescribed).

Dr. Hamilton states (Can. Ent. xvii, 1885, p. 48) that *Scolytus rugulatus* breeds in hickory twigs, but Mr. Schwarz (Proc. Ent. Soc. Washington, i, No. 1, 30,) maintains that this species differs from *S. rugulosus*, and is apparently undescribed. (J. B. Smith, Ent. Amer. ii, 127, 1886.)

33. *Sinoxylon basillare* (Say).

Order COLEOPTERA; family PTINIDÆ.

This beetle in its larval state inhabits hickory wood, in which it bores to a considerable depth, preferring the hard central wood. Its borings are very fine, and firmly compressed. After full development is attained it makes its way out almost at a right angle and emerges through a circular opening in the bark of the hickory. (Horn.)

## 34. RED-SHOULDERED APATE.

*Apate basillaris* (Say).

Order COLEOPTERA; family SCOLYTIDÆ.

Boring deep, small straight holes to the heart of the tree, which is entirely killed by this insect, and transforming at the bottom of the hole.

*The beetle.*—Deep black, and punctured all over; thorax very convex and rough in front; the wing-covers not excavated at the tip, but sloping downward very suddenly behind, as if obliquely cut off, the outer edge of the cut portion armed with three little teeth on each wing-cover, and on the base or shoulders a large red spot 0.20 inch in length. (Harris.)



FIG. 119.—*Apate basillaris*, Smith and Marx del.

## 35. THE HICKORY BARK-BORER.

*Chramesus icoriae* Leconte.

This bark-borer has been bred from the branches and twigs of the hickory by Dr. Le Conte. The genus belongs to a group of Scolytidæ well defined by the club of the antennæ being large, strongly compressed, pubescent, and sensitive, the antennæ themselves being inserted as usual at the sides of the front. The tibiæ are broad, obliquely rounded at the end, and finely serrate. *Chramesus*, says Le Conte, differs from *Polygraphus* in the eyes not being completely divided; they are slightly emarginate, the funicle being attached at the side of the club, the outer joints being slender. Two species (one not mentioned in Le Conte and Horn's work on "Coleoptera of North America") live on the species of *Carya*.

Prof. John B. Smith (Ent. Amer. vi, 53) gives an account of the habits of this Scolytid beetle, with a figure of the mine and of the mouth-parts of the larva, which is also described in full.

It is probable that the young of this and other borers in the hickory are devoured by two species of Cleridæ bred by Dr. Le Conte, viz: *Chariessa pilota* and *Phyllobænus dislocatus*. The former has been observed by Mr. Harrington in the act of devouring *Agrilus egenus* and *Magdalis olyra*.

Several other species of Clerid beetles are said by Mr. Harrington to commonly occur on the hickory and are beneficial to the tree.

36. *Xyleborus celsus* Eichhoff.

Order COLEOPTERA; family SCOLYTIDÆ.

This bark-borer has been bred by Dr. Le Conte from the twigs of the hickory.

37. *Magdalis olyra* (Herbst).

Mr. F. C. Bowditch, in the Quarterly Journal of the Boston Zoological Society (1884), remarks that this weevil, which has heretofore only been known to burrow in the red oak (see p. 80) has been found to infest various species of hickory. The larvæ "tunnel the bark in every direction, leaving only just enough tissue to prevent the bark warping away from the tree." He adds:

As far as my observations extend the species appears to prefer small trees, from four to six inches in diameter. \* \* \* If the tree is small and very badly infested it dies very quickly, and shortly after the beetles have escaped the bark is apt to flake off or curl up in quite large pieces.

38. *Magdalis barbata* Say.

"The beetles," states Mr. Harrington, "are found during the summer months, puncturing the bark of dead and felled hickories, and the larvæ live in great numbers in the bark or between it and the wood. I have found the beetles most abundant from the 15th to the 30th of June." (Report, etc., 50.)

*The beetle*.—Black; prothorax closely punctured; the rounded sides projecting in front in a short acute tubercle. The head prolonged into a slightly curved beak, not deflexed, and as long as the prothorax. The elytra have deep punctured striæ, and are as long as the head and prothorax together. Scutellum covered with white hairs. Length, 6-7<sup>mm</sup>. (Harrington.)

39. *Acoptus suturalis* Le Conte.

As this weevil is said by Mr. Harrington to bore abundantly in dead hickories, in company with *Magdalis olyra*, it presumably infests living trees.

*The beetle*.—A small black weevil, densely clothed beneath and more sparsely above with short yellowish hairs. The elytra are striated and in unrubbed specimens have a wide band of yellowish pubescence across the base, and a narrow one near the tips, which are black, as is also the space between the bands; a white line along the suture interrupts the basal band. (Harrington.)

40. *Tremex columba* (Linn.).

From the following letter, which we have received from Mr. James Angus, of West Farms, N. Y., it seems probable that *Tremex columba* injures the hickory by boring into the trunks. So good and experienced an observer as Mr. Angus would not think of referring the writer to the attacks of this borer if there were not some foundation for his suspicions.

The hickory trees are all dying around here. I should say that one-half of the trees have died within two or three years. In woods that are not crowded and of mixed woods it is quite common to find as many as from three to six dead trees within a stone's throw. Great numbers of *Rhyssa atrata* and *lunator* are now to be seen on the trunks of partially decayed trees. Earlier in the season the Tremex were also abundant. Can it be the latter insects that are doing all this mischief?

Mr. Tyler Townsend confirms Mr. Angus' statement in a note received while this report was passing through the press.

In regard to *Tremex columba* I have found large numbers of the dead adults in February in a standing, dead trunk of hickory in Michigan. They were found as they had died in their burrows, being unable to penetrate the hard bark or else having perished from parasites, for numerous remains of *Rhyssa* were present. In every case the heads of the unfortunate *Tremex* pointed towards the bark, which they had been unable to pierce.

41. *Osmoderma eremicola* (Knoch).

This beetle has been observed by Mr. W. H. Harrington to feed "upon the sappy, partly decayed wood, enlarging the wound and causing further decay, and thus injuriously affecting the tree. He found the insect in the pupa state, inclosed in oval cocoons made from particles of the wood, in a small hollow where decay had commenced from the breaking off of a limb. The cocoon is made in autumn, the beetle appearing the following July. Its larva is said to closely resemble the common white grub, or young of the May beetle.

## AFFECTING THE BARK.

## 42. THE HICKORY-BARK LOUSE.

*Lecanium caryæ* (Fitch).

Order HEMIPTERA; family COCCIDÆ.

Fixed to the bark of the small limbs, a large, very convex oval scale of a black color fading to chestnut brown, in May dusted over with a white powder. Length often 0.40 by 0.25 inch in width. (Fitch.)

## 43. THE HICKORY BLIGHT.

*Eriosoma caryæ* (Fitch).

Order HEMIPTERA; family APHIDÆ.

Forming a flocculent down coating the under side of the limbs, especially of bushes and young trees in shaded situations, multitudes of woolly plant lice.

*Winged individuals.*—Black, with the head, scutellum, and abdomen covered with a white cotton-like substance, the fore wings with an oval salt-white spot near the tip of their outer margin, the veins being obsolete. Length to the tip of the wings 0.12 inch. On walnut bushes in Illinois. (Fitch.)



## 44. THE HICKORY APHIS.

*Lachnus caryæ* (Harris).

Order HEMIPTERA; family APHIDÆ.

Living in clusters on the under side of limbs of the pig-nut hickory early in July, very large plant-lice one-quarter of an inch long, with no terminal stylet and very short horny tubes; body covered with a bluish-white bloom or down, with four rows of little transverse black spots on the back; top of thorax and veins of wings black, as are also the shanks, feet, and antennæ, while the thighs are reddish-brown. (Harris.)

## AFFECTING THE LEAVES.

## 45. THE HICKORY SLUG CATERPILLAR.

*Thecla calanus* (Hübner.)

Order LEPIDOPTERA; family PAPILIONIDÆ.

The onisciform caterpillar of this butterfly feeds on the leaves of the pig-hickory at Providence May 30 and later; the larva is a pale green, flattened, long, oval, cylindrical caterpillar, flat beneath; the body is rounded above and covered with short hairs. It changes to a delicate small butterfly with tails on its hind wings.

## 46. THE HICKORY TUSOCK MOTH.

*Halesidota caryæ* (Harris).

Order LEPIDOPTERA; family BOMBYCIDÆ.

In July and August and early September eating the tender leaves at the ends of the branches, snow-white caterpillars, over an inch long, with rows of round black spots, and along the back eight black tufts of converging hairs and two black pencils of longer hairs near each end of the body; spinning in sheltered corners and crevices ash-gray oval cocoons; the moth appearing the following June. (Fitch.)

In certain years this caterpillar may be rather numerous; it is quite social, feeding in companies and is a general feeder, and, while preferring the walnut, butternut, and sumach, is common on the elm, ash, and linden, and Fitch says he has seen clusters of the caterpillars upon the tamarack or larch; he adds, what has been observed by ourselves, that as they approach maturity they separate and stray off to other trees, and may then be seen on rose bushes, on the apple, oak, locust, etc., the same individual often remaining several days in one place. It ranges from Maine to the Southern States.

The eggs were observed by Harris to be laid on the under side of a linden leaf, forming a broad patch an inch in diameter. The moth appears June 1. The cocoon is oblong oval, and formed simply of hairs.

*Larva before first molt.*—Length, 25<sup>mm</sup>. The little black dorsal tufts very visible, though small; the other hairs thin, and permitting the skin and tubercles to be easily seen. They were mistaken for those of *Hyphantria textor*. (Harris.)

*Full-fed larvæ*.—White, covered with white hairs in short spreading tufts, a row of eight black tufts on the fourth segment; two long, black, pencil-like tufts on the fourth and tenth segments; four white pencils on the second and third, and two on the eleventh and twelfth segments. Head and prolegs black, the surface of the body with minute black tubercles, and a transverse black line between each segment. (Harris.)

*The moth*.—Very light ochre yellow; the long narrow-pointed fore wings are thickly sprinkled with little brown dots, and have two oblique brownish streaks passing backwards from the front edge, with three rows of white semi-transparent spots parallel to the outer hind margin; hind wings very thin, semi-transparent, and without spots. The wings expand about 2 inches. (Harris.)

## 47. THE LUNA MOTH.

*Actias luna* (Linnæus).

Order LEPIDOPTERA; family BOMBYCIDÆ.

Devouring the leaves in August, a large thick-bodied caterpillar, about 3 inches long, apple green, each segment with six small bright rose-red elevated dots, and low down along each side a pale yellow line running lengthwise immediately above the lower row of dots, from which line at each of the sutures a pale yellow line extends upward upon the sides. Spinning a large oval cocoon, which is found among the fallen leaves; the moth, one of our largest insects, appearing late in May and during June; pale green, with eye-like spots in the center of each wing, the hinder pair prolonged into two long, broad "tails."

## 48. THE AMERICAN SILK WORM.

*Telea polyphemus* (Linn.).

Mr. D. L. Harris, of Cuba, Ill., writes me that he has found this caterpillar more abundantly upon the hickory than upon the oak. Mrs. Dimmock has contributed the following bibliographical account to Psyche, iv, 278:

*Attacus luna* Linn. (Syst. Nat., 1758, ed. 10, p. 210). Harris (Rept. Ins., Injur. Veg. 1841, p. 277-278) describes larva, cocoon, and imago, and gives *Juglans* and *Carya* as food-plants; he repeats (Treatise on Ins. Injur. Veg., 1862, p. 382-384) these descriptions, adding a figure of the cocoon and imago; later (Entom. Corresp., 1869, p. 293-234, pl. 4, fig. 14) he describes and figures the larva, specifying the food-plants as *Carya porcina* and *Juglans cinerea*. Morris (Synop. Lepid. N. A., 1862, p. 225-226) describes the larva and imago. Trouvelot (Amer. Nat., Mar. 1867, v. 1, p. 31) gives a note on the cocoon, and adds *Quercus* and *Platanus* to the food-plants. Minot (Can. Entom., Nov. 1869, v. 2, p. 27) describes the egg. Riley (4th Ann. Rept. State Entom. Mo., 1872, p. 123-125) describes the egg and larva, which he states to have five stages, and figures larva, cocoon, and imago; among food-plants he mentions *Liquidambar*, *Fagus*, *Betula*, *Salix*, and plum. Lintner (Entom. Contrib., No. 3, 1874, p. 126-128) describes the larva, which molts four times. Gentry (Can. Entom., May 1874, v. 6, p. 86) describes the normal form of the larva, and a variety of it. Bunker (Can. Entom., April 1875, v. 7, p. 63) mentions how to distinguish the cocoon of this species from that of *A. polyphemus*. Rogers (Can. Entom. 1875, v. 7; Aug. p. 141-143; Oct., p. 199-200) describes egg, larva, cocoon, and imago. Thaxter (Psyche, Sept. [10 Nov.] 1876, v. 1, p. 194) adds *Ostrya virginica* and *Castanea* to the food-plants of the larva.

Saunders (Can. Entom., Feb. 1877, v. 9, p. 32-33) figures and describes the imago. Grote (Can. Entom., Sept. 1878, v. 10, p. 176) states that this species is double-brooded in the Southern United States.

49. THE REGAL WALNUT CATERPILLAR.

*Citheronia regalis* Hübner.

Order LEPIDOPTERA; family BOMBYCIDÆ.

A spiny caterpillar 5 inches long, our largest species, green, with a red head and tail, and stout, sharp, black and red spines, and black and red feet; not spinning a cocoon, but the larva enters the ground in September to transform to a chrysalis, which in July changes to a very large bright orange-red moth, with the fore wings pale olive spotted with yellow, the veins stained reddish, and the hind wings orange-red.

This is our largest caterpillar; it is harmless, though so formidable in appearance, and easily recognized by its size and by the four long horns on the segments just behind the head. It feeds on the black walnut, butternut, hickory, persimmon, and sumach, and is very rare north of New York, and is scarce in the Middle and Southern States. In Georgia it is double-brooded.

50. *Edemasia concinna* (Abbot and Smith.)

According to Abbot and Smith the caterpillar feeds on the honeylocust (*Gleditschia triacanthos*), apple, persimmon, and hickory, the whole brood most commonly together. Its web was formed on the 28th of May, and the fly came out June 12th. It likewise spins in the autumn and comes out in the spring. It thus appears to be double-brooded in the Southern States, but in the Northern States it is single-brooded, and usually occurs on the apple, cherry, and plum trees in August and September, stripping certain branches of their leaves.

51. *Datana angusii* Grote and Robinson.

I have found the caterpillars of this *Datana* on the pig-nut hickory late in the summer at Providence. The body is very dark, and Abbot and Smith in the last century noticed a black *Datana* larva on the hickory, as did Harris (see Harris' Correspondence.) When at rest the head and thoracic segment are thrown over the back, and the eighth segment and those behind it are also held up at right angles to the middle of the body, as usual in other species of the genus.

*Larva*.—Head black, body very dark, with four linear greenish-yellow distinct lines on each side of the body, with numerous long white hairs, some longer than the body is thick, arising from minute black papillæ. Thoracic legs black, but the third pair Scotch-snuff brown at the base, as are the abdominal legs, except the anal pair. Length, 40mm.

52. *Datana ministra* (Drury.)

(Larva, Plate IV, figs. 1, 2.)

According to William Beutenmüller,\* this insect feeds on different species of hickory. (*Carya alba*, *C. microcarpa*, *C. sulcata*, *C. amara*, and *C. porcina*.)† See also Poplar insects.

53. *Apatela funeralis* Grote and Rob.

The caterpillar is said by Mr. Thaxter to feed on the hickory, but no description of the larva has been yet published.

54. *Acronycta lithospila* Grote.

The caterpillar has been bred from the hickory by the late Mr. S. L. Elliot.

*Larva*.—Very dark bluish green, darkest dorsally; head slightly truncate in front, with two slightly raised protuberances on the crown; pitchy, with brown

\*Food-plants of *Datana ministra* (Drury.)

By WM. BEUTENMÜLLER, Ent. Amer.

## TILIACEÆ.

- Tilia americana*, L. (Basswood.)  
*heterophylla*, Vent. (White Basswood.)  
*europaea*, L. (European Linden.)  
*alba*, Waldst & Kit. (White Linden.)

## ROSACEÆ.

- Prunus cerasus*, Juss. (Common Garden Cherry.)  
*Pyrus malus*, Tourn. (Common Apple.)  
*Cydonia vulgaris*, Pers. (Common Quince.)

## JUGLANDACEÆ.

- Juglans cinerea*, L. (Butternut.)  
*nigra*, L. (Black Walnut.)  
*Carya alba*, Nutt. (Shell Bark Hickory.)  
*microcarpa*, Nutt. (Small Fruited Hickory.)  
*sulcata*, Nutt. (Western Shell Bark Hickory.)  
*amara*, Nutt. (Bitter Nut Hickory.)  
*porcina*, Nutt. (Pig-nut Hickory.)

## CUPULIFERÆ.

- Quercus alba*, L. (White Oak.)  
*obtusiloba*, Michx. (Obtuse-leaved Oak.)  
*macrocarpa*, Michx. (Mossy-cup Oak.)

- Quercus coccinea*, Wang. (Scarlet Oak.)  
*rubra*, L. (Red Oak.)  
*palustris*, Du Roi. (Pin Oak.)  
*pedunculata*, Willd. (English Oak.)  
*sessiliflora*, Sal. (The Sessil-flowered Oak.)  
*cerris*, Linn. (Turkey Oak.)

*Castanea vesca*, Gaert. (European Chestnut.)

*Castanea vesca*, v. *Americana*, De Cand. (American Chestnut.)

*Castanea pumila*, Mil. (Chinquapin.)

*Fagus ferruginea*, Ait. (Red Beech.)  
*sylvatica*, L. (European Wood Beech.)

*sylvatica*, var. *purpurea*, Ait. (Purple Beech.)

*sylvatica*, var. *cuprea*, Lodd. (Copper Beech.)

*sylvatica* var. *laciniata*, Lodd. (Cut-leaved Beech.)

*Corylus americana*, Walt. (American Hazel.)

*avellana*, L. (European Hazel.)

*Carpinus americana*, Michx. (Hornbeam.)

## BETULACEÆ.

- Betula alba*, L. (White Birch.)  
 var. *populifolia*, Spach. (American White Birch.)  
*papyracea*, Ait. (Paper Birch.)

†Food-plants of *Lepidoptera*, No. 4.

marks. The body is covered with rather long hairs; along the back is a dull pink stripe, triangularly formed on the six anterior segments, then widening very much until the entire back is covered on segments 7, 8, and 9, then narrowing again to the anal extremity. The middle and broad portion of this mark is darker than the anterior and posterior portions; the hairs spring from small pinkish tubercles, the spiracles also being of a pinkish cast; under side all dull green. Length, 35<sup>mm</sup> (1.40 inches). (Hy. Edwards & Elliott.)

*Moth*.—Resembling closely in its markings a gray *Leucania* or *Xylina*, and in shape of wings and streaky shadings *A. xylinoides*. Ornamentation obscure, the transverse lines marked by even oblique darker shades on the costa. The color is dark steel gray with dull, inconspicuous brownish shadings on the cell. Transverse posterior line dentate. Whitish streaky shadings on the cell accompanying a black discal streak, above the internal angle below a very fine black streak, and again on the submedian interspace before the transverse posterior line, and on a line with the black basal streak. Reniform spot obscure. Fore wings paler gray near the outer margin, the veins marked with dark gray and with dark shade streaks between the ends of the venules, ending in marginal dots. Hind wings whitish, with smoky venules and a faint undefined terminal shade band. Beneath whitish, dusted with smoky scales, and with an obscure discal mark and line on the hind wings. Palpi whitish, with the second joint black on the sides. Expanse of wings 35<sup>mm</sup> (1.40 inches). (Grote.)

55. *Catocala serena* Edwards.

This species is said by Mr. Angus to feed as a caterpillar on the hickory; there is no description of it. It has also been observed on the hickory in Ohio by Mr. Pilate. (Papilio, ii, 69.)

*Moth*.—Fore wings close, even, uniform, smoky gray; lines fine but distinct; transverse posterior line with but one prominent tooth; reniform spot brownish; subreniform spot round, a little lighter. Hind wings light yellow; median band narrow, angulated; yellow interspace, often very narrow. Expands 60 to 65<sup>mm</sup>.

It inhabits the Northern and eastern United States. It also occurs in eastern Siberia. (Hulst.)

56. *Catocala judith* Strecker.

The food-plant of this species is said by Mr. Hulst, on the authority of Mr. Angus, to be probably the hickory.

*Moth*.—Fore wings close, even, light gray, with a dusky shade; lines fine, faint, sometimes partly obsolete, no basal or apical dashes; reniform spot brownish, annulate with whitish; M of transverse posterior line with the upper tooth broad, much the larger; a subterminal lighter band toothed strongly at M of transverse posterior line. Hind wings black, fringes dark. Expands 40 to 50<sup>mm</sup>.

It inhabits the Eastern and Middle States. (Hulst.)

Var. *miranda* Hy. Edw., differs in being smaller and with the fringe of the hind wings whitish on outer margin to apex.

57. *Catocala robinsonii* Grote.

According to Mr. Angus the caterpillar of this moth feeds on the hickory.

*Moth*.—Fore wings even, smooth, pale greenish cinereous, generally without shades; lines fine, distinct; M of transverse posterior line moderately strong; a black shading on the costa at the reniform spot; the latter lighter; a subterminal white space

beyond the transverse posterior line. Hind wings black; fringe white. Expands 75 to 80<sup>mm</sup>. Middle and Western States. *Curvata* is the name given to the form with basal and apical dashes. (Hulst.)

58. *Catocala resecta* Grote.

The caterpillar feeds on the hickory, according to Angus, and Dr. Kellicott has reared it from a caterpillar found on the hickory June 28, which changed to a pupa in July, the moth appearing July 27.

This moth has been raised by Dr. Kellicott, who originally by mistake referred it to *C. flebilis*. (See Ent. Amer., June, 1886, p. 46.)

*Larva*.—Gray, with a greenish tinge; dorsal line rather faint, made up of closely placed lines of black dots; subdorsal line wider and more conspicuous; on each abdominal ring is an illy-defined >— or < situated in this line; the stigmatal line or stripe is still more distinct and continuous; the large, black-ringed, elliptical spiracles are situated, except the first, wholly in this line. The papillæ are white, each bearing a fine brown hair; those on the first thoracic ring, however, are dark or black; on the abdominal rings the posterior pair are situated in the angle of the >— referred to above. Head flattened, bluish gray, with lines of confluent whitish spots so arranged that the surface has the appearance of watered silk; on the top of the head are four brown dots placed at the angles of a square. There is a black line extending from the articulation of the jaws half way up the cranial lobes in front of the cells. Feet ornamented with black slashes. Lateral fringes hoary. Under side of the body bluish white, with black and flesh-colored spots. Length 58<sup>mm</sup> (2.32 inches). (Kellicott.)

*Moth*.—Fore wings pearly cinereous, a dash at the base and at the sinus of the transverse posterior line; lines distinct; M of transverse posterior line strongly produced; teeth nearly equal. Hind wings black; fringe white. Expands 70 to 75<sup>mm</sup>. Middle and Western States. *Flebilis* has a diffuse black shading, reaching from the base longitudinally across the wing to the apex. (Hulst.)

59. *Catocala luctuosa* Hulst.

The food-plant of this species is probably the hickory, according to Mr Hulst.

*Moth*.—Fore wings like *C. resecta* in markings, but with apical shadings; wings broader and outwardly more rounded, and more or less generally covered with a brownish shading, often with a violet tinge. Hind wings black, with fringes broader and dull white, and marked with black at ends of the veins. Expands 75 to 80<sup>mm</sup>. Middle and Western States. (Hulst.)

60. *Catocala insolabilis* Guenée.

This moth has been bred by Mr. Angus from caterpillars found on the hickory, but they have not been described.

*Moth*.—Fore wings light blue gray, heavily powdered with black; clouded with black along the inner margin; generally on the median space, just anterior to this black margin, a triangular pale or white space; basal dash always turned downward outwardly. Hind wings black, fringes dark. Expands 75 to 85<sup>mm</sup>. Middle, Western, and Southern States. (Hulst.)

61. *Catocala angusii* Grote.

With the same habits as *C. insolabilis*.

*Moth.*—Fore wings dark greenish gray; no band on the inner margin, though often a cloud at the sinus of the transverse posterior line and below the apex; no triangular white spot on the median space; basal dash turning upward outwardly; in these respects differing from *C. insolabilis*. Hind wings black, fringe dark, rarely light. Expands 70 to 80<sup>mm</sup>.

*HABITAT.*—With the same distribution as in *C. insolabilis*. *Lucetta* differs in having a longitudinal shading from the base to beneath the apex.

62. *Catocala obscura* Strecker.

Also feeds upon the hickory, according to Mr. Angus.

*Moth.*—Fore wings uniform dull smoky gray; lines fine but distinct; margin of transverse posterior line with the upper tooth much the larger; submarginal space whitish, serrated. Hind wings black, fringes white. Expands 70 to 80<sup>mm</sup>.

Dr. D. S. Kellicott says that "the larva of this species feeds on the leaves of the shagbark hickory, *C. alba*, and in habit agrees very closely with other described species of the genus; it is, apparently, a night feeder, concealing itself by day at rest under the loosened bark of the tree, upon the leaves of which it feeds at night. July 5, 1883, at Pulaski, N. Y., larvæ were taken from beneath the bark of the hickory, and from these, two imagos were obtained. Two sizes were thus obtained on that day; one, evidently soon after its last larval molt, measured 1.6 inches, width of head .17 inch, of eighth and ninth rings .2 inch; the smaller ones were 1.1 inches long; they molted July 19, when they were 1.5 inches long and precisely similar to the larger size when taken July 5."

*Larva.*—The head is somewhat flattened, reticulated with coarse, uneven lines, and a heavy black stripe extends along the lateral borders from the articulation of the mandibles half way to the apex of head lobes. In this character it closely resembles the larva of *C. resecta*, which likewise feeds on the hickory. The antennæ are long, slender, and white.

The color of the skin is dark gray, much darker than in *C. resecta*. The piliferous spots which are arranged nearly at the corners of a rectangle are large and light colored; these are larger than usual on rings 5 and 12, otherwise there are no humps; there are no lateral fringes as in *Ultronia* and *Unijuga*. The dorsal line is very obscure; there are on rings 5, 9, and 10, irregular black crosses; the stigmatal line distinct and black. The stigmata are of the usual shape; the long axis, however, leans slightly forward, rings black, white within. The ventral surface is pinkish with black spots in the abdominal rings except 8 and 9. The color of smaller specimens yellowish gray. One larva, then 2 inches in length, spun the usual, light, very loose cocoon among the leaves July 20; the imago appeared about August 15. The pupa was of the usual form and color, covered with bloom; it measured 1.1 inches. The anal hooklets unusually long. (Kellicott.)

It inhabits the Middle, Western, and probably Southern States.

*Var. residua* Grote. Fore wings of a brighter, bluer color. Hind wings with the fringes often dark.

63. *Catocala habilis* Grote.

"The larvæ of this species were in company with those of *obscura* mentioned above. Different sizes were taken; but slight changes in color or ornamentation were noted at the molts. This larva is quite different from any of the genus heretofore identified by me. It pupated in the usual cocoon; the first to change July 18 gave a moth August 18." (Kellicott.)

*Larva*.—An average mature caterpillar measured 2 inches in length; slender, color dark, in some almost black; skin shining. Along the dorsum there is a broad stripe, lighter than the general hue; on either side a darker one of equal width; the stigmatal stripes almost black; beneath pale whitish, with black spots on the middle segments. Head reddish black, with faint reticulations in white.

64. *Catocala* sp.

Order LEPIDOPTERA; family NOCTUIDÆ.

This caterpillar occurs in June on the pig-nut hickory at Providence.

*Larva*.—Young 13<sup>mm</sup> long. Body very slender, head very small, considerably narrower than the prothoracic segment. Body tapering towards each end, first abdominal segment about as long as all the thoracic ones, the abdominal segments being very long compared with the thoracic ones; third and fourth abdominal segments with minute legs, those on the fourth a little larger than those on the third segment; those on fifth and sixth segments large and rather slender, blackish in front. Anal legs very long, slender and spreading. Supra-anal plate very short and wide, rounded behind. At base of anal legs next to the hind edge of the supra-anal plate are two large shining dark piliferous tubercles; four conspicuous black dorsal piliferous warts. Body dull pearl colored, with two dorsal parallel wrinkled white lines; three similar lateral lines. Upper side of thoracic legs dark. Head and thoracic segments a little more dusky than the abdominal ones; head streaked longitudinally with white and black. Clypeus with a median black line, and sides lined with black. Thoracic feet a little dusky. Four lateral piliferous conspicuous dots on each abdominal segment, arranged in an oblique rhomb. Length 13<sup>mm</sup>. Found on *Carya porcina* May 24, molted about the 26th, becoming 22<sup>mm</sup> long, with the four anterior abdominal feet well developed.

*Full-grown larva*.—June 11. Head dull pearl, marbled with longitudinal irregular black lines, somewhat flattened in front. Body dull pearl, mottled with brown and blackish lines and spots. On top of each segment are four white dots arranged in a square. A pair of rather broad interrupted dark brown dorsal lines, and a similar lateral supra-stigmatal band. Five pairs of abdominal feet, all well developed. Beneath pale, with a median series of about twelve dark red-brown patches connected together posteriorly. Length, June 4, 40<sup>mm</sup>. Although the young larva was supposed to be a Pyralid, after the last molt the *Catocala*-like characters revealed themselves.

65. *Eugonia subsignaria* (Hübner.)

Order LEPIDOPTIA; family PHALÆINDEÆ.

During the past summer specimens of this common northern geometrid were received from Mr. Adam Davenport, of Morganton, Fannin County, Ga. In the accompanying letter Mr. Davenport stated that the insects had first been noticed in the county two years before, and that they had rapidly spread until they were now destroying



forests of hickory and chestnut and were doing much damage to the fruit trees. The principal damage done by these insects at the North has been to the shade trees in the large cities, notably New York and Philadelphia. In these localities there is but one brood in a year, the worms hatching in early spring and feeding upon the leaves until towards the end of June, when they spin up between the leaves. The moths issue in a week, pair, and lay their eggs upon the trunk and twigs of the tree, where they remain until the following spring. The worm is an inch and a half long and nearly black in color. The moth is pure white in color and has a wing expanse of an inch and a half.

As was evinced by reports received by Mr. Davenport, and by the fact that many of the eggs received were deposited upon *leaves*, there is evidently more than one brood each year in Georgia. The eggs were 1<sup>mm</sup> long, half as wide, of a yellowish-brown color, and were placed upon end in small patches. As to remedies, it will prove a very difficult insect to fight in forests; but upon ornamental trees and shrubs and upon fruit trees it will not be difficult to destroy it. The former can easily be syringed with Paris green and water, from a garden syringe or fountain pump. With the latter it will be necessary to jar the trees in mid-day, or in warm sunshine, when the worms are most active. The shock will cause nearly all to drop, suspended by a silken thread; then by using a pole they can be brought to the ground and destroyed by crushing. In forests, however, I can see no means of getting rid of them, unless it should prove that the moths are readily attracted by light, in which case much good could be accomplished by building fires at intervals during the time of flight. (Comstock's Report for 1880, p. 271).

For descriptions of the moth and its preparatory stages see p. 232.

66. *Eugonia alniaria* Hübner.

The larva of this species occurred at Providence in June, in its second stage of growth on *Carya porcina* and *Juglans nigra*. I sent it to Miss Sanders, who states that it molted July 9, again on the 16th, and for the last time July 24, spinning August 9 a beautiful loose web of silk like open lace, within the web hanging the inner oval hammock-like cocoon of close texture, thin and fine. The female emerged August 31.

Mr. L. W. Goodell has raised it from the chestnut at Amherst, Mass., August 20. He describes the caterpillar as "bluish-green, with a thick wrinkle on each ring, those on the fifth and eighth thickest and light brown; on the back of the eleventh ring are two little warts tipped with brown." Length, 2.3 inches, the body largest near the tail and tapering to the head. August 21 it drew a few leaves together and spun a thin pear-shaped cocoon, pupated the 24th, the moth issuing September 13.

Mr. S. H. Scudder has found it on the black birch. "It forms a cocoon by spinning in the midst of a bunch of leaves a close and firm cocoon of a bluntly fusiform shape, having a long neck extending above and below (it hangs perpendicularly) to the end of the many threads; open at both ends by an aperture about one-tenth of an inch in diameter."

*Larva*.—Of the color of the twig (of black birch), dull brownish-red, speckled considerably, and especially above, with dirty-white specks, arranged very frequently in lines, either longitudinal on the sides or curved forward above and becoming transverse. Head a little paler than the body; labrum and feet at base whitish. On the posterior portion of the fifth and eighth segments above there is a transverse paler ridge bordered with black. Length, 2 inches.

*Moth*.—Delicate ocher-yellow, with a reddish tinge toward the edge of the wings and on the head and front of the thorax. Fore-wings with two lines, often interrupted, or only developed on the costa; inner line on the inner third of the wing; the curved outer line, beginning near the inner, diverges and follows a sinuate course, ending much nearer the apex than the inner line, the distance varying; both wings speckled, sometimes thickly, with unusually large spots; outer edge of both wings deeply excavated, especially opposite the second median venule. On the hind wings no lines; an obscure discal clot centered, with a short translucent line. Beneath, much as above, but no lines, except in one case a diffuse dark line crosses the hind-wings. (The female differs in the usual characters of the dentated forms.) Fringe dark, whitish in the notches on both wings. Expanse of wings, 2 to 2.20 inches.

67. *Geometrid larva*.

This measuring worm was observed to be common on the hickory in the Arnold Arboretum at Jamaica Plains, June 4.

*Larva*.—Body thick, of uniform diameter throughout its length. Head brick-red, granulated with fine yellow tubercles, about as wide as the body. Prothoracic segment reddish above, spotted with black. Body bright straw-yellow low down on the sides and beneath, including the spiracles. Above, with alternating yellow and brown lines, the black lines inclosing about eight yellow ones. Length, 22 to 25<sup>mm</sup>.

68. *Geometrid larva*.

This larva is a general feeder on the pig-nut hickory and *Ostrya virginica*, and resembles a canker worm (*A. pomataria*). It was common, May 30, at Providence.

*Larva*.—Pale green, color of the leaf it feeds on. Head small, round, two-thirds as wide as the body, which is rather thick. A rudimentary pair of feet on the fifth abdominal segment. Two subdorsal white threads, and a much narrower lateral thread line; in one specimen a dark dot behind each spiracle; sutures yellowish white. Length, 22 to 23<sup>mm</sup>.

69. *Geometrid larva*.

This measuring worm occurred May 30, at Providence, on the pig-nut hickory.

*Larva*.—With large clasping prothoracic legs. Head somewhat square in front, as wide as the body, with reddish-resinous short curved lines. Segments much tuberculated on the sides, some of the tubercles bearing the spiracles. A broad, irregular spiracular line ending on the first pair of legs. Body black above, with a broken

broad greenish-yellow median band, ending before reaching mesothoracic or posteriorly the eighth abdominal segment. The ninth and tenth segments greenish yellow, including the anal legs. Prothoracic segment yellowish above, interrupted by a median short, broad, black band. Prothoracic and mesothoracic segments with oblique yellowish-brown bands extending to the feet. Length, 25<sup>mm</sup>.

70. *Noctuid?* caterpillar.

(Pl. XXV, Fig. 2.)

For several-years I have noticed a greenish semi-looping caterpillar on the hickory eating large holes in the leaves. In one year they were very abundant. They appear as soon as the leaves begin to unfold, and get their growth by June 15 to 20, when they fall to the ground and pupate. The year in which so many were observed, large numbers were ichneumoned, many caterpillars having an egg affixed to the head. (Fig. 2.) Whether from generally being ichneumoned, or sickly in confinement, after repeated attempts we have failed to rear this common caterpillar.

*Larva*.—Body of moderate thickness; head smooth, not lobed, not quite so wide as the prothoracic segment. Pea-green, of the hue of the under side of a leaf. Spiracles dark. Two subdorsal white lines and below two narrower ones on each side, six in all, one above and one below the spiracles. Length 19<sup>mm</sup>.

71. *Phycis rubrifasciella* (Packard).

Family PYRALIDÆ; order LEPIDOPTERA.

This insect mines the recently expanded leaves and partially expanded large buds of *Carya glabra* and another species with seven leaflets, probably *amara*, making a mass of "frass" under the revolute outer bracts, also boring into and hiding in the base of the leaf stalks. It occurs in abundance on *Carya amara*? in Providence May 25, or before the trees are wholly leaved out. It pupated June 1, 2. In one case the caterpillar pupated June 8 and the moth appeared early in July. June 14 other larvæ were found mining in the stems of the leaves, building out the mouths of the mines with tubes formed of excrement, and making a tent of the leaflets.

*Larva*.—A reddish-brown caterpillar, with the body thick and fleshy, tapering suddenly toward the head and tail; head and prothoracic shield chestnut-brown. Head narrow, much narrower than the prothoracic shield. Thoracic feet dark brown. In the abdominal segments the posterior half of the back is separated from the rest by a deep distinct suture. Piliferous dots minute, with sparse, rather long hairs. Supra-anal plate small, rounded. Length 12<sup>mm</sup>.

*Pupa*.—Of the usual brown color, the end of the abdomen much rounded, projecting from a transverse supra-anal projecting ridge, with the usual stiff curved setæ unusually small and short, from six to ten placed irregularly; in one pupa only six large and well marked, in another eight large ones and two small ones, and scattered in position; in size and situation very different from the pupa of *P. contatella* and that of another species, on *Gleditschia*.

*Moth*.—Antennæ of male with the usual tuft on basal joint; the palpi slender, pointed, ascending vertically. Body and fore-wings slate-ash, glistening; thorax

tinged with reddish-brown, and with the head giving off faint metallic colors; palpi blackish on the outside. Fore-wings rather broad; just within the basal third a straight line of raised scales, extending from the inner edge and stopping short of the subcostal vein, conspicuously black externally with bright vermilion (sometimes wanting), which usually reaches the costal edge. Base of wing slightly paler than middle of the wing. A light, triangular, paler shade in the costal region of the middle of the wing, inclosing two small, conspicuous twin black dots. A submarginal faint, pale, narrow line curving outward in the middle, and with four or five acute scallops. Fringe concolorous with the rest of the wing. Hind wings pale, glistening, cinereous. Beneath, fore-wings quite dusky, with no markings; hind wings much paler, growing darker toward the costa. Legs dark ash, paler at the ends of the joints, especially the hind tibiae, which have a whitish band around them; hind legs whitish within. Length of body, male, .40; female, .40 inch; of fore-wings, male, .38 to .40; female, .40 inch. Orono, Me., and Providence, R. I.

This species is at once recognized by the broad bright-red transverse stripe just within the middle of the wing. This stripe varies much, being sometimes not present, at others not reaching the costal edge. In one additional specimen from Maine the fore-wing has scattered reddish scales at base and beyond the middle, while the dark transverse stripe is wanting, and the red portion forms a broad transverse bright-red band. The larva lives in June and early in July between the leaves of the alder, where it makes a horn-shaped case of black cylindrical pellets of excrement, arranged regularly in circles, the additions being made around the mouth of the case. The case is about an inch and a half long, its mouth a quarter of an inch in diameter. Within it is densely lined with white silk. The pupa is of the usual color, mahogany brown; the end of the abdomen rounded, with six hairs projecting from a transverse supra-anal projecting ridge. On each abdominal segment is a dorsal dusky transverse stripe, widest on the basal segment. The pupa state lasts about two weeks, the moth which I reared in Maine appearing July 24, the larva having been found July 6.

The Museum of the Peabody Academy of Science also contains ten specimens of this moth, reared by Mr. J. H. Emerton. The larvæ were found feeding on the sweet fern (*Comptonia aspenifolia* Ait.), July 7, 1866, at Hamilton, Mass., the moth appearing July 20. The case is quite different in form from that previously described, being regularly oval cylindrical, .55 inch long and .35 inch in diameter. It is constructed in the same manner as those found on the alder. This striking difference in the form of the case may possibly be due to the difference in the form of the leaves of the food plant, the large, broad leaves of the alder inducing the larva to build a horn-like, much elongated case, while the narrow, smaller leaves of the sweet fern may have led to the formation of a short oval case. These differences are such as we would ordinarily regard as specific, but neither do the pupæ nor adults reared from the two plants differ appreciably.

From the foregoing descriptions and remarks it will be seen that this is a variable moth both in its coloration as well as in the habits of the

caterpillar; hence I am inclined to regard the following species described by Mr. Grote as synonyms of the species described by myself in the *Annals of the Lyceum of Natural History, New York, in 1873*. It should also be said that the moths raised from the *Carya* were shown to Prof. C. H. Fernald, who identified them as *Phycis rubrifasciella* Pack. Grote's description of *A. demotella* applies to my specimen; so also does that of *A. angusella*.

After preparing the foregoing account I found among my notes the following extract from an Illinois paper by an excellent observer, which I reproduce, as it shows that this insect is wide-spread in its distribution, and works in the same manner East and West.

In the latter part of May, while visiting a relative who lives in the western part of this county, I saw that many small webs had been spun by some insect around the footstalks of the leaves which grew near the terminal end of the branches of many hickory trees. These webs were always spun on the lower branches, seldom being more than 8 or 10 feet from the ground, and were confined to the second-growth trees. Upon examining these webs more closely there was found a short silken tube, closed at the outer end and opening at the other into a burrow, which in many instances extended through the wood of the present year's growth, but never passing into the old wood. Many of these burrows contained an ashen green sixteen-footed larva, measuring about half an inch in length; the spiracles were ringed with dark brown, and there was a raised brown dot above each, and a pale brown dot on either side of the second segment; the head was pale brown. These larvæ changed to chrysalides in the forepart of June, and produced moths in the latter part of the same month. Although these larvæ live in closed burrows, they are frequently infested with internal parasites; from a small number which I collected I obtained three moths and two parasites known to science as *Phanerotoma tibialis* Haldeman. A small flattened green spider also preys upon them, as one was observed near the mouth of a burrow with one of the larvæ in its jaws.

As these borers always spin a web around the leafstalks which grow around the mouth of their burrows, their presence can easily be detected, and then by means of a step-ladder the infested twigs may be cut off close to the old wood, collected in a basket, and afterwards be burned.

McHENRY COUNTY, ILL., July, 1882.

D. W. COQUILLET.

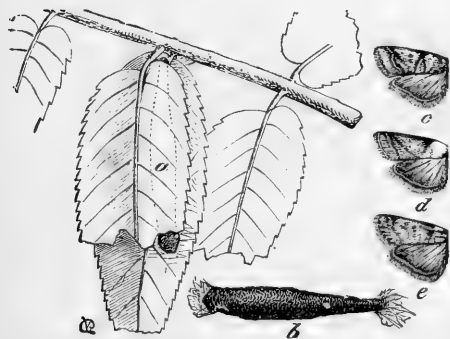


FIG. 120.—Walnut case-bearer; a, larva between two leaves; b, case; c, d, e, variations in the wings. (After Riley.)

## 72. THE WALNUT CASE-BEARER.

*Acrobasis juglandis* Le Baron.

Order LEPIDOPTERA; family PYRALIDÆ.

Drawing two leaflets together and constructing a black case, a small dark greenish worm, changing to a gray narrow-winged small moth. (Riley, IV, p. 42.)

We have observed at Providence, June 1, between the leaves of *Carya porcina*, a similar case, but in the form of a long, slender black cone, rather than spindle shaped.

## 73. THE WALNUT LEAF-ROLLER.

*Tortrix rileyana* Grote.

Order LEPIDOPTERA; family TORTRICIDÆ.

Drawing together the leaves of the black walnut and hickory in May, a colony of small yellow caterpillars; late in the month changing to honey-yellow chrysalids, the moths escaping by the middle or last of June. The latter expands an inch, and is deep ochereous, the fore-wings broad, evenly washed with purplish, with dark velvety-brown small spots, of which there are three at the base, two in the middle of the wing, and one on the edge, while near the apex is a curved row of four or five spots. The hind wings clear bright deep ochereous yellow. (Riley.)

74. *Tortrix (Lophoderus) juglandana* Fernald.

HABITAT.—This species inhabits Massachusetts, New-York, Ontario, Canada, Ohio, Wisconsin. Raised by James Angus on hickory leaves. (C. H. Fernald in Can. Ent., xi, p. 155.)

*The moth.*—Head, thorax and fore-wings reddish brown to dark brown. Fore-wings each with two oblique narrow bands of darker brown than the ground color of the wing; the first, beginning at about the basal third of the costa, extends obliquely across to the middle of the inner border; the second begins near the middle of the costa and extends obliquely across the wing parallel to the first band, and ends at the anal angle; these bands expand somewhat on the costal and inner borders. On the fore-wings of most of the males are scattered scales of a straw-yellow color, especially bordering the oblique bands; fringes of the fore-wings lighter in the middle, but at the apex and anal angle concolorous with the oblique bands. Hind wings above, with their fringes, as well as the abdomen above and the under side of fore-wings, fuscous. Under side of hind wings and legs lighter. Expanse of wings, male, 15 to 20<sup>mm</sup>; female, 20 to 26<sup>mm</sup>.

## 75. THE HICKORY ECCOPSIS.

*Eccopsis permundana* (Clemens).

The larva of this pretty moth has been found in Providence, R. I., to live on the leaves of the white-heart hickory (*Carya tomentosa*), which it folds, and when about to change to a chrysalis lines the fold with a thin layer of whitish silk. I have observed the caterpillars May 24, or as soon as the leaves are unfolded. From the 2d to the 9th of June, the insects changed to chrysalides and the moths appeared on the 23d of the same month. The life-history is then nearly as follows: From eggs laid the previous autumn on the twigs, the insect being probably double-brooded, the caterpillars hatch out simultaneously with the opening of the leaves, living about a week or ten days in this state between the folded leaves or rolling them up sideways or from the apex to the base; in the fold or roll thus made, which it lines with silk, it changes to a chrysalis, remaining about a fortnight in this state until during the third week in June, in southern New England, it appears as a beautifully marked moth flying about and resting on the leaves.

In Illinois, according to Mr. Coquillett (*Papilio*, iii, 102), the caterpillar feeds on the Siberian crab-apple, the cultivated raspberry, wild

blackberry (*Rubus villosus*), and hazel, while in Maine Professor Fernald has bred it on the *Spiræa* (see Comstock, Agricultural Report for 1880). Coquillett gives the following account of its habits: "Lives in a leaf rolled from the apex to the base, or between two or three leaves fastened together with silken threads. Found a great many May 30." His specimens of the moth were named by Prof. C. H. Fernald. Those which I bred were fresh, well-preserved specimens, and on submitting them to Professor Fernald for identification he wrote me that they were probably *Eccopsis permundana* (Clemens).

Unfortunately I did not make a description of my caterpillars, and therefore copy that of Mr. Coquillett:

*Larva*.—Body green, usually clouded dorsally with dull leaden; first segment brownish; head and cervical shield black or pale brownish; piliferous spots and spiracles concolorous; anal plate unmarked. Length, 15<sup>mm</sup> (Coquillett).

*Pupa*.—Of the usual shape and color, abdominal segments having two rows of dorsal spines, while the tip of the abdomen is three-toothed, there being two small lateral and a small median projection. There are also eight small, rather short, bristles curved outwards at the ends, of which four are situated below the median tooth, and two are situated near together on the side near but within the base of the lateral tooth. There are two or three other setæ on the side, but farther from the tip. Length, 10<sup>mm</sup>.

*Moth*.—A rather large species, with the general color brown-ash and umber-brown. Head a little paler than the thorax, the latter with three transverse darker lines above. Fore-wings with three large umber-brown patches, the basal one oblique, extending from the inner edge of the wing and only reaching the median vein. A median, irregular, broad band sending two blunt teeth inwards on the inner side; the outer side with three acute teeth, one in front and a larger one behind the median vein. A large, oval, umber-brown spot on the internal margin of the wing, and another large, oblique one extending from a little below the middle of the outer edge obliquely to the outer fourth of the costal edge, in its course contracting in width and becoming very narrow before reaching the costa, on which it slightly expands, forming one of the small costal brown spots beyond the middle of the wing. The fringe pale, but dusky in the middle. Hind wings dark slate color, as is the under side of both pairs of wings, as well as the abdomen, which, however, is paler at the end. Expanse of wings, 18<sup>mm</sup>.

#### 76. THE VARIEGATED ECCOPSIS.

*Eccopsis versicolorana* (Clemens).

This species also feeds upon the leaves of the white-heart hickory (*Carya tomentosa*) in company with the foregoing species. The larva begins to eat the leaves when they are unfolding, and the moth appears by the middle of June. Unfortunately no notes were made on the caterpillar, as they were confounded with the other species until the emergence of the moths showed that there were two species.

*Pupa*.—Slenderer than that of *E. permundana*, the end of the abdomen tridentate, with the eight bristles arranged as in the foregoing species, but much larger and longer. Length, 8<sup>mm</sup> to 9<sup>mm</sup>.

*Moth*.—Pale, greenish, umber-brown, with whitish patches. Palpi whitish to the tips. Head dark between the antennæ, pale behind and in front. Fore-wings olive green; a dark patch at base, becoming paler towards the inner edge of the wing,

with black specks, then becoming a pale, whitish, somewhat silvery band, crosses the wing. A broad median, dark, olive-green patch; the outer scales raised and dotted with black. Beyond this patch are three light, squarish, costal spots. An oblique, olive-green line passes from the outer margin just above the internal margin to the costa, becoming nearly obsolete before reaching the costa, but ending on the fourth costal spot. An apical dusky spot. Hind wings dark slate, and fore-wings beneath dark slate, with lighter costal spots. Expanse of wings, 15<sup>mm</sup>.

77. *Cacœcia semiferana* (Walker).

This leaf-roller is said by Miss Murtfeldt to occur on "various species of oak, and a strongly marked variety on hickory." (Fernald's Catalogue of Tortricidæ, p. 12.)

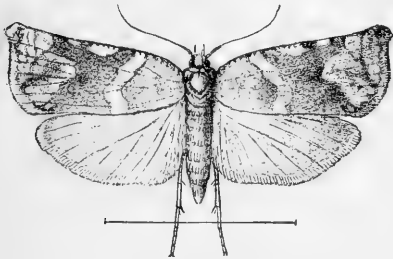


FIG. 122.—*Cacœcia semiferana*. (After Riley.)

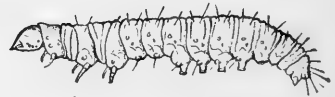
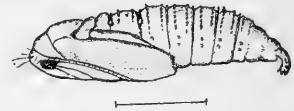


FIG. 121.—*Cacœcia semiferana*. Larva and pupa. (After Riley.)

78. THE WHITE-HEART HICKORY GELECHIA.

*Gelechia caryævorella* Pack.

Order LEPIDOPTERA; family TINEIDÆ.

Although we have numerous species of this extensive genus of Tineid moths feeding upon our forest trees, none, we believe, have been recorded as living at the expense of the hickory.

The larvæ of the present species were found at Providence, R. I., feeding upon the young, freshly unfolded leaves of the white-heart hickory (*Carya tomentosa*), rolling them up. Within the roll the chrysalis was discovered from June 2 to 4. The insect remains about two weeks in this stage, the moths appearing in my breeding box June 17 and 23.

The moth belongs to that section of the genus with moderately wide fore-wings, which are oblong, and moderately pointed at the tip. Professor Fernald informs me that it is allied to *Gelechia bicostomaculella* of Chambers.

*Moth*.—Palpi very long, the third joint slender, one-half as long as the second; second joint with black specks; third black, but white at the tip. The fore-wings broad, oblong. Head, thorax, and wings blackish, with whitish buff-yellow specks and dots. The fore-wings are dark pepper and salt, with a row of five deep black spots along the middle of the wing, increasing in size towards the end of the wing; the basal spot minute; the third large, and sending a branch obliquely inwards to the costa; the fourth patch large, irregularly squarish; above it is a black square costal spot, next to a buff-white, distinct costal spot opposite another on the inner



edge of the wing; the two spots are sometimes almost connected by a light line. The edge of the wing buff-white with black scales. Hind wings and abdomen slate-colored. Length of fore-wing, 7<sup>mm</sup>; width, 1.5<sup>mm</sup>; expanse of wings, about 15<sup>mm</sup> (0.60 inch).

79. *Lithocolletis caryæfoliella* Clem.

This larva mines the upper side of the leaves of the hickory tree in June, July, and September, making a white blotch, or an irregular rather broad tract when there is but one in the leaf, and not throwing the leaf into a fold. Frequently there are several larvæ in a leaf—in one instance I counted twelve. The "frass" is deposited along the middle of the mine. The perfect insects of the spring brood appear in August; from the fall brood I did not succeed in rearing the imago. (Clemens.)

*Larva*.—The larva is flattened, and its physical characteristics are similar to those of the second larval group. The head is light brown; the body dark lead color, becoming yellowish posteriorly, with the mammillæ of the thoracic rings yellowish, and a central spot of the same hue on the first; each ring on the dorsum with a dark brown, shining macula, those on thoracic rings trapezoidal, the remainder oval; on the ventral surface the maculæ are also dark brown, those on the fourth and fifth rings being oval. (Clemens.)

*Moth*.—Antennæ silvery, annulated with blackish. Front silvery. Tuft and thorax reddish orange. Fore-wings reddish orange, with three silvery bands, black-margined exteriorly, the second about the middle of the wing, angulated, with the black margin broad and produced posteriorly on a whitish ground, nearly to the third, which is somewhat interrupted in the middle; the first midway between the second and the base of the wing and also angulated near the costa. The apical portion of the wing white, covered with dispersed black scales, with a few black scales on a whitish ground, on the costa, between the last silvery band and the dusted apical portion; with two hinder-marginal lines, one the margin of the apical scales, the other a dark brownish line in the cilia. Hind wings pale brownish-gray; cilia gray, with a fulvous hue. (Clemens.)

80. *Lithocolletis caryæalbella* Chambers.

81. *Nepticula caryæfoliella* Clem.

This larva is found in the leaves of hickory late in July and early in August. The mine is very like the preceding, but rather wider and longer and not so tortuous, but nearly always recurved and with the central "frass" line. I have taken a specimen as late as the 30th of August, but at this date almost every mine found is untenanted. (Clemens.)

*Larva*.—The larva is pale green, with a dark green central line and brownish head. It is nearly or quite cylindrical, diameter uniform, the anal segments pointed. (Clemens.)

82. THE HICKORY SACK-BEARER.

*Coleophora* sp.

This interesting sack-bearer was found feeding on the unfolding leaves of *Carya porcina* at Providence, May 24. Its sack is flattened elongate ovate, 3.5<sup>mm</sup> in length; the anterior end is square, a little wider than the posterior end, which is more rounded. It is of a pale light horn color.

83. *Coleophora caryæfoliella* Chambers.

The larva feeds in a cylindrical case attached to the under surface of the leaves.

84. *Ypsolophus caryæfoliella* Clemens.

## 85. THE BLACK-EDGED FLEA-BEETLE.

*Systema marginalis* Illiger.

Order COLEOPTERA; family CHRYSOMELIDÆ.

This flea-beetle is said by Mr. Harrington to abound upon the elm, oak, etc., in the summer and autumn, while early in September he found it in great numbers feeding on the foliage of the sweet hickory. (Rep. Ent. Soc. Ontario for 1883, p. 49.)

*The beetle.*—A small, long beetle of a lemon-yellow color, and having the prothorax and wing-covers edged with black. The hind femora or thighs are much swollen, adapting it for leaping like a flea.

## 86. THE HICKORY LEAF-WEEVIL.

*Conotrachelus elegans* Say.

Order COLEOPTERA; family CURCULIONIDÆ.

We have observed this weevil at Providence, busily engaged the last of May, and in 1882 from June 8 to 13, laying its eggs in the partly rolled-up leaves of the pig-hickory (*Carya glabra*), and during the process cutting off the leaves, which hang down, wither, and turn black.

## 87. THE PLUM WEEVIL.

*Conotrachelus nenuphar* (Herbst).

This common weevil was noticed on the leaves of the pig hickory, May 25, at Providence.

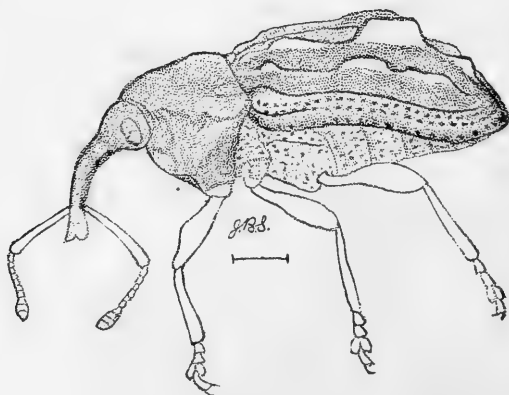


FIG. 123.—*Conotrachelus nenuphar*, Smith del.

## 88. THE PIG-HICKORY SLUG WORM.

*Selandria* sp.

This is a pale green slug worm, representing in form the naked larva of *Selandria caryæ*, with several rows of short, forked white hairs; quite abundant at Providence May 30, eating roundish holes in the leaves of the pig-nut hickory.

## 89. THE THICK-THIGHED WALKING-STICK.

*Diapheromera femorata* Say.

Order ORTHOPTERA ; family PHASMIDÆ.

The following account of this singular insect is taken *verbatim* from Professor Riley's U. S. Report for 1878 :

Certain elongate insects belonging to the *Orthoptera*, and popularly known as the "Walking-stick" or "Walking-leaves," according as they lack or possess wings, have long been recognized as among the most *bizarre* of entomological creatures. Mimicking to a remarkable degree, as their popular names imply, the twigs and leaves upon which they dwell, these insects find their most congenial home in the tropics, where some of the species attain to over a foot in length, exclusive of the legs.

The most common and wide-spread species in North America is the subject of the present sketch.

Owing to its curious, slender, long-legged, slow-moving characteristics, it has been properly dubbed the "Walking-stick," "Stick-bug," "Specter;" while in some localities it is known as "Prairie Alligator," "Devil's Horse," and other odd cognomens, generally indicative of its appearance and of a superstition which is quite prevalent, but most unfounded, that it is poisonous and can sting or bite.

The popular name above employed will serve to distinguish it from another tolerably common species the Two-striped Walking-stick (*Anisomorpha buprestoides* Stål).

This insect has always been considered harmless, or as Harris puts it, has "not proved so injurious as particularly to attract attention." In 1872, however, while lecturing at Cornell University, I noticed that it was unusually abundant around Ithaca, and it was there reported as doing considerable injury to the rose bushes and other shrubs. The following letters from correspondents will also show that Harris's verdict, which is that of all other standard authors, can no longer be considered correct :

"Inclosed find specimens, male and female, of an insect which is proving to be a scourge. About the middle of June I discovered, mostly on standing grass, this same insect, only very much smaller, of a light pea-green color, but not in sufficient numbers to be thought of as a pest. I noticed about August 15, in the reservation of young timber, mostly white oak and hickory, a few trees having the appearance of being burned just enough to kill the leaves. On closer investigation I found many of these insects devouring the leaves. Later, I judge at least 25 acres were completely stripped of foliage; as much so as if fire had run through the wood and killed every tree. They seemed to have no choice as to what variety of timber they attacked. There were many in my peach orchard and lawn. On single trees, far removed from my timber lot, they were as thick as could well be, in many places in heaps. Fences adjoining the timber were fairly covered with them. They have been known for years in this vicinity, but were heretofore always considered harmless. From present appearances they are greatly to be feared as a scourge, consequently anything

relating to them will be read with great interest. I hear from them in Florida, but not in such numbers as here."—[G. C. Snow, Yates County, New York, in New York Weekly Tribune, November 11, 1874.]

"About forty years ago my father set out a grove of locust trees for fencing purposes, at the foot of a rocky, wooded hill. The trees thrrove, and for years have furnished the farm with posts and stakes. When they were young we began to notice on them, now and then, the insects known as "Walking-sticks," and some fifteen years ago they began to increase rapidly, appearing in summer on the locusts, to which at first they seemed to confine themselves, entirely stripping them of their leaves, and have done so every second year since.

"The locusts have nearly all succumbed to the repeated attacks of these repulsive-looking pests, which have for some time extended their operations to the adjoining native trees, most kinds of which they feed upon ravenously.

"I have never by observation been able to discover when or where the eggs are deposited, nor can I find more than a description of the insect in any book within my reach. Will you throw a little light on the subject, and can you suggest any method of destroying these pestiferous walking-sticks?"—[R. E. R., Ferrisburgh, Vt., in Rural New Yorker, November 7, 1874.]

"In June last we gave an account of a remarkable visitation of myriads of the insect known as the walking-stick (*Spectrum femoratum*) in Yates County, New York, and asked for information as to the appearance elsewhere. The following from Mr. E. H. Conklin, Cumberland County, Pa., is the first response, which we hope may call out others. Mr. C. says: 'This insect, though not at all common, and seldom numerous, has made its annual appearance in our peach orchards for forty years, and only once in this time have they been so numerous as to be injurious. In this instance, which was about ten years ago, these insects denuded a row of locust trees that formed a shelter on the northwest side of a peach orchard. For half a dozen rods from this locust row the peach trees were also stripped of their leaves. Previous to this time we never saw them on any other trees except the peach. As to color some are light green, and others brown, amongst male and female. The female has a much heavier body than the male.'—[American Agriculturist, August, 1877.]

A further account of great injury to oak timber by this insect on Mr. Snow's farm was given in the American Agriculturist for June, 1877, and when applications were made through the editor of the said journal for more definite information and for some practical recommendations, so little was any one able to comply with such a request, I deemed the matter of sufficient interest and importance to warrant further investigation. A couple of visits to Esperance farm enabled me to clear up the insect's natural history, and suggested, as the sequel will show, a simple and feasible means of preventing its injuries.

Mr. Snow has about 50 acres of woodland, consisting of fine young trees, mostly the second growth of hickory, and of different species of oak. In 1874 the trees on about 25 acres were totally defoliated. In 1875 the insects appeared in fewer numbers. In 1876 they were even more numerous than in 1874, and covered a larger area. In 1877 again they attracted less attention, while last summer I found that Mr. Snow's accounts were by no means exaggerated. By the middle of August the bulk of the pests were going through their last molt, and by the end of autumn they had stripped most of the trees, showing, however, a decided preference for the black, red, and rock-chestnut oaks over the white oaks and hickories, which they affect but little till after the first-mentioned trees are stripped. The underbrush was also very effectually cleaned of its foliage, and the insects hung from and clung to the bare twigs and branches in great clusters. They settle to roost on the witch hazel, but do not defoliate it until the other trees mentioned are pretty bare. Sumach and thorn are also little affected, while peach and apple in an adjoining orchard were untouched. Whenever they have entirely stripped the trees and shrubs they move in bodies to fresh pastures, crowding upon one another and covering the ground, the

fence-rails, and everything about them so that it is impossible for a person to enter the woods without being covered by them. The timber affected can be recognized by its seared and leafless appearance from a great distance, and upon entering the woods the ear is greeted by a peculiar seething noise, resulting from the motion of the innumerable jaws at work on the leaves. Their depredations first begin to attract attention soon after wheat harvest, and are most noticeable in September. The injury to the trees done in 1874 and 1876 was manifest in the death of most of the black oaks, and according to Mr. Snow's observations, trees die in three years after the first attack.

The unexampled multiplication and destructiveness of this insect at Esperange farm is but one of the many illustrations of the fact long since patent to all close students of economic entomology, that species normally harmless may suddenly become very injurious.

Owing doubtless to its having so generally been considered harmless, the habits of the thick-thighed walking-stick have not hitherto been carefully studied; and it was not known how it passed the winter or where the eggs were laid. These eggs, which were first briefly described by me in 1874,\* are 2.8<sup>mm</sup> long, oval in shape, slightly compressed at the sides, and of a polished black color, with a ventral whitish stripe. They look not unlike some plump, diminutive leguminose seed. They are simply dropped loosely upon the ground from whatever height the females may happen to be, and, during the latter part of autumn, where the insects are common, one hears a constant pattering, not unlike drops of rain, that results from the abundant dropping of these eggs, which in places lay so thick among and under the dead leaves that they may be scraped up in great quantities.

From general observations of specimens kept in confinement it would appear that each female is capable of laying upwards of a hundred. The eggs remain upon the ground all through the winter, and hatch for the most part during the month of May. Some of them, however, continue hatching much later, so that all through the summer and even into the fall young individuals may be found. The embryo just about to hatch lies within the egg with the head pressed against the oval lid, and the body curled around so that the end of the abdomen, which is thickened and contracted, reaches near the mouth. The long antennæ project in front of the head and follow the curve of the body, and the long legs are folded up in the central space. At an earlier embryonic stage the abdomen is enormously enlarged and the members are correspondingly small. The young walking-sticks measure at birth 4.5<sup>mm</sup>, and, with their feelers and legs outstretched, nearly double that length. They are invariably, during early life, of a uniform pale yellowish-green color, and as they have a habit in their earlier days of keeping near the ground, this, coupled with a great readiness to drop whenever disturbed, serves to protect them from observation. They may for these reasons occur in great numbers in the early part of the season without being suspected. The insect changes very little in appearance from birth to maturity except so far as color is concerned, and molts but twice. Growth is rapid, averaging under favorable circumstances about six weeks from birth to maturity. With age the green color gives way to various shades of gray and brown. In this way we find great correspondence with its surroundings. While the vegetation is green the specters are green also; when the foliage turns in autumn they change color correspondingly, and when the foliage is stripped they so closely resemble, in both appearance and color, the twigs upon which they rest—the habit of stretching out the front legs and feelers greatly enhancing the resemblance—that when they are few in numbers it is difficult to recognize them. A few green specimens, more particularly of the males, may always be found, even among the mature individuals.

In contemplating these singular creatures and their wonderful resemblance to the oak vegetation upon which they occur, one can not help noticing still further resemblances. They are born with the bursting of the buds in the spring; they drop their

\* New York Weekly Tribune, November 11, 1874.

eggs as the trees drop their seeds, and they commence to fall and perish with the leaves, the later ones persisting, like the last leaves, till frost cuts them off.

As will have been already noticed, Mr. Snow has found from his own observations that the insects were injuriously abundant every other year, and I have been interested in endeavoring to find an explanation of this fact. The increase of the insect's natural enemies whenever they became excessively abundant, and the consequent decrease of the plant feeder the following year, undoubtedly have something to do with it; but there is also good evidence that a great many of the eggs remain on the ground for two consecutive winters before hatching. Messrs. T. W. Bringham and L. Trouvelot have both found from experience that the eggs of this insect for the most part hatch only after the interval of two years,\* and an examination made of a large number, which I have myself kept the present winter, shows that while some have proceeded far in embryonic development, others show no development whatever, thus corroborating the experience of these gentlemen.

We may very justly conclude, therefore, that the species will only be injurious every alternate year.

Among the natural enemies of this Walking-stick, Mr. Snow has observed that the crows were very abundant about them, as well as some other smaller birds. Turkeys, as well as chickens, also feed upon them, and may be made good use of while the insects are young and remain near the surface of the ground.

Of the insects that prey upon them, I noticed, both in the immature and perfect states, three species of half-wing bugs (*Heteroptera*), namely, *Arma spinosa*, *Podisus cynicus* Say, both in the typical form, and in the variety *obscuripes* as determined by Professor Uhler; also *Acholla multispinosa* (De Geer.)

*Egg*.—Bean-shaped, hard, and highly polished; obliquely truncate at the anterior end, which consists of a dark oval raised rim, inclosing a slightly elevated, convex, densely and deeply punctate brown lid, which is replaced after the young has hatched by the white sunken amnion, which is shed within the egg. Color black, with frequently a faint olivaceous hue, the ventral side in strong contrast, whitish inclining to pale fulvous, and with an elliptical scar recalling the hilum of a seed, the interior slightly depressed, the borders slightly raised. This scar reaches to near the lid anteriorly, and ends in a cord posteriorly, to which cord the black color of the posterior extends in a broad point. There is usually more or less black within the posterior portion of the scar. Average length 2.5<sup>mm</sup>; thickness from side to side, 1.2<sup>mm</sup>.

*Larva*.—When newly hatched 11.5<sup>mm</sup> long, exclusive of antennæ. Color, uniform pale yellowish-green, the front pair of legs speckled with brown. Antennæ with rather prominent bristles. Sex undistinguishable. Femora subequal in size. No femoral spines.

*The adult*.—The colors of the adult are quite variable, and are generally obliterated in cabinet specimens. Shades of gray, brown, and greenish-brown predominate, the head of the male being paler and having three longitudinal fuscous stripes, and the middle thighs having annulate shades of the same color. The front legs of the male and the shanks of the others are almost always green. The colors of the female are more uniform, generally grayish, with paler specks and mottlings on the head and along the back; but occasionally pale green predominates. Structurally the male is at once distinguished by his shorter, more slender body; his longer legs and feelers; his narrower and less dilated front thighs; his swollen middle thighs, and by the greater stoutness of the spines near the ends of the middle and hind thighs, these and the other distinguishing sexual characters being less obvious in the earlier stages of growth.

*Remedies*.—While the insects are young, they may be destroyed by sprinkling the underbrush in the timber with Paris green water, wherever the timber is inclosed so that domestic animals can be kept away from the poisoned vegetation.

\* Proc. Bost. Soc. Nat. Hist., Vol. XI, pp. 88 and 89.

The most satisfactory means of averting the insects' injuries, however, will be found in the destruction of the eggs during winter. This may be done either by digging and turning them under, or by burning over the dead leaves among which they lay.



FIG. 124.—The walking stick. *a*, *b*, eggs; *c*, young just hatching; *d*, male; *e*, female. (After Riley).

#### 90. THE GOLDSMITH BEETLE.

*Cotalpa lanigera* (Linn.).

We have observed this beetle pairing June 1 on the leaves of *Carya porcina*, and it evidently may be counted as occasionally feasting on the foliage of the hickory.

A large number of Hemiptera, such as gall-lice, tree-hoppers, etc., puncture the leaves, causing them to wither or raising galls upon them. The following species have been noticed by Fitch and others:

## 91. THE HICKORY-STEM GALL-LOUSE.

*Phylloxera caryæcaulis* (Fitch).

Forming bullet-like galls, hollow, green, and of a leathery texture, upon the leaf-stalks and succulent young shoots, with the walls of the cavity inside covered with minute white and yellow lice.

## 92. HICKORY-VEIN GALL-LOUSE.

*Phylloxera caryævenæ* (Fitch).

Forming plaits in the veins of the leaves, which project up from the surface in an abruptly elevated keel-like ridge upon the upper side of the leaf and with a mouth opening on the under side, the lips of which are woolly and closed. The wingless females minute, pale yellow, broad in front, and tapering behind to an acute point; antennæ and legs short and tinged with a dusky hue.

## 93. THE HICKORY LEAF-WITHERER.

*Phylloxera caryæfoliæ* (Fitch).

Forming small conical elevations on the upper surface of the leaf of *Carya alba*, each having an orifice in its summit; a very small black plant-louse with a pale abdomen and legs and smoky wings laid flat on its back, and having only three veins in addition to the rib. Length, 0.06 inch. (Fitch.)

## 94. THE SEED-GALL HICKORY PHYLLOXERA.

*Phylloxera caryæ-semen* (Walsh).

Forming fuscous, minute, subglobular, seed-like galls on the leaves of *Carya glabra*, the galls opening in a small nipple on the under side. (Walsh.)

## 95. THE HICKORY ROUND-GALL.

*Phylloxera caryæ-globuli* Walsh.

Forming hemispherical galls about 0.25 inch diameter on the upper surface of the leaves of *Carya glabra* and *alba*, the galls rather flat below, where they open in a slit. (Walsh.)

## 96. THE HICKORY SPINY GALL.

*Phylloxera spinosa* (Shimer).

Forming large, irregular galls, covered with spines, on the petiole of the leaf of *Carya amara*, the galls opening beneath in an irregular, sinuate slit. (Shimer.)

97. *Phylloxera caryæ-septa* (Shimer).

Forming flattened galls with a septum, on the leaves of *Carya alba*, the galls opening both above and below. (Shimer.) Probably, according to Riley, only an abnormal form of *P. caryæ-globulis*.

98. *Phylloxera forcata* (Shimer).

Forming galls much like those of *P. caryæ-semen*.



99. *Phylloxera depressa* (Shimer).

Forming depressed galls on leaves of *Carya alba*, the galls opening below with a constricted mouth fringed with filaments. *Daktylosphæra coniferum* Shimer is, in all probability, Riley claims, the same. (7th Rep. Ins. Mo., p. 118.)

100. *Phylloxera conica* (Shimer).

Forming galls similar to those of *P. depressa*, but without the fringe. (Probably the same, Riley claims.)

101. *Phylloxera caryæ-gummosa* Riley.

Forming pedunculated ovoid or globular galls on the under side of *Carya alba*; the gall white, pubescent, and gummy or sticky, opening below in a fibrous point.

The eggs are almost spherical, pale, and translucent. Larva, mother-louse, and pupa quite pale, the red eyes and eyelets strongly contrasting. (Riley, 7th Rep. Ins. Mo., p. 118.)

102. *Phylloxera caryæ-ren* Riley.

Forming numerous more or less confluent mostly reniform galls on the petiole and leaf-stems of *Carya glabra*; the galls varying from 0.2 to 0.7 inch in diameter, pale green and densely pubescent, and opening in a slit the whole of their length, transversely with the axis of the petiole. (Riley.)

103. *Phylloxera caryæ-fallax* Riley.

Forming conical galls thickly crowded on the upper surface of the leaves of the *Carya alba*. Strongly resembling *P. caryæ-foliæ*, but the height one-third greater than the basal diameter, and opening below, instead of above, in a circular fuzzy mouth. (Riley.)

104. *Lachnus caryæ* (Harr.)

*Stylo nullo, corniculis brevissimis, corpore cinereo, dorso nigro-maculato; femoribus brunneis, tibiis, tarsis antennisque nigris.*

*Larva*.—Body with a cinereous pruina, which is somewhat evanescent on the thorax, so as to exhibit the black color, more or less, on this part. Dorsum of the abdomen with four longitudinal rows of transverse black spots (or four on each segment). Style obsolete; cornicula very short, tuberculiform, rostrum extending only to the middle of the third segment; wings fuliginous, bases ferruginous brown, dilated, costa and nervures black; legs black, hairy, the posterior tibiæ remarkably so; femora, except at tips, ferruginous brown. Length of body .25, of upper wings, .35, of body and wings when at rest .43, expansion of wings .72 of an inch.

Larvæ, pupæ, and winged insects found on the limbs of the *Carya porcina*, July 1, 1831. (Harris' Corr.)

## 105. THE HICKORY GAY-LOUSE.

*Monella caryella* (Fitch).

Scattered upon the under side of the leaves, a small pale-yellow plant-louse with white antennæ alternated with black rings and pellucid wings laid flat upon its back, its abdomen egg-shaped, somewhat flattened, and with only minute rudimentary honey-tubes. (Fitch.)

## 106. THE DOTTED-WINGED GAY-LOUSE.

*Callipterus? punctatellus* Fitch.

A plant-louse like the preceding, but with black feet and a black dot on the base and another on the apex of each of the veins of its fore-wings. The stigma is salt-white, with a brown streak at each end; the second vein is wavy, and at its tip is

curved towards the tip of the first vein ; the third vein arises from the basal extremity of the stigma, and forward of its furcation curves perceptibly towards the apex of the wing ; the fourth vein is longer than the second fork. (Fitch.)

## 107. THE SPOTTED-WINGED GAY LOUSE.

*Callipterus maculellus* Fitch.

Differs from *C. ? caryellus* in having only a slender black ring at each articulation of the antennæ, the feet and a band near the tips of the hind thighs blackish ; the stigma salt-white, its base black, its apex dusky ; fourth vein with a black dot on its base and a dusky one on its apex ; the first vein, apical third of the second vein, and the first and second forks broadly margined with smoky brown ; second vein wavy and parallel with the third vein till near its tip, where it curves towards the first vein, its base a third nearer the third than it is to the first vein ; third vein arising from the anterior extremity of the stigma, with a dusky spot on its apex. (Fitch.)

## 108. THE SMOKY-WINGED GAY-LOUSE.

*Callipterus fumipennellus* Fitch.

Similar to the preceding, of a dull yellow color, with blackish feet and the wings smoky with robust brown veins, the rib-vein much more distant from the margin of the first half of its length than in the other species, and from its middle to the stigma approaching the margin ; the fourth vein equalling the stigma in length. (Fitch.)

## 109. THE BLACK-MARGINED GAY-LOUSE.

*Callipterus marginellus* Fitch.

Pale yellow ; antennæ white, their bases and the four bands black ; a coal-black band in front between the eyes and continued along each side of the thorax to its base ; fore wings pellucid, stigma with the outer margin and rib-vein coral black, first vein with a black dot on its base ; fourth vein slender, black, the other veins colorless ; outer margin of hind wings black. (Fitch.)

## 110. THE FRECKLED LEAF-HOPPER.

*Jassus inornatus* Say.

A cylindrical oblong white leaf-hopper closely inscribed and reticulated with slender black lines and small dots which form irregular spots along the margins of the wing-covers ; its legs white, dotted with black. Length, .25 inch.

## 111. FOUR-STRIPED LEAF-HOPPER.

*Diedrocephala quadrivittata* (Say).

A flattened oblong leaf-hopper of a light-yellow color, varied on the thorax with orange, red or dusky ; its fore-wings olive green, each wing with two bright red or orange stripes, the tips margined with black. Length, .35 inch. (Fitch.)

## 112. THE WALNUT SWORD-TAIL.

*Uroziphus caryæ* Fitch.

A dull brown tree-hopper with the terminal portion of its fore-wings obscure ash-gray ; its abdomen and a ring on its shanks pale-yellowish, and its breast mealy white. Length of male, .30 ; female, .37. (Fitch.)

## 113. THE YELLOW TREE-HOPPER.

*Telamona unicolor* Fitch.

A tree-hopper of a uniform dull ochre-yellow, somewhat like a beech-nut in shape and size, with a prominent hump jutting up on the middle of its back, highest anteriorly and descending with a slight curve to its hind angle, which is very obtusely rounded and but little prominent; its interior angle also rounded and with only a slight concavity below it at the forward end of the hump, while at its posterior base is a strong one, the whole surface with close coarse punctures and showing a few elevated longitudinal lines low down on each side and towards the tip; the upper edge of the hump black and also the tip of the abdomen on its under side; fore-wings glassy, with a black spot on their base and tip, and their veins margined with slender black lines. Length, .45 inch; height, .25 inch.

## 114. THE BANDED TREE-HOPPER.

*Telamona fasciata* Fitch.

Like the preceding species, but smaller and of a tawny-yellow color, its head and the anterior edge of the thorax and the under side paler cream-yellow or straw-colored, with a single small black dot above each eye; its thorax in front and at tip blackish, and also an oblique band across the hind end of the dorsal lump longer than high, longer at its base than above, highest anteriorly, with a stronger concavity at its anterior end than at its posterior, and at its anterior base compressed and forming hereby a shallow indentation upon each side. Length, .38; height, .20 inch. (Fitch.)

## 115. THE SHORT-HORNED TREE-HOPPER.

*Ceresa brevicornis* Fitch.

Very like *Ceresa bubalus* on the apple and wild thorn, but differing in having the horns much shorter, while the sides of the thorax, when viewed in front, are not gradually curved outwards, but are straight or rectilinear, with the horns abruptly projecting from the corner at the upper end of this line. The acute spine at the tip of the thorax is also longer and slenderer. The thorax between the horns is slightly convex. The dried specimen is of a pale dull yellow color speckled with faint pale green dots and with a paler straw-colored stripe, quite distinct, upon the angular sides of the thorax from each eye upward to the horn and from thence to the summit of the thorax. Length, .36 inch. (Fitch.)

## 116. THE FACE-BANDED CIXIUS.

*Cixius cinctifrons* Fitch.

A small four-winged hemipter of a white color, varied with blackish brown, and with three elevated lines upon the face and thorax; its face snow-white, crossed by two black bands, the outer raised lines dotted with white in these bands; the thorax black, tawny yellow on each side beyond the raised lines; neck white with a row of blackish dots upon each side; fore-wings smoky brown, their veins dotted with black in places, their basal edge, an oblique band and a spot in the middle of the outer margin white, their membranous tips white and somewhat hyaline, with a brown band across the transverse veinlets, and the hind margin blackish, interrupted by the snow-white tips of the veins; hind wings black and transparent; under side yellowish-white, with two blackish bands on each of the four forward shanks. Length, .18 inch.

## 117. THE CLOUDY-TIPPED CIXIUS.

*Cixius colapeum* Fitch.

Rarely found on the leaves, a small four-winged homopter of a coal-black color, with clear, transparent wings having a large smoky-brown cloud on their tips; forewings transparent, their veins dotted with black, the dots on the outer margin larger; an irregular and somewhat broken band of a smoky-brown color extending across forward of the middle and a broader one beyond the middle, having a black spot or stigma on the anterior corner of its outer end; between these bands a smoky-brown spot on the inner and a smaller one nearly opposite it on the outer margin; thorax with three raised lines; face black with the raised lines brown; legs dull whitish. Length, .22 inch. (Fitch.)

## 118. AMYOT'S OTIOCERUS

*Otiocerus amyotii* Fitch.

A light yellow homopter; the wing-covers pale sulphur-yellow, with a brown stripe from the base to the middle of the inner margin and thence to the outer tip; a row of blackish dots on the hind edge alternating with the ends of the apical veins, and about six dots forward of the innermost of these, placed on the tips of the subapical and on the bases of the apical veins; three brown stripes on the thorax; an orange-red stripe on each side of the head from the eye to the forward edge below the apex. Length, .25; expanse of wings, .70 inch. (Fitch.)

## 119. THE LARGE GREEN TREE BUG.

*Raphigaster pensylvanicus* (De Geer.)

A large flattened grass-green bug (hemipter) edged all around with a light yellow line, interrupted at each joint of the abdomen by a small black spot, its antennæ black beyond the middle of their third joint, with a pale yellow band on the first half of the last two joints. Length, .60 and .70 inch. (Fitch.)

## AFFECTING THE FRUIT.

## 120. THE HICKORY-SHUCK WORM.

*Grapholitha caryana* (Fitch.)

Order LEPIDOPTERA; family TORTRICIDÆ.

Mining the shucks which envelope the nuts, causing them to be abortive and many to fall from the tree prematurely, a slender white sixteen-footed caterpillar about three-eighths of an inch in length.

Dr. H. Shimer states that the larvæ were found by him in Illinois in August and September, living in the nut of *Carya amara* (bitternut hickory); "they destroy the interior of the nut, causing it to fall to the ground. The imago appeared in the latter part of November; it therefore hibernates in this state, and continues to live in the spring until some time in June, when the nut is sufficiently developed to receive the egg." (Trans. Amer. Ent. Soc., ii, 394.) We have collected this moth (identified by Prof. Fernald) May 20 in a growth of young hickories at Providence; the moth was fresh and unrubbed.

*Moth.*—Sooty black, the fore-wings with reflections of tawny yellow, blue and purple; their outer edge black, with oblique triangular whitish streaks placed at equal distances apart. A very oblique faint silvery blue streak extends inwards from the points of two of these white streaks, namely, the fourth and sixth ones from the tip of the wing; while the usual white spot on the inner margin of the wings is wanting. Expanse of wings, .60 inch. (Fitch.)

## 121. THE HICKORY-NUT WEEVIL.

*Balaninus nasicus* Say.

Order COLEOPTERA; family CURCULIONIDÆ.

This worm, like the chestnut borer, transforms into a long-snouted beetle closely like *B. rectus*, but with a darker, thicker, more curved rostrum, and with the antennæ springing from its middle in the male and from its basal third in the female. Two thoracic paler bands are seen on the thorax, and there is always a pale transverse band behind the middle of the elytra, and a sutural band. In the male the beak is equal to three-fourths the length of the body, in the female to five-fourths. It breeds entirely on hickory nuts (Riley.)

Mr. Harrington states that in the neighborhood of Ottawa, Canada, this species is never found on the hickory, and frequents the hazel almost entirely. Some years it is very numerous on these bushes, and the nuts correspondingly worm-eaten.

*The beetle.*—It is nearly one-third of an inch long (exclusive of the beak), and of an oval shape, being widest across the base of the wing-covers. It is densely clad with very short yellowish hairs, and has a somewhat variegated or mottled appearance, especially on the elytra, due to patches of darker hairs. The beak is very long, slender, curved, and almost black. (Harrington.)

Mr. Harrington states that *B. rectus* is much rarer in the neighborhood of Ottawa, and usurps the claim of *B. nasicus* to be considered the hickory-nut weevil, while a few specimens occurred on the oak. He remarks that *B. rectus* is of the same size as the preceding species, but much lighter in color, and distinguished by its more slender and less curved beak, which in the female is longer than the whole body. (Rep. Ent. Soc. Ottawa for 1883, p. 51.)

122. *Tortrix* sp. ?

Family TORTRICIDÆ?; order LEPIDOPTERA.

Found October 4 to 9, eating a dark mine in the skin of the shell of the walnut itself, making a tunnel, I think a longitudinal one, along one of the quarters of the skin; of about the size of the body, but of irregular thickness.

*Larva.*—Body short and thick, tapering a little towards the end, and somewhat hairy. Head and prothoracic shield honey-yellow; the shield paler than the head, which is dark towards the mouth-parts. Body dull white; each segment with two transverse dorsal ridges, on which are setiferous warts. Length, 7<sup>mm</sup>.

The following species also occur on the hickory.

Order COLEOPTERA.

116. *Leptostylus macula* (Say). See Butternut insects, p. 337.
117. *Phymatodes variabilis* (Fabr.) (Tyler Townsend, Can. Ent., xviii, p. 13).
118. *Monarthrum fasciatum* (Say), breeding in living *Carya alba*. (Chittenden in letter.)
119. *Xylotrechus colonus* (Fabr.). Lintner, iv, 93.
120. *Lepturges querci* Fitch, bred from twigs (Chittenden).
121. *Magdalis olyra* Herbst., bred from branches (Chittenden).
122. *Xanthonia villosula* (Melsh.), on leaves (Chittenden).
123. *Xanthonia stevensii* Baly, on leaves (Chittenden).
124. *Elaphidion villosum* (Fabr.), bred from twigs (Chittenden).
125. *Cyrtinus pygmaeus* (Hald.), beaten from *Carya*, doubtless breeds in the wood (Chittenden).
126. *Attelabus bipunctulatus* Fabr. See Oak insects, p. 204.
127. *Dicerca asperata* Lec. (Chittenden).
128. *Dicerca divaricata* (Say). (Harrington, l. c.)
129. *Dichelonycha elongata* (Fabr.) In June feeding on the bitter hickory. (Harrington, Rep. Ent. Soc. Ontario for 1883, p. 43).

Order LEPIDOPTERA.

130. *Papilio glaucus* Linn.
131. *Halesidota tessellata* A. and S. (Beutenmüller).
132. *Parorgyia achatina* (Abbot and Smith).
133. *Hyphantria cunea* (Drury), *textor* Harris.
134. *Parasa fraterna* Grote. (Beutenmüller).
135. *Pyrophila pyramidoides* Guen. (Coquillett).
136. *Nematocampa filamentaria* Packard.
137. *Hibernia tiliaria* Harris.
138. *Acrobasis caryæ* Grote.
139. *Sisyrosea inornata* G. & R. (Dyar, Can. Ent., xxi, p. 77.) See p. 147.
140. *Limacodes scapha* Harris. See Oak insects, p. 147.
141. *Clisiocampa sylvatica* Harris. (Riley).
142. *Heterocampa pulvereæ* G. & R. See Oak insects, p. 159.
143. *Sesia hospes* Walsh. (Proc. Ent. Soc. Phil., vi, 1866, 270.) Bred from an excrescence or fungus on pig-hickory (Walsh).
144. *Cossula magnifica* Bailey. See Oak insects, p. 59.
145. *Platysamia cecropia* (Linn.). I found the cocoon on the pig-hickory at Providence, the moth appearing June 12. See Maple insects.
146. *Monoleuca* sp. on *Carya glabra* in Georgia. Abbot's MS. paintings (Library Bost. Soc. Nat. Hist).
147. *Taniocampa incerta* Hübn. See Oak insects, p. 172.
148. *Apatela brumosa* Guen. See Oak insects, p. 169.

149. *Scopelosoma sidus* Guen. See Oak insects, p. 116.
150. *Agrotis alternata* Grote. See Oak insects, p. 116.
151. *Catocala desperata* Guen. (French, Can. Ent., xx, 28.)
152. *Catocala palaeogama* Guen. (French, Can. Ent., xx, 108.)
153. *Prodenia cammelinæ* Abbot and Smith.
154. *Catocala vidua* (Abbot and Smith). See Oak insects, p. 178.
155. *Nematocampa filamentaria* Guen. (Forbes, 2d Ill. Rep., 79).
156. *Paraphia deplanaria* Guen. Ohio. (Pilate, Papilio ii.)
157. *Eugonia subsignaria* Hübner.
158. *Cacaecia argyrosipila* Walk. See Oak insects, p. 192.
159. *Gracilaria* sp. (probably *G. blandella* Clem.) Imago unknown.  
The larva when young makes a linear whitish mine in the upper surface of the leaves.

## HEMIPTERA—HOMOPTERA.

160. *Phylloxera caryaeglobosa* Shimer.
161. *Schizoneura caryæ* (Fitch).
162. *Callipterus caryæ* Monell.

## DIPTERA.

163. *Cecidomyia cossæ* Shimer, Trans. Amer. Ent. Soc. ii, 395.
164. *Cecidomyia caryæ* O. Sacken, Monographs, etc. i, 191.
165. *Cecidomyia caryæcolor* O. Sacken, Monographs, etc. i, 192.
166. *Cecidomyia cynipsea* O. Sacken, Monographs, etc. i, 193.
167. *Cecidomyia glutinosa* O. Sacken, Monographs, etc. i, 193.
168. *Cecidomyia nototricha* O. Sacken, Monographs, etc. i, 193.
169. *Cecidomyia persicoides* O. Sacken, Monographs, etc. i, 193.
170. *Cecidomyia sanguinolenta* O. Sacken, Monographs, etc. i, 192.

## INSECTS INJURIOUS TO THE BLACK WALNUT.

(Juglans nigra.)

## AFFECTING THE TRUNK.

1. *Cyllene pictus* (Drury.)

The chief enemy of this tree is the hickory and locust tree borer (*Cyllene pictus*). Fitch states that the beetles which are reared in this tree appear to constitute a distinct variety of a larger size than usual and with their yellow marks changed more or less to a white color.

2. *Allorhina nitida* (Linn.)

Order COLEOPTERA; family SCARABÆIDÆ.

This beetle has been found by Mr. Charles W. Leng to be common in the Carolinas and Georgia attacking the shade trees. "Near Raleigh an avenue of walnuts was specially infested. They appeared to bite

through the bark making a hole one-eighth inch wide and one-half to three-quarters inch long. The bark seemed to be softened with some exudation from the mouth. Most of the cuts I examined reached only to the wood, but a few were much deeper. In the deeper holes I found *Cryptarcha ampla* curled up." (Bulletin Brooklyn Ent. Soc. iv. 76.)

## AFFECTING THE LEAVES.

## 3. THE BLACK WALNUT SPHINX.

*Smerinthus juglandis* Abbot and Smith.

(Larva, Plate XI, fig. 2.)

Order LEPIDOPTERA; family SPHINGIDÆ.

*Larva*.—A large pale blue-green caterpillar with a long caudal horn; head small, and the body attenuated before and behind, and with seven oblique white bands. When disturbed it makes a creaking noise by rubbing together the joints of the fore-part of the body. It enters the earth to finish its transformations. (Harris.)

*Moth*.—Very gray, dark or dusky brown; wings indented on the outer edges; fore-wings with a dusky outer margin, a short brownish dash near the middle, and four transverse brown lines converging behind and inclosing a square dark brown spot adjacent to the middle of the inner margin; hind wings with two narrow transverse brown lines between two brownish bands; thorax with a central brown line; abdominal segments plaited and prominent at the sides. The wings expand from  $2\frac{1}{4}$  to 3 inches. The females are much larger and of a lighter brownish gray color than the males, with the square spot on the fore-wings less distinct. Ranges from Massachusetts to Florida and Georgia. (Harris.)

4. *Datana integerrima* G. and R.

This species has been found by Mr. Pilate to occur commonly on the walnut in Ohio. See p. 150; also Insect Life, i, 177.

5. *Datana ministra* (Drury).

From Mr. D. S. Harris, of Cuba, Ill., we learn that in 1882 the caterpillar of this species "has been so abundant on the black walnut that many persons have cut down their walnut trees when they were near their houses." See p. 302; also Insect Life, i, 125, 161, 177, 200; ii, 256.

6. *Schizura leptinoides* (Grote).

This has also been found by Mr. Pilate to feed on the walnut.

7. *Actias luna* (Linn).

Mr. J. P. R. Carney, of Camden, N. J., writes me as follows regarding the habits of this moth, which he has bred from the walnut:

In all books of natural history, as far as I have seen, the Luna is accredited with spinning a cocoon in the fall and emerging the following May or June. On July 24 I found on a large walnut, facing the residence of Hon. Thomas Dudley, a fine Luna larva. Carefully placing it in my larva box I conveyed it home, and in two days after it spun its cocoon and on August 12 emerged as a moth, a fine male specimen. Not having any female specimen my investigation was brought to a stop, but on looking over my notes I find that on several occasions I have taken the moth during May and



during August as follows: August 18, 1874, three specimens at Cheyney, Pa.; July 29, 1877, one specimen at Plymouth, Ind.; August 27, one specimen at Moorestown, N. J., and on August 28, 1882, one specimen at Fairmount Park, Philadelphia. Of larvæ, the above mentioned July 24, and from September 19 until my last capture (October 10) from five to ten specimens a day, all spinning from two to three days after capture. Now, from my finding the moth in May and August and the larva in July, September, and October, proves to my mind that in this city and county and elsewhere Luna has two-broods instead of one.

#### 8. *Citheronia regalis* (Fabr.).

As early as July 20, 1832, Dr. Harris found on the black walnut a freshly hatched larva of this regal moth, and a few years later, on the 4th or 5th of August, he discovered two large flattened eggs from which similar larvæ were at that time hatched.

*Larva before the first molt.*—Each of the segments has six branching spines, except the eleventh, which has seven, and the twelfth, which has eleven. Body, first segment with four tubercles of a pyramidal shape, the two dorsal ones armed with a barbed spine, terminated by a ball with two lateral obtuse points, the two lateral tubercles with simple barbed spines not half the length of the dorsal spines; second and third segments each with four barbed ball-terminated spines; lateral simple ones wanting; remaining segments, except the last, with four barbed or branched spines; the penultimate segment has, besides, in front of the four, a long dorsal one barbed, and ending in a lunated knob; last segment with nine in two series, five before and four behind, all branched; the dorsal one of the anterior series bifurcated at tip, or nearly lunated. Color of body black above and beneath; an obsolete series of ferruginous lateral lines directed obliquely downward towards the tail, most conspicuous on the posterior half of the body; sixth and seventh segments ferruginous above; spines pale ferruginous, black at tip. July 21, a. m., it cast off its skin. July 25, cast its skin again.

*Pupa.*—Male: Smooth, oblong, robust, thick and rounded before, nearly obtuse behind, and terminating in a very small bifid tubercle. A few elevated points at the base of the antennæ cases, and over the shoulder covers; likewise one on each half of the prothorax; metathorax with two large transverse elevations. A deep furrow between the penultimate (eleventh) and antepenultimate segments, and an elevated ridge beset with minute teeth on the anterior part of the eleventh dorsal segment. Near the anterior edges of the other abdominal segments there is a row of very minute and nearly obsolete teeth pointing backwards. Color, dark chestnut brown. Length, 2 inches. Breadth, nearly  $\frac{3}{4}$  inch. (Harris' Corr., 297.)

*The Moth.*—One of our largest Bombyces, the fore wings expanding from 13 to 14 centimeters (about 6 inches.) Ground color, a leaden reddish brown, marked with bright brick-red and ochereous yellow. Fore wings with a basal yellow spot, a discal blotch, and an outer submarginal row of oval spots, there being two large ones near the costa, and one usually about half as large in the first median interspace. The veins shaded with brick-red. Hind wings yellowish along the costa, elsewhere reddish, with leaden oval spots in the interspaces. Thorax with two broad yellow longitudinal stripes, and between them a linear median stripe. On the first abdominal segment a transverse oblong yellow spot. The sutures of the abdominal segments ochre-yellow.

#### 9. *Catocala elonympha* (Hübner).

The caterpillar of this moth is said by some to feed on the walnut, by others on a species of Glycine. The larva as described by Guenée from Abbot's drawing is gray white, with a roseate tint; without fringes;

variously marked with brown, and with a substigmatal brown line; the back of the caterpillar remains hunched in repose.

*Moth.*—Thorax light gray, with a yellowish tinge; abdomen with the yellowish more marked; fore-wings with the lines distinct, basal space dark, beyond the transverse anterior-line light gray often almost white to the reniform spot, beyond dark gray; reniform spot distinct, the subreniform obsolete **M** of transverse posterior line hardly suggested; subterminal white line distinct. Hind wings rather dull yellow, median band wanting, marginal band broad, indistinct, but even on the inner margin, extending to the anal margin. Beneath, wings dull, indistinct, yellowish, fore-wings with the reniform spot black; beyond, an even, narrow, curved black line, also a broad marginal line; hind wings with discal spot, and three even curved bands, two inner and narrow, one marginal and broad. Expands 40 to 45<sup>mm</sup>. Habitat Eastern and Southern States. (Hulst.)

#### 10. *Catocala innubens* Guenée.

The caterpillar is said by Mr. Hulst to feed on the walnut.

*Moth.*—Fore-wings rich brown, powdered with glaucous scales; lines distinct, black; **M** of transverse posterior line strong; teeth broad, even; reniform spot brown, annulate with pale white; subreniform spot pale, often nearly white, small; at the apex resting in the costa is a large triangular whitish spot. Hind wings reddish orange; median band rather broad, quite even. Expands 65 to 70<sup>mm</sup>. Habitat Eastern, Middle and Western States. (Hulst.)

*C. hindia* has broad, darker brown shading from base to apex.

Var. *flavidalis* Grote has yellow hind wings.

Var. *scintillans* G. & R. has very dark nearly black fore-wings, uniform to the transverse posterior line.

#### 11. *Catocala paleogama* Guenée.

The caterpillar closely resembles that of *C. neogama*, according to Mr. Hulst.

*Moth.*—Fore-wings gray, powdered with greenish gray and black scales, and shaded with blackish, and with bright brown in the subterminal space; lines rather broad, distinct; reniform spot rounded, brown or black, indistinct; subreniform spot pale, small; sinus of transverse posterior line broadly marked, acute, not deep; teeth of **M** strong. Hind wings dark yellow; median band narrow, much constricted, reaching the internal margin. Expands 70 to 75<sup>mm</sup>. Habitat, Eastern, Middle, and Western States.

Var. *phalanga* Grote. Fore-wings with the basal space black, a black band beyond the transverse posterior line, the rest light gray. (Hulst.)

#### 12. *Catocala neogama* (Abbot and Smith).

The caterpillar is said by Guenée to feed on the walnut; it is of a brownish gray color, formed by many longitudinal striæ on a light ground; the piliferous points separate as is usual.

*Moth.*—Fore-wings light gray, marked within the transverse anterior line, at the reniform spot, and beyond the transverse posterior line with light brown; all the lines evident, but not always distinct; **M** of transverse posterior line produced, sinus large; basal and subapical dashes generally present. Hind wings yellow, the median band constricted and angulated. Expands 75 to 90<sup>mm</sup>. Habitat, east of Rocky Mountains and Arizona. *C. communis* has the hind wings a little darker yellow than the type form.

Var. *snoviana* Grote was described from an aberrant and somewhat aborted specimen from Kansas, with fore-wings much more heavily marked with black. It is with great hesitancy that I regard this as a variety. (Hulst.)

13. *Catocala subnata* Grote.

This is said by Mr. Angus to feed on the walnut. The moth is very much like *C. neogama*, but generally larger, with the lines and markings more diffuse, and the teeth of the **M** of the transverse posterior line very strongly produced. It expands from 95 to 105<sup>mm</sup>, though in one case only 70<sup>mm</sup>. Mr. Hulst doubts whether this be distinct from *C. neogama*.

14. *Catocala piatrix* Grote.

Mr. Koebele finds that the caterpillar feeds on the walnut, hickory, and persimmon.

*Moth*.—Fore-wings dark wood-brown, or blackish brown, slightly silky, darker shaded in the sub-basal space on the costa, above the discal cell, and subapically; the transverse anterior line geminate, the outer line sometimes less distinct; the reniform spot shaded with black; the subreniform pale; transverse posterior line with the **M** prominent, and sinus heavy; subterminal line geminate with grayish between. Hind wings deep yellow, internal margin and base dusky; median band not much constricted. Expands 85 to 95<sup>mm</sup>. Eastern United States. (Hulst.)

15. *Catocala mæstuosa* Hulst.

This is said by Mr. Hulst to feed on the walnut, but there is no description of the caterpillar.

*Moth*.—Fore-wings very nearly the color of *C. vidua* (p. 178); lines diffuse, not strongly distinct; transverse posterior line with the **M** strongly marked; sinus comparatively small; no basal dash; reniform spot reddish; a reddish band beyond the transverse-posterior line; transverse-anterior line clouded with black at the costa, and a heavy diffuse black shade from the costa above the reniform through the **M** of the transverse-posterior line to below the apex. Hind wings black, dull gray at base; fringe white, ends of the veins black. Expands 95 to 105<sup>mm</sup>. Southern States. (Hulst.)

16. *Geometrid caterpillar*.

This caterpillar was observed on a walnut at Brunswick, Me., August 20. It died in confinement. In this larva on the abdominal segments (except the eighth where they are transverse) there are four dark glassy bottle-green piliferous dorsal spots, arranged in a short square. On the first abdominal segment they are of equal size, but the two hinder ones are on a slight transverse ridge, the ridge being enlarged under the tubercles. On the second abdominal segment the two hinder piliferous warts are no larger than the anterior, but are situated on a large conspicuous saddle-shaped transverse hump, which is swollen at the origin of each tubercle. The caterpillar is further adapted for protection from its resemblance to a walnut twig by being deeply notched, each notch like a leaf-scar on the twig.

In *Caripeta angustiorata* of the pine, the transverse posterior, saddle-shaped ridges bear two posterior piliferous warts. They have a decided resemblance to the leaf-scars on the redder parts of the twig, which in its ground color the caterpillar mimics. I have observed that this and

the other twig-mimickers do not live among the denser leaves, but at the end of the twig.

*Larva*.—Head as wide as the body, deeply cleft and flattened in front. On each side of the mesothoracic segment is a large prominent tubercle; on second abdominal segment is a double dorsal tubercle; a transverse series of four sharp piliferous tubercles. Supra-anal plate large, broad, flat, triangular, but rather short and blunt at the tip; six piliferous warts on the edge; surface of the body closely granulated. Color of a uniform mottled gray, like the bark of the twig it inhabits, with a conspicuous dorsal black line extending from the mesothoracic segment to the base of the supra-anal plate. On the sides low down between the first and anal legs is a fringe of woolly, somewhat fleshy filaments. A pair of dorsal black dots on the back part of each abdominal segment. Length, 40<sup>mm</sup>.

17. *Acrobasis (Phycita) juglandis* Le Baron.

Dr. Le Baron in his account of this Phycid states that it lives both upon the hickory and black walnut. (See Hickory inshets, p. 311.)

18. *Lithocolletis juglandiella* Clem.

The larva makes an elongated, rather wide tract on the upper surface of the leaves of black walnut, without folding the leaf, and may be found from the beginning to the middle of the month.

It belongs to the second larval group described in the Proceedings of the Academy of Natural Sciences of Philadelphia, November, 1859, and may not be specifically distinct from *L. caryæfoliella*, described on page 315. (Clemens.)

*Larva*.—It is blackish or blackish brown, with a few pale-brownish dots on each side of the thoracic segments, and with the tip of the abdomen and head pale brown. (Clemens.)

19. *Nepticula juglandifoliella* Clem.

The larva mines the leaves of black walnut from the latter part of July to the middle of August. The mine is a very narrow, whitish tract, very often recurved and slightly tortuous, somewhat, although slightly, enlarged at its end, with a very narrow central line of "frass."

"I found a single specimen on the 27th of last August, when the mines appear to be usually untenanted, and, very oddly, it escaped from its mine as I held the leaf, whilst looking unsuccessfully for another specimen." (Clemens.)

*Larva*.—The larva is pale green, almost whitish, rather thick and resembling a Dipteron. (Clemens.)

20. *Gracilaria blandella* Clemens.

The caterpillar when small lives in a linear whitish mine in the upper surface of the leaves, afterwards feeding and pupating under the turned-down edge.

21. *Gracilaria juglandinigrælla* Chambers.

The larva at first mines the leaves beneath, afterwards feeding and pupating under the turned-up edge.

22. *Aspidisca juglandiella* Chambers.

The larva lives in a very small blotch-mine, from which it cuts out a case in which it pupates.

## 23. THE RED-TAILED ATTELABUS.

*Attelabus analis* Weber.

Order COLEOPTERA; family CURCULIONIDÆ.

Rolling up the leaves of the oak and black walnut, a weevil a quarter of an inch long, with a long, slender, cylindrical head and short, broad, thick body. The antennæ, legs, and middle of the breast deep blue-black; the thorax, wing-covers, and abdomen dull red; the wing covers, taken together, nearly square and pitted in rows.

According to Harris, this pretty weevil is found on the leaves of oak trees in June and July. Mr. George Hunt has observed it on the walnut in May before the buds open, at Providence. It is possible that Fig. 65, p. 204, represents the work of this species.

24. *Conotrachelus juglandis* Le Conte.

The larva of this weevil, which is closely allied to that of the plum weevil, was taken from walnuts at Mount Carmel, Ill., by Mr. Shimer. According to Harris, Mr. Say, in a note on the plum weevil, stated that his "kinsman, the late excellent William Bartram, informed him it also destroys the English walnut in this country." It is possible that the insect here referred to was confounded with the plum weevil and belongs to the present species.

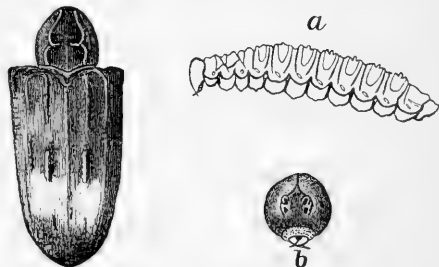


FIG. 125.—*Conotrachelus juglandis*; a, larva; b, head seen in front. Gissler, del.

## THE ENGLISH WALNUT SCALE.

25. *Aspidiotus juglans regis* Comstock.

The following account of this insect is taken from Prof. Comstock's report as Entomologist in the U. S. Agricultural Report for 1880:

*Scale of the female.*—The scale of the female is circular, flat, with the exuvie laterad of the center; it is of a pale grayish brown color; the exuvie are covered with secretion; the position of the first skin is indicated by a prominence which is pink or reddish brown. The ventral scale is a mere film which adheres to the bark. Diameter of scale, 3<sup>mm</sup> (.13 inch).

*Female.*—The color of the female when fully grown is pale yellow with irregular orange-colored spots; oval setæ and last segment dark yellow. This segment presents the following characters: There are either four or five groups of spinnerets; the anterior group is wanting or consists of from one to four spinnerets, the anterior

laterals consist of from seven to sixteen, and the posterior laterals of from four to eight.

There are two or three pairs of *lobes*. The median lobes are well developed, but vary in outline; the second lobe of each side is less than one-half as large as the median lobes, elongated, and with one or two notches on the lateral margin; the third lobe is still smaller and pointed, or is obsolete.

There are two pairs of incisions of the margin, one between the first and second lobes of each side, and one between the second and third lobes; they are small, but are rendered conspicuous by the thickenings of the body wall bounding them.

The *plates* are simple, inconspicuous, and resemble the spines in form. The larger ones are situated one caudad of each incision.

The *spines* are prominent, especially those laterad of the second and third lobes; the fourth spines are a little nearer the first lobes than the penultimate segment, and the fifth are near the penultimate segment; there is also a spine at or near the union of the last two segments.

*Scale of male*.—The scale of the male resembles that of the female in color; it is elongated, with the larval skin near the anterior end; this skin is covered by excretion, but its position is marked by a rose-colored prominence, as in the scale of the female; the anterior part of the scale is much more convex than the posterior prolongation, which is flattened. There is a rudimentary ventral scale in the form of two narrow longitudinal plates, one on each side of the lower surface of the scale. Length, 1.25<sup>mm</sup> (.05 inch).

*Habitat*.—On the bark of the larger limbs of English walnut (*Juglans regia*), at Los Angeles, Cal. Described from sixty-three females; and many scales of each sex.

There are in the collection of the department specimens of *Aspidiotus* from locust, pear and cherry, from New York and District of Columbia, which apparently belong to this species. (Comstock.)

The following insects also occur on the black walnut:

26. *Thecla calanus* Hübn. On *Juglans cinerea*.
27. *Halesidota maculata* Harris. (Harris's Ins.)
28. *Halesidota tessellata* A. and S. (Beutenmüller.)
29. *Orgyia leucostigma* A. and S. (Beutenmüller.)
30. *Parorgyia cinnamomea* G. & R. (Beutenmüller.)
31. *Limacodes scapha* Harris. (Beutenmüller.)
32. *Halesidota caryæ* Harr. (Beutenmüller.)
33. *Datana angusii* Grote & Rob. (Grote & Rob.)
34. *Telea polyphemus* Linn. (D. S. Harris in letter; Riley's notes.)
35. *Heterocampa pulverea* G. & R. See Oak insects, p. 159.
36. *Apatela americana* (Thaxter, Papilio, iii, 17.)
37. *Apatela luteicoma* (Thaxter, Papilio, iii, 17.)
38. *Charadra propinquinella* Grote. See p. 167.
39. *Catocala vidua* Abbott and Smith.
40. *Catocala lacrymosa* Guen. probably. See p. 178.
41. *Eugonia alniaria* Hübner.
42. *Tortrix rileyana* Grote.

#### HEMIPTERA.

43. *Schizoneura caryæ* (Fitch.)
44. *Callipterus caryæ* Monell.

## INSECTS INJURIOUS TO THE BUTTERNUT.

*(Juglans cinerea.)*

## AFFECTING THE TRUNK AND LIMBS.

## 1. THE SPOTTED LEPTOSTYLUS

*Leptostylus macula* (Say.)

Order COLEOPTERA; family CERAMBYCIDÆ.

Under the bark of old decaying trees, a longicorn larva, changing to a pupa in its cell and early in July giving out a small thick long-horned beetle of a brown or chestnut color with the sides of its thorax and a band on its wing-covers ash-gray, the latter sprinkled over with coarse punctures and large blackish dots, the thorax on each side of its disk with a black stripe interrupted in its middle. Length, 0.25 inch.

Dr. Fitch, in his third report, states that the bark of old trees will sometimes be found everywhere filled with these grubs, which in the month of June may be seen changed to short thick pale-yellow pupæ, with a few perfect insects that are newly hatched and have not yet left the tree. Mr. Harrington has taken specimens on the butternut, but not so frequently as on the bitter hickory.

2. *Gaurotes cyanipennis* Say.

This beetle was observed by Mr. F. B. Caulfield pairing and ovipositing on the butternut. (Can. Nat., xiii, p. 60.)

*The beetle.*—Black; antennæ and feet testaceous; elytra blue. Body black, tinged with cupreous, punctured; head densely punctured; a longitudinal, obsolete, impressed line; antennæ rather shorter than the body, testaceous; trophi piceous-yellow; thorax impunctured; an obtuse tubercle each side; scutel black; elytra violaceous blue; punctures numerous, small, profound; tip truncate; humerus rather prominent; feet testaceous. Length two-fifths of an inch nearly. In form of body, it very much resembles *Leptura collaris* and *L. virginea*, to which genus I would have referred it, but for the small thoracic tubercles. (Say.)

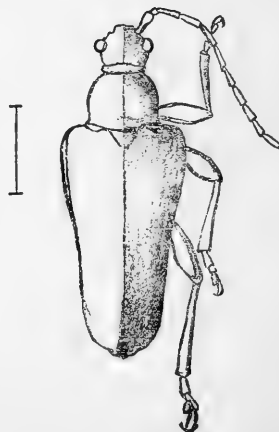


FIG. 126. *Gaurotes cyanipennis*.  
Smith and Marx, del.

3. *Cryptorhynchus parochus* Say.

Several larvæ and pupæ of this weevil have been found by Mr. F. G. Schaupp under the bark of a butternut in Brooklyn, L. I. The duration of the pupa state was from fourteen to sixteen days.

*Beetle.*—Brown variegated; tibiæ not angulated at base; thighs feebly bidentate; the teeth small and distant. Length 6 to 6.5<sup>mm</sup>. Claws simple, divergent. (LeConte.)

## 4. THE MUSCLE-SHAPED BUTTERNUT BARK-LOUSE.

*Aspidiotus (Mytilaspis) juglandis* Fitch.

Order HEMIPTERA ; family COCCIDÆ.

Fixed to the bark of the twigs, minute pale brownish scales, like those of the apple bark-louse, but smaller and not curved ; preyed upon by a minute chalcid fly. (Fitch.)

## 5. THE HEMISPHERICAL BUTTERNUT SCALE-INSECT.

*Lecanium juglandifex* Fitch.

Adhering to the bark on the under side of the limbs, a hemispherical dull yellowish or black scale about 0.22 inch long and 0.18 broad, notched at its hind end, frequently showing a paler stripe along its middle and a paler margin and transverse blackish bands. (Fitch.)

The males, according to Fitch, are long and narrow, delicate two-winged flies, measuring 0.05 inch to the tip of the abdomen and a third more to the ends of the wings. They are of a rusty reddish color, the thorax darker and the scutellum and head blackish, this last being separated from the body by a narrow pale-red neck. The antennæ are slender and thread-like, half as long as the body and eight-jointed. Two slender white bristles as long as the body are appended to the tip of the abdomen. This description will apply to most of the males of other species of *Lecanium*.

## AFFECTING THE LEAVES.

## 6. THE BUTTERNUT WOOLLY WORM.

*Selandria carya* Norton.

Order HYMENOPTERA ; family TENTHREDINIDÆ.

On the under side of the leaves companies of saw-fly larvæ covered with long dense snow-white wool standing up in flattened masses entirely concealing the green worm, eating the leaflets from the outer edge inward, often leaving nothing but the midribs.

These remarkable objects occasionally, though rarely, appear on the butternut in July. The worm presents the appearance (as described in

our "Guide to the Study of Insects," from which the following description and figures are taken) of an animated white woolly or cottony mass nearly an inch long and two-thirds as high. The head of the larva is rounded, pale whitish, and covered with a snow-white powdery secretion, with prominent black eyes. The body is cylindrical, with eight pairs of soft fleshy abdominal legs ; the segments are

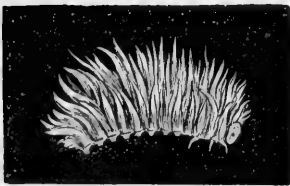


FIG. 127. The butternut woolly worm and the same deprived of its coat.—From Packard.

transversely wrinkled, pale pea-green, with a powdery secretion low down on the sides, but above and on the back arise long flattened masses



offlocculent matter (exactly resembling that produced by the woolly plant-lice and other homopterous insects), forming an irregular dense cottony mass, reaching to a height equal to two-thirds the length of the worm, and concealing the head and tail. On the 27th and 28th of July the larvæ molted, leaving the cast skins on the leaf. They were then naked, a little thicker than before, of a pale-green color, and their bodies were curled upon the leaf. The worms eat out the edge of the leaf. Some time during August two cocoons were spun between the leaves, but I did not succeed in raising the saw-flies. On describing the larvæ in a letter to Mr. E. Norton, our best authority on this hymenopterous family, he kindly sent me alcoholic specimens of the larvæ (without the woolly substance, which dissolves and disappears in alcohol) found feeding on the hickory, which are, apparently, from the comparison of alcoholic specimens, identical with the butternut *Selandria*. The adult fly he named *Selandria caryæ*, and his descriptions are given below.

Previously to this, and without my knowledge, Dr. Fitch, under the name of *Selandria? juglandis*, had apparently briefly described in his third report the same insect, but he was unacquainted with the perfect insect, and was in doubt as to whether the larva was a *Selandria* or not. Under these circumstances we retain Mr. Norton's name. From his account it would appear that the insect also feeds on the hickory (*Carya squamosa*).

*Female*.—Color shining black. The pro- and meso-thorax and scutellum rufous, the apex of the latter black; the nasus and legs white, with their tarsi blackish; the base of coxæ and a line down the upper side of the legs black. Antennæ short; the second joint as long as the first; the four final joints together not longer than the two preceding. Nasus slightly incurved. Claws of tarsi apparently bifid. Wings subviolaceous; lanceolate cell petiolate, the first submedian cell above it with a distinct cross-vein. Under wings with one submarginal middle cell (all other species have this cell discoidal), the marginal cell with a cross-nervure, and all the outer cells closed by an outer nervure, which does not touch the margin. The submedian cell extended nearly to the margin. Length, 0.25 of an inch. Expanse of wings, 0.40 of an inch.

*Male*.—Resembles the female, but the under wings are without middle cells.

*Larva*.—Feeds upon the leaves of the hickory (*Carya squamosa*). They are found upon the lower side of the leaf, sometimes fifteen or twenty upon one leaf, which they eat from the outer extremity inward, often leaving nothing but the strong midribs. They cover themselves wholly with white flocculent tufts, which are rubbed off on being touched, leaving a green twenty-two-legged worm, about 0.75 inch in length when fully grown; darkest above, and with indistinct blackish spots upon the sides. The head is white, with a small black dot upon each side. Specimens were taken upon the leaves July 4. Went into the ground about the 20th of July. The cocoon is formed near the surface of the ground of a little earth or sand drawn together. Four specimens came forth about August 22, all seemingly very small for so large larvæ. (Norton in Packard's Guide to the Study of Insects.)

7. *Smerinthus juglandis* (Abbot and Smith.)

(Larva, Plate XI, fig. 4.)

This caterpillar perhaps more commonly occurs on the walnut, but it also feeds on the hickory (*Carya alba*) and the iron-wood (*Ostrya virginica*).

As early as 1827 Harris found a larva on the black walnut. He says: "It is remarkable for the squeaking sound which it emits, apparently by rubbing the rings of the anterior part of the body together." This specimen entered the earth to pupate as early as August 7.

*Larva*.—Two inches long, .22 inch broad at the eighth segment, .14 inch at the first. Head large; longest diameter, twice that of the first segment; apex quite pointed; color light green, with white lateral granulations. Body elongated, slender, tapering gradually from the seventh segment to the extremities; light apple green, granulated regularly on the annulations with white. Lateral bands, seven, lighter green, approaching white, and made the more conspicuous from the increased size of the granulations toward the broadest part of the band, each annulation adding to it a single granulation; extending over two segments and nearly reaching to the vascular line. Caudal horn slender; .20 inch long, quite rough, with numerous acute granulations, which are more prominent than those of the body.

*Pupa*.—Male: 1.20 inches long, .40 inch broad. Dark brown, almost black, nearly plane ventrally, abruptly rounded anteriorly, and gradually posteriorly. Head-case with two conical, granulated, divergent projections between the bases of the antennæ-cases, and two pairs of smaller ones between the eye-cases, and a pair on the anterior leg-cases. Eye-cases with a tuberculated ridge. Antennæ-cases quite prominent, with a granulation on each joint. Tongue-case buried and not visible, the leg and wing cases meeting at their tips. Stigmata, except the first, which is nearly closed, quite oval. The seventh, eighth, and ninth segments with deep incisures, angulated posteriorly, acutely granulated, and encircled on their posterior margin with a row of spines, sub-obsolete inferiorly and superiorly. The tenth, eleventh, and twelfth segments contracted laterally and flattened inferiorly, the eleventh segment spined on the carination. The terminal segment ending in a broad, flat, rugose, truncate projection. (Lintner.)

*The moth*.—Differs from the other species in having no eye-like spots on the hind wings.

#### 8. THE VIRGINIA TIGER MOTH.

*Spilosoma virginica* (Fabricius).

Order LEPIDOPTERA; family BOMBYCIDÆ.

Occasionally devouring the leaves of the butternut, a very hairy, deep yellow caterpillar, with a black head and body, the latter mottled with black; changing to a thick chrysalis within a cocoon, where it remains until the following June, when it appears as a white moth.

This omnivorous caterpillar, commonly called "the yellow bear," is known to feed on the butternut, grape vine, currant, gooseberry, grasses, and various garden vegetables, and we have found it from the first to the middle of September in Maine feeding on the buckthorn and also the pitch-pine. According to Harris there seems to be two broods of caterpillars and two of the moths. The caterpillars, he states, "are to be found of different ages and sizes from the first of June till October. When fully grown they are about 2 inches long, and then creep into some convenient place of shelter, make their cocoons, in which they remain in the chrysalis state during the winter, and are changed to moths in the months of May or June following. Some of the first broods of these caterpillars appear to come to their growth early in summer, and are transformed to moths by the end of July or the begin-

ning of August, at which time I have repeatedly taken them in the winged state; but the greater part pass through their last change in June." I have observed the full-grown caterpillar at Brunswick, Me.,

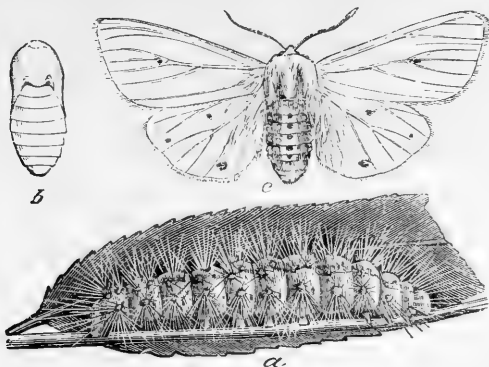


FIG. 128.—c, Virginia tiger-moth; a, its caterpillar; b, chrysalis, all nat. size.—After Riley.

the first and second weeks in August; they spin from the middle of August till September. The following description of the caterpillar is taken from my notes:

*The caterpillar.*—Head of moderate size; body cylindrical, rather short and not very convex; each segment with four tubercles above, two smaller median ones being situated in front of and between two latero-dorsal larger ones; three tubercles on each side of each segment, all giving rise to dense verticils of long, uneven fox-yellow hairs; most of the hairs as long as the body is thick, while others on the back are twice as long, so that in outline the larva is an elongated ellipse, the head and tail being alike concealed by the spreading hairs. The body and head is black or yellowish mottled with black. The hairs are tawny yellow, while the short hairs on the sides of the thoracic rings are black.

*The moth.*—Snow white, with a black dot in the middle of the fore-wings and two on the hind wings; a row of black spots along the back of the abdomen and a row along the sides; between the latter dots a longitudinal deep yellow stripe; the basal joints of the fore-legs are yellow. The wings expand about 2 inches. The eggs are said by Harris to be golden yellow, and to be laid in patches on the leaves of plants.

#### 9. *Paria aterrima*. (Olivier.)

This insect in the imago state, Mr. W. L. Devereaux, of Clyde, N. Y., writes us, "preys upon the foliage and flower-buds of the butternut." Mr. Chittenden also writes to the same effect.

#### 10. THE TWO-MARKED TREE-HOPPER.

*Euchenopa binotata* Say.

Order HEMIPTERA; family MEMBRACIDÆ.

Puncturing the leaves and extracting their juices from July till the end of the season, a small rusty brown or black tree-hopper, with two bright pale yellow spots upon its back, which part is prolonged forward and upward into a compressed horn rounded at its tip and giving the insect a resemblance to a little bird with an out-stretched neck, and the four forward shanks broad, thin, and leaf-like. Length, .25 to .30 inch. (Fitch.)

## 11. THE BUTTERNUT TREE-HOPPER.

*Ophiderma mera* Say.

Belonging to the same family as the preceding, a greenish-gray tree-hopper, shaped like a half cone, with its apex bright chestnut red, and behind its middle a black band which is sometimes interrupted on the summit of the back, and with a blackish spot on the tips of the hyaline fore-wings. Length, .36 inch. (Fitch.)

## 12. THE OBTUSE CLASTOPTERA.

*Clastoptera obtusa* Say.

A short thick almost circular leaf-hopper of a gray color, with fine transverse wrinkles and three brown bands anteriorly, its fore-wings clouded with tawny brown, with streaks of white and a coal-black spot near their tips. Length, .22 inch. (Fitch.)

## 13. THE BUTTERNUT TINGIS.

*Corythaca arcuata* (Say). (*Tingis juglandis* Fitch.)

Puncturing the leaves and sucking their juices, a small singular bug, resembling a flake of white froth, its whole upper surface composed of a net-work of small cells, an inflated egg-shaped protuberance like a little bladder on the top of the thorax and head, the sides of the thorax and of the fore-wings, except at their tips, minutely spinulose; the fore-wings flat and square, with their corners rounded, a large brown or blackish spot on the shoulder, and a broad band of the same color on their tips, with an irregular whitish hyaline spot on the inner hind corner; the body beneath small and black, the antennæ and legs honey-yellow. Length, .14 inch. (Fitch.)

Fitch remarks that this insect becomes common on the leaves of the butternut in May, and continues through the summer and autumn. It may sometimes be met with also on birch, on willows, and other trees.

The following insects also occasionally live on the butternut :

## LEPIDOPTERA.

14. *Halesidota caryæ* Harr., Brunswick, Me.; New York. (Beutenmüller.)
15. *Orgyia leucostigma* Abbot and Smith.
16. *Hyphantria cunea* Abbot and Smith. (See p. 244.)
17. *Actias luna* (Linn). (See p. 330.)
18. *Platysamia cecropia* (Linn).
19. *Telea polyphemus* (Linn). (See pp. 161, 300.) (Riley's notes.)
20. *Datana ministra* (Drury). (See p. 302.)
21. *Grapholitha caryæ* (Shimer).
22. *Lithocolletis caryæfoliella* Clem.

## COLEOPTERA.

23. *Cyllene pictus* (Drury). (See p. 287.)
24. *Stenoscelis brevis* (Boh.). Breeding in wood. (Chittenden in letter.)
25. *Eugnampthus augustatus* (Hbst.) Beaten from trees. (Chittenden.)
26. *Eugnampthus collaris* (Lec.). Beaten from trees. (Chittenden.)
27. *Magdalis salicis*. Bred from wood. (Chittenden.)
28. *Paria canella* and vars. Feeding on leaves. (Chittenden.)
29. *Cryptorhynchus parochus* (Herbst). Several example staken on the trunk of a butternut. (Chittenden.)

## INSECTS INJURIOUS TO THE CHESTNUT.

*(Castanea vesca.)*

## AFFECTING THE TRUNK AND LIMBS.

## 1. THE CHESTNUT TREE BORER.

Making a zigzag burrow under the bark, and sometimes descending nearly 2 inches towards the heart of the tree where it may spend the winter, a longicorn larva nearly three-fourths of an inch long, dirty white, of much the appearance of the hickory or locust tree borer, and transforming in its chamber into the beetle state.

Although the chestnut has been supposed to be remarkably free from borers, we have found that in Rhode Island the trunks are quite liable to the attacks of a borer, which we have not yet traced to the beetle, but which will probably prove to be the species next mentioned (*Arhopalus fulminans*), since this beetle, which is known to inhabit the chestnut, is closely allied to the locust borer in its form, while the larva is also closely like that of *Cyllene picta* and the different species of *Clytus* and its allies. The burrows in outline are flattened, cylindrical, being adapted to the broad flattened front part of the body of the larva. The burrows begin as small zigzag galleries about a line in width and 4 inches long, making about three turns at nearly right angles in this space; they are filled with the castings of the worm; as the larva grows larger it sinks deep in towards the heart of the tree, when the burrow in the deepest part becomes packed with large, long, curved chips, apparently bitten off by the grub for the purpose of forming a chamber, the partition of chips possibly serving to keep out the cold during its winter's sleep.

## 2. THE BROWN CHESTNUT BEETLE.

*Arhopalus fulminans* (Fabricius).

Order COLEOPTERA; family CERAMBYCIDÆ.

Boring into the trunk, a grub like the foregoing, if not the same insect, which transforms into a dark-brown beetle with dark-blue reflections, and the wing-covers crossed by four zigzag fine gray lines.

The following notice of this beetle is taken from my Second Report on the Injurious insects of Massachusetts (1872):

My attention has been called by Mr. R. B. Grover, a student in the State Agricultural College, to the fact that the *Arhopalus fulminans* Fabr. (Fig. 129, enlarged twice), one of the family of longicorn beetles, bores in the trunk. I know nothing further concerning its habits nor of the appearance of its grub. The beetle itself is blackish brown, with slight dark-blue reflections; the legs and antennæ are of the same color, the latter being scarcely longer than its body. The top of the head



FIG. 129.—Chestnut Borer.—From Packard.

and the sides of the prothorax and under side of the body are covered with a pale gray pile, while certain silver markings on the wing-covers are composed of similar

close-set fine hairs. The hairs on the sides of the prothorax inclose a conspicuous black spot, while the top is black, and more coarsely punctate than the wing-covers. The latter are each crossed by four acutely zigzag lines, composed of microscopic hairs, forming **W**-like bands on the elytra, the basal lines being less distinctly marked than the others. The ends of the wing-covers are also tipped with gray, especially on the inner side of the end. The legs are pitchy brown with light hairs, and with a reddish tinge on the terminal joints (tarsi). It is a little over half an inch long.

### 3. THE NOBLE CLYTUS BORER.

*Calloides nobilis* (Say).

A longicorn borer, probably depredating upon the chestnut, and transforming to a large, handsome, black-brown beetle, nearly an inch long, marked with three broken yellow lines and a pair of large round yellow dots on the wing-covers.

Mr. George Hunt informs us that he has found this noble Clytus under the bark of the chestnut at Providence; hence it occurs as a borer of this tree. Its food-tree has not heretofore been known.

### 4. THE TWO-TOOTHED SILVANUS.

*Silvanus bidentatus* (Fabricius).

Order COLEOPTERA; family ATOMARIIDÆ.

Under the bark of logs and decaying trees, probably loosening the bark from the wood, a minute, narrow, flattened beetle, of a light chestnut brown or rust-color, its thorax longer than wide, slightly narrowed towards its base and with a small tooth projecting outwards at each of its anterior angles. Length, .10 to .12 inch. (Fitch.)

Fitch observes that this is an European insect, which, like a kindred species, the Surinam Silvanus, has now become perfectly naturalized and as common throughout the United States as it is in its native haunts. On stripping the bark from recently cut logs of chestnut and of oak, this minute beetle, which is so flattened and thin that it can creep into the slightest crevices, will be found frequently in considerable numbers.

*The beetle.*—The head and thorax often of a darker shade than the wing-covers; the latter with rows of close punctures with a slightly elevated line between each alternate row. Its thorax also is densely and confluent punctured, and commonly shows a very faint elevated longitudinal line in its center. The angles at its base on each side are obtuse, and from these angles forward to the projecting tooth the lateral edges are crenate-dentate, having sixteen little elevated tubercles or minute teeth jutting out at equal distances along the margin. The point of the large anterior tooth forms a right angle. Upon each side of the head behind the eye is also a minute tooth of the same size with those along the sides of the thorax. The surface is slightly clothed with minute inclined bristles. (Fitch.)

### AFFECTING THE LEAVES.

#### 5. THE NOTCHED-WINGED GEOMETER MOTH.

*Eugonia alniaria* Hübner.

Order LEPIDOPTERA; family PHALENIDÆ.

Feeding on the chestnut, a bluish-green caterpillar, with wrinkles, and on the eleventh segment two little warts tipped with brown; transforming to a light ochre-yellow moth with wings deeply notched.

This caterpillar was found by Mr. L. W. Goodell on the chestnut at Amherst, Mass., August 20; on the 21st it drew a few leaves together, and spun a thin, silky, pear-shaped cocoon; became a chrysalis the 24th, and was transformed to a moth September 13.

*Larva*.—Body 2.3 inches long, the body largest near the tail, and tapering to the head; bluish green, with a thick wrinkle on each ring, those on the fifth and eighth thickest and light brown; on the back of the eleventh ring two little warts tipped with brown. (L. W. Goodell.)

*Pupa*.—One and two-tenths inches in length, bluish white, ending in a flattened tail, tipped with black, and on each edge three small black spines, each ending with a minute hook. (Goodell.)

*Moth*.—Short bodied, quite hairy; male antennæ heavily pectinated, wings deeply scalloped; delicate ochre-yellow, with a reddish tinge towards the edge of the wings, and on the head and front of the thorax. Fore-wings with two lines, often interrupted, or only developed on the costa; inner line on the inner third of the wing; the curved outer line, beginning near the inner, diverges and follows a sinuate course, ending much nearer the apex than the inner line, the distance varying; both wings speckled, sometimes thickly, with unusually large spots; outer edge of both wings deeply excavated, especially opposite the second median venule. Hind wings with no lines, only an obscure discal dot. Expanse of wings, 2.2 inches.

This moth ranges from Maine to Missouri. The larva is also described by Mr. S. H. Scudder as living on the black birch. Mrs. Dimmock has published the following account of this insect in *Psyche*, iv, p. 272.

*Eugonia alniaria* Linn. (Syst. Nat., 1758, ed. 10, p. 19) [= *E. magnaria* Guenée]. The eggs of this species are flattened, oblong, 1.1<sup>mm</sup> long, .6<sup>mm</sup> wide, and .5<sup>mm</sup> high. They are of a greenish-brown, somewhat polished bronze color, and when laid upon a smooth surface are arranged side by side in a curve having the length of the abdomen of the female moth for its radius. When laid upon bark and rough surfaces the eggs are in broken, short rows. A single female deposits 500 to 600 eggs. Oviposition takes place in September and October, and the eggs hatch in May and June, hibernation taking place in the egg state, as is the case with some other species of *Geometridæ*. Hellins (*Entom. Mo. Mag.*, March, 1870, vol. vi, p. 222) gives similar dates for oviposition and hatching in England. The larva and pupa are described by Herr (Anleitung d. Raupen d. deutschen Schmett., 1833, p. 258) who enumerates the following food-plants: *Betula*, *Alnus*, *Corylus avellana*, *Carpinus*, *Betulus*, *Ulmus*, apple, pear, stone fruit, and *Tilia*. Herold (*Deutscher Raupenkalender*, 1845, p. 135) gives *Fagus* in addition to the above-mentioned trees. Harris (*Entom. Corresp.*, 1869, p. 320) gives notes on different stages of this species. Kaltenbach (*Pflanzenfeinde*, 1872, pp. 89, 218, and 552) adds *Acer*, *Rosa*, and *Populus* as food-plants. Lintner (*Entom. Contrib.*, No. 3, 1874, p. 165), in a note on *Eugonia magnaria* gives *Syringa vulgaris* as food-plant. Packard (*Mon. Geom. Moths*, 1876, p. 530) quotes descriptions of larva and pupa by Goodell and by Scudder; the former entomologist gives *Castanea vesca*, and the latter *Betula lenta* as food-plant. Rouast (*Annales Soc. Linn. de Lyon*, ann., 1882, [1883], vol. xxix, p. 340) adds *Quercus robur* to the food-plants. Packard (*Bull. No. 7, U. S. Entom. Comm.*, 1881, p. 92) repeats Goodell's description of the larva and pupa, adds one of the moth, and further remarks that Scudder's description "is so different from Mr. Goodell's that I fear it refers to a different insect." This is not, however, the case, but the larva is very variable in coloration. Worthington (*Can. Entom.*, January, 1878, vol. x, p. 16) writes: "This larva evidently changes its color somewhat with different food, as these [larvæ] closely resemble the bark of this tree [maple]." The general coloration may vary to match that of the bark of the tree on which the larvæ feed, but the head, which is the part of the larva that varies most, is slate gray, green, or dull red, in specimens taken

from maple. These larvæ, having molted at least four (probably five) times, pupate from the latter part of July to the end of September; the pupal state lasts from eighteen to twenty days, the imagos flying from the middle of September until the last of October in New England. The larvæ are not rare upon *Betula alba* and *B. lutea*.

#### 6. THE SILVER SPOTTED HEPIALUS.

*Hepialus argenteomaculatus* Harris.

Mr. S. Lowell Elliott has made the interesting discovery that this fine insect during its larval state probably bores into the trunks of the chestnut, as he took the chrysalis from a chestnut stump, in June, on Long Island.

We have in the United States twenty-five described species of *Hepialus*, some of which are undoubtedly synonyms, as pointed out to us by Mr. Henry Edwards. But of the larval habits of these, say twenty species, nothing is known. In Europe the *Hepialus hamali* bores in the roots of the hop vine. Judging by the frequency with which our *Hepialus mustelinus* occurs as a moth resting on the trunk and branches of the spruce, growing amid ferns, I am inclined to think that we may possibly find the larva boring in the roots of ferns growing in spruce woods.

So far as I have been able to ascertain the larvæ of the European species of *Hepialus* feed on the roots of herbaceous plants; thus, according to Stainton, the larva of *Hepialus hectus* "feeds on the leaves of the dandelion;" that of *H. lupulinus* "on the roots of herbaceous plants;" that of *H. humuli* is found "at the roots of hop, burdock, nettle, etc.;" *H. velleda* feeds on the roots of the common fern (*Pteris aquilina*), while the larva of *H. sylvinus* is unknown.

Harris states that the empty pupa skins of this or of an allied species are sometimes found on our sea-beaches.

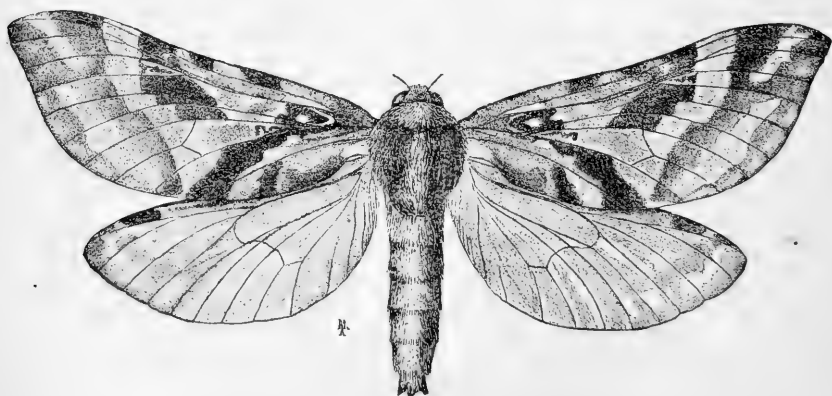


FIG. 130. *Hepialus argenteomaculatus* —Marx del.

*Moth.*—The body is light brown; the fore-wings are of a very pale ashen brown color, variegated with darker clouds and oblique wavy bands, and are ornamented with two silvery white spots near the base, at the inner angles of the discoidal cells;



the anterior spot being round and the posterior and larger one triangular. The hind wings are light ashen brown at base, passing into dusky ocher-yellow. The large specimen is a female, and was taken by Professor Agassiz on the northern shore of Lake Superior. The body is of a dusky ocher-yellow color, tinged on the sides and on the legs with red. The fore-wings are light rosy buff, with brownish ocher clouds and bands, two silvery spots near the base and a whitish dot near the tip. The hind wings above and all the wings beneath, are of a deep ocher-yellow color tinged with red. (Harris.)

7. *Tetracis crocallata* Guenée.

This moth has been raised from a caterpillar found feeding on the chestnut by Mr. L. W. Goodell, at Amherst, Mass. It became a pupa July 15, within leaves drawn together with a few threads. (Canadian Entomologist, xi, 193, 1879.)

*Larva*.—Mature larva, one specimen. Head brown, much narrower than the body; two large dark brown spots in front. Body stout and very slightly attenuated anteriorly, the first and second rings much narrower than the rest and retractile into the third. About a dozen minute black tubercles on each ring. Reddish brown covered with numerous wavy hair lines; paler beneath with a large dirty brown patch inclosing two light brown spots on the sixth and seventh rings. Length when at rest, 23<sup>mm</sup>; when crawling, 28<sup>mm</sup>.

*Pupa*.—Length 17<sup>mm</sup>; ashen gray, tinged with reddish and speckled with brown; a brown dorsal stripe, obsolete on the abdominal segments. Thorax paler with a small dorsal brown spot. Head brown, with a vertical red streak. Abdomen dark brown beneath speckled with reddish, the anal segments with a transverse dark brown dash above. Wings pearly ash with a submarginal row of seven brown spots. Caudal spine round, with two long hooked forks; four slender bristles at the base, two above and two beneath, very much hooked at the tips. (Goodell.)

*Moth*.—In this species the male antennæ are simple, and the wings slightly bent on the outer margin. It may be readily recognized by its uniformly bright ocher-yellow body and wings. A broad oblique coffee-brown band on the fore-wings, extending from just beyond the middle of the outer edge to the apex; discal dot not large, but distinct on each wing. On the hind wings, a single straight line, not reaching the costa; sometimes this line is wanting. Expanse of wings 1.75 inches.

8. *Endropia obtusaria* Guén.

The caterpillar of this fine moth was found June 10 at Providence, and June 19 spun a loose, slight, thin cocoon in a partially rolled-up leaf, transforming June 20 to a pupa. The moth was observed after it had emerged, but flew away, though not till after I had assured myself that it was most probably if not certainly *E. obtusaria* of the chocolate variety. Abbot's larva of *E. obtusaria* lived on the touch-me-not (*Impatiens noli-me-tangere*).

*Larva*.—Head small, flattened, much narrower than the body; squarish, the sides being parallel. Dark slate brown, clypeus and adjoining region pale ash, forming a light triangular spot on the front of the head. Body increasing in width from the eighth abdominal segment to the head; marbled with dark livid slate-colored, wavy, broken, fine close-set lines. Supra-anal plate large, triangular; surface somewhat rough; four piliferous tubercles on the hinder edge or apex, and two behind the middle. A row of four to five small dark tubercles on the three thoracic segments, and four dorsal tubercles on each abdominal segment, those near the hinder edge of the first and fifth abdominal segment larger than the others, and connected by a ridge

which is interrupted in the middle of the body. Anal legs large and broad, with unusually large supra-anal piliferous tubercles. All the legs concolorous with the body; a flesh-colored patch beneath on the first abdominal segment. Length, 42<sup>mm</sup>.

*Imago*.—Quite uniformly chocolate brown or coffee-with-milk color. It is of the same size, and very nearly allied to *E. serrataria*, but is never so yellow, and the wings are less serrate. Certain females are uniformly pale ash-brown, others are yellowish-brown. Usually, however, in both sexes the wings are broadly margined with brown, with two or three black apical spots, and the discal dots are large and distinct. Expanse of wings, 1.60 to 1.80 inches.

9. *Limacodes viridus* Reakirt.

10. *Limacodes* sp.

This larva was observed at Providence September 18.

*Larva*.—Body broadly oval, the edge with a broad, thin margin, from which arises a raised central broad ridge, the surface of which is hollow, with the sides forming the ridges. The entire body is irregularly and coarsely wrinkled, with coarse granulations. The body is pale green, touched with yellow along the two dorsal ridges and along the edge. Along the middle of the back is a row of ten or eleven round yellow spots centered with a dark dot. A row of similar but larger, more diffuse, yellow dark-centered spots between the dorsal ridge and the edge of the body. Head, as usual, retracted within the prothoracic segment; three pairs of thoracic, but no abdominal feet. Length, 8.5<sup>mm</sup>; breadth, 5<sup>mm</sup>.

11. *Notodont?* sp.

This species, while occurring on the chestnut at Providence; in Maine, where this tree does not grow, lives at the expense of the oak.

*Larva*.—Head very large, very much wider than the body; broad and somewhat flat in front, swollen on the vertex; pale green; on the side is a bright, brick-red line edged on each side with straw yellow, which connects with a lateral line which incloses most of the spiracles and ends on the side of the supra-anal plate. A reddish line above, in the middle of the supra-anal plate. Body yellowish green; a double whitish-yellow dorsal line, and below on each side two narrow broken sub-dorsal yellowish lines. The body gradually tapers to the hind legs, which are no longer and not quite so thick as the other abdominal legs. All the legs, including the thoracic, pale green. Length, 22<sup>mm</sup>.

12. *Geometrid larva*.

This measuring worm occurred on the chestnut at Providence, June 10.

*Larva*.—Body slender, head large, swollen, a little wider than the body, and dull reddish amber or pale brick-red. Segments somewhat wrinkled, with four fine dorsal tubercles. Very dark slate color, with paler subdorsal lines. Supra-anal plates pale flesh color; anal legs broad, dark on the front edge, pale flesh behind, with large par anal tubercles. Dark beneath. Length, 10<sup>mm</sup>.

13. *Geometrid larva*.

This larva appears to feed indifferently on the hornbeam (*Ostrya*) or chestnut in the vicinity of Providence, where it occurs as early as June 10.

*Larva*.—Body very thick, of the same diameter throughout. Head somewhat notched, not so wide as the body, pearl colored, spotted with dark irregular oblong-oval spots. Body striped with livid and bright flesh-colored bands, edged with black. Supra-anal plate large, triangular, with four black tubercles; legs rather large and broad. Across the prothoracic segment is a row of from four to six black piliferous shining black tubercles, with long, large, black hairs, and on each of the two succeeding segments is a row of ten such tubercles. On each abdominal segment are two rows of such tubercles, those of the hinder row the largest, and four of them arranged dorsally in a trapezoid. On each side of each segment is a clear caraneous patch, bearing four black piliferous tubercles. Length, 36 to 38<sup>mm</sup>.

14. *Tortrix?* sp.

This leaf roller was beaten from the chestnut at Providence, and on September 18 spun a slight cocoon in a web.

*Larva*.—Body light chestnut-brown. Head broad, marked with black dots; no thoracic shield. The body tapers a little from the thoracic segments to the tail. On each side of the back is a distinct black dorsal stripe. On the side above and below the spiracles is a faint very narrow dark line. The segments much wrinkled; a large median wrinkle divides the dorsal part of the segment into two areas, on each of which is a small black tubercle, giving rise to a brown hair. Length, 20<sup>mm</sup>.

15. *Bucculatrix trifasciella* Clem.

The cocoonet of this species was found on the leaf of a chestnut tree early in July. The cocoon is elongated, ribbed externally, and dark gray. The imago appeared in the latter part of July. (Clemens.)

*Moth*.—Fore-wings ocherous, with three silvery equidistant costal streaks, the first near the base, the last at the beginning of the apical cilia, with the spaces between them somewhat darker than the general hue. On the middle of the dorsal margin is a spot of blackish brown, with a patch of dispersed scales of the same hue exterior to it, limited externally by a silvery dorsal streak. At the extreme tip is a small blackish-brown spot, with an intercilia line of the same hue exterior to it. Cilia ocherous. Hind wings fuscous, cilia the same. Antennæ fuscous. Head ocherous; eye-caps somewhat silvery white. (Clemens.)

16. *Nepticula latifasciella* Clemens.

*Moth*.—Face pale rusty-yellowish; vertex dark brown; palpi and basal joint of antennæ (eye-cap), thorax, a broad fascia about the middle of the fore-wings, and the cilia silvery white, tinged with pale yellowish (except the cilia). The tuft is rather small; the antennæ are pale, grayish fuscous, tinged with silvery; the fascia is very hard, nearly straight on its anterior and convex on its posterior margin; the costal cilia are fuscous; upper surface of abdomen fuscous, lower pale grayish fuscous, and the legs darker fuscous. Alar expansion, 2 lines.

As will be evident on comparison of this description with that of *N. nigriserticella* Chamb. in Cin. Quar. Jour. Sci., ii, 118, there are many points of close resemblance between them, although they are very distinct species. It was taken resting on the trunks of chestnut trees (*Castanea americana*), the leaves of which were full of empty *Nepticula* mines about the middle of August. Kentucky. (Chambers, Bull. U. S. Geol. Surv., iv, i, p. 106.)

17. *Lithocolletis castaneæ* Chambers.

Fig. 131 represents three blotch mines on the upper side of a chestnut leaf, which commonly occurs at Providence, which we suppose to be the work of this Tineid.

## 18. THE CHESTNUT TREE-HOPPER.

*Smilia castaneæ* Fitch.

Order HEMIPTERA; family MEMBRACIDÆ.

Puncturing the leaves and extracting their juices in July, a triangular tree-hopper, shaped much like a beechnut, of a blackish color, tinged with green more or less when alive, its head and the anterior edges of its thorax and all beneath bright yellow, its fore-wings clear and glassy, with a blackish spot on their tips and another on the base, which is often prolonged along the middle of the wing and united with the hind spot. Length of male, 0.25; female, 0.30 inch. (Fitch.)

## 19. THE UNADORNED TREE-HOPPER.

*Smilia inornata* Say.

A tree-hopper of the same size and shape as the preceding, but of a light green color fading to light yellow, with a slender black line along the upper edge of its back, and a very slight duskiess on the tips of its glassy wings. Common on chestnuts and oaks from July to the last of September. (Fitch.)

## 20. THE CHESTNUT GAY-LOUSE.

*Callipterus castaneæ* Fitch.

Order HEMIPTERA; family APHIDIDÆ.

On the under sides of the leaves, puncturing them and sucking their juices in August and September, a small sulphur-yellow plant-louse, with black shanks and feet, its antennæ also black except at their bases and as long as the body, its wings pellucid, their first and second oblique veins and the tip of the rib-vein edged with coal-black, and its thighs straw yellow. Length, 0.09; expanse of wings, 0.15 inch. (Fitch.)

## 21. THE CHESTNUT PHYLLOXERA.

*Phylloxera castaneæ* (Haldeman).

In August and September, on both sides of the leaves, puncturing them and extracting their juices and causing them to curl, a very small louse-like fly of a bright sulphur-yellow color, with a black thorax, breast and eyes, its feet and antennæ tinged with blackish and its wings translucent. The wingless individuals associated with it are entirely yellow, with red eyes. (Haldeman.)

## AFFECTING THE FRUIT.

## 22. THE CHESTNUT WEEVIL.

*Balaninus caryatrypes* (Bohemian).

Eating large cavities in the meat of the chestnut, a soft, white, footless grub, attaining its full size when chestnuts are ripe, and remaining in the nuts through the winter; transforming into a weevil with an exceedingly long and slender beak.

The chestnut is often infested by a large white maggot (Fig. 132, larva of *Balaninus* and chestnut infested), with a yellowish head, which attains its full size at the time the nuts drop. It is found in nuts sent to market, and it is probable that while some of the maggots gnaw their



FIG.. 131—Blotch mines of *Lithocolletis castaneæcella*. Bridgham, det.

way out, and enter the ground in the autumn to transform, others delay until the spring. The worm devours nearly a third or one-half of the interior of the nut, part of the cavity being filled with the castings of

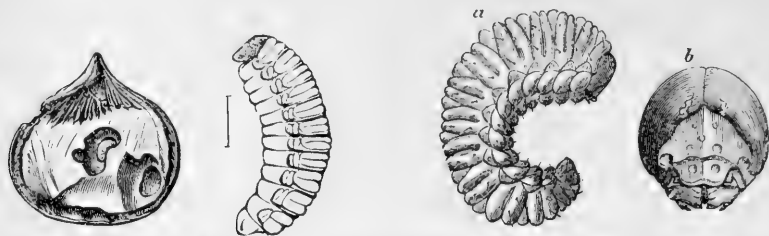


FIG. 132.—Chestnut Maggot. *a*, a second, better drawn, view; *b*, head.—From Packard.

the worm. As the grub is white it is liable to be overlooked and eaten with the chestnut; it makes its exit through a round hole in the shell.

The larva is about a third of an inch long, cylindrical, and of nearly the same thickness from the head to the tail. It is completely footless, as are nearly all nut-inhabiting larvæ. It is very difficult to rear this insect, as I have found after successive trials, and I am indebted to Mr. G. Mooney, of Providence, R. I., for a fresh male and female beetle reared by him from chestnuts collected in Providence. On sending one of the specimens to Dr. G. H. Horn, he kindly identified it as *Balaninus caryatripes*.

To those who raise chestnuts or gather them for the market, the ravages of this grub are of no small importance. The following letter will give the reader an idea of the interest attached to this subject.

MOORESTOWN, N. J., October 26, 1882.

I would be very much obliged to you if you will give me some information concerning the insect that destroys the fruit of the chestnut tree; its name, so that I can find it in the "Guide to the Study of Insects," etc., which I have in vain tried to do; and how to destroy it. My Spanish chestnuts are ruined by it. Not one-third are sound. Notwithstanding the crop last year was a total failure—no fruit at all—this autumn an unprecedented amount of the worms infest a good crop of the fruit. Where the beetle last year deposited its eggs to raise such a crop for this year is beyond my comprehension.

Respectfully, etc.,

S. C. THORNTON.

Dr. Le Conte, in his work on "The Rhynchophora of America," remarks that the beak of these weevils "attains in length and attenuation the greatest development; in the male it is rarely shorter than the body; in the female it is frequently twice the length, and is used to make the perforation into which the egg is subsequently introduced. The great thickness of the husks of the fruits (chestnuts, walnuts, hickory nuts, etc.) depredated on by these insects necessitates a very long perforating instrument to reach the kernel, upon which the larva feeds."

## 22. THE CHESTNUT CATERPILLAR.

Devouring the inside of chestnuts, the larva of a moth which grows to more than half an inch in length, and is cylindrical and thick, of a dirty white color, with a tawny yellow head and sixteen feet. It eats the meat of the nut mostly at its tip and on its convex side, the cavity which it makes being filled with little brown and whitish grains; and a small hole is perforated upon one side of the nut at its tip, out of which a portion of these grains is protruded. (Fitch).

The following insects also prey upon the chestnut:

## LEPIDOPTERA.

23. *Janassa lignicolor* Walker. Miss Emily L. Morton writes me that she has found the eggs of this Notodontian on a chestnut leaf, a group of nine, and that the larva feeds indifferently on oak or chestnut. See p. 157, and Pl. III, fig. 5.
24. *Thecla liparops*. (Scudder.)
25. *Thecla calanus* Hübn. (Beutenmüller.)
26. *Halesidota caryæ* Harr. (Beutenmüller, Ent. Amer., vi, 16.)



FIG. 133. Probably *Halesidota maculata*. Emerton del.

27. *Halesidota maculata* Harris. Probably the species on the chestnut at Providence.
28. *Datana ministra* (Drury). (Beutenmüller, Can. Ent., xx, 17.)
29. *Datana contracta* Walk. (Beutenmüller). See p. 151.
30. *Kronæa minuta* Reakirt.
31. *Parasa fraterna* Grote. Miss Emily L. Morton has bred this Cochlidian from the chestnut.
32. *Parasa chloris* (H. Sch.) See p. 144. On the chestnut (Reakirt).
33. *Phobetron pithecium* (A. and S.) (Beutenmüller).
34. *Orgyia* sp.
35. *Telea polyphemus* Cramer. Half a dozen larvæ, of different ages, occurred on the leaves, Providence, Sept. 18.
36. *Pyrophila pyramidoides* Grote. (Beutenmüller).
37. *Prionoxystus robinia* (Peck). (Beutenmüller).
38. A Notodontian larva.
39. *Anisota stigma* (Fabr.) (Beutenmüller).
40. *Anisota senatoria* Abbot and Smith. Lives on the chinquapin, according to Abbot and Smith.
41. *Pysche confederata* Grote. (Beutenmüller.)
42. *Apatela ovata* Grote. See p. 169. I have found the larva at Providence.
43. *Apatela americana* Harris. (Beutenmüller).
44. *Apatela hammamelis* Guen. (Beutenmüller).

45. *Apatela americana* Harris.  
 46. *Catocala palwogama* Guen. Entire life-history described by G. H. French in Can. Ent., xx, p. 108.  
 47. A *Noctuid* larva.  
 48. *Eugonia subsignaria* Hübner. See Comstock's Rep. Ag. Dept. for 1880, 271.  
 49. *Lithocolletis castaneavella* Chamb. Larva in a blotch upper-surface mine in the leaves.  
 50. *Lithocolletis* sp. Imago unknown. Larva in tentiform mine in the under surface of leaves.  
 51. *Coleophora* sp. Lives in a pistol-shaped black case. Imago unknown. (Chambers in letter.)  
 52. *Tischeria castaneavella* Chamb. Larva mines the upper surface of the leaves.  
 53. *Nepticula castaneafoliella* Chamb. Larva in crooked, linear mines in the upper surface.  
 54. *Tortrix* sp.

## COLEOPTERA.

55. *Anthaxia cyanella* Gory. Bred by Mr. Chittenden from chestnut twigs. May 11th. *A. quercata* Fabr. Was also observed on the leaves of the chestnut and chestnut oak during June and July. (Ent. Amer., v. 218.)

The following notes have been kindly communicated by Mr. F. L. Chittenden:

56. *Callidium areum* Newman. Bred from logs on two occasions (in New York and in New Jersey).  
 57. *Urographis fasciatus*. Beaten from limbs.  
 58. *Euderces picipes* (Fabr.). Bred from twigs.  
 59. *Leptostylus macula* (Say). In all stages, under bark.  
 60. *Hyperplatys aspersus* (Say). Many specimens beaten from a single tree.  
 61. *Liopus variegatus* Hald. Five or six examples beaten from a dead branch.  
 62. *Eupogonius vestitus* Say. Beaten from trees.  
 63. *Cryptorhynchus bisignatus* Say. Taken on two occasions in many specimens on logs; probably lives under bark.  
 64. *Balaninus rectus* Say. Bred from nuts.

## HEMIPTERA.

65. *Corythuca polygrapha* Uhler. (Lintner's Rep., iv. p. 108.)

## PLATYPTERA.

66. The American white ant (*Termes frontalis* Haldeman) sometimes mines and wholly consumes the interior of chestnut fence posts and stakes, while the outer surface remains entire. It also mines old elms, pines, and other decaying trees as well as the sills of houses.



## CHAPTER IV.

### INSECTS INJURIOUS TO THE LOCUST TREE.

(*Robinia pseudacacia.*)

Of insects feeding upon the locust forty-one species are here recorded. By far the most pernicious borer in the trunk and the most deadly enemy of the tree is the locust borer, the first mentioned below. The twigs are often swollen and disfigured by the locust twig-borer. We have observed the leaves to be most damaged by the *Depressaria* caterpillar. The other insects mentioned below are more or less peculiar to the tree, and at certain times may be locally destructive.

#### AFFECTING THE TRUNK.

##### 1. THE LOCUST BORER.

*Cyllene robinia* (Forster).

Order COLEOPTERA; family CERAMBYCIDÆ.

Boring a hole one-quarter of an inch in diameter under the bark and upwards, deep into the wood, and ejecting the dust through the orifice in the bark, a longicorn larva, which transforms to a pupa in its burrow, and late in summer appears as a brown beetle, striped and banded with golden yellow, and with a **W** on its wing-covers; often abundant on the flowers of the golden rod early in September, when they lay their eggs in crevices in the bark of the locust.

This is by far the most destructive pest of the locust, one of the most beautiful and valuable of our shade trees. In New England there is scarcely a tree which does not show the marks of its attacks, and in many localities it has practically been exterminated. In the Western States it is also very destructive; but from observations we made in Kentucky in 1874 the noble locust trees in that State had grown so luxuriously as to apparently escape or overcome the insidious attacks of this borer. It occurs throughout the United States east of the Plains.

The operations of the grub or larva may be detected by a mass of sawdust-like castings at the mouth of its gallery.

The beetles are abundant, feeding on the flowers of the golden rod (*Solidago*), early in September, when we have taken them in Cambridge, Mass., and at Providence, R. I. So wide are the deep yellow spots and

bands that the beetle is nearly all of the shade of deep golden yellow peculiar to the flowers of the golden rod, and thus the insect is an interesting case of "protective mimicry," being protected from the attacks of birds, etc., by their liability to be confounded with the yellow heads of the golden rod.

The best account of these insects has been given, as follows, by Harris :

In the month of September these beetles gather on the locust trees, where they may be seen glittering in the sunbeams with their gorgeous livery of black velvet and gold, coursing up and down the trunks in pursuit of their mates, or to drive away their rivals, and stopping every now and then to salute those they meet with a rapid bowing of the shoulders, accompanied by a creaking sound, indicative of recognition or defiance. Having paired, the female, attended by her partner, creeps over the bark, searching the crevices with her antennæ, and dropping therein her snow-white eggs, in clusters of seven or eight together, and at intervals of five or six minutes, till her whole stock is safely stored. The eggs are soon hatched, and the grubs immediately burrow into the bark, devouring the soft inner substance that suffices for their nourishment till the approach of winter, during which they remain at rest in a torpid state. In the spring they bore through the sap-wood more or less deeply into the trunk, the general course of their winding and irregular passages being in an upward direction from the place of their entrance. For a time they cast their chips out of their holes as fast as they are made, but after a while the passage becomes clogged and the burrow more or less filled with the coarse and fibrous fragments of wood, to get rid of which the grubs are often obliged to open new holes through the bark. The seat of their operations is known by the oozing of the sap and the dropping of the sawdust from the holes. The bark around the part attacked begins to swell, and in a few years the trunk and limbs will become disfigured and weakened by large porous tumors, caused by the efforts of the trees to repair the injuries they have suffered. According to the observations of General H. A. S. Dearborn, who has given an excellent account of this insect, the grubs attain their full size by the 20th of July, soon become pupæ, and are changed to beetles and leave the trees early in September. Thus the existence of this species is limited to one year.

Dr. Horn, who has observed *C. pictus* in the hickory, states (Proc. Ent. Soc. Phil., i, 30) that its excavations are immediately subcortical. "Unlike the *Clytus erythrocephalus*, which also bores in the hickory, its course is not in a line, but it bores in every direction, making extensive excavations. Its borings are coarse and sawdust-like, and are packed with considerable firmness. When about to become pupa the larva bores for a slight depth into the wood, and for a distance of about 3 inches. The aperture is closed with some very coarse splinter-like borings, and after having turned its head in the direction of its previous subcortical dwelling, it undergoes its transformation, and requires about two and sometimes three weeks for becoming a perfect insect."

As is well known, *Cyllene pictus* attacks the walnut and hickory, and occasionally the honey locust, but those individuals living in these trees, unlike the locust brood, evolve the beetle in June, according to Walsh, who has claimed that the males of the hickory brood differ from those of the locust brood in having "much longer and stouter legs and much longer and stouter antennæ, and in having [their bodies] tapering behind to a blunt point"; on the other hand the females are not distinguishable, nor the larvæ. On this account Mr. Walsh regarded the locust and hickory broods as representing two distinct

species. He gives, however, some interesting facts in the *Practical Entomologist*, vol. i, p. 29, regarding the appearance of this insect in the Western States, as follows:

The history of this species is very curious, and as it has only recently been elucidated by myself, and some additional details can now be added, may be briefly summed up as follows: About a hundred years ago this insect was well known to Forster to inhabit the locust in the State of New York. Twenty years ago, although the best Illinois botanists agree that the locust grows wild in the southern part of Illinois, it was still unknown in that State. Shortly afterwards it commenced attacking the locusts in the neighborhood of Chicago, and thence spread gradually in a south-south-west and west direction through the State, sweeping the locusts before it wherever it came. In 1860 it had pretty well destroyed all these trees in central Illinois. Rock Island lies on the Mississippi River 180 miles south of west from Chicago. In 1862 it had reached a point 20 miles east of Rock Island. In 1863 it burst forth suddenly in great swarms from all the locusts in Rock Island, and the two following years about completed their destruction. It has now (1865) crossed the river into Iowa, and no doubt will continue its travels westward as long as it finds any locust trees to prey on.\*

Lest it should be supposed that, agreeably to the belief of all the older writers, the species that inhabit the hickory is identical with that which inhabits the locust, it is proper to add here, that I myself split the hickory insect out of a stick of hickory wood as much as eight years ago in Rock Island; that abundance of hickory grows in the woods within half a mile of that city, and yet that our locust trees were never attacked by borers until 1863, when they were suddenly attacked in the manner mentioned above. Professor Sheldon, of Davenport, Iowa, has also repeatedly, for many years before 1863, split the hickory insect out of hickory wood in Davenport, although, so far as he is aware, the locusts in Davenport had not been attacked by borers up to 1863. Now, if the hickory borer is identical with the locust borer, why did it not attack the locusts in Rock Island and Davenport before 1863 and 1864? And why, when it did attack them, did it appear suddenly in great swarms?

*The larva* is six or seven-tenths of an inch long, somewhat flattened, club-shaped, the thoracic segments being considerably broader than the abdominal ones, but at the same time distinctly flattened above and below. The head when extracted from the thorax appears almost circular and narrower than the prothorax. The latter is twice broader than long, rounded anteriorly, flattened above and below, brownish yellow, covered, especially on the sides and below, with a short golden pubescence. A deep, longitudinal sinuated furrow is visible on each side, a short transverse furrow crosses its posterior end. The upper disk is inclosed between two furrows beginning at the posterior margin, and not reaching the anterior one; a transverse furrow, parallel to the posterior margin, separates a narrow fleshy fold. The anterior portion of this upper disk is irregularly punctured and wrinkled, although shining; in some specimens it has an indistinct, elongated, somewhat oblique brownish spot on each side, about the middle; the posterior portion of the disk is opaque, covered with dense longitudinal wrinkles, among which a straight impressed line is apparent in the middle. The ventral side is irregularly punctured on the sides, and has a depression in the middle which is less apparent in some specimens.

The other two thoracic as well as the two first abdominal segments have, above and below, a transverse flattened opaque disk, limited on each side by a furrow, and

\*Mr. R. V. Rogers, jr., in the *Canadian Entomologist* for August, 1880, p. 151, reports that this beetle was first observed in Montreal in 1855. "In 1862 it was very destructive to the locust trees around Toronto; in 1873 Mr. E. B. Reed saw it in enormous numbers in London, Ontario. Now it seems to be quite at home in all parts of Ontario."

showing some indistinct furrows on its surface; the other abdominal segments have the usual protuberances, on the dorsal as well as the ventral side, marked with wrinkles. The last segment is short and divided in two halves by a transverse fold; the latter half has the anal opening at the tip. All these segments are beset with short golden hairs on the sides. There are no feet, as in the *Lamii*. (Osten Sacken.)

*The pupa* has numerous pointed granulations on the prothorax; similar granulations ending in sharp points are placed in a row on the dorsal segments of the abdomen, near the posterior margin; the same segments have, more anteriorly, a few similar sharp, horny projections. On the penultimate segments these projections are larger and recurved anteriorly at the tip; there are six in a row near the posterior margin, and two others more anteriorly. The last segment has four similar projections in a row. (Osten Sacken.)

*The beetle*.—Body velvet-black, and ornamented with transverse yellow bands, of which there are three on the head, four on the thorax, and six on the wing-covers, the tips of which are also edged with yellow. The first and second bands on each wing cover are nearly straight; the third band forms a **V** or, united with the opposite one, a **W**; the fourth is also angled, and runs upwards on the inner margin of the wing-cover towards the scutel; the fifth is broken or interrupted by a longitudinal elevated line; and the sixth is arched, and consists of three little spots. The antennæ are dark brown, and the legs are rust-red. These insects vary from six-tenths to three-fourths of an inch in length. (Harris.)

Dr. Horn has defined the characters by which this species may be separated from *C. pictus* as follows:

If we examine the under side of the two species, noting the form of the prosternal process, it will be observed that this in *robinia* is nearly square, so that the front coxæ are moderately widely separated. The second joint of the hind tarsi is densely pubescent over its entire surface. The male antennæ are rarely longer than three-fourths the length of the body, and but little if any stouter than those of the female. Generally the **W**-band nearly always joins the transverse band at the suture.

*C. pictus*, however, has a narrow prosternum, nearly twice as long as wide. The male antennæ are much stouter and at least a fourth longer than the body. The **W**-band rarely joins the transverse band. On the hind tarsi the second joint is nearly glabrous along its middle.

The two species differ also in habitat and time of appearance, *pictus* living in the hickory and appearing in early spring, while *robinia* bores the locust and appears in the autumn. (Can. Ent., xiv, p. 240.)

*Remedies*.—An excellent way to save a valuable shade tree from the attacks of this borer is to thoroughly soap the trunk late in August, so as to prevent the beetle from laying its eggs early in September. All insects breathe through little holes (eighteen or twenty in all, nine or ten on each side); now, if a film of soap or grease or oil of any kind closes the openings of these breathing pores, the air can not enter the respiratory tubes which ramify throughout the interior of the body and the insect dies by asphyxiation—*i. e.*, drowns. Harris states that white-washing and covering the trunks of the trees with grafting composition may prevent the female from depositing her eggs upon isolated trees. Also, young trees might be headed down to the ground, so as to destroy the grubs boring in them, and also to promote a more vigorous growth. An excellent preventive remedy is to collect these beetles early in September when engaged in eating the pollen of the golden rod; children could perform this labor.

## 2. THE LOCUST-TWIG BORER.

*Ecdyolopha insiticiiana* Zell.

Order LEPIDOPTERA; family TORTRICIDÆ.

Boring in the twigs of locust, sometimes causing a thickened growth of the stem for the distance of from 1 to 3 inches, a pale whitish larva with brownish head, which cuts its way out when full grown, descending to the ground and transforming into a yellowish-brown pupa in curled leaves upon the surface, and finally emerging a dark-brown moth with dirty pinkish-white on the outer portion of the fore-wings.

We have observed this larva at work at Brunswick, Me., August 20 to 22, the galls being numerous, but copy Professor Comstock's account of the insect, premising that the swelling or galls we observed are about 20<sup>mm</sup> long and 7 to 8<sup>mm</sup> thick. They are quite sticky on the surface, with a hole at the lower end for the exit of the castings. It is interesting to observe how the body of a boring Tortricid is modified to adapt itself to a lignivorous existence. This is seen in the development of rugose semi-chitinous or fleshy patches on the exposed dorsal area of the segments. Professor Comstock's account is as follows:

During the latter part of September the terminal shoots and twigs of several varieties of locust (*Robinia pseudacacia* vars. *crispa*, *tortuosa*, and *inermis*) growing on the department grounds were observed to have an abnormal thickened growth from 1 to 3 inches in length, and enlarging the stem at this place to nearly twice the normal size, the enlargement being quite uneven and irregular. An examination of some of these diseased stems disclosed the fact that a lepidopterous larva was boring along the central part of the stem and feeding upon the tissues. This larva when full grown is about half an inch in length, of a yellowish color, somewhat darker on the dorsal line. Head dark brown; thoracic plate light honey yellow. On the 1st of October these larvæ left the stem through holes which they had cut out to the surface, and descended to the ground, where they transformed to pupæ among the dry and curled leaves which had fallen, and in which they spun thin but tough silken cocoons. Sometimes they crawled between a fallen leaf and the ground, when the cocoon adhered to the leaf on one side and was thickly covered with grains of sand on the other.

The first moth emerged October 17, and others from the 20th to the 27th. An examination of a large number of shoots proves that this insect deserts its burrow to transform on the ground.

Some of the shoots were badly infested; ten places where larvæ were at work were counted in one of them, and the whitish excrements hung in clusters from the holes, which were almost always between two of the thorns, where the egg had probably been deposited. These shoots, however, were not enlarged.

This species was described under the above name by Prof. P. C. Zeller, of Stettin, Germany, from specimens received of Mr. Burgess, who took them in Massachusetts in June and July. Professor Fernald informs us that he has received them from Mr. Morrison taken in Colorado.

*Remedies.*—The only remedies we can suggest are to cut off the infected twigs *before* the escape of the larvæ and burn them. If for any reason this has not been done, it would be well to collect carefully all the leaves beneath the infested trees and burn them to destroy the insects while in the pupal state. This should be done, however, *after*

the escape of the larvæ from the trees and *before* the moths emerge, or not far from the 8th of October at this place (Washington, D. C.).

*Larva*.—Length, 13<sup>mm</sup>. General color, reddish straw yellow. Head, light-brownish; tips of mandibles and a small spot about the eyes, blackish; thoracic and anal plates, light honey yellow. The piliferous tubercles on the dorsum are greatly expanded laterally, so as to give them an elliptical form; the anterior pair on both the third and fourth segments are so expanded that the distance between them is only equal to their length, the posterior pair on these segments nearly or quite obliterated. Anterior warts of the fifth to the eleventh, inclusive, more rounded and brought close together at the dorsal line; those of the posterior side of these segments fusiform, the length quite equal to four times the thickness, and separated from each other by a small space on the first of these segments, but approaching more and more, they touch each other on the dorsum of the more posterior ones. The dorsal tubercles of the twelfth segment are so fused together as to appear like two transverse elevated bars. The remaining warts of the body are as usual, but considerably enlarged, and each surmounted by a fine yellowish bristle.

*Pupa*.—Length, 10<sup>mm</sup>. Color, yellowish-brown. Abdominal segments on the dorsal side armed on each edge with the usual row of spines. Anterior end rounded and smooth, posterior end bluntly rounded, with a row of spines like the larger ones on the segments before, extending two-thirds the way around.

*Moth*.—Of a dark ashy brown color on the fore-wings, with a large patch of a dull pinkish-white color on the outer part, with several small black spots near the middle of this patch. Hind wings a little lighter than the basal portion of the fore-wings. Expanse, 18 to 20<sup>mm</sup> (about .75 inch). (Comstock.)

### 3. *Sciapteron robinia* Hy. Edwards.

This *Ægerian* is extremely destructive in California and Nevada to the white poplar (*Populus alba*) and to the downy poplar (*Populus canescens*), both of these species having been introduced into the Pacific States as ornamental trees. A small avenue of the latter at San Leandro, near San Francisco, was utterly destroyed by the *Sciapteron*, the pupa cases being found sticking out of the holes by hundreds. The perfect insect was rather scarce, as it emerges very early in the morning, and takes flight with the first gleam of sunshine. *Sciap. robinia* also destroys the locust trees (*Robinia pseudacacia*), a grove of this species in Napa County being observed by me in a state bordering upon destruction from the attacks of this insect. (H. Edwards.)

*Moth*.—Upper side: Fore-wings opaque as in all of the genus, rich golden brown. They are slightly darker along the costa, and have a faint purple reflection toward the apex. Hind wings diaphanous, brightly opalescent, with a faint golden brown longitudinal streak at posterior extremity of the cell. Costal edge pale yellow. Fringe golden brown, pale yellow at the base. Head golden yellow, as are the palpi except at the base, where they are brownish. Thorax brown on the disk, golden yellow in front and behind. Abdomen next the three basal segments blackish brown, the second and third edged with yellow. The posterior segments are all bright golden yellow, with the anal tuft a little darker. Under side: Fore-wings golden orange, with a faint lemon yellow discal spot. Hind wings same as the upper. Tarsi and tibiæ golden yellow, blackish at their base. Antennæ red brown above, golden yellow beneath. Expanse of wings 1.35 inches. (Edwards.)

## AFFECTING THE LEAVES.

## 4. THE LOCUST LEAF-ROLLER.

*Pempelia (Salebria) contatella* Grote.

Order LEPIDOPTERA; family PYRALIDÆ.

We have observed these worms in Maine at work on the locust during the middle and last of August. They began to pupate August 28, and the moths appeared June 1 of the following year. They generally draw two leaves together, and in this way their presence is indicated.

On the 29th of August Prof. Comstock found them on the locust (*Robinia pseudacacia*), in the department grounds, drawing the leaves together, the side of one to that of another.

The smallest larvæ observed by Comstock, August 28, at Washington, at this time, were about one-eighth of an inch long, yellowish-green, with jet-black head and thoracic plate. The larvæ transformed to pupæ between the 5th and 8th of September and emerged in the following May.

As none of the pupæ of this insect could be found among the leaves on the tree a careful search was made on the ground beneath, where a pupa was found spun up in a tough silken cocoon to which earth, fragments of leaves, and dry grass were adhering in such a manner as to completely conceal it.

Mr. A. R. Grote, who originally described this species, also described a variety of it under the name of *quinquepunctella*, and stated that it might be a distinct species from *contatella*. Most of the examples mentioned above agree with the typical *contatella*, while one of them is undoubtedly the var. *quinquepunctella*.

This species has also been reported from New England, New York, and London, Ontario.

*Remedy*.—Gather all the leaves beneath the trees after September and burn them.

*Larva*.—Body large, broad, gradually tapering towards the end of the body. Head black, smooth, not so wide as the prothoracic shield, which is large and jet black. (In the young the head and shield are reddish black.) Body pale pea-green; sutures yellowish. Body obscurely mottled with yellowish green. The piliferous warts are minute and obscure, the four dorsal ones arranged in a square. Body obscurely lined with yellowish-green lines, of which there are about five on each side of the dark-green median line. The hairs reddish or horn-colored. Length, 20<sup>mm</sup>.

*Pupa*.—Length, 10<sup>mm</sup>, rather stout. Color, chestnut brown. Anterior end rounded; posterior with a minute beak, curving downward slightly, and armed at the end on each side with a sharp, stout spine extending obliquely out and downwards. In a row between these, at equal distances, are four slim filaments much longer than the spines and hooked at the end. The abdominal segments are covered above and below with coarse punctures, except on the posterior edge, while the wing-covers, head, and thorax above are impressed with irregular striæ. (Comstock, 1880.)

*The moth*.—The fore wings expand 20<sup>mm</sup> to 26<sup>mm</sup> (nearly 1 inch), and are blackish and gray, with a shading of red at the base and near the middle of the wing below the fold. These reddish shades are sometimes wanting. Base of the wing usually whitish gray.

## 5. THE SULPHUR-LEAF ROLLER-MOTH.

*Tortrix sulfureana* Clem.\*

Order LEPIDOPTERA; family TORTRICIDÆ.

Drawing together the leaflets of red and white clover and feeding on the tissues, a small yellowish-green larva, which transforms into a brownish colored pupa, from which emerges a small sulphur yellow moth with purplish red markings.

We copy verbatim Prof. Comstock's account of this insect, which he reports as feeding on the locust. (See Ag. Rep. for 1880.)

During the summer of 1879 small yellowish green larvæ were found in considerable numbers in the District of Columbia, feeding on red clover (*Trifolium pratense*), and also on white clover (*Trifolium repens*). The larvæ were first found May 13, folding the leaflets of red clover into a kind of tube by drawing the edges together with silken threads, which was spun for this purpose. Sometimes they spin two leaflets loosely together, or to the flower head when they are nearly full grown. They issue from either end of this tube, and feed upon the surrounding foliage, of which, when the larvæ are young, they eat only the under surface, leaving the veins and the epidermis of the upper side intact, but when nearly full grown they eat irregular holes through the surrounding leaflets and flower heads.

These larvæ are very active when disturbed, and wriggle from their tubes, suspending themselves by a silken thread, by which they can let themselves down to the ground, and if further disturbed, they wriggle about with great energy.

Some of the larvæ changed to pupæ on the 19th of May in folded leaves, which they lined closely with silk. The perfect insects began to emerge on the 19th, and continued until June 3, when the last of this lot came out. On the 20th of June several larvæ were found feeding in a similar manner to the above on the leaves of white clover on the department grounds. At this time they were less than half grown, but transformed to pupæ by the first of July, the perfect insects emerging from July 5 to 14. About the middle of August more of these larvæ were found on red clover, some nearly grown, others quite small. These became full-grown in a short time, passed their transformation, and emerged as perfect insects from September 1 to 16. Those which changed to pupæ September 1 emerged on the 10th.

From the data now before us it is more than probable that there are three generations in a year in the latitude of the District of Columbia, the first appearing in the perfect state about the last of May, the second in the early part of July, and the third in the early part of September. One full-grown larva was found on clover October 21, and it may be that this species hibernates in the larva state, the same as the codling moth. Professor Fernald informs us that he does not think there is more than one generation in Middle and Northern Maine.

*Distribution.*—These insects are very widely distributed through the United States, having been reported from Maine to Florida, and as far west as Texas and Missouri.

*Food-plants.*—Besides the plants mentioned above—red and white clover—the larvæ of this species were found and fed on locust, strawberry, and grape. Some of the larvæ were also fed upon the cotton plant by way of experiment. Specimens were received from Dr. R. S. Turner, Fort George, Fla., which fed on orange. Mr. B. D. Walsh bred this species from the willow gall *Salicis-brassicoides*, in Illinois.

*Natural enemies.*—One of the larvæ on clover was found to be infested with a Hymenopterous parasite, which, however, failed to emerge.

\* SYNONYMS.—*Croesia?* *sulfureana* Clem.; *Conchylis gratana* Walk.; *Croesia?* *fulvroseana* Clem.; *Croesia?* *virginiana* Clem.; *Croesia?* *gallivorana* Clem.; *Tortrix sulfureana* Robs.; *Tortrix* (*Dichelia*) *sulfureana* Zell. and variety *belfrageana* Zell.; *Cenopsis gracilana* Wlsm.



*Larva*.—Length when full grown, 14<sup>mm</sup>, cylindrical, slightly fusiform. Head and thoracic plate very pale honey yellow, the rest of the body yellowish green with the alimentary canal showing dark green through the dorsum. Eyes, third joint of antennæ, and tarsi, blackish. Piliferous tubercles slightly paler than the rest of the body, each one being surmounted by a brownish hair. Spiracles green with a brown ring.

*Pupa*.—Length, 8<sup>mm</sup>. Color, dark shining brown, lighter at the end of the wing-covers and the parts covering the palpi and base of the antennæ. Front rounded and smooth. Abdominal segments on the dorsal side armed with two transverse rows of small spines inclined backward, those on the posterior edge of each segment finer and closer than those of the other row. Abdomen terminated by a protuberance, flattened above, rounded at the end, hollowed out underneath near the base, and armed with two fine hooks on each side, and four from the end. (Comstock.)

*Moth*.—Of a bright sulphur or golden yellow color, with a V-shaped purplish red mark across each fore-wing, and more or less of the same color along the front or costal and outer border. Hind wings varying from light yellowish to brown. Expanse of fore-wings, half an inch or a little more.

#### 6. THE GREATER LOCUST-LEAF GELECHIA.

*Gelechia pseudacaciella* Chambers.

Order LEPIDOPTERA; family TINEIDÆ.

From eggs laid on the under surface of the leaf hatches a green larva with a reddish head and thoracic plate, and six longitudinal dusky stripes; spinning a slight web between two leaves; changing to a moth in late spring, whose wings expand 0.63 inch. It is somber in color, the fore-wings dark slate, flecked with brown and white; the hind wings pale slate, whitish towards the base.

#### 7. THE LESSER LOCUST-LEAF GELECHIA.

*Gelechia robiniaefoliella* Chambers.

Spinning two locust leaves together and feeding between them, leaving the outer surface and the larger ribs untouched, a minute, greenish white slender larva, which transforms to a chrysalis in the same situation, the moth differing from its closely allied species in the palpi being slender and rather long, while the hind wings are emarginate beneath the apex. (Comstock and Chambers.)

#### 8. THE AUTUMNAL LOCUST LEAF-MINER.

*Lithocolletis robiniella* Clemens.

Mining the under side of the locust leaf late in September and early in October (in the Middle States) a cylindrical larva, with a pale brown head and the body greenish white, sometimes spotted with yellow; the chrysalis contained in a white silken cocoon within the mine, and transforming late in October and early in November into a minute moth with narrow pointed fore-wings, which are golden yellow along the costal edge and with a spot at the tip.

The species of *Lithocolletis* are known by their small size, the narrow, pointed fore-wings, the tuft on the top of the head, and the simple, not ciliated, antennæ. The larvæ mine the upper and under side of leaves and usually transform within a silken cocoon in their burrows. The present species is one of the best known of the genus.

*Larva*.—Body cylindrical, the head pale brown; the body pale greenish white, with a red median dorsal line from the fifth to the ninth segment; on the ninth segment are two irregular chrome-yellow patches, which are sometimes wanting. (Clemens.)

*Moth*.—Antennæ dark brown; front of head silvery white, the tuft dark brown mixed with grayish; thorax dark brown; fore-wings golden yellow above the fold, and dark cinereous, somewhat dusted with blackish beneath it. About the middle of the wing is an oblique silvery costal streak, black-margined on both sides, extending to the fold; another beyond the middle, meeting nearly in the center of the wing at an angle, a dorsal streak from the inner margin, the former black-margined on both sides, the latter internally; another costal streak near the tip, with an internal circular black margin opposite to a dorsal streak of the same hue, and joined or nearly joined to it. Just behind the apical spot is a straight silvery streak, black-margined internally. A black round spot at the tip of the fore-wings. Hind wings shining dark gray. (Clemens.)

#### 9. THE LOCUST DEPRESSARIA.

*Depressaria robiniella* Packard.

Order LEPIDOPTERA; family TINEIDÆ.

Occasionally late in June defoliating the branches, a small green larva with a thick body, black head, and transforming late in July to a light brick-red moth, spotted irregularly with yellow.

The following account of this destructive moth is taken from our 'Guide to the Study of Insects.' The moths of the Tineid genus *Depressaria* comprise rather large species, in which the fore-wings are unusually broad and oblong. The abdomen is flattened above, with projecting scales at the sides. The larvæ are extremely active and feed on a variety of substances; some in rolled-up leaves of composite plants, some in the leaves and others in the umbels of the umbelliferous plants. Many of the worms descend from the plant on the slightest agitation, so that considerable caution is necessary in attempts to collect them. The full-fed larvæ descend to the ground and change to pupæ among the fallen leaves. The perfect insects have the peculiarity of sliding about when laid on their backs.

During the summer of 1868 a large locust tree overhanging our garden in Salem, Mass., was attacked by the present species to such an extent that some of the branches were nearly stripped of their leaves. This moth we described under the name of *Depressaria robiniella* (Guide to Study of Insects, Pl. 8, fig. 14). The larva is thick-bodied, with a black head, and is green, the cervical shield being green. It devours the leaves, drawing them together by threads, and it also eats the flower buds. It was most abundant in the last week of June. It turned to a chrysalis July 8, and in about two weeks the moth appeared.

*The moth*.—The head, palpi, and fore-wings are light brick-red, spotted irregularly with yellow, and the antennæ are slate-brown. The fore-wings are a little darker in the middle, especially towards the inner edge. There is a submarginal darker brown band near the outer edge, which does not reach the costa, and on the outer edge is a row of minute black dots. The hind wings and abdomen are of a pale slate-

gray, and of the same color beneath, while the legs are of a very pale straw-yellow. It differs from most of the species of the genus in having the apex of the fore-wings less rounded than usual, and in this and other respects it is allied to the European *D. laterella*.

#### 10. THE LOCUST LEAF-MINER.

*Gracillaria robinella* (Fitch).

Order LEPIDOPTERA; family TINEIDÆ.

Mining the leaf in July, making a blotch on the upper surface of the leaf, with a number of lateral galleries running out from it, on each side, a flattened pale green worm which passes the chrysalis state in the leaf, the latter falling to the ground, and the following June giving out a minute moth.

This is a common leaf-miner of the locust in the New England as well as the Middle States. Out of the seventeen leaflets which form the locust leaf, usually two or three and often more make the blotches. The mines are not tenanted, Clemens states, at the time the leaf is mined by *Lithocolletis robinella* (Clem., Proc. Phil. Acad., 1860).

The larva makes a pale yellowish mine, usually on the midrib, with lateral branches running out from it. It pupates in a small nidus on some object on the ground.

The late Mr. Chambers wrote me that it is common in New Orleans in February.

*The moth.*—Fore-wings fine brown, somewhat golden, shaded with dark brown. Along the costa are three oblique silvery streaks; on the inner margin are three silvery dorsal spots, placed opposite the spaces between the costal streaks. Near the tip of the wing is a transverse narrow curved silvery line, passing from the costa to the inner angle. (Clemens.)

#### 11. THE LOCUST SKIPPER.

*Eudamus tityrus* Fabricius.

Drawing the leaves together in July, a large pale-green caterpillar about 2 inches long, with a red neck and large red head, with a large yellow spot on each side of the mouth, feeding by night, sometimes pupating between the leaves, and transforming into a stout-bodied, brown butterfly with a skipping, rapid, strong, low flight, and antennæ flattened and bent over at the end. (Harris.)

These voracious worms sometimes strip the leaves of the common locust and especially the viscid locust (*Robinia viscosa*), which is cultivated in New England as an ornamental tree. According to Harris, the females lay their eggs singly during June or early in July on the leaves, the caterpillars hatch in July, and when quite small conceal themselves under a fold of the edge of a leaf, which is bent over their bodies and secured by means of silken threads. When they become larger they attach two or more leaves together, so as to form a kind of cocoon or leafy case to shelter them from the weather, and to screen them from the prying eyes of birds. One end of the leafy case is left open, and from this the insect comes forth to feed. They transform to

chrysalids either among the leaves or desert the tree and seek some retired place, where they spin a slight loose cocoon, within which they remain through the winter, appearing in the imago state by the middle of the following June.

*The butterfly* is brown, the fore-wings are brown with a transverse semi-transparent band across the middle, and a few spots towards the tip of a honey-yellow color; hind wings with a short rounded tail on the hind angles, and a broad silvery band across the middle of the under-side. The wings expand from 2 to 2½ inches. (Harris.)

*Remedies.*—Nearly all the insects which prey upon the foliage of the locust can be gotten rid of by hand-picking and by collecting the leaves in autumn and burning them; in this way cherished shade trees can be protected.

12. *Dasylophia anguina* Abbot and Smith.

The eggs of this moth were sent me by Miss Emily L. Morton, of Newburgh, N. Y., having been laid about the 20th of July. She has never found the larvæ on any other tree than the locust, and then only rarely. The larvæ hatched July 25, at Brunswick, Me.; the first molt occurred July 28, the second August 6, and the third August 10 to 11, the fourth August 20 to 22.

*Egg.*—Spherical, whitish, surface seen under a good lens to be very finely granulated. Diameter, .8<sup>mm</sup>.

*Larva directly after hatching.*—Head very large, nearly twice as wide as the body is behind the middle, rounded, yellowish amber with a lateral black stripe. First abdominal segment shining red, with two high slender subdorsal tubercles; two similar but much smaller tubercles on the eighth segment, which is also reddish. Body deep pea-green, shining, with six very narrow dorsal, subdorsal, and lateral black lines. Anal legs long and slender, dark red, and with the two last abdominal segments (9 and 10) uplifted much as in the full-fed larva, at an angle often of 45 degrees. All the legs, both thoracic and abdominal, dull greenish. Hairs stiff and black, mostly thickened at the end; about as long as the body is thick. Length, 3 to 4<sup>mm</sup>.

*Larva after first molt, July 28.*—Head amber-colored, no wider than the body. Body pale green, the dark brown stripes, especially the dorsal one, more distinct; the dorsal line is continuous; the two lateral ones somewhat broken; the hairs are still black, but not so much thickened as before. Markings nearly as before, but the first and eighth abdominal segments not so deep red as in stage I. Length, 6 to 7<sup>mm</sup>.

*Larva after second molt, August 6.*—More like the mature larvæ. Head of moderate size, but little wider than the body, rounded, dull pale reddish orange. Body smooth and shining, straw-yellow; a dorsal black line ending on the polished black knob on the eighth abdominal segment. Three lateral, more or less interrupted black lines in a whitish band, the middle of the three the faintest. This band incloses on the first abdominal segment a polished jet-black tubercle. Low down on the sides of the body are twelve black spots, one at the base of each foot, when they are present; four black spots on the front part of the supra-anal plate. Anal legs uplifted, extensile, black on the tips. Length, 15<sup>mm</sup>.

*Larva after third molt, August 10 to 11.*—Only differs from the preceding stage in its more distinct, deeper hues, especially the pale lilac tint on ninth and adjoining segments, and the larger, thicker body. The four black spots on the base of the short supra-anal plate are united to form a continuous band. Length, 22<sup>mm</sup>.

*Full-fed larva.*—Head rounded, greenish amber; body smooth, of nearly uniform thickness, with a low rounded jet-black knob on tip of the eighth abdominal seg-

ment, in front of which is a narrow black dorsal line. Anal legs uplifted. Three lateral black lines close to each other and forming a broad dark wavy band. Base of all the legs black, but the legs themselves pale; ground color of body deep pink flesh color. Length, 30 to 35<sup>mm</sup>.

13. THE LOCUST HISPA.

*Odontota scutellaris* (Olivier). *Hispa suturalis* Harris.

Order COLEOPTERA; family CHRYSOMELIDÆ.

In July, blister-like spots appearing upon the leaves, within which is a small flattened, whitish worm, with three pairs of feet; a quarter of an inch long, tapering from before backwards, with projections along each side like the teeth of a saw; remaining a week in the pupa state within the leaf, about the middle of August it issues as a small flattened black beetle with the prothorax and wing-covers, except along their suture, tawny yellow. (Fitch & Harris.)

Harris states that in Massachusetts these beetles may be observed the middle of June pairing and laying eggs on the leaves of the locust tree.

While this species of leaf-mining beetle is met with in the New England States and New York, by information received from Kentucky it is at times quite injurious to locust trees in that State, but can always be kept under by hand-picking.



FIG. 134.—Locust Hispa.—From Packard.

14. *Agrius otiosus* Say.

Order COLEOPTERA; family BUPRESTIDÆ.

Mr. W. L. Devereaux, of Clyde, N. Y., writes us that this beetle "is found in plenty in the beetle stage, feeding on freshly forming foliage, at the tips of new growths of the locust."

15. SAY'S WEEVIL.

*Apion rostrum* Say.

Order COLEOPTERA; family CURCULIONIDÆ.

From June until September, eating numerous small round holes in the leaves, a little black weevil with a slender projecting beak, its thorax with close coarse punctures and an oval or longitudinal indentation back of its center, and the furrows of its wing-covers with coarse punctures; its length, 0.09, and to the end of the beak, 0.12 inch. (Fitch.)

Dr. Harris states that the grubs of this little weevil live in the pods of the common wild indigo bush (*Baptisia tinctoria*), devouring the seeds. He adds:

A smaller kind, somewhat like it, inhabits the pods and eats the seeds of the locust tree, or *Robinia pseudacacia*.

Fitch regards the insect as very variable, and as most probably destructive to the seeds of both the plants here mentioned.



FIG. 135.—Say's weevil.—From Packard.

## 16. THE BLACK LOCUST MIDGE.

*Cecidomyia pseudacaciae* Fitch.

Order DIPTERA; family CECIDOMYIIDÆ.

In July and August, the tender young leaflets near the tip of the stem folded together like a little pod, the cavity inside containing from one to three small milk-white maggots, which descend below the surface of the ground, remaining there in the pupa state about ten days, and then appearing as a small blackish midge. (Fitch.)

According to Fitch, before the small young leaflets, which put forth along the opposite sides of the main leaf-stalks at their tips, become expanded, they are closed together like two leaves of a book; and it is probably at this time that the female midge inserts her egg in the cleft between them, the irritation from which and from the small maggots which hatch from them, keeps the leaflet permanently closed; a slight cavity forming within, in which the worms reside, the leaflet hereby comes to resemble in its shape a small bivalve shell with a more or less wavy edge. The surface remains unchanged outside, but within it assumes a pale greenish yellow color. The attachments of the leaflets to the stalk becomes so weakened when infested by these worms that probably they are generally broken off by the wind, and the worms are thus carried to the ground, instead of crawling down the stalks by night, as is the habit of the wheat midge.

*The female.*—A small blackish midge, the base of its thorax tawny yellow, its abdomen pale yellowish, with the tip dusky and clothed with fine hairs, as is also the neck; its legs black, with the thighs pale except at their tips; its wings dusky, feebly hyaline, with the fringe short; its antennæ with thirteen short cylindrical joints separated by short pedicels; its length, 0.065 inch to the tip of the body.

## 17. THE YELLOW LOCUST MIDGE.

*Cecidomyia robinia* Haldeman.

Order DIPTERA; family CECIDOMYIIDÆ.

In July and August a portion of the edges of the leaves rolled inwards on their under sides and thickened, inclosing one or two very small white maggots, which are varied more or less with orange-yellow; producing a pale orange midge with the sides of its thorax and often three oval stripes on the back and the wings dusky; its antennæ blackish and of fourteen joints in the females, twenty-four in the males; its length, 0.12 inch. (Fitch and Haldeman.)

Professor Haldeman, who described this two-winged gall-fly in Emon's Journal of Agriculture and Science, October, 1847, says that it in conjunction with the *Hispa*, already mentioned, had been so numerous in southeastern Pennsylvania the two preceding summers as to kill the leaves upon the locusts, the trees in August appearing as though they had been destroyed by dry weather.

This insect may be detected by the margin of the leaflets being rolled inwards upon their under sides for a length varying from over a quarter to a half inch, the upper side showing a concavity or rounded hollow at this point. "This rolled portion," says Fitch, "is changed in its

color to a paler yellowish green, and its texture is thickened and succulent." The same leaf sometimes has two or more of these folds along different parts of its margin.

The larva is colorless or watery when young, becoming, as it approaches maturity, opaque and milk white, varied more or less with bright yellow. It is long oval, broadest in the middle and tapering thence to a sharp point anteriorly, the opposite end being bluntly rounded, and is divided into thirteen segments by transverse impressed lines. (Haldeman.)

## 18. THE LOCUST SAW-FLY.

*Nematus similaris* Norton.

Order HYMENOPTERA; family TENTHREDINIDÆ

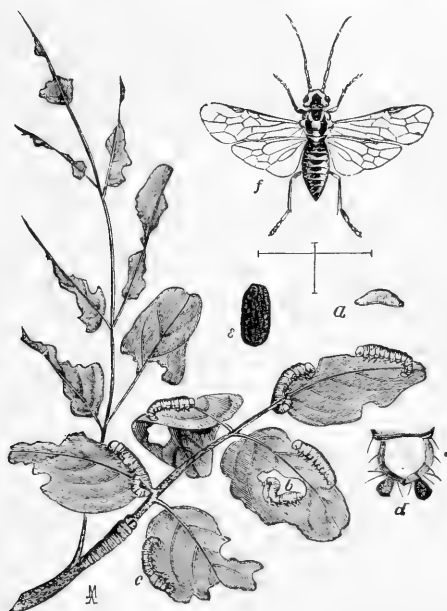


FIG. 136.—Locust saw-fly. *a*, eggs; *b*, *c*, worms; *d*, tail of the same; *e*, cocoon; *f*, fly.—After Comstock.

Eating the leaves of the black locust, a small, soft, green worm two-fifths of an inch long, with twenty legs, and a brownish head; appearing in Washington, D. C., late in August until October; transforming in a dark-brown oval cocoon, and two or three weeks later issuing as a saw-fly nearly one-quarter of an inch long, of a dirty yellow color, with a squarish black patch on top of the head, the sides and front of the thorax black, and a transverse band on top of each abdominal segment. (Comstock.)

This saw-fly inserts its irregularly semi-ellipsoid eggs in a crescent-shaped cut made in the under surface of the leaf by the "saw." In a few days the larva hatches. Professor Comstock thinks there are two and possibly three broods in a season, and that the insect may hibernate both in the adult and pupa stages. I have found this insect common in the larva state on the leaves of the locust at Brunswick, Me. The head of the worm is amber-colored, rather than "brownish."

## 19. BLACK LOCUST SAW-FLY.

*Nematus robinie* Forbes.

From a number of saw-fly larvæ found infesting the black locust (*Robinia pseudacacia*) at Normal, we bred during the latter part of July a small saw-fly related to *Nematus bivittatus* and *aureopectus*, but apparently undescribed. The larva from which this specimen was bred entered the ground July 8, emerging on the 26th. (Forbes' Third Rep. Ins. Illinois.)

*Adult*.—Body stout, pale brownish yellow; mesothorax with a black vitta upon each side; metathorax with a transverse black band continuous with the posterior extremities of the mesothoracic stripes; tergum blackish, with the sides and posterior margins of the segments of the general color; prothorax between the ends of the mesothoracic stripes a little darker brown; head slightly darker than the body, with a quadrate black spot upon the occiput, extending forward to include the ocelli. This area is slightly shining, but the adjacent surfaces of the head are dull, punctured, and rather densely pubescent. Antennæ longer than the head and body, third and fourth joints equal; clypeus emarginate in front. The under parts and legs are uniform pale yellow brown, except the tibiæ and tarsi of the posterior pair, which are dusky, and the genital valves of the female, which are black. Wings hyaline, veins fuscous, costa and stigmata yellowish, second submarginal cell slightly angled at the recurrent nervules, of which there are two about equally removed from the two extremities of the cell. First submarginal quadrate, distinct; posterior margin of wing behind the lanceolate cell slightly tinged with yellowish. Length of body, 4<sup>mm</sup>; expanse, 10<sup>mm</sup>. Described from a single female. (Forbes.)

20. *Parthenos nubilis* Hübner.

Dr. Harris has raised the moth from the caterpillar which in September is found hiding itself in holes of the trunk of the locust, going out at night to eat the leaves; the pupa was found in a loose web on the surface of the ground; the moth appeared June 18.

*Larva*.—First pair of abdominal legs rather smaller than the others, and rarely used in creeping or resting. Color, brown above, finely dotted and variegated with dark brown; body beneath pale brown, with a black spot between the prolegs, and a blackish streak beneath the last three segments. Two zigzag brown lines (almost black posteriorly) form a series of lozenges along the back, one lozenge being on each segment, and becoming gradually narrow behind. Each lozenge, especially those of the hinder segments, has a black spot near the hind angle. A pale line on each side below, and contiguous to the spiracles, and in young specimens a dark-brown line above the spiracles. The latter are black. Head round, dark brown, but spotted with pale points in clusters. Top of first segment marked with a semi-circular, darker, but not horny spot. Legs pale brown as the belly. (Harris Corr., 320.)

*Moth*.—Head rather small, thorax dark ashen, a black line in front, strongly tufted behind; abdomen dark gray above, lighter below, strongly keeled dorsally; forewings pointed, deeply scalloped outwardly, much rounded; color dark ashen; basal and transverse anterior lines distinct, geminate; transverse posterior line obsolete; beyond, a submarginal line, slender, much angulated; a blackish, somewhat triangular apical dash present; reniform spot large, bounded on each side by a light band, starting from the costa, the outer reaching to the outer third, the inner parallel, reaching to the inner margin; these are often nearly white, and coalesce behind the reniform spot; subreniform obsolete; hind wings bright yellow, with two median black bands, irregularly waved, parallel; discal lunule within strongly marked; marginal band toothed on both sides; fringe yellowish. Expands 50 to 70<sup>mm</sup>. Occurs throughout the Eastern States and in Colorado. (Hulst.)



21. *Cymatophora crepuscularia* Tr.

Order LEPIDOPTERA; family PHALENIDÆ.

Larvæ from which the above was bred were taken on white clover at Normal, June 21, the imagos emerging July 10.

*Larva*.—One inch long, slender, with only four prolegs. The head is widely bilobed and reddish brown above, yellowish varied with reddish brown in front, with two small approximate black spots on the middle of the front. The body is green, thickly covered with white granulations, with some black ones intermixed, and has an obscure reddish dorsal stripe. The posterior margins of the middle segments are narrowly bordered with yellow. On the penultimate segment is a large transverse blackish spot, with two small kidney-shaped yellow spots near its middle, approaching each other posteriorly. The legs are pale brown, blackish at base; prolegs black without, pale within; spiracles brown.

The same larva occurred in our collections on the rose and the common locust; taken from the former June 20, and from the latter July 4. We also collected it July 25, from the box elder (*Negundo aceroides*), the specimen pupating August 4 and emerging August 13. It has been found preying on the clover by Professor Forbes (Third Rept. Ins. Illinois).

22. *A Deltoid larva*.

A pale green caterpillar was observed at Brunswick, August 21, feeding on the under side of the leaf, and easily escaping detection since it was of the same hue as the under side of the leaf. September 14 it had made an oval-cylindrical cocoon in the soil at the bottom of the breeding box, the pupa being of the usual mahogany brown color.

*Larva*.—Pale green; body slender cylindrical, of the usual Hypena-like shape. Head as wide as the body, smooth, pale green; a dark green dorsal median line; a narrow thread-like subdorsal white slender line, and a much broader one lower down. All the legs green, thoracic ones a little chitinous at the end. The dorsal tubercles arranged in a trapezoid, but they are minute and give rise to very slender inconspicuous hairs. Length 17<sup>mm</sup>.

23. *Macrobasis unicolor* (Kirby).

Dr. John Hamilton states that a nursery of young locusts was almost defoliated in July by swarms of this beetle. (Can. Ent., xxi, 103.)

## 24. THE RAPACIOUS SCALE INSECT.

*Aspidiotus rapax* Comstock.

Like the pernicious scale insect (*Aspidiotus perniciosus*) this species infests many different plants; and sometimes it occurs in such great numbers as to be very destructive. This is especially the case on evergreens in hot-houses in the North or in the open air in the South; and in California on olive and mountain laurel (*Umbellularia californica*). I have also found it on the following-named plants in California: Almond, quince, fig, willow, eucalyptus, acacia, and locust. (Comstock).

*Scale of female.*—The scale of the female is very convex, with the exuviae between the center and one side, and covered with secretion. The scale is gray, somewhat transparent, so that it appears yellowish when it covers a living female; the prominence which covers the exuviae is dark brown or black, usually with a central dot and concentric ring which are white. Ventral scale snowy white, usually entire. Diameter  $1\frac{1}{2}$ mm (.06 inch).

*Female.*—The body of the female is nearly circular in outline, bright yellow in color with more or less translucent blotches. The last segment presents the following characters: The groups of *spinnerets* are wanting.

Only one pair of well-developed *lobes*, the median, present. These are prominent. Each one is furnished with a notch on each side; the notch on the mesal margin is distad of that on the lateral margin. The second and third pairs of lobes are represented by the minute pointed projections of the margin of the body.

The margin of the ventral surface of the segment is deeply incised twice on each side of the meson; once laterad of the first lobe, and again between the rudimentary second and third lobes. The parts of the body wall forming the margin of these incisions are conspicuously thickened.

There are two simple tapering *plates* between the median lobes, two deeply and irregularly toothed or branched plates extending caudad of each incision, one usually simple and tapering plate between the incisions of each side, and two or three of the same character laterad of the second incision.

The first, second, and third pairs of spines of each surface are situated near the lateral bases of the first, second, and third lobes, respectively; the fourth pair is situated at a little more than one half the distance from the median lobes to the penultimate segment. In each case the spine on the ventral surface is but little laterad of the one on the dorsal surface.

*Egg.*—The eggs and newly hatched larvæ are yellow.

*Male.*—Only dead and shriveled males have been observed.

*Habitat.*—On the bark of the trunk and limbs as well as the leaves and fruit of various trees and shrubs in California and Florida.

Described from seventy-five females and very many scales.

I have named this the greedy scale insect on account of the great number of plants upon which the species subsists. It also occurs in some localities in great numbers, being very destructive. This is especially the case on *Euonymus japonicus* at Fort George, Fla.; and in California on olive near San Buenaventura, and on mountain laurel (*Umbellularia californica*) at San José.

Mr. Elwood Cooper, of Santa Barbara, Cal., who has had some experience with this pest upon his olive trees, says that it is easily kept in check. According to his observations it flourished only upon those trees which are in an unhealthy condition, and as it is chiefly confined to the trunk and limbs it can be removed with a stiff brush and whale-oil soap solution. (Comstock Agr. Rep., 1880).

The following insects also feed on the locust:

#### COLEOPTERA.

25. *Spermophagus robiniae* (Fabricius). Family *Bruchidae* (see Horn, Trans. Amer. Ent. Soc., iv, 311).
26. *Agrius egenus* Gory. Mining under the bark of the twigs and smaller branches, the beetles eating the leaves. (Chittenden, Ent. Amer., v, 219).

27. *Neoclytus erythrocephalus* (Fabr.) Bred from the twigs (Chittenden in letter).
28. *Liopus cinereus* Lec. Bred from the twigs (Chittenden in letter).
29. *Anomæa laticlavata* (Forster.) Devouring the leaves (Chittenden).

## LEPIDOPTERA.

30. The Io moth, *Hyperchiria io* (Fabricius). (See p. 111.)
31. The tussock moth, *Orgyia leucostigma* A. and S.
32. The carpenter moth, *Xyleutes robinæ*, which more commonly affects the oak. (See p. 6.)
33. *Clisiocampa disstria* Hubn. (See p. 117.)
34. *Oedemasia concinna* (Abb. and Smith.) (Riley's Notes.)
35. *Clisiocampa erosa* Stretch. Oregon. (Papilio, i, 67.)
36. *Catocala vidua* Abbot and Smith. (See p. 178.)
37. *Gelechia pseudacaciella* Chamb. Larva feeds externally on the leaves and also in the mines of *Lithocolletis robiniella* (Chambers.)
38. *Xylesthia clemensella* Chamb. Larva bores in dead locust-timber posts, etc. (Chambers.)
39. *Lithocolletis ornatella* Chambers.
40. *Acæa purpuriella* Chambers. The larva makes a small mine and pupates in a small cocoon on the outside of the mine.
41. Tineid sp? unknown. "There is also a lepidopterous (probably Tineid) larva which bores in twigs, eating out the pith. It is striped with the head and next segment piceous." (Chambers in letter.)

## CHAPTER V.

### INSECTS INJURIOUS TO THE DIFFERENT SPECIES OF MAPLE.

(*Acer saccharinum* and *Acer rubrum*.)

The number of species here recorded as infesting the different species of maple, especially the rock or sugar and the red or swamp maple, is upwards of one hundred. Of these only a few are really injurious. Of European insects preying on species of *Acer*, Kaltenbach enumerates sixty-eight species. The maple-borer, *Glycobius speciosus*, is the most deadly foe of these beautiful shade trees, and when once established on a street lined with maples, or in a grove, is difficult to eradicate. No caterpillar strips the leaves as a regular recurrent pest, but they are in the Central States often ruined by the cottony maple scale; otherwise these trees are remarkably free from insect pests, and from their cleanliness and rapidity of growth, as well as dense foliage and beautiful outlines, will always prove a favorite shade and ornamental tree.

#### 1. THE SUGAR-MAPLE BORER.

*Glycobius speciosus* (Say).

Boring into the solid trunks of healthy sugar-maple trees, often killing them, a rather large, footless, cylindrical, whitish grub, changing in July to a large, beautiful, yellow-striped beetle, marked with a golden **W** on the wing-covers.

Although the question as to whether longicorn larvæ will bore into healthy solid wood is by some regarded as undecided, there is no doubt but that the present larva bores for several inches into the trunks of healthy trees, both young maples as well as trees ten or twenty inches in diameter. The following case fell under our own observation. On the grounds of Bowdoin College, Brunswick, Me., for two successive years (1873-74) a number of fine sugar or rock maples, nearly a foot in diameter, and which had been set out for thirty or forty years, suddenly died, and on being cut up into fire-wood were found to be deeply perforated in all directions by larvæ referable to this species by its large size and resemblance to the locust-borer. More than one larva and one borer were found in the same tree. There seemed little reason to doubt but that the grubs were the cause of the sudden death of the tree.

In the summer of 1881 I noticed that one tree in the college campus was partly killed by these borers, and that other trees in different

parts of the town had been bored by them. One tree, over one foot in thickness, had about twelve holes in the trunk, from which the beetles had issued a year or two previous. The leaves during the past summer were small and curled up, and the tree was evidently in a sickly condition. The few *Aphides* and *Psoci*, observable on the leaves in July and August, were not sufficiently numerous to occasion the trouble, and we attribute it to the effects of the borer. Another somewhat larger sugar maple in the same yard, the age of which was about forty-five years, had but two holes in it, made by the same borer, probably in 1878 or 1879; the tree was nearly healthy, with fully developed leaves. A red maple close at hand had not been affected by the borer, and we could not learn that this species (*A. rubrum*) had ever been attacked by this borer. It seems to us that these are clearly demonstrated cases where healthy trees have been killed by borers.

The first observer to notice this borer, and the fact that it destroys living maples, was Rev. L. W. Leonard, who gave an account of its habits to Harris. His attention was called, in 1828, to some young maples in Keene, N. H., which were in a dying condition. He discovered the insect in its beetle state under the loosened bark of one of the trees, and traced the recent track of the larva three inches into the solid wood. In the course of a few years these trees, upon the cultivation of which much care had been bestowed, were nearly destroyed by the borers.

This beetle was said by Mr. E. B. Reed, in 1872, to be gradually destroying the sugar maples at London, Canada, and in the Report of the Entomological Society of Ontario for 1878 Mr. Saunders states that the destruction was spreading rapidly in the streets of the same city. To this society we are indebted for the use of the figure of the beetle.

Regarding its ravages in Vermont, Mr. J. A. Lintner thus writes to the Country Gentleman (1884):

This borer is destroying a large number of our sugar maples, as its burrows usually are carried around the trunk beneath the bark, and when several occur in the same tree they girdle it by their interlacings and thus kill the tree. Even when they are not fatal to the tree, they occasion unsightly cracking of the bark and serious deformities of growth. In the pleasant village of Bennington, Vt., where I am sojourning, I notice that very many of the beautiful sugar maples that ornament its streets and shade its homes are threatened with speedy destruction through the attack of this pernicious borer.

The beetle, according to Harris, lays her eggs on the trunk of the maple in July and August. The grubs burrow into the bark as soon as they are hatched, and are thus protected during the winter. In the spring they penetrate deeper, and form, in the course of the summer, long and winding galleries in the wood, up and down the trunk.



FIG. 137.—*Glycobius speciosus*. Natural size.  
—From Saunders.

This destructive borer was, in 1884, still at work in Maine, where we have made such observations on its egg-laying habits and the mode of

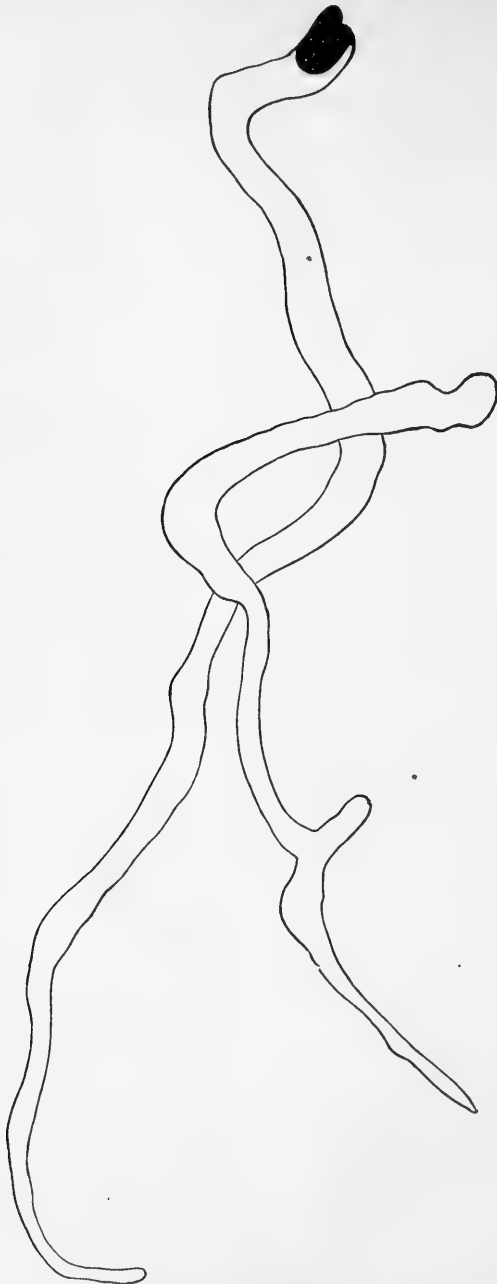


FIG. 138.—Mine of *Glycobius speciosus*, one-third natural size.

life of the freshly-hatched larva, that it now seems possible to prevent its entry into the heart-wood by cutting it out of the bark in the autumn.

The burrows, or mines, either extend under the bark or descend into the wood towards the heart of the tree. Different trees are variously attacked. Where the worms remain under the bark large pieces are loosened and gradually fall off, leaving sometimes nearly one side of the trunk bare. At the same time the general health of the tree is impaired, as shown by the sparseness of the leaves.

The beetles were unusually frequent in Brunswick during late July and especially in August, 1884, at this time laying their eggs. Al-



FIG. 139.—Mine of *Glycobius speciosus* in bark alone. Natural size.

though none were found engaged in the operation, there is little doubt, as will be seen below, that the process is nearly identical with that of the pine-borer, or *Monohammus*. I found two mines of this borer which crossed each other (Fig. 138), though usually each follows an independent course, unless much crowded. On a single tree from one side of which the bark had fallen off in consequence of the attacks of

this insect, there were about twelve "mines" or burrows, of which ten ran up the trunk. The mines were from 15 to 24 inches long, one measuring 2 feet and 8 inches in length. At the upper end the mines are about three-quarters of an inch wide. The mine either finally sinks deep in the wood or extends all the way under the bark until at the extreme end, where it sinks in a little way to form a cell, or chamber, for the chrysalis.

The tree dies slowly, and where the trunk has been mined on one side only the tree lives on, though the foliage be much thinner. Trees may, as we have observed, live for at least five or six years with a number of borers in their trunks.

Fresh from the observations made on the mode of egg-laying in the common pine-borer, I looked, September 12, for the eggs or freshly-hatched larvæ of *Glycobius speciosus*, and found the latter at once. The Rev. Mr. Leonard, of Dublin, N. H., many years ago, in a letter to Dr. Harris, stated that the maple-tree borer, on hatching, remained in the bark through the winter. Upon examining a sugar maple about two feet in diameter, I found that twenty eggs had been laid in different parts of the bark from near the ground to where the branches originated, a distance of about 10 feet. The site of oviposition was recognized by a rusty, irregular discoloration of the bark about the size of a cent, and especially by the "frass," or castings, which to the length of an inch or more were attached like a broken corkscrew to the bark. On cutting into the bark, the recently-hatched larvæ (5 to 7<sup>mm</sup> in length) were found lying in their mines, or burrows, at the depth of a tenth to a sixth of an inch.

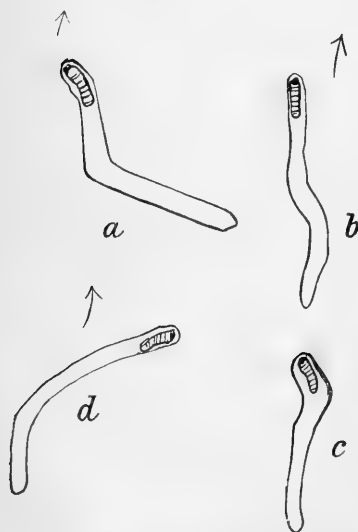


FIG. 140.—Mines of recently hatched larvæ of *Glycobius speciosus*.

The burrows already made (Fig. 140) were about an inch long, some a little longer; the larva usually mines upward. No eggs were found, but they are laid in obscurely marked gashes, about a fifth of an inch long, usually near a crevice in the bark.

These gashes and castings are readily discoverable, and it would be easy to save these valuable shade trees by looking for them in the autumn and winter or early spring, and cutting out the worms. The beetles were not uncommon at Brunswick in July and August in 1884. Of six grubs which I cut out over half seemed unhealthy, perhaps diseased by the water which had penetrated their mines.

I have recommended protecting valuable shade trees by wrapping the trunks with narrow bands of cloth well saturated with kerosene oil in



August and September, so as to drive off the beetles and to destroy the freshly-hatched grubs, but since discovering how easily the grubs and castings of the freshly-hatched worms can be detected a few days or weeks after the eggs have been laid, it seems obvious that the easiest and surest preventive is to cut out the grubs when lying in their autumn and winter quarters just under the surface of the bark. It is almost impossible to destroy the fully-grown worms in their "mines" or burrows, since the latter extend up the tree either directly under the bark or are sunken in the wood. On one tree nearly destroyed by this borer, out of about fourteen mines twelve extended upward. Hence it is useless to try to find the hole and inject oil into it. There now seems no reason why valuable shade maple trees should not be saved by a few hours' close observation and removal of the young grubs, say in September or October.

*The beetle* is black, with a yellow head, with the antennæ and the eyes reddish-black; the thorax is black, with two transverse yellow spots on each side; the wing-covers for about two-thirds of their length are black, the remaining third is yellow, and they are ornamented with bands and spots arranged in the following manner: a yellow spot on each shoulder, a broad, yellow, curved band or arch, of which the yellow scutel forms the keystone on the base of the wing-covers; behind this a zigzag yellow band forming the letter **W**, across the middle another yellow band arching backwards, and on the yellow tip a black curved band and spot; legs yellow, while the under side of the body is reddish-yellow, variegated with brown. Nearly an inch in length. (Harris.)

## 2. THE HORN-TAIL BORER.

*Tremex columba* (Linnaeus).

Order HYMENOPTERA; family UROCIDÆ.

Boring in the trunk and making large round holes, a large white grub with a prominent spine on the end of the body, and transforming in the late summer into a large clear-winged saw-fly, with a long large "saw" on the tail of the female.

This interesting insect bores indifferently in various forest and shade trees, attacking the elm, oak, sycamore, and perhaps more commonly the maple. The holes of this borer may be recognized by their large numbers within a given space, and by their regular, evenly-cut shape, being about the diameter of a lead-pencil. We remember seeing some years ago a tree at Saratoga Springs, in the trunk of which, where the bark had been removed, were a dozen or more of the round even holes made by these insects, which seem to work somewhat in concert. Isolated shade trees along roads and in streets are favorite habitats. Harris says that an old elm tree in his vicinity used to be a favorite place of resort for this saw-fly, numbers of them collecting about it during the months of July, August, and the early part of September. "Six or more females might frequently be seen at once upon it, employed in boring into the trunk and laying their eggs, while swarms of the males

hovered around them. For fifteen years or more some large button-wood trees in Cambridge have been visited by them in the same way."

Prof. J. A. Lintner, State Entomologist of New York, has communicated the following facts to the Country Gentleman:

Something has attacked a large maple tree in front of my house. The trunk looks as if a large dose of buckshot had been shot into it, having fifty or more clean holes about one-eighth of an inch across. Can you tell me what to do to save the tree? I have seen a large insect like a wasp, with several boring arrangements at least 3 inches long each, inserting these into the tree. Do these cause the mischief?

W. S. J.

*Poughkeepsie, N. Y.*

[Answer by Prof. J. A. Lintner, State Entomologist.]

The several holes in the maples have been bored by the larvæ of *Tremex columba*, one of our saw-flies and the largest of our species. The female is armed with a stout borer, the end of which is furnished with teeth, by means of which it is thrust through the bark into the wood, to the depth sometimes of half an inch and the egg inserted. Occasionally the female is unable to withdraw her borer, when she may be captured, during the months of July and August, struggling to escape from the tree. The larva hatching from the egg burrows into the trunk, and when it has nearly matured, by the aid of its strong jaws, it enlarges its round burrow outwardly to the size often of a small lead pencil, to permit the escape of the perfect insect.

While maples are more frequently attacked by this insect than other trees, it is also found in oaks, elms, and sycamores, and more commonly in those planted as shade trees in streets or about dwellings. Unless it is very abundant it does not destroy the tree that it attacks, but the holes soon heal over without serious injury following. Its injuries are far less serious than are those of another borer of the maple, the *Glycobius speciosus* (Say), a beautiful long-horned beetle, the black wing-covers of which are prettily ornamented by a yellow **W**, and by other yellow bands and spots.

"The female, when about to lay her eggs, draws her borer out of its sheath, till it stands perpendicularly under the middle of her body, when she plunges it, by repeated wriggling motions, through the bark into the wood. When the hole is made deep enough, she then drops an egg therein, conducting it to the place by means of the two furrowed pieces of the sheath. The borer often pierces the bark and wood to the depth of half an inch or more, and is sometimes driven in so tightly that the insect cannot draw it out again, but remains fastened to the tree till she dies. The eggs are oblong-oval, pointed at each end, and rather less than one-twentieth of an inch in length." Harris adds, what has been observed frequently by others since his time, that these larvæ are often destroyed by the maggots or larvæ of two singular ichneumon flies (*Rhyssa atrata* and *lunator*). These are the largest known ichneumon flies; they are provided with long, slender borers or ovipositors from 3 to 4 inches in length, which they thrust into the deep holes made by the *Tremex* borers, in the bodies of which they insert an egg.

(We have, however, observed one of these *Rhyssæ* engaged in ovipositing in an elm tree infested with the larvæ of *Compsidea tridentata*.)

The following description of the larva is copied from our report "On the Insects affecting the Cranberry, with remarks on other injurious Insects."\*

*The larva.*—A long, white, cylindrical worm, with the segment behind the head of the same width as the twelfth segment from the head; the thirteenth much narrower, regularly rounded behind, with a deep crease above, leading backward and a little downward to a small, sharp, terminal, dark-reddish horn. The horn is acute, with three teeth above, near the base, and two smaller ones on the under side. Each of the three last rings bulges out on the under side. The head is white, and about half as wide as the segment behind, into which it partially sinks. It is rounded, smooth, with the antennæ represented by small rounded tubercles, ending in a minute horny spine; should the spine be regarded as indicating a joint, then the appendage is three-jointed. The clypeus is broader than the labrum by a distance equal to its own length. The labrum is a little more than twice as broad as long, with the front edge slightly sinuous. The large, powerful mandibles are four-toothed on one side and three-toothed on the other. The maxillæ are three-lobed, the lobes unequal, ending in spines, the middle lobe with two spines, the outer lobe much smaller than the others. The labium or under lip is rather large, rounded, with a spine projecting on each side. The prothorax or segment next behind the head is twice as long as the one behind it, divided into two portions by a suture behind it. There are three pairs of small, soft, unjointed feet, of which the first pair are considerably the largest; they do not project straight out, but are pressed to the body and directed backward. There are ten pairs of spiracles, one pair on the hinder edge of the prothorax, twice as large as the others; the second pair between the second and third rings, and the eight others on the eight basal abdominal segments. Length, 2.25 inches; greatest thickness, .28 inch.



FIG. 141.—  
Larva of  
*Tremex*  
*columba*  
nat. size.  
— From  
Packard.

The larvæ from which the above description was taken were found at Amherst, Mass., early in October, in a tree containing several of the adult insects, which had not left their holes and seemed likely to be destined to pass the winter in the tree. Clementi has, in Ontario, Canada, taken several of the imago with the larvæ from the oak in March, so that it undoubtedly hibernates as an imago.

Mr. W. H. Harrington states (Can. Ent., XIV, 225) that on the 9th of October, 1880, he found one ovipositing in an old beech, which had for some time been much infested by these borers. He also, October 10, visited some old maples which are a favorite resort of these insects, and captured upon one of them a female in the act of ovipositing, while upon the same tree were the bodies of three or four which had evidently very recently perished in the performance of such act.

### 3. THE WHITE-HORNED XIPHIDRIA.

*Xiphidria albicornis* Harris.

Order HYMENOPTERA; family URO CERIDÆ.

This fine saw-fly has been found by Mr. W. H. Harrington not only upon dead trees, but he has usually observed it upon living ones; not

\* In the Tenth Annual Report of the U. S. Geological and Geographical Survey of the Territories for 1876, p. 531. By F. V. Hayden, U. S. Geologist. Washington, 1878.

only on those that are old and hastening to decay, but preferably upon those that are young and presumably vigorous. He observed them almost daily from the middle of June to the end of July on shade trees in Ottawa, or on trees in the neighboring woods. "On a tree not more than 2 or 3 inches in diameter I have seen as many as eight ovipositing at the same time, and have frequently observed two or three at once upon small shade trees. *Tremex* in its endeavors to oviposit through the tough, thick bark of the old trees frequently fails in withdrawing its ovipositor, and scores of such self-immolated martyrs to the propagation of their race may be seen in the autumn dead and dry. This is a fate that rarely befalls *Xiphidria*; indeed, I have only met with one instance of a dead specimen thus anchored. Hence this insect will in many instances deposit successfully a much larger proportion of its eggs than can its larger relative, and thus stands a better chance of rapidly increasing the species. \* \* \* In July last I found in a neighboring wood a dead tree on which the bark had become shriveled and loosened. On removing a large patch of the bark, the surface of the wood was found to be thoroughly riddled with the holes of *X. albicornis*, either empty or still containing dead insects. These had evidently been prevented from leaving their burrows by the death of the tree and consequent drying and hardening of the bark. Many others had partly penetrated the bark and then perished from the same cause. The holes were slightly larger than would be made by an ordinary knitting-needle, and penetrated the solid wood perpendicularly to some depth." (Rep. Ent. Soc. Ontario for 1883, p. 40.)

*The saw-fly.*—With a general resemblance to *Tremex columba*, it is much smaller, and is black, with white markings and yellow legs. Females one half to two-thirds inch long; antennæ white; thorax with a triangular white patch inclosing a black dot on the shoulder and two small spots on the back between the hinder pair of wings. Abdomen jet-black, except four to six light spots or semi-bands on each side. The male is generally smaller, the abdomen flattened and rounded at the tip.

*Remedy.*—Mr. Harrington proposes the use of a preparation made by diluting soft-soap with a saturated solution of washing soda, which must not be made too thin. This should be liberally applied with a brush, so as to fill all crevices in the bark and give it a good coating. As the female of *Xiphidria*, like those of the apple-borers, seems always to deposit her eggs in the trunk below the branches, it would be quite possible to protect in this manner shade trees in towns and districts where the insect was observed, especially recently transplanted trees, which the insect seems to single out as offering special advantages for her future offspring; perhaps because she can perceive in them a weaker vitality, even when they are apparently flourishing. The coating would have to be applied in the early part of June and again a month later, as the insects occur during the greater part of June and July.

4. *Oryssus sayi* Westwood.

This interesting saw-fly has been proved by Mr. W. H. Harrington to breed in the wood of old dead sugar maples, while he thinks that it may also infest the willow, and possibly a variety of trees, but whether it feeds on the wood or is parasitic has yet to be determined. The perfect insect in Canada appears in June. It is very lively in its movements and might be mistaken for a moth. (Can. Ent., xix, p. 81, 1887.)

*The saw-fly.*—Body stout, black, cylindrical. Length about one-half an inch. Face very coarsely punctured, sometimes with a short white line on each side; the vertex prominent, and the lower ocellus surrounded with conspicuous tubercles; eyes moderately large. The antennæ are peculiar: In the male they have eleven joints, the third slightly longer and four to eleven subequal: in the female they have, however, only ten joints, of which 4, 5, and 10 are very short; in both sexes they are touched with white near the middle. The wings are hyaline, with a broad, smoky band commencing near the stigma, and extending almost to the tips. The legs have a spot on the tip of the femora, and a line on the tibia without white. In the female the anterior pair is swollen, the tibiæ crooked, and the tarsi with only three joints. The abdomen has the basal segment very coarsely punctured, or scabrous; the remaining ones polished, shining, varying in color as previously mentioned.

The ovipositor is of special interest, as it differs remarkably from those of the other Uroceridæ. Usually it is not visible, as when retracted the tip is concealed in a deep cleft in the terminal segments. It has the appearance, as stated by Norton, of springing from the last segment, but it is evidently attached much nearer the base of the abdomen, and is protruded from beneath a small ventral scale, which is apparently a portion of the fifth segment. It is very slender, hair-like, and nearly twice as long as the insect, and must consequently be coiled within the abdomen in a manner somewhat similar to that of *Ibalia*. Norton says it is ordinarily concealed in a channel beneath the abdomen; Brullé, and other authors, as rolled spirally within it. (Can. Ent. xix, May, 1887, p. 85.)\*

5. *Oryssus terminalis* Newman.

Mr. Harrington records having taken specimens, "both in the act of emerging from the trunk of a dead maple, and in the act of ovipositing therein." It appears in June.

---

\**Ibalia maculipennis* Hald. "This curious species belongs to the family Cynipidæ, or gall-forming hymenoptera, and is much larger than any of our other species. It is nearly three-quarters of an inch in length and the wings expand about an inch. The head and thorax are stout, but the abdomen is compressed laterally until it is very thin, and has the shape almost of a knife-blade. The ovipositor is very long and slender, and when not in use is retracted and coiled up in the abdomen. The insects are rare, and have only recently been recorded (by Provancher) as occurring in Canada. I find both sexes upon old trees in June, and have found the female ovipositing in the bark. The general color is yellow, with brown spots upon the head and thorax, and with black bands upon the abdomen and the legs. It is possible that the larvæ may be parasitic upon those of one or more of the insects mentioned in this paper." (Harrington, Rep. Ent. Soc. Ontario, 1887, p. 24.)

## 6. THE SIXTEEN-LEGGED MAPLE-BORER.

*Egeria acerni* (Clemens).

Order LEPIDOPTERA; family ÆGERIADÆ.

Following the work of the flat-headed borer, burrowing under the bark of the soft maple, sometimes girdling and killing the tree, a caterpillar with sixteen legs, spinning a cocoon of silk covered with its castings; the moths issuing from the tree late in May and thence through the summer, the worms occurring under the bark through the summer and winter. (Riley.)

This borer is sometimes very destructive to soft and sometimes to sugar maples, especially young trees, in Ohio, Illinois, and Missouri, the moths sometimes emerging in great numbers from the trunks of the trees in May and June. Mr. G. R. Pilate states that the red maple trees in Dayton, Ohio, were greatly infested by this borer, in consequence of which a large number of those shade trees are dead or dying. (Bull. Brooklyn Ent. Club, vol. i, 20.)

Mr. Kellicott remarked in the Canadian Entomologist for January, 1881, that the "larvæ of this moth are annually doing much damage to the hard maples (*Acer saccharinum*), planted so generally in this city [Buffalo] for shade; they are less destructive to the soft maple (*A. rubrum*). It appears that they seldom attack uninjured trees, but depend upon accidents to afford them opportunity to enter the inner bark and superficial wood; when once established they keep at the scar or wound year after year, thus preventing recovery and causing the trunks to become rough and unsightly; in many cases the trees are thus almost ruined. The moths appear most numerous from May 20 to June 15. I have not been able to find, after patient search, this borer in our forest maples."

Professor Riley says he has always found the worms in such trees as have been injured either by the work of the flat-headed borer, by the rubbing of the trees against

a post or board or in some other way. "Where the bark is kept smooth they never seem to trouble it, the parent evidently preferring to consign her eggs to cracked or roughened parts. For this reason the worm is not found in the smoother branches, but solely in the main trunk."

**Remedies.**—"Whether the soap applications will prevent the moth from depositing her eggs is not known; judging from analogy, probably not. Yet it will tend to keep the bark smoother, and in being used to

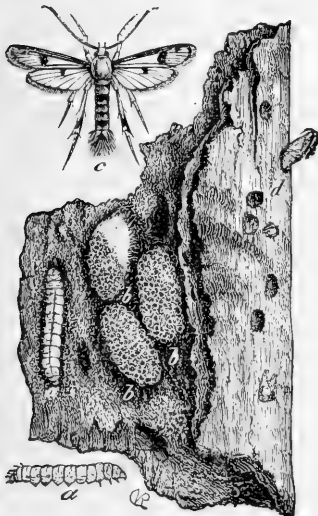


FIG. 142.—*c. Egeria acerni*; a, caterpillar; b, cocoon; d, pupa cases.—After Riley.

shield the tree from the other borer, it will indirectly shield it from this one. Mr. Gennadius recommends whitewashing the trunks, and filling up all holes and fissures with mortar, so as to render the bark as smooth as possible."

Mr. W. Saunders remarks that the female deposits her eggs on the bark of the soft and sugar maple trees, chiefly on the former, and when hatched the young larvæ burrow through the bark and feed upon the inner portion and sap wood, never penetrating into the solid heart-wood. The excavations made by the larva are filled with its brown castings. When it is fully grown it eats its way nearly through the bark, leaving but a very thin layer unbroken; it then retires within its burrow, and having inclosed itself within a loose, silky cocoon, changes to a brown chrysalis. A short time before the moth escapes the chrysalis wriggles itself forward and pushing itself against the thin papery-like layer of bark, ruptures it and protrudes as shown in Fig. 142, *d*. Soon afterward the imprisoned moth in its struggles ruptures the chrysalis and escapes.

"This insect appears to be increasing in numbers every year, and is very destructive, especially to young maple trees. Many of the shade trees in London are much injured by it, and when very numerous it is liable to completely girdle the tree and kill it. It is also found throughout the Middle States. To prevent the moths from laying their eggs the trunks of the trees should be painted about the first of June with a mixture of soft-soap and lye about the thickness of paint, or with a mixture of lime and soap. When once the larvæ obtain an entrance it is very difficult to discover them, and they will then carry on their destructive work all through the summer." (Can. Ent., xiii, p. 69.) (See also Insect Life, ii, 1890, 251.)

*The moth*.—Head and palpi deep reddish orange, thorax ochereous yellow; abdomen bluish black varied with yellow, with a deep reddish terminal tuft. Fore-wings with the edges and median vein bluish black dusted with yellowish; a large discal bluish black patch; end of the wing ochereous yellow with a blackish subterminal band and the veins blackish. Hind wings with a blackish discal patch. Body beneath ochereous yellow, with a bluish black patch on each side of the second abdominal segment. Middle and posterior tibiæ ringed with bluish black; the fore-legs blackish, with the coxæ (or hip joints) touched with reddish orange; expanse of wings about 0.80 inch.

*The larva* is a little over half an inch long, livid white, the head small and yellow, cervical shield paler; with sixteen legs, all of which are reddish. (Clemens.)

#### 7. THE FLAT-HEADED APPLE-TREE BORER.

*Chrysobothris femorata* Fabricius.

In the Mississippi Valley, sometimes riddling soft maples through and through, sometimes confining itself mostly to the inner bark, causing peculiar black scars and holes in the trunk; a flat-headed grub, transforming to a flat, hard-shelled beetle. (Riley.)

While this beetle more commonly infests the oak (p. 64) and the apple, it threatens in the Western States, according to Riley, to impair the value of the soft maple for shade and ornamental purposes.

## E. THE PEACH AND CHERRY FLAT-HEADED BORER.

*Dicerca divaricata* Say.

Order COLEOPTERA; family BUPRESTIDÆ.

(Larva, Pl. XVI, fig. 2.)

Boring in red maple stumps, a flat-headed borer whose prothoracic segment is not so wide in proportion to the two following segments as in *Chrysobothris* larvæ.

Although Fitch says that the beech is undoubtedly the original residence of this borer, now destructive to cherry and peach trees, and that "wherever a dead tree of this kind occurs some of these beetles will almost always be found upon it on sunny days in midsummer," we have found several of the fully and half grown larvæ, with the dead beetle, in a partly rotten stump of the swamp maple at Providence, June 1. The hole for the exit of the beetle is oval cylindrical, 8<sup>mm</sup> in its longer diameter and 4<sup>mm</sup> in its shorter. The following description of the larva was drawn up from the larger specimens; that of the beetle is quoted from Harris:

*Larva*.—Prothoracic segment moderately broad, not so long as wide, but not so wide in proportion to the two succeeding segments as in *Chrysobothris*; the second thoracic segment trapezoidal, narrower than the first by two-thirds of its length; third thoracic segment a little narrower and a little longer than the second. All the abdominal segments about two-thirds as wide as the third thoracic, and round and thick. The terminal segment a little over one-half as wide as the one before it. Prothoracic segment with a large broad rough chitinous surface, with an inverted narrow V with long slender arms to the V. On the underside of the segment the rough surface is divided into two by two nearly parallel longitudinal smooth lines. Length of body, 35<sup>mm</sup>; length of prothoracic segment, 5<sup>mm</sup>; breadth, 7<sup>mm</sup>; width of metathoracic segment, 5<sup>mm</sup>; width of an average abdominal segment, 4<sup>mm</sup>.



FIG. 143.—*Dicerca divaricata*. Marx del.

*The beetle*.—Wing-covers much elongated and spreading widely apart at the end; the insect copper-colored, thickly covered with little punctures; the prothorax slightly furrowed in the middle; the wing-covers marked with numerous fine irregular impressed lines and small oblong square elevated black spots; middle of the breast furrowed; the male with a little tooth on the under side of the shanks of the middle pair of legs. Length, 18 to 23<sup>mm</sup>.

In addition to the above description of the larva, the following characters may be given. The mouth-parts are as described in *Chrysobothris femorata*, and a drawing could not well show the generic or specific differences between *Chrysobothris femorata* and *D. divaricata* as regards these parts. They are as described in *C. femorata*; the labium is the same, but with the front edge perhaps a little less full and rounded. The maxillæ are perhaps a little fuller. Antennæ the same, the third joint minute and rounded. On the whole, the antennæ and maxillæ are a little stouter, and slightly more developed than in *C. femorata*. The labrum is, however, less full and rounded on the front edge. On the mesothoracic segment is a transverse narrow chitinous area, while that



on the metathoracic segment is of a double lunoid shape. The first abdominal segment has a short, narrow dorsal area, shorter than the one on the preceding segment. The lateral linear crescent-shaped impressed lines are well marked.

This larva differs from that of *Chrysobothris femorata* in being considerably larger, the abdominal segments being thicker in proportion to the prothorax, and also in the style of sculpturing on the prothorax. The apex of the **V** is surrounded by a square, deeper-colored area; the disk on the under side is divided by a double line, which widens suddenly in front into halves.

9. THE QUERCITRON BARK-BORER.

*Graphisurus fasciatus* (De Geer).

Order COLEOPTERA; family CERAMBYCIDÆ.

This beetle, more commonly found on the oak, has been found in the pupa as well as adult stage under the bark of the sugar maple in Northern New York by Mr. George Hunt; and we have reared the beetle from a pupa found under the bark of the red or swamp maple, at Providence, June 1. The cell made by the larva for the repose of the pupa is about an inch long, one-third of an inch wide, and one-tenth deep. (See also p. 71.)

10. *Xyloterus politus* Say.

Order COLEOPTERA; family SCOLYTIDÆ.

In this species, according to Leconte, the elytra have ill-defined distant rows of punctures, with interspaces equally strongly punctured, pubescence erect and abundant. He has received specimens from Dr. J. A. Lintner, said by him to depredate on maple trees. "It is easily known," adds Leconte, "by being more hairy than the other species, with the interspaces of the elytra sparsely punctured, so that the rows of punctures appear confused."

11. *Bellamira scalaris* Say.

This longicorn has been taken by Mr. Harrington in the act of ovipositing in a maple stump in July. It also attacks the birch.

*The beetle*.—Head contracted behind the eyes to form a neck; thorax narrow; wing-covers pubescent, glistening, rather wide at the base, but tapering rapidly behind, and shorter than the abdomen. Reddish, with yellowish antennæ and feet. Length, 25<sup>mm</sup> to 30<sup>mm</sup>.

12. THE WHITE ANT.

*Termes flavipes* Kollar.

The following copy of an article by Dr. H. A. Hagen (Can. Ent., xvii, p. 134) shows that this insect, usually only destructive to rotten wood, may rarely attack living trees.

The common white ant (*Termes flavipes*) destroys dead wood, stumps of trees, and timber, just as does its nearest relative, *T. lucifugus*, in Europe. Of the latter species some cases are reported where living pines and oaks have been destroyed in the south of France. For *T. flavipes* only one case is known, in which living grape-vines in a hot-house in Salem were injured (S. H. Scudder, Proc. Boston N. H. S., vol. vii, p. 287). Now the earth in the hot-houses there in Cambridge is largely infested by white ants, but, as far as I know, no destruction of plants has been observed. I was very much interested by the information from Mr. F. W. Putnam that in a garden in Irving street living maples were largely infested by white ants. The evidence of the truth of this information was apparent by the first glance at the trees. They were three in number, some few yards separated, more than 60 feet high, 2 feet diameter at base, and apparently in good condition, except that the bark was in certain places affected or split. Those places had somewhat the appearance of the well-known winter splits of the bark of trees. In removing parts of the bark, directly living white ants, workers and a few soldiers, were found, collected, and proved to belong to *T. flavipes*. Closer observation showed that small open gangs, covered outside by the loose bark, ran along the tree to a height of 30 feet or more. There were on this estate no old rotten stumps, but some of the adjacent uninhabited estates contained them, where probably the nest may be found; nevertheless, the whole estate was so overrun by white ants that they had made along the fence a long track covered with the hard clay-like mud with which they usually fill the eaten parts. As the boards of the fence were thin, it was perhaps judged safer to build the canal outside instead of on the interior of the boards. The house, a frame house, about ten years old, the stables, and the wooden sheds were entirely intact. The estate near to it seemed to be entirely free of the pest. The foliage of the infested trees looked very remarkable. Mr. Sereno Watson, the curator of the Cambridge Herbarium, was at first at loss to determine the leaves; the size, the shape, and the venation would not agree with any known species. But when he saw the tree, he was directly sure that it was only the common *Acer rubrum*. Some fresh shoots near the base of the tree had unmistakably the leaves of the common red maple. All the other leaves were very small, mostly not more than 2 inches broad, the median lobe often short, sometimes blunt, and not longer than the side lobes; the ribs below were about yellowish, and decidedly less dark than on the red maple. The owner of the estate had for ten years not observed any change in the foliage of the trees. During the last winter the upper part of one tree, some 20 feet, broke down in a gale, and proved to be not infested by white ants. Now it was considered safe to fell the whole tree. The bark was, in the place where the gangs went up along the trees, extensively bored and hollowed by the white ants. The wood itself was only 2 feet above the ground filled with the common white ant holes and gangs, but no more than 1 inch deep around the stump. The inner part of the tree showed the wood perfectly sound for 31 feet, except a perpendicular hole of 2 inches diameter in the middle of the tree, going down to the root. This hole, perhaps made by squirrels, had black ants as inhabitants. The two other trees are still standing. In consequence of those facts, I looked around in Cambridge, and have now the suspicion that perhaps the injury done to living trees may be less rare than I had supposed. If similar observations are made by entomologists, I would be thankful to have them communicated to me.

### 13. *Ptilinus ruficornis* Say.

Order COLEOPTERA; family PTINIDÆ.

Mr. Harrington states that he has seen in Canada "great numbers issuing from maple trees, leaving the wood riddled with small holes." The beetles, he says, are very common and attack various trees, both living and dead. "When a tree, say oak, hickory, or maple, has been

injured by blazing or peeling of bark, this little beetle may frequently be seen boring into the exposed wood, or if the injury is an old one, perhaps numbers may be found emerging."

This beetle, Mr. Devereaux writes me, is found in New York in great abundance in the larval state in timber, logs, and cord-wood. It deposits its eggs in the summer of the year in which the tree is cut; many generations following each other for a number of years in the same log.

*The beetle.*—Brownish, with the head almost hidden by the prothorax. The male much smaller, with reddish pectinate antennæ. Length, 5<sup>mm</sup>.

14. *Eupsalis minuta* (Drury).

Mr. Harrington records collecting about twenty of these beetles from under the bark of a large fallen sugar maple. "The larvæ had apparently lived chiefly on the inner layers of the bark and on the sap wood. On another occasion I found specimens emerging from a maple stump." (See Oak Insects, p. 69.)

15. THE SUGAR-MAPLE TIMBER BEETLE.

*Corthylus punctatissimus* (Zimm.)

Order COLEOPTERA; family SCOLYTIDÆ.

The devastations of this beetle have been described by Dr. C. H. Merriam in the American Naturalist for January, 1883:

I noticed that a large percentage of the undergrowth of the sugar maple in Lewis County, northern New York, seemed to be dying. The leaves drooped and withered,



Fig. 144. Mines of *Corthylus punctatissimus*.—Merriam del.

and finally shriveled and dried, but still clung to the branches. The majority of the plants affected were bushes a centimeter or two in thickness, and averaging from one to two meters in height, though a few exceeded these dimensions. On attempting to pull them up they uniformly, and almost without exception, broke off at the level of

the ground, leaving the root undisturbed. A glance at the broken end sufficed to reveal the mystery, for it was perforated, both vertically and horizontally, by the tubular excavations of a little Scolytid beetle which, in most instances, was found still engaged in his work of destruction.

At this time the wood immediately above the part actually invaded by the insect was still sound, but a couple of months later it was generally found to be rotten.

During September and October I dug up and examined a large number of apparently healthy young maples of about the size of those already mentioned, and was somewhat surprised to discover that fully 10 per cent. of them were infested with the same beetles, though the excavations had not as yet been sufficiently extensive to affect the outward appearance of the bush. They must all die during the coming winter, and next spring will show that, in Lewis County alone, hundreds of thousands of young sugar maples perished from the ravages of this Scolytid during the summer of 1882.

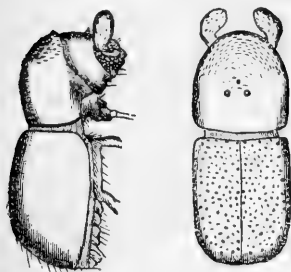


Fig. 145. *Corthylus punctatissimus*.  
Merriam del.

The hole which constitutes the entrance to the excavation is, without exception, at or very near

the surface of the ground, and is invariably beneath the layer of dead and decaying leaves that everywhere covers the soil in our northern deciduous forests. Each burrow consists of a primary, more or less horizontal, circular canal, that passes completely around the bush but does not perforate into the entrance hole, for it generally takes a slightly spiral course, so that when back to the starting point it falls either a little above or a little below it—commonly the latter (see figs. 144, *a* and *b*). It follows the periphery so closely that the outer layer of growing wood, separating it from the bark, does not average .25<sup>mm</sup> in thickness, and yet I have never known it to cut entirely through this so as to lie in contact with the bark.

From this primary circular excavation issue, at right angles, and generally in both directions, (up and down), a varying number of straight tubes, parallel to the axis of the plant (see figs. 144, *a*, *b*, *c*). They average five or six millimeters in length and commonly terminate blindly, a mature beetle being usually found to extend farther and, bending at a right angle, to take a turn around the circumference of the bush, thus constituting a second horizontal circular canal, from which, as from the primary one, a varying number of short vertical tubes branch off, and in very exceptional cases these excavations extend still deeper, and there may be three, or even four, more or less complete circular canals. Such an unusual state of things exists from the specimen from which figure 144, *d*, is taken.

It will be seen that, with few exceptions, the most important of which is shown in figure 144, *d*, all the excavations (including both the horizontal canals and their vertical offshoots) are made in the sap-wood, immediately under the bark, and not in the hard and comparatively dry central portion. This is doubtless because the outer layers of the wood are softer and more juicy, and therefore more easily cut, besides containing more nutriment and being, doubtless, better relished than the dryer interior.

This beetle does not bore, like some insects, but devours bodily all the wood that is removed in making its burrows. The depth of each vertical tube may be taken as an index to the length of time the animal has been at work; and the number of these tubes generally tells how many inhabit each bush, for as a general rule each individual makes but one hole, and is commonly found at the bottom of it. All of the excavations are black inside.

The beetle is subcylindric in outline and very small, measuring but 3.5<sup>mm</sup> in length. Its color is a dark chestnut-brown, some specimens being almost black. Its head is bent down under the thorax and can not be seen from above. (See fig. 145.)

16. *Xyloterus politus* Say.

According to Prof. J. A. Lintner this bark-borer lives at the expense of the maple.

17. *Stenoscelis brevis* Boheman.

Order COLEOPTERA; family CALANDRIDÆ.

This beetle occurred in a partly rotten stump of the red maple in a swamp at Providence, June 1, in company with *Dicerca divaricata* and *Xestobium affine*. All these beetles were submitted to Dr. Leconte for identification. The mines are irregular, sinuous, 1.5 to 2<sup>mm</sup> in diameter, and were quite numerous.

18. *Xestobium affine* Le Conte.

Order COLEOPTERA; family PTINIDÆ.

Several specimens of this beetle occurred June 1 in a rotten stump, with the larvæ, which closely resembles those of *Ernobius*. It makes a sinuous mine 4<sup>mm</sup> in diameter, opening externally by a round hole 3<sup>mm</sup> in diameter; the burrows being filled with fine excrement.

*Larva*.—Body cylindrical, white, soft, very full and rounded at the end, a little the thickest at the thoracic portion; three pairs of thoracic, three-jointed, rather slender feet. Head rather large, more than half as thick as the body. End of abdomen covered with rather dense yellowish hairs. Length, 10<sup>mm</sup>; thickness of body, 3.1 to 4<sup>mm</sup>. Fig. 441 of *Ernobius mollis* in my Guide to the Study of Insects well represents the general appearance of this larva.

BORING IN THE TWIGS.

19. THE ASTER STALK-BORER.

*Gortyna nitela* Guen.

This common borer of the stalks of the dahlia and aster has been observed by Professor Osborn boring in young twigs of the ash, many dead twigs being the proofs of their work. Miss Murtfeldt



Fig. 146.—The aster stalk-borer and moth.—After Riley.

has also observed it in twigs of the maple (*Acer dasycarpum*), and Professor Riley states that it occurs in peach twigs as well as the branches of *Ambrosia artemisiæfolia*. He also states that the young worm in Illinois hatches about the 1st of July, and immediately begins its work of destruction. The plant in which it feeds does not usually

show any signs of decay until the worm is about fully grown, when it wilts and is past recovery. About a month after the worm is hatched it crawls just under the surface of the ground, fastens a little earth together around itself by a slight web, and changes to a chrysalis of a very light mahogany-brown color three-fourths of an inch long, the moth appearing early in September.

*Larva*.—Dull-colored, with wart-like spots; livid or purplish brown; darker before than behind, though varying much as to depth of shading.

*The moth*.—Fore-wings lilac-gray, speckled with minute yellow dots, with a distinct white band running across them. Expanse of wings, 35<sup>mm</sup>.

#### AFFECTING THE LEAF-BUDS.

##### 20. THE MAPLE-BUD BEETLE.

*Platycerus quercus* Weber.

Order COLEOPTERA; family LUCANIDÆ.

This beetle was noticed May 6 by Mr. Harrington gnawing holes in the center of the leaf buds, where, hidden within, it feasts on the growing leaves. "In one instance a pair of beetles (male and female) were found in the same cavity. I have since found the beetles upon the leaves of various trees, and the larvæ in old logs and stumps of elm, etc." (Rep. Ent. Soc. Ontario, 1887, 31.)

*The beetle*.—In *Platycerus* the eyes are almost entire, while the sixth ventral segment is visible (it is not so in *Dorcus*, whose eyes are hollowed out). Body flat, black (reddish beneath in the female), with sometimes a greenish hue; antennæ with the terminal joints lamellate; while the jaws of the male are long and like pincers, those of the female being shorter. Length, 10<sup>mm</sup>. (Horn.)

#### AFFECTING THE LEAVES.

##### 21. THE SPINY MAPLE WORM.

*Dryocampa rubicunda* (Fabricius).

Order LEPIDOPTERA; family BOMBYCIDÆ.

Sometimes nearly stripping soft maples of their leaves, large smooth worms longitudinally striped with pale and darker green lines, and recognizable by two anteriorly projecting black horns on the second segment behind the head, and transforming to a pale, ochre-yellowish, thick-bodied moth, tinged, especially on the fore wings, with a rosy hue, and expanding a little over 2 inches.

Although in the Eastern States this insect, especially the moth, is not common, yet we have observed it as far east as Brunswick, Me., where it feeds on the maple, the moth there appearing the middle of June; in the Western States, Illinois, Missouri, and Kansas, it proves during certain years very destructive, entirely or nearly stripping the soft or swamp and sometimes the silver maple of its leaves, and discouraging people from planting this tree along roadsides. It is known to feed on the oak.

According to Riley, the eggs are deposited in patches of thirty and upward, on the under side of a leaf. Each is about 0.05 inch long, sub-oval, slightly flattened, translucent, and pale greenish.

In Missouri and Kansas the worm is double-brooded, the first brood of larvæ appearing mostly during June and giving forth the moths late

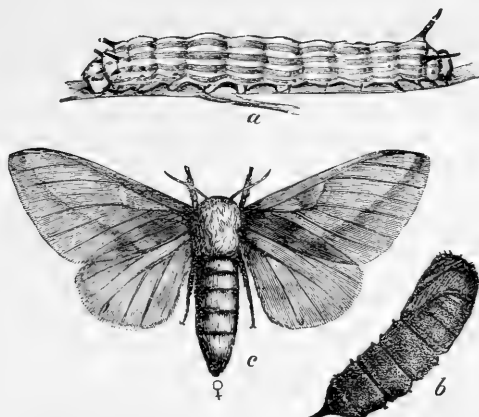


FIG. 147.—The green-striped spiny maple-worm; *b*, pupa; *c*, female.—After Riley.

in July, while the second brood of worms appears in August and September, wintering in the chrysalis state, and not appearing as moths until the following May. The caterpillar molts four times, becoming fully fed within a month, and then entering the ground to pupate.\*

*Larva*.—In the *first stage*, yellow, with a large black head, the spines forming little black tubercles of nearly uniform size. In the *second stage* the head is browner, and the spines and stripes of the full-fed larva more apparent. In the *third stage* like the caterpillar in its fourth or last stage, but smaller. The *fully fed caterpillar* is an inch and a half long; pale yellowish-green longitudinally, striped above alternately with eight very light yellowish-green lines and seven of a darker green, inclining to black, with two slender black spines on the second segment behind the head, and two lateral rows of sharper, shorter spines. Head copal yellow; segments 10 and 11 a little dilated and rose-colored at the sides.

*Chrysalis*.—Rough and pitted, nearly black, with curved horns about the head and thorax, and the movable joints provided with a ring of sharp conical teeth around the anterior edge. (Riley.)

*Moth*.—Fore-wings rose-colored, crossed by a broad pale-yellow band; the hind wings pale yellow, with a short rosy band behind the middle; the body is yellow, the under side and legs rose colored (Harris). In Western specimens, the yellow predominates, the rose-color being but faintly visible, according to Riley, who has also had specimens which were almost white or colorless. The wings expand about two inches. The male antennæ are broadly pectinated like feathers.

*Remedies*.—A *Tachina* parasite, *Tachina (Belvosia) bifasciata* Fabr., and an ichneumon fly prey upon the caterpillars, and thus reduce their numbers. Riley recommends searching for and destroying the moths and eggs late in May, while the worms, when about to leave the trees,

\* See also *Insect Life*, ii, 1890, 276.

“may be entrapped by digging a trench either around the individual tree or around a grove or belt. The trench should be at least a foot deep, with the outer wall slanting under. Great numbers of worms will collect in it, or bury themselves in its bottom, and may easily be killed.”

22. *Hepialus argenteomaculatus* Harris.

Mr. Harrington is authority for the statement that a moth referred to this species has been bred by Mr. Fletcher from a larva found boring in the base of a spiked maple (*Acer spicatum*). (See p. 346.)

23. THE IO CATERPILLAR.

*Hyperchiria io* (Fabricius).

Order LEPIDOPTERA ; family BOMBYCIDÆ.

Sometimes feeding late in summer on the maple, a large, greenish, thick caterpillar, with fascicles of irritant, radiating, sharp spines over the body, spinning a thin silken cocoon among the leaves, and transforming the following May or June into a large, stout-bodied moth ; the males yellow with a very large eye-like spot on the hind wings, and the females purple-brown, the wings of the latter expanding nearly 3 inches.

Although this large caterpillar is a general feeder, devouring in the Southern States the leaves of the Indian corn, as well as the sassafras,

black locust, the false indigo, wild black cherry (*Prunus serotina*), and the willow, currant, cotton, clover, elm, hop-vine, balsam-poplar, balm of Gilead, dogwood, and choke cherry, we have found it in Maine, where it is a rare moth, feeding on the rock or sugar maple, and hence refer to it under this head. The eggs are top-shaped, attached by the smaller end, in patches of about thirty, on the under side of leaves. The caterpillars in the Western States begin to hatch about the end of June, getting their growth in two months, after molting five times. The spines are poisonous to the fingers, and the caterpillar can not be handled



FIG. 148.—Green stinging io caterpillar.—After Riley.

without causing some pain and irritation.

Mrs. Dimmock has summarized in *Psyche* (iv, 275) what is known of the habits of this caterpillar as follows :

*Hyperchiria io* Fabr. (Syst. Entom., 1775, p. 560). Harris (Rept. Ins. Injur. Veg., 1841, p. 283-285) describes the larva and male and female imagos ; later (Treatise on Ins. Injur. Veg., 1862, p. 393-396) he adds to the descriptions figures of the larva,



pupa, cocoon, and male and female imagos; and still later (Entom. Corresp., 1869, p. 295-297) he gives a more extended description of the larva. Morris (Synop. Lepid. N. A., 1862, p. 220) briefly describes the larva. Packard (Guide Study Ins., 1869, p. 299) gives brief notes on this species under the name of *Hyperchiria varia* Walker. Bethune (Can. Entom., Oct., 1869, v, 2, p. 19, 20) briefly describes the larva, and Minot (*op. cit.*, Nov., 1869, v, 2, p. 28, 29) describes egg and larva without recognizing the species. Lintner (Entom. Contrib., No. 2, 1872, p. 146-149) describes the egg, the six larval stages, the pupa, and the cocoon. Riley (Fifth Rept. State Entom. Mo., 1873, p. 133) describes egg, larva in its six stages, cocoon, and imago of this species, figuring larva and male and female imagos; and (Can. Entom., June, 1873, v, 5, p. 109) describes the egg in detail. Reed (Can. Entom., Dec., 1874, v, 6, p.



FIG. 149.—Male of io moth.—After Riley.

227-229, and Ann. Rept. Entom. Soc. Ontario, 1874, p. 11-13) repeats Riley's figures, and describes the different stages very briefly. Grote (Can. Entom., Sept., 1878, v, 10, p. 176) states that this species is double-brooded in the South. The food-plants, as compiled in chronological order from the above and from other notices of this species, are as follows: *Populus balsamifera*, *Ulmus*, *Trifolium*, *Zea mays*, and according to Abbot, *Cornus* and *Sassafras* [Harris, 1841]; *Quercus* and *Robinia viscosa* [Harris, 1869]; *Cornus florida* and *Liriodendron* [Morris]; *Humulus* [Freeman (Amer. Entom., Oct., 1868, v. 1, p. 39)]; *Gossypium* and *Acer* [Packard]; *Salix* [Bethune]; *Populus tremuloides*, *Robinia pseudacacia*, and *Cerasus virginiana* [Lintner]; *Amorpha fruticosa*, *Baptisia*, *Prunus serotina*, and currant [Riley]; *Corynus avellana* [Reed]; *Betula*, *Comptonia asplenifolia*, apple, *Lespedeza*, *Symphoricarpos*, and *Fraxinus* [Goodell (Can. Entom., Sept., 1877, v, 9, p. 180)]; *Prinos verticillatus*, *Rubus villosus*, and *R. canadensis* [Goodell (*op. cit.*, Apr., 1879, v, ii, p. 78)], and *Trifolium pratense* [Pilato (Papilio, May, 1882, v, 2, p. 67)]. The larva also eats *Betula alba*.

*The larva*.—About 2 inches long, of a pea-green color; the spreading, slender spines deeper yellow and often tipped with black. A lateral white line, edged above with lilac.

*The moth*.—Males deep-ocher yellow marked with purple brown, with a large, round blue spot, bordered with black, with a central white dash. The fore-wings of the female are purple brown, the hind wings as in the male. In Massachusetts the moths appear during June or early in July.

## 24. THE IMPERIAL EACLES.

*Eacles imperialis* (Drury).

(Larva, Pl. VI, figs. 1, 1a, 1b.)

Although this pine larva occurs on the elm as well as the maple and other forest trees, it may be mentioned here. It is more fully referred to under the head of pine insects.\*

\*The following list of the food-plants of *Eacles imperialis* Dru., by William Beutenmüller, appeared in *Entomologica Americana*, ii, p. 53.

*Anacardiaceæ.**Rhus glabra*, L. (Smooth Sumac.)*Sapindaceæ.**Æsculus hippocastanum*, L. (Common Horse Chestnut.)*Acer saccharinum*, Wang. (Sugar Maple.)*dasy carpum*, Chr. (White or Silver Maple.)*rubrum*, L. (Red or Swamp Maple.)*pseudoplatanus*, L.*Negundo aceroides*, Moench. (Box Elder.)*Kölreuteria paniculata*, Laxm. (The panicle-flowered *Kölreuteria*.)*Leguminosæ.**Gleditschia triacanthos*, L. (Honey Locust.)*Rosaceæ.**Prunus virginiana*, L. (Choke Cherry.)*serotina*, Ehr. (Wild Black Cherry.)*Hamamelaceæ.**Liquidambar styraciflua*, L. (Sweet Gum.)*Lauraceæ.**Sassafras officinale*, Nees. (Sassafras.)*Lindera benzoin*, Meisn. (Spice-bush.)*Urticaceæ.**Ulmus fulva*, Michx. (Slippery or Red Elm.)*americana*, L. (American or White Elm.)*alata*, Michx. (Whahoo or Winged Elm.)*campestris*, L. (English Field Elm.)*suberosa*, Moench. (Cork-barked Elm.)*Platanaceæ.**Platanus occidentalis*, L. (American Plane or Sycamore.)*orientalis*, L. (Oriental Plane.)*Cupuliferæ.**Quercus alba*, L. (White Oak.)*macrocarpa*, Michx. (Burr Oak.)*coccinea*, Wang. (Scarlet Oak.)*rubra*, L. (Red Oak.)*palustris*, Du Roi. (Swamp or Pin Oak.)*cerris vulgaris*. (Turkey Oak.)*Castanea vesca*, L. (Chestnut.)*pumila*, Michx. (Chinquapin.)*Fagus ferruginea*, Ait. (American Beech.)*sylvatica*, L. (Wood or Common Beech.)*Ostrya virginica*, Willd. (Hop Hornbeam or Leverwood.)*Carpinus americana*, Michx. (Hornbeam, Blue or Water Beech.)*Betulaceæ.**Betula alba*, L. (White Birch.)var. *populifolia*, Spach.*Alnus incana*, Willd. (Speckled or Hoary Alder.)*serrulata*, Ait. (Smooth Alder.)*Coniferæ.**Pinus strobus*, L. (White Pine.)*excelsa*, Wallich. (Bhotan Pine.)*Abies excelsa*, Dec. (Norway Spruce Fir.)var. *pendula*.*Larix americana*, Michx. (American or Black Larch.)*Cupressus thujioides*, L. (White Cedar.)*Taxodium distichum*, Rich. (American Bald Cypress.)*Juniper communis*, L. (Common Juniper.)*Virginiana*, L. (Red Cedar.)

## 25. THE MAPLE DAGGER-MOTH.

*Apatela americana* Harris.

Order LEPIDOPTERA; family NOCTUIDÆ.

In September, a rather large greenish-yellow caterpillar, with long hairs, ornamented with four pencils of long hairs, and a single pencil on the eleventh ring, spinning a dense cocoon under the bark or elsewhere, and transforming into a whitish moth the next summer.

This is not uncommon on maple trees late in the autumn, and its habits are described by Harris, who says that it also feeds on the elm, linden, and chestnut. We have often noticed it in Maine at the end of August and in September.

Mr. Coquillett has bred the caterpillar in Illinois from the oak, on which it was found August 13. On the 19th of the same month it spun a large cocoon, interwoven with the hairs with which its body was covered, the moth emerging on the 24th of May of the following year.

*Larva*.—Body greenish white; a subdorsal and stigmatal black line; on top of the last two segments is a black stripe which widens posteriorly; body thickly covered with short pale yellow hairs; on top of segments 4 and 6 are two pencils and on top of segment 11 is a single pencil of very long black hairs; body beneath black. Head shining black. Length 2.50 inches. (Coquillett.)

26. *Lochmæus olivatus* Packard.

The caterpillar of this species has been reared by Professor Riley.

*Moth*.—Female: Pale olive greenish ash, with white scales and patches; head above greenish ash, in front ashen, and the palpi ash-colored, with no black externally. Thorax darker behind, the tegulæ with white scales. Fore-wings with the basal line indistinct in my specimens (loaned by Mr. H. L. Clark, of Providence); middle line doubly scalloped; the spaces between the dark scallops filled with whitish scales; discal dot distinct, brown contained in a large squarish white patch; on the inner scale of this patch and extending below it is a dark brown patch, forming a broad dusky band, extending from the subcostal vein to the third median venule, ending in two scallops. The outer line is sinuous, the scallops shallow, the line curves outward deeply opposite the origin of the median venules; the line loses itself toward the costa in a diffuse greenish costal patch. There is a distinct submarginal series of about eight subtriangular dusky spots, the largest one situated on the first median interspace; this line is scarcely dislocated as in *L. cinereus*. Wings dusky, with whitish scales and dark line at the base. Hind wings ash, whitish in spots; traces of an outer dusky band, distinct in the center when it is externally shaded with whitish; the band crosses the wing, but is quite faint. Beneath, the lines and spots do not reappear, and both wings are uniformly ash-brown, the line at base of fringe dusky, the fringe whitish ash, spotted with dusky. Length of body, female, 20<sup>mm</sup> ( $\frac{3}{10}$  inch); expanse of wings, female, 52<sup>mm</sup> (2 inches.)

27. *Lochmæus cinereus* Packard.

The caterpillar of this species has been found by Professor Riley feeding on the maple, and closely resembling the caterpillar of *L. olivata* Packard. The type of my original description was captured by myself in Brunswick, Me.; Professor Riley's was bred in Washington, D. C., the moth appearing May 28. Mr. Howard L. Clark has found it not uncommonly in Rhode Island. My original type was from Maine.

*Moth.*—Male and female: Antennæ well pectinated on the basal two-thirds, filiform at the end; the body and wings greenish ash, the wings green, olive sea-green in tint. Head greenish on top, ashen in front; palpi ashen, black on the sides. Thorax ashen, greenish on the sides at the insertion of the wings; on front edge of the thorax a dark brown transverse stripe; a more distinct transverse stripe behind, and the hinder edges of the tegulæ dusky; between the two oblique tegular stripes the hinder part of the thorax is dark brown, including a small tuft on the hinder edge of the thorax and a large two-lobed flattened tuft which covers the base of the abdomen, the posterior edges of the double tuft becoming blackish. Fore-wings rather short and broad, the apex less produced than in *L. olivatus*; the wing unusually free from scalloped bands; two unequal scallops at the insertion of the wing (obsolete in the male before me); middle double-scalloped line well marked in the female (obsolete in the male in front of the median vein); the scallops uneven, two in median space, the largest one rectangular; a short acute scallop in front of the median vein and extended outward along it; two nearly even-sized scallops on the costal edge; a clean space between the middle and outer scalloped lines; outer scalloped line very irregular, scallops deep and heavy black-brown, and the line curving deeply inward from the median vein to near the apex on the costa. The costal edge on outer third, with three distinct narrow linear black spots; the venules marked with black and whitish-gray scales (in the male this outer line is almost obsolete). A submarginal row of eight blackish spots, three of which are situated behind the last median venule; this series is plainly dislocated, the subapical three being set farther inward than those below, and this is a ready means of separating the species from *L. olivatus*. In these females the fore-wings and thorax are yellowish green, while in the male of a clear sea-green. Hind wings dusky ashen, yellowish on the costa, on the outer third of which is the beginning of an outer whitish line, forming two scallops; the wing is pale, almost whitish at base, but dusky toward and at the margin. Beneath, the fore-wings are clear ash, the costa a little dusky, with fine blackish linear marks toward the apex; the submarginal row of blackish spots appear through, but the series is not dislocated; hind-wings not marked, except by three submarginal dusky spots behind the second median venule; abdomen ash, with a faint yellow-green tint; length of body, male, 20 to 21<sup>mm</sup>; female, 23<sup>mm</sup>. Expanse of wings, male, 45<sup>mm</sup>; female, 55<sup>mm</sup> (2.10 inches).

This species may be known by the less pointed fore-wings, quite square in the male, by the clear space between the middle and outer scalloped lines, and by the dislocated series of submarginal dusky spots; the wings in the male are uniformly sea-green, while in the female the tint is yellowish green. My original description in third vol. Proc. Ent. Soc. Philadelphia, is defective, as the type specimen was rubbed, and without the greenish tint of fresh specimens. From *L. olivatus* it is distinguished by being more uniformly and darker green and by the lack of whitish patches. The discal spot is almost obsolete, and with only a slightly marked dusky patch beneath, this blackish patch being large and conspicuous in *L. olivatus*.

## 28. THE MAPLE SLUG WORM.

*Lithacodes fasciola* H. Sch.

Order LEPIDOPTERA; family BOMBYCIDÆ.

We have found the larva of this rather common slug-caterpillar on the maple at Jackson, N. H., September 10. It agrees with Clemens' description of the larva of *L. laticlavia*. (See Proc. Acad. Nat. Sc., 1860, p. 157). In walking the larva, like others of its group, moves on a broad soft disk like a slug, the disk moving in wave-like undulations from back forwards.



FIG. 150.—Maple slug moth. After Packard.

The following description has been taken from Professor Riley's MS. notes:

Like Glover's  $\frac{31}{4}$  apparently. Young found September 5, 1869, on the wild cherry. Length, 0.42. Color pale green, variegated, *i. e.*, spotted and lined with still paler yellowish green. Six pale longitudinal lines, two dorsal, two lateral, and two ventral, all more or less undulating, and all approaching at extremities and diverging in middle of body. Between the dorsal lines each segment is marked with a slightly elevated somewhat triangular pale spot, with a dark center, while on each side of it anteriorly and contiguous to the longitudinal line is a darker green spot. Between dorsal and lateral line there is also a pale spot with darker center and other smaller pale spots each side of it. Anus terminating in an obtuse point as in figure. September 8, 1869. It has formed its cocoons somewhat differently from the others now breeding. It first cut off a piece of leaf large enough to cover its back, and then, after anchoring it with silken cables to a whole leaf, proceeded to form its cocoon between the two. February 11, 1870. The lid, which opens when the imago of these *Limacodes* escapes, is evidently severed before the larva changes to pupa, for upon touching a cocoon of one to-day the lid sprang open, though the larva was dead and had dried up within. July 20, 1870. The moth issued. It is *Lithacodes fasciola* Clem. (Lintner) and = *Limacodes betulæ* Fitch MS. According to Fitch, the larva from his verbal description agrees very well, but he bred his from the beech. September 6, 1870. Found another on cherry to-day. September 20, 1881. Miss Mary Murtfeldt is feeding one on cherry. Found one to-day on hickory. The pale spot in center of joints has no dark center, and near the darker spots, *i. e.*, from each joint, arises along the dorsal pale lines only one such bristle, and from the lateral line only one such bristle. It does not sting. The thoracic legs are distinct. Mr. Lintner has bred it from the horse chestnut. It also breeds on the hard maple and elm (found September 15, 1875).

*Larva*.—Body oval, with a wide dorsal square ridge, hollowed slightly along the middle, where situated on each suture is a yellowish round spot centered with a dark-green dot. The edge of the ridge stained with yellow; on the outer and lower side of the ridge is a lateral row of spots like those in the middle of the back. Body pale-green, with yellow touches and spots besides those described. Head green, but the jaws and labrum dark amber. Along the lower edge of the body is a whitish line. Length, 12<sup>mm</sup>.

29. *Sisyrosea inornata* Grote and Rob.

The specimen from which Fig. 148 was drawn was found under a maple at Amherst, Mass., October 9.

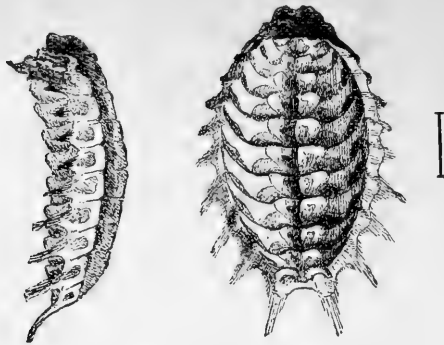


FIG. 151.—Maple slug worm.—Bridgland del.

## 30. THE AMERICAN SILK-WORM.

*Telea polyphemus* Hübner.

According to Mr. E. B. Reed, this insect “frequently attacks maples, and from the enormous size of the caterpillar and its voracious appetite a great deal of damage is often done.” (Report Ontario Ent. Soc. for 1872, p. 39.) Mrs. Dimmock has contributed the following historical account of this insect to *Psyche*, iv, p. 277 :

*Attacus polyphemus* Fabr. (Species insector., 1781, v. 2, p. 168). Among the very numerous articles which have been published concerning this species the following are worthy of citation. Harris (Rept. Ins. Injur. Veg., 1841, p. 278-279) describes larva, cocoon, and imago; later (Treatise on Ins. Injur. Veg., 1862, p. 334-386) he adds a figure of the imago, and (Entom. Corresp., 1869, p. 294, pl. 4, fig. 17) a figure of the larva. Morris (Synop. Lepid. N. A., 1862, p. 226-227) describes larva and imago, and (*op. cit.*, p. 209) describes the egg, which he mistook for that of *Smerinthus excaecatus*. Trouvelot (Amer. Nat., 1867, v. i, p. 30-38, 85-94, 145-149, pl. 5-6) gives an extended account of this species which he tried to rear, on a considerable scale, for its silk; he describes the egg, larva, pupa, and cocoon, and figures the larva, pupa, cocoon, and male and female imagos, as well as *Ophion macrurum*, a parasite of the larva; he says there are at least six varieties of the imagos. Packard (Guide Study Ins., 1869, p. 297, pl. 6-7) repeats Trouvelot's figures. Riley [?] (Amer. Entom., March 1869, v. i, p. 121-122) figures the imago and describes the larva and imago. Riley (4th Ann. Rept. State Entom. Mo., 1872, p. 125-129) describes egg, larva, cocoon, pupa, and imago, and figures larva, pupa, cocoon, and male and female imagos; contrary to Trouvelot, who stated that there are six larval stages, Riley gives the number of molts as four, making five larval stages. Lintner (Entom. Contrib. [No. 1], 1872, p. 6) gives a note on the coloration of the eggs, and (*op. cit.*, No. 3, 1874, p. 152) describes the egg. Gentry (Can. Entom., May 1874, v. 6, p. 86) describes the normal form and a variety of the larva. Grote (Can. Entom., Sept. 1878, v. 10, p. 176) states that this species is double-brooded in the South; Trouvelot (*l. c.*) was unable to raise two broods to maturity in Massachusetts, and Brodie (Papilio, April 1882, v. 2, p. 60) writes that “in long and warm seasons about 50 per cent. are double-brooded, but this is against the increase of the species, as cold weather usually sets in before the larvæ are fully matured.” Packard (Bull. 7, U. S. Entom. Comm., 1881, p. 48) figures the larva. Saunders (Can. Entom., March 1882, v. 14, p. 41-45) figures and describes the larva, pupa, cocoon, and male and female imagos; he further figures *Ophion macrurum*, a parasite of the larva. Brodie (Papilio, May 1882, v. 2, p. 83) states that normally this insect comes from its cocoon at about 11 a. m. Wailly (Bull. Soc. Acclim. France, May 1882, s. 3, v. 9, p. 265) gives some notes upon the larva and imago. A compila-

tion of the food-plants results as follows: *Quercus*, *Ulmus*, *Tilia* [Harris, 1841 and 1862]; *Tilia americana* and *Rosa* [Harris, 1869]; *Acer*, *Salix*, *Populus*, *Corylus*, *Betula*, *Vaccinium* [Trouvelot]; *Carya*, *Juglans nigra*, *J. cinerea*, *Crataegus* (Amer. Entom., 1869, v. 1, p. 121); *Quercus virens*, [Chambers (Amer. Entom., March 1870, v. 2, p. 156)]; apple, quince, plum, *Prunus virginiana*, *Platanus*, *Gleditschia* [Riley]; *Betula lenta* [Young (Can. Entom., Oct. 1880, v. 12, p. 212)]; *Hamamelis virginica* [Kyle (*op. cit.*, p. 213)]; *Castanea vesca*, *Fagus* [Wailly (Journ. Soc. Arts, 31 March 1882, v. 30, p. 523)]; *Tilia europæa*, *Crataegus coccinea*, *C. tomentosa*, *C. crux-galli*, *Amelanchier canadensis*, *Ribes cynosbati*, *Quercus alba*, *Q. macrocarpa*, *Q. rubra*, *Corylus americana*, *C. rostrata*, *Fagus ferruginea*, *Carpinus americana*, *Ostrya virginica*, *Carya tomentosa*, *C. amara*, *C. alba*, *Betula lenta*, *B. excelsa*, *B. alba*, *B. papyracea*, *Alnus incana*, *A. serrulata*, *Salix alba*, *S. humilis*, *Populus grandidentata*, *P. tremuloides* [Brodie (*Papilio*, April 1882, v. 2, p. 58-59)]. Chestnut, as a food-plant, is only mentioned by Wailly, who reared the larvæ in England, but they are often found in eastern Massachusetts, on *Castanea vesca*.

31. THE CECROPIA CATERPILLAR.

*Platysamia cecropia* (Linn).

This caterpillar, larger than the foregoing, also sometimes occurs on

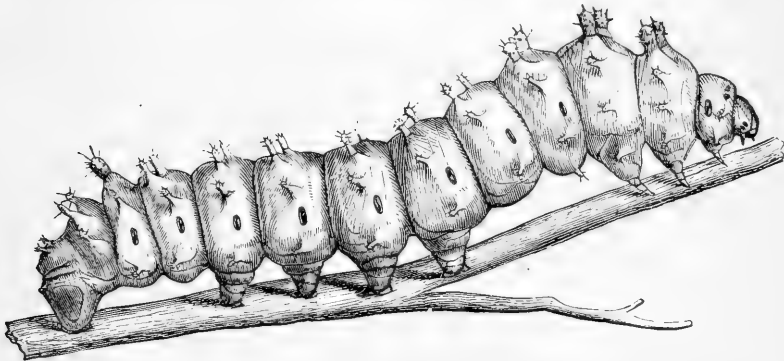


FIG. 152.—Caterpillar of the Cecropia silk moth, nat. size.—After Riley.

the maple. It is about four inches long, and pale green, ornamented with large tubercles colored green, blue, yellow, and red.

Mrs. Dimmock has contributed to *Psyche* (iv, p. 276) the following historical sketch of this insect.

*Attacus cecropia* Linn (Syst. Nat., 1758, ed. 10, p. 809). Harris (Rept. Ins. Injur. Veg., 1841, p. 279-280) describes the larva, imago and cocoon of this species; later (Treatise on Ins. Injur. Veg., 1862, p. 385, 387-389) he adds figures of the larva, pupa, cocoon, and male imago; and still later (Entom. Corresp., 1869, p. 294-295) he again describes the larva. Morris (Synop. Lepid. N. A., 1862, p. 223-224) describes larva, cocoon, and imago. Trouvelot (Amer. Nat., March 1867, v. 1, p. 31) gives a note on the cocoon. Riley (Amer. Entom., Feb. 1870, v. 2, p. 97-102, and 4th Ann. Rept. State Entom. Mo., 187?, p. 103-107) describes the eggs, and figures and describes the larva, pupa, cocoon, and male imago. Sprague (Can. Entom., April 1870, v. 2, p. 82) describes the eggs. Saunders (Can. Entom., Oct. 1871, v. 3, p. 149-155) figures and describes the larva, cocoon, and male imago. Lintner (Entom. Contrib., No. 3, 1874, p. 125) describes the young larva. Worthington (Can. Entom., Sept. 1876, v. 8, p. 165-166) notices some color varieties of the imago. Gentry (Can. Entom., March 1877, v. 9, p. 41-49) describes the egg, different stages of the larva, and cocoon. Grote (Can-

Entom., Sept. 1878, v. 10, p. 176) says this species is double-brooded in the Southern United States. Packard (Bull. 7, U. S. Entom. Comm., 1881, p. 113) figures the larva. Neumoegen (Papilio, Jan. 1882, v. 2, p. 18) states that this species usually emerges from the pupal state at about 5 p. m.; Brodie (*op. cit.*, May 1882, v. 2, p. 83), on the contrary, states that the emergence normally takes place about 10 a. m. Riley and others state that the larva has five stages, but Wailly (Bull. Soc. Acclim. France, May 1882, s. 3, v. 9, p. 266-267) writes that it has six stages. Brodie (Papilio, Feb. 1882, v. 2, p. 32-33) gives a list of 49 species of plants belonging to 20 genera on which the larva will feed: The genera are *Tilia*, *Acer*, *Negundo*, *Prunus*, *Spiraea*, *Crataegus*, *Pyrus*, *Amelanchier*, *Ribes*, *Sambucus*, *Ulmus*, *Quercus*, *Fagus*, *Corylus*, *Carpinus*, *Betula*, *Alnus*, *Salix*, and *Populus*. From other authors the following genera are compiled: *Berberis*, *Liriodendron*, *Syringa*, *Carya*, *Gleditschia*, *Rubus*, *Ceanothus*, *Ampelopsis*, *Cephalanthus*, *Fraginus*, *Vaccinium*, and *Rosa*.

*Larva*.—Body very thick, cylindrical, enlarged at the two last thoracic and first abdominal segments, the segments moderately and evenly convex, not angular, sutures distinct. The head is almost wholly retractile within the prothoracic ring, the latter also partially retractile in the succeeding ring.

Head of moderate size in proportion to the body, rounded, not so wide as the prothoracic segment; green with no markings. It is smaller and less rounded above than in *T. polyphemus*. Head and body green, the color of the upper side of the plum, birch, or oak leaf. Prothoracic segment with a slight transverse ridge in front, on which are four dorsal small light-blue warts and one larger tubercle on the side, in front of and a little lower than the prothoracic spiracle. On each of the three following segments is a pair of short, club-shaped reddish tubercles with black spines; these are succeeded along the abdomen by two rows of six subdorsal, much slenderer but fully as long, bright yellow tubercles, which have two or three black spines on the end. These two rows are terminated by a single bright yellow tubercle on the last spiracle-bearing segment (eighth abdominal), which is nearly twice as thick as the others. Two lateral widely-separated rows of slender, bright-blue, elongated tubercles, ending in two to four black spinules; these are slenderer than the dorsal yellow tubercles, and the two rows are far apart, the row of spiracles being between them; the spiracles are pale glaucous green, surrounded by a very narrow black rim. On the ninth segment is a transverse row of six pale bright cerulean blue tubercles. Thoracic and abdominal feet a little paler green than the body. Supra-anal plate triangular, large, but obtuse at the end. Length, 70<sup>mm</sup>; thickness, 14<sup>mm</sup>. Providence, October 2. Described from a specimen found feeding on the cherry.

### 32. *Edema albifrons* (Abbot and Smith).

This common oak caterpillar has been found by Mr. Reed to frequently occur on the maple. (Can. Ent., xv, p. 204.)

### 33. FOREST TENT CATERPILLAR.

#### *Clisiocampa sylvatica* Harris.

A colony of the worms not fully fed were found June 6, collected in a mass near the ground on the trunk of the maple at Brunswick, Me.; at this time they were molting for the last time. (See Oak insects, p. 117.)

### 34. *Homoptera lunata* Drury.

Order LEPIDOPTERA; family NOCTAIDÆ.

In the Canadian Entomologist (xiv, p. 130), Prof. G. H. French describes the seven stages in the life of the caterpillar of this fine large moth, which feeds, he states, on the maple and willow. The duration



of life from the time the egg is laid until the moth appears was found to be fifty-two days. "The eggs were deposited April 30, and the first moth hatched June 21, the last July 10. During former years I have found the larvæ of this species on the willow and other bushes, and had them spin up to the last of September and come out as moths the forepart of November. In other instances they passed the winter as chrysalids." There are from two to three broods during a season. Mr. Hill has claimed that *H. edusa* and *lunata* are possibly sexes of one species, and Mr. Bean, as well as Mr. Leubner, have concluded that these two species, with *Saundersii*, were all the same species. From one brood of eggs deposited by *lunata* the three forms, *lunata*, *saundersii*, and *edusa*, were obtained, thus reducing two of the forms to sexual varieties, *lunata* being the female.

*Mature larva*.—Head flat, sloping; six ocelli, in shape and number resembling larvæ of *Catocalæ*. Body marked with three dorsal stripes and three on each side, alternating light and dark; but these are less distinct, approaching a uniform brownish drab; the white spots also less distinct. First and second abdominal legs about half the length of the others. A little paler beneath than above, with an elliptical reddish brown spot in the center of each segment. Length, 1.45 inches.

*Pupa*.—Wing-cases covering five segments in front. Tip of abdomen coarsely furrowed and punctured, ending in two long hooks, with several shorter ones arising from the corrugated surface a little way from these. Length, .80 inch. (French.)

*Moth*.—Male: Thorax, abdomen, and wings of a fine red sandy brown color; the first ring of the abdomen with an ash-colored spot. Anterior wings with two whitish oblong spots on the external edges of each; one near the tips, the other at the lower corners. A small whitish bar crosses the fore-wings about a quarter of an inch from the body, and next the shoulders is a spot of the same whitish color. Posterior wings brown, with an oblong whitish spot placed along the external edges, reaching from the abdominal almost to the upper corners. Under side, wings pale sandy-colored, except a few small round dark spots dispersed over them, but scarcely discernible. Margins of all the wings dentated. (Drury.)

*Female (lunata)*.—The head, thorax, abdomen, and wings hazel-colored. Anterior wings with a wavy line, of a dark brown color, placed near the anterior angle, beginning at the posterior and ending at the external edge. At the shoulders and along the anterior margin are several small dark brown clouds and marks that produce a darker shade. Posterior wings with a series of narrow transverse wavy lines, extending from the middle to the external edges. All the wings are dentated. Under side, the breast, abdomen, and wings are all of a paler hazel color. Anterior wings dappled with dark brown on the middle of the anterior edges and spotted with minute, short brown streaks, as well as the posterior. (Drury.) Expanse of wings, 55<sup>mm</sup>.

### 35. THE MAPLE SEMI-LOOPER.

*Ophiusa bistriaris* (Hübner).

Order LEPIDOPTERA; family NOCTUIDÆ.

Late in July feeding on the silver maple, a brownish gray caterpillar 1.40 inch long, with the first pair of prolegs small, the worm having a semi-looping gait.

When about to go into chrysalis it cuts through a portion of a leaf of the tree on which it has fed, and turning it over constructs a snug little case, fastening it up closely and carefully with silken threads, and

in this completes its transformations. After remaining in the pupa state about two weeks, the moth appears. (Saunders.)

We have bred this moth in Maine from the caterpillar. The chrysalis lay in a slight cocoon in a folded leaf of the red maple, the moth issuing in the second week in May.

*The larva* is 1.40 inch long, somewhat onisciform. Head medium sized, flattened, bilobed; color, pale ashen gray, with streaks of pale brown appearing under a magnifying lens as a fine network; a dark brown, nearly black, stripe on each side, and a few short gray hairs scattered over its surface. Body above brownish-gray, with numerous streaks and dots of pale brown. A double irregular dorsal line; other broken lines composed chiefly of dots, none of them continuous. A subdorsal row of whitish dots. On the hinder part of the twelfth segment is a raised crescent-shaped line edged behind with black, and on the terminal one two whitish dots, with a small black patch at their base. Spiracles pale oval, edged with black. Under surface paler and greenish, feet greenish, prolegs bluish-green dotted with brown. The moth is rather large, with broad triangular fore-wings, and is uniformly brown, with two oblique darker bands.

### 36. THE LESSER MAPLE SPAN-WORM.

*Stegania pustularia* Guenée.

Feeding on the leaves early in June, a bluish-green looper striped with whitish and yellowish, producing the moth in July. (Saunders.)

This is a common insect and has been raised by Mr. W. Saunders, who says that the caterpillar is full grown about the middle of June, enters the chrysalis state within a few days after, and produces the moth early in July. We have found it in the woods of northern Maine in August, and it is common in August in the Northern and Western States.

*The larva*.—Body cylindrical, about five-eighths of an inch long, head medium sized, rather flat in front, slightly bilobed, pale green. Body above bluish-green, with thickly set longitudinal stripes of whitish and yellowish. A double whitish dorsal line, with bordering lines of yellowish white, neither of which are unbroken, but are formed of a succession of short lines and dots. Below these, on each side, are two or three imperfect white lines, made up of short streaks, and much fainter than those bordering the dorsal line; spaces between the segments yellowish. The skin all over the body is much wrinkled and folded. (Saunders.)

*The moth* is exceedingly pretty and may be recognized by its white body and wings and four deep golden-ocherous costal spots, with two lines running across the wings, these lines sometimes wanting. It expands an inch.

### 37. THE LARGE MAPLE SPAN-WORM.

*Etrupela transversata* Packard.

Feeding on the red maple in July, a large slender-bodied span-worm, the body thickened behind, carinated on the sides; of a dark purple-brown mixed with reddish; a dorsal reddish-gray crescent-shaped spot on the middle of the seventh segment, behind which is a pair of low kidney-shaped tubercles, and a pair of dorsal pointed black ones on the eleventh; second ring swollen on the sides. Length, when crawling, 46<sup>mm</sup>. Changes to a pupa the end of July in a rolled leaf, the moth appearing August 10. (Goodell.)

*Pupa*.—Pale flesh color, minutely speckled with brown, greenish between the segments; a stigmatal row of large roundish brown spots, one on each abdominal segment, and a dorsal row of obscure triangular spots on the abdomen, which are obso-



a FIG. 153.—*Eutrapela transversata* and, a, var.

lete on the last three rings; a dorsal brown dot on the thorax, with two smaller ones behind it. Wing-cases darker than the abdomen. Caudal spine compressed laterally, dark brown. Length, 13<sup>mm</sup>; width in the widest part, 5<sup>mm</sup>.

#### 38. *Selenia kentaria* Grote.

The caterpillar of this moth is said by Mr. Bruce to be not uncommon on the maple and birch in the vicinity of Brockport, N. Y. He also writes to Rev. G. D. Hulst (*Entom. Amer.*, ii, p. 162, 1886):

It is not generally known that this insect is double-brooded. All the European species are also. The spring brood is so much larger and richer colored than the late summer brood that the latter may be thought to be another species, as was the case with the European.

*Moth*.—Bright ochereous, with the costal half of the wing subviolaceous between the brown lines; a much-curved line, terminating at the same distance from the base on both the costa and the hind edge; a mesial line, obtusely angulated below the costa, straight from the hind edge to the median nervure; a third outer line, straight to the obscure angle just before the costa, and on the edge turned obliquely outward; this line is margined for nearly the whole of its length externally with a subviolaceous hue, throwing off an oblique line toward the hind angle. An apical line, once angulated inward, goes to the indented outer border; beyond deep ochraceous; fringe darker at base, narrowly lined with silvery. Hind wings concolorous with the fore-wings; a mesial, diffuse, brown line, and the outer one subviolaceous. Beneath, base of fore-wings violaceous; costa at base ochereous; inner line nearly obsolete, middle line dark, outer violaceous line very distinct, the apical line connected with it and inclosing an ochereous spot; hind wings ochereous; a mesial, dark, blackish, narrow line on the discal space; an outer, narrow, violaceous line, with spots on the base and hind edge; body ochereous; legs broadly banded with violaceous. Expanse of wings, 1.50 to 1.60 inches.

#### 40. THE CLEFT-HEADED SPAN-WORM.

*Amphidasys cognataria* Guen.

Larva, before the last stage, Pl. v; fig. 5.

This common inch or measuring worm is the largest species we have met with feeding on the maple, poplar, or willow, and may be readily recognized by its deeply cleft head and reddish-brown or green body like a reddish or green willow twig, which it closely mimics. We have noticed it as frequently in Jackson, N. H., as in Maine. It is first

noticed early in August, but becomes fully fed by the first week in September, my specimens transforming September 8, the chrysalis entering the earth. I have also found it fully fed on the white birch at Brunswick as early as August 10. It also feeds on the maple. The moth appears in June in Maine late in May in southern New England and New York. I have raised this moth in Maine from the larch (pupating September 15), also from the Missouri currant, an ornamental shrub; also from the apple, elm, cherry, and the aspen in Rhode Island, though the willow is probably its native food-plant, as it occurs in greatest abundance on that tree. Mr. Lintner states that the larva feeds on the maple; that the caterpillar entered the ground for pupation August 11, the moth emerging the latter part of May. (Ent. Contr. iii, 166.) My specimens emerged in Providence May 13. The larva found on the aspen is greenish and like a fresh aspen twig, with whitish granulations, which are black on the tubercles.

It is subject to the attacks of a species of *Microgaster*, seven larvæ of the latter making their exit from a caterpillar two thirds grown. The following historical sketch of our knowledge of this insect is taken from Mrs. Dimmock's article in *Psyche*, iv, p. 271.

*Amphidasys cognataria* Guenée (Hist. Nat. d. Ins., 1857, v. 9, Uran. et Phal., v, 1, p. 208). Cramer (Bull. Brooklyn Entom. Soc., Aug. 1883, v, 6, p. 48) briefly describes the eggs of this species, of which about five hundred were deposited June 3. Bowles (Can. Entom., April, 1871, v, 3, p. 11-12) (Ann. Rept. Entom. Soc. Ontario, 1871, p. 38-39) describes a variety of the larva which fed on "black currant" [*Ribes ?nigrum*], and Goodell (*op. cit.*, April, 1878, v, 10, p. 67) describes another variety which fed on apple and pear. Lintner (Entom. Contrib., No. 3, 1874, p. 166) briefly describes the larva, giving *Acer* as food-plant, and Packard (Guide Study Ins., 1869, p. 322) gives a few notes on the larva, which he states feeds upon *Ribes aureum*, *R. ?grossularia*, and *Spiræa ?tomentosa*. Pilate (Papilio, May, 1882, v, 2, p. 71) gives "honey-locust" (*Gleditschia triacanthos*) as food-plant. Lintner (Entom. Contrib. [No. 1], 1869, p. 64) gives plum as food-plant. To the above food-plants may be added *Betula alba*, *B. lenta*, *Castanea vesca*, *Salix*, and *Spiræa sorbifolia*. The larva varies from pea-green to brownish gray or even brownish black in general color; as far as noticed the green form is from *Ribes*, *Salix*, and *Spiræa*, while those from apple exhibit all the color variations; on *Betula* and *Castanea* the larvæ are gray. Similar variations have been noticed in the larvæ of *Amphidasys betularia*, a European species. The larvæ often rest in a partially twisted position, with their rigid bodies at a considerable angle from the stem to which they cling, thus imitating very closely twigs and petioles. The larvæ are common in New England in July and August; they pupate from the latter part of July to September, the pupa hibernating under leaves and rubbish.

*Young larva*.—Body cylindrical; segments much wrinkled above, but not tuberculated. Head large and square in front; vertex very deeply notched, each tubercle acute above, conical and rough, granulated; clypeal sutures deeply impressed. Prothoracic segment above broad and flat, transversely oblong, with a slight low tubercle on each side in front, making the cervical shield angular in front. A pair of remote but conspicuous though small round white patches on mesothoracic and the seven following segments. Fifth abdominal segment with a small thick tubercle low down on the side. Anal legs large, broad, and flaring. General color rust-red. Length, 15<sup>mm</sup>.

*Larva before the last molt*.—With the characters of the adult larva; salmon red. Length, 35<sup>mm</sup>.

*Mature larva.*—Twig-like, head very deeply notched, each side above conical; the face flat in front, the surface granulated. Prothoracic segment raised in front into a large granulated piliferous tubercle. On the fifth abdominal segment a pair of large lateral rough tubercles, a little paler than the body; on the eighth segment a pair of converging pale granulated tubercles. Anal legs very large and broad, with a pair of long dorsal sharp fleshy tubercles; supra-anal plate very large, conical and acute, with four setæ near the apex. Body of even width throughout, reddish-brown, like a reddish willow twig, or sometimes greenish. The surface finely granulated with light and black, and with flat rough warts, paler in color than the rest of the body; four on the front edge of each segment, and two dorsal ones behind. It varies in color from reddish-brown to green, thus mimicking willow trees of different colors. Length, 55<sup>mm</sup>.

*Pupa.*—Large, full, stout; dark brown. Cremaster large, stout, a projection on each side in the middle, beyond rounded, sharp, the point ending in a slender fork. Length, 24<sup>mm</sup>.

*Moth.*—A large stout-bodied moth, with heavily pectinated antennæ and rather small wings. Fore-wings narrow, with the outer edge longer than usual; pepper and salt or ash sprinkled with black brown; an indistinct, diffuse, inner, curved line, with a second one nearer and diverging a little on the costa, being nearer together at the base. A third diffuse line incloses the discal spot. An outer distinct black hair-line always present. Hind wings with three dark lines. Abdomen with two rows of obscure black spots. Expanse of wings, 60<sup>mm</sup>.

#### 41. *Geometrid larva.*

This delicate caterpillar was observed both early and late in August, beginning to pupate August 30.

*Larva.*—A very slender, long, smooth larva, with no humps or warts; the head nearly as wide as the body, smooth, slightly bilobed, rounded. Body smooth, cylindrical, glaucous green, the hue of the under side of the red-maple leaf; with only obscure whitish subdorsal lines. Lateral ridge thin, distinct, irregular. Length, 15<sup>mm</sup>

#### 42. *Hypena baltimoralis* Guen.

Order LEPIDOPTERA; family PYRALIDÆ.

The larva of this species was common on the red maple at Brunswick, Me., early in August. The body is very slender, and at first sight it would be regarded as a geometrid. It is cylindrical, slender, tapering considerably toward the long anal legs, which are outstretched. The segments are moderately convex, the sutures being very distinct. The head is rather small, smooth, somewhat bilobed. All the legs, both thoracic and abdominal, are of the same color as the body, which is pale pea-green, of the color of the upper side of the leaf of the red maple, but slightly paler. The sutures between the segments are often straw-yellowish. The body sometimes has a slight purplish tint, the head remaining green. Length, 22<sup>mm</sup>.

August 5 one began to spin a cocoon, the pupa appearing the 7th. It is dark chestnut-brown in color. The moth issued August 17.

43. *Hypena* sp.

This caterpillar occurred on the rock maple September 10, at Jackson, N. H.

*Larva*.—Body long and slender, cylindrical; five pairs of abdominal legs, the first pair half as large as the third and fourth pairs; the anal legs long and slender. Head pale-greenish, with a livid tinge and lined with numerous meandering, brownish, broken, sinuous lines. Body tapering somewhat from the seventh ab- which a lateral dominal seg ment. Two slight tubercles on the eighth abdominal segment, from ridge passes down in front of the spiracles. Length, 30<sup>mm</sup>.

44. *Pandemis lamprosana* Robs.

Order LEPIDOPTERA; family TORTRICIDÆ.

Among the leaf rollers upon the maple, collected May 10, was one of which we kept no description, which resulted in an imago of *Pandemis lamprosana*. (Forbes' Third Rt. Ins. Illinois.)

## 45. THE OBLIQUE-BANDED LEAF-ROLLER.

*Cacæcia rosaceana* Harris.

This nearly omnivorous species (not hitherto reported, however, from the maple) was found by Forbes (Third Rt. Ins. Illinois) rolling the leaves of *Acer dasycarpum* in May. The pupæ and larvæ collected on the 20th of that month, emerged from July 9 to 13.

## 46. THE MAPLE LEAF-CUTTER.

*Incurvaria acerifoliella* (Fitch).

Order LEPIDOPTERA; family TINEIDÆ.

Cutting round holes in the leaves and consuming their pulp in rings and semi-circular spots, and using the round pieces to hide the small white worms between them and the leaf, forming a broad round case adhering to the surface of the leaves.

This larva with its singular case has been described by Fitch, and we have received specimens of maple leaves and cases from Vermont. Early in August the leaves of forest trees begin to wither, and holes appear in them, the orbicular pieces being taken by the little worm to form a broad scale concealing it. The worms fall with the leaves to the ground in the autumn, and there remain transforming in their cases, and late in the spring appear as moths.

*The larva*.—Nearly a quarter of an inch long; slender, cylindrical, soft, and contractile; dull white; head flattened, and like the three succeeding segments, pale rusty brown.

*The moth* with long narrow-pointed wings; the fore pair brilliant steel-blue, the hind wings smoky brown, with purplish reflections. Between the antennæ a dense tuft of erect bright orange-yellow hairs. (Fitch.)

The following additional facts are quoted from Mr. James Fletcher's report as entomologist to the Dominion Government for 1885:

The hard maples (*A. saccharinum* and *A. saccharinum v.-nigrum*) in many localities about Ottawa have been found to be attacked, to a moderate extent, by the curious case-bearing larvæ of this pretty little moth; but on the 12th September last enormous numbers were found to be destroying the foliage adjoining the Government House grounds. The maple trees, for a space of perhaps 4 acres, had the foliage almost all consumed, and the flat disk-like cases which had fallen from the leaves were carpeting the ground, and were also seen in great numbers on the sides of the trees; these larvæ probably had been blown down before mature, and were returning to the foliage to feed. Growing amongst the maples were some beech trees, and these were also eaten after the leaves of the maple had all been devoured. The attack was very severe. The leaves were so perforated and skeletonized, that instead of the woods being green they were cream-colored in hue. The larvæ, when full-grown, are about a quarter of an inch in length, with a brown flattened head, and are of a dirty white color. They cut from the leaves small oblong wads, from which they form cases, which they carry about with them as they feed. The case seems to be fastened at one side to the leaf, and the larva then eats the green part of the upper surface, in circles or parts of circles, leaving the fibers and lower surface untouched. When it has consumed all within reach it moves on to another spot. The cases of the mature larvæ are formed of four wads, two of which are about one-eighth of an inch in diameter, and the larger pair about three-eighths. When full-fed, which at Ottawa is in September, the larvæ fall to the ground inside their cases, where they change to pupæ in a few days, and do not emerge as moths until late in the following spring.

The Rev. T. W. Fyles, of South Quebec, sends me the following account of a visitation, similar to the one experienced at Ottawa last year: "This insect was exceedingly abundant in Missisquoi County in the year 1881. I noticed it particularly in the maple groves belonging to Hon. G. B. Baker, M. P., and Mr. G. F. Shufelt, near the village of Sweetsburgh, Quebec. The leaves throughout extensive maple woods were so skeletonized that they presented a brown and scorched appearance that was very remarkable. It seemed as if a hot blast had passed over large tracts of the woodland. Myriads of the larvæ in their disk-like coatings were to be seen on the leaves and stems of the trees and on the undergrowth. Next season clouds of the perfect insects would rise from the foliage shaken by the passers-by."

47. *Catastega aceriella* Clemens.

The larva forms a moderately long, slender, cylindrical tube at the base of the leaf of maple, *A. rubrum*, early in July, and is covered with a thin transparent web closed in advance. The tube increases in diameter from the beginning to the end, and is placed between two principal veins of the leaf, and the web is extended from one vein to the other.

48. *Lithocolletis aceriella* Clemens.

The larva mines the leaf of maple in September. It mines the upper surface of the leaf, making a flat, rather broad track, casting its "frass" along the middle of the course of it. Physical characteristics like those of the second larval group. The cocoon is circular. The larva is likewise found in the leaf of *Hamamelis virginica*. (Clemens.)

*Larva*.—Head pale brown; body yellowish-green, with oval, dorsal, brown maculæ darkest on their margins; thoracic rings on their sides pale yellowish. (Clemens.)

*Moth*.—Front silvery, tuft reddish-orange and silvery mixed. Thorax reddish-orange. Fore-wings reddish-orange, somewhat metallic, with a white streak black-margined exteriorly, *from the inner basal angle to the fold*; with two oblique silvery bands black-margined behind, one about the middle of the wing, and the other midway between it and the base of the wing. Near the tip is a costal silvery spot, black-margined behind, with an opposite, oblique, dorsal streak of the same hue, likewise black-margined behind, and an oblique, costal, silvery streak continued on the line of the last dorsal, running into the cilia just before the tip, black-margined *above*, at the tip before, and *below* at the tip behind; scarcely with a hinder-marginal line, cilia of the general hue. Hind wings plumbeous, cilia with a fulvous hue. (Clemens.)

49. *Lithocolletis lucidicostella* Clemens.

The larva mines the under side of the maple leaf, *Acer saccharinum*, in July, September, and October. The head is pale brown; body pale green, colored darker by the ingesta. "Frass" collected into a ball within the mine. The pupa is suspended in a web of silk within the mine. (Clemens.)

*Larva*.—Head pale brown; body pale green and colored darker by the ingesta. (Clemens.)

*Moth*.—Antennæ white. Head and tuft silvery-white. Fore-wings, basal portion silvery-white to the middle, *with a discal pale golden streak* from the base, retreating from the costa before reaching the middle of the wing and somewhat suffused with golden beneath the fold. From the middle to the tip pale golden, with four costal silvery streaks, dark-margined internally, and two dorsal silvery streaks, the first opposite the second costal streak and both dark-margined internally; *the first costal streak not decidedly dark-margined*.\* Apical spot black. Hinder marginal line in the cilia dark brown; cilia pale gray. Hind wings shining bluish-gray; cilia gray. (Clemens.)

50. *Brachys* sp.

Mr. V. T. Chambers once wrote me that a *Brachys* larva also mines the leaves of the sugar maple. He added that "the mines and larvæ in the beech, oak, and maple are scarcely distinguishable."

51. *Megachile optiva* Cresson.

Order HYMENOPTERA; family APIDÆ.

This (or a very closely allied leaf-cutting bee) sometimes greatly disfigures maples by cutting pieces out of the leaves for the purpose of making its cells. "I have seen a small tree nearly defoliated by these bees, of which the habits are most interesting." (Harrington, Rep. Ent. Soc. Ontario, 1887.)

---

\* There is some mistake in this sentence. The first *costal* streak is decidedly dark-margined; the first dorsal streak, it is true, has scarcely a perceptible margin—it should probably be *the first costal streak decidedly dark-margined* or else *the first dorsal streak not decidedly dark-margined*.—H. T. Stainton.



## 52. THE OCELLATE LEAF GALL OF THE RED MAPLE.

*Sciara ocellaris* Osten Sacken.

Order DIPTERA; family MYCETOPHILIDÆ.

(Plate xxxviii.)

On the leaves of the red maple (*Acer rubrum*) circular ocellate spots about three-eighths inch in diameter, with disk yellow, and margin and central dot, during one stage of their growth, cherry-red.

The following account of this fly is taken entire from Professor Comstock's report as U. S. Entomologist for 1881:

The foliage of the red maple (*Acer rubrum*) is often seriously injured by certain very small larvæ, which make large and conspicuous spots or galls upon it. This insect is apparently widely distributed. I have observed it both at Washington and at Ithaca, N. Y. In the last-named place it occurs so abundantly that I have repeatedly seen trees every leaf of which was infested.

This insect is so small that of itself it would not readily attract attention, but the result of its work is so conspicuous that it may be seen from a long distance. This appears in the form of a circular spot, three-tenths to three-eighths inch in diameter, which at a certain period of its growth is light yellow in color, with a cherry-red margin and central dot. (See pl. xxxviii, fig. 1.) At other periods the spot is simply light green or yellow. Frequently these spots occur so thickly as to intersect each other and to completely cover the leaf, fifty or more being on a single leaf. At the center of each spot may be seen, on the other side of the leaf, an elevated portion. Corresponding to this, on the lower surface of the leaf, there is a pit, within which the larva lives. Larvæ that were partially grown were found to be held in place in the pit in the leaf by what appeared to be a larval skin. This pellicle covers the body entirely, and is with difficulty removed from it; the edges of the pellicle adhere quite tightly to the leaf. Where the larva is full grown it forces itself from under this skin, which then falls back into the cavity, or is pushed to one side, where frequently it may be seen adhering to the leaf. The larva at this time drops to the ground, into which it enters to undergo its transformation.

The larvæ are translucent, viscid, nearly colorless. Those in the galls are broad oval (see pl. xxxviii, fig. 3); but those which have left them are more elongated, tapering almost equally towards each end. On the lateral margin of each abdominal segment there are one or more short spines, which are directed towards the caudal end of the body; and on the dorsal surface of each abdominal segment, near each lateral margin, there is a small tubular spiracle. There is a distinct head (see pl. xxxviii, fig. 3a), which bears short but conspicuous antennæ. The caudal end of the body (see pl. xxxviii, fig. 3b) bears a pair of fleshy appendages, each of which is furnished with a pair of spines similar to those on the margin of the segment, and a large number of triangular teeth.

The larva spins something like a cocoon a short distance below the surface of the ground. To this cocoon the particles of sand firmly adhere so that it can be distinguished from the soil only with difficulty. The pupa is yellowish white, with large black eyes. When the pupa is about to transform to an adult it emerges for about two-thirds of its length from the cocoon. The pupa skin remains firmly attached in this position. (See pl. xxxviii, fig. 4.)

From larvæ collected at Washington May 15, the adult emerged from June 14 to June 16. I have not yet sufficient data to determine the number of generations each year; but I believe there are several. Larvæ were observed at Ithaca during the latter part of September; they went into the ground September 26.

The galls made by this insect have long been known. Osten Sacken,\* from a study of the galls and the larvæ which he saw in them, proposed the name *Cecidomyia ocellaris* for the species, believing the insect to be a member of the *Cecidomyiidae*. But the fly which I have bred proves to belong to the genus *Sciara* of the family *Mycetophilidae*.† This result is quite interesting, for the species of *Sciara* are usually found "among decaying leaves, in vegetable mold, in cow-dung, under the bark of dead trees," etc.‡ One other species (*Sciara tilicola*) is known to produce a gall. This species infests the leaves of young linden trees in shady, sheltered situations. The lemon-yellow larva, capable of leaping like the cheese-maggot, lives in numbers in the stem, generally near the origin of the last or of the two last leaves. Each of them has a hollow of its own, and produces a swelling of the size of a pea, which it abandons before the transformation. §

*Description of adult male*.—Plate xxxviii, fig. 2, 2b. Head dark, eyes black, kidney-shaped, and meeting in a point on the dorsal surface of the head. Antennæ sixteen-jointed, inserted close together; color dark brown, with the basal segment light yellowish brown. Epicranium quite large and convex; dark brown; bearing three ocelli, which are whitish and glistening. Pronotum light yellowish-brown. Mesoscutum arched, yellowish-brown in the center and darker at the edges. Scutellum dusky-brown. Metathorax dark brown, almost black. Abdomen, with caudal portions of segments, blackish, the cephalic portions yellowish-brown. The claspers lighter brown. Poisers, with knob, blackish and base light brown. Tibiæ and tarsi dusky brown; femora lighter; coxæ still lighter. The distal end of each tibia furnished with two long brownish hairy brushes. (Plate xxxviii, fig. 2a.)

### 53. THE COTTONY MAPLE SCALE.

*Pulvinaria innumerabilis* (Rathvon).

Order HEMIPTERA; family COCCIDÆ.

(Plate xxxi; figs. 1, 2, 3, 4.)

The following account of this pest is copied from Riley's report as U. S. Entomologist for 1884:

This scale-insect stands prominent among the species which have been especially abundant during the past summer. Circumstances appear to have been particularly favorable to its development, and, although it does not spread rapidly, its general appearance this season has caused considerable alarm in many States. It was sent to us during the spring and summer by correspondents in New York, Pennsylvania, Maryland, Virginia, Ohio, Indiana, Michigan, Illinois, and Missouri. For the past thirty years it has attracted considerable attention as damaging shade trees, particularly the maples, in different parts of the country, occurring in extraordinary abundance from time to time, and then almost lost sight of for several years. It is more particularly a northern insect, and although it is often numerous in Virginia and Missouri, we have never received it from, nor heard of its occurrence in the extreme Southern States.

*Life-history*.—The round of life of this species is not strikingly different from that of other Coccids, and is briefly as follows:

The young lice (Fig. 1, c) hatch in spring or early summer, walk about actively as soon as born, and settle along the ribs of the leaves (very rarely on the young twigs). They then insert their beaks and begin to pump up sap and to increase in size, a thin

\* Monograph of the Diptera of North Am., Part I, 199.

† I am indebted to Baron Osten Sacken for the generic determination of this insect.

‡ Osten Sacken, Proc. Ent. Soc. Phil., I, 159.

§ Osten Sacken, Proc. Ent. Soc. Phil., I, 164.

layer of a waxy secretion immediately beginning to cover the dorsum. In a little more than three weeks they have increased to double their size at birth, and undergo their first molt, shedding the skin, it is supposed, in small fragments. After this first molt the waxy secretion increases in abundance and a differentiation between the sexes is observable. The males grow more slender and soon cease to increase in size, covering themselves with a thick coating of whitish wax. The pupa then begins to form within the larval skin, the appendages gradually taking shape, the head separating from the thorax, the mouth-parts being replaced by a pair of ventral eyes. A pair of long wax filaments is excreted from near the anus and these continue to grow during the life of the insect. It is the protrusion of these filaments from beneath the waxy scale which indicates the approaching exclusion of the male. The posterior end of the scale is in this manner raised up, and the perfect insect backs out with its wings held close to the sides of its body.

Meanwhile the female larvæ have been undergoing but slight changes of form. They grow larger and also broader across the posterior portion, but remain flat and with but a slight indication of a dorsal carina. Just before the appearance of the adult males, they undergo another molt and change in color from a uniform pale yellow to a somewhat deeper yellow with deep red markings. (Fig. 3, a, b, c.)

The males (Fig. 2, c) make their appearance from August 1 to September 15, issuing most abundantly about the middle of the former month, and their life is short, seldom exceeding two or three days. They copulate with the females and then die. The latter, soon after the disappearance of the males, gradually lose their bright-red markings and change to a deep-brown color. They grow more convex, and the dorsal layer of wax becomes thicker and more cracked. Before the falling of the leaves they migrate to the twigs and there fix themselves, generally on the under side. After feeding as long as the sap flows, they become torpid and remain in this condition until spring.

At the opening of spring the eggs develop with great rapidity and distend the body greatly, causing it to become convex instead of flat. The color is now yellowish, marked with dark brown, and the insect now absorbs sap with great rapidity and ejects drops of honey-dew. From the middle of May to the first of June the egg-laying commences. The eggs are deposited at the end of the body, in a nest of waxy fibers secreted from pores situated around the anus. This nest is attached to the posterior ventral portion of the body, and adheres somewhat to the twig. As the eggs are protruded into the waxy mass the posterior portion of the body is gradually raised up until it often reaches an angle of forty-five degrees with the bark. The egg-laying continues until on into July, and, after one or two thousand eggs have been deposited, the female dies. It is almost always within this period of egg-laying that the insect is noticed, on account of its large size, but more particularly from the conspicuous white cushion at the end of its body. After the death of the female, her beak breaks off and her body shrivels up, but remains attached to the twig by the cottony mass for a long time, often a year or more.

*Food-plants.*—The ordinary food-plant of this species of bark-louse is the soft or silver maple (*Acer dasycarpum*), but previous to 1879 we had not only found it upon the other species of maple, but also upon grape-vine, osage orange, oak, linden, elm, hackberry, sycamore, rose, currant, and spindle tree (*Euonymus*). In addition to these plants Mr. Putnam mentions locust, sumac, wild-grape, box-elder, beech, and willow. With regard to the specific identity of the individuals from all these different plants there is still room for doubt, though in 1875 we successfully transferred the species from *Maclura* and *Vitis* to *Quercus*. We wrote Mr. Putnam under date of March 25, 1879: "In all essential external characters they are identical, and, until they are shown to be different by the character and arrangement of the secretory pores in the anal plate of the female, they must be assumed to be identical. It is this critical comparative study which would greatly increase the value of your work." This study Mr. Putnam failed to make, and summed up his account simply

with the words: "I do not feel fully prepared to agree with Mr. Riley and Miss Smith in regarding all the *Pulvinariæ* found on these plants as identical, but there is enough evidence to show that this insect is capable of thriving on quite a variety of food-plants, and in the cases where it has been directly introduced from the maple there is no question of its identity." We have also found what is evidently the same species doing considerable damage to the woodbine (*Ampelopsis veitchii*) on our residence at Washington.

*Mode of spreading.*—Owing to the wingless, degraded, and inactive character of the female and the limited capabilities of the young for extended locomotion, the problem as to how the insect spreads from one locality to another seems at first glance rather a difficult one. When we consider the great activity of the young lice, however, and their propensity for fearlessly crawling upon anything which happens to be in their immediate vicinity, the difficulty is lost sight of. We may recognize as aids in transportation (1) the transplanting of trees from infested localities to places free from this insect, (2) birds, (3) other insects, (4) winds, and (5) water. The first of these methods needs no comment. The second is undoubtedly one of considerable importance, though scarcely deserving the prominence given it by some writers. Mr. Walsh, in his first report as State Entomologist of Illinois (p. 41), in speaking of the oyster-shell bark-louse of the apple (*Mytilaspis pomorum*), made the following statement:

"In my opinion the only way in which, as a general rule, bark-lice can spread from tree to tree, when the boughs of those trees do not interlock, is by a few of the very young larvæ, when they are first hatched and are scattered over the limbs of a tree in such prodigious numbers, crawling accidentally onto the legs of some bird that chances to light upon that tree and afterwards flies off to another. I have long observed that when a tree first begins to be attacked by bark-lice, it is only particular limbs and branches that are at first infested, and that these will be swarming while the rest of the tree will be free from lice. And I have further observed that it is the lower horizontal limbs, or branches, or such as birds, with the exception of woodpeckers and nut-hatches, would most naturally perch on, that are first attacked. \* \* \* If all the birds in the world were killed off, I believe that these bark-lice in a very few years would cease to exist."

This is an extreme view, and we have already shown (First Missouri Ent. Report, p. 15) how little the agency of birds is to be compared with that of insects. In the case of the species under consideration, the copious secretion of honey-dew attracts many honey-loving insects, such as bees, wasps, and flies, and these without doubt carry many of the restless young larvæ from tree to tree. Even the natural enemies of the bark-lice assist in this transportation, and Mr. Hubbard states (American Naturalist, May, 1882, vol. xvi, p. 412) that the Coccinellid beetles *Hyperaspidius coccidivorus*, *Chilocorus bivulnerus*, and others, while feeding upon the young larvæ of orange scale-insects, carry many of them from one tree to another attached to their backs and legs.

Mr. Hubbard has more recently come to the conclusion that spiders are very important agents in the distribution of scale-insects, in fact, the most important of all agents, and as his remarks apply quite well to the insect and the topic under consideration, we quote from a letter published in Bulletin No. 2 of this Division, pp. 30-31:

"I have reached the conclusion that spiders play a much more important role in assisting the spread of scale-insects than any other insects. From the beginning of my observations I have noticed that leaves which spiders had folded or webbed together for their nests or lairs almost always proved infested with scale, if infested trees were found in the neighborhood. This I was at first inclined to attribute solely to the protection from enemies and parasites afforded by the web and presence of the spider. No doubt, where the source of infection is near at hand, this may give a sufficient explanation of the observed facts. Lately, however, I have been examin-

ing with great care a lot of one and two year old trees which I set out myself last March. The stock from which these trees were taken was to my certain knowledge almost absolutely free from scale-insects. At the time of setting, the weather was excessively dry and unfavorable; in consequence of which the trees, 600 in number, were badly checked, and to a great extent lost their tops and nearly all their leaves, so that the present growth is all new, produced during the past summer. Notwithstanding, I find, to my surprise, scale-insects beginning to appear on a large proportion of the plants. Upon some of them the insects have begun to spread over the branches, and the exact spot where the trouble began is no longer ascertainable. In a strikingly large number of instances I find two or more leaves bound together with silk and occupied by a spider, and the inner surfaces of these leaves completely coated with scale-insects, when not a trace of the insect can be found elsewhere upon the tree. Furthermore, this lot of trees occupies a position west and north of the remainder of the grove, in the path of the prevailing [S. E.] winds. The adjoining rows of older trees, on the southeast, are many of them quite badly infested with, for the most part, chaff-scale (*Parlatoria pergandii*), there being usually a relatively small number of long-scale (*Mytilaspis gloverii*) mixed with the other species. As is often the case, the proportions of this mixture of species remain quite constant throughout the infested part of the grove. Now, I find in the newly-infested young grove these two scales mixed in about the same proportions, so that no doubt exists in my mind as to the source of their infection. As to the manner in which it has been accomplished, I submit that if, as many persons think, the young lice are transported bodily by the winds, we would have had a very different distribution from that which exists upon the older trees. The larger and heavier young of the chaff-scale would have been carried to a less distance and in smaller numbers than the long scale. (There have been no unusual storms or very high winds during the past summer.) Again, in a chance distribution by the wind I can see no reason for any evident connection with spider-web shelters such as I have mentioned. Individual scale-larvæ do not, so far as I have observed, wander far in search of such protection, and do not need it until the colony becomes sufficiently numerous to attract enemies and parasites. The part played by winds is evidently a secondary one, inasmuch as nearly all the web-inhabiting spiders make use of the wind to carry themselves and their bridges of web from tree to tree, and the spiders transport as passengers upon their bodies the migrating larvæ of the scale insect."

The agency of winds is, as just stated, a secondary one of great importance in transporting spiders, and is of primary value in the carrying of infested leaves and twigs to greater or less distances. That the young lice are blown bodily from one tree to another by heavy winds, as formerly supposed, has been disproven by the experiments of Mr. Hubbard, who has shown that they will cling tenaciously to a twig or leaf under a heavy blast from a bellows or from the mouth.

*Natural enemies.*—The cottony maple scale is subject to the attacks of very much the same natural enemies as other scale-insects. A number of predaceous beetles feed upon the eggs and young larvæ. We have observed the common lady-bird, *Chilocorus bivulnerus*, engaged in this work, and also the Coccinellids *Hyperaspis signata* and *H. bigeminata*. In addition to these Putnam mentions *Anatis 15-punctata*, "the larva of a species of *Ch ysopa*," and "the larvæ of two species of *Reduviidæ*."

The interesting lepidopterous insect *Dakruma coccidivora* Comstock, was originally bred from this bark-louse. Its larvæ construct tubular passages of silk and wax from one Pulvinaria to another on a thickly infested branch, and eat both the eggs and the waxy filaments which surround them. This insect and its curious habits were described at length by Professor Comstock in the annual report of this Department for 1879, pp. 241-243. It has been found preying upon Pulvinaria only in the vicinity of Washington, but in Florida destroys both a large *Lecanium* on magnolia,

a Coccid allied to *Dactylopius* and the common "Turtle-back scale" (*Lecanium hesperidum*).

During the past season, Miss Murtfeldt has noticed a harvest mite in great numbers feeding upon the eggs of this species at Kirkwood, Mo. From specimens sent to the Department, this mite seems to belong to the genus *Eupodes*, and is allied to the European *E. hiemalis*. It is very minute and pale reddish-yellow in color. The body is divided into four distinct segments, two of which belong properly to the abdomen, the last one being the largest, the first the smallest, and the other two about equal in length. The division between the last two segments is a distinct, whitish, transverse line, while the others are indicated by slight lateral indentations and subdorsal impressions reaching to the lateral margin, of the same pale color. This is probably the same mite noticed by Miss Smith, and mentioned in her report previously cited.

Two true parasites are known to infest this scale. The first of these, *Coccophagus lecanii* (Fitch), is very common, and ordinarily infests the scales in great numbers. The adult insect is a minute, black, four winged fly, marked with a crescent-shaped yellow patch in the middle of the body above. According to Putnam there are two broods of this parasite each season, the adults appearing in May and August. The infested lice become more or less inflated, finally turning black and becoming rigid. The females are most commonly infested, though Putnam states that he has bred the parasite from the male scale.

The second parasite was bred by Mr. Putnam after the publication of his article, and was described by Mr. Howard in his paper on the parasites of Coccids (Ann. Rept. Dept. of Agr., 1880, p. 365) as *Aphycus pulvinaria*. This species seems to be rare and has not been bred since. It is minute, dull-yellow in color, with a dusky abdomen and with antennæ variegated with brown and white.

*Remedies.*—The principal remedies which have been proposed in the past are, briefly, heading in the tree, *i. e.*, cutting off the branches, and drenching with a solution of whale-oil soap or a 1 per cent. solution of carbolic acid. During the past season, however, we have recommended nothing but the kerosene emulsions treated of in a previous article, and these will undoubtedly give better satisfaction than anything else that can be used. The best time for spraying the trees will be while the young are hatching, late in May or early in June, and the apparatus described in the article on the cottonwood beetle can be used to the same advantage here.

In Professor Forbes's third report much space is devoted to this pest, which began in 1884 to appear again in noticeable numbers. In destroying the insect the use of whale-oil soap was less satisfactory than that of the kerosene emulsion, "an application of the suds, strong enough to effect the purpose, being very likely to injure the leaves at least as much as the bark-lice would have done." The most useful remedy was found to be a kerosene emulsion diluted with soap-suds to a strength of from 2½ to 5 per cent. and not injuring the leaves.

Miss Murtfeldt reports (Bull. 13, Div. Ent., 1887) as follows concerning the ravages of this insect in Illinois :

This insect has not been troublesome in this part of Missouri since 1884; but in and around Rockford, Ill., I learned that it had been so abundant on the soft maples for three successive seasons as to kill many young trees outright and greatly injure the older ones. I was told that the side-walks shaded by these trees became so defiled and slippery from the exudations of the scale insect that it was difficult and unpleasant to walk on them. The citizens had consequently conceived a prejudice against the soft maple, and many were being cut down or dug up and replaced by other trees.

54. *Psylla annulata* Fitch.55. *Siphonophora acerifoliae* Thomas.

This plant-louse occurs on the soft maple (*Acer dasycarpum*) in Iowa, Illinois, and Missouri.

56. *Pemphigus acerifolii* Riley.

Living in abundant and long cottony excretion, on the under side of the leaves of *Acer dasycarpum*, causing them to curl, and exuding an abundance of thick and very glutinous "honey-dew."

*Winged female*: Alar expanse 10<sup>mm</sup>. Head and thorax bluish-black. Abdomen black, covered with long cottony threads. Antennæ reaching the wing-insertions; annulations not conspicuous; joints 3, 4, 5, and 6 somewhat contracted at base and apex; apical unguis not perceptible; joints 5 and 6 subequal; 4 distinctly clavate; 3 as long as the two preceding together. Wings subhyaline, of a whitish tinge; subcostal vein and the inner margin of the stigma black; oblique veins whitish; stigma short and broad, not angled at the base of the stigmal vein, which starts from a little behind its middle, and is comparatively straight, thereby making the apical cell rather narrow. Terminal distances between the veins subequal, that between second discoidal and cubital somewhat greatest; basal one-third of the cubitus hyaline, but not abortive, as it can usually be traced to its base, which is very close to that of the second discoidal; bases of the two discoidals either approximate or quite contiguous; discoidals of the hind wings proceeding connectedly from the subcostal vein. Larva with five-jointed antennæ, and the promuscis extending beyond tip of abdomen. (Riley.)

57. *Pemphigus aceris* Monell.

Occurred on the under side of limbs of the sugar maple, enveloped in woolly matter, Peoria, Ill., June. A comparison of about fifty specimens each of *P. aceris* and *P. acerifolii* shows that the antennal differences between the two are quite constant.

*Winged female*.—Head and thorax dusky, abdomen dusky, but appearing white from the abundant pulverulent matter. Antennæ long, slender, the apex of the fourth joint reaching the insertion of the wings; the joints subcylindrical, scarcely contracted at base, apical claw not perceptible; fourth and fifth joints subequal, fourth joint not clavate, third joint less than the two preceding taken together. Wings subhyaline, subcostal and oblique veins brownish black. Stigmal vein arising behind the middle of the stigma. Venation closely resembling that of *P. acerifolii*, except that the base of the first discoidal is usually more remote from that of the second discoidal. Length 0.12 to 0.15; expanse of wings 0.20 to 0.22 inch. (Monell.)

## 58. THE GLOOMY SCALE.

*Aspidiotus tenebricosus* Comstock.

This species has been observed by Professor Comstock on the bark of the trunk and limbs of red or swamp maple (*Acer rubrum*) at Washington, D. C.

*Scale of female*.—The scale of the female is very dark gray, agreeing in color with the bark to which it is attached; the protuberance indicating the position of the exuviae is marked with a white dot and concentric ring; in rubbed specimens this protuberance is smooth and black, in all cases the remainder of the surface of the scale is rough. The scale is very convex; the exuviae are usually between the center

and one side. The ventral scale is well developed, especially at the margin, where it is much thickened and is dark colored; the central part is white and adheres to the bark, while the thickened margin is easily removed as a ring. Diameter of scale, 1.5<sup>mm</sup> (.66 inch).

*Female*.—The female is nearly circular, being but slightly longer than broad, and is of a yellowish-brown color. The segmentation of the body is not very distinct. The last segments present the following characters:

Although forty-three specimens were carefully examined, no groups of spinnerets were found.

There are three pairs of well-developed lobes. The median lobes are rounded posteriorly, or often with a slight notch on the lateral margin, and taper to a point anteriorly; the second lobe of each side is somewhat triangular in outline, with the lateral edge serrate; the third lobe is larger than either the first or second lobes, triangular in outline and serrate on lateral margin.

The posterior third of the lateral margin of the segment appears to be of the same structure as the lobes, and has five triangular serrate lobes; the posterior one of these is the largest, and is larger than either of the true lobes.

There are seven club-shaped thickenings of the body wall upon each side of the meson, which are arranged as follows: One terminating near the lateral margin of the first lobe; this extends anteriorly but a short distance beyond the lobe. One appearing to be a prolongation of the mesal margin of the second lobe; this extends anteriorly to a point laterad with the anus. One terminating between the second and third lobes; this is linear, inconspicuous, and sometimes obsolete. One terminating at the base of the plates between the second and third lobes, and also one terminating at the base of the plates between the third lobe and the thickened lateral margin; these two are the largest, and extend anteriorly the farthest of all the thickenings, one terminating at the mesal margin of the third lobe, and one at the mesal end of the thickened lateral margin of the segment.

The plates between the median lobes and between the first and second lobes of each side are very small and often obsolete; there are two small irregularly branched plates between the second spine and the third lobe, and also two similar plates between the third spine and the mesal end of the thickened lateral margin.

There are five pairs of spines on the ventral surface of the segment, and six on the dorsal. Those at the base of the median lobes are very small, the others are conspicuous. The second and third spines of each surface are situated just laterad of the second and third lobes respectively; in each case the dorsal spine is slightly mesad of that on the ventral surface. The fourth spine of the ventral surface is on the penultimate lobe of the thickened lateral margin. The fifth spine of this surface is near the anterior end of the thickened part of that margin. The fourth and fifth spines of the dorsal surface are in each case mesad of the corresponding spines of the ventral surface. There is also a spine on the dorsal side, very near the penultimate segment.

*Scale of male*.—The scale of the male is oval in outline, and of the same color as that of the female; the protuberance covering the larval skin is near the anterior end. The ventral scale is similar to that of the female, except that the margin is not so much thickened.

*Male*.—Only dead and shriveled males have been observed. Described from forty-three females and many scales of each sex. (Comstock Agr. Rpt., 1880.)

#### 59. *Pseudococcus aceris* (Geoffrey).

This species, stated by Signoret, according to Comstock, to be one of the most common in France, would seem to be comparatively rare in the United States. "It has been collected by Miss Emily Smith on maple (*Acer saccharinum*) at Peoria, Ill., and forms the subject of quite an ex-



tensive article by her in the *North American Entomologist*, vol. 1, p. 73 (April, 1880). She also notes its occurrence at Lancaster, Pa., where it has been collected by Dr. Rathvon. The following description of the species is compiled from Signoret and Miss Smith:\*

*Adult female*.—Color, bright yellow (Smith), reddish yellow (Signoret). Length from 4<sup>mm</sup> to 5<sup>mm</sup>. Shape, rounded oval, as large behind as in front. The dorsal integument is smooth, with the divisions into segments obscure; it is filled with *spinnerets* in the form of pores, and is also furnished with many delicate hairs, especially numerous upon the median part of each segment and at the extremity of the abdomen. The antennæ are long and delicate, 9-jointed, second and third longest, the others diminishing in size and length except joint 9, which is longer than the preceding joint and acuminate at tip. The under lip is long, acuminate at tip, which is furnished with many hairs. The tibiæ are nearly three times as long as the tarsi. The tarsal claws are rather short and toothed on their inner side, sometimes truncate at tip; there are only two digitules, those of the claw, the others being only simple hairs. The anal genital ring is large, punctated, and supports six quite long hairs.

*The egg* is light yellow in color when first deposited, later becoming yellow brown. Dimensions given by Miss Smith, 5<sup>mm</sup> to 6<sup>mm</sup> long, and 3<sup>mm</sup> to 4<sup>mm</sup> wide; probably 0.5<sup>mm</sup> to 0.6<sup>mm</sup> by 0.3<sup>mm</sup> to 0.4<sup>mm</sup>.

*The young larva*.—Color, reddish yellow; shape, elongated oval, narrow behind. Antennæ 6-jointed, joint 6 as long as the three preceding joints together. The lower lip is 2-jointed. The body is surrounded by a series of spines and upon the disk of each segment is a series of eight tubercular *spinnerets*, with which alternate short hairs; in front of the head between the eyes are several longer hairs; the anal ring with six hairs; the lateral lobes large, each with one very long hair and several shorter ones. The tarsi a third longer than the tibiæ.

The male larva is red and has 7-jointed antennæ.

*The male*.—Color, red; antennæ, 10-jointed; joint 1 short and stout; joint 2 twice as long as 1; joint 3 three times as long as 1; joints 4 to 10 similar in size and form, decreasing slightly in length. Legs hairy; tarsi one-half as long as tibiæ. Anal filaments longer than all the rest of the insect. (Comstock Agr. Rept., 1880.)

#### 60. *Lygus invitus* Say.

Order HEMIPTERA; family CAPSIDÆ.

The following account of this bug is copied from Professor Forbes's Third Report on the Injurious Insects of Illinois:

Brief mention may properly here be made of a species whose injuries to vegetation have not hitherto been serious, as far as known, but which deserves attention as the near relative of one of the most injurious horticultural species (the tarnished plant bug), and also because, from its own abundance and habits, it may well become the author of serious mischief.

Although not agreeing precisely with any descriptions of *Capsidæ* accessible to me, I have little doubt, after careful study of about forty specimens collected in June, that the species is that described by Say as *Capsus invitus*. It differs materially from Say's original descriptions, but corresponds closely in most particulars with the description of a type specimen of Say's, published by Uhler in his notes on the Heteroptera in the collection of Dr. Harris,\* varying from that only in some color characters of little moment in so variable a genus.

The following description is condensed from that of Uhler, modified with respect to color to conform to our own specimens.

General color pale obscure yellow, varying to yellowish green. Antennæ and

\* Proceedings of the Boston Society of Natural History, vol. xix, p. 407.

transverse carina at base of head very slender, the former nearly as long as the hemelytra. Surface of head polished, impunctured, clothed with short hairs. Tylus slender, short. Eyes large, prominent. Pronotum smooth, very convex, sparingly hairy, finely, densely, and mostly confluent punctured, the punctures forming obscure transverse rugosities. The head and forepart of the thorax are slightly darker yellow, the antennæ are sometimes pale throughout, sometimes embrowned at tip and also at tip of second joint. A broad band on the pronotum, a little within the margin, extends backwards along the inner edge of the calvus, is continued as a dusky shade through the middle of the membrane, deepest along the inner edge of the inner cell, and extends distally into an indefinite dusky shade. This line is intersected at the tip of the corium by a transverse band of the same color, extending to the edge of the hemelytra. When the wings are closed, these marks give the appearance of a median black stripe crossed at the tip of the corium by a black band, and forking at the scutellum. In the darker colored specimens the pronotal bands are frequently connected by a basal shade. The posterior half of the larger cell of the membrane is usually white. In many yellowish specimens the cuneus alone is green. The posterior thighs are commonly infuscate on the distal half, and the anterior tibiæ are often brown at tip. Length to tip of hemelytra 6<sup>mm</sup>. Humeral breadth 1.66<sup>mm</sup>.

On the 12th May the younger leaves of many of the common soft maples (*Acer dasycarpum*) near Normal were observed to be curled and specked with numerous semi-transparent spots, evidently the work of the larvæ of this Capsid, found abundantly upon the affected leaves. On the 30th May specimens collected were all of the second and third stages. On the first of June, the first imagos were seen in the breeding cages and on the trees. By the 5th of that month nearly all the specimens collected had transformed to the imago, and the experiment was not carried further.

61. *Poecilocapsus goniphorus* (Say).

A brilliant scarlet red bug found on different trees, including the maple.

62. *Lygus monachus* Uhler.

The following account by Miss Murtfeldt of this bug appeared in her report as special agent of the Division of Entomology (Bulletin No. 13) :

This bug came under my notice for the first time late in the spring of 1882, infesting the growing points of young soft maples (*Acer dasycarpum*). Most of the insects were at that time mature, but two or three pupæ were found, enough to indicate that the leaves of the maple had been their breeding place. A few specimens were taken, but as the insect was not present in sufficient numbers to give it importance as an injurious species, not much attention was paid to it. During several succeeding springs I occasionally came across a mature specimen—which, from its exceeding agility, both in running and flying, generally evaded capture—but it was not until the present season that the maples were infested to such an extent as to injure and disfigure them.

Just as the leaves were beginning to put forth, close observation revealed the fact that they were all more or less stippled with transparent spots, some mere dots, others a tenth of an inch or more in diameter. As the leaves expanded the delicate cuticle of the upper surface would give way and they presented the appearance of being perforated with holes and much torn and tattered along the margin, marring their beauty for the entire season. If, about the 1st of May, the leaves were carefully examined, there would be found on the under surface of each from two or three to a dozen or more very delicate bugs of a very pale translucent-green color, the embryo wing-pads being almost white. They were further characterized by very long and slender legs, beak, and antennæ, body flat and broad oval in outline; head small,

eyes relatively large, oblong, and bright red-brown in color. The larvæ varied in size from one-twentieth to one-eighth inch in length, and so far as I could discover there were but two larval molts. Scattered about over the leaves were small, round, translucent green eggs rather larger than a *Portulaca* seed. The pupal form was precisely like the larval, except in point of size and relative development of the wing-pads. When the under side of the leaf was turned up for examination the bugs, large and small, would dart on their hair-like legs to the reversed surface, moving with the greatest rapidity and sometimes dropping to the ground in their evident desire to escape observation. The final transformation occurred about the middle of May, after which the companies dispersed. The species is a pretty one, although, from the glassy texture of the entire hemelytra and the general delicacy of coloring, it always has a somewhat immature appearance.

This bug happily lacks the disagreeable odor so common to the species of this suborder and which pertains even to most of its closest allies.

Absence from Kirkwood after the middle of May somewhat interrupted my observations on this insect. On my return, early in June, only a few of the mature bugs remained among the curled and torn leaves on which they had developed. Occasionally throughout the summer a specimen would be met with, as often on the foliage of any other tree as on maple, but there was no second brood. This species, unlike *Capsus oblineatus*, is never to my knowledge found on flowers. It probably secretes itself early in the season, and becomes dormant until the following spring.

The only remedial applications experimented with were Pyrethrum powder and air-slacked lime, both of which were measurably effective, judging by the small scale on which they were tried.

Mr. P. R. Uhler gives the following description of this insect:

*Lygus monachus* n. sp.—Long-oval, pale green or testaceous, coarsely punctate above, sericeous impubescent. Face convex, highly polished, bald; base of vertex with a longitudinal impressed line, towards which a similar line runs obliquely each side from the inner corner of the eyes; antennæ sparsely and minutely pubescent, basal joint thickest, a little longer than the head, tapering at base, second joint thrice as long as the basal, infuscated and a little enlarged towards the tip, third and fourth setaceous, together not as long as the second. Pronotum highly polished, convex, coarsely punctate in transverse wavy lines, each side with a dark brown vitta or long spot; lateral margin smooth, callous at base, the humeral angles subacute, callosities prominent, convex, almost confluent on the middle; lateral flap of pronotum irregularly punctate. Pectoral pieces pale, impunctate. Legs pale green, feebly pubescent; apex of posterior femur usually with one or two fuscous bands, tip of tarsi and the nails black. Scutellum moderately convex, excavated at base, transversely obsolete-punctate, more or less infuscated. Corium coarsely, transversely rostrate-punctate, the clavers more or less infuscated, sometimes with all but the margins covered with dark brown; corium usually with a transverse, dark-brown arc next the posterior border; cuneus long and wide, the incised base fuscous, and the inner margin brown; membrane pale testaceous, with two or more dark clouded spots, the inner submargin of the principal areole, a spot at its tip, and the base next the cuneus all more or less fuscous. Venter pale greenish. Length of body, female, 5<sup>mm</sup>; to tip of wing-covers, 7<sup>mm</sup>; width of pronotum 2<sup>mm</sup>.

*Male*.—Length of body, 4<sup>mm</sup>; to tip of wing-covers, 5½<sup>mm</sup>; width of pronotum, 1¾<sup>mm</sup>.

This has proved to be a very common insect in various localities.

Mr. Cassino collected numerous specimens around Peabody, Mass. Mr. Bolter sent to me a pair from Illinois and Missouri, and I have taken it from alders, maples, and many other kinds of small trees and shrubs on Cape Ann, Massachusetts, also near the base of the White Mountains, and in New Hampshire, and near Quebec, Canada.

Mr. Forbes has also forwarded to me specimens from near Normal, Ill.

It resembles *Lygus invitus* Say, and presents several of the color varieties common to that species, but it is a much larger insect, of a longer figure, and has a more flattened upper surface.

63. *Aleurodes aceris* Forbes.

Order HEMIPTERA; family ALEURODIDÆ.

The following account of this interesting insect is copied from Professor Forbes (Third Report Insects of Illinois):

*Pupa*.—I have noticed, for several years, a peculiar bark louse upon the leaves of the maple, but have not bred it until the present year. The fully developed pupal scale is oval in general outline, somewhat lyrate, broadest posteriorly, contracted in front of the middle. Margins entire, surface densely granulated. The color is chocolate, mottled with white, the white varying in amount and tending to form three transverse bands. The central segmented area is usually irregularly mottled with white, and a quadrate patch, including the vent, is almost always brown; but otherwise the color may vary from nearly uniform brown to almost white. Outline sometimes slightly emarginate posteriorly. Length, .095 of an inch; greatest width, .045; width at anterior fourth, .036.

*Imago*.—Pale yellow throughout; legs and abdomen paler; wings milky white; rostrum black at the extreme tip; veins yellowish; first joint of the antennæ scarcely longer than wide, the remaining joints filiform, the second nearly as long as the four following and about four times as long as the first, the fourth longer than the third, the third and fifth about equal, the sixth fusiform.

At Tamaroa, in southern Illinois, soft maple trees were found badly infested by this bark louse, but elsewhere it has occurred in only trivial numbers. There are apparently two broods of this species in a year, scales collected in August, 1883, emerging April 10 to 24, 1884, and others, collected during the present summer, emerging August 4. From these larvæ several hymenopterous parasites belonging to the genus *Elaptus* escaped September 6, the species of which is apparently new.\*

64. *Phytoptus quadripes* Shimer.

Class ARACHNIDA; order ACARINA.

Mr. H. Garman gives the following account of this mite, which is taken from his article in Forbes' First Report on the Injurious Insects of Illinois:

This mite produces galls on the leaves of the soft maple, *Acer dasycarpum* Ehrh.

This is the *Phytoptus* upon which Dr. Henry Shimer founded his genus *Vasates*. It is a coarsely striate species, the striae numbering from 37 to 42. The length is about .008 inch. The tarsal claw is slightly curved and ends in an evident knob. The feather-like appendage has four pairs of prongs. The color varies from pale yellowish to light orange. Sexually mature females, the young, and eggs occur in the galls in June.

\* *Elaptus aleurodis* Forbes.—Female: Length, .03 inch; that of the head, .005 inch; front wings, .032 inch long and .001 inch wide; posterior wings, .0032 inch wide at the widest point; antennæ as long as the head and whole body; scape stout, arcuate, rising to the top of the head, about as long as the three following joints, nearly smooth, as is also the second joint; remaining joints densely pilose; the club not jointed, as long as the three joints preceding; first joint obconic, second about the same length, but narrower. Color black, surface shining, abdomen alutaceous, head and thorax punctured, antennæ yellow, legs entirely yellow, femora and tibiæ of the middle and posterior legs black, their tarsi yellow. Described from three specimens bred from *Aleurodes aceris*. (Forbes.)

The galls appear with the unfolding of the leaves in spring as slight swellings of the parenchyma, and as the leaf reaches its perfect size they expand usually into top-shaped galls, arising from the upper side of the leaf. The form varies to some extent, some of the galls being discoid or more or less spherical, while occasionally two galls have a common neck and opening. At first the color of the galls is like that of the unfolding leaf, dull purple or green; later it assumes the light green color of the veins and veinlets; and still later changes, in many cases, to purplish. Towards the end of summer it dries up and becomes black. The outer surface is smooth, but the walls are broadly and irregularly impressed, making a very uneven outline. On the under side of the leaf the position of the galls is usually indicated by an impression with a tuft of white hairs in the center, which tuft covers the opening into the gall. Occasionally the opening and tuft are borne upon a slight elevation. The height of one of the largest galls, measured from the upper side of the leaf, was .19 inch; the diameter was .13 inch. The galls are attached at the sides of the veins, and are so numerous on some



FIG. 154.—Leaf of the soft maple (*Acer dasycarpum*), showing the galls produced by *Phytoptus quadripes*.—H. Garman del.

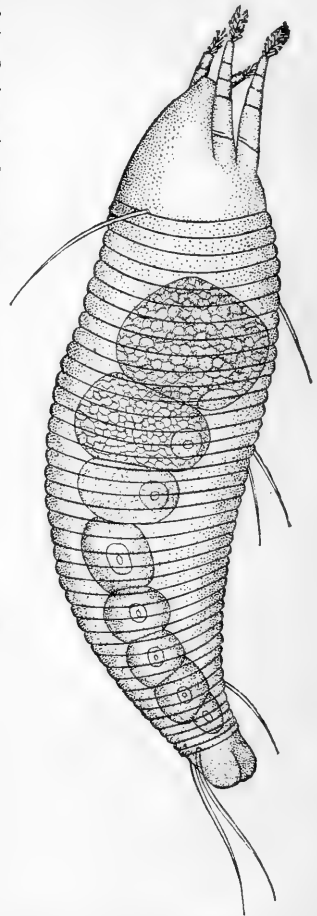


FIG. 155.—*Phytoptus quadripes* Shimer. Side view showing the eggs within the body. From a camera lucida sketch.—H. Garman del.

leaves as to cover the entire upper surface. I have seen trees on which there were very few ungalled leaves, and most of them had curled up and were of a greenish-yellow hue. Three hundred and ten galls were counted on one leaf. Dr. Shimer says thousands occur on some leaves.

Scores of specimens of the *Phytoptus* which produces galls on the leaves of our soft maple may be secured in June, in which the eggs with nuclei and nucleoli may be seen with perfect distinctness.

65. *Phytoptus acericola* Garman.

This mite produces galls on the leaves of the sugar maple, *Acer saccharinum* Wang.

In five examples of this mite the striæ were counted, and in three of them numbered 30, and in the other two 28 and 29, respectively. The prongs of the feather-like appendage seem to be three. The length is about .0075 inch. This form was found in June both among knobbed hairs and in galls on the sugar maple, but there appeared to be only one species represented.

The gall is very slender, tapers to both extremities, and bears a strong resemblance in general form to the nail galls described by Prof. C. V. Riley from the leaves of *Ampelopsis*. The walls are uniformly thin, and present no internal roughness. The height is about .19 inch, and the diameter .045 inch. *Phytopti* were abundant in these galls collected at Bloomington, Ill., June 22, 1881. (Forbes' Third Report.)

The following insects also occur more or less constantly on the maple:

## Order COLEOPTERA.\*

66. *Dicerca divaricata* Say. Observed by Mr. F. B. Caulfield apparently ovipositing on a dead maple, June 12. (Can. Ent., xviii, p. 196.)
67. *Chrysobothris femorata* Lec.
68. *Molorchus binaculatus* Say. Bred from a small twig of a young wild maple. (Chittenden in letter.)
69. *Xylotrechus colonus* Fabr. (See Oak Insects, p. 77.) Found by Mr. G. Hunt under the bark of an old sugar maple in northern New York.
70. *Saperda tridentata* Oliv. Pupæ found in a maple trunk. (W. H. Harrington, Rep. Ent. Soc. Ontario for 1883, p. 35.)

## Order LEPIDOPTERA.

71. *Edema albifrons* (Abbot and Smith) Larva common on the maple at London, Canada.
72. *Heterocampa unicolor* Pack.
73. *Heterocampa guttivitta* Walk. Brunswick, Me.
74. *Callosomia promethea* (Drury).
75. *Schizura ipomeæ* Doublt.
76. *Nadata gibbosa* (Abbot and Smith) Lintner. (Contr., iii, p. 150.) Reed. (Rep. Ent. Soc. Ontario, 1883, 16.)
77. *Limacodes scapha* Harris. (S. Lowell Elliot, MS. notes.)
78. *Empretia stimulea* Clemens. Soft maple, St. Louis. Miss Murtfeldt. (Bull. 13, Div. Ent., p. 62.)

---

\*The following occur in decayed maple wood and stumps: *Alaus oculatus* Linn., (Devereaux, MS. notes); *Osmoderma scabra* Beauvois (Devereaux, MS. notes); *Pyrochroa flabellata* Fabr., *Pyrochroa femoralis* Lec.

79. *Eacles imperialis* (Drury). Thomas. (Ill. Rep.)  
 80. *Hyphantria textor* Harris.  
 81. *Thyridopteryx ephemeraeformis* (Haw.) Riley's MS. notes.  
 82. *Gastropacha americana* Harris. Lintner (Ent. Contr., iii, p. 154).  
 83. *Apatela luteicornis* G. & R.  
 84. *Charadra propinquilinea* Grote. Sup., p. 167.  
 85. *Agrotis C-nigrum* (Linn). Thomas. (Ill. Rep.)  
 86. *Ennomos alniaria* (Linn). Larva abundant on the maple. C. E. Worthington. (Can. Ent., x, p. 16.) See Birch Insects.  
 87. *Endropia armataria* H. Sch. Dimmock. (See Birch Insects.)  
 88. *Boarmia crepuscularia* Fr. (See under Locust and Birch Insects, p. 371.)  
 89. *Nematocampa filamentaria* Guen. Lintner. (Ent. Contr., iii, p. 165; Forbes' Second Rep.)  
 90. *Lophoderus velutinana* Walk. Miss Murtfeldt in Fernald's Catalogue of Tortricidæ, p. 76.  
 91. *Lophoderus triferanus* (Walk.). (See p. 195.)  
 92. *Cenopis reticulatana* (Clem.). Miss Murtfeldt in Fernald's Catalogue of Tortricidæ, p. 20.  
 93. *Platynota flavidana* Clem. Miss Murtfeldt in Fernald's Catalogue of Tortricidæ, p. 22.  
 94. *Cacæcia argyrospila* Walk. (See p. 192.)  
 95. *Gracilaria acerifoliella* Chambers. The larva curls the edge of the leaf of *Acer glabrum*, mountain bush maple, downward. Colorado.  
 96. *Gracilaria packardella* Chamb. Larva rolls the leaf downward into a conical figure.  
 97. *Lithocolletis clemensella* Chamb. Under surface of leaves.

## Order HEMIPTERA.

98. *Pæciloptera pruinosa* Say. (See p. 281.)  
 99. *Aphis aceris* Linn. Occurs on *Acer pennsylvanica* (Fitch).  
 100. *Lecanium acericola* Walsh and Riley. (Amer. Ent., i, p. 14.) Also on box elder (Thomas).  
 101. *Lecanium acericorticis* Fitch. On silver maple, Washington, D. C. (Glover, Agr. Rep., p. 1876. See Thomas, vii, p. 120; American Naturalist, xii, pp. 655, 808.)

## Order DIPTERA.

102. *Cecidomyia aceris* Shimer. On *Acer dasycarpum*. (Trans. Amer. Ent. Soc., i, p. 281.)

CHAPTER VI.  
INSECTS INJURIOUS TO THE COTTONWOOD.

*Populus monilifera.*

AFFECTING THE ROOTS.

1. THE COTTONWOOD ROOT BORER.

*Plectrodera scalator* Fabr.

The following correspondence regarding this borer appeared in a newspaper :

Herewith is an entomological specimen found at the foot of the cottonwoods about my house, and the larvæ are boring the trees. What can I do to prevent their killing my trees?—J. R., Manhattan, Kans.

The large and beautiful black and white long-horned beetle which you send is the *Plectrodera scalator* Fabr. Its larva has long been known to bore in the roots of willows, and as most insects that attack the willow also attack the cottonwood, it is natural that this species should form no exception. I can give no remedy from experience, and can only recommend the same preventive and remedial measures that are used against the round-headed grub. (C. V. Riley.)

AFFECTING THE TRUNK AND BRANCHES.

2. THE POPLAR BORER.

*Saperda calcarata* Say.

Order COLEOPTERA ; family CERAMBYCIDÆ.

In the Western States, including Colorado, it causes wide-spread injury and destruction to the cottonwood trees. (Riley. See the poplar borer, p. 435.)

3. *Hyperplatys aspersus* Say.

Boring in the dry twigs at Columbus, Tex.; the perfect insect is to be found throughout spring and summer, according to Schwarz. (Riley.)

4. *Oberea schaumii* Leconte.

The larva burrowing in the twigs makes a very smooth cylindrical burrow, the perfect insect appearing in the middle of June at St. Louis, Mo. (Riley.)

5. *Oberea mandarina* Fabr.

The larva bores in the thin twigs at St. Louis, Mo., the imago issuing in the middle of April. (Riley.)



6. *Dorytomus mucidus* Say.

This insect is found running on and flying about cottonwood trees early in April and again in August. In October it is found under dead bark of trees in winter quarters. Common. Illinois. (A. S. McBride. Can. Ent., xii, p. 106.)

7. *Eros coccinatus* Say.

Found in April in Illinois in the cottonwood, under logs in the woods. (McBride, *loc. cit.*)

8. *Wallastonia quercicola* (Boheman).

This was taken by Mr. W. Knaus from "cottonwood logs in a somewhat advanced state of decay."

The beetle appears in Kansas in June and July. "The present season I took about a dozen specimens from logs that had been used in a stable for the past seventeen years; a number were taken from the larval burrows, and numbers of small white fleshy larvæ were also observed in the same pieces of timber; these larvæ, I feel confident, were those of *W. quercicola*, but as I found no pupæ and did not continue my observations on their transformation, I can not speak with absolute certainty." He was strengthened in the conviction that the arvæ of this weevil are wood-eating by the fact that it has a close structural relation to the Scolytidæ. (Bulletin Brooklyn Ent. Soc., vii, p. 150.)

9. *Mecas inornata* (Say).

Mr. Walsh has described the excrecence made by this borer in the saplings of the cottonwood and willow in Illinois.

A rather sudden swelling on such of the main stems as are .50 to 1.25 inch in diameter, cracking open in two or three deep, irregular scabrous, brown, more or less transverse, gaping, thick-lipped fissures. This is the appearance presented as early as August and until the following spring; but July 19 nothing is seen but a smooth, elongate swelling of the stem, pithy inside, and without any cracks or roughness outside, and undistinguishable externally from the tenthredinoidous gall, *S. nodus* n. sp., in the form in which it occurs on the same willow later in the season. Very probably, however, as with many if not all *Saperdæ*, the larva is at least two seasons in arriving at maturity, and the normal appearance of the pseudo-gall is not assumed until the following season. The insect does not make its way out in spring through the deep cracks of this pseudo-gall, but each bores a hole for himself in the manner usual in this family. The gall on the cottonwood is absolutely identical with the willow-gall, and was recognized by myself as such at the first glance. It was found exclusively on young saplings. In both cases it was perfectly healthy plants that were attacked. Although this pseudo-gall weakens mechanically the stem upon which it grows, and to such an extent that it occasionally causes the stem to break in two with the wind, yet otherwise the stem never perishes, but on the contrary the wound is gradually healed and overgrown by fresh woody matter (Walsh).

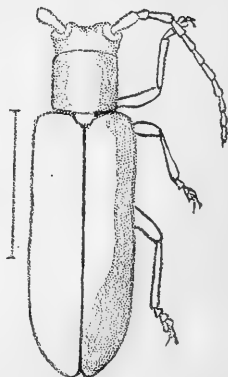


FIG. 156.—*Mecas inornata*.—Smith del.

*Larva*.—July 19, the larva is .10 inch long, or less, and of a pale color. In the spring when it assumes the imago state it is much larger, and differs but little from other larvæ belonging to this genus.

*The beetle*.—In Mecas the claws differ from those of *Saperda* (in which they are usually simple) in being feebly toothed or cleft. Body black, unspotted, cylindrical, covered with short prostrate hair, which conceals the punctures. Palpi black; antennæ rather shorter than the body, and, excepting the basal joints, annulate with cinereous and black. Thorax cylindric, diameters subequal. Elytra entire and subacute at the tip, which is equally antennated from the suture and exterior margins. Length a little less than half an inch. (Say.)

#### AFFECTING THE LEAVES.

##### 10. THE STREAKED COTTONWOOD LEAF-BEETLE.

*Lina scripta* (Fabricius).

Order COLEOPTERA; family CHRYSOMELIDÆ.

An abundant beetle, infesting the leaves of the cottonwood and other species of *Populus* and of willows throughout the West to Colorado, and south to Louisiana,



FIG. 157.—Streaked cottonwood beetle; a, beetle, normal form; b, c, d, e, showing variations.—After Riley.

destroying vast groves; three annual broods; the larva peculiar from emitting from the tips of its tuberculous spines a pungent milky fluid; transforming on the leaf, the pupa remaining in the partially cast-off larva skin; the beetle usually black on the prothorax, with the sides yellow and the wing-covers yellowish, with three interrupted lines of black or bluish spots. It may be destroyed by syringing the trees with a wet preparation of London purple or Paris green. (Riley, Amer. Ent., iii, p. 159.)

In 1884 fresh attention was called to the ravages of this beetle in portions of Nebraska and Dakota, which led to the publication by Professor Riley of an extended account of the insect in his report as U. S. Entomologist for 1884, which we copy, as follows:

During the past season the streaked cottonwood leaf-beetle has done great damage in portions of Nebraska and Dakota. Appearing in enormous numbers, it has entirely defoliated many thousands of trees, and has destroyed many plantations of young saplings. The strip of country over which it has been particularly injurious has been along the banks of the Missouri River in Dakota, as far west as its junction with the Niobrara, and thence down through Nebraska to the Platte, as far west as Dawson County. As a sample of the many communications which have been received during the summer from the infested region, we introduce the following letter, noticing the habits of this beetle, which was forwarded from the General Land Office:

“YANKTON, DAK., June 2, 1884.

“SIR: We forward to you by to-day’s mail a small box containing a number of bugs gathered yesterday on the cottonwood groves in this and adjoining counties. These bugs were first noticed during the season of 1883, when they were confined to only a few timber claims in the towns 97 and 98, range 57, Hutchinson County, Dak. In the fall of 1883 they had covered quite an expanse of country, and from all sides reports came of the destruction of planted groves by these bugs. This spring nearly everybody who owns a timber-culture claim and who has called at our office reported destruction of trees, and we therefore yesterday examined into it, going through towns 95, 96, 97, ranges 55, 56, and 57, and found a condition which is really sickening. Claimants who for years and years have planted their trees, and had now succeeded in getting a good growth of trees growing, have to stand by and look on while their labor of years is destroyed in a few days. Wherever they are they are by the millions; they eat the leaves, and it only takes a few hours to finish a tree, and those trees that were attacked last year have failed to grow again this spring. So far they have attacked principally cottonwood and some box-elder. We would respectfully suggest that these bugs be handed to some expert for report and recommendation as to the best methods of destroying them. There ought also to be something done to protect claimants whose trees are now being destroyed. Most of the timber claims in the counties named have been taken from six to ten years ago, and nearly every claimant has apparently complied with laws, at least we counted from the buggy while on a hill yesterday thirty-six different groves, presumably all timber-culture claims, where the law has been complied with, and where parties would now be entitled to make proof only for these bugs. There ought to be a special act of relief, allowing those parties to make proof, as to replant and to commence all this work over again will be necessarily not only a hardship, but will, in a good many cases, be an impossibility, the time within which proof is required to be made being too short.

“Very respectfully,

“ELLERMAN & PEEMILLER.

“HON. COMMISSIONER GENERAL LAND OFFICE,

“Washington, D. C.”

In 18—, Mr. Lawrence Bruner reported as follows:

“The striped cottonwood beetle (*Plagioderia scripta*) has also been quite numerous in several portions of the West during the year, and did much injury to both cottonwoods and willows upon high land. Especially was this true with respect to the young trees upon tree claims in newly settled areas. There has been considerable vexation at the United States land offices on account of the injuries of this insect and of a species of saw-fly, the larvæ of which attack the foliage of our various species of ash trees, causing them to die. When the time comes for ‘proving up’ there are too few trees growing upon the tract of land, and the result is its probable loss to the enterer.”

Similar letters to this were received from many points in the region indicated.

This species has long been known to feed upon the leaves of the different species of willow, but upon those trees it was never remarkably abundant or injurious. Upon several of the species of *Populus* it was also found, but its great liking for cottonwood seems to be of comparatively recent acquirement. In speaking of this change of habit we remarked as follows, in the *New York Weekly Tribune* for October 9, 1878:

“The interesting feature about this insect to the forester, however, is that it has of late years acquired an especial liking for the cottonwood. It has, indeed, become a most grievous pest in the prairie States, where the cottonwood is largely grown as a shade and ornamental tree, as well as for fuel. We have been surprised, in passing through Kansas and Nebraska more particularly, at the utter devastation which this beetle has produced. Vast groves have been destroyed through its incessant defolia-

tion. Now, the cottonwood is placed by botanists in a genus different from that of the willows, and the strangest thing about it is that the willows are not injured to the same degree, even where growing in the neighborhood of the injured cottonwood. This is partly due, perhaps, to the fact that the willow does not suffer so much from defoliation as does the cottonwood, though it is possible that a special cottonwood feeding race of the species has been of late years developed in those sections where the tree is so largely planted. This would be parallel to the well-known case of the apple-maggot (*Trypeta pomonella*), which, though infesting wild haws and crabs in

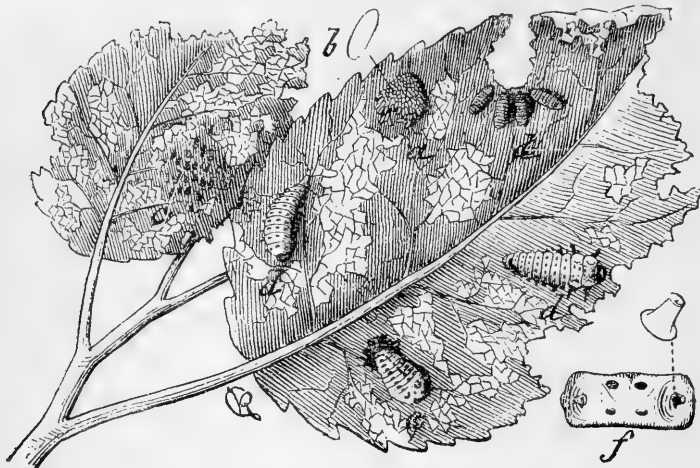


FIG. 158.—Grub of streaked cottonwood beetle *a*, eggs, *b*, one enlarged; *c*, newly hatched larvæ; *d d d*, larvæ of different ages; *e*, pupa, nat. size; *f*, one of the middle segments of the body of larva seen from above, showing tubercles, enlarged. After Riley.

all parts of the country, has only taken to feeding on and injuring cultivated apples in some of the New England States.”

This last conclusion is rendered all the more plausible from the fact that, so far as known, the species in the Eastern States is confined to willow and does not attack the cottonwood.

The perfect beetles wintered in sheltered localities. In the spring, as soon as the cottonwoods begin to leaf out, the beetles pair, and the females begin laying their eggs (fig. 158, *a*, *b*). These are placed upon the young leaves in dense masses of from ten to a hundred eggs. Each egg is elongate-oval, pale yellowish-white in color, rather soft, and about 0.5<sup>mm</sup> long. The larvæ (fig. 158, *c*, *d*) soon hatch and develop very rapidly. At first they are black in color and gregarious in habit, skeletonizing the leaf in the immediate vicinity of the egg-shells. With the succeeding molts the color becomes lighter and they separate, feeding upon leaves at some distance from their place of birth. These larvæ, like those of other species of the genus, are peculiar for emitting from the tips of the tuberculous spines, with which they are furnished, a milky liquid, of a pungent, but not altogether disagreeable, odor. On attaining full growth they transform to pupæ upon the leaf, fastening their hind legs to the leaf, and partially throwing off the last larval skin. The perfect beetles issue soon after. There are at least three annual generations, and probably more, as the development of the insect is very rapid. Professor Snow states\* that in the month of August only fifteen days are occupied from the hatching point to the issuing of the adult.

\* *Observer of Nature*, Lawrence, Kans., November 23, 1875.

*Remedies.*—According to all reports, but little is to be expected from the natural enemies of this species, for birds do not seem to touch it, and, with the single exception of the larvæ of lady-birds, we have neither found nor heard of any other insect enemies.

Inasmuch as it undergoes all of its transformations upon the leaves it is not susceptible to any of the trapping remedies which are used against the quite closely allied elm-leaf beetle (*Galeruca xanthomelana*), which was treated of in our last annual report (pp. 159-170), and the larva of which descends to the ground to enter the pupa state. In that article, however, we gave in detail the results of experiments made with the arsenical poisons, London purple and Paris green, and these results may be applied with certainty to the case of the cottonwood leaf-beetle under consideration. Premising with the fact that while equally efficacious in destroying the beetle, London purple seems to injure the tree less than Paris green, we repeat, for the benefit of the Western reader who may not have access to the report of 1883, the two paragraphs relating to the preparation of the poison and the effects of the mixture:

*Preparation of the poison.*—London purple (one-half pound), flour (3 quarts), and water (barrel, 40 gallons) were mixed, as follows: A large galvanized iron funnel of thirteen quarts capacity, and having a cross-septum of fine wire gauze such as is used for sieves, also having vertical sides, and a rim to keep it from rocking on the barrel, was used. About three quarts of cheap flour were placed in the funnel and washed through the wire gauze by water poured in. The flour in passing through is finely divided, and will diffuse in the water without appearing in lumps. The flour is a suitable medium to make the poison adhesive. The London purple is then placed upon the gauze and washed in by the remainder of the water, until the barrel is filled. In other tests, the flour was mixed dry with the poison powder, and both were afterward washed through together with good results. It is thought that by mixing in this way less flour will suffice. Three-eighths of a pound of London purple to one barrel of water may be taken as a suitable percentage. Three-eighths of an ounce may be used as an equivalent in one bucketful of water. The amount of this poison was reduced to one-fourth of a pound to the barrel with good effect, but this seems to be the minimum quantity, and to be of value it must be applied in favorable weather and with unusual thoroughness. With one-half or three-fourths of a pound to the barrel, about the maximum strength allowable is attained, and this should be applied only as an extremely fine mist, without drenching the foliage.

*Effects of the mixture.*—The flour seems to keep the poison from taking effect on the leaf, preventing to some extent the corrosive injury which otherwise obtains when the poison is coarsely sprinkled or too strong. It also renders the poison more permanent. On the leaves, especially on the under surfaces, the London purple and flour can be seen for several weeks after it has been applied, and the insect is not only destroyed, but is prevented from re-appearing, at least for a long period. By poisoning again, a few weeks later, the insect is deterred with greater certainty for the entire season. By being careful to administer the poison before the insect has worked, and, above all, to diffuse the spray finely but not in large drops, no harm worth mentioning will accrue to the plant from the proportion of poison recommended. The new growth, that developed after the first poisoning, was protected by one-fourth of a pound to the barrel in 1882. From midsummer until autumn the unpoisoned half of the grove remained denuded of foliage, while the poisoned half retained its verdure. The little damage then appearing in the protected part was mostly done before the first treatment. Eggs were laid abundantly throughout the season. Many of these seemed unhealthy and failed to develop, probably because they were poisoned. Many hatched, but the young larvæ soon died. The eggs were seldom deposited on the young leaves that were appearing after the poison was applied, but were attached to the developed leaves, and here the larvæ generally got the poison to prevent their attack upon the aftergrowth. Still the young leaves became

perforated to some extent. The adults, which fly from tree to tree, appeared plentiful without much interruption throughout the season, and often several could be seen feeding on each tree. Possibly many of these may have become poisoned before depositing the eggs.

"The efficiency of London purple being established, it will generally be preferred to other arsenicals, because of its cheapness, better diffusibility, visibility on the foliage, etc. As the effects of the poisons commonly do not appear decidedly for two or three days after their administration, the importance of the preventive method of poisoning in advance can not be too strongly urged. As the effect is slow in appearing, impatient parties will be apt to re-poison on the second or third day, and thus put on enough to hurt the plant when the effect does come. Much depends on dryness or wetness of the weather; but good effects may be expected by the third or fourth day."

In the same report is figured (Plate VI) a simple apparatus which was used to good effect in spraying the trees and which was explained in detail in the text (pp. 168, 169). It is in brief a barrel pump containing a stirrer-bar, attached by a loop to the swinging end of the pump, and which by its oscillations constantly stirs the mixture. The barrel rests upon a skid in the bottom of a light cart in which it is drawn from tree to tree. To the nose of the pump is attached a long, slender rubber hose. To enable the operator to thrust the hose up among the branches of the tree, it is run through a long bamboo pole the septa of which have been burned out by a hot iron rod. At the end of the hose is a short metallic rod to which one of the cyclonic or eddy-chambered nozzles has been attached.

By the use of such an apparatus, which is comparatively inexpensive, a great many trees can be thoroughly sprayed in the course of a day. Such a course requires labor and some expense, but the result can be accomplished in no easier way.

We have already given the general appearance of the egg, and the larva will be readily recognized from the figure (158). It is practically indistinguishable from the larva of the closely allied *Lina lapponica* which feeds upon willow at the North, but the larva of the latter species emits the milky fluid more freely and has perhaps a more pungent odor. We published in the American Entomologist, Vol. III, p. 160 (July 1880), a detailed description of the larva, which it will be unnecessary to repeat here.

The beetle is extremely variable in its coloration, and it may not be amiss in this place to repeat in connection with fig. 157, for purposes of identification, the descriptions which we have given (*ibid.*) of certain of the more marked varieties. Combinations, however, in many degrees, of these varieties occur.

a. *Typical.* Black, with a tinge of blue; basal joints of antennæ beneath, thickened thoracic margin with exception of a small round spot at the middle, elytra with exception of suture and three lines of interrupted black markings, base of femora and part of tibiæ, and sides and apex of abdomen, testaceous yellow. (Common at the West.)

b. *Variations in general coloration:*

1. Base of antennæ, head, underside, and legs of the same yellowish color as upper side. (From Texas.)

α. Thorax testaceous-yellow, or more reddish, with the two lateral markings and a T shaped mark on the disk blackish.

β. Thorax entirely testaceous-yellow.

2. Principal color above and beneath blue; legs blue.

γ. Sides of thorax as in typical form. Elytra with faint yellow marking. (From California.)

δ. Sides of thorax as in typical form. Elytra unicolorous blue. (From California.)

ε. Entirely blue, except a narrow lateral yellowish marking each side on the last abdominal joint.

c. *Variations in the markings of the elytra :*

1. Marked with black as follows: The suture; two, more or less, oval spots near the base, the inner of which is nearer to the suture than to the lateral margin, and the outer on the humerus; three longitudinal striæ on the middle, the intermediate of which is the longest; submarginal curved stria and an oval spot between the latter and the suture. (Common at the West.)
2. Additional marks: A small triangular basal spot in front and between the two subbasal markings. (Illinois.)
  - $\alpha$ . This triangular spot is sometimes connected with the humeral spot. (California.)
  - $\beta$ . Black markings become wider or longer and then often confluent.
  - $\gamma$ . Markings in general becoming smaller, either all of them, or one or several of them. (C. V. Riley, Ag. Rep. for 1884.)

## 11. THE COTTONWOOD DAGGER-MOTH.

*Acronycta populi* Riley.

Devouring the foliage and not unfrequently stripping the tree, a caterpillar which rests curled around on the leaf, and is easily recognized by its body being covered



FIG. 159.—The cottonwood dagger-moth and its caterpillar.—After Riley.

with long, soft, bright-yellow hairs, and a long pencil of black hairs on top of segments 4, 6, 7, 8, and 11. (Riley.)

This caterpillar is sometimes destructive to the foliage of the cottonwood in Missouri. There are two broods of these worms each year; the first brood appearing in June and producing moths by the last of July, the second brood appearing the last of August and throughout September, and passing the winter in the chrysalis state. It is attacked by several parasites, *i. e.*, a *Microgaster*, an *Ophion*, and a *Tachina* fly. When fully grown the caterpillar spins a pale yellow cocoon of silk interwoven with its own hairs, then turning to a chrysalis. It more commonly occurs on the balm of Gilead and *Populus grandidentata*.

*Pupa*.—Is dark shiny brown, and ends in an obtuse point furnished with several forked bristles. It lies within a pale-yellow cocoon of silk interwoven with the hairs of the caterpillar and which is generally spun in some sheltered place, as in a chink in the bark of a tree, etc.

*The moth*.—Fore-wings white-gray near the anal angle between veins 1 and 2, a large and conspicuous spot like a Greek letter *psi*, placed sidewise, and from this spot a somewhat zigzag line runs parallel with the posterior border, forming a large dart-like spot between veins 5 and 6. (Riley.)

12. *Smerinthus modestus* Harris.

Larva on cottonwood in Illinois. (C. E. Worthington, Can. Ent., x, p. 16.)

13. *Cerura borealis* Boisid.

Whether this is the *C. borealis* or not, it is the one mentioned by Abbot and Smith as occurring on this tree as well as the wild cherry and willow. According to them, on the 10th of August, in Georgia, "it inclosed itself in a case made of chips of the wood, and affixed to a branch. The moth came out April 24. It likewise feeds on the wild cherry and willow, and is found also in Virginia, but it is a very rare species."

14. *Ichthyura inclusa* Hübn.

According to Abbot and Smith this species occurs on this tree as well as the willow, in Georgia. "The caterpillars all live in a web, among the leaves spun together. One inclosed itself entirely May 25 and came out June 8. Another, which spun itself up October 25, did not appear till the 8th of March following. The moth is rare in its perfect state, though found in Virginia as well as in Georgia."

15. *Pemphigus populi-transversus* Riley.

Forming a gall upon the petiole near the base of the leaf of *Populus monilifera* and *P. balsamifera*. Missouri, southern Texas, and Colorado. (Riley.)

16. *Pemphigus populi-monilis* Riley.

On the narrow-leaved cottonwood in Colorado forming a series of more or less confluent moniliform swellings on the upper side of the leaf.

17. *Pemphigus populi-ramulorum* Riley.

Forming an irregular globular gall, often somewhat flattened, on the twigs of *Populus balsamifera* in Colorado. (Riley.)

18. *Pemphigus pseudobyrsa* Walsh.

Occurs on *Populus angulata*. (Thomas, viii, p. 151.)

19. *Pemphigus vagabundus* Walsh.

Produces a large irregular gall on the tips of the twigs of certain cottonwoods. (Thomas, viii, p. 151.)

20. *Pemphigus populicaulis* Fitch. (Le Baron.)

Also occurs on the aspen (*Populus tremuloides*) in Wisconsin. (Thomas, viii, p. 149.)

21. *Chaitophorus populicola* Thomas.

Found in July at Carbondale, Ill., and early in September on the under side of young sprouts of *Populus angulata* (cottonwood).



## INSECTS INJURIOUS TO THE POPLAR.

## AFFECTING THE TRUNK.

## 1. THE POPLAR BORER.

*Saperda calcarata* Say.

Order COLEOPTERA ; family CERAMBYCIDÆ.

Often destroying the Lombardy poplar, a yellowish-white grub, nearly 2 inches long, and changing to a gray longicorn beetle, irregularly striped with yellow ochre, the wing-covers ending in a sharp point, flying in August and September.

Harris states that this borer, with the grubs of the broad-necked *Prionus*, almost destroyed the Lombardy poplars in his vicinity (Cambridge, Mass.), and that it also lives in the trunks of the native poplar. The beetles rest on the trunks and branches of various kinds of poplars in August and September, and also fly by night, sometimes entering the open windows in the evening. According to Riley this borer is universally destructive to the cottonwood in the Western States.

This borer has been destructive to poplar trees on the shores of Casco Bay, especially at the head of the bay west of Harpswell Neck, where my attention was first called to its work by ex-Governor J. L. Chamberlain, on whose estate at New Wharf a number of trees had died. The trees in August, 1884, were seen to show unmistakable signs of disease by the leaves curling and withering. The presence of the larva within is easily detected by the masses of castings resembling sawdust, which are thrown out of the holes and fall down the trunk to the ground.

Upon cutting down the trees and splitting them open, not only the full grown larva, or grub, but also one or two pupæ and several beetles were found, the latter ready to issue from their holes. As many as eight or ten larvæ were found mining in a portion of a poplar trunk 10 inches long and 5 inches in diameter.

The wood was perforated in all directions, running under the bark part of the way and sinking in various directions into the wood, some of them extending side by side along the heart of the tree. The longer mines are about a foot in length, and about a centimeter or four-tenths of, and at times half, an inch in diameter. Part of the mine is more or less stuffed with long, slender chips gnawed off by the larva. Mr. Reed, of Scottsville, N. Y., writes to the *American Entomologist* (iii, p. 181) that this borer (identified by Professor Riley) "destroyed two fine trees upon my lawn of the native poplar, or, as it is sometimes called, the trembling aspen. They perforate the trunk midway up amongst the branches, when the top dies or is broken off by the wind."

*The larva.*—About 2 inches long; the body very thick, rather larger before than behind; the segments full and rounded. The first segment broad, sloping obliquely downward to the head. On the upper side of the broad segment (prothoracic) con-

taining the head, is a large square yellowish horny area, succeeded by rough oval areas on the tops of the succeeding segments. These rasps serve as legs, which are wanting in the grub.

The beetle is called the spurred *Saperda* (*calcarata*) from the spine-like ends of the wing-covers. The body is covered all over with a short and close nap, which gives it

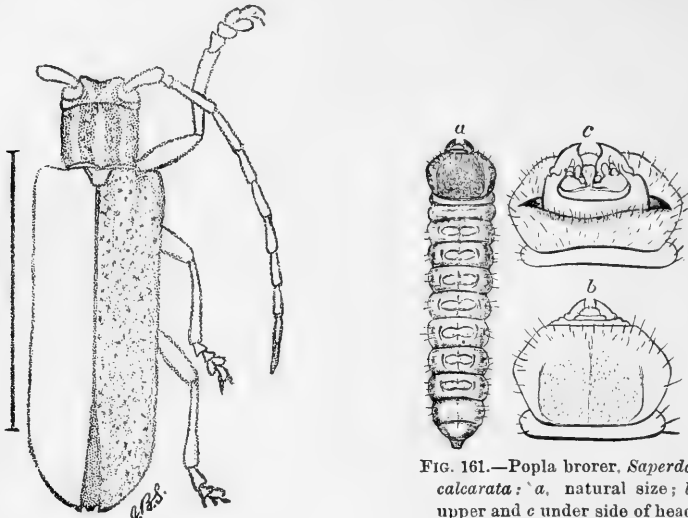


FIG. 160. — *Saperda calcarata*.—  
Smith del.

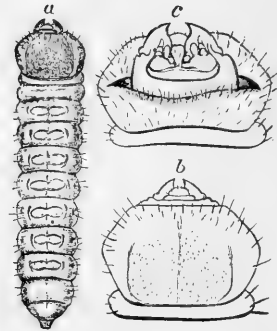


FIG. 161.—Poplar borer, *Saperda calcarata*: 'a, natural size; b upper and c under side of head and first thoracic segment enlarged.—From Packard.

a fine blue-gray color; it is finely punctured with brown, with four ocher-yellow lines on the head and three on the top of the thorax; the scutel is also ocher-yellow, and there are several irregular lines and spots of the same color on the wing-covers; it is  $\frac{1}{4}$  inch in length. (Harris.)

## 2. THE LESSER POPLAR BORER.

*Saperda mæsta* Leconte.

Boring in the poplar and balm of Gilead, selecting the smaller branches, in many places not more than an inch or two apart, and situated chiefly at the base of the buds, the whole length of the excavation not much exceeding an inch; pupating early in May and becoming beetles by the end of May. (See a full account of the larva and its habits in *Canadian Entomologist*, vi, 1874, p. 61.)

The larva.—Nearly cylindrical, tapering a little posteriorly, and about half an inch in length. Head very small, dark reddish brown in front, pale behind. Body deep yellow. Second segment deeper in color and more horny than the other segments; terminal segment a little more hairy than the others. (Saunders.)

## 3. THE POPLAR GIRDLER.

*Saperda concolor* Leconte.

Girdling the trunks of sapling poplars, by carrying a mine around the trunk, which causes a swelling often nearly twice the diameter of the tree.

Our attention was first directed to this borer and the marked effects of its work by Mr. George Hunt. In his company we have found numerous saplings of the common poplar in the woods about Provi-

dence, with the unsightly swellings around the trunk. The upper branches of large trees are also occasionally girdled. From a gall collected at Providence a beetle issued May 31. There may be several mines in the same knot or gall.

*The beetle.*—Uniformly gray, approaching the color of the downy under side of the poplar, with no spots, while the antennæ are black, stained with gray at the joints. Length, 10<sup>mm</sup>.

#### 4. THE BROAD-NECKED PRIONUS.

*Prionus laticollis* Drury.

Order COLEOPTERA; family CERAMBYCIDÆ.

Boring in the wood of the trunks and roots of different poplars, a white soft grub as thick as one's thumb, producing an oval moderately convex black long-horned beetle 0.90 to 1.50 long and less than half as broad, its wing-covers rough from confluent irregular punctures and with two or three raised lines, its thorax with three irregular teeth along each side, and its antennæ of twelve joints resembling little conical cups placed one within the other and projecting upon their lower side like the teeth of a saw; appearing abroad in July. (Fitch.)

Though of late years injurious to the apple, grape-vine, and pine, this beetle may originally have been confined to the poplars, especially as Harris does not enumerate the above-mentioned trees, but says that it

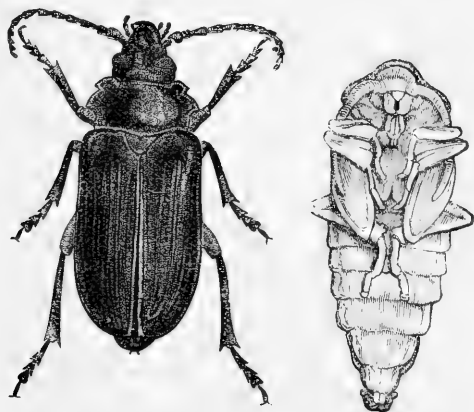


FIG. 162.—Broad-necked Prionus and pupa.—After Riley.

lives in the trunks and roots of the balm of Gilead, Lombardy poplar, “and probably in those of other kinds of poplar also. The beetles may frequently be seen upon, or flying around, the trunks of these trees in the month of July, even in the daytime, though the other kinds of Prionus generally fly only by night.” Prof. S. J. Smith, in his report as Entomologist to the State Board of Agriculture of Connecticut, for 1872, remarks:

I have noticed it in logs of poplar, bass-wood, and oak, and in the trunks of old, decaying apple trees, and Professor Verrill has collected it in great numbers, at New Haven, in chestnut railroad ties (p. 346).

It seems to us most probable that this borer also infests the pitch-pine, since we have seen these beetles flying at noon in abundance in the middle of July on the sandy plains of Brunswick, Me., among pitch-pines, 2 or 3 miles away from any poplars; and have captured them among pines at intervals for twenty-five years past.

*Larva*.—Average length when full grown, 3 inches. Color pale yellowish-white, partly translucent, with glaucous and bluish shadings, and a distinct dorsal line of the last color; 13 distinct segments. Segment 1 rather horny, somewhat longer than 2, 3, and 4 together, broadening posteriorly, slightly shagreened and whiter than the rest of the body, with a rust-colored mark anteriorly, and a slight groove along the middle. Segments 2 and 3 shortest and broadest, the body tapering thence gradually to extremity, though there is usually a lateral ridge on segment 12 which dilates it rather more than the segments immediately preceding it. This segment 12 is also the longest, the terminal one being quite small and divided into three nearly equal lobes. A swelled hump crossed with two impressed transverse lines on segments 4, 5, 6, 7, 8, 9, and 10. Stigmata rust-colored, 9 in number, the first and largest being

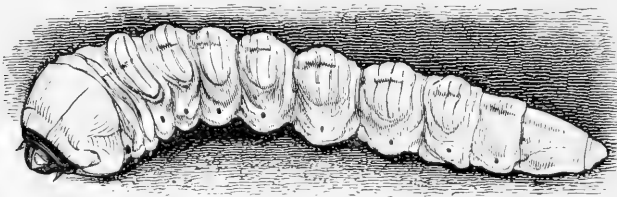


FIG. 163.—Larva of broad-necked Prionus.—After Riley.

placed on a fold in the suture between segments 1 and 2. Head brown, verging to black on anterior edge. Mandibles large, strong, black, with one blunt rounded tooth, giving them a somewhat triangular appearance; antennæ 3-jointed and brown, especially at tip; labrum fulvous, fuzzy and with a brown base; maxillary palpi 4-jointed, the basal joint much swollen, the terminal joint brown, and a ring of the same color at sutures of the other joints; labial palpi 3-jointed, the basal joint also swollen, and the terminal joints and sutures of the others brown. Six rudimentary 2-jointed fuscous feet as shown at Fig. 163 tubercled as on the back, these tubercles being especially prominent on segments 6, 7, 8, and 9, where they recall prolegs. The young larva differs only in lacking the rust-colored mark on segment 1. (Riley, Amer. Ent., ii, p. 232.)

##### 5. *Buprestis fasciata* Fabr.

Mr. Fletcher reports (Canadian Entomologist, xv, p. 203) finding this beautiful beetle common on poplars, and had found a larva in poplar wood which he thought, from its appearance, might belong to that species.

##### 6. THE XYLEUTES BORER.

###### *Xyleutes populi* Walker.

Nothing is known to us concerning this moth, except that the specific name indicates that it occurs on the poplar. The habitat mentioned by Walker, is St. Martin's Falls, Albany River, Hudson's Bay, the original specimen described by Walker being in the British Museum.

## 7. THE POPLAR GOAT-MOTH.

*Cossus centerensis* Lintner.\*

Plate I, figs. 1-12.

Order LEPIDOPTERA; family COSSIDÆ.

Perforating the trunks of *Populus tremuloides*, a worm similar to, but smaller than, the oak caterpillar (*X. robinia*), the moth issuing from the trees during June. (Bailey.)

In connection with the following account by Dr. Bailey we may say that Mr. Fletcher reports that he has found about Ottawa this moth common on the balm of Gilead (*Populus balsamifera*). The pupa is usually extruded from the bark about 4 o'clock in the afternoon, when he has frequently seen them. (Can. Ent., xv, p. 203.)

*Cossus centerensis* (Plate I) was discovered by Dr. Theodore P. Bailey in 1877. For many years previous I had observed that many trees of *Populus tremuloides* had perished from some cause then unknown. The central shoots of other trees of the same species were dead, and it would only require a few years to finish their destruction. Perforations were found in the trunks of these trees, some of recent date and some overgrown with bark, leaving the cicatrices plainly visible.

In July, 1876, a brittle pupa-case of the *Cossus* was found projecting from one of the openings, which gave the first clue to the nature of the borer and destroyer of the timber.

On the 10th of June, 1877, a fresh pupa-case was discovered, and on the 14th of the same month the first *Cossus* was captured, resting upon the same tree trunk. Every season since this capture the *Cossus* has been taken, but in some years in greater numbers than others.

The *Cossus* usually comes forth between the setting and rising of the sun, and when the trees are visited daily the protruding pupa-cases left behind by the escaped imagines informs the collector how many of the insects he may expect to find.

Their color simulates so closely the color of the bark of the trees that it requires good eyes and very close observation to find the moths. One unaccustomed to collect them might view an infested tree for a long time and not find a *Cossus*, when several would be discovered by an expert. An uneven protuberance on the bark, or the short stump left of a decayed broken limb are favorite resting places for the insect.

The moth at first is rather sluggish, and can be easily captured. After it has been abroad for some days it is wild and more or less mutilated. This *Cossus* is not attracted by sugar, as might be expected from its aborted tongue. The moth seems to belong to the genus *Cossus* Fabr., and not to be congeneric with *Xystus robinia*. The head is short, eyes naked, labial palpi small, appressed, scaled. The thorax is thickly scaled, the scales gathered into a ridge behind, and is squarer in front than in *Xystus*, not so elongate or so elevated dorsally. The male antennæ are bipectinate; the lamellæ rather short and ciliate. The female antennæ are serrated. It is allied to the European *Cossus terebra* F., but is a larger insect. It differs from *C. querciperda* Fitch by the absence of any yellow on the male hind wing, and by its darker color and closer reticulations.

In color this species is black and gray. The edges of the thorax and collar are shaded with gray, more noticeable on some specimens than others. The primaries are covered with black reticulations, which are not always identical in their minor details in different specimens, nor sometimes on both wings in the same specimen.

\* The following account of this fine moth was published by the late Dr. James S. Bailey, of Albany, N. Y., in Bulletin No. 3 of the Entomological Division of the U. S. Department of Agriculture.

Beyond the cell there is a transverse continuous line, broader than the rest, and outwardly bent over median nervules. The brown color is blackish over nearly two-thirds of the primaries from the base, and outwardly gray; hind wings rounded in both sexes, with blackish hairs at base, pale and subpellucid, with short gray fringe, before which there is a narrow blackish edging. The abdomen is blackish. The males are smaller than the females. The smallest male expands about 40<sup>mm</sup>, the largest female over 60<sup>mm</sup>. (See Plate I, Figs. 10, 11, and 12.) While thus far the Centre (N. Y.) locality has proved to be the chief home of this *Cossus*, it will undoubtedly be found elsewhere wherever the *Populus tremuloides* is found. Several pupa-cases of this species have been found in the corporate limits of Albany. Usually trees of less than 1 foot in diameter are attacked, although in one instance a pupa-case was found in a tree measuring 16 inches in diameter.

It is a very different matter to observe the changes of insect life from the eggs to the imago when feeding upon the foliage of vegetation than where the larvæ have bored deep into a tree trunk and feed upon the ligneous fiber and its circulating fluids. To obtain this information it has been necessary several times each year to cut down trees bearing indications of its ravages, and to dissect them into fragments the size of kindling-wood. The months of October, April, and June were selected as suitable times for such investigations. October 14 we visited a tree for the purpose of obtaining caterpillars, and from a limb 4 feet in length six caterpillars were taken, two of which were occupying cells as seen in the engraving.

April 2 we cut from a tree a limb 3 feet in length, and in it we found seventeen caterpillars of three distinct sizes, indicating a growth for each year. The larger ones were not fully grown. All of them were actively passing through their tunnels in the wet wood, through which the sap was freely flowing. Not any of the caterpillars were occupying pupa-cells at this time. June 12, 1881, we again visited a tree when the insects were emerging. The tree selected was far advanced in decay, from the effects of the tunneling of the larvæ; only about 4 feet of the trunk was alive, with a few lateral branches in foliage, scarcely enough to support its respiration. In the trunk were found fresh pupa-cases, pupæ, and caterpillars. Again three crops of larvæ were found; the larger ones were inactive and lying in the sap-wood, with their heads close to the bark, which was gnawed nearly through to the outer surface. These caterpillars had evidently taken their last position preparatory to their final transformation into pupæ. Pupæ were also found occupying the same position, and when the bark was removed were visible.

The larva taken October 14 from its burrows is 45<sup>mm</sup> in length, of a pale flesh color. It is a little broader anteriorly. The prothoracic segment is blackish brown above, the dark color edged with dirty orange shading. The head is mahogany brown, shining, slightly roughened. The mandibles are black, with strong teeth. The surface of the head gives rise here and there to single scattered hairs. The antennæ are three-jointed; the second joint gives rise to a single long hair. The seventh, eighth, ninth, and tenth abdominal segments are provided with false feet. The segments are marked with a lateral row of brown dots above the reddish stigmata, and there is a row of similar dots, two to a segment, on each side of the dorsal line. These dots give rise to single pale hairs. The larva moves with freedom either backward or forward. The burrows which it excavates are about 15<sup>mm</sup> in width and terminate in the pupating cell, which is about 40<sup>mm</sup> in length, smooth; the extremity towards the opening is closed by a wad of finer and then coarser filings of the wood. The coarser splinters are not detached entirely from the wood, but are split up by the larvæ all around the top of the cell, and project like bristles, appearing somewhat as those wooden toy trees which are made for children, and which are formed by shaving down the wood and leaving the shavings adhering by one end. These splinters make a firm wad. Against them are piled a quantity of finer chips or thin filings, which are loose but pressed together.

The cell (Plate I, Fig. 7) is about 40<sup>mm</sup> from the outer bark of the tree, and the chrysalis (Figs. 8 and 9) makes its way to the air though the burrow, by means of

its teeth on the segments and the spinose process on the front, by which it forces itself, by stretching and contracting the abdomen, through the wood scrapings which close the cell, until it comes to the end. We have noticed a fine thread of silk proceeding from the spinneret of the larva, although in the cocoon we have found no silk whatever. The cocoon or pupa-cell seems to have been formed by wedging first coarser and then finer strips of the wood together, and seems to be merely a more carefully and smoothly finished enlargement of the original burrow.

*The pupa.*—A specimen of the pupa which I have examined is about 30<sup>mm</sup> in length, narrow, brownish black, shining rugose. The clypeus presents a strong, broad, spinous process, supported at base by lateral projections. On the under side it descends into a wide sulcation terminating in a broad projection. The capital appendages are visible, and here and there arise isolated hairs as in the previous stage. The abdominal segments are provided with teeth over the dorsum, decreasing in size to the stigmatal line. The anal segment is provided with two unequal-sized terminal teeth on each side of the vent. (Plate I, Figs. 8 and 9.)

The chrysalides vary much in size, and some of them are infested with an ichneumon fly, which preys on the caterpillar. A pupa was observed endeavoring to make its way to the surface of the bark, but seemingly unable to extricate itself, when assistance was rendered by enlarging the orifice. It was laid in a paper box for hatching. A few days afterwards many minute ichneumons were observed resting upon the wall near the box. On examination they were found to be escaping through minute holes in the pupa, which would barely admit a No. 3, entomological pin. Fifteen of these perforations were counted in this pupa. I presume that the larva of the *Cossus* is pursued in its burrows by the parent parasite. If so it is curious that the *Cossus* pupa is not killed by the parasites until it has worked itself up to the mouth of the tunnel, thus allowing the ichneumon flies to escape outside.

When ready to emerge, the pupa, by means of stout cusps on its abdominal segments, works itself to the end of the opening, and with its pointed head-case the thin portion of the bark which has been left by the caterpillar's instinct is severed and removed. It pushes itself through the opening as far as the base of the abdomen, by a sort of rotary motion, which acts in its mode of cutting like a carpenter's center-bit. The thoracic end of the pupa, after exposure a short time to the air, becomes dry and splits, and the moth escapes, climbing up the bark of the tree, shaking out its wings until developed. After the moth has escaped the empty pupa-case may still be seen protruding from the entrance of the tunnel. It is not true that *Cossus centerensis* prefers dead wood to burrow in. It is a fact that it is most frequently found in partially decayed trees, for after the larva obtains a lodgment, by its perforations in diverse directions through the heart and alburnum, admitting air and water, it causes irreparable decay. There are three species of poplar found in the vicinity of Centre,\* viz, *grandidentata*, *dilatata*, and *tremuloides*, but as yet *C. centerensis* has only been found in *Populus tremuloides*.

It is stated by Harris that *C. ligniperda* deposits her eggs on the bark near the root of the tree, which I believe is the habit of most of the borers. It would seem from the following that it is not the invariable mode: In splitting open a tree trunk on June 12 a *Cossus* was observed to fly from the cleft, which, on being captured, proved to be a female. It was supposed she had taken possession of a tunnel for the purpose of depositing her eggs. The loose *débris* from the excavations was gathered together, an examination of which revealed *Cossus* eggs. (Plate I, Figs. 1 and 2.) The female was confined in a box; the next morning she had deposited fifty-two eggs; some of them were attached to the sides and others on the bottom of the box. Some of the eggs were deposited singly and some in confused heaps, and were attached to each other and to the box with a viscid substance.

Another female was captured June 20, and in forty-eight hours after being pinned she had deposited sixty eggs, which varied somewhat in color from the former.

---

\*Now called Karner.

The *Cossus* after being pinned is very restive, especially while depositing her ova and by the constant motion of the ovipositor in endeavoring to extrude the ova. The loose abdominal scales are removed and attached to the eggs by the moist viscid fluid with which they are covered, and which often gives them the appearance of being clothed with scales. A few of the ova collected this season have this appearance, but a strong lens exposes the true condition. *C. centerensis* is not so prolific as some of the other species of *Cossidæ*. *C. robinia* Peck and *C. querciperda* Fitch have been known to extrude upwards of three hundred ova. In European species over one thousand ova have been found on dissection. The ruin of whole forests of timber in which these insects revel is doubtless prevented by the destruction of the eggs by ants and birds, the size of the eggs being sufficient to form a tempting morsel. In a state of nature the female *Cossus* deposits a small number of her ova upon each tree which she visits until her supply is exhausted.

This season the enlarged perforations through the bark show unmistakable evidence that the trees had been recently visited by woodpeckers, which could find little difficulty in procuring an abundance of full-grown larvæ.

*C. centerensis* is found throughout the region known as the pine barrens, which cover an area of perhaps 12 square miles between Albany and Schenectady. The soil of this region seems especially well adapted to the growth of the timber which it supports.

At the present time no correct observations have been made in reference to the molts of the caterpillars, but information on this subject will soon be obtained from Mr. A. H. Mundt, of Illinois, who has had opportunities of observing, up to the fourth molt, the caterpillars of *C. robinia*, which are found in the willows and poplars in his vicinity.

*Cossus centerensis* appears every year, and from observations and from numerous examinations of the trees by actual sections during the three months of the year enumerated, I am convinced that the caterpillars are not fully matured until the end of the third year, when they arrive at their perfect or winged state. The pupa state is comparatively short, lasting less than a month before the moth appears. From figures 3, 4, and 5 of Plate I we see representations of caterpillars found October 14, which establish the fact beyond dispute, through observations extending over many years, that it requires three full years for the caterpillar to arrive at maturity.

#### 8. *COSSUS ANGREZI* Bailey.

(Plate II, Fig. 6.)

As this species will probably be found boring in the poplar, we reproduce Dr. Bailey's account of it.

We repeat the original description of this species, given in *Papilio* for June, 1882 (Vol. II, No. 6, p. 93):

"*Cossus angrezi* n. s. female. Head somewhat narrow on the vertex. Collar and head yellowish gray, thorax black; the edges of the tegulæ shaded with yellowish gray. Fore-wings with a nearly white ground, shaded with black, and with black reticulations. Hind wings yellowish gray, mottled with blackish outwardly. The fore-wings have the costal edge pale, marked with black; the black shading obtains on costa at apical third, and over the whole wing at terminal third, extending obliquely downwards and inwards; there are a series of interspatial longitudinal black streaks before the margin, more or less defined. Fringes whitish, dotted with black opposite the ends of the veins, which latter conversely are whitish. Thorax shaded with yellowish gray behind. Abdomen dark gray. Beneath the wings repeat the markings very distinctly, owing to the strong contrast of the pale ground color with the black markings. Expanse, 82<sup>mm</sup>. 1 female. Wells, Elko County, Nev. From the late Mrs. Caroline Chase. Type, coll. James S. Bailey."



This I believe is a true *Cossus*, although the male is not known to me. The shape of the wing is as in *centerensis*. The structure is that of *Cossus*, and not of *Prionoxystus*. The thorax is subquadrate, the vestiture short and thick. The interspacial black dashes along the primaries subterminally distinguish it specifically. The pre-apical transverse black streak or line resembles that of *C. centerensis*. The hind wings are faintly reticulated. The ground color is a yellowish white. The black blotches on fore-wings of *robinia* are here wanting, while there is a diffuse discal shade blotch, another above and beyond it on costa, and the wing shows a wide, soft, blackish shading, obliquely edged inwardly and covering the outer portions of the wing. Except the antennæ my type is perfect. Beneath it is strongly marked, and reminds one of *C. robinia* Peck, but the shape of the wing is not like that species. The thorax is black above, not gray with black stripe or tegulae, and the collar is discolorous, pale yellowish gray. This species ought to be recognizable. The shape of the thorax is like *Cossus*, as is the vestiture, so that I am not prepared to find that the male has the peculiarities of *C. robinia* and *querciperda* Fitch. I hope Western collectors will solve the question. But I can not regard *angrezi* as having anything to do with the question of a Western representative of *robinia*. From Herrich Schaeffer's figure, and what has been published, I believe that *robinia* is found across the continent. (Dr. Bailey, l, c.)

#### 9. THE LOMBARDY POPLAR BORER.

*Agrilus granulatus* Say.

Order COLEOPTERA; family BUPRESTIDÆ.

The following account of this borer is by Prof. T. J. Burrill, and is taken from Forbes' First Annual Report on the Injurious Insects of Illinois.

It is known by every one that the Lombardy poplar lives but a short time in the rich soils of the Mississippi Valley, where its growth is exceedingly rapid. Many suppose that this is due to some degeneration, through the processes of propagation or otherwise, of the constitutional vitality of the tree—that it is inherently short-lived.

After some studies upon this subject, I am quite sure that the early death of the tree comes from other causes, and is due to agencies outside the tree itself and not specially connected with the soil or climate. For the present note, one of these, and only one, may be mentioned.

About the middle of June a small beetle (*Agrilus granulatus* Say) lays its eggs in the crevices of the rough bark, depositing them singly here and there, but sometimes only an inch or two apart, on the trunk and limbs old enough to become roughened by the fissures and cracks of the outer bark. The larvæ penetrate the living bark and gnaw tortuous galleries in it and the young layer of wood just beneath. These galleries are at first as fine as the puncture of a cambric needle, and never become larger than one-tenth of an inch in diameter. For the most part they run in irregularly horizontal directions, or crosswise of the grain of the wood. When numerous, as they often are, they sometimes cross each other, but this is uncommon. They are closely packed with the excrement of the larvæ.

The latter are exceedingly slender, slightly flattened, much elongated, footless and white; the first segment of the thorax is somewhat enlarged, and the minute but sharp jaws apparently project from its front. In October they bore obliquely into the deeper layers of the wood, often one to two inches from the surface, and then usually follow the grain up or down some inches, and turn obliquely outward until within about an eighth of an inch of the surface wood, though this distance varies much. The last inch or thereabouts of the burrow is greatly widened and ends with an obliquely rounded termination. The long, slender larva, towards the last of this

month and throughout the autumn and winter following, may be found in the enlarged portions of its burrow with its head and the first third of its body closely bent backward on the remaining two-thirds of the length, and in this folded form filling the cavity gnawed for itself in the wood. The bend of the body is always sideways, and usually to the left.

About the middle of May the larvæ transform, and the pupæ are found with their heads occupying the position of the fold just mentioned and next to the rounded end of the burrow. The ventral side is always outward, that is, toward the surface of the tree. Two weeks or thereabouts later the pupæ become perfect beetles, and about the first to the middle of June escape by gnawing outward, making, in so doing, a very different cut from that previously made by the larvæ. Seen from without the hole is doubly convex, the curvatures being quite unequal, and meeting at a sharp or slightly rounded angle on either side. As the insect emerges, its back is pressed against the strongly convex side of the excavation.

*The beetle.*—About half an inch long, slender, and sluggish. It makes little or no effort to avoid capture, which is easily enough done. It appears to pass the night at rest in crevices, etc., and moves about only during sunny weather. Eggs are deposited within a few days after the mature beetle gains its freedom. It is thus described by Say: "Body cylindrical, olive-green, granulated; head punctured, with a profound sinus each side for the reception of the antennæ, tip rounded; eyes whitish, with a black, oblong, movable pupil; thorax with an oblique indented line each side, and a longitudinal dorsal one; basal edge sinuated; scutel transversely elongated, with an impressed transverse line behind; elytra scabrous or granulated, without striæ or punctures; an elevated longitudinal line, and an indented large spot at base; tip serro-dentate. Length two-fifths of an inch nearly. This species has three hardly visible fulvous spots on the elytra; one on the depressed base, one near the suture before the middle, and one behind the middle, also near the suture. I have a specimen in which these spots are not at all visible. The elevated line at the posterior angles of the thorax is short, but very obvious."

#### 10. THE POPLAR ÆGERIA.

*Ægeria tricincta* Harris.

The caterpillars bore in *Populus candicans* in winter and spring, the moths perhaps placing their eggs in the deserted burrows of *Saperda mæsta*. They inhabit the branches, suckers, and small trunks in New York, on the smaller stalks raising galls. The larva is dull white, head light brown, otherwise much as in other Ægerian caterpillars. The habits of this borer have been described by Dr. D. S. Kellicott in the Canadian Entomologist (vol. xiii, p. 3) as follows:

During June and July last I obtained several examples of this moth from larvæ secured in April. These larvæ were taken from branches, suckers, and small trunks of *Populus candicans* growing on low lands along the Niagara below the city [Buffalo]. The smaller ones were sometimes found in the sapwood, or just beneath the bark, but the larger ones were generally in the center or pith of the stems; on the smaller stalks they cause considerable galls, quite as prominent as those upon the willow branches made by the larva of the Tortrix, very abundant in the same locality. These poplars are badly infested by the larvæ of *Saperda mæsta*, and I am of the opinion that the moth places her eggs in the deserted burrows of the beetle, the young caterpillars thus easily gaining access to the wood, their home for at least a year. The swellings on the branches caused by the beetle become more enlarged by a second occupation. I have taken them from the stem just above ground, and from limbs of trees many feet high. The larva before transforming prepares a way for final

escape which it carefully guards by means of a silken membrane re-enforced by fragments of wood; it then lines its burrow with silk and spins a firm cocoon about itself.

Kellicott calls attention to the very close mimicry of this moth after certain wasps, seen in the form and color of the moth, its markings, as well as its motions and attitudes.

*Larva*.—The larvæ, when taken, April 15, were of two distinct sizes, the larger measuring from .9 to 1.1 inch in length, the smaller .5 inch and less. The former appeared to increase but slightly before pupation. Dull white with a darker line along the back; head quite strongly bilobed, light brown, jaws and clypeus black; the first ring smooth, slightly clouded with brown, two irregular oblique marks from the posterior border outwards to the front edge. Body somewhat attenuated toward either end; transverse wrinkles, especially on the thoracic rings, well marked; in the small ones there is a slight medio-dorsal indenture; there are also lateral sub-stigmatal wrinkles. Stigmata elliptical, brown, last pair large, placed subdorsally and posteriorly. Above the anal feet, directed backwards, there are two black chitinous teeth; in the younger specimens they are more prominent and upturned. The scanty brown hairs arise from slight papillæ.

*Pupa*.—Light brown. The clypeus is armed with a sharp wedge shaped process, strengthened by ridges at its four angles and also by a median dorsal ridge. The abdominal rings are furnished, as usual, with two transverse rows of teeth, except the anal and pre-anal segments, which have but one row each. The terminal ring is obliquely truncated, having several teeth. Length, .6 inch. (Kellicott.)

*Moth*.—Blue-black; fore-wings opaque; hind wings transparent, with the border, fringe, and transverse line near the middle black; palpi at tip, collar, a spot on each shoulder, and three bands on the abdomen yellow; antennæ short, black; the four posterior tibiæ banded with orange; tarsi yellow, tipped with black; tail flat, with two longitudinal yellow lines. Expands from 1 to 1½ inches. (Harris.) Kellicott adds that the male is considerably smaller than the female, the antennæ strongly pectinated to the apical portion, which is enlarged and hairy. The abdomen has four yellow bands and there are no "longitudinal yellow lines in the tail." Both sexes have a conspicuous white spot bordering the eye in front; four small yellow spots on the upper part of the thorax; two below the base of fore-wings, also a yellow line at the outer edges of the collar; the outer edge of the coxæ of the first pair of legs, also those of the second and third pairs, are of the same color. The fore-wings are more or less washed with red on the basal third. The second abdominal band alone appears on the ventral side; in front of it below is a yellow line.

#### AFFECTING THE LEAVES.

##### 11. THE STOUT POPLAR SPAN WORM.

*Biston ursaria* Walker.

Order LEPIDOPTERA; family PHALENIDÆ.

In some seasons, during July, partially defoliating the Lombardy poplars in Montreal, Canada, large drab or dingy purple span worms, at the end of July burying themselves in the earth, the moths appearing during the last week in April and the early part of May.

According to Mr. G. J. Bowles (Cau. Ent., viii, p. 7) this span worm abounds year after year on the Lombardy poplars in the city of Montreal. "In some seasons the trees are partially defoliated by the larvæ,

and during the last week of April and the first of May the moths are to be found in great numbers." On the 6th of May the moths laid globular eggs .04 inch in diameter, depositing them some days before the leaves expand. May 29 the larvæ began to hatch out just as the poplars were throwing out their leaves. The larvæ change but little during growth. At the end of July they descend and bury themselves in the earth, changing in a few days to pupæ, without forming any cocoon.

*The larva* is from 2 to 2½ inches long, of a drab or dingy purple; head of a lighter shade and spotted with black. First segment behind the head bordered in front with a yellow line, indented behind; fourth to eighth inclusive, each with six very small yellow tubercles, two on the back, one behind, and one below each spiracle. Body striped from head to tail with twelve reddish lines, each bordered on both sides by an irregular narrow black line; six of the reddish lines are on the back and sides, one (interrupted) through the spiracles, and four on the abdomen. Anal segments spotted with black, as also first, second, and third segments. Mouth pinkish, legs pink, spotted with black; spiracles dark. (Bowles.)

*The moth*.—This genus may be known by the large heavy body and rather small wings; the fore-wings have the costa straight, the tip subrectangular; the male antennæ with long pectinations. This species is dark granite-gray, the fore-wings with three transverse, obscure, dusky lines, represented in rubbed specimens by black spots on the costa and veins. First line well curved; second and third lines near together. Half-way between the third line and the outer edge of the wing is a fainter band than the others, represented by a costal square spot, and a black spot on the inner angle. Hind wings with three transverse diffuse bands. The fore-wings expand 1.55 to 2 inches.

## 12. THE TUSSOCK CATERPILLAR.

*Orgyia leucostigma* (Abbot and Smith).

The injury done to the silver-leaf poplar in New York City by this caterpillar has been marked; it was especially noticeable in 1883. Mr. F. Clarkson states that many of the trees in that city were entirely denuded of their foliage, particularly the silver-leaf poplar, the ailanthus alone escaping attack. He suggested to the authorities the previous spring that hand-picking of such cocoons as bore the eggs was the only sure way of exterminating these insects. There is good reason to believe, however, that what the authorities have failed to do a young army of parasites (*Pimpla*), which have put in an appearance during the last fortnight, are now actively attempting, and we shall probably be rid of this moth another year. The ova commenced to hatch out about the 25th of May, and the larvæ began to assume the pupa form about the 21st of June; ten days thereafter the imago was discovered depositing ova." Out of twelve cocoons four yielded the ichneumons. Mr. Clarkson noticed that this parasite forced its eggs through the cocoon on the pupa and that in every case he observed the pupa selected was a female, doubtless from the fact that "its plump condition provides the necessary food for the development of the parasite, which the male pupa of the moth could not furnish." (Can. Ent., xv, p. 168.)

Professor Riley thus sums up the leading points in the history of this pest (Bull. 10, Div. Ent.):

The White-marked Tussock moth has a very beautiful hairy larva or caterpillar marked with black and yellow and red. The female cocoons are to be found during the winter on the trees and upon neighboring fences and tree-boxes, and each cocoon is plastered with a number of eggs, protected by a white, frothy, glutinous covering. The eggs hatch in spring and the young worms feed upon the fresh leaves. The males spin their cocoons after three molts and the females after four. The moths issue in July, pair and lay eggs for a second brood of worms, which in turn transform and bring forth moths in October, the eggs from which hibernate. The male moth is active, with ample wings, which are brown, with a conspicuous white spot, while the female is pale and wingless, and only crawls out of her cocoon to lay her eggs thereon and die. This species is never found on evergreens, and is chiefly injurious to elms and maples, and prefers large and old trees to young ones because of the greater shelter which they offer for its cocoons. In Washington it is yet chiefly confined to our parks, and it has not begun to be as injurious as in cities like Philadelphia and Baltimore, where the trees are older and larger. Two probable egg-parasites and seven parasites of larva and pupa are known to me.

Mrs. Dimmock gives a summary of what is known of its history (Psyche, iv, p. 280) as follows:

*Orgyia leucostigma* Abb. and Smith (Nat. Hist. Lepid. Ins. Ga., 1797, v. 2, p. 157, pl. 79). Harris (Rept. Ins. Injur. Veg., 1841, pp. 261-263) describes the eggs, larva, and imago of this species; apple and *Rosa* are given as food-plants. The same author (Treatise on Ins. Injur. Veg., 1862, pp. 366-368) figures and describes the eggs, larva, cocoon, and male and female imagos, and adds *Aesculus hippocastaneum* to the food-plants; later (Entom. Corresp., 1869, p. 291) he adds further *Salix*, *Celtis*, and *Carya* to the food-plants. Fitch (First and Second Rept. Ins. N. Y., 1856, pp. 202-220) describes the different stages of this species, noting in addition to food-plants mentioned above, *Ulmus*, *Acer*, *Quercus*, and plum. Riley (First Ann. Rept. State Entom. Mo., 1869, pp. 144-147) figures and describes briefly the eggs, larva, pupa, cocoon, and male and female imagos; the figure of the larva is repeated in Amer. Entom., Sept. 1870, v. 2, p. 306. Saunders (Can. Entom., Apr. 1871, v. 3, pp. 14-15) repeats Riley's figure of the larva, and describes the egg and egg-mas. Packard (Bull. 7, U. S. Entom. Comm., 1881, p. 239) repeats Riley's figures of the different stages of this species. Coleman (Papilio, November and December 1882, v. 2, pp. 164-166) describes some variations in the coloration of the larvæ. Clarkson (Can. Entom., Sept. 1883, v. 15, p. 168) mentions that this larva particularly attacks the silver-leaf *Populus*, and calls attention to the fact that ichneumons oviposit in cocoons of this species. The larva feeds upon *Betula alba* and *B. lenta*.

### 13. *Orgyia antiqua* Linn.

The larva of this common European species, which I have found on the aspen and poplar-leaved birch, as well as the thorn tree, differs from that of *O. leucostigma* in having three pairs of lateral tufts, one in front arising from the segment next to the head, and two others, a small white one, arising from the first abdominal segment, and a larger longer black pencil arising from the second segment; while the body is black. I observed the moth many years ago flying about the house early in September, if I remember correctly. The caterpillar becomes full-fed about the middle of August and remains in the pupa state a few days, inclosed in a loose cocoon, on the outside of which the eggs are laid by the wingless female.

*Larva*.—Four dorsal cream-white or pale brownish tufts. Anterior black tufts projecting forwards from the prothoracic ring. Head round and smooth, nearly black, pale reddish on the sides. Body often black, a row of lateral bright red warts giving rise to yellow hairs. Only two dorsal coral-red warts, the one next to the last cream-colored; short tuft wanting, but there is on each side (what *Orgyia leucostigma* wants) a row of three subdorsal reddish warts. The black, broad dorsal stripe so distinct in *O. leucostigma* is broken up by these warts and by brown patches. The terminal tuft is as in *O. leucostigma* but blacker. The main distinction is in the large black lateral pencil on the second abdominal segment with a sligher and shorter pencil in front and (sometimes) behind, yellow, with a few black hairs. The other hairs are quite dense and buff-yellow. A broken black stigmatal line. Under side of body pale greenish yellow. Length 25<sup>mm</sup>.

## 14. THE ANTIOPA BUTTERFLY.

*Vanessa antiopa* (Linn.)

Although I have more usually observed the gregarious caterpillar of this common butterfly feeding on the willow in clusters in mid-summer, it also occurs on the poplar, balm of Gilead, birch, and linden. The butterfly hibernates, appearing in New England (including Maine) sometimes as early as March. It is seen until June, then disappears, to be succeeded by a new brood about the middle of August, the insect having been in the chrysalis state eleven or twelve days. The second brood of caterpillars appear in August and transforms before cold weather into butterflies. The caterpillars are sometimes very destructive. Says Harris:

I have sometimes seen them in such profusion on the willow and elm that the limbs bent under their weight, and the long leafless branches, which they had stripped and deserted, gave sufficient proof of the voracity of these caterpillars.

Mrs. Anna K. Dimmock gives a summary of its history (*Psyche*, iv, p. 282) as follows:

*Vanessa antiopa* Linn. (*Syst. Nat.*, 1758 ed., 10, p. 476). Besides numerous references in European literature, in which *Salix*, *Populus*, *Betula*, and *Tilia* are noticed as food-plants, the following citations of American authors may be mentioned. Harris (*Rept. Ins. Injur. Veg.*, 1841, p. 219, and *Entom. Corresp.*, 1869, p. 280) describes the larva of this species, adding *Ulmus* as food-plant; later (*Treatise on Ins. Injur. Veg.*, 1862, p. 296-298) he figures and describes larva, pupa, and imago. Packard (*Guide Study Ins.*, 1869, p. 258) and Saunders (*Can. Entom.*, April 1869, v. 1, p. 75) describe the larva. (See also Scudder's *Butterflies of the Eastern United States*.)

*Larva*.—Head black, rough, and tuberculated; six or seven large, long black branched spines on each segment behind the prothoracic; body black, minutely speckled with white; with a row of eight dark brick-red dorsal spots. Length, 1½ inches (40<sup>mm</sup>).

*Pupa*.—Dark brown, with large tawny spots around the two rims of sharp tubercles on the back. Length 25-90<sup>mm</sup>.

*Butterfly*.—Borders of the wings much notched; purplish brown above, with a broad buff-yellow border, in which is a row of pale blue spots. Expanse of wings, 3-3½ inches (75<sup>mm</sup>).

15. *Limnitis arthemis* (Drury). (*Basilarchia arthemis* Scudder).

This butterfly is a northern species, occurring in the Adirondacks and White Mountains, where early in July it is sometimes very abundant, gathering by the hundreds in the bright sun around puddles in the

mountain roads. It is less common on the Maine coast. It is double-brooded, appearing, says Harris, late in June, and again late in August. It feeds on the balsam poplar, as well as thorn and birch.

Mrs. Anna K. Dimmock gives a summary of its history (*Psyche*, iv, p. 282) as follows:

*Limenitis arthemis* Drury (Illustr. Nat. Hist. — 1773, v. 2, pl. 10, fig. 3-4). Lintner (Proc. Entom. Soc. Phil., May 1864, v. 3, p. 62-63) describes the larva and pupa of this species, giving as the food-plant *Populus balsamifera*. Scudder (Amer. Nat., Aug. 1839, v. 3, p. 330) gives *Crataegus* as the food-plant, and again (*Psyche*, Aug. 1874, v. 1, p. 13) adds *Betula lenta* and *Populus* to the food-plants. (See also Scudder's Butterflies of the Eastern United States.)

16. *Limenitis disippus* Godart. (*Basilarchia archippus* Scudder.)

The singular caterpillars of this common butterfly frequently occur at Brunswick, Me., becoming full-fed during the last week in July and the first of August. They afford an admirable instance of protective mimicry, as they resemble a mass of bird's droppings attached to a leaf, owing to their shape, attitude, and especially the dark and peculiar pearly limy white patches on the back. The butterflies lay their eggs in midsummer or later and I have found the young larvæ at Providence September 20, in its hibernaculum, consisting of a poplar leaf slit and folded, and sewed together to form a tube in which the caterpillar resides. It left its hibernaculum at Providence as early as May 10, 1890. It remains in the chrysalis state about ten days, my larvæ in Maine pupating July 31 to August 1 and the imagos emerging August 10 to 11.

*Full-fed larva*.—Head resinous brown, rough, coarsely granulated and with sharp tubercles, ending vertically in two acutely knobby tubercles. Mesothoracic segment with two brown dorsal spines, acutely spinulated. Metathoracic second, seventh, and eighth abdominal segments with large, long tubercles, those on the second abdominal segment much the largest, smooth and bearing a rough spinulated spine, the



FIG. 164.—*Limenitis disippus*.—After Riley.

pair on the eighth segment the largest. Body olive-green shading into brown, a lateral white irregular line and an irregular dorsal patch on segments 4 to 6; the fifth segment nearly all pearly white. Length 30<sup>mm</sup>. (See Fig. 40, p. 129.)

*Pupa*.—Suspended by the tail alone. Head deeply conical; a dorsal low thoracic ridge; a very high, thin, compressed rounded smooth ridge on the second abdominal

segment; on each side at base is a silvery band obscurely marked. Body pearly white, spotted irregularly with brown. Head, wings, and limbs olive-brown. Abdomen pearl white, brown towards the end. Length 24<sup>mm</sup>.

*The butterfly*.—Deep orange red, body black, wings bordered and striped with black; in the black borders a row of white spots besides a row of marginal white spots in the scallops, also a row of three white spots in the triangular black spot extending inward from the outer third of the costa of the fore-wing. Eight white spots on the head to be seen from above. Expanse of wings 2½ inches.

#### 17. *Nisoniades icelus* Lintner.

This butterfly has been raised by Mr. S. Lowell Elliot from caterpillars found on different species of poplar and willow at or near New York City. According to Mr. Lintner, the first discoverer of the species, the butterfly is to be seen from May 25 till near the middle of July.

*The egg*.—The egg is of a pale-green color. In shape it is a semi-ellipsoid; its base is flat, and its apex depressed between the tips of the ribs, which terminate exterior to the depression. It is distinctly fluted even to the naked eye, and with a 1-inch lens the ribs may be seen of the number usually of eleven, but not uniformly, for of nine specimens examined one was observed with ten ribs and one with twelve. Connecting the ribs are from thirty to thirty-five transverse striæ. The diameter of the egg is .031 of an inch, and its height .028 of an inch. The larva has not been observed by me. (Lintner.)

*The butterfly*.—Head and palpi dark brown, the latter lighter beneath, and interspersed with gray or gray-tipped hairs. Antennæ brown, annulated with white obscurely above, with the club orange-tipped. Thorax dark brown, with scattered scales of lighter brown. Abdomen dark brown, with some gray scales, especially at the posterior margin of the segments. Anterior wings above dark brown, basally mottled with umber, and sprinkled with yellow-brown and bluish-gray scales. It differs from *N. brizo*, to which it is closely related, by its uniformly smaller size, its wings expanding from 1.20 to 1.40 inches, while the smallest *brizo* expands 1.50 inches. A marked characteristic is the costal patch of bluish scales between the bands. (Lintner.)

#### 18. *Smerinthus excrucatus* A. and S.

The caterpillar of this moth, which heretofore has been supposed to be confined to the wild cherry as well as the apple and plum, has been found by Mr. Fletcher to feed readily on the balm of Gilead and also *Populus alba*, the latter known as the silver abele tree; the larvæ varied much in coloration. (Can. Ent., xv, 203.) Mr. P. Fischer (Can. Ent., xvi, 17) has bred this species from the poplar and linden.

#### 19. *Smerinthus modestus* Harris.

The caterpillar of this rare moth has been found by Dr. Kellicott to feed on the aspen, and by Mr. W. V. Andrews on the poplar (species not mentioned). Mr. R. Bunker, who describes the eggs and early stages (in Can. Ent., ix, 210), does not mention its food-plant. We copy his descriptions.

*Egg*.—One-eighteenth inch in diameter; light green, translucent, smooth, circular, oblate or depressed. Hatched in nine days after being laid.



*Larva*.—One-fourth inch long; light green, slender. Head large, round, slightly depressed medially; face pink, with a purplish tinge; extremity of the body dark sea-green, with a large wart or tubercle, pyramidal in form, upon which rests the horn.

*First molt*.—One-half inch long; apple green, with a light yellow longitudinal stripe below the dorsal ridge; diagonal lines yellowish white; horn purple, straight, very short.

*Second molt*.—Seven-eighths inch in length; rich dark green, finely granulated, giving it a beautiful velvety appearance; thorax adorned with two transverse crests or collars, studded with fine points tipped with white.

*Third molt*.—One and a quarter inches in length; thickest medially, light green, otherwise unchanged.

*Fourth molt*.—One and seven-eighths inches long; light green, coarsely granulated, granules studded with fine white points, giving the skin a frosted appearance; crests on the thorax much reduced in size.

*Fifth molt*.—Three inches long;  $\frac{1}{2}$  inch in diameter; hind crest lost, anterior one much reduced; spiracles small, rust-red; true legs brown; prolegs brownish yellow; horn lost, except a mere rudiment; yellow longitudinal stripes very obscure.

*Pupa*.—Two inches long;  $\frac{5}{8}$  inch in diameter; dark chestnut brown; cylindrical, holding its size well to the sixth segment, thence tapering abruptly and ending in a point or thorn; head obtuse, thoracic portion round, not angular.

*Moth*.—The largest species of the genus. Olive drab; head very small, and without a prominent crest; antennæ of the males transversely biciliated beneath. Forewings scalloped, with a transverse sinuous pale line near the base; a whitish comma-shaped stigma on a broad undulated dark olive-colored central band, and two transverse undulated lines towards the tip; under side purple in the middle of the disk. Hind wings purple in the middle and at base, with a transverse black spot, and an abbreviated dusky blue band near the anal angle. Body very robust, and with the legs immaculate. Expanse of wings, 5 inches.

## 20. THE IO MOTH.

### *Hyperchiria io* Fabr.

The gregarious caterpillars of this moth were observed on the aspen at Brunswick, Me., July 27; the young larvæ, apparently just hatched, occurred July 16, forming a group on an aspen leaf.

*Young larva after hatching*.—Stout, thick bodied; the body is uniformly pale reddish brown, while the large branching spines are brown and black. Length, 5 to 6<sup>mm</sup>.

*Young larva 15<sup>mm</sup> in length*.—Body moderately thick, of the usual shape of the genus. Body pale reddish horn-colored, with six longitudinal paler lines; four rows of dorsal and subdorsal black spinulated spines; and also a similar lateral row (or six rows in all). Head blackish-brown.

*After molting, July 28*.—Length, 17 to 18<sup>mm</sup>. The spinules on the spines are mostly whitish (those at the ends black), giving a grayish appearance to the larva. Head reddish amber; body, reddish-yellow.

*Larva after another molt, August 6*.—Length, 30 to 35<sup>mm</sup>. As soon as the old skin is cast, and while the parts are limp and soft, the spines present a curious appearance; the spinules being short, and placed close together, so that the whole spine forms an elongated conical mass. Soon the spinules stand out and the larva presents the normal appearance. It is now much lighter than before, all the spines being dense and pale, but afterwards they become wholly black or black at the ends, including the hairs, though the general effect of the mass of spines is to give a pale horn-colored yellowish-green hue to the body. Color of the body as before, but there is a

distinct broad deep orange spiracular line, edged slightly above, and broadly below, with whitish. The head is blackish in front, with a whitish V-shaped mark and a whitish dash in the middle of the V or clypeus; labrum whitish.

*Full-fed larva, molted August 16 to 20.*—Same characters as before the last molt, only differing in being much larger. Body cylindrical, with stout spinulated spines arising in whorls from small conical tubercles, arranged in seven rows on the thoracic and five rows on the abdominal segments; the spinules at tip very sharp and poisonous, often ending in a stiff hair; about twelve spinules on each tubercle; some of the lateral abdominal and thoracic spinules tipped with black. Head of the usual size, rather large, pea-green; the eyes, except the posterior one, situated on a black spot; labrum pale amber. Body and spines pea-green. On the abdominal segments is a lateral broad bright reddish spiracular band, broadly edged with white below; this line extends to the end of the outer side of the anal legs. Spiracles whitish, narrowly edged with black; ends of the abdominal legs and entire thoracic legs reddish. Length, 60<sup>mm</sup>.

21. *Gluphisia trilineata* Pack.

Mr. Howard L. Clark has reared this moth from caterpillars found on the balm of Gilead at Warwick, R. I. The moth appeared July 22, having been in the chrysalis state about ten days.

22. *Ichtyura inclusa* Hübn. (*Clostera americana* Harr.)

The caterpillar of this moth occurred on the poplar (*P. grandidentata*?) at Providence, September 11 to 15. They were living within a tent made by drawing two or three leaves together, several smaller branches of the tree having been defoliated by them. It pupated a few days after, the moth appearing in the breeding cage June 1 of the next year.

The following account is copied from Harris, who observed them on the balm of Gilead:

August and September, 1835: Gregarious caterpillars on the balm of Gilead tree; folding up the leaf and lining it with silk as a common web, the petiole being also fastened to the trunk by silk.

*Larva.*—Color of the larva yellow; head, geminate tubercles on the fourth and eleventh segments, tip of last segment, and true feet, black; three narrow dorsal and three broader lateral vittæ, and spiracles, black. The larva is much like that of *Clostera anachoreta* (Ernst, 165, fig. 214) and *C. reclusa* (Ernst, 165, fig. 216) and closely resembled *C. anastomosis*. Thin cocoon formed in a box October 4, 1835. Another cocoon formed in October, 1837, disclosed the imago June 15, 1838.

August 10, 1838: Found the larvæ in great abundance on the balm of Gilead tree. These caterpillars are gregarious, and form a common shelter consisting of a leaf folded longitudinally and lined with a thick web of silk, beneath which the insects are sheltered when not feeding. They eat the whole of the leaves except the veins, which remain untouched. The petioles of the small leaves used as habitations are fastened with silk. The larger leaves subsequently used for shelter are not thus secured. They do not eat the leaves which serve for habitations, but sometimes fold one-half of the leaf and eat the corresponding side. When fully grown the caterpillar measures one inch and a half or more in length. They do not vary in color or markings at different ages. Body slightly hairy, light yellow, the head, true feet, a double wart on the fourth, another on the eleventh anal valve, three slender dorsal stripes and three broader lateral ones on a dusky ground, and the spiracles, black. In the oldest caterpillars there is an orange-colored line, at the sides of the body below the spiracles. The upper lateral black stripe is the broadest and becomes

indistinct towards the second, which gives to the sides the appearance of a broad, dusky stripe marked with three black lines.\* The thinly scattered hairs on the body are whitish, and proceed indiscriminately from the surface, and not from regular tubercles.

The cocoon spun at Providence about the middle of September, is a loose web with abundant brown strands made in a folded leaf.

*Larva*.—Body as wide on the third thoracic segment as on the eighth abdominal. Head as wide as first and second thoracic segments; flattened in front, uniformly deep black. First thoracic segment short and small, with two sublunate black shining spots. On the first abdominal segment are two black rounded fleshy conical tubercles, surrounded at the base with short black hairs, and bearing at the end a white hair. A similar double tubercle on the eighth segment, the latter pair (in life) nodding over backwards at regular intervals independently of the surrounding skin (a very singular phenomenon; the anterior pair does not move). Along the back are four yellow stripes inclosing three black somewhat interrupted lines. On the sides are three broader black bands and a supra-spiracular yellow line. A broad yellow ochereous lateral band inclosing the black spiracles. Thoracic feet black; abdominal feet mostly reddish brown, black near the ends. Body with numerous white hairs arising from small warts. Length, 30<sup>mm</sup>.

*Pupa*.—Large and thick; wings not reaching to the hinder edge of the third abdominal segment; abdomen full and rounded at the end; the terminal spine (cremaster) forming a slender rounded spine scarcely thicker at the end than at the base, and terminating in two forks which are suddenly twisted back or recurved, and ending each in three minute acute spines. Length, 17 to 18<sup>mm</sup>.

23. *Ichthyura strigosa* Grote.

The caterpillar of this interesting species was found July 30, at Brunswick, Me., feeding on the aspen (*Populus tremuloides*). It molted August 10, and about the 20th began to spin a silken cocoon between two leaves. The moth (a male) appeared in the breeding cage at Providence, May 20. Like *I. inclusa*, it sits with the wings folded sharply over the back, with the fore-legs held straight out in front, with the tufted tail upcurved.

*Larva before the last molt*.—Head broader than the body, flattened in front, dull black, with long white hairs. Body flattened, with yellow and reddish longitudinal stripes; three dorsal faint red stripes on a yellowish ground, and three deep lake-red lateral stripes, the lowermost the broadest and deepest in hue. Two bright yellow lateral stripes. Five pairs of flesh-colored abdominal legs, the legs pale amber, colored like the under side of the body. Length, 9<sup>mm</sup>.

*Larva after the last molt*.—Markings much as in the previous stage. Length, 17 to 18<sup>mm</sup>.

The rude cocoon is formed by tying a few leaves together, gathering them by a web at the edges, thus forming a roomy chamber, partly lined with silk, within which the chrysalis rests.

*Pupa*.—Smaller and not so full and rounded at the end as in *I. inclusa*; cremaster as in that species, ending in two stout, very short, recurved spines. Length, 12<sup>mm</sup>.

*Moth*.—One male. Smaller and duller brown than *I. indentata* Pack. Palpi whitish below, dark brown above, as in *I. indentata* (which closely resembles Fitch's *I.*

\* The middle lateral line is very slender, the lower one broader, more distinct than the upper one; and below it, between and below the spiracles, are irregular, blackish spots which sometimes run together so as to resemble a fourth line. The tubercles have hairs as well as the body. (Harris Corr.)

*vau*); front of head slightly broader and squarer; median thoracic brown band as in *I. indentata*. Forewings with the costal edge straighter and the apex less turned up than in *I. indentata*, the apex being slightly more rounded than in that species or in *I. inclusa*. Basal line distinct, making a sharp angle on the median vein, and more incurved in the submedian space than in *I. indentata*; second line much more suddenly incurved than *I. indentata*, the same line being straight in *I. inclusa*; the short third line as in *I. indentata*, but more sinuous. Fourth and outer line much as in *I. indentata*, but the species differs from all the others known by the large conspicuous irregular whitish ochereous patch which fills in the costal curve of this line and extends half way from the costal end of the line to the apex of the wing; no deep brick-red discoloration on each side of costal half of fourth line, so distinct in *I. indentata*, but a long discal blackish stripe extends along the first median venule to the submarginal row of brown dots which are not so distinct as in *I. indentata* or *I. inclusa*; though the marginal row of dark brown lunules is as distinct as in *I. inclusa*. Fringe as in *I. inclusa*, but that on the hind wings much darker. Hind wings darker than in *I. indentata*. Wings beneath much as in *I. indentata*, but there is no reddish tint towards the apex, and the white oblique costal streak is much less distinct. There are traces of a common brown diffuse line. Abdomen a little shorter, the fan or tuft of scales perhaps shorter and expanding wider. Expanse of wings, 25<sup>mm</sup>; length of body, 12<sup>mm</sup>.

#### 24. THE WHITE-S ICHTHYURA.

*Ichthyura albosigma* Fitch.

Order LEPIDOPTERA; family BOMBYCIDÆ.



FIG. 165.—*Ichthyura albosigma*.

and strongly waved in shape of the letter S; width, 1.50. (Fitch.)

#### 25. V-MARKED ICHTHYURA.

*Ichthyura vau* Fitch.

This moth, which is very similar to *I. inclusa*, but darker colored and smaller, with the bands more slender and distinct, may be readily distinguished from that species by its having the first band not dislocated, but in its middle strongly curved backward, the apex of the curve usually forming an acute point. The last band also is much more strongly undulated near its outer end, curving backwards almost in a semicircle, and is of a much more vivid white color, and broadly bordered on its hind side with bright rust-red. Its hind legs also are destitute of the paler band across their middle. Its width is about 1.20.

I am unacquainted with its larva, but, like the other species of this

genus, it doubtless feeds on the poplars and willows. Though quite rare in my vicinity, it is oftener met with than the two other species. (Fitch.)\*

26. *Pheosia rimosa* Pack.

I first found the singular sphinx-like caterpillar of this moth over twenty-five years ago at Brunswick on the balm of Gilead, September 28. The general color was a purplish lead; head and first segment greenish; the horn on the eighth segment is black, the dark shade prolonged into a lateral line; a kidney-shaped spot on the last segment; spiracles black, encircled with white; below is a yellow line. Beneath greenish and yellowish straw. October 6 it pupated.

This moth, originally described by us as *Pheosia rimosa*, differs from the European *dictæa* in its larva, those of the two European species having no horn, the eighth abdominal segment being simply humped. In 1877 Mr. Meske wrote me as follows:

The imago of *Notodonta rimosa* Packard stands very near to the European *Notodonta dictæa* Linné, but the larvæ of those two species are entirely different. The larva of the former is very slender, light green, and has a caudal horn like a sphinx larva; it feeds on *Populus tremulans*. This is the second case in the North American fauna where the imago stands very near to its allied European form, while the larva is entirely different. The first case is *Acronycta occidentalis* as compared with *Acronycta psi* Linné.

The larva has been described by Mr. C. F. Goodhue, who has found it on the poplar and willow in New Hampshire late in September. "The transformation takes place in a slight cocoon of dead leaves fastened together with a few silken threads, on the surface of the ground, much in the manner of *Darapsa myron*." The moth appears in spring as well as in August; it occurs throughout the Eastern and Middle States.

Mr. F. Tepper has raised the caterpillar which occurred on the willow in New York, June 22; it went under ground a few days after, and the moth emerged August 22.

*Larva*.—The body increases in size from the head to the anal segment; it is deeply incised between the segments, much like those of the Sphingidæ in appearance and exceedingly smooth and shiny. Head small and nearly round; first four segments capable of being retracted nearly one-half their length. Head and entire upper parts of body pale slate color, slightly shaded with brown on the dorsal portion. Yellow beneath between the legs; also a slight stigmatal line of the same color. Caudal horn short and black; the black extends from the base of the horn to below

\* Walker (Cat. Lep. Het. British Museum, v, 1058) thus refers to a moth which he describes as *Ichthyura apicalis*:

Mas. Cinerea; caput nigro-fuscum; frons et palpi subtus albida; antennæ canæ ramis cinereis; thorax vitta dorsali nigro-fusca; alæ anticæ fusco-cinereæ, lineâ undulosa albida maculaque costali rufo-fusca; posticæ cinereæ; subtus albida fascia gracili discali undulosa fusciscente.

"Larva brown, thick, with sixteen feet, and with a band on part of the back; feeds on the poplar leaf, which it draws together with silk. Cocoon slight and white. The moth appears in June."—*Barnston MSS.*

a, b. —St. Martin's Falls, Albany River, Hudson's Bay. Presented by Dr. Barnston

the stigmata. Anal shield rusty and rough; stigmata black, encircled with yellow; abdominal feet black, the rest pale yellowish. Another specimen differs in color, being pale lavender, with a slightly darker dorsal line. Under parts between the



FIG. 166.—*Pheosia rimosa*.

legs and a faint substigmatal greenish yellow line. Another slightly smaller was of a bright pea-green color, with a bright yellow stigmatal stripe, in other respects like the former. Length, 1.50 to 1.75 inch.

*Pupa*.—Dark brown. Head-case smooth, deeply incised between the abdominal segments. Anal segment large and smooth, ending in two short points.

*Moth*.—Wings rounded and somewhat produced towards the apex; of a delicate frosty white and brown. Along the ends of the subcostal venules of the forewings are long streaks of brown; in the apical and subapical spaces are two long, longitudinal, broad streaks, oblique and parallel to the costa, which terminate just before the apex; middle of the wing white. A long, broad line extends from the base to just above the inner angle on the outer margin, lined below with white, and deflected upwards along the outer edge. Tuft cinereous. Beneath cinereous, costa darker. The female darker than the male. Hind wings white, the region of the internal angle and tuft dark brown. Legs and abdomen cinereous. Thorax and head cinereous; the tuft on the patagia or shoulder tippets tipped with dark brown. Fringe interlined at base with white. Expanse of wings, 2 inches.

#### 27. *Notodontia stragula* Grote.

(Larva, Pl. V; fig. 1.)

The caterpillar of this moth has been reared by Mr. Tepper in New York. It was found on the poplar July 4; the moth appearing July 27. (Bull. Ent. Soc. Brooklyn, i, 10). Messrs. Edwards and Elliott have found the food-plant to be the willow. (See under Willow Insects)

*Larva*.—Head slate color, mottled with black, and with a pale stripe on each side. Mouth parts with a greenish tinge. Body pale lilac, with the exception of the eleventh and twelfth segments, which are dull golden. The seventh and eighth segments have raised prominences, which are also golden, that of the seventh being the largest. Laterally there are some pale oblique streaks somewhat similar to those of many Spingidæ; these do not meet on the back, where there is a faint slate-colored line. Between the second and sixth segments, and common to all of these, is a darker dorsal shade which re-appears on the eleventh and twelfth segments. The spiracles are white, with a black ring, and the lower lateral line is paler than the rest of the body. The twelfth segment bears a hump, and the sides of the eleventh, twelfth and thirteenth segments are pale brown, mottled with orange. Abdominal legs dull slate-color, mottled with black; thoracic legs black. Length 55<sup>mm</sup>. (H. Edwards and Elliott, Papilio, iii, 129.)

*Moth*.—Anterior wings slaty-gray, shaded with pale buff along internal margin, with a chestnut-brown basal patch and some brown streaks and spots in the terminal space; internal margin crested. Extreme base of the wing brownish; basal line distinct; subbasal space large, grayish at costa, rich chestnut brown below the median vein, pale buff along the internal margin, which latter shade extends from base to internal angle. A very dark brown streak extends from the basal line to the trans-

verse anterior line below the median vein, and a similar streak at internal margin. Transverse anterior line dark brown, grayish at costa, undulate, bordered anteriorly by a pale buff shade from below subcostal vein to internal margin. Median space widest at costa, narrow at internal margin, grayish, with an elongate pale discal spot with dark brown center. Transverse posterior line cinereous, indistinct, subdentate, continued. Terminal space with a series of rich chestnut-brown streaks between the veins, two more, linear, near the apex. Posterior wings pale cinereous with two indistinct median bands; anal angle touched with brownish. Thorax and collar brownish; tegulæ grayish; abdomen cinereous, slightly brownish above. Under surface of thorax and inside of legs brownish, outside of legs and sides of thorax clothed with cinereous hairs. Expanse of wings 1.60 inches. (Grote.)

28. *Edemasia concinna* Abbot and Smith.

The moth has been bred by Mr. Elliott from the willow, and I have found it in different stages of growth on the willow at Brunswick, Me., in August and September. It also feeds on the aspen and blackberry in Maine. I have also found the caterpillar feeding on the huckleberry (*Vaccinium*).

"This curious and well-known caterpillar was received in August from Oregon. Mr. F. S. Matteson, of Aumsville, states that he found it in large numbers on a young apple tree, entirely denuding the branches of leaves. This mention is made as bearing upon the geographical distribution of the species. The gregarious habits of these larvæ when first hatched admit of an easy remedy in hand-picking." (Riley, Rep., 1884.)

Mrs. Anna K. Dimmock gives a summary of its history (*Psyche*, iv, p. 282) as follows:

*Notodonta concinna* Abb. and Smith (*Nat. Hist. Lepid. Ins. Ga.*, 1797, v. 2, p. 169, pl. 85). Harris (*Rept. Ins. Injur. Veg.*, 1841, pp. 307-309) describes larva and imago of this species, and gives as food-plants apple, cherry, plum, *Rosa* and *Crataegus*; this description is quoted by Morris (*Synop. Lepid. N. A.*, 1862, p. 242), and is repeated with figures of larva and imago (*Treatise on Ins. Injur. Veg.*, 1862, pp. 425, 426, pl. 6, fig. 11) and with a colored figure of the larva by Harris (*Entom. Corresp.*, 1869, p. 303, pl. 1, fig. 3). Riley (*Amer. Entom.*, September and October, 1869, v. 2, p. 27) figures larva, pupa, and imago, and adds pear to the food-plants; Riley's figures are repeated by Saunders (*Can. Entom.*, July 1881, v. 13, pp. 138-140). The larva also eats *Betula alba*.

*Larva after first molt*.—Length 7<sup>mm</sup>, body rather slender; head reddish black, with two long vertical tubercles; body reddish amber, with indistinct broken yellow lines; two long dorsal tubercles on first and fourth segments, much longer than those on the outer segments, the tubercles not so conspicuous as in the next stage. August 14.

*Larva after second molt*.—Body bright yellow; head jet black with two tubercles on the vertex; second segment with a jet-black transverse mark. Each of the other segments has a transverse row of eight or ten small black short tubercles, those of the dorsal region being the longest. Between these are a few whitish hairs. Anal segment, thoracic and abdominal feet pitchy dark. Length 12<sup>mm</sup>.

After the second molt some of the larvæ are ichneumonid. September 2 an ichneumon larva had issued from the ventral side of the caterpillar and spun a white thin cocoon; the nearly dead caterpillar was fastened by its back to the cocoon. After

a day or two the caterpillar died and turned whitish, the rows of black warts becoming conspicuous.

*Full-grown larva.*—Head coral-red, smooth above, deeply notched, but not tuberculated, as is also the fourth (first abdominal) segment, which is humped, but the head is smooth and shining, the hump dull red. The dorsal and anal regions dull yellow, with black waved lines; four white subdorsal lines alternating with waved black lines. Lower lateral yellow, with waved black lines. All the segments bear six or eight setiferous black tubercles, looking like black sealing-wax. Anal segment jet-black. Hairs all sordid white. Underside dull yellow, streaked with black waved lines. Abdominal legs yellowish flesh color; thoracic feet black. Length 30<sup>mm</sup> (1.25<sup>mm</sup>). August 29–30.

29. *Cerura borealis* Boisd.

The caterpillar here described occurred in August and September at Brunswick, Me., on the aspen. It apparently differs from those of *C. occidentalis* and *cinerea* in the longer spines on the prothoracic segment in the young larva, and in the smooth slight rounded projections which replace them in the full-grown caterpillar.

*Larva before last molt.*—Length to base of caudal appendages 11<sup>mm</sup>. Head large, full, rounded, dark lilac-brown speckled with yellow, slightly wider than the body except the front part of the prothoracic segment; the latter very broad, over twice as broad as long, the front edge laterally produced, and at each angle bearing a large long spiny tubercle three-fourths as long as the segment itself; the tubercle bearing about twelve setiferous spines; across the posterior edge of the segment is a row of four setiferous spines. On the back of the other segments are four short tubercles arranged in a short trapezium, and on each side of the segments are two smaller sharp tubercles. The dorsal tubercles on the mesothoracic segment are larger than those behind; those on the metathoracic segment smaller than those on any other segment. The body tapers gradually to the end; the supra-anal plate longer than broad, rounded, bearing two long large setiferous fleshy tubercles, which lie between the bases of the spiny anal legs or filaments, which are about one-half or two thirds as long as the body, and yellow, with two broad brown rings, and brown at the tip. Body greenish yellow, marked as usual with lilac brown, this tint mimicking the dead withered brown of the edge of poplar leaves of late summer; it is a dark lilac brown with reddish brown and lilac brown patches, and in this way the caterpillar mimics the dead stained portion of the leaf on which it feeds and thus escapes observation. From head to end of mesothoracic segment a brown patch, succeeded by a pointed brown band which extends to the base of caudal appendages but contracted on the eighth abdominal segment, the dorsal tubercles of which are yellow.

*Larva after last molt.*—Length, except caudal appendages, 17<sup>mm</sup>. Differs from foregoing stage in the prothoracic spiny horns being replaced by smooth, shining tubercles with faint traces of the spines of the former stage; the sides of the thoracic segments more distinctly spotted; with faint traces of broken yellow lines in the middle of the body.

The caudal appendages are soft and extensible on their outer third, forming the “flagellum;” and are quickly jerked up when the creature is disturbed; they are evidently delicate repellent organs.

The close resemblance in the lilac-brown patches of this caterpillar and others of the genus to the sere and brown edges of certain of the leaves is remarkable, and plainly enough serves to protect the caterpillar from observation. I have observed the same in other Notodontians, especially *Schizura unicornis* and allied forms.



30. *Notodontian?* larva.

This larva was observed on the aspen, at Brunswick, Me., August 10; it molted August 12, and on the 20th began to spin a slight silk cocoon between the leaves on the bottom of the breeding box. Within this web it remained for three or four weeks before pupating, the pupa appearing about September 15.

*Larva*.—Head large and broad, flattened in front, vertically; somewhat retractile in the prothoracic segment. Body thick, soft, with numerous yellow conspicuous warts, six on each side of the prothoracic segment. On the second segment behind the head are two twin high coral-red tubercles which are yellow at the base. Body with three transverse yellow stripes, the two hinder ones nearer together than the first and second. Thoracic legs pea-green. Supra-anal plate broad and short, much rounded; anal legs with a transverse yellow and blackish stripe. Length, 20mm.

31. *Clisiocampa californica* Pack.

We have received the following account of a *Clisiocampa* larva found by Mr. H. W. Nash feeding on the aspen in Colorado. The larva did not wholly agree with the description of that of *C. californica* nor *C. constricta*, nor that of a species we have found feeding on the wild rose in Montana, with specimens of which we have compared it, though the latter is undoubtedly *C. californica*. The following year Mr. Nash reared the moth and kindly sent me a specimen, which does not appear to belong to *C. erosa*, *C. constricta*, or *C. fragilis*, with specimens of which I have compared it. But in comparing the moths with specimens of *C. californica* both in Mr. H. Edwards' collection and my own, we both agree that it does not differ from *C. californica* from California. The following letter dated Pueblo, Colo., February 28, 1883, describes its habits and appearance:

I send by mail to-day a *Clisiocampa* with cocoon, as you request in Bulletin No. 7 of the Entomological Commission, specimens and notes of insects injurious to forest and shade trees.

At Rosita, Custer County, on the western slope of the Wet mountains, at an altitude of from 8,000 to 9,000 feet, during the month of June, 1881, the larvæ almost entirely defoliated large tracts of poplars (*P. tremuloides*), and there was scarcely a tree to be found that was not attacked. I saw a few feeding on willows where the leaves were all eaten from the poplars. The moths began appearing about the first of July and were soon fairly swarming about the poplars.

The mature larvæ were 2 inches long; color, light blue spotted with dark brown; two brown stripes along the back; under side bluish black; legs black; tips of prolegs light brown; body sparsely covered with long brown hairs.

H. W. NASH.

32. *Thanaos* sp.

The caterpillar of this butterfly was beaten from the aspen at Brunswick, Me., August 20. A smaller one in a preceding stage occurred at the same date on the willow. It molted August 24.

*Larva*.—Of the usual shape of the genus; head broader than the short, small prothoracic segment; angulated above, rather deeply bilobed; surface rough, granulated; brown in front; black near the mouth and on the sides and behind, with a triangular

black point extending in front from the middle of the vertex. Body pale green, exactly of the color of the under side of the poplar leaf, with a subdorsal pair of white lines; the sutures finely marked with pale straw yellow; the surface slightly wrinkled, and finely, evenly granulated with white. Length, 22<sup>mm</sup>. A smaller larva on the willow in a stage before the last molt has the head wood-brown in front, the head of the aspen larva being entirely black.

33. *Apatela noctivaga* Grote.

The eggs were observed by Mr. Thaxter to be laid on the poplar July 14 [4th]; they hatched July 9. The caterpillar molted 5 times, made a cocoon between the leaves August 9, and the moth appeared in May and June (*Papilio*, iii, p. 15).

*Young larva*.—Greenish-white; dorsal portions of segments 1, 4, 7, 8, and 11 red; the rest more or less tinged with red. Sparsely clothed with long blackish hairs. Beneath greenish-white. Head brown, rather stout, not tapering. Length 3<sup>mm</sup>.

*Larva after first molt*.—July 12. Color dirty greenish. Segmentation very distinctly marked. Dorsal patches dull reddish on upper portion, the other segments (except 9 and 10) suffused with red. Head dirty red, greenish in front. Somewhat thickly covered with tufts of stout black hairs. Length 5.5<sup>mm</sup>.

*Larva after second molt*.—July 12. Much darker than before, the red colors having become dark wine-color, somewhat mottled, and being suffused over the dorsal portion of all the segments except 9 and 10. Sublateral and ventral portions light green, except on segments 1, 2, and 3, which are tinged with red. A whitish lateral line. Body covered with black setiferous warts, on which are set thick tufts of short stout black hairs, those on segment 10 much shorter than the rest. Legs green, edged with red. Abdominal legs banded, green and red. Head dark bluish, mottled, tapering gradually posteriorly and suddenly anteriorly from segment 11. Length 6<sup>mm</sup>.

*Larva after third molt*.—July 20. Dull black above, yellowish beneath. A yellowish lateral line, two yellowish dorsal patches on segment 10, on which the hairs are short. Head blackish, with an anterior yellowish V-shaped mark. Legs greenish yellow; abdominal legs blackish. Segment 11 much humped. Body stout, much hunched in the region of segments 2 to 4. Length 10<sup>mm</sup>.

*After fourth molt*.—July 24. Black above, deeper anteriorly. A distinct yellow lateral band beginning on segment 4 and running just below the stigmata, which are white, contrasting. Thoracic feet yellow; abdominal black. Dorsal patches on segment 10 brighter, otherwise as in preceding stage. Length 13<sup>mm</sup>.

*After fifth molt*.—July 28. Lateral band orange-colored. A broken yellowish stripe at base of legs; two dorsal orange spots on segment 10, and in some specimens two smaller spots on segment 9.

*After fifth and last molt*.—August 1. Much as before, the setiferous tubercles large and rough, jet black, bearing thick tufts of short, stiff black hairs. Lateral band and dorsal spots dark red. Head and abdominal legs shining black (form of body as in *A. brumosa*). Length 30<sup>mm</sup> (1.20 inches). (Thaxter.)

*Moth*.—Forewings dark gray varied with black; ordinary lines white. Basal space black, grayish on the costa; basal half line white, bordered externally by a black line. Transverse anterior line white, widely lunulated, distinct, bordered externally by a black line which commences from a broader black costal mark. Median space large dark gray; median shade band blackish, traversing the reniform spot. Ordinary spots of the normal shape, distinct; reniform spot attenuated, black, with a hardly perceptibly lighter center; orbicular spot round, black, with an ill-defined grayish inner ring. Between the ordinary spots in the lower middle of the ring is a squarish black spot bordered externally by the median shade. Transverse posterior line white, acutely dentated, arcuated in front, preceded near the costa by a whitish

mark and bordered on either side by a black line. Submarginal line broad, white, irregular, interrupted just before the internal angle. Terminal space black, narrow, reduced by the submarginal line which, at about the middle, nearly attains the external margin. Fringes white interrupted with black between the veins; costa with some black and white marks. Hind wings uniformly dark brownish, immaculate; fringes lighter. Under surface of both pair light brownish, with faint discal dots and bands. Thorax gray, varied with blackish on each tegula and the collar. Expanse 1.30 inches. (Grote.)

34. *Apatela* sp.

The caterpillar of this moth was found on the poplar and willow August 10, at Brunswick, Me. September 8 it spun a silk cocoon between a rolled-up leaf, sewing bits of leaves on the outside of the exposed part of the cocoon. The moth appeared May 24 following. The larva would be mistaken for a Notodontian.

*Larva*.—Body compressed. Head compressed, high, deeply incised, bilobed, each lobe ending in a rounded tubercle. Head reddish-brown mottled with yellowish-green. Each segment deeply incised, the setiferous tubercles large, bearing long stiff hairs. The eighth abdominal segment is humped. Last pair of abdominal feet not much larger than the others. Body pea-green, with a deep reddish brown dorsal band twice interrupted and forked on the prothoracic segment; the band is edged with yellow. Thoracic and abdominal feet greenish. Length 12<sup>mm</sup>.

35. *Apatela vulpina* Grote.

“The long, curved hairs,” says Mr. R. Thaxter, “give this larva a very curious appearance when at rest on the under side of a leaf, with its body curved about so as to form what appears to be an oval mass of down that is readily mistaken for a nest of spider’s eggs. The curved hairs seem to come to a sort of focus in the region of segment 9, which is very characteristic. Before entering the ground the body becomes dirty brownish green, the hairs become dirty yellow, the head entirely black, without marks.” It feeds on the poplar and willow. (*Papilio*, iii, p. 15.)

*Larva before last molt*.—Body greenish white, darker below, thickly clothed with long white hairs, slightly tinged with yellow. A jet-black, rather short, thick, black tuft on the median dorsal portion of segments 4, 6, 7, 8, and 11. Head light greenish, with a black dot on the frontal portion, each side of the median line, also two inferior black spots. Legs light green; prolegs banded with black. Length, 30<sup>mm</sup> (1.20 inch).

*Full-fed larva*.—Body light bluish green, whitish above, immaculate and without any black dorsal tufts. Thickly covered with tufts of long, curved yellowish white hairs. A few short black hairs on segments 11 and 12. Head large, dirty-whitish, with a few darker mottlings, and two inferior black spots on either side. Stigmata yellow. Length 45<sup>mm</sup> (1.80 inch). (Thaxter.)

*Moth*.—Allied to *A. leporina* and *lepusculina* (*populi* Riley). Wings creamy yellowish white. Hind wings pure immaculate white. The markings are as in *A. leporina*: a black basal dash; the transverse anterior line consisting of three black spots; a small ringed orbicular spot sometimes wanting; a small lunate black reniform spot. Transverse posterior line fragmentary, but without the dash at the internal angle “*en T*” of *A. lepusculina*, or at most the smallest remnant of it. (Grote.) (Can. Ent., xv, p. 8.)

36. *Raphia frater* Grote.

The caterpillar rests on the midrib on the under side of poplar leaves. It varies considerably in size, the males being much smaller and more slender than the females. It spun a stout, blackish cocoon on bark September 10, the moth appearing June 10 following. "It is this larva or its ally, *R. abrupta*, that is figured in Harris' Correspondence, Pl. I, Fig. 6, as *Notodonta* sp. found under maple." (R. Thaxter, *Papilio*, iii, p. 13.) Mr. Graef had previously reared the moth from a larva found feeding on the silver-leaf poplar. (Proc. Ent. Soc. Phil., ii, p. 435.)

*Larva*.—Color generally dark, somewhat bluish-green, though subject to considerable variation of tint. Body covered with scattered bright yellow points, about twenty on each segment. A dorsal hump on segment 2 surmounted by two short, blunt, red prominences. On the dorsal surface of segments 4, 8, 11 is a transverse mottled red-purple transverse band, interrupted centrally and somewhat crescent-shaped, which is bordered posteriorly and externally with more or less clear yellow. A lateral red point on segments 1 and 2. Legs and prolegs light green, with a minute lateral black point. Length, 40<sup>mm</sup> (1.60 inch.) (Thaxter.)

*Moth*.—Anterior wings bright steel gray, median lines black, distinct. Transverse anterior line black, slightly bent, running in an oblique direction from costa toward the base of the wing till near the internal margin, where it forms a deep sinuate abrupt rounded outward reflection. Median space gray, showing a black zigzag median shade-line and black costal mark. Reniform and orbicular spots distinct, ringed with black, grayish, the former with a dark central streak, the latter contiguous to the transverse anterior line, with a clear, grayish center, and beneath it the clariform spot margined with black. Transverse posterior line black, narrow, angulated, much projected, and arcuated superiorly, followed by a grayish coincident shade. Subterminal space with a slightly brownish tinge; subterminal hair dark gray bordered outwardly by a lighter shade; veins marked with blackish; terminal line black; fringes blackish, narrowly interrupted with gray at the extremities of the veins. Posterior wings whitish, clouded with grayish at anal angles, with a distinct black terminal line, and a very faint median grayish line; fringes gray, darker shaded between the veins. Under surface of anterior wings gray, showing a black, discal lunule and a macular subterminal band. Costa with some small blackish spots. Under surface of hind wings lighter than in the forewings, showing a blackish discal lunule and a similar macular undulating band. Thorax grayish; tegulae narrowly bordered with black; abdomen crested on all the segments, grayish, exceeding the hind wings. Expanse of wings, 1.20 to 1.50 inches. (Grote.)

27. *Catocala meskei* Grote.

This and the succeeding species of *Catocala* (No. 33) have been bred by Mr. R. Bunker from the poplar. The caterpillar is more uniform in color than usual.

*Larva*.—Color light drab or cream. Head bilobed, ringed in front by a narrow, dark brown line; extremity of body forked. Between the fifth and sixth segments is a light brown band. An elevated band of obscure brown occurs on the seventh segment. Under side blackish brown. Length 2½ inches. (Bunker, Can. Ent., xv, p. 100.)

*Moth*.—Forewings dentate, pulverulent, of a rather lighter gray than *C. unijuga*. Median lines black, single, not very distinct. A whitish space before the large bianulate concolorous reniform spot; subreniform spot likewise whitish, closed, joined to the transverse posterior line, the latter jagged but without very prominent discal

teeth, making a deeper and narrower sinus above the vein than in *C. unijuga*. Subterminal line upright, dentate, the shade preceding the blackish line distinct. Terminal line appearing as black lunulated interspacial marks. Hind wings bright red, somewhat pinkish. The black median band is straight, not regularly curved as in *C. parta*, and straighter than in *C. unijuga*, rather narrow, nowhere greatly excavated, rounding and narrower on the interspace between veins 1 and 2 opposite the excavation of the marginal band, arrested at vein 1, but a few blackish scales mark its continuance towards the internal margin. Marginal band narrower than in *C. unijuga*. Ciliæ white, with a few red scales at base, especially at the apices. Beneath, the median band of the hind wings is narrower than above, with the same peculiarities, constricted at veins 2 and 5, and continued by scattered scales beyond vein 1. Expanse of wing 78<sup>mm</sup> (Grote).

### 38. *Catocala relicta* Walker.

The caterpillar of this moth is said by Mr. Hulst to feed on the silver poplar and white birch. The moth has white forewings which are more or less powdered and shaded with black; it is easily recognized by the even white median band on the otherwise black hind wings. It expands 80 to 85<sup>mm</sup>. (Hulst.)

*Moth*.—Male. Black, speckled with white, white beneath. Thorax in front white, with black bands. Abdomen above blackish, whitish between the segments, and with a white apical tuft. Forewings with two white bands, which include a black white-speckled band, and the latter is interrupted in the middle by a black ringlet; the exterior band contains a zigzag transverse black line; exterior border and adjoining part almost white, with deep black marginal lunules. Hind wings blackish brown, with a regular curved white band and with white ciliæ. Length of body 14 lines; of the wings 32 lines. (Walker).

### 39. *Catocala unijuga* Walker.

Two caterpillars of this moth were obtained by Dr. D. S. Kellicott at Buffalo, N. Y., from the trunk of a *Populus candicans*. "They had passed their last molt when taken; although they continued to feed in confinement for five or six days they increased in size but little during that time; their habits were strictly nocturnal. When first observed they were clinging to the bark beneath a limb, lying obliquely, and so flattened and leach-like that together with their gray color and lateral fringes blending with the bark, they were difficult objects to discover. June 22 the larvæ ceased to feed. On the following day they had fastened together some leaves by means of a silken gauze, brownish in color; by the 26th both had transformed." The moths appeared July 15. (Can. Ent., xiii, p. 38.)

*Larva*.—Body attenuated towards each end, especially towards the head. The general color is gray above, below pink with a subelliptical black spot to each segment, those on the thoracic rings not conspicuous. The head flattened, slightly bilobed, lighter in hue than the body and bordered by a well defined black line. The lighter head lobes under a hand lens appear mottled and reticulated with black lines and blotches. The dorsal line is white, made up of patches, illy defined circles and spots alternating; on each ring on either side of the line are two white papillæ from each of which arises a white hair; above the stigmata there is a white interrupted line, below them a black line also interrupted. The stigmata are rather large, elliptical.

whitish, surrounded with a black border. There is a row of stout, heavy filaments just above the line of the legs. No protuberances appear on the dorsal aspect of any of the rings. Length, 2.2 inches.

*Pupa*.—Pruinose, abdominal tip black, bearing eight hooked hairs, the four upper smaller ones turn toward the median line, the four under are larger and turn away from it. (Kellicott.)

*Moth*.—Forewings very light gray, heavily powdered and shaded with black atoms; the base, reniform spot, and terminal space, especially heavily shaded; transverse anterior line geminate, diffuse; transverse posterior line rather heavy; M not very strong, the line below dentate; subreniform white; a diffuse white spot beyond the reniform spot; subterminal line white, dentate. Hind wings red, somewhat shaded at base, with black median band strong, reaching the anal margin; marginal band broad. Expands 80 to 85mm. *C. fucilla* Worthington does not differ from this.

Var. *meskei* Grote. Forewings somewhat lighter than *unijuga*; hind wings with median and marginal bands narrower, the former not reaching the anal margin.

Var. *beaniana* Grote. Forewings darker than in *unijuga*; hind wings with the median band more even, not reaching the anal margin. (Hulst.)

#### 40. *Catocala cara* Guenée.

The caterpillar of this fine moth feeds on the willow, according to Mr. Koebele. In *Papilio* (ii, p. 167) Professor French has given a full life-history of the insect. It molts four times. The eggs were deposited October 6, the larvæ feeding on the willow; the young hatched April 6, and became full-fed, spinning their cocoon May 11 to 20, the moths emerging June 23 to 26, but when not in confinement the moth is not seen until the 1st of August.

*Egg*.—Diameter .04 inch, nearly globular; top a little depressed, containing a little button. (French.)

*Larva*.—Head gray brown; protuberance on the summit of the eyes prominent. Body with ground color gray; very heavily marked and striated with rust-brown, which towards the head almost completely covers the body. There is a brown lunule on the eleventh segment with horns forwards. Underneath clear red-brown between the third and sixth segments. The sixth and seventh segments between and in front of the legs have each a large nearly round spot. The larva is considerably smaller than that of *C. ilia* when full-grown, though the moth is one of the largest, if not the largest, of all *Catocalæ*. (Koebele, Bull. Brook. Ent. Soc., iv., p. 22.)

*Pupa*.—Of the usual shape. Dark brown, covered as usual with a white bloom. Abdomen finely punctured, the tip of the last joint very coarsely so. This ends in four hooks, two longer than the others, while there are two more hooks arising from the punctured portion at a little distance from the four. Length 1.45 inches. (French.)

*Moth*.—Forewings deep blackish brown; lines narrow, distinct anteriorly; lines and veins shaded with olivaceous. Hind wings intense rose-red, with a broad even black median band reaching the oval margin. Expands 85 to 95mm. Middle and Eastern States and northward.

Var. *carissima* Hulst. Forewings rich velvety brown, spotted and flecked with olivaceous scales, which form a large spot at the apex. Expands 90 to 100mm. Habitat, south and east from *C. cara*. *C. sylvia* is slightly more spotted with olivaceous. (Hulst.)

#### 41. *Catocala parta* Menée.

This species has been bred from *Populus dilatata* by Mr. Thaxter (Psyche, ii, p. 35), but he has given no description of the caterpillar.

42. *Catocala amatrix* Hübner.

The caterpillar of this moth was found by Dr. Kellicott under a large-toothed aspen (*Populus grandidentata*), on which it had probably been feeding, as Mr. Fischer, of Buffalo, the following summer bred this moth from caterpillars found on the Lombardy poplar. Prof. G. H. French has also bred it on leaves of the cottonwood and Lombardy poplar. In pupating they spun the leaves together, lining them with a very thin cocoon of silk. He thus remarks on the egg-laying habits of this species:

October 14, 1882, a female *C. amatrix* was brought to me, from which I obtained the next day 261 eggs. These began hatching May 3, 1883, and continued hatching to June 21, making the egg-period from 200 to 249 days. Only the few that hatched first were fed, and the greater part of these failed to reach maturity, owing mainly to a form of bacterial disease that has prevailed in most of the species of caterpillars which I have attempted to raise this year, and it has not been confined to the breeding cages, but has been as destructive in the fields. Two imagines were raised, one pupating June 21 and producing the imago July 25, the other pupating July 8 and hatching August 3. This gives us a minimum period of 277 days from the egg to the imago. I am of the opinion that all our species [of *Catocala*] are single-brooded.

Hulst gives the willow as also its food-plant, but his authority is not given.

The following account of the transformations are copied from Professor French (*Papilio*, iv, p. 8):

*Egg*.—Somewhat spheroidal in shape, in longitudinal diameter being .02 inch and the transverse .035 inch. They are ridged longitudinally, 14 of these reaching the punctured area of the apex, these alternating with shorter ones that do not reach so far. The base is scarcely more flattened than the apex. Color very pale dull olive. Duration of this period from 200 to 249 days.

*Young larva*.—Length .12 inch. Color brown, one dorsal and three lateral stripes a little darker than the rest of the body, hairs and head concolorous, the number of feet 12. Toward the close of this period the sides are more of a brownish yellow with four reddish brown stripes, the lower or substigmatal not clearly discernible at first, and on the venter dark brown spots in the center of joints 4 and 8. Duration of this period six days.

*After first molt*.—Length, .35 inch. Color of the dorsum brownish buff, the sides dark purplish brown; by transmitted light it may be seen divided into four more or less distinct lines, the pale alternate lines narrow and faint. Head brown, not very dark, with faint traces of lines. Scarcely a trace of the center of the dorsum being lighter than the rest of the dorsum. Venter pale, joints four to eight, with each a central black spot. First and second abdominal legs about one-fourth the size of the others. Duration of this period four days.

*After second molt*.—Length, .65 inch. More striped than before, a dorsal stripe somewhat moniliform, the center purplish brown on a yellow field or the outer part of the stripe yellow. Subdorsal line yellow; between this and the dorsal stripe a stripe the color of the center of the dorsal stripe. Joint 8 a little raised, and all but the center blackish. Subdorsal region with two stripes, the upper like the second dorsal, the lower almost black; the substigmatal line and the one separating the two stripes gray. The head striped with a number of blackish longitudinal lines. Thoracic feet yellow, the others yellow with a black base. The black is a purplish black and not clear. Venter pale yellow, with the usual black spots. Duration of this period three days.

*After third molt.*—Length, .75 inch. As before, the dorsal space is composed of three stripes and each side to the lower part of stigmata 2. The central of the three dorsal stripes somewhat elliptical on each joint, the central part pale dull reddish-yellow, outside of this clear pale yellow. The division between this and the next stripe a more or less distinct black line composed of a series of dots, a similar series of dots marking the division between the reddish yellow and the yellow portions of the dorsal stripe.

The second stripe dull pale yellowish red. Subdorsal line another series of black dots, but more nearly a continuous line. Below this line of dots a pale yellow line, bordered below with another line of dots, a similar pale yellow line, and bordering lines of dots separating the two lateral stripes, the series of dots next the lower stripe more prominent. The center or body of the lateral stripes the same as the dorsal in color. Substigmatal line pale yellow, bordered with black. These black lines are so fine that they make but little of the color of the surface except the lower lateral one. Joint 8 elevated in the region of the posterior dorsal piliferous spots, back part of the elevation on back and sides mostly black, except the pale yellow lines; more black also on posterior part of joint 11. Piliferous spots rather prominent, orange, the hairs black. Head paler than the body, a black stripe on each side, and two on each side of the front. Quite a prominent fleshy fringe along the side. Toward the last of this period the general color changes to a grayish red with a yellow tinge between the joints. Duration of this period three days.

*After fourth molt.*—Length, 1.05 inches. Pale reddish gray, the stripes as before but faint, indicated principally by the rows of dots. Sides of posterior and anterior parts tinged with black. Duration of this period eight days.

*After fifth molt.*—Length, 1.40 inches. Ground color very pale lilac white, the body still having some of the appearance of stripes between the joints, but the general appearance is of a uniform color with rows of black dots. Joint 8 still elevated, and the posterior pair of piliferous spots on joint 11 more prominent than the others, pointing back with an oblique black mark from behind them forward. Middle of joint 8 yellowish, with black mottlings on the sides running back to abdominal legs on joint 9. Head nearly a clear color, a black line down the sides of the cheeks and another fine one back, a little brown in front. Stigmata pale brown, finely ringed with black. A little faint yellowish along the back, head, and legs with faint brownish tinge.

*Mature larva.*—Length, 3 inches; width of head, .17 inch; of joint 8, .35; height of joint 1, .15 inch; of joint 8, .35, tapering gradually each way from joint 8, the place where the measurements taken being a little elevated. More distinctly striped than at the beginning of the period, there being three dorsal and three lateral on each side; the central dorsal pale, the parts on each joint somewhat elliptical, the broad part between the joints, the narrow in the center. The whole body dotted with fine black dots that seem to be as during other periods. The second stripe on dorsum darker, more intensified on joint 8. The darker stripes are made darker by the slightly darker ground color. First lateral stripe pale, the dots gathered in its center in slightly elliptical masses, much as in the dorsal, wider than the next. Stigmatal stripe dark, including the dark-brown stigmata. Below this a pale stripe that reaches to the fringe. Color of all the stripes, gray, slightly flesh-colored in the paler ones. Elevation of joint 8 more distinctly black in the dark stripes, the central fulvous on the elevation without the black dots. Piliferous spots orange, rather inconspicuous except the posterior dorsal pair of joint 11, which are prominent and project backward. Head mottled with pale brownish, otherwise as at beginning of period. Three of the ocelli black. Legs pale. Venter pale, without the black dots, the centers of joints 4 and 8 with purplish-black spots, traces of same on other joints. Duration of this period twenty-five days.

*Chrysalis.*—Length, 1.25 inches; length of wing and tongue cases, .65 inch, these reaching to the posterior part of joint 5. Shape to joint 5 cylindrical, the rest of



the way conical. Depth of thorax, .40 inch; of joints 2 to 4, .33. Head, thorax, and wing cases shagreened, rather coarsely, the head end rounded, eye-cases not very prominent. Abdominal joints punctured, tip ending in six hooks in three sets of two each as to length, the two longer turning outward, the two short at the base turning inward. Color, dark chestnut brown, covered with a glaucous powder. Duration of this period from twenty-eight to thirty-four days.

October 14, 1882, a female Amatrix was brought to me, from which I obtained the next day 261 eggs. These began hatching May 3, 1883, and continued hatching to June 21, making the egg period from 200 to 249 days. Only the few that hatched first were fed, and the greater part of those failed to reach maturity, owing mainly to a form of bacterian disease that has prevailed in most of the species of caterpillars I have attempted to raise this year, and it has not been confined to the breeding cages, but has been as destructive in the fields. Two imagines were raised, one pupating July 8 and hatching August 3. This gives us a minimum period of 277 days from the egg to the imago. Supposing that the difference in hatching of the eggs noticed here is their usual way, this accounts for fresh specimens being found in the woods from August to October, and I think very likely with a sufficient number of eggs other species would show a similar trait. I am of the opinion that all our species are single brooded, this being based on observations of different species in the woods and rearing three different species.

This species was fed most of the time on cottonwood, though they were fed for a few days on Lombardy poplar. In pupating they spun the leaves together, lining the leaves with a very thin cocoon of silk. Both specimens obtained were males, one with the forewings uniform gray, the other with the dark longitudinal shade through the middle of the wings. (French.)

#### 43. *Geometrid* sp.

The caterpillar here described occurred on the aspen August 10, at Brunswick, Me.

*Larva*.—Head narrower than the body, somewhat bilobed, smooth, anal legs large, spread out, forming two lateral rounded flaps, when the larva is at rest, with two very large, long, fleshy, conical supra-anal tubercles. General color pale green, like that of the under side of the leaf. Two parallel subdorsal pale yellow, narrow, but distinct lines; the sutures white, spiracles yellowish; thoracic feet green; lower edge of anal legs and tubercles tinged with yellowish. Length, 18<sup>mm</sup>.

#### 44. *Geometrid* sp.

This larva has a flattened body, like that of *Hibernia*; it was found feeding on the aspen at Brunswick, August 25 to September 1.

*Larva*.—Body broad and flat, rather short; head as broad as the body and somewhat flattened. Body dark, the segments transversely wrinkled; dark brown, color of a dark twig; a dark, blackish, broad, dorsal band, with a pale horn-colored band on each side, composed of dark ones alternating with the paler ones; spiracles black; thoracic and abdominal legs pale, spotted with black dots; body beneath and legs livid; head and prothoracic shield mahogany-brown, spotted with black. Length, 18<sup>mm</sup>.

#### 45. *Botis oscitalis* Grote.

The caterpillar has been found by Mr. Coquillet in Illinois living in a folded leaf or between two leaves folded together with silken threads on the willow and poplar. Several were found late in July and again

about the middle of August; one pupated July 27 and the imago issued about August 8.

*Larva*.—Body green; piliferous spots concolorous; spiracles ringed with pale brown; cervical shield green, edged at the sides and behind with black; that on the sides sometimes wanting; head mottled black and white, anal plate unmarked. Length, 16<sup>mm</sup> (.64-inch). Coquillett (*Papilio*, iii, p. 101).

46. *Pyralid? larva*.

(Larva, Plate IV, figs. 10, 10a.)

This caterpillar lives within a large roomy case, made by loosely folding over and sewing together a part of an aspen leaf.

*Larva*.—Body stout; head peculiar, large, and broad; a black line extending around the side to the labrum; on the vertex a double-curved or looped black line, forming a rude double curve on each side, with spots forming a median double black line; a large greenish cervical shield, edged posteriorly with black; ten abdominal legs; body broad and square at end; body and legs pale green; the piliferous warts minute and indistinct. Length, 15<sup>mm</sup>.

47. *Gelechia rhoifrutella* Clemens.

The larva lives on the poplar in a leaf rolled lengthwise and closed at each end. One pupated June 12 and disclosed the moth June 30 (Coquillett). According to Chambers it also lives on the fruit racemes of the sumac.

*Larva*.—Body green; piliferous spots polished black; cervical shield blackish; anal plate unmarked; head yellowish-brown, shaded with blackish. Length, 16<sup>mm</sup> (.64-inch). (*Papilio*, iii, 99.)

48. *Lithocolletis populiella* Chambers.

I have bred a few species from small tentiform mines on the under side of leaves of the silver-leaf poplar, which, though very distinct from *argentinetella* Clem. and *L. fitchella* Clem., I place in the same group with them. It is perhaps nearer to *L. carpinicolella* than to any of the other species figured in the Nat. Hist. Ins. (Chambers).

*Moth*.—Palpi, head, tuft, antennæ, under surface of thorax, legs, and abdomen pure snowy white; upper surface of abdomen and forewings pale golden; there are three white longitudinal streaks on the thorax (one median, and continuous with a dorso-basal white streak on the wings, the other two passing over the tegulæ and continuous with a median basal white streak on the wings); there is also a costo-basal white streak on the forewings, and these three basal ring streaks are of about equal length, and less than one-fourth of the length of the wings. Immediately behind the dorso-basal streak, and scarcely distinct from it (probably sometimes confluent with it), is the first dorsal streak, which approaches a square form, and is dark-margined before and above. Almost opposite to this dorsal streak, but a little behind it, is the first costal streak; it is oblique, not pointed, and is dark-margined before. The second costal and second dorsal are opposite each other, the costal one being the larger of the two, triangular and dark-margined before. The third costal and third dorsal are nearly opposite, the costal being, perhaps, a little farther back, and being larger than the dorsal, and larger also than the second costal; both are dark-margined before. There are only the three dorsal streaks. The fourth costal is just

before the apex, points a little obliquely forward, and is margined behind by a small apical patch of brown dusting. Cilia white, with a brownish hinder marginal line at their base. *Alar expansion* one-fourth of an inch. Ohio and Kentucky. (Chambers, Bull. U. S. Geol. Surv. iv, I, 101.)

49. *Gracillaria* sp.

A caterpillar, presumably a *Gracillaria*, was observed July 31 at Brunswick, Me., turning over the end of an aspen leaf on one side. The moth was not reared. Fig. 167 represents another aspen leaf with the tip folded over, either by this or an allied species. Observed at Brunswick, Me.



FIG. 167.—Aspen leaf folded by a *Gracillaria*.—Bridg-  
ham del.



FIG. 168.—Aspen leaf folded by *Gracil-  
laria*.—Wilder del.

50. POPLAR LEAF-MINER.

Poplar leaves are frequently mined by a worm which we have been as yet unable to identify. The mine has a dark line in the middle, and is otherwise very characteristic; its form is represented by Fig. 169.

51. *Brachys arosa* Melsheimer.

Having frequently found this beetle on the leaves of the oak, we supposed that it might be a leaf-miner of that tree, but Mr. C. P. Gillette, of the Michigan Agricultural College, states in the *Canadian Entomologist* for July, 1887, that he has reared two fully developed specimens of the larvæ from the leaves of the poplar. They finish their mines in October, and early in the following May the beetles appear. The mine is made next to the upper surface of the leaf.

*Larva*.—Whitish; broadest at the head and gradually tapering to the tail; jaws brown and first segment behind the head with brown rectangular plates above and

below; the anal end with a small black spine extending back, which is used by the larva in pushing itself forward. Body quite flat and the segments deeply notched. Length 9<sup>mm</sup>. (Gillette.)

52. *Chrysomela pallida* Say.

Mr. Coquillet has found the larvæ living in communities on the leaves. Several were observed in Illinois to enter the earth to pupate June 1, the beetles issuing about June 19.

*Larva*.—Body black, elongated, much wrinkled and roughened; the sutures of the segments and the under side of the body sometimes tinged with brown; head and cervical shield polished black. Length 8<sup>mm</sup>. (French.)

*Beetle*.—Pale rufous; elytra pale testaceous, immaculate. Body very pale rufous, head obsoletely punctured; an indented, abbreviated line or spot on the vertex; thorax with small punctures which are sometimes obsolete; elytra pale testaceous, with striæ of punctures which become obsolete before the tip; beneath pale. Length 15<sup>mm</sup>. (Say).



FIG. 169.—Mine in a poplar leaf.—Bridgham del.

53. *Crepidodera helzines* (Linn.).

This beetle is very plentiful in New York, according to Mr. Devreaux, feeding on the foliage of the poplar.

## 54. THE POPLAR-LEAF APHIS.

*Aphis populifolia* Fitch.

Inhabits the underside of the leaves of *Populus grandidentata*. Of a chestnut-brown color, mealy; legs hairy, black, pale brown above the knees; veins of the forewings brown, stigma smoky yellow, margined with black; back with two rows of impressed, squarish fuscous spots; on each side, two rows of impressed dots; honey-tubes equaling a third of the distance to the tip. Length to tips of wings .22 inches. (Thomas, 3 Rt. Ins. Ill.)

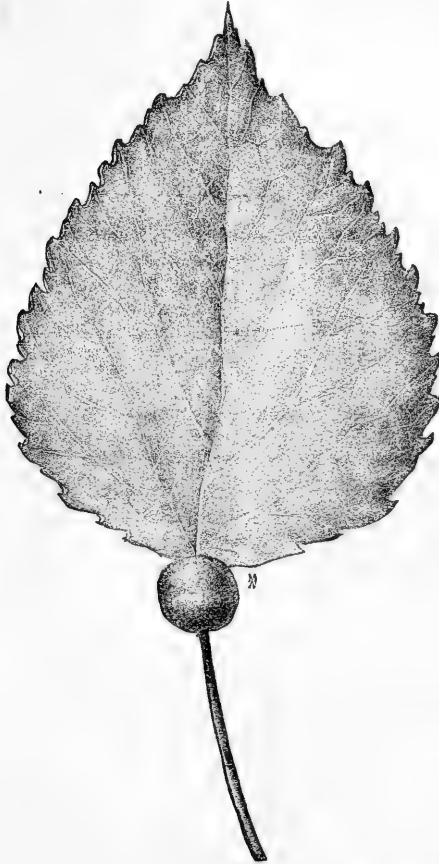


Fig. 170.—The Poplar-stem Gall-Louse. Marx del.

## 55. THE POPLAR-STEM GALL-LOUSE.

*Pemphigus populicaulis* Fitch.

Forming imperfectly globular galls the size of a bullet at the junction of the leaf with its stalk, these galls having a mouth-like orifice on their underside, and a large cavity within, crowded with small dull white lice and their white cast skins, and with winged lice of a blue-black color, their antennæ reaching beyond the base of their wings, the rib-vein of their fore wings black, thick, much thicker at its apex along the inner margin of the stigma, and the short veinlet bounding the anterior end of this spot more slender than the rib-vein; its length 0.10, and to the tips of its wings 0.15. (Fitch.) Observer at Maine and in Rhode Island.

## 56. THE POPLAR GALL-LOUSE.

*Pemphigus popularius* Fitch.

Late in autumn, wandering up and down the trunk of the balsam poplar, a gall-louse closely like the preceding, but its abdomen green, its antennæ short, reaching but two-thirds the distance to the wing sockets, and the rib-vein of its wings not thicker along the inner margin of the stigma; its length 0.13 to the tip of its wings.

The female black, slightly dusted over with a glaucous gray powder; the abdomen dull green with a small coating of white flocculent wool, its opposite sides parallel and its tip abruptly rounded; the antennæ short, thick, and thread-like; the wings dull hyaline, their rib-vein black and the oblique veins slender and blackish with the basal third of the third vein abortive and the fourth vein perceptibly thicker towards its base; and the small branch of the rib-vein bounding the anterior end of the stigma having nearly the same thickness with the rib-vein. (Fitch.)

## 57. THE POPLAR-BULLET GALL-LOUSE.

*Pemphigus populi-globuli* Fitch.

In July, on the leaves of the balsam poplar slightly above their base, an irregular globular apple green gall the size of a bullet, projecting from the upper surface of the leaf, with a curved mouth-like orifice on the under side, the cavity within containing numerous small pale green and smaller dusky lice with the ends of their bodies covered with short white cotton-like threads, and larger winged ones which are of a black color, with the abdomen dusted over with white meal and with thin white woolly fiber on the back, and their antennæ reaching the base of the wings, which are clear hyaline, their veins slender and white or colorless, except the outer marginal vein, which is black to the end of the stigma, and also the rib-vein, which is much thicker at its apex; their length 0.07 and to the tip of their wings 0.11. (Fitch.)

## 58. THE POPLAR-VEIN GALL-LOUSE.

*Pemphigus populi-venæ* Fitch.

In July an oblong compressed excrescence like a cock's comb, of a light red color varied with pale yellow, growing from the midvein of balsam poplar leaves on their upper side with an orifice on the opposite under side; a cavity within containing a multitude of lice and their white cast skins, interspersed with a whitish meal-like powder; those with wings being black, with coarse thread-like antennæ reaching to the base of the wings, which, with their oblique veins, are pellucid and colorless, the coarse rib-vein being blackish and more thick at its tip along the inner margin of the stigma, and the vein of the outer margin being blackish and somewhat coarse from its base to the stigma; its length 0.05 and to the tip of the wings 0.08. (Fitch.)

Other insects occurring on the poplar are the following:

## Order LEPIDOPTERA.

59. *Papilio turnus* Linn. (Miss C. G. Soule, Can. Ent., xviii, p. 129.)
60. *Papilio glaucus* Linn.
61. *Papilio cressphontes* Cramer. On *P. dilatata* (Scudder).
62. *Eugonia j-album* B. and L.
63. *Limenitis archippus* (Cramer) (Lintner, Ent. Contr., ii, p. 166.)
64. *Thanaos persius* Scudd.

65. *Prionoxystus robiniae* Harris. On *Populus candicans*. (Kellicott, Bull. Buffalo Soc. Nat. Sc., iv, p. 30.)
66. *Cossus undosus* Lintner (Contr., iv, p. 130.) At Green River, Wyoming, probably on *P. balsamifera*.
67. *Hepialus argenteomaculatus* Harris. (J. B. Smith in Can. Ent., xx, p. 233.) See Chestnut Insects, p. 346.
68. *Egeria tibiale* Harris. Found in New Hampshire in *P. candicans* Harris. (Amer. Journ. Sc., xxxvi, 1839, p. 305.)
69. *Edemasia concinna* Abb. Sm. (Riley's unpublished notes.)
70. *Telea polyphemus* (Linn.) (W. Brodie, and also Luggler.)
71. *Platysamia cecropia* (Linn.) (W. Brodie, and also Luggler.)
72. *Datana angusii* G. and R., Providence, R. I.
73. *Hyphantria cunea* (Drury.) (*H. textor* Harris.)
74. *Anisota senatoria* A. and S., Providence, October 6, one seen feeding on a poplar leaf.
75. *Amphipyra pyramidoides* Guen. See Oak Insects, p. 171.
76. *Metanema quercivoraria* Guen. See p. 182.
77. *Tephrosia cribrataria* Guenée. Larva on *Populus tremuloides* and *P. fastigiata* (Guenée.)
78. *Apatela oblongata* (Sm. Abb.) Lombardy poplar. (W. Saunders, 3d Rt. Ontario Ent. Soc.) See Willow Insects.

The following Tineidæ occur, according to Chambers, on the poplars, aspens, etc.:

79. *Cemistoma albella* Chamb.
80. *Batrachedra salicipomonella* Clems.
81. *Batrachedra præangusta* Haworth.
82. *Batrachedra striolata* Zeller.
83. *Aspidisca* sp? makes a minute mine in aspen leaves in Oregon. Possibly it is *A. splendoriferella* Clems.
84. *Gracilaria populiella* Chamb. Larva rolls aspen leaves in the Rocky Mountains.
85. *Gracilaria purpuriella* Chamb. Larva mines leaves of silver-leaved poplar. (Can. Ent.)
86. *Lithocolletis populiella* Chamb. Larva in a tentiform mine in under side of leaves of silver poplar.
87. *Phyllocnistis populiella* Chamb. Small serpentine mines in the leaves of Lombardy poplar and aspens from sea-level up to 10,000 feet altitude in the mountains of Colorado. (Chambers in letter.)
88. *Cryptolechia quercicella* Clemens. See p. 182.

#### COLEOPTERA.

89. *Hyperplatys aspersus* (Say). See p. 292.
90. *Saperda vestita* Say. On poplar in July, Providence (G. Hunt, p. 474.)

91. *Dicerca prolongata* Lec. Bores in the aspen (Cockerell, Ent. Month. Mag., London, March, 1888, p. 232; also for the specific characters see Can. Ent., xx, p. 65).  
 92. *Xanthonia villosula* (Mels.). Common on leaves. (Chittenden in letter).

HEMIPTERA.

93. *Chaitophorus candicans* Koch. Balm of Gilead.  
 94. *Chaitophorus populicola* Thos.  
 95. *Pemphigus populiramulorum* Riley.  
 96. *Pemphigus populitransversus* Riley.  
 97. *Pemphigus populimonilis* Riley.  
 98. *Pemphigus pseudobyrsa* (Walsh).  
 99. *Pemphigus vagabundus* (Walsh).

HYMENOPTERA.

100. *Cimbex americana* Leach. (Lugger, Bull. No. 9, Ag. Exp. Stat., Nov. 1889, p. 48).

INSECTS INJURIOUS TO THE BASS-WOOD OR LINDEN TREE.

*Tilia americana* Linn.

AFFECTING THE TRUNK.

1. THE LINDEN BORER.

*Saperda vestita* Say.

Order COLEOPTERA; family CERAMBYCIDÆ.

Boring in the trunk, undermining the bark for 6 or 8 inches in sinuous galleries, or penetrating the solid wood an equal distance, rather slender grubs, with three pairs of thoracic feet, transforming into a greenish snuff-yellow longicorn beetle, with six black spots near the middle of the back.

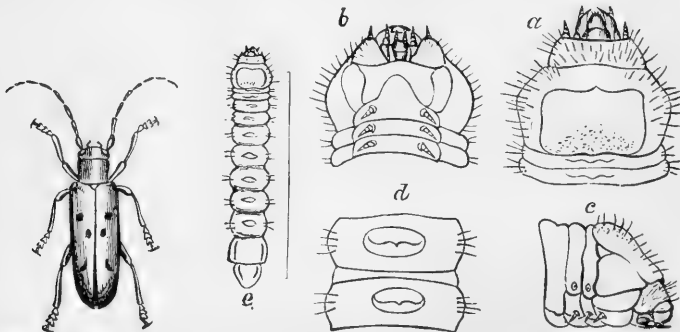


FIG. 171.—The Linden borer, beetle of nat. size. *a*, upper, *b*, under, side of head and three thoracic segments; *c*, side view of head of grub; *d*, top view of two segments, showing the oval spots; *e*, the grub, slightly enlarged.—From Packard.

The beetles, according to Dr. Paul Swift, as quoted by Dr. Harris, were found in Philadelphia upon the small branches and leaves May 28, and it is said that they come out as early as the first of the month,



and continue to make their way through the bark of the trunk and large branches during the whole of the summer. They immediately fly into the top of the tree, and there feed upon the epidermis of the tender twigs and the petioles of the leaves, often wholly denuding the latter, and causing the leaves to fall.

They deposit their eggs, two or three in a place, upon the trunk or branches, especially about the forks, making slight incisions or punctures for their reception with their strong jaws. As many as ninety eggs have been taken from a single beetle.

2. *Pogonocherus nubilus* Lec.

According to Le Conte this longicorn lives in the bass-wood.

AFFECTING THE LEAVES.

3. THE LIME INCH-WORM.

*Hibernia tiliaria* Harris.

Order LEPIDOPTERA ; family PHALENIDÆ.

In May and June, defoliating the branches, a bright yellow looper or measuring worm with a rust-colored head, and ten crinkled black lines along the back, descend-



FIG. 172.—The lime inch-worm, the wingless female, and the male.—From Comstock.

ing at the end of June to the ground and pupating three or four inches under the surface of the soil ; appearing as moths with their buff-brown wings in October and November.

While this worm is often found on apple and elm trees, the lime or linden is its proper food-tree. The females are wingless and grub-like, much larger than the female canker-worm moth, white, marked with two dorsal rows of black patches; they lay their eggs in little clusters in crevices in the trunk or in the branches, and in the spring when the leaves begin to unfold they hatch. Their habits are similar to those of the canker-worm, and the best means of protection against them are those employed against the canker-worm, *i. e.*, the use of tarred paper daubed over with printer's ink or troughs of oil around the trunk of trees to prevent the females from ascending the trees to lay their eggs.

*The male.*—Pale ochreous, with light brown specks and bands. Head, body, front or costal edge of the forewings and transverse band on the wings concolorous, being pale brown. Forewings with a faint, curved, sinuate, diffuse inner line; outer line dark brown, slightly sinuate, with a large obtuse angle in the middle of the wing; it is shaded externally with a broad pale-brown band, which breaks up into flecks on the outer edge; a well-marked discal dot. Hind wings without any markings, somewhat paler than the fore pair. Expanse of wings 2 inches.

#### 4. *Eugonia alniaria* (Linn.).

The caterpillar is called the stick worm from its habit of holding itself out erect like a piece of a twig, to which it bears a close resemblance. It was observed on the linden by Dr. Harris in August and September. When about to pupate it spins an oblong oval, tough but thin, paper-like cocoon, open or loose at each end. The chrysalis is large, covered with bloom. The moth appeared in confinement September 25 to 27. (See Chestnut Insects, p. 344)

#### 5. *Datana ministra* (Drury).

August 26 I found fourteen full-grown larvæ on the bass-wood or native linden, not differing from a colony of seventy-seven larvæ found on the apple August 22 at Salem, Mass., and described below. The young as well as full-grown cluster thickly together, often raising the head and tail in a ludicrous manner.

Mrs. Anna K. Dimmock gives a summary of its history (*Psyche* iv, 279) as follows:

*Datana ministra* Drury (Illust. Nat. Hist. 1773, v. 2, p. 25, pl. 14, fig. 3). Harris Rept. Ins. Injur. Veg., 1841, p. 311-312) describes the larva and imago, and this description is repeated, with the addition of a wood-cut of the larva and a colored figure of the imago, in his Treatise on Ins. Injur. Veg., in 1862; he gives (*Entom. Corresp.*, 1869, p. 308-310, pl. 2, fig. 4) a description with colored figure of the larva. Grote and Robinson (*Proc. Entom. Soc. Phil.*, 1866, v. 6, p. 11-12) describes the imago and the larva with especial reference to distinguishing it from the larvæ of other species of *Datana*. Harris (*l. c.*) gave as food-plants of the larvæ apple and cherry; Riley (*Amer. Entom.*, July-August, 1870, v. 2, p. 263) adds *Juglans nigra*; and Southwick and Beutenmüller (*Science Record*, 15 April, 1884, v. 2, p. 133) in a list of the food-plants of larvæ of species of *Datana*, add, for *D. ministra*, *Quercus*, *Corylus*, *Carya*, *Crataegus*, *Rubinia*, *Betula*, *Tilia*, *Castanea*, and *Fagus*. The eggs of this species, which are often found in groups beneath the leaves of *Betula alba*, are, at least in eastern Massachusetts, very often nearly all destroyed by a minute hymenopterous parasite.

*Larva .70 inch in length, on bass-wood.*—Body much less hairy than the full-grown larva; head black, of the usual size; prothoracic segment swollen, reddish amber, with a transverse black thickened spot giving rise to a few long unequal whitish hairs. End of body with two large black spines directed straight out. Body yellowish, with pale Japan varnish-brown stripes, the dorso-median one twice as wide as the others. Described from forty specimens.

*The same larva after molting, .75 inch long.*—Body black, as in the full-fed larva. Anal spines much stouter, less acute than before; the body is more hairy, and in general much as in the full-fed larva. By August 28 all had molted and begun to feed.

*Full-fed larva on apple.*—Body thick, of very uniform width, smooth, cylindrical, with long white hairs, those on the prothoracic segment and eighth and ninth abdominal segments the longest, being twice as long as the body is thick. The segments are thickened a little behind. Head large, considerably broader than the body, and shining black. Prothoracic shield yellow, with a short black stripe on the lower edge of each side. Body smooth, black, with four greenish-yellow stripes on each side, the stripes being about one-third as wide as the black interspace. Beneath, is a lateral greenish-yellow somewhat interrupted, stripe, and a median fine uninterrupted greenish filiform line. Abdominal legs and base of thoracic legs livid yellow; thoracic legs black. A black blotch on the sides of the abdominal legs. Length 1.40 inches. Described from seventy-seven specimens.\*

#### 6. *Pantographa limata* Grote.

In September the caterpillar of this Pyralid rolls the leaves of the bass-wood in a peculiar manner, as observed by Professor Fernald in Maine and by Miss Murtfeldt in Minnesota. As stated by Professor Fernald, they pupate about the middle of October, the moth in confinement emerging during the first week in November, but probably in nature hibernating as a pupa under the leaves, and appearing as a moth the succeeding spring.

The larva cuts the leaf across from near the middle of the side, past the midrib nearly an inch, in the larger leaves. This cut, which is about an eighth of an inch wide, first starts directly across the leaf, then curves gradually towards the apex, then back to the former direction, so that the entire cut is nearly in the form of the letter **S**, somewhat straightened out. The part beyond the cut is rolled over so as to form a cone with the apex toward the base of the leaf, and when inclosing a larva both ends are turned in, so as to close the openings. In drawing the parts of the leaf together the larva spins the thread from side to side—from the side of the cone to the surface of the leaf beyond, about forty times in a place before moving to another. The second set of threads, which is from a fourth to a half an inch from the last, frequently draws the parts of the leaf together so much that the thread of other bundles hang in a loop. The larva deposits its excrement within the

\* *Datana* sp.—This species occurred on the linden at Brunswick, Me., August 26. Its larva is yellowish, the prothoracic segment being entirely yellowish, and the base of all the thoracic and abdominal feet with a large conspicuous yellow area; four large yellow patches between the four anterior pairs of abdominal and the anal legs. The eight yellow stripes are rather wider than in *D. angusii*.

cone, toward the larger end. When about to pupate, the caterpillar draws a portion of a leaf around it, lining it with silk, thus forming a delicate cocoon.

*Larva*.—Body spindle-shaped, and somewhat stout in proportion to the length. Pea green, about the color of the under side of the leaves of the bass-wood. The usual warts are present, of a dull brownish color and emitting pale hairs. The head, thoracic shield, and legs are pitchy black, while the mouth-parts are a little lighter, and there is a small black spot on each side of the first segment back of the head, just in front of the spiracle. The anal plate is dull brownish. Length, 25<sup>mm</sup> when at rest, and 30<sup>mm</sup> when in motion. (Fernald, Can. Ent., xvi, p. 25.)

#### 7. *Lithocolletis lucetiella*\* Clem.

The larva mines the under side of the leaf of *Tilia americana* (bass-wood) in July, September, and October. The mine is most frequently nearly square in form, and when completed both cuticles of the leaf are left nearly transparent, and the leaf is not folded. The "frass" is cast on the edges of the mine. It weaves an oval cocoon, thin enough, however, to permit the pupa to be seen through the cuticle. The imago appears in August and May.

*Larva*.—The larva is cylindrical. The head pale brown; the body pale greenish white with a series of dorsal brown spots from the third ring posteriorly.

*Moth*.—Antennæ silvery. Head, tuft, and thorax silvery. Anterior wings silvery from the base to the middle, and thence to the tip golden, with a golden costal streak from the base not extended to the middle. About the middle of the wing is a silvery band, broadly margined internally with golden, and with a *minute black point* on the costa internally; a costal silvery spot, margined internally by a *black spot*, nearly opposite to which is a large dorsal silvery streak margined internally by an *oblique black line*; near the tip is a costal, silvery, unmarginated streak curving to the tip; cilia golden at the tip, and on inner margin silvery. No apical spot nor hinder marginal line. Hind wings silver-gray, cilia the same. Abdomen blackish, tipped with silvery gray. (Clemens.)

#### 8. *Coleophora tiliaefoliella* Clem.

The larva feeds on the leaves of the linden from the beginning to the latter part of May, and enters on pupation in the latter days of May or early in June.

The case is black, somewhat pistol-formed; straight along the upper edge, turned abruptly down so as to form a handle-like appendage behind, with a toothed, flattened projection about the middle of the under edge, whence to the mouth of the case it is cylindrical.

At this date the larva does not mine the leaf, but eats holes in it, devouring its substance. The case is fixed to the under surface of the leaf, and is easily seen, even on the leaves of the higher branches.

*Larva*.—The body of the larva is dull, dark-brown and the dorsal plates and head black. (Clemens.)

---

\*I received five specimens of this from Dr. Clemens; it is very distinct from any European species. The exp. al. (omitted by Dr. Clemens) is 3½ lin.—H. T. Stainton.

## 9. THE LINDEN LEAF-BEETLE.

*Chrysomela scalaris* Leconte.

Order COLEOPTERA; family CHRYSOMELIDÆ.

Injuring the leaves, a stout-bodied beetle with silvery wing-covers spotted with green, laying its eggs on the leaves in the spring, from which fat, thick-bodied white grubs develop, with a lateral row of large black dots, and which also prey on the leaves.

While this beautiful and abundant beetle is more common on the alder, it also occurs on the lime-tree and elm. They may be found on these trees in April, May, and June, and a second brood in September and October. We have taken them *in coitu* on the alder in Maine the middle of May. The grubs are hatched from eggs laid by the beetles on the leaves in spring and come to their growth towards the end of June in Massachusetts, according to Harris, who believes that they go into the ground to turn to pupæ.

Since the foregoing account was prepared, we have observed this beetle in all its stages. At Brunswick, Me., during July and August, 1881, it was very abundant on the numerous linden trees in the campus of Bowdoin College, eating rounded holes in the leaves and causing them to turn yellow and unsightly, as if to prematurely fall. Nearly every tree and, in some cases, nearly every leaf on a tree was infested by the disgusting pale grubs, while scattered patches of eggs occurred on the under side of the leaves; and during the first to last of August the beetles were found not uncommonly upon the leaves. The trees could be protected by showering the leaves with London purple in water when the grubs first appear late in June. From these specimens the following descriptions were drawn up:

*Egg*.—Rather large, oval cylindrical, yellow, several together attached by one end; about 1.5<sup>mm</sup> in length.

*Larva*.—Body very thick, curved up like that of the grub of the Colorado potato-beetle, being much swollen behind the thoracic segments, while the tip of the abdomen is curved down. Head honey-yellow, darker over the jaws; antennæ bluish, except at base; eyes black. Prothoracic shield blackish in the young before the last molt; in full-grown individuals not all black, but pale, with four irregularly square black spots. Body behind dirty white with a row of dorsal and lateral dusky spots. Legs pale, spotted with black at the joints. A pair of meso-thoracic spiracles, and eight pairs of smaller abdominal ones. Low down, on the sides of the second and third thoracic segments a curvilinear black spot. Length, 8 to 9<sup>mm</sup>.

*Pupa*.—Body pure white; prothoracic shield with long scattered hairs around the edge and in two groups on the back; antennæ curving around between the eyes and jaws, and with the ends resting on the tips of the elytra. The insect undoubtedly descends into the earth to pupate.

*The beetle*.—Head, prothorax, and under side of body dark coppery green, with scattered pits. Antennæ, palpi, and legs pale pitchy yellow; elytra coppery green and whitish, the green forming a broad median stripe, sending prolongations outwards toward the middle of the elytra, the first pair of branches nearly parallel to the band,



FIG. 173.—*Chrysomela scalaris*.—Smith del.

the second becoming more and more at right angles to the band, the last short and broad near the tip of the body. Eleven rounded dark-green spots in the whitish field; the pair near the shoulders gourd-shaped; two of the spots behind the middle of the elytra touching each other. The pits or punctures near the sutures of the elytra arranged in three lines parallel to the median line of union of the body; elsewhere they are arranged irregularly.

## 10. THE LEAF-MINING HISPA.

*Odontota rubra* Weber.

Mr. W. L. Devereaux writes us from Clyde, N. Y., that this beetle "is a very conspicuous pest here, destroying the entire foliage of every bass-wood in many forests, excepting trees of great height."

## 11. THE LINDEN GALL-MITE.

*Phytoptus abnormis* Garman.

Produces galls on the leaves of the American linden or bass-wood, *Tilia americana* Linn.

The transverse striæ of the abdomen number about 56. This mite differs from all the other Phytopti I have seen in that the abdomen, just before the terminal sucker, is noticeably enlarged. But few specimens have been examined, as they have been very rare. In many of the galls, comparatively large, elongate eggs occur, which probably belong to some larger mite which preys on the gall-mites.

The gall is top-shaped, expanding above and contracting towards the upper surface of the leaves into a neck. It measures .155 inch in height, and .100 inch in diameter. The walls are deeply infolded, sometimes giving rise to unequal lobes. The outer surface is smooth, green and devoid of hairs. The cavity of the gall is made unsymmetrical by the deeper impressions of the wall. The inside of the latter is slightly roughened by small folds, and is clothed with long aciculate, unicellular hairs. These galls occur sparingly on the leaves of large trees in open woods at Bloomington, Ill. (H. Garman in Forbes's 1st Illinois Rt.)

The following insects also occur on the linden:

## Order HYMENOPTERA.

12. *Selandria tilia* Norton (Trans. Amer. Ent. Soc., i, 250).

## Order LEPIDOPTERA.

13. *Limenitis arthemis* (Drury). (Scudder).  
 14. *Grapta interrogationis* (Fabricius).  
 15. *Grapta comma* Harris. "On Linden, October 17." (Riley's MS. notes.)  
 16. *Papilio glaucus* Linn. (Scudder).  
 17. *Papilio turnus* Linn. (Ent. Soc. Ontario).  
 18. *Ceratonia amyntor* Hübn. (Lintner i, 188).

19. *Sciapteron robinia* H. Edwards. Destructive to *Populus alba* in Nevada (Edwards, Bull. Buffalo Ent. Soc., iii, p. 72).
20. *Smerinthus excrucatus* A. and S. (Fischer, Can. Ent., xvi, p. 17).
21. *Halesidota caryæ* Harris. (Beutenmüller).
22. *Halesidota tessellaris* A. and S. (Walsh).
23. *Lochmæus manteo* Doublt.
24. *Phobetrum hyalinum* Walsh.
25. *Parasa fraterna* Grote. (August 27, Miss E. A. Morton, in letter.)
26. *Datana ministra* (Drury). (Beutenmüller).
27. *Clisiocampa distria* Hübn. See p. 119.
28. *Eacles imperialis* (Beutenmüller). On the bass-wood, European linden, and white linden.
29. *Platysamia cecropia* L. (W. Brodie).
30. *Telea polyphemus* Linn. (Riley's MS. notes.)
31. *Apatela hastulifera* (Sm. Abb.), Lintner (Contr., iii, p. 158).
32. *Apatela americana* Harris.
33. *Eugonia subsignaria* (Hübner).
34. *Lithocolletis lucetiella* Clems. Larvæ in tentiform mine on under surface of leaves. (Chambers.)
35. *Lithocolletis tiliavella* (Chamb.). Larvæ in tentiform mine on upper surface of leaves. (Chambers.)
36. *Coleophora tiliæfoliella* Clems. Larva only known. It lives in a case and feeds on the under side of leaves. (Chambers.)

#### Order COLEOPTERA.

37. *Hispa quadrata* Fabr. Mines the leaves. (Chambers.)
38. *Prionus brevicornis* Fabr. In logs of bass-wood (Smith, Rep. Ent. Conn., 1872, p. 346).
39. *Parandra brunnea* Fabricius (in stumps, Schaupp, in letter).
40. *Chrysobothris femorata* Fabr. (Riley's 7th Rep., p. 72.)
41. *Cystophorus verrucosus* (Olivier). Taken from bass-wood, October 29, South Woodstock, Conn. (Chittenden in letter).
42. *Stenoscelis brevis* (Boh.). Taken with the preceding species. (Chittenden.) In decaying wood (Townsend, Can. Ent., xviii, p. 68).
43. *Cucujus clavipes* (Fab.). Under bark (Townsend, l. c., p. 66).
44. *Brontes dubius* (Fab.). Under bark (Townsend, l. c., p. 66).
45. *Alaus oculatus* (Linn.). In dead wood (Townsend, l. c., p. 66).
46. *Elater manipularis* (Cand.). Under bark (Townsend, l. c., p. 66).
47. *Scotobates calcaratus* (Fab.). In dead wood (Townsend l. c., p. 67).
48. *Hoplocephala bicornis* (Oliv.). Under bark and in dead wood (Townsend, l. c., 67).
49. *Tetratoma truncorum* (Lec.). Same as preceding (Townsend, l. c., p. 67).
50. *Orchesia castanea* (Melsh.). Under bark (Townsend, l. c., p. 67).

51. *Eupsalis minuta* (Drury). In dead wood (Townsend, l. c., p. 68).  
52. *Cratoparis lunatus* (Fab.). In decaying wood (Townsend, l. c., p. 68).

Order DIPTERA.

53. The Linden dipterous gall-fly, *Cecidomyia (tiliæ) verrucicola* Osten Sacken. Massachusetts and New York (Osten Sacken).  
54. *Cecidomyia citrina* O. Sacken.  
55. *Sciara tiliicola* Osten Sacken. See p. 411.

Order HEMIPTERA.

56. *Lachnus longistigma* Monell. St. Louis, Mo. Washington, D. C. (Townsend, Insect Life, ii, p. 90).  
57. *Drepanosiphum tiliæ* Koch? (Monell-Thomas).  
58. *Pulvinaria innumerabilis* Rathvon. See p. 412.  
59. *Aspidiotus ancylus* Putnam.  
60. *Tingis tiliæ* Walsh (Proc. Ent. Soc. Phil., 1864, 408).



## CHAPTER VII.

### INSECTS INJURIOUS TO THE BIRCH.

*Betula nigra*, *B. populifolia* and *B. alba*.

A considerable degree of interest attaches to the birch insects, not only because the birch is a beautiful shade tree, but because many of the species injurious to the different species of *Betula* also occur on other shade trees, as the oak, while many of them have established themselves in orchards and gardens. In our Bulletin on Forest Insects we enumerated only 19 species of birch insects; these we increased to 50; afterwards Mrs. Dimmock, in her invaluable article on the insects of *Betula* in North America, published in *Psyche*, enumerated 107 determined species, besides several undetermined.\* Mrs. Dimmock has kindly allowed me to reproduce the article, which I have done, under the head of the different species. I have also added a number, mostly undetermined larvæ, so that now the chapter contains references to or descriptions of 105 species. Kaltenbach enumerates 270 European birch-feeding insects, and judging from the number occurring on other kinds of trees the number in this country will probably ultimately be found not to be less than that of the birch insects of the Old World.

#### INJURING THE TRUNK.

##### 1. THE SLENDER XIPHIDRIA.

*Xiphidria attenuatus* Norton.

Order HYMENOPTERA; family UROCERIDÆ.

This "horn-tail" borer is rarely met with. The generic name was given to it from the appearance of the sword-like ovipositor, which, however, is much shorter than in *Tremex*, a member of the same family. The body of the imago or fly is a little flattened, somewhat turned up behind, and the tip of the abdomen ends in an obtuse point, while the antennæ are short, curved, and tapering at the end.

The present species was taken by Mr. W. H. Patton, on June 6, at Waterbury, Conn., from a dead stick of the black birch. "My atten-

---

\*As some of the species enumerated in her list feed only on decaying wood and under the bark I have not numbered them as true birch-feeding insects, but referred to them in foot-notes.

tion," he says, "was drawn to the spot by finding a *Rhyssa humida* (Say) with its ovipositor firmly driven into the wood. Upon cutting into the stick, this specimen, together with a pupa of the male and several horn-tailed larvæ, were found. The antennæ of the pupa are bent down upon the sides of the face and up along the back of the head. One of the larvæ changed to pupa (female, length 0.32 inch) on the 21st of July. The male agrees well with Norton's description as given in Trans. Am. Ent. Soc. (ii, p. 354), and is very unlike the female." (Can. Ent., xi, p. 14, 1879.)

*Male*.—"Pale honey yellow, antennæ 16 jointed, blackish, two or three basal articles yellowish; a spot inclosing ocelli, tip of mandibles, sides of neck, of meso, and metathorax blackish; tergum irregularly dark; pectus brown piceous; body beneath and legs whitish; wings hyaline, nervures and stigma pale; under wings with two middle cells. Pennsylvania." (Norton.)

*Female*.—"Head and thorax black; tibiæ and tarsi pale; wings hyaline; abdomen red, with six yellow spots. Length 0.40 inch, expanse of wings 0.64 inch.

"Antennæ 16-jointed, black, piceous beneath, especially toward tip. Face below and between antennæ, palpi, and base of mandibles, fulvous. Eyes, except for a short space above, bordered with yellow, the border covering nearly the whole cheek and the anterior and posterior borders, extending backward to meet on the edge of the occiput, thereby inclosing a spot above the eyes, which is black in the center but shading through piceous into the yellow borders. Space about the ocelli finely rugose, with delicate ridges radiating from each ocellus; vertex behind the ocelli polished. A pit or deep puncture midway between the lower ocellus and the insertion of the antennæ. Thorax closely and finely rugulose; scutellum and inclosure on the basal plates polished. Tegulæ, minute spots before the tegulæ, one each side above the anterior wing, and the cenchri, yellow. Trochanters, tips of coxæ and of femora dull yellow; femora piceous, posterior pair black; basal half of tibiæ and basal joints of tarsi, except at tip, yellow; the remainder of tibiæ and tarsi fulvous, becoming brownish on the posterior tibiæ. Wings hyaline, iridescent, nervures and stigma pale piceous. Basal half of the first segment of the abdomen black and roughened with fine confluent punctures; the remainder of this segment and portions of the terminal segment are darker than the other segments of the red polished abdomen. A yellow spot on each side of segments 3, 4, and 7, those on the seventh segment being the largest. Sheath of the ovipositor black; abdomen beneath, except at base of ovipositor, red." (Patton.)

## 2. *Tremex columba* Linn.

Order HYMENOPTERA; family UROCIDÆ.

Mrs. Dimmock gives the following summary of its history (*Psyche*, iv, p. 285):

*Tremex columba* Linn. (*Syst. Nat.*, 1758, ed. 10, p. 929). Harris (*Rept. Ins. Injur. Veg.*, 1841, p. 389-391) describes the egg, larva, and imago of this insect, giving wood of pear, *Ulmus*, and *Platanus* as food of the larva; and (*Entom. Corresp.*, 1869, p. 360) again describes the egg and imago. In *Amer. Entom.*, Nov., 1868, v. i, p. 59, this species is mentioned as injuring oak and pear trees. Packard (*Guide Study Ins.*, 1869, p. 228) quotes Harris's accounts of the habits of this species. Huggins (*Amer. Entom.*, Feb. 1870, v. 2, p. 128) found this insect ovipositing in an apple tree. Packard (*Bull. U. S. Entom. Comm.*, 1881, p. 105, 106) figures the larva, which he states to attack *Ulmus*, *Quercus*, *Acer*, and *Platanus*; and (*op. cit.*, p. 129) says, "In yellow birch at Providence," R. I. Harrington (*Can. Entom.*, Dec., 1882, v. 14, p. 225) gives some notes upon this species and adds *Fagus* to the food-plants.

3. *Cræsus latitarsus* Norton.

Order HYMENOPTERA; family TENTHREDINIDÆ.

The following note is from Mrs. Dimmock's article on birch insects Psyche, p. 286):

*Cræsus latitarsus* Norton (Proc. Entom. Soc. Phil., 1862, i, p. 199). Norton (*l. c.*) describes the male of this species, and later (Trans. Amer. Entom. Soc., 1867, v. i, p. 84) describes the female, and adds, "Bred by Mr. Walsh from larvæ feeding on birch."

## 4. Clytus? larva.

*Xylotrechus colonus* (Fabr.)?.

Plate XII, Fig. 3, represents the mouth-parts of a Clytus nearly allied to if not identical with *Xylotrechus colonus*.

5. *Cossus* sp.

The following note is from Mrs. Anna K. Dimmock (Psyche, iv. p. 274):

Lintner (Entom. Contrib., iv, 1878, p. 244-245) states that the larvæ of a *Cossus*, the pupal cases of which prove to be those of some as yet undescribed species, bore in the wood of *Betula populifolia*.

6. *Chrysobothris 6-signata* Say.

The beetle and pupa of this Buprestid borer were found in the yellow birch June 1, at Providence.

The notes on the three following species are copied from Mrs. Dimmock's Insects of the Birch: \*

7. *Tylonotus bimaculatus* Hald.

*Tylonotus bimaculatus* Hald. (Trans. Amer. Philos. Soc., 1847, v. 10, p. 38) is said by Packard (Bull. 7, U. S. Entom. Comm., 1881, p. 129) on authority of G. Hunt, to be found "under bark of white or paper birch, northern New York."

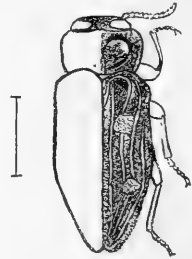


FIG. 174.—*Chrysobothris 6-signata*. Smith del.

\* The following species do no injury to the tree, only living in or under the bark, or in the wood of dead and decaying trees:

*Nyctobates pensylvanica* De Geer (Mém., 1775, v. 5, p. 52; pl. 13, fig. 10). Schaupp (Bull. Brooklyn Entom. Soc., July 1881, v. 4, p. 23) writes of this species, "Pupæ in beech July 15; in hemlock July 18; in birch July 21."

*Campylus denticornis* Kirby (Fauna Boramer., 1837, pt. 4, p. 145). G. Dimmock has reared this species from larvæ found in partly decayed bark of *Betula papyracea* on Mount Washington, New Hampshire. The imagoes emerge from the pupæ about July 1, and are abundant during July in the White Mountains.

*Trogosita corticalis* Melsh. (Proc. Acad. Nat. Sci. Phil., Oct. 1884, v. 2, p. 109), Schaupp (Bull. Brooklyn Entom. Soc., July 1881, v. 4, p. 23) writes of this species, "Larvæ in birch July 8, in beech August 14, in sugar maple July 19."

*Ceruchus piceus* Weber (Observ. Entom., 1801, p. 84). The pupæ are mentioned by Fuchs (Bull. Brooklyn Entom. Soc., Dec. 1882, v. 5, p. 59) as being very common in an old beech stump, and are briefly described. The larvæ are mentioned by G. Dimmock (Direct. Collect. Coleopt., 1872, p. 20) as living "in decayed chestnut and willow." The larvæ are very abundant in decayed and fallen wood of *Betula alba* during autumn. Quite a large number of larvæ taken in Milton, Massachusetts, November 10, 1883, fed through the winter and produced a single beetle. From these

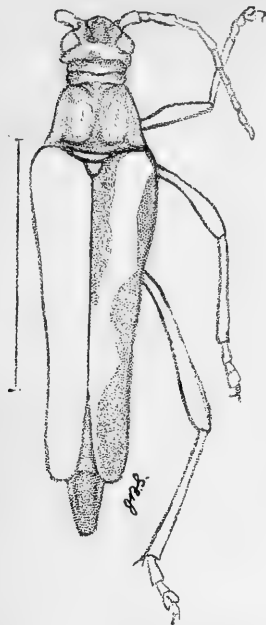


FIG. 175.—*Bellamira scalaris*.  
Smith del.

I have frequently noticed this caterpillar on the leaves of the white and poplar-leaved birch late in September and early in October in Providence. The butterfly appears early in June in New England as soon as the lilac blossoms. The eggs are laid soon after the butterfly appears; the larva passing through five stages of growth.

Mrs. Anna K. Dimmock gives a summary of its history (*Psyche*, iv, p. 283) as follows:

*Papilio turnus* Linn. (*Mantissa*, 1767, v. 1, p. 536). Harris (*Treatise on Ins. Injur. Veg.*, 1862, p. 268, 269) describes and figures the larva and imago of this species, which larvæ were reared seven tachinid flies (allied to *Morinia*), which emerged from June 4 to July 6, 1834. The digestive tract of the larvæ of *C. piceus* is often inhabited by a microscopic undescribed nematode worm.

*Dendroides concolor* Newm. (*Entom. Mag.*, 1838, v. 5, p. 375). G. Dimmock has a specimen in his collection, which he reared from the bark of *Betula papyracea* at the White Mountains, New Hampshire, the beetle emerging July 8, 1874.

*Dendroides canadensis* Latreille (*Consid. Génér.*, 1810, p. 212). Schaupp (*Bull. Brooklyn Entom. Soc.*, July 1881, v. 4, p. 23) writes of this species, "Pupæ in birch July 19, in beech July 23." G. Dimmock found a pupa of this species, June 30, 1874, under decayed bark of *Betula papyracea*, on Mount Washington, New Hampshire; the beetle emerged from this pupa July 8, 1874.

*Mercanthera contracta* Beauv. (*Ins. Afr. et Amer.*, 1805, p. 121, pl. 30, fig. 2). Halde-man (*Proc. Amer. Assoc. Advanc. Sci.*, 1850, v. 2, p. 347) briefly notices the larva of this species. Specimens in the collection of G. Dimmock were taken at Suffield, Conn., by Leroy H. Sykes, in decaying bark of *Betula lutea*.

*Centronopus calcaratus* Fabr. (*Entom. Syst.*, Suppl., 1794, p. 52). Coquillett (*Can. Entom.*, June, 1883, v. 15, p. 102) describes this larva very briefly. This larva is often very abundant in decaying birch wood.—(Mrs. Anna K. Dimmock, *Psyche*, iv, pp. 283-284).

*Mallota posticata* Fabr. The larva has been found by Mr. Lintner in decaying birch wood. (1st Ann. Rep, State Ent. N. Y. 1882, 211-216.)

*Stenoscelis brevis* Boh. occurs in wood (Chittenden).

#### 8. *Gracilia minuta* Fabr.

*Gracilia minuta* Fabr. (*Spec. Ins.*, 1781, v. 1, p. 235). Luger (*Psyche*, Aug.-Sept. 1884, v. 4, p. 204) mentions breeding this species from a band of wood (*Betula lenta*) around a gin-barrel.

#### 9. *Bellamira scalaris* (Say).

*Bellamira scalaris* Say (*Journ. Acad. Nat. Sci.*, 1827, v. 5, p. 278-279). Packard (*Bull. 7, U. S. Entom. Comm.*, 1881, p. 129) writes on authority of G. Hunt, "Beetle and pupa found under the bark of the yellow birch in July, northern New York."

#### 10. *Leptura vagans* Olivier.

This longicorn beetle has been bred by Mr. Chittenden, as he writes me, from larvæ found in the yellow birch.

### AFFECTING THE LEAVES.

#### 11. THE TURNUS SWALLOW-TAIL.

##### *Papilio turnus* Linn.

I have frequently noticed this caterpillar on the leaves of the white and poplar-leaved birch late in September and early in October in Providence.

The butterfly appears early in June in New England as soon as the lilac blossoms. The eggs are laid soon after the butterfly appears; the larva passing through five stages of growth.

Mrs. Anna K. Dimmock gives a summary of its history (*Psyche*, iv, p. 283) as follows:

*Papilio turnus* Linn. (*Mantissa*, 1767, v. 1, p. 536). Harris (*Treatise on Ins. Injur. Veg.*, 1862, p. 268, 269) describes and figures the larva and imago of this species, which larvæ were reared seven tachinid flies (allied to *Morinia*), which emerged from June 4 to July 6, 1834. The digestive tract of the larvæ of *C. piceus* is often inhabited by a microscopic undescribed nematode worm.

*Dendroides concolor* Newm. (*Entom. Mag.*, 1838, v. 5, p. 375). G. Dimmock has a specimen in his collection, which he reared from the bark of *Betula papyracea* at the White Mountains, New Hampshire, the beetle emerging July 8, 1874.

*Dendroides canadensis* Latreille (*Consid. Génér.*, 1810, p. 212). Schaupp (*Bull. Brooklyn Entom. Soc.*, July 1881, v. 4, p. 23) writes of this species, "Pupæ in birch July 19, in beech July 23." G. Dimmock found a pupa of this species, June 30, 1874, under decayed bark of *Betula papyracea*, on Mount Washington, New Hampshire; the beetle emerged from this pupa July 8, 1874.

*Mercanthera contracta* Beauv. (*Ins. Afr. et Amer.*, 1805, p. 121, pl. 30, fig. 2). Halde-man (*Proc. Amer. Assoc. Advanc. Sci.*, 1850, v. 2, p. 347) briefly notices the larva of this species. Specimens in the collection of G. Dimmock were taken at Suffield, Conn., by Leroy H. Sykes, in decaying bark of *Betula lutea*.

*Centronopus calcaratus* Fabr. (*Entom. Syst.*, Suppl., 1794, p. 52). Coquillett (*Can. Entom.*, June, 1883, v. 15, p. 102) describes this larva very briefly. This larva is often very abundant in decaying birch wood.—(Mrs. Anna K. Dimmock, *Psyche*, iv, pp. 283-284).

*Mallota posticata* Fabr. The larva has been found by Mr. Lintner in decaying birch wood. (1st Ann. Rep, State Ent. N. Y. 1882, 211-216.)

*Stenoscelis brevis* Boh. occurs in wood (Chittenden).

is stated to feed on wild cherry. Morris (Synop. Lepid. N. A., 1862, p. 2) describes larva and imago, giving for food-plant "various species of *Prunus*." Saunders (Can. Entom., Feb., 1869, v. 1, p. 53, 54) describes egg and young larva, and later (*op. cit.*, Apr., 1869, v. i, p. 74) describes adult larva. Scudder (Amer. Nat., Aug., 1869, v. 3, p. 330) gives as food-plants: apple, *Crataegus*, *Prunus virginiana*, cultivated cherry, *Alnus*, *Liriodendron tulipifera*, *Fraxinus sambucifolia*, *Betula*, *Tilia*, and *Quercus*, and later (Can. Entom., May, 1872, v. 4, p. 84), on authority of Abbot, gives *Fraxinus trifoliata* and *F. ?platycarpa*. Saunders (Can. Entom., Jan., 1874, v. 6, p. 2-5) describes and figures larva and imago, and (*op. cit.*, Nov., 1883, v. 15, p. 204) adds *Magnolia acuminata* to the recorded food-plants. Gruber (Papilio, May, 1884, v. 4, p. 86, 87) gives notes on the five stages of the larva.

*Larva*.—Body very thick, soft, smooth, cylindrical, thickest on the first abdominal segment, thence tapering rapidly towards the end. On the metathoracic segment two large subdorsal eye-like spots in the middle of the segment, formed of a yellow ring edged externally with black, with a black center containing a blue streak. Posterior edge of the fourth segment yellow, with a narrow black streak behind. Prothoracic segment scarcely wider than the head, with the front edge straw-yellow. Head lilac rust-red. All the feet pale green. Body rich velvety pea-green, whitish green on the under side. Length, 38<sup>mm</sup>.

*The butterfly*.—Yellow, with a broad black edge containing a row of yellow spots; forewings with four short black bands reaching in from the costal edge; the hind wings with long tails and with an orange-red spot near their hind angle. Expanse of wings, 4½ to 5 inches.

#### 12. *Ceratonia amyntor* Hübner.

Already described under the head of elm insects, the only tree upon which we have found this insect in the caterpillar stage. I append the following notes by Mrs. Dimmock, who has found it oftener on the white birch than the elm:

*Ceratonia amyntor* Hübn. (Samml. Exot. Schmett., 1806-1824, v. 2, Lepid. 2, Sph. 3, leg. 4, mand. B, pond. 4) [= *C. quadricornis* Harr. (Amer. Journ. Sci. and Arts, July, 1839, [s. 1], v. 36, p. 293)]. Harris (*l. c.*) describes the larva and imago; the same author (Rept. Ins. Injur. Veg., 1841, p. 227, 228) briefly describes the larva and imago, and later (Treatise on ins. injur. veg., 1862, p. 323, 324) adds a figure of the larva and imago; still later (Entom. Corresp., 1869, p. 282) he briefly describes the egg, young larva, and pupa. Morris (Synop. Lepid. N. A. 1862, p. 205, 206) describes larva, pupa, and imago. Lintner (Proc. Entom. Soc. Phil., Dec., 1862, v. 1, p. 286-293) gives an excellent description of the egg, the five stages of the larva, and the pupa. Minot (Can. Entom., Nov., 1869, v. 2, p. 28) describes the egg and the young larva; he states that the larva molts six times. Andrews (Can. Entom., Feb., 1876, v. 8, p. 40) and Bunker (*op. cit.*, June, 1876, v. 8, p. 120) discuss the brown form of the larva. The before-mentioned authors give only *Ulmus* as food-plant; Goodell (Psyche, July [Dec.], 1832, v. 3, p. 368) gives *Ulmus* and *Betula alba* as food-plants. Taken in Cambridge, Mass., oftener on *Betula alba* than on *Ulmus*. (Psyche, iv, 281, 282.)

#### 13. *Smerinthus excæcatus* Abb. and Smith.\*

Although I have more commonly found this caterpillar on the willow, and sometimes on the poplar and birch, Mrs. Dimmock says it is not

\* I subjoin the description of a *Smerinthus* larva, perhaps of this species, feeding on the leaves late in September and during the first week in October, which began to pupate October 3, at Providence.

*Larva*.—Head rather large, triangular in front, the vertex ending in two minute rounded tubercles, and with a paler green line on the side of the head. Labrum

rare on low white birch shrubs. I have found the egg and young larva on the willow at Brunswick in July, but have not reared an individual through all the stages from the first.\*

The following notes are by Mrs. Anna K. Dimmock in *Psyche*, iv, p. 282:

*Smerinthus excrucatus* Abb. and Smith (Nat. Hist. Lepid. Ins. Ga., 1797, v. 1, p. 49, pl. 25). Harris (Amer. Journ. Sci. and Arts, July 1839, [s. 1], v. 36, p. 290) gives a brief description of larva and imago of this species, which he states to feed upon apple and *Rosa carolina*; Morris (Syn. Lepid. N. A., 1862, p. 209) gives Harris's description of the larva, with slight addition, and adds a description of the young larva and of what he supposed to be the egg—really, however, the egg of *Attacus polyphemus*. Harris (Treatise on Ins. Injur. Veg., 1862, p. 327-328) describes and figures the imago. Lintner (Proc. Entom. Soc. Phil., 1864, v. 3, p. 666) describes the larva without knowing the species, and later (Entom. Contrib., No. 2, 1873, p. 23) he gives its name, and states that the larva described by him (Proc. Entom. Soc. Phil., 1864, v. 3, p. 665) as *S. excrucatus* was in reality *S. geminatus*. Sanborn (Can. Entom., Jan.

slightly reddish; mandibles black. Body of a uniform pale pea-green color, a little more vivid than the under side of the birch leaves. The surface of the skin rough with small conical papillae. Seven lateral stripes pale yellow, moderately broad, beginning in front of each abdominal spiracle on front edge of the segment and extending upon the back of the succeeding segment. The last yellowish stripe extends to the base of the horn or eighth segment, which is moderately stout and long. Neither the caudal horn nor yellowish lateral stripes are stained with lilac. The spiracles are black, with a central white line. The forefeet are rose-red. The abdominal legs concolorous with the body, which is of the same pale yellowish green above and below; the hooks are dark. Length 50<sup>mm</sup>.

\* Mr. William Beutenmüller has published in *Entomologica Americana*, i, p. 196, the following list of food-plants of *S. excrucatus*:

	<i>Leguminosæ.</i>	<i>Corylus americana</i> , Walt (Wild Hazel-Nut.)
<i>Wistaria sinensis</i> , Dec. (Chinese Wistaria.)		<i>Ostrya virginica</i> , Wild. (American Hop Hornbeam.)
	<i>Rosaceæ.</i>	<i>Carpinus americana</i> , Michx. (Hornbeam.)
<i>Prunus virginiana</i> , L. (Choke-Cherry.)		<i>Betulaceæ.</i>
<i>serotina</i> , Ehr. (Wild Black Cherry.)		<i>Betula alba</i> , L. (White Birch.)
<i>Spiræa opulifolia</i> , L. (Nine Bark.)		<i>Betula var. populifolia</i> , Spach.
<i>Rubus odoratus</i> , L. (Purple-Flowering Raspberry.)		<i>Salicaceæ.</i>
<i>Pyrus malus</i> , Tourn. (Apple.)		<i>Salix cordata</i> , Muhl. (Heart-leaved Willow.)
	<i>Urticaceæ.</i>	<i>lucida</i> , Muhl. (Shining Willow.)
<i>Ulmus fulva</i> , Michx. (Slippery or Red Elm.)		<i>fragilis</i> , L. (Brittle Willow.)
<i>americana</i> , L. (American or Wild Elm.)		<i>alba</i> , L. (White Willow.)
<i>alata</i> , Michx. (Whahoo or Winged Elm.)		<i>babylonica</i> , Tourn. (Weeping Willow.)
<i>suberosa</i> , Mouch.		<i>Populus tremuloides</i> , Michx. (American Aspen.)
	<i>Cupuliferæ.</i>	<i>grandidentata</i> , Michx. (Large-toothed Aspen.)
<i>Quercus palustris</i> , Du Roi. (Swamp or Pin Oak.)		<i>angulata</i> , Ait. (Angled Cottonwood.)
<i>coccinea</i> , Wang. (Scarlet Oak.)		<i>monilifera</i> , Ait. (Cottonwood, Necklace Poplar.)

1869, v. 1, p. 48) calls attention to the squeaking noise produced by the larva of this and of other species of *Smerinthus*. Lintner (Entom. Contrib. [No. 1], 1869, p. 56) gives *Prunus pennsylvanica* and *Cratægus* as food plants of the larva. Mann (Psyche, September and October 1877 [8 Mar. 1878], v. 2, pp. 69-72) compares descriptions of the larva of this and of other species of *Smerinthus*, giving *Acer* as food-plant of the larva of *S. excrucatus*. Goodell (Psyche, July [Dec.] 1882, v. 3, p. 368) describes egg and first larval stage of this species. Fletcher (Can. Entom., Nov. 1883, v. 15, pp. 203-204) gives as food-plants apple, plum, wild cherry, *Populus balsamifera* and *P. alba*, and further states that the larvæ varied much in coloration. Saunders (Can. Entom., Jan. 1834, v. 16, pp. 9-11) describes and figures the last stage of the larva and the imago. Fischer (*op. cit.*, p. 17) adds *Tilia* and *Salix* to the food-plants. In Cambridge, Mass., the larva of this species is not rare on low shrubs of *Betula alba*, where it occurs throughout August and September. The larvæ, as observed on *Betula alba*, exhibit no variation. They are somewhat difficult to rear; of thirty-eight larvæ, of which rearing was begun, eight were put in alcohol for preservation; three produced imagos (2 males and 1 female); sixteen died without apparent parasitism, while eleven were killed by *Thyreodon morio*, of which ichneumon only two reached the imago state. One of the pupæ of *Thyreodon* produced a large number of minute hymenoptera—secondary parasites. The egg of *S. excrucatus* often harbors very minute hymenopterous parasites; more than thirty of these hymenoptera sometimes emerge from a single egg of *Smerinthus*, a fact that will give an idea of their microscopical minuteness.

#### 14. THE HICKORY TUSSOCK-WORM.

*Halesidota caryæ* (Harris).

I found August 28, at Brunswick, Me., a whole brood of these caterpillars on a birch tree, almost covering both the upper and lower sides of a leaf.

#### 15. THE WOOLY BEAR.

*Spilosoma virginica* (Fabr.).

The "wooly bear" caterpillar of this species is a general feeder, and is said, among other trees which Mrs. Dimmock enumerates below, to feed on the white birch.

She also adds to the list of birch-feeding insects *Pyrrharctia isabella*\* (under the name "*Spilosoma isabella*"), though as it apparently has only fed on this tree while in confinement, we should as yet scarcely regard it as affecting this tree.

*Spilosoma virginica* Fabr. (Syst. Entom., Suppl., 1775, p. 437). Harris (Rept. Ins. injur. Veg., 1841, p. 247, 248) describes the larva and imago, stating that the larva feeds on leaves of *Plantago*, *Pisum*, *Phaseolus*, *Zea mays*, *Gramineæ*, *Vitis*, *Ribes rubrum* and *R. grossularia*; later (Treatise on Ins. injur. Veg., 1862, p. 349-351) he adds a

\* *Spilosoma isabella* Abb.—Smith (Nat. Hist. Lepid. Ins. Ga., 1797, v. 2, p. 131, pl. 66). Harris (Rept. Ins. injur. Veg., 1841, p. 252, 253) describes larva and imago giving *Trifolium*, *Taraxacum dens-leonis*, and narrow-leaved *Plantago* as food-plants; to this he adds (Treatise on Ins. Injur. Veg., 1862, p. 355, 356) a figure of the larva. Walsh [?] (Pract. Entom., June, 1867, v. 2, p. 103) gives apple as a food-plant of the larva. Riley (Amer. Entom., April, 1870, v. 2, p. 182) figures and briefly describes the larva, pupa, and imago, mentioning only grass as a food-plant of the larva; later (4th Ann. Rept. State Entom. Mo., 1872, p. 143, 144) he reprints these figures. Riley's figures, with a brief description, are again repeated by Saunders (Can. Entom., April, 1873, v. 5, p. 75-77, and Ann. Rept. Entom. Soc. Ontario, 1873, p. 22, 23), and Westcott

figure of the larva and imago, and (Entom. Corresp., 1869, p. 287, 288) he describes the larva and pupa. Morris (Synop. Lepid. N. A., 1862, p. 342, 343) describes larva and imago. Riley (Amer. Entom., July-Aug., 1870, v. 2, p. 272, 273 and 3rd Ann. Rept. State Entom. Mo., 1871, p. 68, 69) describes and figures the larva, pupa, and imago, adding to the above-mentioned food-plants, *Juglans cinerea*, *Syringa*, *Convolvulus*, *Gossypium*, *Helianthus*, *Polygonum*, *Verbena*, and *Geranium*; he also states that the larva has been known "to subsist entirely, from the time it cast its last skin till it spun up, on dead bodies of the camel cricket (*Mantis carolina*)"; later (*op. cit.*, Oct., 1870, v. 2, p. 336) he adds *Petunia* and *Salix* to the food-plants. Lintner (Entom. Contrib., No. 3, 1874, p. 143) describes two varieties of the larva. Bates (Can. Entom., Jan., 1880, v. 12, p. 20) adds ?*Rumex* to the food-plants. Saunders (*op. cit.*, March, 1880, v. 12, p. 56, 57) reprints Riley's figures of the larva, pupa, and imago, and describes them. Packard (Bull. 7, U. S. Entom. Comm., 1881, p. 83-89) describes larva and imago (reprinting Riley's figures of these and the pupa) and adds *Rhamnus* and *Pinus* to the food-plants. The larva also eats *Ampelopsis quinquefolia*, *Ulmus americana*, *Betula alba*, *Fuchsia fulgens*, *Tropaeolum*, *Prunus serotina*, *Syringa vulgaris*, *Vitis labrusca*, *Ipomoea purpurea*, *Pelargonium*, *Martynia proboscidea*, *Acer saccharinum*, *Ricinus communis*, *Lappa officinalis*, and *Nicotiana tobacum*, but specimens fed on *Datura meteloides* died soon after. (Anna K. Dimmock, Psyche, iv, p. 281.)

#### 16. *Phobetron pithecium* Abbot and Smith.

As will be seen by the following statement by Mrs. Dimmock this singular caterpillar is sometimes found on the birch as well as the oak (see p. 143):

*Phobetron pithecium* Abb. and Smith (Nat. Hist. Lepid. Ins. Ga., 1797, v. 2, p. 147, pl. 74). Harris (Rept. Ins. Injur. Veg., 1841, p. 304, 305) describes the larva and imago of this species, stating that the larva feeds on oak, and, according to Melsheimer, on wild cherry; later (Treatise on Ins. Injur. Veg., 1862, p. 421, 422) he adds to this description a poor figure of the larva and of the cocoon; he gives a brief note (Entom. Corresp., 1869, p. 244-245) on the larva. Riley (Amer. Entom. v. 2; September, October, 1869, p. 25; October, 1870, p. 340) gives a good figure of the larva, which he states to feed on apple and Siberian crab-apple; he later (5th Ann. Rept. State Entom. Mo., 1873, p. 126) gives this species in a list of larvæ which have urticating power. Lintner (Entom. Contrib., No. 3, 1874, p. 149) describes the cocoon, and adds plum, pear, and *Corylus americana* to the food-plants. This larva is rarely found in eastern Massachusetts but is a little more abundant in the western part of the State; a favorite food-plant is *Betula alba*. (Anna K. Dimmock, Psyche, iv, p. 208.)

#### 17. *Limacodes scapha* Harris.

The following notes are copied from Mrs. Dimmock's paper:

*Limacodes scapha* Harr. (Rept. Ins. Injur. Veg., 1841, p. 303). Harris (*l. c.* and Treatise on Ins. Injur. Veg., 1862, p. 420) describes the species as larva, which he

(Can. Entom., July, 1873, p. 137) adds a few notes on the larva. Siewers (Can. Entom., July, 1877, v. 9, p. 127, 128) notes a few habits of the larva. Mann (Psyche, Sept.-Dec., 1879 [9 Apr., 1880], v. 2, p. 270) gives some notes on the larva. Riley (Amer. Entom., June, 1880, v. 3, p. 133, 134) reprints his figures of larva, pupa, and imago, and adds some notes on the larva and its parasites. Coleman (Papilio, Jan., 1882, v. 2, p. 18) gives some notes on the variations of color of the larva. Experiments show that the larva feeds readily on leaves of the following plants: *Ricinus communis*, *Acer saccharinum*, *Fiburnum dentatum*, *Lappa officinalis*, *Polygonum persicaria*, *Tropaeolum majus*, *Vitis labrusca*, *Syringa vulgaris*, *S. persica*, *Ampelopsis quinquefolia*, *Prunus serotina*, *Ulmus americana*, *Clethra alnifolia*, *Martynia proboscidea*, *Helianthus annuus*, *Plantago major*, *Spiraea sorbifolia*, *Ribes aureum*, and *Betula alba*; the larva refused *Solanum nigrum* and *Apios tuberosa*. (Anna K. Dimmock, Psyche, iv, p. 281.)



states to live on *Juglans*; later (Entom. Corresp., 1869, p. 300, pl. 3, fig. 8) he figures the larva, and adds apple to the food-plants. Walsh (Proc. Bost. Soc. Nat. Hist., February, 1864, v. 9, p. 298, 299) first describes the imago and says, "The larva fed on hickory leaves, but I have met with two specimens on the button-wood or sycamore." Packard (Guide, Study Ins., 1869, p. 290, and Bull. 7, U. S. Entom. Comm., 1881, p. 77) briefly describes the larva, cocoon, and imago, figuring the last. A single larva of this species, taken on *Betula alba* at Belmont, Mass., 12th August, 1882, pupated 17th September, and emerged 1st July, 1883. The excrement of the larva has a peculiar form, being cup-shaped, with a deep concavity and comparatively thin walls, which are somewhat shriveled about the margin in drying. The larva, when disturbed, exhales an odor difficult to describe. A short time before pupation it turns whitish. (Psyche, iv, p. 297.)

## 18. THE AMERICAN SILK-WORM.

*Telea polyphemus* (Linn).

I have found this caterpillar in different stages of growth at Brunswick, Me., through August, on *Betula populifolia*.

## 19. THE UNICORN CATERPILLAR.

*Schizura unicornis* (Abbot and Smith).

This caterpillar, which is common in orchards, has been detected on the birch by Mrs. Dimmock, whose notes on it are subjoined:

*Cælodasys unicornis* Abb. and Smith (Nat. Hist. Lepid. Ins. Ga., 1797, v. 2, p. 165, pl. 86). Harris (Rept. Ins. Injur. Veg., 1841, p. 306, 307) describes the larva of this species and gives as food-plants plum and apple, and adds to them, on authority of Abbot, *Prinos verticillatus*. Harris (Entom. Corresp., 1869, pl. 2, fig. 8) gives a colored figure of the larva. Payne (Amer. Entom., October, 1870, v. 2, p. 341) notes that the larva mimics partly dead and partly living margins of leaves. Lintner (Entom. Contrib., No. 3, 1874, p. 131) describes and figures the larva, adding *Corylus americana* and *Prunus virginiana* to the previously known food-plants; his figure is copied in Amer. Nat., November, 1874, v. 8, p. 691, 692. Packard (Bull. 7, U. S. Entom. Comm., 1881, p. 136) adds *Cratægus* to the food-plants. The larva also feeds on *Betula alba*.

20. *Schizura ipomeæ* Doubleday.

According to Mr. Koebele the caterpillar occasionally feeds on the birch.

21. *Schizura* sp.

Another unicorn-like larva occurred on *Betula populifera*, Brunswick, August 29.

*Larva*.—Head very large, much larger (about twice) than in *S. unicornis* on elm; full, much enlarged towards the vertex, which is bilobed; a double row of light, almost white, spots down the front, clypeus white; side of head whitish brown, and the head elsewhere is marbled with whitish in a net-work of light brown lines. Hump (dorsal) on the first abdominal segment bilobed and much larger than in *unicornis*; the two forks of the hump deep reddish. The median brown dorsal line is much broader than in *unicornis*. Side of thoracic segments not so light green as in

*unicornis*. A double row of dorsal warts not so wide apart and much larger than in *unicornis*. The dorsal hump on the seventh segment is not so high and is larger and thicker than in *unicornis*, the two terminal warts larger; in front of this hump the dorsal part of the body is dark green as far as the middle of the body, and it incloses a round brown patch in the middle of the dorsal green area. The warts on the back behind the hump are larger than in *unicornis*. The general color is reddish brown, and it wants the two V-shaped silver dorsal patches which characterize *unicornis*. Length, 10<sup>mm</sup>.

22. *Heterocampa pulverea* G. and R.

The caterpillar of this moth, according to Dr. Riley, was observed in Maryland feeding on the birch. See p. 160.

23. *Lochmæus* sp.

A caterpillar allied to, but very distinct from, *L. manteo* occurred on the birch in "Virginia, September 14, 1882." (Riley's MS. notes.) I have seen the two specimens, which are in the Department collection, one of which has two dark red spots on the first abdominal and two much larger distinct oval dark blood-red dorsal spots on the third abdominal segment, while the body is of the color of the underside of a birch leaf.

24. *Dryopteris irrorata* Pack.

Mr. Elliot tells me that he has likewise reared this species from the birch in the vicinity of New York City.

*Moth*.—This species is of a bright ferruginous or brick red, dusted above with brown abbreviated lines and dots, but beneath clear reddish.

Palpi and front of head of a bright rusty red, thorax and forewings slightly shaded with brown. Both pairs of wings are marked nearly alike, being crossed by transverse irrorations which are united into lines near the base of the wing. Within the middle of the wing is a slightly curved irregularly zigzag dark line, which is deeply sinuate in the median space. On the outer fourth of the wing is a line of the same color, which makes an acute angle before reaching the apex of the wing and then suddenly bends back upon the costa. Just beyond this line is a dark transverse streak which only touches the outer edge at the lower part of the apex, which is nearly black. On the secondaries are two parallel black somewhat zigzag lines, the inner being half as long as the outer one. Beneath the outer line only is reproduced, being straight on the forewings, but a little sinuate on the hind wings. Expanse of wings, 1.40 inch.

25. *Dryopteris rosea* Walker.

Mr. S. Lowell Elliott informs me that he has raised this moth from larvæ feeding on the birch in New York. He preserved no description of the caterpillar.

*Moth*.—Forewings very falcate, the body and basal two-thirds of both pairs of wings roseate brown, sometimes yellow; outer margin of the forewings and apex of hind wings rosy brown, or color of a dead leaf. Expanse of wings 27<sup>mm</sup>. When the body and wings at base are yellow (as in Walker's *marginata*) three rosy brown lines cross both pairs of wings, the two basal lines being near together, the outer remote, with a deep rounded sinus near the costa, marked beneath nearly as above.

26. *Prionia bilineata* (Pack).

Order LEPIDOPTERA; family PLATYPTERICIDÆ.

Dr. Dimmock has worked out the history of this interesting moth, as will be seen by the following account by Mrs. Dimmock in *Psyche*, iv, p. 278:

*Platypteryx bilineata* Packard (Proc. Entom. Soc. Phil., Nov., 1864, v. 3, p. 359). Packard (*l. c.*) writes: "Dr. Harris has reared this from the larva, which pupated July 25; imago August 15." Harris (Entom. Corresp., 1869, p. 142) gives a crude figure of the larva of some American species of *Platypteryx*?, and Packard (Guide Study Ins., 1869, p. 293) repeats this figure as that of a species of *Dryopteris*; no food-plant is mentioned by either author. The European species, *Platypteryx lacertula*, feeds on birch. The larva of *P. bilineata* is found upon *Betula alba*, in eastern Massachusetts, about the first of July and again early in September; hibernation takes place as pupa in the September brood. Dr. G. Dimmock will later describe the egg, larva, and pupa of this insect in detail, but the following notes will suffice for the recognition of the larva and pupa. The full-grown larva is about 12<sup>mm</sup> long, tapering from the anterior to the posterior end, which latter terminates in a single point, turned upward, in place of the anal legs. The dorsal surface of each segment bears four tubercles, each supporting a single short hair. The arrangements of these tubercles is peculiar: segment 1 has small tubercles arranged thus . . . ; segments 2 and 3 each have large tubercles arranged \* . . \* (the head in each case supposed to be upward); segments 4-10 each have small tubercles arranged . . . ; segments 11 and 12 each have two large and two small tubercles arranged \* . . . . The slight cocoon is made between leaves of the birch which the larva has drawn together for the purpose, and the pupa within it is densely covered with a white bloom.

*Moth*.—Female: A delicate thinly-scaled species of an ocherous-silvery color; the ocherous scales appearing along the outer border, and lining the transverse lines. These two lines are in the middle of the wing, the outer being a little flexuous; both are dark, the inner one lined within and the outer one lined externally with ocherous. A distinct black discal spot. The forewing is thickly covered with long transverse brown strigæ or short lines, which become near the outer edge oblique and sinuate, forming an obscure submarginal line. Secondaries paler and dusky perlaceous. Discal dot distinct, and beyond is a transverse dark line, once angulated opposite this spot. Beyond this line the wing is obscurely strigated. Beneath, the forewings are more yellowish towards the outer edge, and on the secondaries, especially so beyond the outer line, which, with the discal dot, is much plainer than on the upper surface. Head and body throughout concolorous with the forewings. Expanse of wings, 1.30 inch.

27. *Drepana arcuata* Grote.

Mr. S. L. Elliot has bred this moth from the birch in Central Park, New York. It is closely like the European larva, being green, the head broad, the body tapering behind, ending in a sharp point with red spots on the thoracic segments. Mr. Elliot tells me that it rolls up a leaf, and eats a little off, then goes to another leaf, cuts it, and bends it over, and in this way becomes quite destructive.\*

\* For a detailed account of the metamorphosis of this moth see my article, The Life-history of *Drepana arcuata*, etc., in Proc. Brit. Soc. Nat. Hist., xxiv, 1890.

28. *Drepana* sp.

A pupa taken July 5, 1883, at Cambridge, Mass., upon *Betula alba*, upon which the larva had evidently fed, gave as imago, July 16, 1883, a species of *Drepana*.—(Mrs. Dimmock, Psyche, iv, p. 279.)

29. *Gastropacha americana* Harris.

Though I have found the larva of this moth on the walnut, it appears by the following summary of its habits to live at times on the birch.

*Gastropacha americana* Harris (Rep. Ins. Injur. Veg., 1841, p. 273-274). This author (*l. c.* and Treatise on Ins. Injur. Veg., 1862, pp. 377-378) briefly describes the larva, which he states feeds upon apple, and on authority of Abbot, upon *Quercus* and *Fraxinus*. Lintner (Entom. Contrib., No. 1, 1869, p. 193), in a note upon the larva, gives *Betula* as food-plant and later (Entom. Contrib., No. 3, 1874, p. 154, 155) describes the larva, which he states to feed on *Betula lenta* and *Acer*. Lyman (Can. Entom., Aug., 1874, v. 6, p. 158) describes the eggs of this species. (Mrs. Anna K. Dimmock, Psyche, iv, p. 274.)

The biological notes on the following eight species of Noctuidæ or owlet moths are extracted from Mrs. Dimmock's Insects of the Birch, in Psyche, iv, pp. 273-274:

30. *Orthosia instabilis* Fabr.

*Orthosia instabilis* Fabr. (Entom. Syst., 1793, v. 3, p. 119) [= *Tæniocampa incerta* Hübn.]. Kaltenbach (Pflanzenfeinde, 1872, pp. 429-430, 550, 640) gives the following food-plants for the larva of this species in Europe: Apple, *Ulmus*, *Tilia*, *Salix*, *Quercus*, *Fraxinus*, *Betula alba*, *Populus*, and *Carpinus*; to this list Rôtiast (Annales Soc. Linn. Lyon, Ann. 1882, [1883], N. S., v. 29, pp. 315-316) adds *Amygdalus communis*, *Cratægus oxyacantha*, and *Centaurea jacea*.

31. *Apatela xyliniformis* Guen.

*Apatela xyliniformis* Guen. (Hist. Nat. d. Ins., 1852, v. 5, Noct., v. 1, p. 56). Thaxter (Papilio, Jan. 1883, v. 3, p. 17) states that the larva of this species feeds on *Betula* and blackberry (*Rubus*).

32. *Apatela brumosa* Guen.

*Apatela brumosa* Guen. (Hist. Nat. d. Ins., 1852, v. 5, Noct., v. 1, p. 52). Thaxter (Papilio, Jan. 1883, v. 3, p. 17) states that the larva of this species feeds on *Betula*, *Salix*, and *Populus*.

33. *Apatela dactylina* Grote.

*Apatela dactylina* Grote (Proc. Bost. Soc. Nat. Hist., April 1874, v. 16, p. 239), Thaxter (Psyche, May-June [9 July], 1877, v. 2, p. 35) gives *Betula* and *Salix* as food-plants of the larva of this species.

34. *Apatela americana* Harris.

*Apatela americana* Harr. (Rep. Ins. Injur. Veg., 1841, p. 317). Harris (*op. cit.*, p. 317-318) describes the larva and cocoon of this species; he writes: "The caterpillar eats the leaves of the various kinds of maple and sometimes also those of the elm and chestnut." The same author (Treatise on Ins. Injur. Veg., 1862, p. 436-437) figures larva, pupa, and imago of this species, and adds *Tilia* to the food-plants; and (Entom. Corresp., 1869, p. 311) again describes the larva. In Amer. Entom., April,

1869, v. 1, p. 166, this species is stated to feed on *Populus dilatata* and *P. monilifera*, and Riley (Second Rept. State Entom. Mo., 1870, p. 121) gives *Betula* and *Alnus* as food-plants. Coquillett (Papilio, Jan. 1881, v. 1, p. 6) describes the larva and gives red oak (*Quercus*) as food-plant. Thaxter (Papilio, Jan., 1883, v. 3, p. 17) adds *Juglans*, *Fraxinus*, and *Platanus* to the recorded food-plants.

### 35. *Apatela vulpina* Grote.

*Apatela vulpina* Grote (Can. Entom., Jan., 1883, v. 15, p. 8-9). Thaxter (Papilio, Jan., 1883, v. 3, p. 14-15). describes the larva of this species, and gives *Populus* and *Betula* as food-plants.

### 36. *Apatela spinigera* Guen.

*Apatela spinigera* Guen. (Hist. Nat. d. Ins., 1852, v. 5, Noct. v. 1, p. 45). Thaxter (Psyche, March-April [24 Sept.], 1878, v. 2, p. 121-122) describes the larva of this species and gives as food-plants *Rubus* and *Betula*.

### 37. *Apatela occidentalis* Grote and Rob.

*Apatela occidentalis* Grote and Rob. (Proc. Entom. Soc. Phil., May, 1866, v. 6, p. 16). The larva of this species is described by Harris (Entom. Corresp, 1869, p. 311-312), who found it feeding on plum, cherry, and *Pyrus americana*. Lintner (Entom. Contrib., [No. 1], 1869, p. 62) adds apple to the food-plants. Saunders (Can. Entom., March, 1872, v. 4, p. 50) describes the larva. Packard (Papilio, Nov.-Dec., 1882, v. 2, p. 181) briefly describes the larva and pupa. Thaxter (Psyche, May-June [9 July] 1877, v. 2, p. 35) gives *Ulmus* as food-plant. A specimen taken on *Betula lutea*, at Wachusett, Mass., 26 August, 1882, pupated 30 August, and the imago appeared 12 June, 1883. This larva, which also ate *Betula alba*, did not entirely agree in coloration with Saunders's description.

### 38. *Apatela betulæ* Riley.

An interesting and easily recognized species of the genus *Apatela* has been reared from the black birch by Prof. C. V. Riley, who published the following account of its habits and peculiarities in the Bulletin Brooklyn Entomological Society, vol. vii, May, 1884:

It is a strongly marked species. In some of the paler specimens there is a suggestion of olivaceous; while the darker specimens have more uniformly gray primaries with the strongly relieved transverse anterior pale line, and brown reniform spot and subterminal space as the most prominent features.

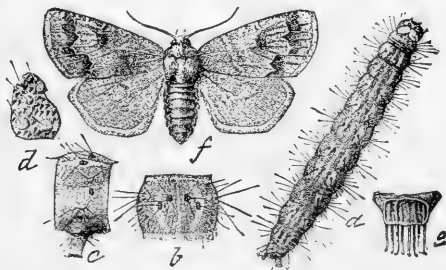


FIG. 176.—*Apatela betulæ*: a, larva, dorsal view; f, imago, nat. size; b, a middle segment of larva, dorsal view; c, do., side view; d, portion of larval skin showing spinose covering; e, cremaster of pupa with spines, dorsal view.

The larva while young is found on the leaves and corresponds thereto in general color. After the last molt it rests stretched on the thickest branches of the tree and is fond of hiding in dark recesses. For pupation it forms a slight cocoon either among leaves or in old wood on the ground, or on the trunk of the tree. There are two

annual generations at Washington, the first larvæ occurring in July and the second brood in October, while the first moths from hibernated pupæ appear in April and the second brood in August.

The species, both in the characters of its larva and of the male genitalia, shows affinities with that group of the genus which includes *morula*, *occidentalis*, *furcifera*, *hasta*, *lobelia*, and *radcliffii*, while the genitalia, alone considered, would separate it from *innotata*, with which, especially the form *grafii*, it otherwise shows the closest relationship. My studies of the genitalia of the genus have, however, so far led to no definite conclusions as to their real value in classification.

*Moth*.—Average expanse of four wings 37<sup>mm</sup>. General color clay-yellow or pale buff, with silver-gray hues. Maculation subobsolete, except the transverse posterior line. Form of body and wings most nearly approaching *tritona*, *i. e.*, primaries short, broad, and with apex rectangular. None of the ordinary longitudinal marks at base or between veins 1 and 2 or 6 and 7; the ordinary maculation much as in *innotata*, but in faint fuliginous and sienna; orbicular usually quite obsolete; where indicated it is by relief basally of the transverse anterior paler line and posteriorly by the paler space between it and the reniform, which is more plainly indicated, especially on the basal side, by a sienna border. Transverse posterior line as in *grafii*, the inner angle between veins 6 and 7 more pronounced, but without the tooth of *tritona*, the outer angle on vein 1 more pronounced and acute; well relieved basally by silver-gray and posteriorly by a sienna-brown line and coincident subterminal shade. Posterior border usually shows a distinct pale line, the fringes being either of the general hue or darker, with paler interruptions on the veins. Secondaries well rounded, clay yellow, with very faint discal and transverse fuliginous shade. Head and thorax concolorous with primaries except a slender brown streak on outside border of tegulæ. Under surface uniformly pale clay yellow, with discal and transverse shade on secondaries intensified, and similar shades on primaries, the transverse line strongly elbowed; borders of wings, especially of secondaries, may also be dotted with brown, though usually concolorous; antennæ beneath, front tarsi, and a patch on outside of palpi dark brown.

Male usually more strongly marked than female. Claspers of male consisting of a long curved hook with a broad excavate main shank and an inferior broad tooth or projection having parallel sides.

Described from nine males and four females reared from larvæ feeding on *Betula nigra*.

*Larva*.—Average length when full grown, 38<sup>mm</sup>. Color greenish gray before last molt, with a whitish medio-dorsal, and an undulating sulphur-yellow subdorsal line, more or less distinct. After last molt vinous brown without the dorsal lines. Sparsely covered (head and legs included) with short white or gray hairs arising from pale papillæ, and thickest at sides and subventrally, so as to give a somewhat gastropachiform aspect. The general surface of the body, which appears smooth to the naked eye, is thickly and evenly beset with minute black points. Ordinary piliferous spots papillose and pale except on dorsum, where they are black with pale papillæ, usually three papillæ to each spot, except on thoracic joints, where there are more. Head rather small, the tops of lobes reddish brown, the face pale yellowish, with distinct black mottlings on the cheeks and bordering the red top. Stigmata with black annulus.

*Pupa*.—Highly polished. Abdominal joints above sparsely and shallowly punctate. Cremaster consisting of a small series of converging ridges dorsally, and ending in some six or more short, almost straight spines in a horizontal row.

### 39. *Charadra propinquinella* Grote.

The caterpillar of this moth has been reared by Mr. Goodell. It feeds on the white birch, living in a sort of case made by folding a leaf or drawing two leaves together and attaching them by their edges with

silken threads. It changed to a pupa within its case September 20, and the imago emerged June 6. (*Papilio*, i, p. 15.) (See p. 167.)

*Larva*.—Head round, slightly flattened in front, brown, smooth, and glassy. Body thickest near the middle, tapering to each end, of a dirty white, with a large black spiracular spot on all the segments except the last two. It is covered with spreading tufts of short, stiff white hairs, several of the hairs on the last two segments long and slender, extending over the end of the body. On each of the fourth and eleventh segments situated close together, one behind the other, are two short pencils of light yellowish red hairs, and on the same segments, just below the hinder pencils, is another longer pencil of the same color. All the segments are thickest through the middle. (Goodell.)

*Charadra propinquinelinea* Grote (Trans. Amer. Entom. Soc., Jan., 1873, vol. 4, p. 293-94). Goodell (*Papilio*, Feb. 1881, v. I, p. 15) describes the larva of this species and gives "white birch" as food-plant. Thaxter (*Papilio*, Jan., 1883, vol. 3, p. 11-12) gives notes on the larva, which feeds on *Betula*, *Juglans*, *Acer* and *Quercus*. (Mrs. Anna K. Dimmock, *Psyche*, iv, p. 274.)

*Moth*.—Female. Size of *C. deridens*, from which it differs at first sight by the propinquity and subparallelism of the median lines, which are not joined at the center of the wing as in our usual species. Whitish or bluish gray. Median lines distinct, propinquitous, subparallel, excavate. Transverse anterior line twice outwardly produced opposite the cell, and once inwardly on internal nervure. Orbicular spot round, evident, filled with whitish, with a central dark dot. Reniform spot contiguous to the transverse posterior line, incompletely ringed with a central dot. Median shade apparent above and below the orbicular spot, where it runs approximate to the transverse anterior line. Subterminal space very wide; subterminal line apparent at the costa, afterwards faint, scalloped. The whitish frosting of the wing becomes lost externally. An interrupted terminal line formed by interspaced white and following blackish dots. Hind wings smoky, dark along the external margin. Head and thorax whitish. Tegulae with black marks. Beneath, the legs and thorax are clothed with whitish hair. The wings show double faint shaded darker transverse bands. Expanse of wings 40<sup>mm</sup>; length of body 15<sup>mm</sup>. (Grote.)

#### 40. *Charadra deridens* G. en.

The following notes on this caterpillar by Mrs. Dimmock (*Psyche*, iv, p. 274) show that it is not uncommon on the birch. (See also p. 166.)

*Charadra deridens* Guen. (Hist. nat. d. ins., 1852, vol. 5, Noct., vol. 1, p. 35-36.) Saunders (Can. entom., Sept.-Oct., 1870, vol. 2, p. 145-146) describes the larva, and Lintner (Entom. contrib., no. 3, 1874, p. 157) figures and describes it. Thaxter (*Papilio*, Jan., 1883, vol. 3, p. 11-12) describes the egg, the seven larval stages, and the cocoon; the larva feeds upon red oak (*Quercus*), *Betula*, and *Ulmus*.

#### 41. *Euplexia lucipara* (Linn.).

The moth has been reared from the birch and *Viburnum* by Mr. S. Lowell Elliot.

*Larva*.—Emerald green. Head greenish testaceous; mouth parts pale pitchy. There is a very faint broken dorsal line, and a shading with a darker green over the entire back. Sutures between the segments yellowish. Spiracles very small, whitish, with a broad black ring. The lower lateral space is pale bluish green. On the top of the twelfth segment, which is somewhat smaller, are two small spots of clear white. The underside is wholly pale bluish-green. Length 35<sup>mm</sup> (1.40 inches. Hy. Edwards and Elliot).

*Moth.*—Fore wings violet-brown, with lilac reflections, and shaded with reddish yellow, principally on the submarginal space, which is clearer in front, and traversed by a fine line parallel to the angulated line; the median space deeper in color; the reniform spot distinct, oblong, of a clear yellow, traversed by a clear brown shade; orbicular spot concolorous, quite large, open at the two ends. Base of the wing varied with spots and streaks. Submarginal line fine, wavy, forming a vague **M** in its middle, and shaded with black in front. Hind wings yellowish, with the veins or cellular lunule and the border broadly black, and containing a yellowish sinuous line. (Guen.).

The four following species of *Apatela* occurred on the white birch at Providence during the last week of September and beginning of October.

42. *Apatela* sp.

*Larva.*—Head large and black, rounded as usual. Body cylindrical, of even thickness throughout, densely covered above with short, evenly cropped, Scotch snuff-yellow-brown hairs, concealing the segments, and rising into a very slight median ridge. The hairs on the prothorax are in front white, especially the long ones, while four long white hairs arise from the second (meso) segment, and there are six to eight long erect white hairs arising from the back at the end of the body. On the third and sixth segments behind the head is a median short erect black spike of hairs, one-third as long as the body is thick; and at the end of the body is a double spike. On the sides of the body the hairs are seen to radiate from mammillæ, and the row of white spiracles is conspicuous. The skin is livid blue-black. Length, 50<sup>mm</sup>.

43. *Apatela* sp.

*Larva.*—Head much smaller than in some *Apatelæ*, but of the usual shape, not so wide at the prothorax, which is considerable narrower than the mesothoracic segment. The body is cylindrical, thickest a little in front of the middle, and the segments are somewhat convex and easily seen, as the segments are not concealed by the hairs. The hairs are short, stiff, and quite thick, and arise from white, rather large, mammillæ which are arranged five on a side on each segment (except the first and two last). Along the middle of the back is a clear space between the mammillæ. The hairs are whitish-yellow. The head and body are black. The mammillæ on the end of the body (8-10 segments) are reddish. There is a broad, lateral, dull, brick-red band below the spiracles, which are white. The under side of the body between the prolegs is dull reddish, but the thoracic feet and under side of thoracic segments are dark, and the prolegs are dark livid purple black. The upper surface of the prothoracic segment has three granulated swollen areas, two oral ones in front and a median one behind. Length, 35<sup>mm</sup>.

The hairs are irritating to the skin, so that these bright-colored caterpillars are not eaten by birds, though often easily found and stung by *Ichneumon*s and *Tachinæ*.

44. *Apatela* sp.

Feeding on the upper branches in full sight a peculiar and rather conspicuous caterpillar. Providence, October 4.

*Larva.*—Head large and full, nearly as wide as the body, jet black. Body long and thick, cylindrical; the three segments behind the head transversely folded dorsally. The lateral line well marked. Body and legs (all) dull black. The posterior half of each segment and the entire prothoracic with their fine white hairs giving a hoary appearance to the upper side of the body. Below the spiracles the hairs are thicker



than above, but otherwise the same. The body beneath is free from hairs and is livid black. The body tapers slightly towards the end; the anal legs are very short and the end of the body in walking is held off the surface. Length, 41<sup>mm</sup>.

45. *Apatela* sp.

The larva here described occurred on *Betula populifolia* at Brunswick, Maine, September 4.

*Larva*.—Head large, rounded, pale yellowish-brown. Body rather thick, arctian-like, white, with radiating tufts of white hairs, a few at each end longer than the others and spreading, some of which are black. A pair of mesothoracic lateral light orange-brown tufts, as long as head is wide; a double median, thicker, shorter tuft of the same color on first abdominal segment, and another just like it on the penultimate (8th or 9th) segment. Length, 24<sup>mm</sup>.

The three following species of the family *Noctuidæ* occurred at Brunswick, Me.

46. *Noctuid larva*.

*Larva*.—Body thick, a little humped dorsally near the end. Head small, not so wide as prothoracic segment. Prothoracic not so wide as mesothoracic, and metathoracic wider than mesothoracic segment.

Body of a general chestnut brown color, the surface finely granulated. Head slightly darker than the body, and with short hairs, the markings on the body obscure. Two transverse rows of black warts on the prothoracic segment, and one on mesothoracic and metathoracic; four dorsal dots arranged in a trapezoid on the abdominal segments.

Each abdominal segment with a pair of lateral, short, diffuse streaks, those on the seventh and eighth segments converging towards the little hump on eighth segment. Body and feet (thoracic and abdominal) livid green.

Length 11<sup>mm</sup>, September 14 to 20.

47. *Noctuid larva*.

*Larva*.—A singular larva, the body green, marked with red and yellow, with a short warted supra-anal horn.

Body thick, broad, slightly flattened. Head nearly as broad as the prothorax, rather deeply bilobed; green, with two broad dark velvety red transverse lines across the front; the hemispheres somewhat produced upward. Six rather large double warts (one large conical rough one), with one on the side at base; the two prothoracic ones much smaller than the four others. On the abdominal segments a low transverse dorsal ridge ending on each side in rounded conical tubercles. In front are the two small hair-bearing warts, and the large warts also bear long hairs. The body is green, color of the leaf. The abdominal segments above mottled with reddish, with a lateral line on posterior two-thirds of abdomen, inclosing the dorsal mottled and tubercled area. The supra-anal plate ends in a large stout acute granulated reddish horn held obliquely outward.

On each segment are three or four small yellowish tubercles. Body beneath pea-green. Length, 15<sup>mm</sup>, August 11, 1882.

In larger ones, 17<sup>mm</sup> long, and some smaller, the body is entirely pale reddish brown color, with no green about it; no red bands on front of head. Head mottled with yellowish brown, and body beneath in some individuals greenish yellow.

48. *Noctuid larva*.

*Larva*.—A large green-headed Noctuid; larva with ten abdominal legs. Head very large, broad, and full, much wider than the body. Four long white strips in front, and an oval lanceolate brick-red patch behind and surrounding the eyes. Thoracic feet,

green at base, marked with black and reddish. Spiracles very conspicuous; prothoracic one large and black, first abdominal black, the rest orange.

The body tapers towards the tail; pale green, wrinkled above. A broad dorsal longitudinal band, with a median fine green line which ends in a red streak on supranal plate. Lateral line folded and large, interrupted and marked irregularly with purple on the thoracic segments.

Length, 22<sup>mm</sup>, August 15 to 18, 1882; observed at Brunswick, Me.

49. *Brephos infans* Möschler.

In this case I depart from my usual rule not to mention any insect unless positively known to feed on the tree stated, since there is so strong presumptive evidence that the larva of this beautiful moth feeds on the birch in this country as well as in Europe. I observed it flying among birches at Cambridge, Mass., early in the spring of 1862 or 1863. I quote the following summary of its habits, published by Mrs. Dimmock in *Psyche* (iv, p. 273):

*Brephos infans* Moschler (Wien. entom. monatschr., Mar. 1862, vol. 6, p. 134-136, pl. 1, fig. 6). Harris (Entom. corresp., 1869, pl. 1, fig. 4) figures the imago of this species. Lintner (Entom. contrib., No. 4, 1878, p. 227-229) gives notes upon the habits of the imago which render it almost certain that the larva feeds upon *Betula*. The larvæ of the European species of this genus feed upon *Betula alba*, the larva of *Brephos parthenias* living between leaves that it spins together upon high twigs. The imagos of *B. infans* are not rare about *Betula alba*, extremely early in the spring, both in eastern and western Massachusetts.

50. *Catocala relictæ* Walk.

The subjoined summary of what is known of the habits of this moth is copied directly from Mrs. Dimmock's article on birch insects, in *Psyche* (IV, p. 273).

*Catocala relictæ* Walk. (List. Lep. ins. Brit. mus., 1857, pt. 13, p. 1192, 1193). Bunker (Can. entom., May, 1883, vol. 15, p. 100) states that *Populus* is the favorite food-plant of the larva of this species. Hulst (Bull. Brooklyn entom. soc., July, 1884, vol. 7, p. 48) says "Food-plant, white birch and silver poplar; and probably all species of *Betula* and *Populus*." The same author (*l. c.*, June, 1884, vol. 7, p. 15-16) gives structural characters and habits of the larvæ of *Catocala*. The European *C. fraxina*, regarded by some authors to be a synonym of *C. relictæ*, feeds, as larva, on *Populus*, *Betula*, *Acer*, *Ulmus*, *Quercus*, and *Fraxinus*. *C. relictæ* has been reared by C. Dimmock, in Springfield, Mass., from a full-grown larva taken under circumstances which made it almost certain that its food-plant was *Acer*.

51. *Noctuid?* or *Notodontid?* larva.

This caterpillar occurred on the white or paper birch, near the summit of Thorn Mountain, Jackson, N. H. It was mistaken for a folded leaf, and was feeding conspicuously on the tree.

*Larva*.—Body very thick and soft, tapering rapidly towards the small anal legs, which are about half the size of the others, the end of the body being often held straight out. Head large, but not so broad as the prothoracic segment; pale green like the rest of the body, with four longitudinal white bands, the outer ones extending nearly to the base of the antennæ; from and including the eyes a broad reddish white patch, and a similar patch on the side of the prothoracic segment, and a much larger one on the side of the mesothoracic segment. Body pale pea-green, nearly the

color of the under side of the birch leaf, with two parallel white dorsal stripes; four whitish yellow dots on the side of each abdominal segment. Spiracles deep orange red. Thoracic legs yellowish, each joint stained black. Length, .37.

52. *Endropia armataria* H.-Sch.

Order LEPIDOPTERA; family PHALENIDÆ.

The following account of this insect is copied from Mrs. Dimmock's Birch Insects, in *Psyche*, iv, p. 272:

*Endropia armataria* Herrich-Schaeffer (Samml. neuer. od. wenig bekannter ausseurer. Schmett., 1850-'58, pl. 65, fig. 373-374). Saunders (Can. Entom., October, 1871, vol. 3, p. 130-131; Ann. Rept. Entom. Soc. Ontario, 1871, p. 38) describes the larva of this species which he found on species of *Ribes*. A female of this species taken June 15, 1883, in Cambridge, Mass., was confined over fresh twigs of *Acer*, *Ribes rubrum*, and *R. aureum*. On June 18 she laid two rows of elongated, flattened eggs upon a leaf of *Acer*; their color was light green, but by June 20 they had become shining carmine-red, which later became dull red. The eggs were 0.7<sup>mm</sup> long, 0.5<sup>mm</sup> wide, and 0.4<sup>mm</sup> high, and were placed closely side by side in rows and gummed to the leaf. They hatched June 27. The larvæ would not readily eat leaves of *Ribes*, but ate, in order of preference, leaves of *Betula alba*, of *Acer*, and of apple. One pupated August 2, 1883, and the imago appeared August 19, 1883; the second pupation occurred August 6, 1883, but the imago did not appear until June 3, 1884; two more pupated August 17, 1883, both of which produced imagos about June 7, 1884. In this case, of the four larvæ which succeeded in producing imagos, all were subjected as nearly as possible to equal conditions, being reared in the same jar, upon the same plants, which were kept fresh with their stems in water, yet one of the imagos appeared the same fall, only seventeen days after pupation, while the three others remained about ten months in the pupal state. Those reared by Mr. Saunders hibernated as pupæ.

53. *Paraphia subatomaria* Guenée.

The caterpillar of this species appears to be a general feeder, not only living on the pine but also on the birch, according to Mrs. Dimmock, whose historical notes we copy:

*Paraphia subatomaria* Guenée (Hist. Nat. d. Ins., 1857, vol. 9; Uran. et Phal., vol. i, p. 272). A larva taken on *Betula alba*, at Belmont, Mass., August 12, 1882, pupated September 19, and a male imago emerged October 8, 1882. This larva was mistaken for a young larva of *Cymatophora crepuscularia*. Another larva, taken on the same species of plant, at Cambridge, Mass., September 10, 1882, pupated September 27, and produced a female imago October 28, 1882. A third larva taken in Cambridge, on the same plant in the fall of 1883, pupated, and would have hibernated as pupa had it not been kept in a warm room; the moth emerged during the winter. Packard (Mon. Geom. moths U. S. 1876, p. 418) writes: "The moth has been raised by Mr. W. Saunders, of London, Canada, from a 'brown geometric larva on the pine, the imago appearing June 24.'" (*Psyche*, iv, p. 272.)

54. *Ephyra pendulinaria* Guenée.

According to the following notes of Mrs. Dimmock this caterpillar appears to occur on the birch as well as the sweet fern.

"When about to transform," says Mr. Scudder, "it slings itself in a thread which crosses its body between the sixth and seventh segments, and closes its anal prolegs tightly in a mass of silk spun at this point,

and on the 17th of July changed to a pupa. On the 12th I found a chrysalis just ready to turn; it was fastened to the midrib of a leaf near the middle, with the threads of the swing well separated and well pushed under."

*Ephyra pendulinaria* Guenée (Hist. Nat. d. Ins., 1857, v. 9, Uran. et Phal., v. 1, p. 414). Packard (Mon. Geom. Moths U. S., 1876, pp. 363-364) gives a description, by S. H. Scudder, of the larva and pupa of this species; the larva fed on *Comptonia asplenifolia*. A larva of this species, taken on *Betula alba*, at Wachusett, Mass., August 26, 1882, pupated August 28, and the imago appeared May 14, 1883. (Dimmock).

*Larva*.—Light green, with longitudinal white lines, and dotted with white spots. A dorsal and three subdorsal lines; the dorsal straight, but the others broken and irregular, the stigmatal edge wrinkled, the white spots irregularly scattered. Body beneath with the white lines interrupted. The last segment, with the anal prolegs and tip of the first pair of prolegs, slightly reddish. Thoracic legs pale greenish, black at the tips. A few scattered hairs on the body. Head faint reddish, marbled with whitish, with two white stripes. Length, 0.40; thickness, 0.12 inch.

*Pupa*.—Light green, a black stripe broken twice towards the end on each side, along the hinder margin of the wing. Two protuberances, one at the base of each wing, white brownish at base; tail piece almost colorless, tip red. Abdominal segments of a lighter color than the rest, with dots of a lighter tint; anterior half of each abdominal segment punctate; posterior half minutely striate; a thread crosses the body, upon which it rests suspended; the thread splits in two, being fastened by four points. It is slightly roofed on the back. (Scudder.)

*Moth*.—Antennæ of male moderately pectinated. Body and wings white, speckled with dark gray or blackish. It differs from *E. myrtaria* in being white, with four lines on the fore-wings and by the large discal ringlets, and the mesial shade. Expanse of wings, 25<sup>mm</sup> (1 inch).

#### 55. *Boarmia crepuscularia* Treitschke.

Mrs. Dimmock, as will be seen by the following statements, has reared the larva of this species from the white birch.

*Cymatophora crepuscularia* Treitsch. (Schmett. v. Europa, 1827, v. 6, pt. 1, p. 190). Goodell (Can. Entom., Apr., 1878, v. 10, p. 67) has described the larva of this species from a single specimen taken on plum, May 30; pupation took place June 6, and the imago emerged June 19. In Europe this very variable larva has often been reared. Herr (Anleitung d. Schmett. u. Raupen \* \* \* 1833, pt. 2, p. 272) gives a good description of the larva, and states that its food-plants are *Aquilegia*, *Salix*, *Populus*, *Alnus*, *Ulmus*, *Spartium*, and *Sambucus*. Kaltenbach (Pflanzenfeinde, 1872, p. 614-615) writes: "A very common geometrid, whose larva is very differently marked according to its food-plant. On *Salix* Borkhausen found it brownish green, on Italian poplar gray green, on *Alnus* brownish gray, on *Ulmus* lighter green than on *Salix*, on *Sambucus* gray brown, etc. Treitschke's specimens, reared on plum, were yellowish. Pupation takes place under the ground; the moth appears in two generations, in spring from hibernated pupæ and again in July. The larvæ appear in June and in September." Kaltenbach (*op. cit.*, pp. 110, 234, 302, and 435) adds the following to previously mentioned food-plants: *Betula alba*, *Genista*, *Quercus*, *Rubus*, *Lonicera*, and *Ligustrum*. The larva of this species is common on *Betula alba* in eastern Massachusetts, where it is found ready for pupation as early as the middle of June. Of three larvæ taken August 12, 1882, one pupated August 29 and hibernated as pupa, developing an imago the next spring; another pupated September 2 and died later, and the third pupated September 2 and the imago appeared September 28 of the same year. Two annual broods of larvæ are therefore probable in New England, as in

Germany, but part of the second brood apparently emerge and oviposit in late autumn, while the rest hibernate as pupæ. (Psyche, iv, p. 271.)

*Moth.*—This is our most common species, and may be known by its large size, the simply pubescent male antennæ, its pale color, and the outer dentate line, that on the fore wings being less sinuous than the corresponding line in *B. umbrosaria*. The wings expand 1.50 to 1.60 inches.

56. *Rheumaptera hastata* (Linn.).

The following notes are by Mrs. Anna K. Dimmock (Psyche, iv):

*Rheumaptera hastata*, Linn. (Syst. Nat., 1758, ed. 10, p. 527.)

Schmiedlein (Naturges. deutsch. Schmett., 1805, pp. 101, 102) describes the larvæ of this species, which he states live socially upon birch between the leaves, which they spin together. Packard (Mon. Geom. Moths, 1876, pp. 165-166) quotes Newman's description of the larva, in which it is stated to feed upon *Betula alba* and *Myrica gale*. Kaltenbach (Pflanzenfeinde, 1872, pp. 413 and 599) compiles authorities for the following additional food-plants of this species: *Rhododendron hirsutum*, *Salix*, and *Faccinium uliginosum*. A larva of this species, taken on *Betula alba*, at Belmont, Mass., Aug. 4, 1883, pupated August 14, and appeared as imago May 17, 1884. This is one of the species of Lepidoptera seen in swarms in parts of the White Mountains, New Hampshire, where specimens were taken from July 8-14, 1874, in the greatest abundance.

The description of the American larva has not yet been published.\*

57. *Geometrid larva*.

*Larva.*—Body cylindrical, moderately slender. Head large, as wide as the body, vertex deeply cleft, the tubercles large, conical, pointed. Prothoracic segment broader than the body behind, swollen on each side in front. Segments transversely wrinkled. On metathoracic segment a pair of very large and very rough lateral tubercles, which are swollen, very prominent and minutely spiny, and a little darker than the rest of the body. The penultimate segment, with a low, rough dorsal hump, marked with two white conspicuous spots. Surface of the supra-anal plate rough, with flattened tubercles on the edge, which is thickened. Anal legs large and broad, the two spines large but obtuse. Body covered with fine sharp granules.

Color dull brick-red, front part of the segments dull whitish-gray, giving the body a checkered appearance. Head reddish in front, the tubercles washed with grayish-white and blackish. Length, 20<sup>mm</sup>. Brunswick, August 16.

It may be recognized by its checkered, dull, birch-red body, and very large protruding rough lateral tubercles on the hinder third of the body, and by the very large head.

58. *Geometrid larva*.

*Larva.*—Like the foregoing, but the body smooth, not granulated, and head with a hollow cleft, and body not checkered. Head as wide as prothorax, with a shallow cleft; the conical tubercles low and broad. Prothorax broad, square in front, swollen on each side into a tubercle. Body cylindrical, smooth, slightly wrinkled, but not granulated. On fifth abdominal segment a pair of small lateral smooth tubercles. A low slight rough dorsal hump on penultimate segment, but no other tubercles; supra-anal plate large and long, moderately smooth, conical edge thickened a little. Anal legs short and broad, posterior spines broad, obtuse. Brick-red,

\**Operophtera boreata* Hübn. Kaltenbach (Pflanzenfeinde, 1872, p. 599) gives *Betula* and *Fagus* as food-plants of this species. Packard (Mon. Geom. Moths, 1876, p. 199) quotes Newman's description of the larva of this species. (Dimmock.) This species has not yet been found in the larva state in America, and hence I do not agree with Mrs. Dimmock in including it in a list of American birch insects.

not checkered, with a greenish tinge, reddish above and beneath, front edge of prothorax pale. Length, 16<sup>mm</sup>. Brunswick, Me., August.

59. *Geometrid larva*.

*Larva*.—Head deeply cleft; the conical tubercles acute, scarcely as wide as the body, which is cylindrical, slender.

On the side of the fifth abdominal segment, low down, is a small greenish-red smooth tubercle. On the penultimate segment a dorsal rust-red irregular low tubercle. Supra-anal plate conical, surface rough with small hair-bearing warts.

Anal legs very large on the sides and with two large spines above. Reddish rust-red above, like the stem of a beech leaf; greenish beneath. Length 15<sup>mm</sup>. Brunswick, Me., August 11-14.

60. *Geometrid larva*.

*Larva*.—A Geometrid like a small dead and dry twig. Head broad and somewhat flattened. Antennæ very large. Head wider than the body, swollen on the sides opposite the middle of the clypeus.

Near the end of the second abdominal ring are two transversely oblong smooth tubercles connected by a ridge; these are the most prominent tubercles; on the fourth segment before the last near the hinder edge is a pair of high, slender, sharp, dark, rough points or tubercles; the pair in front of the first pair of abdominal legs is the largest, and there are numerous smaller scattered fine tubercles, giving a rough appearance to the slender body. Supra-anal plate short and rough on the surface, the anal legs very broad on the sides. The two spines unusually large. General color dark purplish brown, like a dead dry birch twig; head concolorous with the rest of the body. Length, 25<sup>mm</sup>. Brunswick, Me.

61. *Pyralid larva*.

This caterpillar was observed on the white birch at Providence, September 25, making a large loose tent of white silk open at each end.

*Larva*.—Body thick and fleshy. Head not so wide as the prothoracic segment, which is much narrower than the second segment. The head is dull amber, the body pale pink, with four very conspicuous subdorsal lunate black spots, the pair on the third thoracic segment larger than those on the second. The dorsal hairs are short, those on the side and the end of the body much longer. Length, 20<sup>mm</sup>.

62. *Teras ferrugana* (Schiffermüller.)

In Europe this insect feeds on the birch, poplar, and alder, as well as the oak. In this country Walsh has found it to be inquilinous in galls of *Cynips salices-strobiloides*. We have bred it from the white pine. (See Pine Insects.)\*

\* *Teras niveana* (Fabr.) is also found in this country; in Europe lives on the birch, and is to be looked for on that tree.

*Lozotænia musculana* Hübn. This species, which in Europe feeds on the birch, willow, and numerous other plants, is reckoned among American birch-insects, though no one in this country has yet reared it.

*Penthina capreana* Hübn, which in Europe feeds on birch and willow, has not yet been reared in this country. The same may be said of *P. dimidiana* Sodoffsky, which belongs to the same category as the three foregoing species, to which may be added *Sericoris urticana* Hübn, and *Pedisca similana* Hübn (Mrs. Dimmock, Psyche, iv, p. 241).

63. *Eccopsis zelleriana* Fernald.

According to Professor Fernald this insect feeds on the leaves of *Betula populifolia* (Trans. Amer. Ent., Soc., 1882, x, 29).

64. *Eccopsis?* var. of *permundana* Clemens.

This has been reared by Mrs. Dimmock from two larvæ taken in Cambridge, Mass., June 17, on the white birch. It pupated about June 30, the imagines emerging July 10 and 15. Clemens says of *E. permundana*:

*Larva*.—The larva binds together the terminal leaves of *Spiræa*. It is pale green, touched with yellowish at the junction of the segments; head and shield black. The larva may be taken in the middle of June.

65. *Penthina albeolana* Zeller.

The larva of this Tortricid taken by Mrs. Dimmock September 4, at Cambridge, Mass., on the white birch, pupated September 6, the moth appearing on the 24th of the following May. That it is probably double-brooded is indicated by the fact that Mr. Burgess captured a moth (from which Zeller described the species) August 15.

66. *Pædisca solicitana* Walk.

Fernald states that the food-plant of this species is the poplar-leaved birch. (Trans. Amer. Ent. Soc., x, p. 40.)

67. *Pædisca transmissana* Walk.

Mrs. Dimmock remarks that the larva of this species is common during October, about Cambridge, Mass., "when it eats out the inside of the sterile catkins of *Betula alba*. It hibernates as pupa." (Psyche, iv, p. 241).

68. *Cacoecia rosaceana* Harris.

This well-known caterpillar was found feeding on the leaves of the poplar-leaved birch in July and August, the moth appearing the first week in September. Coquillét (Papilio, May, June, 1883, iii, pp. 100, 101) describes the larva carefully and gives the names of twenty-four species of food-plants, to which Mrs. Dimmock adds *Viburnum dentatum* and *Philadelphus coronarius*. (Psyche, iv, p. 242.)

69. *Cacoecia cerasivorana* Fitch.

Professor Fernald states that this leaf-roller lives on the cherry and *Betula populifolia*. Dr. D. S. Kellicott states that this insect was, during the summer of 1882, too abundant in certain ornamental birches in Buffalo. (Bull. Nat. Field Club, 1883, p. 44.)

The four following species of leaf-rolling caterpillars (Tortricidæ) also occurred on the leaves at Brunswick, Me., in August and September.

70. *Tortrix* sp.

*Larva*.—Body slender, tapering quite regularly towards each end; head jet black; prothorax brown black; body behind a little lighter, with three dorsal whitish lines, the median the narrowest, the outer including the black warts; a lateral interrupted pale line, and below a brown whitish raised line, with a black dot on each segment; body warted much as usual. Length 11<sup>mm</sup>. Brunswick, August 11-14.

71. *Tortrix* sp.

*Larva*.—Pale pea-green, dotted with white, larger and stouter than the black *Tortrix*, of the usual form; head and prothorax clear pea-green of the same color as the rest of the body; the warts arranged as usual, but pale green and very distinct, and appearing as whitish green spots; the hairs on the end of the body very long. Length 12<sup>mm</sup>. Eats holes irregularly. Pupa in a folded leaf August 28.

The moth appeared September 2.

Two *Tachinæ* came out August 29.

72. *Tortrix* sp.

This was found eating the upper surface off a folded and curled leaf, leaving a great blotch. Brunswick, Maine, September 14.

*Larva*.—Head reddish, broad, and much flattened; on each side in front a broad conspicuous white line continuous with the front edge of the clypeus; below the line on the side is a black line; antennæ white at base.

Cervical shield large and broad, green like the rest of the body, with a lateral black line; body rather flattened, pea-green, a little dusky along the back; the suture quite distinct, paler green than the rest of the body. Length 18<sup>mm</sup>.

73. *Tortrix* sp.

This insect folds and crumples the leaf, much as does the *Aphis* on the same tree, forming a thin silken cocoon in the bottom of the fold. It avoids the light when the leaf is unfolded and is very active in its habits.

*Larva*.—Body tapering a little before, and especially posteriorly; head not quite so wide as the body; like the prothoracic shield, dusky umber color; body pale amber, with large conspicuous black piliferous warts; sutures distinct, but the segments are not prominently wrinkled; only one posterior distinct wrinkle. The warts are situated in a very short broad trapezoid and one lateral wart is seen from above. Thoracic feet black. Length 5<sup>mm</sup>.

74. *Tortrix* sp. (Fig. 177.)

Feeding on the leaves, folding over a leaf longitudinally in the middle, September 18, at Providence, the following *Tortricid* caterpillar was found. It appears to hibernate as a larva, and, after repeated attempts, I have been unable to rear it:

*Larva*.—Body very narrow, slender cylindrical; head narrow and small, honey-yellow; body tapering to the tail from behind the middle. The segments quite convex, with four dorsal large fleshy tubercles close together on the back of each segment, and two on each side, giving rise to slight hairs. The body is of a very dark olive-green. Length, 11<sup>mm</sup>.



FIG. 177.—Leaf of Poplar-leaved Birch folded by leaf-roller. No. 74.



Figures 178, 179, and 180 represent the work of three leaf-rollers not yet identified.

75. *Argyresthia gædartella* (Linn.).

The histories of this and the next Tineid have been sketched as follows by Mrs. Dimmock :

*Argyresthia gædartella* Linn. (Syst. Nat., 1758, ed. 10, p. 897.) Fabricius (Syst. Entom., 1775, p. 664) writes of this species "Habitat in Aluetis, in betulæ geminis," and Kaltenbach (Pflanzenfunde, 1872, pp. 604-605) states that the larvæ of this species live in the catkins of *Betula* and *Alnus*. Chambers (Can. Entom., August 1875, v. 7, pp. 144-145) notes the discovery of this species in North America, and, after describing the imago, adds: "The larva feeds under the bark and in the young shoots of the birch in March and April." A. Balding (Entom. Monthly Mag., February 1885, v. 21, pp. 203-206) describes the larva, which he found feeding in catkins of *Betula* and *Alnus*. (Psyche, iv, 241.)



FIG. 178.—Leaf of Yellow Birch rolled lengthwise.

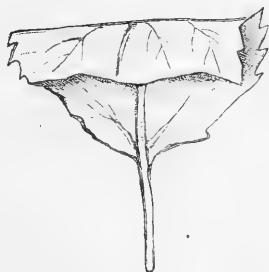


FIG. 179.—White Birch leaf rolled at the end. August 12.

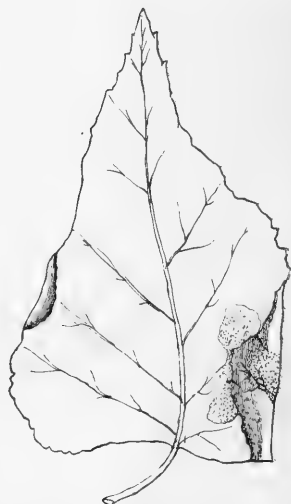


FIG. 180.—Leaf of White Birch folded.

76. *Cryptolechia confertella* Walker.

*Cryptolechia confertella* Walk. (List Lep. Ins. Brit. Mus., 1864, pt. 29, p. 563). The larvæ of this species are common upon *Betula alba* during August and the early part of September. The larva feeds in a rolled portion of the margin of the leaf, where pupation takes place, lasting from three weeks to a month. (Psyche, iv, p. 241.)

77. *Bucculatrix canadensisella* Chambers.

Regarding this Tineid, Prof. J. A. Lintner writes me as follows:

As you have published on *Bucculatrix*, it will interest you to hear that I am breeding *B. canadensisella* Chambers (Can. Ent., vii, p. 146) from the yellow birch (*Betula lutea*).

Professor Lintner has kindly sent me the following account of this insect in advance of his report contained in the Report of the Regents of

the University of the State of New York in 41st report N. Y. State Museum Nat. Hist. for 1887.

Mr. Shelby Reed, of Scottsville, Monroe County, N. Y., sends leaves of the yellow birch, *Betula lutea*, infested with a small caterpillar, which are very numerous (forty-eight had been counted on a single leaf) and eat the upper and lower surfaces of the leaves, leaving only the transparent inner tissue. "The trees infested with them have a brown and scorched appearance, and light comes down through the thickest foliage as through a softened skylight."

The caterpillar is 0.18 to 0.22 long, slender, deeply incised at the joints, tapering at the extremities, and subcylindrical; head pale brown, slightly bilobed, ocelli and mandibles black, mouth-parts projecting: body dull, pale green, bearing a few short hairs on the usual spots and longer ones on the first segment; terminal pair of prolegs projecting. Walks slowly and hangs by a thread when it falls.

A few of the larvæ had spun cocoons on the surface of the leaf when received. On the following day nearly all had made or were engaged in making their cocoons.

*The moth.*—The ornamentation of this species differs from that of any other yet found in this country, and though allied to *B. eidarella* of Europe, it is still quite distinct.

Head white, tuft tipped with dark reddish brown, and the face faintly tinged with purplish fuscous. Upper surface of the thorax brown, margined all around by white. Base of the fore wings white, followed by an oblique brown fascia, which is nearest the base on the costal margin, and is followed by an oblique parallel white fascia; all of these are placed before the middle, and are followed by a large brown patch which occupies the entire wing to the ciliæ, except that it contains a white spot on the middle of the costal margin. The brown patch is margined before on the dorsal margin of the wing by a small tuft of raised brown scales. At the beginning of the dorsal ciliæ is a white spot placed a little before, but becomes almost confluent with a longer white costal streak. Behind these streaks to the apex the wing is pale brown, with a darker velvety-brown apical spot. Ciliæ pale yellowish, with a darker brown hinder marginal line before their middle, not extending into the costal ciliæ. Hind wings pale fuscous. Expanse of wings,  $\frac{3}{8}$  inch. (Chambers.)

#### 78. *Tineid larva.*

The white silken round cocoons of this Tineid were noticed during the first week in September at Brunswick, Me., on the upper surface of the leaf of the white birch, the larva previously feeding exposed on the upper surface and eating little patches on the upper side.

*Larva.*—Body cylindrical, pale greenish; head pointed in front, much narrower than the first thoracic segment; five pairs of abdominal legs, the last pair long and slender, directed backwards. The hairs sparse, and about two-thirds as long as the body is thick, arising from whitish, distinct, piliferous warts. The segments are quite convex, the sutures well marked. Length, 5-6<sup>mm</sup>.

*Cocoon.*—Orbicular, 2 to 3<sup>mm</sup> in diameter, of white silk, inclosing the larva, which is curled up within.

#### 79. *Leaf-blotch miner.*

The blotch mines of this Tineid were observed July 6 to 10 at Brunswick, Me., on the yellow birch. Usually the larva makes one or two mines on the under side of the leaf between the secondary veins, either near the midrib or nearer the edge of the leaf. They are irregularly oval, rounded at each end, forming a brown patch about 10<sup>mm</sup> long by 4-5<sup>mm</sup> wide. On the upper side of the leaf the mine is outlined by a whitish oval line. July 10 most had left the mine, leaving a small mass of black "frass." In some cases the edge of the leaf was turned over or folded over at the apex.

*Larva*.—Head small, pointed in front, half as wide as the body, jet black. Body tapering a little from the prothoracic segment, slightly flattened; prothoracic segment large, nearly as long as wide, with a dark central patch; the second segment slightly larger than the third. Body white, with sparse whitish hairs. Three pairs of dusky legs, short, and extended out laterally. Length, 4<sup>mm</sup>.

80. *Hylotoma dulciaria* Say.

Order HYMENOPTERA; family TENTHREDINIDÆ.

Rev. T. W. Fyles found the larvæ of this species to be injurious to the birches in the vicinity of Quebec during the autumns of 1885 and 1886. The perfect insects which he bred from the larvæ appeared in July, but they probably lay their eggs in August, as it was not until that month that he found the saw-flies in their natural haunts, when they were so numerous as to be "trodden under foot by the passers-by" (Can. Ent., Feb., 1886, Mar., 1887).

*Imago*.—Pale rufous; head, wings, and feet violaceous black. Female: antennæ black, with a violaceous tinge; nasus emarginate, short; head, a spot on pectus and ovipositor-sheaths blue-black; rest of the body testaceous or yellowish red; legs steel blue; spines of the same color; wings, violaceous, subhyaline, less obscure at apex, a larger darker spot below the stigma covering the marginal and the upper half of all the submarginal cells; hind wings with but one middle cell. Wings expand about one inch. (Say.)

81. *Nematus* sp.

Order HYMENOPTERA; family TENTHREDINIDÆ.

This feeds upon the leaves late in September at Providence. It is a large saw-fly larva of the following appearance:

*Larva*.—Head black, body pale yellowish green with two subdorsal rows of eleven large black spots. Tip of body also black, two lateral rows of black spots, the lower one the smaller. Length 22<sup>mm</sup>.

82. *Selandria* sp.

I have found the larva described below feeding on the leaves of the poplar-leaved birch in August and September at Brunswick, Me.

*Larva*.—Body flattened; lateral ridge very large and prominent, spreading out on the sides, the edges scalloped. Head honey-yellow, with two large patches behind on the vertex; eyes and jaws black. Body pale honey-yellow, with a dorsal green patch on the thoracic segments. Length 10<sup>mm</sup>.

83. *Nematus* ? sp.

(Larva, Pl. IV, fig. 11.)

The gregarious larva of this unknown saw-fly occurs in abundance on the white birch at Brunswick, Me., in August. As yet I have been unable to rear it, though one spun a cocoon September 2. The body is yellowish, with five or six rows of large conspicuous black spots.

The following notes on the beetles found living on the leaves of the birch are taken bodily from Mrs. Dimmock's "Insects of *Betula* in North America," published in *Psyche*, iv, pp. 283-285. It should be

mentioned, however, that *Gonioctena pallida* has not yet been found on the birch in this country, though living at the expense of that tree in Europe; and the fungus-eating species\* as well as the Elaterid† and the species of *Ips*, ‡ which may feed on the sap of any deciduous trees, are referred to below as not being, properly speaking, birch insects:

\* *Bolitotherus bifurcus* Fabr. (Entom. Syst., Suppl., 1794, p. 40). The larvæ, pupæ, and imago of this species are found in *Polyporus betulinus*, which grows on dead birch trees. Larva, pupa, and a male imago are figured by Packard (Guide Study Ins., 1869, p. 474). Kirby, as quoted by Bethune (Can. Entom., Nov., 1873, v. 5, p. 211), says that this species is found in a boletus of the birch. Some habits of this beetle are mentioned by Harrington (Can. Entom., Dec., 1882, v. 12, p. 260-261). Candèze (Mém. Soc. Sci. Liège, 1861, v. 16, p. 365-368, pl. 3, fig. 9) gives a detailed description of the larva, with figure; and Hayward (Bull. Bost. Zool. Soc., July, 1882, v. 1, p. 35-36) briefly describes the larva and pupa.

*Hoplocephala bicornis* Fabr. (Gen. Ins. Mant., 1777, p. 215). This insect feeds upon different kinds of fungi, some of them parasitic on decaying wood of *Betula*. Kirby's description of the imago is quoted by Bethune (Can. Entom., Nov., 1873, v. 5, p. 210, 211). Harrington (*l. c.*, Dec. 1880, v. 12, p. 261) mentions its fungivorous habits.

*Diaperis hydni* Fabr. (Syst. Eleuth., 1801, v. 2, p. 585). This species, both as larva and imago, feeds upon *Polyporus betulinus*, a fungus that grows on dead trees of *Betula alba*, and the beetles, according to G. Dimmock, are often very abundant about the first of July. Harrington (Can. Entom., Dec., 1880, v. 12, p. 261) briefly describes the imago.

*Phelopsis obcordata* Kirby (Fauna Bor. Amer., 1837, pt. 4, p. 236). The larva of this species has been found by G. Dimmock, on Mount Washington, New Hampshire, in *Polyporus betulinus*, the large white fungus common on dead trees of *Betula alba*. The imago frequents the same fungus during June, July, and August.

*Thymalus fulgidus* Erichson (Germar Zeits., 1844, bd. 5, p. 458). G. Dimmock (Direct. Collect. Coleopt., 1872, p. 19, 20) writes: "The larvæ feed upon a fungus (*Polyporus betulinus*) which is parasitic upon the trunks of white birch trees." This beetle is common in New England, and its larva agrees very closely with the description and figure of the larva of *T. limbatus* from Europe, as given by Chapuis and Candèze (Mem. Soc. Sci. Liège, 1855, v. 8, p. 417-419, pl. 2, fig. 6). A large number of larvæ, taken in Belmont, Mass., produced beetles after a short period of pupation, on or about June 27, 1878.

† *Melanotus? parumpunctatus* Melsh. (Proc. Acad. Nat. Sci. Phil., Nov., 1844, v. 2, p. 151, 152). A *Melanotus*, probably this species, was taken in the same cavity with its pupal skin, in decaying wood of *Betula alba*, at Milton, Mass., Oct. 17, 1884.

*Melanotus? communis* Gyllenhal (Schönh., Syn. Ins., v. 1, pt. 3: App. 1817, p. 138, 139). A *Melanotus*, probably this species, was taken in decaying wood of *Betula alba*, at Milton, Mass., Oct. 17, 1884.

*Elater protervus* Le Conte (Trans. Amer. Philos. Soc. 1853, s. 2, v. 10, p. 471). Two specimens of this beetle were taken Oct. 17, 1884, at Milton, Mass., in decaying wood of *Betula alba*, under circumstances that left no doubt that they bred in the wood.

*Elater nigricollis* Herbst (Natur. Syst. \* \* \* \* ins.; Käfer, 1806, v. 10, p. 73, pl. 164, fig. 7). Coquillett (Can. Entom., June, 1883, v. 15, p. 101) briefly describes the larva which he obtained from decayed wood of *Quercus*. Reared from decayed wood of *Betula alba*, the beetle emerging May 3, 1883, from wood collected the preceding April, in Cambridge, Mass.

‡ *Ips sanguinolentus* Oliv. (Entom., 1780, v. 2, no. 12, p. 8; pl. 2, fig. 14). G. Dimmock (Can. Entom., April 1871, v. 3, p. 15) notes that he found this species "about fresh-cut maple and birch stumps where the sap was flowing."

*Ips fasciatus* Oliv. (Entom., 1780, v. 2, no. 12, p. 7-8; pl. 2, fig. 13). G. Dimmock. (Can. entom., April 1871, v. 3, p. 15) mentions that this species is found about fresh-cut stumps of *Betula* where the sap is flowing.

84. *Chlamys plicata* Fabr.

*Chlamys plicata* Fabr. (Entom. Syst., Suppl., 1794, p. 111). This species is sometimes found feeding, as imago, on *Betula alba*. The larvæ feed on *Quercus*, *Platanus*, *Rubus*, and *Comptonia asplenifolia*. Riley (6th Ann. Rept. State Entom. Mo., 1874, p. 128-129) describes egg, larva, and pupa; and Packard (Guide to the Study of Insects, 1869, p. 510) describes and figures the larva and its case.

85. *Telephorus bilineatus* Say.

*Telephorus bilineatus* Say (Journ. Acad. Nat. Sci. Phil., 1823, v. 3, p. 182). Packard (1st Ann. Rept. Inj. and Benefic. Ins. Mass., 1871, p. 26-28, pl. 1, fig. 7-8) describes and figures larva and imago and writes that the pupa of this species "early in May becomes a beetle, when it eats the newly expanded leaves of the birch." Riley (4th Ann. Rept. State Entom. Mo., 1872, p. 29-30) describes and figures the larva and imago, stating that the larva has been found to eat larvæ of *Carpocapsa pomonella*.

86. *Aphrastus taniatus* Gyll.

*Aphrastus taniatus* Gyll. (Schönh., Synon. Insectorum, Gen. et Spec. Curcul., 1834, t. 2, p. 460). Good description in Le Conte and Horn's Rhynchophora of Amer. north of Mex. (Proc. Amer. Philos. Soc., 1876, v. 15), p. 99. This species is not rare in Cambridge, Mass., on *Betula alba*.

## 87. THE ROSE CHAFER.

*Macroductylus subspinosus* Fabr. (Syst. Entom., 1775, p. 39). This beetle devours the leaves of *Betula alba*. Its metamorphoses were described by Harris (Mass. Agric. Repos. and Journ., 1827, v. 10, p. 1-12), and many subsequent descriptions and figures have been given, among which may be mentioned Fitch (1st and 2nd Rept. Ins. N. Y., 1856, p. 245-252), Packard (Guide Study Ins., 1869, p. 454), Riley (5th Ann. Rept. State Entom. Mo., 1873, p. 108-110), Thomas (6th Rept. State Entom. Ill., 1877, p. 103) and Lintner (1st Ann. Rept. State Entom. N. Y., 1882, p. 227-232).

88. *Dichelonycha elongatula* Schönh.

*Dichelonycha elongatula* Schönh. (Synon. insectorum, 1817, t. 1, theil 3, p. 210). Packard (Guide Study Ins., 1869, p. 454) says this species "is found in June on the leaves of the birch."

89. *Lonchæa? polita* Say.

Reared in Cambridge, Mass., from decaying *Polyporus betulinus*, a fungus parasitic on dead trunks of *Betula alba* (Mrs. Dimmock, Psyche iv, p. 241).

## 90. THE TRIPLE-ROWED SYNETA.

*Syneta tripla* Say.

Order COLEOPTERA; family CHRYSOMELIDÆ.

In May and the forepart of June, eating the leaves of this and various other trees, an oblong chestnut-brown and closely punctured beetle, with wing-covers usually pale dull yellowish except on their suture, and their punctures forming about three rows between each of the three raised lines; its length 0.25 and about a third as wide. A common insect in New York. (Fitch.)

## 91. THE VARIABLE LEAF-HOPPER.

*Athysanus variabilis* Fitch.

Order HEMIPTERA; family CERCOPIDÆ.

Puncturing the leaves and succulent shoots and extracting their juices, from the middle of June till the middle of July, an oblong oval leaf-hopper of a sulphur yellow color, its wing-covers commonly with an oblique black stripe, their tips hyaline; its thorax and scutel often tawny yellow or black; its length 0.20. (Fitch.)

This insect may every year be met with in numbers upon birch trees and also upon alders. It was once found literally swarming upon a white birch standing apart from other trees. (Fitch.)

## 92. THE SMALLER LEAF-HOPPER.

*Athysanus minor* Fitch.

From the middle of June till the middle of August, a similar leaf-hopper to the preceding, but of a cinnamon color, including its face, and having a colorless hyaline spot on the middle of its wing-covers and a larger one on their tips; its length 0.18 to 0.20. (Fitch.)

## 93. THE WINDOWED LEAF-HOPPER.

*Athysanus fenestratus* Fitch.

From the middle of June till the last of July, a leaf-hopper resembling the foregoing species, but with blackish wing-covers with similar hyaline spots and a small third one placed on the middle of the inner margin, and its forehead black with pale yellow band between its eyes; its length 0.20 inch. (Fitch.)

94. *Athysanus abietis* Fitch.

Order HEMIPTERA; family TETTIGONIDÆ.

Puncturing their leaves and extracting their juices the latter part of May and during the month of June, an oblong black shining leaf-hopper 0.20 long, tapering posteriorly, and broadest across the base of the thorax, with a light-yellow head, having the mouth black and also two bands upon the crown, the ends of which are often united, and commonly with a white streak on the middle of the inner edge of the wing-covers, its legs being pale yellowish varied more or less with black.

"I first met with several specimens of this insect eleven years since, upon the black spruce and fir balsam, on the summit of the Green Mountains, in an excursion hither with that martyr of science, the late Prof. C. B. Adams. Since then I have repeatedly captured this same insect upon birch trees, distant from any spruces, and it is possible it might have been accidentally present on these latter trees in the instance first mentioned, there being numerous birch trees in the same vicinity." (Fitch.)

95. *Enchenopa binolata* Say.

The following note is by Mrs. Dimmock (Psyche, iv, p. 241):

*Enchenopa binolata* Say (Appendix Long's Exped., 1824, p. 301, 302). Common on twigs of *Betula alba*. Riley (Amer. Entom., Aug., 1869, v. 1, p. 248) says its favorite home is *Ptelea trifolium*, but gives grape (*vitis*) and red-bud (*Cercis*) as food-plants. Its age is described in Amer. Entom., Oct., 1880, v. 3, p. 254. Lintner (1st Ann. Rept. State Entom., N. Y., 1882, p. 281-288) gives an excellent general account of imago and eggs, both of which are figured. As food-plants he adds *Celastrus scandens* and, upon the authority of others, *Juglans* and *Robinia*.

96. *Bythoscopus seminudus* Say.

Mrs. Dimmock's note on this insect (Psyche, iv, p. 241) is as follows:

*Bythoscopus seminudus* Say (Journ. Acad. Nat. Sci., Phil., 1829 [Mch. 1831], v. 6, p. 307). Fitch (4th Ann. Rept. [N. Y.] State Cat. Nat. Hist., 1851, p. 58) writes, "found on birch trees."

97. *Callaphis betulella* Walsh.

The notes on the following five insects are by Mrs. K. Dimmock (Psyche, iv, p. 240):

*Callaphis betulella* Walsh (Proc. Entom. Soc., Phil., Dec. 1862, v. 1, p. 301, 302). Walsh (*l. c.*, p. 302) says this species is abundant in Illinois on *Betula nigra*.

98. *Callipterus betulæcolens* (Fitch).

*Callipterus betulæcolens* Riley and Monell (Bull. U. S. Geol. and Geog. Surv. Terr. 1879, v. 5, p. 30, 31) [?=*Aphis betulæcolens* Fitch (4th Ann. Rept. [N. Y.] State Cat. Nat. Hist., 1851, p. 66)], said by Fitch and Monell to feed on birch leaves.

99. *Eriosoma tessellata* Fitch.

*Eriosoma tessellata* Fitch (4th Ann. Rept. [N. Y.] State Cat. Nat. Hist., 1851, p. 68). According to Glover (Rept. U. S. Commiss. Agric., 1876, p. 39) this species has been found in Maryland upon twigs of *Betula*.

100. *Hormaphis papyraceæ* Oestlund.

Found on the paper birch, corrugating them between the veins, forming long folds. (Oestlund.)

## 101. THE KATYDID.

*Phaneroptera curvicauda* De Geer.

*Phaneroptera curvicauda* De Geer (Mém. Hist. Ins., 1773, v. 3, p. 446, pl. 38, fig. 3). This species has been figured, together with the structure of its ovipositor, by Riley (6th Rept. State Entom. Mo., 1874, p. 164-166), who also gives descriptions of the younger stages and eggs. Miss Murtfeldt (*l. c.*) describes the mode of oviposition; the eggs are laid in the margin of leaves—often of oak—between the upper and lower epidermis. Although Riley writes (*l. c.*), "I have had as many as five of these eggs deposited in a single leaf, in one contiguous row, yet they are more often single," yet a single tender leaf of *Betula alba*, taken at Belmont, Mass., measuring about 8 centimeters in length, had the entire margin filled with eggs, presumably of this species. Only two or three leaves were found thus attacked, and the one of which the size is given above contained 102 eggs. (Mrs. Dimmock.)

## 102. THE RED-LEGGED LOCUST.

*Caloptenus femur-rubrum* De Geer.

*Caloptenus femur-rubrum* De Geer (Mém. Hist. Ins. 1773, v. 3, p. 498, pl. 42, fig. 5) often strips the leaves from low bushes of *Betula alba* about Cambridge, Mass. (Mrs. Dimmock.)

The following insects also occur more or less constantly on different species of birch :

## LEPIDOPTERA.

103. *Grapta faunus* Edwards.
104. *Vanessa antiopa* (Linn.).
105. *Papilio glaucus* Linn.
106. *Limenitis arthemis* (Drury). On white birch (Scudder).
107. *Lithacodes fasciola* H. Sch. (S. L. Elliot.)
108. *Adoneta spinuloides* Clemens. (S. L. Elliot.)
109. *Datana ministra* (Drury). (Mrs. Dimmock, Psyche, iv, p. 279; Riley's MS. notes.)
110. *Platysamia cecropia* (Linn). (Pergande in Riley's MS. notes.) W. Brodie.
111. *Hyperchiria io* Fabr. Brunswick, Me.
112. *Eacles imperialis* (Drury). On *Betula alba* and *populifolia*. (W. Beutenmüller.)
113. *Orgyia antiqua* (Linn.). See p. 447.
114. *Clisiocampa disstria* (Hübner). See p. 119.
115. *Selenia kentaria* Grote. (G. D. Hulst, Ent. Amer., II, 162, 1886.) See Maple Insects, p. 405.
116. An unknown caterpillar. (See Can. Ent., xviii, pp. 124-5.)

## HEMIPTERA.

117. *Tingis juglandis* Fitch. (See p. 342.)



## CHAPTER VIII.

### INSECTS INJURIOUS TO THE BEECH.

#### *Fagus ferruginea.*

The beech tree in this country seems to be remarkably favored; a fewer number of insects living at its expense than can be said of any other kind of tree so useful as this is for timber, for fire-wood, for furniture, or as a shade tree. In Europe Kalténbach records one hundred and fifty-four species of beech insects, of which sixty-seven are Coleoptera (six of these, however, are not vegetable feeders, being species of *Tenebrio*, *Mordella*, etc., and should not have been mentioned as peculiar to the tree); of Lepidoptera eighty-one species are enumerated; of Hymenoptera but a single saw-fly occurs on the tree, while there are two European species of *Cecidomyia* and two Aphidæ.

#### AFFECTING THE TRUNK.

##### 1. *Goes pulverulentus* Haldeman.

“The insect,” Dr. Horn says, “is very destructive to living beech trees. It bores into those branches which are about 3 inches in diameter. The length of the channel is about 8 inches.” Mr. Harrington thinks that it probably also bores in hickory, as he has taken several specimens on the bitter hickory in July and August.

*The beetle.*—The chief point of distinction between this species and *tigrinus* appears to be in the vestiture of the elytra and the length of the antennæ. Their size and general color are about the same, but the elytra of *pulverulentus* are uniformly clad with short hairs, and have no appearance of dark bands. The antennæ (at least in some specimens) are slightly longer than the body. (Harrington.)

##### 2. *Tremex columba* Linn.

Mr. Harrington records finding December 8 a living pupa of this insect in the heart of a green beech log over ten inches in diameter.

#### AFFECTING THE LEAVES.

##### 3. *Smerinthus*.

A species evidently of *Smerinthus* and thought by Mr. Saunders to be *S. excæcatus* has been found by Mr. E. B. Reed in September on the beech in Canada. He observed that it produced a singing noise when handled or disturbed. (Can. Ent., i, p. 40.)

*Larva*.—Head large, triangular, of a deep shining green, with lateral yellow stripes; a reddish spot at the apex, paler green and granulated on the back of the head behind the stripes. Body apple green, thickly covered with small greenish-yellow granulations; the anterior segments semi-transparent; on each side seven faint greenish-yellow oblique stripes edged anteriorly with large granulations, the central stripes having a reddish tinge; the last stripe wider than the rest and terminating at the base of the caudal horn; the latter recurved backwards at an angle of  $20^{\circ}$ , purplish red and thickly granulated; the anal plate with a central elongated black patch with a larger granulation on each side. Stigmata small, round, and dull red. Under surface slightly paler than the upper, with a darker central line. Feet pale green, spotted with red; prolegs greenish, semi-transparent. Length,  $1\frac{1}{2}$  inches.

#### 4. *Noctuid larva*.

Several specimens of this caterpillar were found on the beech at Brunswick, Me., the middle and last of August.

*Larva*.—Body Hadena-like in shape. Head brown, marbled with black, smooth, rounded, rather small, not quite so wide as the prothoracic segment; each thoracic segment successively larger than the others, the body increasing in width towards the middle, and gradually tapering to the end of the body. Surface of the body rough and granulated; abdominal segments 1 to 8 with a double dorsal and a lateral row of rough tubercles; a high, narrow double dorsal tubercle on the eighth abdominal segment. Color, reddish snuff-brown, with a black dorsal line widest on the prothoracic segment, and ending on the mesothoracic, followed by a series of seven V-shaped black dorsal median marks *en echelon*; the apex directed backwards from the double tubercle on the back. Length,  $15^{\text{mm}}$ .

#### 5. THE BEECH SPAN-WORM.

*Hyperetis nyssaria* (Abbot and Smith).

Although the alder is one of the food trees of this not uncommon inch-worm, it is known to live on the beech. The specimen reared from the alder by us is described below.

I have reared this moth from a large span-worm found on the alder September 6, at Brunswick, Me., which exactly resembled a small twig of the same shrub. It pupated September 20, in a broad flattened oval cocoon spun between the leaves, and the moth appeared at Providence in the breeding cage May 15 of the following year.

*Larva*.—Head rather small, much narrower than the body, somewhat flattened in front. First thoracic considerably narrower than the second thoracic segment; second and third thoracic segments with lateral slight swellings; the black spiracles are situated on dusky swellings; on the fifth abdominal segment is a dusky dorsal hump, edged in front with white, consisting of two rounded conical tubercles. Supra-anal plate rounded with two stiff terminal setæ; anal legs rather broad, with a setiferous fleshy conical tubercle on the upper edge. General color of head and body lilac-brown; head slightly more reddish, and on the back of each segment is a pair of whitish spots, especially distinct on the second thoracic, but wanting on the first segment. Supra-anal plate and anal legs sea-green, mottled with dusky spots. Length,  $28^{\text{mm}}$ .

*Pupa*.—Body rather thick; mahogany-brown, ends of wings and legs reaching to the posterior edge of the third abdominal segment. Terminal spine of the abdomen (cremaster) large, flattened beneath, broad, triangular; the upper and under surface with fine irregular wavy longitudinal ridges. Four lateral curved bristles and a terminal pair about twice as thick and long as the others. On the under side at the base of the spine are two orbicular areas like flattened tubercles. Length,  $12^{\text{mm}}$ .

*Moth.*—Moths of this genus have long, rather narrow fore-wings, with the apex acute, the outer edge much bent and sinuous. Fore-wings pale whitish, with fine cross specks as usual; the basal cross line is heavy on the costa and bent sharply outwards on the subcostal, with a smaller angle on the median vein and a larger angle on the submedian vein. The great but obtuse angle made by the outer line extends quite near the outer edge of the wing. Half way between the apex and the outer line two brown costal patches; two unequal black patches near the internal angle. Beneath, the lines and cross specks are reddish brown. Expanse of wings, 33<sup>mm</sup>. The specimen does not agree with either of the four figures in my Monograph of Geometrid Moths, differing especially in the shape and direction of the outer line.

According to Mr. W. Saunders, two larvæ were found by him on the beech the 10th of September, in London, Canada. Two of them entered the chrysalis state on the 19th of September, having formed a rude case in which to secrete themselves by binding two leaves together with threads of silk. One of them, he says, produced the imago on the 18th, the other on the 21st of May following.

#### 6. *Geometrid larva.*

This caterpillar was found on the beech on an island in Casco Bay, Maine, July 30.

*Larva.*—Body slender, cylindrical, smaller in the middle than at either end. Head broader than the body, full and rounded; the lateral ridge distinct. Anal legs large and broad. Supra-anal plate broad, with two horizontal bristles arising from two fleshy tubercles. The body is pale yellowish green, with no other markings. Length, 11<sup>mm</sup>.

#### 7. *Geometrid larva.*

This caterpillar occurred on the beech at Providence, May 30.

*Larva.*—Head large, broad, smooth, as wide as the body; pale green, slightly spotted with reddish. Body somewhat flattened, plain; no tubercles. Anal legs very broad and large; supra-anal plate large, broad, rounded behind, surface convex, full; prothoracic segment broad, flaring on the front edge, slightly wider than the head. Body purplish; three double blackish lines, forming a broad dorsal stripe. Behind each spiracle is an oblique raised ridge, with a black speck on it behind and below each spiracle. Supra-anal plate and anal legs greenish. Length, 13<sup>mm</sup>.

#### 8. *Cryptolechia faginella* Chambers.

The larva sews together the leaves of the beech in August and early in the autumn. We copy the following description from Mr. Chambers:

The close resemblance of some allied species makes a more detailed description of this species than that heretofore given necessary.

*Moth.*—The palpi are ochereous, with a blackish line along the under surface of the second joint, continued on to the apex of the third, and another on the outer and one on the inner surface of the third joint. *Cryptolechia (Psilocorsis) quercicella* Clem., according to Dr. Clemens, has the third joint black, with two yellowish-white stripes in front. I, however, have not seen the species, and I know from experience how easy it is to make a mistake as to the number and position of these lines. A species from Texas which I formerly (Can. Ent., vi, p. 231) identified with *faginella*, but which I now consider distinct (*vid. post*), and an undescribed species, of which a single specimen is before me, have the palpi exactly as I have described them in *faginella*—that is, the upper surface of the third joint is ochereous instead of black, as Dr. Clemens' account would make it. *C. faginella* has the head ochereous-yellow, and the thorax of the same color, only darker, as if tinged with fuscous. In

this the Texan species agrees with it. The undescribed species above mentioned, which is from Missouri, and has been bred by Professor Riley and Miss Murtfeldt from a larva feeding on *Ambrosia*, has the head darker than in *faginella*, and of the same color with the thorax. *C. quercicella*, according to Dr. Clemens, has the head and thorax yellowish-brown (as in the Missouri specimen). *P. reflexa*, as described by Dr. Clemens, has the palpi as in *faginella*, as to ornamentation; but from the fact that Dr. Clemens separates it from *quercicella* as a distinct section, characterized by the great length of the palpi, it is not necessary to refer to it further in this connection. *C. faginella* has the basal joint of the antennæ yellowish ochreous, except a wide blackish line, extending along its upper surface; *quercicella* has "two black stripes in front;" and the species from Texas and that from Missouri agree in this respect with *quercicella*. *C. faginella* and also the Texas and Missouri specimens have the stalk of the antennæ ochreous-yellow, with two blackish lines extending along the upper side of the basal half, and the remainder of the stalk has each alternate joint blackish; *quercicella* has simply "a black line above, terminating in black spots." In *quercicella* the fore-wings are yellowish-brown, varied with blackish irregular striae, chiefly from the costa, with a black dot on the end of the disk; *faginella* agrees with this description, except that I should call the ground-color of the wings dull yellowish ochreous, as they are likewise in the Missouri specimen, while in the Texas species the ground color is paler, while the transverse stripes are more distinct, showing also a tendency to become more confluent, especially about the end of the disk, where they present to the naked eye something like a faint dark fascia; *faginella* has a more silky luster than the other species, though this may be owing to the fact that the specimens are newer.

In the Texan specimens and in that from Missouri there is no spot at the end of the disk, and it is not distinct in *faginella*. In *quercicella* "the posterior margin is tipped with blackish, and the cilia are yellowish-brown, containing two dark fuscous hinder marginal lines;" in *faginella* there is a row of blackish spots around the apex and a single faint brownish hinder marginal line in the cilia (which in the single specimen before me are a little injured). In the Missouri specimen there are five very distinct blackish spots around the apex, and behind them in the cilia are two distinct brownish hinder marginal lines. Indeed, the cilia may be called brown, with a median, paler, hinder marginal line. Besides the five distinct spots, there are other very faint ones and the brownish cilia are paler than the spots. The specimens from Texas agree in this respect with that from Missouri. One of these I sent to Mr. Cresson for comparison with Dr. Clemens's type of *quercicella* in the collection of the entomological section of the Philadelphia Academy of Science (formerly American Ent. Soc.). After comparing them, Mr. Cresson informs me that it "is not *Psilocorsis quercicella* Clem., which differs by having a rather broad distinct dusky border on the apical margin of the anterior wings; otherwise they look very much alike."

The species are all of very nearly the same size—about eight to nine lines in expanse of wings. Professor Zeller (Bei. z. Kennt., 1873, p. 40) identifies specimens received by him from Ohio and Texas with *quercicella* Clem. His Texan specimens were collected in the same region of the State from which I have received mine, and as in two collections that I have received from that region there is only one species, I think the probability is that *quercicella* Zell. (*nee* Clem.) is the same species that I have referred to above, and which I formerly identified with *faginella*, but which I now incline to consider distinct, and for which I suggest the name of *cressonella*. I, however do this with some hesitation, for while, with the material before me, I consider the species distinct, I recognize the probability that, with fuller collections of bred specimens of all the supposed species, it is not improbable that they will be deemed at most only phytophagic varieties of a single species. I am not sure but that the species described by me as *Gelechia dubitella* is properly referable to this genus. (Bull. U. S. Geol. Surv., iv, 1, p. 89.)

## 9. THE BEECH LEAF-MINER.

*Brachys æruginosa* Gory.

Order COLEOPTERA; family BUPRESTIDÆ.

Dr. Harris has given in his "Treatise" an account of the larva of *Hispa* which mines the leaf of the apple tree, eating the pulpy substance between the upper and under surface of the leaf. The insect of which we now treat belongs to the family of Buprestids, several species of which, as we have seen, do much injury to our fruit and shade trees in the grub state. They are footless grubs and recognized by the broad, rounded, flattened segment just behind and partially inclosing the head. The young of *Brachys*, etc., depart somewhat from this typical form, owing to their peculiar leaf-mining habits. The first of these is the young of *Brachys æruginosa*, which has been found by V. T. Chambers, esq., of Covington, Ky., mining the leaves of the beech tree, and I am indebted to him for a specimen of the larva here figured (Fig. 181).

I may remark here that a closely allied beetle (*B. terminans*) is often to be seen in Maine resting on the leaves of the oak and beech. The beetles of this genus are flattened, angular ovate, and less than a quarter of an inch in length, and the scutellum is small, as Leconte observes, while the shanks (tibiæ) are linear. In the succeeding genus, *Metonius*, Leconte says that the body is triangular, while the scutellum is large, and the shanks are dilated.

*Larva*.—The body of the larva is rather long, with the segments very deeply cut, being flattened, and produced laterally into a triangular projection, giving a serrate outline to the body, the teeth being obtusely rounded. The segment next behind the head is the widest, the succeeding segments gradually decreasing in width and increasing slightly in length to the end. The terminal segment is about half as wide as the body in its widest portion, and is somewhat triangular, with the sides parallel, and the tip obtusely pointed. The prothoracic segment or the one next the head is broader than long, and has a fleshy projection on each side at the base of the head. On the upper side of this segment is a large, square, slightly horny area. The head is anteriorly pale honey yellow, with two dark longitudinal parallel lines; the horny portion is about as long as broad, much flattened, subtriangular. The antennæ are very minute, slender, three-jointed, with the joints nearly equal in length. The jaws and palpi are so minute that a description will be of no practical use here. The body is finely shagreened, with a few fine scattered hairs. It is whitish, with a slight greenish tinge, and a quarter (.25) of an inch long, and less than a tenth (.07) of an inch broad. It was sent to me alive in September.

The following insects also occur on the beech:

## Order COLEOPTERA.

10. *Dicerca divaricata* Say. (Fitch; and Schaupp in letter; observed by Mr. George Hunt laying its eggs in the bark in July. See also Fitch, Third Report, 48.)

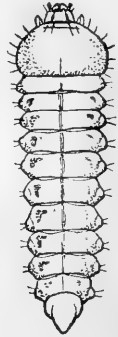


FIG. 181.—The beech leaf-miner, much enlarged.—From Packard.

11. *Chrysobothris femorata* Lec. (Riley, Seventh Report, p. 72.)
12. *Chrysobothris sex-signata* Say. One specimen cut from a beech tree in which it had bred. (Chittenden, Ent. Amer., v, p. 219.)
13. *Scolytus fagi* Walsh. (Pract. Ent., ii, p. 58.)
14. *Parandra brunnea* Fabr. (Schaupp in letter.)
15. *Osmoderma scabra* Beauv. (Schaupp in letter.)
16. *Smodicum cucujiforme* Say. (See p. 28.)
17. *Dryobius 6-fasciatus* Say. (C. G. Siewers Can. Ent. xii, p. 139.)
18. *Acanthoderes 4-gibbus* Say. Bores in dead twigs of beech. (Schwarz.)
19. *Hoplosia nubila* Leconte. "Larva boring in dry beech twigs. Detroit, Mich., Schwarz." (Riley.)
20. *Monarthrum fasciatum* (Say). Boring in living tree.
21. *Xyleborus obesus* Lec. Boring in living tree.

## Order LEPIDOPTERA.

22. *Clisiocampa disstria* Hübn. See p. 119.
23. *Actias luna* (Linn.). (Saunders Can. Ent. vii, p. 33.)
24. *Telea polyphemus* (Linn.). Providence, R. I., September 12.
25. *Hyperchiria io* Fabr. Jackson, N. H., September 10.
26. *Edemasia concinna* Abbot-Smith. Providence, R. I., September 12.
27. *Datana integerrima* Gr. and Rob. (Beutenmüller, Can. Ent., xx, p. 134.)
28. *Datana ministra* (Drury). Beutenmüller. (Can. Ent. xx, p. 17.)
29. *Eccopsis fagigemmana* Chamb. The larva lives in a case made of the outer envelope of the leaf-buds. (Chambers in letter.)
30. *Incurvaria acerifoliella* (Fitch). See p. 409.

## Order HEMIPTERA.

31. *Schizoneura imbricator* Fitch. Beech-tree blight.
32. *Schizoneura fagi* (Linn.).
33. *Aspidiotus ancyclus* Putnam.

The following notes have been received from Mr. F. H. Chittenden:

- Cyrtophorus verrucosus* (Oliv.). Bred from wood.
- Acoptus suturalis* Lec. Imagos taken from wood.
- Stenoscelis brevis* (Boh.). Breeds in wood.
- Phléophagus minor* Horn. Breeds in wood.
- Phléophagus apionides* Horn. Probably breeds in wood; beetle taken on trunks infested with *S. brevis*, *P. minor*, *Acoptus suturalis*, et al.
- Leptostylus macula* (Say). From the same tree as above; many specimens, in copula, on trunk.
- Pandetejeus hilaris* Herbst. Common on trees.
- Ithycerus noveboracensis* (Forst.). Common on trees.
- Cryptorhynchus bisignatus* Say. Taken on the trunk; probably breeds under bark.

Also *Clavicornus*, *Melandryids*, etc. Under bark.

## CHAPTER IX.

### INSECTS INJURIOUS TO THE WILD CHERRY, WILD PLUM, THE THORN, CRAB APPLE, AND MOUNTAIN ASH.

Although only comparatively few species of insects have as yet been found to prey upon the wild cherry, on the wild plum, on the thorn and wild apple, so that they are not subject to very considerable injury, yet these trees are the original food-plants of a large proportion of those which ravage our orchards, and particularly infest the apple, cherry, pear, etc. We have paid but little attention to the insects feeding on these trees, since they are of little consequence as shade or ornamental shrubs or trees, and the lists here given will doubtless be at least doubled, and it is possible that a number of well-known species have by oversight been left out of our enumeration.

The European (German) species of thorn (*Cratægus*) afford food to one hundred and four species of insects, including one species of mite. Of these there are twelve species of beetles, seventy-two of Lepidoptera, while there are six species of saw-flies, the remainder being Diptera and Hemiptera.

### INSECTS AFFECTING THE WILD CHERRY.

*Prunus virginiana, P. serotina, etc.*

#### AFFECTING THE TRUNK.

##### 1. *Cystophorus verrucosus* Oliv.

Order COLEOPTERA: family CERAMBYCIDÆ.

Mr. Harrington records the discovery of this longicorn in the wood of the wild red cherry, and "he also found a large number of larvæ which I think were of the same species, as they occupied similar cavities to that of the beetle." (17th Rep. Ent. Soc. Ontario, 1887, 17).

This beetle resembles *Euderces*, but the elytra are without ivory-like spots, and the eyes are oblique, emarginate.

##### 2. THE CHERRY-TREE BORER.

*Egeria exitiosa* Say.

Mr. W. L. Devereaux, of Clyde, N. Y., writes me that he has observed this borer in the trunk near the ground and in the bark of the roots of

young wild cherry trees. This was undoubtedly the native food-plant of this insect before the importation of peach trees.

### 3. THE CHERRY SLUG OR PEAR SLUG.

*Selandria cerasi* Peck.

Order HYMENOPTERA; family TENTHREDINIDÆ.

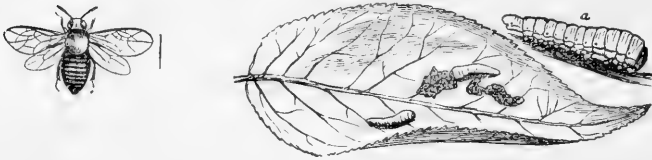


FIG. 182.—Cherry or pear slug; *a*, larva, enlarged three times.—From Packard.

Saw-fly larvæ, exactly like the pear-slug, occurred on the common thorn at Brunswick, Me., August 1, in company with two other species of *Selandria*. It also was observed in the same locality on the wild cherry August 25. The following remarks by Professor Forbes in his First Report on the Injurious Insects of Illinois for 1882, p. 98, will prove of interest in this connection:

Although this species was carefully studied and fully described by Professor Peck in 1790, and also discussed at length by Dr. Harris in his *Insects Injurious to Vegetation in Massachusetts*, I judge from numerous inquiries received this summer that it is not as well known to horticulturists in Illinois as it should be. As it has not yet been treated in the reports of the State entomologists either of Illinois or Missouri, a brief account of it and of the methods of meeting its ravages will not be without value.

This insect was quite abundant and destructive to the cherry throughout the northern third of the State during the past summer, although I neither saw nor heard of any especial injury to other fruit trees. At Elgin, on the 18th of July, several cherry trees were seen with their leaves completely denuded; and smaller numbers of the larvæ were found on the cherry at Rockford, and on the pear and cherry at Waukegan. It was also reported destructive to cherries at Montgomery, in Kane County, and was sent me by a correspondent from Aurora, on the 22d of July, where it was said to have completely defoliated the Richmond cherry, and to have somewhat injured sweet cherries, pears, and the mountain ash. The effect of this destruction of the leaves in midsummer is to compel the tree to put forth new foliage, thus taxing its vitality in a way to endanger the crop of the following year. As the larvæ return again for a second attack upon the trees in autumn, the consequences may easily become serious.

*Description and life history.*—The larvæ, or slugs, as they are improperly called, are white at first, but soon become covered with an olive slime, which gives them something of the appearance of the naked snail, to which the name slug properly belongs. They are further easily distinguished from any other larvæ feeding upon the leaf by the fact that they are much thicker in front than behind, tapering gradually posteriorly. They have twenty very short legs, the first three pairs jointed, the remainder fleshy prominences, commonly known as prolegs. The head is of a dark chestnut color, small, and usually concealed under the forepart of the body. They live mostly on the upper side of the leaves of the trees, eating away all the parenchyma, leaving only the veins and epidermis of the under side. The slugs shed their skins five times, and after the last molt they lose their slimy covering and olive color, and are



then yellow and free from mucus. From the first of July to the middle of August, having gained their growth, they leave the trees and burrow to the depth of 1 to 4 inches, forming an oval cavity in the earth, where the change to pupa occurs. From these cells they escape in the form of saw-flies from the middle of July to the last of August. The winged insect is about one-fifth of an inch in length, and is of a glossy black color, excepting the first two pairs of legs, which are a dirty yellow or clay color, with blackish thighs, and the hind legs, which are dull black with clay-colored knees. The wings are transparent, iridescent, with brownish veins, and with a smoky cloud or band across the middle of the third pair. These saw-flies may be found on the leaves of the trees in early morning or in the cool of the evening, at which time they are sluggish and not easily disturbed. Their eggs are laid singly within little semi-circular incisions through the skin of the leaf. From these a second brood of the slugs soon hatch, which get their growth and go into the ground again in September and October, remaining there until the following spring, when most of them are changed to flies and leave their winter quarters. Some of them, however, commonly remain unchanged in the ground until the following year, so as to continue the species if any complete destruction should overtake the remainder of the brood. These spring flies lay their eggs as already described, usually in June, the minute worms appearing in about a fortnight afterwards.

*Remedies.*—Various substances have been suggested for the destruction of this pest, but unfortunately some of those most generally recommended have really little effect. Among these remedies of doubtful efficiency I may mention fine sand, and dust and ashes. Some experiments made with these substances by Mr. William Saunders, of Ontario, Canada, are worth quoting entire :

“As soon as the slugs were observed at work in the spring, they were treated to a plentiful supply of dry sand, thrown up into the higher branches with a shovel, and shaken over the lower ones with a sieve, which stuck thickly to their slimy skins, completely covering them up. Thinking we must have mastered them by so free a use of this long trusted remedy, we took no further heed of them for some days, when, to our surprise, they were found as numerous as ever. The next step was to test this sand remedy accurately to see what virtue there was in it. Several small branches of pear trees were selected and marked, on which there were six slugs, and these were well powdered over—entirely covered with dry sand. On examining them the next morning it was found that they had shed the sand-covered skin and crawled out free and slimy again. The sand was applied a second and third time on the same insects with similar results, and now being convinced that this remedy was of little value, they were treated to a dose of hellebore and water, which soon finished them. Ashes were now tried on another lot, the same way as the sand had been, with very similar results. It was also intended to try fresh air-slacked lime, which we believe would be effectual, but having none on hand just then, the experiment was postponed and the opportunity of testing it lost for the season.”

A far more serviceable remedy is powdered hellebore, and an experiment with this by the same entomologist is equally conclusive :

“On the 13th of August, at 8 a. m., a branch of a cherry tree was plucked, on which there were sixty-four slugs; the branch had only nine leaves, so that it may be readily imagined that they were thickly inhabited. A dose of hellebore and water was showered on them about the usual strength, an ounce to the pailful, when they soon manifested symptoms of uneasiness, twisting and jerking about in a curious manner; many died during the day, and only six poor, sickly-looking specimens remained alive the following morning, and these soon after died.”

Unquestionably, Paris green or other arsenical poisons would be equally effective if applied to either brood of the worms; but if the trees were bearing, its use would of course be inadmissible except for the second brood. Some have also recommended shaking the flies down from the trees early in the morning, or late in the evening, catching them on cloths and taking care to destroy them before they can escape.

4. *Nematus ventralis* Say.

"From my friend, Dr. E. R. Boardman, of Elmira, Stark County, I learned," says Professor Forbes, "on the 9th June that the common willow slug (*Nematus ventralis* Say) had almost completely defoliated a fine tree of wild cherry on his grounds. The species has long been known as an enemy of the willow, but has not been heretofore reported as injurious to any fruit tree."

5. *Lyda fasciata* Norton.

Miss Murtfeldt reports in Bulletin No. 13 of the Division of Entomology, p. 59, the occurrence near St. Louis of the larvæ of a *Lyda* marked in MS. by Professor Riley, who has often taken it around St. Louis, as *Lyda cerasi*, but which, he informs me, is in all probability *L. fasciata* Norton.

This is a gregarious web-worm, and its colonies covered quite large branches with their brown, viscid webs, in which were mingled the castings and exuviae, forming altogether unsightly and disgusting masses, which greatly disfigure the trees.

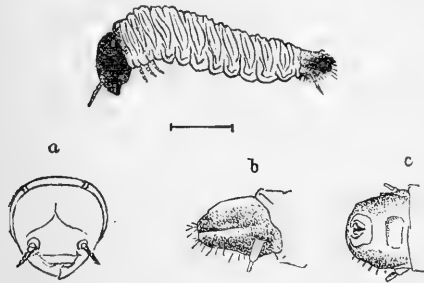


FIG. 183.—*Lyda* larva on wild cherry. *a*, front view of head; *b*, side, and *c*, upper side of end of the body. Bridgham del.

Whether it is this or another species we do not know, but Mr. Howard L. Clark has presented me with several specimens of a *Lyda* larva (Fig. 183), which he collected from the wild cherry at Warwick, R. I. The body is short

and thick, pale yellowish horn color; head and prothoracic shield blackish, as also the last segment of the body, including the slender 3-jointed caudal appendages; thoracic feet blackish. Length 11<sup>mm</sup>.

6. *Smerinthus myops* A. and S.

(Larva, Plate III, fig. 4.)

As observed by G. D. Hulst, the eggs were laid on the wild cherry in New York May 24; the larvæ hatched May 30; they molted June 1, second molt June 6, third molt June 11, fourth molt June 16, the caterpillar leaving its food-plant June 24. The moth emerged July 8, so that probably owing to the great heat of the season the whole life history of the moth was comprised in about six weeks.

I have received specimens from Miss Morton of Newburgh, N. Y., some of which in confinement at Brunswick, molted for the last time July 25, and others began to pupate, while August 3 and 6 two moths emerged after being between two and three weeks in the chrysalis state. From one of them emerged a very large ichneumon

larva. The figure on Pl. III is after a colored drawing by Maj. John E. Le Conte, which I owe to the kindness of his son, the late Dr. J. L. Le Conte. He also figured the unspotted form; in Georgia, according to Le Conte's notes, it feeds on *Cerasus virginianus*, *Cratægus*, and another plant of doubtful species ("Quercus?").

*Larva before the last molt.*—Head produced above; body pale glaucous green; two minute red-subdorsal spots on the mesothoracic segment; two large subdorsal roundish deep-red spots edged with yellow above and beneath (being situated between the yellow lateral bands) on the second and third and seventh abdominal segments; seven oblique lateral yellow lines, that one extending to and upon the horn being the most distinct; thoracic feet red. Length 30<sup>mm</sup>.

*Full-grown larva.*—With the same marks when present as in the preceding stages, but they are smaller; in two specimens there are no spots on the mesothoracic and third abdominal segments, and in another there are no red spots at all. Length 45<sup>mm</sup>.

#### 7. *Adoneta spinuloides* Herrich-Schaeffer.

This has been reared by Hy. Edwards and Elliot from the wild cherry.

*Larva.*—Whole lateral region bright apple green. The dorsal is chestnut brown, narrow on the second segment, widened on third, and still wider on fourth, fifth, and sixth. The seventh is yellowish green, thus breaking the line of the chestnut color. On segment 8 the brown markings again widen out, extending over 9, and narrowing on 10 and 11. On the sides of the back is a row of orange-red tubercles, eleven on each side, bearing very short spines, those of the posterior segments being the largest. There is also a series of non-spinous tubercles above the spiracles. Length 0.40 inch. (Papilio, iii, p. 129.)

#### 8. THE PROMETHEA SILK-WORM.

##### *Callosamia promethea* Drury.

This silk-worm is not uncommon on the wild cherry, as well as the cultivated species; its cocoons we have observed late in the autumn, both in Cambridge, Mass., and Providence. The following historical notice is copied from Mrs. Dimmock's article in *Psyche*, iv, p. 276:

*Attacus promethea* Drury (Illus. Nat. Hist. . . . 1770, v. 2, pl. 11, 12). Harris (Rept. Ins. Injur. Veg., 1841, p. 280-281) describes larva, cocoon, and imago of this species, giving *Sassafras*, wild cherry, *Azalea*, and *Cephalanthus* as food-plants; later (Treatise Ins. Injur. Veg., 1862, p. 390, 391) he repeats these descriptions, adding figures of the male and female imagos. Morris (Synop. Lepid. N. A., 1862, p. 224, 225) describes larva, cocoon, and imago, and adds *Laurus benzoin* to the food-plants. Trouvelot (Amer. Nat., Mar. 1867, v. 1, p. 31) gives a note on the cocoon, and adds *Syringa* to the food-plants. Minot (Can. Entom., May 1870, v. 2, p. 100) compiles a list of the food-plants of the larva, adding to those mentioned above, *Berberis*, *Betula*, *Acer*, *Quercus*, sometimes *Thuja*, and *Pinus*, *Fagus*, apple, peach, plum, silver-bell [*Halesia*]. Riley (4th Ann. Rept. State Entom. Mo., 1872, p. 121-123) describes the egg, five larval stages, and the cocoon, and figures larva, cocoon, and male and female imagos; he adds *Liriodendron* to the food-plants. Lintner (Entom. Contrib., No. 3, 1874, p. 126) describes egg and young larva. W. H. Edwards (*Psyche*, Jan. [27 June] 1881, v. 3, p. 161, 171-174) discusses the variability in the number of molts of *A. promethea*, showing that it molts in West Virginia only three times, thus having

four stages. Brodie (*Papilio*, May 1882, v. 2, p. 83) gives a note on times of emergence, copulation, and oviposition of this species. Saunders (*Can. Entom.*, Dec. 1883, v. 15, p. 231-233) uses Riley's figures of larva, cocoon, and male and female imago, and adds *Populus* to the food-plants of the larva.

9. *Apatela lobelia* Guenée.

Two caterpillars of this moth have been found by Prof. G. H. French in southern Illinois feeding on the wild cherry, September 19.

They pupated October 1, producing two imagines May 10 and May 19. These are interesting larvæ in both of their last larval stages, as the colors are bright. The cherry upon which they fed is the common wild black cherry, *Prunus serotina*, the larvæ resting, when found, on the upper side of the leaf.

*Larva*.—Nearly cylindrical, the body somewhat elevated in the middle, from which it tapers a little both ways; the dorsum of joint 12 with a slight elevation; eight low tubercles on each joint, from each of which arise a few spreading white hairs. Color green; a dorsal stripe that is mostly red on joints 3 and 4, and on the elevated portion of joint 12, the rest of the stripe yellow with a reddish blotch to each joint; the anterior part of dorsum of joint 2, red, separated by green in the middle, yellowish round the edges. Head slightly bilobed; the lower part reddish green, the upper part more red. Length, .80 of an inch.

September 24, they molted when they were 1 inch long, the same shape as before. Color, dark blackish brown, with a magenta dorsal line bordered each side with black, and a patch of the same color on the top of each lobe of the head. The dorsum of joint 2 is pale instead of magenta. Each joint has twelve small orange tubercles, each supporting a spreading tuft of gray hairs.

10. *Lithophane laticinerea* Grote.

The caterpillar of this moth was reared from the wild cherry by Mr. S. Lowell Elliot.

*Larva*.—Pale bluish green, whitish behind. Head bluish green, narrower than the second segment, with a lateral line of very minute black spots. A faint whitish dorsal line. The segments are slightly corrugated, with numerous striæ, and very minute tubercles on each. The spiracles are jet black, with a broad bright lemon-yellow band below them. Feet and legs bluish green. Length, 1.40 inches (Hy. Edwards and Elliot).

11. *Azelina hübnerraria* Guenée.

The caterpillar of this common moth has been raised in abundance by Miss Emily L. Morton from the wild cherry; while, as she writes me, those fed with maple leaves, said to be the usual food plant, died:

*Moth*.—Male antennæ simple, thickened, slightly ciliated; thorax pilose and the wings finely toothed. Reddish or umber brown, a band in the middle of the forewings, but slightly darker than the rest of the wing. Discal dots large, black. Expanse of wings 1.70-1.80 inches.

12. *Hydria undulata*.

(Larva, Pl. v, fig. 9.)

We have observed numbers of the caterpillars of this species on the wild cherry, which had tied the leaves together into a rounded bundle

a foot in length, as late as October 12, at Providence. Some of the leaves were dead and dry, others had been freshly tied October 5. Two or three larvæ inhabit the same leaf; the leaves are cut off at the base of the stalk, and the edges are sewed together here and there, the silk extending along the seam. October 12 several chrysalids were found in slight web like cocoons at the bottom of the breeding box.

*Larva*.—Head as wide as the body, smooth and rounded, shining, bright cherry-red; distinctly bilobed. Body smooth, scarcely wrinkled, dull black, with four equidistant much broken yellow hair-lines, being so many rows of fine dots. Lower and under side bright straw-yellow, with broken interrupted dusky lines, and including the spiracles. A longitudinal black band along the base of the legs. The yellow band above includes three black shining warts on the sides of each segment. Anal plate broad, obtuse, and black. Anal legs black above. Length, 12–13<sup>mm</sup>.

*Moth*.—Body and wings pale fawn-brown. Forewings with about twelve well marked, white, scalloped, parallel, approximate lines, becoming more deeply scalloped beyond the discal spot, which is large, black, with one of the dark lines running through it; the brown lines alternating with the white ones become blackish toward the base of the wing; the submarginal white line is more zigzag than the others, and situated half way between the edge of the wing and the next white line. On the hind wings are about six light lines, becoming whitish toward the outer edge of the wing, as well as more zigzag; the lines are heavier than on the forewings; beneath, the wings are clearer, with the lines more or less obsolete, and the discal dots large and distinct. Length of body, male, 0.50, female, 0.50; expanse of wings, 1.55 inches.

### 13. *Eupithecia*? sp.

The caterpillar described below was found feeding on the wild cherry at Berlin Falls, N. H., September 13, 1887.

*Larva*.—Eupithecia-like in shape, the body being very slender, increasing in width behind. Head as broad as the body in front, somewhat bilobed, but smooth and rounded. Body pale dull amber, with a dark square dorsal patch on each segment, and one on each side alternating in position with the dorsal ones. Two lateral linear dusky lines. Body beneath pale, with no ventral line. Length, 12<sup>mm</sup>.

### 14. *Nepticula*? *prunifoliella* Clem.

Mines resembling those of the *Nepticulæ* may be found in the leaves of the wild cherry, *Prunus serotina*, during the latter part of July and early in August. It is more or less blotchy in the beginning, with frass dispersed and towards the end gathered into a rather broad line, with the grains distinct. I have never found them tenanted, and it is quite possible that they are the work of Dipterous larvæ. The mines are reddish-brown after the larvæ leave them. (Clemens.)

### 15. *Aspidisca saliciella* Clem.

A larva of this genus mines the leaves of wild cherry in July. The mines are usually near the base of the leaf, and are more elongated than any others I have found. The mine is a short tract, not broader than the short diameter of the disk, which is cut out from the end of the

mine, the hole occupying its entire breadth. If the species is distinct, and this I am disposed to doubt, it may be called *A. pruniella*. (Clemens.)

16. *Lithocolletis crataegella* Clem.

This insect is found on the apple and wild cherry (*P. serotina*), without undergoing any variation which I can detect. I thought beyond doubt that that in the leaf of wild cherry must be a distinct species, for the larva has a habit unusual to larvæ of this group, and which I have not noticed in those on the thorn and apple, although, doubtless, they correspond. The habit I refer to, in wild cherry miners, consists in deserting an old mine to form a new one—reminding one strongly of the early habits of the *Ornix* larvæ. The larva enters along the midrib to form a new mine, which I have found in various stages of advancement, besides the old and tenantless mine in another portion of the leaf. (Clemens.)

17. *Coleophora pruniella* Clem.

The larva mines the leaves of the wild cherry early in October, when it is more than half grown.

The case is flattened, having a notch on the upper edge about one-third from the mouth, whence it is curved regularly to the hinder end, and the under edge is nearly straight from the mouth to about one-third of the length from the hinder end, where it is deeply notched and curved towards the upper edge, thus forming a tail-like appendage. On the upper edge, from the mouth of the case to the anterior notch, the edge is regularly curved. (Clemens.)

18. *Tineid larva*.

The three following larvæ were found at Berlin Falls, N. H., on the wild cherry, September 13, 1887. The present species lives in a loose white web in a folded leaf.

*Larva*.—Body tapering towards each end; the sutures rather deep. Head small, amber-colored; body uniformly deep pea-green, with four black piliferous warts on each segment, from which arise pale hairs one-half as long as the body is thick. Length, 9 to 10<sup>mm</sup>.

19. *Tineid larva*.

This caterpillar lines a crumpled leaf with white silk.

*Larva*.—Body tapering towards each end; head small, much narrower than the prothoracic segment, deep amber-color. Prothoracic segment paler green than the rest of the body, with an angular black spot on each side; rest of the body dark dull bottle-green; four large swollen dorsal tubercles arranged in a regular trapezoid, and three lateral warts, one of them bearing a large brown bristle, so that there is a lateral row of large hairs on each side. Thoracic legs blackish; abdominal legs bottle-greenish. Length, 13<sup>mm</sup>.

20. *Tineid* larva.

This species crumples the leaf on one side of the under side of a leaf, eating the parenchyma, and leaving a bare dead spot, lining the tent with a white silken web.

*Larva*.—Closely similar to the foregoing, and perhaps a pale variety of the same species, or in the penultimate molt. Body tapering towards each end. The head pale amber, and the body pale pea-green; the tubercles a little larger, but arranged in much the same way as the preceding species. The black spots on the prothoracic segment very distinct, while the dorsal hairs are as distinct as the lateral ones. Length, 10<sup>mm</sup>.

21. *Crepidodera violacea*.

Mr. W. L. Devereaux, of Clyde, N. Y., writes me that this beetle is "very plenty on new forming foliage in spring, feeding extensively on the leaves and pairing; the larva is difficult to find, but I have bred them on cherry leaves in a cage. I think this species is distinct from the willow flea-beetle *C. helxines*."

22. *Galeruca sanguinea*.

We observed this leaf-beetle in great abundance at Berlin Falls, N. H., September 13, eating holes in the leaves.

*The beetle*.—This species differs from *G. marginella*, which is figured in all its stages in our Guide to the Study of Insects, p. 505, by its deeper, brick-red color; the antennæ and legs are black, and the wing-covers are coarsely punctured. Length 5<sup>mm</sup>.

The following species also occur on the wild cherry:—

23. *Papilio turnus* Linn. On choke cherry, Scudder.
24. *Limenitis archippus* Cram. On wild cherry, Providence, May 11.
25. *Limenitis anthemis* (Drury). On Amelanchier (Scudder).
26. *Cyaniris pseudargiolus* Bd. and Lec. On Amelanchier (Scudder).
27. *Thecla liparops*. On Amelanchier (Scudder).
28. *Clisiocampa distria* Hübn. See p. 118.
29. *Apaletodes torrefacta* A. and S.
30. *Hyperchiria io* (Fabr.).
31. *Sisyrosea inornata* Grote. (Can. Ent. XXI, p. 77.)
32. *Platysamia columbia* Smith. (Can. Ent. X, p. 42.)
33. *Utetheisa bella* (Linn.). Beutenmüller.
34. *Datana ministra* (Drury.) Beutenmüller, Can. Ent. XX, p. 17.
35. *Euclea ferruginea* Pack. It is probably this species which has been found living on the wild cherry by Mr. S. Lowell Elliot.
36. *Euclea* sp. perhaps *delphinii*. Mr. H. Edwards does not know the species (S. Lowell Elliot).
37. *Phobetrum pithecius* (Abbott and Smith.) S. Lowell Elliot.
38. *Parasa fraterna* Grote. (Reared by Mr. S. Lowell Elliot.)
39. *P. chloris* H. Sch.
40. *Lithacodes fasciola* H. Sch. (S. Lowell Elliot.)
41. *Phobetrum hyalinus* (Walsh). (Proc. Bost. Soc. Nat. Hist., ix, p. 299.)

42. *Cerura borealis* Boisd. (G. H. French in Can. Ent., p. 145, 1881.)  
 43. *Telea polyphemus* (Cram.). (Riley's MS. notes.)  
 44. *Apatela furcifera* Guen. (Thaxter, Papilio iii, p. 17. No description of the larva.)  
 45. *Apatela radcliffei* Harvey.  
 46. *Iodia rufimargo* Hübn. See p. 172.  
 47. *Scopelosoma sidus* Guen. See p. 116.  
 48. *Cacæcia cerasivorana* (Fitch). (Coquillett's description of the larva, Papilio, iii, p. 102.)  
 49. *Teras logiana* (Schiff.) Wild cherry. (Clem.)  
 50. *Penthina dimidiana* (Sodoff). Wild black cherry. (Miss Murtfeldt.)  
 51. *Cacæcia argyrospila* Walk. See p. 192.

The following notes have been contributed by Mr. F. H. Chittenden :

#### COLEOPTERA.

52. *Rhyncholus brunneus* Mannh. From stumps of *Prunus serotina*.  
 53. *Phlæophagus apionides* Horn. Occurs with the above.  
 54. *Phlæotribus liminaris* (Harris). Cut from trunk of living tree.  
 55. *Dicerca divaricata* (Say). Cut from wood.  
 56. *Parandra brunnea* (Fabr.). Found under bark of domestic cherry, are very common, and there can be little doubt that, as they are both "general feeders," they will attack wild cherry trees as well.

#### INSECTS AFFECTING THE WILD PLUM.

*Prunus americana*, etc.

##### FEEDING ON THE LEAVES.

1. *Adoneta spinuloides* H.-Sch.

Order LEPIDOPTERA; family COCHLIPODIDÆ.

This Cochliopod, according to Mr. S. Lowell Elliot, feeds on the wild plum as well as the oak, birch, and cherry.

2. *Lithacodes fasciola* H.-Sch.

This Cochliopod also, according to Mr. Elliot, feeds on the wild plum in the vicinity of the city of New York.

3. *Parasa fraterna* Grote.

This slug-caterpillar or Cochliopod has likewise been found by Mr. Elliot near New York feeding on the wild plum.

##### FEEDING ON THE FRUIT.

4. *Thecla henrici* Grote.

This butterfly, says Mr. W. H. Edwards, lays its eggs fifteen in a bunch at the base of a flower stalk, on the upper side; its caterpillar feeds on the small green plums, excavating the inside leaving the



skin entire except at the entrance. The caterpillar hatches at just the right time for them to prey upon the newly formed plums. They grow with the plums, and when the caterpillars are matured the plums are of large size. The butterfly occurs in April.

The following species also occur on the wild plum :

5. *Strymon titus* (Fabr.).
6. *Incisalia irus* (Godart.).
7. *Thecla liparops*.
8. *Papilio glaucus* Linn.
9. *Papilio troilus* Linn.
10. *Chlorippe clyton* B. and Lec.
11. *Basilarchia archippus* (Cram.).
12. *Basilarchia astyanax* (Fabr.).
13. *Smerinthus myops* Abbot and Smith. On *Prunus virginiana*. (J. E. Le Conte, MS.)
14. *Halesidota caryæ* Harris. (Beutenmüller).
15. *Phobetron pithecium* (Abbot and Smith) on *Pyrus* sp. (Abbot's MS. paintings in library Bost. Soc. Nat. Hist.).
16. *Platysamia cecropia* (Linn.).
17. *Clisiocampa americana* Harris ("Castrensis," Abbot's MS. painting, Bost. Soc. Nat. Hist.) on *Pyrus coronaria* in Georgia.
18. *Schizura unicornis* Abbot and Smith. *Prunus virginiana* (Lintner, Ent. Contr., iii).

#### Order Coleoptera.

19. *Calligrapha scalaris* Lec. "Whole swarms along with their larvæ." (Walsh, Proc. Ent. Soc. Phil., 1864, p. 403).

#### HEMIPTERA.

20. *Aphis cerasicolens* Fitch. On *Prunus serotina*.
21. *Aphis cerasifoliae* Fitch. On choke cherry.

#### INSECTS AFFECTING THE SERVICE-BERRY OR JUNE-BERRY.

##### *Amelanchier canadensis*.

1. *Nepticula amelanchierella* Clem.

This is found in the leaves of the service-berry or June-berry, *Amelanchier canadensis*, in June and July. The mine is a rather broad tract, sometimes much contorted, with rather irregular edges, placed most often towards the base of the leaf and having a rather broad "frass" line of a dark-brown color. (Clemens.)

2. *Ornix quadripunctella* Clem.

Early in August the larva may be found in the leaves of June-berry or service-berry making Lithocolletiform mines on the under surface. Towards the middle of the month, it abandons its mine and feeds under

a turned-down portion of the leaf. It weaves its cocoon, which is reddish brown, during the latter part of the month.

*Larva*.—The larva is dirty greenish, with four black dots on the head and four on the dorsum of the second segment. (Clemens.)

The following insects also occur on this tree:

#### Order *Lepidoptera*.

3. *Telea polyphemus* (Cram.).
4. *Platysamia cecropia* (Linn.).

#### Order *Coleoptera*.

5. *Galeruca vittata* (Fabr). Squash beetle. Maine in April and May.

### INSECTS AFFECTING THE WILD THORN.

*Cratægus tomentosa*, etc.

#### AFFECTING THE LEAVES.

1. *Catocala cratægi* Saunders.

The caterpillar occur in Canada on the thorn in June.

*Larva*.—Head flat, medium sized, slightly hairy, grayish, with a few blackish streaks and dots; bilobed, each lobe tipped with reddish, mixed with white; these colors margined before and behind with blackish brown, in which are dots of a paler hue; sides of head pale greenish white, with a faint net-work of brownish lines. Body above greenish ash color, with many minute dots of brownish black, some of them forming indistinct and imperfect lateral streaks; dorsal line very slightly paler than the general color. Second and terminal segments with a number of small whitish dots, each emitting a single hair. On each side of the dorsal line is a row of small tubercles, those on the third segment whitish tipped with black, on fourth reddish tipped with dull white; on the remaining segments they are a little larger and decidedly red tipped with whitish. Between each of these, and running in the same direction, is a small whitish dot or minute tubercle; each and all of these tubercles emit a single brownish hair. The upper portion of the ninth segment is raised, and on its center there arises a thick, fleshy horn about one-tenth of an inch long, slightly curved backwards, of a dull dark reddish color, thickly dotted with black about the base. The usual dark patch on ninth and tenth segments is wanting, except close to the under surface, where it is faintly visible. Twelfth segment scarcely raised, with no black streak behind, but having a faint line formed by a row of black dots extending obliquely down the sides towards the front. Terminal segment flattened; lateral fringe of a decided rosy pink hue; spiracles whitish, encircled with black. Body beneath whitish-green, with a tinge of blue; a central row of brownish-black spots larger and deeper in color on seventh and eighth segments, decidedly paler on second, third, and fourth, and of a reddish-brown on segments from ninth to thirteenth inclusive. Feet pale greenish, faintly marked with brown; prolegs bluish green, hinder three pairs streaked and dotted with black.

Occasionally specimens not full-grown have been met with of a darker shade arising from their being more thickly dotted with black; in these the tubercles have been less decidedly red, while the fleshy horn approached the general color, but was thickly covered with blackish dots. Length about  $1\frac{1}{2}$  inches (Saunders).

*Moth*.—A small species; forewings sordid white, the lines distinct; basal space reddish or blackish; subterminal space somewhat darker than the median; much darker along the inner margin; transverse posterior line with lower tooth of **M** small; a heavy dark shading from **M** of transverse posterior to below the apex; little or no reddish beyond transverse posterior line. Hind wings deep yellow; median band heavy, returning to the base; margin generally slightly interrupted. Expands 40 to 50<sup>mm</sup>.

Lintner's *C. pretiosa* is a variety of this species. It has the basal space black, the lines not coalescing near the inner margin.

### 2. *Catocala blandula* Hulst.

The caterpillar was found by Mr. Saunders, of London, Canada, feeding on the thorn about the middle of June. It has also been reared by Rev. G. D. Hulst.

*Larva*.—Like that of *C. crategi*, but without the prominence on the protuberance on the eighth segment, and with one on the eleventh. (Hulst.)

Head flat, sprinkled with fine, brownish hairs; bilobed, each lobe tipped with whitish; color ashy gray, with a wide black band above extending obliquely down the sides, in which are several dull faint reddish streaks. Body above greenish gray, dotted with very minute blackish dots; on the anterior portion of the second and third segments are a few whitish dots, each emitting a single hair; a broken dorsal stripe of a paler hue imperfectly margined with black, the stripe becoming whiter on hinder portion of fifth, sixth, seventh, eighth, and tenth segments. On fifth and sixth segments are two whitish patches similar in form, almost pointed anteriorly, posteriorly enlarging with the hinder edge concave, thus giving the widened portion a bilobed appearance; posterior portion of fifth segment rather darker than the general color, with a slight purplish tint; hinder portion of ninth segment *slightly* raised and of a deeper color, the dark patch covering the anterior portion of tenth segment and extending down the sides close to the under surface. Posterior portion of twelfth segment slightly raised and margined behind with black, the same color extending obliquely down the sides towards the front. On each segment there is a small tubercle on each side the dorsal line, of a grayish hue, but so small as to be scarcely visible, excepting those on twelfth segment, which are somewhat larger. Terminal segment flattened and spreading, with a few whitish dots on its hinder portion and two reddish-brown tubercles on the anterior portion. Lateral fringe close to the under surface of a delicate, pinkish tint; spiracles blackish. (Saunders, Can. Ent., viii, 74.)

*Moth*.—This species is *C. polygama* of Grote, but not of Guenée. It is the same as *C. crategi*, except that on the forewings the base is always reddish; the **M** of the transverse posterior line with teeth nearly equal; the transverse anterior and transverse posterior lines coalescing posteriorly, and the transverse posterior line edged outwardly with reddish; also somewhat larger. (Hulst.)

### 3. *Noctuid larva*.

This caterpillar was found on the thorn at Brunswick, Maine, September 3 and 4.

*Larva*.—Five pairs of abdominal legs. Head very large and broad; flattened above and much wider than the body, which tapers from the middle to the anal legs, and is slightly contracted in front of the middle. The head is light pea-green, of the same color as the body, the antennæ very large, the long third joint whitish; the deeply-cleft labrum whitish. Along the body are two subdorsal bright straw-yellow lines, rather broad and distinct. Length 16<sup>mm</sup>.

4. *Nepticula crategifoliella* Clem.

The larva may be found in the leaves of the dwarf thorn, *Crataegus parvifolia*, from the middle to the latter part of July. The mine is rather a wide tract, not long, most often tortuous, sometimes turned back on itself, and when nearly straight, with irregular edges, having a narrow, contorted line of frass running through the middle of it. The latter half of the mine will average at least a line in width.

One larva which I especially observed mined a space of *five lines in three days*, at the end of which time it was full-grown. Previously it was not more than half-grown, and the distance mined while under observation forms nearly one-half the length of the entire mine. The larva enters the pupa state during the latter part of July. (Clemens.)

*Larva.*—The larva is rather thick, bright green. (Clemens.)

5. *Lithocolletis crategella* Clem.

The larva mines the underside of blackthorn\* during September and October. The mine is usually limited by two veins of the leaf. The imago appears in April and May.

*Larva.*—The larva is cylindrical with a very pale brown head; the body yellowish, colored dark green by the ingesta.

*Moth.*—Antennæ, front and tuft dark silvery gray; forewings rather deep brownish golden, with a broad silvery basal streak, black margined toward the costa, extending to the tegulæ in front and pointed behind, with the point black-margined on both sides and with the costa black. Four costal silvery streaks, the first oblique but rounded beneath and black-margined on both sides, the others toward the base alone. Three silvery dorsal streaks, the first rather broad, oblique, nearly touching the first costal, and black-margined on both sides, as also the second; the third only toward the base. A streak of black scales in the middle of the wing at the apex, extended backwards between the streaks to the second dorsal and costal. Hinder-marginal line blackish, with a violet metallic hue; cilia dark fulvous. (Clemens.)

6. *Ornix crategifoliella* Clem.

The larva mines the leaves of *Crataegus tomentosa* (blackthorn) in September, and becomes a pupa early in October, weaving a reddish-brown cocoon in a turned-down edge of the leaf. The pupa case is thrust from the end of the cocoon at maturity, the imago appearing early in May. There is, doubtless, a summer brood, but I have not sought for it.

*Larva.*—The head of the larva is brown, the body greenish-white, with the dorsum reddish-brown.

*Moth.*—Labial palpi whitish. Head dark brown and gray intermixed. Antennæ dark brown, faintly annulated with whitish. Forewings dark brown, with a purplish hue. Along the inner margin, from the base to the anal angle, whitish, dusted with dark brownish. In the fold at the base is a dark-brown streak, and a small blotch of the same hue beyond the middle, nearly reaching to the inner margin. Toward

\* In Asa Gray's Manual of the Botany of the Northern United States the name of "black or pear thorn" is assigned to *Crataegus tomentosa*.—H. T. Stainton.

the tip are a few whitish, costal streaks, and at the apex a small, round, dark-brown spot, in a whitish patch, with a circular, dark-brown apical line behind it; cilia, blackish-gray. Hindwings blackish-gray; cilia, rather paler. Abdomen blackish, tipped with dull yellow.

7. *Conotrachelus cratægi* Walsh.

Order COLEOPTERA; family CURCULIONIDÆ.

The late B. D. Walsh found this weevil abundant near Rock Island, Ill., on the hawthorn, also plentifully on the same kind of shrub, near Chicago. (Proc. Bost. Soc. Nat. Hist., ix, 311.)

*The beetle.*—Of the size, shape, and sculpture of *anaglypticus* Say, but differs in the elytra being of a uniform color, mottled with ocher-yellow and white, and in the upper surface of the thorax being whitish, except a large and conspicuous triangular spot at its base, and the anterior margin, which, as well as the inferior surface, is brown. The second tooth on the femora is obsolete.

8. THE BUFFALO LEAF-HOPPER.

*Ceresa bubalus* Fabr.

This singular but very common leaf-hopper, according to Fitch, frequents the wild thorn, and has been found by Mr. John G. Jack to be positively injurious to young apple and pear trees, as they cut the bark when depositing their eggs. "These incisions and the eggs in them were so numerous that in many cases it was impossible to raise the bark for the purpose of budding the trees. The incisions and eggs are usually most abundant on the south and upper side of the limbs, comparatively few being found on the shady or under sides." They begin depositing their eggs, adds Mr. Jack, at Chateauguay, Quebec, August 12, the process going on until the close of October.

*The eggs*, in batches of from five or six to a dozen (rarely more), are deposited obliquely in the bark, and often the incision continues into the wood, if the bark is thin. In this way the bark and wood become fastened together, and will not separate at any season, and the dark spots in the wood and the rough knotty bark bear evidences of the injuries for many years.

The eggs are of a dirty transparent white, about 1.5<sup>mm</sup> in length, smooth, slightly tapering, and sharply rounded towards the interior end, but tapering much more gradually at the exterior end. Although normally round, the sides are generally found to be more or less flattened by pressure from the tissues of the wood and bark of the tree. So numerous were these eggs on some trees that a careful estimate shows that there must be at least from six to eight hundred eggs in a section of the branches not more than an inch long and half an inch in diameter.

They hatch during the first week in June.

A small dipterous egg-parasite has been raised from the eggs by Mr. Jack.

The following insects also live on the thorn:

9. *Basilarchia astyanax* (Fabr.).
10. *Basilarchia arthemis* (Drury).
11. *Uranoles melinus*, on *C. coccinea* and *C. apifolia* (Scudder).

12. *Thecla liparops*.
13. *Thecla calanus* Hübn.
14. *Papilio turnus* Linn. Larva, September 5, at Brunswick, Me.
15. *Thecla falacer* Godart. Harris Ins. Mass., 276.
16. *Thyreus abbotii* Swains. Said in Abbot's MS. paintings to feed on *Cratægus tomentosa* in Georgia. (Library Bost. Soc. Nat. Hist.)
17. *Smerinthus myops* A. and S. See p. 525.
18. *Schizura unicornis* (A. and S.). On thorn-bush at Brunswick, Me., September 5.
19. *Schizura* sp. On thorn-bush at Brunswick, Me., September 5.
20. *Oedemasia concinna* A. and S. (Sanders, Can. Ent., xiii, 139.)
21. *Clisiocampa distria* (Hüb.). See p. 119.
22. *Datana integerrima* G. & R.
23. *Spilosoma virginica* Fabr. On buckthorn, middle of September, Maine.
24. *Orgyia antiqua* Linn. Injurious to thorn hedges in Rhode Island, Miss Dix, Amer. Journ. Sc., xix, p. 62; also observed at Brunswick, Me.
25. *Platysamia cecropia* (Linn.). W. Brodie.
26. *Telea polyphemus* (Cram.). (Riley's unpublished notes.) W. Brodie.
27. *Amphipyra pyramidoides* Guen. See p. 171.
28. *Eubyja quernaria* (A. and S.) On *Cratægus australis*. See p. 188.
29. *Nematocampa filamentaria* Guen. On *C. australis*.
30. *Grapholitha prunivora* Walsh. Living in the fruit, J. Hamilton (Can. Ent., xxi, 34).
31. *Aspidisca splendoriferella* Clem. Larva and mine as in *P. serotina*. (Chambers.)
32. *Tischeria malifoliella* Clem. Larva in a flat, trumpet-shaped, yellowish mine in upper surface of leaves. (Chambers.)
33. *Ornix inusitatumella* Chamb. Larva in white, flat mine, speckled with "frass" in upper surface; pupates in the mine. (Chambers.)

#### Order COLEOPTERA.

34. *Saperda bivittata* Say. On hawthorn.
35. *Anthonomus crataegi* Walsh. (Proc. Ent. Soc. Phil., vi, 1866, p. 266.)
36. *Saperda fayi* Bland. J. Hamilton, (Can. Ent., xx, p. 6, 1888).
37. *Xylotrechus convergens* Le Conte. Bred from branch of an undetermined *Cratægus*, locally known as Red Haw, Iowa. (Le Conte, Trans. Amer. Ent. Soc., viii, p. xxiv.)
38. *Gaurotes cyanipennis* Say. In spring on thorn blossoms and later in the season pairing and ovipositing on the butternut. (Caulfield, Can. Ent., 1881, p. 60.)
39. *Conotrachelus naso* Lec. This and the next species bred from the fruit of the haw. J. Hamilton. (Can. Ent., xxi, p. 34, 1889.)
40. *Conotrachelus posticatus* Say.

## Order HYMENOPTERA.

41. *Crepidodera helxines* (Linn.). Eating leaves of *Cratægus coccinea* (Townsend, MS. notes).  
 42. *Selandria cerasi* Peck. Observed on the thorn late in summer at Brunswick, Me.

## Order HEMIPTERA.

43. *Aphis cratægifolii* Fitch. On leaves of *C. punctata*. (Fitch.)  
 44. *Siphonophora cratægi* Monell. July, St. Louis. (Monell.)  
 45. *Schizoneura cratægi* Cestlund.

## Class ARACHNIDA; order ACARINA.

46. *Acarus? cratægi-vermiculus* Walsh MS. Occurs abundantly both on *Cratægus tomentosa* and *crus-galli*. (Proc. Ent. Soc. Phil., vi, p. 227.)

## INSECTS INJURIOUS TO THE CRAB-APPLE.

*Pyrus coronaria* Linn.

## AFFECTING THE LEAVES.

1. *Catocala grynea* (Cramer).

The caterpillar of this moth has been found by Mr. Koebele to feed on the crab-apple.

*Larva*.—General color silvery gray with a reddish cast. Eyes marked at summit with a lunule of yellowish white, and this lined behind with rust-red extending nearly to the mouth. Body more reddish towards the head. There is a very prominent protuberance of a rust red color at the summit of the twelfth segment. The red is very pronounced at the summit of the legs on the ninth and tenth segments. (Koebele, Bull. Brooklyn Ent. Soc., iv, p. 22.)

2. *Basilarchia archippus* on wild plum. (Scudder.)  
 3. *Basilarchia astyanax* on wild plum. (Scudder.)  
 4. *Aphis mali* Fabr.

## INSECTS INJURIOUS TO THE MOUNTAIN ASH.

*Pyrus americana*.

## AFFECTING THE LEAVES.

1. THE SCURFY BARK LOUSE.

*Chionaspis furfurus* (Fitch).

The following account is copied from Professor Comstock's Report for 1880, p. 315:

Harris described it on apple and pear in Massachusetts; Dr. Fitch found it on pear and choke cherry in New York; Walsh observed it on

apple, crab, and the European mountain ash (*Sorbus aucuparia*) in Illinois; and I have found it common in apple and pear in New York, Maryland, and southern California, and upon black cherry in western New York.

Although this insect has been well known for many years, comparatively little has been written respecting it. This is probably due to the fact that there is another species (*Mytilaspis pomorum* Bouché) which, like this, infests the apple, and which is more common and much more destructive. The scurfy bark-louse was first described, but not named, by Harris in his "Insects Injurious to Vegetation" (Flint edition, p. 254). In this description both the scale formed by the male and that formed by the female are well characterized; but the insects themselves were not studied by Dr. Harris. The description of the scales is remarkable as containing an explanation of their nature and probable mode of formation as follows: The minute oval dark colored scales on one of the ends of these white cases are the skins of the lice while they were in the young or larva state, and the white shells are probably formed in the same way as the down which exudes from the bodies of other bark lice, but which in these assume a regular shape, varying according to the sex and becoming membranous after it is formed." This statement must have been overlooked by Dr. Fitch, who many years afterwards, in his first report as State entomologist of New York, p. 739 (35), in writing of the oyster-shell bark louse of the apple, states that "these scales are the relics of the bodies of the gravid females, covering and protecting their eggs." And in his second report, p. 489 (257), Dr. Fitch, in describing the pine-leaf scale (*Mytilaspis pinifoliae*) states that the three parts of the scale represent seemingly the head, thorax, and abdomen of the living insect.

Through the kindness of Mr. Lintner and the officers of the New York State Agricultural Society I have had the opportunity of studying the Coccidæ in the collection of that society. The specimens were all labeled by Dr. Fitch, and by a very careful study of both the scale and the last segment of the female, of the specimen labeled *Aspidiotus cerasi*, I have been unable to find any character which will separate it from the specimens labeled *Aspidiotus furfurus*, and all of these specimens belong to the same species as the very common pest of the apple and pear, which has been commonly known as *Aspidiotus harrisii*.

The statement made by Signoret\* that this species is the same as that described by Curtis under the name of *Aspidiotus* (*Diaspis*) *ostreæformis* is evidently a mistake. M. Signoret has kindly sent me specimens of *D. ostreæformis*, from which I have prepared the description of that species in this report.

*Scale of female.*—The scale of the female is flat, irregular in outline, many bending abruptly to the right or left immediately posterior to the second larval skin, others straight; in all the scale suddenly widens near the posterior end of the second larval

---

\*Annales de la Société Entom. de France, 1876, p. 604.



skin, thus presenting the form characteristic of the genus; length,  $2^{\text{mm}}$  to  $3^{\text{mm}}$  (.08 to 12 inch); color grayish white with the first skin light gray and second skin usually brown, sometimes dark gray.

Described from many isolated individuals occurring on smooth bark of a small branch. On the rough bark of the trunk the scales are much more irregular in form, and are so massed as to appear like a layer of dandruff.

*Female*.—The body of the female is red, with the last segment light yellow; this segment presents the following characters:

The anterior group of *spinnerets* consists of from eight to thirteen, usually ten; the anterior laterals are from twenty to thirty; and the posterior laterals are from eighteen to thirty-one.

There are three pairs of *lobes*. The median lobes are well developed; the second lobes are smaller, the third are still smaller, being sometimes obsolete; the lobes of the second and third pairs are deeply incised. There are conspicuous elongated pores upon the margin; one laterad of each of the first, second, third, and fourth plates; one cephalad of the incision of third lobe; and one midway between the third and fourth plates.

The *spines* upon the ventral surface are inconspicuous; the first pair obsolete; the second, third, and fourth pairs at or near the bases of the second, third, and fourth plates. Those upon the dorsal surface are quite long; the first spine of each side is between the bases of the first lobe and the first plate; the second and third spines are upon the lateral lobule of the second and third lobes; and the fourth spine is situated about two thirds distance from the third to the fourth plates.

*Eggs*.—The eggs are purplish red.

*Scale of male*.—The scale of the male is very small, being only  $.75^{\text{mm}}$  (.03 inch) in length, narrow, usually straight and tricarinated; larval skin brownish yellow, remainder of scale snowy-white.

*Male*.—Yellow marked with irregular reddish-brown spots; thoracic band reddish brown, sometimes darker than the other markings. Length of body including style,  $.62^{\text{mm}}$  (.02 inch); length of style,  $.18^{\text{mm}}$  (.006 inch). On each side of the anterior part of the thorax there is a black spot which resembles an eye.

## 2. *Dynastes grantii* Horn.

A beetle supposed by Dr. Horn to be this species has been found by Mr. J. Doll to occur in September on the mountain ash in Colorado. "They are always found near the tips of branches, where by means of their projecting thoracic horn they scrape through the soft bark to cause a flow of sap which is very sweet, and of this consists their food." (Bull. Brooklyn Ent. Soc., vii, pp. 120, 151.)

The following insects also occur on the mountain ash:

3. *Apatela occidentalis* G. and R.
4. *Chrysobothris femorata* Fabr. (Harris Correspondence, 311.) See also Bethune (Can. Ent., v, p. 140).
5. *Saperda bivittata* Say. Apple-tree borer.
6. An unknown longicorn borer taken from a tree on Lake Kennebago, Maine, September 4, 1887.
7. *Mytilaspis pomicorticis* Riley.

## CHAPTER X.

### INSECTS INJURIOUS TO THE ASH.

#### *Fraxinus americana*, etc.

Although only about forty-six species are as yet known to prey upon our native species of ash, the number is probably at least as great as that given by Kaltenbach as affecting the ash in Europe, viz, fifty-one. Thus far no species of dipterous gall flies or of Psyllids has been detected on our native species. My own opportunities for observing this tree have been limited, but during September, 1887, I was able to discover seven species new to the tree, living on young bushes on the northern shore of Rangeley Lake, Maine. When used as ornamental or shade trees the different species of ash appear to be in general quite free from insect pests.

Ash lumber does not seem, so far as we know, to be commonly attacked by borers, the only case known to us being that of *Eburia quadrigeminata*, described below by Mr. McNeil. Ash wood is used for carriages, furniture, as well as fence rails, and is a most valuable tree, besides being a beautiful, clean, shade tree.

#### AFFECTING THE TRUNK AND BRANCHES.

##### 1. THE ASH SESIAN.

#### *Fatua denudata* (Harris).

The following account of the habits of this borer has been communicated to me by Mr. W. L. Devereaux, of Clyde, N. Y. :

The *Ægeria denudatum* certainly does great injury; it is more abundant in some swamps than others. It channels its cylindrical burrow from the tap-root directly up the trunk sometimes to a height of 3 or 4 feet, before turning and cutting its way out. The perpendicular burrow is never situated in the center of the tree, but is generally nearer the bark than the heart. The upright or vertical part of the channel is as perfectly made as with a brace and bit. Through this initial invasion, wood ants, members of the Rhynchophora, Cerambycidae, Lamellicorns and Sericorns, obtain a foot-hold, and ere many years we have a hollow ash tree. Some of the Capricorn larvæ are channeling up the heart while certain Xylophagæ are boring into the same decaying sap-wood, and even into living healthy wood, until the merest shell remains to support the still vigorous branches above. The Osmo-dermas, Diaperidii, Tenebrionii, Elateridæ, etc., follow on till the fatal storm-blast gives them the whole remaining trunk and top for larder and shelter, lasting many future broods.

I think the alder must be considered the favorite host of the *Ægeria* (*Fatua*) *denu-data*, as ash trees in swamps not containing alder are almost exempt from their attacks, while no clump of alder is without evidence of their work.

2. *Eburia quadrigeminata* Say.

Order COLEOPTERA; family CERAMBYCIDÆ.

Under the heading "A remarkable case of longevity in a longicorn beetle, *Eburia quadrigeminata* (American Naturalist, xx, p. 1055), Mr. J. McNeil writes as follows:

On the 11th of July, 1886, I caught at sugar, which had been placed upon apple trees for the purpose of attracting moths, a light brown long-horned beetle, marked with ivory-yellow spots on the elytra. My attention was particularly attracted at this time to the insect on account of a peculiar creaking sound which it began as soon as I picked it up. I had no difficulty in finding that the sound was produced by the rubbing of the posterior margin of the prothorax upon the anterior margin of the mesothorax. The same sound could be made after the insect was dead, by working backward and forward its head and prothorax. Several days after this occurrence I captured a specimen, similar to the first, upon the clothes of a friend, but it disappeared before I reached home. On the 17th of July I found a third specimen on a tree but a few feet distant from that upon which I discovered the first specimen; this individual was also evidently attracted by the sugar. Five days later, July 22, 1886, another specimen came into my possession under much more remarkable circumstances. Dr. Boyd, of Dublin, Wayne County, Ind., called my attention as I was walking along the street, and at once proceeded to remove two small corks with which he had closed two openings in the door-sill of his office. He then requested me to explain what had made the tunnels that evidently extended some distance into the sill. In reply to my questions, he stated that his attention had been called to the freshly made openings early in the morning; at that time the holes were much smaller, and were ragged around the edges. These rough edges he had smoothed with a knife so he could stop them tightly with corks. A short time after he made the discovery mentioned, his attention was attracted by a buzzing noise which came from one of the tunnels. This he put an end to by pouring chloroform into the opening, and then plugging it up with a cork. There had been no sound of life from the other tunnel, but he had closed it in the same manner. Upon hearing this I removed the cork from the tunnel where the sound had been heard, and in a moment dragged out by its antennæ a beetle, similar to those whose capture I have already described. This beetle is *Eburia quadrigeminata* Say.

A closer examination of the tunnels in Dr. Boyd's door-step showed that the external openings were in the middle of the length and breadth of an ash door-sill and about 4 inches distant from each other. The size of the tunnels increased rapidly within until the diameter was three or more times as great as at the exit. They extended downward and backward, respectively, 3 and 4 inches. The sill was of painted ash and it as well as the whole building rested directly upon a solid brick foundation. After having completed the above observations, I did not hesitate long in coming to the conclusion that the eggs which had produced this beetle and its fellow that had made good its escape were laid in the green wood in the tree. In response to my questions, Dr. Boyd made the statement that the building was erected in the spring of 1867. This would make these insects not less than nineteen, and probably twenty or more, years old, since the timber was dry when put into the house.

Professor Thomas states that its larva lives and bores in the honey-locust (*Gleditsia triacanthus* Linn.), and from this fact it gets its name of the honey-locust borer.

*The beetle.*—Body entirely pale yellowish brown; antennæ hardly more obviously hairy on the basal joints than on the others; thorax with two black tubercles above,

rather before the middle, placed transversely, and a short spine each side on the middle of the length of the thorax; elytra rather paler than thorax, each with two double, somewhat elevated, bright-yellow, abbreviated very short lines; the two members of the basal spot equal, the other spot is placed on the middle, the inner member is shorter than the exterior one; tip two-spined, the exterior spine the longest; intermediate and posterior thighs two-spined at tip, the inner spine rather the longest. Length .75 to 1 inch. (Thomas, "Sixth report of the Illinois State Entomologist.")

### 3. *Carmenta frazini* H. Edwards.

No account of the habits of this Sesian borer has been published so far as we can learn. It occurred at Washington, D. C. (C. V. Riley.)

*Moth*.—Wholly bronze-black. Fore-wings with a very small vitreous dash near the base and a bright orange discal dot at extremity of cell. Costal margin greenish-black, a purplish tint on the posterior margin. Hind wings vitreous, rather narrowly margined, with a bunch of whitish hairs at their base. Under side of wings a little more golden than the upper. Antennæ, palpi, femora, tibiæ, and tarsi brownish-black. Abdomen with no trace of bands, except on posterior margin of fourth segment, beneath which is pale yellow. Caudal tuft small, brownish beneath, black above. Expanse of wings, 16<sup>mm</sup>. (Edwards.)

### 4. THE SYRINGA BORER.

*Podosesia syringæ* (Harris).

Order LEPIDOPTERA; family SESIADÆ.

This borer has been found by Mr. Hulst to be a pest to ash trees in Brooklyn, and by Mr. H. Osborn it has been observed boring in the young shoots of a species of ash, in Ames, Iowa. The larva, according to Harris, usually bores into the Syringa. In Buffalo Dr. Kellicott finds that it lives under the bark of the old trees. "He has observed a number of the trees, has seen the pupa cases projecting, and has watched twenty or more [issue] from a single tree in a single day. Often one hundred or more were in a single tree." (Ent. Am., i, p. 177.)

*Larva*.—Yellowish-white. Head about two-thirds the width of the prothoracic segment, chestnut-brown, with the mouth-parts pitchy above, whitish beneath, very shiny, and with a deep triangular depression in front. Second segment yellowish, with a waved brownish line posteriorly. Each of the segments bears about eight short brownish hairs. The third segment is slightly broader than the rest, swollen, as it were, at the sides. The spiracles are small, brown, those of the second and twelfth segments being larger than the rest. The anal segment is slightly yellow, with many short brownish hairs. All the feet and legs pale pitchy. Length, .80 inch. (H. Edwards.)

*Moth*.—Brown; fore-wings with a transparent line at base; hind wings transparent, with a brown border, fringe, and subcostal spot. Antennæ, palpi, collar, first and second pairs of tarsi, and middle of the intermediate tibiæ, rust-red; middle of the tibiæ and the tarsi of the hind legs, yellow. Expands 1.20 inches. (Harris.)

### 5. *Gortyna nitela* Guenée.

Order LEPIDOPTERA; family NOCTUIDÆ.

The caterpillar of this moth, which often bores into the stalks of the dahlia and aster, has been observed by Mr. Osborn boring in young twigs of ash, causing the death of many twigs, but he failed to rear

the moth on account of parasites. Miss Murtfeldt has observed the same caterpillar in the twigs of the maple (*Acer dasycarpum*). It seems to bore indifferently into any plant with a soft stem or twig. (Can. Ent., xv, p. 174.)

#### 6. THE ASH TREE CLYTUS.

*Neoclytus caprea* Say.

Order COLEOPTERA; family CERAMBYCIDÆ.

Under the name of ash-tree borer Mr. C. Thomas, besides stating that the larva of this species bores in the ash, adds that it is "quite common in southern Illinois."

Mr. Shelby Reed, of Scottsville, N. Y., in 1880, refers briefly, in the American Entomologist, to "the wide-spread destruction of the black ash forests" in his vicinity, and speaks of the web-worm (*Hyphantria cunea*) and a root-borer as affecting them. Professor Riley, the editor of the journal, in commenting on his letter suggests that the injury was due rather to the root-borer (probably *Neoclytus caprea* Say) than to the web-worm.

*Beetle*.—Dark brownish-purple head; and thorax darkest; eyes nearly circular, behind them a narrow yellow border; thorax barrel-shaped, deep purple, surrounded by three very narrow yellow lines, one at each end and one in the middle; scutel yellow; wing-cases crossed by three yellow bands; first, a semi-circular band from the scutel running backwards and round up to each shoulder; then another of similar shape about the middle, with the circle reversed; then a straight band, and a strong spine at the tip of each; length, half an inch; width one-seventh of an inch.

#### 7. *Tylonotus bimaculatus* (Hald.).

Order COLEOPTERA; family CERAMBYCIDÆ.

This beetle was by its original describer, Haldemann, said to inhabit the ash, and Mr. A. S. Fuller, according to Riley, also reports it as living in the black ash. Mr. Bland (Proc. Ent. Soc. Phil., i, p. 59) records it as "found under the bark of the tulip-poplar."

*Beetle*.—The genus *Tylonotus* is allied to *Elaphidion*, but differs according to Le Conte in the femora being strongly club-shaped, and the antennæ bisulcate.

#### 8. THE ASH TIMBER-BEETLE.

*Hylesinus aculeatus* Say.

Order COLEOPTERA; family SCOLYTIDÆ.

Ash posts in Kansas have been found by Mr. W. Knaus to be tenanted by this borer, though no growing trees were found which had been attacked, those only having been selected which were already in a decaying condition.

"The burrows of this insect were almost *fac-similes* in every particular, consisting of a large central channel from 25 to 100<sup>mm</sup> in length and 1<sup>mm</sup> in width, made by the female, the young larva eating its way out-

ward from this channel, the larval channels constantly enlarging during the larval life, and sinking a little deeper in the wood as the pupa state is reached. These larval channels are from 5 to 45<sup>mm</sup> in length, and from one-third to 1<sup>mm</sup> in width. The central channel is usually slightly sinuous, being governed to some extent by the surface of the wood and the number of beetles at work, they never coming in contact. At about midway of the central channel there is in every instance a change of direction—a curve sometimes hardly perceptible, at other times and usually very marked. The lateral larval channels extend outward at right angles from the central channel, and are about one-third the length of the former, that varying from one to three inches in length.

“In November, 1885, live specimens of this insect were taken from ash trees in the western part of Davis County. The bark of these trees had apparently been abraded about a month previous, and had been at once attacked by *Hylesinus aculeatus*. Large numbers of these had eaten their way from one-fourth to one inch under the bark from the point of entrance and had gone into similar quarters.” (Ent. Amer., ii, 1886, p. 76.) Mr. W. L. Devereaux, of Clyde, N. Y., writes me regarding this beetle as follows :

*Hylesinus aculeatus* does not operate on living trees in its larval state, but the beetles do, and of course the more ash trees cut for rails, etc., the more rapidly will the beetles increase.

*Beetle*.—In *Hylesinus* the tibiæ are serrate; the antennal club elongate-oval, pointed, not compressed; in *H. aculeatus* the club of the antennæ is elongate-fusiform, the bands of the elytra oblique, while the sides of the prothorax are smooth (not muricate, as in the closely allied *H. imperialis* of Dakota and Arizona). Length, 2.2 to 3.4<sup>mm</sup> (.09 to .13 inch). It ranges from Massachusetts to Texas, Kansas, and Oregon. (Le Conte.)

#### 9. *Hylesinus opaculus* Le Conte.

This timber borer has been found by Mr. E. A. Schwarz, living under the dry bark of elm and ash trees. See fig. 72, p. 227.

*Beetle*.—Body elongate, clothed with short, erect yellow hair without scales. Length, 2 to 2.5<sup>mm</sup> (.08 to .10 inch). (Le Conte). According to Riley it differs from the clover beetle (*H. trifolii*) in the shape of the antennæ, the visible labrum, and other points shown in Fig. 72.

### AFFECTING THE LEAVES.

#### 10. THE ASH SAW-FLY.

*Selandria barda* (Say.)

The larvæ of this saw-fly are said by Mr. H. Osborn to at times injure the ash in Iowa. The adults have not been reared, but he feels sure that the larvæ were of the above species. The eggs are deposited in rows along the sides of the petioles just beneath the outer bark, and so neatly that it is almost impossible to detect any break in the epidermis. Usually there are from six to ten on a leaf. They evidently increase much in size before hatching, pushing the bark up in a blister-

like elevation, and if cut out of their covering are found to be very soft, the outer membrane being exceedingly delicate and easily ruptured. The larvæ are evidently hatched within two or three days after the eggs are deposited, and are at first slender, whitish worms, with black heads and thoracic legs. They crawl at once to the leaflets and appear to select the more tender ones for the commencement of their work. They grow quite rapidly and reach the first molt on the third or fourth day. They are mostly found adhering to the under surface of the leaves and forming a coil, though sometimes extended, especially when feeding, and as they eat away the entire leaf, cutting away at the edges or at the holes entirely through the leaf, they eat any poisonous substance sprinkled or dusted on the upper surface. When young they usually keep pretty well clustered together or on the same leaf, but afterwards scatter quite generally, the early clustering being due no doubt to the eggs being laid near together and on the same leaf. The worms molt at least three or four times before reaching maturity. They leave the trees before pupating, which is probably done under ground, passing the winter in the pupa condition. The fly has been observed in abundance from April 15 until June. *Tachina* and *Ichneumon* flies prey upon the false-caterpillars.

*Larva*.—Head polished jet-black, as are the thoracic legs, otherwise the body is clear green, with a slightly darker dorsal line. Eight pairs of abdominal legs. The skin somewhat wrinkled, but neither hairy nor slimy. (Osborn.)

*Saw-fly*.—Body black throughout, except the upper part of the thorax, which is honey-yellow or sometimes orange or reddish, the amount, as well as the shade, differing somewhat in different individuals. The males are more slender and shorter than the females. In some specimens the front legs are partially yellowish. (Osborn, Bull. Iowa Ag. College, 1884, p. 80.)

#### 11. *Selandria* sp.

Miss Murtfeldt describes, in a report to the Agricultural Department, a saw-fly larva which seems to differ from the preceding species in having a double row of short black spines on each segment. She refers to them as follows :

Early in the summer the foliage of the ash trees (*Fraxinus americana*) was much eaten by a Tenthredinid that I have not yet been able to rear, although I have observed it for several successive years. The slug is about the size of, and very similar in appearance to, *Selandria vitis*, being pale-green, with small, immaculate black head and a double transverse row of short black spines on each segment. It inhabits the under surfaces of the leaves, and in feeding perforates them with round holes, of sizes corresponding with its stage of growth. It enters the ground about the last of May and incloses itself in a frail earthen cell. It seems to be but single-brooded, and in the rearing-cage either dries up or molds, without changing to pupa, in the course of the summer.

#### 12. *Selandria?* larva, No. 1.

This and the following saw-fly larvæ occurred frequently on young ash shrubs at Rangeley Lake. They resemble the larvæ of *Nematus*, but differ in having eight instead of seven pairs of abdominal legs.

*Larva*.—Body curled up helix-like; with eight pairs of abdominal legs. Head amber colored; eyes black. Body livid greenish; on each abdominal segment a series of straw-yellow spots inclosing three sides of a hollow square, with a few orange spots at the end of the body. A few minute sharp tubercles on each segment. Thoracic as well as abdominal legs pale livid greenish. Length, 15<sup>mm</sup>.

13. *Selandria? larva*, No. 2.

*Larva*.—Larger than the preceding species; with eight pairs of abdominal legs. Head, body, and legs pale amber, with a dark dorsal stripe from which twelve oblique bands pass down and unite with a broad diffuse lateral band. Length, 18<sup>mm</sup>.

14. *Geometrid caterpillar*.

This larva, of which a description is subjoined, I found September 5, on low ash bushes on the shores of Rangeley Lake, Maine.

*Larva*.—Head broad and flat, as wide as the body; a greenish horn-colored triangular area in front, with a pale brownish transverse stripe across the front between the antennæ. Body slender, cylindrical, with a few transverse dorsal wrinkles. At the end of the first abdominal are two pale, light, small tubercles, situated on a transverse ridge; a similar pair, but larger, on the end of the fifth abdominal segment. On each segment are two minute dark tubercles. Supra-anal plate long, triangular, with large terminal piliferous warts; those on the upper side of the anal legs large. The third pair of thoracic feet larger than the others. Anal legs short and broad. General color of the body dark brown, resembling that of the bark of a twig of the food-tree. Length, 24<sup>mm</sup>.

15. *Sphinx cinerea* Harris.

While the caterpillar feeds on the lilac, becoming fully grown early in September, it has been taken by Mr. W. H. Edwards on the white ash.

*Larva*.—Three to 3.25 inches long; cylindrical, greenish white, shading into white dorsally. Head semi-oval, flat, green, with yellow lateral lines. The thoracic segments transparent, more tinged with green; a few small granulations on the annulations of the segments, which are yellowish green laterally and white dorsally. The seven lateral bands pale yellow, edged with darker green anteriorly, traversing the entire segment above the stigma and continued over six-eighths of the following, in white, edged with pale green above. Stigmata linear, bordered with white. Caudal horn rose color, long, curved, with a prominent base, sometimes tipped with blue. Caudal shield edged with light green. Legs rose color. (Lintner.)

*Pupa*.—Two inches long, .60 broad. Chestnut brown. Head-case depressed, projecting by nearly the length of the first segment beyond it. Tongue-case—its base anteriorly advanced nearly to the vertex of the head-case, regularly ridged transversely, with a medial impressed line having moderately elevated margins—its trunk raised by one-half its diameter from the breast, the tip applied to the breast and slightly bulbous; the buried portion of the tongue-case smooth, extending to the tips of the wing-cases, which are also smooth. Anterior leg case with a prominence over the femur. First segment with a smooth dorsal spot, from which wrinkles radiate. Second segment moderately rounded, with interrupted transverse wrinkles dorsally. Third segment with a dark brown central transverse fold, interrupted dorsally. Central segments broader than the thoracic region, moderately punctuated, with dorsal wrinkles and depressions. Eleventh segment with a small dorsal protuberance. Terminal segment quite tapering. Spine short, blunt, wrinkled, and bifid. (Lintner.)



16. *Sphinx gordius* Cramer.

Usually feeding on the apple, the caterpillar of this species has been found on the ash, as well as on *Myrica gale* and *M. cerifera*.

*Larva*.—Of a bright apple-green color, with a brownish vertical stripe on each side of the head, and seven oblique stripes on each side of the body, which are white and margined above with violet. The caudal horn is reddish brown. Length,  $2\frac{1}{2}$  inches.

*Pupa*.—With a very short, detached tongue case.

*Moth*.—Palpi reddish brown except the apex, which, with the head, sides, and sometimes central part of the thorax, is gray. The rest of the thorax is blackish brown with black metathoracic tufts. The abdomen is ashy gray with a central black line and a broad tapering black band on each side, broken by four or five dull whitish cross-stripes. Under side of thorax and abdomen gray. The forewings are gray, clouded with brownish. The discal spot is small, white and triangular, and from it two fine black lines extend in along the cell and finally unite. The median vein and veins 2, 3, 4, 5, and 6 are marked with black, and there are black dashes between all the veins below the apex, the last forming the oblique apical streak. A curved ashy-brown shade crosses the wing at the basal fourth; another, from the costa a little beyond the middle, ends at the middle of the hinder margin, and a third, crossing a little beyond and parallel to the last, is somewhat toothed on the veins. Outside of this a blackish shade line, bordered on each side with gray, is visible only on the hinder half of the wing. An ashy-brown spot rests on the costa a little before the apex, leaving a gray shade on the upper side of the oblique streak. Fringes brown at the ends of the veins and white between. The hind wings are sordid white, with a central and broad terminal band nearly black. Fringes pure white. The under side of the forewings is brownish gray, and the fringes are as above. The under side of the hind wings is gray, with a narrow central and broad terminal band of dark brownish gray. (Fernald.)

17. *Daremma undulosa* Walker.

This species feeds on the leaves of the white and black ash, lilac, and privet (*Ligustrum vulgare*,) and, according to Rev. W. J. Holland, occasionally on the white and red oak. (Can. Ent., June, 1886.)

*Egg*.—Pale green or aqua marine in color, spheroidal in form, the vertical diameter is four-fifths of a millimeter, one lateral diameter is two millimeters, and the other is one and two-fifths millimeters. The surface is very finely granulated and has pearly reflections. The eggs hatch in eight days.

*Larva*.—The young larva is one-fifth of an inch long, of a very pale greenish yellow color with fine hairs scattered over the surface. The caudal horn is large, straight, and pointed obliquely up and back at an angle of forty-five degrees with the line of the body, and is covered with a fine pubescence. It is smoky brown at the tip only, but before the first molt the brown extends nearly over the whole surface of the horn.

*The first molt* occurs in from four to six days, after which the larva is one-third of an inch long, of a pale green color, the head being a little lighter than the body and having the surface granulated and a pale vertical stripe on each side. There are seven oblique stripes on each side of the body, and a longitudinal stripe of a whitish color but not plainly visible.

*The second molt* is made in from three to five days, after which the larva is three-fifths of an inch long, of a pale green color and with the stripes as before the molt but plainer, and there is added a series of reddish spots on the forward side of the oblique stripes where they cross the longitudinal stripe. The caudal horn is of a

pale watery pink color, and covered with short, blunt spines, from which arise short fine hairs. The surface of the body is somewhat granulated, especially on the forward segments and behind the caudal horn.

*The third molt* is made in from four to six days, after which the larva is about 1 inch long, of a light green color, rather lighter than the under side of the lilac leaf on which it feeds. There is some variation of the ground color at this stage; some are yellowish green while others incline to a bluish green. The longitudinal stripes are now obliterated and the oblique stripes are as in the preceding molt. The legs and caudal horn are pink or pale vinous red, the latter beset with short stout spines as before. The head and three following segments have whitish granulations above, while the last segment has black granulations on the upper side. The head has a broad vertical stripe of a dull whitish color on each side. The spiracles are pale pink with a white dot at each extremity.

*The fourth and last molt* is made in from seven to ten days, after which the larva is about one inch and three-fourths in length and of the same color as in the preceding molt. The stripes on the side of the face, the caudal horn, and the legs are pale pink or flesh color. The last segment is sprinkled with black granulations on the upper side, and the spiracles are bright vermilion with a vertical white slit in the middle. The oblique stripes are greenish white. The larva reaches maturity in from eight to twelve days from the fourth molt, and is nearly 3 inches long. It now changes to a dull brownish color which somewhat obscures the markings, when it descends to the ground, and working its way down into the soil, transforms into a dark brown pupa one inch and three-fourths long, with the tongue-case sunken to a level with the surface.

*Moth.*—Expanse of wings,  $3\frac{1}{2}$  inches. Head and palpi brownish gray, the latter being darker on the middle joints, and the head darker above and lighter on the sides. The thorax is gray with two black lines edged with yellowish crossing the prothorax. These lines meet two similar ones on each side, which run backwards, one on each edge of the patagiae and meeting behind where the patagia is tipped with white. There is also a curved black line preceded by white and followed by yellowish across the hinder part of the thorax. The abdomen is gray with a dark brown line along the middle and two stripes of the same color on each side and the segments are edged with yellowish scales. The whole under side is gray with the breast of a pale coffee-brown color.

The forewings are gray, mixed with yellowish scales and crossed by four pairs of wavy or angulated dark brown lines more or less distinct, which start from the costa at about equal distances apart, and divide it into five nearly equal parts. The pair nearest the base of the costa runs obliquely as far as the cell, giving off one tooth, then it takes a somewhat wavy course to the hinder margin nearly at right angles with it. The second pair is distinct on the costa but crosses the wing a little within the discal spot, as a dark brown shade. The third pair starts at right angles with the costa, and curving around the end of the cell, ends near the middle of the hinder margin. The inner of these two lines is slightly angulated while the outer one gives off quite long and sharp teeth, and the space between them is filled in somewhat with ocher-yellow scales. Between this and the outer pair of lines the space is filled in somewhat with whitish. The outer pair of lines starts at right angles with the costa, curves evenly around to vein 2, and then runs straight to the hinder margin. The outer one of this pair is the darkest and most prominent of all, and is neither undulated nor toothed, while the inner one gives off acute angles on each vein. A black shade line, starting from the apex obliquely, extends into the third pair of cross-lines. A parallel dash crosses the outer pair just below, and there are two parallel black dashes near the middle of the wing extending from the median vein out to the outer pair of lines between the veins. The fringes are white, marked on the veins with dark-brown spots from which brown dashes extend nearly half-way across the terminal space.

The hind wings are dark smoky brown, lighter on the hinder margin, and crossed by three parallel darker brown wavy lines. The fringes are white and marked with brown on the veins. The under side of the wings is gray. The forewing is crossed on the outer part by a dentate line and the oblique apical line is partly reproduced. The hind wings, which are somewhat lighter, are crossed by two dentate yellowish brown lines, one a little before the middle, the other a little beyond. (Fernald.)

18. *Sphinx larva*.

A sphinx larva was not uncommon on the ash at Rangeley Lake, Maine, September 5 to 10, 1887. It seems to differ from any of the preceding species, and I therefore add the following description from a living specimen which died in confinement:

*Larva*.—Head large, of the usual sphinx shape, green, with a broad black lateral very conspicuous band, bordered in front with whitish green. The seven oblique lateral lines are bright straw-yellow, bordered above with black, the latter stripe edged below (between it and the yellow stripe) with white; the first six bands are united at the lower end by a broad distinct whitish band. The horn is rather large and long, rough, with numerous black stout conical spines. The skin is smooth, the body deep pea-green; on the anal legs and supra-anal plate are black dots of unequal size. The spiracles are orange, with a broad paler border; the first seven are embayed in the lower end of the lateral bands. From the last oblique band a pale yellowish-white band connects the upper end of the oblique line with the base of the horn. The thoracic legs black, with two white rings at the joints; abdominal legs green, with a black patch at base. Length, 30<sup>mm</sup>; length of horn, 8<sup>mm</sup>.

With the preceding species was associated a young larva, which may possibly be an earlier stage of the same species. The following description is from life:

*Larva*.—Head narrowing towards the apex; edge square, with conical spines, on a pale yellowish band. Head and body pale green, with yellowish spots on the thickened portions, either arranged in short lines or scattered irregularly. Seven short broad oval, or elongate-oval, pale, oblique purple spots situated near the lower end of the pale yellowish, rather indistinct lateral lines. Horn long and slender, pale reddish, with black spines. All the feet pale, the thoracic ones tipped with roseate. Length, 15<sup>mm</sup>.

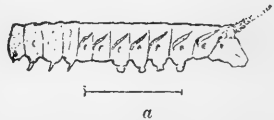


FIG. 184.—Ash sphinx; natural size; a, young ? of 184.—Bridgman del.

19. *Apatelodes angelica* Grote.

According to Mr. Lintner, "eight or ten of the larvæ were collected at Bath (near Albany) during the early part of September, feeding on ash (*Fraxinus*); also by Mr. Meske, at Sharon Springs, on lilac (*Syringa vulgaris*). When not eating they usually occurred resting on and closely appressed to a twig. The first transformation to a pupa was on September 14. The larva has a marked gastropachan aspect. It is now for the first time described.

*Larva*.—Head subrotund, dark brown, the clypeus and two lines on the front lighter brown. Body with the thoracic segments tapering; terminal segments tapering and flattened posteriorly; ventral region flattened; the anal legs projecting behind. Color of the body, gray; numerous fine black linings, an oöng which may be

traced two forming a vascular stripe, and two similar lateral stripes on each side. On segment 1, anteriorly, are four dorsal white lines, posteriorly black; segment 2 is black anteriorly, behind which are irregular black linings; segment 3 as the preceding one; on segments 5 and 10 the dorsal black linings assume a V-shape, the apex resting on the suture and inclosing centrally two yellow-green subelliptical spots, with a similar spot exterior to each within the superior lateral stripe. From the first segment long whitish-brown hairs project over the head, nearly concealing it; from the middle of the second and third segments whitish hairs project forward, of which those on the latter segments are shorter and arranged somewhat in tufts, beneath which, when extended, some short stiff red hairs are seen; laterally, below the stigmata are two rows of fascicles of white hairs of unequal length, mingled with a few longer brown ones, extended rectangularly with the body until to its middle, whence the remainder are directed backward; from the terminal segment white and brown hairs, of greater length than elsewhere on the body, project horizontally, brush-like, backward; short whitish hairs are scattered sparsely over the body.

(The larva escaped before its description could be completed, and the remainder is from memory.) On the vascular line on each segment is a tuft of black hairs about 0.06 inch long, the ends of which converge to a point. The prolegs project laterally, almost hidden by the hairs. Ventrally is a broad fuscous stripe. (Lintner, Ent. Contr., iii, p. 130.)

#### 20. *Gastropacha americana* Harris.

While the singular lappet caterpillar is found at times on the apple, its native food plant is the oak and ash. It may be found on the trees in September, when it spins its cocoon, the moth appearing in New England early in the succeeding summer. In Georgia, according to Abbot, it spins its cocoon in May, the moth appearing the following February.

*Larva*.—Body large, broad, and flat, with hairs on the side spreading out so as nearly to conceal the feet, the hairs arising from large lappets hanging from the side of each segment, the first pair the largest; upper side of the body gray, variegated with irregular white spots and sprinkled with fine, black dots; in front are two transverse velvet-like bands of a rich scarlet color, with three black dots on each band; under side of the body orange-colored with a row of diamond-shaped black spots; length  $2\frac{1}{2}$  inches.—Harris.

*Moth*.—When at rest it would be mistaken for a dry, brown, crumpled leaf, the edges of the hind wings being much notched as are the outer and inner edges of the fore wings; reddish-brown; beyond the middle of each of the wings is a pale band edged with zigzag, dark-brown lines; there are also two or three short, irregular, brown lines running backward from the front edge of the fore wings, besides a minute pale crescent edged with dark-brown, near the middle of the same. In the female the pale bands and dark lines are sometimes wanting, the wings being almost entirely of a red-brown color. The wings expand from  $1\frac{1}{2}$  to 2 inches. (Harris.)

#### 21. *Tischeria quercivorella* Cham.

Mr. V. T. Chambers describes this moth (? *T. quercitella*, Frey, *nee T. quercitella*, Clem.) as follows:

I have not seen the specimens from which Frey described his species, nor the single imperfect one from which Clemens prepared his description. Frey thought his specimens belonged to Clemens' species, but Frey's description applies sufficiently well to the four males and two females before me, and which I can not reconcile with Clemens' account of his species. In *quercivorella*, the face, palpi, and antennæ are very pale lemon-yellow, the vertex being darker, as dark as the forewings. Clemens

says of *quercitella*, "antennæ, head, labial palpi, dark orange-yellow." In *quercivorella* the thorax and forewings are lemon-yellow, with the costal margin more reddish, and becoming more so toward the apex, which is reddish-orange and somewhat dusted with darker scales. Clemens says of *quercitella*, "forewings orange-yellow, apical portion reddish-brown, dusted with dark brown," and does not mention the reddish-orange hue of the costal margin. In *quercivorella* (both sexes) the dorso-apical cilia are paler than those of the apex, which, like those of the hind wings and the entire hind wings themselves, except a fuscous patch at the base, are pale silvery yellow; this fuscous patch and a similar one on the under side of the forewings are peculiar to the male. In *quercitella*, Clemens says the hind wings are "pale yellowish, becoming reddish-brown toward the apex, and the apical cilia dark brownish." This does not apply to *quercivorella* at all. I have quoted the whole of Dr. Clemens' brief description.

In *quercivorella* the under side of the wings is paler than the upper, and does not become darker toward the apex, but has the costal margin stained with fuscous on the forewings. The thorax, abdomen, and legs are pale yellow, as also is the anal tuft; the front surface of the legs and the under side of the abdomen dusted with fuscous. Alar expansion scant three-eighths of an inch. Kentucky and Texas. (Bull. U. S. Geol. Surv., iv, i, p. 97.)

22. *Dynastes tityus* (Linn.).

The following correspondence shows that this gigantic beetle is at times destructive to ash leaves.

Its detestable odor and its habits are also described by Mr. Lugger in *Entomologica Americana*, ii, 163.

Editors COUNTRY GENTLEMAN:

I send by mail to-day a box containing several specimens of a hideous and most offensive beetle which has recently begun its ravages on the ash trees on my lawn, which I ask the favor of you to submit to Professor Lintner, that through him their name and character may be learned, and how to free our trees of their presence. Their odor is so offensive at night that it is disagreeable to sit in the open air.

I learn from my son since writing the above that they are on the forest trees also.

J. W. M.

PERROWVILLE, VA., August 2.

[Answer by Prof. J. A. Lintner, State Entomologist.]

The above communication is of special interest to me, from its presenting more strongly than has ever before been brought to my notice the offensive odor given off by the beetle above noticed—the *Dynastes tityus*. It belongs to the family of Scarabæidæ, which contains many species having quite a disagreeable odor, but very few, if any, have the penetration and pungency of this. Where a large number are congregated, I can well imagine that the atmosphere in their vicinity may become quite unpleasant to the nostrils, for even the dead bodies of half a dozen sent me, although occupying a place, as I am writing upon an open piazza, at a distance of several yards from me, and after having been exposed to the air throughout the night, have rendered their vicinage quite intolerable to some of the unscientific members of my family who had been sitting with me.

The beetle, although horrid in the eyes of the gentleman communicating it, is to the entomologist, from its size, form, and ornamentation, a beautiful and attractive specimen of the Coleoptera. The largest male before me (I have seen larger examples) is 2.5 inches long (3.5 with legs extended), 1.1 inches across the wing-covers, and 0.8 of an inch in thickness of body. The shape of the female is nearly that of the common grapevine beetle, the *Pelidnota punctata*, but the male is armed anteriorly with two black horns, a half-inch or more in length, the upper one being a hori-

zontal projection of the front part of the thorax, and the lower curving upward from the crown of the head. Beneath the color is black, while the thorax and wing-covers

are of a pale olive-brown; the latter dotted irregularly with black spots of various sizes, of which some of the largest are ocellated. The legs are shining black, and are armed with horns and spines.

The grub which produces the beetle fortunately is not to be numbered among our insect pests, as it only attacks, so far as my knowledge of its habits extends, decaying trees. It is of not infrequent occurrence in the State from which these examples were sent, and in other Southern States. It is rarely met with in Pennsylvania, and has never, I believe, been found in the State of New York. Dr. Fitch includes the species among those affecting the cherry tree. The beetles feed upon the leaves of various trees, to which from their voraciousness, when numerous, they prove very destructive.

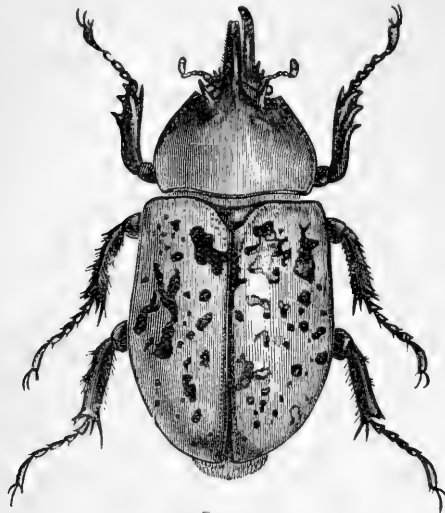


FIG. 185.—*Dynastes tityus*.—After Riley.

When they attack our shade and ornamental trees their ravages may be checked by applications of Paris green or London purple to the leaves by a force pump, or by jarring them from the branches and destroying them when they fall.

### 23. *Thysanocnemis fraxini* Le Conte.

Order COLEOPTERA; family CURCULIONIDÆ.

All that we know of the habits of this weevil is Dr. Le Conte's remark: "Several females collected by Mr. Pettit on ash trees in Canada." (*Rhynchophora*, 214.) He states that *Thysanocnemis* is "a singular genus somewhat resembling *Anthonomus* in appearance, but known at once by the front tibiæ of the male being broader than usual, sinuate, and densely fringed on the inner side with long hair." He describes the species as follows:

*Beetle*.—Ferruginous, clothed with yellow hair. Beak finely punctured, obsolete striate. Prothorax densely punctured. Elytra with punctured striae, and slightly convex, nearly smooth interspaces; with a broad transverse band occupying the middle third, and dilated at the margin, less densely pubescent, and of a darker color. Length, 3.7<sup>mm</sup> (.15 inch).

### 24. THE ASH GALI-LOUSE.

*Pemphigus fraxinifolii* Thomas.

Order HEMIPTERA; family APHIDÆ.

Dr. Bundy, from whom the specimens were obtained, says Professor Thomas in his third annual report, 1879, p. 146, furnishes the following note in reference to them, made at the time they were discovered:

On ash, June, Sauk City, Wis. On the under surface of much deformed, crumpled leaves. Female; abdomen dirty green, somewhat darker at the base, sprinkled with

mealy-white grains at the apex; head, thorax, eyes, antennæ, and legs dingy black; wings pale, unmarked. The particular species of ash (*Fraxinus*) which it inhabits Dr. Bundy has not informed me.

Since the above was written Professor Bundy has furnished the following item: "Found on *F. quadrangulata*, Mx. Leaves much twisted and deformed, especially at the end of infested twigs, but no gall proper."

*Winged individuals*.—Anterior wings with the third discoidal vein simple, arising from the second vein, a short distance from the base of the latter, running almost directly outward toward the apex of the wing; second vein also very oblique and arising very close to the first vein; first vein somewhat dim, subobsolete, slightly curving outward as it approaches the margin of the wing; fourth vein curves very slightly near the base, the remainder being almost straight. Stigma semi-opaque, elongate-rhomboidal, sides nearly parallel, ends with about the same slope; length about three times the width. Subcostal vein quite prominent, somewhat distant from the costa, curving slightly inward or backward where the two branch veins arise. Antennæ short, reaching but slightly beyond the end of the thorax; third joint longest, nearly equal to fourth and fifth; fourth slightly shorter than the sixth; sixth with a small spur at the tip. Posterior wings with two discoidal veins which arise from the same point. Color of winged specimen after long immersion in alcohol: head dark, prothorax pale, thoracic lobes dark; abdomen pale dull yellow, with marginal sutures dark in some specimens; wings transparent, with a slight tinge of milky white; veins very delicate and generally pale. Length of body about .07 inch.

*Wingless specimen*.—Very broadly ovate, length in some scarcely exceeding the widest point; antennæ very short; eyes quite small; dark. (Thomas.)

#### 25. *Aspidiotus ancylus* Putnam.

This species is said by Professor Comstock to infest many plants; he has found it upon the ash, beech, bladder nut, hackberry, linden, maple, oak, osage orange, peach, and water-locust. The following account is taken from Professor Comstock's report as U. S. Entomologist, for 1880:

*Scale of female*.—The scale of the female is usually slightly wider than long, although nearly circular, with the exuvæ laterad of the center, and covered with a thin layer of excretion. This film is white, but it is easily removed, leaving the brick-red exuvæ exposed. That part of the scale immediately surrounding the exuvæ is dark gray, almost black; the margin of the scale is light gray; the whole scale has a reddish tinge. It measures about 1.4<sup>mm</sup> in length and 1.3<sup>mm</sup> in width. Ventral scale white and very delicate.

*Female*.—The female is pale yellowish or pale orange in color, marked with translucent spots. The outline of the body before oviposition is ovate, but becomes more or less circular after the insect begins to oviposit. The last segment presents the following characters:

There are four or five groups of *spinnerets*. The anterior group, when present, varies from a single spinneret to six, but it rarely consists of more than three; the anterior laterals vary from six to fourteen; the posterior laterals vary from five to eight.

Only one pair of *lobes* present, these are large; each is notched at about the middle of the lateral margin; occasionally there is a small notch near the end of the lobe on the mesal margin.

There are two *incisions* of the margin of the ventral surface on each side of the meson, one just laterad of the lobe, and one laterad of the second spine. The part of the body wall bounding these incisions is conspicuously thickened.

There are two *plates* caudad of each incision; these plates are usually simple, but are sometimes toothed; occasionally there is a third plate in one or more of these places. There are three to four irregular slender plates between the third and fourth pairs of spines. The first, second, and third pairs of spines are situated as in allied species; the fourth pair is at two-thirds the distance from the lobes to the penultimate segment. Described from five specimens from maple, two from peach, seven from osage orange, twelve from hackberry, fifteen from ash, and eleven from *Staphyllea trifoliata*.

*Variety*.—A form of *Aspidiotus* was found, the scales of which I am unable to distinguish from those of *A. ancylus*; but the last segment of the female presents the following difference from the typical form of this species: There are no plates between the third and fourth pairs of spines; and the vaginal opening is mesad the anterior spinnerets of the posterior lateral groups, instead of the posterior members of the same groups. The variation in the number of the spinnerets is greater in my specimens of the variety than in those of the typical form, there being in some cases seventeen on the anterior laterals, and nine in the posterior laterals. Described from twenty-one specimens from linden, eleven from beech, eighteen from oak, and four from water-locust.

*Scale of male*.—The scale of the male resembles that of the female in color, but is smaller and more elongated. Length 1.2<sup>mm</sup>, width 0.6<sup>mm</sup>.

*Male*.—The male is easily distinguished from all other species known to us by the small size of its wings. We have bred numerous specimens from seven species of plants: Maple, *Staphyllea*, hackberry, ash, osage orange, peach, and water-locust. These males show considerable variation, and for a time I believed that I had two species. In each the color of the body is orange yellow; in the former, which was bred from peach, the thoracic band is dark brown, and the distal joints of the antennæ are not enlarged; in the latter, which was bred from ash, the thoracic band is of the same color as the remainder of the body, and the distal joints of the antennæ are conspicuously enlarged. These two forms shade into each other, and each was bred from plants which were infested by the typical females only.

*Habitat*.—Davenport, Iowa (Putnam), Washington, and western New York, District of Columbia. (Comstock.)

## 26. THE ASH GALL-MITE.

*Phytoptus fraxini* Garman.

Class ARACHNIDA; order ACARINA.

In Mr. S. A. Forbes' twelfth report as State Entomologist of Illinois, Mr. H. Garman describes two gall-mites found on the ash, the first of which produces galls on the leaves of the green ash, *Fraxinus viridis*, Michx.

The light-green color of these galls so strongly contrasts with the dark leaves that the latter appear at a little distance to be spotted with light. It is a depressed wart-like gall. The center of its cavity is about in the plane of the leaf, as the projection above and below is nearly equal. The outer surface is variously indented, in some cases as if with the fingernail. The outline seen from above is elongate, circular, or quite irregular. The opening beneath is a slit, surrounded by a raised lip clothed with white hairs. One or more folds with many-celled hairs at their free edges project into the interior, dividing it into more or less perfect compartments. The median of these folds is usually largest, and sometimes reaches the

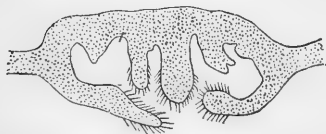


FIG. 186.—Vertical section of a *Phytoptus* gall from a leaf of the green ash (*Fraxinus viridis*). After Garman.



bottom of the cavity just over the opening. Side folds may be formed from the primary ones. The largest gall measured was .13 inch in diameter and .13 inch in height, measuring the projection on both sides of the leaf. Dr. F. A. W. Thomas describes a still more peculiar gall from a European *Fraxinus*. This gall was abundant in central Illinois during the summer of 1880 and 1881.

*The Mite*.—This is a very finely striate species, the striæ numbering from 78 to 81. In one example 70 striæ were counted, but as in others the number was so uniformly above 70, a mistake may have been made in counting. The feather-like appendage has two pairs of widely divergent prongs. An example mounted in glycerine measures .048<sup>mm</sup> in length. Eggs and young occur in June.

27. *Phytoptus* sp.

This species produces galls on the leaves of the white ash, *Fraxinus americana* Linn.

The gall resembles very closely that on *Fraxinus viridis*. Like that it projects equally above and below the leaf. The upper and under surfaces have a slight clothing of white hairs. The walls are thick and are produced into the cavity. The height, measuring that above and below the leaf, is about .085 inch, and the diameter is about the same.

A very peculiar cecidium, quite different in character from the above, was also found on the white ash, but no *Phytoptus* was found in it. It consisted of innumerable small, deformed leaves and twigs which had been prevented from developing by the mites. The whole mass dries up and remains on the trees during the winter, at that time resembling a fungoid growth.

Both of these Cecidii occurred at Bloomington, Ill., in June, 1881.

Striæ from 53 to 58. Feather-like appendage with two pairs of prongs. Length .007 inch. The hairs on the underside of the cephalothorax are easily seen in this species. (H. Garman.)

The following insects also occur on the ash :

Order LEPIDOPTERA.

28. *Papilio turnus* Linn. (Miss C. G. Soule, Can. Ent. xviii, p. 139.)
29. *Papilis glaucus* Linn., on *Fraxinus* of all species.
30. *Sphinx kalmiae* Abbot and Smith. (Lintner, Ent. Contr. i, p. 188.)
31. *Smerinthus geminatus* Say. (Psyche, ii, p. 72.)
32. *Callimorpha suffusa* Smith (Marlatt, Trans. Kans. Acad. Sc., 1887-88, p. 113.)
33. *Spilosoma virginica* Fabr. (Riley's MS. notes.)
34. *Halesidota maculata* Harris. (Harris' Correspondence, p. 290.)
35. *Halesidota caryæ* Harris. (Ohio, Pilate.)
36. *Platysamia cecropia* (Linn.) (Riley's MS. notes.)
37. *Telea polyphemus* (Cram.). (W. Brodie, Canada.)
38. *Callosamia promethea* (Drury).
39. *Hyperchiria io* (Fabr.).

40. *Clisiocampa sylvatica* Harris. (Can. Ent., ix, p. 159; Riley, Third Missouri Rt., p. 126.)
41. *Apatela americana* Harris. (Thaxter, Papilio, iii, p. 17.)
42. *Apatela luteicoma* G. and R. (Thaxter, Papilio, iii, p. 17.)
43. *Paleacrita vernata* (Peck). (On black ash, John Sears, in Packard's Monog. of Geometrid Moths, p. 404.)

## Order DIPTERA.

44. *Cecidomyia pellex* O. Sacken. (Monogr., i, p. 199. Galls on leaves of American ash, *F. americana*.)

## Order HEMIPTERA.

45. *Neoforus petittii* Uhler. This bug occurred in different stages of development on the leaves of the white ash at Rangeley, Maine, September 5 and 6. The specimens were submitted to Dr. Uhler, who writes that there were three varieties among those sent, and that the species has not yet been described, though it is a common Canadian insect.

## Order COLEOPTERA.

46. *Cryphalus asperulus* Sec. Proc. Brit. Soc. Nat. Hist., xiv, 206.

## CHAPTER XI.

### INSECTS INJURIOUS TO THE WILLOW.

*Salix* of different species.

The willows harbor a very large insect population, and form the original food-plant of a number of the species at present living at the expense of our fruit trees.

The number of species in Europe which live upon the willow is said by Kaltenbach to amount to 396. Of this number 94 are Coleoptera, 214 are Lepidoptera, of Hymenoptera there are 40 species, all of them saw-flies eating the leaves; of flies (Diptera) there are 21 species, all with three exceptions gall-flies (Cecidomyiæ), while the remainder consists of Hemiptera, of which 27 kinds are enumerated, nearly all of these being Aphids and bark lice.

It is to be observed that in Europe, as in this country, the number of borers is rather small, willows perhaps ordinarily not being exposed to their attacks, though this may be the result of imperfect observation. Out of 94 kinds of beetles Kaltenbach enumerates about 12 Cerambycidæ or wood-borers, and only two or three bark-borers, while the greater number of the beetles he enumerates are leaf-beetles. Indeed, the large number of leaf-beetles and saw-flies which prey upon the foliage of willows, both in the old and new World, is a noteworthy fact.

The number of species of willow insects we enumerate amounts to 186, and there is little doubt but that the number will be greatly increased by future observations.

#### AFFECTING THE TRUNK.

1. *Xylotrechus annosus* (Say).

In the month of April Mr. Coquillett cut down a willow tree and divided it up into "sled-lengths," when no traces of borers could be seen; but early in March of the following year, while cutting this wood

for the stove, he found it to be infested with the larvæ of some species of longicorn beetle, and placing some of the sticks in one of his breeding cages, where it remained undisturbed until the 7th of May following, he found that nearly all the grubs had assumed the pupa state; two weeks later none but perfect beetles were found. From this he inferred that this species requires only one year to complete its transformations.

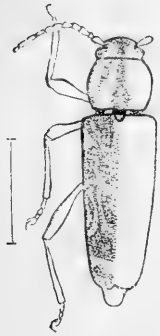


FIG. 187.—*Xylotrechus annosus*.—Smith del.

*Beetle*.—Black, with short gray hairs; a triangular carina between the eyes. Body black, covered with short, gray, prostrate hairs; head with a grooved prominence between the eyes, terminating in a short carina; antennæ but little longer than the thorax; the latter with a naked dorsal stripe; elytra with the hair more densely arranged in some parts, so as to exhibit the appearance of small spots, which are arranged in two bands, in each of which are two spots on each side; the second band is on the middle; near the tip are one or two common spots; tip entire. Length nearly half an inch. (Say.)

## 2. *Pogonocherus mixtus* Haldeman.

That this longicorn bores in the willow has been observed by Mr. F. B. Caulfield (Can. Ent., xiii, 1881, p. 60), as will be seen by the following extract:

In June, 1873, while collecting in a small swamp on Montreal Mountain, I caught a specimen of *Pogonocherus mixtus* Hald. on my coat-sleeve, and as the insect was new to me, I commenced a search for others. Upon examining a dead branch of a small willow growing close by, I found that it had been extensively bored by some small insect. The part attacked was about three feet from the trunk, and at this place the branch for about 12 inches was full of holes, from which the insects had escaped. Not finding them, I searched further along the branch, and near its extremity, where it was reduced to the thickness of a twig, I found a number of the above-named species. They were lying on the branch with their bodies pressed closely against it, and in this position could with difficulty be distinguished from the withered buds. I observed several pairs in coitu, but none of the females were ovipositing. They appeared to be very sluggish, lying almost motionless, although the sun was shining brightly. Having bottled all that were to be seen, I cut off the branch where it had been perforated, and found a number of the beetles in it, but neither larva nor pupa.

## 3. SAPERDA ON THE WILLOW.

Plates XXI, Fig. 4; XXII, Fig. 4, represent a larva found by Dr. Watson in the willow. It is 16<sup>mm</sup> in length; prothoracic segment 3<sup>mm</sup> wide. A pair of prothoracic spiracles and the usual eight pairs of abdominal ones. Antennæ 4-jointed; labrum as long as broad; maxillæ with the lobe very large, extending far beyond the palpi, which are small and 3-jointed. Labium broad and short; palpi short, 3 jointed. Mandibles rounded at tip.

4. *Buprestis fasciata* Fabr.

Mr. George Hunt informs us that he has found an elytron of this beautiful beetle under the bark of the willow in Northern New York in July.

## INJURING THE LEAVES.

5. *Thecla*? sp.

The larva lives in an oval chamber between two leaves, the upper leaf being concave over the site of the caterpillar.

A caterpillar of a *Thecla*? occurred on the willow September 3, at Brunswick, Me.

*Larva*.—Head deeply divided on the vertex, much narrower than the body; pale horn color, with short hairs; black around the eyes and mouth-parts, also on the occiput, this black stripe usually concealed by the prothoracic segment. Body broad oval cylindrical, pale pea-green, with a slightly frosted appearance, due to numerous fine close white dots; two whitish subdorsal lines, fading out on the supra-anal plate. On the under side of the body are white, short, unequal hairs. Thoracic feet greenish, amber at tip. Length 17 to 18mm.

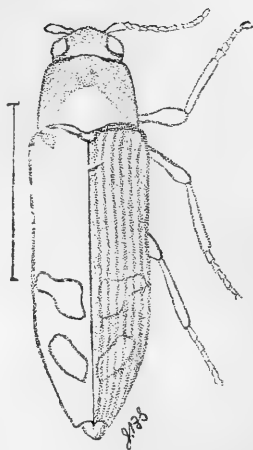


FIG. 188.—*Buprestis fasciata*.  
Smith del.

6. *Thanaos* sp.

This Hesperian caterpillar occurred on the willow at Brunswick, Me., August 20. (See p. 459.)

*Larva*.—Like that on the aspen, but the head is not so wide and is rather fuller, and entirely dull black. Otherwise the body, the color, the widely-separated subdorsal white lines, and the white granulations are the same. Length, 13mm.

7. *Sphinx luscitiosa* Clemens.

Rev. Mr. Hulst states, according to Professor Fernald, that this rare species has been bred from the willow, but the larva has not yet been described, and nothing more is known of its habits.

*Moth*.—Head and sides of thorax gray. Back part of the head above and the upper part of the thorax black, the latter with a few blue and gray scales on the back part. A broad brown stripe extends from the middle of the palpi back under the wings. The abdomen is dull ocher-yellow (gray in the females), with a black line along the middle and a black band broken by dull yellowish white on the edges of the segments along each side. The under side of thorax and abdomen is pale gray. The forewings are pale brown, with the margins sooty black. The band on the outer margin is narrower towards the apex, and has the inner edge wavy. More or less of the veins are black, and a black line extends in along the middle of the cell from the whitish discal dot. This line is double at first, but the two parts unite inwardly. A short black dash rests on the intervenular spaces as far as the apex, the last forming the oblique apical streak. Fringes black. The hind wings are bright ocher-yellow (grayish in the females), with a broad black terminal border and a faint

indication of a central band. Fringes yellowish. The under side of all the wings is dull ochre-yellow, with broad terminal black bands. In the female all the yellow is replaced by dull gray. Expanse of wings, from  $2\frac{1}{2}$  to 3 inches.

#### 8. *Smerinthus excacatus* (Abbot and Smith).

This hawk-moth we have found in the egg and different larval stages on the willow at Brunswick through July and August. Some individuals became much belated. A specimen found at Providence, September 28, pupated October 1, and the moth appeared during the last week of the following June.

*Larva*.—Head conical, granulated, with a yellow (sometimes a white) line meeting at the apex; seven oblique lateral yellowish lines on each side, from the middle of the first one (which is fainter than the others) a line passes forward to the front edge of the prothoracic segment, converging towards its opposite line; the last line is broadest and most distinct, reaching to the base of the caudal horn, which is lilac green; spiracles deep lilac or black; thoracic feet lilac and reddish. Length, .45<sup>mm</sup>.

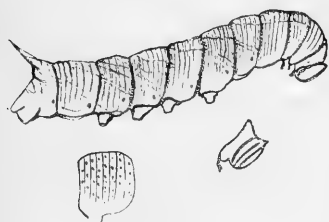


FIG. 189—*Smerinthus excacatus*—Le Conte del.

In the stage before the last, length, 25<sup>mm</sup>.—The body is more closely granulated; the lateral stripes less distinct; the thoracic segments not so small in proportion to the head, and there is a subdorsal double row of reddish spots; the apex of the head is discolored with reddish, while the coarsely granulated caudal horn is yellowish in the

middle and reddish at the end. On the side near the base of the abdominal legs is a dark reddish-brown spot.

#### 9. *Halesidota agassizii* Packard.

Mr. Stretch has in California reared this species (now believed by Mr. Henry Edwards to be the same as *H. maculata* Harris) from the willow. I copy his description of the larva, as it appears to differ from our larva in being usually black. What he describes as a variety is like a larva of *H. maculata* we have found on the sycamore.

The cocoon is obtusely oval, tolerably compact and composed chiefly of the hairs from the body of the caterpillar, with but a small amount of silk in its composition. The larva is double-brooded, and feeds on the willow; the first brood appears on the wing in June, the second being full-fed about the middle of October, and disclosed from the pupa early in the spring.

*H. agassizii* differs from the other species of the genus found in the United States, in the absence of all tendency to semi-transparency in the anterior wings, such as appears in the thinly scaled *tessellaris* and *edwardsii*; or to silvery markings, as in the case of *caryæ* and *argentata*; the costa is also less rounded at the apex than in any of the species mentioned, but the larval characters clearly retain it in the genus.

*Larva*.—Head, body, and prolegs entirely black. Abdominal legs pale dirty yel-

low. Body slightly depressed, densely clothed with evenly cut velvety black hairs, except on the seventh and eighth segments which are bright lemon yellow, with a small black dorsal lozenge-shaped patch of black on each. The caputal and anal segments have numerous slender pencils of pale yellow hairs, much longer than the general clothing of the body, in this respect resembling the larva of *H. tessellaris* but differing from that of *H. edwardsii*, where these pencils do not occur.

*Variety*.—In some instances the black hairs are confined to the two anal and two caputal segments, all the remainder of the body being yellow, with black dorsal patches as in the type.

#### 10. *Halesidota maculata* (Harris).

The eastern *H. maculata* occurred on the willow at Brunswick, Me., August 30. Some had four black pencils on the front of the body, instead of two as Harris describes.

#### 11. THE WILLOW TUSSOCK MOTH.

##### *Orgyia definita* Packard.

Order LEPIDOPTERA; family *Bombycidae*.

Mr. Otto Seifert has reared this moth, and kindly given me his notes, which are presented below. The original specimen from which my description was drawn up was somewhat rubbed, hence the description is imperfect. Mr. R. Thaxter has bred the insect and given me fresh specimens, and I am also indebted to Mr. Seifert for two very well preserved males and a female.

*Eggs* found September 10 on willow, Catskills, Big Indian Valley. They are apple-shaped, opaque, smooth, of cream color, glued together in a cluster about one-half inch long and seven-tenths inch broad. Eggs commenced to hatch May 19.

*Young larvæ* are greenish, much laced (on account of developing protuberances), head yellowish or pinkish white with a black, eye-like spot on each side, mouth-parts light brown.

First molt, May 26; second, May 31; third, June 2 and 3; fourth, June 8; fifth, (?); transforming June 18. Imagines from July 1 to 8.

They molt five times, are very voracious, and feed only on different species of willow (fed in New York with weeping willow).

*Full-grown larva*.—Length from 2 to 2.5 centimeters. Ground color whitish-green, head whitish-yellow with two black spots. A deep black dorsal band, on three first segments only indicated by black spots, from fourth to eleventh segments uninterrupted. Legs and head hairy, the hair tufts are sulphur-yellow, arranged fan-like. Two long black ornamented hair-brushes on first segment and a dense black tuft on eleventh segment dorsally.

*Cocoon* of the same delicate sulphur-yellow color, and is made of a large outer one and a more dense inner one.

*Pupa* light sulphur-yellow, retaining the eye-like black spots on the head. This insect shows wonderfully the development of the imago in the almost transparent shell.

There is in the middle of the black band on the dorsum of the ninth and tenth segments each a yellowish white knob-like excrescence.

The young larvæ, when hatched, stay for a few days on the egg-shells, eating every trace left of the glue and egg-shells, only leaving the web.

The arrangement of warts and tufts is like all the other species, of which this seems to be the most delicate and the larva the plainest in color, having no other color than the greenish-yellow ground color, the sulphur-yellow vestiture and black dorsal band and brushes.

*The moth.*—Male. Differs from *O. leucostigma* by the more rounded, less angular subcostal bend of the extradiscal line; while the same line towards the inner edge of the wing is more angular. The two blackish costal slashes are much longer in *definita* and these are succeeded by two or three long slashes pointed inwards, and these by a series of pointed dots in the median interspaces. The submarginal white sinuous and wavy line, sometimes so distinct in *leucostigma*, is obscure in *definita*, but the white lunule is equally distinct in both species. In other respects the two species are much alike, and are of the same size. Expanse of wings 30 to 31<sup>mm</sup>.

#### 12. *Ichthyura palla* French.

The caterpillars of this moth were found feeding on willows in southern Illinois through the most of September, resting in an inclosure formed of several leaves fastened together at the ends of the twigs, but no more than half a dozen occurred in a nest. Those put in breeding cages pupated before the middle of October; the moths appeared in the following April and May.

The moth is related to *I. inclusa* Hübn. and *I. ornata* G. and R.; more nearly to the latter in size and coloration, but differs from both in several particulars. Besides size and color, it differs from *I. inclusa* in the coloring of its larva. It differs from *I. ornata* in the color of the scales sprinkled over the forewings, the color of the spots outside the fourth line, and the continuation of that line, as it is set here partially obsolete opposite the disc, as well as in some other points. The apices are no more produced than in *I. inclusa*, nor is the costa more bent (French). We would add that judging from two specimens received from Professor French we are inclined to think that this is a variety of *I. inclusa* Hübner.

*Larva.*—Length 1.25 inches when crawling; body nearly cylindrical, two black tubercles, close together, on the top of third and eleventh segments. On the back are four bright but narrow yellow lines alternating with narrow black ones. The stigmatal line is black; above this, or the subdorsal space, an irregular alternation of black and white. Below the stigmata a narrow yellow line; below this, or the substigmatal space, the body is flesh-colored. Head shining black. A few gray hairs scattered over the body. (French.)

*The moth.*—Length of body .56; expanse of wings 1.10 inches. General color of body and forewings pale gray, the latter rather sparsely sprinkled with dark brown scales. Palpi brown above, scarcely projecting beyond the head, third joint concealed by the hairs of the others. Front slightly brownish, a tuft of pale gray scales at the base of each antenna, the usual deep brown mark from the antennæ to the top of the thoracic crest. Forewings with the usual transverse lines almost white. The basal line makes a bend outward on the median vein; from this it goes in a straight course to the submedian vein; from this to the posterior or inner margin it curves a little outward. A second line extends from the costa about one-fourth of the distance from the base obliquely to the posterior margin, near the posterior angle. A third line passes straight across the wing from the posterior margin to the second, a little below the median vein. The fourth begins as a white spot on the costa a little more than two-thirds of the distance from the base, and joins the second on the posterior



margin, making the usual " " as in the allied species. The fourth line is slightly S-shaped in its costal third. Outside the fourth line is a subterminal, somewhat zigzag row of black spots, some of which are often faint or obsolete. In the discal cell there is usually a faint oblique line that seems to be a continuation of the third line, though it does not reach the costa, and the end of the cell sometimes appears like a short line. There are three oblique shades of brownish olive, more or less distinct, that cross the wing parallel to the second line; the first, beginning on the costa inside the basal line, faintly borders that line to the submedian vein, and is seen below that vein on the third line; the second, outside the second line through its whole course, is darkest next the line; the third from both sides of the fourth line to the middle of the outer border faint, except along the line. Just outside the S-part of the fourth line are three grayish-yellow spots with a few reddish-brown scales. Hind wings pale smoky gray with a faint whitish line from the fourth of the forewings to the anal angle. Beneath, the forewings are about the color of the hind wings above, pale along the costa and terminally; the hind wings are paler with a dark transverse line. (French, Can. Ent., xiv, p. 33.)

### 13. *Euclea pænulata* (Clemens).

This caterpillar has been found feeding on the willow September 19, by Professor French, who states that it pupated September 30 in the manner usual to the genus, the moth appearing June 17.

*Larva*.—In general outline somewhat elliptical, the sides and the back tapering from the middle to both ends. Length when full grown, .56 inch; width and height, in the middle, nearly .25 inch. Back dull purplish brown. A fine dorsal line and a broader one on each side, which alternately expands and contracts, of dull purplish orange. On each joint, except the twelfth, is a pair of impressed spots, which appear whitish when seen in certain lights. A subdorsal orange ridge with spiny tubercles which are concolorous with the ridges, except that between the last two there is a shorter black tubercle without spines; the second and third from each end of the body are larger than the others. A similar tubercled ridge is found in the region of the stigmata, except that it does not contain any black tubercles. Subdorsal space dull purplish orange, bordered above and below with purplish brown, each joint containing two whitish impressed spots similar to those on the dorsal space; below the lower line of tubercles dull orange. (French.)

*Moth*.—Body dark reddish brown. Forewings dark reddish brown along all the borders, with a large, central pea-green patch, extending from the base of the wing to the subterminal portion, bordered narrowly on the inner side and behind with white, and deeply indented opposite the middle of the inner margin, where there is a bright brown patch in the reddish-brown border. Hind wings yellowish brown. (Clemens.)

### 14. *Notodonta stragula* Grote.

(Larva, Pl. v, fig. 1.)

This singular caterpillar was found August 25, at Brunswick, Me., by Mr. H. H. Wilder. It has the peculiarity of raising and depressing the two large dorsal horns in the middle of the body; when at rest they are depressed, appearing simply as humps; when erect they are somewhat larger and evaginated, with their pseudojoints like those of a telescope; probably they serve to frighten away ichneumons. My specimens molted for the last time August 31.

*Larva before last molt.*—Head large oval, flattened in front, narrowing towards the vertex, which is slightly bilobed; the head is wider than the thoracic segments; the body is thickest on the second and third abdominal segments, on each of which is a thick fleshy conical soft tubercle, the apex falling over backwards; they may be elevated and somewhat enlarged or depressed, the anterior tubercle the larger of the two; the body is much humped dorsally on the eighth segment; supra-anal plate smooth, much rounded; the anal legs slender, not nearly so thick as the other abdominal legs. General color pearly glaucous whitish gray, somewhat marbled with brown; head of the same color, marbled with brown; a broad faint lateral band shaded behind with white. A brown dorsal line extends from behind the head to apex of second tubercle on third abdominal segment; thence a faint vascular line extends to end of supra-anal plate. The hump on eighth segment pale rust yellowish-red on sides, deeper above in the middle. A pale pinkish stigmatal line. Length, 20<sup>mm</sup>.

*Mature larva.*—Does not differ except in size from previous stage. Under side of body dusky; the pale lilac lateral line sends a branch down the middle of the feet on the sixth abdominal segment. Length, 40<sup>mm</sup>. For description of the moth see p. 456.

15. *Schizura unicornis* (Abbot and Smith).

This species is common both on the willow and thorn late in August in Maine. August 28 one had spun a slight cocoon, but up to September 4 had not pupated.

The dorsal hump is not so soft and retractile or sensitive as in the larva of the following species:

*Larva.*—Has a shorter smaller dorsal retractile than in *Cœlodasys*. Thoracic segments pea-green; the dorsal -shaped mark on the seventh segment is prolonged to the front edge of the sixth segment, this part really forming a separate narrow V, in front of the apex, of which on each fourth and fifth segments is a dusky brown patch, between the reddish-brown piliferous warts. Length, 25<sup>mm</sup>.

Before the last molt the larva is the same as mature form. Length, 15 to 18<sup>mm</sup>.

16. *Schizura larva*.

(Pl. v, fig. 3.)

Several caterpillars of this species were found on the willow at Brunswick, August 25, by Mr. H. H. Wilder. This caterpillar has a retractile horn (much more slender and retractile than in the one on thorn bush) on the first abdominal segment, which may be partially telescoped inwards or invaginated, forming three false joints, and the fork at the end is composed of two movable piliferous slender tubercles which slightly diverge more or less.

*Larva.*—Head very large, high, narrowing and bilobed above; on first abdominal segment an unusually high horn or soft tubercle, forked at the end, the horn itself being extensible; on the eighth abdominal segment a high double conical tubercle; anal legs slender, as usual in the genus; abdominal segments 2 to 7 with two dorsal piliferous warts, those on fourth and fifth segments much larger than the others. Body rust-red, pale green on the side of the three thoracic segments and edged above with white; on the back, between the first and third, there is a broad diffuse whitish lilac band; a distinct large V-shaped yellowish-white mark on the seventh abdominal segment; and two concolorous dots below the seventh pair of abdominal spiracles. Length, 20<sup>mm</sup>.

17. *Cerura occidentalis* Lintner.

(Larva, Pl. XI, fig. 7.)

The caterpillars of this moth were found feeding on willows (*Salix nigra*) by Prof. G. H. French, at Carbondale, Ill., from September 9 to October 5. The moths began to appear the following season from April 30 to June 3.

*Larva*.—Length when fully grown, 1.25 to the fork of the tail. Body slightly enlarged in front and somewhat compressed. In about the middle of the prothoracic segment is a prominent projection on each side, the body sloping from these down to the rather small head; there is but little sloping from the back to segment 9; from this there is a rapid sloping to the anal segment, this ending in the two usual caudal filaments; when withdrawn these are a little more than a quarter of an inch long, but may be extended to three-quarters. Clear bright green, sides spotted with clear purple brown, the spots round the stigmata and at the base of the thoracic and abdominal legs the largest. The back is marked with lilac, varying in shade, and arranged as follows: From the two small contiguous tubercles on the back of joint 2 to the head is a somewhat diamond-shaped space, the broadest part at the subdorsal tubercles on the prothoracic segment. From the tubercles on this segment to those on the next, the lilac is bordered by bright brownish purple with a white line; outside of this, in the middle of this diamond, is a little green shading. From the tubercles on the second joint from the head to the end of the body is another particolored space, lighter than the anterior one. This gradually expands so as to include the stigmata on segment 7, then decreases in width to the anterior part of the anal segment, expanding a little in the middle of this, but contracting again at its posterior part. The lilac of this is like the first, considerably suffused with green on the back, and is bordered with brownish purple and white, though the colors are a little lighter posteriorly. These two dorsal patches are not continuous, but are separated on the second segment by a distinct though small patch of green. The posterior projections are mostly brownish purple, though with somewhat greenish annulations, and when extended a ring of white near the extremity. Head dark lilac. Previous to the last molt the tubercles on the prothoracic segment ("joint 1") were covered with little spines. (French, Can. Ent., xiii, p. 144.)

18. *Cerura cinerea* Walker.

This species has been found feeding on the willow by Mr. Elliot, of New York.

*Larva*.—Pale apple green; head brown; second and third segment also with a brown triangular patch not united to the brown dorsal patch. On the second segment are two raised rough processes, like horns, brown in color. Commencing on the fourth and continuing to the last segment is a brown patch, a mere point on segment 4, spreading out diagonally on 6 and 7, narrowing on 8, a little wider on 9, narrowing again on 10, and wider on 11 and 12. The anal segment is furnished with long filaments alternately brown and green. The lateral green spaces have a number of rather small reddish spots, and on the dorsal brown patch are some small roughened tubercles. Length, 1.30 inches. The younger stages are of a paler color in all parts, without any perceptible difference in the markings. (Edwards and Elliot, Papilio, iii, p. 130.)

*Moth*.—Forewings and thorax more ashy and dusky than in any of the other species; the broad median ashy band not being so distinct as in the other species, since it is but little darker than on both sides of it; the outer margin, also, instead of being clear white or nearly so, is of the same dull ashy hue as the median band.

Hind wings white, with a distinct discal dot, and a series of marginal intervenular dots. Abdomen ashy, not ringed with white as in *multiscripta*. Expanse of wings, 34<sup>mm</sup>.

19. *Cerura multiscripta* Riley.

The eggs are said by Professor Riley to be hemispherical and pale yellowish green, while those of *C. borealis* differ in being jet-black. The caterpillar is closely similar to that of *C. borealis*. (Riley.)



FIG. 190.—*Cerura multiscripta*. After Riley.

Mr. F. Tepper found the larva of this fine moth on the willow July 30; a male imago emerged August 30 and a female September 30. (Bull. Brooklyn Ent. Soc., i, p. 4.) No description of the larva was published.

*Moth*.—Without the broad median band of *C. borealis*, *occidentalis*, and *albicoma*. Forewings crossed by eight usually well-defined lines; the third and fourth lines so meet as to form five more or less complete ringlets; all the lines are scalloped, the outer three being nearly parallel. There is a large well-marked discal ringlet. Hind wings of the females dusky, those of the male white; in both sexes the black spots on the edge of the hind wings are distinct; in this respect the species differs from Walker's *scitisscripta*, of which I have two specimens from Florida. It is not improbable, however, that the two species will be eventually united. Expanse of wings, 27 to 32<sup>mm</sup> (1-1½ inches).

20. *Cerura-like larva*.

Late in August this caterpillar was found on the willow at Brunswick, Me.

*Larva*.—Body somewhat flattened in front; head very large and broad, flattened in front and wider than the body; prothoracic segment very wide, with two fronto-lateral spines, bearing thick short spinules. The body ends in two long filaments, broadly ringed with brown; they are as long as the body behind the head, and spinulated. Two supra-anal tubercles ending in hairs. A short, broad trapezoid of four rounded tubercles. Body yellowish green; head, prothoracic segment above, and seven abdominal segments reddish brown.

21. *Apatela felina* Grote.

Prof. G. H. French has bred this moth from the willow, the eggs having been sent him by Mr. McGlashan, of Truckee, Cal. They were deposited July 6, the larvæ emerging six days later. From the egg to the moth required two hundred and ninety-six days. The cocoon was thin, firm, and tough.

*Young larva*.—Length .10 inch. Body cylindrical; head broader than the body, oblique. Color of the upper parts and sides of segments 2, 4, 5, 7, 8, 9, 12, and 13, reddish purple; the rest of the upper part, and sides and the venter dull whitish; six rows of tubercles from which proceed small clusters of brown hairs, the four rows of dorsal clusters longer than the body; head black; feet purplish. Duration of this period four days.

*After first molt.*—Length .22 inch; shape about as before. The segments that were reddish purple during the first stage are now black; the others white, the tubercles small, black; head black; hairs from the dorsal tubercles dark gray, the others white. Duration of this period, three days.

*After second molt.*—Length .35 inch.

*After third molt.*—Length .60 inch. Three dorsal stripes, a broad gray one in the middle.

*After fourth molt.*—Length 1 inch when at rest. Color of body yellowish green, with a gray dorsal stripe; under parts grayish brown; the whole body covered with fine yellow hairs that spring from the general surface as well as from the tubercles; the tubercles scarcely distinguishable from the general surface save that from these the hairs are more in clusters; a few black hairs in place of the former black pencils. Head black, the front with the usual pale inverted  $\lambda$ ; the sides mottled with black and pale brown. Duration four to five days.

*Mature larva.*—Length when crawling 1.60 inches, when at rest 1.40 inches. (French.)

*Pupa.*—Cylindrical, tapering gradually from segment 5 back, the tongue-case extending only to the anterior part of segment 5; the anterior part of the abdominal segments finely punctured; head rounded, mahogany-brown, the wing-cases and outer anterior parts darker. Cremaster a series of short hooks extending out laterally. Duration of the period two hundred and sixty-nine to two hundred and seventy-five days. Length .80 inch; to end of wing-cases .40, these extending almost to the posterior part of segment 5. (French.)

## 22. *Apatela oblongata* (Abb.-Sm.).

Abbot states that the larva feeds in Georgia on the willow and cotton, the moth appearing in April. Grote mentions the willow as its food-plant (*Papilio*, ii, p. 99), while Thaxter states that it feeds on the button bush and various meadow plants.

In his third report as State Entomologist of Illinois, Prof. S. A. Forbes states that the leaves of the willow at Normal were generally infested both in 1883 and 1884 by the larvæ of *Apatela oblongata*, those collected July 6 pupating on the 11th and emerging on the 29th.

“This insect hibernates in the cocoon, and seems to be either single or double brooded, according to latitude. In Missouri there are two broods in a year, by Professor Riley’s account, the

moths of the first brood escaping from the cocoons in May (the larvæ resulting appearing chiefly in June); and the second brood of moths occurring in July and the larvæ late in the fall. In the Northeast, the

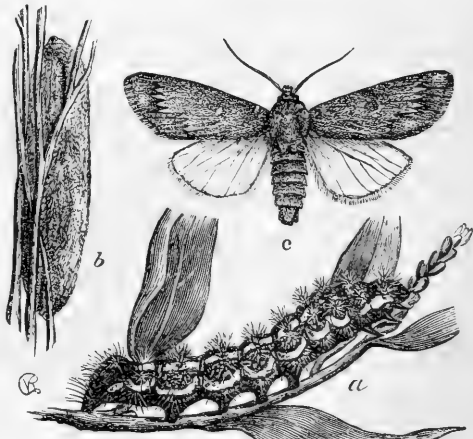


FIG. 191.—*Apatela oblongata*; a. larva; b. cocoon; c. moth. Riley del.

moths escape from the hibernating cocoons in June, as reported by observers in Canada\* and Massachusetts,† and the larvæ are reported only in September and October, during which months the pupæ are found. Previous to the pupation the larvæ spin a cocoon of silk within a bunch of leaves, or sometimes attached to a twig." (Forbes.)

*Larva*.—Prevailing color, black. Each joint with a transverse, dorsal, crimson-red band across the middle from stigmata to stigmata, and containing six warts, each furnishing ten or twelve or more stiff yellow or fulvous bristles, and the two dorsal ones being farthest apart. A subdorsal, longitudinal, yellow line, interrupted by this transverse band and at incisures in such a manner that the black dorsum appears somewhat diamond-shaped on each joint. A broad, wavy, bright-yellow stigmatal line, containing a yellow bristle-bearing wart in the middle of each joint. Lateral space occupied with different sized pale yellow spots, largest towards dorsum. Head chestnut-brown. Venter crimson-black, with bristle-bearing warts of the same color. Stigmata oblong-oval and pale. Thoracic legs black; prolegs with black extremities. Such is the normal appearance of this larva, but it is very variable. In some the yellow seems to predominate over the black, and there is a more or less distinct dorsal line. In some this dorsal line forms a mere speck at the incisures of the middle joints. The transverse crimson band is often entirely obsolete, and the warts distinctly separated, while in others, where this band is distinct, the warts frequently coalesce. (Riley.)

*Pupa*.—Almost black, and shagreened with the exception of a smooth and polished rim, at posterior border of joints, which become reddish, especially ventrally, on the three joints immediately below the wing-sheaths. Terminal joint horizontally compressed, squarely cut off, and furnished with a little brush of short, evenly-shorn, stiff, rufous bristles. (Forbes' Second Rep. Ins. Illinois.)

*The moth*.—Front wings oblong; apex more or less prolonged; posterior margin sometimes rounded, sometimes straight; color ash-gray, caused by numerous dark-brown atoms more or less suffused on a white ground, from which the ordinary lines are barely discernible in the better marked individuals; a row of distinct black dots along the posterior border; the ordinary spots represented by blurred marks or entirely obsolete; the undulate line across posterior fourth of wing distinct, and relieved inside by a pale coincident shade, with the teeth quite aciculate and with the psi-spot so characteristic of the genus, but rarely traceable; fringe narrow and generally entire. Hind wings pure white, with a faint row of dark spots around the posterior border. Under side of both wings white, with a faint fulvous tint and faint irrorations; each wing showing the brown discal spot and the row of points at the posterior border. Head and thorax speckled gray; abdomen whitish-gray; antennæ short, simple in both sexes, gray above and brown below; palpi small. Two specimens with the front wings very dark, showing the ordinary lines and spots conspicuously, and with the antennæ brown above as well as below. Average length, 0.75; expanse, 1.75 inches. (Riley.)

### 23. *Apatela*.

Mr. H. H. Wilder kindly presented me with two larvæ of this species found at Brunswick, Me., August 20.

*Larva*.—Rather large, of the usual shape, regularly tapering towards each end; head all black except the larval antennal joints. Body dull livid green with a broad

\* Report of the Entomological Society of Ontario, 1872, p. 23.

† The Canadian Entomologist, vol. x (1878, p. 66). Psyche, vol. ii, p. 34 (May and June, 1877.)

dorsal black stripe, with fascicles of straw-yellow hairs, which seem to be finely spinulated; there are ten warts on a segment in the middle of the body; the stiff yellow hairs are of nearly the same length and radiate quite regularly from the wart; a few of the hairs are black, from one to three in a fascicle; there are also a few slenderer hairs one-fourth to one-third as long as the body. Length, 40<sup>mm</sup>.

Before the last molt the head is green behind, and in front is a pale V-shaped mark, and the hairs are a little longer in proportion to the thickness of the body.

#### 24. THE HERALD.

*Scoliopteryx libatrix* (Linn.).

(Larva. Plate v, fig. 4.)

This fine moth, common to the New and Old World, is in England called "the Herald." Here, as well as in Europe, it feeds as a general rule upon the willow, but we are told by Mr. H. L. Clark that he has bred it from the wild cherry in Rhode Island.

Its habits so far as they have been noticed are nearly the same as observed in Europe. Mr. Lintner, the State entomologist of New York, says that the caterpillar feeds on and pupates among some of the leaves drawn together by silken threads to which the pupa is attached by an anal spine. The fall brood remains in the pupa state from fifteen to twenty days. He bred a moth which emerged August 3, hence he thinks that there are probably two annual broods of this species, since he has taken it in the early part of May. In Illinois Mr. Coquillett bred a larva which spun its cocoon August 23, while the moth appeared September 7.

Professor Riley's notes show that he found the larvæ at Kirkwood, Mo., in May, 1872; that they began to spin their cocoons May 29; and that the moths began to emerge June 11. On June 17 eggs were found.

We have found the larva on the willow at Brunswick, Me., August 26, when it was nearly full grown. It is easily recognized, since it is one of the few Noctuid caterpillars to be found on the willow, and may be known by its pale green hue and the yellow lateral line, as well as by the yellowish sutures between the body-segments. A chrysalis beaten out of a willow tree during the last week in August disclosed the moth about the 12th of September. Another chrysalis was found at Jackson, N. H., during the second week in September, the moth appearing September 14. The larva had sewed together four or five willow leaves at the end of a terminal shoot, and the cavity thus formed was lined with a thin but dense whitish cocoon in which the pupa was situated with the head upwards, and firmly held in place by the hooks on the abdominal spine. The moth hibernates, appearing in May as soon as the leaves are unfolded, and we see no grounds for supposing that there is more than a single brood of caterpillars or of moths. The chrysalis is quite unlike that of most Noctuidæ which transform in the earth, and have a simple blunt spine.

The cremaster or spine of the present species is much like that of those Geometrids which spin a cocoon. We have thus an interesting

departure from the usual structure and habits of a numerous family of moths, the end of the pupa being specially adapted for a residence in a cocoon to prevent its being shaken out of its exposed pupal abode. Like all tree-feeding Noctuidæ, the caterpillar is well protected from observation by its style of coloration, in the present case the pale green assimilating it to the leaves among which it feeds.

25. *Catocala parta* Guen.

The caterpillar has been reared from the willow by Mr. A. W. P. Cramer and described in *Papilio* (iii, p. 24) by Mr. Henry Edwards.

Mr. Hulst states that it feeds on the poplar, but on whose authority is not stated. Mr. Thaxter, however, has bred it from the willow.

*Larva*.—Dull fawn color. Head, as in all the genus, flattened on the top, with a deep frontal sinus. A black line surrounds the head, except at the junction with the second segment. There is a pale brownish dorsal line, and a subdorsal one, slightly waved, on each segment, and inclosing a darker space. These lines are most apparent at the junction of the segments. A rather broad, brownish lateral line, slightly waved, incloses the spiracles, which are brown. Feet and legs concolorous with the body. At the extreme lateral edge is a row of short sharp cilia. Length, 2.80 inch. (H. Edwards.)

*Moth*.—Forewings close smooth even bluish gray, with basal, apical, and sinus shadings; lines fine, but distinct; **M** of transverse posterior line produced, a white band from within reniform, extending obliquely outward, including the subreniform, not reaching the inner margin. Hind wings rather dull red, median band even, curved, not reaching the inner margin. Expands 80 to 85<sup>mm</sup>. Eastern United States.

Var. *perplexa* is slightly more shaded with blue and lighter.

Var. *petulans* Hulst has yellow hind wings, with just a shading of reddish along the anal margin. (Hulst.)

26. *Catocala concumbens* Walker.

This has been bred by Mr. Saunders from the willow; Hulst adds the poplar as also forming its food-plant.

*Larva*.—Head flat, dark grayish intermixed with red. Upper surface dirty brown with a lightish chain-like dorsal stripe and a very small fleshy protuberance on each side of this stripe on each segment. On the ninth segment is a small protuberance of a brownish color and on the eleventh a mark resembling an oblique incision. A thick lateral fringe of short hair close to the under surface; the latter pinkish with a central row of round black spots which are larger about the middle of the body and much smaller towards the extremities. (Saunders.) Length, 2 to 2.50 inches.

*Moth*.—Forewings pale violaceous brown, mixed with gray, lightest towards the costa; lines fine, but distinct; reniform vague, whitish, pale brown within. Hind wings bright pink; median band very broad, rapidly narrowing towards the anal margin, which it does not reach; the submarginal pink space even through its whole length. Expands 75 to 85<sup>mm</sup>. Northern States. *C. diana* has the abdomen partly pink. *C. hillii* Grote has yellow hind wings in place of pink. (Hulst.)

27. *Catocala babayaga* Strecker.

The caterpillar of this Arizonian species, according to Mr. Doll, feeds on the willow. The moth is like *C. junctura*, except that the forewings are of a rich velvety reddish brown. The wings expand 100<sup>mm</sup>.



28. *Catocala carissima* Hulst.

The larva of this moth has been described by Mr. A. Koebele in the Bulletin of the Brooklyn Entomological Society (iv, 22).

The larva is considerably smaller than that of *ilia* when full grown, though the imago is one of the largest, if not the largest, of all *Catocalæ*. It feeds on the willow.

*Larva*.—Head gray brown. Protuberance on summits of eyes prominent. Body, ground color gray, very heavily marked and striated with rust-brown, which towards the head almost covers the body. There is a brown lunule on the eleventh segment with horns forward. Underneath clear red brown between third and sixth segments. The sixth and seventh segments between and anterior to the legs have each a large nearly round spot. (Koebele.)

29. *Noctuid larva*.

This brightly painted caterpillar occurred on the willow in Maine the first and second weeks in September.

*Larva*.—Head broad and large, wider than the body, which is smooth and of the usual Noctuid shape, the end being smooth and tapering. Head pale carneous, with four longitudinal reddish bands, the two middle ones diverging from each other in front. Body rich dark brown, with a broad subdorsal bright yellow band; a narrower yellow spiracular line, and between it and the subdorsal band a narrow linear whitish line; the spiracular line is edged below with pale lilac. Body beneath and legs pale whitish flesh-colored. Length, 12<sup>mm</sup>.

30. *Noctuid larva*.

This caterpillar occurred on the willow at Brunswick, Me., late in August and through September.

*Larva*.—Body thick and fleshy, rather short, otherwise of the usual Noctuid shape. Head large and full, nearly as broad as the body, pale reddish brown, mottled and watered with a paler hue. General color of body snuff-yellow; a dorsal row of eleven dark brown diffuse spots; a subdorsal row of short oblique marks, extending anteriorly down the sutures. Spiracles ringed with black. Supra-anal plate and anal legs above, brown. All the feet flesh-colored. Length, 22 to 25<sup>mm</sup>.

31. *Cymatophora pampinaria* Guenée.

The caterpillar has been found feeding on the willow by Professor French, who observed that in Illinois it pupated September 16 and October 2, the moth appearing April 17. From a specimen raised by Mr. L. W. Goodell, which, after spinning a few threads on itself, pupated, the moth appeared in confinement November 14. It feeds on the pear, willow, and cultivated geraniums.

*Larva*.—Pale yellowish-green (sometimes gray or brown), with a broad reddish-brown stripe, edged with black on the back, and on each side of the fifth segment is a small black spot. Length, 1 inch.

*Pupa*.—Light brown. Length, .50 inch.

*Moth*.—This is now our most common species of the genus, and may be known by the very distinct line at the base of the abdomen, the basal ring beyond being unusually white, and by the under side of the wings having a broad marginal shade, while

the third line on the fore wing is deeply but quite regularly sinuate, and near the costa acutely dentate. It varies a good deal, especially in the tint of the brown shade accompanying the third line. Expanse of wings, 1.40 to 1.55 inches.

### 32. THE PINK-STRIPED WILLOW SPAN-WORM.

*Deilinia variolaria* Guén.

(Larva, Plate v, fig. 6.)

The caterpillar of this pretty moth is one of the commonest inch worms to be found on the willow.

The genus to which this caterpillar belongs was founded by Hübner for a moth referred by Guenée to *Cabera*. The species of *Deilinia* are distinguished from those of *Corycia* by the pectinated antennæ, the two common lines, and the generally ochereous tint, though the females of *D. variolaria* are with difficulty separated from those of *Corycia*. From *Acidalia* the species differ in having pectinated antennæ, in the want of a decided band on the hind wing, and in the larger palpi. The species is figured on Pl. 10, fig. 26, of Packard's Monograph of Geometrid Moths.

The caterpillar occurred August 10 on the willow at Brunswick, Me. It pupated August 14, and the moth emerged from May 20 till June 6. The moths are seen flying among willows in June and July. We have also found the larvæ July 24, and from that date till the first week in September.

*Larva*.—Body smooth, cylindrical. Head as wide as the body, flattened from above, especially in front; antennæ pinkish. Green with a pinkish tinge; on the side of the head a lateral distinct deep pink line, sutures and upper side of the segments pinkish. There are eight dorsal median spots along the abdominal segments, a central dark brown dot flanked on each side by a pale lilac patch. First pair of abdominal feet deep lilac; anal legs with a vertical anterior lilac line. Supra-anal plate large, triangular, with two minute tubercles. Length, 22<sup>mm</sup>.

*Pupa*.—Thorax moderately stout, at first greenish, finally becoming like the abdomen, mahogany-brown; terminal spine (cremaster) rather stout and blunt, ending suddenly in two large curved bristles with three minute slender much curved ones on each side; the basal pair situated about half-way between the base and the middle of the spine. Length, 10<sup>mm</sup>.

*Moth*.—Front of head deep reddish-ochereous; white on the front edge; palpi deep ochereous; antennæ white. Fore wings with the costal edge rather full. Both wings strigated more or less thickly with brown; sometimes the wings are pure white. In the male, the strigæ (or short lines) are arranged in two parallel lines on both wings. Beneath, pure white, sometimes a complete black discal dot on each wing. Fore and middle legs ochereous. Expanse of wings, 26<sup>mm</sup>. This species differs from *D. erythemaria* (Guen.), also common in the Atlantic States, by its white wings, which are often without lines, and by the deep reddish-ochereous front of the head.

### 33. *Hydria undulata* (Linn.)

(Larva, Pl. v, fig. 9.)

The larvæ were found on the willow at Brunswick, August 5, and for the colored figures on Pl. v I am indebted to Mr. H. H. Wilder. The moth issued May 19, but as the specimen flew away before I pinned it,

though recognizing it in the breeding box, I give the following description of the larva, which differs somewhat from that on p. 527 (wild cherry insects).

*Larva*.—Head smaller than usual, rounded; not so wide as the prothoracic segment; body broad, somewhat flattened; somewhat resembling the figures of *Hibernia*; increasing in thickness to the middle, and thence decreasing to the anal legs, which are small; supra-anal plate small, much bent down; with six piliferous warts at the end. Head amber colored; body deep flesh, somewhat livid, with a slight broken dorsal median dark line and two broad lateral dark reddish brown supraspiracular lines. No other markings, and the piliferous warts very small; beneath reddish flesh-colored. Length, 20<sup>mm</sup>.

34. *Geometrid larva*.

(Larva, Pl. v, fig. 8, a, b.)

Found August 5, on the willow at Brunswick.

*Larva*.—Head broad and flat, square on the sides; as wide as the prothorax; the body very slender, long, cylindrical; remarkably like a slender willow twig, stained irregularly with lilac-gray and reddish brown; a lateral slight swelling on side of mesothoracic segment; two twin dorsal tubercles on end of sixth segment, and a large pair on the succeeding ring; supra-anal plate short, rounded, with two distinct piliferous nipple-like warts on the end. Length, 25<sup>mm</sup>.

35. *Geometrid larva*.

(Young larva, Pl. v, fig. 7, a, b.)

Several caterpillars of this species occurred in Maine on the willow August 6, becoming mature and pupating from the first week in September to the middle of the month.

*Larva before penultimate molt*.—Head large, flattened, as broad as the body, which is rather slender, with a pair of subacute mostly blackish warts on the end of each abdominal segment, and a much smaller less conspicuous pair on the front edge; lateral ridge sharp and well marked, especially posteriorly. Head and body curiously marbled and stained with pale gray and black-brown; head marbled with a dark diffuse stripe on each side, extending back upon the prothoracic segment; from the sides broad triangular blackish patches extend up, their apices nearly meeting on the back at the dark tubercles; these patches connect with an irregular blackish lateral line extending from the base of the thoracic feet along the front edge of the anal feet, which are of moderate size and width. Six piliferous warts in a straight line across the front edge of the supra-anal plate, which is broad, rounded triangular, the surface rough, and the end washed with black-brown. A dorsal dark median line on the front and hinder end of the body, interrupted in the middle. Length, 15<sup>mm</sup>.

*Mature larva*.—With essentially the same characteristics as in the previous stage, but more like a dried willow twig; the piliferous warts are large and end in a short stiff hair; they are mostly black, pale around the base; the spiracles are ringed with black. Length, 40<sup>mm</sup>.

36. *Eupithecia* sp.

This caterpillar occurred on the willow at Brunswick, in August, and made a slight silken cocoon between the leaves September 3.

*Larva*.—Much like that of the *Eupithecia* on the spruce, the body being of the same size and shape; the surface granulated, and with short stiff hairs; reddish caraneous;

a dorsal row of dusky diamond-shaped spots on the abdominal region ; on the thoracic segments three obscure parallel dusky lines, and on the supra-anal plate a dusky median band extends forward to the last diamond-shaped spot. Length, 12<sup>mm</sup>.

### 37. Eupithecia-like *Geometrid larva*.

Occurring on the willow at Brunswick, Me., late in August and early in September.

*Larva*.—Body small, somewhat flattened as in Eupithecia, the surface granulated ; the lateral ridge unusually well developed ; body tapering towards each end ; the head rather small, not so wide as the prothoracic segment ; dull green, with a dull lilac patch near and including the eyes and occipital region. Lateral ridge deep lilac, extending to both edges of the supra-anal plate ; a broad, dorsal dull green longitudinal band ; the setæ are short and stiff, erect. Length, 12<sup>mm</sup>.

### 38. *Geometrid larva*.

This is a common loopworm on the willow in August and early September ; it rolls the leaves somewhat, hiding in the rude tent thus formed. It seems to have the habits of the Pyralids, and reminds one of their larvæ by its well-marked prothoracic shield.

*Larva*.—Body rather broad and somewhat flattened ; head smooth, small, not so wide as the body, shining, deep amber-colored ; general color dusky livid lilac and greenish, marbled and banded with these colors, with no definite markings ; spiracles black ; supra-anal plate rounded, smooth ; a short, dark, shining prothoracic shield. Length, 20<sup>mm</sup>.

### 39. *Geometrid larva*.

This caterpillar began to pupate September 2 at Brunswick, Me.

*Larva*.—Head small, rounded, not so wide as the body. Supra-anal plate moderate, rounded, no stripes, spots, or humps. Greenish, with a reddish tinge.

### 40. THE GREEN-STRIPED PHYCID WORM.

#### *Meroptera pravella* Gr.

(Larva, Pl. v ; fig. 10, a, b.\*)

This is a common insect on the willow, occurring at Brunswick, Me., August 20, and through the month. It spins a web on the under side of the leaf, and pupates from the 15th to 20th of September, the moth in confinement appearing (in the breeding cage at Providence) the end of May (the 25th–31st). The caterpillar, which is longitudinally striped with light and dark green, with black slashes on each side of the head, varies somewhat ; in some there are only four slashes on the head, with no other markings. The moth differs from *Phycis rubrifasciella* on the hickory in having no cross band of raised scales, while the insect is

\* Like all the other figures on the plate, the lithographer's work has been very poorly done, and the printing is also very poor, the red and brown lines are too bright in the plate.

much darker, and the palpi are twice as broad. The moth was kindly identified by Prof. C. H. Fernald.

*Larva*.—Body of the usual form, tapering from near the head to the end. Head of the usual size, not quite so broad as the prothoracic segment; green, slashed vertically, and mottled with large and small brown or jet-black spots. Prothoracic segment a little swollen; the shield not striped like the rest of the body. Body with narrow alternating light and dark green stripes; brown along the back, and inclosing a large round green spot on each segment; the brown portion with three interrupted green lines, one median and two lateral. Piliferous dots minute, not conspicuous. Length, 15<sup>mm</sup>.

*Pupa*.—Of the usual Phycid shape; mahogany-brown; end of the terminal abdominal spine smooth, shining, convex, and ending in a stout curved lateral spine on each side. Length, 10<sup>mm</sup>.

*Moth*.—Body and fore wings dark gray, with brick-red scales and bands. Palpi very broad, especially the second joint; dark gray; vertex of head light gray, with dark scales; antennæ blackish. Prothoracic scales and shoulder tippets (patagia) dull brick red; middle (disk) of thorax gray. Fore wings dark dusky gray, with scattered pale-gray scales; base of wings dull brick-red; a broad, diffuse band of the same color crosses the basal fourth of the wing; on the outer fourth of the wings is a similar broad, diffuse, dull brick-red band, sending a diffuse longitudinal stripe towards the basal band; an incomplete transverse pale-gray line, curved outward in the middle of the wing, borders the inside of the outer reddish band. Costal edge dusky, the reddish bands not reaching it. Fringe of the same dull slate color as the hind wings. Expanse of wings, 20<sup>mm</sup>.



FIG. 192.—Willow leaves sewed together by *Meroptera praveilla*. Wilder del.

#### 41. *Deltoid larva*.

This pretty caterpillar occurred on the willow at Jackson, N. H., September 10.

*Larva*.—Body slender, tapering toward both ends, with two pairs of abdominal legs besides the anal pair, and situated on the fifth and sixth abdominal segments. Head and body pea-green, with two double, more or less broken, whitish yellow lines, each double line becoming single on the thoracic segments. A concolorous slender spiracular line. Thoracic feet pale amber, almost greenish; abdominal feet green. Length, 16<sup>mm</sup>.

#### 42. *Deltoid larva*.

This caterpillar occurred on the willow August 15 at Brunswick, Me.

*Larva*.—Body slender; four pairs of abdominal legs, the first pair smaller than the others, grass-green; a broad dorsal dark band edged with a yellow line. The setiferous tubercles large, black. Head with twelve conspicuous black dots, one pair of which are larger than the others. Length, 15<sup>mm</sup>.

#### 43. *Teras permutana* Duponchel.

This moth, which is common to both Europe and the United States, has been found by Mr. Coquillett to feed on the willow, living between two or three leaves which are fastened together with silken threads.

Two spun their cocoons about June 13, producing the moths June 27; others occurred July 2.

*Larva*.—Body green, the sutures yellowish when the caterpillar is in motion; no well marked cervical shield; a dark-colored dorsal line; an indistinct light-colored stigmatal line; head and body beneath pale green; spiracles ringed with pale brown. Length, 19<sup>mm</sup>, .76 inch. (Coquillett.)

*Moth*.—Head and palpi chocolate brown. Thorax varying from cream color to ochereous, and sometimes stained with brownish. Collar and tips of the crest of a brownish color. The fore wings are of the same color as the thorax from the base out to the oblique band across the middle of the wing, except the portion below the fold, which is clouded with dark fuscous and brown, and a tuft of dark brown scales on the basal third of the fold. The oblique band which starts from the middle of the costa and terminates within the anal angle is of a light reddish brown color, and has a row of scale-tufts along its inner edge. The apical portion of the wing is of the same color as the band, though sometimes clouded with brown, while the space between is somewhat paler than the band, especially on the costa, where it approaches the color of the basal part of the costa. The fringes are of the same color as the outer part of the wing, except at the anal angle, where they are of a dull smoky color. The hind wings are pale yellowish, tinged with fuscous towards the apex. The fringes are lighter than the wings, but with a somewhat darker basal line. Abdomen, pale fuscous. The under side of the fore wings is pale ochereous, mottled or clouded with fuscous. Under side of the hind wings colored as above, but with a few fuscous sprinkles towards the apex. Expanse of wings, from 16 to 18<sup>mm</sup>. (Fernald, manuscript.)

#### 44. THE WILLOW TERAS.

*Teras viburnana* Clemens.

The caterpillar of this common species is of the ordinary shape and green in color, occurring on the willow in Maine during August. The specimen we reared changed to a chrysalis August 19; remained in that condition a little over two weeks, namely, until September 7. The moth has been determined by Professor Fernald.

*Larva*.—Greenish.

*Pupa*.—Body slender; end of the abdomen flattened and excavated, with two large lateral hooks before the tip. Length, 8<sup>mm</sup>.

*Moth*.—Head, thorax and fore wings rust-red. Head above and front of thorax deep rust-red, hinder edge of the thorax bright red. Fore wings rust-red, deeper on the costa; a dusky patch at the base; beyond, on the inner third of the costa, is a broad, paler, square spot, succeeded by a long, dark, deep reddish-brown patch, which extends to near the apex. The rest of the wing is clearer and paler, ash-colored, mixed with brick-red scales. In the middle of the wing on the inner third are two distinct, twin, fine black dots. Beyond are three black dots, forming an oblique line, extending from the median vein to a little beyond the middle of the hinder edge of the wing; a few scattered, black, fine dots near the outer edge of the wing. Fringe broad, reddish externally, dark on the basal half, and grayish on the inner angle of the wing; hind wings uniformly gray slate-colored; abdomen dark brown, paler at the tip. Expanse of wings, 18<sup>mm</sup> (.70 inch.)

#### 45. *Grapholitha galle-saliciana* Riley.

In the Transactions of the St. Louis Academy of Science for 1881 (p. 320) Professor Riley described this gall-inhabiting caterpillar from two specimens which emerged June 17, from galls on willow twigs, at

St. Louis, Mo. The larva was not described. The moth is at once distinguished from the European *campoliliana* Tr. by its pure silvery or satiny-white coloration, untinged with yellow. Its general color is that of the European *Boarmia roboraria* Schiff, but it is much smaller and is very differently marked.

*The moth.*—Male. Thorax olivaceous; primaries olivaceous with a pale ochraceous tinge; an oblique streak from the middle of the costa connecting with a broad somewhat wavy stripe which extends through the middle of the wing to just before the apex; two spots on inner border, one near base, the other (which is larger and more elongate) toward anal angle, and some costal and apical streaks brown-olivaceous; ocellated spot silvery, the center ochraceous, with two black stripes; a silvery streak extending obliquely from the costa to the posterior margin; fringes ochraceous, tinged with fuscous at apex; secondaries gray, fuscous towards tip; fringes white, dusky at base; under surface of primaries fuscous; the fringes, except at apex, and some costal spots ochraceous; secondaries gray. Expanse, 18<sup>mm</sup>.

#### 46. *Tortrix larva.*

This caterpillar occurred August 11 and 12, at Brunswick, Me. It lives between two leaves, the tent or cavity being lined by a slight web.

*Larva.*—Head jet black with black cervical shield. Body stout, broader than the head and shield, gradually tapering behind. Pea-green, color of the leaves; segments yellowish on the hind edge. Body with alternate light and dark green stripes. Length, 17<sup>mm</sup>.

#### 47. *Tortrix larva.*

This caterpillar was found feeding on the willow August 15, at Brunswick, Me.

*Larva.*—Body thick in the middle, tapering towards each end. Head small, much narrower than the prothoracic segment. Body and head pale grass-green; clypeus and mouth parts amber-colored. Setiferous tubercles small, inconspicuous, the hairs minute. Length, 15<sup>mm</sup>.

#### 48. THE PURPLE WILLOW GRACILARIA.

##### *Gracilaria purpuriella* Chambers.

Late in August (the 20th) we found the caterpillar of this beautiful moth, which had turned over obliquely the tip of the willow leaf and securely fastened it to the under side of the leaf, thus making a triangular fold. The worm had eaten the parenchyma from the under (*i. e.*, inner) side, leaving a mass of black castings. The worm soon transformed, remaining about two weeks in the pupa state, and the moth appeared September 19. The moth is a very beautiful creature, with a delicate body, wings, and legs. Our example was perfect, and agreed in all respects with Mr. Chambers' description, which is copied below. He did not, however, describe the caterpillar. He remarks that it is closely allied to the European *G. stigmatella*.

Hestates (Canadian Entomologist, iv, p. 28) that "the larva mines the leaves of the willow (*Salix longifolia*) for a very short time; then, leaving the mine it rolls the leaves from the tip upwards into various forms (usually a cone or helix of three spirals).



FIG. 193.—Willow leaf folded by *Gracilaria*.—Wilder del.

\* \* \* It frequently leaves one roll and makes another, and, when ready to pupate, makes a dense, semi-transparent web over it, upon the ground, not on the leaf, as in many species. The imago emerges in the fall, and most probably hibernates." He again remarks (l. c., v. 46):

The cone sometimes occupies an entire leaf; the apex of the leaf is bent over, so that the left edge touches the right one, to which it is fastened; then the leaf is rolled spirally to the base, and the tip is used to close one end and the base the other, so that the whole leaf is utilized. Many of the mines, however, are by no means so perfect.

Chambers has also bred it from larvæ feeding on the silver-leaf poplar, but, though not occurring on the weeping willow, it is common enough on many of our native willows.

*Larva*.—Body of the usual cylindrical shape; no cervical shield. Head small, considerably narrower than the prothoracic segment. Head and body uniformly greenish yellow. Only four pairs of abdominal legs, and these, with the thoracic feet, are of the same color as the body. Length, 6 to 7<sup>mm</sup>.

*Pupa*.—Very long and slender, so delicate as to scarcely retain its shape when the moth has left it.

*Moth*.—Violaceous, reddish, or brownish purple, according to the light. Face pale violaceous, flecked with brownish purple. Antennæ brown, tinged with purplish, faintly annulate with white at the base of each joint; palpi pale purplish. The triangular white spot at about the middle of the costa is nearly equilateral; its anterior margin is a little concave, the apex reaching the fold, and it has four small spots of the general hue situated in it upon the costa. Fringe bluish fuscous. Posterior femora white at the tip and with a white band around the middle, and their under surface entirely white. Posterior tibiæ and inner surface of intermediate tibiæ white. Tarsi pale grayish fuscous, faintly annulate, with white at the joints. Abdomen purplish fuscous, on a white ground. Expanse of the wings, half an inch (12.5<sup>mm</sup>). (Chambers.)

#### 49. *Tineid larva*.

This larva is common on the willow at Brunswick, late in August, fastening the leaves together.

*Larva*.—Body a little thicker than that of *Gracilaria purpuriella*, being quite thick, with large flattened setiferous tubercles, four in a line across the thoracic segments, and two large ones on the abdominal segments. Head small, very dark amber-colored; prothoracic shield black-brown. Body dull olive green; supra-anal plate and anal legs darker. Long pale hairs along the sides of the body. Length, 7<sup>mm</sup>.



50. *Gracilaria larva*.

Associated with the foregoing species and *Gracilaria purpuriella*, August 20, at Brunswick, Me. It fastens two leaves together, lining the cavity thus formed with white silk. It also turns a whole leaf over, inside out, joining the edges together completely, and making a long irregular pod-like tube.

*Larva*.—Much like that of *Gracilaria purpuriella*, but the segments are fuller, with distinct piliferous warts which are concolorous with the body, the latter being uniformly yellowish green. Head small, much narrower than the prothoracic segment, pale yellowish amber, with a small dark dot on each side; prothoracic segment concolorous with the other segment, but with two brown dots, one on each side. Length, 8mm.

51. *Lithocolletis salicifoliella* Clem.

“During the latter part of June or early in July the leaves of the yellow willow, *Salix vitellina* var. *alba*, should be searched for this insect. The mine is on the under surface, usually near the base of the leaf and along the edge. I found these mines for the first time on the 23d of July of the present year, but they were untenanted, and the imago had escaped, so that I am unable to furnish any further particulars respecting the species.” (Clemens.)

52. *Lithocolletis* sp.

The larva of this minute moth is abundant on the willow. It was observed July 10, and probably is to be found by the end of June. The leaf is folded and rolled inward from near the base to the outer third, and the larva eats holes in parts adjacent on the other side of the mid-rib and on the inside of its case. The moth emerges as early as July 20, leaving the pupa case sticking part way out of the folded leaf. July 10 we found the larva of a small Braconid? larva which had spun a loose silken cocoon, closing the opening of the fold.

*Larva*.—Body pale green; head rounded, jet-black, as wide as the body. Segments of the body coarsely wrinkled transversely. On the three last segments of the hind body are black spots forming two irregular transverse conspicuous lines, and at the end are four black pointed tubercles or spines. Length, 6mm.

53. *Cemistoma albella* Chambers.

The larvæ of this Tineid are said by Chambers to live in large blackish blotch mines.

54. *Aspidisca saliciella* Clem.

“From the beginning to the middle of July the larva may be taken on the leaves of yellow willow. The mine is very small, the excised portion, with which the disk is formed, taking up the greater portion of it. I noticed in this larva a habit, which may be generic, but if so it

has escaped my observation. The larva, after cutting out of its disk, lets itself down by a thread, and in the middle of July the disks may be found suspended under willows, as the larva lets itself down to the surface of the ground. My specimens were taken on July 23, when the mines were generally deserted." (Clemens.)

55. *Nepticula fuscotibiella* Clem.

Though the food-plant and metamorphosis of this Tineid were not mentioned by Clemens (Tineina, p. 182), Mr. Chambers stated that the larva lives in a linear mine bent back on itself.

*Moth.*—Antennæ dark fuscous; basal joint silvery white. Head reddish yellow. Fore wings purplish fuscous, with a rather broad, slightly oblique silvery band exterior to the middle of the wing. On the costa of the wing the band is rather nearer to the base than on the inner margin; cilia pale grayish. Hind wings pale gray, with pale-gray cilia. Thorax dark fuscous, with a purplish hue. Legs and abdomen beneath yellowish, with a brassy luster; the hind tibiæ fuscous.

56. *Gelechia fungivorella* Clem.\*

The following account of this moth is from Clemens' Tineina:

My friend Mr. Benj. D. Walsh, of Rock Island, Ill., writes to me that "the larva mines a cabbage-like gall, *brassicoides* peculiar to *Salix longifolia*, and a pine-cone-like gall on *Salix cordata* named *strobiloides* by Osten Sacken." The ornamentation of the imago is similar to that of *G. roseosuffusella*, the larva of which inhabits the fruit panicles of sumach. Imago occurs August 1 to 15. Bred by Mr. B. D. Walsh, Rock Island, Ill.

*Moth.*—Fore wings roseate-white, freely dusted with testaceous-brown along the inner margin from the base to the tip of the wing, the costal half of the wing being banded with alternate roseate-white dusted with brownish, and testaceous-brown bands; near the base of the wing is an oblique testaceous band extended a little beyond the middle of the wing, margined externally by a roseate-white band, having a central line of brownish atoms. Another testaceous band, placed about the basal third of the costa, is oblique, and extends a little beyond the middle of the wing; its dorsal edge is convex and the costal edge concave; it is broadest in the middle of the wing and terminates in a point, just beneath which is a black or dark brown dot encircled with white or roseate-white. Towards the apex of the wing is a semi-circular testaceous, costal patch margined with white or roseate-white. \*The apical portion of the wing is dusted freely with testaceous, and at the base of the cilia, near the anal angle, are one or two black dots. Cilia testaceous, with a white patch beneath the tip having a central dark-brownish ciliary line, and a white or roseate-white patch at the anal angle.

Antennæ dark brown, slightly annulated with shining white. Head whitish tinted with fuscous. Labial palpi white; second joint with three blackish rings, one at the base, one in the middle and one near the tip; terminal joint with four blackish rings, one at the base, two in the middle, and one at the extreme tip.

57. *Gelechia salicifungiella* Clemens.

"The larva," says Clemens (Tineina, p. 262), mines the same gall, *brassicoides*, as *G. fungivorella*. Mr. Walsh bred six specimens, of which he was kind enough to send me three. Although *fungivorella* is tinged

\* Of this I received two specimens from Mr. B. D. Walsh. The exp. al. is  $5\frac{1}{2}$ x6 lines.—H. T. S.

with roseate in the white markings, I can perceive no tendency in the eight specimens of this imago, that Mr. Walsh has so liberally sent me, to merge into the ornamentation of *salicifungiella*. Certainly the character of the markings is the same in each, and it is possible that we have here but a single species. The imago occurs August 3-13. Bred by Mr. B. D. Walsh."

*Moth.*—Fore wings red, irregularly marked with whitish. Near the base is a whitish band, powdered with dark fuscous, which curves across the fold, including the inner margin, and reaches the middle of the wing; the part beneath the fold is tinged with reddish and sometimes with pale brownish. Adjoining this band exteriorly is a dark brownish-red, curved band, which does not cross the fold. On the costa are three small white spots, one near the tip, one about the middle and one exterior to the brownish-red band. The margin of the wing is powdered with dark fuscous cilia red. Hind wings dark gray; cilia grayish-fuscous.

Head reddish. Antennæ black, annulated with white. Labial palpi pale red; second joint with two blackish rings; terminal joint with three black rings and a black dot at the base, extreme tip black. (Clemens.)

58. *Gelechia, undescribed species* (Chambers).

Imago unknown. The larva sews together willow leaves at great elevations in the Rocky Mountains.

59. *Marmara salictella* Clem.\*

The following account of this moth is copied from Clemens's posthumous work on the Tineina:

The larva mines the young branches of the yellow willow tree. I

---

\* It leaves its mine at maturity to weave a white semi-transparent cocoon within some crevice of the bark of the tree on which it feeds or upon the ground. The exterior of the cocoon is covered with little froth-like globules, which resemble minute pearls.

The imago rests with the front part of the body elevated, and, I believe, the forefeet applied to the breast, like the members of the genus *Tischeria*. The antennæ are held extended at the side of the head, and have a constant trembling motion.

*Larva.*—The larva is much flattened, and the segments separated by deep incisions, particularly on the sides. The head is extremely thin, circular, with a peculiar appendage in front of the mandibles similar to that found in the larva of *Lithocolletis* of the second group, which it likewise resembles in form. Like these it has three feet and three abdominal prolegs and one terminal pair, all very short.

*Moth.*—Hind wings setiform. The subcostal vein is faint, attenuated, and simple. The discal vein free, central and two-branched. The median vein simple. Forewings narrowly lanceolate. The disk long, narrow, and closed. The subcostal vein is well defined from the base to the first marginal branch, which appears to be a continuation of it. But from the origin of the first marginal branch the vein is greatly attenuated, and is deflected towards the middle of the wing and subdivides into two branches opposite the point at which the first marginal branch attains the costa. The two branches into which the subcostal divides are delivered one to the costa just behind the tip and the other midway between this and the costal end of the first marginal branch. The median vein is two-branched, and is well defined from the base to its branches, all of which are attenuated. The posterior branch is short,

have always found it in those that spring from the trunk. Its mine is extremely long and very narrow, being only a track beneath the young and delicate cuticle of the branches sufficiently wide to accommodate the body of the miner. At first it is difficult to detect the same, but after some months it is easily traced by the elevated line of reddish-brown matter that marks the course of it. Thus it is easily found in early spring before the buds have expanded, and the larva may be sought in April, and is easily reared. In the spring the larva is of a dark lemon-yellow color without markings, and at this time the larva can be seen through the cuticle of the branch. About the middle of May, or rather about the 10th of the month, the larva will be found banded alternately with red and yellow, with two black dorsal dashes on the second segment. (I regard the head as the first.) This is the indication that it has reached its maturity, and in a day or two it cuts the cuticle and leaves the mine to weave its cocoon, sometimes in the angle of a bud on the branch of which it has been feeding, and sometimes on adjacent substances.

In rearing this insect it is simply necessary to thrust the branches of the willow into wet sand contained in some convenient vessel and to protect them so that the larvæ can not wander after leaving their mines.

The perfect insect appears after a pupation of about a month, or, as is the case of one specimen specially observed, in twenty-six days. It may be found as an imago, therefore, about the middle of June.

*Moth.*—Forewings dark fuscous, with a silvery white band at the basal third of the wing, and a slightly oblique one of the same hue in the middle, inclined towards the inner angle. Near the tip of the wing are dorsal and costal silvery white spots opposite each other. Behind the dorsal spot is a narrow, somewhat curved white streak, extending from the apical cilia to the middle of the wing. Cilia silvery grayish at the tips. Hind wings grayish fuscous. Antennæ grayish fuscous. Head silvery white. Labial palpi silvery, the hairs of the second joint touched with fuscous. Maxillary palpi dark fuscous. (From Clemens's *Tineina*.)

60. *Batrachedra salicipomonella* Clem.

The following account is copied from Clemens :

This is a very interesting "micro," not only in consequence of the specific resemblance it bears to the European *Batrachedra præangusta*, but of the discovery of its larva by one of our most gifted and promising entomologists, Mr. Benjamin D. Walsh, of Rock Island, Ill.

In the note which accompanied the perfect insects, Mr. Walsh writes:

I inclose herewith several specimens of a moth bred from the Tenthredinidous gall, *salicis-pomum* Walsh manuscript, and a single one from the Cecidomyidous gall, *S.*

and the next is delivered to the tip of the wing, and receives an oblique discal vein from the last branch of the subcostal, which closes the disk. The submedian vein is simple. Head smooth, with appressed scales. Ocelli, — —? Antennæ one-third less long than the forewings. Labial palpi slender, ascending, not higher than the vertex; the second joint is scaly, the third smooth. Beneath the labial palpi are small, ascending maxillary palpi. Tongue naked, as long as the fore coxæ and femora.

*rhodoides* Walsh. This is the insect that I think I mentioned to you as being very prettily marked in the larval state, each segment having a broad black band, and the ground color being whitish. I had a single one come out last summer, but the great bulk of them hibernated either in the larva or pupa state and came out May 8 to 20. They vary but little. I have beaten larvæ of very similar appearance off oak trees.

So far as I am informed the larva is unknown to European Lepidopterists, although it is recorded that the perfect insect, *præangusta*, is very common among willows and poplars in July, and may frequently be observed sitting on the trunks of those trees with the anterior feet put back like *Bdellia* and the head raised a little.

Mr. Walsh has the honor of having made an interesting discovery that puts an end to all uncertainty respecting the larva and its food-plant.

This larva occurred in abundance August 23, and subsequently in the Tenthredinidous gall, *S. pomum*, Walsh manuscript, which grows on the leaves of *Salix cordata*. Each gall contained but a single larva, unaccompanied by the larva of the *Nematus* which makes the gall, which it must consequently have destroyed or starved out, either in the egg or in the larva state.

A single imago came out in the autumn of the same year, but the great bulk of them came out next spring, May 8 to 20, from galls kept through the winter. There can be no doubt of the correlation of larva and imago, because no other Lepidopterous larva or imago occurred in the gall *S. pomum*, though I had three or four hundred of them in my breeding vase. The insect must hibernate normally in the larva state, for I noticed numbers of them in the spring crawling about among the galls. In a state of confinement it generally retires to the inside of the gall to assume the pupa state, though I noticed one or two cocoons spun among the galls. Probably in a state of nature it hibernates in the gall, comes out of it in the spring, and spins its cocoons among dry leaves and rubbish.

I also bred a single imago of this same species, May 11, from the Cecidomyioidous gall, *S. rhodoides*, Walsh, from galls kept through the winter, and I found in the spring a denuded imago of what was apparently the same species, dead and dry amongst a lot of Tenthredinidous galls, *S. desmodiodes*, Walsh manuscript, which is closely allied to *S. pomum*, but occurs on the leaves of a very distinct species of willow. Thus we have three different willow galls inhabited by the same moth, two of them made by saw-flies and one by a gall-gnat.

I have several times beaten off black-oak trees larvæ apparently very similar to this *Batrachedra*, and with the same harlequin-like markings, but whether the two are specifically identical I can not say.

In a subsequent letter Mr. Walsh kindly supplied me with the following description of the larva:

*Larva*.—Length, .20 inch. Body tapering at each end, opaque, milky-whitish, with a few short, whitish hairs. The first segment behind the head with an obsemicircular, shining, glabrous, brown dorsal shield; second segment with an interrupted opaque brown dorsal band on its anterior edge, the interruption occupying about one-third of the band; segments 3 to 12 with an interrupted opaque brown dorsal band on the anterior edge, and segment 11 with a similar band at its tip also. Head yellowish. Legs and venter immaculate whitish. Legs six, prolegs ten, normally arranged. Spins a thread, wriggles much when disturbed, and runs backward with great agility. (Clemens' Tineina. Edited by H. T. Stainton.)

*Moth*.—Forewings fuscous, with a rather broad whitish stripe, freely dusted with fuscous, running through the middle of the wing from the base and along the apical

margin to the tip. Near the basal third of the wing on the dorsal edge of the whitish stripe is an elongate blackish brown spot, and from the middle of the wing towards the tip it is edged on its costal side by a blackish brown line, which contains sometimes a spot of the same hue. The apical portion of the stripe is more freely dusted with fuscous than the other portions. Cilia fuscous. Hind wings fuscous, cilia paler.

Antennæ dark fuscous, without white annulations except near the tip. Head fuscous above, face white. Labial palpi dark fuscous; second joint with a white ring at the extreme tip, sometimes white at the base, with a broad fuscous ring near the tip; terminal joint fuscous, with a more or less distinct whitish central ring, and the extreme tip whitish. (Clemens' *Tineina*.)

61. *Batrachedra prwangusta* (Haworth.)

62. *Batrachedra siholata* Zeller.

Chambers remarks that "the specific distinctness of these three species seems to me not sufficiently established. *B. salicipomella* was bred from galls made by other insects on willows. The mode of feeding of the others is not satisfactorily determined."

### 63. THE AMERICAN CIMBEX.

*Cimbex americana* Leach.

Order HYMENOPTERA; family TENTHREDINIDÆ.

The following account of this insect is copied from Professor Riley's report as U. S. Entomologist for 1884:

During the latter part of May last, Admiral Ammen, who is noted in Washington for his devotion to horticulture and arboriculture, brought us specimens of this large saw-fly, with an account of its injuries to his imported willows, not as usual by the larva, but by the gnawing of the perfect fly, the plantation being described as looking as if a fire had run over it, or as if it had suffered by a severe frost. As this habit was new, so far as we have any records, and as nothing was known of the mode of oviposition in the species, we had the matter investigated. The tips of many of the plants were found to be dark brown and dead; the dried-up portion extended 2 to 4 inches from the tip. Upon investigation it was plain that the cause of the trouble was a very fine but deep transverse incision just below the dead portion of the willow, the incision often extending more than half way around the twig, or there being a number of smaller incisions, one above the other. (Fig. 194, b.) All these incisions were so narrow that they could hardly be supposed to have been made for feeding purposes; but in many instances a number of larger marks, usually of an oblong shape, were visible, and looked as though they had been made for food.

According to Admiral Ammen this injury had been done by the saw-flies in the latter part of May; but on the 5th of June the flies had for the most part disappeared, and Mr. Schwarz, who made examination after our departure for Europe, found at that date but a single female, sitting on a branch of about 5<sup>mm</sup> in diameter, and just in the act of cutting one of the incisures referred to above. The insect worked its mandibles in a very slow and deliberate manner, and made but little headway in cutting during the three or four minutes he watched its workings. Upon examination the twig was found to contain three such incisures, each reaching more than half way around.

*The eggs and mode of oviposition.*—Whether or not the cutting of the tips is made for feeding purposes, it is evident that it has nothing to do with oviposition, as no trace

of the eggs could be found either on the dead part of the twig or in the living portion just beneath. The eggs are deposited between the epidermis and paranchyma of the leaf. When looking over the plants from above, the place of oviposition is hardly perceptible, appearing as a very slight blister-like swelling, accompanied on one side by a faint ferruginous line, but otherwise not differing in color from the rest of the leaf. On the under side, however, these blisters were very plainly visible, being much paler than the rest of the leaf, and having, in the more developed condition, a reddish tinge. These blisters closely resemble those of other saw-flies,

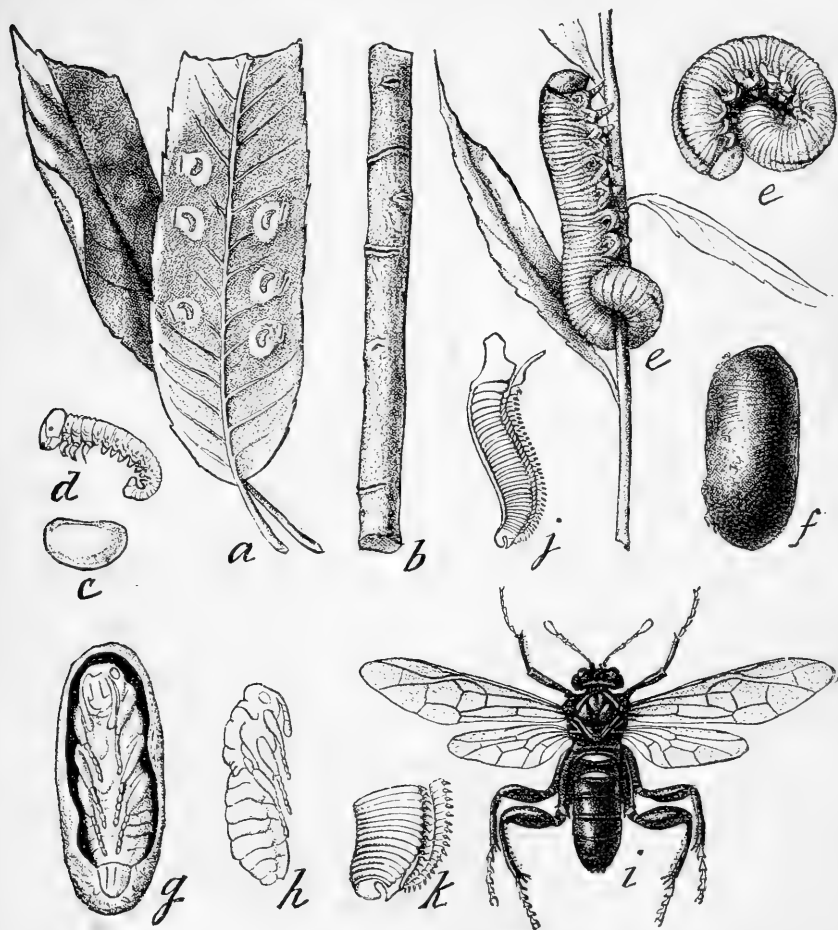


FIG. 194.—Cimbex of the willow: *a*, leaf containing the eggs; *b*, willow twig with incisions; *c*, egg; *d*, young larva; *e*, mature larva; *f*, cocoon; *g*, the same cut away to show the pupa; *h*, *k*, saw of the fly, *i*. After Riley.

which insert their eggs in leaves and are usually nearly circular in outline (sometimes nearly oval), and distinctly elevated above the general surface of the leaf, though otherwise quite flat. They are always on the face of the leaf, usually nearer to the outer margin than to the midrib, never on or near the midrib and rarely extending across one of the side ribs. Their number varies from one to nine or more on a single leaf. Where there are several they are generally situated in a longitudinal row, the individual blisters being then always separated by the intervening side

ribs. Sometimes two rows of these blisters are found on the same leaf. The place of insertion of the ovipositor is always plainly visible, as a nearly straight slit (usually closed) of ferruginous or brownish color at or near that edge of the blister which is nearest to the margin of the leaf, thus indicating that while ovipositing the female fly grasps the edge of the leaf with her fore legs. (Fig. 194, a.)

Leaves infested with eggs, although not rare, were by no means so abundant as should have been expected from the extent of the injury inflicted by the imagos. A great many plants (and among them many with their tops cut off) were not infested, while occasionally a plant could be found with four or five infested leaves, mostly about the middle or near the top of the plant.

The egg, when about ready to hatch, is oblong oval, somewhat flattened, and with its shell so thin and pliable that it not only loses its regular shape by the slightest pressure, but even by the position or movements of the embryo larva within. The shell is perfectly hyaline, with no visible sculpture besides some fine, irregular, and variable wrinkles. Its surface is very sticky. At an earlier stage the egg is elongate and nearly cylindrical. Through the whitish epidermis of the blister the shape of the egg is always readily perceptible as a transverse (*i. e.*, parallel or nearly parallel to the margin of the leaf) object of a decided green color. (Fig. 194, c.)

The young larva, after hatching remains for some time within the blister, but finally leaves it through an irregular slit at the middle of the epidermis. Its color is bluish gray. (Fig. 194, d.)

The recently excluded larvæ are uniformly curled up on the under side of the leaf.

Three varieties of cultivated willows were found to be injured by the perfect saw-fly, while egg blisters could only be found on two varieties.

The willows affected were the American green ozier, the Welsh, and the Golden.

*Remedies.*—It would be quite practicable, considering the small area to be protected and the conspicuous size of the insect and its clumsy movements, to catch the perfect flies by means of a net; but the application of arsenical poisons would be surer, and would also rid the willows of many other enemies.

“For some years” says Mr. Bruner “the large saw-fly (*Cimbex americana*) has attracted my attention at various points in Nebraska, by its habit of frequenting hedges of white willow in preference to the various species of the native willow. During the summer its large, green, slug-like larvæ would be met with from time to time, but not until the present summer have I learned that it appeared in such great numbers as to completely defoliate the trees.

“About three weeks ago (August 31) I visited Mr. G. M. Dodge, of Glencoe, Dodge County, and while driving across the country observed that nearly every hedge of this willow had been more or less injured by some insect which had stripped the trees of most of their leaves. I at once attributed the work to the striped cottonwood beetle (*Plagioderia scripta*), which, as you have shown, has been known to injure various species of willow, as well as the poplars and cottonwood in this and other sections of the country. Upon speaking to Mr. Dodge in reference to the subject, he informed me that the work was that of the above named saw-fly. He also stated that the larvæ had been so numerous on many of the hedges in his immediate neighborhood as to completely defoliate the trees before they (the larvæ) had attained full growth, and that they had therefore proved the cause of their own destruction.

“At other points, however, where the larvæ were less numerous, they have matured, and will evidently make their appearance in force next season, provided no unforeseen providence intervenes.

“Mr. Dodge also informed me that this saw-fly has been steadily on the increase for the past three or four years—always working on the white willow in preference to the native species.”

A *Cimbex*-like saw-fly larva occurred on the willow at Brunswick, Me., August 6, 1886, September 3, 1885. It is represented by the very poor sketch in Pl. v, fig. 11.



*Larva*.—Head large, as wide as the body, rounded, pale yellowish; eyes black, conspicuous; legs pale whitish green; eight pairs of abdominal legs; abdomen closely rolled up when at rest like a *Helix*. All the segments finely wrinkled; the ridges bearing small flattened warts. Spiracles black. Body glaucous-green. Length 18<sup>mm</sup>.

64. *Galeruca decora* Say.

The most numerous and most dangerous of the enemies of the willow referred to by Professor Riley is, beyond question, the willow *Galeruca* (*Galeruca decora* Say), of which young larvæ and imagos were met with everywhere on the leaves. The character of its injury and its natural history do not appear to differ from those of the imported elm leaf-beetle (*G. xanthomelæna*). Its eggs are a little larger, brighter colored, and less acuminate, and the young larvæ of darker color, but not otherwise different. Full-grown larvæ were not found early in June and only a few egg-clusters.

65. *Colaspis tristis* Olivier.

Next in importance, says Riley, comes *Colaspis tristis*, which in the imago state preferably feeds upon the very young, not yet fully developed, leaves. Its larva, which no doubt has subterranean habits, was not met with, and it probably feeds on the roots of some other plant.

66. THE WILLOW DOLERUS.

*Dolerus arvensis* Say.

Order HYMENOPTERA; family TENTHREDINIDÆ.

The following account of this insect is copied verbatim from Professor Forbes' third report on the injurious insects of Illinois:

From one of the most intelligent and observant fruit growers of my acquaintance, I have heard from time to time of a "steel-blue fly" which clustered in spring upon the buds and blossoms of the pear, either eating them or blighting them and causing them to drop. On the 30th March he sent me specimens from his pear trees, and I found them to be the adults of the above two species which are known as willow saw-flies,—so called because their green, many-footed larvæ feed on the leaves of willows. The evidence against these saw-flies lay in the fact that they were abundant and busy upon the opening buds and fresh blossoms of the pear and of some other trees, for many days in succession, and that the blossoms afterwards fell without setting fruit. Afterwards a similar but more positive charge against these insects appeared in the correspondence of the Western Rural, of Chicago, for May 17, 1884, as follows:

"Inclosed you will find a couple of bugs that are working on fruit trees here. They ruin many blossom buds by sucking the sap out of them, sometimes causing them to fall off just before opening. They make their appearance as soon as the trees begin to grow. You will notice there are two colors of bugs—red and black. Is there any way to get rid of them? Poison won't do it, for I have tried London purple. They suck the sap mostly, although I think later in the season they eat the leaves some, but I am not sure of it. They work on pear worse than others."

The first of these species, *Dolerus arvensis*, was originally described by Thomas Say in 1824, and the second, less common but still abundant, by Beauvois in 1805. Although the larvæ of the former, at least, have been known for a long time to feed upon the leaves of willow, they have not otherwise, so far as I am aware, been suspected of any injury to vegetation of economic importance, all the references to them in the literature of entomology being of a strictly technical character. From other insects occurring in similar situations, with which they are at all likely to be con-

founded, they may be distinguished by the following characters in addition to those of the family Tenthredinidæ to which these insects belong :

The first, *Dolerus arvensis*, is a little more than one-third of an inch in length by about one-third as wide, and measures not far from two-thirds of an inch across the extended wings. The head and body are dark steel blue except the thorax, which is variegated with yellow and black.

67. *Dolerus bicolor* Beauv.

Referring to the second species of *Dolerus*, Forbes continues his account as follows :

The other species, *Dolerus bicolor*, is a trifle smaller than the first, brownish yellow except the wings, the head, the middle of the thorax, and the legs, all of which are black.

Both these insects are abundant everywhere in early spring, and the larvæ of both, similar in appearance to green caterpillars, but distinguished by the possession of eleven pairs of legs, feed upon the leaves of the willow a little later in the season.

Careful watching in the field soon convinced me that these saw-flies were neither biting nor piercing the buds or flowers, but that they were merely licking off the semi-fluid exudation from the surface of the bud scales. Dissecting the specimens and examining the contents of their stomachs with the microscope, I found only a clear fluid, without a trace of solid matter except occasional spheres consisting of clusters of threads of fungous parasites. Critically searching the surface of a bud scale which these flies had but just worked over, I saw that no injury whatever had been done to the tissues of the plant, even the slender hairs with which the scales were covered being wholly undisturbed. Watching the flies with a glass, I could see that their biting jaws remained all the time closed, but that their flap-like maxillæ were continually employed in mopping up the moisture from the viscid surface, and as they have no mouth-parts capable of piercing the substance of a plant, it was clear that no injury was being done. Finally, I confined a lot of the saw-flies in a breeding cage with pear buds not yet open. The insects industriously worked over the surfaces of the unopened buds and even entered the flowers as they expanded, but did neither any visible injury whatever. The buds afterwards all opened out in abundant bloom, and remained fresh for several days, while the poor saw-flies, having lapped up all the sirup available, starved to death in the midst of the uninjured blossoms. A little experiment showed that they were especially susceptible to the influence of pyrethrum, and that a single thorough application to a tree would kill all upon it at the time.

The above brief account of these insects is given merely to set at rest the fears of those who, like my correspondents, may be led to attribute to them serious mischief really due to quite other causes. (Forbes.)

68. *Nematus ventralis* Say.

The larvæ of this saw-fly were found by Dr. Harris on leaves of the willow June 22; they spun their cocoons June 24, the flies appearing from July 15 onward. A second brood of these occurred on the narrow-leaved dwarf willow September 5, and on the same shrub a pair of flies apparently recently transformed. The cocoons were made September 20. A swarm of larvæ was also found October 17. (Harris' Corr., p. 270.)

*Larva*.—Six-tenths inch long, greenish black, and with ten heart-shaped ocher-yellow spots on each side, beginning on the second ring. Prolegs fourteen; viz, twelve ventral and two very short retractile ones to the last ring, all of a whitish color; the first pair on the fifth ring, and the rest (except the anal pair) on the following

rings. Body transversely wrinkled, but smooth. Head polished, jet black. Anal segment (just above the flap) with two minute black warts, or truncated, slender tubercles. Curls its tail when at rest. (Harris' Corr., p. 270.)

*Saw-fly*.—Black; venter and feet pale. Male: Hypostoma, palpi, and mandibles at base whitish; orbits above and behind piceous; thorax dilated, triangular line before the wing, and wing-scale whitish; wings slightly dusky, nervures fuscous; feet honey-yellow, posterior tarsi black-brown; tergum black, segments each with a yellow band of which the four terminal ones are interrupted in the middle; venter pale honey-yellow. Length, one-fourth inch. Female: Orbits all round, whitish; white line or spot before the wings with about three obsolete black spots before; feet white, thighs black in the middle, posterior tarsi blackish, tergum black, the bands obsolete; venter white and segments blackish. Length, .3 inch. (Say.)

69. *Selandria?* sp.

This species was observed August 20, at Brunswick, Me., eating irregular round holes in the edge of the leaves and spinning a cocoon.

*Larva*.—Body slender, cylindrical, slightly compressed. Head small, round, amber colored, as wide as the body. The body pea-green; the heart very distinct, forming a dark line with a pale yellowish-green line on each side. The thoracic feet rather long. Seven pairs of abdominal legs; the last (anal) pair modified, being very short, and like the tip of the body, pale lilac; the first two pairs of abdominal legs larger than those succeeding; the sixth pair rudimentary. The spiracles connected by a hair line of yellowish green. Length, 8 to 9<sup>mm</sup>.

70. *Selandria* sp.

The larva of this species folds the leaves of different species of willow longitudinally on one side of the midrib. It spins a cocoon of the usual shape August 28 to 31.

*Larva*.—Head large, round, full, amber colored. Body cylindrical, pale, flesh colored, tapering towards the end, where are two jet-black acute spines, with a broad base extending anteriorly. Body covered with short hairs, and transversely wrinkled. Length, 6<sup>mm</sup>.

71. *Nematus* sp.?

*Nematus?* congeneric with one occurring on *Betula populifolia*, Brunswick, September 6.

*Larva*.—Head small, round, black, body with a lateral ridge; scalloped; each segment with three transverse rows of black warts; the scallops on the lateral ridges black. Thoracic and abdominal false legs, except last pair, blackish. Length, 20<sup>mm</sup>.

72. UNKNOWN SAW-FLY LARVA.

This species occurred on the willow at Brunswick, Me., spinning a cocoon July 17.

*Larva*.—Seven pairs of abdominal legs. Head glaucous green; eyes black. Body pale glaucous green, including the thoracic and abdominal legs; the body frosted, with a double dorsal whitish line, and one on each side below.

73. *Nematus?* larva.

Observed at Jackson, N. H., on the willow.

*Larva*.—Body long and slender; anal plate peculiar, being broad and square, with two lateral projections. Seven pairs of abdominal legs, the last pair short and thick. Head pale greenish amber, with a broad black median straight band extend-

ing from the occiput to the labrum; also a lateral, rather paler, band extending to the black eyes. Body speckled irregularly, especially on the sides, with brown. A dark dorsal vascular line, inclosed by two slender fine yellowish lines. Length, 17<sup>mm</sup>.

74. *LARGE NEMATUS? LARVA.*

This false caterpillar occurred frequently on the willow at Brunswick, Me., late in August.

*Larva.*—Eight pairs of abdominal legs. Body rather thick, long, not usually curled up much at the extremity, with no markings, warts, or spines. Head small, round, amber, greenish in front, eyes distinct and black. Body wrinkled, much as in *Cimbex*, which it approaches in size, pale green throughout; with a dorsal pair of lines composed of obscure diffuse irregular faint yellowish patches on each side of the vascular line; and a similar lateral line, also obscure. Length, 26<sup>mm</sup>.

75. *Chrysomela bigsbyana* Kirby.

Mr. Coquillett has reared this leaf-beetle from the willow, on which it feeds. He found in Illinois two larvæ August 13, which shortly afterwards pupated, the beetles appearing September 5. The species was determined by Dr. Horn. (*Can. Ent.*, xv, p. 22.) It is not uncommon on willows in Maine late in June.

*Larva.*—Body white, tinged with yellow; spiracles black with a white dot in the center of each; on each side of segments 2 and 3 is a curved black dash, the curve downwards; cervical shield concolorous, marked with a blackish spot in the middle of each outer edge; head yellowish brown, ocelli black, in two clusters. Length, 10<sup>mm</sup>.

*The beetle.*—Body green, palpi, antennæ, and legs rufous; anterior margin and sides of the prothorax reddish; elytra pale red with a sutural stripe, a humeral broken bilobed spot, and several dots black or dark green. Color and sculpture of the body like those of the preceding species, from which *C. bigsbyana* differs principally in having the sides and anterior margin of the prothorax reddish yellow; the elytra are of the same color, but the suture itself, especially at the base, a stripe parallel to it, a large humeral bilobed spot, the interior lobe of which is obtusangular or broken, and several irregular dots and spots on the elytra are black-green. Length of the body 4 lines. (Kirby.)

76. *Chrysomela spireæ* Say.

I have found this species on willows in Maine late in June.

*The beetle.*—Head dark green, tinged with brassy; antennæ and palpi rufous; thorax dark green, tinged with brassy; elytra pale yellow, sometimes tinged with rufous; each with about seventeen unequal small green spots; a larger lunate one originating on the humerus; a common green sutural line, which sends off a lateral short branch on each side near the base; beneath blackish green; feet rufous. Length,  $\frac{1}{4}$  inch.

It is very closely allied to the *C. philadelphica* Fabr., but is smaller, and the sutural line is always common, whereas in the *philadelphica* there is a slender subsutural line on each elytron always insulated from the suture throughout its whole length.

77. *Chrysomela philadelphica* Linn.

While this species feeds on the pine, according to Fitch, he also has observed it commonly on the willow.

*The beetle.*—A very convex broad-oval beetle about 0.30 long, of a dark bottle-green color, with white wing-covers sometimes tinged with yellow and having on

them numerous spots and dots of dark green with a black line on the suture widened anteriorly and a second line parallel with this on each side, the antennæ and legs rusty red. (Fitch.)

78. *Crepidodera helvines* (Linn).

The adult *Crepidodera helvines* L. was found repeatedly throughout May in central and southeastern Illinois, devouring the leaves of willows, and scarcely less commonly upon the Lombardy poplar and the balm of Gilead, doing decided injury to young trees in the nurseries. (Forbes's Rep. Ins. Ill., 1883.)

This is also said by Mr. W. L. Devereaux to be very abundant on the leaves at Clyde, N. Y.

79. *Phyllodecta vitellinæ* (Linn).

*The beetle*.—Second and third joints of the antennæ of usual length. Body oblong, a little inclining to ovate, glossy; underneath black-bronzed, scarcely punctured; above bronzed with a copper tint, minutely punctured. First and second joints of the antennæ rufous; scutellum impunctured; elytra punctured in rows, with the interstices indistinctly punctured; tarsi piceous with the first joint rufous.

80. *Galerucella sagittariæ* Gyll.

*The beetle*.—Body brown, a little downy, not glossy. Mouth dirty yellow; prothorax transverse, impressed, reddish-yellow, with three black nearly confluent spots; scutellum subquadrangular, truncated at the apex; elytra grossly but not thickly punctured; suture and lateral margin paler than the rest of the elytron; anus and legs reddish yellow; tarsi darker. Variety B: With the base of the antennæ yellowish underneath, the black spots on the prothorax distinct, and the elytra entirely of a brownish yellow.

81. *Lina (Plagiodes) lapponica* (Linn.).

Larvæ of *Plagiodes lapponica* L., taken on the willow at Normal, June 24, commenced to pupate July 1, and to emerge on the 3d, the last of about sixty appearing on the 8th. (Forbes's Rep. Ins. Ill., 1883.)

82. *Lina (Plagiodes) scripta* Fabr.

Mr. D. W. Coquillett writes me that he has observed this beetle on the willow in Illinois.

83. THE SNOWY TREE-CRICKET.

*Ecanthus niveus* Serville.

This common tree-cricket has been quite frequent, congregating in raspberry and blackberry patches, as well as on white willow hedges, where it often causes much injury by filling the stems and twigs of these plants with its eggs. Several species of *Helianthus* and one *Solidago* are, however, its chief food-plants in Nebraska. Scarcely a single one of these weeds escapes without the eggs of one or more of the crickets being thrust into its pithy substance. (L. Bruner in Riley's Rep. Inj. Ins., U. S. Ag. Dpt., 1884, p. 399.)

84. *Lachnus salicicola* Uhler (*Aphis saliceti* Harr.).

Mr. Monell has described an aphid under the name of *Chaitophorus salicicola* which Professor Thomas (Eighth Rep. Ins. Ill., p. 105) questions whether it may not be *Lachnus salicicola* Uhler. We copy Harris' description of his *saliceti*.

*Stylo nullo, corniculis brevibus fulvis, corpore nigro, immaculato, alarum venis pedibusque fulvis.*

Black, immaculate; wings hyaline, the veins, the antennæ, corniculæ, and legs fulvous. Body black, immaculate; first and second joints of the antennæ black, third fulvous at base, remainder fuscous; corniculæ short, fulvous; legs fulvous, tibiæ at apex and tarsi fuscous. Length, about 1 line. Expanse of wings, above 4 lines.

Inhabits the willow, living on the under side of the extremities of the branches. October 1, 1837.

This species can not be identical with *A. salicis* Linn., which has the body spotted with white. (Harris' Corr.)

85. *Chaitophorus viminalis* Thomas.

This aphid occurs on the young twigs and leaves of *Salix lucida* and *S. babylonica* in Illinois.

*Apteros individuals.*—Varying from pale green to light yellow, with two darker vittæ on the abdomen which are often obsolete. Entire insect covered with long white hair.

*Winged individuals.*—Head and thorax black; abdomen black, except the margins and style, which are yellow. Nectaries a little longer than thick, yellowish, often slightly fuscous. Antennæ hairy; seventh joint filiform, almost as long as the three preceding taken together. Wings hyaline. Length, 1.52<sup>mm</sup>; to tip of wings, 2.54<sup>mm</sup>.

86. *Chaitophorus smithiæ* Thomas.

This aphid lives on the leaves of *Salix alba*, from May to June, at Peoria, Ill. (Miss E. A. Smith.)

*Winged form.*—General color dusky reddish. Wings hyaline; venation very variable. Nectaries two-thirds as long as the tarsi, vasiform, contracted at the base, expanding in the middle and again contracted at the apex; the mouth flaring. Antennæ a little over half as long as the body, the third joint the longest, the fourth and fifth subequal, and the sixth joint two-thirds as long as the preceding. Seventh joint slender, very little longer than the preceding. Rostrum reaching the third pair of coxæ. Length, 2.28<sup>mm</sup>; to tip of wings, 4.56<sup>mm</sup>.

87. *Lachnus dentatus* Le Baron.

Dr. Le Baron describes this species in his second Report on the Insects of Illinois, p. 138. It occurs in great numbers in October and November on the under sides of the branches of the gray willow, and also occurs on small nursery apple trees.

*Moth.*—Black; abdomen dark ash-colored, with six transverse rows of black dots. Antennæ filiform, as long as the head and thorax; two basal joints, short and stout, the third as long as the three terminal ones united; these three equal. Proboscis greenish yellow at base. Forewings with the usual stout subcostal vein, and a very elongate stigma; three discoidal veins (exclusive of the stigmatic vein), much

wider apart at their tips than at their bases; third vein two-forked; hind wings with a subcostal and two discoidal veins, the latter very closely approximate at base and divergent at tip. Thighs dark honey-yellow, broadly tipped with black; tibiae dusky, reddish at the base.

The honey-tubes are subobsolete. The dots on the abdomen are very distinct, especially on the fully grown, wingless individuals. In the intermediate rows the dots are six in number, the two middle ones being smaller than the others. Just behind the middle of the abdomen, and occupying the place of the two middle dots in the fourth row, is a somewhat conspicuous black, conical protuberance, varying in size in different individuals, and sometimes considerably more prominent than it is represented in the figure. Length, two-twelfths of an inch; expanse of the wings, six-tenths.



FIG. 195.—*Lachnus dentatus*; enlarged. After Forbes.

88. *Chaitophorus nigra* Oestlund.

Found by Mr. Oestlund on the leaves of *Salix nigra* as late as October 26.

*Winged form*.—Similar to *Aphis* in general appearance. Entire insect with long white hairs. Head black, rather straight in front. Antennae about as long as the body, black except base of III; I and II as usual and subequal, III longest, IV a little shorter, V a little shorter than IV, VI about one-half of V, VII as long as IV, setaceous; III to V moderately cicatrized. Eyes dark reddish-brown, with a prominent tubercle. Beak rather short, hardly reaching second coxae, pointed. Thorax all black, prothorax well developed, pronotum not narrowed in the middle. Wings as usual. Legs with the femora more or less blackish, and the tibiae pale. Abdomen wholly black or slightly pale, brown along the sides. Honey-tubes tuberculiform, not longer than broad, thickest at base, usually paler than the body. Style tubercle-like, or even knobbed as in *Callipterus*. Length of body .06; to tip of wings .10.

*Wingless form*.—General color a dull blackish-brown. Body flat, obovate or oblong, quite hairy and tubercular in young specimens, becoming smooth in full-grown. Antennae about one-half the body or a little longer, pale at base, dusky towards the apex; relative length of the joints as in winged form; joints with long white hairs, not very numerous. Abdomen usually with the middle and the margins slightly paler. Honey-tubes as in the above form. Length of body .06. (Oestlund.)\*

89. *Rhopalosiphum salicis* Monell.

This aphid occurs on the under side of leaves of *Salix lucida*, *S. nigra*, and *S. babylonica*.

*Winged individuals*.—Head and thorax dusky; abdomen green, with various irregular, darker green markings. Antennae about half as long as the body, not mounted on frontal tubercle; the third and fourth joints somewhat dentate; apical joint half as long again as the preceding; third and fourth joints often subconnate. Nectaries light green, reaching to the tip; the basal portion slender, expanding at the middle to twice its former diameter, and again suddenly contracted at the mouth, which is furnished with the usual annulus. Tail yellowish, about one-third as long as the nectaries. Length 1.52<sup>mm</sup>; to tip of wings, 3.04<sup>mm</sup>. Apterous individuals entirely pale green, with two darker dorsal vittae.

90. *Chionaspis salicis* (Linn.).

Specimens of *Chionaspis fraxini* received from England, states Professor Comstock (Ag. Rt., 1880), are identical with *C. salicis* received

\* Fourteenth Ann. Rep. Geol. and Nat. Hist. Survey Minnesota, 1886, p. 49.

from M. Signoret. Professor Comstock has also received this species from Ithaca, N. Y., and from St. Louis, Mo., in each case occurring upon willow.

*Scale of female.*—The scale of the female is of the form characteristic of the genus, being long, narrow at the anterior end, and broadly widened posteriorly. Exuviae dark yellow, normally covered by a thin layer of white excretion; this, however, is easily removed. Scale, snowy white. Length, 3 to 4<sup>mm</sup> (.13 inch); width near posterior end, 1.6<sup>mm</sup> (.06 inch).

*Female.*—The body of the female is reddish. The last segment differs from that of *C. ortholobis* as follows: The median lobes are joined at the base, and are widely separated at their distal extremities; between the first plate and the second lobe and mesad of the third lobe are prolongations of the body wall, which extend caudad as far as the lobes, and bear elongated pores. Immediately laterad of the third group of plates is a prominent prolongation of the body bearing an elongated pore, while in the case of *C. ortholobis* this is situated at one-third the distance from the third to the fourth group of plates. In *C. salicis* the two lateral groups of plates often consist of three instead of two, and the penultimate segment bears at least six plates; the antepenultimate three or four, and the one anterior to this, one or two.

*Scale of male.*—The scale of the male is long, narrow, with the sides nearly parallel. It is tricarinated and snowy white, with the exuviae yellowish. (Comstock.)

#### 91. *Chionaspis ortholobis* Comstock.

According to Professor Comstock (Ag. Rt., 1880), this scale insect occurs on the willow at San Bernardino, Cal. It infests chiefly the bark of the small whip-like limbs which spring from the trunks of the trees. Many of these sprouts were dead and white with the scales of this species. The eggs were observed September 12.

*Scale of female.*—The scale of the female very closely resembles that of *C. salicis*; it is, however, smaller and narrower. Length, 2 to 2.5<sup>mm</sup> (about .08 inch).

*Female.*—The body of the female is dark purple. The last segment presents the following characters:

The anterior groups of spinnerets consist of from ten to sixteen; the anterior laterals of eighteen to thirty, and the posterior laterals of sixteen to twenty.

The median lobes are almost contiguous; their mesal margins are parallel for more than half their length; the distal margin of each is rounded.

Each of the second and third lobes is deeply incised; the lateral lobule in each case is very small, often obsolete; the mesal lobule is large and rounded; the distal margins of all the lobes are distinctly crenate.

The plates are as follows: One laterad of first lobe; one or two laterad of second lobe; two laterad of third lobe, and two quite large ones quite near the penultimate segment. The penultimate segment usually bears four and the antepenultimate one.

The spines on the dorsal surface are as follows: The first on the base of the lateral part of first lobe; the second and third on the lateral lobule of the second and third lobes, respectively, and the fourth a short distance mesad of the lateral pair of plates. On the ventrad surface there are also four on each side; each spine is laterad of the corresponding spine of the dorsal surface, and cephalad of the base of the corresponding plate or group of plates.

*Eggs.*—The eggs are dark purple.

*Scale of male.*—The scale of the male differs from all other specimens of this genus known to me in not being carinated. It is an elongated oval in outline, being slightly broadest at the middle, and tapering towards both ends almost equally. The larval skin is light yellow; the scale is snowy white.

Described from thirteen males and many scales of each sex. (Comstock, Ag. Rt., 1880.)



92. *Aspidiotus convexus* Comstock.

## THE CONVEX WILLOW SCALE.

The following account is copied from Professor Comstock's report in U. S. Agricultural Report for 1880:

This species, which is very common on the bark of the trunk and limbs of the native willows in California, very closely resembles *Aspidiotus rapax* in the shape and color of its scale. The resemblance of the two species is so great that at first I considered them identical, and concluded that *A. rapax* had spread to the cultivated trees in California from the native willows of that State. But a careful study of the structure of the two forms show them to be specifically distinct. The most striking differences are those presented by the last abdominal segment of the female. In this species there are four groups of spinnerets; the superior laterals consisting of about seven, and the inferior laterals of about four. In *A. rapax* the groups of spinnerets are wanting.

In this species the plates are very much shorter than in *A. rapax*, and very closely resemble the plates in *A. ancylus*. But *A. convexus* differs greatly from *A. ancylus* in the shape and color of the scale and in the wings of the male being long. Described from seven females, two males, and very many scales.

93. *Phytoptus salicicola* Garman.

## Order ACARINA.

Produces galls on the leaves of the long-leaved willow, *Salix longifolia* Muhl.

Striæ of abdomen 46. Feather-like tarsal appendage with three pairs of prongs. Length, .0075 inch. Abundant in the galls in June.

This gall is one of the most remarkable deformations I have seen. It consists of a narrow longitudinal upward fold extending sometimes the entire length of the leaf. Usually there are two of these folds on each leaf, one on each side of the midrib. They may be close to the midrib, midway between it and the margin, or at the margin itself. In cases where the fold begins next the midrib at the base of the leaf, it may gradually leave it so as eventually to form a mere fold of the margin. The opening is a narrow slit running along the under side of the leaf. Color, as seen in the latter part of June, brown. My attention was drawn to this gall by the peculiar appearance of the willow leaves due to the lessening of their widths by the fold. A clump of shrubby willows growing in the margin of a shallow pool of water in the vicinity of Normal, Ill., was badly infested by the galls. (Garman).

94. *Phytoptus* sp.

Produces galls on the leaves of the heart-leaved willow, *Salix cordata* Muhl.

The mite has sixty-three transverse abdominal striæ.

The gall is a wart-like excrescence sometimes projecting above the leaf, sometimes below, and again equally above and below. In some examples the leaf is folded up around the gall, forming a more or less complete rim. Many of the galls are produced above into nipple-shaped prominences. The color may be purple or pale green. A

specimen measured was .083 inch in depth, and .065 inch in diameter. (Garman).

The following insects also occur on the willow:

Order LEPIDOPTERA.

95. *Limenitis ursula* (Fabr.) See p. 128.
96. *Limenitis arthemis* (Drury.) W. H. Edwards.
97. *Limenitis misippus* (Fabr.). Lintner Ent. Contr., ii.
98. *Vanessa antiopa* (Linn.). Maine and Rhode Island. Larva fully grown in Maine September 5.
99. *Grapta faunus* Edw. on *S. humilis* (Scudder).
100. *Eugonia J. album* B. and Lec.
101. *Aglais milbertii* Godt.
102. *Thecla liparops*.
103. *Thecla acadica* Edwards.
104. *Cyaniris pseudargiolus* Bd. and Lec.
105. *Thanaos persius* Scudder.
106. *Nisoniades icelus* Lintner. Feeds on different species of willows and poplars. (S. Lowell Elliot.) See p. 450.
107. *Papilio turnus* Linn. W. H. Edwards, Can. Ent., xviii, p. 139.
108. *Papilio glaucus* Linn.
109. *Smerinthus geminatus* var. *Jamaicensis* (Drury). Ohio (Pilate).
110. *Sesia hospes* Walsh. Proc. Ent. Soc. Phila., vi, 1866, p. 270. Bred from coleopterous pseudogall on, *S. inornata* (Walsh).
111. *Hyphantria cunea* (Drury).
112. *Oedemasia concinna* Abbot and Smith. Brunswick, Me., August 14.
113. *Ichthyura inclusa* Hübn. Feeds on all kinds of willow (S. Lowell Elliot). Ohio (Pilate).
114. *Ichthyura albosigma* Fitch.
115. *Datana integerrima* G. and R. See p. 150.
116. *Apatelodes torrefacta* Abb.-Sm. Eats leaves of willow in confinement (Harris's Corr., p. 307).
117. *Pheosia rimosa* Pack. On willow (Tepper, Bull. Brooklyn Ent. Soc., ii, p. 3; Lintner, Ent. Contr., iv, p. 76).
118. *Orgyia antiqua* Linn. Brunswick, Me., August 8-15.
119. *Schizura* sp. (Lintner, Ent. Contr., iii, p. 151).
120. *Orgyia leucostigma* Abb.-Sm., was rather abundant on the willow in the University grounds at Normal. (Forbes.) (Riley's notes.)
121. *Euclea pænulata* Clem. (French, Papilio, i, p. 144.)
122. *Actias luna* Linn.
123. *Platysamia cecropia* (Linn.). (Riley's Note Book, I.)
124. *Platysamia gloverii* Strecker. On willows about Salt Lake City.
125. *Telea polyphemus* Linn. (W. Brodie, Canada.)
126. *Samia cynthia* (Linn.). "Feeding voluntarily in freedom." P. E. Nostrand (Bull. Brooklyn Ent. Soc., ii, p. 77).

127. *Eacles imperialis* Hübner. G. D. Hulst (Bull. Brooklyn Ent. Soc., ii, p. 77).
128. *Hyperchiria io* (Fabr.). (L. W. Goodell, Can. Ent., ix, p. 180.)
129. *Cerura borealis* (Boisd.). (August and September, New York. Lintner, Contr., iii, p. 151.)
130. *Hemileuca maia* (Fabr.). (Wescott, Can. Ent., 1877, p. 220; C. E. Worthington, Can. Ent., x, p. 16; W. G. Wright, Can. Ent., xx, pp. 30, 32.)
131. *Prionoxystus robinia* (Harris). (Kellicott, Bull. Buffalo Soc. Sc., iv, p. 30, 1881.)
132. *Hepialus argenteomaculatus* Harris. (J. B. Smith, Can. Ent., xx, p. 233.)
133. *Apatela americana* Harris. (Lintner, Ent. Contr., iii, p. 136.)
134. *Apatela connecta* Grote. Ohio (Pilate).
135. *Apatela dactylina* Grote.
136. *Apatela brumosa* Guen.
137. *Acronycta salicis* Harris. (August, Harris, Corr., p. 315.)
138. *Catocala vidua* Abbot and Smith.
139. *Catocala relicta* Walk. All the stages fully described by H. L. Clark (Can. Ent., xx, p. 17).
140. *Catocala briseis* Edw.
141. *Homoptera salicis* Behr. (On willows in California. Behr. Trans. Amer. Ent. Soc., iii, p. 28.)
142. *Eutrapela clemataria* (Abbot and Smith).
143. *Metrocampa perlaria* Guenée. (Saunders, Can. Ent., iii, p. 226.)
144. *Amphidasys cognataria* Guen. Maine, August and September (in larval state).
145. *Botis oscitalis* Grote. See p. 467.
146. *Teras scabrana* (Curt.). (Miss Murtfeldt, Fernald's Cat. Tortricidæ.)
147. *Teras ferrugana* (Schiff.). Galls of *Cecidomyia salicis-strobiloides* Walsh.
148. *Dichelia sulfureana* (Clem.). In quiline in the willow galls of *C. salicis-strobiloides* and *S. brassicoides* (Walsh).
149. *Steganoptycha saliciana* Clem. Willow galls. (Galls of *C. salicis brassicoides* and *S. strobiloides*) Walsh.
150. *Steganoptycha salicolana* (Clem.). Willow galls. (*C. salicis-rhoides* Walsh.)
151. *Coleophora castipennella* Chambers. Larvæ in a pistol-shaped case. (Chambers.)

## Order HYMENOPTERA.

152. *Euura s.-gemma* Walsh. Proc. Ent. Soc. Phila., vi, 1866., p. 250.
153. *Euura s.-ovum* Walsh. *Ibid.*, p. 252.
154. *Euura s.-nodus* Walsh. *Ibid.*, p. 253.
155. *Euura perturbans* Walsh. *Ibid.*, p. 254.

156. *Nematus s.-pomum* Walsh. *Ibid.*, p. 255.  
 157. *Nematus s.-desmodioides* Walsh.  
 158. *Nematus s.-pisum* Walsh. Proc. Ent. Soc. Phila., vi, 1866, p. 250.  
 159. *Nematus trilineatus* Norton. On weeping willow. Packard's Guide to Study of Insects, p. 220; foot note.

The following inquilines or guest-gall saw-flies occur in willow galls:

160. *Nematus inquilinus* Walsh. Proc. Ent. Soc. Phila., vi, 1866., p. 260.  
 161. *Nematus hospes* Walsh. *Ibid.*, p. 261.  
 162. *Nematus mendicus* Walsh. *Ibid.*, p. 261.  
 163. *Nematus fur* Walsh. *Ibid.*, p. 263.  
 164. *Pristiphora sycophanta* Walsh. *Ibid.*, p. 263.

#### Order DIPTERA.

165. *Cecidomyia salicis-brassicoides* Walsh. Proc. Ent. Soc. Phila., vi, 1866., p. 577.  
 166. *Cecidomyia s.-strobiloides* Walsh. *Ibid.*, p. 582.  
 167. *Cecidomyia s.-strobiliscus* Walsh. *Ibid.*, p. 582. (Gall only known).  
 168. *Cecidomyia s.-gnaphalioides* Walsh. *Ibid.*, p. 585.  
 169. *Cecidomyia s.-rhodoides* Walsh. *Ibid.*, p. 587.  
 170. *Cecidomyia s.-coryloides* Walsh. *Ibid.*, p. 588. (Gall only known.)  
 171. *Cecidomyia s.-cornu* Walsh. *Ibid.*, p. 590. (Gall only known.)  
 172. *Cecidomyia s.-siliqua* Walsh. *Ibid.*, p. 594.  
 173. *Cecidomyia s.-triticoides* Walsh. *Ibid.*, p. 599.  
 174. *Cecidomyia s.-batatas* Walsh. *Ibid.*, 606.  
 175. *Cecidomyia s.-verruca* Walsh.  
 176. *Cecidomyia s.-hordeoides* Walsh. *Ibid.*, p. 599. (Gall only known.)  
 177. *Cecidomyia albovittata* Walsh. *Ibid.*, p. 620; vi, p. 227. Inquiline in willow galls.  
 178. *Cecidomyia cornuta* Walsh. *Ibid.*, p. 625. Inquiline in willow galls.  
 179. *Cecidomyia orbitalis* Walsh.  
 180. *Cecidomyia s.-nodulus* Walsh. *Ibid.*, p. 601-604.  
 181. *Cecidomyia salicis* Fitch (= *rigidæ* O. S.) Maine. *Ibid.*, p. 598.  
 182. *Diplosis atrocularis* Walsh. *Ibid.*, p. 626.  
 183. *Diplosis atricornis* Walsh. *Ibid.*, p. 628.  
 184. *Diplosis annulipes* Walsh. *Ibid.*, p. 629.  
 185. *Diplosis 10-maculata* Walsh. *Ibid.*, p. 631.  
 186. *Diplosis 7-maculata* Walsh. *Ibid.*, p. 630; vi, p. 228.  
 187. *Lonchæa* ? sp. I have observed the larva, pupa-case, and fly of this species, which was referred with doubt by Baron Osten-Sacken to the genus *Lonchæa*. The larva was common at Brunswick, Me., raising large blisters on the twigs of the willow. It was figured and briefly described in my Guide to the Study of Insects, p. 412.

## Order COLEOPTERA.

188. *Saperda calcarata* Say. (D. W. Coquillett *in litt.*)
189. *Saperda concolor* Say. Hamilton (Can. Ent. xx, p. 66.)
190. *Mecas inornata* Say. See Cottonwood Insects, p. 427.
191. *Buprestis fasciata* Fabr. Mr. George Hunt informs me that he found an elytron of this beetle under the bark of the willow in northern New York.
192. *Litargus 4-spilotus* Lec. A single specimen, bred August 30 from the Acaridous? gall *S. ænigma* Walsh. Proc. Ent. Soc. Phila., vi, 1866, 265.
193. *Anthonomus sycophanta* Walsh. Proc. Ent. Soc. Phil., vi, 1866, p. 265. Bred by Walsh from the galls made by saw-fly larvæ.
194. *Anthonomus tessellatus* Walsh. *Ibid.* Lives in saw-fly galls.
195. *Erirhinus ephippiatus* Say. Bred by Walsh from Cecidomyioid galls (*S. brassicoides*) l. c., p. 269.
196. *Rhynchites æratus* Say: Brunswick, Me., June.
197. *Rhyncolus angularis* LeC. Under willow bark at New River, Colorado Desert. LeConte (Proc. Acad. Nat. Sc. Phila., March, 1858, p. 81.)
198. *Apion lanuginosum* Walsh. Proc. Ent. Soc. Phila., vi, 1866, p. 269. Bred from dipterous galls.
199. *Apion signipes* Say. "Not rare upon willows, especially when in flower." W. Hague Harrington, Ottawa. (Can. Ent., xvi, p. 117.)  
*Cryptorhynchus lapathi* (Linn.) Juelich Ent. Amer., iii, p. 123.)
200. *Orchestes niger* Horn. "A small black hopping beetle, abundant in spring upon the willows." W. Hague Harrington, Ottawa. (Can. Ent., xvi, p. 117.)
201. *Orchestes subhistus* Horn. This is a pretty species with white bands across the elytra, on willows in bloom. W. Hague Harrington, Ottawa. (Can. Ent., xvi, p. 117.)
202. *Chlamys* sp. (S. Lowell Elliot.)
203. *Haltica alternata* Illiger. Bred from dipterous galls. Walsh, (*l. c.*, p. 270.)
204. *Paria 6-notata* Say. Bred from dipterous galls. Walsh, (*l. c.*, p. 270.)
205. *Cotalpa lanigera* (Linn). Maine, June 23.
206. *Hoplia trifasciata* Say. Maine, June 23.
207. *Dichelonycha elongatula* Schönh. Maine, June 23.
208. *Chrysomela spireæ* Say. Maine, June 23.
209. *Phyllodecta vulgatissima* (Linn). Maine, June 23.
210. *Galerucella sagittariæ* Gyllenh. Maine, June 23.
211. *Plectrodera scalator* Fabr. On small swamp willows in August, in Illinois. (McBride, Can. Ent., xii, p. 107.)
212. *Pachybrachys livens* LeConte. Colorado River, California. (Lec.)

## Order HEMIPTERA.

213. *Lachnus salicelis* Fitch.  
 214. *Mytilaspis* sp. (Comstock's Rep. for 1880, p. 355.)  
 215. *Anthocoris insidiosus* (Say).  
 216. *Tingis ciliata* Say (*T. hyalina*, H.-Sch.). Maine.  
 217. *Capsus* sp. Maine.  
 218. *Evacanthus orbitalis* Fitch. Maine, July 22.  
 219. *Bythoscopus* sp. Maine.  
 220. *Siphonophora?* *salicicola* Thomas. (Eighth Rep., 63.)

## Order PLATYPTERA.

221. *Psocus rufus* Walsh, (*l. c.*), p. 270. Bred from dipterous gall. (*S. brassicoides* Walsh.)

## Class ARACHNIDA; Order ACARINA.

222. *Acarus?* *s. semen* Walsh. Proc. Ent. Soc. Phila., 1866, 226.  
 223. *Acarus?* *œnigma* Walsh. *Ibid*, 227.

## CHAPTER XII.

### INSECTS INJURIOUS TO THE HACKBERRY.

BY C. V. RILEY.

The Hackberry is one of the most characteristic trees in our American silva. What is said of the forms growing in Missouri in my sixth report on the insects of Missouri (1874, p. 137) will apply to other parts of the country in the same latitudes—in fact, throughout its range.

Two tolerably constant forms are easily recognizable: 1. (*occidentalis* Linn.) with broad, roughish, sharply serrate leaves, purple-black drupes, and rather pale bark, which on the trunk is rough and strongly cleft so as to look as if hacked. 2. (*mississippiensis* Bosc.) with smaller, narrower, darker leaves, less serrate and often entire yellow drupes, and darker bark, the trunk appearing knotty. A third form (*crassifolia* Lamk.), having more the aspect of *Ulmus*, occurs less frequently. It is much like *occidentalis*, but with more supple limbs and rougher, thicker leaves, which, when plucked, wilt more rapidly than do those of other forms. Botanists differ as to whether these forms are specific or varietal. Dr. Gray refers them all to *occidentalis*, and, as intermediate varieties are found and the seedlings from the same tree are exceedingly variable, this seems the proper course. But Professor Planchon, who has monographed the genus, considers 1 and 2 good species, and the third doubtful.

In the report already alluded to (pp. 136 *et seq.*) under the head of "Hackberry butterflies," original accounts, with illustrations, will be found of the life-histories of two of our handsomest North American butterflies, which, so far, have been found to feed in the larval state exclusively on Hackberry. They are there treated of under the names, "Eyed Emperor" (*Apatura lycaon*), and "Tawny Emperor" (*A. herse* Fabr.), and the synonymy of the species is fully discussed and the reasons given for preferring the names of Boisduval and Le Conte (*Apatura celtis* and *Apatura clyton*). As the reasoning there has since been confirmed by the adoption of the latter names, both by Mr. W. H. Edwards and Mr. S. H. Scudder in their catalogues, these names will be used in the present instance.\*

---

\* Led by Mr. Scudder's previous writings to adopt the Fabrician names, I nevertheless took some pains to get at the real facts, and concluded, after considerable correspondence, that there was no cause to change the conclusions which I had previously expressed, that we have but two species of *Apatura* in the United States, viz: *A. lycaon* Fabr. = *celtis* Boisd. = *alicia* Edw.; and *A. herse* Fabr. = *clyton* Boisd. = *proserpina* Scudd. But I admitted that there would ever hang a certain doubt about *herse*, and that had I the paper to write over again I would use the Boisduval names, because I believe that science is better advanced by the use of names based upon descriptions of the living animals rather than by unearthing such as are drawn from pencil (and often faulty) imitations, and which admit of doubt and dispute. "In

It will be unnecessary in this connection to give more than a brief recapitulation of the results of my studies on these insects, quoting, where it may seem advisable, the more important facts from the article referred to.

### 1. THE EYED EMPEROR.

*Apatura celtis* Bd. and LeC.

A green caterpillar, with a series of pale, medio-dorsal spots and pale longitudinal lines, with two anal projections and two antlers on the head, usually found singly on the under side of the leaf, transforming to a pale green chrysalis with a serrate back. Two generations annually, the second hibernating in the second or third larval stage upon the fallen leaf. Butterfly of a russety-gray shaded with dark brown, and with eye-like spots on the wings, the female laying eggs singly or in small groups on the under surface of the leaf.

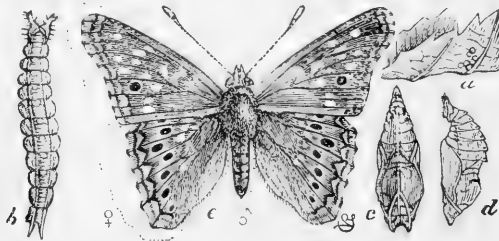


FIG. 196. *Apatura celtis*: a, eggs; b, larva, dorsal view; c, d, chrysalis, dorsal and lateral views; e, imago, male, dotted line showing form of female—all natural size. After Riley.

The larvæ of this species are found on the various species of *Celtis* during May. When at rest they are found on the under side of the leaf, usually on a carpet of silk, and often with a portion of the leaf bent around it, and they reach full maturity by the end of the month.

“In preparing for the chrysalis state the larva spins on the under side of a leaf a little bunch of silk in which to entangle its prolegs. Sometimes, but not often, it partially covers itself with a curled leaf or with two leaves drawn together. Here it rests for about two days, when the larval head and skin split open, and the soft and unformed chrysalis works them back to the extremity of its body. It then secures itself, knocks off the shrunken skin, and soon assumes the delicate green color, marked with cream yellow, and the elegant form (Fig. 196, c, d) which nature has imposed upon it.”

other words, the ‘law of priority’ becomes a nuisance and a positive injury to the science when pushed to the unnecessary extreme of attempting to solve inexplicable riddles.” Mr. A. G. Butler, of the British Museum, admitted (letter, June 15, 1874) that he was all wrong in what he had published on the subject, and concurred in my judgment. Mr. Scudder (May 29, 1874) wrote that upon examining Hübner’s *Doxocopa idyia*, it proved to be the same as a species which he had from Guatemala, and that it is barely possible that this may be *herse* Fabr.; while Mr. Edwards also wrote (July 12, 1874) that he believed *herse* not American. In his recent work, Scudder states that *idyia* [pars] Herr.-Schaeff is *clyton*, but not *idyia* Hübner, while he concludes that *celtis* is not *lycaon* Fabr., a conclusion in which I should hardly follow him, so far as the original drawings justify conclusion.



In the latitude of St. Louis it is not until the middle of June that the first butterflies begin to appear, and by the end of the month the globular, delicate, longitudinally ribbed eggs may be found on the under side of a leaf, either singly or in small clusters.

The young larva in hatching pushes open the crown, which lifts like a cap. The first summer brood of worms feeds for rather less than a month, when they transform and give out the second brood of butterflies during August.

The eggs laid by these in due time hatch, and the young larva is more lethargic than that of the first brood, feeds with less vigor, develops much more slowly, and, after passing through the second or third molt, ceases to eat, shrinks in size, and remains stationary on the under side of the leaf. It also changes from its fresh green color to a dingy grayish-brown, and eventually, with its dying support, falls to the ground and there hibernates.

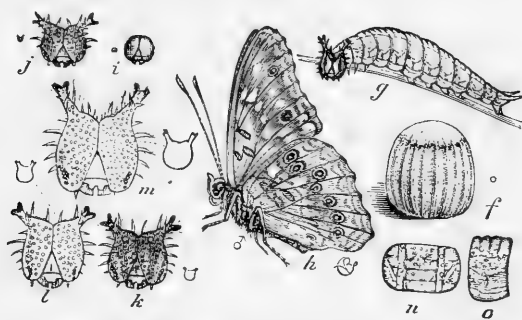


FIG. 197. *Apatura celtis*: *f*, egg, magnified; *g*, larva, lateral view; *h*, imago, underside—natural size; *i*, *j*, *k*, *l*, *m*, the five different larval heads; *n*, *o*, dorsal and lateral views of larval joint—enlarged. After Riley.

The accompanying figures will so fully illustrate the different stages and transformations that no repetition of description is necessary.

*Parasites*.—The only parasite published as attacking this species is the Ophionid, *Limneria fugitiva* Say, reared by Mr. W. H. Edwards in West Virginia, and recorded by Mr. L. O. Howard, in Scudder's Butterflies of New England, page 1883.

In 1874 I found a larva in the third stage being devoured by *Eulophus* larvæ, some of which issued and formed their pupæ under my eye, the perfect flies, an undescribed species, issuing on July 13, of that year. I have reared quite abundantly from the chrysalis of this species the large *Chalcis flavipes* Fabr. and an undescribed Tachinid, while one of my old correspondents, Mr. George W. Letterman, of Allentown, Missouri, once brought me specimens of *Podisus spinosus* which he had found piercing the larva and sucking its juices.

The egg-parasite and the other parasites reared from *Apatura clyton* and presently referred to will doubtless be found preying on *A. celtis* also.

## 2. THE TAWNY EMPEROR.

*Apatura clyton* Bd. LeC.

This butterfly is a larger and more showy one than the Eyed Emperor and it extends farther north and east. Its habits are similar and I have frequently found the larvæ of both species feeding together on the same tree.

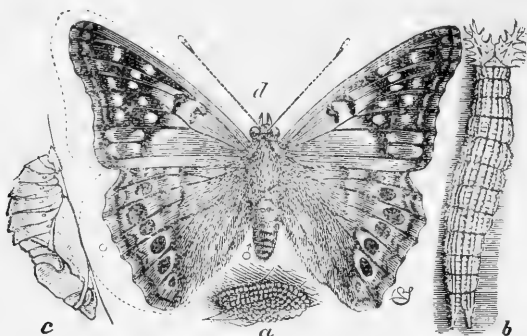


FIG. 198.—*Apatura clyton*: a, eggs; b, larva; c, chrysalis; d, imago, male, the dotted line showing form of female—all natural size. After Riley.

It is less common than *A. celtis* and Boisduval gives *Prunus* as the food-plant of the species; but no one since has recorded it as occurring on trees of that genus, and, as I have already recorded, young larvæ refused to feed on Plum leaves and died rather than eat them.

The eggs of this species are similar to those of *celtis*, and differ mainly in being narrower on the crown, but they are “invariably deposited in dense patches of from 300 to 500, and two, or more often three, tiers deep.”

The structural differences between the young larvæ of the two species are fully set forth in the article alluded to.

“The larvæ are more or less gregarious up to the third molt, after which they scatter. The habit, after they scatter, of hiding within leaves drawn around them, is more determined than in *A. celtis*; and the young of the second brood fall with the leaf, and hibernate huddled together in companies of five and upwards (Fig. 199, q). They have a habit, before separating, of feeding side by side, eating the leaf from the tip downward, but leaving the stouter ribs. Spinning a thread wherever they go, they often, in traveling from leaf to leaf, make quite a pathway of silk; and if the branch be suddenly jarred, they will drop and hang suspended in mid-air, and, after re-assurance, climb up again with the thoracic legs.”

*Parasites*.—My notes would indicate that there were two parasites affecting the eggs of this butterfly, one of them not preserved, and referred to the Trichogrammidæ in my fifth Missouri report. The other, since bred in numbers, proves to be a Proctotrupid belonging to the

genus *Telenomus* and described recently by Mr. Howard, in Mr. Scudder's Butterflies of New England, under the name *Telenomus rileyi*.

Besides this egg-parasite I have reared from the pupa, *Chalcis flavi-*

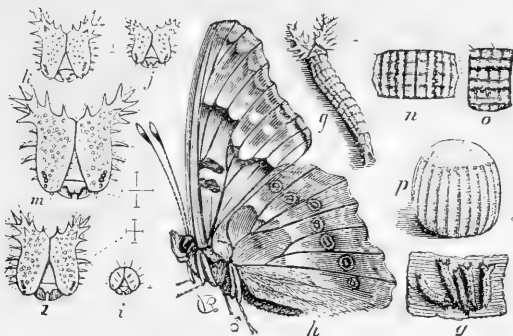


FIG. 199.—*Apatura clyton*: *g*, larva, half grown, dorsal view; *h*, imago, male, underside—natural size; *i*, *j*, *k*, *l*, *m*, the five different heads of larva; *n*, *o*, dorsal and lateral views of larval joint; *p*, egg—enlarged; *q*, larvæ as when hibernating—natural size. After Riley.

*pes* Fabr. and *Pimpla annulipes* Brullé, while *Limmeria fugitiva* Say was reared from the larva by Mr. A. H. Mundt in Illinois, all recorded in Mr. Scudder's work.

### 3. THE INTERROGATION BUTTERFLY.

#### *Grapta interrogationis* Fabr.

A spiny, reddish-brown caterpillar, more or less speckled with white, feeding on the leaves in July.

The very full life-history and bibliography of this species in Scudder's recent elaborate work, "Butterflies of New England," leaves very little, if anything, to be recorded.

The species is by no means rare in Missouri, where it first came under my observation, and while common on the Elm and Hop, is more rarely, yet not infrequently, met with on the Hackberry, as I have frequently observed it on this tree.

The following facts are extracted from notes made in 1870:

The egg with its nine vertical ribs is at first dull bluish-green, afterward becoming grayish-green with silvery reflections. It is laid singly or in chains, one above another, either on the upper or lower portion of a leaf.

The duration in the egg state is four days. Two eggs which I saw a female lay on a leaf May 19, hatched May 23, and the spines on the young larva could be distinctly discerned through the delicate egg-shell before hatching. The length of the egg was .95<sup>mm</sup>; width .7<sup>mm</sup>.

The full-grown caterpillar has the body black, covered with light yellow papilliform points, which are thickest and of a deeper yellow toward the head. It is also

covered with compound spines; two on each side of the second segment black, proceeding from a red wart; two on each side of the third segment, the main stem being red at base, yellow at extremity, and those proceeding from it being black. On all the other segments but the last two (on each side of which there are two compound black spines) there are seven, three on each side and one on the back. That on the back is yellow and smaller than the rest; those nearest this are also yellow, but with black extremities, particularly toward the head; those below these last have a red stalk with black spines proceeding from it, and those along the stigmatal line (which line is very light yellow) are of the same color as that line and very small. Two lines run along the back, closest together near the spines and having the appearance of a succession of links. There are also other lines running parallel with these, but not so distinct, along the sides. Head perpendicular, free, larger than the body, very dark purple-brown, and covered sparsely with small white points from which proceed fine white bristles; on the top it has two black compound spines. Thoracic legs same color as head, the prolegs of a lighter brown. Length,  $1\frac{1}{4}$  inches; diameter, one-fifth inch.

It hangs by the cremaster and anal prolegs\* to a small bunch of flesh-colored silk, and changes to a chrysalis similar in form to others of its group, of a fleshy-brown color shaded with bluish-black. It has a crescent-shaped projection on the thorax, with four golden spots just below. The wing-sheaths are faintly green, having a slight resemblance to a leaf.

Some specimens of the larva are much brighter than others, being speckled or mottled all over with white, and the chrysalis, instead of having four golden, has often four brilliant, silvery, metallic spots, while the whole body may be tinted with gold and green, particularly along the stigmata.

Mr. Scudder says:

Judging from the dates given by Harris's correspondence, the chrysalis state lasts from eleven to seventeen days. Grosse (Canada) says eleven days. Edwards (in West Virginia), seven to eleven. Braun, in Bangor, had them hang twenty days at the end of July.

My specimens at St. Louis remained nine days, on the average, in the chrysalis state, which is most frequent in July, while the butterflies are most numerous in August. The butterfly, therefore, appears in Missouri about the same time as in the New England States, viz, from the last of July to the middle of August, and is probably but two-brooded.

*Parasites.*—Two parasites are found in the eggs, *Telenomus graptæ* Howard, reared at Washington, and *Trichogramma intermedium* Howard, reared by Mr. Scudder at Cambridge. An undescribed *Apanteles* and *Pteromalus vanessæ* Harris are quite frequently reared, the one from the larva, the other from the chrysalis. *Tetrastichus modestus* Howard is a secondary parasite on the *Apanteles*, while a large Ichneumonid, *Hoplismenus morulus* Say, was once reared from it by Miss Pierce at Cambridge, all recorded in Mr. Scudder's work.

---

\*See a paper by the author on the "Philosophy of the pupation of Butterflies," Proc. Am. Ass. Adv. Sc., for 1879, vol. 28, pp. 455-463.

## 4. BACHMANN'S LIBYTHEA.

*Libythea bachmanni* Kirtland.

This remarkable looking diurnal, appearing as if snouted, from the very long porrect palpi, so far as we now know, feeds exclusively upon *Celtis* in its larval state. The butterfly expands about  $1\frac{3}{4}$  inches. It is brownish-black above, the apex of front wings quadrate, the margin slightly sinuate. There are three white spots on the apical third of the wing, the basal spot the largest and oblique. At the base of the wing are three large reddish or fulvous blotches, one of which occupies most of the discal cell. Beneath, the wings are brownish, the apex tinted with lilac, the apical white spots repeated as well as the fulvous blotch in the cell. The hind wings have a fulvous band behind the middle, and are lilaceous beneath.

Its life history was partially worked up by Mr. W. H. Edwards in *Butterflies of North America* (Vol. II, Part I, 1874), and subsequently more fully, by the same author, in the *Canadian Entomologist* (Vol. XIII, 1881, page 226), and from these the following abstract is largely drawn.

It is quite common in the Atlantic States, where its food-plant is abundant, and specimens have been captured in Canada.

It is more rare in the Mississippi Valley, but occurs as far west as Arizona. I have found it, as has also Mr. Schwarz, tolerably abundant in Texas, the larva feeding on the leaves of *Celtis*.

The oblate-spheroid, pale-green egg has eighteen or twenty narrow but prominent ribs, terminating before reaching the summit and crossed by many striæ.

Mr. Edwards says:

The eggs seem to be nearly always laid on the tender terminal leaves of the branch. Usually one egg is laid at the end of a branch, in one of the forks on the leaf stem, but I have seen two eggs on same stem, and occasionally an egg laid on the under side and middle of a leaf. The young larvæ on hatching ascend to the extremity of one of the leaves and remain there stripping the sides, leaving the midrib untouched, whence it is easy to find them. They eat their way out of the egg a little below the tip, but do not eat the egg-shell after emerging, and the empty shell has often guided me to the whereabouts of the young caterpillar.

It will be unnecessary to repeat here Mr. Edwards's description of the larval changes, but I reproduce his description of the full-grown larva and chrysalis:

*Mature larva.*—Seven-tenths to nine-tenths inch; cylindrical, thickened at segments 3 and 4, the dorsum of last segment abruptly curved down to the end; color dark green, the lower side and also feet and legs pale green; each segment four times creased transversely, and on the flat ridges so caused are rows, one to each, of small tubercular flattened points, pale or whitish yellow; from 2 to 13 a white stripe along base, just over the spiracles, and above this the ground is yellowish for a little way; a medio-dorsal yellow line and sometimes a fine line on middle of side; yellow tuberculated points over the legs, in arcs of from 3 to 6; on foremost ridge of third seg-

ment, high on the side, a dead black tubercle, a little raised and rounded in yellow ring; spiracles in black ovals; surface covered with a fine short down; head obovoid, green, smooth, sparsely pilose; the ocelli brown. Occasionally the larvæ in later stages are differently colored. One had the dorsum dark green, edged on either side by a gray line, and successively by a band of yellow, a gray line, and a black band; the third segment is wholly and the fifth partly black. Two others of the same brood were green with a black band along base of body and black patches on 3 and 11.

*Chrysalis*.—Length, .5 inch; helmet-shaped; compressed laterally, the abdomen somewhat carinated; mesonotum high rounded, sloping abruptly to top of head-case, much compressed and sharply carinated; followed by a deep excavation; head-case not prominent, square or nearly so at top, a little excavated, the corners subpyramidal and scarcely at all produced; along carina of abdomen a yellow line which forks and passes round mesonotum to top of head-case; a slight yellow lateral line on abdomen; color green, either deep or with a blue or yellow tint; the abdomen much sprinkled with pale yellow flat points or small spots, a few of these about the head-case. Duration of this stage five days in July, seven days in August.

Mr. Edwards is of the opinion that there are several successive generations, "probably four, that the latter butterflies hibernate, and the survivors are on the wing early in May, and probably in favorable seasons in April. The first generation in descent from the hibernating females are on the wing in June, the second generation in July, the third in August, and late butterflies emerge from chrysalis in September, and these would be of the fourth generation in descent from the hibernating females."

#### 5. THE HACKBERRY DAGGER.

(*Acronycta rubricoma* Guen.)

Order LEPIDOPTERA; family NOCTUIDÆ.

This is a widely distributed species and doubtless coincident with its food-plant, the different species of *Celtis*, on which, according to my own observations as well as those of others (French, 6th Rept. Ill. State Norm. Univ., p. 45, and J. Marten, Trans. Dept. Agr., Ill., Vol. 18, Append., p. 132), it feeds exclusively. It will, in fact, perish rather than partake of any other food that I have so far offered. The species has been represented in the U. S. National Museum from the following States: Texas, Missouri, Illinois, South Carolina, Virginia, and even from Canada, in all of which localities it is probably double-brooded. In its southern range the first brood of larvæ appear during the early part of May, being full grown by about the end of June. The moths from these appear during July and the early part of August, whilst the larvæ of the second brood are full grown from the middle of September to the middle of October, this last brood being, however, very generally parasitized. The second generation of moths (with the exception of a few premature specimens which issue the same fall) makes its appearance the ensuing spring from about the 10th of April till May. Captured specimens in the National collection bear the following dates: By myself, April 20, 1874, July 10, 1874, and September 3, 1874; by Belfrage, Texas, April 11, 21, 29; by S. H. Saunders, Canada, July 10, 1886. The full-grown larvæ are rather handsome insects, which, like

so many of the *Acronyctas*, are in the habit of resting in a curved position. The chief peculiarity of the larva is that it changes the color of its tufts and hairs at the last larval molt.

## OTHER LEPIDOPTERA.

Some other Lepidoptera occur on the Hackberry, but none of them are peculiar to it except, perhaps, the Tortricid and the Tineids. It will suffice therefore, in closing this brief chapter, to indicate some of the species which occur on *Celtis*, and which also occur on other trees and have been already treated of by Dr. Packard in other chapters of this report.

6. *Pædisca celtisana* Riley (Trans. Ac. Sc. St. Louis, 1882.)

7. *Lagoa opercularis* Abbott and Smith.—Never very common, but widespread and a general feeder. My notes show that it occurs also on Oak, Orange, Apple, Pear, Plum, Viburnum, Poplar, Willow, Sassafras, English Ivy, and one has even been found on *Ailanthus*—a tree affected by so very few insects.

8. *Sphinx drupiferarum* Abbott and Smith.—This is also a not very common but widely distributed species occurring from Florida to Canada and from the Atlantic States to the Mississippi, while varieties are found in the extreme Western States, in California, and even in Vancouver. While its principal food-plant seems to be *Prunus*, Abbott and Smith give also *Celtis*. Miss N. Middleton (10th Ills. Rept. on Noxious and Beneficial Insects, p. 104) also gives *Celtis* as one of its food-plants, while Professor Fernald, in his "Sphingidæ of New England," adds Apple and Lilac.

9. *Mamestra* sp. ?—A larva quite closely resembling that of *Mamestra subjuncta* has been found on the Hackberry, but unfortunately not reared. The same species has also been found on Polygonum, Plantain, and Clover.

10. An unbred Geometrid larva resembling somewhat that of *Aletia xyliana* Say has also been found on *Celtis* at St. Catherine's Island, Georgia, by Mr. Schwarz.

11. *Proteoteras asculana* Riley.—This species, which commonly feeds on the Buckeye, has been sent to me by Mr. L. Bruner from West Point, Nebr., on the short twigs of *Celtis occidentalis*. What is, without much doubt, the same species, has also been found upon the young shoots of Maple (*Acer dasycarpum*) as also of Box Elder (*Negundo aceroides*).

12. *Lithocolletis celtifoliella* Chambers.—This is recorded by Chambers as making a tentiform mine on the underside of the leaves of *Celtis occidentalis*.

13. *Lithocolletis celtisella* Chambers.—This species, first recorded by Chambers in 1871 (*Canadian Entomologist*, Vol. III, p. 129), I have also reared plentifully from mines on the leaves of *Celtis* collected in Virginia in 1884.

## 14. THE CELTIS GRAPHISURUS.

*Graphisurus triangulifer* (Hald.).

Larva burrowing under the old bark of *Celtis texana*, partly in the bark and partly in the wood; issuing, in July, as a long-horned beetle.

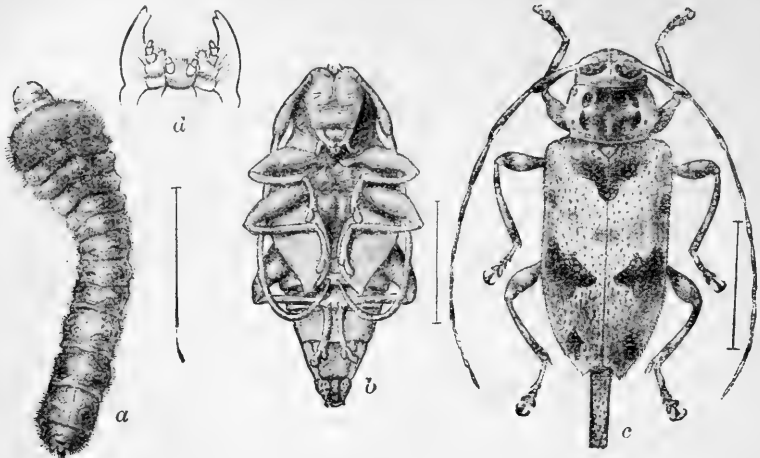


FIG. 200.—The Hackberry *Graphisurus*: *a*, larva; *b*, pupa, ventral view; *c*, female beetle—enlarged; *d*, mouth-parts of larva from beneath—still more enlarged. (Original.)

This insect is not uncommon in the Southwestern States, but was described by Haldeman in 1847 (*Trans. Am. Phila. Soc.*, vol. x, p. 45) from specimens obtained in Alabama. It is a rather pretty beetle, about half an inch long, clothed with fine pubescence and mottled with brown and yellow, the legs and feelers annulate with yellow. Its food-habits and early states have not, I believe, heretofore been recorded. My notes of the insects obtained during the cotton-worm investigation show that it was not uncommon under the bark of the Hackberry, affecting diseased or partly dead trees, so that it injures chiefly in hastening the decay of such timber. Larvæ and pupæ were found by Mr. Schwarz at Columbus, Tex., under the bark of *Celtis texana*, June 15, 1879, and the adult insects were obtained about the end of July.

The larva and also the pupa are very similar to the like states of allied wood-borers, and any description of these states, to be of value, should be based on a comparative study of related forms. Our knowledge is too fragmentary at present to allow of such comparison and the following brief description is based merely on the species under treatment.

*Larva*.—Average length 22<sup>mm</sup>. General color yellowish-white. Mandibles and ring about the head connecting with the base of the mandibles, reddish-brown; head a little more than one-half the width of the prothoracic joint; mandibles strongly tapering from the base, tip slightly excavated or bidentate—the lower tooth projecting somewhat beyond the upper; clypeus trapezoidal, more than twice as wide as long, marked with six deeply impressed lines; labrum rounded, tip truncated, densely clothed on exterior edge with yellowish hairs; antennæ light-colored, three-jointed; two basal joints subequal, tip of second joint truncated, armed with hairs and bearing the minute apical joint near its outer margin; labrum and maxillæ clothed with yellowish hairs; maxillary palpi apparently three-jointed, first joint



one-half longer than wide, apical joint minute; labial palpi apparently two-jointed, basal twice as long as wide, apical minute. The body tapers from the large prothoracic joint to the ninth, the last three joints slightly enlarged; tip of abdomen rounded and subtruncate; horny areas on dorsum, and venter of each joint as in other allied larvæ; prothoracic joint thickly armed with yellowish hairs, especially about the anterior and lateral portions; following joints sparsely armed with hairs on the lateral portions; thoracic legs wanting.

*Pupa*.—Female. Length, 15<sup>mm</sup>; diameter, 8<sup>mm</sup>. Color, yellowish-white. Viewed from above, the first thoracic joint is widest and the second narrowest. The abdomen tapers regularly to the truncate tip; abdominal joints 1 to 6 narrow, subequal; seventh as long as wide and nearly as long as the three preceding together. Dorsum of joints armed with minute brownish points; femora at tips armed with five or six minute spines tipped with yellowish hairs. The wing-cases extend to the tip of the fourth abdominal joint, posterior feet to tip of the seventh joint. The antennæ pass back of the femora of the two anterior pair of legs, turn at the tip of the wing-cases, and reach in front to the base of the middle pair of legs.

#### 15. THE EYED ELATER OF THE HACKBERRY.

*Alaus lusciosus* Hope.

Order COLEOPTERA; family ELATERIDÆ.

This insect is hardly distinct from the common Eyed Elater (*Alaus oculatus* Linn.), and the larvæ and pupæ of the two species are practically identical. Some very slight differences occur in the armature of the last segment of the larvæ, but these may be variable, and at any rate are so slight as to be of no value in separating the two species.

The common species is known to pass its growing stages in the decaying wood of various trees and is mentioned by Dr. Packard on page 424.

On May 26, 1879, Mr. Schwarz found a larva of an *Alaus* under the bark of *Celtis texana* at Columbus, Tex., which may be referred with little doubt to *A. lusciosus*, as a perfect insect of this species was found at the same place in July and August.

#### 16. THE CELTIS BARK-BORER.

*Scolytus fagi* Walsh.

Order COLEOPTERA; family SCOLYTIDÆ.

A whitish, thickened grub one-fourth inch long, occurring under the bark of *Celtis texana*, boring partly in the wood and changing in July into a shining black beetle about three-sixteenths of an inch long.

This beetle was described by B. D. Walsh in the *Practical Entomologist*, vol. 2, p. 58, February, 1867, and the following statement was made concerning its habits: "I obtained many specimens from south Illinois from what I believe was a beech."

Dr. Le Conte, in *Rhynchophora of America*, north of Mexico, gives it, on the authority of Walsh, as depredating on the Beech, but the above reference shows that this food habit can not be positively asserted of it.

I have examined the work of this insect under the bark of *Celtis texana* in Texas, and Mr. Schwarz has collected it in large numbers at Colum-

bus and made careful notes for me. It is found boring partly in the solid wood in all stages. So numerous were the insects that the pattern of the larval burrow, which is usually very characteristic in the Scolytids, was confused and undecipherable. The insect is very destructive to the tree by hastening decay, although it was not observed to attack perfectly healthy trees. The adolescent states show little that is specifically characteristic, the larva having the normal form and lacking legs.

This insect has a persistent enemy in a small predaceous beetle (*Clerus ichneumoneus*) which attacks and destroys the Scolytid when the latter emerges from its gallery and the larva of which, there is every reason to believe, also destroys the Scolytid larva.

The following additional Coleoptera are also known to affect *Celtis*, but are not peculiar to it, the most injurious being No. 20:

#### CERAMBYCIDÆ.

17. *Mallodon melanopus* Linn.
18. *Mallodon serrulatus* Lec.
19. *Smodicum cucujiforme* Say.
20. *Romaleum atomarium* Drury.
21. *Liopus crassulus* Lec.
22. *Ataxia crypta* Say.

#### SCOLYTIDÆ.

23. *Micracis rudis* Lec.
24. *Scolytus muticus* Say.
25. *Phloeotribus frontalis* Oliv.

The following species of Cucujidæ are found under the decaying bark:

26. *Catagenus rufus* Fabr.
27. *Scalidia linearis* Lec.
28. *Ino reclusa* Lec.
29. *Læmophlæus hornii* Casey.

#### CECIDOMYIDOUS HACKBERRY GALLS.

The Cecidomyidous galls occurring on twigs and leaves of *Celtis* often assume a close resemblance to those produced by the Psyllids and are almost as numerous in species as the latter. They have not yet been thoroughly studied, and a full description is not here intended, nor a characterization of the insects which make them and which are very difficult to rear. But a short account of a few of the more striking galls which are liable to be mistaken for those made by Psyllids will be appropriate.

30. Cecidomyidous galls on the tender twigs, either singly or placed in rows of two or more specimens; occurring also singly on the petiole or on the lower surface of the leaf. Gall usually resembling somewhat

a large egg of some diurnal Lepidopteron; short, conical, or subglobular in outline, arising from a circular, truncate base, rounded off at tip where it is furnished with a short spine or nipple; surface dark green, opaque, granulose, usually with faint and shallow longitudinal furrows and usually hirsute with short stout hairs; sides at the base with more or less distinct, irregular protuberances. The gall is not entirely sessile, but only connected with the twig at the central part of its base. A vertical section shows a single spherical cell (rarely two) having a thick whitish-yellow, hard and woody wall. Average height of gall  $4^{\text{mm}}$  (excluding the apical spine); average diameter at base  $3.4^{\text{mm}}$ . The gall varies in shape, some specimens being more conical, others nearly globular or even slightly depressed at tip, while others are not hairy and less opaque, the surface being covered with little pustules. The latter form possibly constitutes a distinct species.

31. Cecidomyidous galls on the tender twigs occurring either singly or in groups of two, three, four or more specimens; rarely, also, singly on the under side or even the upper side of the leaf. The gall bears a close resemblance to the winged seed-capsule (achenium) of a *Rumex*, but the wings vary in number from three to five and are often irregularly developed, while the tip always ends in a long curved spine. The wings terminate in a sharp ridge which is sometimes double. Gall opaque, not hairy, sculpture consisting of faint and irregular transverse striæ; color pale yellowish-green, at apical third usually of a more decided green and darker. A longitudinal section reveals a single large, regularly ovoid cell surrounded by a thin hard wall. Average height of gall  $4.5^{\text{mm}}$ , excluding the apical spine; generally as wide as high; length of apical spine variable, but usually a little more than half the height of the gall.

This gall is easily recognized from its peculiar form.

32. Cecidomyidous galls on the under side of the leaf, always arising from one of the principal leaf-veins, occurring usually singly, rarely in pairs. In form, sculpture, and pubescence the gall bears a most striking resemblance to that produced by *Pachypsylla celtidis-pubescens* (see p. 619) but it is much larger, more globular, and at once distinguished by the absence of the cupuliform depression on the upper side of the leaf which is so characteristic of many *Pachypsylla* galls. A vertical cut through the gall shows a relatively small ovoid cell surrounded by a thick, hard yellowish-white wall. On detaching the gall the base is seen to be truncate and attached to the rib of the leaf by an extremely short conical style which is not visible from the sides. Average height  $3.5^{\text{mm}}$ ; diameter at middle,  $3.5^{\text{mm}}$  to  $4^{\text{mm}}$ .

33. Cecidomyidous galls on the under side of the leaf arising from the leaf-ribs, occurring either singly or in smaller or larger groups. Gall rosette-shaped, resembling the seed-capsule of certain Malvaceous plants of the genus *Hibiscus*, circular in outline, greatly flattened on the top and here furnished with a short central spine or median nipple (frequently broken off); sides sulcate, with from ten to twelve more or

less marked furrows, and with the corresponding interstices convex. Surface of gall not shining, lighter or darker brown, speckled with small irregular blackish pustules, and sparsely beset with moderately long whitish hairs, which are easily abraded. Average height of gall, .75<sup>mm</sup>; diameter, 2 to 3<sup>mm</sup>. Cell oblong oval, inclosed by thick, woody side walls, but with a thin bottom, and at the roof (*i. e.*, toward the upper side of the leaf) covered with a thin soft layer. Gall on upper side of leaf usually visible as a small circular pustule of brownish or grayish color. The gall is also at once recognizable from its shape, but might readily be mistaken for a Psyllid gall.

34. Cecidomyidous galls on the under side of the leaf, either singly or in smaller or larger numbers, usually between the leaf-veins, rarely crossing the large ribs. The gall is a more or less stout conical spine arising from a circular base, and either gradually and regularly tapering toward the tip or more suddenly narrowed a short distance from the base, and then with the sides more vertical; tip more or less acute and often slightly curved. Color pale yellowish, surface a little shining, either without distinct sculpture or with faint longitudinal furrows, especially near the base. Average height, 4<sup>mm</sup>; average diameter at base, 2.8<sup>mm</sup>. The walls of the gall are thin except near the base, where they are thicker; the cell is elongate ovoid, and extends from the base to the tip of the spine. On the upper side of the leaf the gall is visible as a small circular slightly depressed spot of pale color and furnished in the center with a small nipple. While issuing, the perfect insect pushes off the tip of the spine.

35. Cecidomyidous galls on the under side of the leaf arising from the leaf-veins, either singly or in groups or in rows, either assuming a vertical position or more or less reclining or even horizontally placed. Gall cylindrical, or very slightly narrowed at base; at tip always truncate with a median nipple. Color pale yellow, surface opaque, faintly longitudinally striate and usually beset with sparse, long, white hairs, which, however, are easily lost. Average height of gall, 2.5<sup>mm</sup>; diameter, 1.2<sup>mm</sup>. The walls are thin, the cell elongate with the apical side truncate, and the basal end conical. On the upper side of the leaf the gall is barely visible as a small yellowish spot on the veins.

This often occurs in company with the preceding species, of which it may possibly be an extreme but constant variety: at least a form which combines the characters of the two is not infrequent. It is intermediate in size, short, conical, with truncate tip and either hairy or glabrous.

#### HACKBERRY PSYLLIDÆ.

The Hackberry is infested by a number of gall-producing Psyllidæ which are all referable to the genus *Pachypsylla* Riley (Proc. Biol. Soc. Wash., v, 2, 1889, p. 71). The imagos are stout-bodied insects with the head vertically deflexed and rugosely punctate; vertex not narrowing anteriorly; frontal cones more or less oval, well separated from the vertex and at most half as long as the latter; antennæ stout,

and not longer than the width of the head; pronotum and dorsulum strongly ascending and rugosely punctate; anterior wings of varying form and consistency, but never hyaline; pterostigma present; tip of wing between radius and fourth furcal; marginal cells unusually long and narrow; genital plate of male more or less oval (when viewed from the side) and not linear.

The genus belongs to the subfamily Psyllinæ and has no equivalent in the European fauna; but some allied, still undescribed, genera occur in the New World.

The species of *Pachypsylla* are divisible into the following groups, the table being reproduced from my "Notes on North American Psyllidæ" (l. c., 75):

Head and dorsum opaque; front wings submembranaceous or subhyaline, not rugose; pterostigma distinct; both marginal cells very long, narrow, and of about equal size in length; anal style of full-grown larva and pupa long.

Dorsulum and mesonotum alutaceous, glabrous; front wings narrowly rounded at tip, widest in basal half; genital segment of female longer than the rest of the abdomen; anal style of full-grown larva and pupa notched at tip.

Type, *venusta*.

Dorsulum and mesonotum rugoso-punctate, with distinct but very short, sparse pubescence; front wings broadly rounded at tip, widest in terminal half; genital segment of female shorter than the rest of the abdomen; anal style of full-grown larva and pupa pointed at tip.....Type, *c.-mamma*.

Head and dorsum shining, without pubescence; front wings somewhat convex, basal half not wider than terminal half, broadly rounded at tip, distinctly rugose; pterostigma indistinct; marginal cells less narrow, the first shorter and somewhat smaller than the second; genital segment of female shorter than the rest of the body; anal style of full-grown larva and pupa very short, nicked at tip .....Type, *c.-gemma*.

For *P. c.-gemma* I have suggested the subgeneric name *Blastophysa*, but the yet undescribed species are all so closely allied to *P. c.-mamma* that they can only be distinguished with difficulty.

The distinguishing characters of the pupa, which apply also to the full-grown larva, have been alluded to in the above table, and aside from these characters the following description, taken from the pupa of the largest of our species will, in the most important points, also apply to those of the others pecies:

*Pupa*.—Broadly oval in outline; widest at middle of abdomen; depressed anteriorly; abdomen more convex. General color faint bluish-green; upper surface with indistinct roseaceous markings; antennæ and legs pale yellow; wing-pads and tip of abdomen brownish; abdominal spines black. Sculpture not obvious, surface opaque, thinly covered with long, soft, whitish and not clavate hairs, which are more numerous on the abdomen, but which do not form a fringe as seen in other genera. Upper and under sides of body somewhat sharply divided, but the sides everywhere rounded off. Head (including eyes) as wide as the mesonotum at middle; much less inclined than in the imago; anterior margin broadly rounded; frontal lobes not indicated; eyes very large, globular, finely granulated, reaching to the hind margin of the head; ocelli barely visible from above, antennæ thicker than in imago, and, therefore, apparently shorter, but otherwise not different; pronotum separated from head by a deep sulcus, not different in shape from that in imago; dorsulum much shorter than in imago; mesonotum as in imago. Wing-pads smooth, very shining, slightly diverging posteriorly, small and narrow in comparison with those of other genera,

not quite attaining apex of second abdominal joint, those of under wings slightly projecting internally and posteriorly. Abdomen composed of eight joints, widest at middle, gradually narrowing anteriorly and very strongly posteriorly; anal joint drawn out in a horny process; first joint very short, second twice as long as the first, the following three joints still longer, the fourth being the longest and widest; dorsal and ventral sides of joints 2 to 4 separated by a rounded lateral bulging; dividing sutures of segments 1 to 5 very deeply impressed; last three joints much less distinctly divided, more horny, and of darker color, rapidly narrowing posteriorly, and provided dorsally with a number of black, backwardly directed, triangular teeth, arranged as follows: Sixth joint at middle of hind margin with two or three very small teeth placed transversely and with no lateral teeth; seventh joint at middle of hind margin, with a transverse row of four teeth, and on each side with two or three (often obsolete) teeth or tubercles; anal joint with the horny process about half as long as the joint, and nicked at the tip, while at base of process on each side a lateral row of four small, closely placed teeth extends to the under side, and finally on the disk of the joint three teeth triangularly placed, the posterior being the largest; behind this group and just above the base of the process is another tooth nicked at tip.

The pupæ of the other species differ mainly from the above description in the smaller size, the form and length of the anal process, and in the number and arrangement of the abdominal teeth. That of *P. c.-gemma* alone has some other distinguishing characters.

The young larvæ of all species are of a more uniform pale color with less developed wing-pads and the segmentation of the abdominal joints much less evident; they are further distinguished by the smaller number of antennal joints and the weaker development of the abdominal armature.

The galls produced by the species of *Pachypsylla* may be distinguished as follows:

Polythalamous (very rarely monothalamous) galls, never on the surface of the leaf, always singly.

Large gall on petiole and involving the basal portion of the leaf; usually somewhat reniform in shape, and with an opening near the tip.

*P. venusta* O. S.

Smaller gall on the twig, bud-shaped, and without opening.

*P. c.-gemma* Riley.

Monothalamous galls, always on the leaf, usually occurring in great numbers.

Gall blister-like on both sides of the leaf and hardly raised above the surface of the leaf ..... *P. c.-vesiculum* n. sp.

Gall on the under side of the leaf, not blister-like, more or less raised above the surface and assuming various shapes.

Gall on upper side of leaf, blister-like and not forming a depression; on underside of leaf star-shaped or flower-shaped.. *P. c.-asteriscus* n. sp.

Gall on upper side of leaf represented by a depression.

Gall on upper side of leaf, with the outer rim alone depressed, the central portion slightly raised and provided with a median spine; on under side of leaf wart-like, much flattened, with a more or less pronounced depression at middle ..... *P. c.-umbilicus* n. sp.

Gall on upper side of leaf represented by a cup-like depression, the outer rim sometimes elevated.

Gall very large, mammiform without depression or rim on top, usually not pubescent, sometimes with slight down at base.

*P. c.-mamma* Riley.

## Monothalamous galls—Continued.

- Gall smaller, semi-globular, sessile, covered with long soft hair and without impression.....*P. c.-pubescens* n. sp.  
 Gall smaller, globular, subsessile, with a small impression at top, not pubescent.....*P. c.-globulus* n. sp.  
 Gall smaller, not pubescent, sessile, wider than high, very much flattened on top, and here usually with two concentric elevated rims, and provided with a central nipple.....*P. c.-cucurbita* n. sp.  
 Gall smaller, not pubescent, less sessile than the preceding, higher than wide, around the sides near top with longitudinal sulci, the top cup-like, depressed, and without central nipple.

*P. c.-cucurbita* var.?

The following characteristics of the galls are condensed from more elaborate descriptions, which I hope to publish in a more complete paper on the biology of the North American Psyllidæ.

36. *P. venusta* Osten Sacken (Stett. Ent. Zeit., 1861, p. 422).—Generally globular, but often more or less irregularly ovoid, or even elongate. Color varying from pale buff to brown; surface opaque, with scattered, small, flattened postules. Diameter of globular form varying from 7 to 20<sup>mm</sup>. The gall consists of an outer shell and an inner core, which can easily be separated upon cutting the gall open. The outer

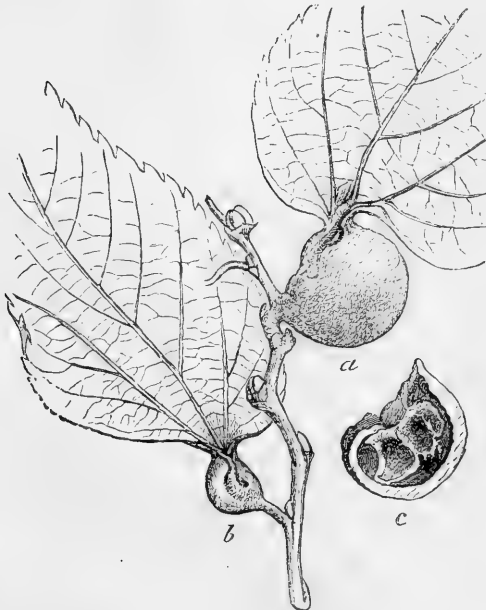


FIG. 201.—Gall of *Pachypsylla venusta*: a, gall fully formed; b, same forming; c, same in section, natural size. After Riley.

shell is very hard and woody, varying in thickness from 1 to 3<sup>mm</sup>. The apical portion of the gall has on one side a slit which is deepest and widest at the tip and connects here with the funnel-like, twisted, basal portion of the leaf. This slit exposes to view the inner core, which consists of the very thin and brittle walls of the irregular cells which fill

the entire cavity of the outer shell. The number of these cells varies according to the size of the gall, but is rarely reduced to a single one.

The full-grown pupa always leaves the gall through the apical opening, and in doing so has to saw its way out through the top of the inner core.

The gall usually occupies the entire petiole, but in rare instances a small portion of the latter is visible between the gall and the twig.

37. *P. (Blastophysa) celtidis-gemma* Riley.—This gall is briefly referred to but not named by Osten Sacken (l. c., pp. 422, 423.) It is much smaller than the preceding, very variable in size, and of irregular shape, but always bud-like, and looking as if formed by the conglomeration of a number of rounded nodules which are separated from the adjoining ones by shallow furrows. Color varying from light reddish-brown to dark brown or the color of the twig; surface of the young gall usually covered with a dense matting of white woolly hairs, which in the more mature gall are more or less completely lost. As in the preceding species, the gall is hard and woody, but entirely closed. It is usually opaque, rarely a little shining, the surface indistinctly sculptured, but occasionally roughened by adhering particles of the scales of the original bud. It has no inner core, and the cavity is entirely filled with the cells, which vary from one to eight in number. The outer wall is never more than one millimeter thick, often less, while the walls dividing the cells are sometimes very thin and sometimes even thicker than the outer wall. The gall occurs only on one-year-old twigs, and is formed by the young larvæ settling on and sinking into such buds as would normally produce a new twig the ensuing year. Each mature pupa saws its way through the wall of the gall in spring and changes to imago immediately after issuing.

38. *P. celtidis-vesiculum* n. sp.—This gall appears upon the upper side of the leaf merely as a flat blister of yellowish or reddish-yellow color and of irregular outline. It is generally rounded, but often influenced and limited by the larger leaf nerves, which are rarely crossed by the gall. On the under side of the leaf the gall is still less conspicuous, and is visible only as a discolored spot with a small rounded nipple in the center. The sculpture of the surface of the gall is the same as that of the leaf, and the walls are not thickened.

This gall often occurs in very large numbers on one and the same leaf, crowding one another, and often confluent. The full-grown pupæ break through the wall of the gall either on the upper or lower side of the leaf. The species is most readily recognized from the very inconspicuous appearance of the gall, and more especially from the fact that it is the only one which is hardly developed on the under side of the leaf, whereas all the other leaf-galls assume there a more or less conspicuous form.

39. *P. celtidis-asteriscus* n. sp.—This gall, on the upper side of the leaf, is very similar to the foregoing species, *i. e.*, represented only by a barely raised, blister-like spot, distinguished from the surface of the leaf mainly



by its lighter color but furnished in the middle with a moderately long spine which is sometimes clavate but readily broken off and often lost when the galls attain maturity or in dried specimens. In this case there is a more or less conspicuous nipple left in the center of the gall. The gall is normally circular in outline, but often irregular and limited by the leaf-nervules. Average diameter,  $5^{\text{mm}}$ ; sculpture coarser than, but of the same nature as, that of the leaf. On the under side of leaf it is barely distinguishable as a slightly discolored spot, but the center rises from a thin base and, spreading out, assumes the form of a small flower (resembling somewhat that of a *Convolvulus*) or a star, and this resemblance to a flower is increased by the presence of a small, rounded, median nipple, which is often surrounded by a circular rim. Average height of this flower shaped excrescence,  $1.25^{\text{mm}}$ ; diameter at top,  $2.50^{\text{mm}}$ . The walls of these galls are a little thicker than the leaf itself, and, as in the preceding species, the cell is a low chamber with a straight roof (*i. e.*, toward the upper surface of the leaf) and the bottom a little convex.

The mature pupa makes its way out through an oval slit always on one side of the roof of the gall.

40 *P. celtidis-umbilicus* n. sp.—This gall occurs on the upper side of the leaf, is regularly circular in outline and abruptly depressed at its outer margin beneath the surface of the leaf. From this outer margin toward the center the gall gradually rises again to about the level of the surface or even above it, the center being furnished with an elongate nipple (frequently broken off). The color in fresh specimens is a little lighter than that of the leaf, but fully developed and dried specimens are more yellow. Surface opaque, either without any decided sculpture, or rugose and with the venation of the leaf still preserved. On the under side of the leaf it is distinctly elevated, averaging  $2^{\text{mm}}$  in height and  $5^{\text{mm}}$  wide, circular in outline, the sides not abruptly elevated but gradually rising, with a larger or smaller shallow depression at top which is often furnished with a small central nipple. Color, yellowish-green in fresh, and more yellow in dried specimens; surface opaque, rugose. Gall woody and hard, the wall at the bottom about  $1^{\text{mm}}$  in thickness; that of the roof about  $\frac{1}{2}^{\text{mm}}$ . Cell formed as in the preceding species, but much larger; mode of issuing of mature pupa also as in the preceding.

There is no difficulty in recognizing this gall, especially from its appearance on the upper side of a leaf.

41. *P. celtidis-mamma* Riley (Johnson's Universal Cyclopædia, 1876, p. 425; Canad. Ent., v, 15, 1883, p. 158; J. Fletcher in Rep. Ent. Soc. Ont. for 1882 [1883], pp. 79, 80).—This gall, on upper side of leaf, is represented by a very regular cup-shaped impression, measuring on the average  $4.5^{\text{mm}}$  across, with the upper, outer rim always regularly circular, and not, or but slightly, elevated above the surface of the leaf; at the bottom of the cup a small median nipple (often obsolete); walls of the impression greenish, the bottom more yellowish.

On the under side of the leaf it is much larger than in any of the other leaf-galls, conical, either slightly narrowing apically or, more frequently, slightly enlarged. The sides are vertical or nearly so; the top broadly rounded without median depression or central nipple. Size very variable; averaging in height 6 to 7<sup>mm</sup>, and in diameter at base 4 to 5<sup>mm</sup>. Color pale greenish yellow, with the tip more brownish; surface opaque, rugosely reticulate; at base often covered with a whitish pruinescence, rarely with a few scattered hairs near the top. (Fig. 202, a.)

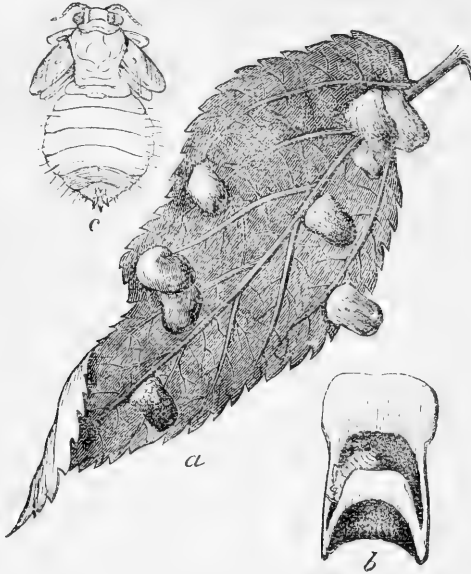


FIG. 202.—Gall of *Pachyphylla c.-mamma*: a, leaf with galls from underside—natural size; b, section of gall showing cup-like depression, and insect in cavity; c, pupa—enlarged. (After Riley.)

The walls of the gall are hard and woody, at the bottom averaging 1.75<sup>mm</sup>, at the roof 0.75<sup>mm</sup> in thickness. The cell (Fig. 202, b) is large, and in cross-section much more crescent-shaped than in the preceding species. The mature pupa issues through an oval slit sawed through the roof, always near the side where the wall is less thick.

42. *P. celtidis-pubescens* n. sp.—This gall on the upper side of the leaf is represented by a small circular cup-shaped

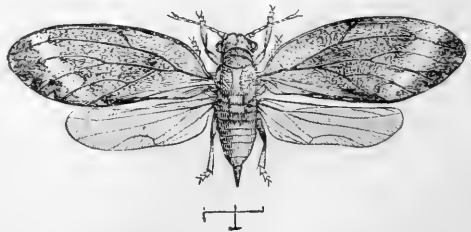


FIG. 203.—*Pachyphylla c.-mamma*: adult—enlarged. (Original.)

impression, surrounded by a rather wide, thickened, and elevated margin, and furnished at the bottom with a small, usually star-shaped, median nipple. The bottom and sides of the impression are

smooth and shining, and occasionally beset with a few scattered hairs; the elevated margin is coarsely rugose-plicate, and usually also shining. Average diameter of gall, including elevated rim, about 3<sup>mm</sup>; without the latter, nearly 2<sup>mm</sup>. On the under side of leaf it is usually semi-globular, entirely sessile, sometimes more flattened, rarely more globular and then less sessile. Surface more or less rugose, not shining, and covered with long but not densely placed white woolly hairs. There is sometimes a small apical nipple surrounded by a slight depression. Average diameter, 3<sup>mm</sup>. Color pale greenish-yellow. The walls are very thin, but much thicker than the leaf itself; the roof is straight and the cell comparatively large and crescent-shaped in a cross-cut. Mode of issuing of mature pupa as in the preceding.

43. *P. celtidis-globulus* n. sp.—A gall on the upper side of the leaf represented by a very circular hole with vertical walls near the top and widening internally; the rim is not thickened, but is vertically elevated above the leaf surface around the opening. The walls and bottom of the excavation are without decided sculpture and of a lighter color than the leaf; the elevated rim is of the same color as and not thicker than the leaf. Average diameter 1.75<sup>mm</sup>. On the under side of the leaf the gall is globular or slightly more pyriform and almost stylate, or slightly more flattened and more sessile. There is a larger or smaller shallow apical depression without central nipple, but sometimes limited by a raised rim. Surface a little shining, finely rugose and not pubescent, rarely furnished with a solitary hair. Average diameter 3.3<sup>mm</sup>.

I have only a single leaf covered with these galls received from Columbia, S. C., collected in the month of September. No imago has been reared therefrom.

This is at once distinguished from the preceding species by the very deep vertical impression on the upper side of the leaf and its globular smooth form on the under side of the leaf.

44. *P. celtidis-cucurbita* n. sp.—This gall, on the upper side of the leaf, forms a cup-shaped impression, deeper than in *P. c.-mamma*, but less deep and with the walls less vertical than in *P. c.-globulus*; the cavity is also not widened internally. The outer rim is not sharply limited and not elevated except in one specimen, where it is thickened and bulging as in *P. c.-pubescens*. The walls and the bottom of the cup are not distinctly sculptured and of a greenish-yellow color (in dried specimens), the rim being reddish yellow and rugose. Average diameter, 1.75<sup>mm</sup>. On the under side of the leaf it arises from a rather slender, but not stylate, base and widens gradually to the middle, thence gradually narrowing toward apex. When viewed from the side the outline of the gall is therefore oval, but the top is always truncate. The sides near the top are furnished with short ribs, which are separated from each other by wide shallow depressions; the apex is formed by an acute rim, which surrounds a cup-shaped depression varying in size and depth according to specimens. Surface neither pubescent nor shining, but finely and indistinctly strigose. Color (dried specimen)

rather bright yellow, brownish near center. Average height of gall, 4<sup>mm</sup>; diameter, 3.3<sup>mm</sup>. Cell as in *P. c.-mamma*, the bottom wall at center much less thick than at sides.

*P. celtidis-cucurbita* var. ?—Gall as seen on the upper side of leaf either as in *P. c.-cucurbita*, or more often as in *P. c.-globulus*, *i. e.*, the impression is vertical and widening internally, but the upper rim is either barely or not at all elevated. On the under side of the leaf it is always sessile, not oval in outline, but depressed and button-shaped; the disk being greatly flattened and with a shallow depression having a small central nipple and surrounded by two concentrical rims, the inner one often obsolete, the outer one rarely so. The sides of the gall have either faint longitudinal furrows or are irregularly rugose. Size very variable; average height, 1.75<sup>mm</sup>; width, 3<sup>mm</sup>.

Whether or not this form is specifically distinct from the typical *P. c.-cucurbita* can not yet be decided. Of the latter I have not many specimens, all from Missouri; while of the variety I have numerous specimens from Missouri and Texas. No specimens strictly intermediate have yet been found.

Besides the galls just described I possess single specimens which apparently represent other species, but their description is postponed until more complete material can be obtained.

The life-history of these Pachyphyllas varies somewhat with the species, but the following summary from my notes gives the essential facts:

Most of the imagos issue in the fall of the year and hibernate in the cracks or under the bark of the tree. The sexes pair in early spring, and as soon as the young leaves put forth, the eggs are deposited singly either on the upper or under sides of the leaf. The young larva settles on the upper side of the leaf and inserts its beak in one of the pores. The irritation from the puncture causes an abnormal growth of the leaf substance, swells around the insect, so that this last appears to sink into the leaf and is gradually carried with the growing gall to the under side. The gall in all Pachyphyllas is due to the action of the young larva, and not to the insertion of the egg. The gall itself soon becomes quite perceptible, but the growth of the larva is very slow in the early part of the season. After the month of July the larva develops more rapidly, and toward the end of September or in October the full-grown pupa with its abdominal spines saws an oval or slightly crescent-shaped opening through one side of the roof of the gall, issues therefrom, and changes to imago immediately afterwards. Many pupæ remain in the galls and fall to the ground with the leaves, where they mostly perish, but some succeed in hibernating and change to imago in early spring.

#### OTHER HACKBERRY INSECTS.

Some few other insects occur on *Celtis*, but they are not important and I have so far found no time to work at them.

## CHAPTER XIII.

### INSECTS PREYING UPON THE ALDER.

*Alnus serrulata* and *A. incana*.

Although the alder is a useless shrub, it harbors a number of borers and other insects which prey on other forest and fruit trees. The following list is by no means a perfect one, and will doubtless be greatly extended by future observations. Alder insects are numerous in Europe: Kaltenbach enumerating 120 species, comprising 33 species of Coleoptera; 63 Lepidoptera; 11 Hymenoptera (Tenthredinidæ), and 13 Hemiptera.

#### BORING IN THE TRUNK.

##### 1. *Fatua denudata* (Harris.)

Order LEPIDOPTERA; family Sesiidæ.

Mr. Devereaux writes me that in New York the alder is very badly infested by this borer, giving as an instance "as many as four holes in a tree 5 inches in diameter." He adds:

I think the alder must be considered as the favorite host of *Egeria denudatum*, as ash trees in swamps not containing alders are almost exempt from their attacks, while no clump of alders is without evidence of their work.

##### 2. *Saperda obliqua* Say.

This beetle has been taken from the alder.

##### 3. *Hepialus argenteomaculatus* Harris.

(*Cossus alni* Kellicott.)

Order LEPIDOPTERA; family HEPIALIDÆ.

Dr. Kellicott\* has described the preparatory stages of this borer, which he at first supposed to be an undetermined *Cossus*. See Ent. Amer., IV, p. 153, 1888; also p. 346.

\* On the preparatory stages of an undetermined *Cossus*, Entomologica Americana, i, 1885, p. 173.

The discovery of the borer was accidental. Passing along the border of a brook, came upon some alders, *A. incana*, which had been drawn out root and branch upon dry ground; one stem had been broken off near the root, disclosing the cylindrical gallery of an insect borer very different from those made by a beetle larva common in the same stems. An examination brought to light numerous examples of a *Cossus* larva in the roots and stems of the alders in the vicinity. The facts in its history were partially made out.

Larvæ of two distinct sizes were about equally abundant; the larger ones at the time, June 29, were molting. As the imagos probably had escaped, it seems pretty certain that the preparatory stage lasts three years, *i. e.*, the smaller larvæ were one year old, the larger two, and these transform next May or June. Several pupa shells (all broken) were found in the openings in the bark, and one pupa, which was dead but in perfect condition. The larva, it seems, bores principally in the roots until the second year, when it begins to work upward in the trunk, and before pupating in the spring of the third year bores out to the surface a few inches above the ground. The pupa cell, a mere enlargement of the burrow a little below the external opening, is not stopped or plugged with chips as is the case in the cell of *C. centerensis*; none were found in the roots and no evidence was obtained that the larva bores in the trunks save towards the end of its period, when it moves upward to prepare a way for the moth to escape where it is out of the way of danger of water, as the alder grows in wet places. This moth escapes as others of its kind do by the pupa worming its way out of the cell so that part of its body protrudes from the tree when the moth emerges, leaving the skin in the opening.

I will describe the larger of the larvæ and compare the smaller one as it may differ.

Length, 1.5 to 1.8 inches. Subcylindrical, tapering very slightly at extremities, slender, width of body .25 inch. Length of smaller ones .8 inch. The head is light yellowish brown above, black about the mouth parts, hemispherical, smooth, or slightly roughened, with a few dark dots from which arise dark hairs, usually worn off the vertex of the larger examples. The second ring is smooth, lighter colored than the head; above the spiracle on either side there are three black spots situated at the corners of a right-angled triangle; the upper one at the right angle bears a coarse brown hair, the other two have finer, lighter-colored hairs; the top of the third ring is likewise smooth and brownish; the remaining body surface except the yellowish piliferous spots and top of ring 13 is white; the longer hairs on the posterior rings are black. The body rings are strongly folded transversely; the yellowish dorsal spots bear brownish hairs; the anterior larger pair are situated rather near together on the broadest transverse fold; the smaller posterior pair are situated on a narrower fold and much farther from the slight dorsal furrow. The stigmata are broadly elliptical, the rings narrow, black scarcely raised above the surface, the color within the ring light brown. The legs are yellowish, hooks black; the prop legs with very many hooklets.

The pupa is slender, length 1.6 inches, width of thorax .33 inch, but slightly curved and of unusually uniform diameter, smooth, under a lens transversely striate, the three anterior rings black, shagreened; on the prothorax there are two conical protuberances which in profile under a strong lens prove to be double-pointed; on the clypeus are two gouge-shaped spines, shining black on outer half, and on the upper roughened base of each of these there is a small conical tooth; on the under side of the head-case, below the gouge-like spines, is a pointed spine directed forwards; back of this are two smaller cusps, one either side of ventral line, and still farther back, apparently over the first tarsal joint of the forelegs, are two smaller points; the transverse rows of dorso-abdominal teeth are as usual, but the teeth are exceedingly fine, increasing in size but little posteriorly; the black, blunt, anal segment bears several small black conical teeth on either side.

I have mentioned this insect above as an undetermined Cossus; that it is one of the Cossidæ there can be, I think, no doubt, and as I understand the descriptions of the preparatory stages of the genus Cossus, it seems to me that it belongs to that genus; therefore I will, for brevity of reference, call it provisionally *Cossus alni*. It certainly is clearly distinct from *C. centerensis*, whose larva and pupa I have had an opportunity to examine from poplars at Corunna, Mich.; in fact, it appears to be distinct from any species whose history is known. It may prove to be one of the doubtful or partially known species. I am aware that Mr. Lintner has referred to a Cossus which bores in the trunk of white birch; I am also mindful that insects are as a rule pretty good botanists, and that *Betula* and *Alnus* are closely related plants, so this insect may prove to be the one discovered in the birch by Mr. Lintner. It ought not to be a difficult matter to obtain the moth in May or June next.

#### INJURING THE LEAVES.

##### 4. *Papilio rutulus* Boisduval.

An inhabitant of the Pacific coast, this caterpillar has been found by Mr. Henry Edwards to feed upon the alder (*Alnus viridis*). Three caterpillars were obtained from eggs observed to be deposited by the female July 8; the caterpillars hatched July 13, the first molt occurred July 15, the second July 18, and the third July 22; the fully grown caterpillars have not yet been observed. (*Papilio*, ii, 112.) Mr. W. H. Edwards afterwards reported that the eggs are laid on the willow in northern California (*Papilio*, iii, 65). The following description of the early larval stages is by H. Edwards,

*Larva on exclusion from egg.*—Head very large, black, shining. Second segment with two tubercles on the sides in front. Body brownish black. Segments 3, 4, 5, 10, 11, 12 with two tubercles each, arranged subdorsally. Extending from the seventh to the ninth segment is a small, but conspicuous, triangular white patch, the vertex of which is directed posteriorly. Feet and legs black.

*After first molt.*—The head now becomes pitchy, the body streaked with shades of brown, longitudinally; the two tubercles on second segment are chestnut-brown, and the whole of the processes brighter and more glossy. The white triangular patch is larger and more distinct, and the posterior segments are delicately mottled with brownish.

*After second molt.*—Head chestnut-brown, with pinkish tinge. The tubercles of the second segment are larger than before, and have become yellowish-brown in color. Between them is a yellowish corrugated fold, and on the dorsum, at the base of the longer tubercles, are two smaller ones, also chestnut brown. Body brownish dorsally, with a green tint throughout; laterally it is pale apple-green. The third segment has six tubercles, the middle and lateral being exceedingly small. Fourth segment swollen, the body here attaining its greatest size, This segment has also six tubercles, the two dorsal being the smallest. The fifth segment has four tubercles, the smaller pair of which are placed anterior to the other. The triangular patch has now become cream-yellow, and encroaches in a point posteriorly on the ninth segment. Segments 9, 10, 11, 12, 13 have each two tubercles, which are directed backward, and increase posteriorly in size, so that those of the thirteenth segment are double the length of those of the ninth. Mouth parts, legs, as well as the whole of the under side, pale bluish green.

*After third molt.*—The head is now pale bright chestnut, with a decidedly pinkish tint, and the mouth parts of a deeper and more decided green. The body has assumed a pale apple-green color, the tubercles are brighter and more approaching to brownish orange, and the triangular patch is buff, with some streaks of green run-

ning through it. The tubercles of twelfth and thirteenth segments are now yellow, and at the base of those of 5, 9, 10, and 11 are some bluish dots. Upon being touched, the young larva exhibited the usual retractile horns. These were situated at the base of the head, between it and the second segment. They were pale orange, much darker at the tips. I regret that I could not carry these larvæ farther than this stage. I was called away from home, and on my return found them dead. Three larvæ were obtained from eggs observed to be deposited by the female upon *Alnus viridis*. The following is the record of changes: Eggs deposited July 8, larva hatched July 13, larva first molt July 15, larva second molt July 18, larva third molt July 22, larva showed retractile horns July 24. (*Papilio*, ii, p. 114.)

#### 5. *Halesidota maculata* (Harris).

The young larva of *Halesidota* with yellow and black tufts occurred upon the alder September 1, 8 to 9<sup>mm</sup> long. They must have just molted, as in a previous younger stage the larva has much longer, more irregular, scraggly hairs along the back.

*Young larva*.—It differs much from the full-grown larva in the body being cylindrical, the hairs long, uneven, and very sparse compared with the full-grown larva. Head narrow, deeply lobed above, black. Segments 4 to 9 yellow above, elsewhere white, and on the sides marked with black lines. On third thoracic and second and seventh abdominal segments the double spike-like black tufts are, though high, not so long as some of the dorsal hairs.

#### 6. *Halesidota caryæ* (Harris).

This also occurred on the alder, with the preceding species.

#### 7. *Limacodes*? sp.

The slug caterpillar described below occurred both on the hazel and alder September 20, at Providence, R. I.

*Larva*.—In outline regularly oval cylindrical, with two subdorsal sharp ridges, dividing the upper surface into a dorsal, and two somewhat wider concave lateral areas. Pale pea-green, the two subdorsal ridges yellow, and with a broken yellow line on each lateral acute ridge. In the median or dorsal area is a median row of round straw-yellow spots, with a small central depression and a lateral row of small rounded alternating dots. Two rows of similar yellow spots on the lateral area. Length, 8<sup>mm</sup>; breadth, 5<sup>mm</sup>.

#### 8. *Apatela hastulifera* (Abbot-Smith.)

This common hairy and tufted caterpillar occurs late in summer and through the early autumn from Maine to Georgia, and is the larva so often found ichneumonized, attached firmly to branches, and perforated on the back and sides with holes out of which the flies have escaped.

We have found the larva on *Betula populifolia* in Maine August 28 to September 4.

*Young larva* 12<sup>mm</sup> in length.—Differs from full-grown larva in the hairs on the upper side of the body being much paler, contrasting less with the yellow on the sides and ends of the body; the hairs are also less closely cropped; head more deeply cleft, the lateral prominences more marked and head less rounded than in full-fed larva observed August 28.



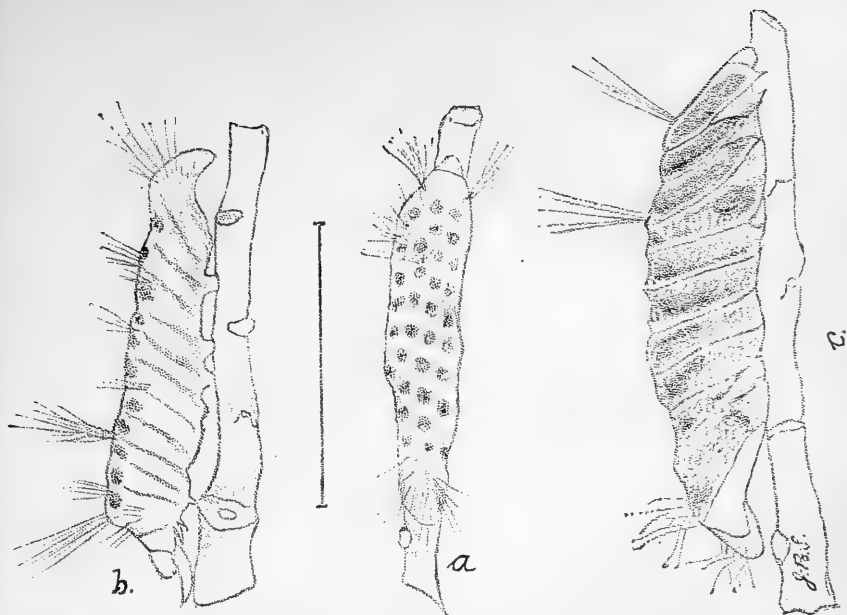


FIG. 205.—Larva of *Apatela* parasitized by *Aleiodes*: *a*, dorsal view; *b*, lateral, showing holes made by the exit of parasites; *c*, the cocoons within the host.—Smith *del.*

*Full-grown larva.*—Head and body black, head large and full, a little wider than the body. Body with pale yellow radiating hairs along the sides low down, but

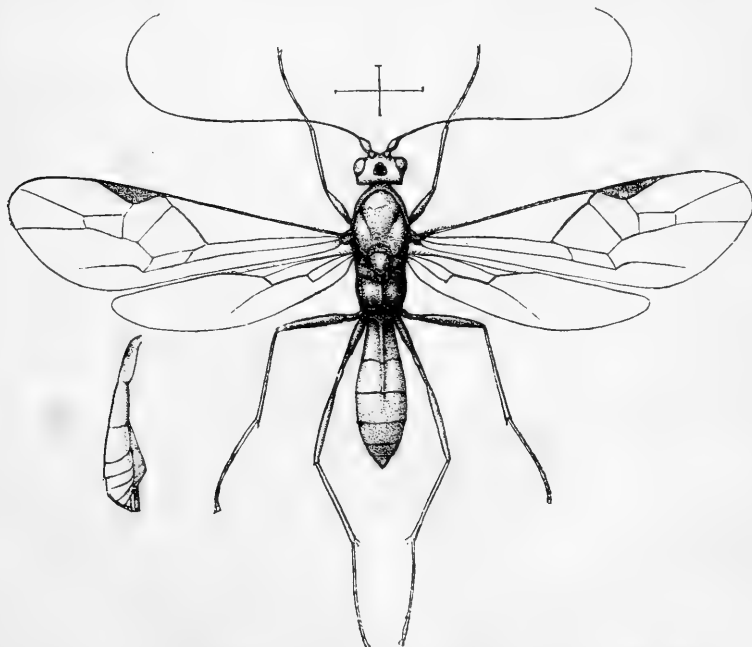


FIG. 206.—*Rhogas lætus* Cress. from *Apatela hastulifera* on alder. After Riley.

above covered densely with umber-brown hairs, forming a slight dorsal crest. The scattered hairs in front and at the end of the body pale yellowish and of unequal

length. A high stiff spike like black double tuft as long as the body is thick on the first and third abdominal segments, and a double spike on the eighth. Length 26 to 27<sup>mm</sup>.

9. *Apatela dactylina* Grote.

This species is said by Mr. Thaxter (Papilio, iii, p. 17) to feed on the alder and willow.

10. *Apatela* sp.

This *Apatela*, allied to *A. oblongata*, occurred on the alder September 4.

This is in form closely similar to *A. oblongata*, but it has no transverse "crimson-red bands," and the lateral line is not "bright yellow," as described in *A. oblongata* by Riley. The moth emerged May 31.

*Larva*.—Head of moderate size, not so wide as the body, black chestnut brown on the vertex. Body blackish brown but the setiferous tubercles and hairs reddish chestnut brown; the tubercles large and bearing often as many as twenty five setæ which are uneven in length, but not much over half as long as the body is thick, and under a lens seem to be spinulate. The raised lateral line is reddish chestnut, concolorous with the setiferous tubercles; thoracic legs dark brown; under side of the body dark livid brown, including the abdominal legs. Length 26–27<sup>mm</sup>.

11. *Eupithecia*? sp.

This span-worm occurred on the alder at Brunswick, Me., late in the season.

*Larva*.—Body slender, tapering towards the hinder end, somewhat flattened. Head small, scarcely as wide as the prothorax; reddish-brownish-yellow, like the rest of the body, which is yellowish, mixed with reddish-brown, with six well marked lozenge-shaped brown patches along the back, the last one succeeded by a brown line ending on the supra-anal plate, the latter moderately large, with two fleshy cylindrical tubercles beneath. The surface of the body is granulated, with a few scattered stiff hairs along the sides and back; the lateral ridge prominent and irregular.

12. *Antepione depontanata* Grote.

(*Larva*, Plate IV, fig. 9.)

A fine large geometrid caterpillar, dark brown, with two silver V-shaped spots behind the middle of the body, was observed July 23, at Brunswick, Me. It molted about July 29 to 30, and began to pupate August 12 in a rolled-up leaf of the alder, becoming a pupa August 15. The moth appeared May 18 of the year following.

*Larva before last molt*.—Head small, flattened, scarcely as wide as the succeeding segment, the body gradually enlarging towards the eighth abdominal segment; second thoracic segment with a large hump on each side; four blackish small dorsal tubercles on each segment; towards the end of fifth abdominal segment a large double hump, forming a high transverse ridge; supra-anal plate large, rounded, with six large piliferous tubercles on the hinder edge; below two large piliferous tubercles at the base of the anal legs; anal legs large and broad. Body dark brown, color of a twig of the alder, with a distinct V-shaped silver spot, the base situated on the hump on the fifth segment; another similar V-shaped mark on the sixth segment; from its apex a row of silver-white dots extends to the hump on the fifth segment; along the back of the three first segments are two parallel silver-white lines. Lateral ridge prominent, and swollen at each segment with a lateral wart. Length, 30<sup>mm</sup>.

*Fully grown larva*.—Length, 40<sup>mm</sup>. Color and appearance the same as in the previous molt, but the markings are rather more distinct.

*Moth*.—Forewings rather broad and short, apex acute, as is the angle in the middle of the outer edge of the wing; the corresponding angle in the hind wings well marked. Body and wings ochreous-yellow. Forewings with a broad dark basal broken band, bent at a right angle behind the subcostal vein; a similar outer or extra-discal band, interrupted on the first and second median interspaces, and bent at right angles on the last subcostal branch. A marginal band, strongly marked on the costa, and succeeded by a row of about five dark spots, the fifth being situated near the internal angle. Hind wings covered by a single diffuse broad median line, curved or bent outward in the middle of the wing. The wings beneath more heavily banded than above, and more strigated than above. Expanse of wings, 32<sup>mm</sup> (1.10 inches.)



FIG. 207.—*Antepione depontanata*, natural size.—Bridg-ham del.

It differs from the specimen figured in my monograph in having the inner and extra discal lines and marginal spots well marked, while the borders of both pairs of wings are without the usual broad, dark shading.

### 13. *Geometrid larva*.

Found on the alder at Brunswick, Me., July 23. This larva began to pupate August 6.

*Larva*.—Head rounded, slightly bilobed, not quite so wide as prothoracic segment, surface marbled with brown. Body rather thick, without humps, but with rather sharp prominent piliferous warts, with four dark warts arranged in a transversely oblong square on top of each abdominal segment, those on the thoracic segments arranged in a transverse line. Anal legs rather short and broad; supra-anal plate rather small, subtriangular, at the end six piliferous warts; general color greenish purple. Length, 17<sup>mm</sup>.

### 14. *Geometrid larva*.

This caterpillar was first observed frequently on the alder at Brunswick, Me., July 23.

*Larva*.—Head small, no wider than the body, smooth, of the same color as the body; the body slender, cylindrical, with no warts; pea-green, the color of the alder leaf; two narrow dorsal thread-like yellowish lines; two wider dorsal lines outside of the median ones; two lateral yellow lines, the lower on the lateral ridge and somewhat broken; the segments wrinkled; anal legs rather small. Length, 13<sup>mm</sup>.

### 15. *Geometrid larva*.

(Pl. IV, fig. 5.)

This unusual form of caterpillar occurred on the alder through August 1 to 18 at Brunswick, Me.

*Larva*.—Body broad and flattened, ringed with brick-red. Head broad and flat, as wide as the body; amber-colored, speckled with brown, in a wide median band on the sides; segments brick-red between the yellowish sutures with interrupted dark red lines, so that the surface of each segment is somewhat checkered. The piliferous warts are large and distinct, while the spiracles are black, those on the prothoracic and eighth abdominal segment being larger than the others. Supra-anal plate and anal legs amber-yellow, spotted with brown; anal legs short but very broad; supra-anal plate rather large, surface shining with six marginal piliferous warts. Thoracic legs dark towards the claws; the abdominal legs amber yellow. Length, 10<sup>mm</sup>

## 16. THE ALDER LEAF-ROLLER.

*Gelechia oronella* Walsingham.

Order LEPIDOPTERA; family TINEIDÆ.

While the leaves of the alder are variously folded and rolled by caterpillars, perhaps the most striking leaf-roller is the above species, which occurred in Maine late in the summer, in August and the early part of September.

The little worm is amber-colored, the body rather thick and cylindrical, but with no distinctive markings. One was observed which had sewed a portion of the edge of the leaf for half an inch in extent with four or five large white silk stitches. The moth, which appeared in the breeding cage May 4 of the following year, is described below.

In another example, probably of this species, the end of the leaf was rolled up one and a half turns, and sewed with three broad strong silk stitches. On unrolling it the end of the leaf was found to be more or less eaten, the roll being gradually drawn in and made more perfect as the caterpillar consumes the tip of the leaf. It pupated September 18.

I am indebted to Professor Fernald for the identification of this species.

*Larva*.—Body rather thick, cylindrical; body and head delicate amber-colored; end of the body with quite long hairs, longer than the body is wide. Length, 6<sup>mm</sup>.

*Pupa*.—Rather thick; mahogany-brown; length, 7<sup>mm</sup>.

*Moth*.—Palpi with the second joint moderately broad, scarcely more than twice as wide as the third joint, which is moderately broad and two-thirds as long as the second joint. Head and palpi whitish-gray; second joint black externally; third joint white with two black rings. Fore wings of the usual shape; white-gray; at the base a black streak parallel to the costa; on the basal fourth of the wing is a pair of converging black spots; beyond is a similar but thicker pair of black spots, and still beyond another pair, one of the spots being situated on the costa; four black costal spots towards the apex of the wing. Hind wings pale glistening gray. Expanse of wings, 18<sup>mm</sup>.

17. *Tineid larva*.

This larva was observed feeding between the leaves of the alder during the first two weeks of August (August 1 to 13), at Brunswick, Me.

*Larva*.—Body slender, tapering towards each end; head pale whitish amber; considerably narrower than the prothoracic segment. On the last segment from four to six long dark hairs. Color, pale grass-green. Length, 7<sup>mm</sup>.

## 18. THE ALDER FLEA-BEETLE.

*Haltica alni* Harris (*H. bimarginata* Say).

In the correspondence of the late Dr. Harris the following mention is made of this beetle:

In traveling from Center Harbor, N. H., to Conway, on the 2d of August, 1854, and from Conway to Upper Bartlett, and subsequently to Jackson, we saw the alders (*Alnus serrulata*) everywhere ravaged by insects which had destroyed their leaves in

the manner of canker worms. Upon examination the spoilers were found not to be all dispersed, and several were seen upon the leaves still continuing their work; at the same time were found in Conway numerous beetles, which proved to be a species of *Haltica*, eating the leaves off the same alders. The larvæ which have ravaged the shrubs were doubtless those of the *Haltica* before named.

We have reared the beetles from the grubs during the past season. At Merepoint, near Brunswick, Me., during the middle of August, 1886, we noticed clumps of alders standing in dry soil partly defoliated, or with skeletonized, brown, or blackish leaves, on which, as well as the still remaining green leaves, were black grubs, sometimes seven or eight on a leaf. All the alders in the region were not molested, the grubs occurring locally. On placing a number of leaves with the grubs in a tin box we found, August 15, a single beetle. We found a white pupa lying loosely on the bottom of the box August 20; soon more pupæ appeared, and the beetles began to appear in considerable numbers the last week of August. It is evident that in nature the larva falls to the ground to transform, the pupæ entering the earth.

Afterwards, September 10, we found whole clumps of alders at the base of Iron Mountain, Jackson, N. H., stripped by the grubs, nearly all the riddled, brown, dead leaves having fallen off and thickly covering the ground under the bushes. Such a wholesale devastation of alders we never witnessed. By this time the beetles had become very abundant, and were apparently feeding on the few leaves still attached to the tree. We again noticed the work of this beetle in September, 1887, at the Glen House, White Mountains, the alders by the river side in front of the hotel having been extensively defoliated. The alder is the source of some of our destructive forest and fruit insects, and should this grub ever spread to other food trees it will be very annoying, though it can be subdued by proper spraying. There seems to be a periodicity in the appearance of this beetle in unusual numbers, Harris having seen the same grubs in great abundance in 1854 in the same region. We have never observed it so common and destructive before in Maine. It is most probable that the beetles hibernate under the leaves and, soon after the leaves expand in May, lay their eggs in masses on them, the grubs scarcely stirring from the leaf on which they are born, until ready to pupate. The grubs are probably distasteful to birds, otherwise they would fall an easy prey to them and be kept within due limits.

*Larva*.—Body somewhat flattened; head scarcely two-thirds as wide as the body in the middle; black, becoming brown in front near the jaws. Body livid brown above; the tubercles black; paler beneath; with three pairs of black jointed thoracic legs; no abdominal legs, but an anal prop-leg. The abdominal segments each with a transverse, oval-rounded, ventral, rough space forming a series of creeping tubercles, and in front on each segment is a transverse, oval, crescentic chitinous area bearing two piliferous tubercles; the back of each segment divided into two ridges, each bearing a row of six sharp tubercles, bearing short hairs; a single ventral row on each side of the ventral plate. Length 7 to 10<sup>mm</sup>.

*Pupa*.—Body rather thick, white. Antennæ passing around the bent knees (ferero-

tibial joints) of the first and second pair of legs, the end scarcely going beyond the middle of the body. Elytra with five or six rather deep longitudinal creases. The

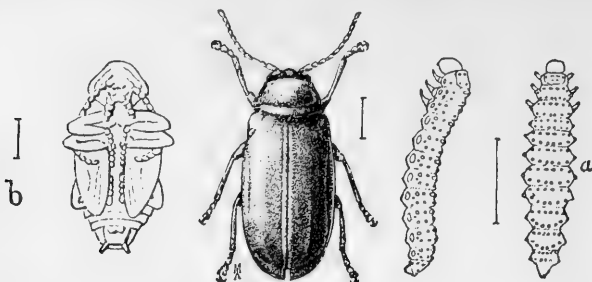


FIG. 208.—*Haltica alni*—Marx del.; a, larva; b, pupa.—Bridgham del.

salient points of the body armed with piliferous warts. Abdominal tip square at the end, with a stout black spine projecting from each side. Length, 6<sup>mm</sup>.

*Beetle*.—Uniformly deep prussian blue, with greenish reflections on the head. Antennal flagellum with fine whitish pubescence; tibiæ clothed with tawny hairs. Length, 5 to 6<sup>mm</sup>.

#### 19. *Attelabus rhois* Boheman.

The singular thimble-like rolls of this weevil may be found in June and July on the alder, and also occur on the hazel, according to Le Conte. When about to lay her eggs, the female begins to eat a slit near the base of the leaf on each side of the midrib, and at right angles to it, so that the leaf may be folded together. Before beginning to roll up the leaf she gnaws the stem nearly off, so that after the roll is made, and has dried for perhaps a day, it is easily detached by the wind and falls to the ground. When folding the leaf, she tightly rolls it up, neatly tucking in the ends, until a compact, cylindrical solid mass of vegetation is formed. Before the leaf is entirely rolled she deposits a single egg, rarely two, in the middle next to the midrib, where it lies loosely in a little cavity. While all this is going on her consort stands near by, and she occasionally runs to him to receive his caresses, to again resume her work. These rolls remain on the bushes sometimes for several days, but probably drop by the time the larva escapes from the egg, and it seems probable that the grub uses the roll for a shelter until it matures and is ready to enter on its transformation to a beetle. From the time of egg laying to the hatching of the larva requires about a week.

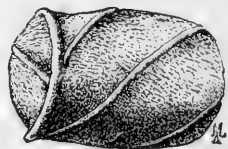


FIG. 209.—Alder leaf rolled by *Attelabus rhois* × 2 times.—Marx del.

*Egg*.—Nearly spherical, though a little longer than thick, .04 inch long and .03 in diameter; the chorion is thin, smooth, and very transparent.

*The beetle*.—In this species the body is pubescent, the front femora are not toothed. Body and limbs dull reddish, with short yellow down. Length about one-fifth inch.

20. *Cimbex americana* Leach.

This *Cimbex* occurred on the alder at Brunswick, September 3.

*Larva*.—Head not so wide as the body, somewhat excavated in front; pale amber with a whitish bloom; eyes large, black; body moderately thick; eight pairs of abdominal legs; the segments with coarse wrinkles, about five to each segment. A black conspicuous narrow dorsal line, fading out before reaching the end of the body. Across each segment two rows of prominent raised white warts, which become more numerous down on the side. Tail curved up to one side. Length, 19 to 20<sup>mm</sup>.

21. *Selandria-like larva*.

(Plate IV; fig. 13, 13a.)

This false caterpillar occurred on the alder September 3.

*Larva*.—Body flat; thoracic legs spreading out; body bottle-green above, with obscure, paler warts; much paler low down on the sides and beneath; body serrated; it differs from the species common on the oak and poplar, in the head being rust-brown above, paler in front, not red on each side. Supra-anal plate small, clouded above. Length, 13<sup>mm</sup>.

22. *Nematus?* sp.

This is the most common saw-fly larva observed on the alder. It first appears early in July and remains on the bushes until early in September. The eggs are laid in pairs, twenty to forty pairs on the under side of the midrib of the leaf. In one example there were about forty pairs of gashes, which are slightly semicircular, opposite to each other, and sometimes so near as to run together. I have found two broods on two leaves, July 23; the leaf had been two-thirds skeletonized. The larvæ apparently, on hatching, walking to the end of the leaf, and beginning at the end, gradually eat out the parenchym between the secondary and smaller veins. At first the larvæ have yellow heads, and two faint lateral double rows of black spots; the adults have black heads, and a distinct lateral black line, the abdomen being curled up snail-like. (Figs. 210, 211.)

*Larva after first molt*.—Length, 4<sup>mm</sup>. Head wider than the body, deep gamboge yellow, with black eyes; bristly; body greenish; papillated, with a double lateral row of dark elongated flattened tubercles.

*Larva fully grown*.—Head jet-black, with short scattered hairs, not quite so wide as the body, which is long and narrow, the end curled up or raised over the back; surface wrinkled and rough, with small piliferous warts, the hairs short; a distinct lateral black line, below which is a double row of black elongated tubercles. Length, 10<sup>mm</sup>.

23. *Nematus* sp.

This saw-fly larva was observed on the alder in September, in Maine.

*Larva*.—Head full and rounded, red, black in the middle above. Two large and one small fleshy prothoracic granulated acute tubercles; four black very sharp fleshy

tubercles on the end of the body, and two paler less prominent ones on the segments in front. Body dull dark olive-green, with a blackish broad lateral stripe. Length, 6mm.



FIG. 210.—Alder leaves skeletonized by saw-fly.—Bridgham, del.



FIG. 211.—Larva of alder saw-fly.

#### 24. *Nematus* sp.

A second, little larger, larva also occurred with the preceding species in September.

*Larva*.—Like the preceding, but larger, without the tubercles; color olive-brown above, paler on the sides. Head brown, with a large vertical black patch and a smaller oval lateral black one. Length, 13mm.



25. *Calligrapha scalaris* Le Conte.

This beetle is a common frequenter of alders, feeding on the leaves, in Maine, through the summer in both the larval and beetle states. Whether the subjoined description applies to this species or not we do not feel sure. It occurred on the alder September 3.

*Larva*.—Body long, flattened, the prothoracic segment nearly as broad as the middle segments of the body. Head reddish, about one-half as wide as the prothoracic segment. Body whitish-green, along the back a row of transverse black spots, two to each segment, and oval-lanceolate in shape; those on the prothoracic segment much larger than the others, together forming a patch longer than broad. On the meso and meta segments is a lateral narrow sublunate black mark. Spiracles black. Length 6<sup>mm</sup> to 8<sup>mm</sup>.

26. *Chlamys plicata* Oliv.

This singular little beetle was observed on the leaves of the alder, in Maine, September 19. The larva and its case have been figured in my Guide to the study of Insects, p. 510.

*The beetle*.—Body obscure, bronzed. Head impressed posteriorly between the eyes, rhinarium, antennæ, and an elevated space adjoining the eyes anteriorly, rufous; nose distinctly punctured; prothorax very finely and concentrically scored, with some scattered indistinct punctures; posteriorly considerably elevated; elevation bifid; behind this elevation the prothorax is produced and emarginate; scutellum obtriangular; elytra tuberculated with several acute, compressed tubercles, the anterior ones carinated; interstices with some scattered deep punctures; space between the four posterior legs punctured with large shallow punctures. Length of body 2 lines. (Kirby.)

27. *Gelechia coryliella* Chambers.

Whether the larva which we describe below is the same or congeneric with that of *Pædisca transmissana*, said by Mrs. Dimmock to be common about Cambridge, Mass., eating the inside of the sterile catkins of the white birch, and hibernating as a pupa—we do not know. The worm in question occurs at Providence through October (and we have found belated individuals as late as November 10) eating the interior of the catkins of both the alder and the hazel. It devours the interior sometimes at the base and sometimes at the apex; it sews together two or three catkins, throwing out a mass of castings which remain in the web. November 10 a larva left the catkin and spun a cocoon lined with silk, and covered on the outside with bits of catkins. The larva appeared to me to be, from its shape and general ap-



FIG. 212.—Mine in catkins of the hazel enlarged.\*—Marx del.

\* The hole made for the exit of the insect is not clearly shown in the cut. It is in the middle of the central catkin.

pearance, a Tineid rather than a Tortricid, and we refer it with doubt to Chamber's *Gelechia coryliella*.

*Larva*.—The body tapers a little towards each end. Head small and narrow; the cervical shield nut-brown. Dull livid whitish; with dark conspicuous piliferous dots arranged on the abdominal segments in a broad trapezoid area. Length 6<sup>mm</sup>.

The following insects also live on the alder:

#### Order LEPIDOPTERA.

28. *Papilio turnus* Linn. In Maine the young larva, 20<sup>mm</sup> long, was observed on the alder.
29. *Telea polyphemus* (Cram.) Providence, R. I., July 23.
30. *Eacles imperialis* Hübner. (Hulst, Bull. Brooklyn Ent. Soc., ii, p. 77.)
31. *Orgyia leucostigma* (Abbot and Smith.). July 23 in Maine before and after the last molt.
32. *Apatela acericola* Guénee. Feeds on birch and alder. (Riley, Rt. ii, p. 121.)
33. *Hyperetis nysaria* A. and S. See p. 516.
34. *Phycis rubrifasciella* (Pack.). See p. 309.
35. *Lithocolletis alnivorella* Chamb.
36. *Lithocolletis alnicolella* (Walsingham, Insect Life, ii, p. 80, 1889.) Mining the upper side of leaves of *Alnus incana*. Siskiyou County, Cal., August.
37. *Lithocolletis auronitens* Frey and Boll. The larvæ of these three species live in tentiform mines in the under side of the leaves. (Chambers, l. c.)
38. *Lithocolletis incanella* (Walsingham, Ins. Life, ii, p. 81, 1889). Mines the under side of alder leaves. Colusia County and Shasta County, Cal.
39. *Gracilaria alnicolella* Chamb.
40. *Gracilaria alnivorella* Chamb. When very young the larvæ of these two species mine the leaves; when older, they roll them downward; *alnicolella* from the tip, *alnivorella* from the side. (Chambers l. c.)
41. *Lyonetia alniella* Chamb. The larva makes a large, brownish blotch mine in the leaves. (Chambers l. c.)

#### Order DIPTERA.

42. *Cecidomyia serrulata* O. Sacken. District of Columbia, on *Alnus serrulata*: (O. Sacken, monogr., i, p. 198.)

#### Order COLEOPTERA.

43. *Dichelonycha elongatula* (Schönh.) Coupling on the leaves June 10, Maine.
44. *Saperda lateralis* Fabr. Mr. George Hunt has found this borer in the alder at Providence, R. I.
45. *Macroductylus subspinosus* (Fabr.). Riley (Insect Life, April, 1890, p. 299).

## Order HEMIPTERA.

46. *Clastoptera* sp.  
 47. *Lachnus alnifoliae* Fitch.  
 48. *Schizoneura tessellata* Fitch. Alder blight; common from Maine southwards.  
 49. *Lygus monachus* (Uhler.) See. p. 420.

## INSECTS INJURIOUS TO THE HAZEL.

*Corylus americana.*

Little attention has been given to hazel insects in this country, as the shrub is not of economic importance. Kaltenbach enumerates ninety-eight species of insects (including one mite) which occur on the European hazel; of these twenty-four are beetles; fifty-nine are Lepidoptera, and the remainder Diptera and Hemiptera, with the exception of a single saw-fly.

1. *Apatela falcula* Grote.

The caterpillar has been found on the hazel by Mr. Coquillett September 25; it entered the earth and spun a thin cocoon September 29, the moth appearing May 25 of the same year.

*Larva*.—Body dark brown, mottled with pale greenish; a dark dorsal line, on each side of which are two rows of prickles, most distinct on the anterior part of the body; the four prickles on top of segment 11 are larger and placed closer together than those on the segments anterior to it; from each of these prickles proceeds one or two short black hairs. Body beneath greenish white. Side of the head pale greenish, the face brownish; length, 1.25 inches. (Coquillett, Papilio, i, p. 6.)

*Moth*.—Allied to *A. tritona* and *grisea*. The external margin is sinuate, not straight, sweeping inwardly below the apices and bulging opposite the median nervules. Forewings dark purple gray, very like *tritona*. A black basal dash, lined above with pale, furcate. Internal margin at base, with a patch of light brown scales. Ordinary spots concolorous, faintly outlined; orbicular spot larger than in *tritona*. Median shade obsolete; median space very wide. Transverse anterior line evident above the basal dash (which slightly exceeds the line) and here blackish; beneath the dash, obsolete. Transverse posterior line shaped as in *tritona*, but without the discal incision; blackish, subdentate, edged outwardly with brown, inwardly with whitish. Black dash on submedian fold not extending within the line. Hind wings whitish at base, outwardly vague and largely blackish. Forewings beneath, fuscous; hind wings whitish, with a faint discal spot and external sinuate macular band. Thorax like the forewings, edged on the sides and behind with light brown. Body beneath, whitish; abdomen above, light gray. Expanse of wings, 35<sup>mm</sup>. Illinois. (Grote, Can. Ent., ix, p. 86.)

2. *Amphyppya pyramidoides* var. *consersa* Riley.

The following account, copied from his note-book, has been given me by Professor Riley:

Found the forepart of July, 1867, by Bolter, on hazel-nut. Length, 1.3 to 1.5 inches. Color, beautiful emerald green, the palpitations visible, but no particular markings either on head, body or foot other than the stigmata formed by a black

ring and pale center. Spun up July 4; in a leaf, July 31. The moth emerged and proved to be *Amphipyra pyramidoides*, August 31, 1868. It seems to be different from the true *pyramidoides*.

January 31, 1871. I have described it as *A. conspersa*. (Third Rep., p. 75, Riley, note-book III, p. 67; No. 168 = 49 = 380 L.)

### 3. *Anagoga pulveraria* (Linn.).

Mr. L. W. Goodell writes me that he found the larva on the hazelnut October 4. It became a pupa October 6, after spinning a thin cocoon within a folded leaf. The pupa is 0.40 inch long, is light brown, tinged with greenish on the thorax.

*Full grown larva*.—Light gray, variegated obscurely with darker gray and a few black points. On the back of the eighth ring was a small hump.

*The moth*.—Body and wings uniform rust-ash, with the broad darker mesial band sending the three attenuated teeth along the venules and by the irregular lilac band on the under side of the wing.

The following note is from Mrs. Dimmock's Birch Insects:

*Anagoga pulveraria* Linn. (Syst. Nat., 1758, ed. 10, p. 521.) Herr (Anleitung d. Raupen d. deutsch. Schmett., 1833, p. 284) describes larva and pupa, and gives *Salix caprea* as food-plant of this species. Kaltenbach (Pflanzenfeinde, 1872, pp. 571 and 598) gives *Salix* and *Betula* as food-plants. Packard (Mon. Geom. Moths, 1876, pp. 483, 489) quotes Merryfield's description of the larva, and states, on authority of Goodell, that the larva is found on *Corylus*.

### 4. *Amphidasys cognataria* Guen?

*Larva*.—Head not so wide as the body, deeply cleft, angular, the sides forming large tubercles; body cylindrical, not humped, except two elevations partly receiving the head tubercles; smooth, finely speckled with black, and with irregular scattered paler spots like those on the hazel twigs; general color like that of hazel twigs. The second and third thoracic segments are a little swollen. When captured it held itself out straight like a stick. Length, 40<sup>mm</sup>; thickness, 6<sup>mm</sup>. It began to pupate September 20.

### 5. *Geometrid larva*.

This and the following measuring worms occurred September 20, at Providence, on the hazel bushes near the city; both mimic the shape and coloration of hazel twigs, though belonging to very different genera:

*Larva*.—Closely resembling a twig of the hazel, even to the pale spots, similar to those on the hazel stem. Body cylindrical, smooth, with a few transverse wrinkles, brown, like that of the branches of the hazel. Head not so wide as the body, smooth and rounded, not notched or angular. On the fifth abdominal segment is a conspicuous transverse hump, marbled with pale olive green. Two subdorsal rows of small pale olive whitish-green spots like the pale spots on the twigs of the hazel. Length, 20<sup>mm</sup>; thickness, 2.5<sup>mm</sup>.

### 6. *Geometrid larva*.

This species occurred June 3 to 25, at Providence, on the hazel; it molted June 13, again June 16, and again June 24 or 25, but did not live to finish its transformations.

*Larva*.—Length, 17<sup>mm</sup>. Body rather slender, of uniform thickness. Head not quite so wide as the prothoracic segment; dark livid, spotted and striped with black; body dull, dark livid, longitudinally striped with black wavy irregular fine lines.

Supra-anal plate very short and broad, rough on the surface, with four fine terminal hairs. Prothoracic segment edged in front with bright yellow, succeeded by five yellow transverse interrupted lines, consisting of two transverse elongated dorsal spots and two placed obliquely on the side. A broken yellow line on the side of the prothoracic segment.

*Larva after another molt.*—Length, 24 to 25<sup>mm</sup>. Body as before, but deep lilac.

*After final molt.*—With the same markings; pale lilac, with the head very large, rounded, and much wider than the body. Length, 35<sup>mm</sup>.

#### 7. *Nepticula corylifoliella* Clem.

The larva makes a long, winding, narrow track in the leaves of hazel in the latter part of July and the beginning of August, and the fall brood may be found early in October. The frass or excrement of the larva is deposited along the middle of the track, forming a minute central black line. The edges of the mine are smooth and but little broader throughout its extent than the width of the miner. The mine is left transparent by the larva from the beginning to the end.

There is another miner in this leaf that I suspect to be a Dipteron. It makes a rather broad, tortuous track, much broader than the preceding, and the "frass" is scattered in separated grains along the middle of the track.

#### 8. *Coleophora corylifoliella* Clem.

The larva mines the leaves of hazel in September and October. The case is three lines long, dark brown, irregularly cylindrical, compressed or flattened at its hinder end, with two teeth about the middle of the upper edge, separated from each other about one-third of the length of the case, and dilated somewhat or rounded on the lower edge between the teeth. Mouth of case not deflected. The mine of the larva is nearly circular.

*Larva.*—It is pale brown with dark brown thoracic, dorsal spots.

#### 9. *Depressaria grotella* Robinson.

The caterpillar lives on the hazel in Illinois, "in a leaf rolled from the apex toward the base, or in a nest formed by fastening several leaves together with silken threads." Of two found May 27, one pupated June 7, and the moth issued June 28; another pupated June 20 and the moth issued July 9.

*Larva.*—Body green, darkest dorsally; cervical shield green, unmarked, head green, with a black dot on each side above the jaws, and sometimes with one or two black spots on each side near the top. Length, 17<sup>mm</sup>. (Coquillett, *Papilio*, iii, p. 98.)

#### 10. *Gelechia tristrigella* Walsingham.

The caterpillar of this moth lives on the hazel in a tube formed by rolling a leaf from the apex toward the base, the tube being closed at each end, as if done by pinching the upper and lower part of the tube together with the thumb and finger. The excrements of the larva are retained in the tube, and when about to pupate the larva crawls into this excrementitious mass and forms an oblong cavity, which it lines

with a very thin layer of silk. Two pupated June 21, and the moths issued July 5. (Thaxter, *Papilio*, iii, p. 99.)

*Larva*.—Like that of *G. agrimoniella* Clem. (which is pale greenish-white, the setiferous spots polished black; cervical shield yellowish green, with two dorsal black spots near the posterior edge), but the thoracic legs are black, with whitish joints; the spiracles situated on the lower edge of third setiferous spots on the abdominal segments. Length, 15<sup>mm</sup> (.60 inch). (Thaxter.)

11. *Nothris trinotella* Coquillett.

The caterpillar lives in a folded leaf on the hazel; one found June 28 pupated July 4, and the moth issued July 21, in Illinois. (Coquillett.)

*Larva*.—Body dark purplish brown, that below the spiracles pale greenish brown; two broken indistinct white dorsal lines, and two similar stigmatal ones, the one below the spiracles the most distinct; piliferous spots black, usually situated on white spots; spiracles black; head and cervical shield yellowish brown; anal plate unmarked. Length, 18<sup>mm</sup> (.72 inch). (Coquillett.)

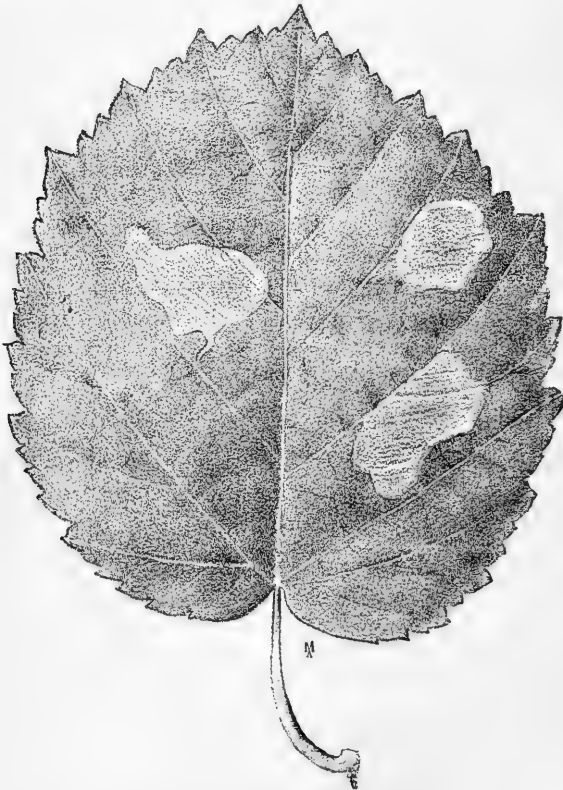


FIG. 213.—Blotch mines of the hazel *Lithocolletis*. Marx del.

*Moth*.—Reddish brown, with three white dots near the center of each forewing, the outermost dot crossed by a black dash; hind wings dull leaden, unmarked. Under side of forewings deep brown, the costal and apical margins marked with pale yellow. Abdomen brown, marked with pale yellow, which on the ventral surface forms two lines; legs brown, the points marked with pale yellow. (Coquillett.)

12. *Lithocolletis coryliella* (Chambers.)

According to the Chambers, the larva makes a nearly circular blotch mine in the upper surface of the leaf. Our figure represents what we suppose to be the blotch mines of this worm, frequently observed at Providence, R. I., in September and October. (Fig. 213.)

13. *Chrysomela multiguttis* Stol.

Mr. D. W. Coquillett, has bred this beetle, which feeds on the hazel, in Illinois. The beetles appeared the middle of June, when they were seen pairing on the leaves.

*The beetle.*—Body dull white; a dark colored dorsal line on which is a row of brown spots; on each side of the body are two rows of brown spots; head yellowish brown, marked with a black spot on each side. Length, 10<sup>mm</sup>.

## AFFECTING THE NUTS.

14. *Balaninus obtusus* Blanchard. Beaten from hazel-nut. New Hampshire to Texas. (Blanchard, Bull. Brooklyn Ent. Soc., vii, p. 107, 1884.)

15. *Balaninus nasicus* Say. Eating the nuts. (Harris, p. 74.)

The following insects also occur on the hazel :

## Order LEPIDOPTERA.

16. *Apatela oblinita* (Abb.—Sm.). (Coquillett, Thomas's Tenth Rep. Illinois.)

17. *Nematocampa filamentaria* Guen. (Forbes's Second Illinois Rep.)

18. *Thanaos icelus* Lintner.

19. *Platysamia cecropia* (Linn.) (Riley's notes.)

20. *Telea polyphemus* (Cram.) Providence, September.

21. *Anisota senatoria* (Abb. and Sm.). Found at Providence feeding on the hazel, wanderers from the oaks near by; also on wild rose.

22. *Lithacodes flexuosa* Grote. Raised from the hazel by S. Lowell Elliot, esq.

23. *Schizura unicornis* (A. & S.) Lintner (Ent. Contr. III, p. 131).

24. *Datana ministra* (Drury.) Beutenmüller. (Can. Ent., xx, p. 17.)

25. *Amphipyra pyramidoides* Guen. See p. 171.

26. *Apatela brumosa* Guenée. (August, Ill. Coquillett, Papilio, i, p. 56.)

27. *Zerene catenaria* (Drury).\* July, Aug., Ill., Coquillett (Papilio, i, p. 56.)

\* REMARKABLE FLIGHT OF ZERENE CATENARIA GUENÉE.—An Associated Press dispatch, reading as follows, appeared in the papers of October —, 1880, Lackawaren, Pa.: "Immense numbers of large white butterflies have made their appearance, to the alarm of the farmers. The mass is so dense in some places that it appears like a snow-storm. Their destruction would probably avert the ravages of the army worm." Through the kindness of Mr. C. W. Shannon, postmaster at Lackawaxen, specimens of this so-called butterfly were received at the Department. They proved to be the quite common geometrid moth known scientifically as *Zerene catenaria* Guenée. The

28. *Eccopsis permundana* Clem. Fernald's Cat. Tortricidæ, p. 29.  
 29. *Eccopsis corylana* Fern. Cat. Tortricidæ, p. 30.  
 30. *Nepticula corylifoliella* Clem. Imago unknown. Larva in a linear, crooked mine in the upper surface.  
 31. *Gelechia coryliella* Chamb. Imago unknown. Larva in the male catkins in autumn. See p. 634 and Fig. 212.  
 32. *Hyale coryliella* Chamb. Larva in a web on the under surface of the leaves. (Chambers, l. c.)

#### Order COLEOPTERA.

35. *Attelabus rhois* Bohemann.  
 34. *Monocesta coryli* (Say). See p. 238.

---

geographical range of the species is extensive, being found from Maine to Colorado. The larva is one of the "measuring worms," is yellow in color, and when full-grown measures  $1\frac{1}{2}$  inches in length. The alarm caused by the unusual swarming of the moths was entirely uncalled for, since the larva has never been known to attack a cultivated crop. The only food-plants known so far are the wild indigo (*Baptisia tinctoria*?), wood wax (?), wild blackberry, and several of the sedges, notably *Carex pennsylvanica*. (Report of U. S. Entomologist for 1880, p. 274.) See also Plate XXXII, fig. 3, 3a, 3b, 3c.



## CHAPTER XIV.

### INSECTS INJURIOUS TO THE SYCAMORE.

#### *Platanus occidentalis.*

Of the insects that we have noticed by far the most injurious is the rather large Pyralid caterpillar mentioned on p. 644, and which we have been unable to raise. With these exceptions the sycamore is rather free from attack. The European *Platanus* has but a few enemies, only five species being enumerated by Kalténbach.

#### 1. *Chalcophora campestris* Say.

While as a rule the species of *Chalcophora* feed on evergreens, the present species, thus far the only one known to live at the expense of deciduous trees, has been found by Messrs. Schwarz and J. B. Smith on the sycamore, which it attacks when dead and dry. Mr. Smith states :

It is likely that *C. fulleri*, which resembles *C. campestris* very strongly in form, will be found to have similar habits. (Ent. Amer., ii, 1836, 71.)

*The beetle.*—Head rugous, with large confluent punctures; front concave, antennæ purple-black, the first and second joints greenish cupreous; thorax unequal, with large confluent punctures each side, and caudiculate along the middle; posterior angles acute; scutellum very small, transverse-suborbicular, indented on the middle; elytra with four distant somewhat elevated lines, and one or two near the suture; in the interstitial spaces are irregular, slightly elevated, transverse lines, hardly visible to the unassisted eye; before the middle of each elytrum is a large, very slightly impressed spot, and another similar one is rather behind the middle; there is also a very small common indented spot on the suture, opposite to the former spot; exterior edge serrated from near the middle to the tip; tip simple, somewhat acute; beneath cupreous polished; a brilliant dilated coppery line extends from the mouth to the pectus; a large groove originates on the anterior part of the pectus, and terminates on the second segment of the venter; tarsi dusky bluish. (Say.)

#### 2. UNKNOWN LONGICORN LARVA IN THE SYCAMORE.

(Pl. xx, fig. 2; xxiv, fig. 8.)

*Larva.*—Body rather flattened, broader behind than usual, the penultimate segment being much wider than usual. Head large and prominent, square and flat, somewhat as in *Monohammus*, being one-half as wide as the prothoracic segment. Mandibles acute, unequally two-toothed, the terminal tooth much the larger. Antennæ very short and thick; two-jointed; second joint extremely small, with two outer spines on the first joint. Near the antennæ on the head are five long bristles. Labrum much rounded in front, as long as broad. Labium broad, with two-jointed palpi; second joint acute, as long as the first is thick. Maxillary lobe narrow, reach-

ing to the end of second joint; third joint about as long as second, rather blunt. No thoracic feet. Prothoracic segment about one-third as long as broad, with a roughened spur on the posterior half, the front edge quite hirsute. The markings or callosities on the back are difficult to describe, but are as figured by Dr. Gissler.

Length, 15<sup>mm</sup>; width of prothoracic segment, 4<sup>mm</sup>; length, 1.6<sup>mm</sup>; average width of the body, 3.8<sup>mm</sup>; length from tips of mandibles to base of head, 1.6<sup>mm</sup>.

Larva found under bark of sycamore tree in Brooklyn, N. Y. Received from Dr. C. F. Gissler.

*Pupa*.—Plate XXIV, fig. 8, represents a Longicorn chrysalis, taken from under the bark of the same sycamore tree as the larva above described, and which may possibly belong to the same species.

### 3. *Halesidota tessellaris* Abbot-Smith.

Order LEPIDOPTERA; family BOMBYCIDÆ.

Found on the sycamore at Providence, R. I., September 20 to 30. It spun a cocoon the 26th, but died in confinement. Harris states that the cocoon is oblong-oval, composed of the hairs interwoven with a very little silk. The moth appears after the middle of June.

*Larva*.—Body of the shape usual in *Halesidota*, hairs of the body delicate buff-yellow; four dorsal pencils in front light sienna brown, with two pairs of shorter lateral white tufts; a pair of whitish tufts near the end of the body. Head yellowish brown. A row of lateral black spots above the base of the abdominal legs. Length, 30<sup>mm</sup>.

### 4. *Heterocampa unicolor* (Pack.).

Mr. Pilot has bred this moth from the sycamore in Ohio. He says the larvæ are common on the sycamore, but hard to rear. (*Papilio*, ii, p. 67.) Professor Riley has also raised it from the sycamore.

### 5. *Nepticula platanella* Clem.

From the beginning to the middle of July the blotches produced by these larvæ may be found on the leaves of the button-wood tree or sycamore. The blotch is often extended over the early portion of the mine, so as to obliterate it, and again the early portion is present, being a slender line from which the blotch is formed. Imago during the latter part of July.

*Larva*.—The larva is pale green and the head pale brown, and it weaves a cocoon of a reddish-brown color during the latter days of July.

*Moth*.—Antennæ dark fuscous, eye-caps large, silvery. Head reddish-ocherous. Forewings dark brown, with a small white, slightly silvery spot on the middle of the inner margin and a very short costal streak of the same hue opposite to it. The cilia very pale yellowish, and the scales behind the cilia of the same hue, tipped with dark brown. Hind wings yellowish-fuscous; cilia fuscous.

The following account is taken from Clemens' *Tineina* :

I ascertained, during the fall of 1861, that there is more than one species of *Nepticula* that mines the leaves of the sycamore tree, and that all of them are double-brooded. The first brood may be taken early in June and July, and the second during the latter part of September and early in October.

The mine and larva of one species are described in the November and December number of the present work for 1861, page 83, and the imago in the January and

February number for 1862, page 133; but it may be well to repeat here, for the purpose of comparison, a more circumstantial description of the mine of the species to which allusion is made.

The mine of *Nepticula platanella* begins as a very slender track, the entire length of which is filled with frass. This is very soon expanded into a round, conspicuous, blister-like blotch, on the upper surface of the leaves, which sometimes obliterates the early portion of the mine; but in this event it is still perceptible on the separated epidermis as a slender, dark-brown line. After the blotch has been formed, the "frass" is diffused over the floor of the mine, discoloring its surface.

#### 6. SYCAMORE MINER, NO. 2.

Mines in quite a straight line, when its course is along a vein of the leaf, otherwise it is slightly winding. The mine begins as an extremely minute tract, and is gradually enlarged towards the extremity. A day or two before leaving its mine the larva enlarges the end into a small blotch which has attached to it a long linear track, with a central line of blackish frass. In the enlarged portion of the mine the frass-line changes into one of scattered and separated grains.

The imago of this species is undescribed, and although I secured cocoonets last fall, which may produce imagos in the spring, I shall be glad if some new observer rears imagos in the coming summer and records a description of them.

*Larva.*—The larva is of a lively or bright green color, with a dark green central line of intestinal matters. Head pale brownish. The body tapers somewhat from the thoracic rings. The larva was not taken from the mine for description. (Clemens.)

#### 7. SYCAMORE MINER, NO. 3.

Mines at first in a very narrow, transparent track, having a blackish central line of frass, the track being usually much contorted. At this stage of its larval life, which is its earliest period, the miner can scarcely be detected by the naked eye. Three or four days before pupation the larva begins to enlarge the linear mine into a blotch. This enlargement takes place most often over the course of the old linear mine, the latter half of which furnishes the basis of the blotch, and hence leaves within it a blackish frass-line. The edges of the blotch are irregular; in the mine of *Platanella* the blotch is circular or nearly so, and the early portion of the mine is filled with frass, while the blotch is formed by dilating the linear track after it becomes five or six lines long.

*Larva.*—The larva, when young, is transparent; color white, tinged with greenish, with the thoracic segments swollen, giving it a fusiform appearance. Subsequently it becomes of a pale-green color, retaining, however, the swollen thoracic rings. (Clemens.)

#### 8. THE SYCAMORE LEAF-FOLDER.

Order LEPIDOPTERA; family PYRALIDÆ ?

A caterpillar, very active in its movements when disturbed, was observed folding a leaf of the sycamore (September 15 to 30, at Providence) and spinning a large whitish web in the crease. It eats the inside of the leaf. In the autumn of 1885 this caterpillar was very abundant, often three tentiform webs on the under side of a leaf, and at least every other leaf contained a worm. September 25 to October 1 it made an oval, broad, thick, somewhat reddish silk cocoon between the leaves and attached the mass to the bottom of the box, the cocoon being rather tough and dense, with bits of leaves fastened to the outside.

*Larva*.—Body of the usual form, tapering towards the head and tail. Head not so wide as the prothoracic segment, pale whitish green. Body pale whitish green; two dusky subdorsal longitudinal lines, with faint lateral dusky lines beginning on the side of the prothoracic segment. Spiracles large, conspicuous and dark. Each segment with one large transverse dorsal wrinkle a little behind the middle. Ten abdominal legs. Length, 20<sup>mm</sup>.

9. *Tineid larva*.

The sycamore trees in and about Providence have for several years been much infested by this caterpillar, one or two of which are to be found in nearly every leaf. It makes one or two large folds in the leaf, living within a web in the crease. At the end of September (the 25th) it forms an irregular oval cocoon among the leaves preparatory to pupating. The cocoon is broad and flat, formed of reddish silk.

*Larva*.—Of the usual cylindrical shape, tapering a little towards each end. Head not so wide as the first segment behind, somewhat pointed; amber-colored, with two distinct black spots on each side. Body pale straw yellow, with sparse pale hairs, one-third as long as the body is thick. Thoracic feet dark, abdominal ones concolorous with the body. Length, 10<sup>mm</sup>.

*A larger larva*.—Straw-yellow, with two subdorsal dark-brown lines, and behind the head a supra-spiracular line extending as far as the third pair of spiracles. Spiracles black. Length, 20<sup>mm</sup>.

10. THE SYCAMORE BLOTCH-MINER.

This miner forms on the upper side of the leaf in October a broad mine doubled on itself and meeting so as to form a long, irregular round blotch one-half inch in diameter.

The following species also occur on the sycamore :

Order LEPIDOPTERA.

11. *Eacles imperialis* Hübner. Raised by Abbot in Georgia. (Manuscript plate in library Bost. Soc. Nat. Hist.) Illinois (Walsh).
12. *Halesidota caryæ* (Horr.). Beutenmüller.
13. *Nepticula maximella* Chamb.
14. *Nepticula clemensella* Chamb. The larva of these two species and *N. platea* live in the upper surfaces of the leaves. (Can. Ent., v, p. 125. Chambers.)
15. *Cirrho platanella* Chamb. The larva feeds on the under side of the leaves, and pupates in a tube composed of silk and the down from the leaves. (Chambers.)

Order COLEOPTERA.

16. *Cyllene crinicornis* Chev. On Platanus in Texas. Dr. Brous. (Le Conte in Trans. Amer. Ent. Soc., viii, p. xxiv.)
17. *Chlamys plicata* (Fabr.) Kansas, Marlatt (Industrialist, Mar. 3, 1888).

Order HEMIPTERA.

18. *Corythuca ciliata* (Say).
19. *Pulvinaria innumerabilis* Rathvon.
20. *Lachnus platanicola* Riley. D. C.

## INSECTS INJURIOUS TO THE HOP-HORNBEAM OR IRON-WOOD.

*Ostrya virginica.*

This tree doubtless affords food and shelter to a much greater assemblage of insects than that whose names are here recorded, for little attention has as yet been given to finding them.

1. *Apatelodes torrefacta* (Abb. and Sm.).

According to Abbot and Smith the interesting caterpillar of this fine moth in Georgia "feeds on the iron-wood [or hop-hornbeam], gall-berry, sassafras, etc. It went into the ground June 20; came out the 14th of July. Another went in the 17th of October and came out on the 25th of April."

Dr. Harris describes the larva, and his description, which we copy, agrees almost exactly with Abbot's figure. Harris refers to the moth under the name "*Astasia torrefacta?* Sm.-Abb.," but apparently there is little doubt that his larva was of the same species as the one figured by Abbot. He found it on the burdock July 23, 1828, and says it "eats leaves of willow well." Another larva was found on a leaf of *Prunus virginiana*.

*Larva.*—Body cylindrical, above pale yellow, beneath greenish black. Segments very distinct, almost annulose, sides and incisures greenish-yellow, head of same color, tips of mandibles black; no tubercles, but the body is covered with lanuginous hairs, flexuous backwards, of a pale sulphur color; second segment above, with a long plume of ferruginous hairs, directed a little forwards; the same segment has a conspicuous, transverse, oval spot each side; third segment with a black spot on each side; fourth to ninth, inclusive, with an interrupted black line or on each a linear, dorsal, black spot, furnishing a short fascicle of a few erect black hairs; legs blackish; pro-legs thick at base, pyriform or tapering at tip, and furnished with a semicircular, unguiferous, red plate. The hairs are all simple or unbearded.

*July 24, A. M.*—Cast its skin. The wool which now covers it is of a beautiful white color, the hairs being all directed backwards except those of the first segment, which curve forwards; second and third segments each side, with a dorsal plume of erect hairs, nodding backwards, blackish at tip; penultimate segment with a tuft separating into two depressed plumes; dorsal segments each with a short tuft of erect black hairs; sides with an arrow-shaped, blackish spot, not furnishing hairs.

*August 3.*—Divested itself of its long hairs, and appeared only thinly covered with short ones; length, nearly 1½ inches.

*August 6.*—Became a pupa without a cocoon. It would probably have entered the earth if permitted.

*August 4, 1838.*—Found on a leaf of *Prunus virginiana*, a caterpillar with the body pale yellow, covered with flexuous yellow hairs, and an orange-colored pencil, tipped with black, on the anterior part of the eleventh segment.

*August 7.*—Changed its skin; the hairs became white, a pencil on the second, third, and eleventh segments black, and very short black tufts on each of the intervening segments. Body beneath ash-colored; prolegs with deep orange-colored cushions.

2. *Noctuid larva.*

The larva here described occurred June 10 at Providence.

*Larva.*—Head large, as wide as the body, deep shining amber-red. Body smooth, rather thick, of a rich velvety reddish brown above, bounded low down on the sides by a white line, below which the sides are reddish flesh-colored. The three anterior pairs of abdominal legs are livid, while the anal and thoracic legs are reddish. Length, 17<sup>mm</sup>.

3. *Acidalia* ? sp.

This caterpillar occurred at Providence June 10, both on the pig-hickory and hop-hornbean. Though they were abundant, they did not live in confinement.

*Larva.*—Body very slender; head large, flattened in front, otherwise full, rounded, and wider than the body, which is very slender, of uniform thickness, with no tubercles; smooth, with a prominent lateral ridge. Anal legs large and broad; supra-anal plate large, equilaterally triangular. Head, body, and legs yellowish green, with no spots. Length, 12<sup>mm</sup>.

4. *Coleophora ostryæ* Clem.

The larva, according to Clemens, mines the leaves of iron-wood (*Ostrya virginica*) in October and during spring.

The case is flat, rather wide, and the edges nearly parallel except near its mouth. The upper edge is slightly curved, and almost at the hinder end is a slight notch, which is sometimes wanting, and the hinder end is squarely excised. Color of the case pale reddish-brown.

5. *Aspidisca ostryæfoliella* Clem.

The larvæ may be found on the leaves of iron-wood during the latter part of September and early in October.

About the 10th of October all the mines are untenanted. There may be a spring brood in the leaves of the *Ostrya*, but I have not observed any.

The mine is large when compared with those found in the leaves of other plants, and the hole left by cutting out the disk is out of proportion to the size of the mined portion. (Clemens.)

6. *Nepticula ostryæfoliella* Clem.

The larva in July and August makes a rather wide, most frequently much contorted, transparent mine, with a narrow, central, black line of "frass;" sometimes the early portion of the mine is filled up with "frass," and in others the line of "frass" is distinct from the beginning. From the middle to the end of the mine whence the larva escapes it will average nearly a line in width. (Clemens.)

7. *Nepticula virginiella* Clem.

In the leaf of iron-wood, *Ostrya*, it makes a very narrow long track, not broader than the width of the larva, the interior of which is filled

up with dispersed grains of frass, and which is dark brown whilst the larva is mining.

*Larva*.—Very slender, of nearly uniform diameter, terminal segments pointed, pale green, with a darker green central line; head pale brown.

It should be sought early in September.

On the 14th of the month it is nearly full-fed. (Clemens.)

8. *Lithocolletis ostryæfoliella* Clem.

The larva mines the under side of the leaves of *Ostrya*, and may be found early in July and October. The mine is usually near the margin of the leaf, is flat at first, but is gradually thrown into a fold, the separated epidermis corrugated. When completed the epidermis has changed to a pale brown color. The larva undergoes its transformation in a cocoon composed of "frass" and silk, in the form of a small ovoid ball suspended within the mine. The imago appears in August and May. (Clemens.)

*Larva*.—The larva is cylindrical, with the body pale yellow, colored on the dorsum beyond the third segment dark green by the ingesta.

*Moth*.—Antennæ silvery. Front silvery, tuft fuscous and silvery mixed. Thorax silvery, with the basal part of tegulæ pale golden. Forewings pale golden, with an unmarginated, median, silvery basal stripe, and a silvery streak along the basal portion of the inner margin. Forewings pale golden, with four silvery costal streaks, all except the last black-margined internally; with two dorsal streaks of the same hue, black-margined internally. The first costal and first dorsal streaks opposite, quite oblique and broad at their bases, the second dorsal opposite the second costal streak. The basal streak is moderately broad, and extends quite to the middle of the wing. Apical spot black; hinder marginal line blackish; cilia fulvous gray. Hind wings gray, cilia fulvous gray. Abdomen pale fulvous. (Clemens.)

The following insects also occur on this tree :

Order LEPIDOPTERA.

9. *Smerinthus juglandis* Abb.—Sm. Sept. 5, N. Y. Lintner.
10. *Telea polyphemus* (Cram.) W. Brodie (Can. Ent.).
11. *Anisopteryx pometaria* (Harris.) Providence, R. I., May and June.
12. *Lithocolletis coryliella* Chambers.
13. *Lithocolletis tritæniæella* Chamb. Larva in a roundish blotch mine in the upper surface of the leaves.
14. *Æva ostryæella* Chamb. Larva in a flat mine between two ribs, with a row of "frass" on each side.
15. *Gracilaria ostryæella* Chamb. Imago unknown. The larva when very small makes a linear, whitish mine in the upper surface of the leaves. (Chambers.)

Order COLEOPTERA.

16. Weevil. The late Mr. Chambers once wrote me that a Curculionid larva makes a tentiform or bladder-like mine in the tips of the leaves of the iron-wood.

Order HEMIPTERA.

17. *Psylla carpini* Fitch.

## INSECTS INFESTING THE WATER BEECH, HORNBEAM.

*Carpinus americana.*

Order LEPIDOPTERA.

1. *Basilarchia astyanax* Scudder.
2. *Heterocampa pulverea* G. and R.
3. *Halesidota caryæ* (Harris.) Beutenmüller.
4. *Lithocolletis coryliella* Chamb.

Order DIPTERA.

5. *Cecidomyia pudibunda* O. Sacken. On the leaves, District of Columbia. (Osten Sacken.)

## INSECTS INJURIOUS TO THE SASSAFRAS.

*Sassafras officinale.*

1. *Papilio troilus* Linn.

The caterpillars feed during June and July on the leaves of sassafras and prickly ash, partially folding them into a slight web. Harris has figured and described the early stages of this butterfly, which appears from the middle of June to the early part of July; the caterpillars occur in August and September, pupating in the latter month. Pilate reports it as feeding on sassafras in Ohio.

*Young larva.*—When small the caterpillars are blackish, with a white line on the side. After first molt olive or green on the back; two black ocelli on the third segment, four small orange-colored spots placed two and two, with a central blue dot in each, the two anterior between the black ocelli and adjoining them, and the others behind them. Back with about eight blue dots, two and two; sides and tail whitish; head pea-green; a more dilated white spot behind each side of the enlargement of the anterior part of the body.

*Full-grown larva.*—Back pea-green, sides yellowish, head and under side pink; a cross black line on the first segment; two orange-colored spots on the third and fourth segments, those on the third with black centers. Length about 2 inches.

2. *Lagoa opercularis* (Abbot and Smith).

Order LEPIDOPTERA; family BOMBYCIDÆ.

This moth inhabits the Southern States. The caterpillar is thus referred to by Abbot and Smith (*Lepidopterous Insects of Georgia*, p. 105):

The caterpillar feeds on the black haws, sassafras, plum, etc. It spun on the 21st of September, and the moth appeared July 18. This species always shapes its web or cocoon as in the figure, fastening it to a twig. The flat end opens and shuts like a door, and is fitted with the greatest exactness. The insect continues in this web all winter in the worm state, not changing to a chrysalis till within a short time of its final transformation into a fly. The caterpillar is shaped like the roof of a house, the hairs rising on each side gradually to a ridge down the middle of its back.



*The moth.*—Tawny yellow, thorax with darker patches. Basal two-thirds of costa dark, below deeper tawny, with wrinkled white and blackish hairs in lines. Tibiæ provided externally with long white hairs, while the denser tarsal hairs are mostly



FIG. 214.—*Lagoa opercularis*, after Riley. Larva and cocoon, after Hubbard.

black. Abdomen with rather long, dense, evenly cut coarse hairs, forming a short, broad anal tuft. Length of body, .65; expanse of wings, 1.90 inches. North Carolina to Texas.

### 3. *Lagoa pyxidifera* (Abbot and Smith).

The caterpillar of this species, according to Abbot and Smith, feeds on the winter whortleberry, sassafras, red root, oak, etc. "When taken the caterpillar was entirely clothed with long white hairs. On the 26th of July it shed its skin, and then appeared as in the figure. It has fourteen holders, and the head is retractile. The web was formed on the 7th of August, and the moth came out May 18, following. Like the former, it does not change to a chrysalis till the spring, but it has not, like that, a door to its web. Many individuals of this species do not spin till late in autumn. The moth is closely similar to the foregoing, but we have never seen it.

The following species also occur on the sassafras:

## Order LEPIDOPTERA.

4. *Papilio glaucus* (Linn.).
5. *Apatelodes torrefacta* (Abb.-Sm.)
6. *Callosamia promethea* (Drury.)
7. *Samia cynthia* Hübner. S. D. Hulst (Bull. Brooklyn Ent. Soc., i, p. 91.)
8. *Hyperchiria io* (Fabr.)
9. *Teniocampa incerta* (Hüb.). See p. 172.
10. *Eurypela clemetaria* (Sm.-Abb.)
11. *Platynota flavedana* Clem. Miss Murtfeldt in Fernald's Cat. Tortricidæ, p. 22.
12. *Eudemis botrana* (Schiff.) Clemens (see Fernald's Cat. Tortricidæ, p. 28.)
13. *Sericoris niveiguttana* (Grote.) Miss Murtfeldt (Fernald's Cat. Tortricidæ, p. 36.)
14. *Gracilaria sassafrasella* Chamb. The larva, when very young, mines the leaves; when older, rolls them downwards. (Chambers.)

## INSECTS INJURING THE HONEY-LOCUST.

*Gleditschia triacanthos.*

## AFFECTING THE LEAVES.

1. *Sphingicampa bicolor* (Harris).

The habits and transformations of this fine moth have been studied by Dr. H. S. Jewett at Dayton, Ohio. (*Papilio*, ii, 38.) He says the larvæ change only in size during the last molt, and are from 2 to 2½ inches long when fully grown. They began to quit feeding on the 20th of June, entering the ground within a few hours after ceasing to eat. There they pupated within an oval cell lined with a thin cocoon of silk, the first casting its skin on the 24th. The moths began to appear July 3 and had nearly all emerged by July 10. The insect is three-brooded in Ohio, hibernating in the pupa state. Besides feeding on the *Gleditschia*, they also devour the leaves of the Kentucky coffee tree (*Gymnocladus canadensis*). Mr. Pilate has also bred it from the honey-locust.

*Egg*.—Smooth, pale green.

2. *Pempelia gleditschiella* Fernald.

Order LEPIDOPTERA; family PYRALIDÆ.

The following account of this insect is taken from Professor Comstock's Report for 1879.

A large number of larvæ, in different stages of growth, were found August 12, drawing together and feeding on the leaves of the honey-locust (*Gleditschia triacanthos*) on the department grounds. The general color was greenish yellow, though there was considerable variation among them. These larvæ transformed to pupæ from the 3d to the 15th of September. When full-grown they descend to the surface of the ground, where they spin a loose cocoon of coarse gray silk, which is completely covered with fragments of dried grass, leaves, or other substances, which so conceals them that they are difficult to be found. Two of these moths emerged in the latter part of September, but the most of them during the last half of the following May and early part of June, so that it is more than probable they pass the winter in the pupa state on the ground under the trees.

We give below a description of the species by Prof. C. H. Fernald:

Head, palpi, antennæ, thorax above and beneath, legs and forewings light ashy gray. Most of the examples have a purplish tint on all these parts, deepest on the thorax above and basal portion of the forewings. A black dash broken in the middle crosses the thorax behind the middle, starting from under the patagiæ on either side. Forewing with a broad black band crossing it at the basal third, which consists of three or more lines of raised black scales, the outer one curving obliquely across from the costa to the median vein, sometimes a little beyond, then inward to vein 1, where it forms an obtuse angle, the apex pointing towards the base of the wing; then outwardly, taking the same general course as the first part of the line, to the inner border; within this, and separated by a very narrow line of the general color of the wing, are two diffuse black lines of raised scales; the inner one seems to fuse with the one beyond before reaching the costa. This band is followed by a

lighter shade, which extends as far as the discal dots, of which there are two of jet-black raised scales on each angle of the cell, the lower one being a little more remote from the base of the wing. Outer line scarcely visible in most of the examples, of the general color of the wing, dentate throughout its course, and bordered on each side with a very pale shade of brown, which is darker, and broadens on the costa. A row of terminal black dots. The middle of the wing sparingly sprinkled with black scales. Fringes concolorous with the wing. All the wings beneath, hind wings above, and abdomen light brown. All the tibiæ and joints of the tarsi with whitish. Expanse, 19 to 22<sup>mm</sup>.

*Habitat*.—District of Columbia. Described from fifteen males and eleven females. (C. H. Fernald.)

*Larva*.—When full-grown, 16<sup>mm</sup> in length, greenish yellow, with three longitudinal brown stripes on each side of the dorsal line, extending from the thoracic to the anal plates, and alternating with narrow lemon-yellow stripes, the last one being on the line of the spiracles. Head, thoracic and anal plates with more or less brown marks and blotches. There is a great variation in these larvæ in the intensity of the brown markings, but they can readily be recognized by a black lunate spot on the under side of the subdorsal tubercle of the third segment, behind the thoracic plate.

*Pupa*.—Length, 10<sup>mm</sup>; dark brown, rounded anteriorly; posterior end with a small spine on each side, extending obliquely out and backward, the end curving backward. In a line between these stand four fine hooks, much longer than the lateral spines. Abdominal segments, except the last, covered with coarse punctures, except on the posterior edge. Wing-covers reaching to the fourth abdominal segment.

### 3. THE ASH-GRAY BLISTER BEETLE.

*Lytta cinerea*.

This beetle, Mr. L. Bruner says, in Bulletin 13, Division of Entomology, p. 34, "has been observed several localities in northern Nebraska to entirely defoliate young hedges of honey-locust. Until the present summer I have not observed this insect attacking the honey-locust since the summer of 1876 or 1877. At that time a nursery of small trees of this kind was entirely stripped of leaves by them, as were also several larger ones standing alone."

The following species also occur at times on this tree, which, so far as I have observed it, is rather free from insect pests:

### Order LEPIDOPTERA.

4. *Eudamus tityrus* Fabr.
5. *Euclea quercicola* H. Sch. Ohio, Pilate, Pap. ii, p. 67.
6. *Adoneta spinuloides* Clemens. Ohio. *Ibid*.
7. *Schizura unicornis* (Abb.-Sm.). *Ibid*.
8. *Schizura biguttata* (Abb.-Sm.). *Ibid*.
9. *Heteropacha rileyana* Harvey. *Ibid*.
10. *Anisota bisecta* Lintner-Harvey. *Ibid*.
11. *Datana integerrima* G. & R.
12. *Amphidasys cognataria* Guen. *Ibid*.
13. *Spilosoma lunilinea* Harvey. *Ibid*.
14. *Catocala innubens* Guen. French, Can. Ent., xx, 1888, p. 170.

15. *Boarmia pampinaria* Guen. *Ibid.*
16. *Heterogenea shurtleffi* Pack. *Ibid.*
17. *Anisopteryx vernata* Peck. Providence, May and June.
18. *Laverna? gleditschiella* Chamb. Larva burrows in the thorns.  
(Chambers.)
19. *Helice pallidochrella* Chamb.
20. *Agnippe bicolorella* Chamb.

#### Order COLEOPTERA.

21. *Eburia 4-geminata* (Say).
22. *Spermophagus robiniae* Sch. In seeds.

### INSECTS INJURING THE HORSE CHESTNUT, OR BUCKEYE.

#### *Æsculus glabra.*

##### BORING IN THE TERMINAL TWIGS.

##### 1. BUCKEYE STEM-BORER.

#### *Steganoptycha claypoleana* Fernald.

##### Order LEPIDOPTERA; family TORTRICIDÆ.

The following account is by Prof. E. W. Claypole in *Psyche* (iii, p. 463):

Several years ago I noticed, in the early part of May, that many of the leaves of the Ohio buckeye, *Æsculus glabra*, drooped and withered very soon after they had unfolded from the bud. For two or three years these drooping leaves caught my attention. On gathering them I uniformly found a small hole in the leaf-stalk, from which a tunnel, sometimes 12<sup>mm</sup> in length, ran along the stalk. Above this hole the leaf was dying, below it the stalk was still alive. In some few instances I found in the tunnel a small yellowish caterpillar, evidently the author of the mischief. Wherever the hole in the stalk was closed with droppings the caterpillar was present, but whenever the hole was open the caterpillar was gone, leading to the inference that it had escaped through the opening.

In the early part of May, usually about the 2d or 3d, I found the drooping leaves of the buckeye in great numbers. I gathered, May 8, a quantity of the leaves, and among them, a single specimen in which the caterpillar was in the main stem of the young shoot and not in the leaf-stalk—the only instance of the kind that I have met with. Taking the specimens home, I placed them under a bell glass in order to determine the first point in doubt, the destination of the caterpillars after leaving the leaf-stalk. Two days afterwards, on May 10, I found that the leaf-stalks were all empty, and the caterpillars hidden in the faded leaf at the top of the stem, in which they had previously burrowed. On May 15, five days later, the caterpillars were still in the dead leaves, and I went to the trees to try and find some more specimens, but was unsuccessful. However, on May 21, I found a few rolled-up leaves containing caterpillars, brought them home, and placed them with the others.

On May 23, the surviving caterpillars were still feeding, but there were many dead ones.

On May 25 I found the first chrysalis among the leaves. It was light red in color, with eight rings on the abdomen. The rolled-up leaf was lined inside with silk. These facts show nothing in any way peculiar, and the same description would apply to thousands of other chrysalids.

A caterpillar examined on May 13, 1881, was 1 centimeter long, semi-transparent, yellowish in color, with a yellow head, and this appearance was retained, except that the caterpillar became a little darker, until it went into the pupal state, about May 20.

It was difficult to see what the caterpillars lived upon, as the fresh leaves that I put with them were not attacked. I have noted this point for several years and have come to the conclusion that the food of the larva is the dead dry leaf in which it is rolled up. I have looked carefully on the trees and can find no eaten or nibbled leaves near those containing the caterpillars, so, apparently, its habit is the same, in this respect, both in captivity and in its native habitat.

On June 9, fifteen days after entering the pupal state, the first moth emerged. It was small, with a peculiar hopping flight, the forewing mottled black and white, and the hind wing more uniform in color, dusky, and slightly spotted with black near the tip.

It appears as if the second stage in the life of this insect is that in which it most frequently falls a prey to its foes. During its earliest existence it is sheltered in the tunnel it has bored in the stalk, and there seems no cause but the want of room to prevent its remaining there and burrowing down the whole length of the stem. But these quarters soon become too small for it, it leaves the tunnel by the hole at which it entered, and betakes itself to the dead and curled leaf. Here it is easily found by other insects, and, from the difficulty of obtaining specimens in this stage, I infer that a very large number are destroyed by their enemies.

Specimens of the perfect insect were sent to Dr. C. V. Riley and were referred by him to Prof. C. H. Fernald. Though the specimens were somewhat rubbed and the peculiar markings consequently faint, both these entomologists inclined to refer them to *Proteoteras æsculanum*, a new genus and species described by Dr. Riley in 1881,\* though at first there was a suspicion that the insect was *Sericoris instrutana* Clem.,† the larval state of which was not then fully known. Specimens, however, raised during the present season from larvæ obtained in Ohio ‡ have thrown doubt on this identification, but no specimen has been obtained sufficiently perfect to decide the question. Dr. Riley, however, informs me that the study of a specimen bred in 1873 from the blossom of the buckeye, which specimen he finds specifically identical with mine, renders it certain that the insect is not *Proteoteras æsculanum*.

Dr. Riley has very kindly allowed me to see his notes on and figures of *P. æsculanum*, which show several points in which that species markedly differs from the species which I reared. These points are as follows:

(1) The larva here described bores the leaf-stalk of the buckeye and only once have I found a specimen in the terminal twig. *P. æsculanum* bores the terminal twig as well as the leaf-stalk.

(2) *P. æsculanum* bores the terminal twigs of maple (*Acer dasycarpum*). I have never seen a specimen of this insect here described on a maple, nor have I seen a maple twig or leaf showing indications of its presence.

(3) *P. æsculanum* often forms a swelling or pseudogall on the stem. The species here alluded to never forms a gall.

(4) *P. æsculanum* lives in the gall apparently through almost its whole larval stage. The insect here described, however, quits the leaf-stalk at the end of two or three days and lives in a rolled-up leaf.

(5) *P. æsculanum* bores the stem to a depth of from 13<sup>mm</sup> to 50<sup>mm</sup>. The insect here alluded to seldom or never exceeds 13<sup>mm</sup> in its boring.

\* See Trans. Acad. Science St. Louis, v. 4.

† See Proc. Amer. Assoc. Advanc. Sci., 1881.

‡ It is perhaps worthy of notice that among these few specimens (in 1882), a single *Loxotania rosaceana* Harris, made its appearance. Also that although the buckeye is commonly planted at my present residence, in Perry County, Pa., yet I have never seen a sign of the presence of this insect upon it.

In the mean while Professor Fernald has referred the insect provisionally to the genus *Steganoptycha* Stephens (1834), under the name of *S. claypoleana*.

In *Papilio* (iii, 191) Professor Riley remarks: "Through the courtesy of Prof. E. W. Claypole we received this spring from Mrs. L. H. Lewis some larvæ of the buckeye stem-borer noticed in November, 1882, issue of the *American Naturalist* (p. 914), and have obtained therefrom a number of perfect moths." The reference by Professor Fernald, he adds, to *Steganoptycha* is evidently correct. He then states: "None of the larvæ we received were boring in the leaf-stem, but rolled themselves up in the green leaves upon which they fed. It is doubtless more of a blossom and leaf feeder than a stem-borer. The larvæ were feeding during the first half of May, and the moths issued during the first week in June."

*Moth.*—The general resemblance of some of the specimens to others of *Proteoteras æsculana* is great, but with the perfect specimens the differences upon close inspection become quite marked. *S. claypoleana* lacks the notch in the posterior borders of the forewings, the tufts of raised scales on the disk of the same, and the peculiar tufts or pencils of hairs on the upper surface of the hind wings in the male, between the margin and the costal vein. It is a shorter, broader-winged species; the ocellate spot is less distinctly relieved, the median oblique band more broken, the basal-costal portion paler and contrasted along the median vein with a darker shade, which may be almost black, and which broadens posteriorly till near the middle of the wing, where it is abruptly relieved by a pale space obliquing basally. By these characters the species is easily distinguished from *æsculana*, and it is withal a grayer species with the pale and dark shades more highly and abruptly contrasted. (Riley l. c.)

## 2. *Proteoteras æsculana* Riley.

Professor Riley's account of this worm is to be found in the Transactions of the St. Louis Academy of Sciences, iv, p. 321. He bred it from larvæ boring in the tender terminal twigs of the buckeye and maple in Missouri.

## AFFECTING THE LEAVES.

### 3. *Apatela hamamelis*.

According to Mr. R. Thaxter (*Psyche*, ii, p. 35) this species lives upon the horse-chestnut, but he gives no description of the caterpillar.

### 4. *Tortricid larva*.

Several tortricid larvæ occurred on the leaves of the horse-chestnut at Salem, Mass., August 20 to 27, of which the following is a brief description:

*Larva.*—Pale reddish brown, curiously mottled with pale green, forming much interrupted, very irregularly edged brown lines. Beneath grass-green. Head greenish, irregularly speckled with brown. A dark green dorsal line. It spun a cocoon of silk, with very fine bits of leaves woven in.

The following also prey on the buckeye:

## Order LEPIDOPTERA.

5. *Orgyia leucostigma* (Abb. and Sm.) Riley (MS. notes).
6. *Cacæcia argyrospila* Walker. California on *Æsculus californica*. (See p. 192.)
7. *Sericoris inscrutana* Clem. Claypole. (Fernald's Cat. Tortricidæ, p. 35.)
8. *Lithocolletis guttifinitella* Clem. Var. *æsculisella* Chamb. Larva in a flat, blotch mine in the upper surface of the leaves. (Chambers.)

## INSECTS OF THE SWEET GUM.

*Liquidambar styraciflua.*1. *Ingura præpilata* Grote.

The moth has been reared on sweet gum leaves by Mr. S. Lowell Elliot.

*Larva*.—Yellowish apple-green. Second segment with yellow line in front. All the segments have about fifteen to eighteen yellow spots irregularly disposed. Most of these spots are lozenge-shaped, those of the subdorsal region being somewhat linear. Spiracles dull orange, with bright lemon-yellow stigmatal line. Length, 16<sup>mm</sup> (.64 inch). (Hy. Edwards and Elliot.)

2. *Hyphantria cunea* (Abbot and Smith).

A large brood of the caterpillars was observed, April 7 and 8, on the sweet gum trees at Enterprise, Fla., in the stage of growth preceding the last molt. The caterpillars were very much lighter than I had ever before seen in the Northern States, and I supposed they might be a different species, but the moths on emerging at Providence were of the *textor*, or unspotted form.

*Larva before the last molt*.—Body pale greenish yellow, with black dots, which contrast more with the very light colored body than usual. After the last molt the body is much darker, especially above.

The following insects also occur on the sweet gum:

## Order LEPIDOPTERA.

3. *Gluphisia trilineata* Pack. (S. Lowell Elliot.)
4. *Telea polyphemus* (Cram). Riley (MS. notes).
5. *Platysamia cecropia* (Linn.). Riley (MS. notes).
6. *Actias luna* (Linn.).
7. *Callosamia promethea* (Drury).
8. *Eacles imperialis* (Drury).
9. *Phyllocnistis liquidambarisella* Chambers. Larva in a long winding linear mine in the upper surface of the leaf. (Chambers.)

## INSECTS INJURIOUS TO THE SOUR GUM TREE.

*(Nyssa multiflora.)*

## AFFECTING THE LEAVES.

1. *Everyx chærilus* Cramer.

This sphinx, besides feeding on the leaves of the sour gum (*Nyssa multiflora*), feeds on those of the grape, Virginian creeper (*Ampelopsis quinquefolia*), sheep-berry (*Viburnum lentago*), arrow-wood (*Viburnum dentatum*), cranberry tree (*Viburnum opulus*), clammy azalea (*Azalea viscosa*), and purple azalea (*Azalea midiflora*).

*Larva*.—Head very small, as in all the genus, pale yellow green, with a darker median line; second segment yellow green with numerous irrorations. The spiracles in this segment are orange in the center, pale yellow above and below. In the other

segments they are orange, white above and below. Segments 3, 4, and 5 are also pale yellow green, the two latter swollen into a hump. The remaining segments are all bluish green, covered with white dots, and with a darker dorsal line. On segments 5, 6, 7, and 8 are oblique whitish bands, but on the posterior segments these are lost in a continuous line to the base of the caudal horn, which is bluish at the base, pale green at the tip, and white in the center. The anal segment is yellow green, as also are the abdominal legs. The thoracic feet are green, with the sides orange red. Previous to change the caterpillar assumes a purplish leaden hue, the dorsal and lateral lines becoming blackish. One specimen is pinkish, with the four anterior and the anal segment of a brownish cast, and with a dark dorsal stripe. The lateral line is also brown.

*Pupa*.—The pupa is purplish brown, with the pink tint over the whole surface slightly mottled. Wing-cases also mottled with black, spaces between the segments pitchy brown. (H. Edwards and Elliot.)

*Moth*.—Expanse of wings from  $2\frac{1}{2}$  to 3 inches. The upper side of the head and thorax is of a rust-red color, varying to a brownish red, with the tips of the patagiæ and a spot on the side of the thorax at the base of the forewings pale gray. The abdomen is fawn-colored, and the segments are narrowly edged with pale yellowish. The forewings are reddish brown with purplish reflections. The basal half is sprinkled with grayish scales and crossed by four curved brownish lines, and there is a discal dot of the same color. The outer part of the wing is of a darker reddish-brown color and crossed by several indistinct paler lines, the inner edge being oblique and straight. The terminal space is colored like the base of the wing. The hind wings are rusty brown. The entire under side is pale rusty brown with indistinct terminal bands on the wings and two faint cross lines on each. (Fernald.)

## 2. *Antispila nyssæfoliella* Clem.

The larva mines the leaves of *Nyssa multiflora* in September. When full fed the larva weaves an oval cocoon within the mine, and cutting the two skins of the leaf into a corresponding form, permits it to fall to the ground. There is thus left an oval hole in the deserted mine. The imagoes appear during the following May.

*Larva*.—The head is dark brown; first segment dark brownish; body very pale green, with dark atoms along the dorsum; ventral surface with a line of two black spots. After the last molting the first segment is black, and the dorsal spots become a black vascular line.

*Moth*.—Head above dark brown. Face, labial palpi and forefeet shining yellowish ocherous. Antennæ dark brown; basal joint yellowish ocherous. Forewings dark brown with a greenish reflection, and the base with a bright coppery hue. Near the base is a rather broad, bright golden band, broadest on the inner margin, where it is nearest the base, and constricted at the fold of the wing; a spot of the same hue on the costa, at the apical third of the wing, and one on the inner margin, midway between this and the band; cilia somewhat coppery, and rather grayish at the inner angle. Hind wings purple brown; cilia grayish ocherous. (Clemens.)

The habits of this larva are like those of *A. cornifoliella*. (Chambers.)

## 3. *Nepticula nyssælla* Clem.

The larva makes a narrow tortuous mine in the leaves. Imago unknown. (Chambers.)

## 4. THE SOUR GUM SCALE.

### *Chionaspis nyssæ* Comstock.

The following description is taken from Professor Comstock's Report for 1880, p. 316. It is figured on his pl. xvii, f. 4.



*Scale of the female.*—The scale of the female is snowy white, with the exuvia yellowish. It is flat, quite delicate in texture, and varies greatly in shape; it widens suddenly near the posterior end of the second skin, often becoming as wide as long; some specimens are straight, others are bent to the right or left. Length, 1.5<sup>mm</sup> (.05 inch).

## INSECTS INJURIOUS TO THE PRICKLY ASH.

### *Zanthoxylum americanum.*

#### AFFECTING THE TRUNKS AND LIMBS.

##### 1. THE PRICKLY ASH BORER.

#### *Liopus xanthoxyli* Shimer.

Order COLEOPTERA; family CERAMBYCIDÆ.

This borer was discovered May 25, in Illinois, by Dr. Shimer, in trunks of the prickly ash, which had been barked during the previous July. In the burrows were several pink-orange pupæ, invariably lying with their heads outward; from these he bred an undescribed species related to *L. alpha*. The beetle appeared on the tree about the middle of June. He sent one specimen from which the following descriptions have been drawn up:

*Larva.*—(For figs. see my first Rep. Inj. Ins. Mass.) Is very much like that of *Liopus facetus*. The head is a little more than half as wide as the prothoracic ring. The basal (occipito-epicranial) region is transversely oblong, the basal piece (occiput) being very short, and transversely almost linear, and separated by a well-marked



FIG. 215.—1. *Liopus xanthoxyli*.

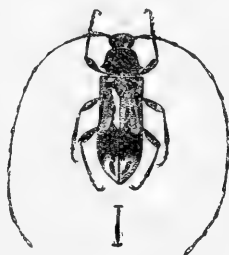


FIG. 216.—2. *Liopus facetus*.

suture from the middle portion (epicranium) of the head, the latter being nearly four times as broad as long, with the front edge straight; it is white, with the front edge pitchy black. The clypeus is smooth, trapezoidal in form, and three times as wide as long. The upper lip (labrum) is thin, hairy, transversely elliptical, a little less than one-half as long as broad. The basal chin piece (submentum) is a large transversely oblong area, with the front edge piceous, and very slightly hollowed, while the posterior edge is very deeply hollowed out. The chin (mentum) is nearly square, widening at the base, which is continuous with the base of the maxillæ, the whole posterior edge being well rounded. The labial palpi are three-jointed, the basal joints of each palpus being large, and no longer than broad, and touching each other; the second joint is much slenderer, and about half as thick as the basal joint;

the third joint is not quite so long, and is scarcely half as thick as the second; its tip is acute, and reaches out as far as the end of the second joint of the maxillary palpi. The maxillary palpi are four-jointed, very broad at the base; the first joint is scarcely half as long as broad; the third is a little longer than the second, while the fourth is much slenderer than the others and about the length of the second joint. The mandibles are large and powerful, when closed not reaching as far as the end of the maxillary palpi; the ends are truncated, gouge-like. On the prothorax is a large, obscurely marked, squarish, very slightly horny (chitinous) area, scattered over with hairs, especially on the anterior edge. On the upper side of each segment of the body is a broad oval area, with a series of oval gatherings or folds on each side of the transverse mesial main fold; those on the three rings succeeding the head (thoracic) are the same, but broader. There are no rudimentary thoracic legs. The end of the abdomen is blunt, well rounded, with the extreme tip forming a rounded portion. It is .35 of an inch in length.

*Pupa.*—White, and in the single specimen observed was quite far advanced, the body being covered with hairs. The wings were quite free from the body, and the antennæ curved around outside the wing-covers, their tips meeting at the base of the head. The first and second pairs of legs are folded at right angles to the body, the third pair being oblique to the body. The tips of the first pair of tarsi reach to the base of the second pair of tarsi; the tips of the second pair of tarsi do not reach to the base of the third pair of tarsi, the third tarsi not reaching to the tip of the abdomen by a distance equal to nearly their length. The prothorax is full and convex, the hinder portion being larger in proportion to the rest of the body than in the adult beetle. It is a quarter of an inch in length.

*The beetle.*—The beetle is characterized by four raised lines on each wing-cover, with five or six black dots on each line or rib. An oblique black line diverges from each side of the scutellum. Just in front of the middle is a triangular pale space, bounded behind by an oblique dark line. In color it resembles the bark of the ash; it is a quarter of an inch in length. Gray, with bands and spots of blackish pubescence. Antennæ about one and one-half the length of the body, joints blackish at the articulations; hoary, mottled with cinereous and light brown between. Elytra hoary-cinereous, or slightly shaded with light brown, marked with an imperfect broad transverse band before the middle and with two oblique bands and many smaller spots of blackish behind the middle; in some specimens the gray predominates, in others black, in a few the bands are almost obsolete, being merely spotted with black. Thorax with two broad longitudinal lines converging to a point in form of the letter V; each side behind the middle with an angular spine-like projection. Head depressed between the antennæ, gray, with some small black spots; on the occiput a posterior median half-line and many small black spots, not equally well defined in all specimens. Beneath cinereous, incisures blackish; legs gray, somewhat spotted with black. Length, about .25 inch. (Shimer.)

## 2. *Micracis suturalis* Le Conte.

Order COLEOPTERA; family SCOLYTIDÆ.

Observing a small round hole, like a pin hole, in a dead prickly ash bush, Dr. Shimer cut out two specimens of this timber beetle, and afterwards obtained more by cutting in the dead wood, "where the bark was adherent and where the *Liopus* larvæ had not worked. They are only found in imago now, and in this state appear to have entered; their holes are entirely free from chips and I usually found them with their heads inward; their holes frequently intersect and wind in various directions; sometimes they have several external openings, and when

approached they usually go deeper in, if possible. I never took one by beating on the bushes. I saw one on the trunk of a prickly ash, but it escaped by falling to the ground.

*The beetle.*—In the genus *Micracis* the funicle is six-jointed; club pubescent and annulated on both sides, outer joints of funicle slighter broader, not fringed; elytra aculeate at tip.

In this species the club of the antennæ is more than one-half longer than wide; the gular space between the eyes is wide; the punctures of the elytra are fine and arranged in numerous distinct rows; there are a few short hairs near the tip in some specimens, but in others even these are wanting. Length, 2.5<sup>mm</sup> (.10 inch).

### 3. THE HOG CATERPILLAR OF THE ORANGE.

*Papilio cresphontes* Fabr.

Order LEPIDOPTERA; family PAPILIONIDÆ

The following account of this caterpillar, which is said by Mr. Barnes (*Psyche*, iii, p. 162) to feed on the hop tree, is taken from Professor Comstock's report for 1880, also Mr. Hubbard's report on Orange Insects, who states that it "is found commonly in the swamps of Florida, feeding upon the tupelo (*Nyssa aquatica* L.) and upon the red bay (*Persea carolinensis* Nees.) It seems, however, to prefer the orange and its relatives to all other plants." Besides the prickly ash, according to Mr. Saunders, it lives on *Dictamnus fraxinella* in Canada West (*Rept. Ent. Soc. Ontario*, 1880). In Texas it feeds on *Zanthoxylum carolinianum* (Boll, *Psyche*, ii, p. 289). In southern Illinois the prickly ash is its usual food (Freuch). There are two broods in southern Illinois.

"In speaking of the caterpillar of this butterfly in his report on orange insects (*Patent Office Report, Agriculture*, 1858, p. 265), Mr. Glover stated that it was very injurious to the foliage of the orange. Boisduval and Le Conte (*Histoire des Lépidoptères et des Chenilles de l'Amérique Septentrionale* 1833) say concerning this caterpillar that it lives upon all the trees of the genus *Citrus*, and is in some parts of America in a measure a scourge to the orange growers. I, myself, found several of the chrysalides upon orange trees in my recent visit to Florida, and since my return specimens of the caterpillars have been sent to the department by Mr. G. W. Means, of Micopany, Fla.; Mr. H. S. Williams, Rock Ledge, Fla.; and Mrs. Rebecca A. Minor, of Houma, La., all reporting them as doing more or less damage to orange foliage. Mr. A. T. Harvey, of Lake Griffin P. O., Sumter County, Fla., informs me that he has had many orange seedlings completely defoliated by these larvæ—'orange dogs,' as they call them in that part of the country."

*The eggs.*—Deposited singly upon the leaves; are subglobular in form, somewhat flattened on the side of attachment, and yellowish white in color after hatching. What their color is before hatching we are unable to say, as the only specimen received at the Department hatched on the journey. They were sent by Dr. Turner

from Fort George, Fla. In confinement the larvæ occupied thirty days in attaining their full growth, and remained two weeks in the chrysalis state before giving forth the butterfly.

The young caterpillars are almost precisely like the full grown ones in form and color, except that the gray markings are darker and the white blotches not so extensive as at a later stage of growth.

*Larva.*—The full-grown larva is something over 2½ inches in length, and is very peculiarly marked. The belly and legs are brownish; the first four segments have upon each side a longitudinal white band; between these two bands above, the body is brownish, with large spots of a darker color; upon the middle segments, beginning with the fourth and ending with the eighth, there is a large white space shaped like a lozenge, one of its corners reaching to the first pair of prolegs on each side; several brownish dots are to be seen upon this band; another similar white or cream colored blotch covers the posterior part of the body; this blotch also contains some brownish dots; the sides of the body between these white spots are of a uniform dull brown. One of the most striking points connected with these larvæ is one which they hold in common with other members of the genus, namely the possession of two long red fleshy filaments or "tentacles" upon the first thoracic segment, and the power to withdraw or extrude them at will. Upon being disturbed the larva always protrudes these organs, which, by the way, have a very disagreeable odor, and directs them towards the place of disturbance. It is considered that these organs are a protection to the caterpillars against the attacks of ichneumon flies and other parasitic and predaceous insects.

*Pupa.*—The chrysalis of this insect affords one of the most marked instances of protective resemblance which it has ever been our good fortune to see. It is nearly an inch and a half in length, is irregularly forked at its upper end, has a prominent point upon its breast, and is suspended by a loop of silk around its middle, its tail being also fastened to the supporting twig or leaf. Its color (I have only examined the hibernating chrysalides) is of varying shades of gray and brownish, so exactly of the color of the orange bark that it is extremely difficult to see it. The irregular projections of the head and breast, and sundry markings resembling cracks in the bark, and even minute lichens growing upon it, bear out the striking likeness to a bit of a knotty orange branch most perfectly. It is worthy of remark that Mr. Glover states that the chrysalis is greenish in color, but this discrepancy may be explained by the probability that he was describing the chrysalis of one of the summer broods, or one which had just transformed.

*Butterfly.*—The adult insect is one of the handsomest of the southern butterflies. Its spread of wing is from 4 to 5 inches. The ground color above is black, and an irregular triangle of broad yellow spots includes a large part of the wings. The under side of the wings is yellowish with black nervures and a row of crescent-shaped blue spots on the secondaries.

There are usually four broods of the butterflies in the course of a season, the last brood wintering in the chrysalis state, and the adults making their appearance the ensuing April.

From what we have been able to learn these caterpillars have not been abundant enough of late years to do much damage, yet from the statements of Boisduval and Le Conte, and of Glover, referred to before, they have undoubtedly been so in years past. This being the case, the obstacle to free development which has kept them in check is liable at any time to be removed, and we may have them abundantly any year.

That the scent organs have not succeeded in making them free from the attacks of parasitic insects is shown by the fact that from chrysalides collected at Jacksonville, Fla., in January, were bred several specimens

of a *Tachina* fly. It is possible, however, that the eggs of the parasite were deposited after the caterpillar had transformed to the chrysalis.

As to remedies, it will not be difficult to keep these insects in check by hand-picking, as they are easily seen on account of their size. The butterflies being so conspicuous can without much trouble be caught in hand-nets.\* (Comstock.)

Mr. Hubbard states that it has a single parasite (*Chalcis robusta* Cresson) which preys upon it, though rare.

The following Lepidoptera also feed on this tree:

4. *Papilio troilus* Linn.
5. *Chrysophanus thæ* Bd. and Lec.

## INSECTS OF THE TULIP TREE.

### *Liriodendron tulipifera.*

#### 1. *Phyllocnistis liriodendronella* Clem.

The larva mines the small terminal leaves of the branches of the tulip tree. It is without feet. The body tapers from the head, the terminal portion being slender and pointed, deeply incised, almost moniliform. Head thin and flat. It makes a broader linear mine on the under side of the leaves, leaving a brownish "frass" line. The mine is much contorted and very long, so as often, if not always, to take up the entire under surface of the leaf, winding over it so as to detach nearly all the under epidermis. This is extremely delicate, of bluish-white color, and often the greater portion of it is detached by abrasions.

The larva may be taken from the beginning to the latter part of July. My own specimens were found on the 22d of July, at which time they were nearly full-fed. Taken in the latter part of the month, it is very easy to rear the larva and obtain the most perfect imagos.

*Moth.*—Forewings silvery white, the posterior portion of the wing pale golden, with a broad pale golden streak along the middle of the wing above the fold, arising at its base. About the middle of the costa is a pale golden, oblique costal streak black-margined on both sides, which coalesces with the posterior end of the median streak. The costal cilia silvery, containing three diverging black streaks. The apical spot black with a silvery scale or two before and behind it, and at the extreme apex two black lines on the cilia, diverging from the apical spot. In the cilia of the hinder margin is a black curved line, and at the beginning of the cilia of the hinder margin is a dorsal silvery spot. Hind wings silvery gray; cilia the same. Antennæ, head, labial palpi, silvery white. (Clemens).

The following insects also occur on the tulip tree:

### Order LEPIDOPTERA.

2. *Papilio glaucus* Linn.
3. *Callosamia promethea*, var. *angustifera* Walker: (Akhurst in Riley, Bull., vi, p. 55.)

---

\*Of other insects belonging to this genus which feed upon orange, Boisd. and Le C. mention *P. epius* in the East Indies, *P. demoleus* in western Africa, *P. lysithous* in Brazil, and state that there are several others which they could cite.

4. *Samia cynthia* Hübner. (G. D. Hulst, Bull. Brooklyn Ent. Soc., i, p. 91.)  
 5. *Bronchelia hortaria* Guenée. (Abbot manuscript in Guenée.)

## Order COLEOPTERA.

6. *Acanthoderes monisii* Uhler. (Leconte, Trans. Amer. Ent. Soc., viii, p. xxiv.)

## Order HEMIPTERA.

7. *Siphonophora liriodendri* Monell. (St. Louis, June and July, Monell.)  
 8. *Lecanium tulipiferae* Cook. (American Naturalist, xiii, p. 324.)

## Order DIPTERA.

9. *Cecidomyia liriodendri* O. Sacken. (Monogr., i, p. 204, on leaves.)  
 See also Garden and Forest, ii, p. 605.  
 10. *Cecidomyia tulipiferae* O. Sacken. (Monogr., i, p. 202.)

## INSECTS INJURIOUS TO THE SUMACH.

*Rhus glabra.*

1. *Gelechia rhoifruetella* Clem.\*

Order LEPIDOPTERA; family TINEIDÆ.

The larvæ may be found in April, or early in May, in the fruit spikes of sumach (*Rhus typhina*), where they feed on the crimson hairs and exterior envelope of the drupes, without, however, eating the drupes themselves. The larvæ are concealed in galleries formed in the fruit spikes, and their presence is indicated by strings of "frass" clinging to the exterior. The cocoon is a slight silken web woven among the "frass" near the surface. The imago appears about the middle of June.

*Larva*.—The larva is immaculate, and varies in color, from dark reddish-brown to a pale brown, dotted with rows of darker-colored dots, each giving rise to a hair; the head is brown and the shield blackish.

*Moth*.—Head, face and thorax grayish-fuscous. Labial palpi rather dark ochereous. Antennæ ochereous, annulated with black. Forewings grayish-fuscous, dusted with dark brown, and with four dark fuscous dots, one near the base of the fold, two near the middle of the wing (one on the fold and one above it), and one on the end of the disk. Near the end of the wing is an indistinct grayish band. Hind wings fuscous, cilia the same. (Clemens.)

\* Of this I received three specimens from Dr. Clemens; it has considerable resemblance with our *G. populella*, but the anterior wings are broader and blunter, and the anterior segments of the abdomen are not pale. The exp. al. is 8 lines. H. T. Stainton.

2. *Chrysocorys erythriella* Clem.\*

Order LEPIDOPTERA; family TINEIDÆ.

The larva feeds on the fruit racemes of sumach.

"Frass" scarlet. The cocoon was woven on the outside of the racemes. It was ovoid and appeared to consist of coarse silk and but a single thread, being woven so as to leave large meshes, enabling one to see the pupa through it distinctly. At maturity the pupa case is thrust forth. The pupa is pale green, with the head-case distinctly separated from the case of the thorax. The length of the larva is about two lines, of the pupa about one and a half.

*Larva*.—It tapers anteriorly and posteriorly, incisures deep, segments elevated in the middle with a single row of transversely arranged epidermis joints on each ring, each one giving rise to one or two rather stiff hairs; abdominal legs very slender and short, terminal placed posteriorly. Head with a few hairs, ellipsoidal, pointed, rather small, and pale brown. The body is uniform dark green.

*Moth*.—Head, face, and thorax fuscous, with a greenish-brassy hue. Labial palpi ocherous, terminal joint fuscous. Antennæ bronzy-yellowish fuscous. Forewings reddish-fuscous, with a greenish-brassy hue; cilia fuscous. Hind wings reddish-fuscous, cilia the same.

## 3. SUMACH LEAF-ROLLER.

This leaf-roller rolls the leaves from the tip a quarter to a half way to the stalk, or it ties the leaves together in various ways; and sometimes simply turns over the edge of a single leaf. Before pupating it makes a long, slender spindle-shaped delicate thin cocoon.

*Larva*.—Congeneric with the smaller larva on the sycamore; thoracic feet pale yellow like the body, with two lateral conspicuous black prothoracic spots.

4. *Datana perspicua* G. and R.

This notodontian has been bred from the sumach in New York City by S. Lowell Elliot.

## INSECTS INJURIOUS TO THE POISON IVY.

*Rhus toxicodendron*.*Lithocolletis guttifnitella* Clem.

The larva may be taken in August and September in the leaf of *Rhus toxicodendron* (Poison Oak), mining the upper surface in a rather broad, tortuous track, and there are ordinarily several in the same leaf. The larva belongs to the second larval group. The cocoon is circular, formed within the mine as usual in this group in a little circular depression. (Clemens.)

*Larva*.—The head is a fine pale brown; the body yellowish posteriorly, becoming brownish above, with a dorsal and ventral dark macula.

\* Of this I received two specimens from Dr. Clemens; it is closely allied to our *C. festaliella*. The exp. al. is 4½—5 lines. H. T. Stainton.

*Moth*.—Front silvery, with a reddish hue. Tuft and thorax reddish-orange. Antennæ blackish-brown. Forewings rather deep reddish-orange, with two silvery bands black-margined behind, one in the middle of the wing and nearly straight, the other midway between this and the base of the wing and obliquely placed. Before the costo-apical cilia is a costal silvery spot, black-margined on both sides, with an opposite dorsal spot, black-margined behind. The apical portion of the wing is dusted with blackish, dispersed scales, with a white spot near the tip above the middle of the wing. There are two hinder-marginal lines, one the margin of the dispersed scales, the other dark brownish in the cilia. (Clemens.)

## INSECTS AFFECTING THE CATALPA.

### *Catalpa bignonioides*.

#### AFFECTING THE LEAVES.

##### 1. THE CATALPA SPHINX.

(Plate XXXVIII.)

*Sphinx catalpæ* Boisd.

Order LEPIDOPTERA; family SPHINGIDÆ.

An account of this sphinx by Prof. Riley (with an excellent plate) which we are kindly allowed to reproduce, appeared in his report as U. S. Entomologist for 1882, p. 189.

The caterpillar frequently defoliates the Catalpa, though usually a very rare insect. It differs from others of the family in laying its eggs, sometimes 1,000 in number, in a mass on the leaves or stems or branches; the larvæ being at first gregarious. At Atlanta, Ga., there are three or four broods during the summer; the last brood hibernating in the pupa state beneath the ground, the moth appearing in March. In summer it is six weeks from the time the egg is laid till the moth appears.

#### AFFECTING THE PODS.

##### 2. THE CATALPA-POD DIPLOSI.

*Diplosis catalpæ* Comstock.

The following account is taken from Professor Comstock's report for 1880:

In the early part of August the unripe and normally green pods of the Indian bean (*Catalpa bignonioides*) upon the Department grounds were noticed in many cases to have partly turned brown in a strange manner, one-half or more of the pod remaining green, while the remainder appeared to be dry and of the color which it usually has when ripe. Upon opening one of these abnormal pods the mass of seeds was found to be fairly filled with active, footless little yellow maggots, none of them more than 3.25<sup>mm</sup> long. When disturbed they wriggled from the pod and fell to the ground, or bringing the two ends of the body together and suddenly straightening



with a sudden jerk, they would jump to a distance of several inches.\* The seeds themselves and the whole contents of the pod were in every case in a decaying condition. The larvæ were of very different sizes, some apparently being nearly full-grown, while others were evidently very young.

Some ten days after the pods had been placed in a breeding jar the adult flies began to appear—minute yellow midges with dusky wings. From that time on through the fall occasional examinations of the pods showed larvæ of all sizes still at work, many of the pods becoming entirely brown and dry before the middle of September. It was often a puzzling thing, in examining these pods, to find the points where the larvæ made their exit, for the pupa state is passed under ground. Usually one, two, or three small orifices would be found, through which all the inhabitants of the pod must have issued. The manner in which this hole is made is a mystery. Examined from the inside, it shows marks of gnawings around its edge, and frequently spots are found where attempts to pierce the pod have evidently been made, but unsuccessfully. Yet as *cecidiomyid* larvæ have no horny masticating jaws, how have they made these orifices? In pods which had evidently been attacked earlier in the season, while younger and tenderer, the holes were much larger and more abundant. Occasionally the pod will have become so dry that it will have cracked, and in such cases of course no other hole would be necessary.

*Larva*.—Length, 3.25<sup>mm</sup>; greatest breadth (at middle of body), 0.7<sup>mm</sup>. Color varying from pale whitish to orange. Breast bone bright honey-yellow, .21<sup>mm</sup> long, and .06<sup>mm</sup> wide at the fork. Integument very smooth, transverse ridges barely perceptible, with a high power near the juncture of the segments. Sides of the body show the dividing line of the segments only as a slight notch, the junctures between the head and first thoracic segment and the eighth and ninth abdominal segments being most marked. Body apparently with fourteen segments. Antennæ apparently 4-jointed; first joint short and broad; second joint short, much narrower than joint 1; third joint three times as long as joint 2, but of same diameter; joint 4 a mere point at tip of 3, apparently the continuation of a tube which can be seen in joint 3. Stigmata very small, at the summit of almost imperceptible tubercles, the prothoracic tubercles and those upon the eighth abdominal segment being larger, more dorsal, and situated, the prothoracic at the front and the eighth abdominal at the hind border of its segment. The anal segment is very convex anteriorly, and almost truncate posteriorly, four or more small posterior projections being present.

*Adult male*.—Length of body, 1.3<sup>mm</sup>; length of wing, 1.8<sup>mm</sup>; length of antennæ, 2.5<sup>mm</sup>. Antennæ, 26-jointed (2 x 24); joints pediceled, alternately single and double; single joints each with a whorl of long hairs; double joints with a whorl of delicate short hairs preceding the long one. Head slightly gibbous above, the eyes meeting upon the summit. Cross vein given off at one-half the length of the subcostal, not very oblique; second longitudinal vein nearly straight for three-fourths of its length, when it curves downward and reaches the margin of the wing somewhat beyond the apex; third longitudinal vein straight for one-half of the wing-length, when it forks, the branches forming a right angle first, which is, however, lost by the almost immediate downward bend of the upper branch. General color, light yellow; antennæ fuscous, except basal joints, which are yellowish; legs somewhat shaded with fuscous, and furnished with quite long whitish hairs upon the femora; thorax above, with a long longitudinal dusky stripe on each side, also faintly dusky toward head; abdomen light yellow, with many short whitish hairs; balancers and claspers yellow, the latter dusky at tip; wings dusky, with a bluish iridescent appearance.

\*This habit is mentioned by Osten Sacken (Monogs. Dipt., i, p. 183) in the following words: "The larvæ of several species, for instance, *Cec. loti*, *Cec. pisi*, and *Cecid. rumicis*, have the power of leaping. Dr. Loew remarks that all such larvæ belong to the subgenus *Diplosis*. *Cec. populi* Duf. performed its leaps by straining the horny hooks at the tip of its abdomen against the under side of the thoracic segments." (Dufour's Ann. Sc. Nat., 2d ser., xvi, p. 257.)

*Female*.—Length of body, 1.6<sup>mm</sup>; length of wing, 2.3<sup>mm</sup>; length of antenna, 1.3<sup>mm</sup>. Antennæ 14-jointed (2 x 12); joints pediceled, subcylindrical, and subequal, each joint with two whorls of short and delicate hairs, a whorl at each end of the joint, the hairs of the posterior whorl being somewhat longer than those of the anterior. Color as with the male, a little more dusky perhaps on the thorax. In other respects, except in generative organs, resembles the male.

Described from four male and nine female specimens. (Comstock Ag. Rt., 1880.)

## INSECTS INJURIOUS TO THE WITCH HAZEL.

### *Hamamelis virginica*.

#### 1. *Gracilaria superbifrontella* Clem.

The larva (says Clemens) may be found in the middle of July, in cones, on the leaves of *Hamamelis virginica* (witch hazel), and the imago appears early in August. This insect must approach very closely the European *swederella*.

*Larva*.—The head of the larva is pàle green; body pale green, darker-colored by the ingesta, with the teuth ring whitish, and the cervical shield pale brown.

*Moth*.—Labial palpi yellow, tipped with brownish. Antennæ dull yellow, with very faint brownish rings. Head stramineous, tinged with reddish-violet on the forehead. Thorax stramineous, with teguæ externally striped with reddish-violet. Forewings beautiful reddish-violet, with a shining stramineous patch on the inner margin at the base, and a large costal triangle of the same hue, reaching almost across the wing, and extending along the costa from the basal third, nearly to the apex. Hind wings blackish gray; cilia dark fuscous. (Clemens.)

#### 2. *Catastega hamameliella* Clem.

The larva constructs a little, short tube of frass along the midrib of the leaf of witch hazel, *Hamamelis virginica*, during the latter part of September. The tube is begun in the angle made by a vein and the midrib, and the triangular space between them is covered with a thin web of silk, having beneath it the tube. (Clemens.)

*Larva*.—The larva is nearly cylindrical, slender, with the head pointed. It is of a uniform, rather pale-green color. (Clemens.)

The following insects also occur on the witch hazel:

3. *Halesidota carya* (Harris). Beutenmüller (Ent. Amer., vi, p. 16).
4. *Eccopsis footiana* Fernald. Kellicott, Bull. Buffalo Soc., iv, 1882. Fernald's Cat. Tortricidæ, p. 36.
5. *Sericoris niveiguttana* Grote. Kellicott, Bull. Buffalo Soc., iv, 1882. Fernald's Cat. Tortricidæ, p. 36.
6. *Semasia argutana* (Clem.) Clemens in Fernald's Cat. Tortricidæ, p. 45.

## INSECTS INJURIOUS TO THE MAGNOLIA.

*Magnolia umbrellata, acuminata, etc.*

## Order LEPIDOPTERA.

1. *Papilio turnus* Linn. Abundant on *Magnolia acuminata*, London, Canada (Saunders, Can. Ent., xv, p. 204).
2. *Papilio troilus* Linn.
3. *Callosamia promethea* (Devereaux in letter) on *M. acuminata*.
4. The larva of *Phyllocnistis magnoliella* Chambers makes a long, winding linear mine on either surface of the leaves. The imago is unknown, and it may prove to be *P. lirioidendronella* Clem. (Chamb. Bull., Hayden's U. S. Geol. Surv., 1878, iv, p. 108.)
5. *Psylla magnolia* Ashmead. (Can. Ent., Nov. 1881, p. 224.)

## INSECTS INJURIOUS TO THE PAPAWE.

*Asimina triloba.*

## Order LEPIDOPTERA.

1. *Papilio ajax, telamon, and marcellus.* Ohio. Pilate (Pap., ii, p. 65).
2. *Sphinx hyleus* Drury. (Proc. Amer. Ent. Soc., iii, p. 434.) Ohio (Pilate), (W. J. Holland, Can. Ent., June, 1886).
3. *Parasa chloris* H. Sch. Ohio. Pilate (Pap., ii, p. 67).
4. *Apatelodes torrefacta* A. and S. Ohio. Pilate.
5. *Amphalocera cariosa* Lederer. (Larva described by French, Rep. Curator S. Illinois Normal Univ., 1880, p. 46.)
6. A Lithosian in all its stages is represented in Abbot's MS. drawings, Pl. 54 (the Emmler copy, with Harris' notes), preserved in the library of the Boston Society of Natural History.

## Order COLEOPTERA.

7. *Aphrastus tæniatus* (Say). (Riley, Amer. Nat., Nov. 82.)

## INSECTS INJURIOUS TO THE TREE OF HEAVEN.

*Ailanthus glandulosus.*

## Order LEPIDOPTERA.

1. *Samia cynthia* Hübner. (Imported.)
2. *Oeta compta* Clemens. (Riley's First Report.)

## INSECTS INJURIOUS TO THE BOX ELDER.

*Negundo aceroides.*

1. *Phytoptus* sp.

Class ARACHNIDA; order ACARINA.

Mr. H. Garman (Forbes' First Rep. Ins. Illinois) mentions this insect which gives rise to growths of hairs on the leaves of the box elder, *Negundo aceroides* Mœnch.

Few specimens of this *Phytoptus* have been seen, though the growths have been carefully searched for them. One of those examined had 45 transverse striæ, and was .005 inch long.

The galls or cecidii consist of mats of tangled white hairs on the under side of the leaves, situated in slight concavities; on the upper side of the leaves the cecidii are seen as correspondingly slight convexities on the surface. The younger leaves and those of shoots at the base of trees are sometimes almost entirely converted into cecidii, the peculiar hairs appearing even on the upper side of the leaves. Such leaves never expand, but curl up and seem, from the abundance of the hairs, to be clothed with a fine mealy substance. These growths are similar to cecidii of certain oaks.

The growths are very abundant on box elders planted for shade on the streets of Normal, Ill., and have been seen on young trees in the nurseries of the neighborhood.

#### Order LEPIDOPTERA.

2. *Amphipyra pyramidoides* Guen. See p. 171.
3. *Platysamia cecropia* (Linn.) (Riley's MS. notes.)
4. *Lithophane cinerosa* Grote. Thaxter (Psyche, p. ii, p. 35).
5. *Gracilaria negundella* Chamb. Larva curls down the edge of a leaf.
6. *Cacæcia semiferana* (Walk.)

#### Order HEMIPTERA.

7. *Pulvinaria innumerabilis* Rathvon. (Comstock, N. Amer. Ent., i, p. 25.)
8. *Chaitophorus negundinis* Thomas. (In Illinois in June, Miss Smith, Thomas' Eighth Rept. Ill., p. 103.)
9. *Lecanium acericola* Walsh and Riley. See p. 425.

#### Order COLEOPTERA.

10. *Chrysobothris femorata* Lec. (Riley's 7th Rep. Ins. Mo.)

### INSECTS INJURIOUS TO THE MESQUITE.

#### *Prosopis.*

#### Order COLEOPTERA.

1. *Chrysobothris octocola* Le Conte. Texas, Arizona, and Colorado River, of California; lives in species of *Prosopis*. (Le Conte, Rev. of Buprestidæ of U. S. Trans. Am. Phil. Soc., 1859, p. 230.)
2. *Cyllene antennatus* White. "Lives in the mesquite wood," Arizona. Horn (Trans. Am. Ent. Soc., viii, p. 135).
3. *Bruchus uniformis* Le Conte. Colorado desert; abundant in the pods of *Prosopis* and *Strombocarpus*. (Le Conte.)
4. *B. prosopis* Le Conte. Found with the preceding. (Le Conte.)

## INSECTS INJURIOUS TO THE PERSIMMON.

*Diospyrus virginiana.*

## Order LEPIDOPTERA.

1. *Spilosoma virginica* Fabr. Riley (MS. notes).
2. *Orgyia leucographa* Walker. Larva described by French (Rep., Curator S. I. Normal Univ., 1880, p. 44).
3. *Edemasia concinna* (Abb.-Sm.). Riley (MS. notes).
4. *Cenopis reticulatana* (Clem.). Miss Murtfeldt (Fernald's Cat. Tortricidæ, p. 20).
5. *Tolype vellela* (Stoll). See p. 165.
6. *Aspidisca diospyriella* Chamb. Larva in a minute blotch mine, from which it cuts out a case in which it pupates. (Chambers, *l. c.*)

## Order HEMIPTERA.

7. *Aphis diospyri* Thomas (Eighth Rep. Ill., p. 5).
8. *Psylla diospyri* Ashmead (Can. Ent., Nov. 1881, p. 222).

## Order COLEOPTERA.

9. *Brachystylus acutus* Riley (Amer. Nat., Nov., '82).

## INSECTS INJURIOUS TO THE CALIFORNIA BAY OR LAUREL.

*Laurus.*

1. *Ptilinus basalis* Le Conte. (Trans. Amer. Ent. Soc., viii, p. xxiii.)
2. *Micracis hirtella* Le Conte.

## INSECTS AFFECTING THE CHINA TREE.

The China tree (*Melia azedarach*) has always been considered as perfectly free from any insect attacks whatever. No caterpillar of any kind has ever been found feeding on its foliage; no Buprestid or Scolytid beetles bore in its trunk or branches, and no gall insects disfigure its leaves or twigs. This tree, with its beautiful dense foliage, is, in fact, to be highly recommended as a shade tree in the South, and especially in those cities which are so badly infested with the bagworm (*Thyridopteryx ephemeraeformis*). This immunity enjoyed by the China tree from the attacks of insects is not perfect, however, as we have recently received from Alabama some twigs and leaves infested with the scales of a Coccid belonging to the genus *Lecanium*; but, what is more interesting, the twigs are covered with the waxy scales of a *Ceroplastes* of really beautiful appearance and new to science. The leaf-cutting ant (*Atta fervens*) shows a decided partiality for the leaves of this tree in Texas. (Riley.)

## INSECTS INJURIOUS TO THE DOGWOOD.

*Cornus florida.*1. *Antispila cornifoliella* Clem.

Order LEPIDOPTERA; family TINEIDÆ.

The larva lives in a blotch mine, from which it cuts out a case in which it pupates on the ground.

The larva mines the leaves of *Cornus florida* in September. It may possibly be a variation of *nyssæfoliella*. The larvæ of the insects are very like each other, but I do not know whether that of *cornifoliella* undergoes the same change of coloration after the last molting as that of *nyssæfoliella*. Its mode of preparing for pupation is the same as the previous species, but whilst the individuals of *nyssæfoliella* on a single tree are almost innumerable, those of *cornifoliella* are not abundant. (Clemens.)

*Larva*.—The head and shield dark brown; body nearly white, with seven minute black points along the dorsum, and eight on the central surface, somewhat larger and more distinct.

*Moth*.—Head, face, labial palpi, and forefeet dark brown. Antennæ dark brown; basal joint somewhat ochereous. Forewings rather dull dark brown, with a coppery hue. Near the base is a rather narrow golden band, not constricted on the fold, and rather indistinct toward the costa, where it is somewhat suffused with a coppery hue, and nearest the base on the inner margin. At the apical third of the wing is a small golden spot, and nearly opposite, on the inner margin, another of the same hue, with the hinder portion of the wing tinged with a bright reddish coppery hue, cilia dark grayish. Hind wings purplish brown; cilia somewhat paler, with a coppery hue. (Clemens.)

2. *Coleophora cornella* Walshingham. Lives in curiously shaped case on leaves of *Cornus pubescens*, in California.

## INSECTS INJURIOUS TO THE BOX.

*Buxus sempervirens.*

## 1. THE EUROPEAN BOX PSYLLA.

*Psylla buxi* Linn.

While making some observations for the Bureau, Mr. Koebele found toward the end of May, in the garden of Mr. James Angus, near New York City, large numbers of a flea-louse infesting box. The insects (at that time mostly larvæ or pupæ and a few imagos) thickly crowded the young growth of the plants, and the whole hedge showed at the first glance a sickly appearance, the tender shoots being more or less yellowish in color and evidently dying. In our breeding cages the imagos continued to develop throughout the month of June, but outdoors no further observation on the life-history of the insect could be made. The species proved to be identical with the European Box Psylla,

(*Psylla buxi* Linn.), a species hitherto not known to occur in America. It is of a pale-green color with hyaline wings, the anterior and middle portions of the thorax (pronotum and dorsulum) having brownish, longitudinal markings, the larva and pupa being of still paler, uniform, greenish color, and not deviating in form from the larvæ of other species of the same genus. The winged insect bears a deceptive resemblance to our native Hornbeam Psylla (*Psylla carpini* Fitch), and can only be distinguished from this upon close examination, the most obvious difference being the absence of a distinct pterostigma in the Box Psylla.

Mr. Angus attempted to brush the Psylla off with a stiff broom, but this is a remedy of very questionable value, and a much simpler and doubtless more effective way of getting rid of this pest would be the application of diluted kerosene emulsion in a very fine spray.

There is no danger that this newly imported Psylla will infest any other plant besides the box, but, if not kept in check, it is liable to spread and to do serious damage to the plant in all those sections of the country where it is grown and esteemed as an evergreen ornament. (Report of Professor Riley for 1881, p. 410.)

#### INSECTS INJURIOUS TO THE BLACK ALDER.

##### *Prinos verticillata.*

1. *Hyperchiria io* Fabr. (L. W. Goodell, Can. Ent., 1879, xi, p. 79.)

#### KENTUCKY COFFEE TREE.

##### *Gymnocladus canadensis.*

This tree is perhaps as abundant in this part of Kentucky as anywhere else, but the only Lepidopteron that I have ever found feeding on it is an undescribed Psylla, of which I have sent all my specimens to Mr. C. V. Riley. (Chambers, in letter.)

## CHAPTER XV.

### INSECTS INJURIOUS TO THE PINE.

*Pinus strobus, P. rigida, etc.*

The number of species here recorded as living on the pines alone amounts to from 165 to 170, while the total number will probably prove to be nearly double that given. Kaltenbach in his work on Plant Insect-enemies does not separate those of the pine from those of the spruce, fir, and larch, but "lumps" them all together under one head, whether peculiar to the pine, the fir, or the larch. This is a mistake, although, as is well known, a large proportion of the insects which are known in this country to prey upon the pine also occur on the spruce and fir, as well as the hemlock and larch; yet a goodly number of species live exclusively on one kind of tree, notably some of those found on the hackmatack or larch. We have, therefore, been careful to record the insects of each tree separately.

Kaltenbach in his "pine" insects enumerates two hundred and ninety-nine species, of which there are one hundred and thirty Coleoptera, but of these about twenty species are carnivorous beetles, which for the most part prey on the borers, or are scavengers, and should not have been placed among the plant-eaters, but in a separate note or appendix by themselves. A large proportion of the borers are Scolytids, over twenty species being enumerated, besides about forty species of the weevil family. Of longicorn borers there are in Europe about twenty species. The Buprestids are less numerous apparently than in North America, only five species being mentioned, while as in this country few species of leaf-beetles prey on coniferous trees, their leaves being hard and apparently lacking in nourishment for such beetles, which prefer the more succulent leaves of hard-wood trees.

Of European pine-caterpillars Kaltenbach enumerates seventy-one species, none of them being those of butterflies; the proportion of silk-worms (Bombyces), span-worms, or Geometrids, and of leaf-rollers is much as in North America; of the Tineids only twelve species are reported as feeding on these conifers, and we have called attention to the very small number which occur on coniferous trees in the United States.

The species of saw-flies which infest the coniferous trees of Europe, as on this continent, form a numerous company, Kaltenbach enumerating thirty-eight. Only six flies (Diptera) are mentioned; while the



bugs (Hemiptera) which gather on these trees are the representatives of fifty-four species, of which twenty kinds are plant and bark lice.

In his excellent works devoted to the insects of the maritime pine of France, M. Edouard Perris in the volume on beetles alone enumerates about one hundred species which live at the expense of this single species of pine.

Of the pine insects which are described in the following pages perhaps the Pine moth of Nantucket has occasioned locally the most direct and perceptible injury; but upon the whole the most insidious and widely destructive kinds are the timber-borers, and of these the grub or larva of *Monohammus confusor*, called in the Southern pine districts "the sawyer," does the most damage.

Next to this borer, the white pine weevil (*Pissodes strobi*) does most injury to timber, since it deforms the trees, causing the growth of gnarled, many-headed trees, which, were it not for their attacks, might have grown into tall straight trees fitted to make masts or to be sawed into the best lumber.

Attention has been called to the longevity of these borers, which, as beetles, may live for years in articles of furniture or timbers of houses, if from some cause prevented from pairing and laying their eggs. It is not outside of the range of possibilities that the timbers of bridges and other structures may be weakened by the unseen mines or tunnels of longicorn borers and of timber beetles. Mr. W. H. Harrington is responsible for the following statement which bears on this point:

A number of years ago, a train of passenger-cars crashed through a high bridge, built of timber and comparatively new, and many lives were lost. The accident was caused by the rapid decay of the timber, and a celebrated entomologist on examining them found that the exterior had been bored by myriads of these little beetles, and water filtering into their tunnels had rotted the wood."\*

#### AFFECTING THE ROOTS.

##### 1. THE WHITE GRUB.

*Lachnosterna fusca* Fröhling.

Order COLEOPTERA; family SCARABÆIDÆ.

We have been told by Henry G. Russell, esq., that on his plantations of evergreen trees at East Greenwich, R. I., the common white grub, presumably the young of the May beetle, attacks the roots of seedling larches, white pine, and Douglass' pine and has at times done them so much injury that he has had to replant them four times. I am also told by Prof. C. E. Sargent, director of the Arnold Arboretum at Brookline, Mass., that this grub has at times attacked and killed his young larches and any delicately rooted plants, such as Azaleas. They do the most injury in August, when they are large. In wet seasons

\* Transactions of the Ottawa Field Naturalists' Club, No. 2, p. 31, 1881.

their work is not so apparent, since the roots grow rapidly, but in dry seasons they become most destructive and annoying.

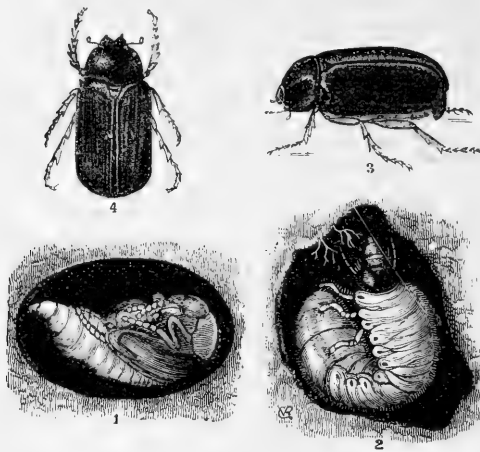


FIG. 217.—May beetle and its transformations—2, larva  
1, pupa.—After Riley.

#### AFFECTING THE TRUNK.

##### 2. THE LARGE PINE FLAT-HEADED BORER.

*Chalcophora virginiensis* (Drury).

Order COLEOPTERA ; family BUPRESTIDÆ.

Boring in the sap-wood and girdling the tree, a flat-headed, white grub ; the track beginning as narrow and shallow groves on the surface of the wood, forming irregular wavy or serpentine tracks, which gradually increase in width as the larva grows, ending in a large hole where the grub pupates ; the beetle occurring on the leaves in spring and autumn.

The habits of this beetle in its preparatory stages are probably much like those of *Chrysobothris femorata*, which infests the oak, and the galleries which it makes under the bark are much like those of the oak buprestid. No thorough observations have been made upon the natural history of this interesting beetle. It appears in the Northern States toward the end of May, and through the month of June, as Harris states, while we have observed it in Maine on pine trees the middle of July, and Fitch states that it occurs upon the leaves of the pine in autumn. Harris says that in the larva state it bores into the trunks of the different kinds of pines, and is oftentimes very injurious to these trees.



FIG. 218.—*Chalcophora virginiensis*.—Marx del.

*Beetle*.—Oblong oval, brassy or copper-colored, sometimes almost black, with hardly any metallic reflections. The upper side of the body is roughly punctured ; the top of the head is deeply indented ; on the

thorax are three polished, black elevated lines; on each wing-cover are two small square impressed spots, a long elevated smooth black line near the outer, and another near the inner margin, with several short lines of the same kind between them; under side of the body sparingly covered with short, whitish down. Length 0.8 to 1.10 inch.\* (Harris.)

3. *Chalcophora*, probably *C. virginiensis*.

(Larva, Pl. xvi, fig. 1.)

I have little doubt but that the following description is that of the larva of the foregoing species, and that at any rate it is a true *Chalcophora*.

Compared with Loew's figure of the larva of *Chalcophora* (Ent. Zeitung, Stettin, 2ter Jahrgang, 1841, Tab. I, figs. 1-8) our species differs mainly in the larger chitinous prothoracic disk, though the V-shaped mark is the same. In the shape of the body, in the form of the mesothoracic and metathoracic segments, and the end of the abdomen, our larva appears to be a *Chalcophora*. The first abdominal ring is longer and narrower than in Loew's figure. The labrum is peculiar in this genus, on account of the lateral lobes; in this respect it resembles the figure of Loew; while the antennæ, maxillæ, and labium are nearly as he figures them. Under these circumstances we think there is no reasonable doubt but that this larva is a *Chalcophora*, and probably, from its large size, *C. virginica*, which, according to Harris, bores in the pine.

The two specimens described were taken from under the bark of the pitch pine, May 26, Providence, R. I.

*Larva*.—Compared with *Dicerca* the head is much larger and better developed, while the prothorax is of the same size, and the abdomen is fully as thick, but rather longer. Prothorax and the V-shaped mark one half narrower than in *Chrysobothris femorata*, and with no markings around the apex, as in *Dicerca*. The prothoracic disk has very large, coarse, transverse, raised linear chitinous points, which are more or less confluent, forming irregular transverse wavy ridges. The disk on the under side has similar markings, and a single narrow deeply impressed median line, which extends from the front to the hinder edge.

No roughened area on the succeeding segments, but on the mesothoracic are two remote converging curved lines, and on the metathoracic segment are similar lines, which extend nearer the front edge; the curved lines inclose a subtrapezoidal space.

---

\* *Chalcophora virginiensis* is stated by Fitch to be always an inch or more in length, but I have measured a great many specimens and find that few exceed an inch in length, the rest varying from seven-eighths of an inch up to the maximum of slightly over an inch. This species is duller in color than the preceding species, and the raised lines on the elytra are less sharply defined. It can be further distinguished by two impressed spots on each elytron interrupting the second line. This species has been found by me almost invariably crawling, or at rest, upon the sunny side of the trunk or limbs, instead of among the leaf clusters. Its color tones so well with the bark of young trees that it is not easily seen, until this habit of frequenting the sunny side of the tree is known, when it can be more readily found. We have already noticed that *liberta* closely resembles the young cones and thus have in these beetles two very good instances of protective coloring and habits. *C. virginiensis* is not so abundant as *C. liberta*, but is by no means rare and is not infrequently found about the city on the sidewalks or crawling on houses or fences.—W. Hague Harrington in Trans. Ottawa Field Naturalist's Club, No. 2.

Antennæ large and well developed, compared with those of *Dicerca* and *Chrysobothris*; 3-jointed; the basal joint membranous, third joint nearly as long as the second, and blunt at tip. Labrum rounded on the edge, fuller than in *Dicerca*. Maxilla large and well developed; maxillary lobe smaller in proportion to the base of the maxilla than in *Dicerca* or *Chrysobothris*. Palpus two-jointed; basal joint much larger than the maxillary lobe (in *Dicerca* and *Chrysobothris* it is much smaller); second joint one-fourth as large as first, being proportionally much smaller than in the above mentioned genera. Labium much as in the said genera, being rounded in front.

Total length of body, 41<sup>mm</sup>; length of prothorax, 5<sup>mm</sup>; breadth, 8<sup>mm</sup>; length of the three thoracic segments together, 8<sup>mm</sup>; breadth of fourth abdominal segment, 4<sup>mm</sup>.

The hairs on the body are much coarser than in the other genera mentioned.

This larva may be distinguished by the large head, the well-developed antennæ, the large maxillæ, with the lower joint of maxillary palpus small; by the very coarse and linear markings on the prothoracic disk above and beneath; by the absence of roughened areas or callosities on the meso- and metathoracic segments, and by the long, thick abdomen.

The mesothoracic segment is shorter and the metathoracic is as long as in *Dicerca*.

#### 4. THE LESSER CHALCOPHORA.

##### *Chalcophora liberta* Germar.

Very similar to the Virginian *Buprestis*, but always smaller sized, measuring from 0.75 to 0.90 in length, with the second raised line of the wing-covers broader than the first or inner line, and totally obliterated where it is crossed by the posterior impressed spot, its middle portion between the two impressed spots usually showing a few scattered punctures. (Fitch.)

“This species is much more common in eastern New York than the Virginian *Buprestis*, the beetles appearing upon the leaves of pines throughout the summer and autumn. From a small grove of young pines only a few rods in extent upwards of a hundred specimens were taken the middle of last September, one or two being found upon almost every tree and bush; whilst only four individuals of the preceding and two of the following species were found in company with them. They had probably been bred in the numerous stumps of larger trees which had been cut down the year before by the side of this grove. They stationed themselves at the tips of the limbs, clinging to the leaves with their feet, with their heads inwards, their position, shape, and size giving them a close resemblance to the young aments or fruit cones which were growing from the same points on several of the limbs; and they appeared to be eating the young buds, which are probably the food on which all these beetles subsist after arriving at their perfect state.” (Fitch.) This *Buprestid* is also found in Maine, but after several years' attempts we have not been able to clear up the habits of either species of *Chalcophora*, or to detect the larvæ.

“*Chalcophora liberta* very closely resembles the last species in its markings, and might readily be mistaken therefor by those not familiar with both. It is smaller, however, being only from three-quarters of an inch to an inch long and is somewhat different in color. It is generally of a bright coppery-red, but varies greatly in this respect,

specimens being found of all shades from brassy black or purple to orange-bronze. This beetle, like the preceding one, is frequently found (especially upon saplings) in the center of a cluster of leaves, head inwards, and in this position would, by the inexperienced observer, be probably taken for a young cone. It appears to feed upon young cones and leaves at such times, and these are probably the food of all the pine-investing Buprestians after reaching the perfect state, as I have found nearly all the species thus situated in the leaf clusters. This beetle, *C. liberta*, is quite abundant, as will be seen when I mention that Mr. Fletcher and Mr. Gresta (a former member of this club) collected with me in one afternoon (September 21, 1878), in a small grove of saplings and young trees, over one hundred specimens, and that a couple of days afterwards we collected in the same place over half as many. On the 23d September, 1880, I captured in about an hour twenty-eight (thirteen males and fifteen females) and could easily have obtained more. The larvæ of these beetles had probably bred in trees, or stumps and logs in the neighborhood, and had resorted to these saplings to feed and pair." (W. Hague Harrington in Trans. Ottawa Field Naturalists' Club, No. 2.)



FIG. 219.—*Chalcophora liberta*.—Marx del.

##### 5. THE OREGON BUPRESTIS.

*Chalcophora angulicollis* Le Conte.

A beetle intimately related to the preceding species I met with in a collection of insects, made at The Dalles, on Columbia River, many years since, by Rev. George Gary, of the Methodist Episcopal Church, and presented to me by the late Dr. Skilton, of Troy. Its close relationship to the species above described renders it altogether probable that its larva is similarly pernicious to the pine timber of the region where it abounds. And as no insect of this genus has hitherto been recorded as an inhabitant of that vicinity, that I am able to discover, I herewith submit a short account of its distinctive marks. (Fitch.)

The beetle slightly exceeds an inch in length, with the elevated smooth lines and spots, black and for the most part broader than the rough intervals between them, which are burnished brassy, tinged with coppery red. Its sculpture is very similar to that of the species last described above. The elevated line on the middle of the thorax is here twice as broad as in that species, and at each end is rapidly but not abruptly widened to double the breadth which it has in the remainder of its length, these widened portions having a few scattered punctures. Both at the apex and the base this widened portion is confluent with the irregular elevated stripes which are placed upon each side of the middle. The smooth pyramidal spots on the base opposite the middle of the anterior end of each wing-cover are here larger and more prominent than in either of the foregoing species and each of these spots has the shape of a right-angled triangle, the line bounding its outer side running directly forward instead of obliquely inward and forward, each spot being also more broad than long. The rough depression which extends forward from these spots to the anterior angles

of the thorax has in its middle a well marked, elevated, smooth spot, which is oblong and placed obliquely, with an oblique groove on its outer side separating it from a smooth and somewhat triangular spot on the outer margin, which is more distinct in this than in either of the preceding species, and produces a slight undulation of the outer edge, this edge being almost rectilinear with the opposite sides, parallel with each other two-thirds of their length, and then abruptly or angularly inclining inwards to the anterior angles. The wing-covers have the elevated lines much broken and irregular, resembling those of the preceding species, though on a particular examination several differences will be noticed. (Fitch.)

This insect has also been found by Dr. Le Conte, at Sacramento, Cal.

#### 6. *Chalcophora fortis* Le Conte.

This beetle has been observed by Mr. W. Hague Harrington on the pine. I extract his account of it from the transactions of the Ottawa Field Naturalist's Club, No. 2, p. 28.

The largest species is *Chalcophora fortis*, a remarkable fine beetle, varying from one to one and two-tenths inches in length, and being about three-tenths of an inch wide. Their color is a coppery brown, but newly emerged specimens have often a golden-greenish burnish, or a powdery appearance caused by very minute particles of wood scattered in the indentations of the elytra and thorax. The brilliancy of their appearance is increased by raised lines and patches on the thorax and elytra, which are polished and show off against the remaining surface as work of burnished metal does against a grained or frosted ground. This beetle is comparatively rare, but perhaps as common in this locality as in most parts of the country.

#### 7. THE TOOTH-LEGGED BUPRESTID.

##### *Chrysobothris dentipes* (Germar).

Though usually occurring in oak trees, occasionally living under the bark of the white pine, where it makes a flat, shallow burrow, sometimes half an inch broad and ending in an oval cell, in which the larva occurs in autumn, winter, and early spring.

We have already noticed this Buprestid among oak borers. We have found, May 20, at Providence, R. I., the dead beetle in its burrow under the bark of a white pine stump.

#### 8. HARRIS'S BUPRESTIS.

##### *Chrysobothris harrisii* Hentz.

Order COLEOPTERA; family BUPRESTIDÆ.

Appearing on the trees in May and becoming most common about the middle of June, a small beetle 0.32 long, of a brilliant blue-green color with black antennæ and feet, and in the male the sides of the thorax and the thighs copper-colored, its surface punctured, with a groove on the middle of the thorax and two indentations near the base of each wing-cover, slightly separated by a raised line, the inner one running into a groove which extends along the suture to its tip. Its larva living under the bark of young trees and small limbs. (Fitch.)

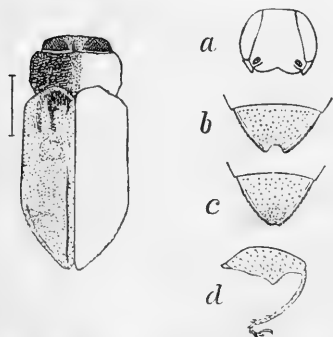


FIG. 220.—*Chrysobothris harrisii*: a, head seen from front; b, last male segment; c, do. female; d, first leg.—After Horn.

According to Le Conte this beetle inhabits the twigs of the white pine. Mr. George Hunt also informs us that it inhabits the white pine in Rhode Island, where he has collected it late in June and during July.

9. *Chrysobothris trinervia* Kirby.

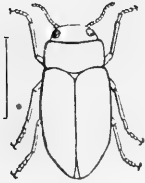


FIG. 221.—*Chrysobothris trinervia*.  
—From Packard.

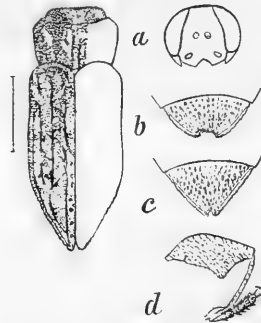


FIG. 222.—*Chrysobothris trinervia*; a, head seen in front; b, last male ventral segment; c, do. female; d, first leg of male.—After Horn.

As this beetle occurs in the pine forests of Colorado, it is most probable that it bores in pine trees. It is a rather small, short, broad species, dull blackish, with faint metallic reflections. Surface of the body, especially the wing-covers, with irregular ridges, the inner one parallel to the inner edge of the wing-cover; wing-covers with smooth, elevated areas, between which the surface is minutely pitted with dense golden punctures. Body clothed beneath with short, coarse hairs. Length, 0.45 inch. (Le Conte.) We collected a specimen on the Divide, Colorado, July 12. Prof. F. H. Snow has taken it at Santa Fé, N. Mex.

10. THE GOLDEN BUPRESTIS.

*Buprestis striata* (Fabr.)

Order COLEOPTERA; family BUPRESTIDÆ.

Appearing upon pine and spruce trees in May and June, a brilliant and sparkling copper-red beetle, 0.55 to 0.70 long, its wing-covers marked with a broad brilliant bluish-green stripe on each and with four elevated smooth lines in which are several deep punctures, the two outer lines nearly or quite united at their hind ends and the exterior middle one a fourth shorter, the depressed spaces between these lines twice as wide as the lines and rough from coarse confluent punctures; its thorax with a wide shallow groove along the middle, which is sometimes very slight, the surface covered with coarse punctures which become dense and confluent along the sides, as they are upon the head also, which has a slender elevated line along its middle; the under side brilliant coppery. (Fitch.)

“ Like most of the other insect borers in the pine, it appears to be the dead wood of logs and stumps which this species prefers to living trees.

T. B. Ashton informs me that he once found the fragments of one of these beetles in the interior of a pine log. I have met with it, in two instances, stationed at the tips of the limbs of young spruce trees in my yard, and it is probable that in its perfect state it feeds upon the tender young buds of the pine and the spruce." (Fitch.)

Mr. George Hunt tells us that it occurs on the white pine and yellow pine (*P. rigida*) in northern New York.

Le Conte states that it inhabits the Middle States, Canada, and the Lake Superior region. It varies in brilliancy of color; the male is narrower than the female, and has the tip of the abdomen more distinctly truncate, or, rather, more broadly rounded.

Allied to this species is *Buprestis lauta* (Le Conte), which is abundant in Washington and Oregon; while we have received it from Utah, through Mr. J. L. Barfoot, curator of the Salt Lake Museum. It has also been detected by Prof. F. H. Snow at Santa Fé, N. Mex. The male is a little narrower, says Le Conte, than the female, but the tip of the abdomen is somewhat truncate in both.

*Buprestis radians* (Le Conte) also inhabits Oregon. It is shaped like the male of *B. lauta*, but may be known by the very hairy front and prosternum. The tip of the abdomen is somewhat truncate.

Nearly allied to the two last named is *B. adjecta* (Le Conte) from Oregon. It is said by Le Conte to be broader even than the female of *B. lauta*, with intermediate elevated ridges on the elytra; the tip of the latter is distinctly bidentate, while the abdomen is less strongly punctured and scarcely truncate.

#### 11. THE ULTRAMARINE BUPRESTIS.

##### *Buprestis ultramarina* Say.

This species has been found by Fitch in the middle of July in a forest of pines and other trees, and is probably a pine insect. It is said by Le Conte to be a broader form than *B. decora* Fabricius, to which it is allied, with the intervals of the elytra less irregularly punctured, especially towards the suture, with the tips rounded, or hardly truncate, not bidentate as in that species. The abdomen is broadly rounded at the apex. The following description is quoted from Fitch's Fourth Report:

The Ultramarine Buprestis is half an inch long and of a brilliant green color tinged with golden yellow, the sides of the thorax being pure golden, with also a stripe along the middle, where is a very slight wide groove, scarcely obvious. The wing-



FIG. 223.—*Buprestis striata*.—  
Smith del.



covers are brilliant blue, which color is margined on each side and at the base with golden yellow tinged with green, the suture and outer margin being burnished coppery red. On each wing-cover are about eight rows of large deep punctures placed closely together, and some of them united or confluent, and between each of these rows is a series of smaller round punctures. Their tips are cut off transversely, and on the side next to the suture is a minute projecting tooth. The scutel is circular, deeply concave, and green, with its sides blue. The thorax is covered with close, deep, coarse punctures, which are more dense and confluent on each side. The head is rough from similar confluent punctures, with a slender, smooth, elevated line in its middle. The antennæ are black with the basal joints coppery red. The under side is burnished coppery with the sutures of the abdomen green. (Fitch.)

## 12. SPOTTED-WINGED BUPRESTIS.

### *Buprestis lineata* Fabricius.

A shining brassy-black beetle, sometimes blue-black or dark bottle-green, of the same shape with the preceding and .45 to .65 long, each wing-cover with from three to six pale tawny yellow spots of irregular shape and very variable, the mouth and throat often and sometimes the face of same color, and also a spot on each side of the last segment of the abdomen beneath; the wing-covers with several impressed lines and a row of punctures on each of the interstices between them, the thorax with coarser close punctures and a single large one on the middle of its hind edge. (Fitch.)

"I have met with this beetle, in July, on pines growing at a distance from any other trees, an evidence that it had been bred from them. The spots on its wing-covers are extremely variable, being alike in no two specimens.

"The more usual form is slightly larger, measuring .60 to .75 in length, and the wing-covers with two tawny orange stripes on each, the inner one of which is widest at its base and does not reach to the tip. Here also the last segment of the abdomen beneath has a tawny orange spot on each side, and the throat, mouth, and face, and a stripe on each side of the thorax are yellow, varied in places with red." (Fitch.) It occurs not infrequently in the Middle and Southern States according to Le Conte. I have found, in company with Mr. Calder, the elytra of this beetle under the bark of the white and pitch pine, in Providence, R. I.

## 13. *Buprestis maculiventris* Say.

Mr. W. Hague Harrington, of Ottawa, gives the following account of this beetle in the Transactions of the Ottawa Field Naturalists' Club, No. 2, p. 30 :

*Buprestis maculiventris* is a brassy-brown species, from five-eighths to six-eighths of an inch long, common upon both old and young trees in June and July. I am inclined to think it feeds also upon spruce, as while in Cape Breton last August I noticed a couple of these beetles in a section wooded almost entirely with spruce, pines being rarely met with. It is easily distinguished by the yellowish-red spots on each side of the segments of the abdomen beneath, and by smaller spots of the same color upon the shoulders of the thorax and upon the face. Its wing-covers are thinner and softer than those of preceding species, and often have a rumpled appearance as if bent in two or three places. It is inferior in beauty to our other Buprestidæ. I have found several of the beetles emerging from the pine timbers of the Maria street bridge about the end of June.

14. *Buprestis rusticorum* Kirby.

This is an abundant insect in the pine woods of Oregon and Washington, and appears to range eastward into British America. We have found it in pine woods at Manitou, Colo., July 16, while it is not uncommon in New England, Mr. George Hunt finding it at Providence, R. I. The body is brown, with an olive-green tint. Head and thorax punctured. Each wing-cover with five ridges, four of them well marked and smooth, the interspaces with scattered punctures. On the head between the eyes are five yellow spots; two simple dots, two long spots on the orbits, sending two projections outward, and a line in front sends three projections upwards. Two unequal yellow spots under the eyes. Labrum and labium yellow. Fine orange-yellow spots on each side of the end of the abdomen beneath. Length, 0.65 to 0.92 inch. Le Conte also adds that this species is nearly allied to *Buprestis maculiventris*, which occurs in the northeast from Pennsylvania to Newfoundland.



FIG. 224.—*Buprestis rusticorum*.—From Packard.

Regarding this beetle, Mr. W. H. Harrington remarks in the Transactions of the Ottawa Field Naturalist's Club,

No. 2, p. 30 :

The last of the Buprestians which I have to describe is, in my opinion, the gem of them all, so brilliant is it, especially in the sunlight. It is also the smallest, the males only averaging four-sixteenths of an inch in length, and the females five sixteenths. The larvæ inhabit young saplings and the small limbs of larger trees. The beetles are found on the trees during June and July, seeming to delight in the hottest and brightest days of these months, and displaying in such weather great activity whereas on a cool, cloudy day they are much less alert. When among the leaves they are, from their color, very difficult to see, and if shaken off upon a beating-net they take wing with such swiftness as very frequently to escape capture. The instant they drop upon the net they are off like a flash of emerald light. The color of the female is a uniform vivid green or blue-green, with the exception of the antennæ and feet, which are black, but the male has the thighs and sides of the thorax coppery or bronzed, and is thus easily distinguished, as well as by his smaller size.

## 15. YELLOW-DOTTED BUPRESTIS.

*Melanophila fulvoguttata* (Harris).

Appearing upon pines in June, a more flattened beetle than the foregoing, 0.30 to 0.43 long, of a brassy black color with three pale yellow dots on each wing-cover placed towards the hind part and equidistant from each other, the hindmost ones nearest the suture and the middle ones farthest from it; the fore ends of the wing-covers moderately rounded and fitting into corresponding concavities in the base of the thorax; the whole surface covered with shallow rough punctures running together transversely and somewhat resembling the grained side of morocco leather, and the thorax having an indentation on the middle of its base like the impression of the head of a pin. (Harris's Treatise, p. 44.)

## 16. DRUMMOND'S BUPRESTIS.

*Melanophila drummondi* Kirby.

This species, with *Buprestis rusticorum*, and *Chrysobothris trinervia*, we have collected in the pine timber of the mountains of Utah in the American Fork Cañon, late in July, and it is probable that all will be found to inhabit the trunks of coniferous trees. It also inhabits Oregon and Washington as well as Alaska and New Mexico. (Santa Fé, Snow.) Le Conte describes it as being densely punctured, shagreened, with shining, metallic colors, especially on the prothorax, with three bright yellow spots on the posterior two-thirds of each wing-cover, the anterior spot being the larger. Length, 0.40 inch.



FIG. 225.—Drummond's *Melanophila*.—From Pack'rd.

## 17. THE PITTED BUPRESTIS.

*Dicerca punctulata* Schönherr.

Occurring mostly upon the pitch pine (*Pinus rigida*), an obscure coppery or black beetle, half an inch long, convex above with the tips of its wing-covers tapering, and this narrowed portion more lengthened than in any of the foregoing species, their surface occupied with close fine punctures and double rows of coarse ones, the narrow spaces between these rows often elevated in places, the elevations forming smooth oblong spots or irregularly interrupted ribs; the thorax with coarser confluent punctures and with four elevated smooth stripes, the outer ones narrower and interrupted by a slight depression in the surface back of their middle; and finally, a smooth transverse elevation upon its front, extending from one eye to the other, is a mark whereby this species may be readily distinguished from most of those related to it. (Fitch.)

I have found a dead beetle under the bark of the pitch pine in the same stump with *Buprestis lineata* in May, 1881, at Providence, R. I.

## 18. THE TUBERCULATED BUPRESTIS.

*Dicerca tuberculata* Laporte.

This is another beetle which is met with upon the pitch pine, and resembles an individual of the preceding species of a more brassy tint and having all its marks more coarse, rough, and irregular; but the rows of coarse punctures on its wing-covers are at equal distances from each other instead of being in pairs, the intervening spaces having many irregular elevated black polished spots, and the elevated transverse line upon the front is interrupted and less prominent, and its size is rather larger, being about 0.60 inch long. (Fitch.)

## 19. THE PINE DICERCA.

*Dicerca tenebrosa* Kirby.

Mining under the bark of the white pine, the beetle occurring in October. (G. Hunt.)

Le Conte describes this beetle as follows:

Ashy bronze or obscurely bronze, the prothorax dilated on the sides, which are rounded in front, sinuous behind, coarsely punctured; behind broadly excavated on each side, with apical and basal shining smooth rugosities; a definite dorsal deep

furrow with smooth sides, somewhat interrupted in the middle; elytra densely punctured, with alternate oblong, raised, shining interstitial spaces, prolonged entire to the apex; length, .57 to .75 inch. Male with the pectus broadly sulcate, villose; the intermediate tibiæ armed with an internal acute tooth; the last ventral segment truncate-emarginate. Female with the pectus smoother, less sulcate; the last ventral segment tridentate; the intermediate tooth obtuse, defined by minute incisions.

Abundant at Lake Superior; according to Kirby found in latitude 65° and in the Rocky Mountains. In addition to the characters given above, Le Conte adds:

The under surface is copper-colored, coarsely and densely punctured on the sides, abdomen and prosternum, less densely on the metasternum and middle of the first segment of the abdomen; the divided portions of the mesosternum are coarsely and tolerably densely punctured. The outer costæ of the thorax are interrupted so as to form on each side an apical and basal callosity. A female from Newfoundland differs by the epipleuræ being green, the under surface of the prolonged extremity of the elytra blue, and by the incisures between the anal teeth being more widely separated.

Mr. George Hunt has found this beetle under the bark of the white pine in the Adirondack Mountains, New York, in October.

#### 20. THE COMMON LONGICORN PINE-BORER.

*Monohammus confusor* Kirby.

Order COLEOPTERA; family CERAMBYCIDÆ.

Boring a hole, in outline round and regular, deep in the wood of sound, though usually in decaying trees, and doing much injury to pine timber; a large, soft, white, fleshy, nearly cylindrical grub, the segment next the head larger than the others, flattened, horny, and inclined obliquely downward and forward, the succeeding rings very short, with a transverse oval rough space on the middle above and below; pupating inside in the wood, the beetle emerging from a round hole half an inch in diameter; the beetle one of our largest longicorns, with very long antennæ; the body brownish-gray, the wing-covers spotted with black and white; length, 1.20 inch.

Nothing was known of the habits of this borer by Harris, in the third edition of whose treatise the beetle is well figured. In 1860 Dr. Fitch gave an excellent account of the habits, and a brief description of the larva and pupa and adult, in his Fourth Report on the Noxious Insects of New York. The following description of the larva and pupa is based on specimens obtained at Brunswick, Me., and compared with some received from Mr. F. C. Bowditch, who published in the American Naturalist, August, 1873 (p. 498), an account of the habits and transformations. He sent me a block of pine wood split off, containing the terminal portion of the cell, stuffed with large chips arranged quite regularly. In the museum of the Peabody Academy of Science, at Salem, is a piece of planed plank, which had been sawed so as to uncover part of the hole, with the beetle within, as seen in Fig. 227. Fitch states that this and *Monohammus scutellatus* and *marmoratus* are the most common and pernicious borers which occur in the pine timber of New York. On a still summer's night as well as in the day-time the peculiar grating or crunching noise which the larvæ make in gnawing the wood may be

distinctly heard at a distance of eight or ten rods. "That the insect does not open a passage out of the wood, whereby to make its exit, until it attains its perfect state, I infer from the fact that several of these beetles gnawed their way out of one of the pillars of the portico of a newly-built house in my neighborhood some years since, the noise being heard several days before they emerged, and while they were still some distance in the interior of the wood." (Fitch.)

Mr. Bowditch found, June 9, at Brookline, Mass., this species in *Pinus mitis*, the yellow pine, in which were several holes about the size of a pencil. He makes the following statement in regard to its habits:

On removing the bark I found an adult insect already free—the heads of several others appearing through the wood. On further investigation during the next few weeks I obtained from the tree no less than eighty of these beetles in all stages of development, which, considering the size of the tree, was a large number. I observed that the largest beetles were near the foot of the tree. \* \* \* After remaining in the pupa state during a space of time, which varies according to circumstances, it is transformed to a beetle, and after a short time gnaws its way out, appearing from the first of June to the middle of July.

I have found numbers, at least twenty, of these larvæ under the bark of the white pine (*Pinus strobus*), at Brunswick, Me.,\* in the early part of June, but no pupæ or beetles, though most of the larvæ were fully grown. Some were one-half an inch long and had, without much doubt, hatched from eggs laid in the preceding June or July, so that the larvæ must live nearly two years before transforming. My attention was called to their presence in the tree by the creaking sound made by the larvæ, the noise being heard a rod from the tree. Some of the larvæ were molting. In this process the entire head of the tegument about to be cast is pushed off anteriorly, while the thin skin of the rest of the body peels off from the prothorax backwards.

Mr. A. C. Goodell, of Salem, Mass., presented the museum of the Peabody Academy with an adult of this species which came from a pine bureau about the year 1875. The bureau had been in his house for about fifteen years previous, being newly made when purchased. The family had heard the creaking noise for some time before the insect appeared; and, after inquiring into the circumstances, I have no doubt but that the insect had lived in the bureau for fully fifteen years.

This longevity is probably due to the fact that the insect had not coupled, it being well known that continence in insects leads to the prolongation of life far beyond their natural term of existence. Further observations and experiments on this point are greatly needed.

Apropos of this interesting subject I quote the following observations of Dr. Fitch:

The wood of the apple tree was formerly highly valued for cabinet work in this country. In 1786 a son of General Israel Putnam, residing in Williamstown, Mass., had a table made from one of his apple trees. Many years afterward the gnawing

\* I have also found the cells under the bark of the white pine at Providence, R. I.

of an insect was heard in one of the leaves of this table, which noise continued for a year or two, when a large long-horned beetle made its exit therefrom. Subsequently the same noise was heard again, and another insect, and afterwards a third, all of the same kind, issued from this table-leaf, the first one coming out twenty and the

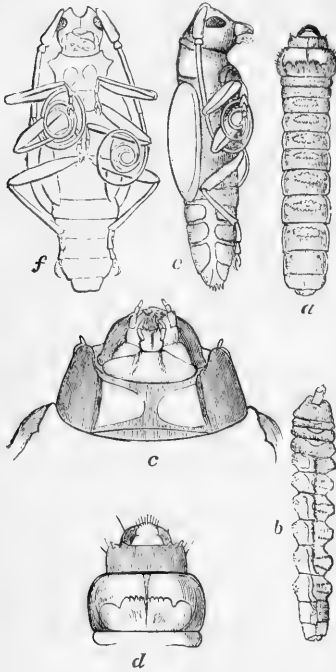


FIG. 226.—Larva of *Monohammus confusor*; *a* top, *b* side view, nat. size; *d* upper, *c* under side of the head, enlarged, *e* side, and *f* under side of pupa.—From Packard in Hayden's Survey.

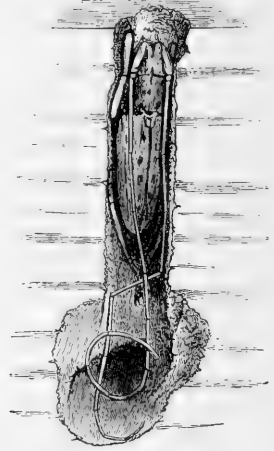


FIG. 227.—*Monohammus confusor*, the beetle in its cell in a piece of planed plank.—After Packard.

last twenty-eight years after the trunk was cut down. These facts are stated more fully in the History of the County of Berkshire, published at Pittsfield in 1829, p. 39. This, I believe, is the longest period of an insect remaining alive in timber of which we have any record, and it is desirable to ascertain, if possible, what insect this was. John J. Putnam, esq., of White Creek, N. Y., was a young man residing at his father's when these remarkable incidents occurred. On showing to him specimens of all the larger long-horned beetles of this vicinity, he points to *Cerasphorus balteatus* as being the same insect, according to the best of his recollection, but is not certain but it might have been the *Callidium agreste*.

“This testimony, in connection with what President Fitch, of Williams College, says of the insect in the notice above referred to—‘its color dark glistening brown, with tints of yellow’—releases us from all doubts upon this subject, as the *agreste* is of a uniform brown, whilst the *balteatus* commonly presents traces, more or less distinct, of an oblique yellowish spot or band near the middle of the wing-covers.”

Mr. Sereuo Watson adds the following case in a letter dated Her-

barium of Harvard University, Botanic Garden, Cambridge, Mass., April 3, 1882:

I have been looking over the copy of your insect "Bulletin No. 7," sent to Dr. Gray, and have been much interested in it.

I think that I can add an instance of the longevity of insects to those given on page 154, though there may be more of doubt attached to it. My grandfather in 1790 built a house at East Windsor Hill, Conn., the back porch of which was supported by large turned pillars upon bases some 15 inches square and 2 feet high, the whole, I presume, from a single piece of timber, and resting upon the hewn-stone underpinning, and well painted. Now, in my boyhood, some forty-five years afterward at least, our attention was for a long time attracted to a gnawing sound in the base of one of these pillars, and at length there escaped a large brown beetle, if I remember rightly. The hole, as large as my little finger, is probably to be seen there yet. The pillars I suppose to be of our common "yellow pine," *Pinus rigida*.

Although this borer is destructive to the white pine, I have not yet met with an instance where a living pine tree has been killed outright by it. In Maine, however, wherever the fir abounds, this insect is very destructive. While the fir is the least valuable of our timber trees, it is a beautiful shade and ornamental tree, though short-lived. It is especially liable to attack from this borer. In passing along any road in Cumberland County, particularly near the sea-coast, and also on the islands in Casco Bay, great numbers of dead firs are to be seen perforated with the round holes, large enough to admit a lead-pencil, made by this borer for the exit of the beetle.

I have already given instances in Bulletin 7, United States Entomological Commission, pp. 220, 236, of living fir trees killed by this borer. During the past summer I have observed several, at least four or five, living firs in which these borers were at work. The trees were either wholly fresh and alive or some of the branches were dead, as well as a part of the bark on one side. A large number of fully grown worms were taken out of a fir on Frenchman's Island, which was dead on one side, the other half of the tree being alive, and the leaves all fresh and green. There seems no reasonable doubt but that this tree, then, is attacked while in a perfectly healthy state by this borer, and killed after one or two years.

How thoroughly one or two females of this beetle may stock a single tree with young borers may be seen by reading the following account of observations made by us in the summer of 1884. It should be stated in this connection that we have been told by an intelligent lumberman near Rangely Lake, Maine, that large masses of living firs in that region have been killed outright by the borer, which is undoubtedly this species of beetle.

This beetle is a member of the family of long-horned beetles; its antennæ or feelers being about twice as long as the body. Its body is nearly as thick as one's little finger, and it is of a mottled gray color, marbled with white and dark-brown irregular patches. Thus marked it is, while resting on the bark of a moss-grown and lichen-covered fir, spruce, or

pine tree, protected from the observation of birds, its colors being so assimilated to those of the bark of either of those trees that it readily escapes observation. The beetle appears early in June, and is to be found through the summer until early in September; and at any time in July and August, as well as the first week in September, it lays its eggs in the manner to be described.

The exact mode of the deposition of their eggs by the Longicorn beetles is imperfectly known so far as we are aware.

Professor Riley has described in detail in the *New York Weekly Tribune*, February 20, 1878, the mode of oviposition of the Round-headed Apple-tree borer (*Saperda bivittata*), and his account has since been confirmed in the *Rural New Yorker* for January 12, 1884, by Mr. C. G. Atkins. The beetle makes a straight slit in the bark. Perris, in his *Insects du Pin Maritime*, describes the mode of oviposition of *Ergates faber* and *Criocephalus rusticus*, but not of *Monohammus*. We have been fortunate enough to observe the female beetle while at work making the incision with her jaws, though we have not observed the final act itself of deposition of the eggs. While examining the fir trees on the western shore of Birch Island, Casco Bay, Maine, on a warm, sunny afternoon of August 30, I saw a male *Monohammus confusor* standing on the bark of a living fir about 9 inches in diameter, within the distance of 2 inches from a female, whose jaws were buried in the bark of the tree on the western side of the trunk, which was exposed to the full rays of the sun.

On beginning to make the incision, each of the large, sharp, strong jaws of this beetle is pushed directly into the bark; they are then apparently brought together, and the result is a slight curvilinear gash which descends obliquely in the bark. It is probable that the beetle pries up the pad thus formed, so that the freshly cut edges are exposed, and an opening is thus formed into which the egg is thrust. While watching the female at work the male dropped to the ground, and his consort becoming alarmed withdrew her jaws from the incomplete incision, when I seized her. To the end of her abdomen were attached a few fragments of the reddish bark of the fir, and two or three small green pellets, probably excrement; but this showed that she had already deposited at least one egg, and that the labor was slight, the end of the abdomen probably being simply extended and thrust into the gap of the incision. The Longicorns, like most other beetles, have no true ovipositor, but the

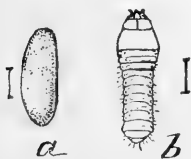


FIG. 228.—a, egg; and b, freshly hatched larva of *Monohammus confusor*.

end of the abdomen is a simple, flattened, horny tube, in which the oviduct terminates; the end of this sheath or tube is probably thrust into the gash made by the jaws.

By prying up the pad formed by the jaws a shallow but roomy cell or chamber is made for the egg, which lies nearly or quite horizontally, not vertically.



The egg (Fig. 228, *a*) is very large, ovo-cylindrical, well-rounded, but but tapering somewhat at each end, of a dirty-white color, and in length is  $4\frac{1}{2}$ mm.

On visiting the tree a week later and removing a portion of the bark and examining it, September 6-8, the eggs had in some cases hatched and the larvæ had begun to descend slightly into the bark. On hatching they begin at once to gnaw a mine, throwing their castings out through the gash originally made by the female, so that it was easy to ascertain without disturbing the bark whether the eggs had hatched or not. The larvæ indifferently lie with either side, dorsal or ventral, presented outwards. Three days after (September 12) several had bored through the pieces of bark, making the usual flattened oval hole, but probably in nature the larva remains hidden in the bark through the winter, not beginning to penetrate the wood until the following spring.

The length of the larva when freshly hatched was 5-6mm, and the body was rather stouter than in the fully-grown larva. (Fig. 228, *b*.)

How many eggs are laid by the female is not known, but, probably, judging by their large size, comparatively few.

Another female was found on the same tree. Over a hundred gashes had been made on the western side of this fir tree over a space 4 feet long; the gashes were so fresh that they must have been made on that and the previous days. They were quite conspicuous, and could, after one had become familiar with their appearance, be detected at the distance of 5 or 6 feet from the tree. I suspect that the sexes couple frequently during the operation of egg-laying, as the male was standing so near his mate with his antennæ outstretched and intently watching the female while at work. The males are also probably polygamous.

The industry of the female is well shown by the number of gashes made (Fig. 229 *a*, *b*), some of which did not, however, contain any eggs. In the space of a square inch there were three gashes, while in the region where they were thickest forty were counted in half a square foot. Of course when they hatch all do not live to pass through their transformation. Whether the woodpeckers seek for and discover the larvæ ensconced in the bark is doubtful, and yet it would be easy for them or other birds to pick the grubs out of their hiding places. So far as my observations have gone the holes made by the woodpeckers in forest trees are for the purpose of getting at the inner bark rather than for insects. But a careful examination of woodpeckers shot in coniferous forests would throw light on this subject.

In regions where the white pine grows it is infested by the Monohammus. The spruce is also often infested, but I have not seen clear cases where either of those trees have been killed outright by this destructive borer. But during the past summer (1885) I have seen on the islands in Casco Bay and taken out the full-grown larvæ from at least six or seven living firs, which must have been killed by the attack

of this borer, and which has been the evident cause of the death of many firs in Maine.

I have seen hundreds, perhaps nearly a thousand, dead firs whose trunks were riddled with the holes of these borers. The spruce is less frequently killed, but I have taken from a dead tree two pieces of spruce bark, each about 6 inches square, one containing sixteen and the other eighteen holes through which the beetle had escaped. Fig. 230 represents one of these specimens of natural size.



FIG. 229.—Oviposition of *Monohammus confusor*; a, a, a, jaw punctures; b, one of them laid open to show position of egg—natural size. (Original.)

That the larva is not less than two years in attaining its growth is proved by the fact that on examining the same tree in which we saw the female ovipositing, August 30, 1884, the next season, June 26, 1885, I took from under the bark a larva 14<sup>mm</sup> in length, or about one-third as long as the mature worm.

*Larva*.—Body soft, white, long, nearly cylindrical, being but slightly flattened, entirely footless, all the abdominal segments of the same width, except the minute small one. From the first abdominal segment (or fourth from the head), the body increases in width, being widest on the prothoracic segment (or the one next to the

head). This segment is transversely oblong, being as wide in front as behind; it is a little more than twice as wide as long. The head is large and square, not narrowing in front, but as wide anteriorly as posteriorly. When the head is forcibly pulled out it is found to be as long as broad; anterior one-fourth of head, deep mahogany red, becoming blackish on the edge. Clypeus very short and broad, about four times as broad as long. Labrum rather wide, not much contracted at base, rounded in front, with very stout bristles on the margin. Mandibles gouge-like, the ends oblique, hollowed out, with the outer edge produced into a point. Antennæ very minute, three-jointed, the second and third joints about as long as the basal. The

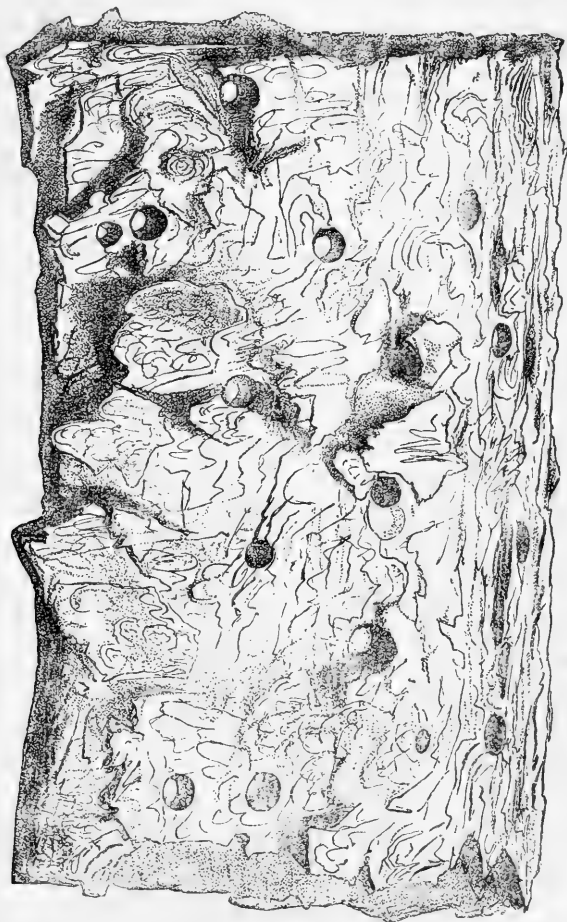


FIG. 230.—*Monohammis confusor*, bark showing exit perforations of mature beetles. (Original.)

maxillæ form a basal joint, throwing off a three-jointed palpus, and an inner lobe armed with stiff bristles, reaching to the end of the second joint of the palpus. The 2-jointed labial palpi reach to as far as the middle of the brush-like lobe of the maxillæ; the second joint is about as long, but half as wide, as the basal. The middle of each segment, especially the third to the seventh above and below, with a transverse callous spot. The upper side of the first abdominal segment has a very narrow oblong square area impressed upon it. The callous spot is best marked on the fifth segment, consisting of an area about one-third as long as broad, with a square, shal-

low sinus posteriorly, and with the sides projected inwards; it consists of two series of callous spots, the outer forming the limits of the area as above described, and the inner series forming a simple transverse, narrow, lanceolate, oval spot. The callous spot on the under side has a sinus in front, but slightly rounded behind. The one on the seventh segment (below) is but little more than one-half as wide, with a broad sinus on the hind edge, and with the sides directed obliquely inwards. Terminal segment very small, half as wide, and one-fourth as long as penultimate segment. Nine spiracles, the first on front edge of second thoracic (mesothoracic) segment. Length when fully grown,  $1\frac{1}{2}$  inches.

This larva may be known from that of *Rhagium lineatum* by its lack of any thoracic feet and by its much longer, more cylindrical body, and differs at once by the long, square head, that of *Rhagium* rounding in front; by the wider clypeus, and proportionately wider and shorter labrum. The palpi and antennæ do not differ much. The callous spots on the abdominal segments are smaller and otherwise different from those in *Rhagium*.

*Pupa*.—The pupa is far advanced, being nearly ready to change to a beetle, the body becoming dusky and horn-colored, while the characteristic dark spots have already appeared on the wing-covers. The antennæ are coiled up three and a half times at the end between the fore and the middle pairs of legs, and the genus may be recognized by their great length and the deep excavation in the head between them, as well as by the lateral short spine on the prothorax.

The wing-covers in my single specimen reach to the third abdominal segment, and are pressed obliquely to the side of the body. The salient portions of the upper side of the abdominal rings are provided with fine spines. End of the body sinuate.

In the absence of another pupa of this genus for comparison, additional characteristics can not now be given. Length, three-fourths of an inch.

Mr. George Hunt has taken both this species and *M. scutellatus* "coming out of the white pine" in July in northern New York and in Rhode Island. Prof. F. H. Snow records it in the seventh volume of the Transactions of the Kansas Academy of Science as occurring in the Baptist church in Lawrence, Kans., "where repairs had been made with pine lumber."

Although I have seen no specimens of the larva or of the beetle from the Southern States, I have no doubt but that it is the larva of this species which from North Carolina southwards is called the "sawyer." Mr. Thomas C. Harris, of Raleigh, N. C., has informed me that a larva of this description has killed many pines in that State. In June, 1884, he sent me the following extract from a local paper, which bears on this subject:

We were informed by Maj. C. W. McClammy, of Scott's Hill, Pender County, that the pine trees are dying in his own and other sections of Pender and New Hanover Counties. It is supposed that it is the "bore-worm" or "sawyers," which played such havoc with the pines something over thirty years ago, that are operating upon them now. Their ravages are not confined to the old trees, the young ones dying just as rapidly and numerously.

The following extract from the Scientific American refers to what is with little doubt the species we are now considering:

A correspondent of the Northwestern Lumberman says: It is not generally known, yet a fact, that extensive and valuable forests of yellow pine in the Southern States are destroyed by a worm, commonly called here at the South a "sawyer," or flat

head. It is the opinion of a majority of the people in the South that the worm follows the death of the yellow pine, but close investigation has proved that although they never attack a forest or body of timber without first having a dead tree to start upon, they do not adhere to the rule after once getting a start. For instance, should a tree from any cause be felled or lodged against other timber, where the two are standing very close together, the worm will enter the adjacent timber though it be green and alive, and in this manner continue to spread until the entire forest is destroyed. Indeed, I have known instances where only a small sapling lodged against other timber caused considerable injury to the timber by souring, and thus attracting the parent worm or saw-fly, and after accomplishing their work on the sapling they lose no time in removing their forces and attacking any of the timber that may be next closest; and in this way continue to spread until vast forests are denuded of their timber.

The parent fly, or rather bug, is  $1\frac{1}{2}$  inches long, and of an iron-gray color. It has two feelers, or indicators, projecting from the head, from 2 to  $2\frac{1}{2}$  inches long, about the size of a very coarse horse-hair. They are also provided with two teeth, operated by them similar to a pair of pincers, which are used in cutting through the pine bark to deposit their eggs. They attack the trunk of the tree first, and at any time during the summer season, but they seem to be more numerous and destructive during the months of June and July. The bug begins by eating numerous small holes through the bark, and very dexterously it deposits from four to six eggs in the edge of the sap, at the bottom of the hole thus made. From two to three days after the eggs are deposited in the sap, they hatch and produce a worm one-fourth of an inch long, which immediately begins eating the sap, and steadily continues until the sap of the entire tree is consumed. A full grown worm is  $1\frac{1}{2}$  inches long, and is at any age a clear, white color, excepting the head, which is dark red. They have no legs, but are seemingly jointed, and perfectly powerless to get about or travel, unless they are in their hole, where they utilize those joints to answer them the purpose of legs, and travel with astonishing rapidity.

As the worms become full grown and the sap scarce, they enter the sappy portion of the timber, and cutting and forming a hole as they go of sufficient size to admit them, they thus wind about through it and render it worthless, even before it has been damaged by decay. So prevalent and sure are they in the summer months that the mill men of the South dare not keep a supply of logs longer than a few weeks in advance, unless they are provided with a boom or body of water of some sort to place them in, which is the only means of effectually preventing the logs from being eaten.

## 21. THE MARBLED PINE-BORER.

### *Monohammus marmoratus* Randall.

A large white grub very similar to the last preceding one, and boring in the interior of the wood, often in the same trees and logs with it. The beetle coming abroad in July and very similar to the preceding, but always smaller, measuring 0.75 to 0.90 in length, and distinguished from it by having the short hairs coating the base of the spine on each side of the thorax of an ocher-yellow color instead of white, the thorax with numerous confluent punctures across its middle, its wing-covers ash-gray marbled with fawny brown cloud-like spots, and punctured like the preceding species, but the punctures here becoming much more dense towards the base and running into each other, the antennæ in the females with an ash-gray band at the base of each joint, their length in the two sexes as in the preceding species. (Fitch.)

This is not a particularly common insect, though more closely allied to the foregoing species than the following better known one.

## 22. THE WHITE-SCUTELED PINE-BORER.

*Monohammus scutellatus* Say.

A large white grub, closely like the foregoing, and boring in the wood in a similar manner, in the month of June producing a beetle of similar form but of a shining black color, its wing-covers having small patches of short hairs here and there resembling spots of white mold, their surface rough from coarse confluent punctures and the thorax similarly punctured across its middle, its base and apex with irregular transverse wrinkles, and its sides with a conical spine, which is not clothed with hairs; the scutel coated over with white hairs, and the antennæ double the length of the body in the males, and in the females with a gray band on the base of each joint, its length varying from 0.60 to 0.75. (Fitch.)

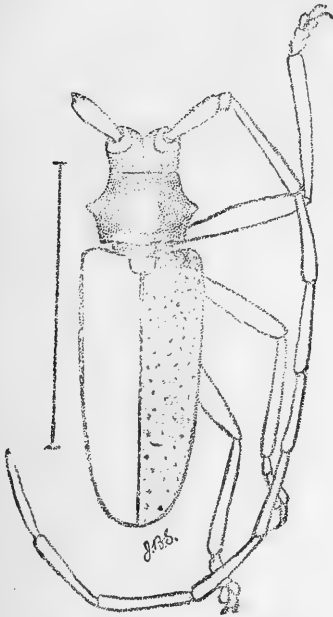


FIG. 232.—*Monohammus scutellatus*.—  
Smith del.

This is a common and sometimes abundant beetle in Maine and northern New England generally, and especially in the lumber regions of Lake Superior, whence I have received it in large numbers. It also occurs in the pine forests of British America and in Washington and Oregon along the Pacific coast. Though I have taken it on the white pine, in Maine, in July, I can not relate more concerning its habits and larval forms than is contained in Dr. Fitch's brief account given above.

## 23. THE PINE-EATING GAY-BEARD.

*Eupogonius pinivora* Fitch.

Order COLEOPTERA; family CERAMBYCIDÆ.

A small grub resembling a young apple-tree borer, mining the wood of the pine, and in July becoming a small cylindrical long-horned beetle, which is found upon the leaves, 0.25 long and about a third as broad, clothed with numerous erect black hairs on the body and antennæ, and gray ones on the legs; its color shining pale chestnut, with irregular and oblique and transverse spots and streaks of gray on the wing-covers, which are coarsely punctured, the punctures dense on the base and fine on the apex; its thorax narrower, slightly darker colored, closely punctured, having a very small tooth-like point on each side and along its middle a gray line which is widely interrupted in the center, the sides and also the head with thin gray pubescence; its antennæ shorter than the body, coarse, and the joints becoming suddenly shorter after the fourth; its under side blackish brown, the legs pale chestnut.

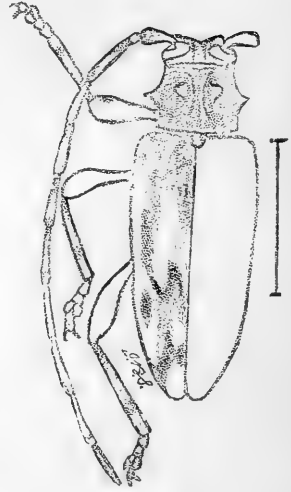
This species is of the same color with *E. tomentosus* of Haldeman, which, however, is larger, with gray hairs instead of black, and the wing-covers with ocher-yellow spots and streaks. (Fitch.)

## 24. THE COMMIXED LEPTOSTYLUS.

*Leptostylus commixtus* Haldeman.

Order COLEOPTERA; family CERAMBYCIDÆ.

A small long-horned beetle occurring on the leaves of the pine in July, its appearance and shape closely like that of the prickly *Leptostylus*, and its larva probably having similar habits and the same form; the beetle 0.25 to 0.36 long, its thorax closely punctured, blackish obscurely varied with ash-gray and with elevated black dots placed symmetrically, the sides convex and with a small angular tooth back of their middle; its wing-covers coarsely and closely punctured, dull and gray varied with paler gray and with black clouds and dots, two faintly elevated ribs on each wing-cover of a slightly paler gray tint alternated with black dots, the inner rib having an elongated black spot near its base, another beyond the middle, and a third one farther back, formed by obscure dusky transverse clouds which cross the ribs at these places; the sides black, alternated with a whitish cloud-like spot near the base, and a smaller one near the middle. (Fitch.)

FIG. 233.—*Leptostylus commixtus*.—Smith del.

## 25. THE LESSER PINE-BORER.

*Asemum mæstum* Haldeman.

(Larva, Pl. XIX, Fig. 1.)

Order COLEOPTERA; family CERAMBYCIDÆ.

Perforating the trunk of the white pine in all directions and sinking into the heart of the tree, making a flattened cylindrical hole or mine when seen in outline; a rather small larva, which emerges late in May through oval holes in the bark, especially around the base of the trunk; the beetle blackish brown with short antennæ and legs.

The transformations of this common borer, which apparently attacks the tree in health as well as in disease, like the species of *Monohammus*, were first briefly described and figured in our "Guide to the Study of Insects" from specimens found in all stages under the bark of the oak early in May at Salem, Mass. I have also received a larva of this species from Dr. Shimer, which was found by him boring in the grape-vine. Since then Mr. Riley has bred it from the Scotch pine, and Mr. Schwarz has found the pupa under the bark of pine stumps in Florida in March. During the past May I have found, in company with Mr. Calder, at Providence, the perfect beetles, and also the pupa in deep burrows or mines in white-pine stumps. I have heretofore regarded

the holes made by this borer as probably those of *Chalcophora virginiensis*, but they are regularly oval cylindrical, less flattened oval than those made by a Buprestid, and exactly like those of other flat-bodied longicorns. The openings, usually most abundant on the south side of the tree or stump, in the base of the trunk of the white pine, are at times very numerous, as many as ten in a space of 5 square inches. They are, on the average, 6<sup>mm</sup> wide by 3<sup>mm</sup> deep, or half as deep as wide. The sides are smooth, but the orifice is often partially concealed by projecting portions of the bark. The holes are deep, extending 6 or 8 inches towards the heart of the tree. Seen longitudinally the "mine" or tunnel is about a quarter of an inch (6<sup>mm</sup>) wide, sometimes wider, and ends in an elongate oval cell, wherein the pupa rests. Some extend up and down under the bark, while most of them plunge deep into the wood.

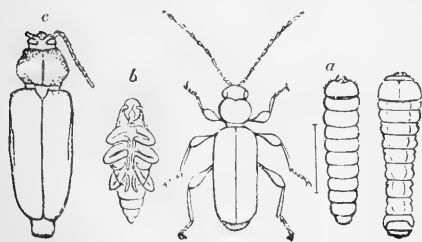


FIG. 234.—a, Larva; b, pupa and beetle (enlarged twice) of the lesser pine-borer.—From Packard. c, the beetle, after Leng.

*Larva*.—Prothorax inclined downwards towards the head; quite long and not very wide, being no wider than the mesothoracic and metathoracic segments, the squarish area being very long, naked on the basal third, the front margin pale brown, chitinous. Mesothoracic and metathoracic segments as wide as the prothoracic; the metathoracic slightly longer and fully as broad as the mesothoracic segment. Abdominal segments rather broad, the second the shortest and the seventh the longest; the eighth two-thirds as long

as the seventh and considerably narrower; the ninth one-quarter as long as the eighth and three-fourths as wide; the tenth only seen from beneath, and about two-thirds as wide as the ninth, and bilobed at the end. On the two hinder thoracic and the first abdominal segment are transverse regular oblong areas bounded by impressed lines; on segments 2 to 4 the callosities are narrower, and the anterior side is pointed; on the sixth and seventh they are a little longer than broad and contracted posteriorly. Beneath are similar callosities, but the anterior edge is feebly indicated, the sides being most distinct. Thoracic feet minute, 3-jointed, small and rather short; third joint one-half as thick as the second. Head: Clypeus very small, membranous; labrum small, narrow, though longer than wide, and well rounded in front; mandibles solid, thick, rounded at tip; antennæ 4-jointed, rather slender; second joint about one-half as long as the first and about one-quarter shorter than the third; the fourth minute, slender, about two-thirds as long as the third is wide. Maxillæ with the lobe rather broad, not very hairy, extending as far as the end of the maxillary and labial palpi; maxillary palpus 4-jointed; first joint much shorter than long, flattened, spherical; second subspherical; third one-half as long as the second; fourth longer than the third, but only about one-half as thick. Mentum narrow, about one-third as long as wide; ligula long and narrow; labial palpi 3-jointed; first joint a little longer than thick; second very short, spheroidal, a little less than one-third as long as first; third conical, considerably longer than the second and one-half as thick. Length, 12<sup>mm</sup>; length of prothoracic segment, 2<sup>mm</sup>; breadth, 3<sup>mm</sup>; breadth of eighth abdominal segment, 2.5<sup>mm</sup>.

The pupa is .44 inch long. It is flattened and rather broad, and may be readily identified from the other pupæ of the genus, as it has the characters of the species, viz, by the short antennæ, which do not extend quite as far as the hinder edge of the



metathorax, the joints composing it being much shorter than in the other species. It may also be recognized by the two raised longitudinal lines on the wing-covers corresponding to those on the wing-covers of the beetle; the wing-covers extend to near the middle of the second abdominal segment, and the tips of the hind legs reach nearly to the posterior edge of the third abdominal segment. The end of the abdomen is square, and ends in two sharp, slender incurved hooks, which are dark red at tip. Length, .44 inch.

The beetle differs from two larger common beetles (*Criocephalus agrestis* and *obsoletus*) with which it associates, by its much smaller size, which, however, is very variable, and by the much shorter antennæ, the joints being much shorter and thicker and more coarsely pitted than in the two species above named. It is brown-black, with a rounded, flattened prothorax, and two longitudinal ridges along the wing-covers.

I have taken this beetle at Nederland, in Colorado, June 30; it undoubtedly preys upon coniferous trees in the Rocky Mountain region. It is also said by Le Conte to occur in Russian America (Alaska).

26. *Criocephalus agrestis* Kirby.

(Pupa, Pl. xvii, fig. 3, 3a.)

Boring into pines from Maine to Colorado and the Pacific coast, a rather large white longicorn larva; assuming the pupa state in May and the beetle state in June and July.

This large beetle closely resembles *Asemum moestum*, but is about twice as large, with much longer and slenderer antennæ; it is also characterized by the three large irregular pits on the top of the prothorax; these pits are also seen in the pupa, and by them the pupa noted below was identified as belonging to this species. In color and the two high ridges on each wing-cover it closely resembles the more abundant *Asemum moestum*.

I found what I regard as the pupa of this species under the bark of the pitch-pine at Providence, May 20, 1881. From its close resemblance to the pupa of *Asemum moestum*, from the form of the prothorax and the three pits which correspond so closely to the beetle, I do not doubt but that the pupa should be referred to *C. agrestis*.

The antennæ of the pupa are long and reach to the basal sixth of the wing-covers; they thence re-curve, so that the tip touches the basal third of the fore tibiæ. The end of the abdomen has two spines, much as in the pupa of *Asemum moestum*; the wing-covers have each two longitudinal parallel straight raised lines, while the body in general is flat and rather broad, as in the beetle. The pupa is 25<sup>mm</sup> in length; breadth of body, 7½<sup>mm</sup>.

*Criocephalus productus* Le Conte I have taken in Colorado and in Utah, and I have received it from Tacoma, Wash., on the shores of Puget Sound. It undoubtedly inhabits pine trees, and represents the Eastern *C. agrestis*.

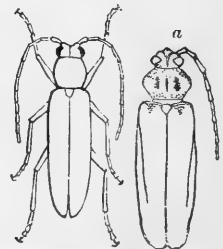


FIG. 235.—*Criocephalus productus*.—From Packard. a, the same after Leng.

27. *Ædilis nodosus* Fabricius.

Found under the bark of the pine from June to September. The specimens collected about Philadelphia are quite small compared with those found in the pine forests of New Jersey. (Bland, Proc. Ent. Soc. Phil., i, p. 97.)

28. *Ædilis obsoletus* Olivier.

Taken under the bark of pine stumps at and near Philadelphia. Not common. (Bland, *l. c.*)

## 29. THE PINE EUDERCES.

*Euderces pini* Olivier.

Order COLEOPTERA; family CERAMBYCIDÆ.

To distinguish this beetle from *Psenocerus supernotatus* it is only necessary, says Dr. John Hamilton, to remember that the prothorax of *E. pini*, instead of being pitted, is longitudinally rugose, and that there is on the elytra anterior to the middle a smooth, ivory white, obliquely transverse line, which is wanting in *P. supernotatus*. (Can. Ent., xvi., p. 36.)

A small cylindrical long-horned beetle, having a wide separation between its thorax and abdomen, giving it some resemblance to an ant, 0.23 to 0.30 long, of a bright chestnut color, with its abdomen and the posterior third of its wing-covers black, the wing covers crossed obliquely forward of their middle by a silvery white line which does not reach to the suture, and posteriorly on the fore part of their black portion a gray band, which is placed in a shallow groove running obliquely and parallel with the silvery line; the thorax covered with fine impressed lines running lengthwise.

This is said by Olivier to have been found on pines around the city of New York, but it is probably a Southern insect. (Fitch.)

## 30. BLACK-HORNED CALLIDIUM.

*Callidium antennatum* Newman.

Order COLEOPTERA; family CERAMBYCIDÆ.



FIG. 236.—*Callidium antennatum*.—After Leng.

A flattened long-horned beetle, appearing in May and June, about 0.52 long, of a deep Prussian blue color, often with shades of green in places, its antennæ and legs black, its thorax hairy, and as broad as the wing-covers, with the sides strongly rounded and above on each side of the middle a little round hollow spot, and its wing-covers rough from close shallow punctures. (Fitch.)

Dr. Harris regarded this as identical with the European *C. violaceum*, deeming the latter to have been probably introduced into Europe from this country. (Treatise, p. 88.) But entomologists now consider the insects of the two continents to be distinct species. Ours, doubtless, has the same habits with that

of Europe, the larva living in the trunks of pines, excavating a wavy shallow track under the bark, which is packed full of sawdust, and when almost fully grown sinking itself obliquely downwards several inches into the wood, to repose during its pupa state.

Specimens occur in which the thorax is plainly narrower than the wing-covers, more distinctly punctured, and destitute of the two impressed spots. These are the violet-colored *Callidium*, *C. janthinum* of Dr. Le Conte and of Dejean's Catalogue. But individuals appear to occur of all intermediate varieties, and I am therefore inclined to think they can scarcely be regarded as constituting two distinct species. (Fitch.)

We have observed this beetle in considerable numbers under pine boards, and also flying, at Brunswick, Me., in the middle of May. Mr. George Hunt has observed it in pine trees at Providence, R. I. We found at Providence, May 14, a dozen or more individuals under the bark of a dead *Juniperus virginiana*. The track made by the larva, as we supposed it must have been of this insect, was irregularly wavy, like that of other longicorn grubs, and filled its castings compactly with a fine dust; it was shallow and 4 or 5 inches long. Whether it was made before the death of the tree is unknown, but the work of this and its fellows had loosened the bark, several larvæ having been at work together.

Regarding the confusion existing between this beetle and *Psenocerus supernotatus* Dr. John Hamilton writes as follows (Can. Ent.):

Five times this has appeared on the lists of some of the more accurate of my correspondents, and as many times, instead, have I been sent *Psenocerus supernotatus* Say. I could scarcely account for this, and for the great demand for so common and so widely distributed an insect as *P. supernotatus*, till an appeal for the correctness of the determination *pini* was made to the Journal of the Acad. Nat. Sci., ser. 2, v. 2, p. 158, the writer stating that Dr. Le Conte had several years ago so named his insect. Reference to the place cited shows that Dr. Le Conte then regarded the *Callidium pini* Oliv. and the *Clytus supernotatus* Say as one species, which he placed in the genus *Psenocerus*. Subsequent investigation proved that *pini* (which had been unknown in nature to Dr. Le Conte) was different from *supernotatus*, both as to species and genus. The error was corrected in the books, but it has given rise to a great mistake in the tradition of the insect. I have not yet seen *pini*, but from the description of Dr. Le Conte (Smithsonian Misc. Coll., 1873, vol. vi, p. 202), it certainly resembles *P. supernotatus*. To distinguish them at a glance, it is only necessary to remember that the thorax of the former, instead of being pitted, is longitudinally rugose, and that there is on the elytra anterior to the middle a smooth, ivory white, obliquely transverse line which is wanting on the latter. *E. pini* seems rare. *P. supernotatus* is one of the few Cerambycids that occasionally hibernates. In February of the present year I found three in the folds of a *Cecropia* cocoon taken from some currant bushes.

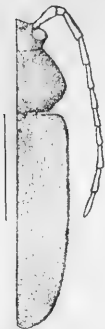


Fig. 237.—*Hylotrupes bajulus*.  
—After Leng.

### 31. THE PORTER HYLOTRUPES.

*Hylotrupes bajulus* Linnæus.

Order COLEOPTERA ; family CERAMBYCIDÆ.

A beetle very similar to the preceding in its shape and habits, appearing in July and August, .45 to .75 long, of a black color, its thorax nearly circular and clothed with white hairs, with a smooth polished black line in its center, and a callous-like spot on each side of it, and its wing-covers with very coarse, shallow confluent punctures and some downy whitish spots, forming two irregular bands near the middle.

This species is supposed to have been introduced in its larva state in timber from Europe, and is found in our country only near the sea-coast. (Harris' Treatise, p. 88.)

### 32. THE LESSER PRIONUS.

*Orthosoma brunneum* De Geer.

Order COLEOPTERA ; family CERAMBYCIDÆ.

A flattened long-horned beetle, 1.00 to 1.30 long, and less than a third as broad, with its opposite sides parallel, its thorax twice as broad as long, and with three sharp teeth on each side, its wing-covers with two or three slight elevated lines, its antennæ scarcely as long as the body, and its color chestnut red, darker anteriorly

Two dozen or more of the grubs were taken, May 26, by Mr. Calder and myself from a very soft, rotten pine stump; up to June 24 they had not pupated in confinement, but by the 5th to the 8th of July one of them became a pupa.

Mr. Calder has also found the fully grown larvæ in August in maple logs at Warwick, R. I., and in the rotten wood of another deciduous tree. So that it appears that this beetle lives indifferently in the soft, decayed logs or stumps both of hard and coniferous trees.

*Larva*.—Described while alive. Body cylindrical, not flattened, the segments very distinct, as the sutures are deeper than usual; head moderately broad; prothorax large and broad and rather long, being 9<sup>mm</sup> broad and 4½<sup>mm</sup> long; surface rough on the posterior two-thirds. On each of the first to seventh abdominal segments is a transverse oval cylindrical fleshy area, each with three transverse folds, the area on the seventh ring being nearly twice as long (antero-posteriorly) as that on the first, the areas becoming longer and narrower, *i. e.*, more rounded, going backward towards the seventh segment; the end of the abdomen smooth and shining; each thoracic segment with a pair of slender three-jointed feet. Length, 35<sup>mm</sup> (1¼ inches).

In addition to the description on p. 161 of Bulletin 7, the following characters may be noted :

Head about one-half as wide as the prothorax. Front edge of epicranium rough, black, with a spine on each side below, projecting over the clypeus ("epistoma" of



FIG. 238.—The lesser Prionus.  
Natural size.—After Riley.

Perris); upper edge overhanging and irregularly denticulated. Clypeus subchitinous. Labrum much broader than long, well rounded in front, with numerous stiff bristles. Antennæ three-jointed; basal joint partly covered by a projection from the epicranium; second joint one-half as long and about three-fourths as thick as the first; third joint nearly three times as long as the second, somewhat barrel-shaped, being contracted at base and obtusely conical at the distal end. Maxillæ with the lobe well developed, the lobe not being very broad, abundantly bristled, and extending as far as the end of the third palpal joint. Maxillary palpus 4-jointed; third joint but slightly longer than the second, the fourth as long as the third, but one-half as thick, conical, pointed at the end, and extending well beyond the closed mandibles. Labium: mentum short and very broad; ligula nearly as long as broad, front edge well rounded. Palpi 2-jointed; basal joint thick and short, globose; second joint conical, contracted in the middle as if subsegmented. Mandibles acute, slightly bidentate. Feet moderately stout, three-jointed, the two basal joints nearly alike, the third conical, and bearing a single claw. Length of the specimen, 75<sup>mm</sup>; width of prothorax, 11.5<sup>mm</sup>; of prothoracic disk, 10<sup>mm</sup>; length of prothorax, 8<sup>mm</sup>; length from base of head to tip of labrum, 4<sup>mm</sup>; width of head, 6<sup>mm</sup>; length of antennæ, .8<sup>mm</sup>; of leg, .6<sup>mm</sup>; width of mesothoracic segment, 12.5<sup>mm</sup>; of first abdominal segment, 11.5<sup>mm</sup>; of fourth abdominal segment, 10<sup>mm</sup>; length of eighth abdominal segment, 4<sup>mm</sup>; of ninth, 8<sup>mm</sup>.

*Pupa*.—Antennæ bent near their end at right angles and laid across the end of the elytra, the latter reaching to the middle of the hind tarsi. End of the abdomen terminates in a singular ruffle-like expansion, armed on the edges with stout spines. Hind tarsi reaching to the middle of the fifth abdominal segment. The body considerably curved. Maxillary palpi extended well beyond the end of the mandibles. Prothorax with a broad-based spine on the side. The projecting parts of the abdominal segments with fine spines, and segments 3 to 5 with a pair of transverse, thin, dark-brown chitinous patches. Length, 30<sup>mm</sup>.

*Beetle*.—In this genus the hind femora are not deeply furrowed; there are several short elevated ridges on the inner surface, while the antennæ are filiform. The prothorax is tridentate, and the body is throughout light brown. The fifth ventral segment is rounded in the female, but broadly truncate in the male, leaving the sixth visible. Length, .90 to 1.75 inches.

### 33. *Prionus emarginatus* Say.

Probably injuring shade or timber trees in Utah, a dark-brown beetle of the following appearance:

Body castaneous; head, thorax, and breast covered with long yellowish ferruginous hair; antennæ fourteen-jointed, glabrous, perfoliate, imbricate; the imbrications emarginate beneath; mandibles black at tip; thorax but slightly margined, one-toothed on the middle of the lateral edge; angles obtusely rounded; elytra somewhat unequal, punctured; feet and venter subglabrous. Length, nearly seven-tenths of an inch. Female glabrous; antennæ simple. Length, four-fifths of an inch. This species exhibits the general form of *brevicornis*, but the thorax is proportionally much narrowed, and the characters above detailed prove it to be very distinct from that species. The lepaceous processes of the antennæ are so profoundly emarginate beneath as to appear each bilobate. I obtained it on the Arkansas River near the mountains. (Say.)

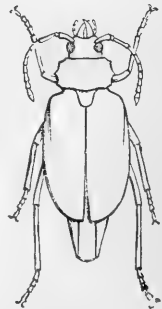


FIG. 239.—*Prionus emarginatus*.—From Packard.

34. *Ergates spiculatus* Le Conte.

Bores in *Pinus ponderosa* in Colorado. (A. S. Fuller. Amer. Ent., iii, p. 238.)

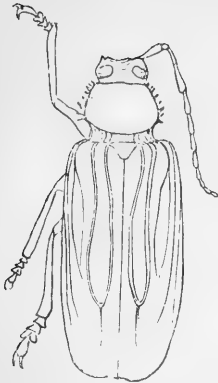


FIG. 240.—*Ergates spiculatus*.—After Leng.

35. *Criocephalus nubilus* Le Conte.

The larva bores in roots of yellow pine (Tampa, Fla.), the beetle appearing in April. (E. A. Schwarz. Amer. Ent., iii, p. 238.)

## 36. HARRIS' PRIONUS.

*Tragosoma harrisii* Le Conte.

Order COLEOPTERA ; family CERAMBYCIDÆ.

A beetle closely resembling Prionus, but with much shorter antennæ, only one tooth on each side of the thorax, and several raised lines on the wing-covers.

This rare insect, which has only been found hitherto in New England and Newfoundland, inhabits New York also, and I infer it to be bred in the pine, having in one instance met with the beetle, dead, under the loose bark of one of these trees. (Fitch.)

"A specimen of this species was found by Mr. Gibbs east of Fort Colville [Oregon]. It probably extends its range across the continent in more northern latitudes." (Le Conte, Proc. Acad. Nat. Sc. Phil., Nov., 1861, p. 354.)

Mr. George Hunt has collected it among the pine forests of the Adirondacks, northern New York.



FIG. 241.—*Tragosoma harrisii*.—After Smith.

## 37. THE RIBBED RHAGIUM.

*Rhagium lineatum* Olivier.

(Larva, Pl. XXI, figs. 1, 2.)

Order COLEOPTERA ; family CERAMBYCIDÆ.

Common in the pitch pine, several often in the trunk of the same tree, excavating a broad irregular patch in the outer surface of the sap-wood, the cavity being mostly filled with sawdust, a yellowish white grub about an inch long, divided into segments of nearly equal length and width, except the second which is the broadest, and the last which is narrowest with its end rounded; surrounding itself with a broad oval ring of woody fibers, like short threads, placed between the bark and the wood, in which to pass its pupa state; changing to a beetle, which lies in the same cell through the winter and comes abroad in the spring; the beetle 0.40 to 0.70 long,

long and narrowish, its head and thorax much narrower than the wing-covers, cylindric, clothed with soft gray hairs upon a black ground; the thorax with a black stripe above and one on each side, where is also a stout spine; the antennæ only reaching the base of the wing-covers, which are dull yellowish gray variegated with black, each with three elevated lines, the outer two uniting at their tips. (Harris' Treatise, p. 102.)

We have found the beetles and pupæ of this beetle under the bark of a white pine log at Salem, Mass., in abundance in October, and have also detected it frequently in Maine in the same situations in the spring, April 24, both in the larval and adult state.

This larva is very common under the bark of pines which have been cut down for a year or more, so that the larva evidently gets its growth in a year. It may be easily recognized by its large size, the broad, flattened head and body, the latter not narrowing behind; the prothorax is small in proportion to the head, while the antennæ are minute, two-jointed. The form of the body, and especially of the hard, corneous head admirably adapts it for its work of loosening the bark, and thus forwarding the decay of stumps and fallen trees.

*Larva.*—Body long and narrow, head remarkably large, as wide and as large as the prothoracic segment.

Head behind with a triangular incision; the apex of the incision is met by a curved line passing back from the outside of the antennæ, dividing the epicranium into two areas. Clypeus more solid than usual. Labrum about twice as wide as long, and moderately rounded in front. Antennæ minute, very short, two-jointed, the joints much shorter than broad (when retracted), and the second joint blunt at tip. Mandibles large, with three teeth on the cutting edge. Maxillæ composed of two broad segments and a third narrower one bearing the maxillary lobe and palpus; the lobe long and narrow, curved inward, reaching to the middle of the third palpal joint; palpus three-jointed, the basal joint somewhat swollen at the end; second as long as the first, tapering toward the distal end; third small, conical, as long as the second is thick. Mentum wider than long, square; ligula square, but slightly convex on front edge; labial palpi three-jointed, second joint a little slenderer than first, but of the same length; third joint slender and as long as the second is thick.

Prothoracic segment not so much wider than the rest of the body as in the Longicorn larvæ in general; sides straight, retreating posteriorly; surface flat and chitinous; meso and metathoracic segments as wide as the prothoracic, but a little more than one-half as long as the first abdominal segment. Thoracic feet long and slender, four-jointed, the fourth joint minute, corneous, second and third joints of the same length, the third two-thirds as thick as the second.

Abdominal segments increasing very slightly in length to the eighth, which is slightly longer than the preceding ones, but a little narrower than the seventh; the ninth shorter and nearly one-quarter narrower than the eighth; the tenth scarcely visible from above, one-quarter to one-fifth as wide as the ninth, and deeply cleft posteriorly. Callosities very large, soft, not well defined, being elongate, transversely-oval areas, bounded laterally by curvilinear impressed lines. Beneath, the callosities are a little more distinctly marked, with a transverse deeply impressed straight median line, into which short curved lines pass, the whole area being oval-cylindrical, compressed in the middle. The hairs on the body rather long.

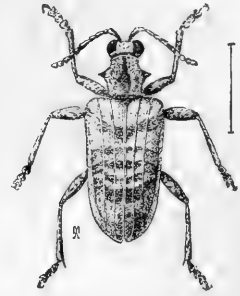


FIG. 242.—*Rhagium lineatum*.—Marx del.

Length of the body, 26 to 30<sup>mm</sup>; in one 30<sup>mm</sup> in length the head is 3 to 4<sup>mm</sup> long and 6<sup>mm</sup> broad; prothorax 2.3<sup>mm</sup> long and 6<sup>mm</sup> broad; breadth of eighth abdominal segment, 5<sup>mm</sup>.

The cell in which the larva rests during the winter, and in which the pupæ and beetles reside, is irregularly oval, about 2 inches long and one-third as wide, very shallow, and partly surrounded by a wide border of closely packed chips gnawed off from the wood, and partly by the excrement or reddish sawdust-like closely packed material, derived originally from the inner part of the bark. The entire cavity is thus about 4 inches long and 2 wide, and very irregularly oval in outline. It seems probable that this larva does not make a regular wavy burrow, but remains in one spot, eating out in all directions from a comparatively fixed point; in this respect it differs from many other Cerambycid larvæ.

### 38. WOOD-ENGRAVER BARK-BEETLE.

*Xyleborus cælatus* Eichhoff. (*X. xylographus* of Fitch.)

Order COLEOPTERA; family SCOLYTIDÆ.

(Plate XXIV; figs. 2, 2b, larva; 3, 3a, pupa.)

In the outer surface of the sap-wood and inner layers of the bark, mining a long slender thread-like track, usually straight, lengthwise, 4 to 8 inches long, from which numerous smaller short tracks branch off mostly at right angles, a small bark-beetle 0.12 long, which comes abroad mostly in May, of a chestnut color, the declivity at the tip of its wing-covers having four or five minute projecting teeth upon each side. (Fitch.)

This, like other bark beetles, has a compact cylindrical body at least three times as long as broad, with the thorax forming almost half of the entire length, and having the head deeply sunk in its anterior end and almost hid. The antennæ are quite small, and are composed of a long basal joint, which becomes thicker towards its tip, and is followed by five very small joints surmounted by a large, round, flattened club, which is divided by sutures into three or four segments.

This species is glossy and bearded with fine hairs. Its thorax is shagreened anteriorly with minute elevated points, which further back become less dense, and the basal half is covered with fine punctures, with a smooth line above along the middle from the center backwards. The wing-covers have rows of coarse punctures and minute ones on the interstices between these rows, and their tips are abruptly declined as though cut or gnawed off, the outer margin of this declivity having four or five small projecting teeth upon each side. It is usually chestnut colored, with the antennæ and legs paler, but individuals may be met with of the varieties mentioned below :\*

\*Mr. Schwarz remarks (Ent. Amer., ii, p. 41): A glance at Fitch's description plainly shows that he was mistaken in the identification of the species and that he had before him what is now known as *X. cælatus* Eichh. Moreover, *X. xylographus* belongs to a group of species which do not live under the bark, but enter the solid wood. *X. saxeseni* Ratz. is said by Eichhoff (*l. c.*, p. 280) to occur in North America, and this could only be identical with *X. xylographus*. Say's name, however, would have priority.

Variety *a*, *nigricollis*. Thorax black.

*b*, *niger*. Thorax and wing-covers black.

*c*, *fulvus*. Thorax and wing-covers pale yellowish.



“The wood-engraver bark-beetle is the most common and probably the most pernicious of all the insects infesting the forests of white pine in the State of New York, and of yellow pine (*P. variabilis*) in the States south of us. Whilst it is old and decaying or dead trees that most of the larger borers which we have described above attack, this small insect is liable to invade trees that are in full health and vigor, those that are young as well as old, mining beneath the bark and loosening it from the wood, so completely separating it that it breaks off in large pieces. Frequently, on elevating this loosened bark, its inner layers and the whole outer surface of the wood are found plowed in every direction, and the furrows are so intricate and confused that it is impossible to follow the track which any one individual has traveled. But in places where they have been less numerous, the work which each insect has performed is distinctly marked and is so regular and artistic in its appearance as to have suggested to Mr. Say the name of the wood-engraver as a most appropriate designation for this beetle. The cut on the following page is an exact copy of the tracks made by one of these beetles and its young, their natural size.\* It will be seen to consist of a main central track running nearly straight, from which numerous smaller short ones branch off at nearly right angles. Though I have not observed the habits of these insects sufficiently to be perfectly certain respecting all the points in their operations, the course they pursue in forming these tracks appears to be as follows: The female having selected a situation which will furnish suitable sustenance to her young, bores through the bark to the outer surface of the wood, and then mines a passage between the bark and the wood, in a straight line lengthwise of the tree or limb where no obstructions occur to cause her to deviate from her course. The male probably accompanies her and shares with her in this labor, each working by turns. Thus a long slender cylindrical gallery is formed, which is excavated about equally in the outer surface of the wood and in the inner layers of the bark. In some instances, two, three, or even six tracks will be seen to start from one point, running in opposite directions, but always lengthwise of the tree or limb, and with lateral branches so similar to those in the figure that I am in doubt whether they are the work of this or one of the other species which belong to this tree. Upon each side of the main track little notches are excavated at intervals, whilst the work is in progress, similar to those represented in our figure of the tracks of the pine bark beetle on the succeeding page, though larger than those, being about equal to the width of the track in their length, but less in their width, and having their outer ends evenly rounded. In each of these notches from one to four eggs are placed. And as the beetles mine their way onwards, the fine dust which they form probably becomes strewed along the track behind them. Then, as they travel backwards and forwards in the burrow from time to time, the little stiff hairs with which their

---

\* The cut is not reproduced.

bodies are bearded serve as a brush to sweep this dust into these lateral openings. Thus the mouths of these notches become filled and the eggs therein covered and concealed from any predaceous insect which may enter the burrow after the parent has completed her work and before the eggs have hatched and the young have mined their way beyond the reach of such enemies. The female continues her operations until her stock of eggs is exhausted, forming a burrow from 4 to 8 inches or more in length.

“The eggs of this beetle are about 0.025 long, of a broad, oval shape, and a watery white color. They may be met with in their newly formed burrows beneath the bark the forepart of June. They probably hatch in ten to twenty days, according to the temperature of the atmosphere at this time. The infantile larva is invariably found lying with its back towards the sawdust with which the notch in which it is bred is filled, its mouth being thus brought in contact with the soft innermost layer of the bark at the extremity of the notch—the elastic nature of the sawdust probably aiding in pressing its mouth against its destined nourishment. Thus it has only to part its jaws and close them together again to fill its mouth with food. And by repetitions of this motion a cavity is gradually formed between the bark and the wood, into which its head sinks, and afterwards its body. This cavity consequently takes a direction outwards at right angles with the central burrow. And thus the larva eats its way onward until it has obtained its growth, forming hereby a gallery varying in its length from about 1 to 3 inches, as the material consumed has been of a quality more or less nutritious, and winding and turning where impediments have been encountered or the track of another larva has been approached. Many of these lateral galleries, however, end abruptly before they are half completed, the worm having been destroyed by insect enemies or some other casualty. And it is curious to notice how these little creatures respect the territory which is already in possession of another, changing their course to avoid any encroachment thereon; and if one of them finds himself so surrounded and hemmed in by other tracks that it becomes impossible for him to refrain from encountering them, he so shapes his course as to cross his neighbor's road as nearly as possible at right angles instead of obliquely, thus intruding thereon as little and for as short a time as possible. Sometimes also two females happen to excavate their galleries parallel with each other, and so near that no adequate space remains between them for their young to mine their burrows, the beetles having been unaware of their proximity, no doubt, until too much labor had been expended to admit either one to abandon the ground and go elsewhere. In such cases the eggs are all placed along the outer side of each gallery, and thus the larvæ all mine their way outward in opposite directions to each other.

The larva is a plump soft white worm, broadest anteriorly, and with its body bent into an arch or having its tail turned partially inward

under the breast. By transverse impressed lines it is divided into thirteen segments, the head being counted as one. Its head is polished and white, at least during the first periods of its life, with its mandibles chestnut brown, and no indications of eyes, and no feet, but with their places supplied by two small round retractile teat-like protuberances on the under side of each of the three segments next to the head. Having completed their growth, they sink themselves into the wood to repose during their pupa state. The small round hole which they perforate in the wood for this purpose is seen at or near the outer end of each burrow in which the worm has lived to reach maturity.

The pupa resembles the perfect insect in its size and shape, with the rudimentary legs and wings inclosed in sheaths and appressed to the outer surface of its body in front. After taking on its perfect form it perforates a small round hole through the bark and comes out from the tree." (Fitch.)

Bark-borers of this genus are said by Le Conte to have the body stout, cylindrical, with the slope of the elytra oblique, scarcely flattened; the funicle of the antennæ with four distinct joints, and the sensitive surface of the antennæ concentrically annulated. In the present species along the slope of the elytra are two prominent tubercles and some smaller marginal ones, the elytra are strongly punctured in rows, the interspaces with rows of distant punctures, while the tibiæ are strongly serrate.

From eight hundred to a thousand specimens of this bark-borer, with hundreds of larvæ and many pupæ, were found in July and August at Brunswick, Me., under the bark of a white pine stump about 22 inches in diameter, the tree having been cut down the preceding November. The bark was honey-combed with its holes, the pupæ resting in cells in the bark. The mines usually run obliquely through the thick bark, not sinking into the sap-wood, so that no regular mine was formed, and it is difficult to give a good description of it. The diameter of the track and of the hole for the exit of the beetle is slightly larger than that of *Xylosterus bivittatus*. It is often two-striped, but this is due to the fact that it begins to turn dark in the middle of the elytra after transforming. It also occurred in abundance under the bark of the spruce, in the same place, associated with *X. bivittatus*.

Two Scolytid or bark-boring beetles were observed in abundance, May 30, 1882, near Providence, under the bark of white pines (*Pinus strobus*), engaged in reproduction and egg-laying. The larger of these was *Hylurgops pinifex* Fitch, the smaller *Xyleborus calatus* Eich. Bringing specimens to my house, the next day I was able to observe their habits more closely. The following notes refer entirely to *X. calatus*. The female was in her hole, the end of her abdomen extending straight up out of the perpendicular hole or "mine;" a male approached her and rubbed the end of her body with his fore pair of feet,

the female apparently responding by moving back and forth in her mine. After a moment or two the male visited another female in her hole and caressed her in the same manner, then returned to the first female and inserted his intromittent organ in the female, the end of whose body was depressed, so as to leave a space between it and the end of the elytra. Union continued for six minutes, during which time the hindermost pair of feet of the male kept stroking the end of the abdomen of its mate, while its antennæ were vigorously moving. At the end of this time it immediately withdrew and disappeared down another hole, the female descending her mine. From these facts we infer that the male of this species is polygamous.

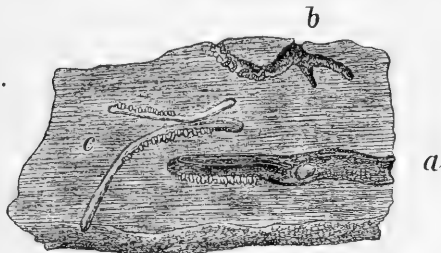


FIG. 243.—*a*, mine of *Hylurgops pinifex*, with eggs; *b*, mine with young larvæ; *c*, mine of *Xyleborus cælatus*, with eggs. Gissler del.

While boring, at least in confinement, the borings or dust are thrown out around the mouth of the mine in a heap. The mine or tunnel is from an inch to an inch and a quarter long; at close intervals on one side there are lateral deep notches in which two to three or four eggs are irregularly laid; or the eggs are carefully deposited side by side; the lateral notches are then filled with borings or dust by the movements of the female in her main tunnel, the eggs being inclosed in the mass of borings. (Fig. 243.)

*Hylurgops* does not make lateral notches, but places her eggs side by side in a single recess on one side of the mine.\*

This and the other bark-beetles of the pine have numerous insect enemies which wage incessant war upon them. Various species of small beetles pertaining to the families *Staphylinidæ*, *Histeridæ*, etc., are always to be met with under the loose worm-eaten bark of pines, and M. Perris has ascertained that these insects resort to this situation for the purpose of rearing their young, their larvæ being predaceous and subsisting upon the larvæ and pupæ of the bark-beetles. (Fitch.) We have found this species common under the bark of pines in Maine, the beetles flying in April and May.

### 39. *Xyleborus pubescens* Zimmerman.

“Among a large colony,” remarks Mr. Schwarz (*l. c.*, p. 41), “of this beetle which I found boring into *Pinus inops* near Washington, I discovered two specimens of the male.” The difference in general appearance between the two sexes is very striking.

\* See Third Report U. S. Entomological Commission, Chapter X, p. 280, 1883. Compare also Schwarz in Proc. Entomological Society of Washington, I, p. 47.

*The beetle, male.*—It is only one-third the size of the largest female; the elytral striae are finer, the tubercles at the declivity smaller, the thorax much shorter, not longer than wide, anteriorly much more suddenly rounded and distinctly depressed.

*The female* (or one supposed to be the subject of its description) is said by Le Conte to be closely allied to *X. xylographus*, but differs by the punctures of the elytra being larger, and the hairs longer; the small punctures of the hind part of the thorax are also more evident, and the denticles of the posterior declivity of the elytra are fewer, being scarcely more than two on each of the alternate intervals. Length, 1 line. (Trans. Amer. Ent. Soc., ii, p. 145.)

#### 40. THE COARSE-WRITING BARK-BEETLE.

*Tomicus calligraphus* Germar.

Under the bark of the pitch pine and other species of pine, mining long and often zigzag tracks lengthwise of the tree, these tracks having short, coarse, irregular branches, a chestnut-brown bark-beetle 0.18 to 0.22 long, clothed with numerous yellowish gray hairs, its thorax rough anteriorly from close elevated points, and punctured posteriorly, its wing-covers with rows of coarse punctures, their tip broadly excavated as though with a gouge-chisel, the surface of this excavation rough from coarsish punctures, and its margin on each side with five or six small unequal teeth. Appearing mostly in the month of May. (Fitch.)

“This species was originally named *exesus*, or the excavated bark-beetle, in allusion to the tips of its wing-covers, in the old Catalogue of Rev. F. V. Melsheimer, under which name a short account of it was published by Mr. Say in the year 1826. Germar, however, had described it two years before, under the name *calligraphus*, meaning elegant writer, which name it must retain, although not happily chosen, the tracks which this beetle forms under the bark being coarse, irregular, confused, and far less beautiful than those of many of the species of this genus.

“It is in the pitch pine that this beetle mostly occurs in the State of New York, but I have also met with it in the limb of aged white pines, and farther south it is common in the yellow pine. Its burrow is somewhat like that of *Xyleborus cœlatus*, consisting of a single long furrow extending lengthwise of the tree or limb, from 6 to 12 inches in length, but it is less straight in this species, being usually curved more or less, and according to accounts it is often perfectly zigzag. The same notches are formed along its sides as noticed in the foregoing species, in which the eggs are deposited; but the lateral burrows which branch from the central one have no regularity whatever to them, being given off sometimes obliquely and sometimes at right angles, sometimes abruptly widening into a broad, irregular, flat cavity, and sometimes continuing of the same width through their whole length, either straight, irregularly wavy, or tortuous, turning here and there wherever an unoccupied space occurs into which they can be extended. These branches are usually of the same width with the central gallery, and like it are furrowed equally deep in the outer surface of the wood and the inner surface of the bark. The pupa state is passed in a cell excavated in the bark, and not in the wood, as in the foregoing species, and when

changed into a beetle this cell is extended onwards through the bark for the escape of the insect. Being a larger species than the preceding, the galleries which it excavates, and the holes it perforates through the bark, are proportionally larger. Several dead individuals may usually be found in the galleries of this as of the other species." (Fitch.)

I have found the "mines" or galleries of this bark-borer under the bark of the southern pitch pine at Houston, Tex., where it seemed to be abundant. Beetles taken from the mines were sent to Dr. G. H. Horn, who kindly identified them as *T. calligraphus*. Fig. 244 represents a typical mine. It consists of a primary or main gallery or mine which is  $3\frac{1}{2}$ mm wide; the holes for the exit of the beetle, of which two are represented in the engraving, being 2mm in diameter. The primary gallery is nearly straight, with, in the cases noticed by us, only one set of secondary galleries arising on one side, as represented in the figure. The secondary galleries are from 1 to nearly 2 inches in length, and at the end a little over half as wide as the main gallery. At one end the main gallery

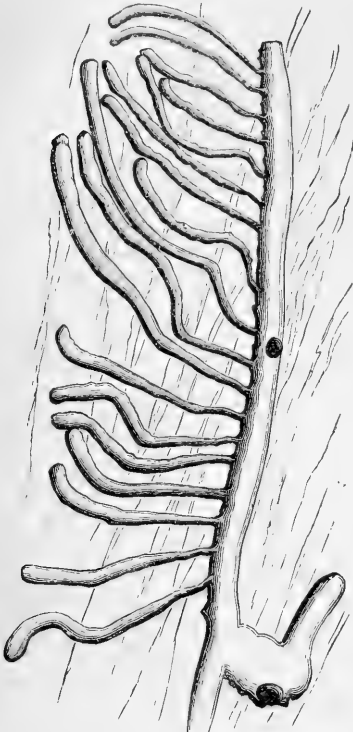


FIG. 244.—Mine of *Tomicus calligraphus* in southern pitch pine, Houston, Tex.—Packard del.

opens into a broad irregular cell, where the worm probably transforms into the pupa, connecting with the hole for the exit of the beetle.

Another form of cell without any lateral or secondary galleries is represented at Fig. 245. The arrow indicates a point in the gallery made when the larva was small. A specimen taken from this mine was also submitted to Dr. Horn for identification. It occurred under the bark of the southern or yellow pine at Atlanta, Ga., where I collected it in April, 1881.

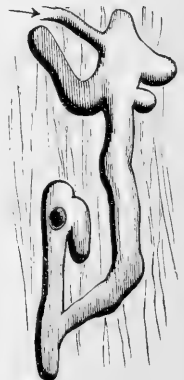


FIG. 245.—Primary mine of *Tomicus calligraphus* in yellow pine, Georgia. Packard del.

## 41. THE SOUTHERN TOMICUS.

*Tomicus cacographus* Le Conte.

Injuring the pines of North Carolina and southward even more than *T. pini* in the north; a very similar beetle, with similar habits.

This is the *Bostrichus pini* of Zimmermann, but not the one so named by Say. It inhabits, according to Le Conte, the Southern and Western States. It is said by Le Conte to be similar to *Tomicus calligraphus*, but is usually of smaller size (3.5 to 4<sup>mm</sup>, .14 to .16 inch); the cusp of the second interspace is very small, and that of the third is wanting; that of the fifth is compressed and scarcely more prominent than that of the fourth interspace, and is somewhat connected with it; there are but two teeth between the tooth of the fifth interspace and the terminal acutely elevated margin, and these teeth are all of them less prominent than in *T. calligraphus* in some specimens (male), but equally prominent in others (female), though less acute than in *T. calligraphus*. The interspaces from the third outward are marked each with a regular series of punctures behind the middle, whereby it differs from the next species (*T. confusus* Le Conte, of southern California and Arizona). The club of the antennæ is quite similar to that of *T. calligraphus*.\*

The mine made by this species has been found under the bark of the southern pine at Atlanta, Ga., the beetle from it having been labeled by Dr. Horn. The mine is like that of *C. calligraphus*, but the main burrow is narrower, being 2½<sup>mm</sup> wide, and the holes are smaller, the beetle itself being smaller. Living beetles were taken from the mine March 28, 1881.

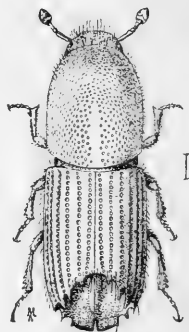


FIG. 246.—*Tomicus cacographus*.—Marx del.

## 42. THE PINE BARK-BEETLE.

*Tomicus pini* Say.

From a common center excavating several broad shortish galleries lengthwise of the trunk in opposite directions, resembling the spread fingers of a hand, a bark-beetle very similar to the preceding, but of smaller size, measuring only .15 in length, and with but four small teeth on each side of the concave declivity at the tips of its wing-covers, and usually showing more or less distinctly an impressed line along the middle of the hind part of its thorax. (Fitch.)

“The tracks formed by this insect are so different from those of the other species that they are recognized at a glance. They occur under the bark of old trees of the white pine, and have some resemblance to

\* A number of other Scolytids which probably infest the pine are described by Le Conte in his work on the Rhynchophora of America north of Mexico, where all the species are characterized, and to which the reader is referred.

the fingers of a hand spread apart or to the track of a bird. From a common center they run off in opposite directions up and down the tree, lengthwise of the grain, moderately diverging or nearly parallel with each other, appearing when the bark is stripped off like linear grooves in the outer surface of the wood and inner surface of the bark. They

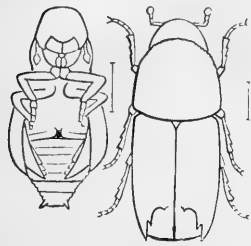


FIG. 247.—Pine bark-borer and pupa.—From Packard.

are about .10 wide and 1.50 to 2.00 long, all those belonging to the same cluster being of nearly equal length. Along the sides of these grooves several short sinuous excavations or notches appear, in which the eggs have been placed, where they would remain undisturbed by the beetle as it crawled backwards and forth through the gallery. The accompanying figure\* is a representation of one of the clusters of these tracks, copied from the surface of the wood.

In this instance the commencement of some of the galleries, and the principal part of the lower one on the right hand, had been excavated wholly in the bark, and thus made no mark upon the wood.

“M. Perris has ascertained that with the European *Tomicus laricis*, which excavates several galleries from a common center like the insect now before us, a male beetle is found in each of the galleries, whilst only one female is associated with them, she being stationed sometimes alone, in the center, and at other times in one of the galleries in company with the male. And from his observations it appears that these galleries are excavated by the males, each of them being the work of one individual, whilst the female supplies the whole of them with eggs.

“As there are no lateral galleries branching off from these main ones, I infer that the young of this insect move and feed along the sides of the galleries in which they are born, and that thus these galleries become widened and broad as we find them, their width being much greater than those of the other species, although the insect is but the usual size.” (Fitch.)

We have little to add to the foregoing account as to the habits of this bark-borer. It is common in the pine woods of Maine, making burrows under the bark, not always so regular as Fitch's figures.

This timber beetle is common in the timber region of the Rocky Mountains of Colorado, boring irregularly into the inner bark of *Abies menziesii*. The burrows are like those made by the same insect in the white pines from Maine to North Carolina. On the Atlantic coast the more regular burrows radiate from a common center. Those observed on Gray's Peak were .08 inch in diameter.

In the pupa the body ends in two long, pointed, horn-like appendages arising from each side beneath. The ends of the hind tarsi extend to

\* Not here reproduced.



the terminal third of the wings. The antennæ are clavate, not extending beyond the coxæ of the first legs. It is larger, more bulky than the adult. Length, 0.22 inch.

The beetle (Fig. 247) is cylindrical, with the head and prothorax together three fourths as long as the rest of the body; end of the abdomen suddenly truncated, slanting, forming a scoop, the declivity smooth, concave, and bounded by high walls, which are four-toothed on each side, the third from the top the largest. On each wing-cover are eight lines of fine, raised tubercles; prothorax with concentric rows of fine tubercles, but smooth on the posterior third. Seen from beneath, the wing-covers project well beyond the end of the abdomen. Color, pale tan-brown, a little paler on the thorax than on the wing-covers. Body covered with stiff, dense hairs. Length, 0.20 inch.

#### 43. THE LITTLE BARK-BEETLE.

*Pityophthorus annectens?* Le C.\*

Under the bark of small sapling pines, mining exceedingly fine slender wavy burrows running in every direction, a cylindrical chestnut-brown bark-beetle much smaller than any of our other species, measuring only 0.06 in length, its surface shining and pierced with small deep punctures which on the wing-covers are placed in close rows, the thorax but half as long as the wing-covers and rough anteriorly from dense minute elevated points, the middle of the outer edge of the wing-covers showing a slight concavity, the declivity at their tips with a moderate excavation formed by a smooth longitudinal groove upon each side of the suture, the suture itself being elevated and having on each side of it an impressed line in which are minute punctures, the outer margin of the declivity with numerous fine bristles, but without any projecting teeth, and the tips of the wing-covers drawn out into a very small acute point.

"This beetle very closely resembles the *T. ramulorum* of Perris, which mines the small twigs of European pines, but it is evidently a distinct species. It was described by Dr. Harris in the Transactions of the Natural History Society of Hartford, Conn., vol. i, p. 82, from a specimen imperfectly displayed, which he met with in the collection of Mr. Halsey, but he had no knowledge of its habits. And this I believe is the only notice of this insect which has hitherto appeared. Its minute size has probably caused it to be overlooked by collectors, although it is so common that the bark of dead young pines which are 2 inches in diameter or less can seldom be broken away without coming upon its tracks, with some of the dead insects in them. Its tracks are readily

---

\* Le Conte states that this is not the *Tomicus pusillus* of Harris, as Fitch supposed, "but is quite different, and is closely allied to *T. ramulorum* Perris, which is considered by Eichhoff as the same with *typographus* Ratzeburg." Le Conte adds in a letter that this is most probably *P. puberulus*. He also in the same letter adds: "*P. annectens* Le C., found in Florida in *yellow pine*, resembles in sculpture *ramulorum*, and agrees with Fitch's description of 34 [of Packard's Bulletin] in having the elytral punctures arranged in rows, and the sutural angle acute. It may really be the same as your 34, but as the localities are so widely apart, and the food tree different, I am unwilling to express a positive opinion until I can compare the specimens."

distinguished from those of other species by their extreme slenderness, and being packed with fine white sawdust they resemble a tangled mass of small threads lying upon the surface of the wood. On coming to inspect them particularly, small irregular cavities will be noticed, one of which is represented by a knot-like appearance. This cavity is appropriately termed the nuptial chamber by French and German writers. From it there are usually four galleries leading off in opposite directions and running obliquely to the grain of the wood, but curving, commonly, till they obtain a longitudinal direction. And from these numerous smaller and irregular wavy galleries branch off, at right angles or nearly so, and overspread the whole surface with a seemingly confused multitude of little furrows. The bark being quite thin in the young trees to which these beetles resort, their galleries are excavated mostly in the wood, the surface of which is deeply grooved whilst only a shallow impression is made on the inner surface of the bark. But at the end of each of the lateral galleries a deep cavity will be noticed, sunk in the bark, in which cavities the insects repose during their pupa state.

“The accompanying figure of the tracks of these beetles handsomely illustrates some of the facts which have already been stated above under the Wood-engraver bark-beetle, and it may interest the reader to notice some of the habits of these insects as shown by this figure.\* In its upper half two leading galleries are seen running parallel with each other and so near together that no adequate space exists between them for any young larvæ to form their burrows there without encroaching upon each other or crossing the tracks already made. The parent beetles appear to have been aware of this, and accordingly so disposed of their eggs that all their young with but two or three exceptions mined outwards, traveling away from each other. Again, on the outer side of the left gallery two notches are observed, in which no eggs appear to have been placed, the parent beetle probably perceiving, what the figure indicates, that there was not suitable room to the left of these notches to duly accommodate all of the other larvæ that would traverse that spot. Furthermore, it will be noticed that of the burrows leading off to the right, above the large knot or nuptial chamber, the worm which excavated the fourth one, soon after commencing his journey, perceived that the course he was pursuing would run his track into that of the third one. He hereupon abruptly alters his course, bearing directly away from the track of this neighbor until he has attained a suitable distance therefrom, and he then travels forward again, keeping at this exact distance from his neighbor's path. But this soon brings him into proximity with another neighbor upon the other side; and he now becomes aware of the fact that he is between two paths that are approaching each other, and that will consequently come so near together forward of him that he can not proceed onward without running into one or the other of them. In this dilemma, to encroach the least that is possible

---

\* Not reproduced.

upon his neighbors, he makes an abrupt turn so as to go square across one of these tracks. But this only serves to bring him into similar proximity with another track, and after this comes another and another; and now he reaches a fifth one, running in a different direction, requiring another alteration of his course to cross it at right angles. But we need not follow this subject further. Others also of these galleries, when carefully inspected, will be found scarcely less curious. How wonderful is nature, that thus presents an interesting subject for our study in each particular track an inch or two in length which a family of little worms make as they eat their way along in the bark of a tree, the parenchyma of a leaf, or elsewhere. How marvelous, that in such minute and seemingly unimportant and insignificant operations we invariably meet with so much to admire! (Fitch.)

Your No. 34, as I see by reference to Fitch's report, is quoted textually from that author, and, if my opinion be well founded, is not different from your 35, unless it be *anectens*. If there are any types to be seen, please have them sought for, and send me one. I have forgotten what became of Fitch's collection. (Le Conte in letter.)

This may possibly be the insect which Dr. Fitch has regarded as the *Tomicus pusillus* of Harris. We have found the mines in abundance under the bark of the white pine at Providence, R. I., sometimes four or five occurring in the space of 6 or 7 square inches. They vary a good deal in irregularity, and we will select the one here figured for description as being one of the more regular mines. The main gallery is slightly sinuous, from  $1\frac{1}{2}$  to 2 inches long, originally notched alternately on the sides, the notches where the eggs are laid being the starting point for the secondary galleries where the larvæ have hatched and lived. About fifteen secondary galleries arise from each side of the primary mine, the longest being about two-thirds as long as the primary gallery; all end in a slight enlargement in which the larva transforms, or connect with the hole through the bark for the exit of the insect. (The figure, as engraved, makes the main gallery and branches somewhat wider than in nature, and wider than in my original drawing.) The width of the main gallery is  $1\frac{1}{2}^{\text{mm}}$ ; of the secondary gallery,  $1^{\text{mm}}$ . In some cases two

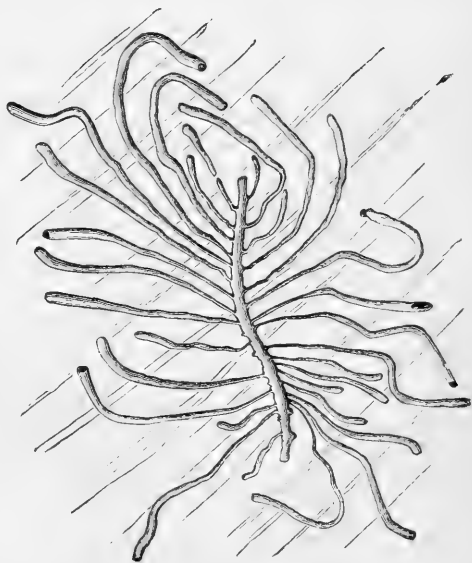


FIG. 248.—Mine of least white-pine bark-borer, Providence, R. I.—Packard del.

main galleries cross each other, while in another case two unite to make a figure 8, but in such a case the secondary galleries do not cross the main ones, and in examples where two main galleries run parallel and somewhat near each other, they do not send secondary galleries into the narrow interspaces between the two main galleries.

On submitting specimens of the beetle to Dr. Le Conte for identification, he writes us that it is a species of *Pityophthorus*, not described. Dr. Le Conte adds: "Blanchard writes that *Hypophlæus tenuis* depredates on this species." (Le Conte afterwards identifies it as probably *P. puberulus*.)

44. *Xyleborus impressus* Eichhoff.

Le Conte states that this species occurs in Georgia under pine bark.

45. PINE TIMBER-BEETLE.

*Gnathotrichus materiarius* (Fitch).

Order COLEOPTERA; family SCOLYTIDÆ.

In the interior of the sap-wood, mining slender straight cylindrical burrows in a transverse direction, parallel with the outer surface, from which very short straight lateral galleries branch off at right angles above and below, a rather slender cylindrical black shining bark-beetle, 0.15 long, with pale dull yellow legs and antennæ, the forepart of its thorax and of its wing-covers tinged with reddish yellow; the thorax equaling two-thirds the length of the wing-covers with a small elevated tubercle in the middle, forward of which it is rough from minute elevated points; the wing-covers with rows of minute punctures, their tips rounded, the upper part of the declivity with a shallow longitudinal depression or groove along the suture, forming a slight notch.

"The insects belonging to the genus *Tomicus* and kindred genera of the same family by their habits divide themselves into two distinct groups. The larger portion of them reside in or immediately beneath the bark of different trees, and are currently termed bark-beetles. But this designation is inappropriate for another portion of them which dwell in the interior of the wood, and there excavate their galleries. The name timber-beetles appears to be the most appropriate for these. Another point in which, from the observations of M. Perris, these two groups appear to differ in a remarkable manner is the relative numbers of the two sexes. With the bark-beetles there are commonly several males in company with but one female, and the former appear to perform the chief part of the labor in the excavation of their galleries. With the timber-beetles, on the other hand, the females are much the most numerous, and probably mine their galleries without any assistance from the other sex. M. Perris states of one of the species that upwards of fifty females were met with in the burrows they had excavated without a single male being found there.

"It is the habit of these timber-beetles to penetrate the tree in a straight line, passing inwards through the bark and into the sap-wood to a depth of from half an inch to 2 inches, and then abruptly turning they extend their burrow in another straight line parallel with the outer surface and at right angles with the fibers of the wood, for a length of 2 to 6 inches. The only instance in which the burrow of the species now under consideration has come under my notice was recently in a billet of stove wood, which unfortunately did not contain the extreme end of the gallery. The annexed cut\* is an exact representation of this burrow, in which a live and a dead beetle were found, both of them females, and the only specimens of this species which have come under my observation. The transverse burrow was excavated in the sap-wood at the depth of half an inch from its outer surface. Near its middle it was crossed by another perforation extending from the outside directly towards the heart of the tree, which is indicated by a black dot in the figure; and at this point the burrow curved slightly outwards towards the exterior surface, as represented in the section above the principal figure in the cut; and at its end on the left, where it passed out of the billet of wood, it commenced curving inwards towards the heart of the tree. Twelve lateral burrows of the same diameter as the transverse one extended upwards and two downwards, as shown in the figure, all of the same length, each one having been excavated probably by a single larva. The gallery of our insect thus differs widely from that of the European species (*T. eurygaster* Erichson) which mines in the interior of the pine, which has no lateral burrows branching off from it.

"The presence of these timber-beetles in the wood can be distinguished from those which mine under the bark by the little piles of sawdust which they throw out at the mouth of their burrows, this dust being so much more white and clean, and not composed in part of the brown or rust colored particles of gnawed bark which are intermixed with the dust produced by the bark-beetles. (Fitch.)

*The beetle.*—In addition to the short description of this beetle which is given above, it may be observed that the head is finely punctured, the punctures on the face giving out small pale yellowish hairs, while those on the vertex or crown are destitute of hairs, and there is a slight transverse elevation of the surface between the face and the vertex, from which an elevated smooth line extends backwards along the middle of the vertex. Thorax, when viewed from above, with its base transverse and rectangular, its basal angles rectangular, its opposite sides parallel for a distance equaling the length of the base, and from thence rounded in a semicircle at its anterior end; its surface anteriorly with minute asperities, which, viewed vertically, appear like fine transverse wrinkles; its basal half with very minute punctures, and in its center a small transverse tubercle. Wing-covers with fine shallow punctures in

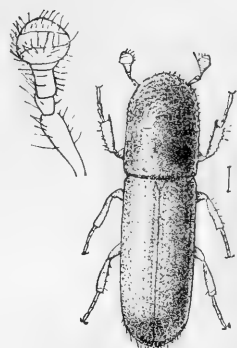


FIG. 249.—*Gnathotrichus materarius*. Marx del.

\* Not reproduced.

rows; the upper part of the apical declivity moderately depressed in the middle, producing a slight concavity in its outline when viewed from above anteriorly, the suture not elevated in this depression, but showing a slightly impressed line along each side; the hind end bearded with hairs similar to those upon the front. Under side black, the legs and antennæ pale dull yellow. (Fitch.)

We have found this beetle in the pine woods of Maine; it was kindly identified for us by Dr. Le Conte. It bores deep into the sap-wood of *Pinus strobus* in long nearly straight burrows; the beetles may be found in them in March, their heads pointing towards the center of the tree.

46. *Gnathotrichus asperulus* LeC.

Mr. Schwarz remarks that this beetle is perhaps not rare, but not easily recognized. "It bears a close resemblance to the smaller and rubbed specimens of *Pityophthorus minutissimus*, from which it differs mainly by the vestiture of the antennal stub. I beat two specimens from *Pinus inops* near Washington in May. In this tree it will probably be found boring in the same manner as *G. materarius*. Le Conte gives its length as 1.5<sup>mm</sup> (.06 inch.)"

Mr. W. H. Harrington states that about the middle of May pine saplings may often be seen with drops of balsam oozing out of the bark and standing like beads of amber all over the trunk and limbs. Each of these drops show where one of these minute beetles has perforated the bark. On examination, many will be found still in their tiny burrows beneath the bark, usually in groups of three or four, and others will be found boring their way through the bark to deposit eggs.

47. *Pityophthorus sparsus* LeConte.

The late Dr. Le Conte wrote on October 13, 1881, as follows regarding this beetle:

The species found by Blanchard (to me No. 36) under white pine bark is *P. sparsus* and is easily known by the prothorax having a smooth spot each side behind the middle, and by the very shining luster. The elytra are feebly and sparsely punctured, the declivity is deeply sulcate near the suture, and on the outer limit of the groove are two or three acute cusps. This species is depredated on by *Hypophylæus tenuis*.

48. *Xyleborus sparsus* LeConte.

A number of beetles from the bark of a dead white pine (*Pinus strobus*) received from the Peabody Academy, Salem, Mass., were referred to this species by Dr. Horn.

49. THE SPRUCE TIMBER BEETLE.

*Xyloterus bivittatus* Mannheim.

(Larva and pupa, Plate XXIV, figs. 1, 1<sup>a</sup>.)

This insect, though common under the bark of the white pine in Maine, is especially destructive to the spruce and fir, and for a further account the reader is referred to spruce insects.

Occurring under the bark of the pine in Alaska, Canada, and Virginia, a bark-borer closely allied to *Xyleborus*, with the prothorax strongly punctured, not roughened in front; length, 4.4<sup>mm</sup> (0.17 inch). (Le Conte.)

#### 50. THE BORING DENDROCTONUS.

*Dendroctonus terebrans* (Olivier).

Order COLEOPTERA; family SCOLYTIDÆ.

Perforating larger holes in the bark than any of the preceding bark-beetles, and mining curved galleries in every direction in the inner layers of the bark, and slightly grooving the outer surface of the wood, a cylindrical light chestnut-red or yellowish fox-colored beetle 0.23 to 0.33 long, bluntly rounded at each end, thinly clothed with yellowish hairs, its thorax narrowed anteriorly and with coarsish shallow punctures and a slightly raised line along the middle, at least on the posterior half, a faint blackish line along the middle of the upper part of the head, and its wing-covers rough, with rather shallow furrows, in which are coarse indistinct punctures. Appearing abroad early in May, numerous in pine forests, and in lumber and mill yards. Its larvæ common under the thick bark of pine logs and stumps; a yellowish-white footless grub thinly clothed with yellowish hairs, and divided into thirteen segments, its head polished and horny, of a tawny yellow color, with the mouth black, and the neck having on each side, above, a large polished spot tinged with tawny yellow. (Harris's Treatise, page 75.)

With this account, taken from Harris, our own observations agree. The cells are smaller than those of *Pissodes strobi*. We have found the larvæ and immature beetles in abundance in Brunswick, Me., in the middle of March. The burrows are very irregular, winding about under the bark, while the very irregular cells are from half an inch to an inch long, and nearly a quarter of an inch wide, and surrounded with the white woody chips made by the larva before pupating.

Le Conte states that in this species the prothorax is very densely and coarsely punctured; the hairs of the elytra not being very long. It has been collected in Canada, Georgia, Oregon, and California, as well as the pine woods of New England and northern New York. "The specimens from the Pacific slope are larger, and the punctures of the prothorax are rather smaller and more dense, but these differences do not seem to me worthy of specific distinction. Some specimens from New Hampshire and Canada have the prothorax more sparsely punctured, almost as in the next species (*D. similis*), from which they are only distinguished by the shorter hairs of the elytra. Length 5.2 to 8<sup>mm</sup> (.2 to 3.2 inch).

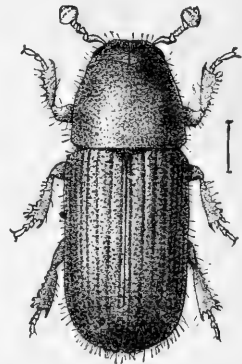


FIG. 250.—*Dendroctonus terebrans*.—Smith and Miss Sullivan del.

#### 51. THE RED POLYGRAPHUS.

*Polygraphus rufipennis* Kirby.

Boring irregular galleries under the bark of the pitch pine, somewhat like those of *Tomicus pini*, but much less regular and twice as wide and deep, a reddish brown bark-borer.

This beetle, abundant in the New England States, is not uncommon in Colorado. I met with it at Blackhawk and at Manitou. It probably bores in the pines and spruces of the Rocky Mountains. It is short and stout, reddish brown, the head and prothorax smooth and shining, though finely punctured, while the wing-covers are coarsely punctured and dull-colored, being a little darker than the rest of the body. Length, 0.35 inch.

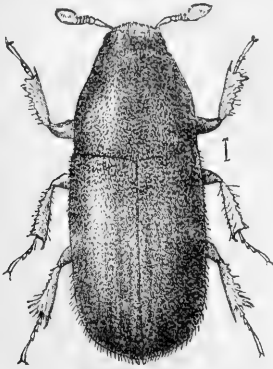


FIG. 251.—*Polygraphus rufipennis*.—Smith and Miss Sullivan del.

Le Conte states that he has received specimens from Alaska, Canada, and Anticosti. I have a specimen from Tacoma, Wash., identified by Dr. Horn. It is a common northern species. It is only to be distinguished from *D. similis*, says Le Conte, by the declivity of the elytra being smoother and more shining, and almost without asperities; and by a slight difference in the punctures of the prothorax, which are of unequal size. The dorsal line of the prothorax is sometimes narrow and elevated, sometimes obsolete. Length, 6<sup>mm</sup> (.24 inch). The distinctive characters given by Le Conte are these: Prothorax punctured, with smaller punctures intermixed; hairs of elytra long. We have found it at Providence, R. I., in its burrows under the bark of the white pine.

Allied to these bark-borers, and undoubtedly infesting coniferous trees, are the following:

*Dendroctonus similis* Le Conte, Colorado. "A smaller and somewhat more elongate form occurs in Canada, Texas, and Colorado, but I do not think it capable of being separated as a distinct species."

*Dendroctonus punctatus* Le C. New York.

*Dendroctonus simplex* Le C. Canada.

*Dendroctonus brevicornis* Le C. Middle California.

*Dendroctonus frontalis* Zimmerman. Lake Superior to Georgia.

## 52. THE PINE HYLURGOPS.

*Hylurgops pinifex* (Fitch).

(Larva, Plate XXIII, fig. 4.)

Order COLEOPTERA; family SCOLYTIDÆ.

"A beetle which closely resembles the preceding, and is frequently met with in company with it upon pine lumber in mill yards early in May, requires to be noticed in this place. I am unable to find any description of this species, although it is so common it can scarcely have been overlooked by authors till this time. It is the *Hylastes pinifex*, or the pine-destroying Hylastes of my cabinet. Its habits are



doubtless very similar to those of the boring *Hylurgus*, but the beetle is always slightly smaller, measuring 0.20 in length, and is darker colored, being deep chestnut red or sometimes black, tinged with chestnut. It moreover is destitute of the hairiness of that species, having only a thin fine short beard on the hind part of its wing-covers. Its thorax and wing-covers have the same sculpture with that. Its head shows no line along the middle, except upon the upper lip, where is a slender short elevated one, which ends before it reaches a slight trans-

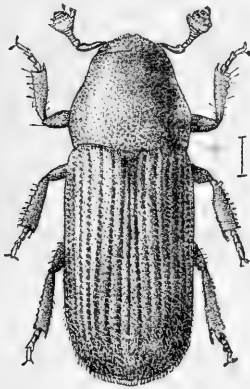


FIG. 252.—*Hylurgops pinifex*.—Smith and Miss Sullivan del.

verse depression which crosses the lower part of the face. Its body beneath is black, the legs dark chestnut, with the thighs commonly black. It moreover differs generically from the preceding in having seven, instead of but four, small joints in its antennæ, between the long club-shaped basal joint and the knob at the tip, which knob is shaped like an egg, and is divided by transverse lines into four short joints. Its shanks also have only fine denticulations along their outer

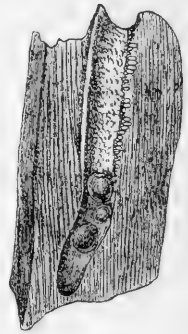


FIG. 253.—Mine of *Hylurgops pinifex*, with eggs along the lower side.—Gissler del.

edge near the tip, in place of the coarse saw-like teeth, which are seen in the foregoing insect. It thus pertains to the genus *Hylastes* of Erichson." (Fitch.)

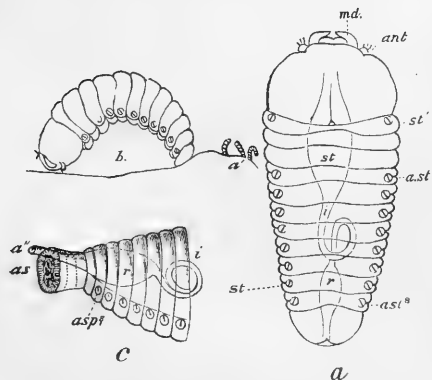


FIG. 254—*Hylurgops pinifex*, a, larva immediately after hatching; a', nat. size; b, side view; c, end of body; i, intestine; r, rectum; as, anal sucker; a', vent; st', thoracic stigmata; ast¹, first abdominal; ast⁸, eighth abdominal stigmata.—Gissler del.

I have found several beetles of this species (identified by Dr. Horn) under the bark of a white pine stump, at Brunswick, Me., August 15 to 20, 1881. The tree was felled in November, 1880. The beetles had evidently recently transformed from the pupa state, as they were with one exception pale red, the color of the fully mature beetle being black-brown. According to Eichhoff this beetle is the same as *Hylastes glabratus* Zetterstedt. Also see p. 708.

Fig. 254 represents a freshly-hatched *Hylurgops*, which is 1.5mm in length. The head is very large, while the spiracles are distinct, and the stomach (st), intestines (i), and rectum (r) are distinctly visible.

1.5mm in length. The head is very large, while the spiracles are distinct, and the stomach (st), intestines (i), and rectum (r) are distinctly visible.

It will be seen that the rudimentary feet of the early embryo have disappeared. When the larvæ hatch, as soon as they are free from the shell, according to Dr. Gissler's observations, they attach themselves to the surface of the bark in the manner seen at Fig. 254 *a*, and turn around for half an hour before beginning to feed. Fig. 254 *b* represents one of these larvæ at this time. Fig. 254 *c*, was drawn by Dr. Gissler to represent the end of the body of one of these larvæ, to show the form of the infra-anal sucker-like extremity of the last abdominal segment, which is produced and soft at the end, with perhaps temporary dermal glands to secrete an adhesive fluid. The anus is seen to project above and beyond this sucker, *r* representing the rectum, *i* the intestine, and *st* the pyloric end of the stomach.\*

## 53. THE COAL-BLACK HYLASTES.

*Hylastes porculus* Er. (*carbonarius* Fitch).

A beetle so closely like the preceding that it merits to be noticed in connection therewith is the *Hylastes carbonarius* of my cabinet. It is 0.20 long, of a pure black color, except its feet and antennæ, which are chestnut red. Its face shows no transverse depression inferiorly, but has an elevated line along the middle, reaching a third of its length. The smooth line along the middle of the thorax is less distinct than in the foregoing species, being slightly if at all elevated, and the punctures of this part are more coarse. Its wing-covers are not bearded posteriorly, and its general form is plainly more narrow and slender than that of the Pine Hylastes. The only specimen I have seen was captured the middle of July in the yard in front of my dwelling. (Fitch.)

## 54. THE PALES WEEVIL.

*Hylobius pales* Herbst.

Order COLEOPTERA; family CURCULIONIDÆ.

A large dark-chestnut colored or black weevil, 0.30 to 0.40 long, sprinkled over more or less with dots, whereof one on the middle of the outer side of the wing-covers is more bright, these dots being formed by fine short yellowish gray-hairs. Quite common in May and June among pine trees, and in mill yards, and on piles of pine lumber; with its long cylindrical snout perforating the bark and crowding an egg into the hole, the larva from which, similar in its appearance to that of the white-pine weevil, burrows beneath the bark, loosening it from the wood. (Harris's Treatise, p. 61.)

This is a very common pine insect, which ranges from Maine and Lake Superior to Florida. LeConte states that the head is very densely, though not coarsely, punctured, and is nearly opaque; the

\*Third Rep. U. S. Ent. Comm., 280, 1883.

prothorax is coarsely and rugosely punctured. The pubescence of the clypeal spots is sometimes yellow, sometimes gray. Length, 6.8<sup>mm</sup> to 10.2<sup>mm</sup>; .27 to .4 inch. There are several closely allied species which probably will be found to depredate on the pine.

Our own observations on this borer were made many years ago at Brunswick, Me. The burrows run under the bark of the trunk of the white pine; they extend irregularly over the inner surface of the bark, sinking down into the sap-wood, where in the autumn the larva makes a cell nearly a quarter of an inch deep, arched over at the top with a thick roof of "sawdust" or chips it had bitten off from the wood; over a surface of four square inches were eight or ten cells. Each cell in the middle of March contains a yellowish-white footless grub, half an inch long. Two weeks later we found two pupæ and two perfect beetles, one apparently having just thrown off its pupa skin.

The history of the *pales* weevil seems, then, to be somewhat as follows: In May and June the beetle bores its way out from the cell, partially creeping out of the old larval burrow; flies about on sunny, warm days in April and May, then lays its eggs either on the sides of the opening of its old burrow, or in the crevices of the bark. Early in summer the young worm hatches, and burrows under the bark throughout the summer, until it matures in the autumn, and makes the cell deep in the sap-wood, where it hibernates, and about the first of April changes to a pupa.

The cycle of its life is completed when the beetles fly forth early in May, and seek their mates, preparatory to laying the eggs from which a third generation is born. We have found the weevils flying about in Providence, R. I., during the middle of May.

#### 55. THE TWO-FORKED SOUTHERN TIMBER-BEETLE.

##### *Carphoborus bifurcus* Eichhoff.

Inhabiting the southern pine; mine consisting of a long, sinuous, narrow, primary gallery, from which rather short secondary galleries run out at nearly right angles; the beetle being minute.

Le Conte states that the species of this genus are next allied to *Dendroctonus*, but are minute in size and with long bodies. The elytra are striate with large approximate punctures. The funicle of the antennæ is five-jointed; first joint large and rounded, the others closely united, forming a short, conical mass, as in *Phloeosinus*; club large, slightly pubescent, moderately compressed; rounded, obtuse at tip, and divided by two straight sutures; the first joint of the club is more shining than the others. There are three species of the genus, *C. simplex* inhabiting the Mohave Desert, California. *C. bifurcus* differs from *C. bicristatus* in having the first and third interspaces of the elytra all moderately elevated, the second not much narrowed on the declivity or inclined end of the elytra. The punctures of the elytral striæ are also larger.

Le Conte seems to suggest that the two eastern species may eventually be united. Length, 1.5<sup>mm</sup> (.06 inch).

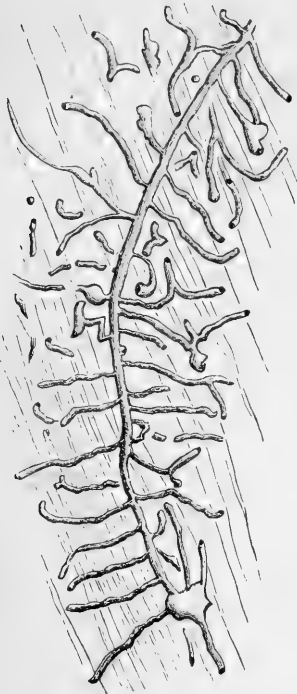


FIG. 255.—Mine of *Carphoborus bifurcus*; natural size.—Packard del.

The mine of this beetle I found under the bark of the southern pine at Montgomery, Ala., the beetles taken therefrom having been submitted to Dr. Horn for identification. The figure well represents an average mine. The primary gallery is nearly 4 inches long, very narrow, somewhat sinuous, ending at one end in a broad cell from which three or four secondary galleries pass off. About twenty secondary galleries pass off on each side at right angles to the main gallery, but not all in the same plane, as the figure shows; they are rather short, less than an inch in length, and sometimes end in a broad, irregular cell; the round dark spots in the figure indicate the holes in the bark for the exit of the insect. It appears to be a common pest in the Gulf States.

56. THE TWO-CRESTED SOUTHERN TIMBER-BEETLE.

*Carphoborus bicristatus* Chapuis.

In Georgia occurring under pine bark, according to Le Conte. Length, 1.8<sup>mm</sup> (.07 inch).

The five following Scolytids also occur on the pine. The notes are taken from Le Conte's essay on the Rhynchophora, or weevils of the United States.

57. *Hypomolyx pinicola* Le Conte.

This species was originally described by Couper (Trans. Lit. and Historical Society of Quebec, 1864), under the name of *Hylobius pinicola*. The body is elongate, ovate, broader behind, the eyes small, elytra oval, convex; the beak is as long as the prothorax, rather stout, slightly curved; the prothorax is rather small, subserrate on the sides, very coarsely punctured, thinly clothed with coarse hair, carinate in front; the elytra are densely punctured, mottled with small spots of yellow hair; striæ composed of large elongate deep punctures. Length, 13.5<sup>mm</sup> (.5 to .3 inch).

58. *Hilipus squamosus* Le Conte.

The genus *Hilipus*, says Le Conte, largely developed in tropical America, is represented by a single rare species found in Georgia and Florida, where it occurs under pine bark. It differs from *Hylobius* in

the body being ornamented with small scales instead of spots of fine pubescence. It is a beautiful black insect, with a broad white lateral vitta on the prothorax, and a very irregular one on the elytra, with many scattered small spots, densely clothed with depressed, very small, round, chalky white scales. Punctures of elytra very large, distant; interspaces smooth, shining, except where covered with scales. Length, 14.4<sup>mm</sup> (.57 inch).

59. *Crypturgus atomus* Le Conte.

(Larva, Plate XXIV, Fig. 4, 5, 5a, 5b; Pupa, Fig. 5c.)

Canada, Massachusetts, and New York; under bark of dead pine branches. Length, 1<sup>mm</sup> (.04 inch).

This species, though common in white pine bark, is especially destructive to the spruce, and is more fully described under the head of spruce insects. It occurred in abundance at Brunswick, Me., in all stages of development, from the fully-grown larvæ to the beetle, under the bark of white pine stumps (the trees having been felled the previous November), from the middle of July until the 1st of September, and probably still later.



FIG. 256.—*Crypturgus atomus*.  
Smith del.

60. *Ernobius tenuicornis* Le Conte.

Order COLEOPTERA; family PTINIDÆ.

According to Le Conte this beetle has been detected in the boughs of *Pinus rigida* in Massachusetts by Mr. Blanchard. (Trans. Amer. Ent. Soc., viii, p. xxiii, 1880.)

61. THE PITCH-EATING WEEVIL.

*Pachylobius picivorus* (Germar).

A black weevil very similar to *Hylobius pales*, but destitute of any spots or dots, and having the same habits. This occurs in the southern part of our State, and becomes common farther south, but I have never met with it to the north of Albany. (Fitch.)

Le Conte separates as a distinct genus from *Hylobius*, *H. picivorus*, which differs greatly from the other allied species of *Hylobius* by the tibiæ being much shorter and stouter and expanding at the tip. It is abundant under pine bark, adds Le Conte, in the Southern States, less frequent in the Middle States.

62. THE PINE SESIAN.

*Harmonia pini* Kellicott.

Order LEPIDOPTERA; family ÆGERIADÆ.

Boring in autumn under the bark and into the superficial layers of wood, usually just below a branch, a white smooth caterpillar an inch long, transforming to chrysalids late in May, the moth appearing from the middle to the end of June. (Kellicott.)

Mr. Kellicott gives the following account of this insect:

When studying the larval habits of *Pinipestis zimmermani* in 1878-'79, I met with the larva and pupa skins of two moths evidently different from the pine pest, yet

having quite similar larval habits. During the past summer I succeeded in getting the moth of one of them; it is an *Ægerian*, as I think, undescribed, but I would not venture upon describing it had I only the imago; but as I am able to give mainly its history, and having done so much tramping and climbing for its sake, that I have come to feel a proprietary right, I undertake to name and describe it as new. As its proposed name implies, the larva inhabits the pine, boring under the bark and into the superficial layers of the wood. From the wounds thus made pitch exudes, which, through the action of the larva and the warmth of the sun, forms hemispherical masses over its burrows; in these masses the pupa cells are finally prepared and the inactive stage passed. The larva occurs more frequently than elsewhere just below a branch; sometimes about the border of a wound made by the axe, or where a limb has been wrenched off by the wind; rarely in the axil of the branch. It appears to attack larger trees than the Zimmerman's pine pest, and more frequently occurs at considerable altitude. I have taken them 30 to 40 feet from the ground. While they sometimes, perhaps as a rule, take advantage of the broken cortex, I have found them where it appeared that they had worked through the same into the soft layer.

I have found the larva in the following localities: Hastings Center, N. Y.; Portage, N. Y.; Buffalo, N. Y. (?); Point Abino, Ontario. At the first-named place they were found in several instances numerous enough to seriously injure trees of moderate growth. I have taken the larvæ in autumn from 0.25 to 0.75 of an inch in length; they finally attain a length of 1 to 1.1 inch; diameter quite uniform, 0.18 of an inch. Color white; head light brown, flattened; first thoracic ring slightly clouded with brown, smooth; no trace of an anal shield; true legs scarcely colored, prolegs prominent, crowned with two rows of about eight hooks each. The brown hairs arise from papillæ, the base of each hair being surrounded by a brown annulation. The spiracles are but slightly elliptical, last pair large, placed subdorsally.

Before transforming they prepare a cell in the extruded pitch mingled with their *débris*; this they line with silk, but spin no other cocoon. While in their burrows they move through the soft pitch with impunity, but if removed from the same they soon die from the incumbrance of the hardening pitch adhering to them.

I have found the pupa the last of May; the moth appears from the middle to the end of June. It may be that others come in July and August, for I have found larvæ apparently full grown in July. On the 15th of July I brought to my rooms, devoted to the rearing of insects, some blocks of wood containing such apparently mature larvæ, expecting them to complete their transformations in a few weeks at most; they are still in the pitch cells unchanged (November). Is it a case of retarded development, due to the drying of the bark and wood?

*The pupa* has a length of 0.73 of an inch. Color light brown with the extremities dark. Over the dorsal portion of the abdominal rings are the usual rows of teeth; those on the anterior margin scarcely extend below the spiracles. The clypeus is without a pointed process; the medio-dorsal ridge of the thorax is unusually prominent.

When about to transform it bores through the pitch wall and escapes, leaving the pupa skin protruding.

*The moth* (female) expands 1.2 inch. Forewings opaque; hind wings transparent. Color blue-black, as follows: forewings, the clothed portions of hind wings, head, palpi, thorax, upper part of abdomen, antennæ, and legs. The neck fringe and the sides of the collar are orange, also the ventral side of the abdomen and the tail fringes, as well as a band on the fourth abdominal ring. The antennæ are long, slightly enlarged toward the end; there is a decided orange line on the under side of the antennæ for one-third their length; the tarsi are smoky. The male is smaller, but marked the same as in the female. (*Canadian Entomologist*, xiii, pp. 5-7, 157, 1881.)

\* Dr. Kellicott has added the following observations on this *Ægerian* borer:

*On the larval period of Harmonia pini, and a parasite of same.*—The original description of this moth, together with the facts, so far as known, in its history, were published in the *Canadian Entomologist*, vol. xiii, 1885. The last week in June of this year I had an opportunity to visit the "old homestead" in Oswego County, N. Y., where I obtained a limited number of imagines and certain additional facts pertaining to its preparatory stages; these I present for the consideration of this club, together with specimens of the moth, the pitch masses in which the pupæ form, with pupa shells protruding, and a dipterous fly parasite of the species.

I have elsewhere (*Canadian Entomologist* xiii, 157) shown that the larva does not transform until at least two years old; I think now that I have evidence that it does not change until the third year. The facts are these: In June, 1883, two pitch exudations on a small pine were marked; these were fresh and were supposed to contain larvæ one year old and which would probably give moths in June 1884. Accordingly, I made arrangements for having the same cut out and sent to me at Buffalo in May, 1884. The plan failed, however, and, as it turned out, the oversight led to good results. On revisiting the spot in June of this year I at once identified the pitch cocoons marked in June, 1883, then one year old, and on examining them I could find no reason for thinking that moths escaped from them in 1884. On opening one of them a live chrysalid was found within; the other was cut out with an axe and on July 6th gave a moth, now in my collection.

These facts do not amount to demonstration, although to me they indicate a high degree of probability that the life-period of this *Ægerian* is completed the third year. For, by way of application, the fully formed pitch masses of June, 1883, were caused by larvæ hatched in 1882, since the imagos of 1883 were just appearing, and had moths issued in 1884 the opening, pupa shell, and pupa cell would have been easily seen until 1885. It is scarcely possible that eggs were laid in 1883 from which larvæ occupied these masses formed by a previous generation or by some other animal. On examination of scores of examples I have failed to find traces of any other insect in the pitch, at least such as could cause the exudation. *Pinipestis zimmermanni* causes somewhat similar formations, but they are readily separated from those of the *Ægerian*.

The egg and the very young larvæ have not been seen by me; the former is evidently deposited near a wound in the tree, the young not being able to penetrate the outer bark of the pine trunk. They rarely occupy branches and have not been found in small trunks, *i. e.*, from three to five years' growth; on the other hand they prefer young pines from 6 inches to a foot in diameter, especially such as have grown up when the original pine forests have been mostly removed.

For obvious reasons larvæ boring into woody stems or the roots of trees or shrubs are well protected from insect parasites. A few references occur, however, to instances of hymenopterous parasites of our wood-boring *Ægerian* larvæ; one, *Phaogenes ater*, parasitic in *Podosesia syringæ*, has been noticed by G. H. French, *Papilio* i, 106, and another, an *Ichneumon*, in the same, by Herbert Osborn, *Papilio* ii, 71. Thus far I have found no mention of a dipterous parasite of any of our species of the group. The two-winged fly exhibited with the examples of *Harmonia pini* escaped from a pupa of the same and is a parasite of the same. May 30, 1885, at Portage, N. Y., I removed a mass of pitch that proved to contain a pupa; it was kept in a proper box when it soon lost its motion and the puparium of the fly was observed within its shell. The fly appeared June 20. It has been sent to Dr. C. V. Riley for identification, but it was not in his collection and it was not specifically identified; it is a species of *Tachina*. I am at a loss to understand, knowing the larval habits imperfectly, how the fly can possibly deposit its egg upon the moth larva, as it lives continuously, as I suppose, within the pitch. There must be some means of obtaining air, and possi-

bly there are openings left for that purpose. I have not been successful in finding out how the matter is managed. The pupa cell is covered at the outer extremity by a thin layer of rather brittle pitch; it may be a fact that this is sometimes destroyed when the temporarily exposed inhabitant is victimized. Had the parasite occupied the body of the host since the previous summer, it seems that the latter would have been too much exhausted to have completed its transformations. But why guess out the history of this parasite and its relations to the host? Now that its existence is known of, the facts of its history may be readily determined.

Professor Riley remarked that he had been very much interested in the paper. He could not recollect any instance when the larval life had been so long, and the *Ægeridæ* as a rule are supposed to require only one year to undergo their transformations. As to the manner in which the *Tachina* reaches the *Ægeria* larva, it is probable that the latter must come to the surface rather often to expel the excrement from its burrow and the *Tachina* could take advantage of that. Once fastened the egg is very secure.

Professor Lintner asked whether the larva feeds on the pitch. Dr. Kellicott said that the excrement is mixed with pitch, but the larva makes regular burrows in the wood and undoubtedly feeds upon the wood. He said the larva is always more or less coated with pitch, and when removed from its burrow dies in a short time from the stiffening of this substance. He assumed that the larva must come out sometimes for air, but did not see that there is any arrangement similar to that of *Pædisoa scudderiana*, which has a little trap-door arrangement which it can open at will.

*Larva*.—When fully grown, 16<sup>mm</sup> to 18<sup>mm</sup> in length. The head is shining chestnut brown, the mandibles black. The body is livid or blackish green, naked, with a series of black dots, each dot giving rise to a single, rather stout bristle. The prothoracic shield is blackish. The larva has three pairs of thoracic or true-jointed feet, and four pairs of abdominal or false feet, besides anal claspers.\* (Grote.)

*Chrysalis*.—Cylindrical, smooth, narrow, blackish brown, about 16<sup>mm</sup> in length. The head is pointed, there being a pronounced clypeal protuberance; the segments are unarmed; the anal plate is provided with a row of four spines, and two others, more slender, on either side of the mesial line, below the first. (Grote.)

*Moth*.—The wings expand 30<sup>mm</sup>. Blackish-gray, shaded with reddish on the basal and terminal fields of the forewings. There are patches or lines of raised scales on the basal field and on the anterior and darker portion of the median space. The median lines are prominent, consisting of double black lines inclosing pale bands. The inner line at the basal third is perpendicular, W-shaped or dentate. The outer line at the apical fourth is once more strongly indented below the costa. The black component lines do not seem to be more distinct on one side than on the other of the pale included bands or spaces. The median field is blackish, becoming pale towards the outer line; it shows a pale, sometimes whitish cellular spot, surmounted with raised scales. The terminal edge of the wing is again pale or ruddy before the terminal black line. Wings blackish. The hind wings are pale yellowish white, shaded with fuscous on the costal region and more or less terminally before the blackish terminal black line; fringe dusky. Beneath, the forewings are blackish, marked with pale on the costa; hind wings as on the upper surface. Body blackish gray, with often a reddish cast on the thorax above and on the vertex. The eyes are naked, the labial palpi long, ascending, with a moderate terminal joint. Tongue rather long. The gray abdomen is ringed with dirty white; the legs are dotted with pale. The species differs from the European *abietella* by the raised scale tufts on the wings, and Zeller declares it to be distinct from any European species. (Grote.)

\* Mr. Kellicott found that the larva hibernates, as April 12 he found the caterpillars of various sizes from .25 to .7 inch in length. "None of those taken were 'livid or blackish green,' but dull white; nor do the hairs arise from a 'series of black dots,' but from light-brown ones. I take it to be a case where a naked hibernating larva is lighter than during the warm summer. Otherwise the caterpillars were as described by Mr. Grote."



63. *Ægeria pinorum* Behrens, MS.

“ Mr. Behrens sends me a colored drawing and description of an insect to which he gives the above name. It comes from Monterey, in *Pinus insignis*, from which larvæ have been obtained. From these larvæ he bred one specimen from which the drawing was made. He says the larva lives under the bark of the tree, feeding on the inner bark and perhaps outer wood. From the wound made by the larva there is quite a flow of resin, the pupa being formed in the inner flakes of this resin. By detaching such flakes of resin, 5 or 6 inches long, about as wide, and more than an inch in thickness, pupæ and larvæ have been discovered nicely ensconced in rounded holes next to the bark.

“ The wings are vitreous with golden scales scattered over the surface, the veins dark; legs dark and golden; body steel blue with six golden bands, the last the terminal tuft.

“ Mr. Behrens did not state whether the specimen was a male or a female, but I think from the drawing it was a male.” (G. H. French in Can. Ent., xxi, 163, Sept., 1889.)

## 64. THE PITCH-DROP WORM.

*Nephopteryx (Pinipestis) zimmermanni* Grote.

Order LEPIDOPTERA; family PYRALIDÆ.

In June and July wounding the trunk of the red and white pine below the insertion of the branches, the presence of the larva being detected by the exuding pitch; the larva livid or blackish green, eating on the inner side of the bark and making furrows in the wood; in July spinning a papery cocoon, the moth appearing from ten to fourteen days afterwards.

Mr. A. R. Grote has called attention in the Canadian Entomologist (vol. ix, p. 161) to this pest of the red pine (*Pinus resinosa*) and white pine (*Pinus strobus*). The caterpillar occurs in the months of June and July, when the trees affected show by the exuding pitch that they are suffering from the attacks of this insect. The wound occurs on the main stem below the insertion of the branch. The worm in July spins a whitish, thin, papery cocoon in the mass of exuding pitch, which seems to act as a protection to both the larva and the chrysalis. The moth appears in ten to fourteen days after the cocoon is spun.

Mr. Grote adds that the worm usually infests the main stem at the insertion of the branches; and from the fact that the pitch of the trees protects the caterpillars no wash would injure the insect; hence extermination with the knife is the only remedy.

In vol. x of the same journal (p. 20) Mr. C. D. Zimmerman, the original discoverer of this pest, gives some further account of it. He writes

that there is scarcely a pine more than 4 feet high on his grounds which is not more or less affected by this borer. "I have found it on *Pinus strobus*, *P. rubra* or *resinosa*, *P. austriaca*, *P. sylvestris*, *P. cembra*, Corsican, lofty Bothan and Russian pines. *P. sylvestris* seems to suffer most, as the limbs, and often the main stems, are constantly breaking off. Only a few days ago one of our finest specimens of *P. strobus* (a tree over 30 feet in height and almost perfect in shape) had about 6 feet of the top broken off—the effects of this borer. I am in hopes the small parasitic flies I found in the larva will soon get the upper hand, so as to keep them in check."

Additional observations have also been made by Mr. D. S. Kellicott, who states\* that the moth is pretty widely spread, as it occurs not only in foreign and native pines in and about Buffalo, but that he has "found it quite abundant in small white pines of the forest at Cheektowaga, Erie County, N. Y. At this place I found many plants had been dwarfed and ruined by their ravages. It also occurs, to what extent I am unable to say, at Hamburg and Clarence Center, in the same county. I recently visited a portion of this State, Oswego County, formerly clad to some considerable extent with white pine, and there are yet standing some virgin forests of this splendid tree. In divers places in that county I found our borer; it is so abundant, in one locality at least, that it proves a grave enemy to the young pines of second growth where the primitive trees have been removed by the lumbermen. There is near Hastings Center an old slash in which at least one-half of the many such small pines have been injured; indeed, in one neglected corner, among scores scarcely one tree had escaped. In this instance, also, many pines were stunted, while some thus weakened had been broken off by the wind." \* \* \* "In a clump of pines, whose trunks were from 6 inches to 1 foot in diameter, many of the larger ones had been 'boxed,' *i. e.*, inclined incisions had been cut by the axe through the sap-wood in order to catch the pitch exuding from the wound. Around the borders of these 'boxes' the galleries with both pupa skins and living larvæ were plentiful. It appears that the larva can not penetrate the outer bark of other than quite tender trees; nor could I find evidence of their attacking the branches of larger trees, although I had opportunity to examine such that had been felled during the winter just past. Since the larva so readily takes advantage of a wound, may it not stand related as a messmate to other borers?" \* \* \* "I have found the moth's galleries in both trunk and branch, both above and below the whorls (usually below), sometimes completely girdling the stem, thus killing the portion above; in one instance I found a gallery passing from one whorl to the one above."

This larva, observes Dr. Kellicott (*Ent. Americana*, i, 1885, p. 173), does not produce so large an excrescence as *Algeria pini*. "The excrescences are also more irregular, often a mere line or track of

---

\*Canadian Entomologist, xi, p. 114, 1879.

pitchy exudation marking the track of the larva from whorl to whorl or twig to twig. This larva also when removed from its burrow lives but a short time, owing to the hardening of the pitch."

## 65. THE WHITE-HORNED UROCERUS.

*Urocerus albicornis* Fabricius.

Order HYMENOPTERA ; family UROCERIDÆ.

A large black four-winged fly an inch long, having some resemblance to a wasp, but with a stout cylindrical body having the head and abdomen closely joined to the thorax, the base of the shanks and of the feet white, and also the antennæ except at their ends, and a spot behind each eye and another on each side of the abdomen, the wings smoky transparent. The abdomen ends in a point shaped like the head of a spear, below which is a straight awl-like ovipositor about .40 long, with which it bores into the tree to deposit its eggs, the worm from which forms winding burrows in the wood, and is of a thick cylindrical form, divided into thirteen nearly equal segments, including the head, which is small, polished and horny, the last segment being largest of all and ending in a conical horn-like point, and the under side with three pairs of very small legs anteriorly.

These insects vary considerably in their colors and marks, and the two sexes are very dissimilar. The male, according to Dr. Harris, is black, with a white spot behind each eye, and a flattened rust-colored abdomen. (Harris's Treatise, p. 427.)

## 66. THE YELLOW-BANDED UROCERUS.

*Urocerus abdominalis* Harris.

A four-winged fly similar to the foregoing, about 0.80 long, of a blue-black color with from two to four of the middle segments of its abdomen bright orange yellow, and also a broad band on the antennæ and the four forward legs except at their bases, its wings hyaline, tinged at the tips with a smoky color. There is sometimes a yellow spot behind each eye, and the hind knees and some or all of the joints of the hind feet are usually yellow. My specimens are males, nor has any female answering to this been found, and I am forced to entertain suspicions that it is the true male of the preceding species. These insects are not common. (Harris's Treatise, p. 428.)

67. *Bembecia sequoia* Hy. Edw.

Order LEPIDOPTERA ; family ÆGERIADÆ.

In 1881 Mr. Henry Edwards wrote us that this Ægerian was devastating the pine forests of Mendocino County, California, and was particularly destructive to *Sequoia sempervirens*, *Pinus ponderosa*, and *Pinus lambertiana*. The eggs appear to be laid in the axils of the branches, the young caterpillar boring in a tortuous manner about its retreat, thus diverting the flow of the sap, and causing large resinous nodules to form at the place of its workings. These gradually harden, the branch beyond them dies, and the tree at last succumbs to its insignificant enemies. Hundreds of fine trees in the forests of the region indicated are to be seen in various stages of decay. A similar habit

seems to prevail in the life-history of *Sciapteron pini* Kellicott, a species described by its author in the Can. Entom., 1881. (See p. 726.)

*Moth.*—Male. Forewings with the margins all black, the costal edge rather broad. Hind wings, with the costal and base of the abdominal margin, pale yellow. Beneath, the forewings have the margins lemon yellow, as far as the discal mark, beyond this, black. Hind wings as on the upper side. Head and antennæ jet black. Palpi lemon yellow, black at the sides. Fore femora, orbits of eyes and base of wings beneath lemon yellow. Middle and hind femora black. Tibiæ lemon yellow, bordered with black. Thorax with collar, tegulæ, the two narrow dorsal lines, and a basal line lemon yellow. Abdomen, with all the segments except the fourth, narrowly bordered with rich lemon yellow. Caudal tuft yellow below, blackish above. Female similar, but a little larger and more robust, the abdominal band broader and better defined. Expanse of wings, male, 24<sup>mm</sup>; female, 30<sup>mm</sup>. (H. Edwards.)

#### 68. THE PINE BLIGHT.

*Coccus pinicorticis* Fitch.

Order HEMIPTERA; family COCCIDÆ.

Externally, upon the smooth bark of young trees, patches of white flocculent down-like matter, covering exceedingly minute lice, invisible to the naked eye. (Trans. N. Y. State Ag. Soc., 1854, p. 871. Compare also an article by Dr. H. Shimer in Trans. Amer. Soc., ii, pp. 383-385.)

#### AFFECTING THE TWIGGS.

#### 69. THE WHITE-PINE WEEVIL.

*Pissodes strobi* Peck.

(Larva, Plate XXIII; Fig. 5; pupa, fig. 6; also Plate XXVII.)

Order COLEOPTERA; family CURCULIONIDÆ.

In May, depositing numerous eggs in the bark of the topmost shoot of young trees, the larvæ from which mine in the wood and pith, causing the shoot to wither and die, thereby occasioning a crook or fork in the body of the tree at this point; an oblong oval and rather narrow weevil about a quarter of an inch long, of a dull dark chestnut-brown color, with two dots on the thorax; the scutel and a short irregular band back of the middle of the wing-covers milk white, the wing-covers also variegated with a few patches of tawny yellow.

For many years past our attention has been drawn to the deformities produced in forest trees by this beetle, as well as the injury it commits in plantations and to ornamental trees on lawns and about houses.

Dr. Fitch has already outlined the natural history of the insect in his fourth report. We have not yet been able to detect the beetle in the act of egg-laying. Fitch says that the weevil deposits her eggs in the bark of the topmost shoot of the tree, dropping one in a place at irregular intervals through its whole length. "The worm which hatches from these eggs eats its way inwards and obliquely downwards till it reaches the pith, in which it mines its burrow onwards a short distance farther, the whole length of its track being only about half an inch.

But such a number of young weevils are usually placed in the affected shoots that many of them are cramped and discommoded for want of room. The worm on approaching the pith often finds there is another worm there, occupying the very spot to which he wished to penetrate. He thereupon, to avoid intrusion upon his neighbor, turns downward, and completes his burrow in the wood outside of the pith. Those, also, which enter the pith, are often unable to extend their galleries so far as is their custom without running into those of others. When its onward course is thus arrested, the worm feeds upon the walls of its burrow until it obtains the amount of nutriment it requires and is grown to its full size."

The eggs of this species are probably similar in shape, but considerably larger than those deposited by the timber beetles, whose eggs and larval development are figured and described in the third report of the United States Entomological Commission (p. 280, Plate XXII, figs. 1, 8, 9, 10. See also p. 722.) According to Ratzeburg, the European *P. notatus* lays its eggs in the lower internodes of young plants, boring into the sap-wood with its beak. Its habits thus differ much from our species, and it does not seem to affect the terminal shoot. The grub or larva does not differ from those of other borers found in the pine, as there is a great persistence of form in boring grubs, both of the weevil family and the bark-borers or Scolytids. The grub of *Pissodes strobi* (Plate XXII, fig. 5) is rather slenderer than those of *Hylurgus*, *Dendroctonus*, or *Hylurgops pinifex*. Compared with the latter very common borer the body is 8<sup>mm</sup> in length, while that of *H. pinifex* is only 5 to 6<sup>mm</sup> in length.

While from their similar tunnel-making habits the larvæ of the two families mentioned are, owing to adaptation to their surroundings, very similar, the pupæ are very unlike, those of the white-pine weevil being at a glance distinguishable by their long snout, which is folded on the breast, and the beetle, as seen in the figure, has a long, slender snout, while the body is reddish brown, with two irregular white spots, one behind the middle of each wing-cover. When engaged in laying their eggs at the reddish-brown extremity of a pine twig, near the buds, these weevils are undoubtedly protected by their shape and color from the observation of birds, some kinds of which are constantly on the search for such beetles.

While living in their "mines" or tunnels, the grubs are exposed to manifold dangers from carnivorous grubs, particularly the young of beetles of the family *Tenebrionidæ*, etc. We have not detected any Ichneumon or Chalcid larvæ or flies in their burrows, but these are not uncommon in those of the Scolytid bark-borers. At all events these insect enemies keep the larval pine weevils within due limits, otherwise their injurious effects in forests would be more marked.

The presence of the grub of the white-pine weevil in a branch or twig or under the bark of a young or old tree, may be at once known by its peculiar cells. When the grub is full-fed and ready to change to the

chrysalis state, it either transforms within a small branch in the pith or under the bark. In the latter case it sinks an oval cylindrical hole in the pith wood, and builds up over it, in the space between the loosened bark and the wood itself a white covering, composed of the long chips or fibers of the pith wood, the little fibers being closely interwoven and matted together, so as to form a cocoon of a tolerably firm consistence, which contrasts in its white color with the under side of the bark. The cocoon thus made is not usually, if ever, lined with silk. The length of the entire cell is 12<sup>mm</sup>; its breadth is 5<sup>mm</sup>. *Hylurgus terebrans* constructs similar cells, but they are much smaller. Most of the bark-borers, however, do not transform in such cells, but in their tunnels.

While the insect is especially abundant in Maine, I have also found it in abundance in September on the ornamental white pine bushes on the grounds of the State Agricultural College, at Amherst, Mass. When the white pine is set out on plantations it has thus far been tolerably free from the attacks of this pest. On the extensive plantation of Henry G. Russell, esq., at Greenwich, R. I., who has planted trees on a larger scale than any one else in New England, only scattered trees have been affected. Fig. 2, Plate XXVII, has been drawn from a terminal twig on one of these trees. Part of the twig was mined under the bark, the tunnels ran close together, there being seven or eight on one side of a twig about a third of an inch in diameter. They run up and down the twig, more or less parallel, beginning small, when the larvæ hatched and becoming slightly larger as the grub grew, until at the end of 4 or 5 inches they sink into the cell, the grub having become full-fed and making its cell designed for its final transformation.

When the pith is mined, the cells form enlargements of the tunnel, and in the case before us the cells are so thick as to touch each other, there being six cells in a length of not over two inches. When the cells are made exteriorly, but under the bark, they are usually about an inch apart, and as we have said, at once by their light color and convex surface, attract attention when the bark is torn off.

While this weevil does much injury to the young white pine trees, it is by no means restricted to such growths, but lays its eggs in the bark and mines the sap-wood of large pines and other coniferous trees.

Thus I have found the beetles more commonly, and in different stages of growth, in the white pine April 24; at this date the beetles begin to appear; and the beetles do not all make their exit from under the bark and fly about by the end of spring, but I have found the beetles under the bark May 30, and even as late as the 11th of August, when a pupa and beetle occurred, the latter somewhat pale and immature.

This weevil is of common occurrence in the bark of spruce trees 6 to 10 inches in diameter, where I have found them during the middle of August at Brunswick, Me. The grub and pupa occurred near the Glen House, White Mountain, New Hampshire, at the end of July in the fir; on the 30th of July I took five mature beetles from under the bark of a hemlock tree. I have never noticed, however, spruce, fir or hemlock

trees which had been deformed, as is not uncommonly the case with the white pine.

The life-history of this weevil, then, in brief, is as follows: The eggs are laid early in summer, at intervals, on the terminal shoots of the white pine, or sometimes in the bark of old trees; the grub on hatching bores into the pith, or simply mines the sap-wood; it becomes full-grown at the end of summer, hibernates, and transforms in the spring to the pupa, most of the beetles appearing through May, when they pair and the eggs are laid, but some delay their appearance till June, July, and even August.

Thus far we have said nothing as to the remarkable effects produced by the grubs upon the young trees. When the terminal shoot of a small tree, say 4 or 5 feet high, is filled in midsummer with these grubs, perhaps fifteen or twenty, or more, gouging or tunneling the inner bark and sap-wood, and for a part of the way eating the pith, the shoot, with the lateral ones next to it, as well as the stock immediately below the terminal shoot, will wilt and gradually die; the bark will loosen, the pitch will ooze out, and by September the shoot will be nearly dead, black, and the bark covered externally with white masses of dry pitch.

The tree thus pruned will fail for one and probably several succeeding summers to send out a new terminal shoot; the result will be that the adjoining lateral shoots will continue to grow, their direction will be changed to a nearly upright one, and instead of a tall shapely young tree, destined to be the pride of the forest—and there is no finer ornamental evergreen tree in our lawns or parks than the white pine—it becomes distorted, prematurely bent, or its noble shaft becomes replaced by one, two, or half a dozen or more stunted, shriveled aspirants for leadership.

In walking through any forest of white pines of secondary growth in New England or northern New York, one's attention is drawn to these deformed trees. They are not necessarily dwarfed, as some are among the largest and noblest trees of the wood. They may occur singly, but often there are several, differently affected, growing near each other, though not in clumps. Some have but a single bend, a single shoot growing up, the original, and perhaps several, lateral shoots, having been destroyed; one, we well remember, consists of two shafts which separate about 6 feet from the ground (see Plate XXVII, fig. 3).

The most remarkable example which we have seen in the Maine woods stood in a wood southwest of Bowdoin College, but which has since been cut down. Fortunately, shortly before the destruction of the tree, we requested Prof. G. L. Vose, then of Bowdoin College, to make a drawing of the tree. He kindly sent us the accompanying excellent sketch (see also Plate XXVII, fig. 4), in part reproduced, with the following letter, giving the measurements of the tree:

BRUNSWICK, ME., *September 5, 1881.*

I send you a sketch of the tree, not, as you will see, in any way as a work of art, as I make no pretense in that line, but as a botanic specimen. The arrangement of

branches is according to nature. I took a point about 150 feet southwest of the tree, so as to separate all of the branches. The height is about 100 feet; the height of trunk before it begins to branch, 12 feet; circumference at 4 feet above ground, 10 feet; at 2 feet above ground, 10 feet 9 inches. The spread of the top is 35 or 40 feet.

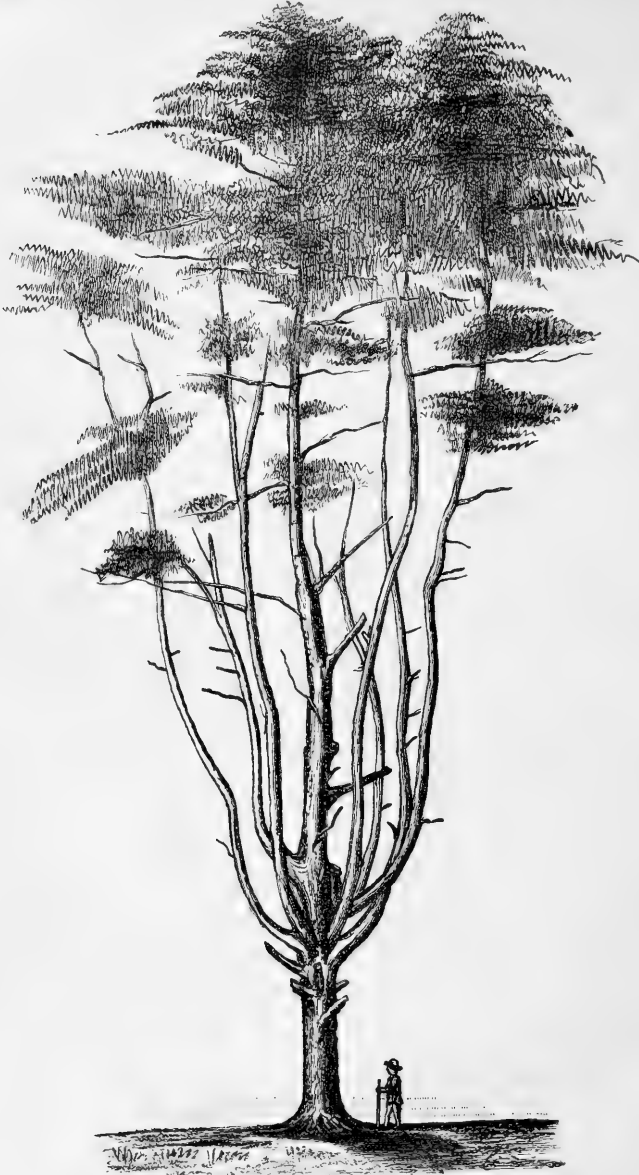


FIG. 257.—A giant pine, deformed by the weevil. Vose del.

Looked at sideways the tree is not so symmetrical. The sketch is just as I made it on the ground. I thought I would not work over it at home, as I might change it by so doing.

Very truly, as ever,

GEO. L. VOSE.



Fig. 5, Plate XXVII, is from a photograph of a white pine tree in East Providence, R. I., which is of the same general shape, but a smaller and shorter tree, still growing in a thick wood, its fellows, however, much smaller. The tree is about 70 feet in height and 32 inches thick before it branches, the trunk sending out nine branches, the lowermost being about 3 feet from the ground.

In these two examples we should judge that the terminal shoot only was destroyed by the weevil, while the lateral shoots survived, but grew more vertically than they would have done if the terminal shoot had not been injured, while their size became unnaturally large.

It is comparatively easy to prevent this deformation of small young trees in lawns and about houses or even on large plantations if the disease is combated in time; the wilting terminal twig should be examined and the grubs cut out. If a wash of Paris green were applied or a block of carbolic acid soap securely placed in the crotch the grubs would be destroyed or driven off. The time to apply the remedies is at the middle or end of July.

We add Fitch's account of this weevil:

This is a common insect in New York, and specimens of it may be found around and upon pine trees at all times of the year, but it is in the month of May that they are abroad in the greatest numbers, and it is chiefly at that time that their eggs are deposited. Young thrifty-growing pines are its favorite resort, and among these it selects those that are most vigorous, and whose topmost shoot has made the greatest advance the preceding year. But I have seen it so numerous that not only the topmost shoots of every tree in the grove, but many of the lateral ones also, were invaded and destroyed by it.

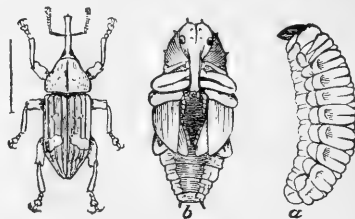


FIG. 358.—White-pine weevil; a, larva; b, pupa, enlarged nearly three times.—From Packard.

It is in consequence of its smooth straight growth to such a lofty height that the pine has been prized beyond any other timber for large buildings and bridges, and is especially valuable for the masts of ships. So very highly were the American pines esteemed for this last purpose, at an early day, that they were ranked with the precious metals, and a large portion of the lands of the State of New York were originally granted by the British crown, with an explicit reservation of "All mines of Gold and Silver, and also all White and other sorts of Pine trees fit for Masts, of the growth of twenty-four inches diameter and upwards at twelve inches from the earth, for Masts for the Royal Navy of us, our heirs and successors," under the stringent condition that "If they, our said grantees or any of them, their or any of their heirs or assigns, or any other person or persons by their or any of their privity, consent or procurement shall fell, cut down or otherwise destroy any of the Pine trees by these presents reserved to us, our heirs and successors, or hereby intended so to be, without the Royal Licence of us, our heirs and successors for so doing first had and obtained, that then, and in any of these cases, this our present grant, and every thing therein contained, shall cease and be absolutely void, and the lands and premises hereby granted shall revert to and vest in us, our heirs and successors, as if this our present grant had not been made, any thing herein before contained to the contrary in any wise notwithstanding." Now the perfect straightness of the pine, which has adapted it so eminently for this important use, and has caused it to be thus valued,

depends upon the healthy growth of its leading shoot for a long succession of years. If this leading shoot is destroyed the onward growth of the tree is checked until one of the lateral shoots starts upward and becomes the leading shoot. But this causes a crook in the body of the tree at the place where this latter shoot originally arose, and thus the main value of the tree is destroyed. And it would appear to be a spirit of pure malevolence that instigates the white-pine weevil to select the leading shoot of this tree in which to deposit its eggs, when its young can be nourished equally well in the lateral shoots, where they would do little injury, or perhaps would be a direct benefit to the tree by cutting off the ends of the branches, and thus promoting the upward growth of the main trunk.

The tree that is attacked continues its growth upward during the fore part of the season as usual, sending out from the summit of the shoot that is infested a leading shoot, with a number of lateral branches around its base. But the growth of these new succulent twigs is arrested, and they begin to wilt and wither about the middle of July, the worms having by this time become so large and mined and wounded the stalk below to such an extent that its juices are exhausted, and it fails to transmit any nourishment to these tender green shoots at the summit, which consequently dry up and perish.

If the affected shoot be now examined, little oval cells about 0.30 long, placed lengthwise of the stalk, will be discovered all along its center, so close in some places that their ends are in contact, and in other places more or less widely separated, with the intervening space stuffed with sawdust, whilst here and there in the wood on each side of the pith similar cells show themselves. In each of these cavities lies a white glossy worm, its body soft, plump, and curved into an arch, 0.30 long, and not quite a third as broad at its anterior part where it is broadest.

This *larva* is divided by transverse constrictions into thirteen segments, including the head, with the breathing pores forming a row of small round tawny yellow dots along each side. Its head is about half the width of the body, round, flattened, polished and horn like, tawny yellow, with an impressed line along its middle, a faint whitish line on each side parallel with this, and a more distinct transverse arched white line anteriorly, and a minute black dot on each side representing the eye; the mouth darker colored, with the points of the mandibles slightly projecting, these organs being black, triangular, and with exceedingly minute sharp teeth along their inner edge. The neck has two smooth pale tawny-yellow spots above. It has no feet, but their places are supplied by roundish elevations of the skin on the under side of the three segments next to the head. The surface shows a few very fine short hairs, particularly on the ends.

These larvæ change to pupæ and to perfect insects in their cells, the latter coming abroad mostly early in the spring. The short description at the commencement of this account will suffice to distinguish this weevil from all our other species. It varies in its length from 0.20 to 0.30. Dr. Harris thinks they are more than a year in obtaining their growth, but I am quite confident the eggs deposited in the spring become mature beetles by the following spring or earlier.

In midsummer, as soon as the shoot in which these insects are nestling becomes withered and dry, the thin bark covering it is commonly seen to be broken and peeled off in spots, or all its lower part is torn away, and newly perforated holes, larger than the mouths of the burrows of this insect, may be observed here and there in the wood. This is the work of small birds, which are very efficient and serviceable in ferreting out and devouring the larvæ and pupæ of this weevil. And, in addition to these, it has several insect enemies which aid in restraining it from becoming excessively numerous. But notwithstanding the great inroads which are hereby made upon its ranks, this is quite a common insect in every part of our State and country where the pine abounds, deforming these valuable trees and retarding their growth. The proprietor of every grove of young pines should therefore make it a rule to examine them every year, in August or September, and cut or break off the top of every tree that is

blighted by these weevils and commit it to the flames. With every shoot that is thus treated, from ten to fifty or more of these weevils will be destroyed, which otherwise will come abroad the following year to dwarf and deform a number of the other trees in the same manner. No one, on casting this subject over in his mind for a moment or two, will doubt but that a few hours devoted to such work, or a whole day, should it be required, will be time well spent, and labor that will be amply rewarded."

To the foregoing account, copied from Fitch's Fourth Report, we will add that we have observed the weevil in all its stages of growth at Brunswick, Me., under the bark of white pine shrubs, the last of April, the larvæ at this date being more numerous than the pupæ or beetles. Our larvæ were .32 inch long. The pupa is white, the tip of the abdomen being square, with a sharp spine on each side. It is .30 inch in length. There are often to be seen in the forests of Maine trees, from 2 to 4 feet in diameter, variously distorted by the attacks in early life of this weevil.

#### 70. THE WHITE-PINE APHIS.

*Lachnus strobi* Fitch.

Order HOMOPTERA; family APHIDÆ.

Colonies of plant-lice on the ends of the branches, puncturing them and extracting their juices, the bark of the infested trees having a peculiar black appearance; numbers of ants in company with them, and traveling up and down the trunks of the trees which they inhabit. The winged individuals 0.20 long to the tips of their wings, black, hairy, and sometimes slightly dusted over with a white meal-like powder, with a row of white spots along the middle of the abdomen, the thighs dull pale-yellow at their bases, and the forewings hyaline, with black veins, of which the forked one is exceedingly fine and slender. The wingless individuals far more numerous, 0.12 long, brownish black with a white line along the middle of the thorax and white spots along each side of the abdomen, which are sometimes faint or wanting, the antennæ pale, with their tips black.

#### 71. THE PARALLEL SPITTLE-INSECT.

*Aphrophora parallella* Say.

Order HEMIPTERA (Homoptera); family CERCOPIDÆ.

In June, a spot of white froth, resembling spittle, appearing upon the bark near the ends of the branches, hiding within it a small white wingless insect having six legs, which punctures and sucks the fluids of the bark, and grows to about a quarter of an inch in length by the last of that month, and then becomes a pupa of a similar appearance, but varied more or less with dusky or black, and with rudimentary wings resembling a vest drawn closely around the middle of its body; the latter part of July changing to its perfect form, with wings fully grown, and then no longer covering itself with foam, but continuing to the end of the season, puncturing and drawing its nourishment from the bark as before. The perfect insect a flattened oval tree-hopper, 0.40 long, with its wing-covers held in form of a roof, its color brown from numberless blackish punctures upon a pale ground, a smooth whitish line along the middle of its back, and a small smooth whitish spot in the center of each wing-cover, its abdomen beneath rusty brown. (Fitch.)

The reasons why I regard this species as pertaining to the genus *Aphrophora*, to which Say had assigned it, instead of the genera in which it has recently been placed, will be found stated under a kindred species in my Third Report, No. 98. (Fitch.)

What I suppose to be this insect is also very common on the pitch pine at Brunswick, Me. The pupæ are common late in July, but early in August the insects acquire their wings.

#### 72. THE SARATOGA SPITTLE-INSECT.

*Aphrophora saratogensis* Fitch.

A similar insect with the same habits with the preceding, but differing from it in having the punctures uncolored, and the head above with its anterior and posterior margins parallel. It is of a lighter color than the foregoing, being pale tawny-yellow varied with white. It is much more attached to the pitch-pine than to the white pine, and is very common upon the small trees of that kind growing upon the sandy plains of Saratoga County. (Fitch.)

#### 73. THE PITCH-PINE TWIG TORTRIX.

*Retinia comstockiana* Fernald.

Boring into the twigs and small branches of the pitch-pine (*Pinus rigida*), causing an exudation of resin; yellow-brown larvæ, about 10<sup>mm</sup> (.39 inch) long, transforming within the burrow, and giving forth small brown and gray moths. (Comstock.)

An examination of the pitch-pines in the vicinity of Ithaca, N. Y., in the early part of the past summer,\* revealed the fact that they were infested to a considerable extent by a heretofore undescribed pest. Upon the smallest twigs and limbs and upon the terminal shoots of the trees were observed exuding at intervals masses of pitch, mixed with the excremental pellets of some larva. In most cases there were two distinct layers of the resin to be seen, the lower dry, hard, whitish, weather-beaten, having evidently been exposed during the winter, while the upper mass was fresh, softer, and of a hoary, bluish color on the surface, yellowish beneath, having the appearance of a comparatively recent exudation. These resinous lumps, when occurring upon twigs or limbs, were, in the great majority of cases, upon the upper side, and were seldom found upon a larger limb than the one represented in the cut.

A longitudinal section through one of these lumps showed a channel of greater or less size leading directly to the heart of the twig, and extending along toward its base for a distance of from 25 to 50<sup>mm</sup> (1 to 2 inches). In this burrow was found a rather stout, yellowish-brown larva, apparently nearly full grown, and measuring about 10<sup>mm</sup> (.29 inch) in length. In other burrows the short, stout, brown pupæ were found. They were quite active, and retreated to the bottom of the

---

\* The account is copied textually from Professor Comstock's Report, 1879.

mine when the resin was cut into. A ring of strong spines surrounded the posterior border of each segment and enabled them to move about

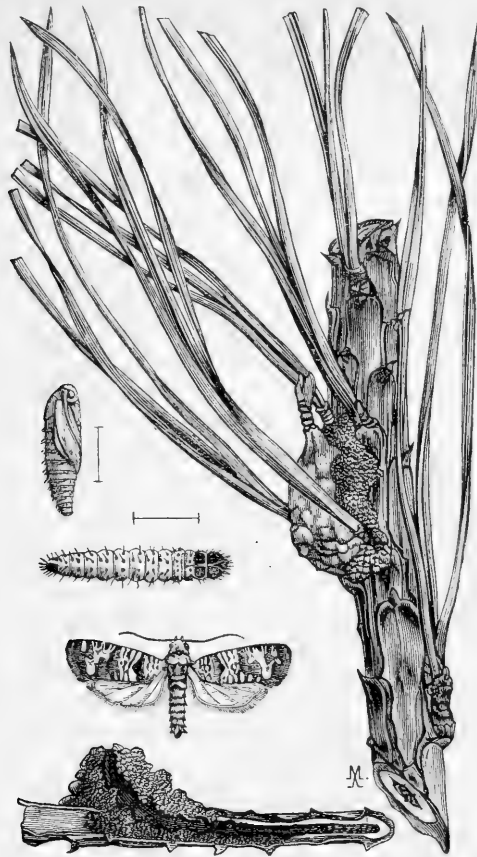


FIG. 259.—*Retinia comstockiana* Fernald, larva, pupa, adult and work.—From Comstock.

in the mine with considerable rapidity. From other lumps the empty pupa skin was protruding for half its length, the pupa having worked itself to that position before giving forth the moth.

Some of the burrows examined extended in both directions from the point of entrance. Occasionally, also, the twig at the point where the resin exuded was completely girdled, and in other cases eaten out to such an extent that a very slight force would suffice to break it off. The larvæ were in some cases found with their heads at the mouth of the burrow, but in the majority of instances the opposite was the case.

The moth which issues from the burrows is quite small and soberly colored. In the figure it is represented natural size; the darker shades are dark rust color, and the lighter light gray. It belongs to the family Tortricidæ, the larvæ of which are usually leaf-rollers.

From what we have been able to learn, we conclude that there are two broods of this insect in a year, and that the second brood hibernates in the larva state. May 25, burrows were found from which the moths had already issued. In the breeding cages at Washington the moths issued until June 20, when the last one made its exit. August 23, larvæ were received which were nearly full grown, and were presumably of the second brood. In the following January nearly all the larvæ found were only about half grown; none were more than two-thirds grown.

At the approach of winter the larvæ prepare their burrows for hibernation by lining them with delicate layers of white silk, which often form tubes closed at the lower end. The larva remains through the winter with its head at the posterior end of the mine. Before the change to the chrysalis state, however, this position is reversed and the head is towards the opening.

Wherever a twig is pierced and bored by one of these larvæ the leaves begin to turn yellowish and the twig often dies. In many cases, however, more than one of the larvæ are to be found in a single twig, and this of course more certainly insures its death. It seems probable that the principal damage done is the disfiguring of the shape of the tree by the destruction of the terminal shoots.

The moths bred from the burrows were submitted to Professor Fernald, who decided that they represented a new species, probably belonging to the genus *Retinia*. This species he describes in the Canadian Entomologist, vol. xi, p. 157. We quote Professor Fernald's description of the moth, and append descriptions of the larva and pupa so that the insect may be recognized in whatever stage it is found.

It is probably this caterpillar which in the summers of 1873-'74 proved very destructive to the pitch-pine bushes in and about Brunswick, Me., causing the upper part of the bush to turn yellow and die.

April 2, 1883, we found a larva in a burrow situated partly in pitch, head downwards. We also noticed that the new growth of leaves at the end of the twig infested were about one-third as long as the normal needles.

*The moth.*—Head in front, basal joints of antennæ and palpi white; last joint of palpi and a few scales upon the outside of the middle joint dark gray. Eyes black, vertex light sulphur yellow to straw yellow, antennæ dark brown, annulated with whitish. Thorax above white, with a few scattered gray scales; beneath silvery white. Abdomen above light brown, with a silvery luster; lighter at the end of each segment; beneath lighter; last segment in the females darker brown above and beneath, and without the silvery luster. Anal tuft in the males light straw color. Fore and middle legs light brown, femora and tibiæ of hind legs white, tarsi of all the legs brown, ringed with white. Forewings ferruginous brown, the extreme costal edge from base to near the apex dark brown. A number of small white spots rest upon the costa, four hairs beyond the middle, from all of which stripes composed of white and leaden-hued scales extend, more or less irregularly, across the wing at nearly right angles with the costa, and having something of a wavy appearance in some specimens, with some indication of a basal patch, a central and subterminal

band composed of the leaden and white scales. Fringes light brown above and beneath; forewings light brown beneath; ferruginous apically, with the white spots of the costa well indicated. Hind wings above and beneath grayish brown, with a tinge of ferruginous in some specimens and with darker irrorations on the costa and outwardly; fringes long at the anal angle, somewhat lighter and with a darker line near the base. Expanse of female, 18-20<sup>mm</sup>; male 18-20<sup>mm</sup>. Habitat.—Ithaca, N. Y. Described from two males and three females.

I have provisionally referred this species to the genus *Retinia*, for although it agrees with the definition of the genus as given by Heine-mann in other respects, the venation of the forewing differs in the origin of veins four and five, which are not from the same point, but a little remote from each other; the distance between veins five and six at their origin is about twice the distance between veins four and five.

The moth has also been taken by Mr. Otto Luger at Baltimore, Md.

*Larva*.—Length, when full-grown, 12<sup>mm</sup>, cylindrical, tapering very slightly at the ends. General color yellowish; head, thoracic plate, and piliferous spots brown and highly polished; anal plate dusky and somewhat polished, under a high power covered with shallow pits. The piliferous warts are large and quite prominent, each bearing a stiff hair. Their arrangement is normal. The anal shield is furnished with two transverse rows of four hairs each; the posterior row, from a dorsal view, appearing to fringe the end of the body. The stigmata are light colored, surrounded by a dark-brown chitinous ring. Thoracic legs and bases of prolegs brownish.

The young larvæ differ in being darker colored. The head and thoracic shield are lighter; the piliferous spots are hardly discernible; the stigmata are much larger in proportion to the size of the larva, and their dark circumference is very strongly marked.

*Pupa*.—Length, 7<sup>mm</sup>. General color dark shining brown, darkest on dorsum of thorax and head; wing-sheaths broad, extending to third abdominal segment. The posterior border of each abdominal segment dorsally elevated to a spiny ridge, bearing many strong backward-directed spines. Anal segment somewhat truncate, with a number of slender hooked filaments. Eyes very black and prominent. Between the eyes two pairs of the hooked filaments, having their origins close together and spreading. (Comstock.)

Two species of Ichneumonid parasites have been bred from the larvæ, both furnished with long ovipositors to pierce the resinous mass. One is a species of *Agathis*; the other is *Ephialtes comstockii* Cresson, described in Mr. Comstock's Report.

#### 74. THE PINE MOTH OF NANTUCKET.

*Retinia frustrana* Seudder.

Order LEPIDOPTERA; family TORTRICIDÆ.

(Plate VII.)

Infesting the new growth of the pitch-pine (*P. rigida*) and *Pinus inops* (and perhaps of other species), spinning a delicate web around the terminal bud, and mining both the twigs and the bases of the leaves; one or several small yellowish larvæ which transform within grayish cocoons, either in their burrows or fastened to the twigs, and become small copper-colored moths, with wing expanse of 12<sup>mm</sup> (.47 inch).

We reproduce, with the author's permission, the greater part of Mr. Scudder's pamphlet with the above title, published by the Massachusetts Society for the Promotion of Agriculture, Boston, 1883:

The pines on the island of Nantucket (*Pinus rigida* Miller), set out some twenty or thirty years ago, are fast dying in large numbers from a cause hitherto unknown. A great many have already perished, and most of the living trees look sickly. On the "Old South Road," from Nantucket to Siasconset, all the trees on one side of the road are quite dead, or fast dying, while upon the opposite they are comparatively healthy looking, although seriously affected.

On September 19, 1876, I went to this spot to discover, if possible, the difficulty. I chose first a dead tree on Mr. Crosby's land, and cut it down, carefully examining the trunk, boughs, twigs, bark, and roots; there was no sign of the work of any insect sufficient to have caused the death of the tree—none more than would be found on any healthy tree. Next I selected a tree that was nearly dead, the uppermost boughs only being in leaf, and a few bunches of needles appearing at different points on the trunk. I cut this down and examined the trunk, boughs, bark, and roots as before, with negative results; but when I searched the living twigs I found, always at the extreme tips, a great many recently dead needles, and in connection with them a small lepidopterous insect, and in such numbers, both here and on hundreds of trees afterwards examined, as to leave no room for doubt that this insect is the sole cause of the trouble. The only other insect at all common was the larva of a geometrid moth, which had nibbled the leaves extensively, but not enough to cause serious damage, or to strike at all at the life of the tree; wherever the mark of the blight was found upon living trees the first-mentioned insect was present in vast numbers, and very nearly all the damage that had been inflicted was directly traceable to its devastations. It is a minute moth of the family of Tortricidæ, referable to the genus *Retinia* (or *Coccyx* of some authors), and may be described as follows:

Head covered, especially above, with hoary tipped, smoky-brown scales, giving it a speckled appearance; palpi rather longer than the head, the middle joint expanding into a compressed disk-like plate, half as large as the head, and covered with silvery gray scales, which are dusky towards the base, the apical joint minute, slender, dusky; antennæ equally and narrowly annulated with dark brown and white. Thorax and patagia of much the same color as the summit of the head, but the front portion of each tinged with pale amber, while the hinder portion inclines to silvery gray, sometimes to a decided degree.

The ground color of the front wings is divided between a dull yellowish umber and a deep reddish umber, deepening at points to a bright ferruginous. The former prevails in the lower half of the outer two-thirds of the wing, and in an oblique subapical band, subparallel to the outer margin. The latter elsewhere, but becoming subinfuscated in the basal third of the wing; the brightest parts of this tint are found in a large quadrate patch depending from the middle of the costa, and an oblique, slightly arcuate streak, directed inward from the apex, and often continued a little out of line over the lower half of the wing, breaking the lower pale patch in the middle of the outer half of the wing. Both of these umber tints are overlaid by frequent transverse, perfect or broken stripes of lustrous pearly gray, which, with the diversity of the ground color, give the insect a very variegated appearance. Nearly all of these pearly stripes run at right angles to the costa, and are distributed as follows: The most important and persistent are the two broadest, which divide the wing into nearly equal thirds, the outer striking the inner angle of the wing where the fringe terminates; another, nearly as constant, crosses the wing a little beyond the middle, is slightly bowed outward, and united at the middle with the outer of the two already mentioned, forming with it an **H**, with one straight and one bowed leg; often, on the left wing, it more nearly resembles a **K**; besides these



there are numerous, often partially confluent, short bars or stripes on the upper half of the wing, and, next the inner margin, very brief similar bars, increasing in size toward the base, and on the basal third forming a dull pearly patch. The whole of the basal third or fourth of the wing is traversed irregularly by transverse pearly lines, often nearly or quite confluent; and in some individuals the whole basal half is of nearly uniform pearly hue. Many of these pearly scales appear to have fuliginous bases, so that where the patches are broadest the color is usually duller. The outer edge of the wing is marked by scattered black scales, edged within and sometimes without by a delicate white line; and the fringe, which is very long, especially below, is pearly fuliginous, often deepening apically to black, and with all the scales minutely white tipped, forming transverse lines of white upon the darker ground. Hind wings very pale silvery gray, slightly infuscated, the fringe infuscated only at base, outside of a silvery hue. Legs silvery gray, the tarsi infuscated above at the base of all the joints. Abdomen silvery gray, more or less infuscated above, or sprinkled with brownish fuscous scales.

Expanse of wings, 12 to 14<sup>mm</sup>; length of body, 4.75 to 5.75<sup>mm</sup>; length of antennæ, 3.5<sup>mm</sup>. Described from twenty specimens.

There seems to be no colorational distinction between the male and the female, but considerable general variation, both in the markings and in the tints of this beautiful but destructive insect. Some individuals occur in which the deeper colors are intense, while at the other extreme the pearly scales have spread so widely, and at the same time the more brilliant tints have become so subdued, as to give the whole insect a drab appearance. The two shades of umber also grade into each other in all cases, being seldom sharply separated. The markings as above described are those most prevalent.

The eggs seen were not described.

*Larva* (fig. 4).—Slender, cylindrical, slightly depressed, of a pale-brown color above, the thoracic segments slightly darker, with a faint pale mediodorsal line which broadens and becomes somewhat yellowish on the two hinder segments, on the last occupying nearly the whole breadth of the segment; the lower part of the sides and the under surface are dirty luteous. The head varies from castaneous to pitchy castaneous, is broader than long, obscurely subcordate, the lateral hemispheres being tumid above, and separated by a deep and narrow groove; the antennæ and most of the mouth-parts are pale luteous, the ocelli black. The prothoracic shield is of the color of the head, transversely obovate, more than twice as broad as long, and divided by a pale mediodorsal stripe; the hinder margin is broadly rounded, the front margin nearly straight, and the lateral margins rounded subangular, posteriorly melting into the hind margin. The anal plate is scarcely darker than the body, small, almost semicircular, but less than twice as broad as long, and slightly tumid. The legs are of the color of the under surface of the body, but are marked with fuscous, the claws reddish; the prolegs are also fuscous, and the spiracles edged with piceous. The body is uniformly but rather sparsely clothed with microscopic hairs, scarcely perceptible with a good lens; and besides these has longer and stouter, but still delicate pale hairs, about as long as the width of the body, scattered over the upper surface, arising one each from minute piceous warts, which are definitely arranged on both sides of the body; two on a segment in a dorsal-pleural row, two on a segment in a ventro-pleural row, and one on a segment in a stigmatal row. There are similar hairs scattered more irregularly on the head and prothoracic shield. Length, 13<sup>mm</sup>; breadth, 2<sup>mm</sup>.

*Chrysalis* (figs. 2, 2a, 3, 3a).—Almost uniformly castaneous, with wing-cases, eye-covers, antennæ, and sometimes some of the hinder edges of the dorsal scuta of the abdomen dusky. The rostrate prolongation of the anterior extremity of the body (fig. 2) is bent downward at a slight angle, preserving above the curve of the head, pretty strongly and uniformly compressed, docked apically, triangular as viewed laterally, the sides hollowed, and the upper surface slightly sulcate, its lateral edges a little

elevated or margined, and all the ridges marked with black. The pronotum is depressed below the surface of the head, but bounded posteriorly by a sharp, elevated backward directed ridge, higher than the mesosternum. All the abdominal segments behind the first (fig. 2a) are furnished with anterior and posterior dorsal transverse rows of minute, sharp, conical tubercles or points, the rows nearly equidistant, those of the movable segments longer than the others, and with the points directed backward. The anterior row is a little more extended than the other, and is formed on most of the segments of larger and more distant points; in advance of it, at the line to which the posterior edge of the preceding segment reaches, is a shorter, delicate, fine-edged ridge, and a similar but blunter ridge continues the posterior row of tubercles around the body. The very tip of the abdomen (fig. 3a), which is truncated and blunt, bears a slight coronet of points similar to those of the transverse rows. Length, 6<sup>mm</sup>; breadth, 1.25<sup>mm</sup>.

The moth appears to be most nearly allied to the European species *R. duplana* Hübn. and *R. sylvestrana* Curtis. From specimens of the former, which Professor Zeller was kind enough to send me from Germany, it differs by its much smaller size, and the much greater irregularity of its markings, these being almost always clustered into four or five narrow, equidistant, transverse belts in *R. duplana*; a tendency to such a transverse disposition of the markings exists also in *R. frustrana*, as indicated above, but mostly confined to two comparatively broad belts. From *R. sylvestrana*, as far as I can judge by descriptions, and by a pair of English specimens sent me for comparison by Professor Fernald, it differs by its slightly lesser size, the color of the head and palpi, the different disposition of the markings of the wing, and their more brilliant and more highly variegated tints; in *R. sylvestrana* the stripes are numerous, very slender, and tend toward confluence on the basal half of the wing, giving it a somewhat hoary appearance, in which respect it resembles *R. duplana* rather than *R. frustrana*. The pupa of *R. frustrana* also agrees with that of *R. duplana*, and is distinguished from that of other *Retiniæ* (that of *R. sylvestrana* is not known) in the rostrate prolongation of the anterior extremity of the body (see figs. 2, 3); the close affinity of *R. frustrana* to the two above-mentioned species will therefore be readily granted.

Although I have not been able to follow the history of this insect completely, it is probably double-brooded, and differs therein from the European species, which it most resembles. *R. duplana* flies in Germany once a year only, appearing by the end of March or the beginning of April, and living some time into May; the larva is full grown by the end of June or the beginning of July, when it changes to pupa, and in this condition continues eight months in the year. *R. sylvestrana* is said to appear on the wing in England in June and July, and has a similar history to the preceding, excepting in its later changes. *R. frustrana* appears in Nantucket between these two periods, or toward the end of April,\* and flies at least during May; probably most of the brood has emerged by the end of the first week in May. Eggs were seen in one instance May 15, and a nearly grown larva on June 18. Caterpillars may be found fully grown, together with an occasional chrysalid, in the middle of July; a little later chrysalids only can be found; and again, several years ago, I found larvæ in great abundance, with an occasional chrysalid, about the middle of September. Soon after that all change to chrysalids, for, in a subsequent year, Mr. S. Henshaw, who visited the island September 17 to 19, and examined the trees carefully, found not more than one-sixth in the larval state, the rest in chrysalis. In all proba-

\* The earliest specimens obtained one year from chrysalids only a week or two in confinement in a warm room appeared on April 25; the earliest of those kept the same year in a cellar appeared May 8. A single living moth, and another just dying, were discovered among the twigs confined in a box as late as June 23; how long they had been out of chrysalis there were no means of judging, but possibly several weeks.

bility, then, the insect is double-brooded, flying in May and August, and wintering in chrysalis.

Curious as this difference in the number of broods between these allied species in Europe and America may seem, it is quite in accordance with what occurs in other Lepidoptera, where analogous species are found upon the two continents. I have not studied this subject in the nocturnal Lepidoptera, but among butterflies I have found that nearly all the species which are identical, or very closely allied, on the two continents have at least one brood per annum more in North America than in Europe. Specifications of half a dozen of these cases will be found in the American Naturalist, Vol. X, pp. 603, 604. This seems to be largely due to climatic causes, and it naturally follows that, when an injurious insect is imported from Europe to America, its ravages here are likely to surpass any thing charged to it in its proper home—a point which should be taken into account by students of economic entomology.\*

Retinia, the genus into which this insect falls, is represented in Europe by no less than eleven species, four or five of which are common, and four were found by Ratzeburg more than forty years ago doing extensive injury.† They all feed upon coniferous trees, perhaps exclusively upon pines, and all live upon the twigs; according to Ratzeburg again, all are single-brooded with a single exception (*R. resinella*), where a generation of moths appears only once in two years. When I first observed the injury at Nantucket, no species of this genus had been found in this country; but since then one or two have been found in this section, and doing a considerable amount of injury to pines.‡ Now that attention has been drawn to them, no doubt other notices will follow, showing that we have to deal with a whole group of insects, specially destructive to pines, both in Europe and America; but our Nantucket species proves much more dangerous than the European *R. duplana* and *R. sylvestrana*.§

The different species of this genus attack the trees in somewhat different methods, but they all agree in selecting the tenderest growing shoots for their ravages, and in destroying this sensitive and essential part by boring into the heart and devouring the sappiest and pulpiest portion at the base of the needles. Some, like a species recently found by Mr. Comstock of the Agricultural Department in Washington upon *Pinus inops*,|| live a part of the time, at any rate, outside of the twig, for their webs

---

\* Mr. C. V. Riley (2d Rep. Entom. Missouri) asserts that destructive insects introduced from America into Europe make no headway against their more "highly developed" allies on that continent, while the reverse is true of European pests introduced here, "the stronger and more favorably organized species overpowering and starving out from time to time their less vigorous and less favorably organized competitors." Unfortunately he gives no facts to support this highly organized theory. [The facts in support of Riley's assertion are, it seems to us, very patent. We have always regarded such introduced species as prepotent, like weeds introduced from Europe, which overpower and drive out native plants. The Phylloxera of the vine, however, has multiplied in Europe as rapidly, if not much more so, than in its native country.—A. S. P.]

† Three of these four have now been found on the Pacific coast of the United States.

‡ A brief notice of these will be found in the appendix.

§ Fernald's Catalogue of Tortricidæ (1882) gives eight species, of which, however, only three, including *R. frustrana*, are found in the eastern United States. Of the five found on the Pacific slope, where the insect fauna has, as is known, a decidedly European aspect, four are believed to be identical with European species, and among them *R. duplana* and *R. sylvestrana* occur.

|| Since this was written Mr. Comstock has published his notices of this species (Rep. U. S. Dept. Agric., 1879, pp. 236, 237, pl. 5, fig. 2), which he considers, on Professor Fernald's authority, to be the same as that here described. There can be no

may be seen inclosing the base of the bud and the surrounding new leaflets; but most of them, like *R. frustrana*, live entirely within the shoot from the moment they have bored their way into it, and undergo therein their transformations.

The injury done by *R. frustrana* to the pitch pine (*Pinus rigida*) of Nantucket is soon detected in the months between May and September by noticing the dead needles at the very tip of a shoot otherwise of a fresh green color, or only partially withered near the dead needles. The egg must be laid, as Ratzeburg presumes it to be in the European species, between the scales of the bursting bud, from whence the caterpillar eats its way at birth into the very heart of the bud near the extreme tip; for to this part are the youngest caterpillars confined. From this point the growing caterpillar burrows down the stem, often for from 4 to 6 centimeters, and thus eats the very life out of the tree; for with one of these insects at nearly every bud, as was the case in the tree I cut down, and in the accessible branches of many others examined at different times, the tree must speedily perish. As the caterpillar works downward, one by one the needles find their supply of nourishment cut off, cease their further growth, lose their color, and wither—the change in coloration of the needles showing the progress of the pest. Fig. 6 shows the appearance of one of these twigs in which the caterpillar has bored a couple of centimeters. Some of the terminal needles, as may be seen by comparison with fig. 5, which represents an unharmed twig of the same tree, have scarcely had a chance to grow at all before being robbed of their means of support, and have turned quite yellow; further down the stem, where also they are wholly withered, they are a little longer; still further they are longer yet, and only partially withered, showing more recent attack; and it is not until the wholly green and fresh needles are reached that they are of the normal length. The difference between an uninjured twig and one that has been attacked is really greater than appears by comparison of figs. 5 and 6; for, as will be seen on comparing the lower normal needles of each, fig. 5 represents a shoot with much shorter needles than fig. 6 would normally have had throughout. The dome-shaped contour of the needle tips in the healthy shoots is well represented in fig. 5, and the contrast to this which fig. 6 exhibits is very marked, and tells the story of the damage done. The specimen represented in fig. 6 was chosen rather to exhibit this point, being perhaps more marked than usual. Generally the whole shoot is unnaturally swollen and disfigured by the pitch that has exuded from the injuries caused by the caterpillars, as may be seen on removing the needles; this appears in fig. 9 of the plate, to compare with which a healthy shoot with the needles removed is shown in fig. 7.

As the insect is probably double-brooded, the second generation has to attack shoots already grown or nearly grown, in which case, of course, the change of contour of the tip, seen on comparing fig. 6 with fig. 5, does not ensue; but the withered needles are all of nearly the full length, as shown in fig. 8. In this figure the stem has been cut longitudinally, to show the nature and extent of the borings of the caterpillar. The middle of the stem is found pierced by a slender cylindrical passage as far as the dead needles continue; the passage is lined with silk and foul with excrement, which has been removed from the specimen drawn. As far as the boring has been carried the withered needles fall from their position on being touched, having nothing but a shell for their support.

When the caterpillar is fully grown it selects a place within its burrow wherein to change to chrysalis; this is usually at the bottom of the burrow, but in a thick

doubt of their very close relationship, but the difference in the habits of the larvæ in the two localities, both during active life and when about to undergo metamorphosis, would be very singular if they belong to the same species. The specimens carefully studied by him, also, were found on a different species of pine. I have made no comparison, but only desire here to call the attention of those who may hereafter study this insect to this fact. For further account of Mr. Comstock's observations see the close of this paper.

shoot may be in any part, even toward the tip, where it can push a lateral passage obliquely toward the base of one of the needles. Such a burrow, vertical in this case and not oblique, may be seen in fig. 8 on the right hand of the regular burrow at the tip of the shoot. Several indeed may occupy different parts of the same shoot; the place selected is slightly enlarged to form a longitudinal cell, at the upper or outer end of which a passage is eaten into the open air, which may generally be seen without difficulty from the outside, if looked for near the base of the needles while the nest is uninjured. The holes left by the fallen needles must not be taken for these outlets; these never seem to be taken advantage of, for from them usually exudes more or less pitch, closing the opening. To find on emergence from chrysalis that the means of egress of the moth was gone would prove disastrous to its life. Half through the eaten opening the chrysalis forces its way when about to change to the imago.

It appears then that this insect, by selecting for its food in the larval state the point where the greatest amount of nourishment exists, has chosen well for itself but ill for the tree. The very richness of the nourishment of which it robs the tree tends to the immense abundance of the insect, which, attacking the tree at every growing point, effectually puts an end to its life. The nearly dead tree I cut down was not more than  $7\frac{1}{2}$  centimeters in diameter and perhaps 4 meters high; all but the very topmost boughs were dead, and here the foliage was extremely scanty, yet I could certainly have obtained forty or fifty caterpillars and chrysalids from this one tree.

At first sight, certainly, there seems nothing to prevent this insect from continuing its ravages and destroying every pine on the island. The only encouragement in this view is that then for want of pines the moth must die. In the hope of finding some natural means of its destruction, I have sought for parasites which might at least keep it in check. One such I found the first day, feeding upon a larva; and by inclosing many infested twigs in a tight box I have obtained three kinds of hymenopterous parasites—one a species of *Bracon* proper, another a minute *Perilampus*, both apparently undescribed. The latter is far the more abundant, but neither appears to be sufficiently common for us to place much reliance upon them, although they unquestionably serve to a certain extent to reduce the numbers of the moth. The only possible method of combating this evil is directly to destroy the *Retinia* in some one of its stages. Bonfires every day at dusk in the vicinity of the woods during the last week in April and the first week in May would doubtless destroy great numbers of moth laden with eggs, and would give healthy employment and no small delight to the small boys of the island. But apparently the only effectual means of destruction is one indicated by the history of the insect, but which would be useless on the main land or without concerted action on the part of the inhabitants of the island. As already stated, the affected are speedily distinguished from the uninjured shoots soon after the caterpillar has commenced its work, by the presence of dead needles at the apex of an otherwise green shoot; the presence of the enemy is thus infallibly disclosed. The month of June then is the time for operation and the work to be done can be done once for all by breaking or cutting from every pine tree on the island every affected shoot.

To be of any radical use this must be done during a single year, to leave none for propagation; for the same reason it must be done to every tree, great or small, from the topmost boughs of the tallest trees to seedlings just springing from the ground; every scattered tree or seedling upon the island must be searched. I examined one isolated tree, about a meter high, growing a kilometer or thereabouts from the woods on the south shore, and it was thoroughly infested. To leave such a tree would be to have the labor and expense of the proposed assault in vain. The work must be completed within the month of June, since it is at this time that the caterpillar is only partly grown in its burrow, and will infallibly die if the shoot is removed from the tree; its sustenance will be gone and it can not crawl about sufficiently to find

and enter another tree. This is not a part of its accustomed line of action, and it could not recover from so rude a shock as robbery of its home. There would be no absolute need of burning the broken shoots, but this might be done where there is any danger of their falling near seedlings, which it is possible the wandering outcasts might enter; and it should certainly be done if the operation has to extend into July, when the caterpillar might be ready to change to chrysalis, which it could do in its burrow whether the shoot were attached to the tree or fallen to the ground. Since some more advanced caterpillars might as early as June undergo such transformation, doubtless the most thorough way would be to have the work finished before the end of June and to burn every broken shoot; to cut off any suspected shoot rather than to leave one affected, or even to remove every growing shoot.\* But anything less radical than the means here suggested would be wasted labor. Leave them alone and the pine woods of Nantucket are doomed to destruction; to plant new trees would be to add fuel to flames. There is no possible escape but in some radical and concerted action such as is here suggested; and this is possible only because of the isolation of Nantucket and the comparatively small extent of its little forest. Ten men, each armed with a pair of hedge shears and ladders of some sort, ought to accomplish it in the month. Whether it will "pay" is for the Nantucket people to decide. But if they will not do it, their next best plan is to cut down the entire forest, sell the wood, and burn the brush, leaving not even a seedling anywhere; then to pasture the sheep upon the spot for two years, and carefully destroy every seedling that springs up outside the fences which confine the sheep. After that it would be safe to plant again by seed.

We add Professor Comstock's notes on this insect:

"About the middle of May, 1879, the scrub-pines (*Pinus inops*) in Virginia, near Washington, were found to be greatly injured by small lepidopterous larvæ. On many trees there was scarcely a new shoot to be found which was not infested at its tip by from one to four yellowish black-headed caterpillars. They were so completely concealed while at work that their presence would scarcely be noticed, and the effect of their work was hardly visible until the twig was almost completely destroyed. Upon close examination a delicate web was seen inclosing the base of the bud and the surrounding new leaflets, resembling much the nest of a small spider. When this web was removed one or several little yellow caterpillars were seen retreating into a mine

---

\*I am told by good botanists that the tree would probably recover from this Cæsarian operation, and it might be easier and more rapid than to select the affected shoots. It certainly would be safer. Dr. G. L. Goodale has called my attention to the following passage, which seems to him to indicate that the tree would survive: "The pitch pine," says Smith, "differs from other trees of this family, its stump throwing up sprouts the spring after the stem has been felled, but these do not attain any considerable height. The fallen trunk throws out sprouts in the succeeding summer; and the bundles of leaves of both are remarkable for issuing from the axil of a single leaf in the same manner as in the young plant."—Michaux, *N. Amer. Sylva*, vol. iii, pp. 89, 90, note (1853).

Mr. George B. Emerson also says of the same tree: "Its stump throws up sprouts the spring after the stem has been felled. These continue to flourish, with apparent vigor, for several years; but I have never seen them attain any considerable height. The fallen trunk itself throws out sprouts in the succeeding summer; and the bundles of leaves of both are remarkable for issuing from the axil of a single leaf, in the same manner as is observed in the young plant."—Emerson, *Trees and Shrubs of Mass.*, State ed., p. 73, 8vo, Boston, 1846.

in the bud or into the bases of the leaves, which were also mined; or not infrequently they dropped from the twig, suspending themselves by a silken thread. The bud was often so hollowed that it dropped to pieces almost at a touch.

"At the time when they were first noticed larvæ of almost all sizes were to be found. Some were apparently almost full-grown, while others had evidently not been long hatched. The nearly full-grown specimens measured 8<sup>mm</sup> (0.31 inch) in length. The first pupæ were obtained early in June. Most of the larvæ transformed within the burrows which they had made, first spinning more or less of a silken envelope about themselves. Others, however, issued from their mines and spun rather tough grayish cocoons between the leaves. The pupæ were short, stout, and brown in color, with each segment furnished dorsally with two serrated lines, one consisting of large and the other of fine teeth.

"The first moths issued June 13, the pupæ having previously worked their way, by means of the spines just mentioned, into such positions that they could give forth the moths without injury to the latter, and a few weeks later almost every shoot had one or more of the empty pupa skins protruding from it. Specimens of the moths were sent to Professor Fernald, who determined them as identical with Mr. Scudder's manuscript species *Retinia frustrana*.

"In the latter part of July specimens of the twigs of *Pinus rigida* were received from Mr. S. H. Gage, of Ithaca, which had evidently been infested by the same insect, although no living inhabitants were to be found. In September other specimens were received from the same gentleman, and this time pupæ and one larva were found. According to Mr. Gage the insect is not very common in that locality.

"In the latter part of August individuals of the second brood were very abundant in the scrub-pine in the vicinity of Washington. As before, they were found in almost every stage of growth, and the difference was even more marked. In one instance five larvæ of greatly differing sizes were found in one shoot. The smaller ones were boring into the bases of the leaves, and the larger ones into the twig proper. The largest of the five had made quite a long channel from the tip of the bud down into the heart of the twig. Pupæ were also found at this time, which did not give forth the moth until late in the winter.

"The usual mode of hibernation is in the pupa state. A thorough search in January in the field showed only pupæ. The pupæ collected

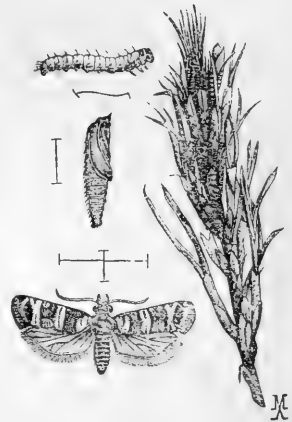


FIG. 260.—*Retinia frustrana* Scudder: Larva, pupa, adult and work.—From Comstock.

in August and September did not begin to give forth the moths in the breeding cages before early January, February, and March, and were greatly hastened without doubt by the heat of the room. On February 15, however, a few twigs were collected, from one of which, on February 28, a full-grown larva had emerged and was found crawling about the cage. This would seem to indicate occasional larval hibernation.

“As to remedies, the only one which I can suggest at present is that involving the somewhat arduous task of picking off the infested twigs in early winter and burning them. Whether the salvation of the trees will be worth this labor in greatly infested regions will depend entirely upon their value to those interested.”

#### 75. THE PITCH-PINE RETINIA.

*Retinia rigidana* Fernald.

Order LEPIDOPTERA ; family TORTRICIDÆ.

Inhabiting terminal shoots of *Pinus rigida*, and of similar habits to the Frustrating Retinia, a gray, brown, or blackish larva 8<sup>mm</sup> ( $\frac{1}{3}$  inch) in length, which in its perfect form becomes a small moth with dingy white wings, marked with dark red and silvery gray. (Comstock.)

“In the summer and fall of 1879 Mr. S. H. Gage, of Ithaca, N. Y., sent to the department specimens of the pitch-pine containing Tortricid larvæ and pupæ, which in their work resemble *Retinia frustrana*, but differ from that insect in coloration and in being slightly larger. These developed into a moth intermediate in characters between *R. frustrana* and *R. comstockiana*, and which has been described by Prof. C. H. Fernald as follows :

*The moth.*—Head sordid white, with a yellowish tinge ; front and palpi inclining more to ashy ; antennæ brown, annulated with white ; thorax above very light gray, washed with dull ochereous ; deepening to a coppery tint on the front of the patagiæ. Thorax beneath, abdomen, and hind wings above and beneath, and fore wings beneath light gray with a silky luster ; fringes of the hind wings lighter, with a line near the base concolorous with the wings.

Fore wings above sordid white, with a basal patch occupying the basal fourth of the wing, composed of about four irregular cross streaks of dark red, alternating with similar streaks of silvery gray, the outer red streak sending out a tooth on the fold. The light space following the basal patch has several small gray costal spots, from which light ochereous streaks extend across the wing. A dark-red band extends across the wing beyond the middle, divided on the costa by a geminate white spot. Below the cell the basal half of the red band is replaced by stripes of light ochre yellow and silver white ; the remaining portion of the red band below the cell is curved outwardly, making this part convex on the outside and concave on the side towards the base. The apical portion of the wing is dark red, changing to bright ochre yellow inwardly, and towards the anal angle divided by a subterminal geminate broken line of silvery scales, extending from the costa to the anal angle. Fringe reddish purple. The costa from the basal patch to the terminal band is marked with geminate white spots alternating with gray. Posterior femora and tibiæ very light



silky gray; fore and middle femora and tibiæ gray, with coppery reflections, the tibiæ banded with white. All the tarsi gray, with whitish tips.

*Expanse.*—Female, 18<sup>mm</sup>. *Habitat.*—Ithaca, N. Y. Described from two females, one in the collection of the Department of Agriculture, the other in my collection.”—(Comstock.)

## AFFECTING THE LEAVES.

## 76. ABBOT'S WHITE-PINE SAW-FLY.

*Lophyrus abbotii* Leach.

Order HYMENOPTERA; family TENTHREDINIDÆ.

From midsummer until October, and sometimes as late as November, clustering on the twigs and smaller branches of the white pine, soft, smooth-bodied, yellowish-white worms about an inch long, with three, and posteriorly four, longitudinal rows of large black dorsal spots; late in the autumn transforming in tough brown pod-like cocoons attached to the twigs, within which they hibernate, changing to pupa (in Illinois) about the middle of May, the four-winged fly with broad pectinated antennæ appearing about the 1st of June. (Riley.)

By far the most destructive insects to the foliage of the pine and fir are the different species of false caterpillars or larvæ of the pine saw-fly or *Lophyrus*. When present at all these larvæ exist in colonies, keeping together until they are ready to undergo the chrysalis state; and after stripping the leaves of one twig or small branch, pass on to adjoining twigs until a large branch or nearly one side of a tree will be denuded of leaves. Such effects we have often seen in isolated pitch-pine trees in the woods of Maine. Still more destructive are these larvæ to plantations of young pines on Cape Cod, where, if not prevented, they may strip tree after tree of a young growth of seedling pines. Moreover, an allied species (*L. lecontei*) is annoying to the ornamental Austrian pines and Scotch firs on lawns and in shrubberies, so that we have placed these insects at the head of those destructive to the leaves of coniferous trees.

Mr. W. C. Fish writes me that worms which I have identified as being of this species do “much mischief among the pines on Cape Cod. These pines are small, having been growing but from six to twelve years from seed planted by the farmers in order to renew the soil on their poorer lands. Whole acres of these small pines are (1868) being destroyed

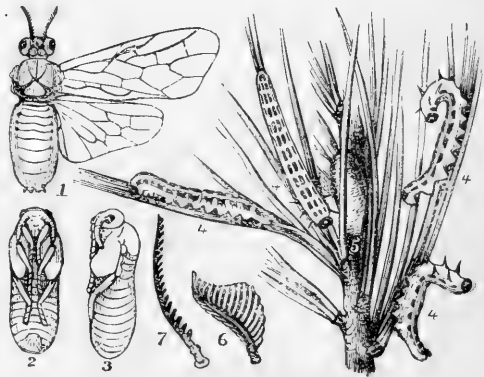


FIG. 261.—Abbot's white-pine saw-fly; 1, female, enlarged; 2 and 3, pupa, enlarged; 4, larvæ, natural size; 5, cocoon, natural size; 6, male, 7, female, antenna enlarged.—After Riley.

by this insect. Their habits are very similar to those of the fir saw-fly, *Lophyrus abietis* of Harris, though they are more gregarious than he describes that species to be. They eat the needles down to their insertion, thus stripping one twig after another. The larvæ spin their cocoons among the leaves, and the flies appeared about the middle of August. Out of thirty one individuals but one was a male."

Professor Riley, in his Ninth Report, states that this saw-fly in its larval state is destructive in Indiana, Illinois, and Wisconsin. He states that the perfect insects are quite irregular in coming out of the ground, many of them issuing in May, but others not until toward the end of summer. "On opening cocoons that had passed the winter I have found many yet containing the larva the latter part of June, while others of the same brood had become flies six weeks before. \* \* \* In ovipositing the female saws beneath the epidermis on one of the flat sides of the leaflets, and pushes into the slit an egg, which is whitish, ovoid, .08<sup>mm</sup> long on an average. As the egg swells it forms a conspicuous bulging of the epidermis, and the mouth of the slit opens and exposes more and more a portion of the egg." It is preyed upon by an ichneumon fly (*Limneria lophyri* Riley).

Dr. F. W. Goding, of Rutland, Ill., sent me some of these worms, September 23, 1884, with the remark that they had been defoliating the white pine. "Over a quart was destroyed beneath one tree by kerosene."

*Larva*.—Average length, .80 inch, though many will measure an inch. A soft, dingy-white worm, having often a greenish or bluish line superiorly. On all joints but the first, which is entirely white, two oblong square black spots along the back, and another somewhat rounder spot each side; these become somewhat diffused on the three latter joints, forming on the last a single black patch. Three black thoracic legs, fourteen abdominal and two caudal prolegs. Thoracic joints largest; the three last smallest and tapering. Some are marked very regularly, while in others the white space on the back between the spots on segments 5, 6, 7, and 8 is much wider than between the others. This is probably a sexual difference, since those thus marked are shorter, thicker, and of a yellower white than those regularly marked. After each change of skin the head is at first white like the rest of the body, with the usual eye-spots black. No markings while young.

A cluster of about twenty larvæ probably of this species occurred on a twig of the white pine August 9, at Brunswick, Me. These molted for the last time August 11, the epicranium splitting apart on each side of the clypeus. They spun cocoons, but the flies did not appear.

*L. abietis*, with regular but faint bands, is evidently the primitive form, and *L. abbotii* and the other spotted larvæ the secondary and later forms. How did the *double* dorsal line originate?

*Larva*.—Head black, body flesh-white, the black spots contrasting very much with the pallid ground-color of the body. A dorsal row of eleven pairs of black spots, each spot oblong and about one-third as wide as long. A row of eleven lateral black nearly square spots, which are a little longer than broad. Supra-anal area black. Thoracic feet black; eight pairs of abdominal pale feet. Length 22<sup>mm</sup>.

## 77. THE FIR SAW-FLY.

*Lophyrus abietis* Harris.

Defoliating the leaves of the fir, spruce, as well as the pitch-pine; larvæ similar to the foregoing, the flies appearing late in July and also early in May. (Harris.)

The following account of the fir saw-fly is taken from Harris' Treatise:

For some years past many of the fir trees cultivated for ornament in this vicinity have been attacked by swarms of false caterpillars, and in some instances that have fallen under my notice have been nearly stripped of their leaves every summer, and in consequence thereof have been checked in their growth and now seem to be in a sickly condition. My specimens of this kind of saw-fly, which were raised from the caterpillars in the summer of 1838, came out of their cocoons towards the end of July in the same year; but I have also found them on pines and firs early in May.

To this account Dr. Fitch makes the following comments:

I suspect Dr. Harris's observations upon this species were not full, and that like the analogous saw-fly which we have noticed on the pine, No. 273, there are two generations of this species annually; for we are informed that the perfect insect appears in May, producing a crop of worms in June and July, from the cocoons of which the perfect insects come out the last of the latter month. But Dr. Harris supposes that most of these cocoons remain unhatched through all the hot weather of August and September and the winter succeeding, to give out the flies which appear in May. It is much more probable, however, that the flies all come out of their cocoons about the beginning of August, and, like the species we have seen on the pines, produce another brood of worms in autumn, which has escaped the notice of Dr. Harris; and it is these which lie in their cocoons through the winter and give out the flies which are met with in May.\*

*Young larva half grown.*—Pale yellowish green, with a black head, no spots.

*Larger ones ready to pupate* on pitch pine. Head black. Body a little duller green than pine needles, with a broad paler longitudinal line. A diffuse paler subdorsal line, a broad pale green lateral line, and a dark line of scollops at base of abdominal legs. Thoracic feet black, interrupted with green at the joints, the abdominal feet pale green. The body not spotted. Head black, green near and above the labrum. Length 1<sup>3</sup>/<sub>4</sub>mm. The end of body curled up like a *Nematus*. August 8, they made pale cocoons between the leaves.

*The male saw-fly* is smaller than the female, with broadly pectinated antennæ, and is one-fourth of an inch in length; body black above and brown beneath, legs dirty leather-yellow color.

*The female* is about three-tenths of an inch long; body yellowish brown above, with a short blackish stripe on each side of the middle of the thorax; body beneath and legs paler, of a dirty leather-yellow color; antennæ short, tapering to a point consisting of nineteen joints, and toothed on one side like a saw. (Harris.)

78. *Lophyrus* (neither *abietis* nor *abotii*!).

Body of the shape usual in the genus. Head pale behind, with fine dark dots, and a dark median line connecting in front with a large black area between the eyes, inclosing a subtriangular pale spot. Labrum, jaws, and palpi black; eye large, distinct, black; antennæ distinct, black. Body dark olive green, with a paler green dorsal stripe; a subdorsal stripe of the same hue, below which is a broad even lateral olive-green stripe. Below this line and beneath, the body is greenish yellow. A

\* *Lophyrus abietis*? on pitch pine, August 1, 1880.

broken dark olive line along the side at base of the abdominal legs, the latter pale greenish yellow; thoracic feet black, pale green at the articulations. Length, 13<sup>mm</sup>. On the pitch pine, Brunswick, Me., August 16, 1883.

#### 79. LE CONTE'S SAW-FLY.

*Lophyrus lecontei* Fitch.

Clusters of dirty yellowish, black-spotted false caterpillars on the outer branches of ornamental pines and firs on lawns, stripping the leaves and disfiguring the shrubs.

Dr. Fitch described under the above name this saw-fly, but did not rear it from the larva, though inferring that it was the parent of certain false caterpillars, of which he found two broods on "pines, particularly those set in our yards for ornaments, stripping the limbs which they invade of their leaves." He further says:

When nearly mature these worms are so large that the end of a single leaf of the pine probably furnishes them a very insufficient mouthful, hence two worms often unite, standing face to face, and thus hold the five leaves which grow from each sheath on the white pine pressed together in a bundle as they eat them, commencing at the tip and gradually stepping backwards as the leaves become shorter. It is only the old leaves of the previous year's growth which these worms consume, never touching the new ones at the outer end of the limb; hence they injure the tree much less than they would were they to strip the limbs they invade of the whole of their foliage. At least two broods of these worms appear annually, the one in July, the other in September and October, the latter often remaining on the trees after frosty nights have occurred. Having finished feeding, they leave the tree and inclose themselves in cocoons under fallen leaves or other shelter on the surface of the ground, in which they remain during their pupa state.

*The female*.—Length, 0.38 inch to the tip of the abdomen, and 0.48 inch to the end of the wings. It may at once be distinguished from all our other described species by the joints of its antennæ, which are twenty-one in number. It is shining dull, tawny yellow, with the antennæ black, and also the abdomen and base of the thorax. The under side is paler yellow, with two broad black stripes on the abdomen. The wings are smoky hyaline, their veins black. Captured the middle of May. (Fitch.)

Riley states that this saw-fly has been found feeding on the Scotch and Austrian pines in New Jersey. The larva he describes as an inch long, dirty or yellowish white, with dorsal black marks wider before than behind, and usually broken transversely in the full-grown individuals. They are further apart than in *L. abbotii*. The lateral spots are somewhat square, with an additional row of smaller black marks below them, and the last segment is entirely black above.

The antennæ of the male fly are twenty-one jointed, and have on one side seventeen large and on the other seventeen small branches, there being eighteen on one side and fifteen on the other in *L. abbotii*. The female may at once be distinguished from *L. abbotii* by her abdomen being jet black above, with a small brown patch at the end and a transverse line of the same color just below the thorax.

*Remedy*.—These saw-flies, living as they do, in societies in large masses of coarse castings like sawdust, are easily detected by the eye, and can readily be removed by hand, especially in the case of ornamental shrubs. Also shower and jar the trees.

80. *Lophyrus pinetum* Norton.

Besides the species of *Lophyrus* above mentioned, there are four other species of this genus, which probably live on coniferous trees, and also the following species known to infest the pine: *Lophyrus pinetum* Norton, female, with nineteen antennal joints, on pine (Norton in Packard's Guide, p. 226).

## 81. THE PITCH-PINE SAW-FLY.

*Lophyrus pini-rigida* Norton.

With the general habits and appearance of the preceding species, but so far as yet known confined to the pitch-pine.

This saw-fly was described by Mr. Norton in our "Guide to the Study of Insects." The larvæ are allied to those of *Lophyrus abietis*, and during one summer ravaged the young pitch-pines, which had been raised from the seed on a plantation at Eastham, Mass., on Cape Cod. The female lays her eggs singly in one side of a "needle" of the pine, though sometimes an egg is inserted on each side of the leaf.

*Female*.—Length, 0.30; expanse of wings, 0.65 of an inch; antennæ 17-jointed, short, brown; color luteous brown, with a black line joining the ocelli; a black stripe down each of the lobes of the thorax above and the sutures behind; body paler beneath; the trochanters and base of the tibiæ waxen; claws with an inner tooth near the middle; wings very slightly clouded; cross nervure of the lanceolate cell straight.

*Male*.—Length, 0.25; expanse of wings, 0.55 of an inch; antennæ 15-jointed, black, quite short, with twelve branches on each side, those at the base nearly as long as the sixth and seventh; apical joint simple, enlarged at base; color of insect black, with the abdomen at apex and beneath yellow-brown; legs the same color at base; below the knees whitish. The male looks precisely like that of *L. abietis*, but the form of the antennæ is different, being much shorter. The female looks much like *L. abdominalis* Say, taken on the pine near New York. (Norton.)

Mr. W. C. Fish wrote me some years ago from Eastham, Mass., as follows regarding this insect and the attacks upon it by the white-winged crossbill:

In the fall of 1868 there was a second brood of the larvæ of *Lophyrus pini-rigida* Norton. On the 16th of September I noticed a few nearly grown, but the greater part of those seen at that date were very small. On the 15th of October I noticed large flocks of the white-winged crossbill hovering over and alighting upon the young pines that were infested with these larvæ. There were certainly three or four hundred birds in some of these flocks. I soon learned that they were feeding upon the larvæ, as I had many opportunities to watch them while feeding among the trees. I also took numbers of the larvæ from the stomachs of several individuals that I shot.

I had one in confinement several days, feeding it with these larvæ. Those out of doors seemed to discard the head and harder legs of the larvæ, but the one in confinement swallowed the insect entire. These birds were abundant through November and December, and more or less common all winter. Some of the larvæ were found quite late in November, after we had experienced severe freezing weather. I saw them frozen stiff several times.

On the 27th of November I took several into the house, where they spun their cocoons and the saw-flies came out the next spring. So well did the crossbills do

their work that the *Lophyrus* was rare the next summer (1869). If this wholesale destruction of the larvæ had not occurred, there would have been acres of young pines destroyed.

I did not meet with the red crossbill until January, when I met a flock at Sandwich; in February I met a flock here (Eastham). Neither of these birds are common visitors to the Cape. I have not known of any visiting us the past winter. I never met with one until 1868, but residents of Eastham informed me that the white-winged species was with them in the fall of 1867. An old lady in East Falmouth informed me that a number of years ago they visited her orchard and damaged her apples by cutting them off to get the seeds.

## 82. THE LYDA SAW-FLY.

Infesting the Austrian pine, tying the needles together with a silken web filled with castings, forming a mass about 6 inches in diameter, with the needles of the pine scattered through the mass, the leaves being separated by the false-caterpillars from the branch.

We have noticed this false-caterpillar on but a single occasion, and then failed to rear the worms to the winged state. The following account is taken from our article entitled "Injurious Insects, New and Little Known," in the Report of the Massachusetts Board of Agriculture for 1870:

Late in September of 1869, Dr. William Mack, of Salem, Mass., brought into the museum of the Peabody Academy of Science some singular false-caterpillars which had assembled on a single branch of an Austrian pine, on his place, and had tied the needles together with a fine silken web filled with castings, forming a mass of castings about 6 inches in diameter, with the needles of the pine among them, the leaves being separated by the larvæ from the branch.

The larva is that of a species of *Lyda*, and while doing little injury to the tree, so far as known, yet merits a short description. Dr. Ratzburg figures a similar species in his work on forest insects, and states that the *Lyda campestris* of Europe, to which our species seems closely allied, is sporadic in its attacks on the pine and never proves very destructive.

*The larva.*—The body is cylindrical, a little flattened, and thickest in the middle, with small thoracic slender legs, which are not used much in walking, the larva wriggling along when placed on a smooth surface. The head is pale reddish with a black spot between the antennæ; the prothorax is black above and the body reddish olive-green, with a rather broad purplish line along the middle of the back. There are no abdominal legs, and the end of the body is somewhat flattened, with a black round spot on each side of the anal plate; beneath is a broad transverse incision. Below, and arising from each side, is a long, corneous, three-jointed, slender out-stretched appendage of the size and form of the antennæ. The under side of the body is mottled with greenish and reddish as above, with a reddish median line. On the side of the thorax

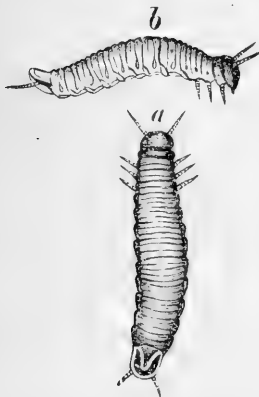


FIG. 262.—*Lyda* saw-fly larva on Austrian pine, enlarged.—From Packard.

are two rows of dots, and two rows along the middle on the ventral side of the three thoracic wings.

The two following species also occurred on the white pine :

83. *Lyda* sp.

*Larva*.—Body green all over, including the head ; the latter small, round, shining green, with a slight amber tint ; antennæ and mouth-parts and labrum darker. Body thickest in the middle, tapering towards the head and tail. The segments regularly wrinkled transversely, four wrinkles to a segment ; anal legs three-jointed ; basal joint amber-colored, the two others blackish. Thoracic legs greenish, with a slight amber tint. Supra-anal plate much as usual. Length, 17<sup>mm</sup>. On white pine, August 8 to 10, 1883, Brunswick, Me.

84. *Lyda* sp.

*Immature larva*.—Head and body of a uniform pale horn-brown ; head of the same color as the body, finely spotted with pale brown ; antennæ pale brown, seven-jointed. Caudal, antennæform appendages pale-brown, three-jointed ; first joint about three times as long as the second, the third slightly shorter than the second, darker than the rest of the appendage, acute and slender. The segments have no markings, but are wrinkled above. Supra-anal plate rounded, edge somewhat thickened. Length, 15<sup>mm</sup>. Allied to the European *L. campestris*. On *P. strobus*, October 2.

85. *Lyda* sp.

(Plate x, fig. 6.)

This larva was found on the pitch-pine at Providence, September 27, forming a very slight loose black web around the extremity of the branch of a young tree, the web inclosing the stumps of the partially eaten leaves. It is nearly related to the European *Lyda pratensis*.

The nature of the three-jointed abdominal appendages is curious. Are they the homologues of the legs or special structures ? They do not seem to be used during actual locomotion as prolegs, but may be of use in moving about between the pine needles and in the loose web.

*Larva*.—Body rather thick, cylindrical, the segments moderately convex, the sutures moderately distinct ; the segments wrinkled, there being four well marked wrinkles on top of each segment. The head is narrower than the prothoracic segment, round, deep brownish honey-yellow, paler in front and inclosing the two diverging oval patches ; a single prominent black eye on each side. Antennæ very long and slender, seven-jointed. The three pairs of thoracic feet long and slender, much attenuated, six-jointed, the terminal joints long and slender. The abdominal segments with not the least sign of feet, but transversely wrinkled much as above. The only abdominal appendage is one of a very singular nature ; a pair of long slender three-jointed lateral appendages arising from the end of the lateral ridge of the body, which is situated below the spiracles. The appendages, which are black, with white articulations, apparently arise from the end of the penultimate segment of the body. They curve and project out laterally so that most of their length is seen from above. The basal joint is longer and larger than the others ; the second, as long as the first, is thick ; the third a little longer than the second and acute, the point much attenuated. On top of the end of the body is a triangular area, the apex ending near the end of the broad, rounded, flattened supra-anal plate. Body pale shining brick-red ; a broad diffuse red dorsal line ; a lateral line of large red patches, one on each segment ; ground color deep salmon or flesh color. Prothorax chitinous, pale shining brick-red ; A series of lateral, vertical, lanceolate-oval reddish raised spots between the spiracles. Length, 22<sup>mm</sup>.

## 86. THE PINE PIERIS.

*Pieris menapia* Felder.

The following account of this destructive insect is copied from Mr. Stretch's article, contributed to *Papilio* (ii, 103-110).

While in company with Professor Hagen and Mr. Samuel Henshaw, of the North Transcontinental Survey, during the present summer, it was my fortune to find this delicate butterfly in excessive profusion, and as it must now take rank among our injurious insects, it is thought that the following notes may be worthy of publication.

*Distribution.*—The species was first seen by our party at Spokane Falls, in Washington Territory, near the Idaho line, on July 22, the altitude above the sea being about 1,900 feet. The few specimens captured were all males and much worn. A number of others were seen, but their peculiar habit of flitting around the tops of the larger trees prevented capture. On July 23 I found the larvæ and pupæ in great numbers on the trunk of a yellow pine, at a point on the Colville road, about ten miles north of the crossing of the Little Spokane River, and about ten miles south of Loon Lake, but did not notice the insect on the wing. At Loon Lake a few worn specimens were seen (all males), and I again found the larvæ and pupæ on the trunks of pine trees in immense numbers, say not less than from 200 to 300 within six feet of the ground. Between Loon Lake and Brown's, the latter place being fifty-four miles from Spokane Falls, the same phenomena were again noticed, but with the difference that the imago was emerging in great numbers. I took probably seventy specimens, both male and female, in a few minutes, and over one hundred and fifty in the course of the day. It would easily have been possible to make the number 1,500. Most of those taken were picked off the trunks of the trees, just fresh from the pupa, having never been on the wing. At Brown's both larvæ, pupæ, and imago were equally common, though not many of the latter were on the wing until towards evening, as the day was cloudy. Towards evening the sun shone out for a few minutes, and instantly the air was alive with butterflies, flitting round the pines in countless numbers, and glistening against the dark green of the young timber like the most delicate snow-flakes. Some idea of the immense numbers of the insect may be gathered from the fact that in the infested district near Brown's, on every little pine, though not more than two feet high, on each terminal bunch of needles, from one to twelve larvæ or pupæ could be counted, and every weed could show its quota of pupæ. Our trip did not extend northward beyond this point, but the appearance of the forest showed that we had not reached the limit of the plague. On July 25 we returned to Loon Lake, finding the insect in all stages, from full grown larva to imago, excessively abundant, with eggs, larvæ, and pupæ on both the fir (*Abies balsamii*) and tamarack (*Pinus contorta*), as well as on the pines. Returning south, the insect was common for eight miles; in the next three it grew gradually rarer, and then we lost it altogether, though this may be partly the result of the greater rarity of yellow pine timber (*Pinus ponderosa*) and the predominance of fir and tamarack along the line of travel. On July 27 we saw a few sporadic butterflies as we approached Spokane Falls, say five miles from town. Round the latter place it did not seem to be abundant, but occurred on the 28th in greater numbers, as we approached Cheney by rail, and was seen about ten miles west of that place, or about twenty-five miles southwest of Spokane Falls, near the edge of the timber.

What the extension of this affected area may be it is impossible to say, as there are no accessible data at hand; but as the insect is found in California, in Plumas County about Lake Tahoe and elsewhere, more than 630 miles to the southward, and also in Colorado and Vancouver's Island, it is evidently of very wide distribution, latitude in the north taking the place of altitude in the south; and consequently the same phenomena which we are here called to note may occur in localities where the tim-



ber is both denser and more valuable than in that under consideration. Whether it occurs in the Coast Range in Washington Territory I do not yet know, although we might expect its presence, as the Cascades offer a similar vegetation, as well as from the general similarity of the Rhopalocerous fauna on both sides of the great Columbia Plateau, as evidenced by the occurrence of the same species of *Pieris*, *Colias*, *Argynnis*, *Satyrus*, and *Papilio*. The area actually visited where serious damage has been already committed extends about twenty-five miles north and south, with an unknown width, and in this region *all* the yellow pines have been nearly or totally stripped of their foliage, as well as many of the smaller species of *Coniferae*.

*The appearance of the forest* is peculiar. The first impression was that fire had scorched the tops of the trees, so brown and withered did they look in their clothing of dark, blackish moss; and before the cause of this effect was discovered, it was only by persistently remembering that all the large fir trees were green that the idea could be kept out of the mind.

*Life history.*—Unfortunately we were only able to study the insect for about seven days, or from July 22 to 28, inclusive. During this period we witnessed the pupation of the first brood, the emergence of the imago from this brood, and the deposition of the eggs. Whether these eggs will hatch this season or remain as eggs until next spring we do not know. If they do hatch, as is probable, the larvæ will be innumerable and produce wide-spread devastation. Neither do we know at what period the butterflies appeared in the spring, or whether they appeared at all. From analogy there ought to have been a spring brood, of which we found the descendants; but if so, they do not appear to have specially attracted the notice of the scattered settlers, although they observed great numbers last year during the summer. It is therefore evident that, so far as observations in this part of the country are concerned, there is yet much to be learned. All parties, however, who were questioned on the subject agree that the season of 1881 was the first in which the abundance of the pests was such as to cause general comment, the opinion being often expressed that it was not previously known, although this is evidently erroneous. As the winter of 1880-'81 was exceptionally severe and peculiar in some of its meteorological phenomena, it becomes of importance to solve the query whether the sudden increase of this species was due to peculiar climatic conditions which destroyed great numbers of its parasitic or other enemies without impairing its own vitality. Certain it is that the silence of the forest was most remarkable, the absence of birds being specially noticeable, while bats were more than rare throughout the whole region traversed by our party, on both sides of the great plateau.

*Habits of the imago.*—The perfect butterfly, when just out of the chrysalis, is one of the most beautiful but at the same time most delicate of its race. It is fragile in the extreme, and soon loses its freshness from its habit of creeping into and between the pine needles in search of the female, or for the purpose of laying its eggs. Great numbers must perish accidentally in high winds; indeed, dead or damaged ones were plentiful in the dust of the roads. Copulation takes place almost directly after emergence, often before the wings are fairly dried; sometimes the male being as fresh as the female, sometimes old and worn. The average duration of life is probably very short, and in this connection it would be interesting to ascertain whether the worn males first seen were relics of the first brood or exceptionally early stragglers of the second.

*The egg.*—Examination of the abdomen of a female just after copulation disclosed 49 well-formed eggs. Search for eggs on the terminal needles disclosed them in groups ranging from 3 to 22 in number, deposited in a row on the needles, the eggs not being set upright, but at an angle of about forty-five degrees, overlapping each other like shingles, and apparently thoroughly cemented together. Those found were on young trees which had not been touched by the first brood of caterpillars. A female found in copula in the morning was imprisoned about 2 o'clock on a pine fascicle, and by six o'clock had laid 16 eggs in a continuous row. These were pale

green, ovate, with a small white coronet or raised circular ridge at the top, and somewhat flattened on the sides that touched each other.

*The larva.*—The earlier stages did not pass under review, but there is no reason to suppose that they differ materially from those about to pupate, which alone came under our observation. Just as the eggs were not laid on the extreme terminal needles, so the larva does not commence feeding on the youngest and supposedly the most succulent needles, but on those which form the base of each terminal fascicle, continuing its devastation towards the tip; but even in cases where all the needles have been denuded, in no case was the terminal bud touched; indeed, the needles are only devoured down to the dry sheath which encases their base. On many trees all the needles were gone; on many others there yet remained a few of the terminal ones, and such trees, as Dr. Hagen suggested, conveyed the idea of immense candelabra. It is evident that many of the larvæ pupate on the few remaining needles, where such exist, invariably with the head uppermost; but many forsake the parent tree, and these are probably such as have consumed all the food in their immediate vicinity. While many larvæ were found ascending the trunks of the larger trees, but very few were found descending them, while a large number were seen hanging at the end of long silken threads, swaying to and fro in the wind. Experiments on these by Mr. Henshaw and myself fully proved the fact that the larva lets itself down from high trees by means of this thread to the ground, abnormal as the habit is among the butterflies. In one case, where the thread was fully 50 feet in length, I passed my hand beneath the larva to satisfy myself that it was not descending a spider thread already woven (of which I had a suspicion on account of the great number of threads over the bark of the larger trees), and found no connection with the ground. I then caught the thread above and the larva descended gently, while swaying in the wind, but detached itself directly it touched the first object. Mr. Henshaw obtained the same results. Among the larvæ which thus reach the ground it is evident that many attempt to regain the upper limbs, for I have found several trees which had been girdled by stripping off the bark over a length of some four feet, and on such trees several hundred larvæ had been caught on the sticky, resinous surface thus exposed. Perhaps the most extraordinary circumstance connected with the change to the pupa was the occurrence of many pupæ suspended on their threads, in which case the larval skin is shriveled up round the last segment of the pupa.

While the favorite food plant appears to be the yellow pine (*Pinus ponderosa*), both *Pinus contorta* and *Abies balsamii* were slightly affected, the latter much the least, and it is not unlikely that these two trees will form the staple food of the next brood in the districts where the yellow pines have been denuded, should it hatch during the present season, as is probable.

*Enemies.*—The absence of birds has already been noted. May it not be that the larva is distasteful to them? As is well known it generally happens in the case of native insects that while they may gain a temporary ascendancy they are ultimately checked by an overwhelming army of parasites, which relegate them to their normal position in nature. We might thus expect such a thing to occur in this case. Whether this natural check may come into play this year or be delayed for several years we are not in a position to say. The search for parasitic insects was not productive of either species or numbers. *Ichneumonidæ* were particularly scarce on the wing, both round the trees and on adjacent flowers. Indeed, the only conspicuous enemy was a large heteropterous insect allied to *Pentatoma*, which was not uncommon and certainly lived on the larvæ, having been taken by myself in the act of sucking out the nearly empty flaccid skin. Many such skins were found upon the needles and on the ground around the base of infected trees. The numbers of this insect, however, were apparently not sufficient to produce any appreciable result.

Whatever hope is based on relief from parasitic insects, so far as we know at present, must rest on the large number of parasitical pupæ, although even here the

percentage does not appear to be very large, although they are numerically numerous, at least I judge so from the following observations. The normal color of the pupa is pale green. All those pupating on the needles of the young pines or shrubby plants in the underbrush were of this color, a close search failing to reveal an exception, while the larger proportion of those on the bark of the large trees were blackish brown. An examination of a number of these makes it probable that they are all diseased, not a few containing a larva either dipterous or hymenopterous, certainly the latter in one case at least (one pupa contained a large ichneumon nearly ready to emerge, which was accidentally killed). It is somewhat strange that all these dark pupæ should occur on the bark of large trees. May it not be that their diseased condition had prevented the secretion of silk, and that being thus prevented from dropping to the ground in the usual way they had wandered part of the way down the tree before the final change, their restlessness being due to the same cause?

*Probable damage to the forest.*—While the affected trees, at a casual glance, look dead and are evidently considered by the settler to be killed, it is still an open question whether they are really so. It is true the foliage is gone and the tree must have an impaired vitality, but as long as the terminal bud remains untouched the tree would partially recover itself in the ensuing spring unless again stripped of its scanty covering. In this case it is probable death would ensue. What remedial measures can be adopted it is too soon to say. Observations should be carried on for the balance of the season, and I have suggested the propriety of this course to Professor Pumpelly, who is at the head of the North Transcontinental Survey.

That such an increase of this butterfly is extremely rare, or that if it does occur frequently it is not fatal to the trees, is proved by the otherwise healthy condition of the timber. The number of trees which may be put down as absolutely dead, but yet standing, is very small, and the fallen trees are practically absent, even in the worst districts. I am therefore in hopes that the plague is only temporary and the damage more imaginary than actual.

(Unfortunately my pupæ were killed in transit by the breakage of a bottle of chloroform, so that I have failed to raise their parasitic contents.)

*Technical notes.*—Mr. Henry Edwards has given a good description of the pupa in the Proceedings of the California Academy of Sciences, but was not acquainted with the larva. I therefore add a description of the mature form. I have not Mr. W. H. Edwards's figure of the male for reference, but know that it must be good.

Mr. Strecker's figure of the female reminds me of specimens I have seen from California, though it is roughly drawn, but it does not resemble a single female among those taken on this trip. Indeed, when I first took the female I made the suggestion that we had found a new species, as there was no trace of red on the secondaries beneath, and the predominant color was black. Not having types before me for comparison, I am unable to determine whether or not the insect now under consideration is worthy of a special name, and I therefore add a full description of both sexes for future reference.

*Description of imago.*—Head and body black above, with white hairs, the latter white beneath. Palpi yellowish, with fringe of black hairs; antennæ black.

*Male.*—Primaries pure white, with jet-black markings as follows: Fringes white; a black costal streak, narrowest at the base, extending to the discal vein, at which point it is suddenly bent inwards and extends over the discal vein to the median nervules. A black apical patch deeply three-notched inwardly, and cut square off on the second median nervule, containing five white spots; the costal one small, the second long and ovate, the third and fifth about the size of that on the costa, the fourth minute.

Secondaries pure white, with a few black scales at the base of the median vein; and sometimes in specimens which are very dark beneath there are visible portions of the submarginal band, as seen beneath.

Beneath, the primaries show the same general markings, but the white spots in

the apical black patch are much larger, with more diffuse margins, and are increased to six in number by the addition of one between the first and second at the extreme tip of the wing.

Secondaries pure white; all the veins black, with a narrow submarginal band, most remote from the margin about the middle of the outer edge. Occasionally the veins are intensely black, with the scales spreading more or less over the disk of the wing, in which case there are many powdery black scales, most concentrated along the outer and inner margins, the former in this case having a narrow terminal black line. Fringes white.

In occasional specimens there are traces along the costa and on the outer margin between the nervules of the red markings so characteristic of the female.

*Female*.—The primaries differ from the male by the extension of the black apical patch to the inner angle, it gradually narrowing thereto from the second median nervule, and containing a small white spot between the first and second median nervules. The same ornamentation is repeated beneath.

The secondaries above are white, with a marginal and submarginal narrow black band; the nervules, black between these bands, dividing the inclosed space into

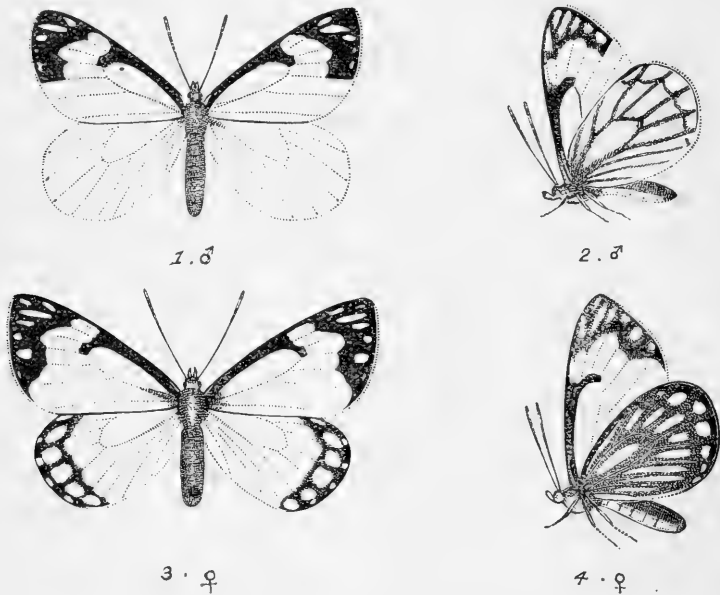


FIG. 263.—*Pieris menapia*. After H. Edwards.

six unequal lunules, as in the male beneath; the outer band sometimes faintly interrupted between the veins with a few orange or brick-red scales.

Beneath, all the veins are broadly black, as are both the outer bands, reducing the white spaces to a series of narrow intervenular patches and six reduced outer lunules, giving the wing a very gray appearance. On many specimens there is no red at all; on others the whitish costal openings and a small patch in the terminal black band between each of the nervules are of a brick-red.

*Habitat*.—Country round Spokane Falls, Washington, July 26.

Alar. expanse, male and female, 2. to 2.20 inches.

Mr. Strecker's figure very fairly represents the upper side of the females here described, but the under side is totally unlike, so far as the secondaries are concerned. In all I have seen from the locality quoted there is more black than white on the

secondaries beneath. None of them have so much red; many none at all, and not one shows any trace of the streak near the inner margin. As I have not access to the description of the female by Felder, I forward a series to the editor of *Papilio*. Should he find them to differ largely from Felder's description, I would suggest the name of "*suffusa*" for this variety, as it is very constant.

*Description of larva.*—General color green. Head green, covered with small white points; mouth-parts dusky; low down on each side a curved row of four black dots.

Body clear green, tinged with purplish, and with two lateral yellowish-white stripes. In the dorsal green stripe the purplish tint shows itself as a faint dorsal line, and on the edge of the upper lateral line, leaving clear green between. The upper edge of the upper lateral stripe is clean cut; the lower edge more diffuse, shading into green, and that color being tinged with purplish along the upper edge of the lower lateral stripe, which is somewhat broader than the upper one and better defined. Anal segment somewhat horny, narrow, and slightly notched at the tip. Venter dusky green. Prolegs black. Abdominal legs dusky green. Length, 1 inch.

NOTE.—I have in this paper assumed that all the damage done to the yellow pines was caused by *P. menapia*. It is only fair to state that on the edge of the timber, north of Spokane Falls some 4 or 5 miles, I came across a large Bombycid larva which denudes the foliage in a similar manner. From one small pine, not more than 12 feet high, I took some thirty specimens and might have taken a hundred. These were in a district where *P. menapia* was uncommon. We did not have time to make any extended search on other trees, but it may be possible that a portion of the damage has been done by these insects. It could not have been common, however, in the affected district, as a close watch on the habit of *menapia* did not reveal its presence. I have a number of cocoons of this insect, from which I hope to raise the imago, which is probably allied to the genus *Parorgyia*. If I succeed, I will put the observations on record.—[San Francisco, August 9, 1882.]

#### 87. THE PINE THECLA.

*Thecla nippon* (Hübner).

Order LEPIDOPTERA; family LYCENIDÆ.

Feeding upon the leaves in summer, a flattened oval worm, .75 long when full-grown, of the same deep green color as the leaves, with a light yellow stripe along the middle of its back and a white one on each side, and a brown head; changing to a short thick grayish pupa with two rows of small blackish spots, and outside of these a row of more conspicuous rust-red ones, which is attached by its tail and by a thread around its middle in form of a loop; giving out a smallish butterfly which comes abroad in April and the fore part of May; 1 to 1.15 in width across its wings, which are of a dusty rust color and without spots above, paler grayish beneath, the fore ones with a dislocated black band beyond the middle, edged on its hind side with snow white, and beyond this a row of black crescents, each with a white spot in its concavity, and the hind wings similarly but more complexly variegated. (Fitch.)

Boisduval says:

This insect lives in Georgia and Florida, on several species of pine, and is very rare and seldom seen in collections.

It is, however, a common species in the State of New York, in all our forests where pine trees abound, coming out with the first warm days of spring, before collectors are much abroad in search of insects, and continuing but a short time. (Fitch.)

## 88. THE SOUTHERN PINE SPHINX.

*Ellema coniferarum* (Abb.-Sm.).

(Young Larva, Plate XXXIV, figs 1, 1a-1j, details.)

The following account of the transformations of this moth is copied from Mr. A. Koebele in Bulletin Brooklyn Entomological Society (iv, p. 20). A manuscript plate by Abbot in the library of the Boston Society of Natural History gives an excellent colored figure of the larva, which is represented as feeding on *Pinus rigida*.

*Mature larva.*—The larva of this insect was originally figured by Abbot and Smith, and is by them represented as being checkered with light and dark-gray squares. This form was found by me at Tallahassee, on *Pinus palustris*, but infested by parasites, and another in the jaws of *Pasimachus subsulcatus*, but as feeding indiscriminately on all kinds of pine. The pink color occurs in the larva only after the third molt. The most remarkable part of the history of the insect is the extraordinary change which takes place in the shape of the head of the larva at different periods of its growth. Immediately after birth it is round. With the first molt it becomes angular and Smerinthus-like. This is very much increased with the second and third molts, so that in these it is fully four or five times its width, running up to a sharp point at the summit. When disturbed at this age the larva thrusts down the extremity of its head so it lies straight in a line with the body. Ordinarily it carries the point erect. There is very much variation in the imagines. Front wings broader or narrower, many uniform ash-gray in color, many have the two black dashes near the middle of the fore wing, some have only one. Some have a band of lighter gray across the wings, and some have dark lines and markings. Some, apart from the color of the abdomen, which remains uniform, exactly resemble *Sphinx pinastri* of Europe.

*The egg.*—It is very dark green and hatches in eight days. The larva develops to full size in about six weeks. It goes into the ground to pupate and remains in the pupal state a month or more. There are at least two broods each year.

*Larva.*—The much more common form is light yellowish green in color with three white lines on each side, one just below the dorsal line, a second stigmatal, and the third half way between these. The back stigmatal spaces and the under part of the body are strongly marked with red. The body is cylindrical, hardly varying in size from one end to the other. There is no caudal horn through all its history. The head is of medium size, light yellowish green, edged along the collar with a blue line. There is a black line running from each corner of the mouth to the summit of the head and there they meet one another. The head is rounded, somewhat conical, flattened in front. The length of the full-grown larva is 2½ to 3 inches.

## 89. HARRIS'S PINE HAWK-MOTH.

*Ellema harrisii* (Clemens).

(Larva, Plate XI, fig. 5.)

A grass-green caterpillar with no caudal horn, but a caudal plate granulated and edged with white, with yellow subdorsal and lateral bands, and a white stripe bordering the stigmata; becoming fully fed and leaving the white pine about the middle of September, the pupa subterranean, and the moth appearing about the middle of June in New York. (Lintner.)

The different pine hawk-moths are of little economic importance, as they are of great rarity both in the caterpillar and moth states; but from a scientific point of view these moths present much interest. Beside the pines, we have found the young larvæ on the spruce, late in August, at Brunswick, Me.



FIG. 264.—*Ellema harrisii*; a, male; b, female. (The left wings represent the under side). After Lintner.

I found on *Pinus strobus*, October 2, at Providence, a caterpillar which I refer to this species, as the green checks on the back are obsolete and the face is red, not green as in *E. pineum*, according to Lintner, and yet the back is checkered on segments 2 to 4 behind the head. The caterpillar feeds stretched out like other pine larvæ, the yellowish-white lines resembling the under side of a reversed needle of the tree in a bunch, which have yellow and white reflections. "*Ellema harrisii*," writes Mr. Lintner, "is distinct from *Ellema bombycoides* of Walker." I have an example of the latter, and there can be no doubt in the case. Even the antennæ are quite different.

*Young larva*.—Head very large, vertex high, ending in a large cone. Supra-anal plate large, long, triangular, ending in two blunt conical tubercles. Head pale green, vertex, from which two faint white bands pass down by the eyes. Clypeus and labrum honey-yellow, black on the sides. Two dorsal and two lateral continuous linear white lines. A broken substigmatal broad snow-white line. Thoracic feet pale green; abdominal feet tipped with red. Molted August 30. Length, 20mm. For numerous interesting details, drawn by Dr. Gissler, see Plate xxxiv.

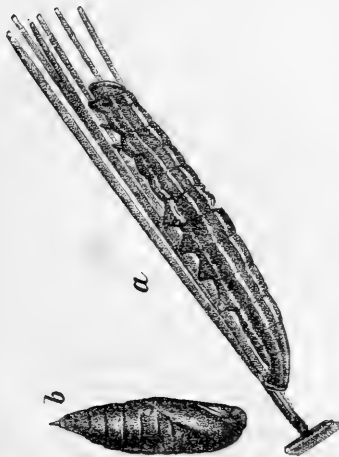


FIG. 265.—*Ellema harrisii*—a, larva; b, pupa. Lintner del.

Feet pale reddish. Along under side of abdomen a broad dull reddish median band.

Supra-anal plate triangular, acute at apex. Anal legs large, reddish on the edges. Length, 30<sup>mm</sup>.

*Full-grown larva*.—Body tapering a little towards the head and decidedly towards the end. Head not so wide as the prothoracic segment, acutely triangular, conical seen in front, ending on the vertex in a subacute point and slightly notched. Face dull brick-red, at the point above towards the apex darker; the front is widely bordered with straw-yellow; head behind green. Body green, of the same hue as that of the pine leaves; along the back is a broad dull brick-red dorsal stripe, wanting on the prothoracic segment, and represented by isolated patches on the two following segments and ending before the end of the supra-anal plate. This band is bordered with a whitish-yellow line. Half way between this and the spiracular line is a straw-yellow even line, becoming white on the terminal second and third segments; it ends on the apex of the supra-anal plate, making its two sides white. The green spaces between the lines and along the under side of the body are dotted with white. A lateral infra-spiracular broad white line, interrupted at the sutures, becoming yellow towards the head. Above this line, along the posterior two-thirds of the body, is on each segment an elongated lilac patch inclosing the black spiracles of the latter, edged with white. Thoracic feet green; under side of the body behind the thoracic feet with a broad dull median lilac band, including the abdominal feet. Supra-anal plate narrow, acutely conical, the tip lilac. The anal legs broad, angular, and edged with lilac. Length, 45<sup>mm</sup>. Lintner does not, in his description, refer to the stigmatal lilac patches.

*Pupa*.—Chestnut-brown, with a rough, not produced head-case. Tongue-case buried, parting the leg-cases, but terminating just before reaching the tips of the wing-cases. Incisures rounded. Posterior segments tapering. Stigmata black; terminal spine black, contracted at base, minutely bifid. Length, .95 to 1.10 inches. (Lintner.)

#### 90. THE CHECKERED PINE SPHINX CATERPILLAR.

*Ellema pineum* Lintner.

A caterpillar like the foregoing, but with a dorsal row of squares, and transforming to a moth, which is readily distinguished from *Ellema harrisii* by the darker ground-color of its wings, the absence of the gray shades, and its much less distinct markings. (Lintner.)



FIG. 266.—*Ellema pineum*.—a, male; b, female. (The left wings represent the under side.) After Lintner.

Mr. Lintner, in his Entomological Contributions contained in the Twenty-third Report of the New York State Cabinet, describes the male and female of this pine sphinx, and also describes the larva as follows:

*Larva*.—Length, 2 inches. Color, grass green. Head subtriangular, green, bordered with bright yellow, within which, at the apex, is a  $\wedge$  of black. Body subcyl-



indrical, tapering at the extremities, and without a caudal horn. Dorsally, a reddish-brown line interrupted on the hinder portion of each segment by a square of green traversed by diagonal lines; a subdorsal yellow line borders the above; lateral stripe yellow; substigmatal stripe white, interrupted at the sutures by light green; ventral stripe and prolegs rose-red. Feeds on the white pine, and matures about the middle of September, when it enters the ground and forms a cell, where it becomes a chrysalis.

91. THE IMPERIAL SPINY CATERPILLAR.

*Eacles imperialis* (Drury).

Order LEPIDOPTERA; family BOMBYCIDÆ.

(Larva, Plate VI, figs. 1a, 1b.)

Among the leaves of the white pine in the Northern States, late in August and through September, a large, thick, pale-green caterpillar between 3 and 4 inches long, with the head and legs pale orange, with six thorny, yellow knobs behind the head; pupating in the ground and changing late in June to a large, handsome, yellow moth, speckled with brown, and with a very light purple-brown band across the outer margin of each wing.

The transformations of this moth were first described by Harris, but the earlier stages have more recently been fully described by Mr. Lintner, in his Entomological Contributions, No. II. Though usually feeding on the white pine in the New England States, where we have seen it in the breeding-cages of entomological friends, it also feeds on the oak, button-wood, etc., and will eat the leaves of the chestnut. It is too rare to be of any economical importance, but will always attract the attention of lovers of fine, rare insects. The moth lays its eggs late in June, hatching in about a week or ten days; the larva, according to Lintner, molting at least four, if not five times.

*Larva*.—Three or 4 inches long and more than half an inch in diameter, and for the most part of a green color, slightly tinged with red on the back, but many of them become more or less tanned or swarthy, and are sometimes found entirely brown. There are a few very short hairs thinly scattered over the body; the head and the legs are pale orange-colored; the oval spiracles are large and white, encircled with green; on each of the rings, except the first, there are six thorny knobs or hard and pointed warts of a yellow color, covered with short black prickles; the two uppermost of these warts on the top of the second and of the third rings are a quarter of an inch or more in length, curved backwards like horns, and are of a deeper yellow color than the rest; the three triangular pieces on the posterior extremity of the body are brown, with yellow margins, and are covered with raised orange-colored dots. (Harris.)

*Pupa*.—Subterranean, not contained in a cocoon, about 2 inches long, of a dark chestnut-brown color, rough, with little elevated points, especially in front; the end of the body with a long forked spine, and surrounded, on each ring, with a notched ridge, the little teeth of which point towards the tail. Three of the grooves or incisions between the rings are very deep, thus allowing a great extent of motion to the joints, and these, with the notched ridges and the long spine at the end of the body, enable the chrysalis to work its way upward in the earth, above the surface of which it pushes the fore part of its body just before the moth makes its escape. (Harris.)

*Moth*.—Ocher-yellow, spotted with purple-brown, with a large patch at the base, a small round spot near the middle, and a broad, wavy, light purple-brown band

toward the outer edge of each wing; in the males there is another purple-brown spot covering nearly the whole of the outer hind margin of the fore wings, and united to the band near that part; the body is yellow, washed with purple-brown along the back. It expands from  $4\frac{1}{2}$  to over 5 inches. (Harris.)

92. *Citheronia sepulchralis* Grote and Robinson.

Closely allied to *C. regalis* is the above named species whose caterpillar feeds on the pitch-pine. It is closely allied to the larva of *C. regalis*, but the horns on the three thoracic segments are paler, slenderer, and unicolorous. It ranges from Maine to Georgia.

I have found a nearly full-grown caterpillar of this rare moth on the pitch-pine at Brunswick, Me., August 5, which lived in confinement until the 17th of the month. The following year a younger one occurred on the white pine during the second week in August.

*Young larva*.—Length, 11<sup>mm</sup>. Head large, pale brick-red. Body pale green, tubercles straw-yellow, green at base. The dorsal tubercles all nearly the same size except the prothoracic ones, which are nearly one-half as large as the mesothoracic; those on mesothoracic, metathoracic, and first abdominal segments of equal size and only a little larger than those on the other abdominal segments. Eighth pair of abdominal ones larger than the others and nearly as large as the thoracic ones. The long slender spines on the thoracic segments black, those on the abdominal in part black, especially the inner ones.

*Larva, probably before the last molt*.—Head full, rounded, retractile in the prothorax, nearly concolorous with the body, being corneous. Body uniformly horn-brown, the color of old dark parchment, with no green shade about it. On each thoracic segment a long slender warted subdorsal spine, the prothoracic pair projecting a little in front and smaller and one-third shorter than the other four, which are recurved. The six long thoracic spines are succeeded by a dorsal row of short stout smooth acute spines with a dull orange-red tint. Each spine has two or three small slender dark spinules and about three terminal unequal spinules. On the side of each thoracic segment are two short conical tubercles with a few stiff spinules. On the abdomen above the spiracles is a row of dull orange-reddish smooth spines, and below a row of much slenderer spines, which are spinulated much like the dorsal thoracic ones. These spines are situated on the folds of the lateral ridge of the body. Below this spiracular row of spines is a subventral row of small spines on the three thoracic segments, and which are large and long on the first and second abdominal segments and on the last three segments. On the middle of the eighth segment is a large straight dorsal stiff spine nearly as large as the larger thoracic ones. At its base behind are two minute spines. On the segment behind (ninth) is a median stout spine, making the middle one of a transverse row of seven spines on that segment. Supra-anal plate flat, obtuse, variously and obtusely tuberculated, especially around the edges, as are the sides of the large anal legs and the sides of the prolegs, which are very retractile. The spiracles are large, black, and very conspicuous, the last pair larger than the others. There are also scattered smoky-black blotches, a row on the front edge of each segment and one at the base of the dorsal spines. Length, 50<sup>mm</sup> (2 inches). The larva of *sepulchralis* (of which Professor Riley has blown larvæ of four stages) differs from that of *C. regalis* in the stage before the last molt in having only six spines on the anterior end and two pairs of straight spines on the end, those on the prothoracic segment longer in proportion than in *C. regalis*, and all ending in bulbous enlargements. In the mature larva all the spines are shorter, and the spinules have shorter spines. Length, 100<sup>mm</sup> (4 inches).

93. *Tolyte laricis* Fitch.

Mr. A. R. Gilbert, of Rochester, N. Y., reports finding six cocoons of this moth on the white pine (*Papilio*, iii, p. 25). Mr. R. Bunker also has found sixteen cocoons on the white pine. (*Can. Ent.*, xv, p. 160.) It seems, however, to be more common on the spruce and larch. (See *Larch Insects*.)

94. *Halesidota argentata* Packard.

This moth has been raised by Dr. Behr from larvæ found feeding on pine leaves in the Sierra Nevada Mountains, near Grass Valley. No description was made, but Mr. Stretch says they were dark brown, somewhat resembling that of *H. edwardsii*.

*Moth*.—Head and thorax pale buff yellow; base and sides of the front walnut brown; center of prothoracic pieces brown. Patagia margined with brown, within very broadly so. Fore wings walnut brown with five rows of large irregular round or ovate silver white spots, except the costal spots, which are buff yellow; two basal spots yellow; inner margin of the wing buff as far as the first line, which is slightly curved, the middle dot of which last is much smaller than the others. In the second line, which is straight, the submedian spot is transversely broad, oblong; costal spot largest. The third row does not extend to the inner margin. The spots making up the marginal and last row are uniformly round. Fringe and termination of nervules pale buff. Hind wings white; middle of the costa, the apex, and discal dot brown; beneath much as above, a little paler. Legs buff, base of femora and tips of tibiæ and tarsi broadly annulated with brown. Abdomen buff above, beneath brown. Expanse of wings, 2.05 inches.

## 95. THE YELLOW BEAR.

*Spilosoma virginica* Fabr.

I have found this omnivorous caterpillar feeding on the pitch pine in Maine the first of September.

## 96. THE PINE PARORGYIA.

*Parorgyia parallela* G. & R.

(Larva, Plate XXXV; fig. 3.)

This fine moth was first bred from larvæ on the pine in June and also in October, by Mr. Lintner, who reared the larva from eggs laid July 25 by the moth in confinement. His caterpillar developed fully by the first week in November. This species has also been reared by Mr. Seifert, of New York City, and we also have it from eggs received from Miss Morton, of Newburg, N. Y., and also from eggs sent us by Prof. R. Thaxter, from Aiken, S. C. We fed our larvæ on oak leaves, which they freely ate, thriving well in confinement.

*The moth*.—Female. Is a large thick-bodied moth, with short, broad wings and heavily pectinated antennæ. It is named from the dark parallel longitudinal stripes on the upper surface of the fore wings. The fore wings are pale olive-ash, much clouded with brown and with scattered dark scales. The basal half of the front

edge of the wing is olive-ash; the median vein is dark; below a broad black longitudinal stripe runs from the base of the wing out towards the outer edge. The inner median line is dentate, while the outer is distinct, black, and scalloped. Marginal line brown. Expanse of wings, 2 inches. (See Figs. 42, 43, p. 136.)

## 97. THE PINE TUSSOCK MOTH.

*Orgyia* sp.

Order LEPIDOPTERA; family LIPARIDÆ.

A larva quite different from *Orgyia leucostigma* occurs frequently on coniferous trees, including pines, spruce, and fir. It differs from that of *O. leucostigma* in having a pair of large prothoracic lateral black pencils.

*Larva*.—Differs from *O. leucostigma* in having a pair of large prothoracic lateral black pencils, the posterior supra-anal tuft being as usual. The pair of lateral black tufts are about half as long as the anterior pencils and project straight out from the second abdominal segment, immediately in front of which is a pair of much slenderer cream-colored pencils also projecting straight out. Of the four dorsal tufts, the two anterior ones are smoky black, the two posterior ones dusky cream-colored. Behind the dorsal tufts are three coral retractile warts, and a lateral row of coral warts. The head is black. All the feet, both thoracic and abdominal, are yellowish. Length 20<sup>mm</sup>.

In another large *Orgyia* larva (whether of this species I am uncertain) found August 30 on the pine or spruce, the four dorsal tufts are colored alike, being tinged with reddish-brown, especially towards the end. Behind the last dorsal tuft are six coral warts from which pale hairs radiate, and there are three greenish median retractile warts, besides the lateral row of coral warts extending along the body.

In the larva of *O. antiqua* as described by Harris, the back is yellow, with four yellow tufts; the sides are dusky and spotted with red; there are two long black prothoracic pencils but no lateral prothoracic ones; but a black pencil on each side of the fifth ring, and the usual one on the top of the eleventh ring; the head is black, and there are two retractile coral warts on top of the ninth and tenth rings.

## 98. THE WHITE PINE TUFTED CATERPILLAR.

*Platycerura furcilla* Packard.

Order LEPIDOPTERA; family NOCTUIDÆ.

(Larva, Plate XI, fig. 5).

Found in September usually on the white pine; a dull-red caterpillar, banded with brighter red; a white lateral line, with reddish hairs in clusters, and on the first, third, fourth, and eleventh segments two long pencils of red hairs; spinning a cocoon among fallen leaves, the gray moth appearing about the middle of June.

This is another interesting caterpillar, whose history has been traced by Mr. Lintner. The worm when in the attitude of feeding, with its terminal pair of legs clasps the leaves at the sheath, and extends its body along a leaf until it commences to bend, when, by detaching successively the first and following pairs of prolegs, it forces the leaf through

its legs until its tip is held between them. The caterpillars spin their cocoons beneath leaves lying in the bottom of the breeding-cage, the moth emerging June 12. It is interesting to see that this, like several other caterpillars of the pine in this country and Europe, are colored red like the pine shoots, and are thus perfectly protected from their enemies.

Though usually occurring on the white pine late in August and through September, as observed in Maine and Rhode Island, it also occurs on the hackmatack, where we have observed several half-grown ones in Maine, August 20. It spins its cocoon about the middle of September; the moth appearing the following June.

The caterpillars are usually reddish, the color of the base of the pine needles, but occasionally they occur without any trace of red.

*Larva before the last molt.*—Head large, rounded, reddish, not so wide as the prothoracic segment, which is broad, swollen on the side; a pair of stiff spike-like tufts of hair arise from the two dorsal tubercles, which are reddish at base and blackish at the end. These two are succeeded by a pair one-third as long, and the tubercles behind throw off erect as well as laterally radiating reddish hairs. The tufts and tubercles are a little larger on the third segment from the end of the body. There are two rows of lateral hairy warts and a row at the base of the legs. Body and hairs pale rust-red, a lateral irregular whitish stripe sending prolongations upwards; an interrupted dorsal median white line. Legs reddish. Adapted for protection by its rust-red color, which is like that of the terminal pine twigs. It may be known by the pale rust-red color, the short thick hairy body, and the prothoracic stiff erect black and red tufts. Length 15<sup>mm</sup>.

*Larva after the last molt.*—The body is black, with sparse, dull, light-yellow hairs radiating from dark or pale mammillæ. A pair of long prothoracic straight tufts projecting over the head, and a pair of long similar erect ones on the eighth segment. All the legs reddish. Length, 28<sup>mm</sup>. Some mature ones at Providence turn black, and in form are like the larva figured by Lintner, the spikes whitish, but the broken lateral line still white.

*Moth.*—Antennæ pectinated; fore wings rather triangular, ashen white, dusted with fine dark scales. The fore wings are crossed by a twice-bent basal black line, within which at the insertion of the wing is a short basal spot. A second straight line crosses the wing just before its middle, and from it branches at nearly right angles a line which becomes straight above the second median nervule and parallel to the inner line, thus inclosing a large square area which is concolorous with the rest of the wing. There is a submarginal obscure line, shaded externally with white, which is irregularly zigzag, and runs down more than usual in the second median interspace towards the margin of the wing. Hind wings whitish, especially on the outer border, with a broad obscure dusky submarginal line. Expanse of wings, 1.50 inches.

99. *Apatela oblinita* Abb. and Sm.

The caterpillar of this moth occurred on the pitch pine August 8 to 12. It began to spin a cocoon on the 12th by drawing needles together and spinning a cocoon between them, and the moth appeared June 1 of the following year.

*Larva.*—Body cylindrical, short and thick, with large rounded tubercles from which arise short tufts of radiating yellow hairs, often tipped with black. Body dark green with a broad dorsal longitudinal band. Two lateral interrupted narrow black lines. Head shining black.

## 100. THE PINE PHEOCYMA.

*Pheocyma lunifera* Hübner.

The caterpillar of this noctuid moth is of frequent occurrence on pine trees, especially the white pine and pitch pine in Maine, where I have observed it for several years. In northern New England the larva occurs through August into the first week of September, when it transforms into a chrysalis, the moth appearing May 10. I am indebted to Prof. John B. Smith for the identification of the species.

The caterpillar is, like nearly all those which live on trees, protected from the observation of its enemies, such as birds, ichneumons, etc., by its similarity in color to the bark of the twigs on which it often rests, while the reddish stripes are concolorous with the base of the needles of the pine.

The caterpillars vary a good deal. Some are wood or horn brown, or the body is decidedly reddish, with the longitudinal band more distinct than usual; some are green with white lines, but the warts and head as in the more usual varieties. They are closely similar to the larvæ of *Homoptera* and *Catocala*.

*Larva*.—Body long and slender, tapering considerably behind the fourth pair of abdominal legs. Head not so wide as the body, rather deeply bilobed, with a lateral V-shaped white spot. A pair of small prominent tubercles on top of the eighth abdominal segment, and in place of them on the segments is a pair of more widely divergent short black dashes; on the segment next to the last is a transverse ridge. Anal legs long and slender. General color of the body wood or horn brown, of the shade of old twigs, sometimes reddish or greenish. Head marbled with a set of transverse wavy whitish lines on each side of the median line. Body with a lateral row of black dots; beneath much paler, glaucous green. Length, 35<sup>mm</sup>. The larvæ are very variable; in some the body is reddish with longitudinal bands much more distinct than usual; in some the body is pale pea-green, a little paler than the pine leaves; there is a firm, quite wide medio-dorsal line, and on the sides a wider white line next to the broader very conspicuous pale red spiracular line, which is similar in color to the reddish sheath of the pine leaf. Head reddish, with the characteristic oval white spots on each side. In others (as pitch pine) the body is beautifully marbled with gray and whitish. A V-shaped white spot on the side of the head. On the segment next to the last abdominal are two small inconspicuous warts. A faint, broad, grayish-white dorsal band, broadly interrupted at the sutures of the segments by an irregular transverse umber-brown stripe. A faint lateral broad band, containing on the side of each segment a clear white point. Length, 42<sup>mm</sup>.

*Pupa*.—Of the usual rather slender *Catocala* shape, covered with a slight whitish bloom. The abdominal tip rather blunt, the surface corrugated with irregular longitudinal furrows above and on the sides; spine small, bearing at the end two very large, long, stout bristles curved outwards at the ends, which are blunt; at their base are two pairs of slender bristles. Length, 17<sup>mm</sup>.

*Moth*.—Body and wings dark ash-gray and reddish brown; thorax crested, dark reddish brown, with two blackish transverse lines. Patagia with a white stripe behind the middle and white scales at the tip; hinder part of the thorax dusted with white. Fore wings black and reddish brown at base, with interrupted and broken black and white lines. Within the middle of the wing is a broad, slightly sinuous whitish-gray band. A large black mark forming a hollow square, the hollow grayish, at the end of the discal space. Beyond this spot are two nearly parallel black

lines, the inner bent inwards at a right angle upon the costa, and sending an angle into the extra-discal space; the line is bent outwards on the first median vein, then curving inwards and ending on the hind margin of the wing. The outer line curves outwards on the costa towards the apex, is bent on the first median vein, and behind is nearly parallel with the inner line. A fine black scalloped hair-line at the base of the fringe, which is darker on the points of the scallops. Hind wings with a double black curved band beyond the middle, the space within the lines filled in with black towards the hinder edge of the wing. An indistinct broad diffuse shade passes across the wing just within the middle. On the under side of both pairs of wings the discal dots are present, and there is a diffuse dark line common to both wings. Expanse of wings, 36<sup>mm</sup>.

101. *Noctuid caterpillar.*

(Plate VI; fig. 2.)

Among the leaves of the white pine at Providence was, October 2 to 14, a mimetic caterpillar of the following description:

It began to pupate October 4. One pupa found on the 4th. One of the larvæ turned black, retaining the three dorsal white stripes, but with a row of about ten black spots on each side above, and head large, with two black lines, the head generally marbled with dark. This is, I think, a *state* of the present species without doubt. Another one is green, with two subdorsal and a lateral row of black spots next both white stripes.

*Larva.*—Of the usual noctuid form, the body tapering gradually towards both ends. Color of the head and body a little paler green than the pine needles. Head small, narrower than the prothorax, rounded; pale honey-yellow, greenish above. Body smooth, with four distinct longitudinal white stripes. A median dorsal white line and two subdorsal at nearly the same distance from the median as from the spiracular one, which is a little broader and more scalloped. Spiracles ringed with black, all the feet green; the body of the same color beneath as above. Length, 23<sup>mm</sup>.

102. *Noctuid larva.*

A white and red striped noctuid occurred on *Pinus strobus* at Brunswick, August 5, and one on the hemlock August 14.

*Larva.*—Body thick, cylindrical, rapidly tapering towards and bending down towards the short stout anal prolegs. Head round, green. Clypeus and antennæ whitish; labrum reddish, head retractile in the prothorax. Body pea-green, color of pine leaves. Three broad dorsal white conspicuous lines; a lateral similar spiracular white line tinged with straw-yellow, lined with red on the upper edge, the white line containing the spiracles. Below, near the base of feet, is a similar white line interrupted at the sutures. Thoracic feet reddish. Abdominal legs reddish at tip. Length, 34<sup>mm</sup>.

## 103. THE PINE THERINA.

*Therina seminudaria* Walker.

We have reared this moth from a caterpillar found feeding on the white pine at Providence, R. I., but failed to prepare a description of the larva. It passed the winter in the chrysalis state, the moth emerging in May.

*Pupa*.—Moderately slender, thorax spotted with brown, wings slashed and spotted with brown; abdomen with a dorsal and two lateral rows of irregular spots, and the segments also surrounded by a circle of spots. Terminal spine moderately large, not corrugated below, above coarsely pitted with more or less confluent punctures, the end bearing two long, straight, stout bristles, a pair of small bristles on the upper side near the end of the spine; a small pair beneath, and a larger pair, one on each side. Length, 13<sup>mm</sup>.

*The moth*.—Smoky hyaline ash color, often whitish; head ochereous. Palpi rather stout, ascending, passing a little beyond the front; third joint rather long, conical. Antennæ ochereous, ashen above, with long, delicate, fine, close-set, black pectinations. Body pale cinereous, with an almost imperceptible ochereous tinge. Fore wings with a basal, slightly curved, dark, diffuse line, which is especially marked on the veins; discal dot distinct but diffuse, rather larger than in *T. fiscellaria*; an outer, not very oblique, slightly sinuate, dusky line, sometimes angulated on the first median venule in both wings; it is thickened on the venules, curving inward a little toward the base; the wings are rather thickly flaked with smoky strigæ, especially on the costa and outer edge. Hind wings without any discal dot; the single line a little curved, not reaching to the costa; wings very transparent at the base. Beneath, whitish, very transparent; the lines faintly appear; no discal dot; costa tinged slightly with ochereous. Hind wings scarcely angulated, the angle being almost obsolete. Expanse of wings, 38<sup>mm</sup>.

This is a very variable species, in rubbed examples being unusually pale transparent ashen, but dusky in fresh specimens. The lines are arranged much as in *E. fiscellaria*, but where the wings are slightly rubbed they are represented by a series of punctures on the venules. The unusually long, filiform, closely set pectinations of the antennæ, and the granite-gray wings, with dusky lines, not tinged with ochereous, will distinguish it from the other species. It varies greatly, the lines in one female being twice as far apart as in another, and the outer line in some being almost straight, in others a little bent. If I had had Mr. Grote's types alone of male *E. bibularia* and female *pellucidaria*, I should have regarded them as distinct; but, with the addition of other specimens of both sexes, I have felt compelled to unite them, as the species seems to be as variable as in *T. fiscellaria*. One Kentucky female expands only 30<sup>mm</sup>.

#### 104. THE PINE MEASURING WORM.

*Paraphia subatomaria* Guenée.

Order LEPIDOPTERA; family PHALÆNIDÆ.

Feeding on the pine, a brown measuring worm, the moth appearing June 24. (Saunders.)

The caterpillar of this moth is not known farther than that its color is brown.

*The moth* is a delicate species with deeply serrated and angulated wings. The present species differs from the others of the genus by its whitish color, being rarely somewhat ochereous, while the base and outer edge of the forewings are as pale as the middle portion; the under side of the wings are rather pale. The wings expand 1.30 to 1.70 inches.



105. *Caripeta angustiorata* Walker.

The caterpillar of this Geometrid moth is common on the white pine in August and September in Maine and Rhode Island, where I have observed it, and is protected from observation by its resemblance to the smaller twigs of the pine. It is quite variable in its coloration. August 8 to 9, at Brunswick, Me., it spun a white web with minute meshes, the cocoon not being a loose one, and on the 9th it assumed the pupa state. The moths issued in May in the breeding boxes.

*Larva*.—It is rather large and thick-bodied, the body being somewhat thickened at the first pair of abdominal legs. The head is slightly angular above, as wide as the segment next to it, the latter being rather small and not angular in front, but provided with small warts. On the metathoracic and abdominal (except second and third from the end) segments is a prominent transverse saddle-shaped ridge, ending on each side in a dark warty tubercle. On the penultimate segment are two dark, rather high dorsal tubercles, situated near together. Behind these two tubercles, and situated on a transverse wrinkle, are two small dark warts, and on a succeeding wrinkle are six warts; on the supra-anal plate are four warts, while on the edge, which is obtuse, are four small warts from which project four hairs. There are similar hairs on the edge of the anal legs, which have a deep crease parallel to the front edge, and two large spines. Lateral ridge rather prominent, interrupted at the sutures between the segments. In color this larva is pale lilac, with whitish gray specks, being of a slate color or decidedly reddish, like a twig of the trees, and variously marbled with dark brown, or sometimes with greenish livid tints. The head is marbled with transverse parallel wavy lines. Length, 30 to 32mm.\*

*Pupa*.—The chrysalis is brown, sometimes green on the head and thorax, including the limbs and wings; with an obscure dorsal row of irregular spots, forming a nearly continuous line or band; and a lateral row of large obscure spots. On the second segment from the end of the legs are two warts. The spiracles are unusually distinct. Length, 15mm.

*The moth*.—This fine moth differs remarkably from any other of our Geometrids in the opaque, rich velvety ochereous forewings, with the three broad silvery lines and large oblong discal dot. Antennæ well pectinated. Forewings opaque, deep ochereous and paler at base; on the inner fourth is a white line forming a single, large, acute angle on the median vein, along which it is prolonged beyond the basal third of the wing, extending out nearly to the discal dot, which is silvery-white; just beyond the latter is a broad silvery line, diffuse on the outside, which curves inward just below the median vein, and slightly inward opposite the discal dot. Half way between this line and the outer edge of the wing is a row of irregular white spots, from which sometimes run whitish streaks to the fringe, which, between the white spots, is ochereous brown. Hind wings pale whitish ochereous. Expanse of wings, 1.60 inches.

\*Another larva was described in my notes as follows:

*Larva*.—Body gradually increasing in width from head to anal legs. Head much flattened, not so wide as the prothoracic segment, the latter narrower than mesothoracic segment. A large lateral tubercle on each side of mesothoracic segment, blunt and irregular in form. A rather prominent transverse ridge on the segment behind the middle. There are four scattered tubercles on the other segments, but they are much smaller than in the species on the *Pinus strobi*, and not in pairs connected by elevated ridges. On the second segment from the end are two high dorsal acute tubercles close together, and behind them a transverse row of eight small acute warts. Supra-anal plate obtuse, ending in two small acute tubercles. An acute spine-like wart on each anal leg. Anal legs of moderate size. Deep brown, with a dull reddish tinge; body not mottled nor so variegated as in white pine genus. Color of a dark twig, but not so much mimicking a pitch-pine twig. Length, 40mm. Brunswick, Me.

## 106. THE RED-HEAD INCH-WORM.

*Semiothisa bisignata* (Walker).

(Larva, Plate VI, fig. 3.)

This is one of the most common of the inch or span worms which live at the expense of our coniferous trees. It occurs abundantly on the white pine in the neighborhood of Providence as late as October, and in Maine, at Brunswick, occurs in July, August, and September. Its green body is of the hue of the leaves among which it lives, while the reddish sides of the head, and the reddish thoracic legs are in harmony with the tints of the reddish sheaths of the pine needles; the white lines are like the white lines on the needles; hence it would be difficult we imagine for an insectivorous bird to detect such a caterpillar. It is to be found in Maine not only on the white and pitch pine, but on the spruce and fir. It transforms into a chrysalis in August, and through September as late as the 20th, and appears the following June, not spinning a cocoon, but entering the earth to pupate. I have found it difficult to keep the pupæ over winter, and was fortunate after several unsuccessful attempts at hibernating the pupa, to have one moth issue, November 15, and to find that it belonged to a well-known species, which flies commonly in pine woods throughout New England in June.

In the neighborhood of Providence I have noticed that the caterpillar is often without the reddish patches on the sides of the head.

*Larva*.—The body is of the width and length of a fir leaf, being rather thick and uniformly so. Head green in the middle, bright reddish on the sides, mottled with red-brown, and with two converging, narrow oval, pale red spots in front just below the vertex; clypeus tinged with red. Body pale green; a broad dorsal whitish green band of the same color as the under side of a fir leaf, and containing a median darker dorsal stripe. The band is whitish on the edges, next below which are two very narrow dark-brown hair lines. A whitish line below the stigmata, and still farther below a narrow whitish line, and two parallel dark subventral lines. The thoracic legs reddish; the abdominal legs green. Length 18–20<sup>mm</sup>.

*Pupa*.—Body of the usual shape, and mahogany-brown color, and of the usual proportions, with the surface rather coarsely pitted. The cremaster is a rather broad stout spine, ending in a rather long slender cylindrical spine; there are no curved spinules on the sides, as in the species which spin a cocoon. Length 11 to 12<sup>mm</sup>.

*The moth*.—Antennæ of male flattened, serrate, ciliated. Forewings as falcate as in *S. praeatomata*; hind wings very much angulated, more so than in *S. praeatomata*, the angle being very marked. Head, antennæ, and palpi bright reddish-ocherous. Body and wings whitish-ocherous, gray, densely speckled with brown, being much paler than usual. Forewings crossed by three brown lines, arising from moderately sized costal spots. The inner line much curved, somewhat angular below the costa, but not enlarged on the costa. Second line arising from a rather large light-brown costal spot; it is not curved and is rather diffuse. Outer line tremulous, curved outward between the costa and median vein, darker on costa. A reddish-brown, oblong, broad costo-apical spot nearly touches the line; this spot is continued across the wing by a faint reddish shade, especially marked between the first and second median venules. Below this spot, in the middle of the wing, the marginal brown line, elsewhere not interrupted, is continuous and well marked in the apical sinus. No discal

dot. Fringe pale and concolorous on both wings. Hind wings with a broad doubled shade about midway between the faint discal dot and the outer edge of the wing (sometimes wanting). Beneath, whitish, with a decided ochereous tint, speckled thickly with brown. An inner and outer ochereous-brown line common to both wings; the outer line broad on the costa, and on the hind wings accompanied by an outer shade. Discal dots on both wings dark, distinct. Legs ochereous. Expanse of wings, 1.20 inches.

## 107. THE EVERGREEN CLEORA.

*Cleora pulcherrima* Minot.

The caterpillar of this pretty moth is of common occurrence on the pine as well as the spruce, fir, and hemlock. In certain years it is quite common, and was observed in greater abundance on spruce and firs along the road from the Glen House, White Mountains, to Jackson, N. H., than elsewhere. It is so common on these trees as to merit especial attention.

The caterpillars were observed in the White Mountains during the first week in July. They began July 18 to spin a loose, thin, open, slight yellowish cocoon among the leaves, the pupa state lasting about three weeks, the moths appearing August 14. On the coast of Maine it occurs on the hemlock, some of the caterpillars being without the usual black spots on the sides of the body. The moths are found flying in the woods through September. The caterpillars are also found on the Maine coast in July and early in August, pupating August 5 to 8, and the moths appearing during the last week in August, remaining in the pupa state about fourteen days. At Providence we have beaten the chrysalides out of hemlocks early in October, the moths appearing soon after. The green chrysalides, which are striped with white, are very pretty objects. They rest among the leaves in a loose network of yellow silk threads, retaining their hold by the curved hooks on the large spine (cremaster) at the end of the body. The caterpillar is a very pretty one, being yellowish, spotted with black on the head and body. It is somewhat similar to the larva of *Zerene catenaria*, but less conspicuously marked.

*Larva*.—Body moderately thick, of the same diameter throughout, smooth, with no warts, but somewhat wrinkled. Head of the same width as body, slightly wider than the prothoracic segment, and above slightly swollen on each side of the deep median suture; pale whitish, sometimes reddish brown, with five or six large black spots and smaller minute dots. Body whitish horn (testaceous, often reddish) with a yellowish tint. On the first segment are four dorsal black dots arranged in a square; on the second and third segments a single transverse row of four unequal black dots, as also on the abdominal segments. A lateral band, yellow except near the sutures, below which, on the sides of the body, are four narrow, wavy, broken, dark hair-lines, arranged in two sets. Supra-anal plate with four black spots; anal legs of moderate size, flesh red, spotted with black-brown. Thoracic feet pale flesh color, or banded with brown and dark at the tips. Body beneath pale flesh, with two dark, faint lines. Often on each side of the clear, reddish-brown back is a row of long, narrow, lanceolate, oval, snow-white spots, edged narrowly, but distinctly, with brown. The lateral band is sometimes very distinct, and incloses on the upper edge the black, distinct

spiracles; the band is irregularly edged above and below with dark brown. Sometimes a narrow white medio-ventral hair line is present, narrowly edged on each side with dark brown, and inclosed by the same reddish-brown tint as along the back. Length, 24 to 30<sup>mm</sup>.

*Pupa*.—Body green, becoming usually brown; thorax green above, spotted with brown, the wings and legs pea-green, with two subdorsal white stripes along the abdomen, and a lateral white stripe; beneath, four longitudinal brown stripes. The pupa often becomes brown, and the wings slashed with light brown, the antennæ and fore-legs of the same color, while the middle and hind legs are white. The terminal spine is rather slender, long, ending in two long, large, excurved hooks; a pair of much smaller ones at their base, and two pairs on the sides, *i. e.* one pair on the sides near the base, and the other farther underneath. Length, 11 to 15<sup>mm</sup>.

*Moth*.—With unusually broad, transparent wings, which are white or pale ash. Head deep yellow. Forewings crossed by two black lines, the inner with four scallops, the outer line sinuous, scalloped, with a great curve outward between the subcostal and the third median venule. Opposite the discal dots are three acute, smaller scallops, all of equal size. Fringe whitish, distinctly checkered with black on the ends of the venules. Hind wings with a scalloped outer line, often obsolete toward the costal edge, varying in its distance from the outer edge; beyond this line the wing is darker than at the base. Expanse of wings, 33<sup>mm</sup>. Its range, so far as known, is from Maine and Canada to the Middle States.

108. *Eufidonia notataria* (Walk.).

This moth is common in the Northern States in dry pine woods and open fields with scattered pine bushes, in June and early in July. Its flight is rather weak and vacillating, as in many geometrid moths. The genus differs from both *Ematurga* and *Fidonia* in the presence of six instead of five subcostal venules, the first being long and free. It also differs in the long, somewhat swollen hind tibiæ, and the unusually short, rather stout tarsi. The moth is white, with brown spots and bands, and with feathery antennæ. Mr. L. W. Goodell has reared it at Amherst, Mass., from caterpillars found on the white pine. He has since sent me the following notes on this moth:

I got the eggs of *F. notataria*, from a moth confined in a box. They were laid July 3, hatched August 11 and 12, and pupated September 17 to 24. No cocoon was made. The moths appeared May 25 to June 4. I have often found the larvæ in different stages of growth from the first of August to October. The larvæ closely resemble the leaves of the pine on which they feed, and are difficult to find, but are easily captured by beating the branches. I think it must be double brooded, though I have never found the larvæ of the first brood. I did not preserve any of the larvæ, which I much regret.

*Egg*.—Oblong, covered with hexagonal depressions and bright green in color. Length, 0.6<sup>mm</sup>; width, 0.3<sup>mm</sup>. Duration of egg-stage, twelve days.

*Young larva*.—Length, 2<sup>mm</sup>; head twice as wide as the body, round and deep ochre yellow; body dull yellowish green, with a faint paler stigmatal stripe.

*Mature larva*.—Body of uniform thickness, deep green, with a narrow subdorsal and stigmatal white stripe, and a dorsal greenish-white hair line; dorsal space pale green; ventral space yellowish green. Head brownish green, with a lateral white stripe, which is a continuation of the spiracular stripe of the body. Length at rest, 25 to 26<sup>mm</sup>; when crawling, 26 to 27<sup>mm</sup>; duration of larval stage thirty-five to forty days.

*Pupa*.—Brown, the spaces between the segments and a dorsal line darker; wings dark green. Subterranean. (L. W. Goodell.)

*Moth.*—Body and wings white, tinged on the veins with ochereous, speckled and banded with rust red. Fore wings whitish at base; beyond, a broad diffuse brown band as wide as the thorax; beyond, an equally broad, white band, with scattered brown specks, and inclosing the large round discal spot. A broad, extradiscal band, separated by a white band or line of varying width from the brown margin of the wing. Hind wings white, less densely speckled and banded than the fore pair, with a large, round discal dot. Fringe smoky-brown, with narrow, white checks. Hind wings white, usually less densely speckled and banded than the anterior pair, sometimes with three irregular brown bands, two beyond the large round discal dot; a marginal brown line, which is sometimes wanting. Abdomen and legs whitish. Length of body, .36 to .40 inch; expanse of forewings, .95 to 1.15 inches.

109. *Zerene catenaria* (Drury).

(Larva, Plate xxxii; figs. 3, 3a, 3b, 3c.)

What was without much doubt a belated caterpillar of this species was found on the white pine October 5, but the body was not so clear a yellow, and the two black spots on the side of each segment were not well defined. A chrysalis was also beaten out of a pitch pine August 31; another out of a hackmatack August 30. The moths from these chrysalids appeared September 15 and 16. From these facts I think this caterpillar occasionally at least feeds upon different coniferous trees. Its food plants, however, are the blackberry, woodwax, and wild indigo, though in Maine I have found it most abundant on *Carex pennsylvanica*.

*Larva.*—Head as wide as the prothorax, full, rounded, distinctly bilobed, ash-brown, finely dotted with dark, and with six to seven large black dots on each side.

Body a little thicker at first abdominal feet than elsewhere; the body slightly widening towards this point; it is cylindrical, the segments wrinkled above.

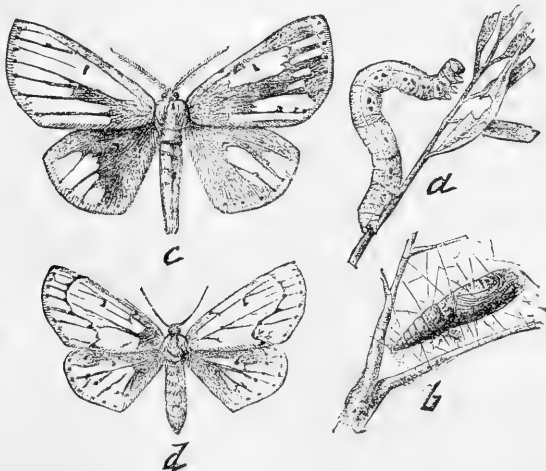


FIG. 267.—*Zerene catenaria*.—c, male; d, female; a, larva; b, pupa—all natural size. From Riley.

The body is above and as a ground color a light yellowish ocher-brown, with yellow-ocher patches here and there; with broken, fine lines, one pair on each side dilating on the back of each segment into a minute black dot, one behind the

other. A broad lateral flesh-colored band containing the large black conspicuous spiracles, four to five broken black lines, the uppermost black lines being heaviest.

Beneath greenish yellow, with six brown hair lines. Supra-anal plate broad, triangular, apex pointed, but somewhat obtuse.

Length, 30<sup>mm</sup>.

*Pupa*.—Head and thorax very pale green, spotted with scattered black spots. Abdomen white, with a yellowish tint, especially at the sutures. Body rather stout, apex of the abdomen produced into a pair of large long spines, with three pairs of smaller ones curved at the end.

*Moth*.—It is easily recognized by its large size and plumose male antennæ, the snow-white thin semi-transparent wings, with a black narrow zigzag line on the inner third of the wing, often obsolete. A distinct discal spot. A scalloped black line half way between the discal dot and the outer edge. Expanse of wings, 1.10 to 1.80 inches.

#### 110. Geometrid caterpillar.

In some of the caterpillars the head is a little reddish on the sides, but the distinct white stripes indicate that it is a different species from *Semiothisa bisignata*, and the legs are green. It is common on the pitch pine in Providence in September and October. October 4 it began to pupate, not cocooning. Undoubtedly the chrysalids enter the ground.

*Larva*.—Head as wide as the prothoracic segment, but not so wide as the body; head moderately full and rounded, but not so much so as usual. Body rather slender, tapering very slightly towards the head, and rather more so towards the end. Head and body green, exact color of the needles of the pine, with white stripes of the same tint (glaucous white) as the white in the hollow of the three-cornered leaves. Two parallel straight rather broad lines on the front of the head are continuations of two much broader dorsal median white longitudinal bands, separated by a thread-like median green stripe. These two white bands are whiter on the sides than within. The lateral ridge is twisted with white, forming a lateral white line. The two dorsal white lines are continued upon the supra-anal plate which is not acutely triangular; the two spines of the anal legs are rather prominent. Thoracic and abdominal legs green, like the rest of the body. Length 23<sup>mm</sup>.

#### 111. GEOMETRID CATERPILLAR.

This harlequin geometrid larva is found on the pitch pine, July 25 to August 2, in Brunswick, Me.

*Larva*.—Body thick, of uniform width, slightly flattened. Head not so wide as the body. Head reddish, smooth, deeply bilobed on the vertex, each lobe boss-like, reddish and shiny. Body and head reddish brown, of the general color of the red sheath of the needle, curiously checkered. On the hinder edge of each segment a small prominent tubercle, each connected by a transverse pale line. A lateral tubercle low down on each side, in front of each of which is a bent whitish line, forming an interrupted lateral band. Above, behind each pair of tubercles is a large, dull, dusky, smoky, square patch, each patch alternating with a similar pale-brown area. The body besides is marbled and variously marked with brown and pale and darker points. The segments beneath have a transverse tuberculated ridge, and the caterpillar altogether is a very singular and unusual form. Length 25<sup>mm</sup>.

#### 112. GEOMETRID CATERPILLAR.

*Larva*.—Mimics a dark old twig. Head as wide as the body, which is moderately thick, rounded but slightly tuberculated, somewhat as in *Caripeta*. No dorsal tubercles, the four minute inconspicuous dorsal warts are situated in a trapezoid, the two

anterior nearer together; all dark. The segments (5-6) are wrinkled dorsally, the high large folds very prominent on the side, so that it appears rough and tuberculated and is thus assimilated to the rough, older, dark part of a twig. Color, dull wood-brown, exactly like that of the twig on which it rests at base of leaves. Length 22mm.

#### 113. THE 10-LINED PINE SPAN-WORM.

Order LEPIDOPTERA; family PHALÆNIDÆ.

*Larva*.—Body three-fourths of an inch in length, dull green, darker than the leaves; body very slender; head large, considerably wider than the body, deeply divided by the median line, pale greenish yellow. Body on the upper side with ten narrow linear wavy dark purplish lines, which disappear before reaching the supra-anal plate, which is small, flattened, not prominent; it is subtriangular in form, the apex not sharp. Similar purplish lines on the under side of the body. Thoracic and first pair of prolegs purplish; the last pair greenish. This though not a strictly mimetic form, is sufficiently so to escape ordinary detection, not being much darker than the leaves. Observed August 17, on leaves of the pitch-pine at Brunswick, Me.

#### 114. THE RED AND YELLOW STRIPED PINE SPAN-WORM.

Feeding in September on the leaves of the pitch-pine, a stout reddish brown measuring worm, striped with straw-yellow; the moth unknown.

This is another reddish caterpillar which is somewhat assimilated in color to the pine twigs among which it feeds. Unfortunately the moth is unknown. We have found it the 1st of September, at Brunswick, Me., and also September 20, at Amherst, Mass.

*The caterpillar* is thick-bodied and rather short. Head large and smooth, not tuberculated above, but swollen somewhat on both sides. The sides of the body are swollen, and there is a lateral tubercle on the side of each segment; the anal lateral plates are large and spreading; the dorsal anal plate large, rounded at the end, and semi-elliptical rather than rounded. It is reddish brown, with minute straw-yellow lines; a pale straw-yellow median dorsal line dilating on each wing; a pair of dark brown dots on the hind margin of each segment; on the sides an irregular deep yellow line. Head reddish, dusted with yellow and dark brown speckles. Length not quite .70 inch.

#### 115. THE PINE-NEEDLE SPAN WORM.

Feeding on the leaves, a small measuring worm, closely mimicking the form of a dead red-pine needle.

This is the most striking case of mimicry we have seen on the pine; the caterpillar, as it stands out stiff, holding on to the twig with its hind feet, after the manner of measuring or span worms, would easily be mistaken for a dead, dry, red pitch-pine needle! We have found one specimen on the pitch-pine at Brunswick, Me., September 1. On the 5th it made a slight silken white cocoon and assumed the semi-pupa condition.

*The caterpillar* is slender and unusually flattened, tapering more than is common towards each end of the body. The head is small and narrow, but rather full. The color and form of the body is surprisingly like a dead red needle of the tree; it could readily be mistaken for it, since the end of the body suddenly tapers like the pine-needle itself. Color rust red, a darker dorsal line.

## 116. GEOMETRID CATERPILLAR.

This caterpillar, which occurred on the white pine at Brunswick, August 5, differs from a similar allied genus on the pitch pine in the body having a pair of tubercles on each abdominal segment, and in being generally more variegated.

*Larva*.—Body large, gradually increasing in width from the head to the anal legs, and much warted. Head small, not quite so wide as the prothoracic segment, which latter is narrower than the metathoracic. Head slightly bilobed, hemisphere well rounded. On each side of each segment a transverse ridge, ending on each side in a small black tubercle. On the third ring from the end the tubercles are near together. Lateral line rough and with small warts. On top of metathorax is a transverse row of seven small warts. General color, wood-brown, slightly darker than the twig of the pine, but tuberculated like one. Mottled prettily with dark and light flecks.

It is a genuine mimetic caterpillar. A sharp spine on hinder part of each anal leg. Length, 40<sup>mm</sup>.

## 117. GEOMETRID CATERPILLAR.

*Larva*.—Head bilobed, each lobe rounded, front flat, with a broad transverse whitish band, including the clypeus, and tinged on the edge with reddish below; above this band the front is dark. Body rather slender, smooth, not wrinkled; a large lateral, smooth, rounded tubercle, low down on the side of second abdominal segment; the tubercle is dark brown, smooth, and white in front. Eighth abdominal segment slightly humped dorsally. A pair of white dorsal dots on front edge of each abdominal segment; obsolete, however, on posterior part of body. Four dark piliferous dots on tip of each abdominal segment, the two in front more remote from the posterior pair than usual. Spiracles forming a black ring. In appearance and color it mimics a smooth light brown pine twig. Length, 25<sup>mm</sup>.

## 118. PHYCID CATERPILLAR.

Order LEPIDOPTERA; family PHYCIDÆ.

This caterpillar forms at the base of the terminal leaves of the pitch-pine, in Maine and Rhode Island, through September into October, a large mass of castings, sometimes 3 inches long, enveloped in a thin light web. October 20 one was observed making a loose, thin, slight web over the end of a branch, leaving its nest and crawling over it. The larva also resides in a long, slender, twisted tube made of its castings lined with silk. Several attempts to carry the larvæ through the winter proved unsuccessful.

*Larva*.—The body rather thick, a little flattened, not tapering rapidly towards the end. The head large, but not quite so wide as the prothorax, in which it can retract. Head pale chestnut-brown, with jet black patches behind and on the sides; two elongate black marks on the middle of the vertex. Cervical shield concolorous, with the head broad and crescent-shaped. Each abdominal segment is divided transversely behind the spiracle by a deep impressed line, while each portion of the segment thus divided is finely wrinkled.

The ground color is a pale chestnut with a broad dark subdorsal longitudinal band which extends down the sides to just above the spiracles. The terminal tenth segment is clear pale chestnut. Under side of the body and feet pale chestnut with scattered black dots. No dorsal tubercles, although the hairs are present. Length, 16 to 17<sup>mm</sup>.



## 119. THE SNOOT-MOTH CATERPILLAR.

Order LEPIDOPTERA; family PYRALIDÆ.

*Larva*.—Body with ten pairs of prolegs; body pale green, concolorous with the leaves on which it feeds; head small, much narrower than the body, of a very pale amber color; a faint dorsal and two subdorsal linear pale lines. Lateral ridge pale yellow. Each segment above with four black minute papillæ arranged in a trapezoid, and two on the side. All the legs concolorous with the body. Occurred August 17, on pitch-pine at Brunswick, Me.

120. *Tetralopha diluculella* Grote.

Order LEPIDOPTERA; family PYRALIDÆ.

Feeding upon the leaves of the terminal twigs of pine, which they draw together loosely with silk, and in which they deposit their excrements, the whole forming an irregular mass nearly 3 inches long and 2 in thickness, stout, dull, greenish-yellow, or drab-colored larvæ, transforming into brownish pupæ, from each of which emerges a moth, with dark brown and gray markings.

“Some of the terminal twigs of pine (*Pinus taeda*) infested by the larvæ of this insect were collected by myself in January, 1880, near Jacksonville, Fla. The appearance of these infested twigs is somewhat striking; the leaves around the end are loosely held by threads of silk, which also hold the excrements of the larva in a more or less irregular mass, varying from 1 to 3 inches in length, and from 1 to 2 inches in thickness.

“The larva is about eight-tenths of an inch in length, rather stout, of a greenish yellow or drab color, with two very distinct, quite broad black dorsal stripes, and a narrow one on each side.

“When mature the larva descends to the ground, where it spins a loose cocoon of yellowish brown silk, to which is attached a covering of grains of sand or other loose materials, and within which it transforms to a pupa, in which state it passes the winter.

“The moths from the larvæ mentioned above emerged during the following April. They have an expanse of about an inch. The fore wings are dark brown, nearly black on the basal third, beyond which is a broad, light gray band crossing the wing, while the portion beyond the band is dark brown followed by gray. Hind wings dark ashy, with a silky luster. The colors are not as clear in the males.

“Mr. Grote described this insect from examples taken in New York, and stated as follows:

The species recalls the figure of *Hemimatia scortealis* Led., but the wings are larger, and it does not seem possible that Lederer should have overlooked the strong generic characters.

“It certainly does agree closely with Lederer’s description and figure, and may yet prove to be that species, but Lederer’s types must be examined to make sure of this, for it is possible that he made a mistake in locating his species. A species of *Microgaster* was found parasitic on this insect.” (Comstock.)

We add the following description of the larva and pupa:

*Larva*.—Length when full-grown 20<sup>mm</sup>, cylindrical, slightly tapering posteriorly, and quite stout, of a dull greenish yellow color, somewhat paler beneath, with a narrow black stripe on each side about twice the width of the last, and equally distant from it and the middle of the dorsum. This stripe extends from the thoracic to the anal plate. The head, thoracic, and anal plates are of the same ground color as the body. Eyes and end of mandibles black; several irregular black bands on each side of the head, extending from the posterior side forward to about the middle; thoracic and anal plates with a few scattered brown dots, the latter with an irregular row of black points across the anterior side.

*Pupa*.—Length 11<sup>mm</sup>, robust, light brown, rounded at both ends, the posterior armed with a cluster of fine hooks; the abdominal segments are covered with coarse punctures, except on the posterior edge. Wing-covers extend to the end of the fourth abdominal segment. (Comstock, Ag. Rept. for 1880.)

#### 121. THE SILVER-PINE TORTRICID.

*Grapholitha bracteatana* Fernald.

Order LEPIDOPTERA; family TORTRICIDÆ.

Infesting the cones of *Abies bracteata*, a small Tortricid larva. After transforming, the pupa protrudes itself nearly two-thirds of its length, and from this emerges a small dark-colored moth with white and metallic markings.

“On the 14th of August, 1880, cones of the *Abies bracteata* were sent to this department by Mr. George R. Vasey, from Jolon, Cal., one of which was infested with Tortricid larvæ. Three of the moths emerged on the 13th of September, 1880, one on the 15th, and another on the 20th.

“The seeds of this cone, as well as those of others sent at the same time, were infested with Cecidomyid larvæ. The Tortricid larvæ worked only in the scales of the cone, while the Cecidomyids were confined to the seeds.

“Mr. Vasey, who sent the cones, states that ‘the *Abies bracteata* Nutt., locally called silver pine, extends from the northern boundary of San Luis Obispo County 40 miles northward, in cañons on both sides of the Santa Luca range. It is a handsome and striking tree, 100 to 150 feet high, in shape pyramidal, with an elongated peak. The white under surface of the leaves produces a *silvery sheen* when the sun shines upon them at the right angle.’”

“The following description of this moth has been written for this report by Prof. C. H. Fernald:

Head, palpi, thorax above, and basal third of forewings dull ocher yellow, inclining to cinereous on the thorax and base of the wings in certain lights; last joint of palpi very small, somewhat darker; legs, thorax, and abdomen beneath straw-yellow; outer side of the tibiæ and the basal portion of each joint of the tarsi pale cinereous.

Forewings externally ocher yellow, overlaid with dark-brown scales. Costa marked with fine geminate white spots, from which are continued metallic blue stripes. The first costal spot begins a little before the middle, the second a little beyond the middle, the others following at about equal distances from each other towards the apex, alternating with and cut by dark brown, the third and fourth not geminate in some

examples. A triangular white spot rests upon the middle of the hinder border of the wing, divided at the base by light brown, extending obliquely up and outward to the middle of the wing, where it meets the metallic stripe from the first costal spot. The metallic stripe from the second costal spot extends obliquely for a short distance towards the anal angle, where it is joined with the one from the third costal spot, then curving downward they extend as one stripe nearly across the wing, forming the inner boundary of the ocellus. The metallic stripes from the two outer costal spots also unite a little below the costa and extend across the wing parallel with the last, forming the outer boundary of the ocellus and, curving inward, unite with the other beneath the ocellus, and just above the anal angle. The dark brown between the costal spots extends down between the metallic stripes, suffusing more or less the other yellow of the wing. Ocellus straw-yellow, with three parallel dark-brown dashes, sometimes only represented by one or more dots. The basal portion of the wing forms an acute angle near the middle of the cell, and is somewhat suffused with brown where it rests against the first oblique stripe and the white spot of the inner border. Fringe metallic blue or purple, according to the light, with a basal dark-brown line and a few white scales below the apex.

Hind wing and abdomen above, and under side of all the wings, fuscous; fringes of hind wings a little lighter. Costal spots of the forewings reproduced beneath. Expanse, female, 12<sup>mm</sup>; male, 9-10<sup>mm</sup>. Habitat, California. Described from three males and two females, one male and one female in my collection, the rest in the collection of the Department of Agriculture. (Comstock.)

#### 122. THE SULPHUR-LEAF ROLLER MOTH.

*Dichelia sulphureana* Clemens.

This leaf-roller is common on *Pinus strobi* at Brunswick, Me., and was also found on *P. rigida* the first week in August.

August 5 it began to make a slight cocoon by drawing together the leaves into a rude tube and spinning a slight cocoon between them. The pupa was found between the leaves August 7th. The moth appeared August 16 to 17.

Says Mr. Forbes (3d Report Ins., Illinois):

Professor Comstock believes this leaf-roller to be at least three-brooded, the larvæ of the first brood occurring in May; of the second, in June, and of the third, in August.

Larvæ collected by him May 13 pupated in part on the 19th, and emerged as moths from the 19th of May to the 3d of June. Those collected June 20 pupated July 1, and emerged July 5 to 14; and those taken August 15 pupated September 1, and emerged September 1 to 16. Later larvæ were found October 21.

In Illinois there seem also to be several broods, as indicated by the following facts from our breeding-cage records, but it is not possible to fix their number or to assign them limitations of time.

Larvæ collected May 17, this year, began to pupate on the 30th, and to emerge June 7. Those obtained May 23 pupated June 11 to 21, and commenced to emerge June 19. Others taken June 7 emerged June 26 to 28. Those pupating July 6 emerged July 11 (Coquillett), and those taken August 18 pupated on the 20th, and completed their transformations on the 31st of the same month. Hence, without actually breeding from the egg, we can only say that the insect breeds all summer, and that it apparently hibernates in the larval stage as indicated by the late date of Professor Comstock's larvæ mentioned above.

It agrees well with Robinson's Pl. V., fig. 37, though differing in some respects. According to Fernald's Catalogue of Tortricidæ, this

common species feeds on the clover, *Vitis*, *Ranunculus acris*, and is an inquiline in willow galls. Forbes has found it to be destructive to corn.

*Larva*.—Body tapering towards each end. The head is honey-yellow, considerably narrower than the body. The body is pale livid green with a corneous hue. There are no lines or any distinctive markings, except the four usual warts or small tubercles which are arranged as usual in this family in a trapezoid. From these warts arise hairs one-half as long as the body is thick. At the end of the supra-anal plate is a flattened tubercle with spines. Length 15<sup>mm</sup>.

*Pupa*.—Length 8<sup>mm</sup>. Color, dark shining brown, lighter at the end of the wing-covers and the parts covering the palpi and base of the antennæ. Front rounded and smooth. Abdominal segments on the dorsal side armed with two transverse rows of small spines inclined backward, those on the posterior edge of each segment finer and closer than those of the other row. Abdomen terminated by a protuberance, flattened above, rounded at the end, hollowed out underneath the base, and armed with two fine hooks on each side, and four from the end. (Comstock, Rep., 1881).

*Moth*.—This insect may be described in general terms as a brownish yellow moth, the fore wings of which are marked by two V-shaped brown bands (the apex of the angle pointing backwards), so placed that when the wings are closed these markings form an X.

The palpi are long, nearly or quite twice the length of the head, yellow above, deep red laterally and beneath. The antennæ are reddish brown; the head and thorax are yellow above, tinged with red or purple at the sides; the patagia red in front, yellow beyond. Anterior wings golden yellow, finely reticulated with red or purplish (sometimes the reticulations are wanting), costa tinged with purple at base. A purple spot on the middle of the internal margin throws out two diverging lines, one of which attains the costa at the basal third, the other ending just below a similarly colored subapical costal spot. The internal margins more or less tinged with purple, somewhat constant, and deepest towards the base; fringes yellow. Posterior wings above and beneath varying from pale yellowish fuscous to dark fuscous or blackish. Under surface of anterior wings clouded centrally with fuscous; the margins paler, sometimes yellow. Abdomen brownish, legs pale silvery brown, anterior ones darkest. Expanse, female, 14 to 17<sup>mm</sup>; male, 17 to 19<sup>mm</sup>. (Forbes.)

#### 123. *Teras ferrugana* S. V.

The larva was beaten from the white pine (*P. strobi*) at Providence, October 5.

*Larva*.—The body is rather large, 20<sup>mm</sup> in length, broad and flat. Head flattened, held out horizontally, reddish above, with a dark broad line around the edge. The body is green, with a reddish tint. The cervical shield is concolorous with the body, and edged behind with dark black-brown, forming a curved line. Over the body above are scattered pale flecks.

The caterpillar pupated in the bottom of the breeding-box without making any cocoon.

*Pupa*.—Slender, 7 to 8<sup>mm</sup> in length, of the usual pale horn-brown color. Each abdominal segment is provided with two dorsal transverse rows of close-set spines.

The tip of the abdomen is suddenly truncated, compressed from above downwards, the edge is hollowed within, the edge itself curvilinear, with a small spine on each side. It differs from that of *T. viburnana* in the end being broad, square, and flattened vertically, while the hooks are almost obsolete.

The moth appeared October 20 or 21. I am indebted to Prof. C. H. Fernald for kindly identifying it. According to his Catalogue of Tor-

triciæ of North America, this common European species feeds in Europe on the beech, birch and oak (Heinemann), and according to Walsh, is in this country an inquiline in galls of *C. salicis-strobiloides*. It could not have been mixed with other Tortricids in my breeding tin box, as it was the only Tortricid in the little box, hence I think there is no doubt but that it at least occasionally feeds on the white pine. The larva is very characteristic and easily recognizable.

*Moth*.—Costa full near the base; slightly excavated before the falcate apex; outer margin full and rounded below the apex. Ground color flesh-red brown, with scattered leaden scales; a median white spot, beyond which are a number of lead-colored scales; an oblique row of leaden scales goes from this spot to the costa at a point beyond the inner third of the costa, and the other to a point half way between the costal end of the first line and the apex; a few white scales on the first line. Hind wings lead-gray. Length of body 6<sup>mm</sup>; expanse of wings 14 to 16<sup>mm</sup>.

#### 124. THE PINE AMORBIA.

*Amorbia humerosana* Clemens.

This leaf-rolling moth was bred from the white pine in Maine, the moth appearing in May. It is a large species of *Tortricidæ*, the fore wings with the costal edge full. The head, thorax, and forewings are whitish ash, with dark specks, but with no distinct lines and markings. There are two whitish patches in the middle of the forewings, on each side of which are a few fine black specks; in the middle of the outer fourth of the wing is a whitish patch. There is a marginal row of fine black points. The fringe is pale; the hind wings are pale gray slate color. Expanse of wing, 24<sup>mm</sup>. The larva was not described. It has been bred from the benzoin bush and the poison ivy by Mr. L. W. Goodell. The species ranges from Canada and Maine to Pennsylvania.

#### 125. THE PINE TUPE-BUILDER.

*Tortrix politana* Haworth.

Order LEPIDOPTERA; family TORTRICIDÆ.

Cutting off the ends of white pine needles, and spinning together a tube of the stumps, in September, and also to be met with probably early in summer, a pale-green leaf-roller, pupating late in September.

About ten years ago I found, in September, on the young white pines in the grounds of the Massachusetts Agricultural College, at Amherst, Mass., numerous pretty tubes such as are figured in the adjoining engraving. The larva, probably in August and early in September, gathers together about fifteen needles of the white pine, tying them into a bundle by silken threads; then, usually eating off about one-third of the ends, forms a tube, within which the worm lives. Some full-grown larvæ were found September 22 which had gathered the leaves together without cutting them off, the tube extending the whole length of the leaves. It is possible that the larvæ of the first brood early in summer cut off the ends of the tube, while the approach of cold late in September pre-

vents those of the second brood from giving the finishing characteristic touches to their tubular domiciles.



FIG. 268.—Tubes of the pine tube-building leaf-roller; natural size.—After Packard.

The larva is .30 inch long, pale green, a little paler than the pine leaves; darker over the region of the digestive canal. Body with minute warts of the same color as the body, from which arise short, slender, pale hairs. Head pale horn color, with a darker somewhat reddish patch on each side of the head; on the clypeus just behind the labrum a triangular spot; labrum reddish horn color. It is very active, climbing out of its tube and letting itself down by a thread when disturbed. The worms found at the end of September were about fully grown. There must be two broods of worms, as the dead chrysalids were found in some of the tubes. When about to pupate the worm spins a slight web within its tube. One larva pupated in confinement September 21. In Providence two pupated as late as the first or second week in November. Mr. Emerton informs us that he raised the moth, which we failed to do, but the specimen was unfortunately lost.

We have found the young larvæ one-quarter grown on the white pine at Brunswick, Me., in August. They had not cut off the ends, but had merely drawn the leaves together with silken threads.

We also add Professor Comstock's account published in the U. S. Agricultural Report for 1880.

On the 15th of October the Department received from Professor Gage, of Ithaca, N. Y., a number of the tips of branches of white pine (*Pinus strobus*) which were infested with the larvæ of a species of Tortricid. From six to ten of the terminal leaves were drawn together lengthwise, forming a kind of tube, which was lined inside with delicate white silk. Sometimes the leaves of one fascicle were drawn together, but more frequently those which were near each other from different fascicles. The tube is open at each end, the outer being cut off squarely or obliquely, very often leaving two or more of the leaves untouched.

This tube seems to serve as a protection to the larva, from which it comes out to feed upon the ends of the very leaves of which the tube is composed. In this way

the leaves are shortened, the larva feeding upon one after another only at the end, thus shortening them gradually until the larva is fully grown, when there are sometimes one or more of the leaves left untouched. Those first attacked gradually become dry and yellow, loosening from their bases, and are only held in place by the green ones.

The full-grown larva is three-eighths of an inch long, of a yellowish green color, with dark or blackish head and olive-green thoracic plate.

The moths emerged from the 26th of December to the 30th of January, and have the head, thorax, and fore wings of a dull rust-red color, with two oblique paler bands, one a little before the middle, the other beyond, parallel to it, crossing the fore wings. Hind wings and upper side of the abdomen silky gray. Expanse of wings, half an inch.

These moths are not easily disturbed, and if the branches upon which they are sitting be shaken they drop to the ground, feigning death, not even moving when touched.

Specimens were sent to Professor Fernald for determination, who replied as follows:

"This species has been determined for me by Professor Zeller as *Tortrix politana* Haw. It feeds here on white pine as you describe, but Wilkinson gives *Myrica gale* as the food plant in England, and Heinemann gives *Ranunculus acris* and *Centaurea jacea* as food plants in Germany. If our species is really identical with the European *T. politana* it must be very polyphagous."

He further says:

"I am not able to learn that it ever has been observed feeding upon any of the *Coniferae* in Europe."

As Professor Fernald thinks there is still a chance that this is not identical with the European *Tortrix politana* Haw., he has prepared the following description for this report:

*Imago of Tortrix (Lophoderus) politana* Haw.—Alar expanse, 13-14<sup>mm</sup>. Head, palpi, thorax above, and upper side of forewings, yellowish-red. Thoracic tuft, basal patch, oblique and apical bands dark rust-red. The space between the basal patch and central oblique band is narrow, scarcely lighter than the basal patch, and indicated by a lighter edging on each side of the space which begins at the basal third of the costa and extends obliquely across the wing to the middle of the hinder margin. The space beyond the central band is similar to the last, beginning near the outer third of the costa and extending obliquely across the wing to the anal angle. The outer margin in some specimens is of the same color as the interspaces, and the costa is more or less flecked with light yellow. Fringe yellowish, with grayish scales at the anal angle. Hind wings and abdomen above, silky gray or slate color; under side and fringes lighter. Under side of fore wings light fuscous, with lighter yellowish diffused spots along the costa and outer border. Under side of abdomen and thorax light straw yellow, as are also the legs. Fore and middle legs annulated with brown.

#### 126. THE PINE LEAF-MINER.

*Gelechia pinifoliella* Chambers.

Order LEPIDOPTERA; family TINEIDÆ.

Mining the leaves of different species of pine, a minute, brown, narrow, cylindrical larva.

"For several years the leaves of the common pitch pine (*Pinus rigida*) in the vicinity of Ithaca, N. Y., have been seen to be extensively mined by the larvæ of a Tineid, the life history of which we have first studied the present season. The end of the leaf, and in many cases the entire

leaf above its base, becomes dead and brown, and when opened it is found to be entirely eaten out, and to contain, in the proper season, the larva or pupa of the above-mentioned insect.

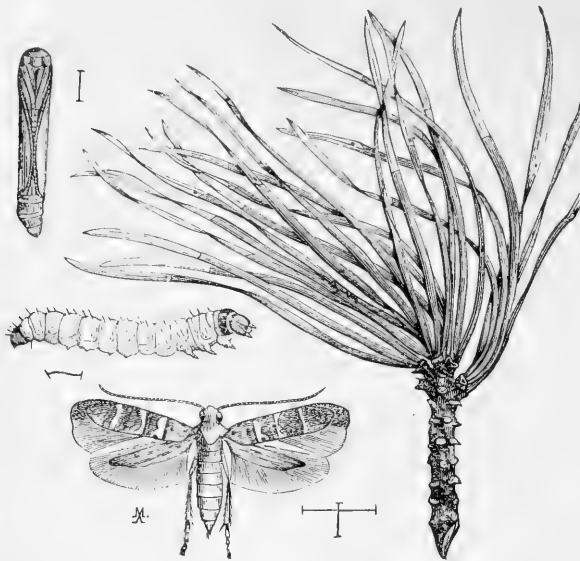


FIG. 269.—The pine leaf miner, larva, pupa, adult, and work.—After Comstock.

“What are in all probability the eggs of this insect have been found deposited singly near the base of the leaves. They are nearly round, flattened on the side of attachment, and slightly so on the opposite side. Their average diameter is  $1.4^{\text{mm}}$  (.05 inch). The general color is reddish brown, differing in intensity with the stage of development. The surface of each egg is marked with numerous delicate carinæ, which meet at the center, somewhat resembling those of the cotton and boll worms figured in the article on cotton insects. We have not proof positive that these are the eggs of this leaf miner, but their size, appearance, and place of deposit seem to indicate that they are.

“The work of the growing larvæ is well shown in the plate, and also the larva itself, highly magnified. From a study of the mines, the larva appears to burrow towards the end of the leaf first. Should it arrive at the end of the leaf (and it almost invariably does) before attaining full growth, it reverses its position and mines towards the base. The hole of entrance and of future exit is apparently in all cases enlarged and the excrement pushed through, as there is but little frass to be discovered in the mine, while it can always be found in a greater or less quantity at the opening or on the leaves below. No instance has been observed in which one larva has injured more than a single leaf of *P. rigida*; but a specimen of this insect was found in Virginia upon the common scrub pine (*P. inops*), the leaves of which are shorter and more



slender than those of the pitch pine, and, from observations made upon it, it would seem that one leaf, if small, does not afford all of the food needed by a larva.

“When found on the 1st of January this specimen was hibernating, the mouth of its burrow being covered with a thin silken curtain. Six days after, being transferred to a warm room, it was found that this curtain had been broken and the insect had left its mine. It was soon found on another leaf, and the same day formed a new burrow, where it continued to eat until January 23, at which time it had completely excavated the leaf. After this date all operations appear to have been suspended, and there were no signs of life in the burrow until March 3, when a Proctotrupid parasite issued.

“Leaves of *P. rigida* are frequently observed to be completely mined out, and nearly full-grown larvæ are occasionally found crawling about over the leaves and twigs; so it seems probable that with this species of pine also two leaves may sometimes be successively mined by the same larva.

“The full-grown larva is nearly 5<sup>mm</sup> in length (.19 inch). Its color is light brown, with the head and prothoracic shield and the anal plate black. The body is clothed with a few delicate hairs. The form of the larva is shown in the figure. Upon reaching full growth the larva spins a slight covering to the mouth of the mine and retreats a short distance above it (from 10<sup>mm</sup> to 15<sup>mm</sup>). There, after spinning a few supporting lines of silk, it transforms to a long and slender chrysalis, light-brown at first but afterwards nearly black. When removed from the mine the pupa is very active, jerking the short end of the abdomen (which extends below the wing cases) from side to side with rapidity. The duration of the pupa state is from ten to fourteen days. The moth makes its exit from the pupa shell without disturbing the position of the latter, leaving it attached by its threads some distance up the mine, and works its own way to the entrance.

“There are certainly two broods of this insect each year, probably three, and possibly more in exceptional seasons. Of the general hibernating habits of the genus, Stainton says: ‘Of a few species the young larvæ live through the winter, but I believe the greater number pass the winter in the egg and pupa state.’ With the present species the nearly full grown larvæ have been found during the winter, but not in great numbers. What we consider to be the egg of this species has also been found in apparently healthy condition in midwinter, and the insect, without much doubt, hibernates in both of these forms, and possibly in either of the others. The moths of the first brood issue during the entire month of June, the difference between the earlier and later ones probably depending upon the form in which they hibernate.

“As we have stated before, larvæ almost identical in appearance with those found on *Pinus rigida* in New York have been discovered on

the scrub pines (*P. inops*) around Washington. These larvæ were bred to the perfect state and proved to be the same species.

"A leaf-miner of precisely the same habits and of almost the same appearance was found the past winter in the leaves of the southern pine (*P. australis*) at Macon, Ga., a point where, owing to a sudden fall of some 400 feet in altitude, the northern and southern floras meet in a remarkable manner. Progressing southward, a careful search was made for additional specimens of this leaf-miner, but none were found except in this one locality. Assuming the identity of the two forms (they have since been bred and proved identical), it puzzled us for some time to discover how the species could have reached *P. australis*, since the southernmost limit of *P. inops* is South Carolina, and *P. rigida* is essentially northern. It was not until we discovered the same miner in leaves of the yellow pine (*P. mitis*) that we were able to solve the problem. The yellow pine is not only found north, but also extends south until at Macon, Ga., we can see it mingling with the northernmost specimens of *P. australis*." (Comstock.)

*Moth*.—Palpi simple; hind wings excised beneath the tips. Head white, flecked with scales of the general hue of the insect, which may be called a brownish-yellow. Palpi white; the second joint longer than the third, brownish-yellow flecked with fuscous scales on the outer side; third joint white, with a brownish-yellow annulus about its middle, and another near the tip; antennæ white, each joint crossed by a brownish band. Thorax and forewings of the general hue above mentioned, flecked with fuscous scales. On the forewings are three white fasciæ, placed respectively at about the basal, middle, and apical fourths of the wing length; the apex is densely dusted with fuscous on a white ground, and the dorsal margin is sparsely flecked with brown. The fasciæ also are more or less margined with brown scales, and the third one is sometimes interrupted in the middle; and the fuscous scales which margin the first and second fasciæ (especially along the second, near the fold) form minute tufts of raised scales. Cilia grayish, with interspersed black scales, which are tipped with white. Under side of the forewings brownish. Hind wings pale grayish with white cilia; abdomen brown above, whitish toward the apex beneath. Expanse of wings three-eighths inch. (Chambers, in Comstock's Report.)

*Egg*.—Seen from above, appears globular, with a diameter of  $14^{\text{mm}}$ ; seen from the side, appears so compressed that its long diameter is nearly twice the length of the short. Color reddish brown. Surface marked with delicate, close, meridional carinæ, meeting at the center above and below. (Comstock.)

*Larva*.—Length when full grown,  $4.2^{\text{mm}}$ ; average width,  $.58^{\text{mm}}$ . Sub-cylindrical; all segments except head and anal segment nearly equal in diameter, the exceptions smaller. Color yellowish brown; head, prothoracic and anal plates dark brown; mouth-parts yellowish; prothoracic shield strong, completely divided longitudinally in the middle by a moderately wide suture. (Comstock.)

*Pupa*.—Length,  $4.4^{\text{mm}}$ ; average width,  $.71^{\text{mm}}$ . Head obtusely rounded; wing-sheaths extending to sixth abdominal segment; antennal sheaths reaching nearly to end of wing-sheaths, all compactly soldered. General form very nearly cylindrical; sixth and seventh abdominal segments spreading at posterior borders; dorsal side of anal segment furnished with a cluster of from 10 to 15 delicate tentacular or hook-formed filaments. Color, when first transformed, light yellow brown, soon changing to very dark brown, almost black, on head, thorax, wings, and crural sheaths; abdomen of a lighter brown, growing still lighter towards the anus.

*Parasites*.—A minute chalcid parasite was bred from the specimens found in *P. rigida*. From 8 to 12 of the larvæ of this parasite are usually found within the

body of one of the leaf-mining larvæ. They are pale milk-white in color, and the alimentary canal blackish; they are long and slender in form. A very small Tachina fly was also bred, both from the northern and southern specimens. (Comstock in Agricultural Report for 1879.)

We have found at Brunswick, Me., young pitch-pine trees the leaves of which had been attacked by this larva; the injury was quite local, not general. We found larvæ April 4, 1883, on the outside of the leaves of *P. rigida*, on leaves affected last year, boring in the needles near the middle. This is the only Tineid recorded, as far as we know, as living on the pine, which seems remarkably free from the attacks of this family.

#### 127. THE PITCH-INHABITING MIDGE.

*Diplosis resinicola* Osten-Sacken.

Order DIPTERA; family CECIDOMYIDÆ.

Feeding early in May, and again towards the middle of June, in companies of thirty or forty, in the pitch exuding from wounds in the bark of the pitch-pine, small, slender, footless, orange larvæ, changing to two-winged midges or gall-flies late in May and the middle of June. (Comstock.)

The following account of this interesting fly is taken from Professor Comstock's Report for 1879:

In 1868, Mr. Sanborn exhibited before the Boston Society of Natural History specimens of a "Cecidomyious larva," which he had found feeding in companies of thirty or forty in the pitch exuding from wounds in the bark of *Pinus rigida*. "Whether they were the prime cause of the injury to the tree was not plainly apparent." (See Proceedings Bost. Soc. Nat. Hist., xii, p. 93.) In the Proceedings of the Entomological Society of Philadelphia, 1871, p. 345, Osten-Sacken records the discovery of similar larvæ in the exuding resin of *Pinus inops* at Tarrytown, N. Y. These he reared to the perfect state, and gave the species the name of *Diplosis resinicola*.

Early in May the two-or-three-year-old branches of *Pinus inops* in the vicinity of Washington were observed to be quite extensively infested by these insects, which were then in the larva state and actively feeding. They shortly turned to pupæ, and the first midge emerged May 26. On June 11 larvæ of the same species were found upon the twigs of *Pinus rigida* at Ithaca, N. Y. Pupæ were also found in the same twigs, and June 13 the first midge issued. In February, 1880, I collected specimens of similar larvæ at Orange Lake, Florida, on twigs of *Pinus taeda*, which, upon the appearance of the adults on March 1, were found to be of the same species.

Fig. 87 (from Comstock) shows well the work of this insect. The lumps of exuding resin may contain from two to thirty of the larvæ, which, when full-grown, measure on an average 6<sup>mm</sup> (about one-quarter of an inch) in length. While still feeding they are pale-orange in color, but after ceasing they become of a bright orange. The spiracles of the anal segment are at the summit of two protruding tubercles, and around each is a small whorl of four fleshy papillæ. The other spiracles are small and black. The larvæ are much elongated, and are widest at the 6th segment; the undersides of segments 1 to 7 are furnished each with two transverse rows of short black or brown spines, probably for locomotive purposes. While burrowing in the bark and resin the anal tubercles are always at the surface. When, however, the larva contracts to pupate, the end of the body is drawn in, but an open channel is left so that the air has free access. When about to give out the adult, the pupa works its way to the surface of the resin and protrudes half its body, so that there is no danger of the midge becoming fastened in the sticky gum. Dried lumps of resin,

fairly bristling with protruding pupa skins, are a common sight on trees affected by these insects. The adult insect is large, measuring 9<sup>mm</sup> (.354 inch) in wing-expanse. The head is blackish, the thorax gray, and the abdomen dark red. The male antennæ are 26-jointed, with alternate single and double joints, all pediceled; the female, 14-

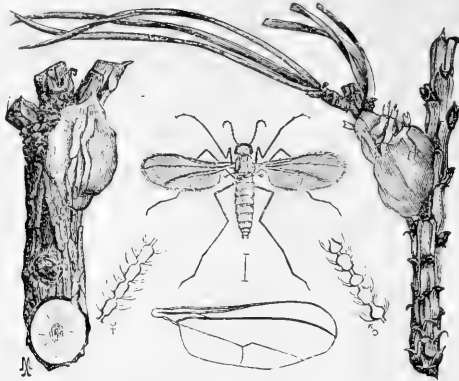


Fig. 270.—The pitch-inhabiting midge.—After Comstock.

jointed. The main peculiarity of the adult form is in the remarkable gibbosity of the head, the eyes joining together at the summit and covering nearly the whole head. The wing-venation and other points are shown in the figure. The resin exuding from the wounds in *P. inops* is perfectly clear, and permits one to count the number of the larvæ and to watch their every motion.

“We have as yet no data upon which to state definitely whether the eggs of the midge are laid upon the uninjured bark, and it is the work of the larvæ in the bark which causes the resin to exude, or whether it is only in resinous exudations, caused by a bruise or by the work of some other insects that the eggs are laid. In the clear lumps on *Pinus inops* the larvæ are always observed with their heads applied to the abraded bark.

“Somewhat similar, though evidently distinct larvæ were found feeding in the resin exuding from the wounds made by the larva of *Retinia comstockiana* in the twigs of *Pinus rigida*. It is probable that they may be Osten-Sacken’s *Cecidomyia pini-inopsis*, but it is difficult to say positively as his description of this species is so very indefinite.” (Comstock.)

Upon the loblolly pine (*P. taeda*), however, it is milky, and the presence of the insect can not be ascertained without opening the mass.

We have noticed the work of this gall-fly at Providence, the cast pupa skins being found protruding from the masses of pitch June 28. We have also observed it for many years past at Brunswick, Me.

#### 128. THE PITCH-PINE NEEDLE GALL FLY.

##### *Diplosis pini-rigida* Packard.

Shortening and deforming the needles of the pitch pine, in Maine, early in May, orange-colored larvæ, which spin a cocoon toward the end of May; the fly appearing probably in June, as the second brood of larvæ occur late in September.

\* In the year 1862 or '63 I observed in an isolated young pitch-pine (*Pinus rigida*) at Brunswick, Me., that many of the leaves or needles were less than half as long as usual, and much swollen at their base, as seen in the adjoining cut. These deformed needles were quite numerous on the tree, and, so far as I am aware, have not been previously noticed.

The larva is situated at the base between the inner two of the three needles, which grow from one-third to one-half of their normal length, and by the irritation set up by the worm the united base of the leaves swells into a bulbous expansion about the size of a pea, or four times the original thickness of the needle, while the third or outer needle is sometimes not altered in size, but simply shortened and aborted. The bud-scales of the primary leaves are burst and hang down in shreds about the bulbous swelling of the secondary leaves or needles. The larva, which was found in the autumn of the same year (September 22), does not apparently bore into leaves, as it has no means of making its exit unless it works its way out of its prison through an oval hole between two of the leaves. It has to do so in some way, however, for when fully fed it makes its exit, ascends to the terminal buds, and pupates on one of them, exposed to the air. Sometimes there are two larvæ, one on each side of a leaf.

The cocoons are pale, oval, and covered with the pitch which exudes from the buds of the tree, and were found May 20. When the fly issues from the cocoon it creeps half way out of its cocoon, leaving its pupa-skin partially remaining, with the old pupal integument of the antennæ, wings, and legs separate.

On the 10th of June I opened the cocoon and found the pupæ of a chalcid fly, and afterwards found specimens of the adult, which, on making their exit, bore small holes through the sides of the cocoon.

The history of the species is apparently somewhat as follows: The eggs are probably laid at the base of the needle early in May, or possibly in the preceding autumn, or possibly the larva winters in its gall, though this is not probable. At any rate the worms pupate within spun silken cocoons about the middle or the third week in May, and the fly probably appears in the early part or about the middle of June, when the eggs are laid for the second brood of worms, which we have found September 22. A large percentage are destroyed by the chalcid fly.

These deformed needles were observed on the pines of the campus of Bowdoin College, Brunswick, Maine, August 4, 1882, though no larvæ



FIG. 271.—Pitch-pine needles shortened and deformed by the pitch-pine needle gall-fly.—From Packard.

\* The following account and figure are taken from Hayden's Tenth Annual Report of the U. S. Geographical and Geological Survey of the Territories for 1876. Washington, 1878, p. 527.

were detected, but I found the larvæ September 27, 1882, at Providence, R. I.

*Larva*.—Deep orange in color, with the "breast-bone" retractile. The lateral swollen region of the body is well marked, convex, and the segments are short, quite convex.

*Female described from life*.—Antennæ 14-jointed, about half as long as the body, brown, with sparse, irregular verticils of gray hairs, the ten terminal joints twice as long as broad, and pedicellate. Clypeus and epicranium testaceous brown, the clypeus (hypostoma) having a few long gray hairs curving over and downward. Palpi concolorous with the ends of the antennæ.

Thorax shining black, with four lines of white hairs, as in *C. pini* DeGeer; the sides including the prothorax, reddish; scutellum reddish-brown, while the trochanters are much darker, the first pair being nearly black, the two posterior pairs reddish-brown. Legs brown, paler beneath, with gray hairs, the tarsal joints darker at the articulations, covered with fine silvery hairs.

Wings rather short and broad, with scarcely any pubescence; fringe long, veins dark brown; the subcostal (first longitudinal) vein terminates at the middle of the wing (in *C. salicis* it terminates much beyond this point); the median vein terminates at or perhaps a little below the apex; it curves around rapidly, following the curve of the margin; cross-vein very minute, very oblique, almost obsolete, situated a little before the middle of the first longitudinal vein; third longitudinal vein straight, but turning down to the inner margin at nearly a right angle. The venule which, in continuation of the main vein, is bent upward at its origin, thence goes straight to the outer edge, inclosing a triangular space. The halteres are pale flesh-colored.

Abdomen blood-red, with slight sparse hairs. The segments on the terminal half of the abdomen are edged with black, and the tip of the abdomen is blackish, while the genital armature is flesh-colored. Length, .10 inch.

This species differs decidedly from *Diplosis pini* Loew, ♀, in that the basal joints of the antennæ are not yellow, but pale brown. The clypeus (hypostoma) is reddish-brown, not reddish-yellow. The abdomen is blood-red, and the hairs are too few to give a silvery reflection; the legs do not seem whiter beneath than above; the wings are not densely pubescent as in Loew's description of *D. pini*, but are sparingly so. The cross-vein is difficult to find, and then is only seen in certain positions. It is smaller, being only a tenth of an inch long.

In its habits it seems to differ from Osten-Sacken's *Diplosis pini-inopis* in that the apparently similar pale, oval, resinous, pitchy cocoons are placed on the buds of the pine-needles, which were somewhat deformed, and could thus be easily distinguished from others not affected; as well as by the resinous pitchy exudation covering them. (This was observed May 20.) The food-plant is also different, *Diplosis pini-inopis* living on the Jersey or scrub pine (*Pinus inops*), which does not extend so far north as New England, particularly Maine.

#### 129. THE PINE SAWFLY (*Lophyrus* sp.).

Order HYMENOPTERA; family TENTHREDINIDÆ.

Body pale yellowish-green, segments with numerous fine transverse wrinkles; head black; thoracic legs black. Observed August 17 on pitch pine at Brunswick, Me.

## 130. THE PHILADELPHIA CHRYSOMELA.

*Chrysomela philadelphica* Linnæus.

Order COLEOPTERA; family CHRYSOMELIDÆ.

Feeding upon the leaves from May till September, a very convex broad-oval beetle about 0.30 long, of a dark bottle-green color with white wing-covers sometimes tinged with yellow and having on them numerous spots and dots of dark green with a black line on the suture widened anteriorly and a second line parallel with this on each side, the antennæ and legs rusty red. This is also common upon willows, with other species closely similar to it. (Fitch.)

## 131. THE PINE CHRYSOMELA.

*Glyptoscelis hirtus* Olivier.

Order COLEOPTERA; family CHRYSOMELIDÆ.

Feeding on the leaves in May and June, a thick cylindrical beetle resembling the Cloaked Chrysomela, No. 27, but with the pubescence much thinner than in that and the other American species of this genus. Its color is brassy, more brilliant on the under side and tinged with coppery. The male is usually 0.28 and the female 0.35 long. (Fitch.)

## 132. THE SARATOGA LEAF-HOPPER.

*Aphrophora saratogensis* Fh. var.

Order HEMIPTERA; family CERCOPIDÆ.

The larvæ form masses of froth on the leaves of the white pine in June, acquiring wings the last of July and in August in Maine. Common. (Named by Dr. Uhler.)

## 133. THE WHITE-NECKED PINE-BEETLE.

*Dichelonycha albicollis* Burmeister.

Order COLEOPTERA; family SCARABÆIDÆ.

A small beetle half an inch long or somewhat less and resembling the Rose bug, No 50, in its shape but with wing-covers of a shining brilliant green, becomes quite common upon pines about the middle of May, eating the leaves, and continues about a month. It may be distinguished from the several other species of the genus to which it belongs by its thorax having a more distinct but a very shallow groove along its middle. (Fitch.)

*The beetle.*—This species has a black head with its fore part dull pale yellow. Its thorax is black and is covered with incumbent ash gray or yellowish hairs, but not so close as to hide the ground beneath, whilst the scutel is densely coated with white hairs. The bright green wing-covers are dull pale yellow along their outer margin and also on their inner edge. They are rough from confluent punctures and show three smooth raised lines on each, running lengthwise. The legs are pale yellow with the hind feet and inner side of the hind shanks black or blackish, and the fore shanks have at their outer tips two projecting teeth with a small tubercle indicating the place of a third tooth. Its length varies from 0.40 to 0.50. (Fitch.)

## 134. THE PINE ANOMALA.

*Anomala pinicola* Melsheimer.

Order COLEOPTERA ; family SCARABÆIDÆ.

Feeding on the leaves in June and July, beetles resembling the common May beetle, No. 76, but of a much smaller size, being only 0.35 long, black, shining, their wing-covers slightly tinged with chestnut with the suture and outer margin broadly black, their antennæ pale dull yellowish, and their feet pitchy black. I only know this species from specimens from the South, but as it occurs in Pennsylvania it will probably be found also in our own State. (Fitch.)

## 135. THE PINE CLASTOPTERA.

*Clastoptera pini* Fitch.

Order HEMIPTERA ; family CERCOPIDÆ.

Puncturing the leaves and sucking their juices, in July, a small shining broad oval tree-hopper 0.14 long, of a black color, its head pale yellow with a black band on its anterior margin, its thorax prettily sculptured with fine tranverse lines and with a

Fig. 272.—Larva of *Clastoptera* on pine; a, side view.

pale yellow band anteriorly, its wing-covers with a broad hyaline white margin on the outer side, interrupted with black back of the middle and having a shining black dot near the tip, its under side and legs pale yellow. (Fitch.)

## 136. THE TESTACEOUS CLASTOPTERA.

*Clastoptera testacea* Fitch.

A similar insect to the preceding, but of a pale yellow color, 0.20 long, its scutell darker tawny red or yellow, its wing-covers with a shining black dot near the tip, and often with a black dot upon each side of the breast. Appearing upon pines and also on oaks the latter part of July and in August. (Fitch.)

## 137. THE WHITE-PINE LEAF-HOPPER.

*Bythoscopus strobi* Fitch.

Order HEMIPTERA ; family CERCOPIDÆ.

Puncturing the leaves and sucking their juices in May, an oblong tawny yellow or yellowish brown leaf-hopper, 0.20 long, its wing-covers inscribed with numerous blackish lines and dots, with a few small spots mostly on the outer margin, and crossed by three broad bluish-white bands, its legs pale yellowish with numerous black dots from which arise small spines. (Fitch.)



## 138. THE PINE-LOUSE MIMIC.

*Camaranotus confusus* Hirschl. var. *occidentalis*?

This bug closely resembles the pine Lachnus, or even a dark ant, and is common running about the terminal twigs of the pine. I have observed it in abundance in Maine. (Named by Mr. Uhler.)

## 139. THE GREEN PINE TETTIGONIA.

Order HEMIPTERA; family CERCOPIDÆ.

Occurring in August in Maine on the pitch pine, a pretty, delicate green Tettigonia-like form, exactly of the color of the pine leaves. Pupa with some faint yellow markings.

## 140. THE PINE CIXIUS.

*Cixius pini* Fitch.

Order HEMIPTERA; family FULGORIDÆ.

Puncturing the leaves and sucking their juices in May and June, a brownish black four-winged fly, 0.23 long, its thorax diamond-shaped, with three elevated longitudinal lines, its forewings transparent but not clear and glassy, stained with smoky yellow, forming a few transverse spots, their veins white, alternated with numerous black dots, its legs pale with the thighs brown. (Fitch.)

## 141. THE VERNAL DIRAPHIA.

*Diraphia vernalis* Fitch.

Order HEMIPTERA; family PSYLLIDÆ.

Upon the leaves, puncturing them and sucking their juices, a small orange yellow four-winged fly, 0.15 long, with a square flattened head concave on its upper side and with a slight impressed line along the middle of its whole length and a small notch in the middle of the anterior edge; the antennæ projecting forward from the anterior corners of the head, short and thread-like, of the same length with the head, their basal joint largest and forming one-fourth part of their total length, their tips black and ending in two short fine bristles of unequal length; the forewings thick and leathery, feebly transparent, dull pale brownish yellow; the breast and hind breast coal black, and the legs dull whitish. (Fitch.)

## 142. THE COMMON PINE APHID.

*Lachnus strobi*.

This is the most common aphid on the white pine, and is at times very destructive to young trees. It has been for several years a great pest on the pines on the estate of H. G. Russell, esq., at East Greenwich, R. I. The best remedy is spraying the bushes with insecticides.

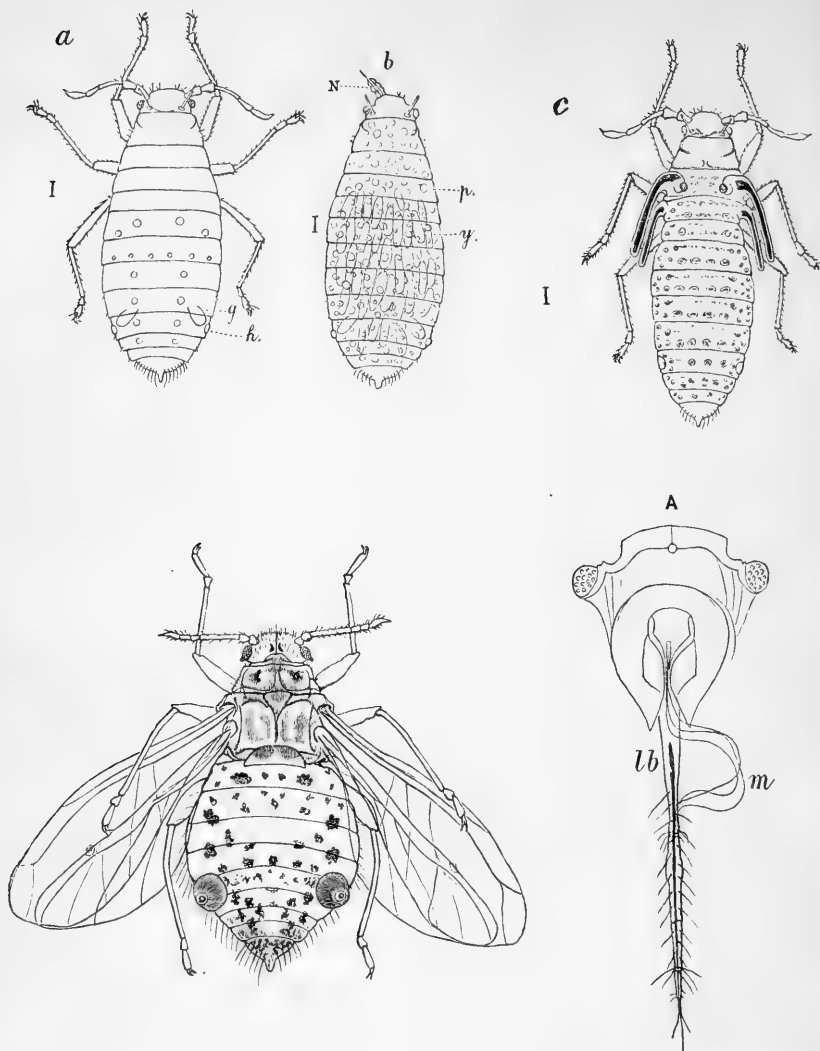


FIG. 273.—Pine *Lachnus*. *A* head and beak, *lb* labrum, *m* mandibles; *a*, larva, male; *b*, female, body filled with eggs; *c*, pupa (yellowish); *g*, odoriferous gland; *h*, orifice of the "honey-tube"—Gissler del.

143. THE WHITE PINE SCHIZONEURA.

*Schizoneura pinicola* Thomas.

Order HEMIPTERA; family APHIDÆ.

Feeding on the tender shoots of the young white pines in Illinois, their presence indicated by slender snow-white silky webs, and usually covered with a clear white, cottony secretion which appears to shoot out from the body in little ribbon-like flakes; the insects pale green. (Thomas.)

144. *Psylla tripuncta* Riley.

A pretty reddish or pale brown species; spun on leaves April 4, 1883; wings with three broad brown stripes; an oblique stripe in middle of wing.

Professor Riley states that *Psylla tripuncta* is "very common on pine trees from Canada to Florida" (Amer. Ent., fig. 17, p. 62).

## 145. PINE-LEAF CHERMES.

*Chermes pinifolia* Fitch.

Order HEMIPTERA; family APHIDÆ.

Stationary upon the leaves, usually towards their ends, puncturing them and sucking their juices, a very small black fly 0.08 long to the tip of its abdomen, and 0.12 to the end of its wings, which are dusky gray, its abdomen dusky red and slightly covered with fine cottony down. (Fitch.)

"The females of these insects do not extrude their eggs. Clinging closely to the leaf with their heads towards its base, they die, their distended abdomens appearing like a little bag filled with eggs. The outer skin of the abdomen soon perishes and disappears, leaving the mass of eggs adhering to the side of the leaf, but completely covered over and protected by the closed wings of the dead fly. I have met with the dead females thus adhering to the leaves the first of July, and have noticed the same insects on the leaves in full life and vigor the middle of May."

The rib vein of the forewings runs straight to the outer margin forward of the tip, and gives off from its middle on the outer side a very oblique branch which runs to the outer margin, its tip producing a slight angular projection of the edge of the wing, and the whole space on the outer side of the rib vein beyond this branch is more opaque than the rest of the wing and of a smoky yellowish color. From its inner side the rib vein sends off three simple oblique veins, the last one of which ends in the extreme tip of the wing. The hind wings have an angular point on their outer side beyond the middle, and a longitudinal rib vein, which, forward of its middle sends off a branch almost transversely inward, its tip curved backward. The antennæ are short, thread-like, and composed of four or five small joints. It will hence be seen that this insect is a true Chermes—the first species of this genus that has been discovered in this country. (Fitch.)

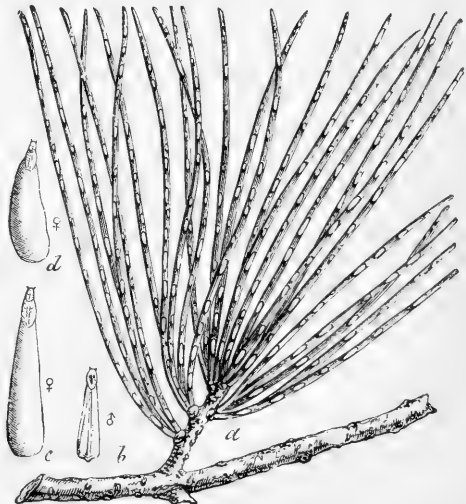


FIG. 274.—Pine-leaf scale-insect; a, natural size on pine leaf; b, male; c, d, female scale. After Riley

## 146. THE PINE-LEAF SCALE-INSECT.

*Mytilaspis pinifolia* (Fitch.)

Order HEMIPTERA; family COCCIDÆ.

Fixed upon the sides of the leaves of young trees, exhausting them of their juices and causing them to turn yellow; small oblong flattish white scales, with a pale yellow spot upon their pointed end. (Fitch.)

This insect is injurious in the Western States, according to Riley, who describes and figures it in his Fifth Missouri Report. The disease to which it gives rise is sometimes called the "white malady." Riley states that it produces two broods a year in Missouri, *i. e.*, one in July and again in October. It occurs on the white pine, red pine, Bhotan pine, yellow pine, and Cembra pine, and sparsely on different species of imported pines. I have also noticed it at Brunswick, Me.

## 147. THE PINE INHABITING APHIS.

*Aphis pinicolens* Fitch.

Found solitary on the pine. Straw yellow, densely covered with white powder; antennæ black, bases pale, with a dusky ring; fore wings with a fuscous spot on the tip of each vein; t. veins brown, hyaline at their bases, the costal one straw yellow; honey-tubes very short. Length to tips of wings 0.25 inch.

This probably belongs to another genus, but I am unable to place it from the short description given by Dr. Fitch. Such is also the case with reference to the preceding species, which possibly belongs to *Chaitophorus*, and may be identical with my *Ch. populicula*. I give them as I find them, with the hope that some one into whose hands this report falls may be able to settle this point satisfactorily by finding the species. (Thomas, 3d. Rt. Ins. Ill.)

148. *Lachnus australis* Ashmead.

This plant louse, according to Mr. William H. Ashmead, in Florida clusters upon the new and tender branches of the southern pine (*Pinus australis*), which they puncture with their remarkably long beaks, causing the sap to exude, and the branch upon which they exist to become gummy and sticky. Mr. Ashmead has bred from it three species of ichneumons, two of them allied to *Aphidius*, and the third a Chalcid parasite.

*Wingless female*.—Length .08 to .16 inch. Uniform light brown; head small; eyes large and round, bulging out on each side; beak extremely long and slender, reaching to the last ventral segment; antennæ 6-jointed, reaching to the hinder part of the thorax; joints 1 and 2 bead-like; third longest, widest at apex; thorax twice as wide at hinder part as the head; abdomen very broad, wider than long, with numerous black spots on top, arranged in transverse rows; nectaries (honey-tubes) black, tuberculous, nearly obsolete; legs very long, setaceous, and black, excepting basal third of tibiæ, which is yellowish.

*Winged male*.—Blackish. Length .08 to .10 inch. Expanse of wings about .35 inch. Head black, punctate, outer margin pale yellowish; prothorax dark brown or blackish, greenish yellow along the suture next the head; antennæ short, reaching below the middle of the thorax; mesothorax beautifully marked with pruinose bands, starting from each corner of the scutellum, which is transverse and pruinose; they curve inwards and meet on top of the mesothorax, forming one band, which runs straight forwards, dividing again obliquely into two bands, to the juncture with the prothorax; two pruinose dots on each side of this band; wings hyaline, front pair with a very long, thick stigma, with the third vein remarkably thin and three-branched; hind wings with two oblique veins; abdomen with a dorsal row of whitish or pruinose

spots on five abdominal segments, also along each side, and twelve brownish subdorsal round spots; under surface uniformly pruinose; legs black, excepting tibiae, which are partly yellowish; beak long, reaching to the last ventral segment, pale in color to near the tip, which is black. (Ashmead Can. Ent., XIII, 67).

## 149. THE PINE-LEAF SCALE INSECT.

*Chionaspis pinifolia* (Fitch).

(Plate XXXIII; figs. 2, 2a, 2d.)

*Scale of female.*—The scale of the female is snowy white in color, with the exuviae light yellow; it is usually long and narrow, as represented at Fig. 2b; sometimes, however, it is broad, as represented at Fig. 2c. (Scale from leaf of *Pinus pallasiana*.) The shape of the scale apparently depends on that of the leaf to which it is attached. Thus on the broader-leaved pines the broad scales are more common. Length of scale, about 3<sup>mm</sup> (.1 inch).

*Female.*—The body of the female is purplish red; the last segment presents the following characters:

The anterior groups of *spinnerets* consists of from seven to ten; the anterior laterals of twelve to twenty; and the posterior laterals of fourteen to eighteen.

The median *lobes* are somewhat circular in outline, with their distal ends diverging slightly; there is an arched thickening of the body wall connecting the anterior ends of the lobes. The second and third lobes are each deeply incised; the mesal lobule is in each case the larger.

The *plates* are long, simple, tapering to a point; there is one laterad of each of the three lobes of each side, and one midway between the third lobe and the penultimate segment. There are elongated marginal pores in the following situations: One laterad of each of the first and second plates: one at the base of the mesal lobule of the third lobe; two between third and fourth plates; and two between the fourth and the penultimate segment.

The *spines* on the ventral surface are so delicate as to be almost invisible; their bases, however, are easily seen; they are situated on mesad of the base of each of the first, second, third, and fourth plates. The spines on the dorsal surface are quite long; the first is near the base of the first lobe, the second between the lobules of the second lobe, the third on lateral lobule of third lobe, and the fourth a short distance mesad of the fourth plate.

*Scale of male.*—White and carinated, as in other species of this genus.

*Male.*—Uniformly orange-red; eyes black. (Comstock Ag. Rt., 1880.)

150. *Aspidiotus? pini*, new species.

*Scale of female.*—The scale of the female is much elongated, with its sides parallel and ends rounded. The exuviae are nearly central, and are covered with secretion. The color of the scale is dark gray, often approaching black, with the margin lighter, and sometimes with a bluish, brownish, or purplish tinge. In many specimens of the fully formed scale the part covering the exuviae is more or less distinct, appearing like a small scale with a light margin superimposed upon a larger scale. Length of scale, 2<sup>mm</sup>–3<sup>mm</sup> (.08–.12 inch); width, .4<sup>mm</sup>–1<sup>mm</sup>.

*Female.*—The last segment of the female presents the following characters:

The *spinnerets* are more or less elongated, and are arranged in two groups, which occupy the position of anterior laterals in other species. Each group consists of from eleven to sixteen spinnerets.

The *lobes* are quite small; the first and second of each side are abruptly narrowed near the distal extremity; the third lobe is notched once or twice. About one-third of the distance from the third lobe to the penultimate segment is a lobe of the lateral margin of the body of about the size of the third lobe.

The *plates* are short and irregular; there are two with distal extremities fringed between the median lobes: two similar to these between first and second lobe of each side; the lateral member of this pair of plates is much wider than the mesal one; between the second and third lobes are usually four plates, each with its lateral margin fringed; between the third lobe and the lobe on the lateral margin of the segment are four or five plates similar in form to those between the second and third lobes; two of these plates are usually very small. The segment is narrowed caudad by a succession of notches.

## 151. THE NORFOLK-ISLAND-PINE COCCUS.

*Rhizococcus araucariæ* (Maskell).\*

(Plate XXIX, Figs. 1, 1a—1g).

“The genus *Rhizococcus* was erected by Signoret to receive an insect (*R. gnidii*) which he found on the roots of *Daphne gnidium*, and which differs, according to his description, from the species of *Eriococcus* in no important anatomical character, except in the antennæ of the female being 7-jointed. The specimens (female only) which Signoret studied were naked; but he had not sufficient material to ascertain if the insect makes a sac or not in its most advanced stage.

“During the past year I have studied two bark-lice which agree with the characters given for *Eriococcus*, except that the females have 7-jointed antennæ, and remained naked until they are fully grown. These species I place provisionally in the genus *Rhizococcus*, and submit the following characters, drawn from the species described here, for that genus.

Antennæ of larva and of the adult female 7-jointed; ano-genital ring with eight hairs; tarsi of both male and female each with four digitales; margin of body of young and of female in all stages fringed with tubular *spinnerets*, which are covered with a waxy excretion; adult male with single ocellus behind each eye, and a pair of bristles on each side of penultimate abdominal segment, each pair supporting a long white filament excreted by numerous pores at its base. The fully developed female makes a dense sac of waxy matter within which the eggs are laid and the shriveled body of the insect remains; the full-grown male larva makes a similar sac within which it undergoes its metamorphoses.

“During the summer of 1880, I found very common on the Norfolk Island pine (*Araucaria excelsior*), growing in open air in southern California, a bark-louse, which is probably the species that was described in New Zealand by Mr. Maskell the year previous under the above name.

“When a tree is badly infested with this pest it becomes blackened with a black fungus, which I presume is *Fumago salicina*, which accompanies coccids on orange and other trees. This is often the first indication of the presence of the insect which is observed. But when an infested tree is carefully examined, numerous white, cocoon-like sacs containing the full-grown insects may be seen closely applied to the sides or bases of the leaves. Frequently these sacs are so massed at the ends of the

\* *Eriococcus araucariæ* Maskell. Transactions and Proceedings of the New Zealand Institute, vol. xi, p. 218.

twigs that the bases of the leaves are completely covered. The immature insects are not so easily seen with the unaided eye, as they differ but little in color from the tree. They are greenish yellow, and are usually to be found in the angles formed by the bases of the leaves. The larvæ of both sexes and the adult females are similar in form (see Plate X, Fig. 1b). The posterior end of the body is furnished with two prominent lobes, each terminated by a long hair. Between these lobes there is a conical mass of white waxy matter projecting backwards. The margin of the body is fringed with a row of tubular *spinnerets*. These *spinnerets* are more numerous on the adult female than on the larva; in both stages each one is covered with waxy matter, which often extends beyond the end of the *spinneret*. Excepting these filaments and the caudal tuft, but little excretory matter is to be seen; so that although the insect resembles a mealy bug in the form of its body it differs greatly in appearance. The female when full grown measures 2.3<sup>mm</sup> (.09 inch) in length. When the female is ready to lay her eggs she excretes a cocoon-like covering to the body, composed of white waxy threads (Fig. 1). This sac is dense like felt, but easily torn; it is open on the middle line of the ventral surface or very much more delicate on that part. It adheres to the tree quite firmly, remaining where excreted after the death of the insect. As the eggs are laid, the body of the female shrinks away, making room for them, and finally it becomes a very small pellet in the anterior end of the sac, the remainder of the space being filled with eggs. These are light yellow in color. When the male larva is ready to undergo his metamorphoses, he secretes a covering to his body resembling the sac excreted by the female, except that it is very much smaller, measuring only 1.33<sup>mm</sup> (.05 inch) in length (Fig. 1). From this sac the adult insect emerges as a delicate fly-like creature, with two large wings and a pair of long waxy filaments projecting from posterior part of the abdomen; these filaments are very conspicuous, being white and longer than the body of the insect. (See Plate X, Fig. 1a.)

“Color of body white with many irregular brown markings.

“I have not sufficient data to ascertain the number of generations of this insect each year. August 27, I found specimens in all stages of development.” (Comstock.)

The following insects also occur on the pine (W. H. Harrington, Trans. Ottawa Field Nat. Club, No. 2, p. 33):

#### Order COLEOPTERA.

152. *Buprestis consularis* Gory.
153. *Asemum atrum* Mannh.
154. *Callidium janthinum* Le C.
155. *Atimia confusa* Say.
156. *Cryptocephalus notatus* Fabr.

157. *Glyptoscelis hirtus* Oliv.  
 158. *Scythropus elegans* Couper.  
 159. *Hylobius stupidus* Schönh.  
 160. *Pissodes affinis* Rand.  
 161. *Dorytomus mucidus* Say.  
 162. *Tomicus semicastaneus* Mannh.  
 163. *Podapion galicola*. (In galls on small limbs ( $\frac{1}{2}$ – $\frac{3}{4}$  inch in diameter) of *Pinus resinosa*, June 25. (W. H. Harrington in letter.)  
 164. *Dryocætes affaber*. Mannh.) June 25, the cones of *Pinus resinosa* were found frequently inhabited by *Dryocætes affaber* (?), both beetle and larva. Their attacks were readily noticed by the small aborted cones. The terminal shoots of branches seemed also sometimes infested by the same beetle. I inclose a specimen of the beetle for your determination. It seems larger than a beetle which I found a few years ago boring the terminal shoots of white pine, and which you determined as *D. affaber*. (W. H. Harrington in letter.)  
 165. *Cryptocephalus schreibersii*. (W. H. Harrington in letter.)  
 166. *Pytho americanus*. In shallow cells under bark of old logs and stumps. (Harrington in letter.)

#### Order LEPIDOPTERA.

167. Another span worm, living on the moss on pine trees, and found alive in Cambridge, Mass., in January, by Mr. Hill, is closely assimilated in color to the moss itself.  
 168. Also a handsome noctuid caterpillar we have found on the pitch-pine at Salem, Mass., which is red, marked with yellow, and would be readily overlooked from its mimicry of the red twigs of the pine. It may be the larva of a species of *Trachea*, and may represent the *Trachea piniperda* of Europe.  
 169. Dr. Hagen has observed pine needles hollowed by an unknown Tineid. (Can. Ent. xii, 121, 1880.)

#### Order HEMÍPTERA.

170. *Chermes pinicorticis* H. Osborn, Iowa Ag. Report, p. 96, 1881.



## CHAPTER XVI.

### INSECTS INJURIOUS TO THE SPRUCE.

#### *Abies nigra* and *alba*.

Although most of the insects of the spruce also occur on the fir and those of the latter tree may, with very few exceptions, occur on the spruce, yet for the sake of clearness we will treat of them separately.

The spruce, owing to the rarity of the pine, is the most valuable soft-wood timber tree of New England. It still abounds in the northern parts of Maine, New Hampshire, and New York, and with judicious treatment on the part of lumber owners will remain a perennial source of profit. Locally the most deadly foe of spruce and fir is the Bud Worm, while both trees have for some years and still are being decimated by the attacks of timber beetles, as set forth in the following pages.

#### AFFECTING THE TRUNK AND BRANCHES.

##### TIMBER OR BARK BEETLES.

##### Species of *Scolytidæ*.

*The destruction of spruce and firs in northern New England in 1878-'87, (see map, Plate XII.)*—The forests of spruce and fir in Maine, northern New Hampshire, and New York began about the year 1874 to be destroyed by the wholesale.

The main cause of destruction of the spruce and fir in northern New England and adjacent parts of Canada and New Brunswick we now believe to be due to the attacks of bark-borers of different species.

The agent in the local destruction of the spruce and fir along the Maine coast from Portland to Thomaston was without doubt a caterpillar, the larva of *Tortrix fumiferana*, described in succeeding pages. The following remarks will therefore apply to the damage wrought in northern New England, away from the coast:

In the summer of 1880, during a hasty visit to Brunswick, Me., and the shores of Casco Bay, I noticed the great destruction that had been effected in the spruce growths on Merepoint and on some of the adjacent islands of Casco Bay, but failed to detect the cause of the disease, supposing that it was too extensive to be attributed to the attacks of insects, and that some meteorological cause, as severe winters

or the attacks of some fungus, would better account for a destruction so widespread and apparently sudden.

During the last half of the summer of 1881 and subsequent summers, spent in Maine, I was enabled to make a more careful examination into the causes of the disease, and think that without much doubt it was wholly due to the attacks of the caterpillar above mentioned.

About the middle of July I went from Brunswick, Me., to the White Mountains, and observed a good many dead spruces and firs in the woods on either side of the road from Gorham to the Halfway House upon Mount Washington. The dead spruces and firs were in nearly all cases, especially those which had evidently been cut down during the preceding winter (1880-'81), riddled by the mines or burrows of the bark-borer (*Xyloterus bivittatus*).

The spruces were also infested by the common longicorn borer, *Mono-hammus confusor*, the larvæ being found to have bored the tree in all directions.

Living hemlock trees, 15 to 20 inches in diameter, were infested by large unknown longicorn borers under the bark, while the bark itself was mined in all directions by *Hadrotrymus*, whose burrows were very abundant in logs cut down during the past winter near the Glen House, and in barks stripped from the logs; and the mines also occurred in the bark of living trees.

About the 1st of August, during a visit to Peak's Island, in Portland Harbor, large numbers, sometimes entire clumps or groups, of dead spruces were found to have been perforated by small bark-borers; not only the trunks but the larger and smaller branches, the beetles being still at work. Some of the spruces were partly killed, the upper branches retaining their leaves.

At Brunswick, Me., the dead spruce trees were found to be infested with myriads of three common borers (*Xyloterus bivittatus*, *Xyleborus calatus*, and *Pityophthorus puberulus*), the bark being mined in every direction, the beetles occurring in the larva and pupa, as well as adult or beetle condition. Some of the trees, only partly dead, had the bark of the trunk and branches filled, so to speak, with these mischievous borers, and the results of their united labors were equivalent to barking or girdling the tree not only in one spot, but the entire tree; the deadly nature of the attacks of such a host of bark-borers mining and feeding upon the inner bark and sap-wood, the most vital part of the tree, was sufficiently obvious. The stumps of firs and spruces, as well as of white pines, which had been cut down the previous November, were swarming with these small Tomici in all stages of development, their numbers being astounding. In two hours I took 1,000 specimens of *Xyleborus calatus* from one pine stump.

But if there had been any doubt as to the nature of the disease which carried off the spruces at Brunswick, in the woods southeast of the college grounds, in the course apparently of a single year, several seasons,

mostly spent in Maine, demonstrated satisfactorily to my own mind that large, healthy firs, a foot in diameter, may be killed by the attacks of longicorn borers (*Monohammus dentatus*), assisted by the smaller and far more numerous bark-borers, and aided, perhaps, by caterpillars, with the final assistance of the common longicorn, *Rhagium lineatum*. Several living firs with only the lower branches dead were observed with the bark perforated with the holes made by the common longicorn pine-borer (see p. 685) and a Buprestid borer, while the boughs were tenanted by bark-beetles and their young. Fir trees along the road to Harpswell from Brunswick were also observed to be perforated in the same manner; and if a dozen longicorn borers can not only injure but kill outright large, healthy sugar maples, as has been observed in Brunswick, Me. (see p. 374), there is no reason why firs from 6 inches to 1 foot in diameter should not perish from a similar cause; or if multitudes of small timber beetles or bark-borers girdle the tree from top to bottom with their mines, we do not see why this is not an efficient cause of rapid decay and death.

A. G. Tenney, esq., has kindly handed us the following extract from the Home Farm, for July 14, 1881, published at Augusta, Me.:

Some time ago two or three articles appeared in our journal concerning the injury to the spruce timber in the northern portions of our State, caused by a minute little insect about whose history little seems to be known. Since then we have received much information concerning them from a most intelligent gentleman resident in northern Somerset, who has been extensively engaged in lumbering for many years, and who has visited the spruce forests summer and winter, and observed the working of this very destructive insect.

The gentleman informs us that the first appearance of the insect was in 1874, and he has reason to believe it is now much on the increase, as he thinks on some townships there are now thirty dead trees from this cause, where two years ago, on adjoining townships, there was but one. The insect appears about the first of June, and on landings and jams of spruce; the air is full of them. They are about as large as a black fly, and are of a brownish, or dark snuff-color, the head half the size or length of the body. They are very tenacious of life, being hard and horny, and it is almost impossible to crush one between the thumb and finger. They are seen for about two or three weeks, during which time the logs and standing trees in the wood are bored full of holes about the size of a timothy straw, in which the eggs are laid, the larvæ of which appear the next summer. In felling trees in winter, thousands of these grubs drop out, from one-sixth to one-eighth of an inch long. The chickadees are very fond of them, and may constantly be seen following the lumbermen and picking up their food. If the spruce are cut the first year they are attacked, they make very good lumber, but the second year, or after the sap-wood has turned black, they are quite worthless, unless the tree is 2½ feet through, in which case the heart-wood is worth something for lumber, after the sap-wood is dead. The rapidity with which the wood of standing trees that have been punctured by these insects decays is noticeable from the statement that in autumn, when parties are exploring, the blazing of an apparently sound tree with the axe reveals the fact that the sap-wood is thoroughly gone.

We have previously stated that Dr. Franklin B. Hough, the United States Commissioner of Forestry, visited this State last autumn and made an exploration of our northern forests, for the purpose of gathering information as to the extent of the ravages of this insect. In a letter to us, under date of May 6, 1881, he writes:

"I am well informed as to the extent of damages being done to the spruce timber in

Maine and some places, and have been collecting information by circulars, correspondence, and personal inquiry for two or three years. The same mortality has been going on in the 'North Woods' of New York for five or six years, and has been made a special study under State authority. In 1868 there was published a report by the French Government upon the injuries done to spruce forests in that country, the principal part of which I have translated for use in my next report. I am under the impression that so far as the ravages of the insect are concerned, the worst is over—at least such is the opinion of lumbermen with whom I have corresponded—although the reality is sad enough. It has not been relatively greater in your State than in New York, but the losses reach to a fearfully great amount in your State on account of the great abundance of spruce in your forests. As for the remedies employed in Europe to check the ravages of insects in the spruce, they are altogether too expensive for us. We can only save what is dead, and the lumbermen are doing this as fast as possible; but notwithstanding this, a great deal will be lost. I have facts showing that like mortality has occurred long ago in other sections of the country, lasting a few years and then disappearing—as this will—perhaps being succeeded by a different growth of timber, as is observed in New York. The replies to circulars sent out last fall, indicate that the local extent of its duration will not last so long as apprehended."

Portions of the Adirondack region were, in 1876, visited by Mr. C. H. Peck, State botanist of New York, who thus reports on the evil in the Thirtieth Annual Report of the New York State Museum of Natural History for 1877 (Albany, 1879, pp. 23, 26):

While on a collecting trip in the Adirondack region, in July and August, my attention was repeatedly arrested by the extensive ravages of the spruce-destroying beetle, *Hylurgus rufipennis* Kirby, of which a partial account was given in the twenty-eighth report. The green slopes of Mount Emmons, commonly called Blue Mountain, and of several mountains to the north of it, had their beauty, and their value too, greatly impaired by the abundant intermixture of the brown tops of dead spruces. The destruction was also visible along the road between Newcomb and Long Lake, and on the mountain slopes far to the north of this road. Again, on the trail from Adirondack to Calamity Pond, there was sad evidence that the little destroyer had invaded also the forests of Essex County. From what I have seen at Lake Pleasant, in the southern part, and from information concerning the Cedar River region, in the central part of Hamilton County, there is reason to believe that much of the spruce timber of this county has already been invaded by the beetle. How much farther this destructive work has extended or will extend, it is impossible to say; but one thing is certain—it is still in progress. For the purpose of gaining more knowledge of the insect, I cut down, at South Pond, a tree that had recently been attacked by it. It was about 20 inches in diameter at the base; the foliage was still fresh and green, and there was nothing, except the perforations in the bark, to indicate that it was at all affected. The bark peeled from the trunk without much difficulty, the sap-wood was perfectly sound, and the heart-wood also, except a small portion in which there was a slight appearance of incipient decay. Longitudinal furrows, varying from 1 to 6 inches in length, were found under the bark, and each furrow was occupied by one or two beetles. The furrows are excavated from below upwards. In the short ones but one beetle was found, and but one perforation communicating with the external air. In the longer ones two beetles (probably the two sexes) were usually found, and from two to four perforations afforded means of ingress and egress. The lowest perforation, which is the one by which the beetle first enters and commences its furrow, is often found closed or "blocked up" by the dust and debris thrown down by the excavator in the progress of the work. The second perforation is generally 1 or 2 inches above the first. I failed to discover whether it is made by the second beetle for the purpose of ingress or by the first beetle. The third and fourth perforations are in a nearly direct line above the other two, and are probably made from within outwardly, but

for what purpose is uncertain. In one instance the two beetles were found at work making these perforations, boring through from the inner surface of the bark. In one instance the third was less than half an inch above the second, so that there would seem to be no particular necessity for it.

The eggs of the insect are deposited along both sides of the upper part of the furrow. They lie close together, almost or quite in contact with each other. When the larvæ emerge from the eggs they begin to feed upon the soft cambium and to work their way under the bark at right angles to the main furrow. They are at first so minute and work so close together that they make no distinct furrows, but seem rather to devour entirely a very thin layer of the cambium; but as they increase in size they begin gradually to form distinct furrows and to take directions more divergent from each other, and from their original course. In this way colonies from contiguous furrows at length run together, and in time the whole is surrounded by their multitudinous pathways, and the death of the tree is accomplished. Great care is taken by the parent beetles to keep their furrows separate. No instance was observed in which they ran together. In one instance the course of a furrow was changed to avoid running into the lateral furrows of a colony of larvæ just above. No furrows were found in the tree more than 10 or 12 feet from its base, thus indicating that the attacks are made upon the lower part of the trunk. The attacks are not made simultaneously. Some of the furrows in this tree were scarcely more than an inch long, and, evidently had been just commenced. Others were fully excavated and contained eggs, and in others still the larvæ had hatched and commenced their work, but in none were they fully grown. In another tree, a few rods distant from the first, the attack had evidently been made earlier in the season, for the larvæ were further advanced in size and the bark on one side of the tree was well loosened, though, strange to say, the other side of the trunk was comparatively unharmed. I was unable to discover why, in this instance, the attack was limited to one side of the trunk. It is pretty evident, therefore, that the trees are attacked all along during the months of June and July, and possibly as late as August. I suspect, also, that the parent beetle, after having established a colony in one place, may emerge from her furrow to repeat the operation in another place, either in the same trunk or in a different one, but this I was not able to ascertain definitely.

A whitish fungus, *Polyporus volvatus* Pk., scarcely larger than a hickory nut, occurs in considerable abundance on the trunks of spruces killed by this beetle. The mycelium of the fungus grows beneath the bark, and the external plant is connected with it through the perforations made by the insect. Hence this fungus becomes a conspicuous indicator of the track of the beetle and tells the tale of its destructive power.

In a subsequent report, the thirty-first, Mr. Peck thus refers to the injuries by bark-borers of the balsam fir:

The wood of the balsam is of little value for lumber, owing to the small size of the tree. It contains resin and burns freely, but with a crackling noise. The smoke is very penetrating and irritating to the eyes. Near the summits of the mountains, however, it is almost the only available wood for camps and camp-fires. The bark of this tree furnishes the well-known "Canada balsam," a clear viscid resin of considerable repute in medicine and much used in mounting objects for the microscope. The resin is obtained from small vesicles or "blisters" in the bark.

It is generally more abundant in the thrifty, smooth-barked trees of low damp lands, than in the stunted growths of the mountains. Because of the value of this tree as a producer of balsam, and because of its beauty and fitness to adorn parks and pleasure grounds, it ought to be cherished and preserved. But like its companion, the spruce, it has its insect and fungoid foes. While at Summit, in Schoharie County, in September, I noticed in a small grove of balsams that a dozen or more of the trees had recently been killed or were then dying. The leaves had nearly all changed their color, but for the most part yet remained on the trees.

An investigation showed pretty conclusively that an insect was the cause of the death of the trees. A minute bark-mining beetle, both in its mature and in its larval state, was found between the bark and the wood. The beetle perforates the bark, excavates its furrow along the inner surface in a horizontal direction, and deposits its eggs along the sides of the furrow, which is less than one-sixteenth of an inch in diameter. As soon as the eggs are hatched, the larvæ begin to mine furrows of their own at right angles to the original gallery, one part eating their way upward and another downward between the bark and the wood. These larval galleries are nearly parallel to each other, and are at their beginning so minute that they are scarcely visible to the naked eye; but as the larva advances in its course it increases in size and the diameter of its furrow increases in like manner. The larvæ were found (in some instances transformed to the mature beetle) each in the larger end of its own furrow. It will be observed from the direction of the original furrow how powerful an agent for mischief this minute beetle is. Its work is carried on in the most vital part of the tree. Three or four beetles attacking the trunk at or about the same height and on different sides of the tree would completely and effectually girdle it and destroy its life. Even a single beetle, by extending its furrow entirely around the trunk, would accomplish the same result, but no furrows were found thus extended. The length of the original furrows appeared to be less than 4 inches. The beetle itself is scarcely more than one line long, and belongs to the genus *Tomicus*. The species is probably undescribed. In the case of the spruce-destroying beetle more workers are necessary to kill the tree because the main furrows are excavated longitudinally or parallel to the axis of the trunk, while in the case of the balsam-destroying beetle the original furrow is excavated at right angles to this axis, and therefore cuts off or destroys the vital action over a much broader space.

The destruction of the balsams was not limited to the single grove in which it was first observed. In several places along the road between Summit and Jefferson dead and dying balsams were noticed; but the affected trees were not very numerous, and it would not be a difficult matter, with prompt and united action, to arrest the progress of the mischief. If each man, on whose land the balsams grow, would, as soon as signs of the presence of the trouble are manifest, cut the affected trees, strip off the bark and burn it, he would, by so doing, destroy the colonies of larvæ and prevent the further spread of the mischief. It is not at all probable that trees once attacked and showing signs of death can be saved, and it would be far better to cut them immediately than to allow them to remain as nurseries for these tiny marauders.

The spruce and firs in the Adirondacks, however, seem in general less affected than in Maine. Mr. John H. Sears, an observing botanist of Salem, Mass., who made a trip there late in the summer of 1881, writes me that "the spruce and other coniferous trees are remarkably healthy, noticeably so from Ticonderoga, Essex County, through Clinton County to Rouse's Point; and in Canada northward to Montreal, from Lyon Mountain to Chateaugay, there are large and handsome specimens over three feet in diameter.

A writer also called attention in 1883 to the death of spruces, in a letter to the Nation, under the heading "Decay of Spruce in the Adirondacks," which we copy:

TO THE EDITOR OF THE NATION:

SIR: Apropos of your recent article on "The Adirondack Forest," there is a danger now menacing, and even upon, the Adirondack forests much more serious than the lumbering you fear (though that has been going on in a large way for certainly thirty years past), in the gradual dying out, from some unexplained cause, of the spruce timber. In one of the large untouched tracts in Essex county, where the pro-

portion of spruce is great to the other timber, I was unable last summer to find one tree in twenty alive, and what few there were not dead showed promise of speedy dissolution. I was told by men familiar with the county that this state of things existed, in a somewhat modified form, throughout a greater part of the Adirondack region. This dead spruce will, in the course of a year or two, become worthless, commercially, through the attacks of the worms; and if the dying out is as general as I suppose, the region will be bereft of its timber through natural causes much sooner than if a much larger rate of lumbering than the present was begun.

D. SAGE.

BROOKLYN, December 7, 1883.

*Similar destruction of spruces in Maine in 1818.*—The following letter from Hon. R. H. Gardiner, of Oakwoods, near Gardiner, Me., written to Mr. A. G. Tenney, editor of the Brunswick Telegraph, will corroborate the idea that the visitations of bark-beetles are in a degree periodical:

OAKWOODS, August 27, 1881.

DEAR SIR: You requested in the last number of the Telegraph information about dying spruces, for the purpose of aiding Professor Packard in his investigation of the enemies of the spruce. I can render no aid in the matter, but would remind you of a fact that may be forgotten, that in the year 1818 every spruce tree west of the Penobscot was killed by an insect. I cannot remember this, but have often heard my father speak of it. From 1833 to 1836 I was interested in the lumber business on the Kennebec, and no spruce were ever seen among the rafts of logs, though spruce from the Penobscot was sold in Boston. Now, little else than spruce is cut on the upper waters of the Kennebec, but every spruce tree has grown since 1818.

I would have written direct to Professor Packard, but thought it probable the fact I speak of was known to him, and I only mention it now to you in case it may have been forgotten.

Yours, very truly,

R. H. GARDINER.

*Similar destruction of forests in Germany and in Scandinavia.*—Widespread devastations in spruce forests have occurred at intervals within the past century in Europe, and this has been generally attributed by entomologists and foresters to the operations of these timber beetles or, more properly, bark-borers. As bearing on this point we quote from an article which appeared in Nature, for October 14, 1880:

In an article in Danish, entitled "Om Grantörken og Barkbillen," by J. B. Barth, the author, who is one of the first authorities in Norway on questions of forestry and arboriculture generally, explains his reasons for differing from the opinion, commonly received, that the desiccation and ultimate death of the Norwegian spruce (*Abies excelsa*) are due to the attacks of *Tomicus typographus* (*Bostrychus typographus*), which is usually regarded as the most pernicious of all the insect enemies of the Coniferæ. Herr Barth does not dispute the fact that this beetle is to be found often in large numbers on trees affected by abnormal drying up, whether still standing or cut down; but, in his opinion, although disease in the tree may be the cause, it is not the result of the presence of the *Tomicus*, which he believes to have absolutely no effect on the condition of the bark. According to this view the numerous agents employed in Germany and elsewhere to eradicate this beetle have no result but waste of labor and money, the only remedy against the drying up of the bark being a more scientific mode of clearing forests, in which the trees often perish either through overcrowding, or, more frequently, through reckless felling by which cold blasts are

allowed to fall directly on the interior. Herr Barth's views are in opposition to those of the majority of the working foresters of Germany and Scandinavia, but his extensive acquaintance with home and foreign forests, his great practical experience, and his reputation as a naturalist, entitle them to all possible respect, although it is not to be supposed that his plea for the innocuousness of the *Bostrychus typographus* will be admitted without much sifting of the evidence, seeing that this insect is generally believed by German foresters to have been the cause of the destruction of the forests of the Harz Mountains, when between 1780 and 1790 two million trees died of desiccation.

In pursuance of the work of the last season, I visited the Adirondack region of New York in June and July of the present season, and then made an extended journey through Aroostook County, Me., visiting the Moosehead Lake region, and spent the remainder of the summer at Brunswick, Me., and on the shores of Casco Bay. My object in visiting northern New York and Maine in the latter part of June and early in July was to ascertain whether the Spruce-bud Worm described in my last report was concerned in the widespread destruction of spruce and fir in those important lumbering regions. The result showed that this caterpillar, which has in former years been so destructive to the spruce and fir in Cumberland and adjoining counties, has not been at work to any appreciable extent in the northern forests. Indeed, not a caterpillar of this species (*Tortrix fumiferana*) was to be found after diligent search in the Adirondacks nor in Aroostook, and at Moosehead Lake but a single specimen was captured, early in July (the 7th), showing that it was much less common this year than at the Rangely Lakes last season. Here it may be remarked that the same caterpillar was found late in June (the 22d) to be less common about the shores of Casco Bay than in 1883. This shows that this destructive insect is gradually becoming scarce. During 1884, 1885, and 1886 the young trees were observed to be growing up, and to have already, in some degree, effaced the desolate appearance of the tracts which had been destroyed and from which the dead timber had been cut. In 1885, 1886, and 1887 not a single specimen either of the caterpillar or moth could be found on the shores or on some of the islands of Casco Bay.

*The destruction of spruces in northern New York in 1884.*—I spent about two weeks in the middle part of June in the Adirondacks, passing through the more mountainous portions, from the Ausable Chasm to Schroon Lake, spending most of the time at Keene Flats, at Beede's Hotel, in the heart of the forest region. Mr. Beede, who was formerly a lumberman and guide through these forests, informed me that the spruce had been dying for the past fifteen years, and that on the mountains surrounding the hotel about one spruce in ten had died; and from our observations and those of George Hunt, esq., of Providence, who kindly accompanied me on this journey and who has visited these woods for many years past, we should judge this to be a moderate estimate. The trees had not died in masses or clumps, but simply individually, and in places only were the dead trees especially thick. That they had



not died from the attacks of caterpillars was also evident from the appearance of the trees, particularly the terminal branches, which showed no traces of having been eaten back by worms, such as is the case on the coast of Maine; moreover, no traces of the bud-worms were to be found either on the young trees bordering open fields or roadways or in the forests.

Mr. Beede, like others, attributed the death of these to drought, but it was observed that the trees were dying in damp, protected places as well as in situations where severe drought might injuriously affect them, and that the pines and maples, as well as other trees, were in a healthy condition. The path up to the summit of the "Giant of the Valley" led through spruce woods, in which there were numerous dead and dying spruces. None or scarcely any dead spruces or firs were observed which did not have the bark filled with bark-borers, species of *Dendroctonus* and *Tomicus*, or allied genera.

Two large living spruces, the wood full of sap and the leaves fresh and green, were examined, and in the bark were numerous beetles of the genus *Hylurgops*, both in the worm or grub state and in the beetle stage. These beetles, while in the young or worm condition, run their galleries into the sap-wood and partially girdle the tree. There were enough worms in these trees to ultimately kill them, and there was no doubt but that these two trees were doomed to death by this cause. We mention these cases especially, as it is doubted by some entomologists in Europe whether living, healthy trees are attacked by borers.

*The destruction of spruces in northern Maine.*—Passing into Aroostook County by railroad by way of New Brunswick, we learned that the spruces were still dying in portions of that province in great numbers. For example, we were told that Mr. Gibson, of Fredericton, in the winter of 1882-'83 sent parties up the Nashwaka River, a branch of the St. John, with the expectation of cutting 40,000,000 feet of spruce lumber; but half of it was found to be dead. An examination of the spruces in the vicinity of Presque Isle, Ashland, and Patten showed that the bud-worm had not been at work in those parts of Aroostook, nor along the road from Patten to Mattawamkeag.

In townships 8 and 9 (range 7 or 8 ?), on the headwaters of the St. Croix and Mattawamkeag, I was informed by a lumberman of unusual powers of close observation that the spruce trees had only been affected during the past five years. When he first went into the woods he found the trees dying, and then advised the owners to fell them; this was the best possible advice, but it was not taken. He said the trees would make good lumber for the second year after they showed signs of dying, as it takes two years for them to become wholly dead. He estimated that over the region he lumbered in, about one in eight trees had died; in some localities two-thirds had been killed. He was the only lumberman we have met who unhesitatingly attributed the disease to borers, though we have been told by heavy owners of lumbering

regions that the borers were the cause of the disease. This man repeatedly removed the bark, and, as he said, "found it full of little white worms." He also assured me that he found similar worms in *living* spruce trees, and that the result of their work was to girdle the tree.

From conversations with different lumbermen it appears that a spruce tree a foot in diameter gets its growth in from forty to fifty years. The larger trees can be culled out of the same lumbering region every ten years. Lumbermen have the impression that a spruce tree grows rapidly. This of course depends on the soil, position, and climate. We have found the past season that spruce saplings about 4 feet high get their growth in three years; it is easy to ascertain this by the difference in the color and appearance of the bark. Whether the spruce grows more rapidly than hard-wood trees remains to be ascertained. Standing in a yard of a house in Maine, a sugar-maple, which had been a rapid grower, and which we know to be about forty-eight years old, measured, in September, 1884, 1 foot from the ground,  $24\frac{3}{8}$  inches in diameter. The horndike oak, on the campus of Bowdoin College, raised from an acorn planted on the first commencement day of the college, on the first Wednesday of September, 1806, now measures (1885), at 1 foot from the ground, 30 inches in diameter, having therefore attained its present dimensions in seventy-eight years.

From Mattawamkeag we went to Moosehead Lake. Throughout the great range of forests to be seen from the lake at and south of Mount Kineo no dead spruces were to be observed; though a single bud-worm (*Tortrix fumiferana*) was beaten from a young spruce July 6. Here, however, as everywhere else, dead spruces occasionally occurred whose bark was filled with Scolytid beetles.

From E. S. Coe, esq., of Bangor, to whom we are indebted for information regarding the destruction of spruce timber in Maine, we learned that large tracts of spruce timber near Kennebago Lake, on the height of land between the Androscoggin and Forks of the Kennebec, had been destroyed.

Mr. Coe also informed us that he learned from General Smith, of Norridgewock, that the spruce growth about that town and Waterville early in this century had been diseased, and died very much as in the past few years.

From various persons we learned that the evil is now abating, and without doubt if the tracts of dead spruce, at least those near settlements or villages, could be cut down and removed, leaving, however, the spruce undergrowth, a new growth of spruce would spring up, which in forty or fifty years could be profitably lumbered.

*The disease due to bark and timber beetles.*—From the foregoing statements the reader will justly infer that the great destruction of spruce and forest trees throughout northern New England in 1879, and four or five years following, was due to the attacks of beetles, chiefly the small cylindrical bark-borers, belonging to the coleopterous family *Scolytidæ*;

three species, *Pityophthorus puberulus*, *Xyloterus bivittatus*, and *Xyleborus cælatus*, being the principal aggressors.

That the disease was not due to fungi has been shown by a thoroughly competent botanist, Prof. Charles H. Peck, of Albany, N. Y. That it was not due to extremely cold weather in winter is probably certain, from the fact generally observed by us that spruce and fir forests, over any given area, are not universally killed, as among groves of dead spruces and firs many living perfectly healthy trees exist, while the pines and hemlocks have been unharmed. By cutting down portions of forests and thus letting in cold, severe winter blasts, general and widespread destruction of entire forests may ensue, as has been shown to have been the case in France. Why pine trees should have, in general, escaped the ravages of these beetles, all of which we have found in greater or less abundance under the bark of dead pines, and especially in dead stumps, we can not explain, except from the well-known fact that most vegetable-eating insects prefer one species of tree and retain that preference for successive generations.

Our experience teaches us that not only spruces, firs, and pines are attacked and killed by boring beetles, but the experience of others, notably that of Dr. C. Hart Merriam, shows that entire groves of sugar-maple saplings in northern New York have been killed outright by a little bark-borer (p. 389). The following extract will show the nature of the attack and the result to healthy, living trees :

About the 1st of last August (1882), I noticed that a large percentage of the undergrowth of the sugar-maple in Lewis County, northeastern New York, seemed to be dying. The leaves drooped and withered, and finally shriveled and dried, but still clung to the branches. The majority of the plants affected were bushes a centimeter or two in thickness, and averaging from 1 to 2 meters in height, though a few exceeded these dimensions. On attempting to pull them up they uniformly, and almost without exception, broke off at the level of the ground, leaving the root disturbed. A glance at the broken end sufficed to reveal the mystery, for it was perforated, both vertically and horizontally, by the tubular excavations of a little Scolytid beetle which, in most instances, was found still engaged in his work of destruction.

At this time the wood immediately above the part actually invaded by the insect was still sound, but in a couple of months it was generally found to be rotten. During September and October I dug up and examined a large number of apparently healthy young maples of about the size of those already mentioned, and was somewhat surprised to discover that fully 10 per cent. of them were infested with the same beetles, though the excavations had not as yet been sufficiently extensive to affect the outward appearance of the bush. They must all die during the coming winter, and next spring will show that in Lewis County alone hundreds of thousands of young sugar-maples perished from the ravages of this Scolytid during the summer of 1882.

As has been stated in our Bulletin on Forest-tree Insects, it is well-known that healthy, large sugar-maples are often attacked and killed outright by the borer which attacks that valuable shade tree. The instances of the death of healthy trees of various kinds from the attacks of internal pests or of bark-boring beetles are so numerous that we

are now inclined to believe that the death of the spruces in northern New York and New England is almost wholly due to this cause. It is the belief among some lumbermen that the spruces are dying of old age. There is undoubtedly a natural limit to the life of any tree, but why should this cause have been confined to the spruce only within the last ten or fifteen years? Spruces, like other trees, have died of old age since the world began! Again, summer droughts and winter storms and severe cold weather should not affect the spruce more than any other tree of our forest, especially the pine and the hemlock. On the contrary, the spruce is our hardiest tree. It lives farthest up on mountain summits; it is the northernmost of our evergreen trees, living nearer the Arctic circle than even the larch. It can withstand severe drought, flourishing on rocky ground where the soil is thinnest; it grows luxuriantly in swamps where the ground remains frozen later than elsewhere, and the arrangement of its branches enables it to withstand heavy snows and winter storms as well, if not much better, than any other tree of our northern forests. The adverse forces of nature, winds, gales, frost, snow, sudden heat, and drought have acted for ages upon the spruce, and by the processes of natural selection the weak qualities of other evergreen trees have apparently been eliminated from it; it has survived and persisted by reason of its unusual powers of endurance, its toughness, and insensibility to the rigors of a northern and subarctic climate. It has, however, of late years, and perhaps periodically, been the special prey of boring insects, species which also attack its allies and the pines, but which seem, in regions from which the pine has been eliminated by the ax of the lumberman, to concentrate their forces on this tree.

*Remedies.*—When a growth of these trees is invaded by insects boring in or under the bark, the loosened bark should at once be stripped off and burnt. If the tree is dead it should be cut down and the bark stripped off and at once used for firewood, even if the wood is kept for future use as fuel. Trees infested by caterpillars may leave out again and gradually assume nearly their original health and vigor. But the best remedies are those of a preventive nature. In the present case, though the evil is apparently diminishing in Maine, our observations have taught us that the dead firs and spruces wherever examined are teeming with thousands and even millions of small bark-beetles in all stages of growth. It would therefore be wise to prevent any further spread of the evil by cutting down dead spruce and fir timber and selling it off for fuel. Forests should be thoroughly cleared, and even pine stumps should be barked and the bark burned, for, as already stated (p. 175), we have taken thousands of these spruce beetles from under the bark of white-pine stumps. In fact, stumps, in the summer succeeding the falling of the tree, are a general resort for all sorts of destructive boring insects; and should it be too expensive a matter to pull up such stumps, if the bark is torn off, the naked stump will be much less frequented by noxious insects.

1. THE UNARMED SPRUCE BARK-BORER.

*Xyloterus bivittatus* Kirby.

Order COLEOPTERA ; family SCOLYTIDÆ.

(Larva, Plate XXIV ; fig. 1 ; pupa, 1a.)

This is the most destructive pest of the spruce, the beetle most concerned in the ravages of spruce forests in northern New England from 1878 to 1881. We first observed it July 22, 1881, in spruce stumps near the Glen House, in the White Mountains, N. H., the tree having evidently been cut down within a few months ; the beetles were very abundant, and though there were no perforations in the bark, there were small holes between the bark and the wood on the top of the stump, the beetles having availed themselves of the shrinkage of the bark due to drying of the wood, to effect an entrance between it and the wood itself ; here they were congregated in abundance and were apparently engaged in making the primary galleries of their mines and laying their eggs. It was also found under the bark of dead standing or fallen spruces. Afterwards (July 27) this bark-borer was found in abundance, many larvæ, a few pupæ, and beetles in great numbers, under the bark of partly living and dead spruces at Brunswick. The burrows made were small and irregular, slightly larger than the size of the beetle, and were much like those made by *Xyleborus cælatus*, with which it was commonly associated. It was also found at Merepoint. The trees at Brunswick teemed with them, and many fewer beetles than those observed would suffice to completely girdle and kill the tree.

This beetle has its insect enemy ; we observed a green chalcid fly under the bark, July 27, and a month later, August 25, chalcid larvæ nearly fully grown were found under the bark so near the larvæ of this beetle, that we feel justified in supposing that it must have been feeding on them. (See Plate XXIV ; figs. 6, 6a.)

In the genus *Xyloterus*, according to Leconte (Rhynchophora, p. 357), the club of the antennæ is oval, compressed, and solid, without articulations ; the shining cornuous part extends forwards in a narrow band as far as the middle, except in *X. politus*, where it is entirely basal, and the club is indistinctly divided by one round suture ; the rest of the surface is opaque, finely pubescent, and sensitive. The funicle is composed of two parts as in the two preceding genera ; the first joint is large, and stout as usual, the remaining part is about equal in length, forming a pedicel to the club, and is divided by two not well marked transverse sutures, thus causing the funicle to be 4-jointed.



FIG. 276.—*Xyloterus bivittatus*—a, antenna ; b, one of the longer bristles, enlarged.—Gissler del.

The eyes are moderately finely granulated and completely divided. The head is large, exerted, and in the ♂ is deeply concave. The prothorax is broader than long, and strongly asperate in front in the ♀, less in the ♂. The tibiæ are dilated, finely serrate on the outer edge, rounded at tip, and very feebly mucronate at the inner angle; the tarsi have the joints 1-3 rather stout, nearly equal in length; fourth very small, fifth slender, as long as the second and third united, with simple divergent claws. The hairs are not serrate or verticillate, as in *Pityophthorus*, but slender and smooth.

The four species in our fauna are easily recognized :

Elytra with well defined striae of punctures, interspaces nearly smooth.....	2.
Elytra with ill-defined distant rows of punctures, interspaces equally strongly punctured, pubescence erect, abundant.....	4, <i>politus</i>
Prothorax finely and sparsely punctured at the sides towards the base.....	1, <i>retusus</i>
Prothorax finely but less sparsely punctured at the sides towards the base.....	2, <i>bivittatus</i> .
Prothorax scabrous and granulate behind the middle.....	3, <i>scabricollis</i> .
<i>X. bivittatus</i> Mannh., Bull. Mosc. 1858, 236; <i>Apate biv.</i> , Kirby, Faun-Bor. Am. iv, 192, Pl. 8, Fig. 5; <i>Bostrichus cavifrons</i> Mannh., Bull. Mosc. 1843, 297 (♂); <i>ibid</i> , 1852, 359; <i>Xyloterus cav.</i> , Mannh., <i>ibid</i> , 1852, 385.	

Maine, Canada, Alaska, Vancouver's Island; length 3-3.3<sup>mm</sup>. 12-13 inch. Varies greatly in color. Usually the front part of the prothorax, the suture and the margin of the elytra are black; sometimes only a short, pale stripe is seen on each elytron. (Identified by Dr. Horn.)

Mr. Schwarz remarks that Eichhoff cites this species as a synonym of the European *X. lineatus* Oliv., and adds "I think he is right. His *X. vittiger* described from California, is undoubtedly only a color variety of the same species." (Ent. Amer., II, p. 41.)

## 2. THE SPINY SPRUCE BARK-BORER.

*Xyleborus calatus* Zimmerman.

Order COLEOPTERA; family SCOLYTIDÆ.

(Larva, Plate XXIV; figs. 2, 2b; pupa, 3, 3a.)

As the foregoing species has smoothed unarmed elytra, we have named it the "unarmed spruce bark-borer," while the present species, which is also destructive to spruce, though abundant in pine trees (p. 175), being gouge-shaped at the end of the body with two prominent teeth on side we would name "the spiny spruce bark-borer." Its habits and mines are apparently like those of the foregoing species, but the mines are a little larger, as is the beetle itself. We noticed the beetles in great numbers with several pupæ under the bark of the spruce at Brunswick, August 22, and under another tree, observed August 27, there were many pupæ, and numerous pale beetles which had only recently cast off their pupal skins. There were all stages between very pale beetles and the dark, black-brown fully mature beetles; some with a short, broad dark stripe on each wing-cover; this might be thought at first sight a

different species, and indeed it is probable that from variations in age and size, too many species of these bark-borers have been described.

Leconte states that the genus *Xyleborus* has "the body stout, cylindrical; declivity of elytra oblique, scarcely flattened; funicle of antennæ with four distinct joints; tibiæ finely serrate on the discal half

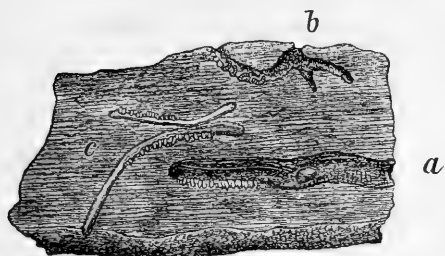
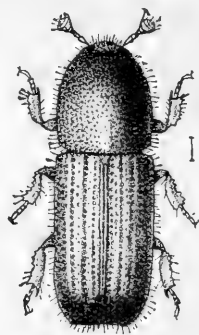


FIG. 277.—c, mine, with eggs, of *Xyleborus cælatus*.  
Gissler del.



278.—*Xyleborus cælatus*.  
J. B. Smith and Miss Sullivan del.

of their length and rounded at tip." *X. cælatus* ranges from Canada to Texas and California. In this species "the declivities of the elytra at the end of the body are with two prominent tubercles, and some smaller marginal ones; elytra strongly punctured in rows: interspaces with rows of distant punctures." (Identified by Dr. Horn.) See also p. 709.

### 3. THE LEAST SPRUCE BARK-BORER

*Crypturgus atomus* Le Conte.

(Larva, Plate XXIV; figs. 4, 5, 5a, 5b; pupa 5c.)

Order COLEOPTERA; family SCOLYTIDÆ.

This minute bark-borer, though often occurring in white-pine bark, must not be confounded with *Pityophthorus puberulus* of the white pine (p. 715), as its burrow is very different. The present species is  $1\frac{1}{5}$ mm long, and  $\frac{2}{5}$ mm in diameter. The mine consists of a short sinuous primary gallery about one-half inch long, which gives off at intervals about ten short secondary galleries from each side, but they are not made in the same plane, next to the sap-wood, as in *P. puberulus*, but penetrate only the bark itself in all directions, so that no regular pattern is formed. The beetle is extremely numerous, a great many mines being densely situated within a square inch of surface. They were observed in great profusion in the larva, pupa, and beetle states at Brunswick, Me., during August; in standing dead trees as well as spruce stumps; also in white-pine stumps. Many of our observations on this and the foregoing species, as well as the Rhagium, were made by the side of Maquoit

street, Brunswick, on land from which timber was felled, as we were informed, in November, 1880, so that the period during which the insects had been at work was known quite exactly.



FIG. 279.—*Crypturgus atomus*.

This species has been kindly identified for us by Dr. John L. Le Conte, of Philadelphia, who has also prepared the following description, which is much more complete than the original description in the Transactions of the American Entomological Society. (Vol. II.)

This beetle is said by Eichhoff (Eur. Borkenkäfer, 166) to be a synonym of *Crypturgus pusillus* Gyllenhal.

*The beetle*.—Slender, dark, piceous, shining, prothorax distinctly longer than wide, sparsely and coarsely punctured; elytra very finely not densely pubescent, striæ composed of shallow punctures, interspaces as well as the striæ without distinct punctulations. Length, 1<sup>mm</sup> +. Head with a broad short beak, slightly convex, finely not densely punctulate. Prothorax distinctly longer than wide, slightly rounded on the sides, gradually narrowed from the middle to the tip; disk transversely convex, not polished, but very imperceptibly granulate, sparsely and strongly punctured. Elytra cylindrical, not wider than the prothorax, convexly declivous behind; sparsely clothed with very short and fine yellowish pubescence; striæ composed of rather large shallow punctures, interspaces not narrower than the striæ, almost imperceptibly punctulate. Beneath nearly smooth, sides of metasternum with a row of punctures, sides of ventral segments feebly punctured. Legs piceous, front tibiæ with five distinct acute teeth on the outer edge, which is also sparsely fringed with long yellowish hairs, with a fine apical spine at inner angle; tarsi yellow, narrow, third joint not dilated. Antennæ with the scape long, the first joint of the funicle large, rounded; second indistinct, closely connected with the club, which is large, oval, not pointed, solid, polished, and corneous, except along the apical margin, where there is a spongy sensitive band.

#### 4. THE PINE-TIMBER BEETLE.

*Pityophthorus materarius* (Fitch).

This bark-borer has been noticed on p. 718. We found numbers of them at Brunswick in August, 1881, which were identified as such by Dr. Horn, under the bark of a spruce, which had been cut down the preceding November; a few larvæ occurred with these.

#### 5. *Hylurgops pinifex* Fitch.

This species, noticed on p. 722, as occurring in pine stumps, was also found mining under the bark of spruce stumps of trees felled in No-



vember, 1880. The track was made at the beginning of the roots, and is slightly sinuous, 2 or 3 inches long; 3<sup>mm</sup> wide, while the diameter of the hole for the exit of the beetle is 2½ to 3<sup>mm</sup> in diameter.

6. *Cupes concolor* Westwood.

Order COLEOPTERA; family CUPESIDÆ.

This beetle has been found by Mr. G. Hunt upon or among spruce boards in a tannery in northern New York; hence he thinks it may be a spruce insect.

7. THE PINE LONGICORN BORER.

*Monohammus confusor* Kirby.

Order COLEOPTERA; family CERAMBYCIDÆ.

This common and pernicious borer has been described and figured on pages 685-694. It occurred under the bark of dead spruces at Brunswick, August 3 and 27. At the latter date three sets of the larvæ occurred—one measuring about 6<sup>mm</sup>, another 9<sup>mm</sup>, and a third from 16 to 20<sup>mm</sup> in length. There were no fully grown worms. It is possible that the eggs from which these came were laid in the early summer; but it is more likely that they were deposited by the female during the previous summer, as the beetle is not to be seen except from June to early September.

8. THE LONG-LEGGED MELANOPHILA.

*Melanophila longipes*.

Order COLEOPTERA; family BUPRESTIDÆ.

This beetle is thought by Mr. George Hunt to bore into the wood of the spruce, as he has found it on charred spruce timber under such circumstances as to lead him to believe that it depredates on this tree. Nothing is known of the habits of the larva.

*The beetle.*—Body deep black, immaculate; thorax with an obsolete indented line; scutel small, subangulated; elytra finely granulated; an obtuse, obsolete, elevated line from the shoulder to the tip; tip abruptly terminated by a small spine in the center; beneath polished, slightly tinged with violaceous. Tarsi of the intermediate and posterior feet elongated, as long or longer than the tibia; first joint equal to the three following ones conjointly; fourth joint bilobate, very short. Found in Pennsylvania and the Western States. (Say.)

Le Conte states that it inhabits Pennsylvania, Kansas, and the Lake Superior region; that it is very closely related to the European *M. appendiculata*, but on comparison the thorax is less rounded on the sides, which are less sinuate posteriorly. As in that species, the sculpture is very indistinct at the middle and the small carina at the basal angles nearly parallel with the margin. The elytra are more grad-



FIG. 280.—*Melanophila longipes*.—Smith del.

ually narrowed behind, and the apex is rectilinearly attenuated from the suture, while in *M. appendiculata* the inner outline of the tip is concave, though not so much so as in *M. atropurpurea*. The tip of the abdomen, as in the others of this group, is slightly emarginate, with the angles acute.

Rather long and slender larvæ, with the segment next behind the head much narrower than in *Chrysobothris*, occurred in abundance under the bark of a dead spruce at Brunswick, August 27. They were nearly fully grown. The larvæ of either this or an allied species also occurred under the bark of a spruce near the Glen House, near Gorham, N. H., July 22.

9. *Melanophila* sp.

(Pl. XVII, Fig. 4; XXII, Fig. 1.)

Head of moderate size. Antennæ very short, 3-jointed; second joint much shorter than long; third very short and blunt, much more so than the unknown (spruce) genus, or in *Chrysobothris* or *Dicerca*. Labrum much as in the other genera mentioned; rather narrow, and moderately full on the front edge. Maxillary lobe well developed, with a spine pointing inwards; maxillary palpi with the second joint as long as the first. Labium slightly indented in the middle, but so slightly so that it can not be represented in a figure. Mandibles tridentate. Prothorax unusually short, about half as long as broad, the sides well rounded; the roughened chitinous disk is very small, not much over one-third as wide as the entire segment; it is round, slightly longer than broad, inclosing a narrow inverted V, which extends the whole length of the disk. On the under side the disk is subtrapezoidal, widening at base, the sides hollowed out, and narrower than long. The meso and metathoracic segments unusually long, and of the same size, being about two-thirds as wide as the prothorax. First abdominal a little shorter than the second abdominal segment; segments 2 and 8 of the same size, and very full and rounded on the sides. The ninth segment somewhat narrower than the eighth, and the tenth is one-third to one-half as wide as the ninth. Length, 12 to 19<sup>mm</sup>; in one 12<sup>mm</sup> long the prothorax is 1<sup>mm</sup> long and 2.5<sup>mm</sup> broad; the eighth abdominal segment about 1.5<sup>mm</sup> broad.

This is evidently a species of *Melanophila*, and differs from the other genera mentioned in the short and wide prothoracic segment, in the very small disk inclosing a narrow V, and being trapezoidal beneath, while the abdominal segments are very convex, and broad in proportion to the prothorax. It may also be identified by the very slightly bilobed labium and well-developed maxillæ.

This is No. 2 "unknown Buprestid larva," on the spruce, p. 228 of Bulletin 7, and No. 4, p. 241, on the hemlock.

10. FLAT-HEADED SPRUCE BORER.

*Melanophila* sp.

In the form and size of the head, prothorax, and body, including the tenth segment, closely like *Dicerca*, but the sculpturing is decidedly different. The description of the proportions of the prothorax and succeeding segments of the body in *Dicerca* will apply to this species. The prothoracic disk is, however, very different; it is transversely rounded-oval, very regular in shape, and smaller than the disk of *Dicerca*; it is

considerably wider than long, and the sides are well rounded; the surface of the disk is slightly convex and covered with short linear chitinous raised markings, which do not, however, form curvilinear lines, except in a slight degree on the hinder edge, especially in the inverted V. The V-shaped mark is much as in *Chrysobothris*. The raised markings on the disk differ decidedly from those of *Chrysobothris* in not being round dots, but transversely linear in form. The apex of the V is not inclosed in a square area, as in *Dicerca*, and the V is much narrower. The disk on the under side of the prothoracic segment is much as on the upper, the V being represented by a simple median line. A pair of mesothoracic stigmata, and eight abdominal pairs. Head of the same size as in *Dicerca*. Labrum much rounded on the front edge, and much more contracted at the insertion in the fleshy clypeus than in *Chrysobothris*. Antennæ with the second joint a little longer than in *Dicerca*, the third joint about one-third as long as the second joint, tomentose and rounded at tip. Labium longer, fuller, more rounded on the front edge, and a little narrower than in *Dicerca*, the edge not being notched. It is more contracted at base than in *Dicerca*, and the rudimentary palpi are more distinct than in *Chrysobothris* or *Dicerca*. Maxillæ a little slenderer than in *Dicerca* and *Chrysobothris*, three-jointed; maxillary lobe much narrower, one-third less so than in *Dicerca*, but not reaching beyond the distal end of the second palpal joint. The two palpal joints are a little longer and slenderer than in *Dicerca*; first joint much narrower than in *Dicerca*, the second joint conical at tip, and as long as the first is thick.

Entire length, 20<sup>mm</sup>; length of prothorax, 3<sup>mm</sup>; breadth, 5<sup>mm</sup>; breadth of eighth abdominal segment, 2.5<sup>mm</sup>.

This is not an *Ancylocheira* nor *Anthaxia*, according to Perris' figures, but is related to *Melanophila*. Unlike the larvæ of this genus, however, it has no "unguiform spine," but three equal radiating spines on the tip of the lobe, while the lingula is entire. It can not be a *Buprestis* (*B. maculiventris*) as it differs from *Buprestis* (*Ancylocheira*) as described by Perris, in the entire labium and the much longer labrum, as well as the much shorter lobe of the maxilla and in the marking of the prothorax.

It occurred on the spruce at the Glen, White Mts., N. H., and under the bark of spruce, at Brunswick, Me., August 27.

#### 11. *Asemum moestum*.

We cut out from a spruce at Keene Flats, Adirondacks, a dead specimen of this species; it probably not infrequently bores into this tree.

#### 12. THE WHITE-PINE WEEVIL.

##### *Pissodes strobi* Peck.

This common weevil, which is described and figured on p. 734, we have found the past season from the 10th to the 15th August, at Brunswick,

under the bark of the spruce. The cells, like those found in the pine branches, were situated under the bark of the trunk of spruces 6-12 inches in diameter, and contained the pupa or more commonly the imago. The beetles were also found flying about at this date.

### 13. THE RIBBED RHAGIUM.

*Rhagium lineatum* Olivier.

Already described on p. 704, this insect occurred in the larva state in abundance under the bark of spruce stumps and standing trees, loosening the bark, but never doing any mischief, as far as we are aware, to the living tree. Small larvæ, only 4 or 5<sup>mm</sup> in length, occurred in spruce stumps August 25, while others were 14<sup>mm</sup> long. Fully grown ones occurred in neighboring pine stumps, and one, after having been kept in confinement until the last of September went into the pupa state. The eggs from which the smaller ones hatched were probably laid in the early summer; the trees containing these grubs were cut down in November, 1880, so that it is not probable that the larva lives more than one year.

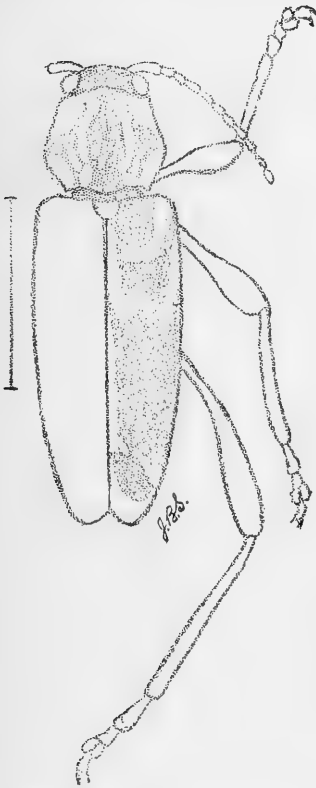


Fig. 281.—*Xylotrechus undulatus*.

### 14. *Xylotrechus undulatus* Say.

This longicorn is with little doubt a borer in the spruce (see Lintner Ent. Contr. IV, 96), and I have beaten it out of spruce trees at the end of July. I have also received it from Tacoma, Wash., and it occurs in Northern New York according to Mr. Hunt.

### AFFECTING THE LEAVES.

### 15. THE SPRUCE-BUD WORM.

*Tortrix fumiferana* Clemens.

Order LEPIDOPTERA; family TORTRICIDÆ.

(Plate VIII, moth, figs. 1, 1a; larva, figs. 1b, 1c, 1d; pupa, 1e, 1f. Map, Pl. XII; also, for ravages, Pls. XIII and XIV.)

The most destructive enemy of the spruce and fir in Lincoln, Sagadahoc, and Cumberland Counties, Me., is the Spruce-bud worm.

The habits of this insect while in confinement have been studied by Prof. C. H. Fernald, formerly of the Maine State Agricultural College, Orono, Me., and his account published in the American Naturalist

for January, 1881. In the account of the ravages of a caterpillar on the spruces on the coast of Maine in Bulletin 7 of the United States Entomological Commission, we refer to this insect, which we were unable to identify, as, after repeated search in the latter part of the summer, we failed to discover any traces of the insect in any stages. In our account we gave greater prominence to the operations of borers and bark beetles than to those of this caterpillar; and while considerable damage was undoubtedly done to spruces and firs in Sagadahoc and Cumberland Counties by those beetles, from further inquiries and field-work carried on in June and July, 1883, in different parts of Maine, we now have little doubt but that the destruction of spruces and firs along the coast of the State was mainly due to the attacks of this insect.

The different climatic causes alleged to destroy forest trees in general, would, in the present case, have injured pines and hard-wood trees as well as spruces and firs, and the destruction would have been general; whereas the trees have been killed by a caterpillar which is not known to live upon pines nor any trees but spruce, fir, and occasionally the hemlock and larch. Individual trees, or clumps of trees, were attacked, whether in high and exposed situations or in hollows; occasionally from such centers the worms seem to have increased and spread from year to year, until all the trees in localities several square miles in extent were killed. Moreover, as we have seen in the case of the attacks of the larch worm, the defoliation of spruces and firs repeated two and perhaps three summers is sufficient to either kill the tree outright, or so weaken it that bark-boring beetles can complete the work of destruction. We are now inclined to the opinion, then, that the Bud Tortrix is the sole or at least main cause of the destruction of spruces and firs in Cumberland, Sagadahoc and Lincoln Counties, Me., and that by their attacks they render the trees liable to invasion by hosts of bark beetles.

We next visited Harpswell Neck, and found from our own observation and by inquiry from others that a large proportion of the spruces and firs for a distance of about 10 miles have died within about four years. The pleasure of driving over this picturesque road, with its striking northern harsh and wild scenery and frequent glimpses of Casco Bay, in former years greatly enhanced by riding through bits of deep, dark spruce forests, has been not a little marred by the acres and even square miles of dead spruces, stripped of their dark sea-green foliage, reduced to skeletons, and presenting a ghastly, saddening, and depressing sight, which border the road. And, indeed, one may travel through the spruce forests of the coast from Portland to Rockland and meet with similar sights.

We visited late in August, in company with A. G. Tenney, esq., the farm of Mr. William Alexander, passing, before reaching the road leading to his house, an area of several acres from which the spruce growth

had been cut off in consequence of their widespread destruction by insects. Mr. Alexander informed us that the spruce trees were, in his opinion, killed by small caterpillars which have been at work for five years, but which were most destructive in 1879. These caterpillars he described as being the young of a small brown moth which laid its eggs in autumn; the caterpillars hatching from them were not inch-worms, but when fully grown the body tapered towards both ends, and were about three-quarters of an inch long, and were most destructive June 20, when they are seen among the buds at the ends of the branches, where they draw the leaves together, eating the buds and not the leaves. He had also seen borers in the trees, but he thought the death of the tree should be attributed to the bud-worms rather than to the borers. As will be seen further on, a number of caterpillars were found by us late this summer feeding upon the leaves of the spruce and fir, but the worm observed by Mr. Alexander was probably one of the leaf-rolling caterpillars, a species of the family *Tortricidæ*. A number of spruces and firs with their leaves still on but of a bright red, were observed scattered along the roadside; but no signs of leaf-worms or borers were observed in such trees, although the dead, leafless trees were infested with bark-borers.

I was informed by the late C. J. Noyes, esq., of Brunswick, who was a summer resident at Merepoint, that in June and the first week in July, 1878, the spruces and firs were attacked by great numbers of "little measuring worms, like the currant worm in shape," which eat the buds at the ends of the branches; since 1878 they had mostly disappeared, and in the summer of 1881 he had noticed only four or five.

From Harpswell Neck we traced dead spruces and firs around to West Bath, where extensive forests had been destroyed and numbers of dead hemlocks were observed, while the wood was attacked and the bark undermined and perforated by Buprestid borers, bark-borers, and the pine-weevil (*Pissodes strobi*). We have nowhere seen hemlock trees, which are more exempt than any other coniferous trees from the attacks of insects, so much infested.

The death and destruction of spruce forests were reported to us at Rockland, Me., and at Calais, Me., the destruction having been observed by Mr. Sewall at the latter town in 1879. From these facts there is good reason to suppose that perhaps a third of the spruce and fir forests from near Portland to Calais have been destroyed by insects, most of the work of destruction having been accomplished four or five years ago, during 1878-'79.

Similar damage has been done at points ten or twelve miles from the sea and in the interior of the State. The injury was especially noticed in North Topsham, near the Bowdoinham line. According to the statements of Mr. Willis, the agent of the Feldspar works in North Topsham, forwarded by Dr. C. A. Packard, of Bath, Me., the spruces were in 1879 attacked by borers and also by small caterpillars, "not measur-

ing worms" (probably like those observed by Mr. Alexander at Harpswell). The trees thus defoliated leaved out, becoming green again; and in 1880 and 1881 the evil seemed to be diminishing, as has been noticed at other places.

*Further facts regarding the extent of the ravages of the spruce bud-worm in Maine.*—The following facts regarding the extent of the ravages of this caterpillar on the coast of Maine were gathered during the summer of 1883, and for want of space omitted from the report published in that of the Entomologist of the Department of Agriculture.

The westernmost locality at which the spruce bud-worm was observed was on Peak's and other islands in Portland Harbor, the spruce not extending in any great quantity west of that city. The spruces about Sebago Lake were also destroyed by this worm or a similar caterpillar, in 1878, as we are informed by Rev. Mr. Kellogg, a Mr. Townsend being his authority. Around the shores of Casco Bay and on many of the islands, especially Birch Island, Orr's Island, Jewell's Island, and Great or Harpswell Island, also on Harpswell Neck, Mere Point, Prince's Point, as well as other peninsulas extending into Casco Bay, wherever the spruces and firs grow thickly, extensive areas of these trees were observed; also similar masses of dead spruce were observed along the Maine Central Railroad, from Portland to Brunswick, and thence to Bath; also on the shores of Cathance River, at and near Bowdoinham, Me. Wherever the fiords or narrow bays and reaches extend inland, in Cumberland and Sagadahock as well as Lincoln Counties, the spruce and fir forests clothing their shores had been invaded by this destructive caterpillar. Wherever the spruces were abundant on the Kennebec River, below Bath, particularly on the eastern side, at and near Parker's Point, and also at and west of Fort Popham, there were extensive patches of dead spruces. Similar but smaller masses of dead spruce were observed along the steamer route from Bath to Boothbay Harbor, at and to the eastward of Southport; none were observed on Mouse or Squirrel Islands. In the course of a journey, at the end of July, from Brunswick along the coast to Eastport, we were able to ascertain the eastern limits of the ravages of this worm. Several clumps of spruces which had just died were seen on the Knox and Lincoln Railroad before reaching the Wiscasset Station. At Waldoboro, southeast from the station, was an extensive area of dead spruces which presented the same characteristic appearance as in Cumberland County, and for two or three miles beyond Waldoboro there were to be seen large masses of dead spruces and firs. Beyond Warren no dead spruces were to be seen; none were observed about Rockland, Camden, Blue Hill, or the islands of Penobscot Bay; none on Mount Desert, or on the islands from Mount Desert to East Machias, nor on the road from East Machias to Lubec, although the predominant growth is spruce. No dead spruces were to be seen about Eastport, nor along the St. Croix River, to Calais, and none along the railroad from St. Stephen's to Vanceborough and thence

to Bangor. From personal observation and inquiry it is safe for us to report that east of the Penobscot River, in eastern Maine, south of Aroostook County, there are no areas of dead spruce. Returning to Brunswick from Bangor, the characteristic patches or large clumps of dead spruce and fir were not seen until we reached a point south of Richmond, and near Bowdoinham, on and near tide-water on the CATHANCE RIVER. The general absence of any extensive areas of dead spruces around the Rangeley Lakes and the White Mountains has already been referred to in our report. It thus appears that the injury from this worm has been confined, at least south of Aroostook County, to an area on the coast extending from Portland to Warren, and extending but a few miles inland from the sea or tide-water. (See map, Plate XII.)

The injury resulting from the attacks of the bud-caterpillar are characteristic, as we have stated, the trees dying in masses or clumps of greater or less extent, as if the moths had spread out from different centers before laying their eggs and the caterpillars, hatching, had eaten the buds and leaves, and caused the trees to locally perish. From all we have learned the past season we are now convinced that the spruce bud-worm (*Tortrix fumiferana*) is the primary cause of the disease on the coast. As remarked to us by the Rev. Elijah Kellogg, of Harpswell, Me., who has observed the habits of these caterpillars more closely than any one else we have met, where the worms have once devoured the buds the tree is doomed. This, as Mr. Kellogg remarked, is due to the fact that there are in the spruce but a few buds, usually two or three at the end of a twig; if the caterpillars destroy these the tree does not reproduce them until the year following. If any one will examine the buds of the spruce and fir they will see that this must be the case. Hence the ease with which the attacks of this caterpillar, when sufficiently abundant, destroy the tree. We have not noticed that the spruce and fir throw out new buds in July and August after such an invasion, the worm disappearing in June. On the other hand, the hackmatack or larch when wholly or partly defoliated by the saw-fly worm (*Nematus*) soon sends out new leaves. By the end of August we have observed such leaves about a quarter of an inch long. In the following spring a larch which has been stripped of its leaves the summer previous will leave out again freely, although the leaves are always considerably, sometimes one-half, shorter. Now, if any one will examine the leaf buds of the larch it will be seen that they are far more numerous than in the spruce and fir or other species of the genus *Abies*, being scattered along the twig at intervals of from a line to half an inch apart. Hence the superior vitality of the larch, at least as regards its power of overcoming or recuperating from the effects of the loss of its leaves in midsummer. Besides this, the bud-worm of the spruce and fir is most active and destructive in June, at the time the tree is putting forth its buds, while the hackmatack, which drops its leaves in the autumn, has become wholly leaved out some weeks before the saw-fly worms appear. For



these reasons, while the spruce and fir usually die if most of the leaves and buds are eaten after the first season's attack, the larch may usually survive the loss of leaves for two seasons in succession.

In addition to the facts regarding the great abundance of the bud-worm we may cite information given us by Prof. L. A. Lee, of Bowdoin College, who observed the bud-worms in June, 1880, upon the spruces at Prince's Point, Brunswick, and had no doubt but that they were sufficient to cause the death *en masse* of these trees. In 1883 we visited the locality, and many of the trees had been cut down for fuel.

Professor Carmichael of Bowdoin College informs me that he noticed the ravages of these worms, or similar ones, on Jewell's Island in 1876.

From Rev. Mr. Kellogg we learned the following interesting facts regarding the appearance of a similar, most probably the same, species of caterpillar, even upon the same farm that was ravaged in 1878, early in this century. According to Capt. James Sinnett and Mr. John Jordan, of Harpswell, the spruces of Harpswell and Orr's Islands were destroyed in 1807. Captain Bishops, whose son made the statement to Mr. Kellogg, cut down the dead spruces on these islands and worked six weeks boiling the sea-water with fuel thus obtained, in order to make salt. This was during the embargo which led to the war of 1812 with Great Britain. It is interesting to note that the bud-worm in 1878 appeared on the same farm on which the spruces had been destroyed by a worm in 1807, or about eighty years previous.

During the season of 1886 and 1887, as in 1885, no traces of the caterpillar or moth of *Tortrix fumiferana*, formerly so destructive to firs and spruces, were discovered. The moths must be now as rare as before 1878. Great progress has also been made by the younger growth of these coniferous trees in repairing the desolation caused by the attacks of this worm.

*Its Habits and Transformations.*—The spruce-bud worm, as we observed in Cumberland County, also at Phillips, and near the Rangeley Lakes, on the road from Phillips to Rangeley, where the trees by the roadside, as well as in the woods, were attacked by them, so that they looked as if a light fire had passed through them, feeds upon the leaves or needles of the terminal shoots, both the first and previous year's growth. The worm gnaws the base of the needles, separating them from the twig, meanwhile spinning a silken thread by which the needles and bud-scales are loosely attached to the twig; the worm moving about in the space between the twig and the loosened needles and bud-scales, and not, like many leaf-rolling caterpillars, living in a regular tube.

The caterpillar sometimes draws together two adjacent shoots, but this is rarely done; hence while it is at work it scarcely alters the appearance of the tree, and its presence is only known when the worms are abundant enough to partly defoliate the trees.

The worms in June, 1883, were in Cumberland County most abundant

where the dead or partially dead spruces abounded; but individual worms could be obtained by beating any spruce or fir in any locality, showing that in years of immunity from its attacks the insect is a widespread and at times common species. We found the worms most abundant in spruces, firs, and even hemlocks, July 1 and 2, between Phillips and Rangeley, but after passing through all the Rangeley Lakes, and going from Errol, N. H., to Berlin, Gorham, Jackson, and Conway, N. H., we found that the spruces and firs throughout Northwestern Maine and the White Mountain regions had suffered no widespread damage. One and perhaps two rather extensive tracts of dead spruces were observed at a distance from the stage road near Rangeley, but throughout the vast spruce-clad forests observable from the lakes themselves no such tracts of dead trees were to be seen. On the contrary, the spruce forests of the Rangeley Lake region appeared to be as green and fresh as any forest we have ever seen. The dead spruces at the water's edge of the middle lakes were evidently due to the high water held in by the middle and lower dams during the last two years. As in any forest, there were individual dead trees, sometimes small clumps of them, where the trees had died as the results of tornadoes or of borers. The persons living by the lakes, lumbermen and others, informed us that there had been no extensive destruction of evergreen trees in this region.

The spruce-bud worm attains its full size and stops feeding, ready to transform to a chrysalis, in Cumberland County, by the 20th to 30th of June, and about the Rangeley Lakes and in the White Mountain region a few days or nearly a week later.

When about to change to a pupa it remains in its rude shelter or hiding place under the loosened leaves of the shoot, where it turns to a chrysalis, without spinning a regular, even, thin cocoon. It remains in the chrysalis state about six days. Those pupating at Brunswick, Me., June 28 and 29, issued as moths July 4 and 5. When the moth is ready to break forth from the pupa, the latter wriggles part way out of its hiding place, and the moth issues, leaving the rent pupa skin projecting half way out of the end of the shoot. The moths then appear from the first to the middle of July. July 16, after our return from an absence of two weeks, we found that the moths of both sexes had issued and that the females had laid their eggs in curious little patches on the sides of the breeding-box. They must have issued about the 5th to 7th of July, and immediately laid their eggs, as in one patch the shells were empty, with a small orifice in the shell, out of which the larvæ had crept. Another patch was found with a dark spot in each egg showing the head of the embryo caterpillar; these hatched July 18, 19. It thus appears that the embryo develops, and the caterpillar hatches, in about ten days after the eggs are laid.

The eggs are very curious and very unlike those of most moths. They are pale green, scale-like, broad, flat beneath, moderately convex above,

oval cylindrical, a little longer than broad, and in all those which I examined, both those containing the embryos and those which were empty, the surface, contrary to Professor Fernald's statement, was under a lens seen to be finely but irregularly granulated. The shell is thin, and at first unusually soft. Length, 0.9 to 1.4<sup>mm</sup>; breadth, 0.8 to 1<sup>mm</sup>. The patches were about 3<sup>mm</sup> in diameter, and composed of as many as thirty eggs. The eggs overlapped each other irregularly, leaving about a third or fourth of the surface of each egg exposed.

From the form and size of the egg-mass it is evidently attached by the moth to a terminal twig. The caterpillars on hatching, as Fernald observes, do not eat the shell. They hatch about or soon after the middle of July, and it is most probable that the caterpillars become partly, perhaps almost wholly, grown before the end of autumn, and pass the winter among the terminal shoots of the tree, to finish their transformations the following June and July. It is certain that there is but a single brood of caterpillars. Professor Fernald, in his article in the *American Naturalist*, describes the process of egg-laying. He has bred from the worms an ichneumon (*Pimpla conquisitor*), several dipterous parasites and a hair-snake. We have found the insect to be remarkably free from parasites, having bred about twenty-five of the moths without rearing any parasites.

*Larva, first stage.*—When first hatched the young caterpillar is uniformly pale pea-green, with a yellowish tint. Head dark brown, but the cervical shield pale amber, with two dark dots on the hinder edge; hairs nearly half as long as the body is thick; length 2.5<sup>mm</sup>. At this time the young worms are very active, letting themselves down by a thread as readily as when fully grown.

*Larva before last molt.*—Body not quite so thick as full-fed worm; more uniformly rust-red brown; the piliferous warts duller in color, sometimes not much paler than the rest of the body towards the head, though higher and more distinct towards the end of the body. Head black and prothoracic shield black, the latter pale on front margin; no well-marked, broad, lateral, yellowish-brown band such as characterizes the adult. Length 12 to 13<sup>mm</sup>.

*Larva (full-fed).*—Body unusually thick and stout, tapering gradually from the middle to the end, and slightly flattened from above, as usual; head not quite so wide as the body, of the usual form, dark, almost black-brown, but lighter than before the last molt; mouth-parts dark, with paler membranous rings at the articulations; antennæ with the terminal joint black.

Prothoracic shield pale brown, paler than the body, with a pair of dark blotches on the hinder edge in the middle, and other scattered, smaller, dark, irregular blotches, of which two are situated in the middle of the front edge, the latter pale whitish. Body rich umber-brown, diffused with olive-green, especially on the sutures; with very conspicuous and showy, large, whitish-yellow, piliferous warts, forming flattened minute tubercles, with a dark center from which the hair arises. On the top of the second and third thoracic segments is a transverse row of four such warts on each segment; on the upper side of the abdominal segments are four warts arranged in a short trapezoid; they are far apart transversely, but unusually near together antero-posterior to the body; on the penultimate segment is a median, broad, light-yellowish spot on the hinder edge of the segment; a large, round, convex area, forming the supra-anal plate, from which arise about six fine, long, pale-brown hairs. Anal legs spreading, with two or three piliferous callosities; the terminal segment and anal legs concolorous, with an irregular, broad, pale-yellowish, lateral band reaching

to the prothoracic segment, and slightly tinged with ferruginous. In this band, on the side of each segment, is a pale-whitish, flattened wart, directly in front of and adjoining the spiracle; along the narrow, lateral, fleshy ridge on each segment is a long, narrow, pale-yellowish wart. Beneath dull, livid greenish, with (on each segment) a transverse row of four bright-yellowish warts, concolorous with those above; the two inner ones are minute, the outer ones much larger. Thoracic legs black-brown; the four pairs of abdominal median legs are pale, almost whitish; all the hairs are fine and light-brown in color, and one-half as long as the body is broad. Length 19<sup>mm</sup>.

*Pupa*.—Body very thick, the thorax especially unusually swollen; the body, soon after changing, pale horn-colored, striped with brown; antennæ and legs dark horn-color or dull tan-brown; wings pale, with the veins dark; the thorax pale horn, spotted with dark tan-brown, with three irregular, dark, dorsal stripes; meso-scutellum and metanotum dark; abdominal segments above, with two rows of stout spines; a lateral row of dark spots, and a median spot on the two basal segments; similar spots on the succeeding segments lengthened and connecting the lateral spots. Beneath are two irregular rows of diffuse spots; the hinder edge of the segments darkened; the terminal segment uniform dark, shining, tan-brown, ending in a long, stout point, on each side of which are two tightly-curved spines, and two stouter but less curved larger ones at the end, arising from a common base. Length 12<sup>mm</sup>.

*Moth*.—A large species, with a stout body and large broad, oblong fore wings; the costa not excavated towards the apex, but full and regularly though slightly curved, the apex being rectangular; head and body umber-brown. Palpi very stout; terminal joint short. Fore wings umber-brown, the brown sometimes replaced by rust-red; ground-color bluish-slate; on the inner fourth of the costal edge are four unequal, triangular, brown spots, the second and fourth connecting with an elongated transverse brown patch in the middle of the wing. From a point at or just within the middle of the costa a very oblique, distinct, broad, brown band crosses the wing in a zigzag course, ending at or near the outer third of the internal edge of the wing. This broad band extends out towards or connects with a preapical brown patch on the costa; it also sends an angle inwards behind the median vein, and again another angle outward opposite the inwardly-directed angle. There are often two distinct, costal, whitish dots (sometimes wanting) just before the apex, while the apex itself is brown. There is also a large brown patch in the middle of the wings near the outer edge. There are numerous fine, short, transverse, brown lines dividing the wing into squares or checks, bordered with brown. The bands and short lines are more or less confluent or separate, varying much in this respect. Some females differ in the umber-brown, being bright rust-red, and the clay-blue pale ferruginous brown, while the broad, median, zigzag band is umber-brown on the edges and bright rust-red in the middle, and the wing is covered with an irregular net-work made by the short transverse and longitudinal dark-brown lines inclosing rust-red or smoky-red patches.

Legs, body, and hind wings glistening umber-brown; tarsi ringed with pale brown. The abdomen of the female is very stout, that of the male ending in a long, distinct, hairy tuft. Described from perfectly fresh specimens, five males, eight females. Length of body, 9 to 10<sup>mm</sup>; of fore wing, 10 to 12<sup>mm</sup>; expanse of wings, 19 to 22<sup>mm</sup>.

#### 16. THE SPRUCE NEMATUS.

*Nematus integer* Say.

Order HYMENOPTERA; family TENTHREDINIDÆ.

(Plate XXVII, figs. 6, 6a, 6b, 6c.)

Although this insect is not, so far as known, especially destructive to evergreen trees, yet it is common over the Northern States and may at times prove obnoxious. It occurs on the spruce in Maine in the latter

part of summer, and feeds separately, not being gregarious as in most species of *Lophyrus* or the Larch *Nematus*. It is possible that the fly escapes from the cocoon in the autumn, but as a rule it without doubt passes the winter in the cocoon, the fly making its appearance in the late spring and early part of June, specimens having been found dead in the breeding-box in the middle of May.

*Larva*.—The body is long, broader than the head; pale pea-green; of the color of the leaves of the spruce among which it feeds. The head is smooth, of the same color as the body, with a dark patch extending upward behind each eye. Body not spotted, but with a dorsal dark-green stripe, bordered on each side with whitish glaucous green. Along the body is a lateral conspicuous broad white stripe, the stripe much scalloped below. Body beneath and abdominal legs uniformly green; thoracic legs pale honey-yellow, except at base. Length, 17<sup>mm</sup>.

*Cocoon*.—Of the usual oval cylindrical form; of a pale horn color, of the usual density, the walls being opaque. Length, 13<sup>mm</sup>; diameter, 4<sup>mm</sup>.

*Saw-fly (imago)* [two females].—Antennæ nine-jointed; flagellum minutely hirsute, seven-jointed, the two basal joints of flagellum equal in length; head and body dull amber yellow (testaceous); eyes black; ocelli situated in a dark-brown patch; a black irregularly triangular spot above the insertion of each antenna, being situated in a pit between the eyes and the inner edge of the broad orbits. A single minute triangular black spot between the antennæ; clypeus, labrum, and palpi pale dull amber (testaceous), concolorous with the head; the mandibles dark at tips.

Prothorax above not spotted. Mesonotum with three longitudinal, dark, broad stripes; præscutum dusky reddish brown, pale on the sides; on the middle of each half of the scutum a broad blackish band reaching the front edge, but not extending posteriorly behind a point parallel with the apex of the scutellum. Behind and between the ends of these dark bands are two small dark spots. Scutellum on the posterior half dark brown; the metascutum is black. Sides of the thorax and beneath pale faded amber (testaceous), with a triangular black spot on the sides of the prothorax below and in front of the wings.

Abdomen of the same color as the rest of the body, but on the sides and beneath with a greenish tinge; above black, especially towards the base, next to the thorax; the segments above being banded transversely with black on segments 1 to 8, the bands growing shorter (transversely) behind, until on the eighth segment the dark band is scarcely wider than long; the black bands extend on each side of the front edge of each segment, forming a point on each side. Under side of meso- and meta-thorax a little dusky.

Fore and middle pair of legs testaceous; extreme tips of tibiæ and tarsal joints with a very narrow black ring; last tarsal joint with the pad (pulvillus) and end of claws dark. Hind<sup>3</sup> legs: femora in color testaceous; tibiæ a little dusky, paler towards the femora; all the tarsal joints equally dusky. Ovipositor at base reddish horn color, tip blackish. Wings with the veins blackish brown; costal edge paler; stigma dark testaceous; four subcostal cells, the first or innermost four-sided, subquadrate. Length of antenna, 5<sup>mm</sup>; length of body without antennæ, 8<sup>mm</sup>; length of a fore wing, 8<sup>mm</sup>.

This agrees in all respects with Mr. Norton's description of *Nematus integer* Say, var. *a* (Trans. Amer. Ent., i, p. 216). It is recorded from Maine, Massachusetts, Connecticut, New York, Pennsylvania, and Indiana. It thus seems to be a widely distributed species. It is closely allied to Say's *N. vertebratus* and to Norton's *N. trilineatus*, but the pale fore and middle tarsi and the greenish tint distinguish it. The description of the larva is taken from Bulletin 7, U. S. Ent. Comm., p. 234, No. 20.

## 17. THE FIR HARLEQUIN CATERPILLAR. -

*Olygia versicolor* Grote.

Order LEPIDOPTERA ; family NOCTUIDÆ.

Late in summer in Maine, feeding on the leaves of the fir and spruce, is to be found a singularly humped and spotted caterpillar, with four pairs of abdominal legs.\*

Professor Riley writes me as follows regarding this insect :

The same species was also found in Virginia July 5, feeding on birch, walnut, and one also on dead oak leaves, on which later all were feeding.

The Virginia specimens were all parasitized except one, from which the moth issued July 22.



FIG. 282.—*Olygia versicolor*: a, from blown specimen, Marx del; b, from alcoholic, Brigham del.

*Larva*.—Body short, much swollen on the second ring behind the head and the first abdominal segment, and humped between the last and the penultimate abdominal legs. Head very small, striped with black. Ground tint a wood color mottled with gray and black, with scattered white spots. An irregular lilac dorsal band. A pair of conspicuous white dots on the hump behind the head, and another pair on the posterior hump. Body very much variegated in tints and it is difficult to describe briefly all the details of the markings. Length, 12 to 14<sup>mm</sup>.

*Pupa*.—Body short and thick; the end of the abdomen unusually blunt, and rounded. Cremaster (or terminal spine) rudimentary, minute, with two outwardly curved divergent long slender spines. Length, 10<sup>mm</sup>.

18. *Noctuid larva*.

This Noctuid larva occurred on the spruce in Maine.

*Larva*.—Body a little higher than wide, especially posteriorly. Head small, rounded, somewhat bilobed, not quite so wide as the prothoracic segment, which is narrower than the two succeeding segments and narrower than the metathoracic segment. The body is thickest and highest in the middle. On the third segment from the end is a conspicuous hump somewhat divided, with a pair of lesser tubercles behind. Anal legs oblique and rather long and large. Body velvety brown, but with somewhat of a reddish tinge. On each segment a large triangular area, the apex directed backwards. Also on each segment a transverse row of black warts and two in front, so that the four dorsal warts are in a trapezoid. The side of the hump near the end of the body is paler and in front is a lateral conspicuous yellowish streak. Length, 11<sup>mm</sup>.

19. *Noctuid larva*.

This caterpillar occurred in the Adirondacks at Keene Flats, in June.

*Larva*.—It was pale green, the color of the spruce leaves, of the usual smooth form, with five white distinct lines. Head shining and green. Length, 15<sup>mm</sup>.

\* Described by Grote in Can. Ent., VII, Pl. 1, fig. 4. See also Smith, Ent. Amer., Aug., 1889, p. 119.

## 20. THE SPRUCE THERINA.

*Therina fervidaria* Hübner.

This common insect feeds in Maine on the spruce, as the pupa was found early in August, and the moth was disclosed August 21. The larva was unfortunately not described. Abbot bred it in Georgia from the *Halesia diptera*, and from his manuscript sketches, preserved in the library of the Boston Society of Natural History, we prepared the following description. The pupa is described from our own specimen.

*Larva*.—Body cylindrical, smooth; head of the same width as the body, which is yellowish green above, pale purplish below. Two fine, blackish, lateral lines, with a pale line above.

*Pupa*.—Rather slender, whitish gray, slashed and spotted with brown on the side, but much less so than in *Th. seminudaria*; head, thorax, and wings nearly unspotted; terminal spine and bristles as in *Th. seminudaria*. Length, 12<sup>mm</sup>.

*Moth*.—Pale ochereous, more so than usual, head and front of the thorax and antennæ deep ochereous. Wings dusky, speckled with smoky spots (though varying in degree of irroration). Wings well angulated, the angle of the fore wings often acute, on the hind wings forming a slight tail. Outer line dark brown, bordered externally with ochereous. Inner line situated either on or a little within the inner third of the wing, a little curved. Discal dot dark, distinct, sometimes wanting on the hind wings. Outer line sinuate, or zigzag, varying greatly, the angle on the first median venule being slight or very marked on both wings; on the hind wings a single line only. Beneath, much paler; the lines re-appear, but are diffuse and smoky. Legs, tibiæ, and tarsi of the two pairs of fore legs brown, hind legs pale ochereous. Expanse of wings, .38 inch.

21. *Tephrosia cribrataria* Guen.

Order LEPIDOPTERA; family PHALENIDÆ.

The caterpillar of this geometrid moth occurred on the spruce at Brunswick, Me., June 5. The specimen was sent to the office of the Entomologist at Washington and there bred, while it is stated in the Department note-book that the pupa rested on the ground and was not attached to any leaves, etc., and the structure of the cremaster agrees with its subterranean habits.

*Larva*.—Not described.

*Pupa*.—Body rather thick and stout; color light brown (but not so light as that of *Caripeta divisata*); surface coarsely pitted. Cremaster large, stout, and long, rough and tuberculated above at the base, and with no spines at the base or end, the point being long, smooth, and acute.

## 22. THE EVERGREEN SPAN-WORM.

*Thera contractata* Packard.

Order LEPIDOPTERA; family PHALENIDÆ.

A very common caterpillar on various evergreen trees, such as the spruce, white pine, hackmatack, and the bush or common Juniper, is a little green caterpillar, striped with white, which is so assimilated in color to the glaucous green leaves with their whitish under side as to enable the caterpillar to escape ordinary observation.

During the past summer (1887) I have found this caterpillar most frequently on the common bush juniper in Maine, but in former years have beaten the chrysalids out of the trees already mentioned.

The caterpillar is found in July, but becomes fully grown from the 1st to the 15th of August. Before transforming, it spins the leaves together with a few coarse silk threads and remains in the tree. Those reared on the juniper became chrysalids by the 19th or 20th of August, and the moths appeared by the 9th of September, so that the pupa state lasts about three weeks. The moths continue to appear until the middle or last of September. Those found on the spruce appeared September 15, and a pupa found on the white pine disclosed the moth September 13. Probably by the middle of September all the moths have appeared. Whether they hibernate and lay their eggs in spring, or whether their eggs are laid in the autumn on the terminal twigs, and the species is alone represented during the winter by the eggs, remains to be ascertained.

The moth is easily recognized by the sharp fore wings with the narrow, dark, mesial band, which is black and very narrow on the inner edge, and by the pale zigzag line re-appearing beneath, also by the black streak near the apex and a smaller apical black dot. It is closely related to the European *T. juniperata*, which feeds on the common juniper.

*Larva*.—Body smooth, cylindrical; head smooth, slightly bilobed, not quite so wide as the body. Head and body green, the color of the upper side of the juniper leaves on which it feeds. A broad pale glaucous white dorsal band, on each side of which is a yellowish-white line, which extends along the sides of the supra-anal plate, but not meeting its fellow at the apex. Anal legs broad and large, green, with two tubercles which are large and rounded conical. Thoracic legs pink. Length, 16<sup>mm</sup>.

*Pupa*.—Of the usual family shape; green, with a white lateral stripe from the head to the tip of the abdomen, and another lower down along the abdomen, as well as two parallel dorsal whitish stripes. Abdominal spine larger and longer than usual, flattened vertically, acute, surface corrugated; two stout terminal bristles excurved at the ends, a much smaller pair at base of these and along the sides of the spines two additional pairs. Length, 6<sup>mm</sup>.

*Moth*.—Pale ash, base of fore wings with two bent parallel black lines, the outer heavier, and marked with longitudinal stripes on the veinlets. Beyond is a broad pale band slightly bent on the median vein. Still beyond is a median band margined with black, narrowing more than usual on the inner margin of the wing, where the two black margins meet, forming two contiguous black patches; in front the band incloses obscure ashen ringlets. A black discal dot; beyond, an obscure pale patch. A white zigzag marginal line, the sharp scallops inclosing dark dots. Hind wings uniformly pale ash color, crossed by two dusky lines. Expanse of wings, 25<sup>mm</sup> (one inch).

### 23. *Eupithecia larva*.

This caterpillar was beaten from spruce trees June 11, at Beede's, Adirondacks.

*Larva*.—Body very slender. Head much flattened, as wide as the body in front, the latter widening a little towards the first pair of abdominal legs. Supra-anal plate ending in two large long spines; lateral ridges distinct, narrow; below it a little



lighter than above, but similarly marked. Head and body pale lilac, reddish brown; four black fine dots on each side above. Surface of the body with fine but obscure lines; two fine parallel dorsal lines on the last three abdominal segments. Length, 26<sup>mm</sup>. This is not a mimetic form, while No. 22 mimics the shape of a twig.

24. *Geometrid larva.*

This species occurred with No. 21.

*Larva.*—Pale ash-gray, with black spots, resembling a bit of spruce twig. Head small, much narrower than the body, square, somewhat bilobed. Body narrowing towards each end, with the segments a little swollen behind; third abdominal segment with a prominent black lateral tubercle; smaller but similar tubercles on the other segments. At each suture is a transverse, short, pale ash line flanked by a dark patch. Each thoracic and first abdominal segment with a triangular or V-shaped black spot, with the apex prolonged behind; the marks are less distinct on the hinder part of the body. Body beneath nearly as above. Length, 24 to 25<sup>mm</sup>.

25. *Geometrid larva.*

This caterpillar occurred on the spruce August 11, at Brunswick, Me.

*Larva.*—Body thick, tapering a little towards both ends. Head rounded, not bilobed, as wide as prothoracic segment. Body with no spines or humps. Ground color pale light horn color, with a reddish tint, almost pale salmon, with four dark distinct, hair-bearing small warts above and one low down on each side. Five dorsal slender wavy dark lines, the outer line embracing the dark small warts. On the sides of the body and beneath are similar dark wavy lines on a salmon ground. The head has six longitudinal diffuse lines. Length, 20<sup>mm</sup>.

26. THE SPRUCE EPIZEUXIS.

*Epizeuxis æmula* Hübner.

Order LEPIDOPTERA; family PYRALIDÆ.

While in the Adirondacks, in June, 1884, at Beede's hotel, Keene Flats, I beat from the spruce near the hotel two caterpillars, which I considered to be without doubt leaf-rollers of the family *Tortricidæ*. They were in general appearance much like the Spruce Bud-worm (*Tortrix fumiferana*), though a little smaller, but with a well-marked dorsal and lateral line, which are more characteristic of Pyralid than Tortricid larvæ.

Soon after, June 14 or 15, one of the caterpillars spun in the tin breeding box a cocoon covered with black scurf from the terminal twigs of the spruce.

During the past season, in Maine, I collected another caterpillar on the spruce, June 9, but failed to make a description of it or to notice the number of abdominal feet; the moth appeared June 24. From this it would appear that the normal food-plant of the caterpillar is the spruce.

There are four species of this genus of moths in this country, the better known one besides the present species being *E. americana* (or *Helia americana*). But their habits are strangely dissimilar, since Prof. C. V. Riley has stated in the American Naturalist for October, 1883 (p.

1070), that *E. americana* feeds in the larva state in the nests of an ant (*Formica rufa*). He also stated that so far as he knew this was the first lepidopterous insect known to develop in ants' nests. This statement, however, elicited from Lord Walsingham the following statements, published in the same magazine (January, 1884, p. 81): "Noticing your mention of *Helia americana* as a myrmicophilous lepidopteron, I would remind you of *Myrmicocela ochraceella* Tgstr., which is found also in ants' nests. It is allied to the true *Tinea*."

According to Guenée, however, the larva of *E. americana* "lives on leguminous plants, as *Hedysarum*, *Melilotus*, *Pisum* etc., and even on corn, and is very destructive." He adds that the chrysalis is contained in a cocoon spun between leaves.

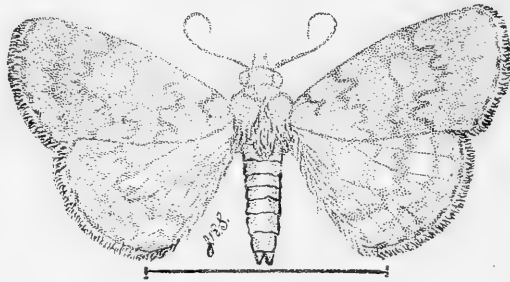


FIG. 283.—*Helia cœmula* Smith del.

*Larva*.—Body moderately thick, slightly tapering towards each end, dull brown, with a well-marked dorsal and lateral line; the piliferous warts arranged much as in *Tortrix fumiferana*, which the larva somewhat resembles, but the warts not so conspicuous. The head is slightly paler than the body.

*Pupa*.—Body short and thick, rather fuller than usual, color pale horn-brown. Abdominal spine broad and thick, subconical, rounded; vertically flattened above and beneath, the surfaces being somewhat convex, and the sides ridged above and below. At the extreme end of the spine are two long slender bristles curved at the end; on the upper side of the spine are two bristles which converge and are closely connected with the two at the tip. Length, 8 to 9<sup>mm</sup>.

*Moth*.—Fore wings ash-gray, darker on the outer half, crossed by three black lines. The first line, situated at the base of the wing, is short, and represented by a black costal mark, succeeded by a curved black line ending just behind the median vein, not crossing the wing. Second line zigzag, situated on the basal fourth of the wing; it begins as an oblique mark on the costa, edged within with white; behind, the line makes two sharp teeth; on the median vein it points inwards, and again outwards in the submedian space. The third line is much broader and less wavy; it curves inward on the discal space, partly inclosing a large diffuse, discal, ocherous patch. Above this patch on the costa is a black mark bordered on each side with white; a submarginal, fine, wavy, white line. At the base of the fringe is a black interrupted line. Hind wings ocherous gray, crossed by three diffuse wavy blackish lines. Expanse of wings, 20 to 22<sup>mm</sup>.

## 27. THE PITCH-DROP WORM.

*Pinipestis Zimmermanni* Grote.

This is said by Mr. Zimmerman to be destructive to young spruces in New York. (Can. Ent., XII, 59. See p. 731.)

## 28. THE REDDISH-YELLOW SPRUCE-BUD WORM.

*Steganoptycha ratzeburgiana* SAX.

A caterpillar not before observed by us was found to be very injurious to the white spruce, and in a less degree to the black spruce on Squirrel Island, Booth Bay Harbor, Maine. July 11 the white spruce shoots particularly were found to have been, in many cases, stripped bare of their leaves, especially the terminal fresh shoots. The shoots had been stripped either wholly or only on one side, some of the young trees being badly injured, and as they were used as ornamental shrubs around the summer cottages on that island, their beauty was seriously marred. They also affected the white-spruce trees growing wild among the rocks on the shore, while but a few black spruces had been injured. The shoots and branches were fairly alive with the moths, which, on being disturbed would rise up in great numbers and then settle down upon the leaves. Upon sending a specimen to Prof. C. H. Fernald, of the Maine State College, who is the leading authority on the *Tortricidæ*, a family of leaf-rolling moths, he kindly informs me that it is a new depredator, only recently detected in this country. His letter to me reads as follows :

MAINE STATE COLLEGE,  
DEPARTMENT OF NATURAL HISTORY,  
Orono, Me., October 4, 1884.

MY DEAR PROFESSOR: Your card and the insect have come to hand. I have taken this insect at Mount Desert in the latter part of July, 1882, in abundance around spruces in which the terminal twigs were destroyed. This was presumptive—though not positive—evidence that they were the ones that caused the destruction of the twigs. I found them again this summer, early in July, on Islesborough, around spruces in the same way as described above. I have also received the insect for determination from New Hampshire. This, I believe, is the entire history of the insect in this country, for it has never been sent to me except as above, and it is not in any of the collections of the country to my knowledge.

I at once determined it to be a *Steganoptycha*, and as it agreed with nothing in my American collection, I turned to the foreign species and found that it was near, if not identical with, the European *S. ratzeburgiana* Sax. I have three examples from Germany which vary somewhat, as do the specimens of this country. I have now given them a critical examination and comparison, and believe them to be identical. I made a microscopical examination of the genitalia of the males, and find them alike. So far as any studies which can be made on the imagos go they would be regarded as identical.

If you found the larvæ and made any studies on them, I would be glad to have you compare them with what the following authors say, and let me know whether they agree or whether the early stages differ. See the following works, which I think comprise the entire history of the literature of the subject: Ratzeburg, *Forest Insects*, Vol. I, p. 227, Plate 12; Fig. 3, Imago; 3 L., larva; and Plate 13, Figs. 3 and 4, twigs destroyed by the larvæ: Zeller, *Isis* (not in my library), 1846, 242: Herrich-Schaeffer, *Schmetterlinge von Europa*, Vol. V, p. 208: Heinemann, Wickler, p. 212, who states that the larvæ live in spring in the young shoots of *Pinus abies*. Duponchel describes it on page 568, and gives a fair figure on Plate 266 under the name *tenerana*, mistaking it for Hübner's *tenerana*, which belongs to another genus. Stainton's *Manual*, Vol. 2, p.

238, under *tenerana*, says, "not scarce among fir trees." Wilkinson, British Tortrices, p. 186, under *tencrana*; Freyer (not in my library); Guenée, Index methodicus, 26, under the name *errana*: Westwood, British Moths (not in my library), *pinetana*; Kaltenbach, Die Pflanzenfeinde, p. 698—you may get some help from this; Frey, Die Lepidopteren der Schweiz, p. 325.

Yours, truly,

C. H. FERNALD.

Dr. A. S. PACKARD.

Like the dark olive-brown bud-worm (*Tortrix fumiferana*) this worm eats around the bud in June, gnawing off the leaves and thus loosening them, so that they remain attached by a loose, slight web filled with the castings, and under this mass the caterpillar lives concealed from the prying gaze of insectivorous birds.

As it was late for the caterpillars, nearly or quite all having transformed into moths, only a single belated worm was found, which, there is the strongest presumptive evidence for believing, is the young of the moth in question. It is much smaller, nearly one-half as large and entirely different from the caterpillar of the common spruce-bud worm (*Tortrix fumiferana*) and is of a general reddish-yellowish hue.

The body is flattened, the head of a deep reddish honey-yellow, while the body is pale rust-red, with a darker dorsal stripe and a paler band on each side. The piliferous warts are paler than the ground color. The body low down on the sides and beneath is yellowish. All the legs, both thoracic and abdominal, are pale honey-yellow. Length, 7<sup>mm</sup>.

Without doubt the caterpillar hibernates when nearly full-grown, attacks the shoots in June when the new leaves are growing out, and goes into the chrysalis state by the end of the month, the moths appearing during the first and second weeks of July. Of course it is desirable that the caterpillar be reared, so as to leave no doubt as to its identity with the moth in question.

When the young trees and shrubs are found to be affected, they should be sprayed with Paris Green or London purple in solution.

*Moth*.—General color carneous and light brown. Palpi very broad at end of second joint, the tip, including the last joint, dusky. Head with a large flattened vertical tuft, hanging "bang"-like over the forehead. Fore wings dotted with black along the costa. From the inner third of the costa a fine, narrow black line extends obliquely to the middle of the wing, then making a sharp angle on the median vein, and thence going to the inner edge of the wing opposite the point of origin on the costa; between this line and the base of the wing are two fine broken irregularly curved black lines. In the middle of the wing from the costal black spots, three black lines converge to a number of black scales in the middle of the wing, opposite but outside of the point of the bent line; below these black scales is a darker brown patch. On the outer fourth of the wing a large, conspicuous triangular flesh-colored patch extends to near the internal angle. In the middle, on the costa, is a black speck, as also along the sides, and the apex of the patch is seen under a good lens to be edged with white. Beyond the patch, in the middle of the wing, are a few black scales and a short white line. A black apical spot. Fringe blackish. Hind wings dark slate color; legs branded with blackish. Expanse of wings, 14<sup>mm</sup>.

## 29. THE BLACK-HEADED SPRUCE BUD-WORM.\*

*Teras variana* Fernald.

This caterpillar is so commonly met with on the spruce and fir that we have given it the above English name, though there are other species which have green bodies and black heads. We first met with it on the terminal shoots of the black spruce on Peaks Island, in Portland Harbor, June 22, 1881, and also at Brunswick and Harpswell on the day following, where it was associated with the caterpillars of the Spruce Bud-worm (*Tortrix fumiferana*). Unlike that species it does not, so far as we have observed, cause any decided alteration in the appearance of the shoots of the tree, not being social or abundant enough to strip the leaves from a single shoot, as in the case of the Spruce Bud-worm, or the Reddish-yellow Spruce Bud-worm (*Steganoptycha ratzeburgiana*) found on the white spruce last season.

The egg-laying habits are not yet known, as none of the moths on issuing from the chrysalis mated or proceeded to deposit eggs.

The caterpillars usually live near the ends of the shoots, feeding on the new leaves, which begin to grow out early in June; cutting off the tender leaves they make a passage way between them and the shoot, which they line with white silk. When disturbed they rapidly crawl out of their silken retreat and let themselves down to the ground by a silken thread. They are very active in their habits and in confinement in tin boxes will squeeze through the narrow space between the box and the cover, so that only an unusually tightly closed box will confine them. Sometimes, at least in two instances, the caterpillars constructed a case of the leaves which they had cut off at the end of a fresh bud.

The caterpillars were very abundant in 1881 in spruce and firs on the shores and islands of Casco Bay, from June 10 until July 20. As full-grown larvæ are abundant during the early part of June, it seems that it hibernates among the shoots of the tree during the winter, and that as in the case of the Spruce Bud-worm (*Tortrix fumiferana*) it hatches in August, or at least late in the summer, and becomes nearly fully grown before cold weather sets in.

The caterpillar when fully grown is of the usual shape of a leaf-roller, deep green, with a dark reddish head and cervical shield; before the last molt the head and prothoracic or cervical shield are black.

From the 14th to the 16th of June the caterpillars change to chrysalids within the slight white cocoon they spin among the bases of the leaves next to the shoot. The moths begin to issue early in August, and continue to appear until the middle of the month. In one case the insect pupated from July 6th to the 10th, the moth issuing on the 19th; hence the pupal period lasts about two weeks. Others which pupated July 14 to 16 appeared three weeks later. None of the insects lingered

\* Extracted from U. S. Department of Agriculture, Division of Entomology, Bulletin No. 12, p. 17.

in the pupa state beyond the 14th of August. The moths are subject to great variation, the details of which are given in the description. In their color they are assimilated to the moss-covered bark of the larger branches of the trees on which they rest.

The caterpillars are sometimes preyed upon by ichneumons, two small Ichneumonidæ having been bred from pupæ in confinement. No Chalcid parasites have yet been observed to prey upon this species.

Should the worms attack shade or ornamental firs and spruces, they can be subdued by spraying and striking the branches and shoots so as to dislodge the worms.

*Larva before the last molt.*—Body pale green, nearly of the color of the fresh leaves, with the head and cervical or prothoracic shield black. Length, 10–11<sup>mm</sup>.

*Full-grown larva.*—Body pale pea-green, moderately thick, gradually tapering from the middle to the end of the body. Head of the usual shape, somewhat bilobed, not so wide as the body; dull reddish amber, or greenish-yellow amber-colored in front; partly brownish-black behind and on the sides, the black forming two patches on the vertex. Prothoracic or cervical shield black on a greenish ground; varying to greenish-amber edged behind with blackish; sutures and lateral ridge slightly tinged with yellowish. On the body-segments the piliferous warts green, not distinct; arranged as usual in a trapezoid. Thoracic legs greenish amber-colored, first pair larger and darker than the others; abdominal legs pale green, concolorous with the body. Length, 12–14<sup>mm</sup>.

*Pupa.*—Body rather slender, the double rows of dorsal spines as usual, but the spines are smaller and not so sharp as usual. End of the abdomen broad, square, and much flattened vertically, with a small down-curved spine on each side; on the square edge of the tip are from four to six slender, small, curved, stiff bristles. There are two similar bristles on the under side within the edge of the square tip. Length, 8–9<sup>mm</sup>.

*Moth.*—Head white or subocherous; palpi dull gray, with white scales. Thorax either white and black or reddish ocherous with white scales. Fore wings with the basal third either black, gray, or snow white; usually dark gray; on the outer edge of the dark portion are two groups of sharply raised scales. Beyond is an irregular white band, the white sometimes obscured by gray scales; this band is very irregular in width, being narrow on the costa, widening towards the middle of the wing; it is indented on the inner side at the second tuft of raised scales; where the band is widest, viz, on the outer edge behind the middle of the wing, is a deep sinus, very distinct in those specimens where the band is white; on each side of the mouth of the sinus is a sharp tuft of raised black scales, and within (one near the costa) are the smaller tufts. In those specimens in which the rest of the wing is whitish there is a large triangular dark spot, with the base resting on the costa; usually, however, the outer third of the wing is dusky or clear gray, with dark specks and clouds, and the triangular patch is obscured. Sometimes when the wing is clear gray the veins on the outer third are hardly clouded with a darker shade of gray. Hind wings and abdomen slate gray. Expanse of wings, 12–15<sup>mm</sup>.

This is a very variable moth, but the four or five raised tufts are nearly always present. Some striking varieties are here noted:

(a) Fore wings gray, with a broad whitish-gray band just before the middle of the wing; the large dark triangular spot not present.

(b) The outer third of the wing concolorous with the band, thus leaving a large distinct triangular spot.

(c) Fore wings snow white at base, with a snow-white band near the base, in the outer edge of which the sinus is very distinct; the outer third of the wing is either white or blackish.

(d) The base of the fore wings clear, deep ochereous, and ochereous streaks on the thorax.

(e) The most aberrant form, and which would readily be referred to a distinct species if it had not been reared from the same kind of caterpillar. It has a dark grayish-white head, and two black bands on the thorax. The fore wings are dark gray, finely lined and mottled with black, but interrupted by a broad, very conspicuous, clear ochereous band extending from the base of the wing to the apex, inclosing the median vein and submedian fold. There is only a single high black tuft on the lower edge of the basal third of the wing. One appeared July 30, and another August 20. Hind wings dark slate gray, with an obscure ochereous slash at the apex.

The following description was prepared by Professor Fernald from five specimens sent him:

Head and palpi ashy gray, the latter a little darker on the outside.

The thorax is dark ashy gray with a few blackish cross-streaks on the forward part of it, and there is a stout thoracic tuft tipped with reddish brown on the posterior part.

The fore wings are ashy gray, variegated with black and white, with a few yellowish scales intermingled. The basal pitch is black, more or less broken with whitish, and has three black tufts of scales on the outer edge—one on the fold, another on the cell, and the third between this last and the costa. An oblique band, white on the costa, but suffused below, starts from the basal third of the costa and crosses the wing outside of the basal patch. The inner margin of this band is slightly angulated, the most prominent angle being on the fold. The outer side of the band gives off a prominent angle on the cell, which ends at a large tuft of black scales near the end of the cell, and there are several other tufts along the outer margin of this band. The surface of the outer part of the wing is of a somewhat leaden blue color, especially when worn, and mottled with black, white, and yellow scales, but the black is mostly in coarse streaks containing several small tufts. The costa beyond the middle is blackish, with three small white spots at nearly equal distances apart. The fringes of the fore wings, of the upper side of the hind wings, and of the abdomen are darker gray with a silky luster. The under side of the hind wings is lighter, with darker cross-streaks or reticulations, which are much brighter towards the apex. The under side of the fore wings is dark gray, except along the costal border, where the markings of the upper side are dimly reproduced. The legs are brown on the outside, but pale yellowish within and on the end of the joints. This seems to be a very variable species, and at first sight one might think that there were more than one species.

One variety has the top of the head yellowish, and the oblique band and outer part of the wing dull whitish and slightly touched with yellowish. Another variety is quite dark, and has a broad bright ocher-yellow band through the middle of the fore wing from the base to the apex.

A third variety, in very poor condition and bred on white spruce in Ashland, Me., has the head white and the basal part of the fore wings white with only slight traces of the black tufts and markings. Expanse of wings, 14<sup>mm</sup> (Fernald).

### 30. THE FIR TORTRIX.

*Tortrix packardiana* Fernald.

This moth was bred from the fir on Peaks Island, Casco Bay, Maine, and sent to Professor Fernald, who regarded it as new and sent us the following description:

Head whitish; palpi and thorax ashy gray; fore wings with a whitish ground color and marked with black, which is more or less overlaid with pale bluish or whitish scales. The black basal patch has an obtuse angle pointing out on the mid-

dle of the wings. An oblique black band broken in the cell crosses the middle of the wing. A black patch rests on the costa before the apex, marked with one or two white costal spots; a similarly colored patch within and above the anal angle, and still another on the outer border inclosing the apex, sends in a square projection towards the end of the cell. All the black markings are overlaid more or less with white scales, and the white portions of the wings are somewhat stained with gray. The fringes are dark smoky-brown.

The hind wings and abdomen above are ashy gray. Fringes lighter. Under side of the fore wings ashy gray, with the white costal marks reproduced. Under side of the hind wings whitish, irrorate with gray. Expanse of wings, 16 to 18<sup>mm</sup>.

Bred from the fir by Dr. A. S. Packard, for whom I name this species in recognition of his extensive and valuable work on North American insects. (Fernald.)

### 31. THE RED SPRUCE BUD-WORM.

*Gelechia obliquistrigella* Chambers.

Associated with the preceding bud worm there occurred in abundance, both on the terminal shoots of the spruce and fir, a little reddish cylindrical caterpillar, about two-thirds as large as the larva of *Teras variana*, and very active in its habits. It occurred as early as the 10th of June, but it disappeared earlier than the caterpillar of *Teras variana*, and the moths, which were common, flying in spruce at and soon after the middle of July, were not seen after the first week in August.

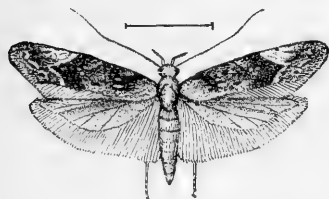


FIG. 284. *Gelechia obliquistrigella*.

The caterpillars were beaten from the trees from June 10 to July 17; after that it was impossible to find any of them. The moths began to appear July 16-19, and continued to emerge in the breeding boxes until August 1. The duration of the pupa state is about one week.

It is evident that the species is single-brooded and that the caterpillar is hatched in August, and becomes nearly full-grown in the early autumn, hibernating when nearly full-fed, since the fully grown caterpillars are abundant by the first week of June. The species has been identified for me by Professor Fernald. It was described from Kentucky by Mr. Chambers, but the larva and food-plant have been hitherto unknown.

When about to pupate it spins a small, thin, delicate cocoon, being a tubular case of silk covered with bits of the scales of the spruce or fir buds. It is placed next to the shoot in the débris made by the larva at the base of the leaves. Length, 6<sup>mm</sup>; diameter, 2<sup>mm</sup>.

*Larva*.—Body cylindrical, of the usual form, reddish brown in color, and about 6 to 7<sup>mm</sup> in length.

*Pupa*.—Body rather thick, of the usual pale mahogany brown color, the antennæ and tips of the wings on the under side reaching to the middle of the fifth abdominal segment. End of the abdomen full and rounded, with about ten unequal, irregularly situated slender bristles, which are slightly curved at the end; besides these there are several fine bristles along the side of the body near the tip. Length, 5<sup>mm</sup>.



*Moth*.—Head cream-white; antennæ with the basal (second) joint white, beyond ringed with white and black. Palpi white, first and second joint speckled with black, second (longest) joint ochereous at the end; third (last) joint with two black rings of unequal size, the outer the longer; the tip white. Fore wings moderately wide, oblong ovate. Ground color ochereous whitish gray; costal region blackish, base black. A broad oblique band proceeds from the costal edge to the middle of the submedian space, ending in two white spots; there are some whitish scales on the outer edge of the band. Just before the middle of the wing is a broad irregular black band, and beyond it in the submedian space a black spot. A third broad black band crosses the wing, ending on the hind margin and breaking up into three black spots on the hind margin; the band incloses near them two twinned white dots. Near the outer fourth of the wing is a conspicuous white line, sharply bent outwards just behind the middle of the wing; beyond the apex of the angle of the line are several white scales. At the base of the fringe is an oblique line of black scales. The fringe, like the adjoining part of the wing, is of mixed gray ochereous, with black scales. Hind wings rather broad, pointed, pearly slate gray. Legs, including tarsi, banded with black. Expanse of wings, 13<sup>mm</sup>.

When rubbed the green color of the fore wings becomes paler, and the three oblique black bands are more distinct.

### 32. THE SPRUCE PLUME-MOTH.

*Oxyptilus nigrociliatus* Zeller.

The chrysalis of this Plume-moth was beaten from the branches of the spruce June 23, at Brunswick, Me., under such circumstances as to lead me to believe that the larva feeds on this tree. In Europe no member of the family to which it belongs (*Pterophoridae*) is stated, so far as we have been able to ascertain, to feed on coniferous trees, so it is worthy of mention, though too infrequent to be of much significance. The moth issued July 10, and has been named for me by Professor Fernald.

The larval skin occurred with the chrysalis; the head is of the normal form, pale in color, while the cast skin showed that the body was covered with long, dense hairs.

*Pupa*.—Like that of *Pt. periscelidactylus*, the thorax being obliquely truncated, and the body somewhat compressed. Thorax in front with six pairs of long, curved, stiff hairs, those of the abdomen in two dorsal rows of five pairs, and a lateral row of short, stout spines; from each of the dorsal spines radiate four slender hairs; from the spines of the lateral row arise two hairs which are curled and parallel with the longitudinal axis of the body. The wings extend to near the middle of the sixth abdominal segment. Color, pale green; wings and body whitish green. Length, 7<sup>mm</sup>.

*Moth*.—Uniform dark brown, fore wings forked with four white costal spots, the third the largest and widest, the fourth linear, oblique, and extending on the second or hinder division of the wing; the latter with a white spot near the base. Scallop of the fringe white, a black patch at the internal angle; hinder edge of the wing white, apex blackish. Expanse of wings, 16<sup>mm</sup>.

### 33. *Lophyrus abietis* Harris.

This species is common on the spruce. From July 1–30, 1884, it was abundant, spinning its cocoon July 30. Following is a description of the larvæ we found:

*Larva*.—Head black; eight pairs of abdominal legs; body dark green, the color of a fir leaf; no median dark stripe; a broad lateral conspicuous dark stripe, and below a second dark broken stripe along the lateral ridge.

34. *Lophyrus* sp.

On spruce September 11, 1887; a *Lophyrus* larva, with the head reddish; the body pale yellow, with the dark stripes unusually distinct, especially a broad lateral dark brown stripe. An allied species is represented on Pl. VIII, figs. 5, 5a.

35. *Lyda* sp.

(Plate X; fig. 7, 7a.)

Order HYMENOPTERA; family TENTHREDINIDÆ.

A *Lyda* larva, new to me, occurred on the spruce July 1 to 7, 1886, at Brunswick, Me., making a mass of castings  $1\frac{1}{2}$  inches in diameter, near the end of the branch, and forming galleries among the castings. The worms, on being placed in another branch, soon spun a large web, within which they glided about. They were kept for a number of weeks in confinement under the best possible conditions, but finally died.

*Larva*.—Body rather long and slender, but moderately thick; head and prothorax of the same thickness. Head black, prothoracic segment jet black, with a dorsal shield and a lateral rounded boss. Thoracic feet black. Subanal abdominal legs 3-jointed, black, basal joint paler at base. Body dull livid olive green, stained with faint purplish. A dorsal and a vertical median dark diffuse line. Body much wrinkled, with purplish warts on the wrinkles. A distinct lateral raised line. Supraanal plate large, with a V-shaped raised area and lateral ridges, the sunken spaces between the raised ridges dark. Length, 23<sup>mm</sup>.

36. *Lyda* sp.

This species appears to be different from the preceding species; it occurred on the spruce at Brunswick, Me., September 18, 1884.

*Larva*.—Body of the usual shape. Head dark, pitchy-brown; the prothoracic shield small and of the same color as the head. Body pale, flesh-reddish-brown.

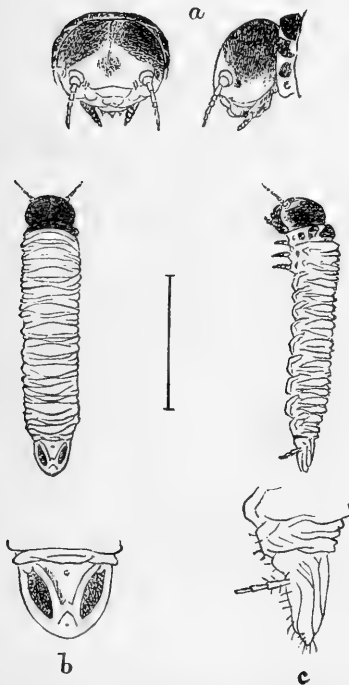


FIG. 285.—*Lyda*, on spruce; a, head, front and side; b, end of body seen from above; c, from side. Brigham, del.

37. THE SPRUCE BUD-LOUSE.

*Adelges abieticolens* Thomas.

Order HEMIPTERA; family APHIDÆ.

Deforming the terminal shoots of the spruce, producing large swellings, which would be readily mistaken for the cones of the same tree.

We take the following account and illustration from our Guide to the Study of Insects:

The genus *Adelges* was proposed by Vallot for certain broad, flattened plant-lice which attack coniferous trees, often raising swellings on twigs like pine and spruce cones. The antennæ are short, 5-jointed and slender; there are three straight veinlets arising from the main sub-costal vein and directed outwards, and there are no honey tubes; otherwise these insects closely resemble the Aphides. A species closely related to the European *Adelges* (*Chermes*) *coccineus* of Ratzeburg, and the *A. strobilobius* of Kaltenbach, which have similar habits, we have found in abundance on the spruce in

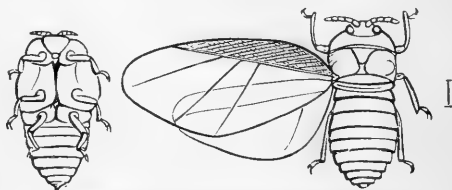


Fig. 286.—The Spruce louse.—From Packard.

Maine, where it produces swellings at the ends of the twigs resembling in size and form the cones of the same tree. We would add that each leaf-bud is enlarged, having an *Adelges* under it. As those nearest the base mature first and leave their domicile, the deformed leaf-bud stands out from the axis of the shoot, thus giving the cone-like appearance to the end of the shoot.

This has since been described by Prof. Cyrus Thomas in his Third Report on the Injurious Insects of Illinois, p. 156.

38. THE EUROPEAN SPRUCE BUD-LOUSE.

*Adelges abietis* Linn.

We observed this species in considerable numbers on the Norway spruces on the grounds of the Peabody Academy of Science at Salem, in August, 1881. The deformation produced in the terminal buds and twigs were like those figured in Ratzeburg's *Die Waldverderbniss*, Bd. i, Pl. 28, figs. 1, 2.

39. SPRUCE-TREE PLANT-LOUSE.

*Lachnus abietis* Fitch.

Occurring on *Abies nigra*; the wingless females pubescent, broadly oval, blackish, clouded with brown, with a faint ashy stripe on the back; under side mealy, with a black spot near the tip; antennæ dull white, with a black ring at the tip of each joint. Length to the tip of the abdomen 0.15 inch. (Fitch.)

It is probably this species which we have found in abundance on the terminal branches of spruces at Brunswick, Me., in July and August.

## 40. THE SPRUCE-TREE LEAF-HOPPER.

*Athysanus abietis* Fitch.

Order HEMIPTERA; family TETTIGONIIDÆ.

Puncturing their leaves and extracting their juices the latter part of May and during the month of June, an oblong black shining leaf-hopper 0.20 long, tapering posteriorly, and broadest across the base of the thorax, with a light-yellow head, having the mouth black, and also two bands upon the crown, the ends of which are often united, and commonly with a white streak on the middle of the inner edge of the wing-covers, its legs being pale yellowish varied more or less with black.

"I first met with several specimens of this insect eleven years since, upon the black spruce and fir balsam, on the summit of the Green Mountains, in an excursion hither with that martyr of science, the late Prof. C. B. Adams. Since then I have repeatedly captured this same insect upon birch trees, distant from any spruces, and it is possible it might have been accidentally present on these latter trees in the instance first mentioned, there being numerous birch trees in the same vicinity." (Fitch.)

## AFFECTING THE CONES.

## 41. THE SPRUCE CONE-WORM.\*

*Pinipestis veniculella* Grote.

This is the first occurrence, so far as we know, of a caterpillar preying upon the terminal fresh young cones of the Spruce. We have previously† called attention to the Spruce Bud-louse (*Adelges abieticolens*) which deforms the terminal shoots of the spruce, producing large swellings which would be readily mistaken for the cones of the same tree. Another species of Bud-louse (*Adelges abietis* Linn.), which appears to be the same as the European insect of that name, we observed several years since (August, 1881) in considerable numbers on the Norway Spruces on the grounds of the Peabody Academy of Sciences at Salem.

The species of caterpillar in question was observed, August 24, in considerable numbers on a young spruce 10 to 20 feet in height at Merepoint on Casco Bay, Maine. The cones on the terminal shoot as well as the lateral upper branches, which when healthy and unaffected were purplish green and about 1½ inches long, were for the most part mined by a rather large Phycid caterpillar. The worm was of the usual shape and color, especially resembling a Phycid caterpillar not uncommon in certain seasons on the twigs of the Pitch Pine, on which it produces large unsightly masses of castings within which the worms hide.

\* Reprinted from Bulletin U. S. Department of Agriculture, Division of Entomology, No 13, 1887.

† Guide to the Study of Insects, p. 523, and Bulletin 7, U. S. Ent. Comm., p. 234.

The Spruce Cone-worm is usually confined to the young cones, into which it bores and mines in different directions, eating galleries passing partly around the interior, separating the scales from the axis of the cones (Fig. 287). After mining one cone the caterpillar passes into an adjoining one, spinning a rude silken passage connecting the two cones. Sometimes a bunch of three or four cones is tied together with silken strands; while the castings or excrement thrown out of the holes form a large, conspicuous light mass, sometimes half as large as one's fist, out of which the tips of the cones are seen to project (Fig. 288). Besides these unsightly masses of castings, the presence of the caterpillars causes an exuda-

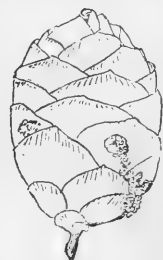


FIG. 287.—Single pierced cone (original).

tion of pitch, which clings in large drops or tears to the outside of the adjacent more or less healthy cones. Where much affected the young cones turn brown and sere.

The same worms had also attacked the terminal branches and twigs of the same tree, eating off the leaves and leaving a mass of excrement on one side of the twig, within which they had spun a silken gallery in which the worm lived.

On removing the bunches of diseased cones to Providence, one caterpillar transformed in a warm chamber into a moth, which appeared the end of October; its metamorphosis was probably accelerated by the unusually warm autumnal weather. All the others had by the 1st of November spun within the mass of castings a loose, thin, but firm, oval cocoon, about half an inch long and a quarter of an inch wide, but the larvæ had not yet begun to change



FIG. 288.—Mass of infested cones (original).

to chrysalids. Whether in a state of nature they winter over in the larval state within their cocoons, or, as is more likely, change to pupæ in the autumn, appearing as moths by the end of spring, remains to be seen.

The chrysalis is of the usual Phycid appearance, rather slender, but with the abdominal tip blunt, with no well-marked cremaster or spine, though ending in the usual six curved stiff bristles, by means of which it hooks on to the walls of its cocoon, thus maintaining itself in its natural position.

I found only one tree next to the house thus affected by this worm. It is probable that in a dense spruce growth the trees would be less exposed to the attacks of what may prove a serious enemy of shade spruces. The obvious remedy is, to burn the affected cones and mass of castings late in summer.



FIG. 289.—Spruce Cone-worm (enlarged, original).

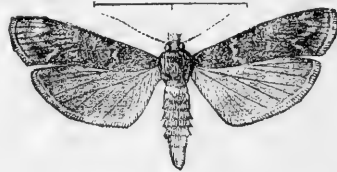


FIG. 290.—Moth of Spruce Cone-worm (enlarged, original).

*Larva*.—Of the usual Phycid form; the head and prothoracic shield deep amber brown; the body reddish carneous or amber-brown, with a livid hue; a faint, dark, dorsal, and a broader, subdorsal line; piliferous warts distinct; each segment divided into a longer anterior and shorter, narrower, posterior section, bearing two dorsal piliferous warts, besides a lateral one. Length 16<sup>mm</sup>.

*Pupa*.—Of the usual Phycid appearance; rather slender, the abdominal tip blunt, with six long slender up-curved bristles. Length 9<sup>mm</sup>.

*Moth*.—1 male. Forewings long and narrow, stone-gray, with no reddish or brownish tints. Head, palpi, and body dark gray with white scales intermixed. Forewings dark and light gray; a broad basal light pitch; before the middle of the wing a white zigzag line composed of a costal and median scallop. A square whitish distal patch, and half way between it and the outer margin is a narrow white zigzag line inclosed on each side by a dark border, the line being deeply angulated three times. Edge of the wing next to the base of the fringe deep black, interrupted by narrow pale gray spots. Fringe dusky, with fine white scales. Legs banded with black and gray. Hind wings pale gray. Expanse of wings 22<sup>mm</sup>; length of body 10<sup>mm</sup>. (Identified by Prof. C. H. Fernald.)

In "A note on *Dioryctria decuriella* and its allies," in the Entomologists' Monthly Magazine for March, 1888, E. L. Ragonot remarks: "The North American *Pinipestis reniculella* Grote and *P. abietivorella* Grote I consider only dark forms of *decuriella* Hb., and, of course, the generic name of *Pinipestis* Grote is simply synonymous with *Dioryctria* Z." He states that *D. decuriella* Hübn. (*abietella* S. V.), feeds both on firs and pines, and that the larva "lives in the cones, young shoots, and decayed wood of the coniferæ."

#### 42. THE PINE NEPHOPTERYX.

*Pinipestis Zimmermanni* Grote.

This is said by Mr. Zimmermann to be destructive to young spruces in New York. (Can. Ent., XII, p. 59.)

The following insects also occur on the spruce :

Order LEPIDOPTERA.

43. *Eacles imperialis* Hübner. This caterpillar is reported by Mr. Hulst to feed on the spruce. (Bulletin Brooklyn Ent. Soc., ii, p. 77.)  
 44. *Grapholitha bracteata* Fernald, Comstock's 1880 Rep. Dept. Ag., p. 265. Affecting *Abies bracteata*.

INSECTS INJURIOUS TO THE ROCKY MOUNTAIN SPRUCE AND DOUGLASS SPRUCE.

*Abies menziesii* and *A. douglasii*.

AFFECTING THE TRUNK.

1. THE ROCKY MOUNTAIN SPRUCE TIMBER-BEETLE.

*Dryocates affaber* Mannh.

Order COLEOPTERA ; family SCOLYTIDÆ.

This beetle occurred (July 7, 1875) in abundance in all stages in a growth of *Abies menziesii*,\* the common spruce of the Rocky Mountains, at Kelso's Cabin, 11,200 feet elevation, on the road to Gray's Peak. It bores into the bark and near the sap-wood in all directions, its burrows resembling those of *Tomicus pini*, with which it is associated, being irregular but much smaller.

The larva is of the usual form of those of the family, being cylindrical and of the same thickness throughout, with the end of the body full and suddenly rounded ; segments convex, especially the thoracic ones, and slightly hairy. Head two-thirds as wide as the body, rounded, honey-yellow. Length, 0.15 inch.

The pupa is much like that of *T. pini*, with two anal soft, sharp tubercles. As my specimens are further advanced than those of *T. pini*, the wings being free from the body, and the abdomen longer, it is impossible for me to draw up a good description. In one example the pupa had retained the larval head, but it was split behind so as not to interfere, probably, with the development of the adult beetle.

The beetle differs from *Tomicus pini* in its much smaller and slightly slenderer body. The head and prothorax are two-thirds as long as the rest of the body. The abdomen is not scooped out at the end as in *T. pini*, but truncated, moderately rounded, and the end of the abdomen reaches to the end of the wing-covers, which are square at the end instead of excavated as in *T. pini*. Color reddish brown, much as in *T. pini*. The body is covered with fine, stiff, straight hairs. Length, 0.14. (Packard in Hayden's Report for 1875.)

This insect is said by Le Conte to occur in the Lake Superior region, British Columbia, and Alaska.

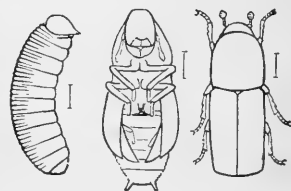


FIG. 291.—a, larva ; b, pupa ; c, beetle of the Rocky Mountain spruce timber beetle.—From Packard.

\* This tree was kindly identified for me by Mr. Sereno Watson, from specimens of the leaves and cones sent him for identification.

## 2. THE PINE TIMBER BEETLE.

*Tomicus pini* Say.

This insect, already described on page 168, is common in the timber region of the Rocky Mountains, boring irregularly into the inner bark of *Abies menziesii*. The burrows are like those made by the same insect in the white pines of New England. The main burrows of the mines observed in Colorado were .08 inch in diameter.

## 3. THE COMMON LARGE RED TIMBER BEETLE.

*Polygraphus rufipennis* Kirby.

This beetle, so common in Maine and British America, is also common in the coniferous trees of the mountains of Colorado, where I have met with it at Blackhawk and at Manitou. (See p. 721.)

## 4. THE LARGE TIMBER BEETLE. \*

*Dendroctonus terebrans* (Olivier).

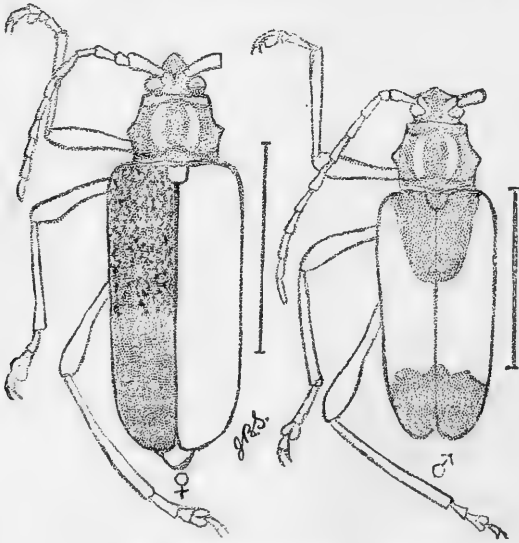
This common eastern form, which occurs from Maine to Georgia, and in California and Oregon, also probably infests the pine and spruce of elevated regions. I have a specimen from Tacoma, Wash., on Puget Sound, a lumbering town, which was identified by Dr. G. H. Horn. (See p. 721.)

## 5. THE WESTERN SPRUCE LONGICORN BORER.

*Anthophilax mirificus* Bland.

Order COLEOPTERA ; family CERAMBYCIDÆ.

This beautiful beetle I found June 16, 1877, under the bark of a large fir-like spruce, probably *Abies menziesii*, on the side of a high hill near

FIG. 292.—*Anthophilax mirificus*. Smith del.

Virginia City, Mont. The small male was sexually united with the black female, and there were several other females near by. From



these circumstances I have little doubt but that it bores into this tree. There is a great disparity in size and color between the sexes, and the male is much the smaller and is blue-black, with most of the elytra deep brick-red, the ends of the elytra being blue-black, as well as an oblong oval spot at the base of the united elytra; the terminal two-thirds of the abdomen is reddish; it is 16<sup>mm</sup> long; the female is 21<sup>mm</sup> long, and entirely blue-black. It was identified by Dr. Horn.

6. *Scolytus unispinosus* Lec.

Mr. J. B. Smith gives the following account of this borer in *Entomologica Americana*, II, 1886, p. 125.

A few days since (July 12, 1886) Mr. L. E. Ricksecker, of Sylvania, Occidental P. O., Cal., sent me a section of Douglass spruce (*Abies douglassii*) infested by a Scolytid, about which he writes as follows: "The wood is a small section from the upper limb of a Douglass spruce, which was cut down on April 9, 1886. Many species of Coleoptera attacked the tree on the same evening in a perfect swarm. Next day and thereafter but few of these were seen. Other species, however, made their appearance, and among these were numbers of *Scolytus unispinosus* Lec. For a week I could see them moving hurriedly up and down the limbs of the prostrate tree. Then they became less, and by May 6 only a few stragglers could be found.

Noticing that something was boring in these limbs and throwing out little piles of dust, I cut out patches of bark, and found in every case two *Scolytus* occupying a straight gallery; one, presumably the male, being at the opening, and the other at the far end. At that date, May 6 to 10, the burrows were about an inch long; now (July 4), the main burrow is two to three inches long, with about twenty-six side galleries on each side diverging therefrom. The parent beetles are gone, but at the end of each side gallery is a larva, working farther and farther away from the main gallery. They work only in the layer of bark nearest the wood, leaving a slight impression of their galleries on the wood. When full-grown they turn towards the surface and there await their transformations."

To this interesting account of Mr. Ricksecker a few notes based on the specimen (now in the National Museum) and on the literature may be not uninteresting.

The specimen shows two complete main galleries with the larval galleries—about 30<sup>mm</sup>—a length of 1½ inches—at irregular intervals on each side. These extend at first at right angles with the main gallery, but become sinuous almost immediately, and the larvæ change their direction, working upwards above and downwards below the middle of the main burrow. Those larvæ nearest to the center work longer at right angles, but eventually turn either upward or downward, and sometimes change the course of the gallery. One gallery shows a larva that first worked at right angles for a distance, and then started downward until it came very close to another gallery. Rather than enter this it changed its course; went obliquely upward for a distance, and then again turned downwards at right angles. Two larval galleries from the same main gallery rarely cross each other, but sometimes two main galleries are close together, and then the larval galleries cross and re-cross in the wildest confusion. The main galleries are sunken about as deeply into the wood as in the bark; but the larval galleries are deeper in the bark. At the point of entrance there is an enlargement of the gallery, of a size sufficient to permit the beetle to turn.

There are also, in the specimen, five main galleries, with either no larval galleries at all or just started. One of these galleries is interesting, for here the beetle came in, formed a small cell, and started downward for half an inch, then changed its mind, and turning, started upward for about an inch. In the main galleries no eggs seem to be laid within 4<sup>mm</sup> of the entrance. Before the parent beetle has finished

its burrow the eggs laid nearest the entrance have hatched, and the larval galleries will be from 3 to 4<sup>mm</sup> in length at the entrance before the last eggs are deposited.

In general appearance the galleries of *unispinosus* resemble most nearly those of the European *Sc. intricatus*. But the most interesting point in Mr. Ricksecker's communication is the food-tree. No other species of *Scolytus* whose food-habits are recorded lives on conifers. All attack deciduous trees. So striking a departure from the general habits of the genus is rather remarkable, and furnishes another instance of the dangers of reasoning from analogy.

Mr. E. A. Schwarz has furnished me with a list of food plants of the European and American species, which is as follows:

*Sc. amygdali*. Feeds on *Amygdalus*.

*Sc. ratzeburgi*. Feeds on *Betula*.

*Sc. carpini*. Feeds on *Carpinus*.

*Sc. pruni* and *rugulosus*. Feeds on *Pyrus*, *Prunus*, *Cratægus*.

*Sc. intricatus*. Feeds on *Quercus*.

*Sc. geoffroyi*, *pygmaeus*, *kirschi*, *multistriatus*. Feeds on *Ulmus*.

The American species, of which the food habits are known, are the following:

*Sc. quadrispinosus*: *Carya*.

*Sc. fagi*: *Celtis*, *Fagus* (?).

*Sc. muticus*: *Celtis*.

*Sc. rugulosus*: *Prunus*, *Pyrus*. (Imported from Europe.)

*Sc. unispinosus*: *Abies douglassi*.

Of the remaining five species *Sc. californicus* is tolerably common in collections, but the others appear to be exceedingly rare; in fact, it is questionable whether any but the typical specimens are known. The second food plant of *Sc. fagi* (*Fagus*) is somewhat in doubt. Dr. Le Conte (Rhynch, p. 372) says: "Depredates on beech trees, according to Mr. Walsh;" but, on referring to Mr. Walsh's original article (Pract. Ent. II, p. 58), we find the following statement: "I obtained many specimens in South Illinois, from what I believe was a beech." Thus it still remains somewhat doubtful whether the species really infests the beech.

Dr. Hamilton states (Can. Ent. XVII, 1885, p. 48) that *Scolytus rugulosus* breeds in hickory twigs, but Mr. Schwarz (Proc. Ent. Soc., Washington, I, No. 1, p. 30) maintains that this hickory species is different from *rugulosus*, and apparently undescribed.



FIG. 293. Mine of *Scolytus unispinosus*.—After J. B. Smith.

## CHAPTER XVII.

### INSECTS INJURIOUS TO THE FIR TREE.

#### *Abies balsamea.*

##### AFFECTING THE TRUNK.

###### 1. THE PINE LONGICORN BORER.

###### *Monohammus confusor* Kirby.

Fully grown larvæ, very large and long, and evidently ready to pupate, occurred under the bark of a dead fir near the Glen House, White Mountains, July 22. A fir tree was without doubt killed by these borers at Merepoint, Brunswick, Me., as from the freshly cut stump a fully grown dead larva and beetle were taken from the holes, several of which were in the tree. The holes were round and 7<sup>mm</sup> in diameter. Other trees were observed here and also on the Harpswell road with large round holes in the bark, evidently the work of this borer. In 1882 I saw a fir at Phippsburg basin which had plainly been nearly killed by this larva; the tree was mostly dead, some of the branches with red leaves; a number of holes were in the trunk. We have also called attention (p. 688) to the fact that living firs are often killed by a borer answering to this species in the forests about the Rangeley Lakes.

###### 2. *Xyloterus bivittatus* (Kirby).

This beetle occurred, though not commonly, under the bark of the fir near the Glen House, July 22.

###### 3. *Xylebores cœlatus* Zimmermann.

This beetle occurred in abundance in a fir stump, with the larvæ, August 27, at Brunswick.

###### 4. *Crypturgus atomus* Leconte.

This minute species occurred frequently under the bark of a fir stump at Brunswick late in August.

###### 5. THE WHITE PINE WEEVIL.

###### *Pissodes strobi* Peck.

This weevil, with the larva and pupa, was found under the bark of a fir tree on the Mount Washington carriage road, near the Glen House, July 22.

6. *Rhagium lineatum* Olivier.

Larvæ of this beetle, one-half grown, occurred August 27, at Brunswick, in a fir stump.

## AFFECTING THE LEAVES.

## 7. THE FIR-TREE SAW-FLY.

*Lophyrus abietis* Harris.

Order HYMENOPTERA; family TENTHREDINIDÆ.

This pest of the fir which also infests pines has been described on page 757.

The specimens I found of this species, the females of which I raised from the larva and submitted to Mr. E. Norton for identification, had larvæ, of which the following description is taken from my notes. Much like that on the cedar and juniper, but darker green, with a black head and thoracic feet. Median dorsal stripe pale instead of dusky, and besides a pale subdorsal stripe, with a whitish green lateral firm stripe. Beneath paler green than above. Of the same size. It spun a light silk cocoon August 23. The imago was found dead in the breeding box September 14, 1881, and must have left the cocoon during the first week in September. The antennæ are black, serrated. Body dull horn-yellow; abdomen a little paler, more amber colored; legs concolorous with the body. Wings smoky, with black veins. Length 7<sup>mm</sup>. Cocoon regularly oval-cylindrical; of a pale silken brown; length 8<sup>mm</sup>.

## 8. THE TUSSOCK MOIH.

*Orqyia leucostigma* Abbot-Smith.

Order LEPIDOPTERA; family BOMBYCIDÆ.

Feeding on the leaves of the fir in July and August in Maine, a hairy caterpillar with two black pencils of hairs in front, one median, one behind; four medio-dorsal short thick yellow tufts, succeeded by three dorsal coral-red tubercles, on the back.

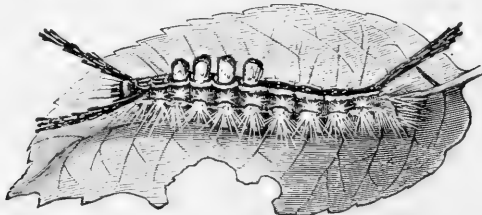


FIG. 294.—The tussock caterpillar, nat. size.—After Riley.

The hairs of this caterpillar are quite poisonous, and if they get through or into the skin prove very annoying. I once crushed one of these

pretty caterpillars in endeavoring to brush off one which was crawling on the back of my neck; the hairs were thus forced into the skin and

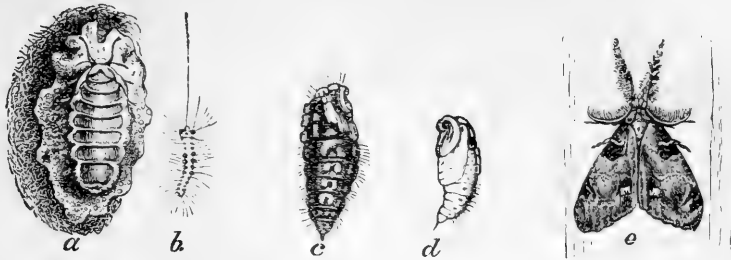


FIG. 295.—The tussock moth; *a*, female; *e*, male; *c*, female pupa; *d*, male pupa; *b*, freshly-hatched larva. Nat. size.—After Riley.

caused, as the result, the skin to smart severely for forty-eight hours. The female was first seen flying at Brunswick, Maine, Aug. 29.

#### 9. *Olygia versicolor* Grote.

This species occurred on the fir, Aug. 28–31, at Brunswick, Maine.

*Larva*.—Head rather large, as wide as prothorax, blackish, not striped but marbled with black. Seen from above the body is of nearly uniform thickness. Along the back a series of broad triangular black patches, lined on each side with silver, the silver streaks making a series of sets of oblique streaks. The hump at the end of the body is high, and lined with silver on each side. The ground color is a rich black-brown. Length, 13<sup>mm</sup>.

#### 10. THE WHITE-LINED CATERPILLAR.

Order LEPIDOPTERA; family NOCTUIDÆ.

Feeding on the leaves of the fir in August in Maine, a larva of the usual Noctuid form. Head nearly as wide as the body, smooth; body rather thick, smooth, pale pea-green. A dorsal somewhat broken snow-white line, and two wider subdorsal ones. A broken bright-red lateral line, edged below with white and yellowish. Ends of all the legs reddish. Length 22<sup>mm</sup>.

#### 11. A NOCTUID LARVA.

Order LEPIDOPTERA; family NOCTUIDÆ.

Feeding on the leaves in August in Maine, a cylindrical noctuid larva with ten pairs of abdominal legs. Head of moderate size, as wide as the prothorax; body thicker just in front of the middle. Segments of the body rather convex; prevailing color pale horn-brown, mottled with yellowish or reddish brown; with four black rounded button-like tubercles arranged in a trapezoid on the top of each segment. Length, 18<sup>mm</sup>.

#### 12. THE FIR PARAPHIA.

*Paraphia deplanaria* Guenée.

We have three species of *Paraphia*, two of which feed in the larval state on coniferous trees, Mr. William Saunders having bred *P. subatomaria* from the pine, on which it feeds in early summer, the moth ap-

pearing late in June; the larva is not, however, known farther than that its color is brown.

The caterpillar of the present species was found June 23, at Brunswick, Me., on the fir; on the 27th it became a chrysalis, and the moth escaped about a week or ten days later.

*Larva*.—Body cylindrical; in color and appearance like a fir twig. Head rounded, somewhat bilobed; body with no humps. Supra-anal plate rounded, not pointed at the tip, with six hairs. Color reddish brown with a greenish tint. Head greenish, mottled, and finely spotted, especially on each side of the vertex, with reddish brown; a row of lateral irregular dark blotches. Length, 22<sup>mm</sup>.

*Pupa*.—Of the usual shape, but rather stout; dark tan-brown in color. Terminal spine (cremaster) large and stout, the surface corrugated at the base, ending in a fork, each branch of which ends in two excurved hooks. Length 12<sup>mm</sup>.

*Moth*.—Forewings subocherous, with a median whitish band, beneath ocherous. The male may be distinguished by its smaller size, by the wings being more ocherous, by the distinct discal dots, and by the rather distinct median white band on the forewings. The female differs greatly from the male, being much larger and with the wings more serrate, the two inner lines more or less obsolete, the border of both wings being much darker than the inside of the wing, the border sometimes having a lilac tinge. From the female of *P. subatomaria* it differs in its still smaller size, in having usually but one subapical spot instead of three, as is usually the case in the other species, and in the outer border of the wings being darker or more decidedly ocherous. The wings of the female are more deeply serrated than in the other species. Expanse of wings, 22 to 35<sup>mm</sup>.

### 13. *Aplodes coniferaria* Pack.

Order LEPIDOPTERA; family PHALENIDÆ.

The following account was published by us in the American Naturalist:

We have reared six moths from curious 14-flapped larvæ found feeding in August on the fir and hemlock, and described in Bulletin VII, U. S. Ent. Comm., p. 238, and referred by us to *Aplodes*. The caterpillar is dull, brick-red, with seven pairs of broad dorsally-situated flat flaps on each side. It bears a striking resemblance to the small reddish twigs of the fir with the leaf scars.

From the 4th to the middle of September the caterpillars made between the twigs a loose, slight, open cocoon of bits of small twigs and leaves, held together by silk, within which the pupa rested through the winter.

Walsh's description of the larva of *Aplodes mimosaria*, which he bred from the oak, is too brief for comparison, but our specimens do not disagree with his diagnosis, though we have never found it on the oak, but frequently on the coniferous trees mentioned.

On sending specimens to Mr. J. A. Lintner, to compare with his types of the species in his possession, he kindly writes as follows:

"Differs from *mimosaria* in the outer line of front wings being nearer to the margin and the inner line being angulated on the submedian instead of curved. The outer line of secondaries is nearer to the margin than in *mimosaria* and is more regular.

"It approaches nearer to *latiaria*, but the two lines are more approximate, and the inner line is more angulated on the submedian. It also has an inner line on the secondaries which *latiaria* has not."

*Larva*.—It bears a striking resemblance to the small reddish twigs of the fir with the leaf-scars. Body dull brick-red, with seven pairs of broad flat flaps on each side, those in the middle of the body being the largest. Head angular on the sides, deeply

incised; when at rest retracted partly under the projecting prothoracic segment. The last segment with a large triangular thick lateral flap. Two dorsal dull yellowish sinuous lines, separated by a narrow median reddish line. Body beneath with dull obscure sinuous, somewhat broken, coarse yellowish lines. On the last segment are two high sharp tubercles. Supra-anal plate rounded. Body roughly granulated. A light dull whitish yellow lateral stripe, extending down on the anal legs. Length, 15<sup>mm</sup>.

Some of the caterpillars occurring on the fir have a smoother body, less wrinkled, and the head is not red, but pale green. There is a conspicuous white spiracular line; and two subdorsal pale yellowish indistinct lines; the sutures are distinctly yellow.

*Pupa*.—Of the usual form, rather slender, brown, the abdomen bright brick-red above between the wing-covers; the end horn-brown and mottled; there is a blackish dorsal line and a dark stripe along the antennæ and veins of the wing, the branches being spotted with black. In another specimen the wing-covers were red and the body, including the abdomen, horn-colored; the terminal spine is short, moderately stout, with eight unequal curved slender spinules. Length, 9 to 10<sup>mm</sup>.

*Moth*.—Six specimens, two of them males, issued from the chrysalids in the breeding box, in Providence, between April 20 and 25. They were all of uniform size, the wings expanding about 25<sup>mm</sup>. They differed but slightly from *A. mimosaria*, though much smaller; compared with one of the latter the hind wings are more angulated, while the outer white line on the same wings is less bent in the middle. The lines on the fore wings are as in *A. mimosaria*, but vary in distance apart. The head and abdomen are marked as in *A. mimosaria*; the male hind tibiæ are as in that species. It differs decidedly from the two other species of its size, *A. approximaria* and *latiaria*.

#### 14. *Semiothisa bisignata* (Walker).

(Larva, Plate XXXII; fig. 1, 1a-1h.)

Though more common on the pine, the figures on Plate XXXII were drawn from a specimen collected on the fir, at Brunswick, Me., August 27-30. For details see Explanations of the Plates.

It also occurred on the pitch pine July 15 to August 3, at Brunswick, Maine.

#### 15. THE FIR-NEEDLE INCH-WORM.

*Eupithecia luteata* Pack.

Order LEPIDOPTERA; family PHALENIDÆ.

(Larva, Plate x; fig. 4.)

This is a common caterpillar on evergreen trees, excepting the pine, and was described in Bulletin 7, U. S. Entomological Commission, p. 237; No. 8 also, p. 206, No. 83. The caterpillar is rather flat, the surface granulated, the body reddish and bearing a remarkable resemblance to a red, dead fir-leaf. It turns to a chrysalis late in August and early in September in Maine, and the moth appears the following May and June.

This is one of the most remarkable cases of mimicry yet noticed among those feeding on coniferous trees. Often on beating them into an umbrella, which I used in collecting caterpillars, have I hesitated to pick

them up, waiting to see whether or not they were simply dead fir-leaves; in some cases the caterpillars themselves answered the question by walking off at their peculiar measuring gait.

The caterpillar changed to a chrysalis August 25; the pupa appearing September 7, at first greenish, became pale mahogany brown. Length 6<sup>mm</sup>. It was frequently observed on *Pinus strobus* in August.

*Larva*.—Feeding in August on the leaves of the fir and very closely mimicking the reddish partly dead leaves or needles; a measuring or inch worm, with the body flattened from above downward and tapering at both ends, thus closely approximating the form of the fir-leaf. Head small, narrower than the body; smooth, pale, mottled and spotted with reddish. Body reddish, covered with fine whitish papillæ; a faint blackish, somewhat broken narrow dorsal line; a fine pale whitish subdorsal line. Lateral line yellowish in partly grown caterpillars, obsolete in larger ones, becoming distinct on the sides of the not large sharply acute supra-anal plate; two large acute spines below the plate. Body beneath of a peculiar glaucous greenish white, with a median reddish line. Thoracic and abdominal legs dull livid reddish. Length 20<sup>mm</sup>. Observed not unfrequently at Brunswick, Me., late in August; also found feeding at Brunswick on the low-bush common juniper (*Juniperus communis*) August 26-29, 1881.

*Moth*.—Differs from *Eupithecia miserulata* in the much longer, more pointed fore wings. The palpi are also larger, acute, and black. It has four regularly curved parallel black lines on both wings; it is also characterized by the broad, clear, flesh-yellow or luteous band situated between the discal dot and the extradiscal line. Expanse of wings, 22<sup>mm</sup>.

#### 16. THE ANGULAR-HEADED, MARBLED FIR INCH-WORM.

Order LEPIDOPTERA; family PHALENIDÆ.

(Plate x, fig. 2.)

Feeding on the leaves in Maine, late in August, also on cedar, August 30, 1883, a very slender inch-worm; the body tuberculated, blackish brown. Head angular; the vertex angulated above on each side. Body with five pairs of well marked small prominent lateral tubercles; sutures between the segments not well marked, so that it is difficult to tell on which segment the tubercles are situated. Body wood-colored, it is the shade of the bark of the tree, mottled with black-brown, reddish gray and gray markings. Head marbled or mottled like the body, with a whitish line along the top of each side, and continued along the prothoracic segment, and in the form of two broken white faint lines along the sides towards the end of the body. Anal legs much larger than the other abdominal legs. Length about 20<sup>mm</sup>.

This caterpillar is not specially mimetic, though it is probably protected from the search of birds by its general resemblance to a dry fir twig. It may be recognized by its angular head, dark marbled body, colored like the bark of the branches on which it rests, and by the five pair of sharp, prominent small tubercles. It closely resembles in coloration the caterpillar, *Olygia versicolor*. Plate XXXIII, figs. 1, 1a-1h, also represent the caterpillar.

#### 17. THE TEN-LINED PINE SPAN-WORM.

Feeding on the leaves of the fir, hemlock, and spruce, an inch-worm with a very slender body, with minute prominent tubercles, and a large, full, rounded head; the latter deeply divided in the middle, and much wider than the body. The general color a



flesh tint, with 8-10 blackish-brown lines on top of the body. Head reddish, mottled with dark brown. On the side of nearly each segment a pair of dark acute tubercles and below the bright straw-yellow lateral ridge (the line is broken in fully grown larvæ) is a black irregular flattened broad eminence. Supra-anal plate large, projecting far behind and, like the pair of anal legs, flesh red. Body beneath deep flesh-colored, with dark linear stripes. Length of body 20<sup>mm</sup>.

This caterpillar, which may be recognized by its slender body, with 8-10 dark lines, the broken lateral straw-yellow line, and the large rounded deeply incised head, is common not only on the fir, but also on the spruce and hemlock late in August and early in September in Maine. In fully grown caterpillars on each segment of the body are two high rounded subdorsal and two larger lateral tubercles, which are reddish flesh-colored tipped with black, and there are two rounded supra-anal tubercles. This caterpillar is infested by a *Microgaster*, a single one of these small ichneumon larvæ issuing from the body and spinning a cocoon during the last week of August. The same caterpillar is described under Pine insects No. 112, p. 784.

#### 18. GEOMETRID CATERPILLAR.

This caterpillar occurred on the fir, June 27 to 29, 1885. It pupated about July 6. Pupa quite different from that of *Thera* :

*Larva*.—Body rather full and thick. Head smooth, somewhat bilobed, well rounded, not quite so wide as the body. Head and body green, a deeper tint than the upper side of a fir leaf. Two linear subdorsal pale yellow lines, and a broader lateral deeper straw-yellow line. Anal legs no larger than the pair in front. Length, 18<sup>mm</sup>.

#### 19. GEOMETRID CATERPILLAR.

This caterpillar occurred on the fir, July 1 to 12, 1887. It pupated July 30-31:

*Larva*.—Head flattened; slightly bilobed, as wide as the body. Body slender, thickening a little towards the eighth abdominal segment. On end of fourth abdominal segment two large tubercles with a regularly curved whitish line in front. A pair of similar piliferous dorsal swollen tubercles on eighth abdominal segment. Other abdominal segments with four minute dark dorsal tubercles. Color of head and body like a small dead fir twig, marbled and lined with gray and black-brown. Supra-anal plate light-colored, with six piliferous tubercles and supra-anal tubercles of the legs large and swollen, conspicuous. Anal legs rather large. Length, 35<sup>mm</sup>

#### 20. GEOMETRID CATERPILLAR.

This caterpillar has the head rounded, is like a twig, and is quite unlike any other species. It occurred at Brunswick, August 30 to 31, on the fir :

*Larva*.—Head moderately large, not quite so wide as the body, which is moderately thick. Head rounded, somewhat bilobed, the lobes well rounded, marbled with reddish. Body smooth, a small double hump on the penultimate segment, and the mesothoracic segment is somewhat swollen on each side, while the lateral line is rather prominent. General color is dark wood-brown, the head reddish and the body

marked with black and here and there dashed with reddish. Supra-anal plate small and obtusely pointed, and concealing the small dorsal spines. A dorsal interrupted dark stripe and lateral obscure, more or less dark lines. The body is crossed in front of the middle by a curved blackish line, curving anteriorly and forming a conspicuous line, being oblique on the sides of the body. The slight hump is black, inclosing a white area in front. An oblique silvery line on each side of the first abdominal legs, and the lateral line is touched with silvery.

The minor markings are too complicated to describe, but it mimics in appearance and color a twig of the fir. Length 15<sup>mm</sup>.

#### 21. THE RED AND YELLOW STRIPED PINE SPAN-WORM.

(Plate x, fig. 3; Plate xxxiii, fig. 2, 2a-2f.)

The larva, described on p. 784, also occurred on the fir on the grounds of Bowdoin College, Aug. 28-31, but I have been unable to carry it through its transformations. The figure on Plate x has been very poorly reproduced by the lithographer; and fig. 2a, in Plate xxxiii, represents the body as narrowing too much at the end.

#### 22. THE FIR TORTRIX.

*Tortrix packardiana* Fernald.\*

This moth was bred from the fir on Peaks Island, Casco Bay, Maine, and sent to Professor Fernald for identification (see p. 849).

#### 23. TORTRIX CATERPILLAR.

This caterpillar occurred on the fir June 26 to 28, at Brunswick, Maine. It began to pupate June 29, making a slight silk cocoon among the leaves at the end of the season's growth. Ichnumoned and died.

*Larva*.—Body of the usual shape, full, cylindrical, and soft, with five pairs of abdominal legs. Head small, pale greenish amber, with a short black stripe on the side, much narrower than the prothorax which is narrower than the rest of the body. Length, 12<sup>mm</sup>.

#### 24. THE PINE LEAF-MINER.

*Gelechia pinifoliella* Chambers.

The leaves of the fir were found at Brunswick, Me., to be affected by this miner much as in the pitch pine (p. 792), the terminal third of the leaf being paler than the rest. A dead pupa skin was found July 15.

#### 25. THE FIR SCALE-INSECT.

*Lecanium* sp.

On the upper side of a fir leaf a single specimen of *Lecanium* was found at Brunswick, which was low, flat, broad, oval, blackish, almost as broad as the leaf.

\* This description first appeared in U. S. Department of Agriculture, Division of Entomology, Bulletin No. 12, p. 19

## 26. THE FIR MITE.

Order ARACHNIDA; suborder ACARINA.

Quite prevalent on the fir, working at the base of the leaves at the ends of the twigs, in summer and early autumn, in Maine; little dark mites, with rounded bodies, and quite active in their movements, causing the leaves of the fir especially to curl up, and to show the light under side. These little active mites spin a slight web in the axils at the end of the shoots. They are dark brown, with a yellowish head and thoracic region, while the legs and under side are of the same yellowish tint. They were observed from the middle of July until the 1st of September at Brunswick, Me., and occurred on the white pine as well as on the fir trees.

The following species are also said to occur on the fir:

## Order LEPIDOPTERA.

27. *Loxotaenia afflictana* (Walk.). Fernald's Cat. Tortricidæ, p. 13.
28. *Lophoderus velutinana* (Walk.). Miss Murtfeldt in Fernald, l. c., p. 16.
29. *Gelechia obliquistrigella* Chambers.



FIG. 296. —Work of a mite on fir.



## CHAPTER XVIII.

### INSECTS INJURIOUS TO THE HEMLOCK AND LARCH.

#### *Abies canadensis.*

Dr. Fitch refers to the remarkable immunity of the hemlock from the attack of insects, yet it will be seen in the following pages that a number of pests attack both the trunk and leaves; still this tree is much freer from insect enemies than the spruce and fir. He states, however, that the porter *Hylotrupes* (*H. bajulus* Linn.) is reported to sometimes attack this fortunate tree, and that the larva of *Eacles imperialis* is said to occasionally feed on it, as well as a bug.

#### INJURING THE TRUNK.

##### 1. THE CANADIAN LEPTURA.

*Leptura canadensis* Fabricius.

Order COLEOPTERA; family CERAMBYCIDÆ.

Probably mining the trunk of the hemlock, a longicorn larva changing to a rather large handsome black beetle, with the black wing-cases deep red at the base, and antennæ broadly ringed with reddish.

Mr. George Hunt, of Providence, tells me that he has found the pupa of *Leptura canadensis* in the stumps of the hemlock in July in the Adirondacks, New York. The beetle is rather a large one and is black, the surface coarsely and densely punctured. It may readily be identified by the base of the wing-covers being deep red, while the antennæ are broadly ringed with paler red, the joints in the middle being alternately red and black. It is three-quarters of an inch in length.

##### 2. A LARGE LONGICORN BORER.

Order COLEOPTERA; family CERAMBYCIDÆ.

Mining under and loosening the bark of fallen hemlock logs near the Glen House, White Mountains, N. H., a large longicorn borer with the general appearance of *Monohammus*, but belonging to a different genus. Length of the different specimens from 7 to 17<sup>mm</sup>.

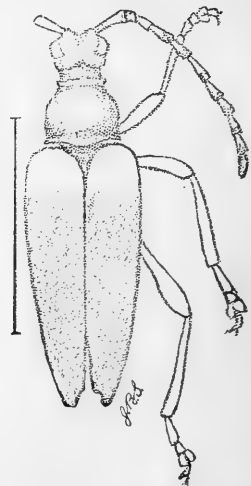


FIG. 297.—*Leptura canadensis*.  
Smith del.

Plate XII, Fig. 5, represents the Longicorn larva mentioned on p. 241 of Bulletin 7 (No. 2), as found in abundance under the bark of the hemlock at the Glen, N. H., July 22. It is 19<sup>mm</sup> in length; width of the prothoracic segment, 4.5<sup>mm</sup>.

3. A SHORT, THICK LONGICORN BORER.

Order COLEOPTERA; family CERAMBYCIDÆ.

Found under the bark of dead hemlocks at Bath, Me., July 30, a short, thick unknown longicorn borer.

Plate XII, Fig. 6, represents a Longicorn larva found under the bark of the hemlock, and mentioned on p. 241, Bulletin 7 (No. 3), as having occurred at Bath, Me., July 30.

The body is remarkably short and thick; as wide near the end as across the prothoracic segment. It is 20<sup>mm</sup> in length. Mandibles rounded; antennæ long and slender, 4-jointed; maxillæ with the lobe long, extending as far as the end of the 4-jointed palpi. Labium narrow; palpi large, 3-jointed. Labrum small and narrow.

4. A BUPRESTID BORER.

Order COLEOPTERA; family BUPRESTIDÆ.

Found under the bark of dead hemlocks at Bath, Me., July 30, a Buprestid larva of different sizes, perhaps a species of *Dicerca*.

Plate VI, Fig. 5, represents a Buprestid larva, mentioned in Bulletin 7, p. 241 (No. 4). It is 20<sup>mm</sup> in length, and Dr. Gissler's figures so well represent the larva that a longer description will not at this time be needed.

5. THE WHITE PINE WEEVIL.

*Pissodes strobi* Peck.

This weevil and its cells were found in hemlocks among a number of small standing dead spruces, which had, like them, been killed by the attacks of Longicorn borers, and by the following species of bark-borer:

6. *Crypturgus atomus* Le Conte.

This minute bark-borer was observed in considerable numbers in standing dead hemlocks at Bath, Me., July 30.

7. THE HEMLOCK BARK-BORER.

*Hadrobregmus foveatus* (Kirby).

Order COLEOPTERA; family PTINIDÆ.

The bark of hemlock trees and of hemlock logs, as well as the separated bark piled up by the roadside near the Glen House, in the White Mountains, last summer, was found to be perforated in all directions

by this beetle, which has been obligingly identified by Dr. G. H. Horn, of Philadelphia. Not only the bark of dead trees, but that of healthy large trees had harbored great numbers of these beetles. They, however, had disappeared from the holes at the date (July 22) I was at the White Mountains, and but a single dead specimen was found. Similar mines were found in a hemlock at Brunswick, Me.

#### 8. THE BROWN PRIONUS BEETLE.

*Orthosoma brunneum* (Förster).

Order COLEOPTERA ; family CERAMBYCIDÆ

Mr. F. G. Schaupp writes me as follows concerning this beetle, which is not harmful to the tree, attacking it usually when in the last stages of decay :

In a hemlock tree I found, July 20, in New York, hundreds of the larvæ of all sizes from 5-50<sup>mm</sup> in length, the wood being exceedingly hard and tough, but although the new developed imagines (soft) were very abundant, and although I found some moldy dead pupæ, I could not find a live pupa.

#### AFFECTING THE LEAVES.

9. *Tolyte laricis*. (Fitch).

Aug. 30, I beat a freshly evolved specimen of this moth from a hemlock tree at Brunswick, Me., so that I have no doubt it lives on this tree as well as the larch and white pine.

10. *Tetracis lorata* Grote.

Order LEPIDOPTERA ; family PHALENIDÆ.

The moth was bred from a large twig-like caterpillar found on the hemlock at Brunswick, Maine, August 25. The moth appeared in the breeding-box April 25. *Tetracis crocallata* feeds on the sumac, according to Mr. Saunders.

*Larva*.—Head flattened, square in front but not notched, slightly full on each side of a slight median impressed line. Pale gray, with a diffuse straight vertical band on each side, the middle being clear whitish gray. These dark latero-frontal bands and the pale gray median band are continued on to the prothoracic segment. The median whitish band is continued on to the meso-thoracic segment, but forms there two linear parallel white thread-like lines inclosing a linear brown median line; on each side of this ring, directly behind the prothoracic spiracle, is a large rough tubercle; the granulations coarse and prominent; white on the sides, above tawny-brown. On the first and second abdominal segments is a pair of swollen infra-spiracular rounded tubercles, concolorous with the body. The body is dull reddish brown. The two piliferous warts are connected and converted into a transverse tubercle, becoming larger towards the fifth abdominal segment; the tubercles behind rather large but not connected. From the fifth abdominal segment to the end of the supranal plate extends a black median line. Along the sides of the abdomen, on segments 2-5, is a lateral raised short brown line edged below with pale gray; these are situated in front of the spiracles. Below are three large tubercles on each segment,

and there is a tubercle beneath. Hence the caterpillar represents a large rough twig, with leaf-scar-like tubercles. Anal plate sharp, triangular, tuberculated. Anal legs large. Length 38<sup>mm</sup>.

*Pupa* is rather thick; the body in front, including the wings, horn-brown, speckled with blackish; abdomen reddish brown. Spiracles distinct black. Terminal spine large, ending in two long straight acute spinules. Length 17<sup>mm</sup>.

*Moth*.—Body and wings uniformly cream-white; wings unspotted, with a single dull, ochereous, oblique, straight line extending from just beyond the middle of the inner edge to the costa, ending just before the apex; hind wings with no line, immaculate. No discal dots on either wings. Beneath immaculate, the band not re-appearing on the fore wing. Expanse of wings 1.75 inches.

It differs from *T. crocallata* by the cream-white wings, the dull ochereous line on the fore wing, while the apex of the fore wing is not so pointed as in *T. crocallata* or *aspilates*, and there is no line reproduced beneath, and no traces of a discal dot beneath. The hind wings are much more obtuse than in *T. crocallata*.

#### 11. *Caripeta divisata* Walker.

Order LEPIDOPTERA; family PHALÆNIDÆ.

One larva of this species was found September 15, 1884, feeding on hemlock. It changed to a pupa October 11, and gave out the moth July 2, 1885, having been sent as a larva to the office of the United States entomologist at Washington, where it was reared.

*Larva*.—Head pale grayish-brown, with darker, transverse, fine, wavy lines. Dorsum grayish yellow with a medio-dorsal pale dusky arrow-like mark, its point directed forward, on each segment. Piliferous warts black. Lateral line yellow, around the stigmata orange.

*Pupa*.—Body very thick and stout, pale brown, somewhat frosted over on the head and thorax, the body becoming mahogany brown towards the tip of the abdomen. Surface coriaceous, rough, with elongated pits. Cremaster flattened, very rough at base, ending in two large down-curved hooks and two pairs of very small curved lateral bristles. Length, 14<sup>mm</sup>.

*Moth*.—This fine moth may be recognized by the nearly white ground-color of the wings, with the broad, mesial, blackish, mottled band, darker on the edges, bordered on each side with a broad white band, and inclosing a large oblong, oval, white discal spot. It differs so much from *C. angustioraria* that it would scarcely be referred to the same genus. Expanse of wings 1.55 inches.

#### 12. *Eupithecia luteata* Pack.

Order LEPIDOPTERA; family PHALÆNIDÆ.

(Larva, Plate X; Fig. 4.)

Feeding on the leaves late in August in Maine, a slender-bodied measuring inch-worm of the general color of the terminal twigs, and not quite so wide as a hemlock leaf. Head not so wide as the body, with a moderately deeply impressed median line; pale flesh-colored, mottled, with pale reddish brown spots, and with long brown hairs. Body mostly greenish yellow, the tints pale and delicate. A dorsal row of diffuse elongated spots, extending backward from the transverse blackish stripes on the sutures between the segments. On each of the three thoracic segments is a transverse row of black warts and hairs, sit-



uated on the hinder edges of the second and third segments from the head; but nearer the middle in the segment next to the head. All the abdominal segments covered with fine whitish warts, giving a shagreened appearance to the skin. The lateral raised line very prominent; the body not being thick, but appearing as if partly shriveled below a dusky lateral stripe. Supra-anal plate large, broad, flat, subtriangular. On the underside of the body a median dusky linear stripe, on each side of which the body is whitish. Two faint dusky subdorsal lines, one on each side. This caterpillar, as it occurs on the hemlock, varies a good deal; some examples being transversely banded with brownish-red, giving them a checkered appearance.

13. *Eupithecia* sp.

Order LEPIDOPTERA; family PHALENIDÆ.

This caterpillar was beaten from the hemlock at Providence, September 19.

*Larva*.—Head rounded, slightly bilobed; as wide as the body, which is smooth, not granulated, the segments distinctly wrinkled; lateral ridge quite distinct. Head and body yellowish green, next to the sutures straw yellow; no distinctive markings. Length 16<sup>mm</sup>.

14. THE 10-LINED PINE INCH-WORM.

Order LEPIDOPTERA; family PHALENIDÆ.

This was also found on the hemlock at Brunswick, August 27.

Head rounded, bilobed, the lobes a little prominent above, but scarcely angular; fully as wide as the body; reddish brown, with a dark transverse diffuse band across the vertex, and fine wavy dull brick-red transverse stripes.

Body moderately thick, with no humps or tubercles, but transversely wrinkled; general color dull brick-red brown, with lighter lilac and whitish markings. This larva may at once be recognized by a series of large dorsal lozenge-shaped whitish-lilac spots, behind each of which is a pair of black dots inclosing a conspicuous white one. The fourth of these lozenge-shaped pale lilac spots enlarges into a pale patch surrounding the body. Beneath, pale lilac passing in the middle into a livid greenish tint. Supra-anal plate rounded, rough with piliferous tubercles; anal legs broad and long. Length 18<sup>mm</sup>.

Feeding on the hemlock in the grounds of the Butler Asylum, Providence, Rhode Island, September 18, 1883.

Bull. p. 206, no. 83.

15. THE RED AND YELLOW STRIPED PINE SPAN-WORM.

We have observed a caterpillar on the hemlock September 29, which belonged to this species, but was larger than any I had before observed. The body is provided with seven lozenge-shaped pale patches centered with dark. Length 37<sup>mm</sup>.

## 16. GEOMETRID LARVA.

This caterpillar occurred on the hemlock September 11, 1882, at Brunswick, Me.

*Larva*.—Head deep honey-yellow with a reddish tint. Body greenish, marked with red. Head rounded, slightly bilobed, as wide as the prothorax. Each segment checkered with a blackish dark patch. Three parallel linear longitudinal dorsal blackish lines, which are broken. A lateral rather broad black broken line. Anal legs rather broad but short; supra-anal plate moderate, apex rounded, rather short, probably beginning to pupate. Length, 10 to 12<sup>mm</sup>.

## 17. GEOMETRID LARVA.

This caterpillar, fully grown, was beaten from a hemlock June 11 to 15, at Beede's, Keene Flats, Adirondacks. It mimics a twig, being reddish, with yellowish markings.

*Larva*.—Head as wide as the body; slightly bilobed, the lobes smooth; yellowish brown, with two sinuous reddish brown lines in front. Body transversely wrinkled, rather thick; lateral ridges moderately developed. Reddish brown marked with darker tints, and a blackish irregular spot on the side of each segment. Above is a well-marked dorsal broad pale yellowish line, dilating on the middle of each segment, and on the first abdominal, extending to the black dots on the side. Anal legs stout, concolorous with the fore legs, which are of the same color as the body. Body beneath much as above and on the sides, though a little paler; but with no median line. Length, 20<sup>mm</sup>.

## 18. TORTRICID CATERPILLAR.

Family TORTRICIDÆ; order LEPIDOPTERA.

*Larva*.—Body slender, of uniform width, suddenly tapering towards the end. Head as broad as the body, black; prothoracic shield black, as broad as the body, which is somewhat flattened, more so than usual; color livid greenish, whitish; segments somewhat wrinkled, piliferous, rather large, full, whitish; concolorous with the body; hairs one-third to one half as long as the body. First pair of thoracic feet black, the others concolorous with the rest of the body and the abdominal legs; the last segments paler and concolorous with the body beneath. Length, 7<sup>mm</sup>.

## 19. THE HEMLOCK GELECHIA.

*Gelechia abietisella* Pack.

Order LEPIDOPTERA; family TINEIDÆ.

(Plate IX, fig. 2, 2a; Plate XXVI, figs. 7, 7a, 7b.)

During the spring of 1883, the hemlock trees, large and small, in the vicinity of Providence, R. I., were observed to be much disfigured by the attacks of a small Tineid worm, causing sear and dead patches of leaves on the smaller branches and twigs of both large and small trees.

The small pale-green caterpillars bite off from six to eight leaves, constructing a broad flat irregular case; the leaves on being separated from the twig turn red or yellowish, thus forming a conspicuous patch.

This rude case is held together with silk, the worm living in a rude silken tube, and feeding upon the inside of the leaves. The length of this tube, within which the little caterpillar finally changes to a chrysalis, is from 8 to 10<sup>mm</sup> in length.

The worms are found from the 1st of May through the month of June. One changed to a pupa in its tube about the 20th to 25th of May, and the moth (in confinement) appeared June 1. Other chrysalids were found in the tubes from June 20 to 30, the moths making their appearance early in July.

The moth is beautifully marked, and probably examples occur throughout the summer. Without doubt the eggs are laid on the twigs or leaves in the summer, and the caterpillars become almost full-fed before the winter, hibernating in their cases, becoming active in the spring. The worms are preyed upon by an ichneumon, the oval cocoon with one pupa which had recently transformed, and another ready to imagnate occurring in the cases June 9.

*The full-grown larva.*—Body slender, cylindrical, not flattened. Head of the normal form, not modified in shape as in leaf-mining larvæ; not so wide as the body, smooth, amber colored. Body tapering slightly towards both ends, pale green, of the same hue as the under side of the leaves of the hemlock. Cervical shield well marked, greenish amber. Each segment is dorsally divided by a transverse suture into two slight folds, on the anterior and larger of which are four dark green piliferous warts, arranged in a straight line, and two on the hinder division or fold. There are similar warts on the sides and beneath. Legs 6 + 8: the thoracic feet are pale, blackish at tip. The four pairs of abdominal legs are concolorous with the body. The supranal plate amber-green, with a few long setæ, as long as the body is thick. Length, 6<sup>mm</sup>.

*Pupa* (alive).—In form slender, spindle-shaped, the head considerably narrower than the body, which gradually tapers from the thorax to the end of the body; antennæ and wings reaching to the hinder edge of the fifth abdominal segment. End of the abdomen rather blunt and rounded, with a few very fine hairs. Along the side of the abdomen a row of short, thick spinules, one on the side of each segment, none on the back; a pair of such spines on the under side of the sixth segment. Eyes reddish; body pale amber, with a greenish tint on the thorax. The two terminal segments darker than the rest of the abdomen, and concolorous with the head. Length, 4 to 5<sup>mm</sup>. less connected on the extreme costal edge; three equidistant black points on the submedian vein, the first situated opposite a point half way between the two basal costal spots; the second opposite the end of the second costal spot, and the third opposite the third costal spot; the third spot is sublinear and ends on the edge of the wing at the internal angle. On the costal part of the apex of the wing is a curved row of four black spots, the fourth situated at the extreme apex of the wing, and on the outer and hinder edge are two or three minute black dots, between which and the fringe is a white patch, the fringe being also streaked with white. All the black spots are more or less edged on one side with white scales. The fringe on the outer costal half is lead color with minute black scales at the apex of the wing. Below and within, the long silky fringe is much paler. Hind wings very narrow, almost linear at tip, and with the fringe concolorous with the fringe of fore wings below and within the apex. Body and legs pale glistening buff-yellow. Hind tibiæ long, with a wide fringe; first pair of tibial spines twice as long and about one-half as thick as second pair; the tarsi ringed with black and white. Length of body, 5<sup>mm</sup>; of fore wing, 5<sup>mm</sup>; expanse of wings, 11<sup>mm</sup>.

20. *Tortrix* sp.

This is in general form and markings of the body like *Tortrix fumiferana*, but the head and prothoracic shield are entirely different. Head flattened, a double dark lateral line, the two connecting with the dark lower edge of the prothoracic shield, which forms a conspicuous lateral line. Head and prothoracic shield copal-brown; front edge of the clypeus whitish, the white extending around the side of the head above the eyes. Each abdominal segment with four dorsal and three lateral pale-green piliferous warts, which are conspicuous on the reddish-brown body. Supra-anal plate and anal legs dull greenish. Length, 18<sup>mm</sup>. On leaves of the hemlock August 20 to 30. The larva before pupating spins a thin silken cocoon among the leaves.

## 21. THE HEMLOCK LEAF-SCALE.

*Aspidiotus abietis* Comstock.

At Ithaca, N. Y., Professor Comstock found this scale quite common on the lower surface of the leaves of the hemlock.

*Scale of female.*—The scale of the female very closely resembles that of *Aspidiotus pini*, except that it is usually more nearly circular. This is probably due to the difference in the shape of the leaves which the two species infest. The color of the scale is dark gray, often approaching black, with the margin lighter, and sometimes with a bluish, brownish, or purplish tinge. As with *A. pini*, in many specimens of the fully-formed scale the part covering the exuvia is more or less distinct, appearing like a small scale with a light margin superimposed upon a larger scale. Length of scale, 1.3 to 2<sup>mm</sup> (.05 to .08 inch); width about nine-tenths of the length.

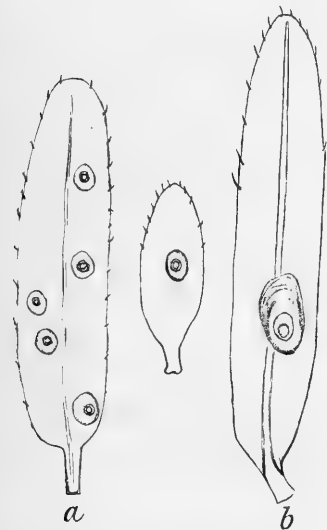


FIG. 298.—Hemlock leaf-scale, much enlarged. Packard del.

*Female.*—The last segment of the female presents the following characters: The groups of

spinnerets are wanting. The mesal and second lobes are well developed; their distal extremities are rounded; the third lobe of each side is small and acutely pointed. The plates are rather short and irregularly fringed; there are two between the mesal lobes; two between each mesal and second lobe; three between each second and third lobe, and usually three laterad of each third lobe. The spines of the dorsal surface are as follows: One laterad of each mesal lobe; one upon each second and third lobe, and one laterad of the most lateral plate. Each ventral spine, with the exception of the first, which is wanting, is situated laterad of the corresponding dorsal spine.

*Scale of male.*—The scale of the male is as wide as that of the female and a little longer. It resembles that of the female in color.

*Male.*—The male is of bright orange color, with the thoracic band very dark brown, nearly black. Described from many specimens of each sex. (Comstock.)

I have found this species not infrequently on the leaves of the hemlock at Brunswick, Maine, in May. Fig. 298 is from camera drawings.

Besides the foregoing, the following geometrids were common on the hemlock August 14, p. 867, Nos. 15, 16, 17, 18, 19, 20.

Also the following:

22. *Parogyia parallela*.

23. *Semiothisa bisignata* (Walk.) Observed Aug. 4, Brunswick, Me.  
 24. *Aplodes coniferaria* Pack.  
 25. *Cleora* sp.  
 26. 10-lined pine-span worm, No. 82, Bulletin No. 7.

## INSECTS INJURIOUS TO THE LARCH OR TAMARACK.

### *Larix americana.*

#### AFFECTING THE LEAVES.

In Bulletin 7 of the United States Entomological Commission we enumerated all the insects known to affect or in any way to prey upon the larch or hackmatack. There were none then known to abound upon or to seriously injure this tree, which has heretofore been supposed to be as free as even the hemlock from insect pests. The hackmatack, as is well known, is one of the most important lumber trees in Maine, as it sends down a single large root, which grows laterally, forming a bend at right-angles to the trunk, so that it is used for "knees" in building vessels, the smaller trees being used for the same purpose in boat-building. It is also used for railroad ties.

The larch grows in wet swamps, or standing water, where the spruce or hemlock as well as pines would not flourish, hence its growth enhances the value of extensive swampy tracts in Maine, where the water often stands all summer, even through the severest droughts.

#### 1. THE LARCH SAW-FLY WORM.

##### *Nematus erichsonii* Hartig.

Order HYMENOPTERA; family TENTHREDINIDÆ.

(Plate IX, Fig. 1, 1a, 1b, 1c, 1d, and Plate XXVI, Figs. 1, 1a, 2, 3, 4, 6.)

*Its devastations in Maine.*—Our attention was first called to this insect late in August, 1882, and we first saw the effects of its ravages at Brunswick, Me., where it had partly or entirely stripped the hackmatacks in a very wet swamp on the banks of the Androscoggin River, on the farm of Hon. C. J. Gilman, who called our attention to the ravages which had been committed earlier in the season. On examining the growth in company with him, we found that most of the trees, both large ones, 6 to 10 inches in diameter, and small saplings, 6 to 15 feet in height, had been attacked; some of the trees were stripped, others partially so, while others had wholly escaped. The trees in the middle of the swamp appeared to have suffered most, while the smaller ones on the edge or on higher land were less injured.

By jarring the trees a few young, half-grown worms of the second brood which had not yet undergone their last molt, and a single fully-grown larva were collected, while the cocoons from which the saw-flies

had escaped earlier in the season were found lying upon the ground or in the moss under the trees. No cocoons with the pupa within, or any other fully grown worms, were to be found.

On the same day (August 30) we examined a noble larch on Mr. Gilman's ground, which had been nearly killed, as he informs us, by these or similar worms.

On September 6 we found that the hackmatacks in cold, boggy, wet land on the crown of Rocky Hill, near Brunswick, had suffered more than elsewhere. Many of the trees were wholly or partially defoliated. According to Mr. Simpson, the injury was here done "about haying time," July, 1881, but the worms had been at work in June and July of the present year. The trees at the time of my visit (September 6) were putting out a new set of leaves on the terminal shoots, the needles or leaflets being from one-third to one-half an inch in length. We also noticed from the railroad train in going from Brunswick to Boston, about the middle of September, that the hackmatacks had been stripped near Portland and Saco; no trees being observed west of Saco, along the line of the Eastern Railroad.

Our attention, however, had previously been called to this insect by its ravages near Augusta, Me., where it first, perhaps, attracted general attention.

The following notice appeared in the *Daily Kennebec Journal* for July 25, 1882:

A white worm about three-fourths of an inch long is destroying the foliage of the hackmatack and fir trees in certain sections in this vicinity. The trees appear all bare and brown, as though scorched by fire.

On applying for specimens and further information to the editors, we received the following note from Mr. W. A. Newcomb, of the *Journal*, under date of July 31:

I send you to-day some of those worms that are eating the hackmatack trees. I could not find any of the large, full-grown worms, and I think they have gone into the chrysalis state. These that I send are just hatched out, and were all the specimens I could find.

Mr. Newcomb afterwards (August 21) sent me the fully grown worms of this brood, which were then at work on the trees.

The following correspondence and extracts will give an idea of the extent of the ravages of this worm in Maine. The "juniper" is evidently a local name for the hackmatack:

Another destructive pest has put in its appearance in the shape of a green worm. It preys on the juniper trees. All the juniper trees in the swamps, and the shade trees, look as though fire had scorched them; the entire foliage is eaten in a few days by millions of these worms.—*Dover Corr. Bangor Commercial*, July 28, 1882.

FOXCROFT, August 17, 1882.

Your card to the *Commercial* is before me. The worms which destroyed the juniper foliage came like a shower, and lasted about a week; they eat the trees clean, and departed all at once, no one knows where or when. I have tried to find one to-day, but could not. The worms were green, smooth, about three-fourths of an inch long,

clustered together on a branch, and they ate continually, I should think, by the quick work they did in stripping the trees. No juniper escaped destruction. The lower limbs of some trees were left untouched.

C. HILL.

We are especially obliged to Charles G. Atkins, esq., Fish Commissioner, and who traveled extensively during the last summer, for information and specimens. He writes as follows :

MANCHESTER, ME., August 25, 1882.

The editor of the Kennebec Journal wrote me that he had sent you one batch of hackmatack worms, and was about to send you another. Doubtless you have all you need. I did not come upon specimens until too late, though now that I have once found them, I marvel that the affected trees did not sooner attract my attention. They are all about here.

I have just returned from a trip to Grand Lake Stream, Washington County, and will give you the results of my observations on hackmatack insects.

From Grand Lake Stream to Princeton, and thence to Forest Station, by stage, a distance of 40 miles, the hackmatacks (there called *juniper*) had been attacked by some insect that had shorn off the foliage of the upper part of each large tree. In all that distance I did not see a dozen trees less than 25 feet high that had been touched, but of those of 30 feet and upward in height 90 per cent. or more had been attacked at the top and denuded (almost completely) down on an average, say 8 feet or 10 feet from the top. The terminal shoots of the main stem and branches did not appear to have been eaten off, but the side whorls of leaves were mostly gone. In some cases the outer extremities of large limbs below the region generally denuded had been attacked near their extremities. There were no worms to be seen on the trees. I climbed one tree and searched it carefully, but found nothing. On descending, however, I found a larva crawling on my coat-sleeve, a greenish slate color, some three-fourths of an inch long, with black head, which I send you in vial. In Hinkley Township I noticed some sphinx larvæ on hackmatack tips, and inclose one. I suppose it was feeding, but did not verify supposition.

From Forest to Bangor, wherever I saw large hackmatacks they had been generally denuded to a greater extent than on the first part of the route, and the work was worse as I approached Bangor, and a smaller class of trees had been attacked than in Washington County.

I ascertained by inquiry that the devastations extended eastward as far as Orland in that direction, beyond which I know nothing.

From Bangor westward the depredations everywhere appeared (I came by rail to Readfield), and on going to a remote part of my farm where hackmatacks grow, I find they have generally suffered, but I notice here that trees under 10 feet in height have generally *escaped*. Here I find that the dormant buds on the sides of the twigs have begun to push out a new growth, which is now one-fourth of an inch long.

I find lots of empty pupa cases in the turf under one of the trees, and send some in a vial; possibly some of them may contain pupæ. No worms to be seen now.

Mr. A. P. Buck, of Foxcroft (postal messenger on E. & N. A. Railroad) told me that they were at work in his vicinity, and had committed more havoc than anywhere on the E. & N. A. Railroad, and even small trees had been completely stripped.

Hon. Z. A. Gilbert, of East Turner (post-office), (his farm is in the northwest corner of Greene and southwest corner of Leeds, or near the Androscoggin River), says the hackmatack worms have been operating in his vicinity for three years. After the first attack the trees all leafed out. After the second some died, and now, after the third, many appear likely to die.

I showed the larva I got in Washington County to both Buck and Gilbert, and they thought it might be the same that they had seen in their sections, except that Mr. G. thought his worms were more positively green in color. He said it was characteristic of them to work first at the top of the tree, as I had observed in Washington County.

Mr. G. is secretary of the Maine Board of Agriculture. It looks as though our hackmatack forests might be totally destroyed by this insect.

I inclose some clippings from the *Home Farm* referring to this insect.

I also send you some terminal shoots of white pine, in which you may find living specimens of a borer in three stages; I suppose it is *Pissodes strobi*. In one grove of white pine on my farm it has taken 10 per cent. of the leading shoots.

CHARLES G. ATKINS.

GRAND LAKE STREAM, ME., *February 27, 1883.*

In September, after receiving your request to send the cocoons to Providence, I examined them (hurriedly), and finding some defective ones concluded the whole lot was worthless. I went out once afterwards to get some more, but did not find them. I now think the cocoons I had were mostly sound in September or October, and possibly may be now, but my keeping them dry and generally warm all this time may have destroyed their vitality. Such as they are I mail them to you herewith.

I learned from E. C. Smith, of New Sharon, Franklin County, that the worm in question infested the hackmatacks in that town last year. Also from Z. A. Gilbert, secretary Board Agriculture, that in August, 1882, he made a trip to Aroostook County, and, my inquiries having called his attention to the matter, he looked for indications of the presence of the hackmatack worm and saw none. He was acquainted with them at home, in Androscoggin County.

Very truly yours,

CHAS. G. ATKINS.

The hackmatack in the region near to and south and southeast of the Rangeley lakes, and near Phillips, Me., were also defoliated in the early part of the summer of 1882, as we have been informed by Dr. H. G. Miller, of Providence, R. I., who went to the lakes in August.

In the summer of 1883 we found the females laying eggs, and young hatched out late in June and early in July, from Brunswick to Phillips, about Lake Umbagog, especially at Errol, N. H., and by the middle and last of July the trees were nearly stripped of their leaves throughout Maine, and many trees were fatally injured.

*Its ravages in New Hampshire.*—In Franconia, as we have been informed by Prof. W. W. Bailey, of Brown University, Providence, the hackmatacks were stripped of their leaves about the middle of July, 1882, the smaller trees suffering most. The trees were observed by him August 10. We noticed at Errol, on Umbagog Lake, numerous trees which had been killed by the worms, and from the number of worms seen July 4th do not doubt that many trees in that section were at least partly stripped a week or two later.

*Its appearance in Massachusetts.*—We learn from Mr. Andrew Nichols that the European larches were, in 1882, attacked by "worms" in the vicinity of Danvers, Mass. In July, 1883, the worms abounded on the same trees, specimens being sent us by Mr. Nichols. We observed worms at work in July, 1883, on the European larch at Lawrence, Mass., and they were also destructive at Danvers, Mass. Prof. C. S. Sargent, director of the Arnold Arboretum, Brookline, Mass., and special agent of the United States Census, Forestry Division, writes us as follows:

I have not heard of any injury to our native hackmatacks. Three or four years ago, however, I noticed that specimens of the European larch in this immediate neighborhood were suffering from the attacks of a larva, which I gathered and submitted to Dr. Hagen. I inclose his note upon the subject.



A copy of Professor Hagen's letter is here inserted :

MUSEUM OF COMPARATIVE ZOOLOGY,  
Cambridge, Mass., July 7, 1881.

The larvæ belong to the Tenthredinidæ (Hymenoptera), to *Nematus erichsonii* Hart. In the Canadian Entomologist, Vol. XIII, No. 2, p. 37, 1881, I have given a short notice concerning the same, sent last year from the Arboretum. The museum is very rich in *Nematus*, but does not possess this species, which is very rare in Europe, and has only twice before 1840 been observed to be very obnoxious to the larch in Holstein by Tischbein and in the Harz by Saxesen. Ratzeburg, in his last work, remarked only that it is rare, but may prove to be rather obnoxious. The species is, so far as I know, not described among the United States species, surely not under its original name.

The following note by Dr. Hagen, extracted from the Canadian Entomologist, is the one referred to in the foregoing letter :

*Nematus erichsonii* on *Larix europæa*.—A large number of larvæ, very young to nearly full-grown, some probably full-grown, were sent living, with the twigs. The larvæ agree perfectly with description and figure in Ratzeburg's Forst-Insecten, Tom. III, Pl. 3, Fig. 4. The species is not represented in the collection here, neither in the larva nor in the imago state. It is not mentioned in Mr. Norton's catalogue of N. Am. Tenthredinidæ. I have to remark that the larvæ of the three other species living in Europe on *Larix*, viz, *Lyda laricis*, *Nematus soleus*, and *compressus*, from their description, do not agree with those sent to me. I am indebted to the Harvard Arboretum and its director, Mr. Charles S. Sargent, for these specimens.—Canadian Entomologist, Vol. XIII, No. 2, p. 37, 1881.

*Its appearance in northern New York*.—Mr. George Hunt, of Providence, who is a close observer of plant and insect life, and who annually visits the Adirondack region in the vicinity of Scroon Lake, informs us that about July 25 and early in August the hackmatacks were seen to be entirely defoliated, no leaves being left on the trees by the 1st of August; he observed the effects of the worms at Horicon, Warren County, and Scroon Lake, in Essex County, as well as at Pottersville. The region affected was very extensive, covering many square miles in different swamps. No worms were observed in 1881. He has presented us with some of the worms, which are of full size, and do not differ from Maine specimens. They were fully grown July 28.

Notwithstanding the efforts made to rear the larvæ of this species last summer, no perfect insects were obtained, the cocoons furnished us by Mr. Atkins having been all parasitized by a species of *Pteromalus*, a parasite of the hymenopterous family Chalcididæ; while of two false caterpillars which spun cocoons, neither had hatched up to the time of writing.

On referring to the great work of Ratzeburg on forest insects, the admirable colored figure of the larva of *Nematus erichsonii* which he gives exactly represents the peculiar style of coloration of our worms; we had identified it as perhaps this species, or as the young of one representing it in this country.

It appears by the foregoing extracts that Professor Hagen had examined the larva and had identified it as *Nematus erichsonii*. We are unable to find any differences in the larvæ from the figure of the Euro-

pean species, and the cocoons are of the size and form as figured by Ratzeburg. A description of the fully grown larva is not given by Ratzeburg. The eggs are described by Ratzeburg (after Tischbein) as about one-half a line ( $\frac{1}{2}$ ''') long, white, transparent, laid in a row upon and within the young larch shoots. The following is a free translation of his description of the saw-fly, which he calls the large larch saw-fly, and figures in Theil III, Pl. III, Fig. 4.

4 to 5''' long and wings expanding 10 to 11'''. In sculpturing and coloring so great a similarity with *N. septentrionalis* ♂ that it would be mistaken for it were it not for the tarsal scoop-like dilatation in latter species; but there is in place of the wing-band only a light shade in the largest cubital cell; both the femoral hooks and apophyses are almost clear, the wing-angle of the prothorax brownish white; the whitish femoral rings are only clear on the hinder legs, and on the abdomen at most the four middle rings are reddish-brown. The punctures are finer than in *N. septentrionalis*, especially on the scutellum and on the rather shining mesosternum.

Ratzeburg states that he himself has not observed this insect, which occurs in Germany and other parts of Europe. It appeared on the larch in the Harz Mountains as well as on the plains of Holstein. The larvæ are social, but do not occur in such thick, crowded clusters as do those of *Lophyrus*. The flies make their appearance toward the middle of June. The eggs are laid usually in a single row on the upper end of the young shoots, two or three sometimes being placed together along the shoot. The eggs are inserted in a little slit made by the ovipositor under the epidermis. They hatch at the end of June and early in July, and the larvæ stop eating, becoming fully grown, toward the middle of August. They then fall from the trees and spin their cocoons under the moss; here they pass the winter, and in the following May enter the chrysalis state within the cocoon, to appear as four-winged flies in June. From a forestry point of view, adds Ratzeburg, the insect might become injurious since the larvæ have already in certain seasons abounded on the larches in sufficient numbers to attract the attention of forestry officers in Holstein.

The habits of the American worm are evidently like those of the European species; and it is very probable that the insect is common to both Europe and Northeastern America. At any rate our species could not have been introduced with European larches, since its ravages have been committed in the wilder, less frequented portions of Maine, New Hampshire, and New York, as well as on the sea-board in towns long settled. In brief, the habits of our species are as follows: The eggs are laid in the terminal young shoots of the larch from about the middle of June, in Massachusetts, to the early part of July in Northern Maine, the larvæ feeding on the leaves late in June and in July and early August. By the last of July to the first week in August, according to the latitude, the worms are nearly fully grown, while a few half-grown ones occur on the trees in Maine in the last week of August and the early days of September. It is very doubtful whether there are two broods. We will now give a more detailed account of its habits.

The eggs had all hatched by June 23 to 28; few were to be found at Brunswick, although the incisions made by the female were commonly observed. The female saw-fly makes about a dozen incisions in the terminal young, fresh, green shoot, sometimes in one of the side shoots next to the terminal one; judging by the shape of the hole, the eggs are of the shape described by Ratzeburg, *i. e.*, oval cylindrical and about 1.5<sup>mm</sup> in length. The eggs are placed in two rows, alternating, not exactly parallel, one being placed a little in advance of the other. The eggs are inserted at the base of the fresh, soft, young, partly-developed leaves of the new shoot, which is usually by June 20-30, only about an inch or an inch and a half in length. The presence of the eggs causes a deformation of the shoot, which curls over, the incisions being in all cases observed on one (the inner) side of the shoot. In many cases a last year's shoot was observed with the scars of the incisions on the concavity of the shoot. That the incisions were made by the saw-fly was proved by finding a freshly hatched but dead larva in one of the holes. Sometimes one or two of the leaves die in consequence of the wounds made at their base.

After the foregoing lines were written we fortunately observed a female in confinement, June 29, while engaged in the process of ovipositing; we should judge that the operation of sawing the slit and depositing the egg required not less than five minutes, and perhaps not much more than that length of time. The fly had been evidently at work for some time previous, as a number of eggs had been laid along the shoot; she had begun at the farther end and worked down to the base of the new, fresh, green shoot. She stood head downward while engaged in making the puncture, and was not disturbed by our removing the larch twig from the glass jar and holding it in our hand while watching the movements of the ovipositor under a Tolles triplet. The two sets of serrated blades of the ovipositor were thrust obliquely into the shoot by a sawing movement; the lower set of blades was most active, sliding in and out alternately, the general motion being like that of a hand-saw. After the incision is sufficiently deep, the egg evidently passes through the inner blades of the ovipositor, forced out of the oviduct by an evident expulsive movement of the muscles at the base of the ovipositor. The slit or opening of the incision after the egg has passed into it is quite narrow and about 1 $\frac{2}{5}$ <sup>mm</sup> in length. While engaged in the process the antennæ are motionless, but immediately after the ovipositor is withdrawn they begin to vibrate actively, the insect being then in search of a site for a fresh incision.

After making the foregoing observations we found at Phillips, Me., July 1, and Errol, N. H., July 4, numerous twigs containing eggs, and the flies were also observed upon the trees ovipositing. Although the slit is at first closed, as soon as the embryo increases in size the twigs swell where they have been incised by the ovipositor, and the slits enlarge and gape more or less, becoming much larger and more conspicuous

than when the eggs are first deposited. It would thus appear that oviposition takes place about a week later in the vicinity of Brunswick, Me., than in Essex County, Mass., and about a week later in northern Maine and New Hampshire than on the coast at Brunswick.

When the larva hatches, the incision gaps open, leaving an oval hole. Out of this gap the larva creeps, and it rarely eats the terminal shoot, but crawls upon the leaves of the whorls next to the terminal shoot. At first it nibbles one side of the needle or leaf, leaving it half eaten and rough, serrate, and partly withered along the edge. The half-eaten, withered leaves of unequal length in a whorl on the end of the smaller branches enable one to detect the presence of the young worms on the tree.

Usually after the young larvæ have shed their first skin, they collect on the verticils of the larch and almost invariably begin to eat the needles, one after another, beginning at the distal end and eating the leaf obliquely until only a short stump is left; in this way one verticil after another is eaten, and when the worms are half-grown they occasionally collect around the main stem of the twig in singular clumps or clusters, the hinder part of the body curled over their backs, and, owing to their oblique posture in reference to one another, appearing like a ball of worms. This singular appearance was briefly noticed by Ratzeburg. The castings, or excrement, are long, cylindrical, more or less truncated at each end. Our saw-fly differs slightly, as has been described, from the German in the eggs being laid at the base of the leaves on the newly-grown shoots, rather than on or just under the epidermis of the last year's shoots, where we have repeatedly and in vain searched for them. The larvæ were observed to hatch out from June 20 to 30 at Brunswick, Me.

The larvæ appear to attain their full size in about five to seven days after hatching; certainly less than or not more than ten days. There appear to be but three molts or changes of skin, *i. e.*, four stages of the larvæ. In casting the skin, the head splits open along the median line of the vertex, and the epicranium or sides of the head split apart on each side, leaving the clypeus and labrum in place; then the body is drawn out of the rent, the skin adhering to the needle or leaf.

*The egg.*—Slender, cylindrical, tapering rapidly towards each end. Length, 1.2mm.

*Larva at the time of hatching.*—The head very large, much wider and higher than the body before the latter falls out from eating; dusky or smoky green, not black, darker in front on the clypeus and labrum than elsewhere; eyes black; thoracic legs smoky green. Body uniformly pea-green: the head and thoracic legs soon become darker, and the body fills out and becomes a little larger after the larva has taken food. Length, 3-3.5mm.

*Larva after the first molt.*—Body pale green, without the glaucous pearly bloom of the two later stages; head and thoracic feet black; the segments wrinkled as in the adult; but the short black spines of the two later stages are not to be seen. Length, 5-7mm.

*Larva after the second molt.*—It now has the peculiar glaucous green bloom of the adult on the upper part of the body, the body being pale pea-green beneath and low

down on the side, while the black spines on the abdominal segments are distinct and arranged as in the full-fed worm. Length, 12<sup>mm</sup>.

*Larva of fourth and last stage* (Pl. IX, Fig. 1b). Length at first, 14-16<sup>mm</sup>. Body with three pairs of black thoracic and seven pairs of abdominal legs, the color of the under side of the body. (The larva may be distinguished from *Lophyrus* worms by having one pair less of abdominal legs, the latter having eight pairs.) Body rather long and slender; less plump than in *Lophyrus abietis*. Head round, jet black (it is usually reddish in *Lophyrus*); seen from in front, regularly circular, mandibles 4-toothed; maxillæ 4-jointed, the joints longer than in *Lophyrus*; the mala or innermost lobe broad and large at the end, with about ten stiff long setæ (in *Lophyrus* the mala is much smaller, with only three very short setæ or stiff spines). The body is of a peculiar glaucous-green color, like that of the under side of the leaves; the glaucous-green dorsal region is plainly separated from the paler under side of the body by a definite line. There are no lateral stripes or spots. The first three (thoracic) segments behind the head are plain, with no minute warts; but around each abdominal segment except the last run two parallel double rows of minute dark dots or warts.

The worm is at once distinguished from any other saw-fly larvæ, on pines, spruce, and firs, by its larger size, its color, and by its jet-black head and its seven pairs of abdominal legs.

*Cocoon*.—Larger and darker than that of *Lophyrus abietis*. Length, 10<sup>mm</sup>; diameter, 5<sup>mm</sup>.

*The imago or saw-fly* (5 females).—A very large, thick-bodied, black species, with abdominal segments 2 to 5, and part of the sixth, bright resin-red.

Head black; maxillary and labial palpi pale whitish flesh-color. Antennæ tapering to the end, black, 9-jointed; the scape with two small short joints, the second shorter than the first; the flagellum 7-jointed, the second joint considerably shorter than the first, and slightly longer than the third; the two terminal joints of equal length and slightly paler than the rest of the antennæ. The clypeus and especially the labrum covered with white, stiff, short hairs, as also the genæ in front. Head and thorax uniformly black, under the triplet seen to be pilose. Basal segment of the abdomen black, segments 2 to 5 bright resinous red, including the basal third of the 6th, this segment beneath being entirely red.

First and second pair of legs, including the trochanters, pale flesh color, the femora, however, somewhat reddish and tipped at the distal end above with black; the third pair of femora red, like the abdomen, black at tip; tibiæ pale, black on the outer third; tarsi black, the under spines pale, including the base of the claws. End of abdomen and ovipositor black. Wings with the costa as far as the stigma reddish; stigma and veins black. Only three subcostal cells, the basal squarish one not being completed, a short obsolete vein projecting from near the stigma.

Length of body, 11<sup>mm</sup>; of antennæ, 6.5<sup>mm</sup>; of forewing, 9<sup>mm</sup>; expanse of wings, 20-21<sup>mm</sup>. One specimen considerably smaller than the others.

*Remedies*.—It is obvious that in swamps in the remoter parts of the country these worms can not be subdued; they will run their course for a term of years. To prevent their killing shade trees, particularly small ones, jarring the trees will prove a good remedy, the worms once shaken off the tree can not ascend the trunk, as they do not, like canker worms, climb trees or let themselves down by a thread. Small trees may also be showered with solutions of Paris green, or the various fluid insecticides recommended in the recent reports of the Entomologist of the Department of Agriculture and in the Introduction to this report.

*Parasites*.—A number of cocoons sent us in 1882 by Mr. Atkins were

found to be in every case tenanted by a minute chalcid parasite, belonging to the genus *Pteromalus*. If new it may be called *Pteromalus nematocida* (Plate XXVI, Fig. 5). About a hundred of these issued from the cocoons in the breeding-box during May, 1883. This parasite must therefore be a most destructive enemy of the larch worm.

We also noticed several bugs, a species of *Podisus*, near the common *spinus*, preying upon the fully-grown worms; it ascends the trees and pierces the worm with its beak, carrying it down the tree, and sucking its blood, rendering it lifeless.

*Further data regarding the hackmatack or larch worm.*—The following facts were gathered during the summer of 1883 in Maine and New Hampshire, and other points in New England and New York, and are here put upon permanent record.

We have already stated in the Entomologist's report that the larch saw-fly (*Nematus erichsonii*?) begins to deposit its eggs at Brunswick about the 20th of June. During a journey to the Rangeley Lakes and the White Mountains this saw-fly was observed depositing its eggs, July 1, at Phillips, where it was observed to be abundant. It was also observed on the 2d at the Mountain View House, Rangeley Lake; also on the larches along the Five Mile Carry from the middle Dam to Umbagog. It was also observed depositing eggs in trees at Errol, N. H.; and along the route from Errol to Berlin, N. H., it was observed at work July 4, while a number of dead trees were noticed which had died from the effects of their attacks during the preceding season. We learned that they had been destructive last year in Cambridge, N. H.

Early in July these worms were also observed by us on the European larch in Lawrence, Mass., and they were abundant on the European larch on the grounds of Andrew Nichols, esq., of Danvers, Mass. July 16, the larches along the track of the Eastern Railroad from Saco to Portland were observed to be brown, having been partly defoliated by the *Nematus* larva; some of the trees were almost entirely stripped.

During the last week in July we went from Brunswick to Rockland, and thence along the coast to Eastport, returning to Brunswick by way of Calais and Bangor. The larch is a very common tree in the eastern portion of Maine, especially along the coast, on the islands, and in the northeastern and northern part of the State. It is comparatively rare west of the Kennebec River. It appears, then, that throughout the State the larch was this summer partly stripped, and a small proportion of the trees was killed. The growths and forests of larch at this time assumed a peculiar light yellowish brown appearance, as if a light fire had passed through the trees, scorching them and causing them to change their color. This singular tint was characteristic of the larches wherever we went. We noticed this appearance in the larches from Brunswick to Rockland, at Camden and Blue Hill; also on Deer Isle and adjacent islands; also at and about Southwest and Bar Harbors, and other points on Mount Desert Island and the islands eastward; also at

Machiasport ; but along the road from this town to Lubec the larches had suffered less than at other points in the eastern part of the State. At Saint Stephens injured larches were observed as well as at Vanceborough and the counties west of Mattawamkeag, thence to Orono and about Bangor, and between that city and Waterville.

From Mr. C. G. Atkins, United States assistant fish commissioner, we learn that the larch worm was abundant, stripping the trees, at Bucksport, and also at Cherryfield, Machias, and New Sharon.

General C. F. Walcott, of Boston, who, in September, 1883, spent several weeks at and about the Forks of the Kennebec, informs us that he noticed numerous dead hackmatacks in masses on Wood stream, which enters Wood pond, which is a part of Moose River. He did not, however, see any dead spruce in this region in clumps or masses, although his guide, an experienced boss lumberman, informed him that a great many spruce trees were dying in that region.

In the Adirondack region, from Scroon Lake to North Elba and about Mount Marcy, the larches were universally attacked by this worm, as we are informed by George Hunt, esq., of Providence, R. I., who made a journey of about 100 miles through this region in July.

*Condition of the hackmatack in 1884 and 1885.*—In last year's report I thus summed up the condition of our larches or hackmatacks in 1884 :

On the whole, then, while a small proportion of larches have been killed by this worm, this vigorous tree, though defoliated for two successive summers, seems, in the majority of cases, to survive the loss of its leaves, though it threw out much shorter ones the present summer. Possibly 10 per cent. of our northern larches died from the attacks of this worm. Very probably the numbers of this insect will diminish during the next year, and the species may ultimately become as rare as it has always been in Europe, until a decrease in its natural insect parasites and favorable climatic causes again induce its undue multiplication.

The foregoing prediction has been almost fully verified during the past summer, as the insect has been much scarcer than in 1884. A few were seen on the larch in Brunswick, Me., in July, 1885, but they were not numerous enough to do any harm, and I have not heard of their devastations in any part of Maine. The same appears to have been the case in the Adirondack region of New York. Mr. George Hunt, who passed the summer at Scroon Lake, tells me that he saw very few of the worms during the past summer, and he judged that they had not been generally so destructive as the year preceding. As the result of their ravages during the preceding years, he thought that about one-third of the larch trees had died. It would seem as if the visitations of the worm were over, and that for some years to come it would be a rare insect, existing within its usual or normal limits.

The larch saw-fly was, in 1886, found to be still not uncommon. It was observed July 1 at Brunswick, Me., locally, the worm having freshly hatched upon a few trees, but it did not do any more harm than the previous year.

During the early part of September, however, it was observed in

abundance along the Cherry Mountain road from Fabyan's to Jefferson, N. H., a few miles north of the White Mountain house. The larches had been ravaged rather severely and many of the worms were still lingering on the branches, feeding upon the leaves; while many young trees had been stripped, wholly or in part, of their leaves. Some dead larches were also to be seen.

In this year (1885), Mr. John G. Jack reports that the larches at and around Chateauguay, Quebec, were "all attacked," and were more abundant than in former years. Mr. Jack further remarks:

My father has told me that about thirty years ago the tamarack woods were entirely defoliated, and looked as though scorched by fire, and he thinks that the saw-fly larvæ were probably the cause. It was more noticeable at that time, as there were large tracts of land covered with tamarack forest that have now entirely disappeared. (Rep. Ent. Soc. Ontario, 1887, p. 17.)

*Its devastations in Canada.*—Mr. Fletcher remarks in the Canadian Entomologist, November, 1884, that during the summer of 1884 he had observed enormous damage done by the larch saw-fly; "he had first noticed it near Quebec, and had traced it all down the Intercolonial Railway, wherever any larch trees occurred, as far as Dalhousie, where he found it abundant." He found a small bug (*Podisus modestus*) destroying the larvæ at Brome, P. Q.

Rev. T. W. Fyles in the same journal stated that this saw-fly had extended its ravages along the Beauce Valley to the neighborhood of Quebec, where it had stripped the larches bare. A second growth of leaves had appeared and this probably would save the trees.

## 2. SPHINX CATERPILLAR.

This fine caterpillar, which I have as yet been unable to identify, was found by Mr. C. G. Atkins at Hinckley, Washington County, Me., August 22, 1882. The following description was drawn up from a freshly preserved alcoholic specimen, with the colors still fresh.

*Larva.*—Head elevated a little towards the vertex, which, however, is not conical, the sides of the head slightly square, with a dark purple line bordered in front with white; head flat in front, greenish yellow; body green, sprinkled with minute dark rings with a clear center; seven lateral, oblique, dark purple bands becoming paler behind, and then white; the seventh connects above with the black purple conspicuous band on each side of the long slender horn. Supra-anal plate edged with white; thoracic feet reddish, abdominal feet concolorous with the body. Length, 37<sup>mm</sup>.

## 3. *Platysamia columbia* Smith.

This fine moth in its early state feeds upon the larch, where it has been found by the late Mr. Anson Allen as well as Mr. Charles Fish, of Orono, Me. The species was described by Prof. S. I. Smith, who found the cocoons alone "mostly attached to *Nemopanthes canadensis* and *Rhodora canadensis*; a few were found upon *Kalmia angustifolia* and maple, and one upon the larch." The following descriptions of the early



stages were published by Prof. C. H. Fernald, in the Canadian Entomologist, X, p. 44:

*Egg*.—Subglobose, slightly compressed, the compression being least upon the side from which the young escapes; cream-colored, clouded with reddish brown, and attached to the object upon which the female deposits by means of a dark brown adhesive substance, which appears to be the same as that which is clouded over the surface of the egg, but the greater abundance of it at the point of attachment produces a much darker color. Greatest diameter, 2<sup>mm</sup>.; medium, 1½<sup>mm</sup>; least diameter, 1⅓<sup>mm</sup>. The eggs hatched in fourteen and fifteen days after they were deposited.

*Young larva*.—Length immediately after escaping from the egg shell, 4<sup>mm</sup>. Color black; some of the individuals show a greenish tinge around the base of the tubercles. Body cylindrical, slightly tapering towards the posterior extremity; head large, rounded, sparsely clothed with long hairs. The second (first after the head), third, fourth, fifth, and sixth segments each with eight tubercles, the lowest one on each side much smaller than the others. The seventh, eighth, ninth, tenth, and eleventh segments have each six tubercles, rather smaller than the corresponding ones on the preceding segments. The twelfth segment has five tubercles, two on each side corresponding with those on the preceding segment in size, and one on the middle of the dorsum of the same size as the upper ones on the third segment. The thirteenth segment has four tubercles on the anterior edge, and one at the base of each anal proleg. The tubercles are smooth, cylindrical, gradually enlarging towards the base and at the summit, the least diameter being about two-thirds the way up; length equal to about three times the least diameter, surmounted with from two (on the smallest) to six finely serrated, radiating bristles, which are about twice the length of the tubercles. Duration of this stage, eight to nine days.

*After the first molt*.—Length (taken a short time before the second molt), 15<sup>mm</sup>. Color, pea-green. Tubercles and bristles, mandibles, palpi and antennæ, a spot about the eyes, a stripe on each side of the clypeus, the legs and a spot on the outside of the prolegs black, second, third, and fourth segments each with four black spots on the posterior edge, and a row of black spots on each segment after the head, on the line of and behind the stigmata. Duration of this stage, five to seven days.

*After the second molt*.—Length (taken soon after the second molt), 20<sup>mm</sup>. Color, pea-green, with a bluish tint upon the dorsum. Black markings as in preceding stage. Duration of this stage, four to five days.

*After the third molt*.—Length, 35<sup>mm</sup>. Color, pea-green, lighter on the dorsum. Marked with black as in the two preceding stages. All the tubercles with the basal portions blue, except those on the second segment, and the lower one on each side of the third to the sixth segment inclusive. Duration of this stage, six to nine days.

*After the fourth molt*.—Length, 50<sup>mm</sup>. The head at the time the larva escaped from the egg-shell was proportionally large, but during the succeeding stages it did not grow so fast as the other parts of the larva, and at the beginning of this stage, but more especially at its close, it was proportionally small. Duration of this stage, ten to twelve days.

*Mature larva*.—Length, 76<sup>mm</sup> (about 3 inches). Thickness between the segments, 13<sup>mm</sup>; of largest part of segment, 15<sup>mm</sup>. Head pea-green, sparsely clothed with fine yellowish hairs. Mandibles and outer joints of antennæ, and palpi, spot about the eyes, two spots on the gular (these may have occurred in the previous stages, but were not observed), and a stripe on each side of the clypeus, black, the latter sometimes wanting. Basal joints of antennæ and palpi and the labrum greenish blue. General color of the body pea-green, rather lighter than the head, and lighter above than on the sides, with the faintest tinge of blue between the segments. Last joint of the legs and claw black. Stigmata oval, white, surrounded by a fine black line.

The tubercles were greatly changed at the fourth molt, both in form and color. The first and lowest on the second segment is small, conical, black, and surmounted

by a few, short, stout, black spines. The second is more rounded at the top, shining black at the base, and resembling white glazed porcelain at the apex, with four black spines. The next two are smaller, about  $2\frac{1}{2}$ mm apart on the front edge of the segment, the lower of which is about 5mm from No. 2. These are very small and black, the upper one having a trace of greenish white at the apex, and both are surmounted with several short black spines. The lowest tubercles on segments 3 to 6, inclusive, are small, with black bases, apices resembling white glazed porcelain, and generally two black spines. The tubercles of the next row above, extending from the third to the last segments, inclusive, are very similar in form and color, but larger; those of the row above this are slightly pear-shaped, a very little thickened towards the outer end, of the same color as the preceding, and surmounted with from four to six short stout black spines. Those of the next row on the third, fourth, and fifth segments, and the corresponding ones on the opposite side of the dorsum—by far the largest on the larva—are pear-shaped, largest outwardly, porcelain-white at the base, with a band of shining black above, and a bright coral-red top, with from six to eight stout black spines. The tubercles of this row on the sixth to the eleventh segments, inclusive, are nearly as tall, but slimmer than those preceding, slightly curving backward, porcelain white at the base, a very light straw color above and armed with two black spines at the top. The dorsal tubercle of the twelfth segment is very similar, but larger, and armed with several black spines. The tubercle at the base of the anal proleg is smaller than those before it, of a light bluish color, with black at the base outside.

The most striking differences observed between *P. columbia* and *P. cecropia* in a brood of the latter raised by the side of the former are, first, the smaller size of *columbia* at each of the stages; the mature larva of *columbia* is about 3 inches in length, that of *cecropia* about 4. Secondly, *columbia* is of a clear light pea-green color, *cecropia* a dull bluish green, giving a much darker aspect to this larva. This distinction of color is so marked that, if once observed, the one can never be mistaken for the other. Thirdly, *columbia* has three pairs of coral-red tubercles, one pair each on the third, fourth, and fifth segments; *cecropia* has two pairs, one pair each on the third and fourth segments. Then the color of these differ; those of *columbia* are a true coral or vermilion-red, while all the *cecropias* I have seen have these tubercles a color somewhat approximating that of resin. The remaining dorsal pairs of tubercles to the twelfth segment and the central one on the twelfth are lemon-yellow, while in *columbia* they are white at base and a very light straw color above. The remaining tubercles of *cecropia* are black at the base, but with the look of white glazed porcelain above. The distinctive characters show no tendency to run into each other in any of the examples I have seen. As perhaps having a bearing upon the question whether *columbia* is a hybrid between *cecropia* and *promethea*, I will say that in six years of careful collecting at this place I have never taken a *promethea*, nor has one ever been taken here to my knowledge, yet the empty cocoons of *columbia* have occasionally been found, mostly in larch trees, in one instance about 40 feet from the ground. I am therefore convinced that *columbia* is a good species, but whether distinct from *gloveri* I am not prepared to express an opinion.

#### 4. THE RED TUSSOCK-MOTH.

*Orgyia antiqua* (Linn).

This tussock caterpillar occurred frequently on the larch at Brunswick, in the early part to the middle of September.

#### 5. THE WHITE SPOTTED TUSSOCK-MOTH.

*Orgyia leucostigma* (Abb. & Smith).

We have found the caterpillar of this moth late in August in Maine spinning its cocoon and preparing to transform into the chrysalis state.

## 6. THE IMPERIAL SPINY CATERPILLAR.

*Eacles imperialis* Hübner.

Noticed on the tamarack by G. D. Hulst (Bulletin Brooklyn Entomological Society, p. 77).

7. *Platyserura furcilla* Packard.

The caterpillar of this moth occurs frequently in Maine on the larch; usually of its normal style of coloration; one occurred with the ground color reddish, frosted over with silvery white, while another was very striking in coloration, the ground color being deep black, with large pure white patches and a dorsal row of large white heart-shaped spots.

## 8. THE LARCH LAPPET MOTH.

*Tolyte laricis* (Fitch).

Though a rare insect, and probably never destined to prove specially injurious to coniferous trees, its habits, as worked out by Mr. Fitch, and more fully by Mr. Lintner, are of unusual interest. It is confined, so far as yet known, to New England and New York, while its congener, *T. velleda*, ranges over the eastern and southern United States. The following account is taken from Mr. Lintner's first annual report of the State Entomologist of New York:

The larva is wonderfully adapted to elude the gaze of its enemies, its body being flattened, as observed by Fitch, "somewhat like that of a leech, and on each side of each segment projects a little lappet or flat lobe. These lappets are pressed down upon the surface of the limb on which the worm is at rest. The sides of the body are also fringed with hairs which are similarly appressed to the limb. Thus all appearance of an abrupt elevation or an interstice to indicate the ends and sides of the worm is obliterated, and it resembles merely a slight swell of the natural bark, the deception being made complete by the color, which is commonly identical in its hue with the bark. And when there are spots or marks upon the caterpillar, they imitate the glandular dots, scars, and other discolorations which will be seen upon the bark around it. Even upon the closest scrutiny the eye fails to detect anything by which we can be assured that this elevation is not a tumor which has grown in the bark. The cocoons which they construct upon the limbs are equally exact counterfeits of the bush. One of these upon a limb of the wild black cherry is \* \* \* placed longitudinally in the slight angle formed exteriorly where one limb branches from another, and a piece of putty could not be more perfectly molded into this angle and smoothed off so as to leave no inequality. The bark of the cherry is blackish with transverse whitish streaks, and this cocoon presents the same colors, and of tints almost the same; and what is most remarkable, it in one place shows a whitish streak continued from the bark upon the surface of the cocoon. And finally, in their perfect state, the moths imitate appearances which are common upon the particular trees on which they dwell; those upon deciduous trees, in the colors and scalloped margins of their wings, resembling a tuft of withered leaves, those upon evergreens resembling a scar where the turpentine has exuded and concreted into a whitish mass."

There are, says Lintner, two annual broods. From the eggs laid the previous autumn the caterpillars hatch late in April, which become

moths in June and July; these at once deposit eggs which give the second brood of moths in September. The female lays about fifty eggs, and those observed by Mr. Lintner hatched from April 5 to 30.

*Egg.*—Glossy reddish brown, broadly oval, somewhat flattened upon its attached side, about 0.05 inch long by 0.04 inch broad; the surface, under a magnifying power of fifty diameters, shows irregular hexagonal reticulations, of which the elevated lines are divided by a fine impressed line. The shell is moderately thick. The larva eats an opening in one end of sufficient size for its escape, but in some instances a large portion of the shell is subsequently eaten. The eggs laid under my observation have been so covered with the anal hairs of the moth as almost entirely to hide them from sight. Fig. 15\* represents a cluster of them.

*Larva, first stage.*—The larva, on emerging from the egg, measures one-tenth of an inch in length, is of a dull green color, with a black dorsal line. The head shown in Fig. 16, enlarged to six diameters, is brown, crossed centrally by a white horizontal line, another shorter one beneath parallel to it, just above the mouth-parts, and two nearly perpendicular ones on the superior front of the head, obsoletely united below by a curved line. Rows of tubercles traverse the body, from which long hairs proceed, of which those of the first segment are longer than the body, and those on the terminal segment are as long as the body. The legs are long and project laterally—more conspicuously so when the caterpillar is walking. Twelve of the larvæ died during this stage before attaining their first molting. Their greatest length was one-fourth of an inch. This stage was of varying duration, extending from sixteen to thirty-three days.

*Larva, second stage.*—The first molting commenced on April 21st, and terminated on the 8th May, extending over seventeen days—a considerable less range than that shown in the hatching of the eggs (17:25). The following is the record of the observed moltings:

Larvæ.		Larvæ.	
April 21.....	2	May 2.....	3
April 22.....	7	May 3.....	1
April 23.....	8	May 5.....	2
April 24.....	5	May 7.....	2
April 28.....	1	May 8.....	1
April 29.....	1		
		Total.....	33

On emerging from its first molt the larva measured 0.3 inch. The frontal lines of the head, before nearly perpendicular and parallel, now converge below, resembling the letter **U**; the brown portions, under a lens, show indistinct mottlings (see Fig. 17). The body tapers regularly from the first to the last segment. The dorsal line is brown, with pale borders. On the summit of the third segment is a fuscous patch, behind which extending over the incisure, is a pale patch, convex in front and straight behind, bounded by the four tubercles of the fourth segment. On the seventh segment is a small pale patch. The sides of the body are gray, with irregular linings; a sub-dorsal row of black tubercles bear several long black hairs, beneath which is a dull orange interrupted line. The tubercles of the substigmatal row bear numerous shorter white hairs.

During their rests from feeding the larvæ resort to the stems, where, with flattened body pressed to the surface and with head extended, they can scarcely be discovered.

At the close of this stage, which ranged from seven to eighteen days, the larvæ measured one-half an inch in length.

\* Mr. Lintner's figures are not reproduced.

*Larva, third stage.*—The second molting commenced seven days after the earliest of the first, and continued until May 9, thus overlapping the first molt. The molts recorded (eight not observed) are as follows:

Larvæ.		Larvæ.	
April 28 .....	1	May 6 .....	1
April 29 .....	1	May 8 .....	1
April 30 .....	4	May 9 .....	2
May 1 .....	5		
May 2 .....	6	Total .....	25
May 5 .....	4		

Immediately following this molting, the larva measures 0.55 inch. The frontal white lines of the head are more convergent, approaching a **V**, and some confluent lateral lines are seen resembling a **B** (not well shown in the figure), the brown portions are distinctly mottled, and numerous white hairs are given out from beneath the white transverse band (Fig. 18). The color and markings of the body are nearly as in the preceding stage. The subdorsal tubercles are more prominent and are slate colored apically; two or three long black hairs proceed from each in a horizontal direction. The short, gray lateral hairs are now so numerous that they form a fringe to the body, which, as the larva rests on a leaf of the pine, were downward and inward, so that some of the tips meet underneath. The subdorsal stripe is geminate, marked with orange opposite each tubercle. The tubercles of the third segment are more prominent than the others.

*Larva, fourth stage.*—The third molting, as in the second, commenced seven days after the earliest of the preceding molt, on May 5th, when but about two-thirds of the larvæ had undergone their second change. Of the duration of this molt, or of the dates of molting, no record was kept.

The larvæ show the following dorsal markings: Resting on segments 3 and 4, a sublenticular yellow spot, bordered with velvety black, and bisected by a narrow, brown mesial line; on segment 7, a yellow spot, of which the anterior portion is split by a wedge-shaped brown projection—its greatest breadth between the tubercles, extending on segment 8 and terminating in a point between the tubercles of this segment. In some examples a somewhat similar shaped spot of paler yellow is seen on segment 9, extending a little on segment 10. The yellow lateral markings, which in the former stage formed an interrupted line below the tubercles, are reduced to a series of indistinct ochreous spots at the base of each tubercle. The cylindrical tubercles on segment 3 are quite projecting and rounded at the tip; the subdorsal tubercles present the following ratio of size in the order of their occurrence: 1, 2, 7, 9, 6, 10, 5, 4, 12, 11, 8, 3, (that on segment 1 being the largest, and on segment 9 the smallest). The subjoint of segment 12 has two elevated black points. The barbed gray hairs composing the fringe have some barbless ones mingled with them. The legs are luteous, marked with black exteriorly, and are nearly hidden by the overlapping fringe.

Beneath, on segment 2, are three small mesial spots; on segment 3 are two spots; on the following segments an obscure, larger one mesially on each ring; the body ventrally is marked with crinkled lines.

Previous to the fourth molting the larvæ measure 1.2 inch. The 8th tubercle in the subdorsal row is conical; the 11th has a broad base, extending anteriorly to the incisure. Upon the first five segments the barbed hairs of the fringe are more numerous.

This stage, as was ascertained later, was the last larval stage of a portion of the brood; a part entered upon a fifth stage. The head of these, taken from cast head-cases at their fourth molting (enlarged to six diameters, as the preceding ones), is represented in Fig. 19.

*Mature larva.*—The largest attained a length of nearly one inch and a half. The color is a dull brown, resembling that of the bark of the pine twig. The head is covered with black hairs superiorly, and with gray hairs anteriorly. When extended, the

front of segment 1 is pale green, and the incisure of segments 2 and 3 is shining black. The three dorsal spots are pale greenish-yellow; the central spot, on segment 7, has a *fleur-de-lis* form; the following one, on segment 9, is small and geminate, and on segment 11, in a number of the larvæ, is a fourth spot, usually smaller than the preceding. Of the tubercles, arranged in subdorsal rows, those on segment 8 are the largest, exceeding in height and diameter of base those on segment 2, and are directed somewhat backward. A lens shows short hairs over the body, and on the summit of the tubercles are larger ones, curving inward; the body is lined with short black streaks. From the tip of the lappets long black hairs of an unequal length are given out, while their margins and intervening portions of the body bear numerous shorter gray hairs, many of which are barbed; these form a fringe directed downward when the larva is resting on a small branch, wholly concealing the legs and nearly hiding the long prolegs. In addition to these lappets (a substigmatal row), there is a single one of a little larger size on the first segment, in front of the first spiracle, the hairs of which project along the side of the head. All the lappets are margined with a black line which is more distinct upon the anterior one; the first three point forward, the others backward. The larva has the power of elevating or depressing one or more of the lappets at pleasure; when in motion they are borne horizontally; at other times, all but the thoracic ones are depressed. The prolegs are obscure greenish. The ventral region is of the same color, with a lenticular blackish spot on the first five segments.

*Cocoon*.—The first cocoon was spun on the 17th of May, forty-three days after the earliest hatching of the larvæ. Within two days seven cocoons were made; in all, thirty-three were obtained. For the reason that the twigs upon which the larvæ had been fed were of a small size, and without the branches at the giving off of which the cocoons are usually placed, nearly all were spun upon the flat sides of the feeding cage, where they presented the appearance shown in Fig. 20; none were placed in the angles or corners. Their ground-work usually extended at some distance beyond the cocoon proper, for while its average length was less than one inch, that of the ground-work often exceeded one inch and a half. The cocoon is of a pale gray color, elongate oval, quite flattened beneath, its elevation being but about one-half its breadth, roughened externally, smooth interiorly, moderately firm and thick, but diaphanous, composed of two layers of silk, which are usually more closely united than represented in Fig. 21, which shows the under surface with the thin lower layer forming the ground-work removed, disclosing the pupa-case from which the moth has emerged through the ruptured upper part of the cocoon.

*Pupa*.—The pupa is dark brown, about 0.60 inch long, from 0.27 to 0.30 inch broad across the wing-cases, and only about 0.18 inch thick, being much flattened beneath. The incisures are deep and the segments well rounded, and continuing broad in the female, as shown in the figure, until their abrupt termination. The anal segment is tipped upon its upper side with two minute sharp teeth or by a bifid tubercle, having a small granulation (shown under a lens) on each side. The male pupa is readily recognizable by its narrower terminal segments, and the well-defined antennal cases showing at the point of the antennal twist a sensible contraction, and above it a broad lobe like expansion outwardly beyond the regular curve of this portion of the pupa. The features of the female pupa are essentially shown in the pupa case, represented within its cocoon, in Fig. 21.

*Pupation*.—The pupation was quite brief—only twelve days, if three days be allowed for the change within the cocoon of the larva to the pupa. The first moth emerged June 1. The following is the record of dates of emergence of the thirty-three examples obtained; it is of interest in not showing the priority in the time of the male, which is found in many lepidoptera, but a singular alternation between the sexes of the first half of the brood

Date.	Male.	Female.	Date.	Male.	Female.
June 1.....		1	June 14.....	2	1
June 4.....	1		June 15.....	1	
June 5.....		3	June 16.....		2
June 6.....	3		June 17.....	1	
June 7.....		3	June 18.....		1
June 8.....	2		June 19.....	1	
June 9.....		3	June 20.....	1	1
June 11.....	1	2	Total.....	15	18
June 12.....	2				
June 13.....		1			

9. *Apatela* sp.

Observed near Fabyan's, on the Cherry Mt. road, N. H., September 10. It had been ichneumonized.

*Larva*.—Head large, wider than the thoracic segments; with a black curvilinear stripe on each side, not meeting its mate on the vertex. Body tapering rapidly to the anal legs, which are smaller than the other abdominal legs and held out backward. Supra-anal plate moderately large, rounded, somewhat pointed at the apex. Body white, with a very broad bright yellow dorsal band over half as wide as the body, and inclosing on each segment a large transversely deep oblong pink spot; the prothoracic segment stained on the front edge with pink. Length 4<sup>mm</sup>.

10. *Noctuid caterpillar*.

This larva occurred on the hackmatack in Maine June 16; it was a young one, and died in confinement.

*Larva*.—Body moderately thick, (legs: 6 thoracic; 10 abdominal), of the usual noctuid form, but with no peculiar markings. Head full, of the usual shape, nearly as wide as the body, yellowish green. Body of a delicate pale green, tinged with yellow. A dorsal firm white stripe and two subdorsal rather narrower white stripes. On top of each abdominal segment are four white warts arranged in an oblong (transversely) square. Below the subdorsal line is a broken white line, and below this an infra-stigmatal white line. All the feet concolorous with each other and the head. Length 12<sup>mm</sup>.

11. *Amphidasys cognataria* Guen.

A large Geometrid occurred on the hackmatack at Brunswick August 31. It began to pupate September 14. See also p. 405.

*Larva*.—Very large, body cylindrical, thick. Head rather deeply cleft, allied to other cleft-head ones, but head not so deeply cleft, nor is the body cleft, and it is two to three times as large as the other species. Head pale brown, colored in front, dark behind on the vertex, suture of apex of clypeus blackish. Head large, as wide as the prothoracic segment, the latter turned up in front, the sides being angulated. Body smooth, finely granulated with whitish and gray. A pair of small not very conspicuous slender tubercles on the sides of the fifth abdominal segment. A little lighter than the rest of body, and concolorous with the two diverging rough elongated warts on the penultimate segment. The body itself light mud-brown, with a slight reddish lilac tint, with two rows of small white subdorsal whitish spots, disappearing on thoracic and two last segments. Supra-anal plate large, long, acute, granulated with white on the surface. The two anal legs rather broad, the spine large and sharp. Length 40<sup>mm</sup>; thickness 8<sup>mm</sup>.

12. *Geometrid larva.*

A large Geometrid was found on the hackmatack at Brunswick, August 30, which died in the breeding box.

*Larva.*—Body large and thick cylindrical, marked exactly like a larch twig. Head rather small,  $\frac{3}{4}$  as wide as the body, flattened, horizontal in position. Prothoracic segment a little wider than the head, smooth, not enlarged, but meso-segment is swollen in front, and especially on the sides, into a large rough lateral tubercle, which is warted, between the lateral tubercles is a transverse row of black warts. On the hinder end of each segment is a transverse ridge, ending on each side in a small wart. These ridges become larger toward the end of the body, especially the sixth abdominal segment, on the succeeding segments the ridge is wanting, the lateral warts remaining. The large anal plate is not regularly triangular, but ends in four tubercles with two on top; the anal legs are not very wide, but the dorsal spines are very large, acute, and prominent. The sides of the legs are warted. The body is stone-gray, variably marbled and mottled with black and white or pale gray, so as to closely resemble a light larch twig. The sides of the pro- and meso-rings are white; above on meso- is a short double white line; the folds of the lateral ridges are marked with black, and there is a median black dorsal line extending from the third from the end to the end of the supra-anal plate. Under side gray, as above. Length 45<sup>mm</sup>; thickness of body 5<sup>mm</sup>.

13. *Eupithecia* sp.

This larva was taken from a hackmatack June 25.

*Larva.*—Much like the larva of *E. palpata*, but not so much flattened. Head rather full, as wide as the body; rounded. Body pale pea-green, a little paler than the leaves on which it feeds. Suture and lateral line washed with straw (faint) yellow. Supra-anal plate broad, rounded, segments somewhat wrinkled transversely. Abdominal legs concolorous with the body. Thoracic legs greenish amber; hindermost pair dark amber. A slender, delicate-colored species. Length 11<sup>mm</sup>.

14. *Eupithecia* sp.

Another larva of this genus, with the body more cylindrical, occurred June 27 on the hackmatack. It also occurred June 23 on the spruce. In the latter specimen the body is deeper yellow, with the markings a little more distinct, but otherwise it agreed with the specimen described below.

*Larva.*—The body is more cylindrical, but the head is shaped as in the larva of *E. palpata*. Head yellowish. Body of even width throughout, a little wider than head; surface finely but distinctly granulated; a broad, continuous, medio-dorsal brick red stripe; a lateral narrow scalloped reddish-purple stripe. The space between the dorsal and the subdorsal lines more or less suffused with purplish red and the surface sprinkled with yellow granulations. Body elsewhere yellow; under side livid; on each side a narrow pink-red stripe extending down the sides of the two pairs of abdominal legs. Supra-anal plate regularly triangular, scutellate; beneath the apex are two large piliferous conical warts. Anal legs as in *E. palpata*, broad and large. Length 12<sup>mm</sup>.

15. *Eupithecia* sp.

This larva occurred July 10 to 25 in Maine; pupating August 2. Several also occurred on the fir August 5 to 7, and were common on *Pinus strobus*. It begins to eat the ends of the leaves August 5. One of them on the latter tree spun a slight cocoon August 14. As unfortu-



nately the larvæ died in confinement, the description is here given with a view to future identification of the imago.

*Larva*.—Body smooth, of even thickness, cylindrical. Head and body uniformly pale pea-green. Four broken dorsal white stripes. Sutures tinted straw-yellow. Thoracic feet greenish amber; abdominal feet green. Spiracular line white and yellow, inclosing the distinct reddish spiracles. Supra-anal plate broad triangular; as long as broad and pointed; surface roughened at the end. Length 20<sup>mm</sup>.

16. *Geometrid caterpillar*.

This larva occurred on the hackmatack in Brunswick August 30. By September 25 it became fully grown, and commenced to pupate. The fully-grown larva differed in being not so much humped as the young larva described below. Unfortunately it did not live through the winter.

*Young Larva*.—Length, 20<sup>mm</sup>. Body slender cylindrical, a little thickened on pre-anal thoracic segments. Head very deeply cleft; as wide as the body in the middle, but not so wide at the prothoracic region. Prothoracic segment much enlarged, with a hump on each side of the front edge. On fifth abdominal segment a pair of very prominent lateral long tubercles and legs moderately large, the dorsal acute tubercles of moderate size. Body dull brick-red, with a squarish patch on the front of each segment marbled with black and whitish. There is a median black line on the thoracic region. Body glaucous grayish, white under the last third of abdomen. It may be recognized by its dull brick-red body checked with dark, the humped prothorax, and two prominent tubercles on the fifth abdominal segment. No warts or papillæ; the body a little wrinkled.

17. *Geometrid larva*.

This caterpillar occurred on the hackmatack, in Maine, June 27 to 28.

*Larva*.—Body very long and slender, exactly mimicking a slender dark twig. Head very large, much wider than the body, being unusually large in proportion to the body; full, rounded, but somewhat flattened; in front black, with two short brown stripes on each side of vertex; antennæ whitish flesh-color; sides of head mottled with brown and black. Thoracic feet flesh-colored, mottled with black spots.

A high double transverse black tubercle on fifth abdominal segment. Two small round black mamillæ-like warts on penultimate segment. Last segment very large and broad; pale horn-brown. Supra-anal plate five-sided with 6 piliferous warts on the edge, 2 on the apex behind; 4 black small high rounded warts on back part of each segment, arranged in a square; 2 fine, light, not distinct supra-stigmatal lines. Lateral raised ridge distinct. Abdomen beneath reddish, with 7 to 8 black warts at the end of each segment. From all the warts arise short, upright, stiff hairs. Length, 18<sup>mm</sup>.

18. *Geometrid caterpillar*.

This caterpillar occurred at Brunswick, July 19. Beginning to pupate among leaves and becoming a pupa the 21st. Also found on the hackmatack in a following year in the middle of July; it will feed on the fir.

*Larva*.—Body smooth, of even thickness throughout. Head as wide as the body, smooth; sides rounded; sutures well impressed. Head deep blood-red, black on the sides, while the entire clypeus is bright green. Body bright green, exact color of leaves, with a distinct dark, firm, almost black, stripe along the side, edged above

with an obscure stripe paler than the green in the middle of the back. Both the thoracic and abdominal legs deep purple-red. Anal legs moderate, green on the sides. Lateral ridge forms a white and yellowish line. Beneath, two subventral dark stripes edged on each side with white. Length, 20<sup>mm</sup>.

19. *Geometrid larva.*

This caterpillar occurred on the hackmatack, in Maine, August 3.

*Larva.*—Head not so wide as the body, rather small, the front, especially towards apex, much flattened. Second and third abdominal segments swollen on the sides, and eighth slightly humped and black above. Supra-anal plate rough above, ending in 3 stout, piliferous tubercles below. Surface rough. Body dark green, with vertex of head, upper part of third thoracic segment, and of second and third and rest of abdominal segments blackish, as if scorched by a fire. Between these patches the upper side is dull rust-red, as is the head in front. Sides of body dark green, tinged with dark. All the thoracic and abdominal legs dark rust; sides of second and third abdominal segments blackish. Length, 23<sup>mm</sup>.

20. *Geometrid larva.*

This caterpillar occurred on the hackmatack, at Brunswick, Me., August 30. It began to pupate September 25.

*Larva.*—Body slender, cylindrical, a little thickened on pre-anal, and thoracic segments. Head very deeply cleft; as wide as the body in the middle but not so wide as the prothoracic region. Prothoracic segment much enlarged, with a hump on each side on the front edge. On fifth abdominal segment a pair of very prominent lateral long tubercles. Anal legs moderately large, the dorsal acute tubercle moderate. Body dull brick-red, with a squarish patch on the front of each segment marbled with black and whitish. There is a median black line on the thoracic region. Body glaucous, grayish white under the last one-third of abdomen. It may be recognized by its dull, brick-red body, checkered with dark, by the humped prothorax, and by the two prominent tubercles on fifth abdominal segment. No warts or papillæ, the body being a little wrinkled. Length 20<sup>mm</sup>.

*September 25, fully grown larva.*—Prothoracic segment not so much humped as when young.

21. *Geometrid larva.*

This caterpillar occurred on the hackmatack, at Brunswick, August 4, 1882.

*Larva.*—Large, dark, twig-like, with deeply notched head. Head large, as wide as the body, very deeply notched, each tubercle acutely conical. Prothoracic shield square, with a flattened boss on each side of front edge. Body cylindrical, with a lateral conical conspicuous tubercle on each side of the segment in front of the first pair of abdominal feet. Lateral line not prominent. On top of segment in front of supra-anal plate a transverse interrupted ridge, composed of two oblique, yellowish brown tubercles. Skin somewhat roughened, twig-like, but darker than twigs of hackmatack. Anal legs large and broad, each ending behind in a spine. Supra-anal plate large, flat, triangular. Skin with raised black and white papillæ. Length, 22<sup>mm</sup>.

22. *Geometrid larva.*

This caterpillar occurred on the hackmatack August 18 to 23, 1883, in Maine. It rests like *Drepanodes varus*, head down, and lengthwise to the twig, which it resembles somewhat, especially the darker ones, and is easily overlooked.

*Larva*.—Head rounded, as wide as the body, marbled with brown, elongated, mostly crosswise dots. Body smooth, moderately thick, of the same color. Body dull lilac gray, with darker irregular bands and spots. The most conspicuous and distinctive markings are a series of long, dark, diverging (posteriorly) lines (a pair on each segment), forming a blackish V, of which there are about eight. Segments with one crease; a little convex, but with no tubercles or warts. Length, 15<sup>mm</sup>.

## 23. TORTRICID CATERPILLAR.

This and the following species were beaten from the leaves of the hackmatack, at Brunswick, Me., June 23 to 26.

*Larva*.—Body tapering towards both ends; somewhat flattened; head rather small, not so wide as the prothoracic segment. Head and cervical shield amber-brown, and the thoracic feet of nearly the same color, but rather darker. Body horn-colored, with a slight reddish tinge. Prothoracic shield much narrower than the succeeding segment. Piliferous warts dark, conspicuous; the trapezoid in which the dorsal ones are arranged forms an almost oblong square; the fine hairs are very short, about one-fourth as long as the body. Two rows of lateral warts. Supra-anal plate rounded, concolorous with the head. Beneath a little paler, with a greenish tint. Length, 6<sup>mm</sup>.

## 24. TORTRICID CATERPILLAR.

## Order LEPIDOPTERA; family TORTRICIDÆ.

*Larva*.—Body slender, of uniform width, suddenly tapering towards the end. Head as broad as the body, black; prothoracic shield black, as broad as the body, which is somewhat flattened, more so than usual; color livid greenish, whitish; segments somewhat wrinkled, piliferous, rather large, full, whitish; concolorous with the body; hairs one-third to one-half as long as the body. First pair of thoracic feet black, the others concolorous with the rest of the body and the abdominal legs; the last segments paler and concolorous with the body beneath. Length, 7<sup>mm</sup>.

## 25. THE LARCH SACK-BEARER.

*Coleophora laricella* Hübner.

Dr. Hagen notices the occurrence of this European Tineid on the European larch at Northampton, Mass. "In April they showed to a large extent pale needles and many little larvæ of the well-known sack-bearing form. In May numerous slate-colored moths appeared." (Can. Ent., 1889, p. 125.)

26. *Selandria*? sp.

## Order LEPIDOPTERA; family TENTHREDINIDÆ.

This worm is common on the hackmatack through June, July, and August in Maine, but is not gregarious.

*Larva*.—Three pairs of thoracic legs, seven abdominal pairs. Head small, pale horn-red; eyes black, not so wide as the body, which is considerably swollen on the second and third thoracic segments, much as in *Selandria cerasi*; body behind rather long and slender, tapering gradually to the end; pale delicate green, with five or six flattened folds crossing each segment. Two faint dark green narrow dorsal ones on each side of the heart or middle of the body; a dark green prominent lateral supra-stigmatal line; the main trachea makes a silvery lateral line. Thoracic feet greenish horn-yellow at tips; abdominal feet pale green, exactly concolorous with the body. Length, 11 to 12<sup>mm</sup>.

## 27. THE FIR LOPHYRUS.

*Lophyrus abietis* Harris.

A Lophyrus-like false caterpillar, which may have been the larva of *Lophyrus abietis*, in 1877 attacked a plantation of Scotch larches. The following letter, written by Mr. B. M. Watson, proprietor of the Old Colony Nurseries, Plymouth, Mass., under date of July 5, 1877, will give the facts in the case:

I have a large plantation of Scotch larches, twenty-five years old, 40 to 50 feet high, many hundred trees, which is attacked by a caterpillar (inclosed) which I have at hand. Do you know it or its remedy? The trees are much riddled by them, and the foliage more than two-thirds destroyed. The trees look bare and unsightly. We have had them several years. They began at one end and have advanced to one-fifth of the plantation; the other four-fifths are not infested.

I have also observed the young at the end of August, at Brunswick, Maine, both on the fir and larch.

The use of a fluid preparation of Paris green or London purple thrown over the trees by a garden pump or modern spraying machine, figured in the Introduction to this Report, would so reduce the number of these caterpillars that a second year the trees would leave out again and not show much marks of injury. The Lophyrus sawflies are sporadic and periodical in their attacks, though occasionally doing great and wide-spread injury.

## 28. THE LARCH APHIS.

*Lachnus laricifex* Fitch.

Order HEMIPTERA; family APHIDÆ.

Solitary upon the small twigs, stationed in the axils of the tufts of leaves, with its beak sucking the juices that should go to the leaves, a wingless brown plant-louse slightly tinged with coppery, 0.12 long, with a dull white line along the middle of its back and a similar whitish band at the sutures of each of the abdominal segments, in which bands on each side of the middle are three black punctures, the short tubercles on each side of the tip deep black, the under side dull white and dusted with white powder, the legs pale with the feet and knees black and also the apical half of the hind thighs and shanks, and the antennæ pale with black tips. (Fitch.)

Many of these lice were noticed on a particular tree the latter part of May, but no winged ones were to be found. Ants, as usual, were guarding them and drinking the honey dew which they ejected. Many of them were accompanied with four or more young, huddled close around the base of the sheath from which the leaves arise. These were scarcely half the length of the parent, of a light dull yellow color with two brown spots above on the base of the abdomen, the legs and antennæ similarly colored to those of the parent but more pale. (Fitch.)

Scattered individuals were observed at Brunswick, Me., in August.

## 29. THE LARCH CHERMES.

*Chermes laricifoliae* Fitch.

Order HEMIPTERA; family APHIDÆ.

Solitary and stationary upon the leaves, extracting their juices, small black shining flies 0.10 long, having the abdomen dark green, the legs obscure whitish, the wings nearly hyaline with pale brown veins, and the large stigma-spot upon their outer margin beyond the middle more opaque and pale green.

This is closely like the pine Chermes, but has the wings more clear, and differs also in some of the details of its colors. (Fitch.)

Dr. Hagen notes its occurrence in the Arnold arboretum. (Can. Ent., 1889, p. 126.)

## 30. THE RED MITE.

*Tetranychus telarius* Linn.

In June, the foliage of the larches in the grounds of the University at Normal were seriously affected by the red mite (*Tetranychus telarius* L.), some of the trees seeming likely to die. On one of those worst infested we tried the effect of spraying with a kerosene emulsion made with soap, and diluted to contain  $2\frac{1}{2}$  per cent. of kerosene. The insects were greatly reduced in number by a single application, but not all killed. The tree soon revived appreciably as compared with those not treated. (Forbes's Third Rep. Ins. Ill.)

The following insects also occur on the larch:

## Order LEPIDOPTERA.

31. In July and August troops of white caterpillars with black dots and along their backs eight black tufts of hairs. The larvæ of the hickory tussock moth (*Lophocampa caryæ*), are sometimes found on this tree, nearly stripping the leaves from the limbs which they occupy. (Fitch.)
32. In Labrador I have found the larva of what I suppose to be *Arctia quensellii* feeding upon the larch in July. As this insect also inhabits the summit of Mt. Washington, N. H., it should be looked for there on larches.
33. *Pieris menapia*. Injures the tamarack on the Pacific coast. (Amer. Nat., Oct., 1882.)

## Order COLEOPTERA.

34. *Dendroctonus* sp. In immense numbers under the bark of sickly and dying trees. Harrington, Can. Ent., XVI, p. 218. See also Proc. Ent. Soc., Wash., I, p. 175.
35. *Hylesinus opaculus*. Associated with the preceding beetle. Harrington, Can. Ent., XVI, p. 218.
36. *Tomicus pini*. Harris's Treatise, etc., 88.

## CHAPTER XIX.

### INSECTS INJURIOUS TO THE JUNIPER.

#### INSECTS INJURIOUS TO THE TREE-JUNIPER.

##### *Juniperus virginiana.*

#### AFFECTING THE TRUNK.

##### 1. THE JUNIPER BARK-BORER.

##### *Phloeosinus dentatus* (Say).

Order COLEOPTERA; family SCOLYTIDÆ.

Making a short straight primary gallery, with about 15 to 50 longer secondary galleries branching from it at nearly right angles, often ending in round holes perforating the bark; a small white curved grub, changing to a light brown cylindrical beetle.

We have observed the depredations of this common beetle on the junipers about the city of Providence. The attacks were confined to sickly or dead trees; whether the cause of death was due to the attacks of this beetle or not could not be ascertained. The beetles were found May 2 and 13 alive in the burrows, which also contained the fully grown larvæ, but no pupæ were observed. In one fallen juniper tree, the trunk of which was about 5 inches in diameter, the mines were unusually close together and abundant, fifteen occurring on one side of the trunk in a space about one foot long. Selecting a separate average mine for description, such as is figured in the accompanying engraving, the main or primary gallery is 18<sup>mm</sup> to 25<sup>mm</sup> (1½ to 2¼ inches) long and 3<sup>mm</sup> wide, widening at one end into a trilobed chamber twice as wide as the main gallery. In a gallery 25<sup>mm</sup> long, including the three-lobed cell, from which no lateral or secondary galleries proceeded, there were forty-eight secondary galleries on one side and fifty-one on the other, the mouths of the opposing tunnels being alternately arranged. The secondary galleries being a little less than one-half millimeter in width; those arising at each end of the primary gallery are 45<sup>mm</sup> long; those arising near the middle from one-third to one-half and two-thirds as long; the ends of the tunnels are about .5<sup>mm</sup> in width, and they often communicate with the hole made by the insect for its exit through the bark, which is 1.5<sup>mm</sup> or a little less. These holes are indicated by the round

black spots or large dots at the end of some of the galleries, as seen in the engraving. The holes may open out straight through the bark as usual, or sometimes obliquely. The galleries in May are closely packed with the excrement or castings of the worms, which is tan color or the color of the bark, showing that the insects, though sinking their galleries a little way into the wood, as proved by the shallow grooves they make in the wood, for the most part burrow through the inner bark, thus loosening it from the wood and causing it to peel off.

The secondary galleries of the same cell rarely cross each other, unless owing to a knot in the trunk or to other irregularities in the wood; but, as seen on the right side of the engraving, one may make a turn and directly cross four or five others, or one from an adjacent mine may cross the galleries of another mine. As a rule, however, the mines of the juniper bark-borer are beautifully regular, and the wood very prettily sculptured.

I have little doubt but that this is the beetle, as it agrees with it in color and size, which I found in considerable numbers under the bark of the cedar or *Thuja occidentalis*, in northern Maine in 1861. The dead cedars were much infested with these beetles, while they were not noticed in upright, healthy trees.

Mr. Warren Knaus states that in Kansas this bark-borer is very destructive to junipers and arbor vitæ.

This insect was first noticed in Salina in the summer and fall of 1884, attacking the junipers on the grounds of a number of the residents of the city. They were then in great numbers, many trees having been entirely destroyed, and others badly injured. The damage was done entirely by the perfect beetle, no larvæ having been observed. The injury was almost invariably confined to the base of the lateral offshoots of the branches of the tree, the beetle burrowing under the bark, and eating around the base of the twig, causing its destruction. Every twig from the trunk outward would be attacked, and a few burrows were also observed on the stems or trunks of the trees themselves. No primary gallery of the perfect insect has been found to exceed three-quarters of an inch in length. I have found no secondary or larval galleries.

Packard, in his "Insects Injurious to Forest and Shade Trees," says he has observed

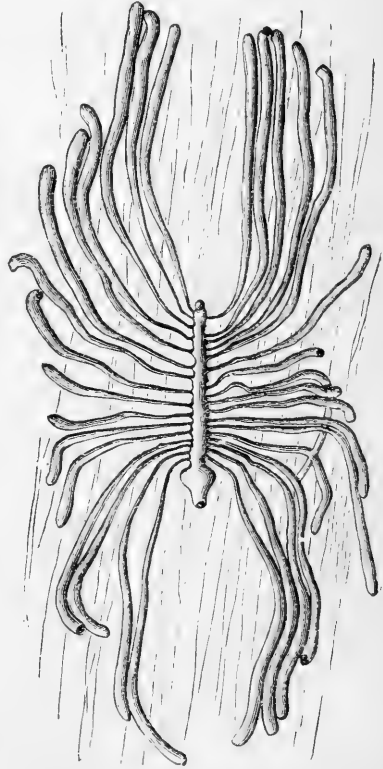


FIG. 299.—Mine of the juniper bark-borer.  
Packard del.

this insect as early as the 1st of May. I have never observed it making attacks earlier than the 1st of September, continuing until the latter part of October.

The attacks of this insect are made on healthy trees, and I have seen no less than fifteen cedars entirely killed in the public square of Clay Center, Kans., that would average six inches in diameter at the base. This *Scolytid* is not a native, but has been introduced in cedar posts brought to the lumber-yards from Michigan and Arkansas. I have examined posts from Arkansas which contained the perfect beetle, (but dead), larvæ, and pupæ. When these pupæ had completed their transformations, cedars in close proximity to the lumber-yard were at once liable to attack.

The primary gallery of this insect as examined in Arkansas cedars is short and straight, being from 18 to 25<sup>mm</sup> in length, and 3<sup>mm</sup> in width. The gallery widens at one end into a trilobed chamber twice as wide as the main gallery. The number of lateral or secondary galleries on each side varies from 15 to 60. These secondary galleries are from one-half to 1<sup>mm</sup> in width, and those arising near the ends of the main gallery are about 45<sup>mm</sup> in length, those arising near the middle are about one-half as long.

The burrows are about one half in the wood and one half in the bark. The secondary galleries rarely cross each other, and when they do, it is owing to some inequality in the surface of the wood, or the close proximity of the burrows.

This bark-borer is not without its enemies. I found fully one-half the pupæ cases examined contained nothing but the remains of a parasite that had destroyed the pupa, and had itself failed to escape. The perfect fly was also seen passing over the surface of the bark, seeking a favorable point to make an attack on his victim. Specimens of this fly were sent to Mr. L. O. Howard, Assistant U. S. Entomologist, who pronounced it a *Chalcid* fly belonging to the genus *Spathius*.

Lecoute states that it inhabits the Middle and Eastern States and Canada, and gives the following description of it:

*The beetle.*—In the genus *Phloeosinus* the funicle or stalk of the antennæ is much shorter than the club; the first joint is rounded; the remaining four joints are closely united and gradually become broader; the club is large, oval, compressed, obtusely rounded, and divided by straight well-marked sutures. *P. dentatus* is rather smaller than the other species of the genus, except *P. punctatus*, with the declivity of the elytra more abrupt and flattened, and less convex; the striæ are impressed and scarcely punctured, the interspaces are wide, densely and strongly granulate and rugose; the rugosities becoming acute tubercles on the declivity of the alternate interspaces; second interspace not depressed on the declivity and furnished with a row of smaller tubercles in some specimens, but not in others. This difference is probably sexual. The head is granulate-punctate, and the front is not carinate.

## 2. THE PRUSSIAN BLUE PINE-BORER.

*Callidium antennatum* Newman.

In company with the juniper bark-borer, mining dying and dead juniper trees; its mine a long, shallow, irregular sinuous gallery about 6<sup>mm</sup> wide in the broadest part; the beetles occurring under the bark early in May in southern New England.

This common borer has already been noticed as infesting the pine (p. 700). It is nearly as common, perhaps, in the juniper; at least I have found it so in the vicinity of Providence, R. I., where it mines dead or dying juniper trees in company with *Phloeosinus dentatus*. In one small tree, three inches in diameter, nearly a dozen mines occurred, and as many of the beetles were taken from under the bark on the 2d and



again the 13th of May, 1881. It is probable that the beetles had hibernated in their mines, having transformed into the pupa state the previous autumn. The mines may be recognized by their long sinuous shape, beginning very small and gradually widening and ending in a broader space or cell where the larva transforms into the beetle condition; just before the cell, at its widest part, it measures 6<sup>mm</sup> in width. The larva, as it eats its way along under the bark, does not sink deeply into the wood, simply scoring it, while the gallery is filled behind it with the tan-brown castings of the worm, consisting of partly digested bark, forming a fine paste which hardens and compactly fills the shallow groove. In general appearance the mine of this borer does not essentially differ from that of most of the superficial longicorn borers of other trees. The beetle is entirely deep Prussian blue, and may be readily identified by its color. It varies much in size.

3. THE BLUE-CLOUDED HYLOTRUPES.

*Hylotrupes ligneus* Fabricius.

We have not personally observed the habits of this borer, which is said by Mr. George Hunt to bore under the bark of *Juniperus virginiana* in Rhode Island. The beetle may easily be recognized by its brown head, antennæ, prothorax, and legs; while the wing-covers are yellowish, with two large adjoining dark Prussian blue patches at the base, the patches rounded behind and extending to the middle of the wing-covers; the terminal third of the wing-covers are also deep Prussian blue, so that only the edges and a transverse copal-yellow band across the wing-covers are left. It is from 9<sup>mm</sup> to 12<sup>mm</sup> in length.

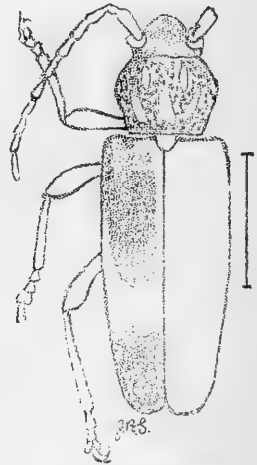


FIG. 300—*Hylotrupes ligneus*.—Smith del.

AFFECTING THE LEAVES.

4. THE JUNIPER TWIG INCH-WORM.

*Drepanodes varus* Grote and Robinson.

Order LEPIDOPTERA; family PHALENIDÆ.

(Larva, Plate x, fig. 1.)

Very closely resembling the smaller twigs of the juniper, a rough-bodied span or measuring worm an inch and a half long, transforming to an ocher-brown moth.

The accompanying engraving well represents this singular mimetic form, which so closely resembles in form and color the smaller twigs of the juniper. Two of the caterpillars are represented, one holding itself

out from the stem by means of its two hinder pairs of feet, while the other clings close to the stem. It is nearly an inch and a half long and less than a line in thickness. Its body is quite rough, with a few prominent tubercles, in size and form resembling the scales left by the falling off of the leaves of the juniper.

The moth may be known by the falcate fore wings, by the three dark spots at the inner angle of the fore wing, and the dark transverse lines; in the females the inner line of the forewings is much curved and sinuate.



The caterpillar was received from Norwich, Conn., early in June, and on the 17th changed into a beautiful pea-green chrysalis, the moth appearing the 29th of the same month.

I have beaten the males and females of this moth out of white pine trees as late as October 5, at Providence, and they probably lay their eggs at that time; perhaps it is double-brooded.



FIG. 301.—Moth, larva, and chrysalis of the juniper twig inch-worm.—From Packard.

*The moth.*—It has unusually falcate forewings. The ground color of the upper side of the wings is a pale fawn-brown, with a rusty but no purplish tinge, as in some other species of the genus; but the body and antennæ are pale fawn-brown. The fore wings at the base are fawn-brown, but with rather thick-set black scales, especially towards the inner line. This line is curved zigzag, rusty fawn-brown, and is very distinct; it begins at the basal third of the costa, and curving around opposite the discal dot, in a generally oblique direction, ends nearly as far from the base of the wing on the inner edge as on the costa; below the median vein the line is acutely zigzag, forming a tooth just below the lowest median veinlet, followed by a curve inwards on the submedian vein. The discal dot is small, black, but distinct. Just beyond the dot the wing inside of the outer line is rusty, becoming deeper in tone next the line. The outer line is straight, white, narrow, but sharply defined, and forms an acute angle opposite the apex, being reflected back on the costa. The line is shaded externally with dense black scales, becoming thinner towards the outer edge of the wing.

From the apex of the bend on the outer line starts a black streak, which is interrupted in the middle, but ends on the lower side of the hooked apex of the wing, which is unusually long and large. The fringe is rust-colored, with the edge white. The outer edge of the wing is deeply hollowed out just below the apex, but below is full and convex. The hind wings are like the fore wings, but without the inner line. The discal dot is distinct, and the outer line is straight, ending just before reaching the costa. There is a broad costal white area. The legs and under side of the wings are fawn-colored, densely speckled with black, giving it a peculiar silky, glossy appearance, suffused with a very slight wine-colored tint. The surface of both wings is uniform; the discal dots are more diffuse than above, being more distinct on the hind wings. The outer line is white, distinct, broader than above, and bent at right angles upon the costa, but the line disappears before reaching the hind edge, which is whitish. The black stripe sent out from the

angle of the line and re-appearing on the hinder edge of the apex of the wing is much as above. On the hind wings the line is straight, broader than on the fore wings, and extends upon the costa. The body is half an inch (.50) in length, and a fore wing measures .65 of an inch in length, both together expanding 1.30 inches.

#### 5. THE JUNIPER BASKET-WORM.

*Thyridopteryx ephemeraformis* (Haworth).

Order LEPIDOPTERA ; family PSYCHIDÆ.

Feeding sometimes in great numbers on the juniper and the white cedar, a worm living in a large case, 1 to 2 inches long, covered with bits of twigs, the female wingless and worm-like ; the male dark brown, with small hyaline wings.

The cases of this remarkable worm we have found on the juniper tree in Virginia, and according to Harris it sometimes abounds so as to be very destructive to the white cedar (*Cupressus thujoïdes*) in lawns. The following brief account is taken from my "Guide to the Study of Insects:"

The male of the basket-worm is stout-bodied, with broadly pectinated antennæ and a long abdomen, the anal forceps and the adjoining parts being capable of unusual extension in order to reach the oviduct of the female, which is wingless, cylindrical, and in its general form closely resembles its larva, and does not leave its case. On being hatched from the eggs, which are, so far as known to us, not extruded from its case by the parent, the young larvæ immediately build little elongated basket-like shallow conical cases of bits of twigs of the cedar, and may then be seen walking about, tail in the air, this tail or abdomen covered by the incipient case, and presenting a comical sight. The case of the full-grown larva is elongated, oval cylindrical, and the fleshy larva transforms within it, while it shelters the female through life.

Mrs. King writes to Psyche (iii, p. 241) that near Dallas, Tex., hundreds of cedar trees may be seen stripped of all foliage and killed by this insect, with their branches laden with its cases. It sometimes feeds on the scrub oak. The female in Texas finishes her transformations from the middle of March to the middle of May. The larvæ may be found at all seasons and in various stages of growth. The eggs mature in three, six, or eight weeks, according to the season, the young larvæ appearing by the latter part of June. I have observed the cases of *Æceticus abbotii* on the cypress at Enterprise, Fla.

As a remedy hand-picking is an easy and thorough means of getting rid of these creatures if abundant enough to be annoying ; or the trees may be sprayed.

The following insects also occur on this juniper :

6. *Incisalia niphon* (Scudder).

7. *Mitura damon* (Scudder).

8. *Papilio troilus* Linn. On *Juniperus sabiniana* (Scudder).

9. *Eacles imperialis* (Drury). Gentry (Can. Ent., vi, 87.)

## INSECTS INJURIOUS TO THE COMMON JUNIPER.

*Juniperus communis.*

## 1. THE LOW-BUSH JUNIPER INCH-WORM.

*Eupithecia miserulata* Grote

Order LEPIDOPTERA; family PHALÆNIDÆ.

Feeding on the common low spreading juniper bush, a small pea-green span-worm, with a narrow thread-like subdorsal and a wider lateral white line, changing early in June to a chrysalis contained in a thin white cocoon, the small moth appearing at the end of the month and through the summer.

This small delicate common moth was reared by Mr. Cassino at Salem, Mass., and like its European congeners lives on the bush juniper (not on *Taxus baccata*, as stated in my monograph of geometrid moths). The larva was found late in May, and June 4 began to spin, the pupa being inclosed in a slight white cocoon. It ranges from Maine to Texas.

*Larva.*—Of the characteristic form, being rather thick in the middle, the body seen dorsally decreasing in thickness from the tail to the head. Supra-anal plate large, triangular, not acutely pointed, deep red, white on the edges. Head small, not so wide as the prothoracic ring, pea-green, color of the leaves on which it feeds, dorsal line dark-green; subdorsal white, and a wider lateral white line. Segments transversely wrinkled. Body provided with short, black, scattered hairs. Length, 0.50 inch.

*Pupa.*—Four abdominal segments project beyond the ends of the wings, the thorax and under side of the wings and limbs with a greenish tinge; the rest of the body pale horn-brown, as usual. Head full, convex between the eyes. End of abdomen with a long rounded spine, with three pairs of long hairs curved outwards at the end. Length, 0.23 inch.

*Moth.*—This is our most common pug-moth, and may be distinguished by the pointed fore wings, with the numerous transverse lines angulated sharply outward, the extradiscal line forming a sharp angle opposite the discal dot, and notched inward on the subcostal vein; by the distinct submarginal wavy white line ending in a large white twin-spot at the inner angle; by the fine dark lines on the hind wings, and by the heavy black costal spots and marginal lines on the under side. The fore wings expand 0.85 inch.

## 2. THE JUNIPER WEB-WORM.

*Dapsilia rutilana* Hübner.

Order LEPIDOPTERA; family TORTRICIDÆ.

The following account is taken from Professor Riley's report to the Department of Agriculture for 1878, with the accompanying illustration:

"This leaf-roller has been found to seriously injure the imported Irish and Swedish junipers (*Juniperus communis* var.) in nurseries on Long Island, having first become known in this country in 1877; it has

not yet been found on our native juniper. It is a well-known English and German moth. There is one annual brood of worms. The insect hibernates at different stages of larval development, and the chrysalis is found throughout the spring months. The moths begin to appear as early as April, but continue to issue during the summer. The worm from birth webs the leaflets together, and lives within a more or less perfect silken tube, this tube being more complete around the hibernating individuals. The sprigs and branches affected by the worm present a seared and brown appearance, and a tree badly affected may be recognized at a great distance." Riley adds, in a later report:

"Among the insects to which I have given some attention during the year is one which may be known by the above popular name. Mr. P. H. Foster, of the Babylon nurseries, Babylon, L. I., had already corresponded with me about the ravages of this worm in 1877, and, after rearing the perfect moth and ascertaining the principal facts in its natural history, I had given no further attention to the matter until the following letter was received:

BABYLON, L. I., *May 13, 1878.*

DEAR SIR: I send you, by mail this day, some specimens of diseased juniper. I find a very small worm encased in a covering, some of which, no doubt, can still be found in the specimen sent. Also one perfect insect and one pupa can be found. I have in my nursery some 200 to 300 fine Irish and Swedish junipers, and unless I can find a remedy they will soon be worthless to me.

Yours, respectfully,

P. H. FOSTER.

"The injuries of this insect had never before been reported in this country, but the species has long been known to affect junipers in the south of England and other parts of Europe. The probability is, therefore, that it is a comparatively recent importation, though Mr. Foster can give me no information that satisfactorily bears upon the point, since he himself never imported any junipers, but obtained his stock when quite small of Messrs. Higgins, of Flushing.

"Heine\* cites this species as having but a limited distribution, reaching in Germany to Mecklenburg. It is rare there, the moth appearing

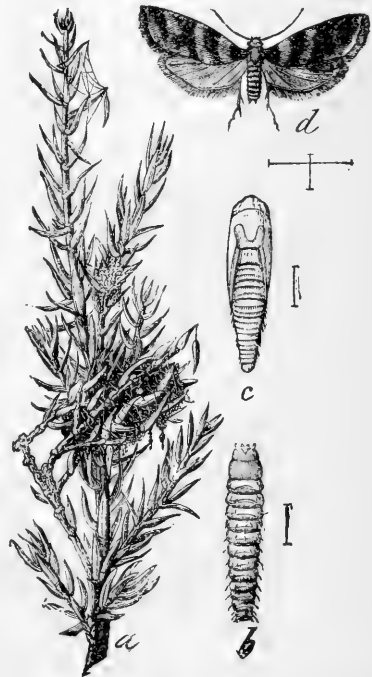


FIG. 302.—The juniper web-worm; *a*, sprig of juniper, showing manner in which the larva works; *b*, larva, dorsal view; *c*, chrysalis, dorsal view; *d*, moth; *b*, *c*, *d*, enlarged.—After Riley.

\* Schmetterlinge Deutschlands und der Schweiz.

in June and July. In England the moth is known to appear as late as July and August.

"All the facts ascertained about the habits of the species would indicate that there is great irregularity in development, though but one annual brood. The insect hibernates at different stages of larval development, and the chrysalis is found throughout the spring months. The moths begin to appear as early as April, but continue to issue during the summer.

"The eggs, which are not yet known, are doubtless laid singly upon different parts of the tree during the summer months and the worms begin to appear in autumn. I found no trace of them in July, and Mr. Foster has often wondered what became of them during the summer.

"The worm from birth webs the leaflets together and lives within a more or less perfect silken tube, this tube being more complete around the hibernating individuals. The sprigs and branches affected by the worm present a seared and brown appearance, and a tree badly affected may be recognized at a great distance. The Irish and the Swedish junipers (varieties of *J. communis*) are both badly affected, but I did not find it on the *Juniperus virginiana*, which is indigenous to the island.

"It is difficult to reach this worm by any application that will kill it by contact, and for that reason the only way of ridding the trees of it is to use some poison, like Paris green or London purple, that will be eaten when the worm issues from its web to feed.

"In point of fact, Paris-green water proved effectual in some experiments made with it at the department on living worms in confinement, whereas gasoline, which Mr. Foster applied to the trees, seemed to have little effect.

"Another web-worm, *Ypsolophus marginellus*, feeds in a similar manner on juniper in England, but is not found in this country."

*Larva*.—Normally constructed, carneau in color, the head and prothoracic shield highly polished, deep gamboge-yellow. The head retractile, oblique. Ocelli and mandibles more dusky. Body wrinkled, tapering very gradually from the mesothoracic joint to the end. Normal complement of legs. The piliferous spots extremely small and indicated more by the short, pale, glistening setous hairs arising therefrom. Wrinkles as in Fig. 302. Hind borders of abdominal joints slightly thickened dorsally.

*Chrysalis*.—Color honey-yellow, the skin so delicate that the colors of the imago show clearly through it prior to emergence. Normally shaped, elongate, slender; the abdominal joints having, superiorly, two transverse rows of rather minute spines; the end blunt and unarmed; the venter with a few blunt, setous hairs; the antennal sheaths reaching not quite to the tip of the wing-sheaths. Average length, 5<sup>mm</sup>.

*Imago*.—Average expanse, 12<sup>mm</sup>. Primaries bright glossy orange, crossed by four reddish-brown bands. The second band from the costa is slightly angulate; the third band has the form of a letter K, the top of the K being usually closed, though occasionally open. The apical band is wedge-shaped, reaching nearly to inferior angle. Frequently this coalesces with the inferior part of the third band. Indeed, as Wilkinson states,\* though constant in color and size, much variation is found in the ornamentation of the fore wings. Hind wings dark gray, with cilia of same color. (Riley.)

\* British Tortrices, p. 318.

## 3. THE SIX-SPOTTED METACHROMA.

*Metachroma 6-notata* Say.

Order COLEOPTERA ; family CHRYSOMELIDÆ.

Feeding on the leaves in July, an oblong pale shining beetle, .15 long, narrower anteriorly and punctured, the punctures in rows on the wing-covers becoming very faint towards their tips, and on each wing-cover three black spots, the forward one long and narrow, the other two situated on the middle, parallel and almost in contact, the inner one placed rather farther back.

## 4. THE APPLE LIOPUS.

*Liopus facetus* Say.

Order COLEOPTERA ; family CERAMBYCIDÆ.

Feeding on the leaves in July, a small black long-horned beetle .18 long, with long slender hair-like tawny-yellow antennæ, their basal joint and the tips of two or three following joints black ; its thorax with an ash-gray stripe on the middle and an oblique one on each side of this, the hind ends of these stripes sometimes uniting and forming a letter W ; its wing-covers with a large ash-gray spot forward of the middle and almost reaching the suture, having in it an oblique triangular black spot, and towards the tip an ash-gray band concave on its hind side.

Mr. Say states that he obtained his specimens from the juniper, but its occurrence thereon was perhaps accidental, as I have found it on apple trees in a section of country where no juniper grows. (Fitch.) We may add that the European *Liopus nebulosus* Linn., though usually living in the apple and other fruit trees, also in Europe, mines the *Pinus abies* and *P. picea*. (See p. 658; fig. 216).

## 5. THE JUNIPER SALMON-TINTED CATERPILLAR.

Order LEPIDOPTERA ; family NOCTUIDÆ.

Feeding on the leaves of the low-bush juniper, in August, in Maine, a small noctuid caterpillar with five pairs of abdominal legs. Body thickest a little in front of the middle. Head small, rounded, pale honey-yellow, as wide as the prothoracic segment. Body flesh colored, finely striped with alternating reddish flesh-colored and whitish fine wavy lines ; two subdorsal reddish lines on each side of the body. The body of this caterpillar is short and thick but sharp at the end, somewhat as in *Leucania*. When observed, August 27 to September 12, the caterpillar was about 6<sup>mm</sup> long.

## 6. NOCTUID LARVA.

Order LEPIDOPTERA ; family NOCTUIDÆ.

Beaten from the juniper, August 5, at Brunswick.

*Larva*.—Head honey-yellow, with two darker stripes on each side of the clypeus. Body umber brown, with two broad conspicuous straw-yellow stripes, edged narrowly above with blackish, and a similar lateral spiracular stripe. Body beneath and all the feet pale blackish. Length, 27<sup>mm</sup>.

## 7. THE JUNIPER TWIG INCH-WORM.

*Drepanodes varus* G. & R.

This caterpillar found on the tree-juniper, also appears to live on the low-bush juniper, as we beat from a bush the last of August a beautiful green chrysalis which agrees closely with that of *Drepanodes varus*. This chrysalis is of the size and exact form represented in Fig. 301, is smooth bodied, pale pea-green, the exact color of a leaf of its food plant. The body is paler than the wings, with two pale subdorsal yellow stripes; the tip of the abdomen is red.

8. *Caterva catenaria* (Drury).

A specimen occurred on the juniper August 6, which pupated August 10, 1883.

9. *Thera contractata* Packard.

I have had this moth from the juniper, on which it commonly occurs. (See p. 841.)

## 10. THE FIR-NEEDLE INCH-WORM.

This caterpillar was found feeding on the juniper at Brunswick, Me., August 26-29, 1881.

## 11. THE JUNIPER PLANT-LOUSE.

*Lachnus* sp.

Common on the juniper at the ends of the branches.

## 12. THE JUNIPER WHITE-STRIPED INCH-WORM.

Order LEPIDOPTERA; family PHALÆNIDÆ.

Feeding on the leaves of the low-bush juniper, late in summer, in Maine, a rather short cylindrical inch-worm, pale pea-green, the color of a juniper leaf. Head full, rounded, as wide as the body; segments a little wrinkled transversely. Lateral ridge sharp, white, the white line extending along the side of the obtusely triangular supra-anal. No other longitudinal stripes, nor any other markings.

13. *Lophyrus* sp.

The larva of this species closely resembles that of *L. abietis*, as it has the same shape and eight pairs of legs, but it differs in the yellow head, and the body has often a decidedly yellowish hue. Along the body is a dorsal and lateral dark stripe, though frequently the stripes are obsolete. The thoracic feet are black. It is common through July, August, and the early part of September. Unlike *L. abietis* it is very hard to rear in confinement, the larvæ sickening and dying. It spins a cocoon like that of *L. abietis* in August and the early part of September, but in confinement the fly does not appear.



## 14. THE JUNIPER SCALE INSECT.

*Diaspis carueli* Targ. Tozz.

This scale insect is said by Professor Comstock to be very common at Washington, D. C., on various species of juniper and allied plants. Its numbers are reduced by a chalcid parasite, *Aphelinus mytilaspidis* Le Baron. The following account is by Comstock, and is copied from the U. S. Agricultural Report for 1880 :

*Scale of female.*—The scale of the female is circular, snowy white, with the exuviae central or nearly so, naked, and yellow. Diameter of scale, 1 to 1.5<sup>mm</sup> (.04 to .06 inch). Figs. 2, 2a, 2b.

*Female.*—The females are yellow, circular in outline, a little elongated posteriorly. The last segment of the body presents the following characters :

The anterior group of spinnerets consists of about eight, the anterior laterals of from ten to sixteen, and the posterior laterals of about eight.

There are four lobes which are nearly in a straight line, the end of the body being truncate. These lobes are quite small, rounded posteriorly and are equidistant from each other. The second lobe of each side is deeply incised, but the lateral lobule is very small and in many cases concealed by the margin of the segment.

Each lateral margin of the segment is divided into three subequal, more or less distinct lobes, each lobe ends posteriorly in one or two lobules, each of which bears an elongated pore on its dorsal surface.

The plates are short and in some cases subtruncate at extremities; they are situated as follows: two between median lobes; two inconspicuous ones laterad of first lobe of each side; two laterad of second lobe; usually one on the anterior part of the first lobe of the lateral margin; one or two near the middle of the second lobe of the lateral margin, and two or three on the third or anterior lobe of the lateral margin.

The spines on the dorsal surface are situated as follows: one upon the first lobe near its lateral margin; one on lateral lobule of the second lobe; and one a short distance mesad of the mesal plate of each of the three lobes of the lateral margin. On the ventral surface the spine accompanying the first and second lobes of each side are obsolete. There is one at the base of the plate of the first lobe of the lateral margin; one between the plates of the second lobe, and one near the middle of the third or anterior lobe of the lateral margin.

*Scale of male.*—The male scale is white and very small, being only 1<sup>mm</sup> (.04 inch) in length; it is elongated, with a prominent median ridge; the larval skin is naked and light yellow in color. See Fig. 2b.

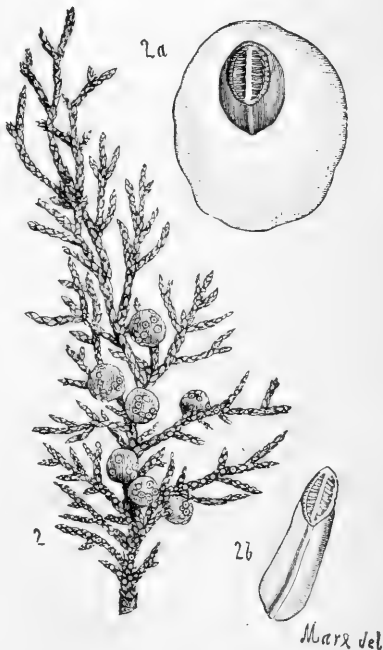


FIG. 303.—The juniper scale-insect.—From Comstock.

*Male*.—The color of the body is light orange yellow, with the thoracic band of the same color. The terminal joints of the antennæ are enlarged.

*Habitat*.—This species is very common in Washington, where we have found it infesting the following named species of juniper and arbor vitæ: *Juniperus chinensis*, *J. rigida*, *J. oxycedrus*, *J. japonica*, *J. communis*, *J. reresii*, *Biola orientalis*, and *Thuya occidentalis*. It was collected by Prof. Targioni Tozzetti, near Florence, Italy. (Comstock.)

## CHAPTER XX.

### INSECTS INJURIOUS TO THE CEDAR, CYPRESS, ETC.

#### INSECTS INJURIOUS TO THE CEDAR.

##### *Thuja occidentalis.*

##### 1. THE CEDAR TINEID.

##### *Bucculatrix thuiella* Packard.

Order LEPIDOPTERA ; family TINEIDÆ.

Feeding on the leaves and spinning slender, small, conspicuous white cocoons attached to the leaves, and transforming to a narrow-winged beautiful pearly-white moth, dotted and marked with brown.

The following account is taken from my first report to the Massachusetts Board of Agriculture :

This is a little moth, of which the caterpillar is unknown, though I found the moths and cocoons in abundance on a cedar tree in Brunswick, Me., July 10. It is undoubtedly similar in its habits to a little moth which lives not uncommonly on the apple tree, and has been described by Dr. Clemens under the name of *Bucculatrix pomifoliella*. Its long, slender, white cocoons may be found, at any time after the leaves have fallen, on the branches of apple trees.

Dr. Clemens says that "the larva feeds externally on the leaf of the apple, at least at the time it was taken, in the latter part of September. It is cylindrical and sub-moniliform; tapers anteriorly and posteriorly; with punctiform points and isolated hairs; first segment with rather abundant dorsal hairs; three pairs of thoracic feet and five abdominal pairs. Head small, ellipsoidal, brown; body dark yellowish green, tinged with reddish anteriorly; hairs blackish and short. Early in October the larva enters the pupa state, wearing an elongated, dirty white, ribbed cocoon, and appears as an imago during the latter part of the following April, or early in May." The present species seems to be undescribed, and may be called *Bucculatrix thuiella*. It belongs to the extensive Tineid family, and its general appearance is sufficiently indicated by the drawing.

*Moth.*—The body and wings are pearly white, and the antennæ are white, with brown wings, while there is a low broad tuft of white scales between the antennæ, the crest being much flatter than in the species living on the apple. The forewings are white, and crossed in the middle by a broad brown band, and beyond this band by alternating white and brown stripes, crossing from the front edge (costa) of the wing. On the end of the wing, and in the middle of the outer edge, is a conspicuous

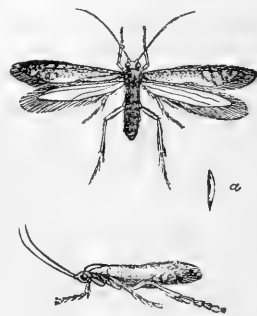


FIG. 304.—The cedar tineid enlarged; a, cocoon, nat. size.—From Packard.

black spot, like the eye in a peacock's feather. To describe the wing and its markings more fully—the basal half of the wing is white, unspotted, except a short, transverse brown band, extending from the inner edge, not quite to the middle of the wing. On each side of this band is a row of two or three minute dots. The middle band is broadest on the hind edge. Beyond and arising from the costa, where they are broadest, and extending to the opposite side of the wing, are six brown lines, alternating with white interspaces. These lines run together in the middle of the wing, brown dots being added, but which end as distinct lines on the inner edge of the wing. The three outermost lines are much curved, and, with the curve of the fringe, form a circular area, in the middle of which, on the base of the fringe, is the curvilinear, rather thick, dark brown spot. The long fringe on the end of the wing is white at base and brown at the end. The hind wings are pale brown, acutely pointed, with a long silvery fringe. The tibiæ and tarsi of the fore legs are brownish, while the hind legs are white, with a long fringe on the hindermost tibiæ. The length of one forewing is .18, and the length of the body is .13 inch.

The cocoon is white, tough, dense, slender cylindrical, and .20 inch in length. It is fastened by one side to the leaf, and differs from that of the apple *Bucculatrix* in not being ribbed longitudinally. A minute, beautifully brilliant green ichneumon (*Chalcis*) fly seems to attack in considerable numbers the chrysalids of this insect, as nearly half of those reared by me turned out one of these parasites. It is a species of a genus allied to *Eulophus*, having the antennæ pectinated, the terminal joints throwing off five long branches. It differs, however, from *Eulophus* among other characters by having a short, thick body, a small, conical abdomen, and short, thick antennæ. The forewings are broad, triangular.

We noticed these beautiful moths again in 1881, at Brunswick, flying about a cedar hedge in considerable numbers from the middle of July until early in August.

2. THE BAG-WORM.

*Thyridopteryx ephemeraformis*, Haw.

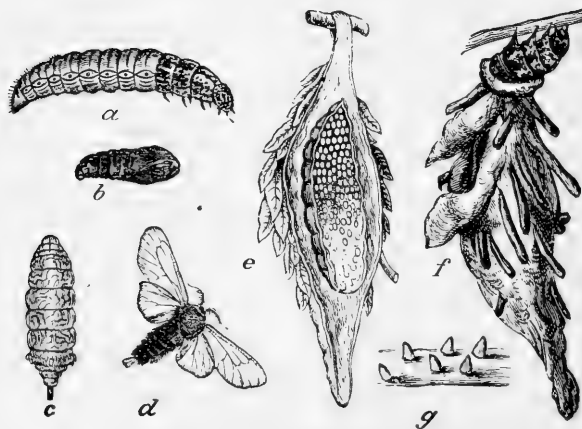


FIG. 305.—The Bag-worm, (*Thyridopteryx ephemeraformis* Haw.) a, Larva, fully grown; b, male chrysalis; c, female moth; d, male moth; e, bag containing female chrysalis, with eggs; f, fully grown larva carrying its bag; g, young worms in their cases.

The general abundance of this pest upon cedars and some other trees in southern Illinois calls for special mention. The small conical bags,

attached to the twigs of the tree, can not be mistaken for anything else. Many of these contain the eggs, which remain throughout the winter and hatch in the following May. They may consequently be removed and destroyed by hand in the winter and spring, or the trees may be protected by spraying with Paris green or other similar poison in June or July, when the worms are eating the leaves. (Forbes' First Report Ins. Illinois.)

3. *Eupithecia miserulata* Grote.

We have found the caterpillar on the cedar August 30, 1883. It pupated September 29 to October 1, and the moth appeared May 12 of the following year.

*Larva*.—Body slender, sutures well marked. Head small rounded, not bilobed, not so wide as the body. Uniformly pale green, being exactly concolorous with the leaves. No humps or warts, the sutures marked with yellow, while the lateral ridge is marked with greenish yellow, forming a prominent interrupted greenish yellow lateral line. Supra-anal plate very short, smooth, obtuse at apex, the edges marked with greenish yellow. Anal legs thick and short, not broad. No dorsal spines. Length 12<sup>mm</sup>.

*Pupa*.—Body slender, of the usual form; green.

4. THE FIR SAW-FLY.

*Lophyrus abietis* Harris.

False caterpillars closely resembling those found on the fir, and identical with that found on the low-bush juniper, occurred on two cedar hedges in Brunswick, from July 18 to the last of August. But a few scattered individuals occurred. We will give a description of the variety found on the cedar.

Body cylindrical, broadest on the thoracic segments; all the segments finely transversely wrinkled. Head small round, deep, amber-colored; eyes black. Body pale green with a broad diffuse dark green medio-dorsal and a lateral stripe. Body paler beneath. Thoracic feet black. Eight pairs of abdominal feet green. Length 13<sup>mm</sup>.

One was found without the three dark stripes. This species differs from the others in the caterpillar having no dark spots on the body as seen in most *Lophyrus* larvæ.

5. THE PROMETHEA MOTH.

*Callosamia promethea* (Drury).

Said by Mr. Riley to feed on the arbor vitæ. (Fourth Rep., 123.)

6. *Ematurga faxonii* Minot.

Professor Riley has reared this moth from caterpillars found on the arbor vitæ. It also occurs on the cranberry.

7. *Noctuid?* larva.

This caterpillar was observed at St. Augustine, Anastasia Islands, on the common red cedar, April 14. The specimens were probably immature.

*Larva*.—Body swollen on the thoracic segments, and also a little humped on the eighth abdominal segment. Head held down in a sphinx-like attitude, smooth and green. Body pale green, like a cedar leaf in hue, and so mottled and marked with yellowish green as to resemble the leaves of the cedar with their yellow-lined scales. A broken dorsal yellowish line, and a latero-dorsal line of larger yellowish spots. On each side of each segment are two longitudinal yellow spots with a lateral one between them. A lateral row of faint yellowish patches. Length, 8mm.

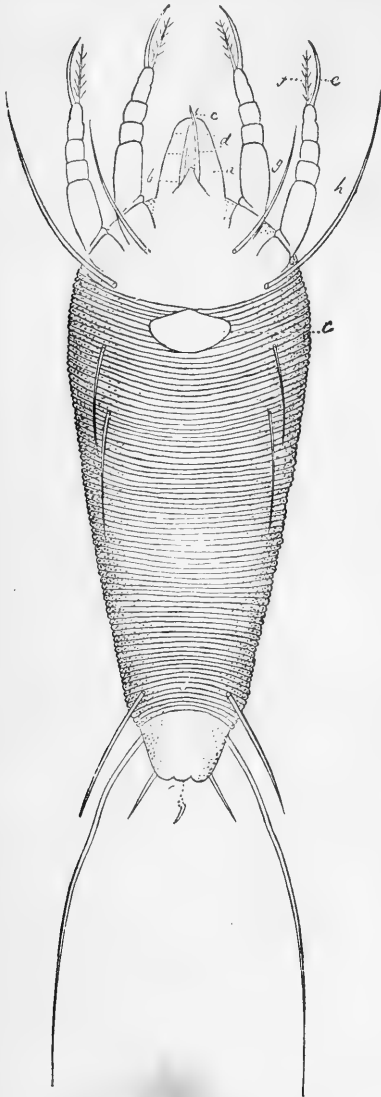


FIG. 306.—*Phytoptus thujæ* (ventral view); a, rostrum; b, labium; c, chelicerae; d, appearance of joints seen on the rostrum; e, tarsal claw; f, feather-like tarsal appendage; g, one of the first pair of hairs on under side of cephalothorax; h, one of the second pair of hairs on the under side of cephalothorax; i, genital plate; j, abdominal sucker.—After Garman.

#### 8. *Phytoptus thujæ* Garman.

According to Mr. H. Garman (in Forbes's first report on the injurious insects of Illinois) this mite occurs on the leaves of the American arbor vitæ, *Thuja occidentalis* Linn., in summer, and in the buds and under the leaves in winter.

"In the latter part of the summer of 1880 my attention was called by Prof. S. A. Forbes to the diseased condition of arbor vitæ hedges in and about Normal, Ill., and upon searching the trees this *Phytoptus* was found creeping about the leaves. I was inclined at the time to refer the condition of the hedges to injuries inflicted by the mites earlier in the season, for they were not sufficiently abundant at the time the examination was made to cause serious inconvenience to the plants. Since then the trees have regained their usual thrifty appearance, and the mites, although still present on them at all times of the year, have not been more abundant at any time than they were when first discovered. The *Phytoptus* of the arbor vitæ spends the winter in the buds and under the margins of the leaves. It can be secured in midwinter by bringing infested twigs into a warm room."

Adults of this mite measure from .005 to .0065 inch in length, with the greatest transverse diameter about .002 inch. They are whitish and semi-transparent. Of

the three pairs of hairs attached to the dorsal surface the first pair is attached at the posterior margin of the cephalothorax, the second between the last two abdominal striæ just before the terminal sucker, and between the hairs of this pair is the third pair, consisting of two short and straight hairs. The hairs of the second pair are abruptly bent at about the fourth of their length from the attachment. The first of the three ventral pairs of hairs has twelve, and the second twenty-four, striæ behind the cephalothorax; to the third pair are attached six striæ in advance of the terminal sucker. The legs are strongly compressed, project downwards, and the feather-like tarsal appendage bears five pairs of prongs. The striæ of the abdomen number about 80.

The following larvæ also occurred in Maine, on the cedar, August 29, 1883: p. 784, No. 112, and *Semiothisa bisignata*.

#### INSECTS INJURIOUS TO THE CYPRESS.

##### *Taxodium distichum*.

##### 1. ABBOT'S SACK-BEARER.

##### *Oiketicus abbotii* Grote.

I have picked the deserted cases of this interesting sack-bearer from the cypress at Enterprise, Fla., where it was abundant.

##### 2. *Hylonicus cupressi* Baird?

An excellent colored plate representing a fine species (perhaps *Hylonicus cupressi* Baird) is to be seen in the Oemler volume of Abbot's manuscript paintings in the library of the Boston Society of Natural History.

##### 3. *Orgyia inornata* Beutenmüller.

Mr. Beutenmüller has described the early stages of this moth, which he has bred from the cypress and live oak. (*Psyche*, v, pp. 165, 300.)

##### 4. *Geometrid larva*.

The span-worm described below occurred on the cypress at Enterprise, Fla., April 7 to 8.

*Larva*.—Body smooth, cylindrical, unarmed. Head smooth, no wider than the body, and like the body, pale green. The body pale green, of the color of the cypress leaves, with two slightly darker lines on each side of the body. Length, 29<sup>mm</sup>.

##### 5. *Cecidomyia cupressi-ananassa* Riley.

Tennessee. (Riley, *American Entomologist*, ii, pp. 244 and 273. Fig. 153, gall.)

## INSECTS INJURIOUS TO THE SEQUOIA GIGANTEA.

1. *Gonops fissunguis* Leconte.

“Three specimens from Big Trees, California.” (Leconte’s Rhynchophora.)

## 2. A LONGICORN BORER.

While at the Big Trees of the Mariposa Grove, we observed that one of them had been mined under the bark by what may have been a longicorn borer, as the mine was broad and shallow, being about 4<sup>mm</sup> broad and about four inches long.

## 3. THE SEQUOIA ÆGERIAN.

*Bembecia sequoiæ* Hy. Edwards.

Order LEPIDOPTERA; family ÆGERIADÆ.

Very destructive to *Sequoia sempervirens*, as well as to *Pinus ponderosa* and *P. lambertiana*. H. Edwards. (Papilio, Vol. I, p. 181.)

“*Bembecia sequoiæ* Hy. Edw. is devastating the pine forests of Mendocino County, California, and is particularly destructive to *Sequoia sempervirens*, *Pinus ponderosa*, and *Pinus lambertiana*. The eggs appear to be laid in the axils of the branches, the young caterpillar boring in a tortuous manner about its retreat, thus diverting the flow of the sap, and causing large resinous nodules to form at the place of its workings. These gradually harden, the branch beyond them dies, and the tree at last succumbs to its insignificant enemies. Hundreds of fine trees in the forests of the region indicated are to be seen in various stages of decay. A similar habit seems to prevail in the life-history of *Sciapteron pini* Kellicott, a species described by its author in the Canadian Entomologist, 1881.” (H. Edwards in Bull. U. S. Ent. Comm., No. 7, Appendix.)



## EXPLANATIONS TO PLATES.

### PLATE I.

- FIG. 1. *Cossus centerensis*. Group of eggs as deposited, natural size.  
 2. Egg magnified 9 diameters.  
 3. Caterpillar from time of emerging to October 14—four months' growth.  
 4. Caterpillar of one year and four months' growth.  
 5. Caterpillar of two years and four months' growth.  
 6. Mature caterpillar, three years old; ready to pupate.  
 7. Pupal cell.  
 8. Male pupa.  
 9. Female pupa.  
 10. Male *Cossus*, unspread.  
 11. Female *Cossus*.  
 12. Female *Cossus*, showing ovipositor. Bailey del.

### PLATE II.

- FIG. 1. *Cossula magnifica*. Pupa case.  
 2. *Cossula magnifica*. Male.  
 3. *Cossula magnifica*. Female.  
 4. *Cossus querciperda*. Male.  
 5. *Cossus querciperda*. Female.  
 6. *Cossus angrezi*. Female. Bailey del.

### PLATE III.

- FIG. 1. *Sphinx chersis*. On ash. John E. LeConte del.  
 2. Same.  
 3. *Deilephila lineata*. On elm. J. Bridgham del.  
 4. *Smerinthus myops*. John E. LeConte del.  
 5. *Janassa lignicolor*. Riley del.  
 6. *Hyarpax aurora*. Miss Emily L. Morton del.  
 7. *Adoneta spinuloides*. Miss Emily L. Morton del.  
 8. *Metanema quercivoraria*. John E. LeConte del. (His No. 47).  
 9. *Endropia* sp. John E. LeConte del. (His No. 46).

### PLATE IV.

- FIG. 1. *Datana ministra*. Before the last molt. H. C. Bumpus del.  
 2. *Datana ministra*. Full fed. H. C. Bumpus del.

### PLATE IV—Continued.

- FIG. 3. Noctuid larva. H. C. Bumpus del.  
 4. Noctuid larva on beech. H. H. Wilder del.  
 5. Geometrid larva on alder. H. H. Wilder del.  
 6. Same.  
 7. Geometrid larva on red maple; 7a, nat. size; 7b, head; 7c, end of body enlarged. Wilder del.  
 8. Geometrid larva on oak; a, end of body enlarged. Wilder del.  
 9. *Antepione depontanata*. Wilder del.  
 10. Pyralid larva on poplar; a, head and prothoracic segment enlarged. Wilder del.  
 11. Nematid (?) larva on alder. Wilder del.  
 12. *Selandria* (?) larva on alder; a, end of body enlarged. Wilder del.  
 13. *Selandria* (?) larva on alder; a, end of body enlarged. Wilder del.  
 14. *Selandria* (?) larva on birch; a, end of body enlarged. Wilder del.

### PLATE V.

- FIG. 1. *Notodontia stragula*, before the last molt. Wilder del.  
 2. *Cerura* on willow. Wilder del.  
 3. *Schizura* on willow. Wilder del.  
 4. *Scoliopteryx libatrix*. Wilder del.  
 5. *Amphidasys cognataria*, before the last molt. Wilder del.  
 6. *Deilinia variolaria*. Miss L. Sullivan, del.  
 7. Geometrid larva on willow; a, head; b, end of body, enlarged. Wilder, del.  
 8. Geometrid larva on willow; a, head; b, end of body, enlarged. Wilder del.  
 9. *Hydria undulata*, larva. Wilder del.  
 10. *Meroptera pravella*; a, head; b, end of body, enlarged. Wilder del.  
 11. *Cimbex americana* before last molt. Wilder del.

### PLATE VI.

- FIG. 1. *Eacles imperialis*; 1a, front view, with head elevated. J. Bridgham del.  
 2. Noctuid larva on pine. H. Bumpus del.  
 3. *Semiothisa bisignata* Walk. Miss L. Sullivan del.  
 4. *Lyda* sp. on pine. Wilder del.

## PLATE VII.

The original drawings, both plain and colored, were made by Mr. J. Henry Blake, of Cambridge.

- FIG. 1. *Retinia frustrana*. The moth, enlarged three diameters.
2. Side view of chrysalis, enlarged three diameters. 2a. One of the abdominal joints enlarged nine diameters, to show the rows of spines and ridges.
  3. Front view of chrysalis, enlarged three diameters. 3a. The terminal joints of the abdomen, enlarged nine diameters, to show the arrangement of spines and hairs at the tip of the body.
  4. Full-grown caterpillar, enlarged four diameters.
  5. Terminal shoot of the pine in an uninjured, natural condition.
  6. Terminal shoot which has been attacked by the insect when the apical leaves were only partly grown; away from the tip the needles have nearly or quite attained their full growth before the mining operations of the caterpillar had sapped their supply of nourishment.
  7. Terminal shoots in a healthy condition, stripped of its needles, to contrast with fig. 9.
  8. An infested shoot cut open to lay bare the mine of the caterpillar in its latest stage, the refuse which nearly fills it has been removed. The length of the terminal needles shows this shoot to have been well advanced in its growth before it was attacked.
  9. A shoot similar to that represented in fig. 7, but which has been distorted by the attacks of the insect.

## PLATE VIII.

- FIG. 1. *Tortrix fumiferana*: 1a, enlarged; 1b, side; 1c, dorsal view of caterpillar; 1d, the same enlarged; 1e, pupa; 1f, the same, enlarged. Miss J. Sanders del.
2. *Tephrosia cribrataria*. Miss L. Sullivan del.
  3. *Lophyrus* sp. on cedar. Bumpus del.
  4. *Lophyrus* sp. on spruce. Wilder del.
  5. *Lophyrus* sp. on spruce; a, end of body enlarged. Wilder del.
  6. *Syrphus* larva, on cedar. Bumpus del.

## PLATE IX.

- FIG. 1. *Nematus erichsonii*: 1a, natural size; 1b, larva in different stages. 1d, twig of larch defoliated, Miss Sullivan del.; 1c, cocoon nat. size.
2. *Gelechia abietisella*: 2a, the rude cases of dried hemlock leaves, Miss Sullivan del.
  3. Geometrid larva on larch: a, head; b, end of body, enlarged. Wilder del.

\* The green shades in this plate are too light, and the red in Fig. 7 is too bright.

## PLATE X.

- FIG. 1. *Drepanodes varus*. Two caterpillars closely mimicking a juniper twig. Emerton del.
2. Geometrid larva. Miss Sullivan del.
  3. Geometrid larva. Miss Sullivan del.
  4. *Eupithecia luteata*. Miss Sullivan del.
  5. Geometrid larva on pine. Miss Sullivan del.
  6. *Lyda* sp. on pine. Miss Sullivan del.
  7. *Lyda* sp. on spruce. Wilder del.

## PLATE XI.\*

- FIG. 1. *Ceratomyia amyntor*. J. A. Lintner del.
2. *Sphinx kalmiae*. J. A. Lintner del.
  3. *Smerinthus excecatus*. J. A. Lintner del.
  4. *Smerinthus juglandis*. J. A. Lintner del.
  5. *Ellema harrisii*. J. A. Lintner del.
  6. *Nadata gibbosa*. J. A. Lintner del.
  7. *Cerurc. occidentalis*. J. A. Lintner del.
  8. *Platyserura furcilla*. J. A. Lintner del.

## PLATE XII.

Map of Maine, showing the regions known to have been infested by bark-boring beetles and other borers, and by the spruce-bud worm. The red line indicates only approximately the boundary line between the Canadian and Alleghanian faunas, the line having been drawn by Prof. C. H. Fernald and myself.

## PLATE XIII.

Spruce woods devastated by the spruce bud-worm. New wharf road, Brunswick, Me.

## PLATE XIV.

Nearer view of spruce killed by the spruce bud-worm; same locality as on pl. XIII.

## PLATE XV.

OVIPOSITOR OF CYNIPS Q. FOLII, EUROPEAN OAK GALL-FLY.

- FIG. 1. Abdomen of Cynips, showing the great dorsal segment, the peduncle, and the disposition of the ovipositor within.
2. The whole ovipositor: a, lateral scale; a', its valve; b, anal scale; b', stylet; c, support of the stylet; e, base or support of sting; f i.
  3. Profile, showing the relation of the genital armature to the rest of the abdomen; the sixth sternite has been drawn to show its full size.
  4. Anal scale (b) and stylet; e i, supports and body of the stylet; c, piece uniting the two scales.
  5. Lateral scale, a, and a' sheath; d, support of the sting; f.
  6. Transverse section of the body through the sting (diagrammatic): R, internal armature; o, oviduct; a, lateral scale; a', its valve; e, support of the stylets i; b, anal scales; c, piece uniting two scales; f, sting; d, its support.

## PLATE XV—Continued.

- FIG. 7. A second section simpler and more theoretic than the first.
8. Diagrammatic. All the elements of the sting have been reduced to pieces of the same form. After Lacaze-Duthiers.

## PLATE XVI.

- FIG. 1. *Chalcophora virginica*: *ant*, antenna; *lbr*, labrum; *md*, mandible; *mx*, 1st maxilla; *mx'*, 2d maxilla (labium); *lp*, labial palpus (this lettering the same for the other figures on plates XVI-XXV); *l*, *pal*, labial palpus, enlarged; *s*, seta; *ch*, chitinous support.
2. *Dicerca divaricata*, enlarged about twice; *b*, head and three thoracic segments, seen from beneath.
3. Unknown larva, sweet gum tree, Houston, Tex.; *v*, ventral view; *p*, prothorax; *m*, mesothorax; *m'*, metathorax.
5. Buprestid larva from under hemlock bark; *a*, natural size; *b*, head and prothorax from above; *c*, the same, drawn from below.

All the figures and details drawn by Dr. C. F. Gissler.

## PLATE XVII.

- FIG. 1. *Elaphidion parallelum*: *a*, from above; *b*, from beneath; *f*, ligula-like process situated behind and not between the labial palpi.
2. Unknown longicorn larva under bark of pin oak, Houston, Tex.; *v*, under side.
3. *Criocephalus agrestis*: pupa, dorsal view, enlarged 2 times.
- 3a. *Criocephalus agrestis*: pupa, ventral view.
4. *Melanophila*, under bark of spruce; *v s*, under side of prothoracic disc. (See, also, pl. XXII, fig. 1.)
- Gissler del.

## PLATE XVIII.

- FIG. 1. Unknown longicorn larva, from under bark of pitch pine, Atlanta, Ga.,  $\times 2$  times; *va*, head and five succeeding segments, from beneath; *vb*, 4th abdominal segment, from beneath; *vc*, 7th abdominal segment, from beneath; *lat*, lateral view of head and four succeeding segments, with prothoracic and 1st abdominal spiracle; *md*, two views of the mandibles. Length of larva, 37<sup>mm</sup>; width of prothoracic segment, 10<sup>mm</sup>; length of same, 4.5<sup>mm</sup>; width of mesothoracic, 9.5<sup>mm</sup>; of 1st abdominal segment, 9<sup>mm</sup>. Average width, 8.1<sup>mm</sup>.
2. *Saperda tridentata*. Length, 18<sup>mm</sup>; width of prothoracic segment, 5<sup>mm</sup>; *v*, under side of head and five succeeding segments; *lat*, lateral views of the same; *md*, three views of the mandibles.
- All the figures enlarged, and drawn by C. F. Gissler, under the author's directions.

## PLATE XIX.

- FIG. 1. *Aseum maestum*: *v*, under side of thoracic segments, showing the three pairs of legs; with the three succeeding segments; *lat*, lateral view of head, three thoracic and 1st abdominal segments.
2. Longicorn larva, under bark of oak, Atlanta, Ga. Length 18<sup>mm</sup>; width of prothoracic segment 5.2<sup>mm</sup>; ventral view same as dorsal. Body narrowest in the middle; prothoracic segment short and very broad; the elevated areas or callosities dark and prominent; antennæ long, 4-jointed; 2d joint much shorter than the first; 4th joint minute, half as long as the 3d is thick; labrum rather narrow; 3 pairs of short, acute thoracic feet.
3. Longicorn larva, under bark of *Pinus strobus*, May 26. Length 14<sup>mm</sup>; *x*, two fleshy processes with horny tips, on the median area of tergum of 9th abdominal segment.
4. Longicorn larva, on sweet gum tree (*log*), Houston, Tex. Length 10<sup>mm</sup>; *e*, end of body, showing a curved spine on the dorsal side of the 9th abdominal segment, and on each side of the latter a fleshy process with a terminal bristle.

C. F. Gissler del.

## PLATE XX.

- FIG. 1. *Orthosoma brunneum*; *v*, under side of three thoracic (with feet) and first two abdominal segments; *lat*, side of head and four succeeding segments showing the feet; *lbr*, labrum and clypeus with front edge of epicranium.
2. Longicorn larva from sycamore: *v*, under side of the three thoracic and four basal abdominal segments.
3. Pupa of a longicorn beetle (*Oncideres?*) found under bark of pin oak, April. Length, 18<sup>mm</sup>; width of prothorax 4.4<sup>mm</sup>.
- Gissler del.

## PLATE XXI.

- FIG. 1. *Rhagium lineatum*, dorsal view: *v*, under side of head and pro- and mesothoracic segments; *vms*, one of the middle ventral segments, magnified six times; *ml*, mala of the maxilla.
2. *Rhagium lineatum*, vertex, top of head; *ep*, front of epicranium; *oc*, eyes; *cly*, clypeus, membranous on the edge; *ch*, two chitinous supports of (*lbr*) the labrum; *ml*, mala or single lobe of the maxilla *mx*; *md*, mandible.
3. Longicorn larva from oaklog, Providence, May 20. *v*, under side of thoracic segments, showing the legs; *ml*, mala of maxilla; *mx'*, labium; *sm*, submentum; *m*, mentum; *lig*, ligula.
4. *Saperda* larva from willow.
- Gissler del

## PLATE XXII.

- FIG. 1. *Melanophila*: *lbr*, labrum and front of head, with the antennæ (*ant*); *s*, prothoracic stigma; *s*, one of the abdominal stigmata.
2. *Xylotrechus colonus*: *lat.*, side view of head and 6 succeeding segments.
- 2a. *Xylotrechus colonus*, mouth parts: lettering as in other figures.
3. *Xylotrechus colonus*?, under bark of black birch, Providence, May 20.
4. Details of mouth-parts of *Saperda* larva from willow trunk, represented at Plate XXI, Fig. 4.
5. Longicorn larva found under hemlock bark, The Glen, N. H., July 22.
6. Longicorn larva found under bark of hemlock, Bath, Me., July 30. Enlarged; *md*, outer; *md*, *i*, inner side of the mandible. All the figures enlarged. Gissler *del.*

## PLATE XXIII.

- FIG. 1. Unknown larva from log of sweet gum tree, Houston, Tex.
2. Pupa. Glen, N. H., July 22.
3. *Xestobium affine*, mouth-parts of larva.
4. *Hylurgops pinifex*, and mouth-parts.
5. *Pisodes strobi*, larva (9<sup>mm</sup> long) and mouth-parts.
6. *Pisodes strobi*, pupa: *hd*, front of head and beak, with antennæ; *ab*, end of abdomen, with the fleshy lateral processes. Gissler *del.*

## PLATE XXIV.

- FIG. 1. *Xyloterus bivittatus*, larva.
- 1a. *Xyloterus bivittatus*, pupa.
2. *Xyleborus cælatus*, larva.
- 2b. *Xyleborus cælatus*, mandible.
3. *Xyleborus cælatus*, pupa, dorsal view.
- 3a. *Xyleborus cælatus*, pupa, end of abdomen much enlarged.
4. *Crypturgus atomus*, larva.
5. *Crypturgus atomus*, larva: *md*, mandible; *mz'*, labium.
- 5a. *Crypturgus atomus*, larva: *md*, mandible.
- 5b. *Crypturgus atomus*, maxilla.
- 5c. *Crypturgus atomus*, pupa, end of body.
6. Chalcid parasite of *X. cælatus* or *Crypturgus atomus*; *w*, wing; *ant*, antennæ.
- 6a. Chalcid parasite, larva, 2<sup>mm</sup> in length.
7. Unknown larva, 4<sup>mm</sup> in length, under bark of pine, probably preying on lignivorous scolytid larvæ. Maine.
8. Pupa of longicorn larva, under bark of sycamore tree, Brooklyn, N. Y.: *p*, end of abdomen seen from above.
9. *Hylurgops pinifex*, pupa.
- All the figures enlarged. Gissler *del.*

## PLATE XXV.

- FIG. 1. *Selandria* larva, common on *Carya porcina*, with details of mouth-parts: *leg*, leg; *mz*, maxilla; *gal*, galea (=mala exterior); *lac*, lacinia (=mala interior). Other letters as heretofore.

## PLATE XXV—Continued.

- FIG. 2. *Paleacrita vernata* (before last molt), on *Carya porcina* and sometimes on oak, May 25, June 20: n. s., larva of natural size, head downward; *p*<sup>3</sup>, third leg; *mz* and *mz'*, maxilla and labium (the dotted line ends on the maxillary lobe or mala); *sp*, spinneret at end of lingua; *p*, maxillary palpus; *cly*, clypeus; *lbr*, labrum; *l*, fleshy lobe.
3. Unknown larva, common under bark, preying on destructive scolytid beetles.
4. Unknown larva, yellowish, under bark; 8<sup>mm</sup> in length; *ab*, end of abdomen.
5. Carabid larva, under bark of pine; length, 4<sup>mm</sup>.
- All the figures enlarged. Gissler *del.*

## PLATE XXVI.

- FIG. 1. *Nematus erichsonii* head of larva before last molt.
- 1a. Same, full-grown larva.
2. Maxilla of same, from above; *g*, galea; *lac*, lacinia; *palp*, palpus.
3. Same, underside; *mz*, maxilla; *mzp*, maxillary palpus, *mz'*, labium; *mz'p*, labial palpus.
4. Mandible of same.
5. *Pteromatus nematocida* Pack., parasitic on same. L. O. Howard, *del.*
6. *Nematus integer*, head and thorax; *psc*, praescutum; *sc*, scutum; *sc*l, scutellum.
- 6a. Same, ovipositor; 9, 10, 9th and 10th abdominal segments; *ov*, ovipositor; *c*, cercopod.
- 6b. Same, wing.
- 6c. Same, antenna.
7. *Gelechia abietisella*, larva enlarged (natural size indicated by hair line).
- 7a. Same, head and thoracic, and first abdominal joints more highly magnified.
- 7b. Same, terminal joints on same scale as last. All the figures magnified. (Packard—Gissler, *del.*)

## PLATE XXVII.

- FIG. 1. *Pisodes strobi*: *a*, larva; *b*, pupa seen from beneath.
2. Mines made by the larva: *b*, transformation cells.
3. White-pine trees at Brunswick, Me., deformed by killing the leading shoot when young.
4. A large white-pine tree at Brunswick, Me., supposed to have been deformed by this weevil. Vose *del.*
5. A white-pine tree in East Providence, R. I., deformed by this weevil. From a photograph by A. A. Packard.

## PLATE XXVIII.

- FIG. 1. *Kermes* sp. G. Marx *del.* From Comstock.
2. *Chionaspis pinifolii*. Marx *del.* From Comstock.

## PLATE XXVIII—Continued.

3. *Chionaspis quercus*: 1c, legs. From Comstock.
4. *Asterodiaspis quercicola*. From Comstock.

## PLATE XXIX.

- FIG. 1. *Rhizococcus* on Araucarian pine: 1a, male 1b, its tail; 1d, female; 1c, end of its body; 1e and 1f, its legs; 1g, edge of its body; 1h, antenna.
2. *Rhizococcus quercus*: 2a, edge of body; 2b, a leg. After Riley.

## PLATE XXX.

- FIG. 1. *Pulvinaria innumerabilis*: a, egg before hatching; b, egg after hatching; c, newly-hatched larva, ventral view—greatly enlarged, natural size indicated in circles. After Riley.
2. a, leaf with male scales—natural size; b, single male scale; c, male dorsal view—enlarged. After Riley.
  3. a, female scales in fall—natural size; b, do., dorsal view; c, do., ventral view—enlarged. After Forbes.
  4. a, b, females with egg-masses in late spring on maple leaf and stem of *Maclura*—natural size. After Riley.

## PLATE XXXI.

- FIG. 1. Geometrid larva on pine. Length, 13<sup>mm</sup>;
- 1a, dorsal view. Gissler del.
  2. Geometrid larva on pine. Head, front view: 2a, labium; 2b, the five simple eyes and tactile hair between them; 2c, a mandible; 2d, labium; p, labial palpus, sp, spinneret; 2e, supra-anal plate and one of the anal legs. Gissler del.
  3. *Caterva catenaria*; 3a, dorsal view; 3b, front of head; 3c, side of a segment Marx del.
  4. *Selandria* larva on willow. Emerton del.
  5. *Pityophthorus puberulus*, antenna. Gissler del.

## PLATE XXXII.

- FIG. 1. *Semiothisa bisignata* on fir: 1a, side view; 1b, front view of head; 1c, labium; 1d, Maxillæ (mx) and labium (lb) seen from beneath; labial palpus (lp); sp, spinneret; 1e, antenna; 1f, mandible; 1g, a thoracic leg; 1h, supra anal plate and anal legs. Gissler del.
2. Geometrid larva on hemlock, enlarged: 2a, end of body. Gissler del.
  3. *Dasylophia anguina*? Emerton del.
  4. *Seirotonta bilineata*. Emerton del.
  5. *Apatela pruni* Harris. Emerton del.

## PLATE XXXIII.

- FIG. 1. Geometrid larva on fir, 10<sup>mm</sup> in length, 1a, the same side view; 1b, head seen from in front; 1c, labium; 1d, antenna; 1e, labium; 1p, labial palpus; sp, spinneret;

## PLATE XXXIII—Continued.

- 1f, mandible; 1g, end of an abdominal leg; 1h, supra-anal plate and anal legs. Gissler del.
2. 2a, Geometrid larva (same species as pl. x, fig. 3) x 7 times, and larva natural size (the body tapers too much at the end); 2b, imbricated structure of the cuticle on vertex of head; 2c, arrangement of light brown pigment at the side of the head, with rose-red pigment veins; 2d, ocelli, the lens convex, hyaline, pigment dark brown and directed downwards towards the genæ; 2e, supra-anal plate; 2f, side view of supra-anal plate and anal legs (the plate is drawn too long). (The labium, mandibles, maxillæ, labium, and antenna the same as pl. xxxi, fig. 2. Gissler del.

## PLATE XXXIV.

- Ellema harrisii*, young, 15<sup>mm</sup> in length. 1a, dorsal view; 1b, front view of the head, showing position of the eyes, (b') (labium incorrectly drawn). 1c, labium; 1d, antenna; 1e, maxillæ (mxp, maxillary palpi), and labium; the latter turned downward, showing along the ventral margin glandular digitate, transparent appendages (lp, labial palpi); 1f, portion of the head torn away to show antenna (ant), mandible (md); 1g=1g'. 1h, mandible; 1i, ventral view of last segment, with last pair of abdominal legs; 1j, a thoracic leg. C. F. Gissler del.

## PLATE XXXV.

- FIG. 1. *Mallodon melanopus*, larva, dorsal, ventral and side view; a, head seen from above; b, the same seen from below. Marx del.
2. *Nola ovilla*, dorsal and side view. J. Bridgman del.
  3. *Parorgyia parallela*; dorsal and lateral view; natural size. J. Bridgman del.

## PLATE XXXVI.

- Row of poplars on Fourteenth street, Washington, defoliated by the fall web worm. From Bull. 10. Div. Entomology.

## PLATE XXXVII.

- FIG. 1. The European gipsy moth, male. After Kirby.
2. The same, female. After Ratzeburg.
  3. Caterpillar, nat. size. After Ratzeburg.
  4. Pupa in loose cocoon. After Ratzeburg.

## PLATE XXXVIII.

- Sciara ocellaris*. 1, leaf of *Acer rubrum* with galls; 2, adult, male; 2a, tibial spurs and brushes of same; 2b, claspers of same; 3, larva; 3a, head of larva; 3b, caudal end of larva; 4, cocoon and pupa skin. After Comstock.

## PLATE XXXIX.

FIG. 1. *Sphinx catalpæ*. *a*, egg-mass; *b*, newly-hatched larvæ; *c*, a larva one-third grown; *d*, dorsal view of one of its joints; *e, f, h*, differently marked larvæ; *g*, dorsal view of one of the joints of *f*; *i*, do. of *h*; *j*, pupa; *k*, moth—nat. size; *l*, egg—enlarged. Marx del.

## PLATE XL.

## DEVICES FOR UNDERSPRAYING TREES WITH INSECTICIDES.

[From Ann. Rept. U. S. Dept. Agr., 1883.]

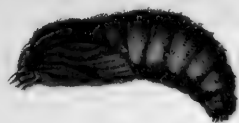
FIG. 1. *Parts of hose-pole device for spraying trees*: Bamboo pole, *bb*; drip-washer, *j*; hose, *hx*; side hook, *v*; eddy-chamber nozzle, *n, m*; spray, *z, s*.

## PLATE XL—Continued.

FIG. 2. *Metallic hand-pipe with diagonal nozzle*: Hose, *h*; metallic pipe, *t*; diagonal eddy-chamber nozzle, *n*; its removable face, *i*; spray, *s*.

3. *Barrel rest or skid*: Two coupling-cleats *bb*; two side rests, *aa*; chamfered concave, *cc*.

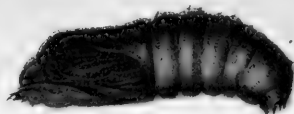
4. *Stirrer-pump with barrel and mixer-funnel in section*: Funnel, *u*; its cylindrical sides, *gg*; funnel base, *tt*; spout *p* (in bung-hole, *k*); gauze septum, *d*; barrel, *kk*; trunnions, *i*; trunnion-eyes, *e*; wedge, *v*; lever-fulcrum, *f*; pump-lever *ii*; swing of the lever-head and piston-top, *abc*; cylinder packing-cap, *c*; cylinder, *q*; its swing, *xy*; stirrer-loop or eye, *h*; stirrer-bar, *mn*; rope, *ww*; bungs, *r, z*.



8



1



9



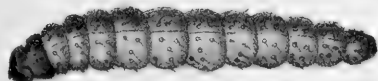
3



2



4



5



6



10



11



12



7







Fig 2.



Fig 3.



Fig 1.



Fig 4.



Fig 5.



Fig 6.

LITHO & LIBERTY PRINTING CO. NY





Fig. 6

Fig. 5

6'

Fig. 3

Fig. 4

Fig. 1

Fig. 7

Fig. 9

Fig. 8

Fig. 2

LE CONTE, BRIDGHAM, PILEY AND MISS MORTON, DEL.

GILES' LITHO & LIBERTY PRINTING CO.

INSECTS OF THE OAK, ELM, ASH ETC.



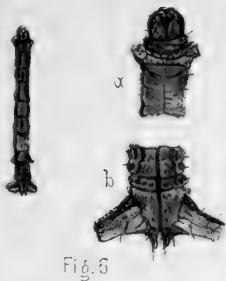


Fig. 6

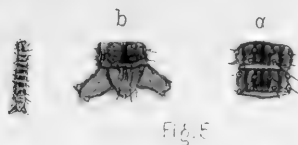


Fig. 5

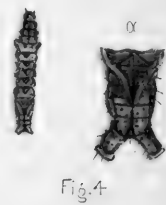


Fig. 4

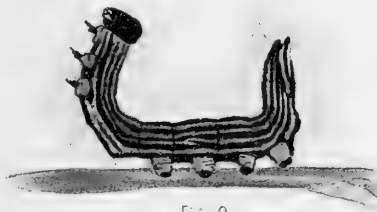


Fig. 2



Fig. 1

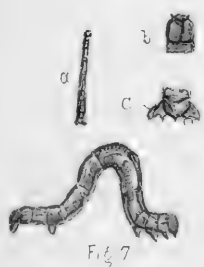


Fig. 7

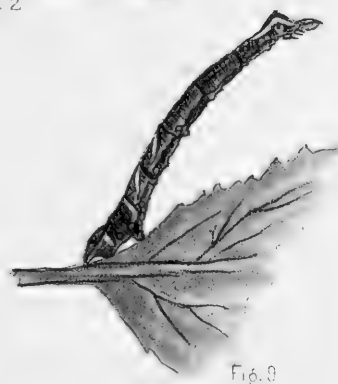


Fig. 9



Fig. 10



Fig. 8



Fig. 11

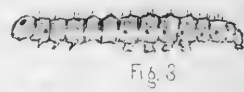


Fig. 3



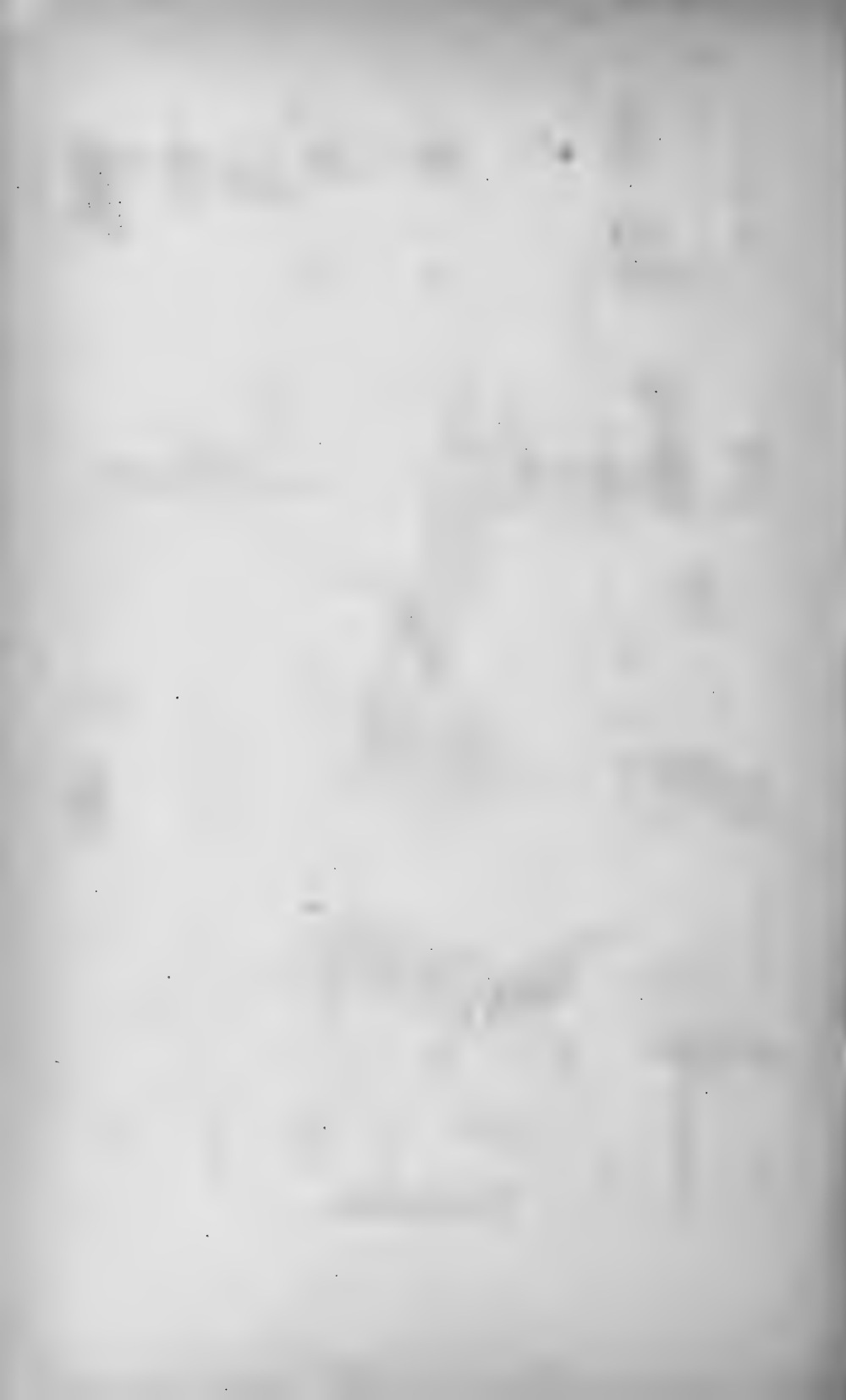
Fig. 12

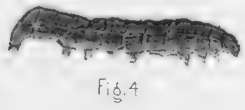
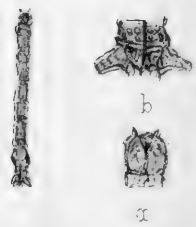
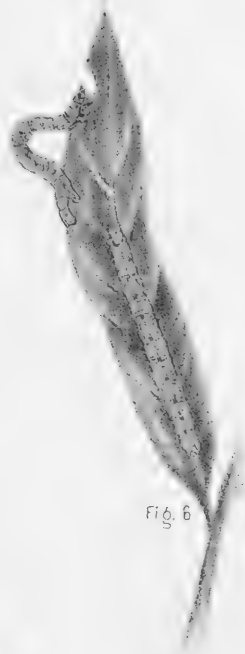
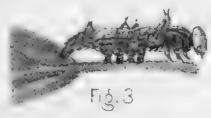
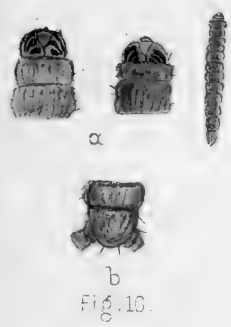
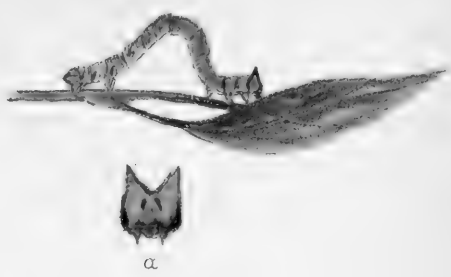


Fig. 13



Fig. 14













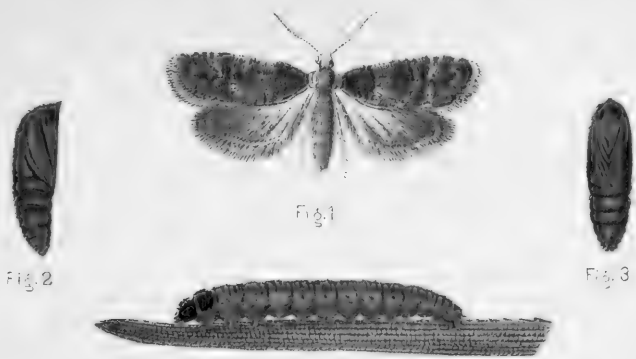


Fig. 1

Fig. 2

Fig. 3

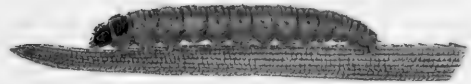


Fig. 4



Fig. 5



Fig. 6



Fig. 7



Fig. 8



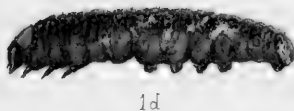
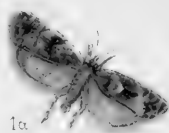
Fig. 9

2"

3"

THE PINE-MOTH OF NANTUCKET.





FILES LITHO & LITHO PRINTING CO.

THE SPRUCE-BUD TORTRIX, ETC.

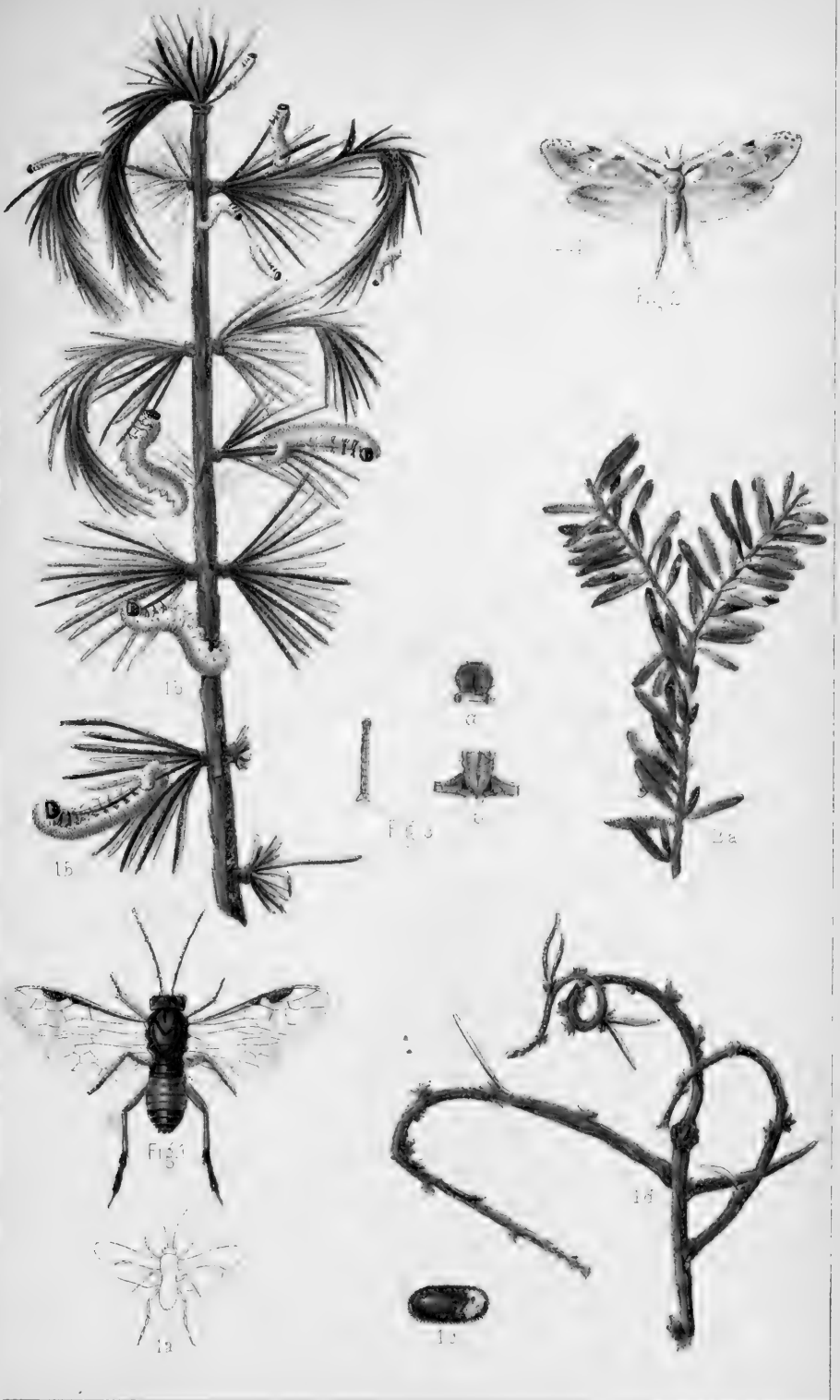
100

100

100

100

100



LILLIE SULLIVAN, PINX.

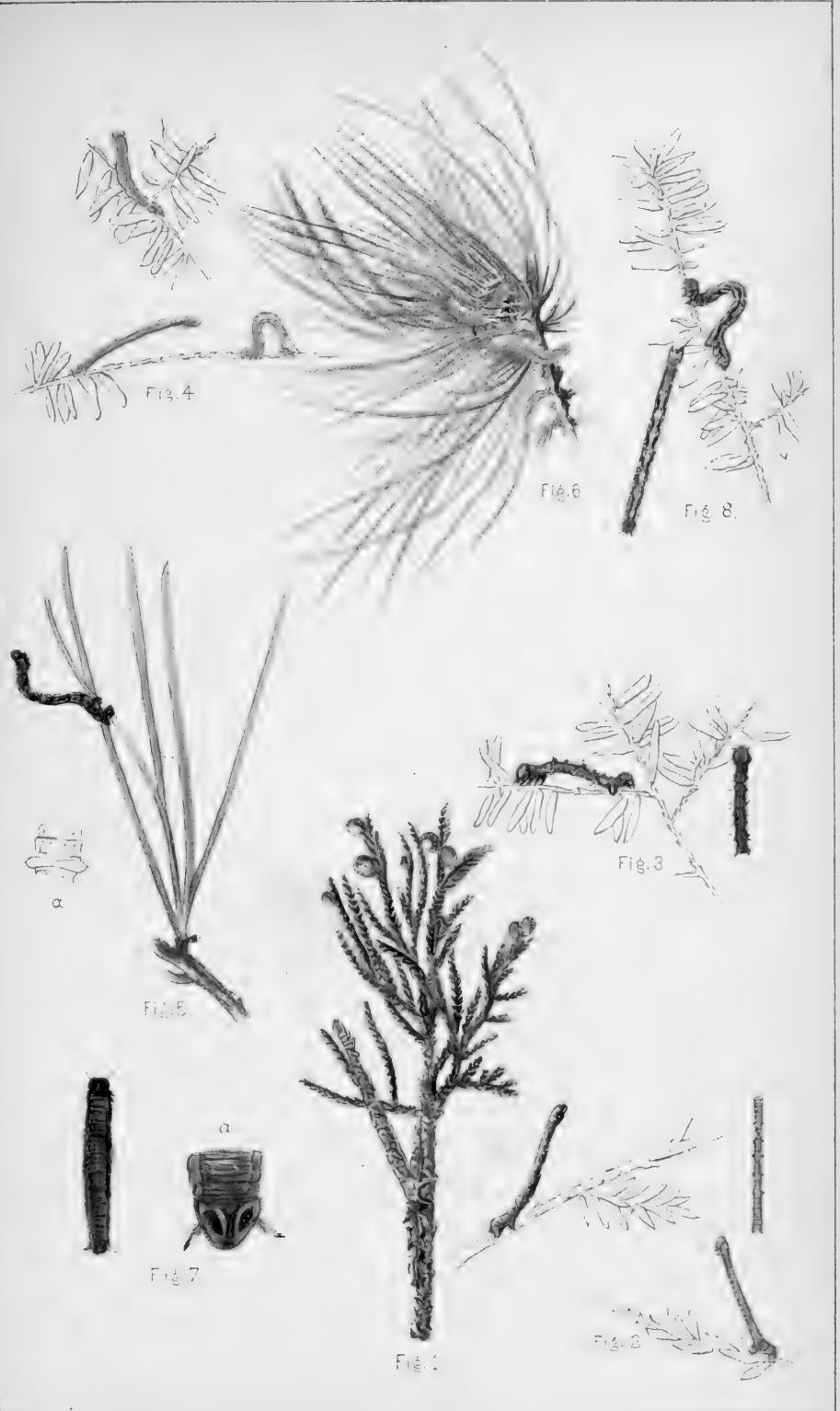
THE LARCH SAW-FLY, ETC.

Handwritten text, possibly a name or title, written vertically.



Handwritten text, possibly a name or title, written vertically.





INSECTS OF EVERGREEN TREES.



Fig. 3.



Fig. 2



Fig. 4.



Fig. 6.



Fig. 5



Fig. 5.

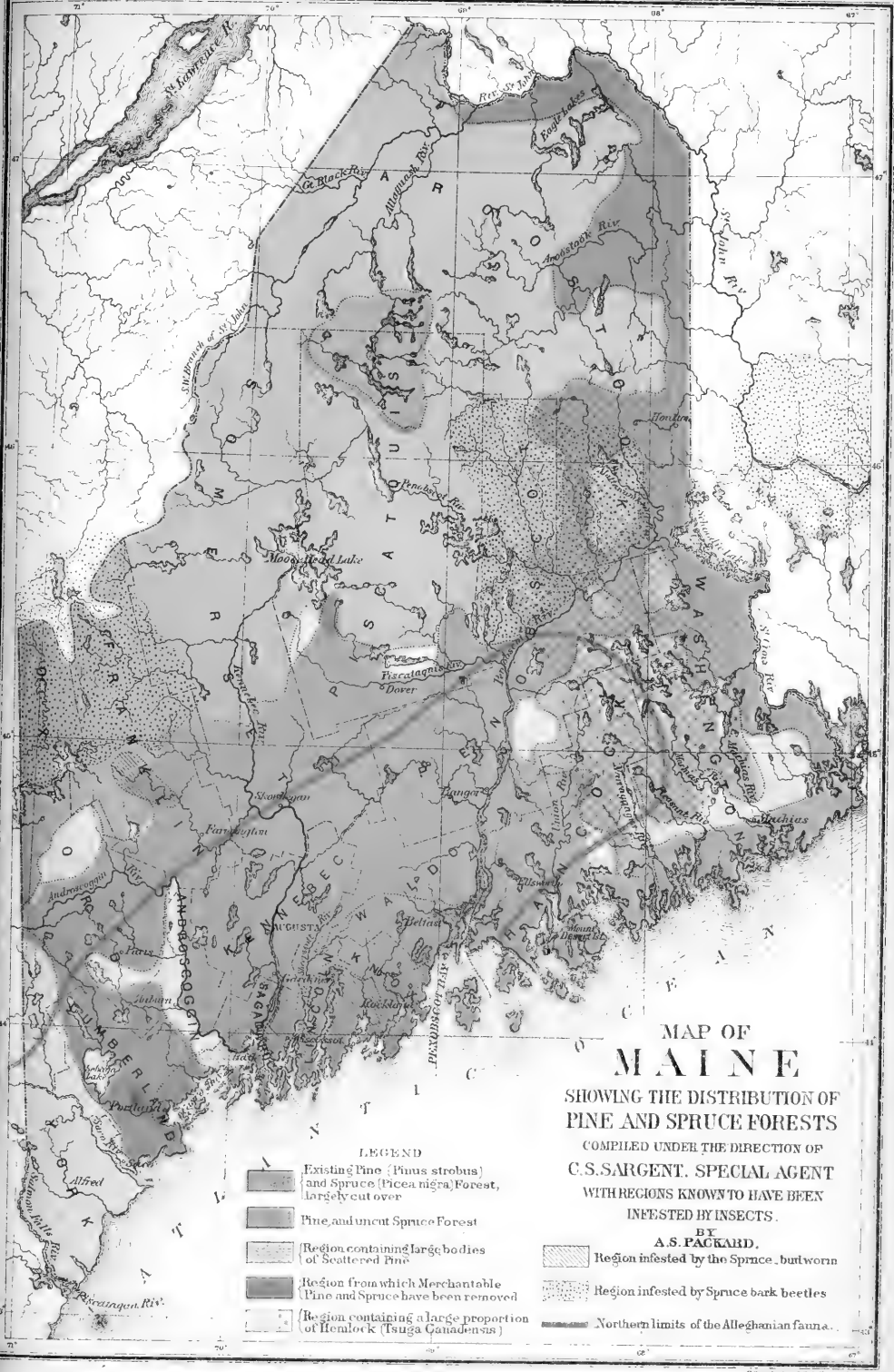


Fig. 1.



Fig. 7.





# MAP OF MAINE

SHOWING THE DISTRIBUTION OF PINE AND SPRUCE FORESTS  
 COMPILED UNDER THE DIRECTION OF  
 C. S. SARGENT, SPECIAL AGENT  
 WITH REGIONS KNOWN TO HAVE BEEN  
 INFESTED BY INSECTS.






BY  
**A. S. PACKARD,**

Region infested by the Spruce-buttworm

Region infested by Spruce bark beetles

Northern limits of the Alleghanian fauna.

**LEGEND**

-  Existing Pine (*Pinus strobus*) and Spruce (*Picea nigra*) Forest, largely cut over
-  Pine and uncut Spruce Forest
-  Region containing large bodies of Scattered Pine
-  Region from which Merchantable (Pine and Spruce) have been removed
-  Region containing a large proportion of Hemlock (*Tsuga Canadensis*)

Scale



Giles Lith. & Lab. Print. Co. N.Y.

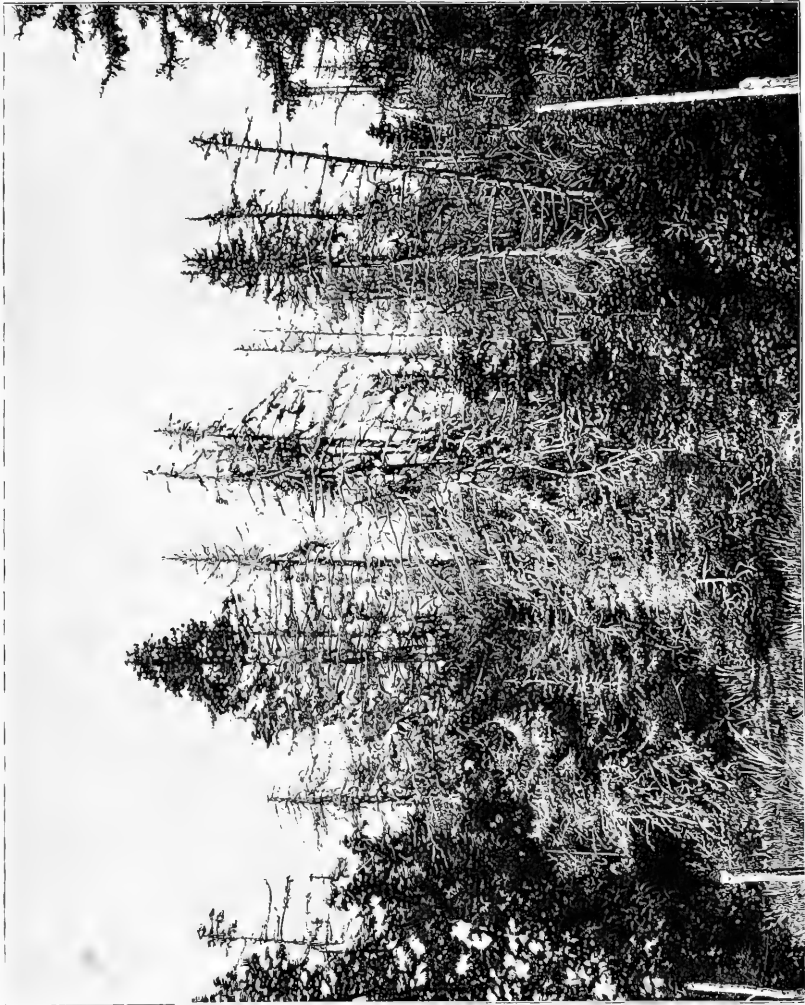




SPRUCE WOODS DEVASTATED BY THE SPRUCE BUD-WORM, ON THE NEW WHARF ROAD, BRUNSWICK, MAINE.  
From a photograph.



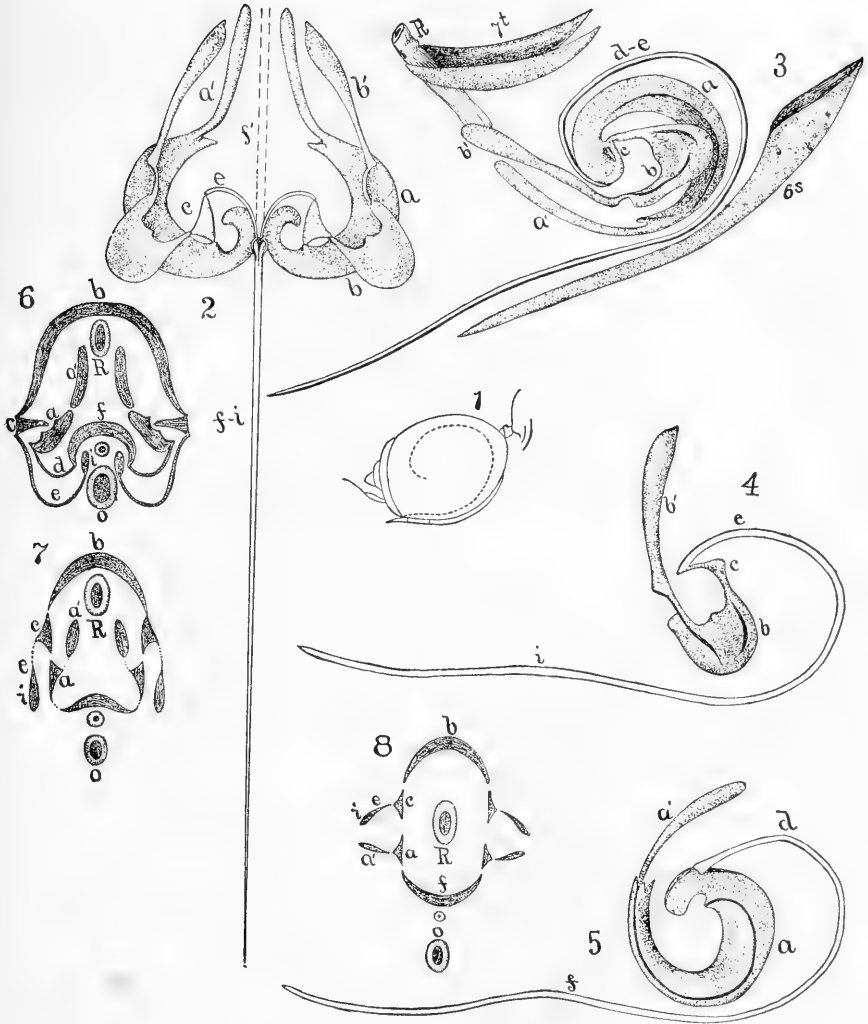




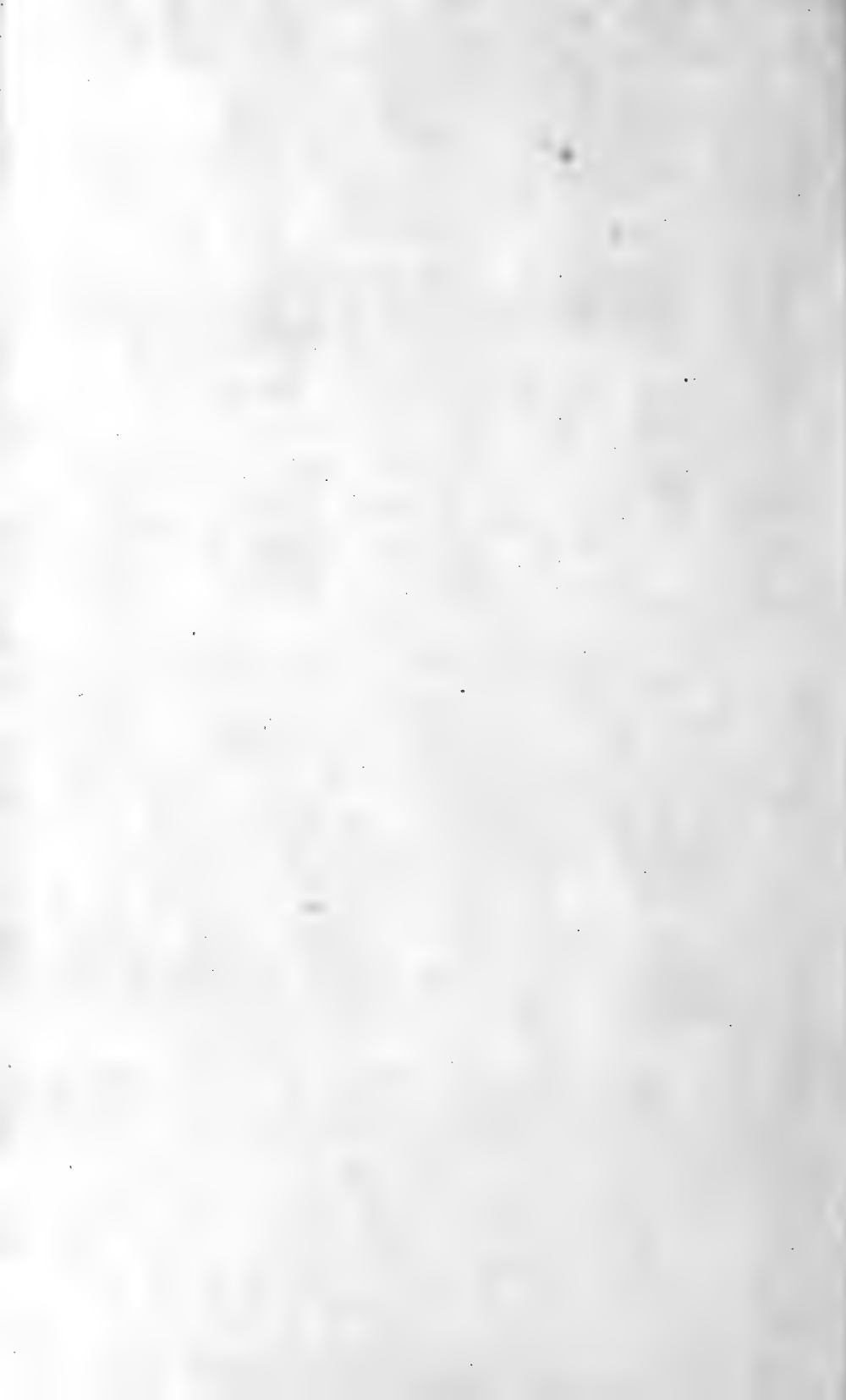
NEARER VIEW OF A PORTION OF THE SAME WOODS AS IN PLATE XIII.

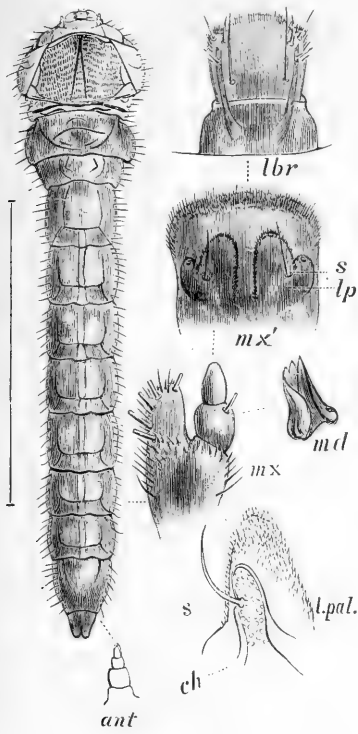
From a photograph.



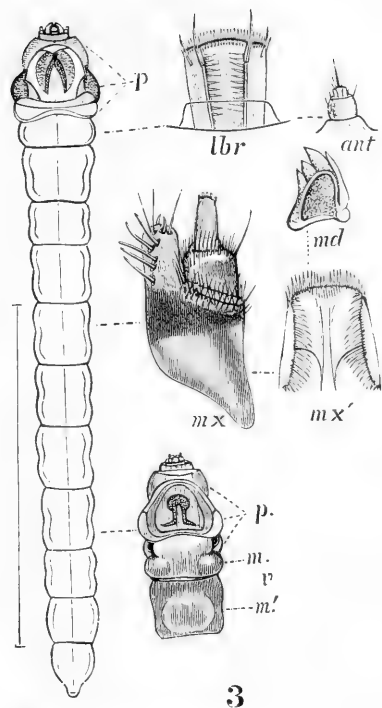


OVIPOSITOR OF CYNIPS, THE OAK GALL-FLY.

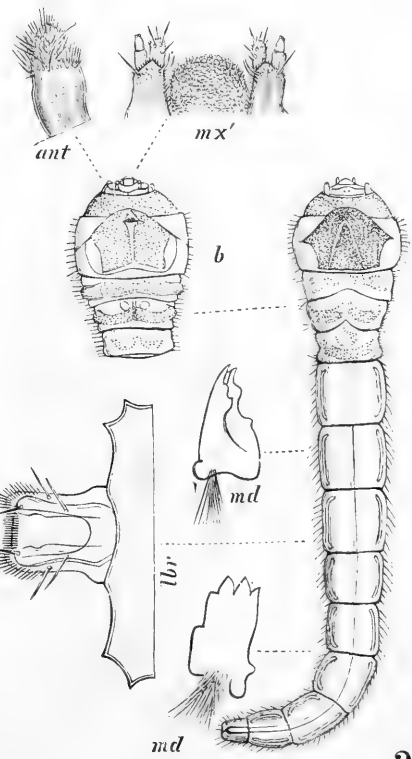




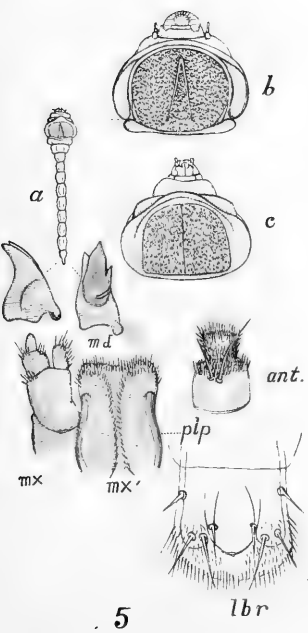
1



3



2



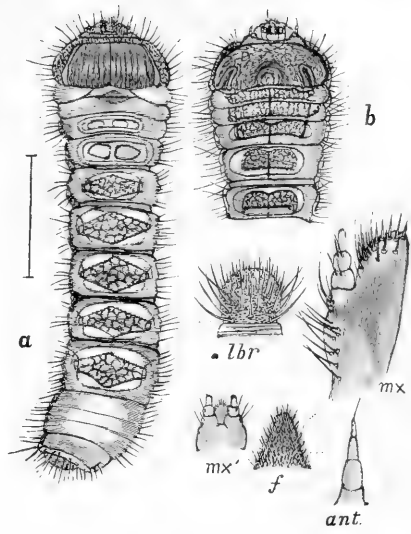
5

1. *Chalcephora virginica* ?

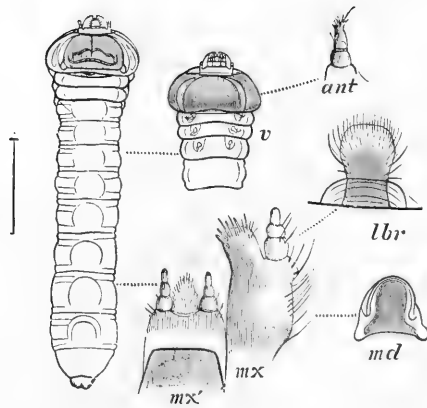
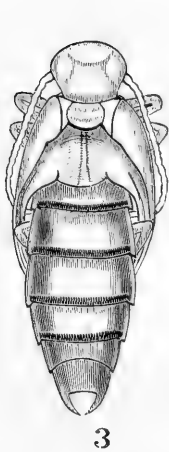
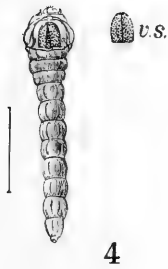
2. *Dicerca divaricata*.

3, 5. Unknown.





1



2

1. *Elaphidion parallelum*.

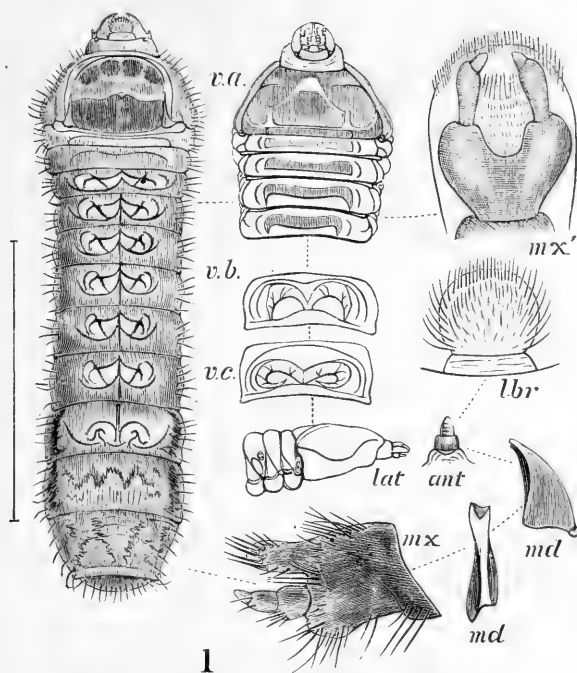
2. Unknown Longicorn larva in oak.

3, 3a. *Crioccephalus agrestis*.

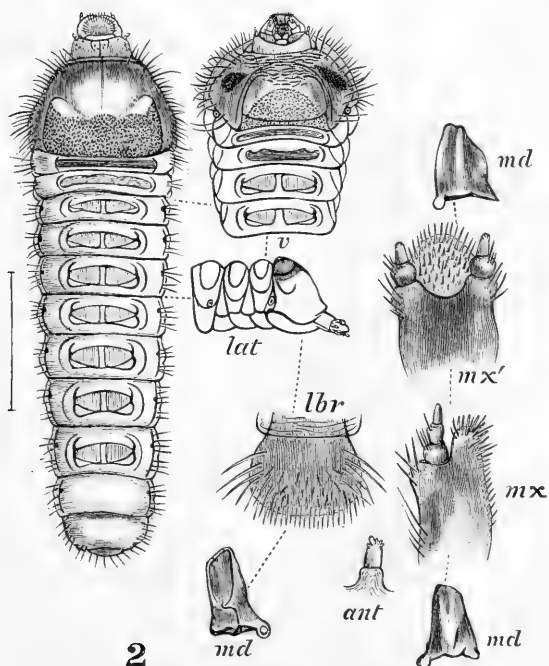
4. *Melanophila*.







1

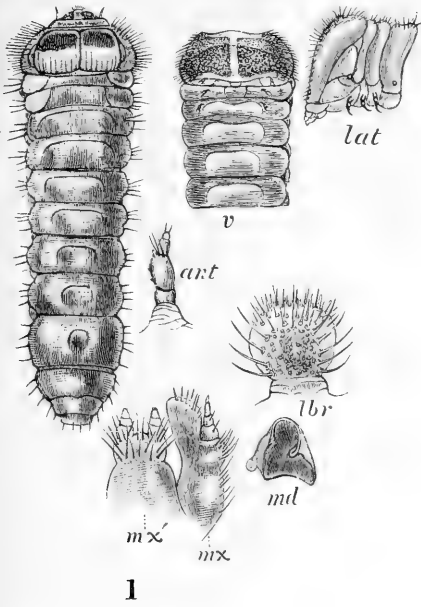


2

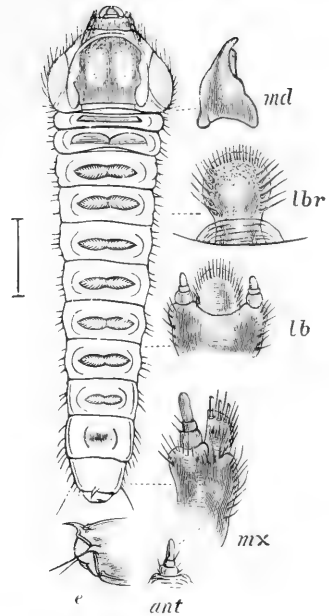
1. Longicorn larva, from pitch pine.

2. *Saperda tridentata*, boring in the elm.

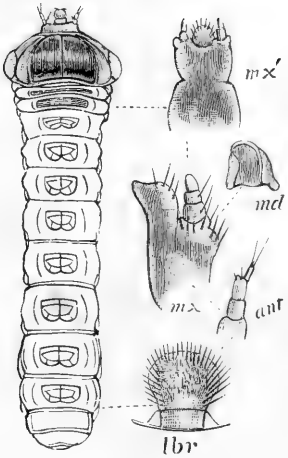




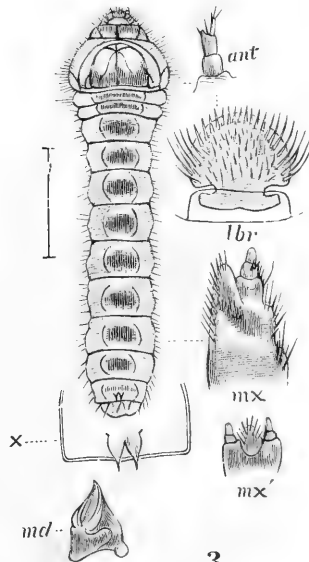
1



4



2

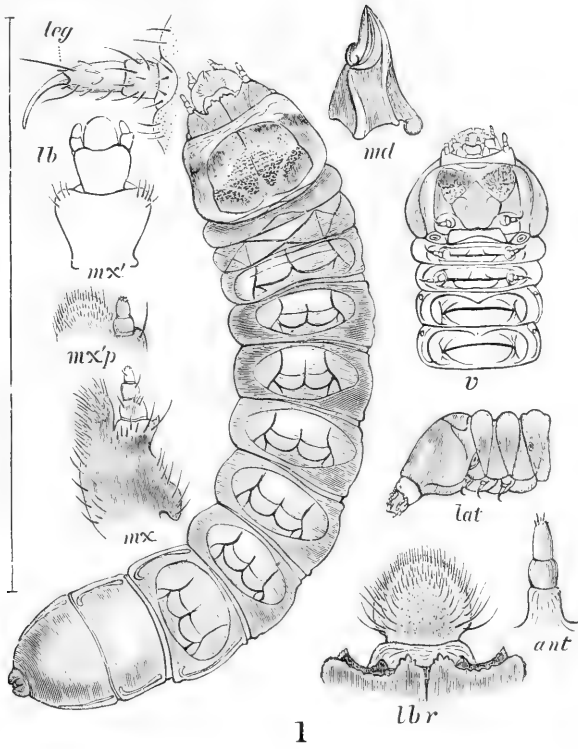


3

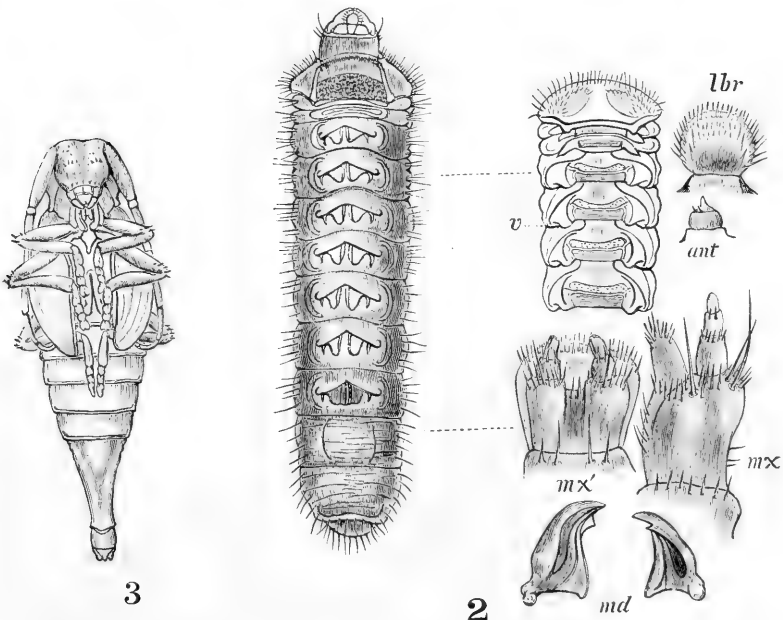
1. *Aseum mæstum*.  
3. Larva, in white pine.

2. Longicorn larva, living in oak.  
4. Longicorn larva, in sweet gum.

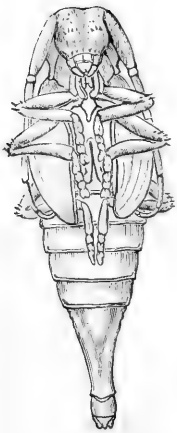




1



2



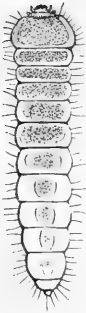
3

1. *Orthosoma brunneum*.

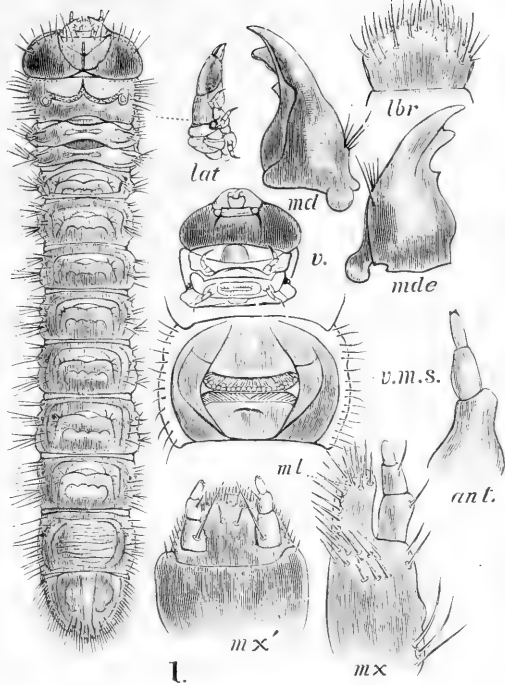
2. Sycamore borer.

3. Pupa, under oak bark.

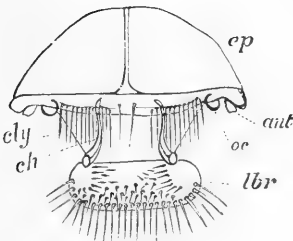




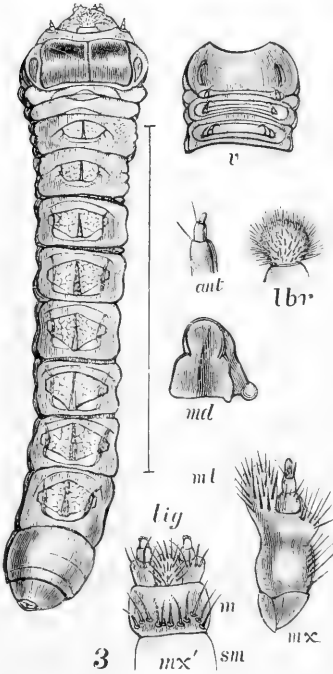
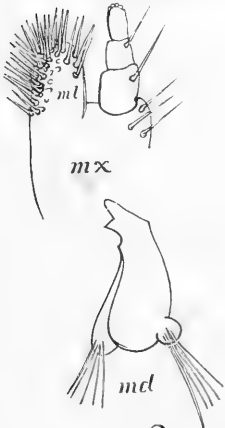
4



1.



2

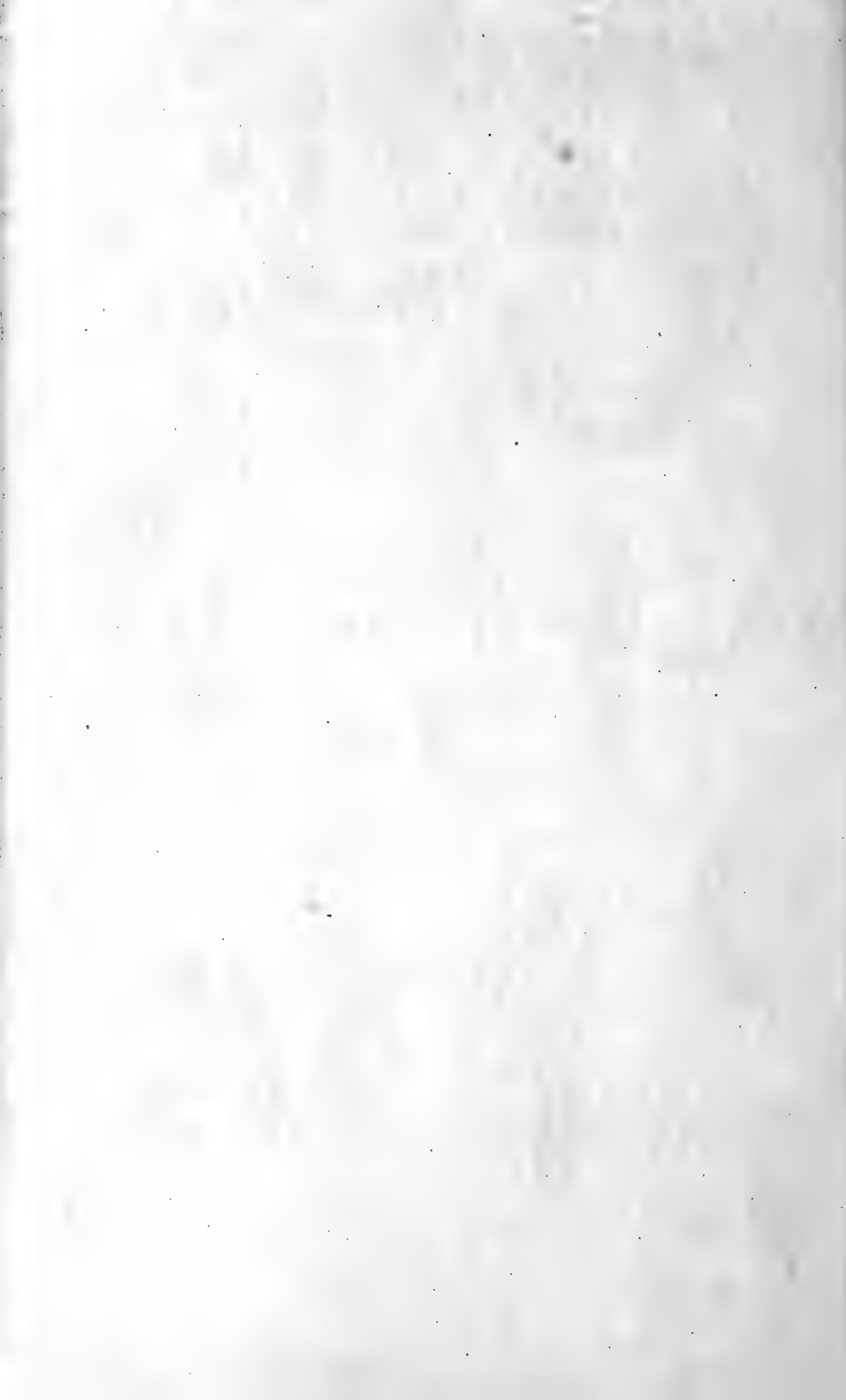


3

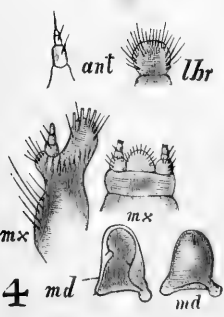
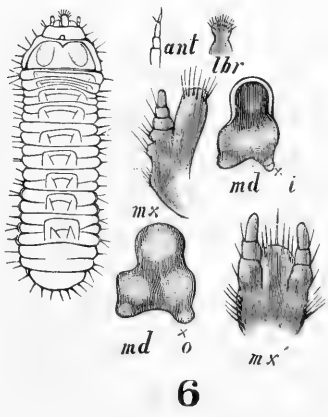
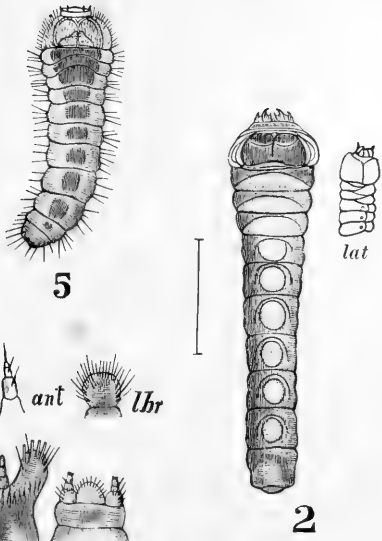
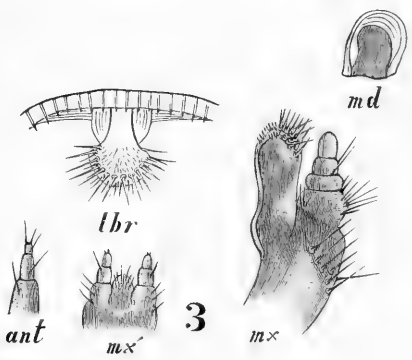
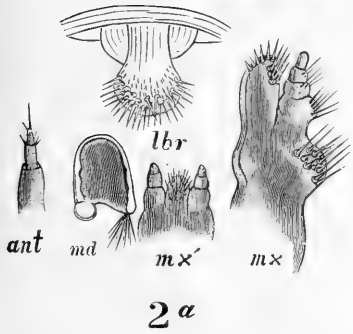
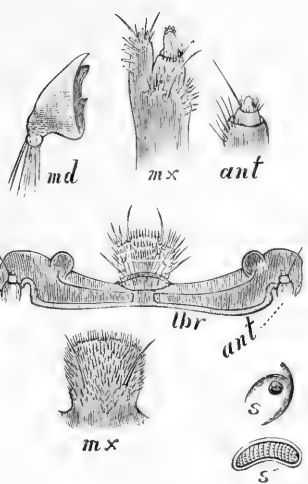
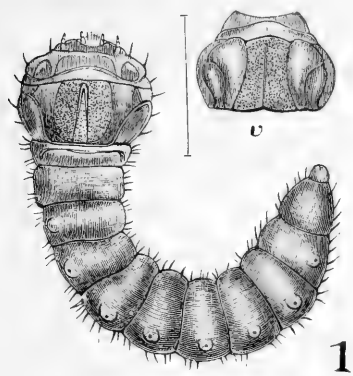
1, 2. *Rhagium lineatum*, in pine.

3. Longicorn larva, in oak.

4. *Saperda*, from willow.







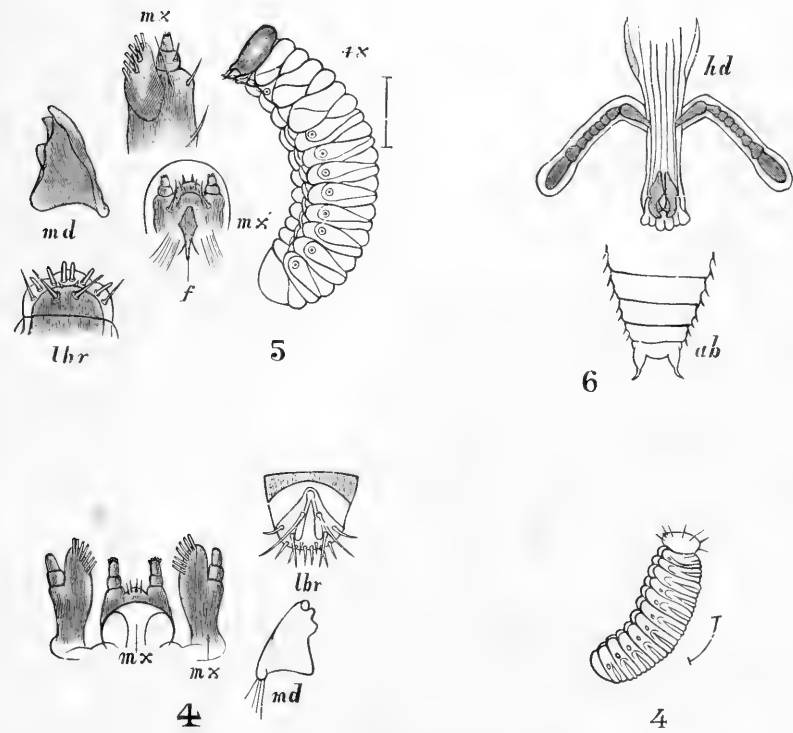
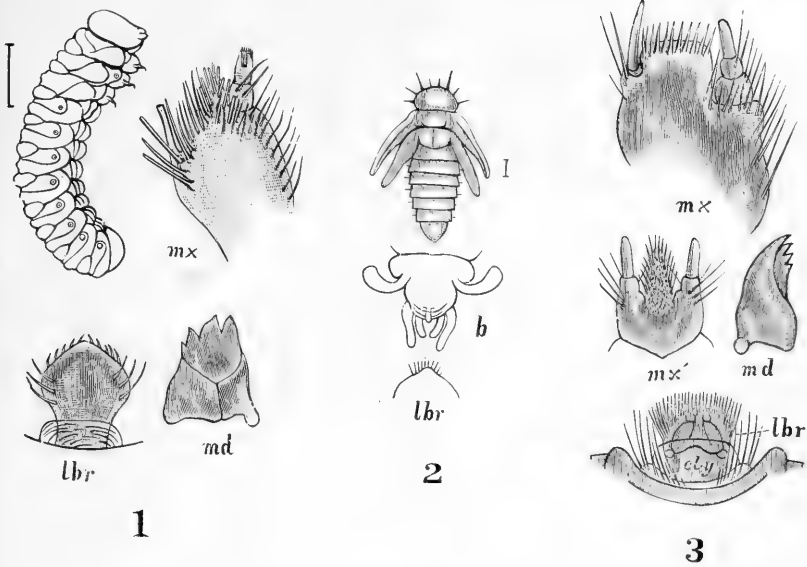
1. *Metanophila*.

4. Details of Willow *Saperda*.

2, 2a, 3. *Xylotrechus colonus*.

5, 6. Hemlock borers.





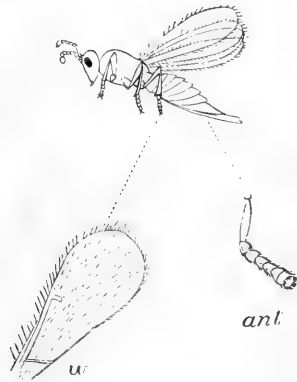
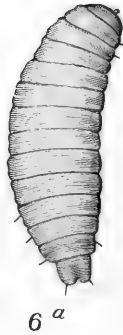
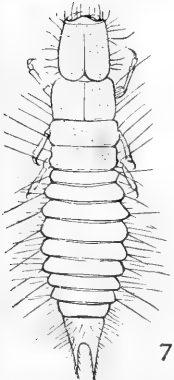
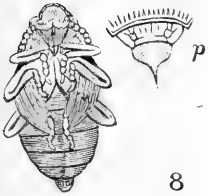
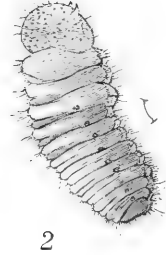
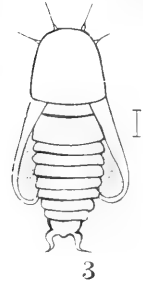
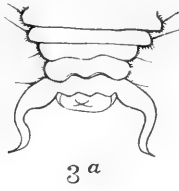
1, 2. Unknown.

3. *Xestobium affine*.

4. *Hylurgops pinifex*.

5, 6. *Pissodes strobi*.





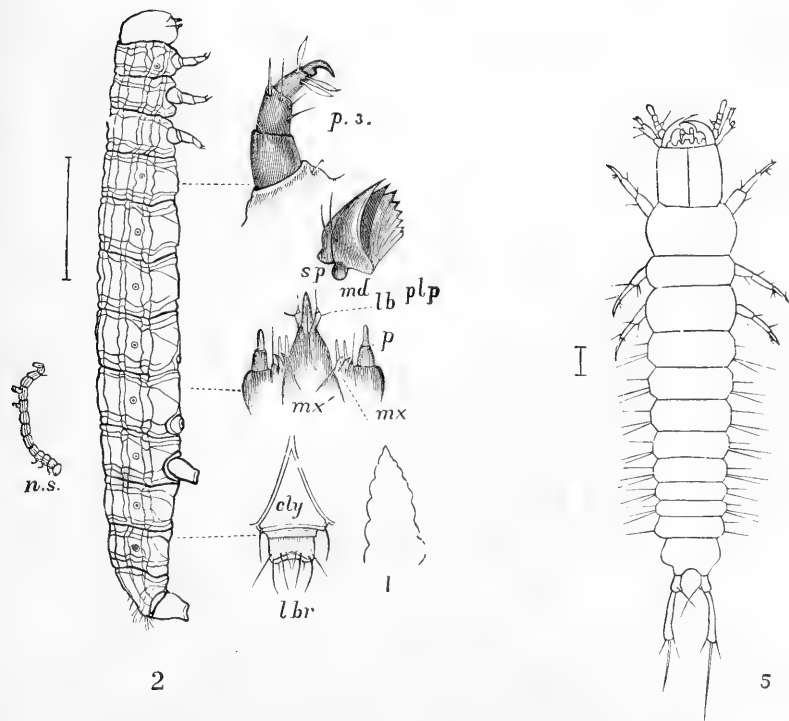
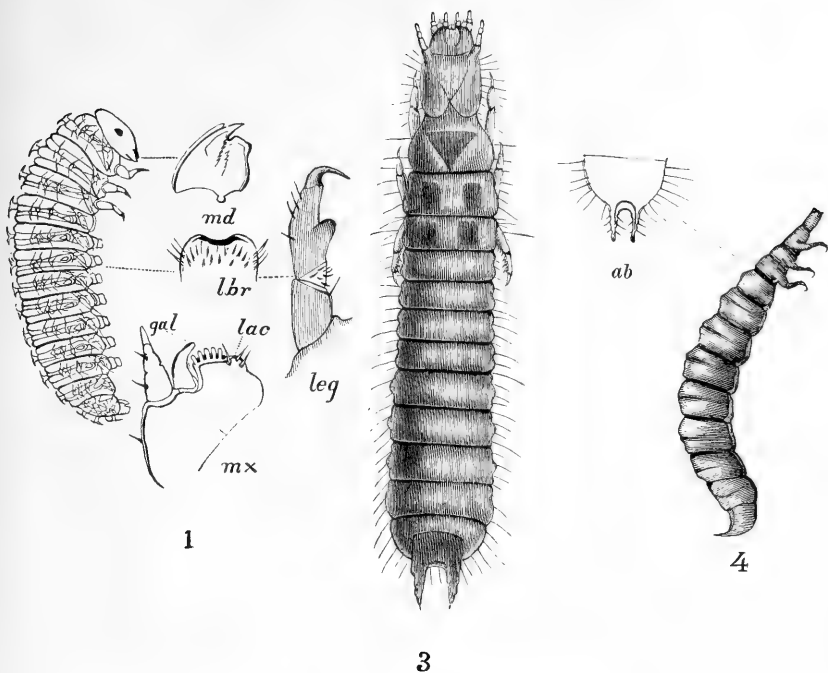
1, 1a. *Xyloterus*.  
6-8. Miscellaneous.

2-3a. *Syleborus cœlatus*.

4-5c. *Crypturgus atomus*.

9. Pupa of *Hylurgops pinifex*.

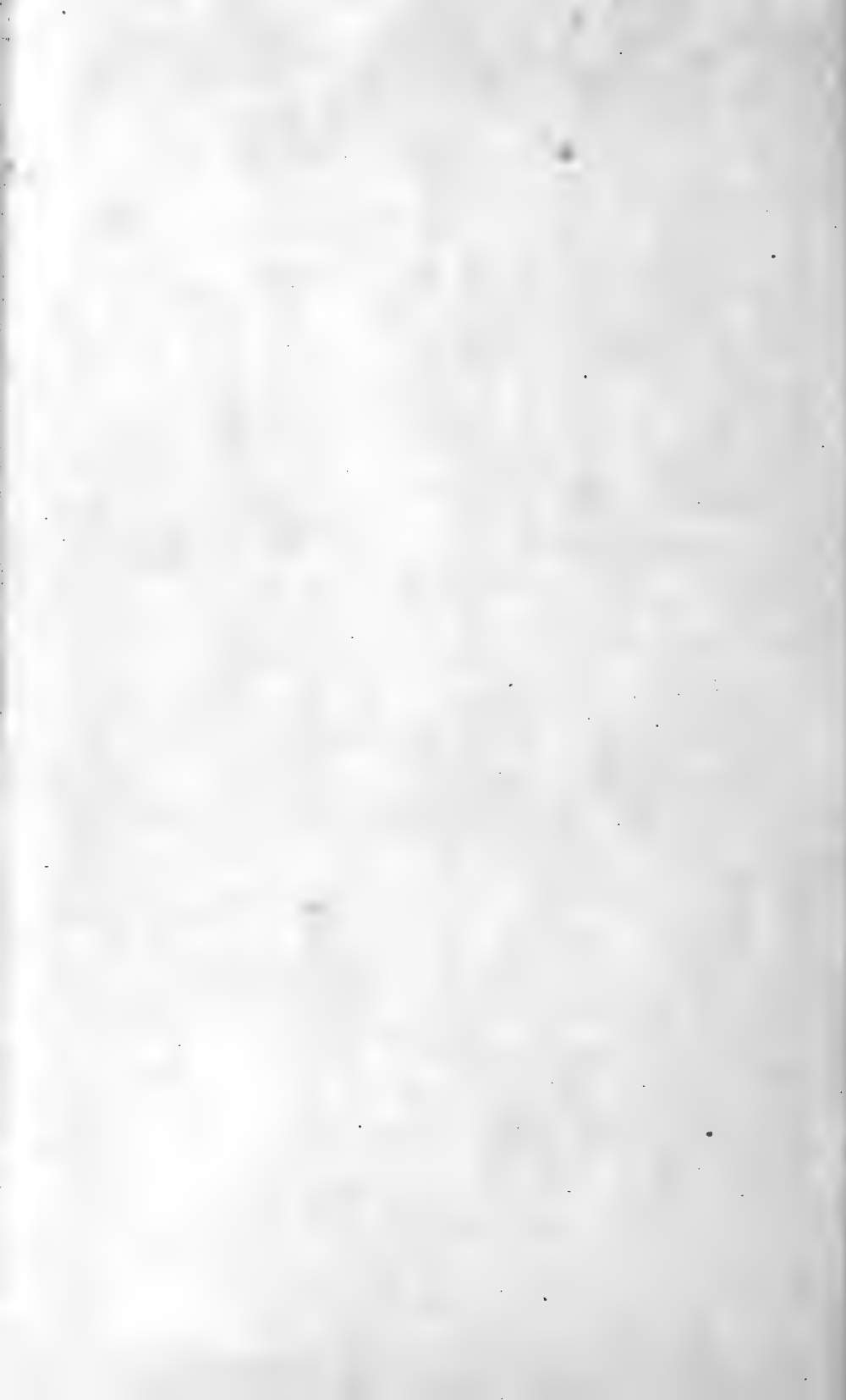




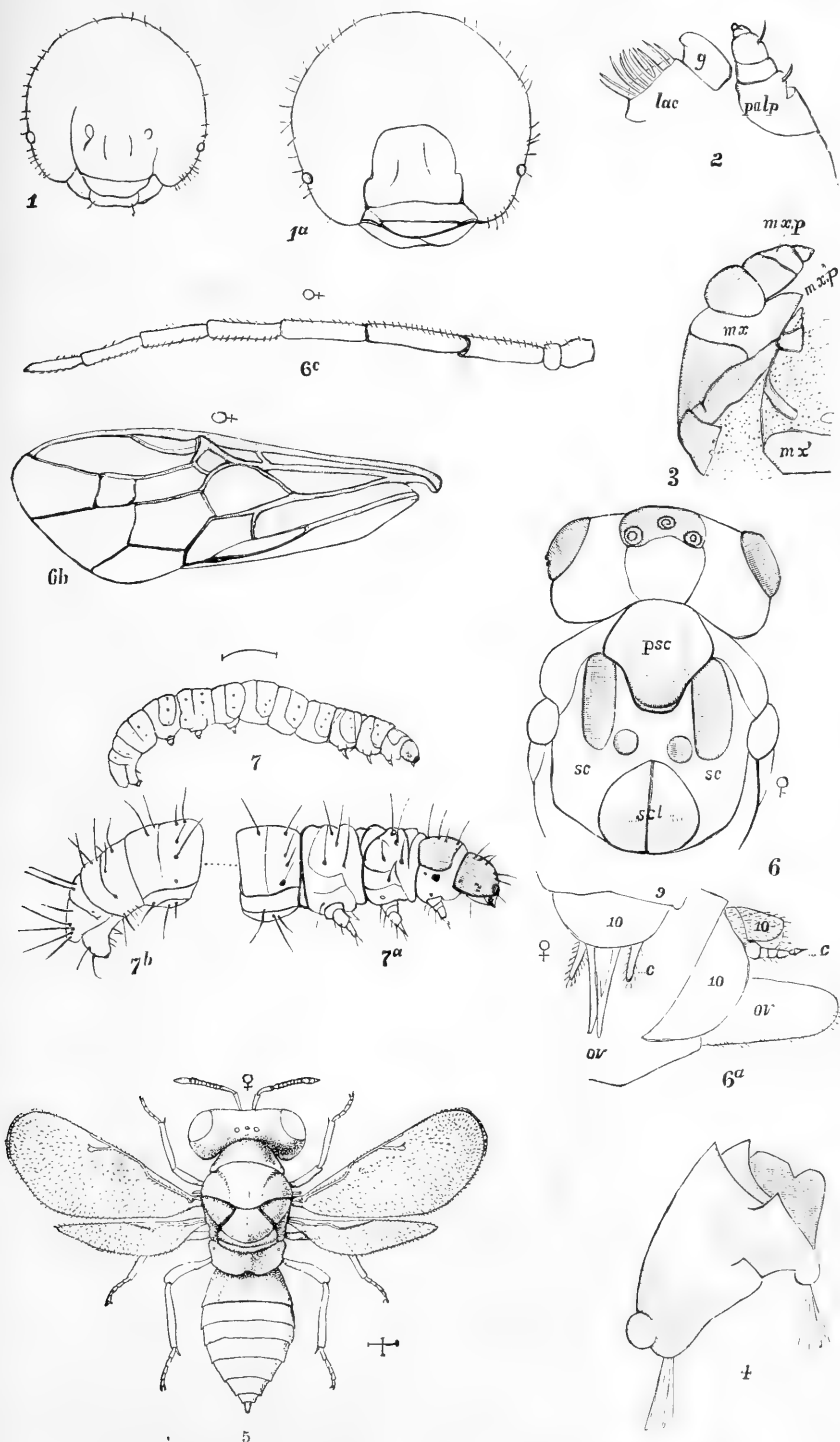
1. *Selandria*, on hickory.

2. *Paleacrita vernata*, on hickory.

3-5. Coleopterous larvæ, attacking pine bark-borers.



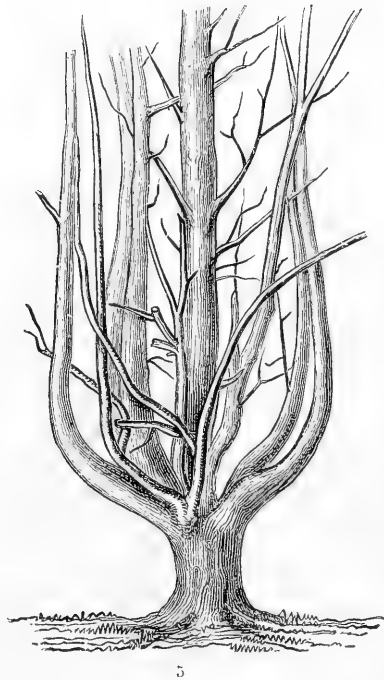
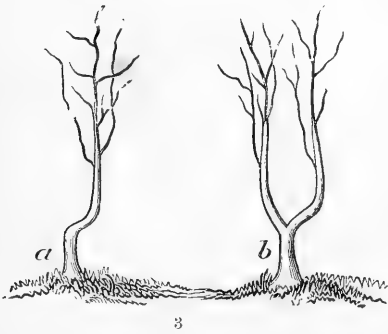
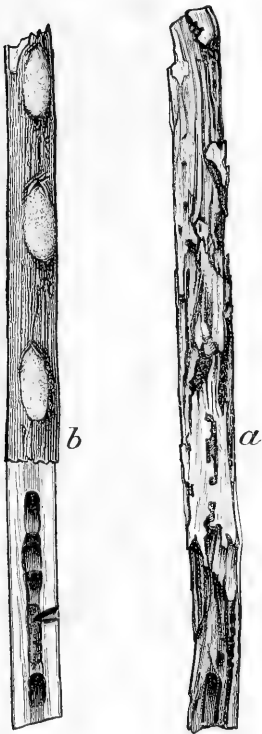
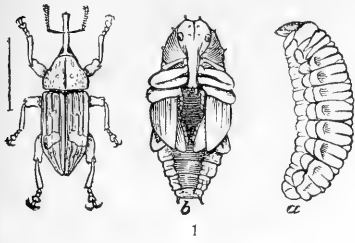




1-5. Larch saw-fly and its details.  
5. *Pteromatus nematicida*.

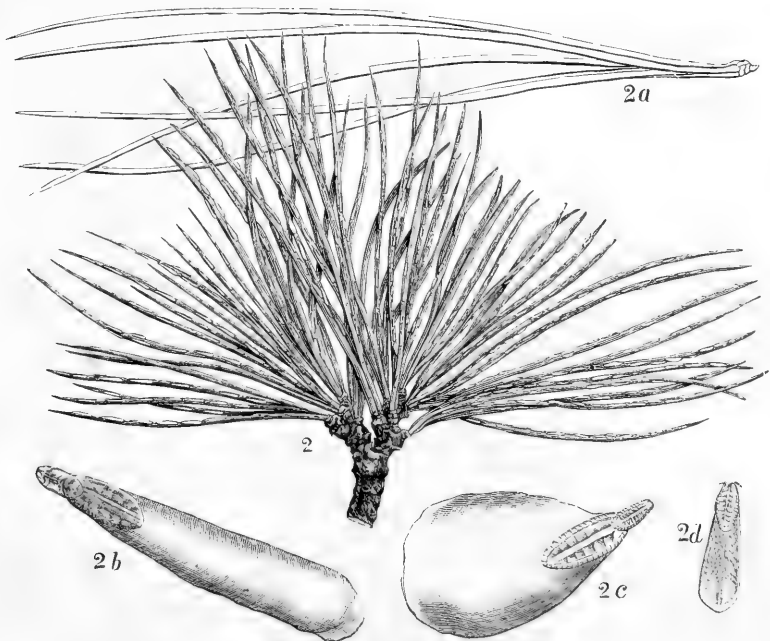
6, 6a-6c. *Nematus integer*.  
7. *Gelechia* of hemlock.





THE WHITE-PINE WEEVIL AND ITS WORK.



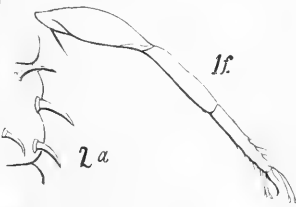
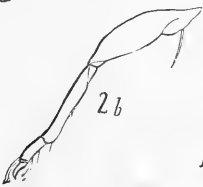
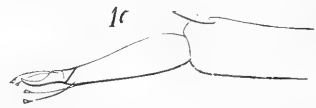
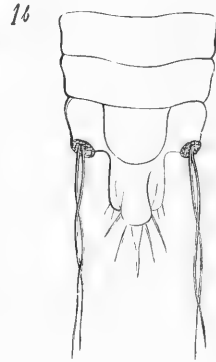
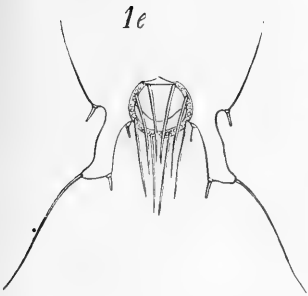
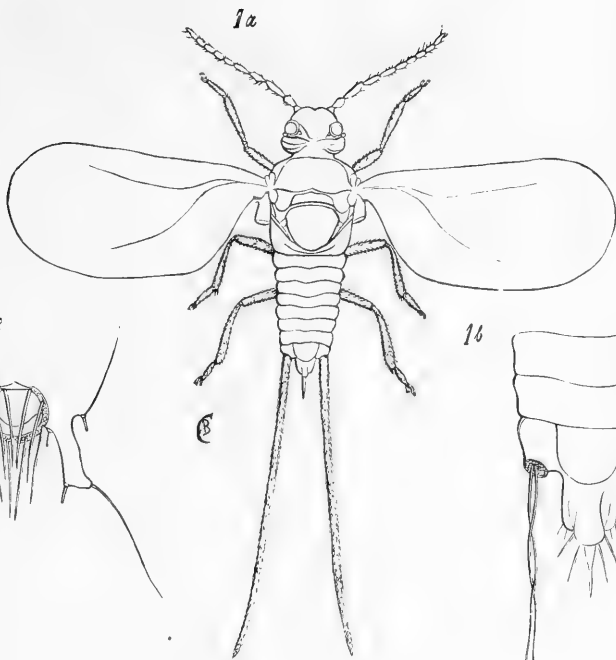


BARK-LICE OF OAK AND PINE.

- 1. *Kermes* sp. *Quercus agrifolia*.
- 2. *Chionopsis pinifolii*.

- 3. *Chionopsis quercus*.
- 4. *Asterodiaspis quercicola*.





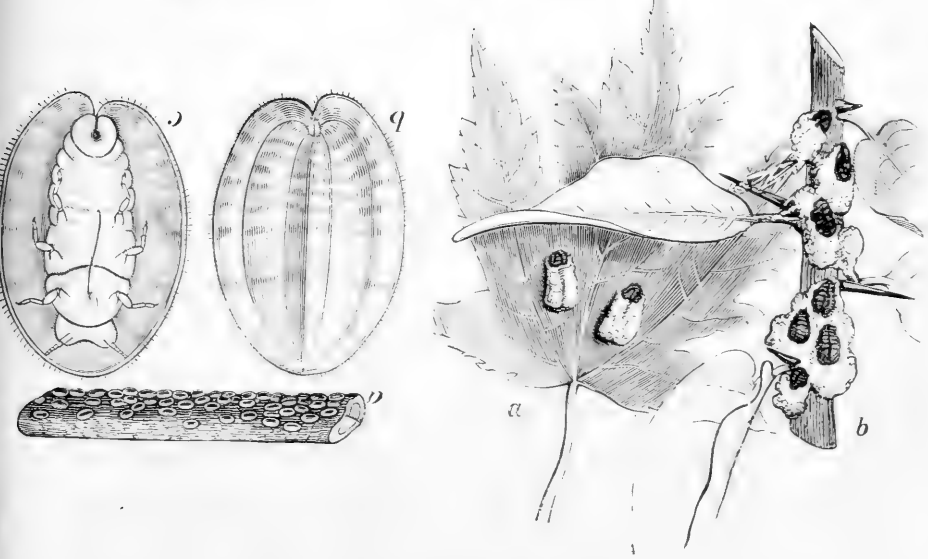
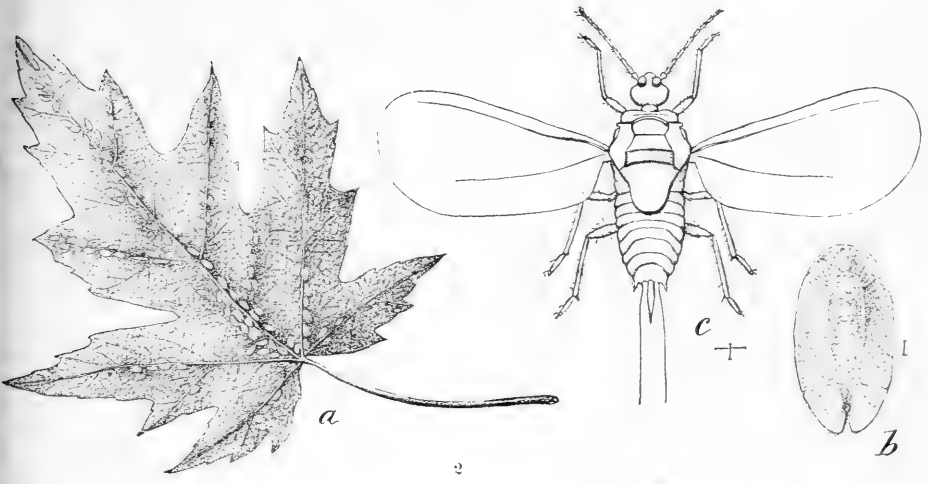
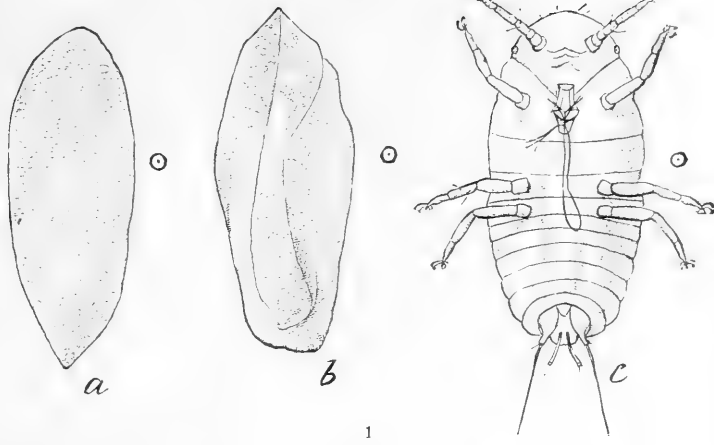
BARK-LICE OF PINE AND OAK.

1. *Rhizococcus*, on Araucarian pine.

2. *Rhizococcus quercus*.

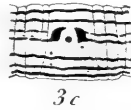
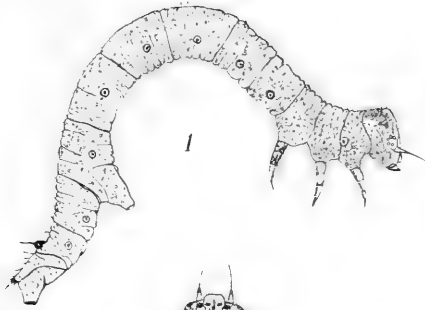




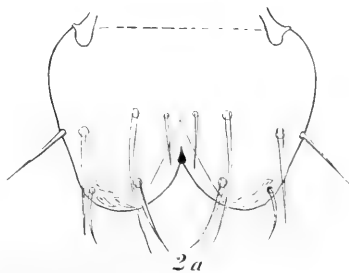
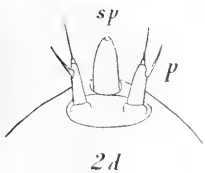


MAPLE BARK-LOUSE.



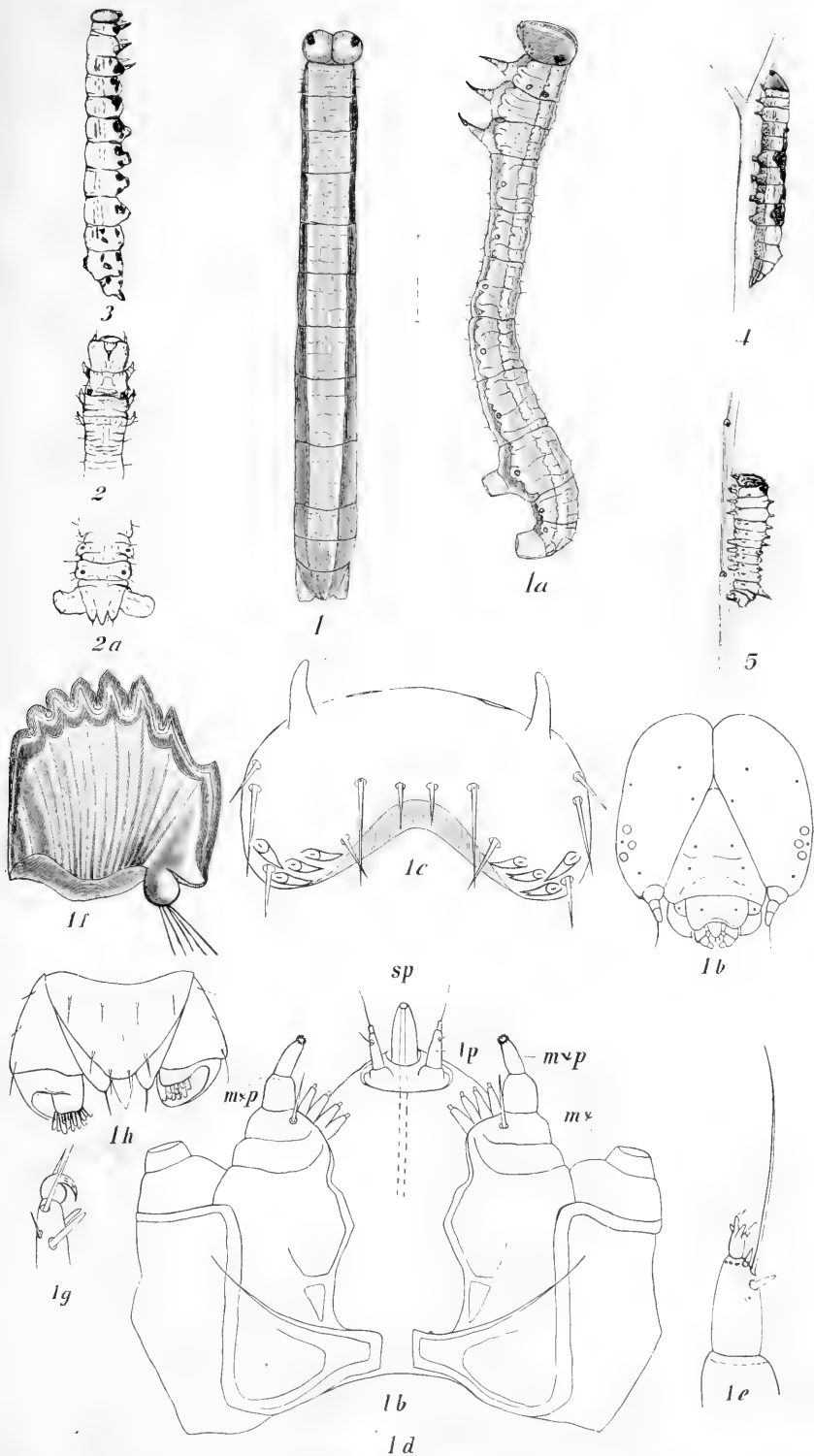


1d



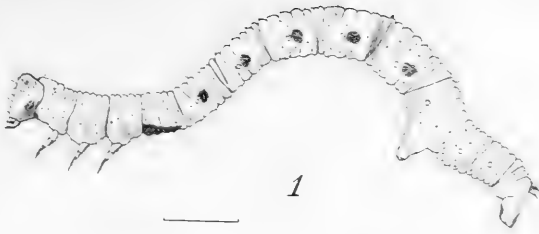
PINE SPAN-WORM, ETC.



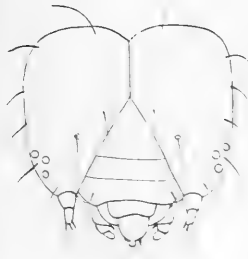


SEMIOTHISA BISIGNATA, ETC.





1



1b



1c



1h



1a



2a



1e



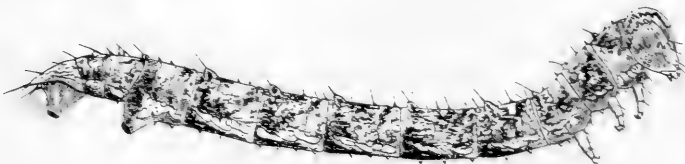
1d



1f



1g



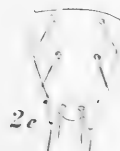
2



2b



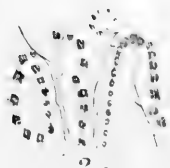
2d



2e



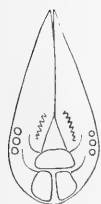
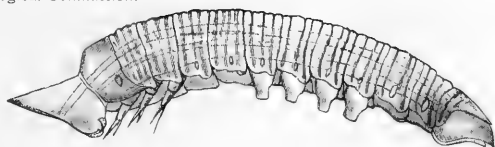
2f



2c







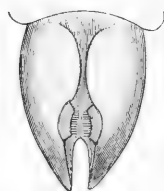
1b



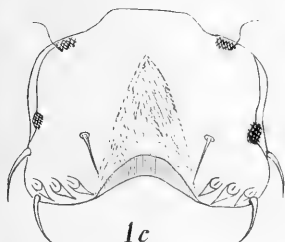
b'



1a



1i



1c



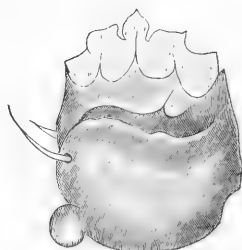
1j



1g



1d

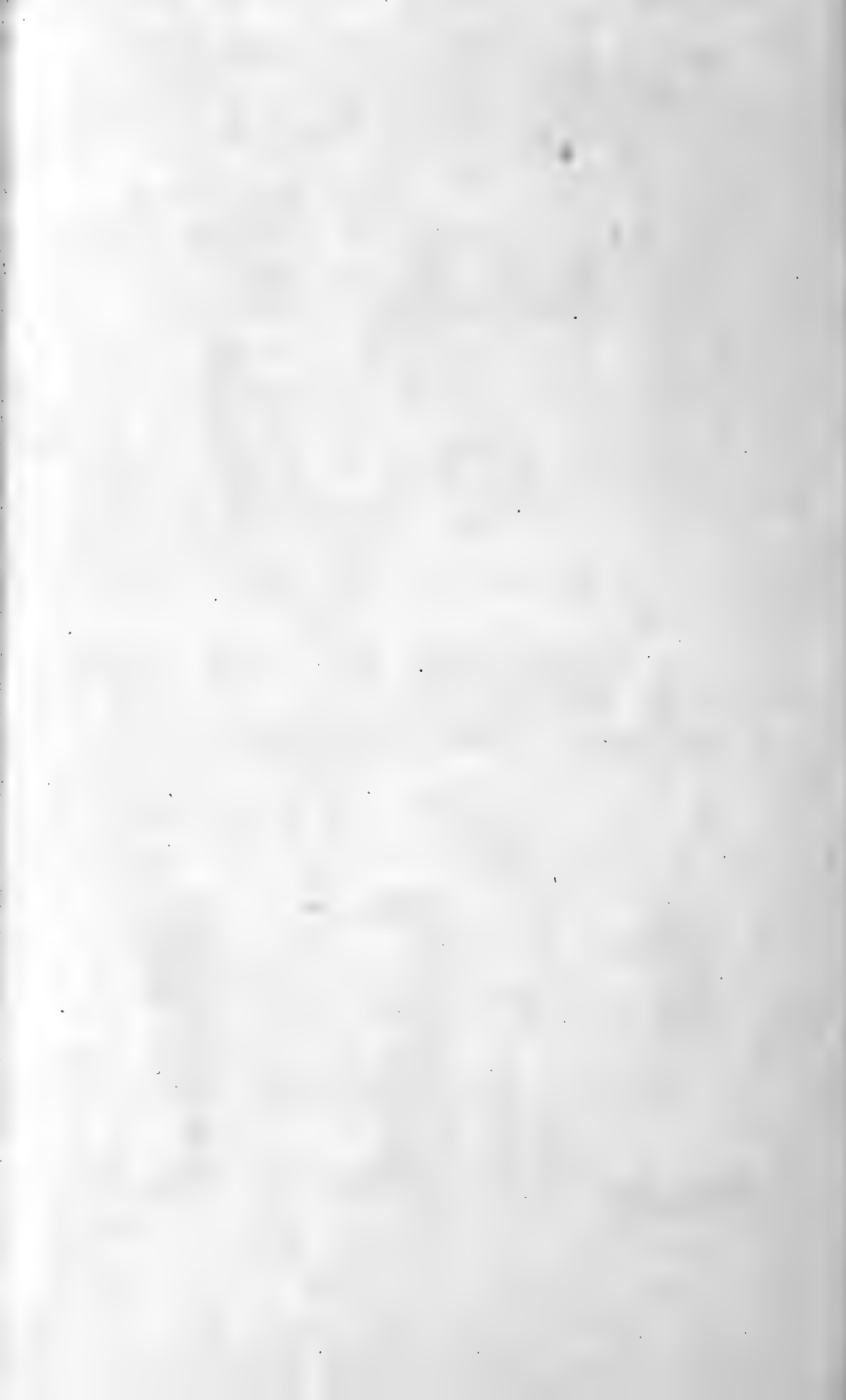


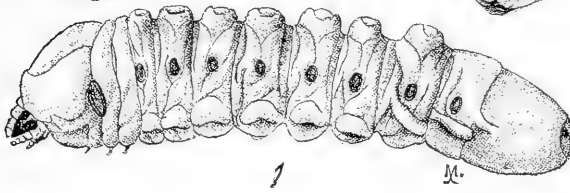
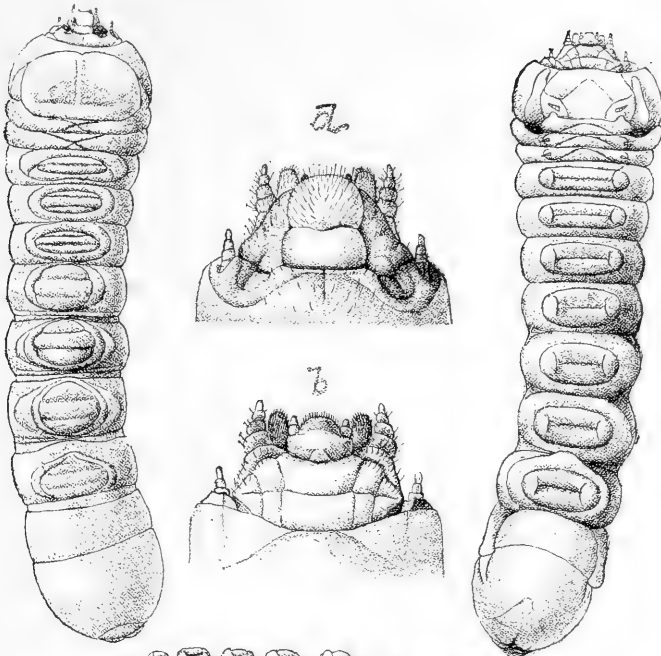
1h



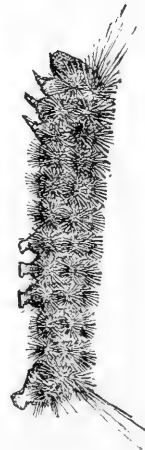
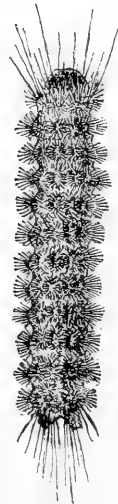
1f

YOUNG CATERPILLAR OF ELLEMA HARRISII.





HP



3

1. *Mallodon melanopus*.

2. *Nola ovilla*.

2

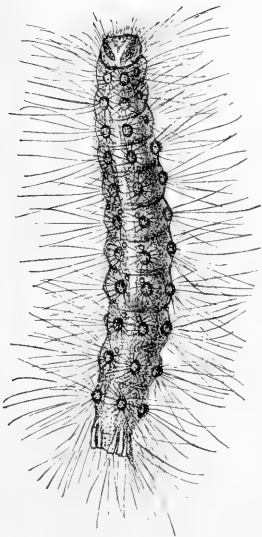
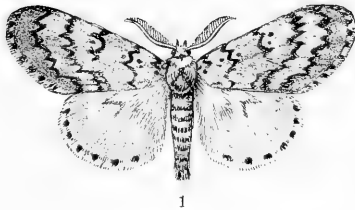
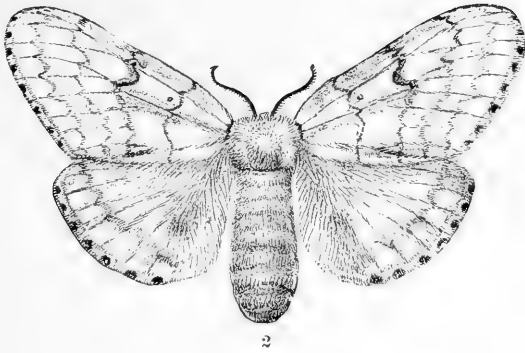
3. *Parorgyia parallela*.





RAVAGES OF WEB-WORM ON POPLARS ON ONE SIDE OF A WASHINGTON STREET AND EXEMPTION OF MAPLES ON THE OTHER.

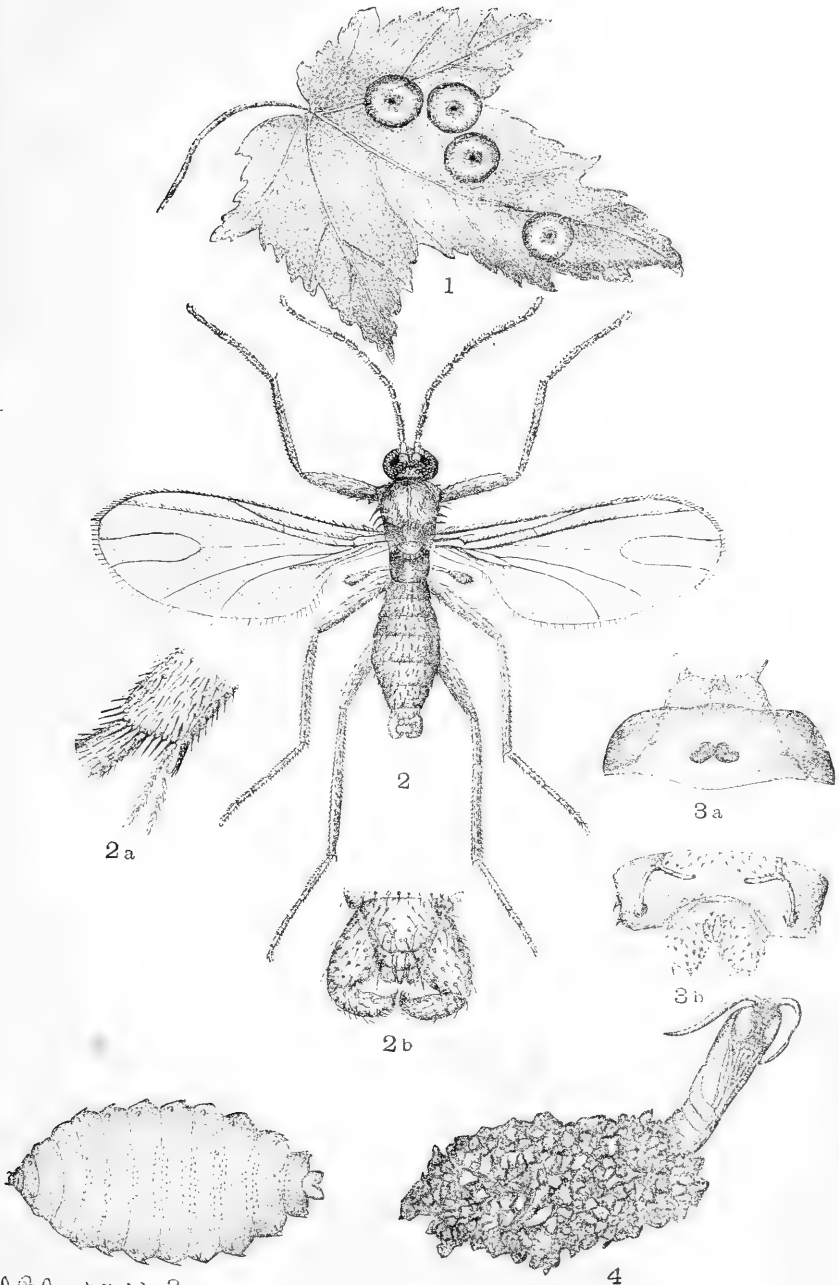




THE GYPSY MOTHS AND ITS TRANSFORMATIONS.



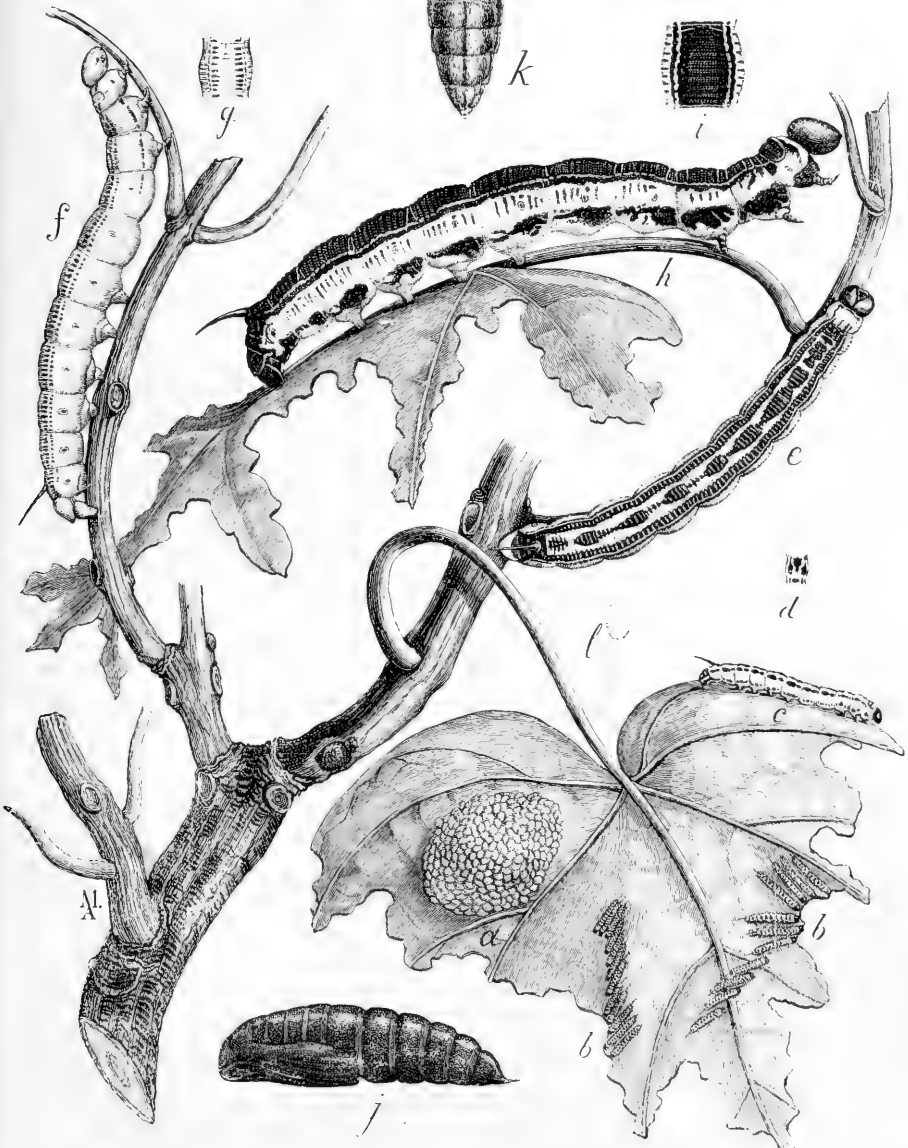
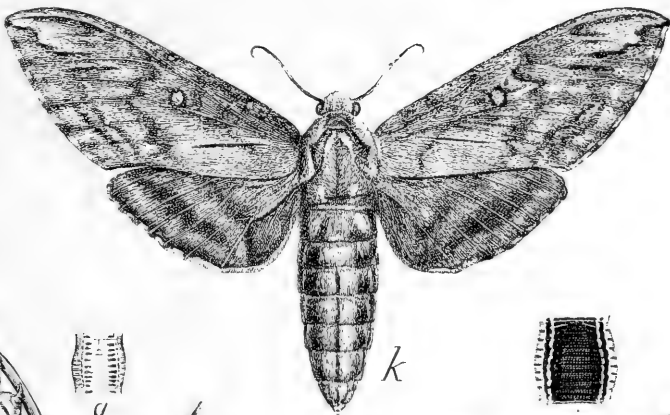




A. B. Comstock del. 3

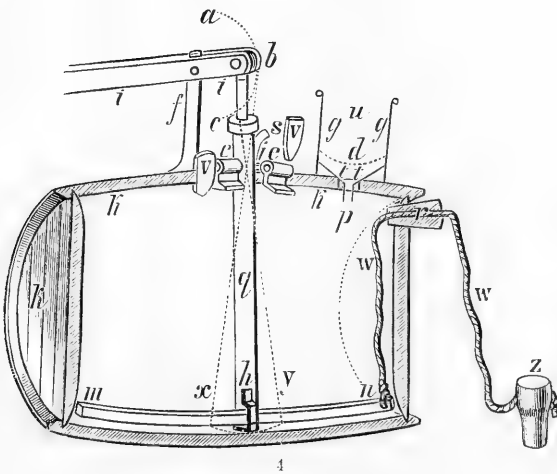
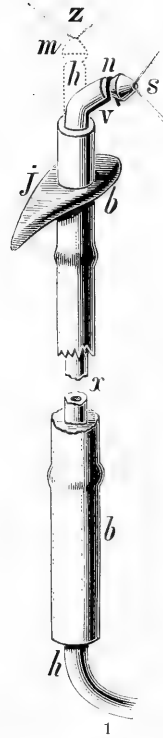
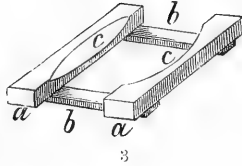
4



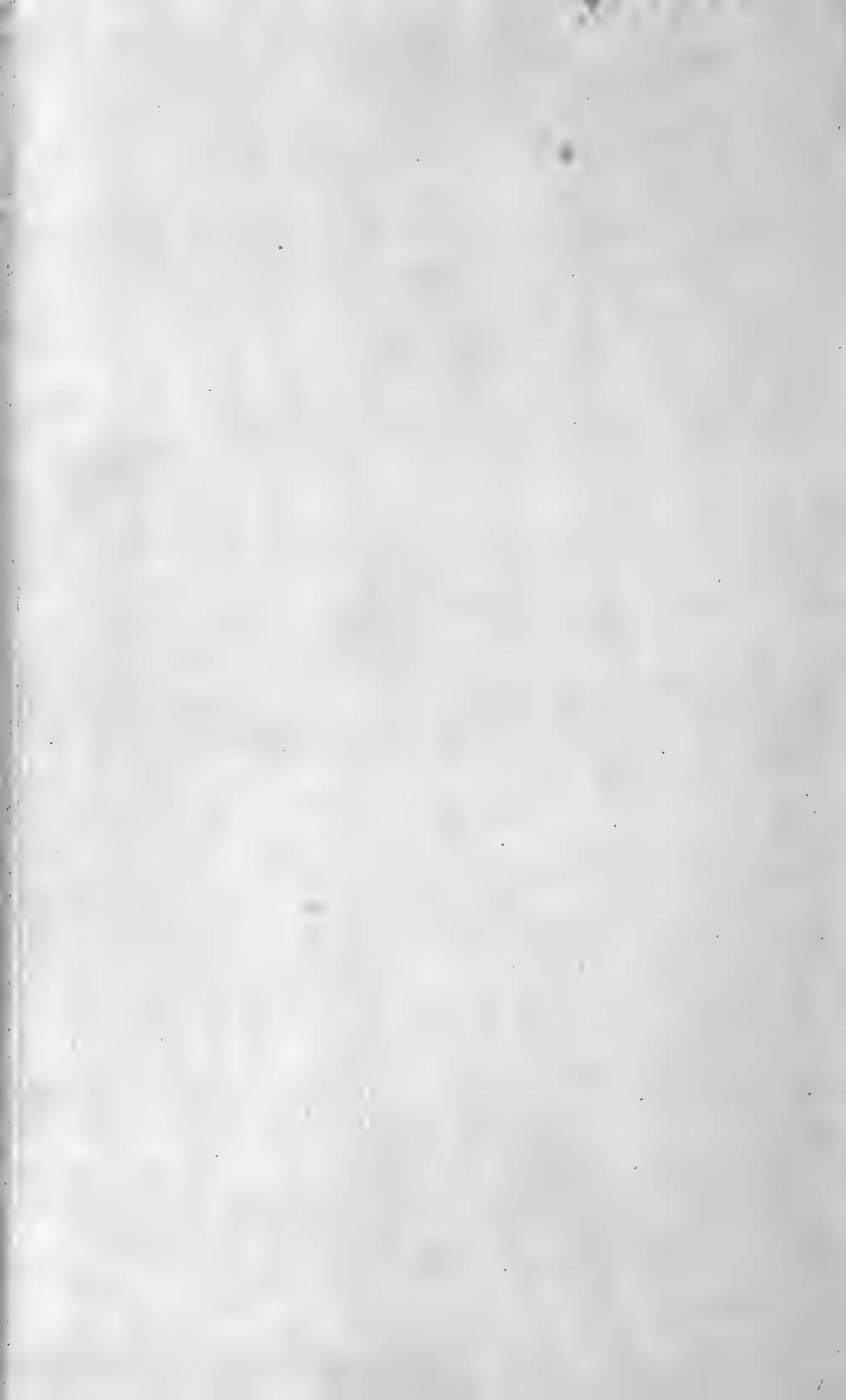


THE CATALPA SPHINX.





DEVICES FOR UNDERSPRAYING TREES.



# INDEX OF INSECTS \*

	Page		Page.
Abbot's sack-bearer.....	921	Allorhina nitida.....	329
white pine saw-fly.....	755	American Cimbex.....	237
Acaea purpuriella.....	373	silk-worm.....	<b>16</b> , 300, 400, 488, 530, 532
Acanthoderes morrisii.....	663	Amilaphis triplipunctata.....	185
quadrigibbus.....	90, 221, 520	Amorbia humerosana.....	790
Acarus? cratægi-vermiculus.....	537	Amphalocera cariosa.....	668
enigma.....	600	Amphibolips, species of.....	104
s. semen.....	600	Amphidasys cognataria.....	<b>405</b> , 597, 638, 652, 897
Acidalia?.....	647	Amphipyra pyramidoides.....	<b>171</b> , 473, 536, 637, 669
Acorn moth.....	216	Amyot's Otiocerus.....	326
worm.....	215	Anacharis subcompressa.....	108
Acrobasis caryæ.....	328	Anagoga pulveraria.....	638
juglandis.....	311, 334	Anatis 15-punctata.....	415
Acoptus suturalis.....	297, 520	Andricus, species of.....	105
Acraspis, species of.....	106	Androchirus fuscipes.....	223
Acronycta lithospila.....	302	Anisopteryx pometaria.....	231, 648
populi.....	433	vernata.....	<b>230</b> , 653
rubricoma.....	608	Anisota bisecta.....	652
salicis.....	597	pellucida.....	126, <b>127</b>
Actias luna.....	<b>300</b> , 330, 342, 520, 596, 656	senatoria.....	<b>124</b> , 353, 453
Adelges abieticolens.....	853	stigma.....	<b>125</b> , 353
abietis.....	853	Anomæa laticlavata.....	373
Adoneta spinuloides.....	149, 514, 525, 530, 652	Anomala pinicola.....	801
Æaea ostryæella.....	648	Ant, white, American.....	354, 387
Ædilis nodosus.....	700	Antepione depontanata.....	628
obsoletus.....	700	Antiope butterfly.....	238
Ægeria acerni.....	384	Antispila cornifoliella.....	671
exitiosa.....	521	Anthaxia cyanella.....	354
pinorum.....	731	viridicornis.....	293
tricincta.....	444	viridifrons.....	229, 292
Ægerian.....	728	Anthocoris insidiosus.....	600
Ægilips? aciculatus.....	108	Anthonomus cratægi.....	536
? obtusilobæ.....	108	sycophanta.....	599
Agnippe biscolorella.....	653	tessellatus.....	599
Agrilus bilineatus.....	222	Anthophilax mirificus.....	858
egenus.....	291, 372	Antispila nyssæfoliella.....	656
granulatus.....	443	Ants.....	13
otiosus.....	367	Apate basillaris.....	296
Agrotis alternata.....	116, 173, 329	red-shouldered.....	296
C. nigrum.....	425	Apatela.....	461, 498, 897
saucia.....	173	acericola.....	536
scandens.....	173	afflicta.....	168
Alaus oculatus.....	284, 481	americana.....	218, 336, 353, 397, 481, 494, 556
Alder borers.....	623	betulæ.....	495
flea-beetle.....	630	brumosa.....	169, 328, 494, 597, 597
leaf-roller.....	630	connecta.....	597
Aleurodes aceris.....	422	dactylina.....	494, 597, 628

\* When a common species of insect is specially described and frequently referred to on other pages, the number referring to the page containing the fullest description and figure is put in heavy-faced type.

	Page.		Page.
<i>Apatela falcata</i> .....	637	<i>Aspidotus cerasi</i> .....	538
<i>felina</i> .....	566	<i>convexus</i> .....	595
<i>funeralis</i> .....	302	<i>furfurus</i> .....	538
<i>grisea</i> .....	272	<i>harrisii</i> .....	538
<i>hamamelis</i> .....	218, 353, 656	<i>juglandis</i> .....	338
<i>hastulifera</i> .....	481, 626	<i>juglans regia</i> .....	335
<i>lobeliae</i> .....	168, 218	<i>obscurus</i> .....	101
<i>luteicoma</i> .....	218, 336, 425, 556	? <i>pini</i> .....	807
<i>morula</i> .....	272	<i>rapax</i> .....	371
<i>noctivaga</i> .....	460	<i>tenebricosus</i> .....	417
<i>oblinita</i> .....	473, 567, 775	<i>Aspidisca diospyriella</i> .....	670
<i>occidentalis</i> .....	167, 282, 495, 539	<i>juglandiella</i> .....	335
<i>ovata</i> .....	169, 353	<i>ostryæfoliella</i> .....	647
<i>radcliffei</i> .....	530	<i>saliciella</i> .....	527, 579
<i>spinigera</i> .....	495	<i>splendoriferella</i> .....	473, 536
<i>ulmi</i> .....	273	<i>Aster stalk-borer</i> .....	391
<i>vinulna</i> .....	273	<i>Asterodiaspis quercicola</i> .....	102
<i>vulpina</i> .....	461, 495	<i>Ataxia crypta</i> .....	221, 612
<i>xyliniformis</i> .....	494	<i>Athysanus abietis</i> .....	512, 854
<i>Apanteles glomeratus</i> , introduction of ..	17	<i>fenestratus</i> .....	512
<i>hyphantriæ</i> .....	254	<i>minor</i> .....	512
<i>Apatelodes angelica</i> .....	549	<i>variabilis</i> .....	512
<i>torrefacta</i> .....	529, 596, 646, 650, 668	<i>Athous cucullatus</i> .....	223
<i>Apatura celtis</i> .....	602	<i>Atimia confusa</i> .....	809
<i>clyton</i> .....	604	<i>Attacus luna</i> .....	300
<i>Aphides</i> .....	13	<i>polyphemus</i> .....	488
<i>Aphis aceris</i> .....	425	<i>Attelabus analis</i> .....	335
<i>cerasicolens</i> .....	531	<i>bipustulatus</i> .....	203, 328
<i>cerasifoliae</i> .....	531	<i>rhois</i> .....	632, 641
<i>cratægifolii</i> .....	537	<i>Azelina hübnearia</i> .....	526
<i>diospyri</i> .....	670	<i>Bactra?</i> <i>argutana</i> .....	282
<i>mali</i> .....	537	<i>Bag-worm</i> .....	258, 918
<i>pinicolens</i> .....	806	<i>Balaninus caryatrypes</i> .....	350
<i>populifoliae</i> .....	471	<i>nasicus</i> .....	216, 220, 327, 641
<i>salicti</i> .....	592	<i>obtusus</i> .....	641
<i>lion</i> .....	16	<i>quercus</i> .....	220
<i>woolly, of oak</i> .....	212	<i>rectus</i> .....	215, 327, 354
<i>Aphycus pulvinariæ</i> .....	416	<i>uniformis</i> .....	220
<i>Apion lanuginosum</i> .....	599	<i>Bark beetle</i> .....	706
<i>rostrum</i> .....	357	<i>beetles, enemies of</i> .....	18
<i>signipes</i> .....	599	<i>remedies against</i> .....	28
<i>Aploides, coniferaria</i> .....	864, 879	<i>borer, hickory</i> .....	294, 296
<i>mimosaria</i> .....	189	<i>least spruce</i> .....	825
<i>Aphrastus tæniatus</i> .....	511, 668	<i>quercitrion</i> .....	71
<i>Aphrophora parallela</i> .....	741	<i>lice</i> .....	14
<i>saratogensis</i> .....	742, 800	<i>louse, hickory</i> .....	298
<i>Apple Liopus</i> .....	913	<i>muscle-shaped butternut</i> .....	338
<i>Arctia quenselii</i> .....	903	<i>scurvy</i> .....	537
<i>Argyresthia austerella</i> .....	283	<i>Basilarchia archippus</i> .....	128, 217, 449, 531, 537
<i>gœdartella</i> .....	507	<i>arthemis</i> .....	448, 535
<i>Arhopalus fulminans</i> .....	221, 343	<i>astyanax</i> .....	128, 217, 531, 535, 537, 649
<i>Arma modesta</i> .....	164	<i>Basket-worm, cylindrical</i> .....	142
<i>Arthropoda</i> .....	6	<i>Batrachedra præangusta</i> .....	473, 582
<i>Artipus floridanus</i> .....	220	<i>salicipomonella</i> .....	473, 582
<i>Asemum atrum</i> .....	809	<i>striolata</i> .....	584
<i>mœstum</i> .....	697, 829	<i>Bear, wooly</i> .....	489
<i>Ash borer</i> .....	541	<i>yellow</i> .....	773
<i>gall-louse</i> .....	552	<i>Beech span-worm</i> .....	516
<i>mite</i> .....	554	<i>Bees</i> .....	13
<i>saw-fly</i> .....	544	<i>fertilizing maple</i> .....	13
<i>Sesian</i> .....	540	<i>Beetle, timber, American, silky</i> .....	81
<i>timber-beetle</i> .....	543	<i>bark</i> .....	706
<i>tree Clytus</i> .....	543	<i>enemies of</i> .....	18
<i>Aspidiotus abietis</i> .....	878	<i>spruce</i> .....	811
<i>ancylus</i> .....	482, 520, 553	<i>blister, ash-gray</i> .....	652



	Page		Page
Beetle, characterized .....	7	Bug, wheel.....	251
coarse-writing bark .....	711	Buprestidæ, characterized .....	7
goldsmith .....	321	Buprestis adjecta .....	681
little bark .....	713	consularis .....	809
May .....	22	Drummond's .....	684
pine bark .....	713	fasciata .....	438, 559, 599
timber .....	718	lauta .....	681
spruce timber .....	720	maculiventris .....	682
thunderbolt .....	74	Oregon .....	678
timber, sugar maple .....	389	radians .....	681
two-crested southern timber .....	726	rusticorum .....	683
two-forked southern timber .....	725	striata .....	680
Bellamira scalaris .....	387, 486	tooth-legged .....	60
Belonocnema treata .....	104	ultramarina .....	681
Belted Chion .....	287	viridicornis .....	229
Belvosia bifasciata .....	393	yellow-dotted .....	683
Bembecia sequoia .....	733, 922	Burr-oak gall-mite .....	213
Biorhiza, species of .....	106	Butterflies, characterized .....	7
Birch leaf-blotch miner .....	508	Butternut bark-louse .....	338
tineid larva .....	508	scale insect .....	338
Biston ursaria .....	445	tingis .....	342
Elastobasis coccivorella .....	219	tree-hopper .....	342
Blight, pine .....	774	wooly worm .....	338
Blistar beetle, ash gray .....	652	Bythoscopus .....	60
Boarmia crepuscularia .....	502	seminudus .....	513
pampinaria .....	425, 653	strobi .....	801
Bolitotherus bifurcus .....	510	Cacœcia argyrosipila .....	192, 195, 329, 425, 530, 655
Bombycidæ, characterized .....	8	cerasivorana .....	505, 530
Borer, bark, spruce .....	811	fervidana .....	193
enemies of .....	18	grisea .....	218
flat-headed .....	64	rosaceana .....	505
flat-headed, apple .....	385	semiferana .....	314, 669
cherry .....	386	Callaphis betulæcolens .....	513
flat-headed spruce .....	828	betulella .....	513
hickory .....	287	Callidium antenuatum .....	700, 906
horn-tailed .....	79, 379	æreum .....	354
in general .....	7, 27	janthinum .....	809
linden .....	474	Calligrapha scalaris .....	531, 635
locust twig .....	359	Callimorpha clymene .....	217
of willow .....	557	suffusa .....	555
poplar .....	426	Callipterus caryæ .....	329, 336
prickly ash .....	656	castaneæ .....	350
sixteen-legged maple .....	384	discolor .....	210
sugar-maple .....	374	fumipennellus .....	324
Bostrichus bicornis .....	92	hyalinus .....	222
Botis oscitalis .....	467, 597	maculellus .....	324
Brachys .....	410	marginellus .....	324
ærosa .....	205, 469	? punctatellus .....	323
æruginosa .....	519	punctatus .....	210
ovata .....	205	quercifolii .....	211, 212
Brachystylus acutus .....	670	ulmicola .....	278
Breeding, artificial, of insect-parasites .....	16	ulmifolii .....	278
Brenthian, northern .....	69, 389	Callirhytis .....	105
Brephos infans .....	500	Calloides nobilis .....	344
Bronchelia hortaria .....	663	Callosamia promethea .....	424, 525, 555, 650, 656, 662, 668, 919
Brontes dubius .....	481	Caloptenus femur rubrum .....	513
Broods of insects .....	19	Calosoma scrutator .....	194
Bruchus prosopis .....	669	Camara notus confusus .....	803
uniformis .....	669	var. occidentalis .....	803
Bucculatrix canadensisella .....	507	Campylus denticornis .....	485
thuiella .....	917	Canker worm, spring .....	230
trifasciella .....	349	Capsus .....	600
Buck moth .....	162	Caripeta angustiorata .....	779
Bud-worm, spruce .....	830	Carmenta divisata .....	874
Buffalo leaf-hopper .....	535	fraxini .....	542

	Page.		Page.
Carpenter moth.....	28, 373	Cecidomyia caryæcolor.....	329
worm.....	53, 58	citrina.....	482
Carphoborus bicristatus.....	725	cornuta.....	598
bifurcus.....	725	cossæ.....	329
simplex.....	725	cupressi-ananassa.....	921
Catagenus rufus.....	612	cynipsea.....	329
Catastega aceriella.....	409	glutinosa.....	329
hamameliella.....	667	liroidendri.....	663
timidella.....	220	nototricha.....	329
Caterpillar, forest tent.....	117	orbitalis.....	598
hog.....	660	pudibunda.....	649
in general, described.....	7, 9	pellex.....	556
saddle-back.....	146	persicoides.....	329
skiff.....	147	pini-inopis.....	797
unicorn.....	491	pseudacaciæ.....	368
Caterva catenaria.....	783, 914	q. majalis.....	207
Catocala amasia.....	<b>175</b>	q. pilulæ.....	206
amatrix.....	<b>465</b>	robinæ.....	368, 370
amica.....	174	salicis.....	598
androphila.....	174	salicis-brassicoides.....	598
angusii.....	305	s.-batatus.....	598
babayaga.....	570	s.-cornu.....	598
blandula.....	533	s.-coryloides.....	598
briseis.....	597	s.-gnaphalioides.....	598
cara.....	464	s.-hordeoides.....	598
carissima.....	571	s.-nodulus.....	598
chelidonea.....	175	s.-rhodoides.....	598
coccinata.....	179	s.-siliqua.....	598
concumbens.....	570	s.-strobiliscus.....	598
cratægi.....	532	s.-triticoides.....	598
d lilah.....	175	s.-verruca.....	598
desperata.....	329	sanguinolenta.....	329
elonympha.....	331	serulata.....	636
epione.....	178	strobiloides.....	14
fratercula.....	174	tulipifera.....	663
grynea.....	218, 537	Cecropia caterpillar.....	<b>401</b> , 532
habilis.....	306	Cedar Tineid.....	917
ilia.....	177	Celtis, bark-borer.....	611
innubens.....	332, 652	Graphisurus.....	610
insolabilis.....	304	Cemiosoma albella.....	473, 579
judith.....	303	Cenopis pettitana.....	195
lachrymosa.....	178, 336	quercana.....	194
luctuosa.....	304	reticulatana.....	194, 425, 670
meskei.....	462	Centipedes.....	6
micronympha.....	174	Centronopus anthracinus.....	221
moestuosus.....	333	calcaratus.....	221
neogama.....	332	Cerambycidae, characterized.....	7
obscura.....	305	Ceratonia amyntor.....	<b>242</b> , 480, 486
palæogama.....	329, 332, 354	Ceresa brevicornis.....	325
parta.....	464, 570	bubalus.....	535
piatrix.....	333	Ceroptres, species of.....	107
polygama.....	179	Ceruchus piceus.....	223, 485
relicta.....	304, 463, 500, 597	Cerura borealis.....	434, <b>458</b> , 530, 597
robinsonii.....	303	cinerea.....	565
serena.....	303	occidentalis.....	565
similis.....	175	multiscripta.....	566
subnata.....	332	Chaitophorus candicans.....	474
ultronia.....	176	negundinis.....	669
unijuga.....	463	nigræ.....	593
verrilliana.....	176	populicola.....	434, 474
vidua.....	178, 329, 336, 373, 597	quercicola.....	212
Cecidomyia, galls on hackberry.....	612	smithiæ.....	592
aceris.....	425	spinosus.....	213
albovittata.....	598	viminalis.....	592
caryæ.....	329	Chalcids.....	16

	Page.		Page.
<i>Chalcis flavipes</i> .....	603	<i>Clastoptera obtusa</i> .....	342
<i>ovata</i> .....	261	<i>pini</i> .....	801
<i>Chalcophora campestris</i> .....	642	<i>testacea</i> .....	801
<i>angulicollis</i> .....	678	<i>Cleora pulchra</i> .....	781
<i>fortis</i> .....	679	<i>Clisiocampa americana</i> .....	121, 531
<i>liberta</i> .....	677	<i>californica</i> .....	119, 459
<i>virginiensis</i> .....	675	<i>constricta</i> .....	117
<i>Charadra deridens</i> .....	166, 282, 497	<i>diestia</i> .....	117, 373, 481, 514, 520, 529, 536
<i>propinquilinea</i> .....	167, 336, 425, 496	<i>erosa</i> .....	373
Checked pine sphinx .....	770	<i>fragilis</i> .....	120
<i>Chermes</i> .....	100	<i>sylvatica</i> .....	117, 328, 402, 556
<i>galliformis</i> .....	100	<i>Clytanthus albofasciatus</i> .....	292
<i>laricifolia</i> .....	903	<i>Clytus borer</i> .....	344
<i>pinicorticis</i> .....	810	?larva .....	485
<i>pinifolia</i> .....	805	oak .....	77
Cherry-tree borer .....	521	<i>Coccus, Norfolk Island pine</i> .....	808
Chestnut beetle .....	343	<i>pini corticis</i> .....	734
borer .....	343	Cock's comb elm gall-louse .....	277
gall-louse .....	350	<i>Cœlodasyg biguttatus</i> .....	155
phylloxera .....	350	<i>Colaspis tristis</i> .....	587
tree-hopper .....	350	<i>Coleophora</i> .....	283, 354
weevil .....	350	<i>caryæfoliella</i> .....	316
<i>Chilocorus bivulnerus</i> .....	415	<i>castipennella</i> .....	597
<i>Chionaspis furfurus</i> .....	537	<i>cornella</i> .....	671
<i>nyssæ</i> .....	656	<i>corylifoliella</i> .....	639
<i>orthobis</i> .....	594	<i>discostrata</i> .....	220
<i>pinifolia</i> .....	807	<i>laricella</i> .....	961
<i>quercus</i> .....	103	<i>ostryæ</i> .....	647
<i>salicis</i> .....	593	<i>pruniella</i> .....	528
<i>Chion cinctus</i> .....	287	<i>quercicella</i> .....	220
<i>Chlamys plicata</i> .....	205, 511, 599, 635, 645	<i>tiliæfoliella</i> .....	478, 481
Chlorippe clyton .....	531	of hickory .....	315
<i>Chramesus icoria</i> .....	296	of oak .....	202
<i>Chrysobothris chlorocephala</i> .....	69	<i>Colopha ulmicola</i> .....	277
<i>dentipes</i> .....	60, 679	Commixed <i>Leptostylus</i> .....	697
<i>femorata</i> .....	64, 291, 385, 424, 481, 520, 539, 669	<i>Conotrachelus cratægi</i> .....	535
<i>harrisii</i> .....	679	<i>elegans</i> .....	316
<i>lineata</i> .....	682	<i>juglandis</i> .....	335
<i>octocola</i> .....	669	<i>naso</i> .....	536
<i>6-signata</i> .....	485, 520	<i>nenuphar</i> .....	316
<i>solieri</i> .....	62	<i>posticatus</i> .....	536
<i>trinervia</i> .....	680	<i>Coriscium</i> .....	219
<i>Chrysocorys erythridella</i> .....	664	<i>albanotella</i> .....	220
<i>Chrysomela bigsbyana</i> .....	590	<i>Corythuca arcuata</i> .....	208, 342
<i>multiguttis</i> .....	641	<i>ciliata</i> .....	645
<i>pallida</i> .....	470	<i>polygrapha</i> .....	354
<i>philadelphica</i> .....	590, 800	<i>Corthylus punctatissimus</i> .....	389
<i>scalaris</i> .....	237, 479	<i>Coscinoptera dominicana</i> .....	221
<i>spireæ</i> .....	590, 599	<i>Cosmia orina</i> .....	173
<i>Chysophanus thoe</i> .....	662	<i>Cossula magnifica</i> .....	59, 328
<i>Cicada pruinosa</i> .....	96	<i>Cossus</i> .....	485
<i>septemdecim</i> .....	49, 95	<i>alni</i> .....	623
<i>seventeen-year</i> .....	49, 95	<i>angrezi</i> .....	442
<i>Cimex americana</i> .....	237, 474, 584, 633	<i>reticulatus</i> .....	60
<i>Cirrha platanela</i> .....	645	<i>undosus</i> .....	473
<i>Citheronia regalis</i> .....	301, 331	<i>Cotalpa lanigera</i> .....	274, 321, 599
<i>sepulcralis</i> .....	772	<i>Cottonwood dagger-moth</i> .....	433
<i>Cixius cicutifrons</i> .....	325	root-borer .....	426
cloudy-tipped .....	326	streaked leaf-beetle .....	428
<i>colcepeum</i> .....	326	<i>Cratoparis lunatus</i> .....	482
face-banded .....	325	<i>Crepidodera helxines</i> .....	470, 537, 591
<i>pini</i> .....	803	<i>violacia</i> .....	529
<i>Clastoptera</i> .....	637	Cricket, tree .....	230
		snowy .....	59
		<i>Criocephalus agrestis</i> .....	699

	Page.		Page.
Criocephalus nubilus .....	704	Datana contracta .....	<b>151, 266, 353</b>
productus .....	699	integerrima.....	<b>150, 330, 520, 536, 596, 652</b>
Cræsus latitarsus .....	485	ministra .....	<b>218, 282, 302, 330, 342, 353, 476</b>
Cryphalus asperulus .....	556		481, 514, 520, 529
Cryptarcha ampla .....	330	perspicua .....	664
Cryptocephalus notatus .....	221, 809	Deilephila lineata .....	271
schreibersii .....	810	Deilinia variolaria .....	572
Cryptolechia confertella .....	507	Deiopeia bella.....	257
faginella .....	517	Deltoid larva .....	<b>371, 575</b>
quercicella .....	198, 220, 473	Dendroctonus boring .....	721
schlagenella .....	197	larch .....	903
Cryptorhynchus bisignatus.....	204, 354, 520	brevicornis.....	722
lapathi .....	599	frontalis.....	722
parochus .....	337, 342	punctatus .....	722
Crypturgus atomus.....	<b>727, 825, 861, 872</b>	similis.....	722
Cryptus.....	14	simplex .....	722
Cucujus clavipes.....	223, 481	terebrans .....	<b>721, 858</b>
Cupes concolor.....	827	Dendroides canadensis .....	223
Curculionidæ, characterized .....	7	Dendrotettix quercus .....	214
Cut-worms, climbing .....	173	Depressaria grotella .....	639
Cyaniris pseudargiolus.....	529, 596	robinella .....	364
Cyllene antennatus .....	669	Diaperis hydni .....	510
crnicornis.....	645	Diapheromera femorata .....	222, 317
pieta .....	<b>287, 329, 342</b>	Diaspis carueli .....	915
robinæ .....	355	Dicerca asperata .....	221, 328
Cymatophora crepuscularia.....	371	divaricata .....	328, <b>386, 424, 519, 530</b>
pampinaria.....	571	lurida .....	290
Cynipidæ, in general.....	10	punctulata .....	<b>634</b>
Cynips, species of .....	106	tenebrosa .....	684
quercus-aciculata.....	11	tuberculata .....	684
q. arbos .....	112	Dichelie sulphureana .....	597, 789
q. batatus .....	11, 111	Dichelonycha albicollis.....	800
q. caducus .....	115	elongata .....	328, 511
q. clavula .....	113	elongatula .....	599, 636
q. cornigera .....	114	Dicrocephala quadrivittata .....	324
q. decidua .....	115	Dilophogaster californica .....	99
q. duricaria .....	113	Dinoderus punctatus.....	223
q. ficus .....	111	Diplodus luridus .....	<b>194</b>
q. flocci .....	115	Diplosis annulipes .....	598
q. flocciola .....	115	atrocularis .....	598
q. glandulus .....	113	atricornis .....	598
q. globulus .....	111	catalpæ .....	665
q. operator .....	11	catalpa-pod .....	665
q. pedunculata .....	114	decimmaculata .....	598
q. palustris .....	113	pini .....	799
q. pezomachoides .....	113	pini-inopis .....	799
q. prunus .....	115	pini-rigidæ .....	797
q. rileyii .....	115	resinicola .....	796
q. tuber .....	112	septemmaculata.....	598
q. sculpta .....	114	Diraphia vernalis .....	803
q. seminator .....	112	Dolerus arvensis .....	587
q. spongifica .....	11, 115	bicolor .....	588
q. strobilana .....	113	Dorcaschema nigrum .....	293
q. tubicola .....	115	Dorytômus mucidus .....	<b>427, 810</b>
q. ventricosa .....	114	Drepana .....	494
Cypress sphinx .....	921	arcuata .....	493
geometrid .....	921	Drepanodes varus .....	907
Cyrtinus pygmæus .....	328	Drepanosiphum ? quercifolii .....	209
Cyrtophorus verrucosus .....	481, 520, 521	tilæ ? .....	482
Dagger-moth, western .....	167	Drummond's Buprestis .....	684
Dakrura coccidivora .....	415	Dryobius sex-fasciatus.....	227, 520
pallida .....	218	Dryocampa rubicunda .....	<b>392</b>
Dapsilia rutilana.....	910	Dryocetes affaber .....	<b>810, 857</b>
Daremma undulosa .....	131, 217, <b>547</b>	Dryophanta, species of.....	106
Dasylophia anguina .....	366	Dryopteris inornata .....	492
Datana angusii.....	218, <b>301, 336, 473</b>	rosea .....	492

	Page.		Page.
Dularius brevilineus.....	228	Euclea sp.....	529
Dynastes tityus.....	551	ferruginea.....	529
grantii.....	539	pænulata.....	563
Dysphaga tenuipes.....	291	querceti.....	144
Eacles imperialis.....	218, 282, 396, 425, 481, 514, 636, 645, 656, 771, 857, 893, 909	quercicola.....	652
Eburia quadrigemina.....	293, 541, 653	Eucoila impatiens.....	108
Eccopsis.....	505	mellipes.....	108
corylana.....	641	pedata.....	108
footiana.....	667	stigmata.....	108
fagigemæana.....	520	Eudamus tityrus.....	365, 652
inornatana.....	219	Eudemis botrana.....	650
permundana.....	312, 641	Enderces picipes.....	354
versicolorana.....	313	pini.....	700
zelleriana.....	505	Eufidonia notataria.....	782
Ecdytophla insiticihana.....	359	Eugnaptus angustatus.....	342
Ecyrus dasycerus.....	292	collaris.....	342
Edema albifrons.....	152, 282, 402, 424	Eugonia alniaria.....	307, 336, 344, 476
Elaphidion atomarium.....	91	j-album.....	472
mucronatum.....	91	subsignaria.....	232, 306, 329, 354, 461
inermis.....	290	Euschistus servus.....	252
parallolum.....	89	Entrapela clemataria.....	179, 650
villosum.....	83, 328	transversata.....	181, 404
Elater lusciosus.....	611	Euura.....	13
manipularis.....	481	s. gemma.....	597
nigricollis.....	223, 510	s. nodus.....	597
protervus.....	510	s. ovum.....	597
Ellema confiferarum.....	768	s. perturbans.....	597
harrisii.....	768	Eupithecia.....	527, 573, 574, 898
pineum.....	770	?.....	628
Elm bark-louse.....	280	larva.....	842
borer.....	224	luteata.....	865, 874
Callipterus.....	278	miserrulata.....	190, 910, 919
gall-louse, cock's comb.....	277	Euplexia lucipara.....	497
Galeruca.....	237	Eupodes.....	416
great.....	238	Eupogonius pinivora.....	696
leaf-beetle, imported.....	234	vestitus.....	292, 354
louse, woolly.....	227	Eupsalis minuta.....	69, 389, 481
span worm.....	232	Evacanthus orbitalis.....	600
Ematurga faxonii.....	919	Evergreen span-worm.....	841
Emperor, eyed.....	602	Everyx cherillus.....	656
tawny.....	604	Fatua denudata.....	540, 623
Empretia stimulea.....	146, 424	Fidia.....	221
Enchenopa binotata.....	341, 512	Figites ? chinquapin.....	108
Endropia armataria.....	425, 501	impatiens.....	108
bilinearia.....	183	Fir harlequin caterpillar.....	840
obtusaria.....	347	mite.....	869
pectinaria.....	184	Lophyrus.....	902
textinaria.....	185	needle-inch-worm.....	914
English walnut scale.....	335	saw-fly.....	757
Ennomos alniaria.....	425	Tortrix.....	849
Ephyra pendulinaria.....	501	scale-insect.....	868
Epirrita cambricaria.....	233	Fitch's oak-leaf miner.....	201
dilutata.....	233	Flea-beetle, black-edged.....	316
Epizeuxis americalis.....	843	Forest tent caterpillar.....	402
æmula.....	843	Galeruca californiensis.....	237
Ergates spiculatus.....	704	decora.....	587
Eriosoma caryæ.....	298	sanguinea.....	529
quercu.....	98	vittata.....	532
tessellata.....	513	xanthomelæna.....	234
ulmi.....	277	Galerucella sagittaria.....	591
Eriethinus ephippiatus.....	599	Gall-flies.....	10, 104
Ernobius tenuicornis.....	427	guest.....	107
Eros coccinatus.....	427	dipterous.....	14
Eubyja quernaria.....	188, 536	Gall-louse, poplar-stem.....	471
		Gastropacha americana.....	122, 425, 494, 550

	Page.		Page.
Gaurotes cyanipennis.....	337, 536	Grapta faunus.....	514, 596
Gay-louse, black-margined.....	324	interrogationis.....	<b>240</b> , 480, 605
dotted-winged.....	323	progne.....	241
hickory.....	323	Graptodera carinata.....	276
smoky-winged.....	324	chalybea.....	237
spotted-winged.....	324	Greedy scale-insect.....	371
Gelechia abietisella.....	876	Grubs.....	7
caryeovorella.....	314	Grub, white.....	674
coryliella.....	635, 636, 641	Guest gall-flies, on oak.....	107
fungivorella.....	580	Gnathotrichus asperulus.....	720
gallægenitella.....	220	materiarius.....	718
obliquistrigella.....	850, 869	Hackberry cecidomyian galls.....	612
oronella.....	630	dagger.....	608
querciola.....	220	galls.....	612
quercifoliella.....	220	Psyllidæ.....	614
quercinigræella.....	220	Hadrobregmus foveatus.....	872
quercivorella.....	220	Halesidota agassizii.....	560
pinifoliella.....	792, 868	argentata.....	773
pseudacaciella.....	<b>363</b> , 373	caryæ.....	217, 282, <b>299</b> , 336, 342, 481, 489, 531, 555, 626, 645, 649, 667, 903
rhoifruetella.....	468, 663	edwardsii.....	133
rubensella.....	220	maculata.....	<b>133</b> , 336, 353, 555, 561, 626
salicifungiella.....	580	tessellaris.....	217, <b>265</b> , 481, 643
tristrigella.....	639	tessellata.....	134, 328, 336
Generations of insects.....	19	Haltica alni.....	630
Geometer, notched-winged.....	344	alternata.....	599
Geometrids.....	546, 784, 786	bimarginata.....	630
Geometrid caterpillars.....	9, 274, 332, 899	chalybea.....	237
larva, 308, 348, 374, 517, 573, 407, 467, 500, 504, 609, 629, 638, 843, 867, 876, 899, 921		Hamadryas bassettella.....	220
Gipsy moth.....	138	Harmonia pini.....	727, 729
Girdler, poplar.....	436	Hapithus agitator.....	280
Gluphisia trilineata.....	<b>270</b> , 452, 656	Harris's pine hawk moth.....	768
? ulmi.....	270	Prionus.....	704
Glycobius speciosus.....	374	Helia americana.....	843
Glyptoscelis hirtus.....	800, 810	Helice pallidochrella.....	653
Goes debilis.....	82, 286	Hemileuca maia.....	162
oculatus.....	286	Hemirhipus fascicularis.....	19
pulcher.....	286	Hemiteles thyridopterigis.....	261
pulverulentus.....	515	utilis.....	261
tigrinus.....	82, <b>285</b>	Hepialus argenteomaculatus.....	217, <b>346</b> , 394, 473, 623
Goldsmith beetle.....	274, 321	silver spotted.....	346
Gonops fissunguis.....	922	Herald.....	569
Gortyna nitela.....	391, 542	Heterachthes quadrimaculatus.....	293
Gracilia minuta.....	486	Heterocampa guttivitta.....	<b>218</b> , 424
Gracilaria.....	469, 579	marthesia.....	160
acerifoliella.....	425	pulverea.....	<b>159</b> , 326, 328, 492, 649
alnicolella.....	636	subalbicans.....	158
alnivorella.....	636	unicolor.....	424, 643
blandella.....	329, 334	Heterogenea shurtleffii.....	653
juglandinigræella.....	334	Heteropacha rileyana.....	652
negundella.....	669	Hibernia tilliaria.....	218, 282, 328, <b>475</b>
packardella.....	425	Hickory Aphis.....	299
populiella.....	473	bark-louse.....	298
purpuriella.....	473, 577	blight.....	298
robinella.....	365	borer, common.....	285
sassafrasella.....	650	Eccopsis.....	312
superbifrontella.....	667	leaf-weevil.....	316
Graphisurus fasciatus.....	<b>72</b> , 387	leaf-witherer.....	322
triangulifer.....	610	nut-weevil.....	327
Grapholitha bracteatana.....	788, 857	pig, slug-worms.....	317
caryæ.....	342	round gall.....	322
caryana.....	326	sack-bearer.....	315
galle-saliciana.....	576	shuck-worm.....	326
prunivora.....	536	slug caterpillar.....	299
Grapta comma.....	480	spiny gall.....	322

	Page.		Page.
Hickory stem gall-louse .....	322	Ichthyura albosigma .....	454
tussock moth .....	299	americana .....	282
twig-borer .....	288	inclusa .....	434, 452
vein gall-louse .....	322	palla .....	562
white-heart Gelechia .....	314	strigosa .....	453
Hilipus squamosus .....	726	vau .....	454
Hispa, leaf-mining .....	480	Imperial spiny caterpillar .....	771
quadrata .....	481	Inch-worm, angular-headed, marbled .....	866
suturalis .....	367	ten-lined, pine .....	866, 875
Holcaspis, species of .....	106	Inch-worms .....	9
Holococera glandulella .....	216	Incisalia irus .....	531
Homohadena badistriga .....	173	nippon .....	909
Homoptera lunata .....	218, 402	Incurvaria acerifoliella .....	408, 520
Hoplia trifasciata .....	599	Ingura .....	218
salicis .....	597	præpilata .....	656
Hoplismenus morulus .....	606	Ino reclusa .....	612
Hoplocephala bicornis .....	481, 510	Inquilinæ, on oak .....	107
Hoplosia nubila .....	520	Insecticides .....	31
Hormaphis papyraceæ .....	513	apparatus .....	38
Horn-tail borer .....	379	Insects, broods of .....	19
Hyalè coryliella .....	641	generations of .....	19
Hydria undulata .....	526, 572	forest, remedies against .....	27
Hylastes, coal-black .....	724	hibernation of .....	23
glabratus .....	723	homœothermal .....	21
pinifex .....	722	influence of temperature on .....	19
poreulus .....	724	in general .....	6
Hylecætus americanus .....	81	insectivorous .....	14
Hylesinus aculeatus .....	543	metamorphoses of .....	6
liminaris .....	227	orders of .....	6
opaculus .....	227, 544, 903	parasitic .....	14
piniperda .....	20	poikilothermic .....	21
Hylobius pales .....	724	Interrogation butterfly .....	240, 605
stupidus .....	810	Iodia rufago .....	172
Hyloicus cupressi .....	921	rufimargo .....	530
Hylotoxa dulciana .....	509	Io moth .....	373, 394, 451
Hylotrupes bajulus .....	702	Ips fasciatus .....	510
ligneus .....	907	sanguinolentus .....	510
Hylurgops, pine .....	722	Ithycerns noveboracensis .....	94, 520
pinifex .....	709, 722, 826	Janassa lignicolor .....	157, 353
Hylurgus rufipennis .....	814	Jassus inornatus .....	324
Hymenôrus communis .....	223	Juniper bark-borer .....	904
Hypæpax aurora .....	156	basket-worm .....	909
Hypenâ .....	408	inch-worm .....	910
baltimoralis .....	407	twig inch-worm .....	907, 914
Hyperâsips bigeminata .....	475	web-worm .....	910
signata .....	415	plant-louse .....	914
Hyperchiria io .....	218, 282, 373, 394, 451, 514, 520, 529, 555, 650, 672	salmon-tinted caterpillar .....	913
Hyperetis nyssaria .....	516, 636	scale-insect .....	915
Hyperplatys aspersus .....	354, 426, 473	white-striped inch-worm .....	914
Hyphantria cunea .....	244, 328, 342, 473, 656	wood-borer .....	906
punctatissima .....	247	Katydid .....	513
textor .....	217, 244, 326, 425	Kleidotoma vagabunda .....	108
Hypomolyx pinicola .....	726	Kronæa minuta .....	150, 353
Hypophleus tenuis .....	718, 720	Lachnus abietis .....	853
Hypothenemus dissimilis .....	221	alnifoliæ .....	637
erectus .....	221	australis .....	806
Hypulus simulator .....	223	caryæ .....	299, 323
Ibalia anceps .....	108	dentatus .....	592
ensiger .....	108	laricifex .....	902
maculipennis .....	108, 383	longistigma .....	482
montana .....	108	platanicola .....	645
rufipes .....	108	quercicolens .....	208
Ichneumon .....	14, 729	quercifoliæ .....	222
mode of oviposition of .....	15	saliceti .....	600
		salicicola .....	592

	Page.		Page.
Lachnus strobi.....	741, 803	Lithocolletis.....	354, 579
Lachnosterna fusca.....	674	aceriella.....	409
quercina.....	221	æriferella.....	220
Lacosoma chirodota.....	141	albanotella.....	220
Ladder Chrysomela.....	237	alnicolella.....	636
Læmophloeus hornii.....	612	argentifimbriella.....	220
Lagoa crispata.....	139	argentinotella.....	282
opercularis.....	140, 609, 649, 650	auronitens.....	636
pyxidifera.....	650	basistrigella.....	220
Larch Aphis.....	902	bethuneella.....	219
Chermes.....	903	bicolorella.....	219
mite.....	903	bifasciella.....	219
saw-fly worm.....	879	caryæalbella.....	315
Sphinx.....	890	caryæfoliella.....	315, 342
Laverna ? gleditschiæella.....	653	castanææella.....	219, 350, 354
Leaf-hopper, hickory, freckled.....	324	celtifoliella.....	609
three-banded.....	281	celtisella.....	609
Leaf-roller, locust.....	361	cincinnatiella.....	219
obliquely-banded.....	408	clemensella.....	425
red-banded.....	195	coryliella.....	641, 648, 649
sulphur.....	362, 789	eratægella.....	219, 528, 533
Lecanium acericola.....	425, 669	fitchella.....	201, 220
acericorticis.....	425	fuscocostella.....	220
caryæ.....	298	guttifinitella.....	655, 664
fir.....	868	hageni.....	220
juglandifex.....	338	hamadryadella.....	199
oleæ.....	98	incanella.....	636
quercifex.....	98	intermedia.....	220
quercitronis.....	98	juglandiella.....	334
tulipiferae.....	663	lucetiella.....	478, 481
Lepidoptera, in general, described.....	8	lucidicostella.....	410, 478
Leptostylus commixtus.....	697	mirifica.....	220
macula.....	328, 337, 354, 520	obstrictella.....	220
Leptura vagans.....	486	ornatella.....	373
Lepturges querci.....	328	ostryæfoliella.....	648
Leptura canadensis.....	871	populiella.....	473
zebra.....	91	robiniella.....	363
Libythea bachmanni.....	607	quercialbella.....	220
Limacodes ?.....	626	quercipulbella.....	220
biguttata.....	147	quercitorum.....	220
cippus.....	144	salicifoliella.....	579
scapha.....	147, 328, 336, 424, 490	tiliæella.....	481
viridis.....	348	triteniæella.....	648
Lime inch-worm.....	475	tubiferella.....	200, 220
Limenitis archippus.....	472, 529	ulmella.....	282
arthemis.....	242, 448, 480, 514, 529	unifasciella.....	219
disippus.....	128, 449	populiella.....	468
misippus.....	596	Lithosian.....	668
ursula.....	128	Lithophane cinerosa.....	669
Limneria fugitiva.....	164, 603	laticinerea.....	526
pallipes.....	255	Live-oak Thecla.....	129
Lina lapponica.....	591	Lochmæus.....	270, 492
scripta.....	428, 591	cinereus.....	398
Linden borer.....	474	manteo.....	158, 481
gall-mite.....	480	olivatus.....	397
leaf-beetle.....	479	tessella.....	160
Liopus cinereus.....	291, 373	Locust Depressaria.....	364
crassulus.....	612	Hispa.....	367
facetus.....	913	leaf Gelechia, greater.....	363
querci.....	73	lesser.....	363
variegatus.....	354	leaf-miner.....	365
xanthoxyli.....	656	autumnal.....	363
Litargus 4-spilotus.....	599	leaf-roller.....	361
Lithacodes fasciola.....	217, 399, 514, 529, 530	midge, black.....	368
flexuosa.....	641	saw-fly.....	369



	Page.		Page.
Locust, red-legged .....	513	Melanophila longipes .....	827
seventeen-year .....	49, 95	Melanotus ? communis .....	510
skipper .....	365	parumpunctatus .....	510
twig-borer .....	359	Melliopus latiferræana .....	219
Lonchæa ? .....	598	Melsheimer's sack-bearer .....	142
polita .....	511	Meroptera pravella .....	574
Longicorn pine-borer, common .....	685	Metaclroma 6-notata .....	913
Lophocampa caryæ .....	903	Metanema quercivoraria .....	182, 282, 473
Lophoderus juglandana .....	312	Meteorus hyphantriæ .....	253
mariana .....	219	Metrocampa perlaria .....	597
triferanus .....	195, 282, 425	Micracis hirtella .....	670
velutinana .....	196, 425, 869	rudis .....	612
Lophodonta angulosa .....	154	suturalis .....	656, 670
Lophyrus .....	757, 799, 852, 914	Microclytus gazellula .....	81
abbotii .....	755	Microgaster .....	14, 16
abietis .....	757, 851, 862, 902, 919	Microlepidoptera .....	9
lecontei .....	758	Midge, black locust .....	367
pinetum .....	759	pitch-inhabiting .....	796
pini .....	20	yellow locust .....	368
pini-rigidæ .....	759	Mite, harvest .....	416
Loxotænia afflictana .....	869	fir leaf .....	920
Luna moth .....	300, 330, 342, 656	red .....	903
Lyctus striatus .....	223	Mites .....	6
Lyda saw-fly .....	760, 761, 852	Mitura damon .....	909
fasciata .....	524	Molorchus bimaculatus .....	293, 424
stellata .....	21	Monoleuca .....	328
Lygus invitus .....	419	Monarthrum fasciatum .....	328, 520
monachus .....	420, 637	mali .....	94
Lymexylon sericeum .....	81	Monella caryella .....	323
Lyonetia alniella .....	636	Monocesta coryli .....	238, 641
Lytta cinerea .....	652	Monohammus confusor .....	685, 827, 861
Machimia tentoriferella .....	220	marmoratus .....	694
Macrobasis unicolor .....	371	scutellatus .....	696
Macroductylus subspinosus .....	636	Mordella 8-punctata .....	223
Magdalis armicollis .....	225, 228, 229	Moths, characterized .....	7
barbita .....	297	Mytilaspis .....	600
olyra .....	80, 297, 328	Mytilaspis pinifoliæ .....	805
salicis .....	342	pomicorticis .....	539
Maia moth .....	162	pomorum .....	280
Mallodon dasystemus .....	79	Myzocallis bella .....	209
melanopus .....	50, 612	Nadata gibbosa .....	153, 424
serrulatus .....	612	Nantucket, pine moth of .....	745
Mamestra .....	609	Nematus .....	589, 633, 634
detracta .....	116	of birch .....	509
Mantis carolina .....	251	erichsonii .....	879
Maple bark-borers .....	391	fur .....	598
borer, 16-legged .....	384	hospes .....	598
bud-beetle .....	392	inquilinus .....	598
cottony scale .....	412	integer .....	838
dagger-moth .....	397	mendicus .....	598
large span-worm .....	404	s. desmodioides .....	598
leaf-cutter .....	408	s. pisum .....	598
lesser span-worm .....	404	s. pomum .....	598
ocellate, leaf-gall .....	411	similaris .....	369
semi-looper .....	403	trilineatus .....	598
slug-worm .....	399	ventralis .....	524, 568
sugar, borer .....	374	Nematocampa filamentaria .....	182, 328, 329, 425, 536, 641
twig-borers .....	391	Neoclytus caprææ .....	229, 543
worm, spiny .....	392	erythrocephalus .....	228, 273, 373
Marmara salictella .....	581	Neoforus petiti .....	556
May beetle .....	22, 26	Neoptochus adpersus .....	222
Mecas inornata .....	427	Nephoteryx ? ulmi-arrorrella .....	282
Megachile optiva .....	410	undulata .....	282
Melanophila drummondii .....	684	zimmermanni .....	731
fulvoguttata .....	683		

	Page.		Page.
Nepticula amelauchierella .....	531	Olygia versicolor .....	840, 863
anguinella .....	219	Oncideres cingulatus .....	222, 288
castanea-foliella .....	354	Onychia armata .....	108
clemensella .....	645	quinquelineata .....	108
corylifoliella .....	639, 641	Ophiderma mera .....	342
cratægifoliella .....	534	Ophion purgator .....	269
fuscotibiella .....	580	Ophiura bistrariis .....	403
juglandifoliella .....	334	Orange sawyer .....	290
latifasciella .....	349	Orchesia castanea .....	481
maximella .....	645	Orchestes subhirtus .....	599
nyssæella .....	656	Oregon Buprestis .....	678
ostryæfoliella .....	647	Orgyia .....	353, 774
platanella .....	643	antiqua .....	447, 514, 536, 892
platea .....	219	definita .....	135, 561
prunifoliella .....	527	gulosa .....	134
quercicastanella .....	219	inornata .....	217, 921
quercipulchella .....	219	leucostigma 217, <b>262</b> , 336, 342, 373, 486, 636,	
saginella .....	219	655, 670, 862, 892	
virginiella .....	647	Ornix cratægifoliella .....	534
Nerice bidentata .....	267	inuitatumella .....	536
Neuroterus, species of .....	107	quadripunctella .....	531
Nisoniades icelus .....	450	quercifoliella .....	220
Noctuid .....	777	Orthosia instabilis .....	172, 494
caterpillar .. 309, 354, 449, 500, 516, 533, 570,		Orthosoma brunneum .....	82, 702, 873
647, 840, 863, 897, 913, 919		Oryssus sayi .....	383
on pine .....	810	terminalis .....	383
Noctuidæ, characterized .....	8, 9, 10	Osmoderma eremicola .....	223, 283, 298
Nola ovilla .....	132	scabra .....	223, 283
Nothris trinitella .....	640	Otiocerus amyotii .....	326
Notodonta stragula .....	456, 563	Oxyptilus nigrociliatus .....	851
Notodonta? .....	348, 353	Ozognathus cornutus .....	222
Notodontian larva .....	459	Pachylobius picivorus .....	727
November moth .....	233	Pædisca celtisana .....	609
Nyctobates pennsylvanicus .....	223, 485	solicitana .....	505
Oak-bark weevil .....	80	transmissana .....	505
blight .....	98, 212	Pachnæus distans .....	222
burr, gall mite .....	213	Pachybrachys livens .....	600
carpenter-worm .....	<b>53</b>	Pachypsyla, c. asteriscus .....	616
chermes .....	100	c. cucurbita .....	617, 621
gall-flies .....	<b>104</b>	c. gemma .....	615
forked-tail .....	160	c. globulus .....	617, 621
leaf Cryptolechia .....	197	c. mamma .....	615, 620
leaf-miner, white blotch .....	199	c. pubescens .....	617
leaf phylloxera .....	208	c. umbilicus .....	616, 619
leaf roller .....	191	venusta .....	615
Liopus .....	173	c. vesiculum .....	616
live, root-borer .....	50	Packardia nigripunctata .....	149
post, locust .....	214	Paleacrita vernata .....	<b>230</b> , 556
pruner .....	<b>83</b>	Palthis asopialis .....	218
sack-bearer .....	202	Pandectius hilaris .....	71, 520
scale insect .....	98	Pandemis lamprosana .....	408
tussock-caterpillar .....	133	limitata .....	219
worm, rosy, striped .....	127	Paniscus cephalotes, mode of egg-laying of	15
orange, striped .....	124	Panopoda carneicosta .....	172
spiny .....	125	roseicosta .....	173
Oberea mandarina .....	426	rufimargo .....	172
schaumii .....	426	Pantagrapha limata .....	477
Ocellate leaf-gall .....	411	Papilio ajax .....	668
Ocneria dispar .....	138	cresphontes .....	472, 660
Odontota rubra .....	202, 480	glaucus .....	217, 328, 472, 480, 531, 555,
scutellaris .....	367	650, 662	
Æcanthus niveus .....	222, 230, 591	marcellus .....	668
Edemasia concinna 218, 301, 373, <b>457</b> , 520, 536, 670		rutulus .....	625
Æta compta .....	668	telamon .....	668
Oiketicus abbotii .....	921	troulus .....	649, 662, 668, 909

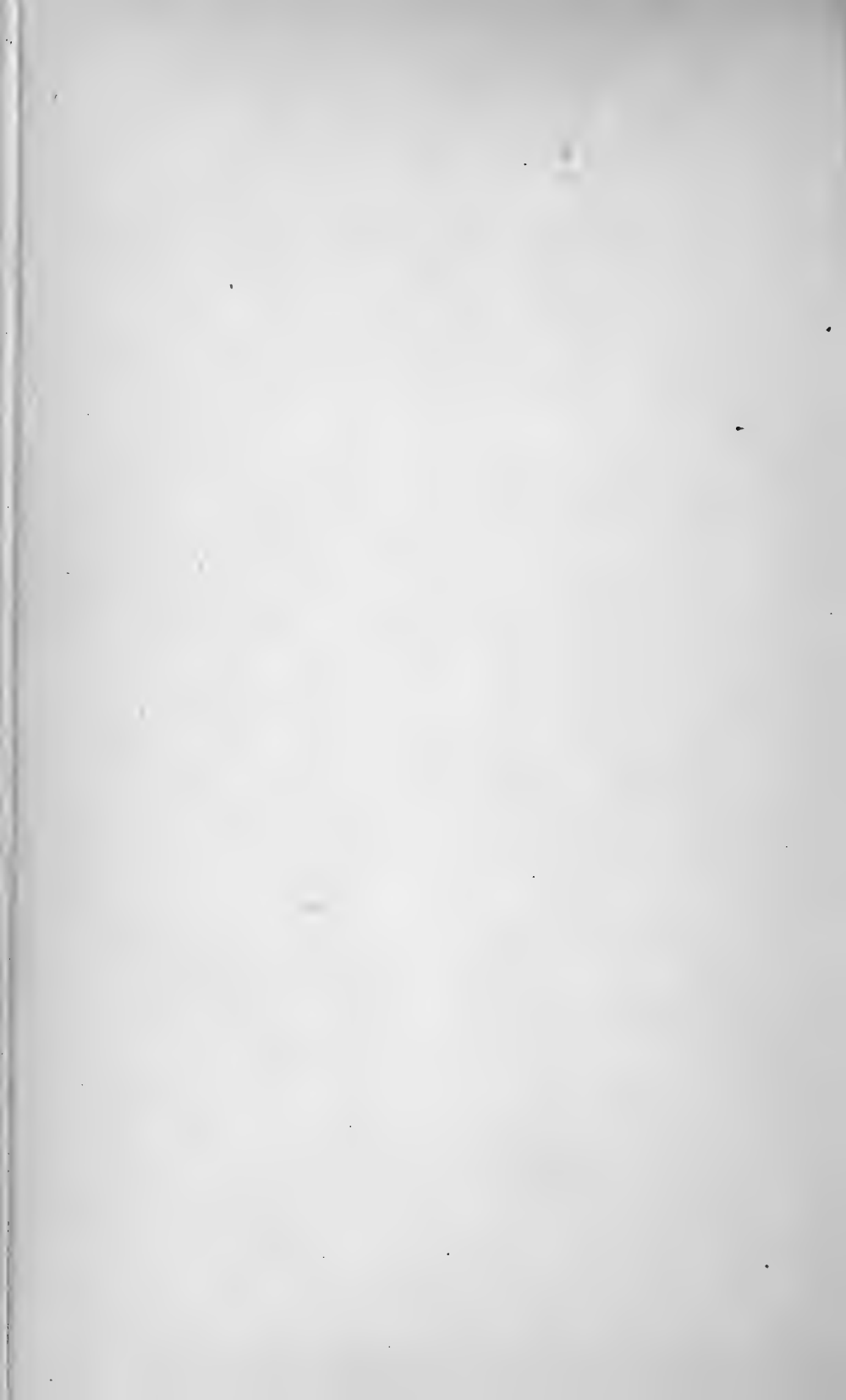
	Page.		Page.
<i>Papilio turnus</i> .....	217, 472, 480, <b>486</b> , 529, 531, 536,	<i>Phyllosecta vitellina</i> .....	591
	555, 668	<i>vulgatissima</i> .....	599
<i>Panandra brunnea</i> .....	223, 530	<i>Phylloxera caryæcaulis</i> .....	322
<i>Paraphia deplanaria</i> .....	329, 863	<i>caryæfallax</i> .....	323
<i>subatomaria</i> .....	501, 778	<i>caryæfoliæ</i> .....	322
<i>unipunctaria</i> .....	185, 282	<i>caryæglobosa</i> .....	329
<i>Parasa chloris</i> .....	144, 282, 353, 529, 668	<i>caryæglobuli</i> .....	322
<i>fraterna</i> .....	145, 328, 353, 529, 530	<i>caryæsemen</i> .....	322
Parasites, insect, artificial breeding of....	16	<i>caryæsepta</i> .....	322
<i>Paria aterrima</i> .....	341	<i>caryævena</i> .....	322
<i>cyanella</i> .....	342	<i>caryægummosa</i> .....	323
<i>6-notata</i> .....	599	<i>caryæren</i> .....	323
<i>Parorgyia achatina</i> .....	135, 328	<i>castaneæ</i> .....	350
<i>cinnamomea</i> .....	356	<i>conica</i> .....	323
<i>clintonii</i> .....	282	<i>depressa</i> .....	323
<i>leucophæa</i> .....	137	<i>forcata</i> .....	322
<i>parallela</i> .....	135, 773	<i>rileyi</i> .....	208
<i>Parthenos nubilis</i> .....	370	<i>spinosa</i> .....	322
<i>Pelidnota punctata</i> .....	223	<i>Phymatodes of grape</i> .....	75
<i>Pempefia contatella</i> .....	361	<i>variabilis</i> .....	74, 328
<i>gleditschiella</i> .....	651	<i>varius</i> .....	76
<i>quinque punctella</i> .....	361	<i>white-banded</i> .....	76
<i>Pemphigus acerifolii</i> .....	417	<i>Phyton pallidum</i> .....	294
<i>aceris</i> .....	417	<i>Phytoptus</i> .....	555, 668
<i>fraxinifolii</i> .....	552	<i>abnormis</i> .....	480
<i>popularius</i> .....	472	<i>acericola</i> .....	424
<i>populicaulis</i> .....	434, 471	<i>fraxini</i> .....	554
<i>populi-globuli</i> .....	472	<i>on willow</i> .....	595
<i>populi-monilis</i> .....	434	<i>quadripes</i> .....	422
<i>populi-ramulorum</i> .....	434	<i>quercii</i> .....	213
<i>populi-transversus</i> .....	434	<i>salicicola</i> .....	595
<i>populi-venæ</i> .....	472	<i>thujæ</i> .....	920
<i>pseudobyrsa</i> .....	434	<i>ulmi</i> .....	281
<i>ulmifusus</i> .....	283	<i>Pieris menapia</i> .....	<b>762</b> , 903
<i>vagabundus</i> .....	434	<i>Pigeon tremex</i> .....	79
<i>Penthina albeolana</i> .....	505	<i>Pimpla conquisitor</i> .....	194, 261
<i>dimidiana</i> .....	530	<i>inquisitor</i> .....	261, 265
<i>Periclistis, species of</i> .....	107	<i>Pine Amorbia</i> .....	790
<i>Perilitus communis</i> .....	254	<i>Anomala</i> .....	802
<i>Periphora melshheimerii</i> .....	142	<i>beetle, white-necked</i> .....	800
<i>Petrophora diversilineata</i> .....	189, 282	<i>blight</i> .....	734
<i>Phalænide, characterized</i> .....	8	<i>borer, common longicorn</i> .....	685
<i>Phaneroptera curvicauda</i> .....	222, 513	<i>white-scuteled</i> .....	696
<i>Phelopsis obcordata</i> .....	510	<i>lesser</i> .....	697
<i>Pheocyma lunifera</i> .....	776	<i>Chrysomela</i> .....	800
<i>Pheosia rimosa</i> .....	455	<i>Cixius</i> .....	803
<i>Philadelphia Chrysomela</i> .....	800	<i>Clastoptera</i> .....	801
<i>Phleophagus apionides</i> .....	530	<i>Dicerca</i> .....	684
<i>minor</i> .....	284	<i>eating gay-beard</i> .....	696
<i>Phleosinus dentatus</i> .....	904	<i>Eudercis</i> .....	700
<i>Phleotribus frontalis</i> .....	612	<i>hawk-moth</i> .....	768
<i>liminaris</i> .....	530	<i>leaf, Chermes</i> .....	805
<i>Phobetrum hyalinum</i> .....	529	<i>miner</i> .....	792, 868
<i>pithecium</i> .....	143, 353, 490, 529, 531	<i>scale insect</i> .....	805, 807
<i>Phœogenes ater</i> .....	729	<i>louse, mimic</i> .....	803
<i>syringæ</i> .....	729	<i>measuring-worm</i> .....	778
<i>Phoxopteris burgessiana</i> .....	197	<i>Nephoteryx</i> .....	844
<i>murtfeldtiana</i> .....	196	<i>Parorgyia</i> .....	773
<i>Phryganidia californica</i> .....	122	<i>Pheocyma</i> .....	776
<i>Phycis rubrifasciella</i> .....	<b>309</b> , 636	<i>Pieris</i> .....	<b>762</b> , 903
<i>Phycid caterpillar</i> .....	786	<i>Retinia</i> .....	754
<i>worm, green-striped</i> .....	574	<i>pitch, twig Tortrix</i> .....	742
<i>Phyllaphis niger</i> .....	208	<i>saw-fly</i> .....	799
<i>Phyllocnistis liquidambarisella</i> .....	656	<i>Sphinx, Southern</i> .....	768
<i>liriodendronella</i> .....	662	<i>sulphur leaf-roller</i> .....	769
<i>magnoliæella</i> .....	668	<i>Thecla</i> .....	767

	Page.		Page.
Pine, ? Therina .....	777	Prionus californicus (?).....	221
silver Tortricid .....	788	emarginatus .....	703
tube-builder .....	790	laticollis .....	<b>52</b> , 437
tussock moth .....	774	lesser .....	702
white, Aphis .....	741	Pristiphora sycophanta .....	598
Lachnus .....	741	Prodenia cammellinæ .....	329
leaf-hopper .....	801	Progne butterfly .....	241
Schizoneura .....	804	Promethea moth .....	424, <b>525</b> , 555, 656, 662, 668, 919
tufted caterpillar .....	774	Proteoteras asculana .....	609, 655
weevil .....	734	Pruner, oak .....	<b>83</b>
Pinipestis reniculella .....	854	Psenidæ .....	104
zimmermanni .....	844, 856	Psenocerus supernotatus .....	701
Pissodes affinis .....	810	Pseudococcus aceris .....	418
strobi .....	<b>734</b> , 829, 861, 872	Pseudothyatira cymatophoroidea .....	167
Pitch-inhabiting midge .....	796	Psilocorsis quercicella .....	198, 219
pine-needle gall-fly .....	797	Psocus rufus .....	600
Pityophthorus annexens .....	715	Psyche confederata .....	142, 353
sparsus .....	720	Psylla annulata .....	417
materarius .....	826	buxi .....	671
minutissimus .....	221	carpini .....	648
puberulus .....	812	diospyri .....	670
pubipennis .....	93	European box .....	671
querciperda .....	93	magnoliæ .....	668
Plagioidera lapponica .....	591	tripunctata .....	805
scripta .....	591	Psyllidæ .....	13
Plant lice .....	13	Pteromalus .....	265
Plateceticus gloverii .....	142	puparum .....	16
Platycerura furcilla .....	774, 893	vanessæ .....	606
Platycerus quercus .....	392	Ptilinus basalıs .....	670
Platygaster lecanii .....	98	ruficornis .....	388
Platynota flavidana .....	425	Pulvinaria innumerabilis .....	277, <b>412</b> , 645, 669
Platypus compositus .....	18	Pyralidæ, characterized .....	8
Platysamia columbia .....	529, 890	Pyralid larva .....	468, 504
cecropia .....	218, 282, 328, 342, <b>401</b> , 514, 531, 532, 536, 555, 596, 656, 669	Pyrophila pyramidoides .....	328, 353
gloverii .....	596	Pytho americanus .....	810
Plectrodera scalator .....	426, 599	Quercitron bark-borer .....	71, 387
Podapion gallicola .....	810	Raphia frater .....	462
Podisus spinosus .....	194, 252, 603	Raphigaster pensylvanicus .....	326
Podosesia syringæ .....	542	Red-head inch-worm .....	780
Pœcilocapsus goniphorus .....	420	Regal walnut caterpillar .....	301
Pœcilopectera pruinosa .....	281, 425	Retinia comstockiana .....	742
Pogonocherus mixtus .....	558	duplana .....	749
nubilus .....	475	frustrana .....	745
Polygraphus, red .....	721, 858	rigidana .....	754
rufipennis .....	721, 858	sylvestrana .....	749
Polyphemus caterpillar .....	7	Rhagium lineatum .....	704, 830, 862
Poplar borer .....	426, <b>435</b>	Rheumaptera hastata .....	503
gall-louse .....	472	Rhogas lætus .....	627
girdler .....	436	Rhizococcus araucariæ .....	808
goat-moth .....	439	quercus .....	103
leaf aphıs .....	471	Rhopalosiphum salicis .....	593
lesser .....	436	Rhynchites æratus .....	599
Lombardy, borer .....	443	Rhyncolus angularis .....	599
span-worm .....	445	brunneus .....	530
Porter beetle .....	702	Rhyssa atrata .....	380
Hylotrupes .....	702	lunator .....	380
Post-oak locust .....	214	Ribbed Rhagium .....	704
Prionia bilineata .....	493	Romaleum atomarium .....	612
Prionidus cristatus .....	251, 265	Rose-chaffer .....	511
Prionoxystus querciperda .....	<b>58</b>	Sack-bearer, Melsheimer's .....	142
robiniaæ .....	<b>53</b> , 353, 373, 597	Salebria contatella .....	361
Prionus .....	221	Samia cynthia .....	596, 663, 668
broad-necked .....	52, 437	Saperda of willow .....	558
brown .....	82	bivittata .....	536, 539
		bivittata, oviposition of .....	689



	Page.		Page.
Spruce Nematus.....	838	Thera contractata.....	841, 914
plant-louse.....	853	Therina endropiaria.....	186
plume-moth.....	851	fervidaria.....	186, 841
Rocky Mountain timber-beetle.....	857	seminudaria.....	777
Stegania pustularia.....	404	Thunderbolt beetle.....	74
Steganoptycha claypoleana.....	655	Thymalus fulgidus.....	510
ratzeburgiana.....	845	Thyreus abbotii.....	536
saliciana.....	597	Thyridopteryx ephemeriformis.....	217, 258, 425
salicicolana.....	597		909, 918
Stenoscelis brevis.....	284, 342, 391	Thysanocnemis fraxini.....	552
Stenosphenus notatus.....	288	Thysanoes fimbicornis.....	293
Stenotrachelys approximaria.....	187	Timber beetle, Rocky Mountain spruce.....	857
Strongylium tenuicolle.....	19	remedies against.....	28
terminatum.....	223	Tineidae, characterized.....	8, 9
Strymon titus.....	531	Tineid, larva.....	528, 529, 578, 630, 645
Sycamore leaf-folder.....	644	Tingis arcuata.....	208
miners.....	644	ciliata.....	600
Synechroa punctata.....	222, 229	juglandis.....	342, 514
Syneergus, species of.....	107, 108	Tillomorpha geminata.....	294
Syneta tripla.....	511	Tischeria badiella.....	219, 319
Syringa borer.....	542	castaneaeella.....	219, 254
Systema blanda.....	222	citrenipennella.....	219
marginalis.....	316	complanoides.....	219
Tachina.....	16, 256, 729	concolor.....	219
bifasciata.....	393	malifoliella.....	536
Tæniocampa incerta.....	172, 328	pruinoseella.....	219
Telamona fasciata.....	325	quercitella.....	219
unicolor.....	325	quercivorella.....	219, 550
Telea polyphemus.....	7, 161, 282, 300, 336, 342, 353, 400, 491, 520, 532, 536, 555, 596, 636, 648, 656	tinctoriella.....	219
Telenomus.....	265	zelleriella.....	219
bifidus.....	253	Tmetocera ocellana.....	219
graptæ.....	606	Tolyte laricis.....	773, 873, 893
Telephorus bilineatus.....	511	velleda.....	165, 282, 670
Tephrosia cribrataria.....	841	Tomicus cacographus.....	713
Teras ferrugana.....	504, 597	calligraphus.....	711
logiana.....	530	pini.....	713, 858, 903
permutata.....	575	pusillus.....	717
variana.....	847	semicastaneus.....	810
viburnana.....	576	southern.....	713
Termes flavipes.....	283, 387	typographus.....	22, 29
frontalis.....	354	Tomocera californica.....	99
Tetracis crocallata.....	347	Tortricidae, characterized.....	8
lorata.....	873	Tortricid larva.....	655, 901
Tetralopha diluculella.....	787	Tortrix.....	354, 327, 349, 806, 878
Tetraneura ulmi.....	283	albicomana.....	219
Tetranychus telarius.....	903	flaccidana.....	192
Tetrastichus modestus.....	606	fir.....	868
Tettigonia, pine.....	803	fumiferana.....	820, 830
Thanaos.....	459, 559	juglandana.....	312
brizo.....	131, 217	larva.....	577
juvenalis.....	131	paludana.....	194
persius.....	472, 596	packardiana.....	849, 868
Thecla.....	559	pitch-pine twig.....	742
acadica.....	596	politana.....	790
autolyceus.....	130	quercifoliانا.....	191
calanus.....	129, 130, 217, 299, 336, 353, 536	rileyana.....	312, 336
edwardsii.....	130	rosaceana.....	218
falacer.....	536	sulfureana.....	362
favonius.....	129	Tragidion fulvipenne.....	91, 221
henrici.....	530	Tragosoma harrisii.....	704
liparops.....	217, 353, 529, 536, 596	Tree-bug, large green.....	326
niphon.....	767, 909	hopper, banded.....	325
strigosa.....	217	butternut.....	342
Thelia univittata.....	98	short-horned.....	325
		two-marked.....	341

	Page.		Page.
Tree, butternut, white-lined.....	98	Willow-borer .....	557
yellow .....	325	Cimbex .....	584
Tremex columba .....	79, 283, 298, <b>379</b> , 484, 515	Dolerus .....	587
Trichogramma ? fraterna .....	265	Gracilaria, purple .....	577
intermedium .....	606	Saperda .....	558
Trogosita corticalis .....	485	span-worm, pink striped .....	572
Troxylón parallelopipedum .....	223	tussock-moth .....	561
Tussock moth, white-spotted .....	<b>262</b> , 373, 862, 892	Wollastonia quercicola .....	427
worm, hickory .....	489	Wood-engraver bark-beetle .....	706
Tylonotus bimaculatus .....	485, 543	Woolly elm-tree louse .....	277
Typhlocyba tricincta .....	281	Worm, pitch-drop .....	731
Typocerus zebratus .....	80	Xanthonia stevensii .....	328
Unicorn worm .....	269	villosula .....	328
Uranotes melinus .....	535	Xestobium affine .....	391
Urocerus, white-horned .....	733	Xiphidria albicornis .....	381
yellow-banded .....	733	attenuata .....	483
abdominalis .....	733	white-horned .....	381
albicornis .....	733	Xyleborus bivittatus .....	720
Urographis fasciatus .....	354	celus .....	92, 297, 706
Uroxiphus caryæ .....	324	caelatus .....	<b>812</b> , <b>824</b> , 861
Utetheisa bella .....	529	fuscatus .....	93
Vanessa antiopa .....	238, <b>448</b> , 514, 596	impressus .....	718
Vernal Diraphia .....	803	pubescens .....	710
Virginia tiger-moth .....	340	retusicollis .....	93
V-marked Cacæcia .....	192	saxesenii .....	706
Walking-stick .....	317	sparsus .....	720
Walnut, black, Sphinx .....	330	xylographus .....	706
case-bearer .....	311	Xylesthia clemensella .....	373
English, scale .....	335	Xylentes populi .....	438
leaf-roller .....	312	robiniaë .....	373
sword-tail .....	324	Xyloterus bivittatus .....	<b>812</b> , <b>823</b> , 861
Weevil, iron-wood leaf .....	648	politus .....	387, 391
chestnut .....	350	Xylotrechus colonus .....	<b>77</b> , 328, 424
gray-sided oak .....	71	convergens .....	536
hickory-nut .....	327	undulatus .....	830
leaf-rolling .....	203	Yellow bear .....	773
oak-bark .....	80	Ypsolophus caryæfoliella .....	316
pales .....	724	querciella .....	220
pitch-eating .....	727	quercipomonella .....	202, 220
Say's .....	367	Zanclognatha minivalis .....	218
white-pine .....	734, 829	Zerene catenaria .....	783
Wheel-bug .....	251	Zeuzera æsculi .....	282
White grub .....	674		





## INDEX OF NAMES OF PLANTS.\*

- Abies balsamea*, 761, **859**.  
*bracteata*, 787.  
*canadensis*, **871**.  
*douglasii*, **855**, 857.  
*excelsa*, 396.  
*menziesii*, 713, **855**.
- Acacia*, 371.
- Acer*, 119, 192, 447, 484, 489, 494, 497, 500, 501, 525.  
*dasycarpum*, 250, 391, 396, 407, 413, 417, 420, 422, 425, 543, 609.  
*glabrum*, 425.  
*pennsylvanica*, 425.  
*pseudoplatanus*, 396.  
*rubrum*, 250, **374**, 375, 396, 417.  
*saccharinum*, 249, **374**, 396, 409, 410, 418, 424, 490.  
*spicatum*, 394.  
*var. nigrum*, 409.
- Aesculus californica*, 119, 192.  
*flava*, 250.  
*glabra*, 250, **653**.  
*hippocastanum*, 249, 396, 447.
- Ailanthus*, 261, 609.  
*glandulosus*, 249, **608**.
- Alder*, 249, 269, 279, 495, 512, 516, 541, **623**.  
*black*, 672.  
*European*, 2.  
*hoary*, 396.  
*smooth*, 396.  
*speckled*, 396.
- Almond*, 371.
- Alnus*, 402, 487, 495, 507.  
*incana*, 148, 396, 401, **623**, 624.  
*maritima*, 249.  
*serrulata*, 396, 401, **623**.  
*viridis*, 625.
- Ambrosia artemisiæfolia*, 391.
- Amelanchier*, 402.  
*canadensis*, 249, 401, 529, **531**.
- Amorpha fruticosa*, 395.
- Ampelopsis*, 402.  
*quinquefolia*, 249, 490.  
*veitchii*, 414.
- Apios tuberosa*, 490.
- Apple*, 49, 64, 66, 94, 95, 116, 117, 118, 119, 143, 150, 165, 167, 173, 189, 192, 231, 243, 248, 257, 269, 271, 299, 301, 302, 395, 401, 437, 447, 450, 457, 476, 487, 488, 489, 490, 494, 525, 528, 535, 537, 538 547, 550, 699.
- Apple, crab, Siberian*, 312, 490.  
*Apricot*, 149, 249.  
*Arbor vitæ*, 261, 917.  
*Arbutus menziesii*, 119.  
*Ash*, 119, 138, 257, 299, 391, 395, 429, **540**.  
*black*, 556.  
*European*, 248.  
*green*, 564.  
*mountain*, 64, 233, **537**.  
*prickly*, 250, 649, **658**.  
*white*, 248, 555.
- Asimina triloba*, 249, **668**.
- Aspen*, 198, 199, 406, **435**, 447, 450, 451, 459.  
*American*, 248, 488.  
*large-toothed*, 488.
- Azalea*, 525, 674.
- Balm of Gilead*, 52, 433, 448, 452, 455, 591.
- Baptisia*, 395.  
*tinctoria*, 367.
- Bark, nine*, 488.
- Basswood*, 158, 302, 437, **474**, 477.  
*white*, 302.
- Bay, Californian*, **670**.
- Bean*, 195.
- Beech*, 64, 79, 138, 250, 291, 381, 401, 402, 413, **515**, 611, 858.  
*American*, 396.  
*blue*, 396.  
*common*, 396.  
*copper*, 302.  
*cut-leaved*, 302.  
*European*, 2.  
*wood*, 302.
- purple*, 302.  
*red*, 302.  
*water*, 396.  
*wood*, 396.
- Benzoin bush*, 790.
- Berberis*, 402, 525.  
*canadensis*, 249.
- Betula*, 300, 308, 402, 476, 487, 494, 525.  
*alba*, 119, 124, 247, 249, 302, 346, 395, 396, 401, 406, 457, 476, **483**, 487, 488, 489, 490, 491 513.  
*excelsa*, 401.  
*lenta*, 401, 406, 449, 486, 494.  
*lutea*, 346, 486, 495, 508.  
*nigra*, 249, **483**, 513.  
*papyracea*, 302, 401, 480.

\*The number of the page on which the plant or tree is most fully referred to is put in heavy-faced type.

- Betula*, *populifolia*, 169, 302, 396, **483**, 485, 488, 491, 626.  
*Biola orientalis*, 916.  
*Birch*, 138, 149, 155, 158, 160, 166, 167, 169, 342, 395, 405, 449, 457, **483**, 489, 490, 491, 636.  
     black, 308, 345, **483**, 495, 513.  
     European, 2.  
     paper, 302, 485, 500.  
     poplar leaved, 447, 485.  
     white, 238, 242, 249, 302, 396, 406, 463, 485, 489, 495, 500, 501, 502, 503, 505, 508, 513, 574.  
     yellow, 484, 485, 486, 508.  
*Blackberry*, 116, 119, 155, 269, 274, 312, 457, 494, 782.  
*Bladder nut*, 553.  
*Box*, 671.  
*Box elder*, 413, 425, 609, 668.  
*Buckeye*, 609, **653**.  
     Ohio, 250.  
     sweet, 250.  
*Buckthorn*, 340, 536.  
*Buckwheat*, 271.  
*Butternut*, 299, 301, 302, **337**, 536.  
*Button bush*, 249, 567.  
*Buttonwood*, 266, 643.  
*Buxus sempervirens*, 249, **671**.  
*Carex pennsylvanica*, 782.  
*Carya*, 119, 249, 401, 402, 447, 476, 858.  
     alba, **285**, 302, 305, 323, 328, 339.  
     amara, 292, 302, 309, 326.  
     glabra, 309, 316, 322, 323.  
     microcarpa, 302.  
     olivæformis, 294.  
     porcina, **285**, 300, 302, 307, 311, 315, 321, 328.  
     squamosa, 339.  
     sulcata, 302.  
     tomentosa, **285**, 291, 296, 312, 313, 314.  
*Carpinus*, 402.  
     americana, 128, 160, 249, 302, 396, 401, 488.  
*Castanea americana*, 249, 349.  
     pumila, 249, 302, 396.  
     vesca, 300, 302, 307, 396, 401, 406, 476.  
     vesca, v. *americana*, 302.  
*Castor-oil plant*, 250.  
*Catalpa bignonioides*, 249, **665**.  
     speciosa, 249.  
*Ceanothus*, 402.  
*Cedar*, 905, 906, **917**.  
     red, 261, 396, 919.  
     white, 396, 909.  
*Celastrus scandens*, 512.  
*Celtis*, 50, 447, 858.  
     crassifolia, 601.  
     mississippiensis, **601**.  
     occidentalis, 249, **601**.  
     texana, 610, 611.  
*Cephalanthus*, 402, 525.  
     occidentalis, 249.  
*Cerasus virginiana*, 395, 525.  
*Cercis*, 512.  
     canadensis, 171, 249.  
*Cherry*, 64, 95, 117, 143, 144, 148, 149, 172, 173, 189, 194, 248, 301, 336, 406, 457, 476, 487, 495, 505, 522, 529, 538, 552.  
     choke, 396, 488, 529, 531, 537.  
     common garden, 302.  
*Cherry*, wild, 116, 117, 118, 128, 143, 145, 147, 148, 149, 163, 176, 192, 434, 450, 487, 489, 490, **521**, 569.  
     wild, black, 396, 488.  
*Chestnut*, 74, 143, 145, 149, 150, 169, 307, 396, 401, 437, 494.  
     American, 302.  
     European, 302.  
     horse, 396, 447.  
*Chickweed*, 271.  
*China tree*, **670**.  
*Chinquapin*, 302, 396.  
*Chionanthus virginicus*, 250.  
*Choke cherry*, 529.  
*Citrus*, 660.  
*Clematis*, 249.  
     rosea, 180.  
*Clethra alnifolia*, 181, 490.  
*Clover*, 195, 362, 371, 609, 789.  
*Coffee tree*, Kentucky, 250.  
*Comptonia aspenifolia*, 310, 395.  
*Conifers*, 248, 502, 511.  
*Convolvulus*, 249, 490.  
*Corn*, 195.  
     Indian, 146.  
*Cornus*, 395.  
     alternifolia, 249.  
     florida, 249, 395, 671.  
*Corylus*, 401, 402, 476.  
     americana, 249, 302, 401, 488, 490, 491, **637**.  
     avellana, 302, 395.  
     rostrata, 401.  
*Cotton*, 249, 567.  
*Cottonwood*, 248, **426**.  
     angled, 488.  
*Crab apple*, **537**.  
     siberian, 312.  
*Cranberry*, 195.  
*Cratægus*, 119, 249, 401, 402, 457, 476, 487, 489, 491, 522.  
     australis, 188, 536.  
     coccinea, 401, 536.  
     crus-galli, 401.  
     parvifolia, 534.  
     tomentosa, 401, **532**.  
*Crotalaria*, 257.  
*Cupressus thujoides*, 396, 909.  
*Currant*, 181, 182, 281, 241, 271, 340, 395, 402, 413.  
     Missouri, 406.  
*Cydonia vulgaris*, 249, 302.  
*Cypress*, 921.  
     American bald, 396.  
*Datura meteloides*, 490.  
*Diospyros kaki*, 249.  
     virginiana, 249, **670**.  
*Dog-wood*, 144, 176, 269, **671**.  
*Dock*, bitter, 271.  
*Elder*, 248.  
     box, 64, 248, 396, 413, 425.  
*Elm*, 138, 144, 166, 167, 185, 189, 192, 195, 221, **244**, 293, 299, 316, 380, 395, 401, 402, 406, 413, 447, 476, 484, 491, 494, 495, 497, 544.  
     American, 396, 488.  
     American, white, 249.  
     English, field, 396.  
     European, 2  
     cork-barked, 396.

- Elm, red, 238, 396, 488.  
   slippery, 224, 238, 243, 249, 396, 488.  
   whahoo, 396, 488.  
   white, 277, 396.  
   wild, 488.  
   winged, 243, 396, 488.  
 Eucalyptus, 371.  
 Euonymus, 413.  
   atropurpureus, 249.  
   japonicus, 372.  
 Fagus, 110, 300, 402, 476, 484, 525, 553, 588.  
   ferruginea 250, 302, 396, 401, **515**.  
   sylvatica, L., 302, 396.  
   var. cuprea, 302.  
   var. laciniata, 302.  
   var. purpurea, 302.  
 Fern, sweet, 310, 501,  
 Ficus carica, 250.  
 Fig, 250, 371.  
 Fir, 138, 196, 512, 688, 754, 773, 780, 859, 898  
   European, as changed by insects, 25.  
   diseases of, produced by insects, 25.  
   Norway spruce, 396.  
 Fraxinus, 119, 395, 402, 494, 495.  
   americanus, 248, **540**.  
   excelsior, 248.  
   † platycarpa, 487.  
   quadrangula, 553.  
   sambucifolia, 487.  
   trifoliata, 487.  
   viridis, 554.  
 Fringe tree, 250.  
 Fuchsia fulgens, 490.  
 Galactia glabella, 131.  
 Gall berry, 646.  
 Geranium, 249, 490.  
 Gilead, balm of, 433, 439, 448.  
 Gleditschia, 402, 406, 541.  
   triacanthos, 250, 301, 396, 401, **651**.  
 Glycine, 331.  
 Golden rod, 355.  
 Gooseberry, 271, 340.  
 Gossypium, 395, 490.  
   album 249.  
 Gramineae, 489.  
 Grape, 75, 171, 248, 271, 281, 340, 362, 413, 437, 512.  
 Grass, 489.  
 Grasses, 340.  
 Gum, sour, 250, **656**.  
   sweet, 250, 274, 396, **656**.  
 Gymnocladus canadensis, 250, 651, **672**.  
 Hackberry, 50, 79, 249, 280, 281, 291, 413, 447, 553, **601**.  
 Halesia, 525.  
   diptera, 186.  
 Hamamelis virginica, 249, 401, 409, **667**.  
 Haw, 249, 536.  
   black, 649.  
   red, 536.  
 Hawthorn, 158, 535.  
 Hazel, 126, 138, 163, 169, 171, 313, 327, 402, 626, 635,  
   **637**.  
   American, 302.  
   European, 2, 302.  
   nut, wild, 488.  
   witch, 282.  
 Heaven, tree of, 668.  
 Helianthus, 249, 490.  
   annuus, 490.  
 Hemlock, 485, 780, 865, 867, **871**.  
 Hibiscus syriacus, 249.  
 Hickory, 88, 89, 116, 117, 130, 134, 135, 147, 160, 172,  
   178, 192, 195, 228, 229, 269, 274, **285**, 333,  
   334, 339, 356, 447, 489, 491, 858.  
   bitter, 292, 294, 337.  
   bitter, nut, 302.  
   pig-nut, 286, 299, 301, 302, 306, 316, 647.  
   shagbark, 286, 289, 292, 305.  
   shell bark, 302.  
   small fruited, 302.  
   western shell bark, 302.  
 Holly, 248.  
 Honey locust, 406, 541, **651**.  
   suckle, tartarean, 144.  
 Hop vine, 240, 241.  
 Hornbeam, 138, 302, 348, 396, 448.  
   European, 2.  
   hop, 396, 488, **646**.  
 Horse chestnut, 467, **653**.  
   Californian, 192.  
 Huckleberry, 457.  
 Humulus, 395.  
 Ilex, 248.  
 Impatiens noli-me-tangere, 347.  
 Indigo, wild, 367, 782.  
 Ipomea purpurea, 490.  
 Iron wood, 339, **646**.  
 Ivy, English, 609.  
   poison, **664**, 790.  
 Jasminum, sp., 249.  
 Juglans, 118, 130, 249, 491, 495, 497, 512.  
   cinerea, 300, 301, 302, 336, 337, 401, 490.  
   nigra, 302, 307, 312, 329, 401, 476.  
   regia, 336.  
 June berry, 531.  
 Juniper, 220, 700, 881, **904**.  
   common, 191, 396, **910**.  
   European, 2.  
   low-bush, **910**.  
 Juniperus chinensis, 916.  
   communis, **910**.  
   japonica, 916.  
   oxycedrus, 916.  
   reerii, 916.  
   rigida, 916.  
   virginiana, 396, 700, 904.  
 Kalmia, 250.  
   angustifolia, 890.  
 Kentucky coffee tree, 651, **672**.  
 Köhreuteria paniculata, 396.  
   panicle-flowered, 396.  
 Lappa officinalis, 490.  
 Larch, 138, 299, 406, 674, **879**, 890.  
   American, 396.  
   black, 396.  
   European, 901.  
   Scotch, 902.  
 Larix, 249, 299.  
   americana, 396, **879**.  
   europaea, 883.  
 Laurel, 250.  
   Californian, **670**.  
   mountain, 371, 372.

- Laurus, 670.  
benzoin, 525.
- Lepedeza, 257, 395.
- Leverwood, 396.
- Ligustrum vulgare, 250, 547
- Lilac, 248, 546, 547, 609.
- Lime, **474**.
- Linden, 64, 138, 158, 240, 272, 299, 412, 413, **448**, **474**.  
487, 489, 553.  
American, 249.  
European, 249, 302.  
white, 302.
- Lindera benzoin, 396.
- Liquidambar, 300.  
styraciflua, 250, 396, **656**.
- Liriodendron, 395, 402, 525.  
tulipifera, 487, **662**.
- Locust, 117, 178, 250, 299, 336, **355**, 395, 413.  
black, 56.  
honey, 150, 250, 301, 396, **651**.  
water, 553.
- Lonicera spec., 249.
- Maclura, 249.
- M gnolia, 250.  
acuminata, 487, 668.  
umbrella, 668.
- Maple, 152, 154, 155, 167, 181, 182, 194, 195, 196, 262, **374**, 489, 494, 501, 543, 526, 553, 609, 890.
- Maple, red, 250, **374**, 391, 396, 404, 407, 409, 411, **417**.  
rock, 78, 79, 407.  
seeds of, rendered fertile by insects, 13.  
soft, 64, 192, 374, 416, 417, 422, 425.  
silver, 250, 396, 403, 413, 425, 447.  
spiked, 394.  
sugar, 396, 424, **514**.  
swamp, **374**, 396, 417.  
white, 250, 376.
- Martynia proboscidea, 490.
- Melia azedarach, **670**.
- Mesquite, **669**.
- Morus rubra, 250.
- Moulds, inducing disease in plants, 27.
- Mountain ash, **537**.  
European, 538.
- Mulberry, red, 250.
- Myrica cerifera, 144, 257.
- Myrtle, wax, 144.
- Negundo aceroides, 248, 396, 402, 609, **668**.
- Nemapanthes canadensis, 890.
- Nicotiana tabacum, 490.
- Nyssa multiflora, 250, **656**.
- Oak, 29, **48**, 266, 269, 299, 314, 335, 344, 395, 397, 401, 402, 413, 437, 447, 469, 476, 487, 490, **494**, 497, 511, 519, 525, 550, 553, 609, 650.  
bear, 125.  
black, 110, 117, 125.  
black jack, 109, 110, 161.  
burr, 109, 110, 153, 168, 174, **209**, 213, 218, 396.  
chestnut, 53, 109, 110, 354.  
enceno, 109.  
European, 2.  
English, 205, 302.  
ground, 133.  
Hind's, 110.  
laurel, 109, 117, 134, 189, 205.
- Oak, live, 60, 65, 79, 93, 129, 137, 174, 176, 187, 191, 208  
217, 218, 401.  
mossy cup, 302.  
obtuse leaved, 302.  
over-cup, 109.  
pin, 110, 207, 302, 396, 488.  
post, 110, 117, 214, 221.  
red, 80, 110, 125, 127, 131, 168, 169, 211, 217, 218,  
297 302, 396, 495, 497, 511.  
scarlet, 109, 302, 396, 488.  
scrub, 125, 126.  
sessil-flowered, 302.  
Sonoma, 121.  
swamp, 488.  
chestnut, 109, 396.  
white, 109.  
Turkey, 302, 396.  
water, 109.  
white, 109, 125, 131, 169, 218, 302, 396.  
willow, 109, 110, 165.
- Oenothera biennis, 271.
- Olive, 371, 372.
- Orange, 140, 290, 362, 609, 660.  
osage, 194, 242, 413, 553.
- Ostrya virginica, 249, 300, 308, 339, 348, 396, 401, 488, **646**.
- Papaw, 668.
- Paulownia imperialis, 249.
- Peach, 64, 116, 119, 391, 525, 553.
- Pear, 64, 119, 144, 173, 189, 194, **274**, 336, 406, 484, 490,  
535, 537, 538, 609.  
cultivated, 248.
- Pecan, 79, 294.
- Pelargonium, 490.
- Persica vulgaris, 249.
- Persimmon, 133, 137, 158, 165, 171, 194, 288, 301, 333, **670**.
- Petunia, 490.
- Phaseolus, 489.
- Phatimia arbutifolia, 119.
- Philadelphus coronarius, 505.
- Pine, 250, 437, 438, 590, **673**.  
Austrian, 759.  
Bothan, 396.  
Corsican, 731.  
Douglas, 674.  
European, 2, 62.  
pitch, 340, 676, 741, 758, 760.  
red, 730.  
Russian, 731.  
scrub, 709, 744, 751.  
silver, 787.  
southern, 711, 724.  
white, 396, 504, 674, 733, 755, 870.  
yellow, 686, 703, 706, 710, 763.
- Pinus, 250, 490, 525.  
austriaca, 731.  
cembra, 731.  
contortus, 761.  
excelsa, 396.  
inops, 709, 744.  
insignis, 730.  
lambertiana, 732, 922.  
mitis, 686.  
palustris, 767.  
ponderosa, 703, 732, 761, 922.  
resinosa, 730.

- Pinus*, *rigida*, **673**, 744, 752, 758.  
*rubra*, 731.  
*strobis*, 396, **673**, 719.  
*sylvestris*, 731.  
*tæda*, 786.  
*variabilis*, 706.  
*Pisum*, 489.  
 Pitch-chains, 27.  
*Plane*, *American*, 396.  
     *oriental*, 396.  
*Plantago*, 489.  
     *major*, 490.  
*Plantain*, 609.  
*Platanus*, 300, 401, 485, 495, 511.  
     *occidentalis*, 249, 396, **642**.  
     *orientalis*, 396.  
*Plum*, 117, 119, 143, 169, 176, 243, 257, 269, 271, 300, 301,  
 401, 406, 447, 450, 457, 489, 490, 491, 495, 502, 525,  
 609, 649.  
     *wild*, 149.  
     *wild red*, 249.  
*Polygonum*, 490, 609.  
     *persicaria*, 490.  
*Poplar*, 52, 138, 171, 182, 184, 238, 292, 360, 402, 405, 428,  
**435**, 448, 495.  
     *balsam*, 248, 449.  
         *silver-leafed*, 462, 463, 468, 473.  
     *downy*, 360.  
     *white*, 360.  
     *European*, 2.  
     *Lombardy*, 249, 443, 445, 591.  
     *necklace*, 488.  
     *silver-leafed*, 446.  
     *tulip*, 543.  
     *white*, *European*, 248, 274.  
*Populus*, 402, 494, 500, 526, 570, 609, 609.  
     *alba*, 248, 360, 489.  
     *angulata*, 434, 488.  
     *balsamifera*, 248, 395, 401, 434, 139, 449, 488,  
         489.  
     *canescens*, 360.  
     *candicans*, 444, 463, 473.  
     *dilatata*, 249, 472, 495.  
     *fastigiata*, 473.  
     *grandidentata*, 401, 433, 452, 465, 488.  
     *monilifera*, 248, 426, 488, 495.  
     *tremuloides*, 248, **435**, 434, 439, 461, 488.  
*Portulaca oleracea*, 271.  
*Post oak*, 214, 221.  
*Prickly ash*, 250, 649, 658.  
*Pride of India*, 175.  
*Primrose*, *evening*, 271.  
*Prinos verticillata*, 491, **672**.  
*Privet*, 250, 547.  
*Prosopis*, 669.  
*Prunus*, 257, 402, 487, 858.  
     *americana*, 249, 530.  
     *armeniaca*, 249.  
     *avium*, 248.  
     *cerasus*, 248, 302.  
     *pensylvanica*, 489.  
     *serotina*, 395, 396, 490, **521**, 526, 527.  
     *virginiana*, 249, 396, 401, 487, 490, **521**, 609,  
         646.  
*Ptelea trifolium*, 512.  
*Purslane*, 271.  
*Pyrrhopappus carolinianus*, 180.  
*Pyrus*, 248, 402, 531, 858.  
     *alba*, 495.  
     *americana*, 495, 537.  
     *coronaria*, 537.  
     *malus*, 302, 488.  
*Quercitron*, 72.  
*Quercus*, 48, 395, 401, 402, 447, 476, 484.  
     *alba*, 249, 396.  
     *coccinea*, 249, 302, 396, 488.  
     *cerris*, 302.  
     *cerris vulgaris*, 396.  
     *emoryi*, 100.  
     *ilicifolia*, 131.  
     *imbricarius*, 131.  
     *macrocarpa*, 153, 213, 302, 396.  
     *myrtifolia*, 103.  
     *obtusiloba*, 131, 302.  
     *palustris*, 205, 302, 396, 488.  
     *pedunculata*, 302.  
     *phellos*, 249.  
     *prinos*, 210, 249.  
     *robur*, 205.  
     *rubra*, 249, 302, 396.  
     *sessiliflora*, 302.  
     *virens*, 187, 191, 208, 401.  
*Quince*, 302, 371, 401.  
*Ranunculus acris*, 789.  
*Raspberry*, 124, 125, 139, 281, 312.  
     *purple flowering*, 488.  
*Red-bud*, 512.  
*Red haw*, 536.  
*Red root*, 560.  
*Rhamnus*, 249, 490.  
*Rhododendron*, 250.  
*Rhodora canadensis* 890.  
*Rhus cotinus*, 250.  
     *glabra*, 396, **663**.  
     *toxicodendron*, 664.  
     *typhina*, 663.  
*Ribes*, 249, 402.  
     *aureum*, 406, 490.  
     *cynosbati*, 401.  
     *grossularia*, 406, 489.  
     ? *nigrum*, 406.  
     *rubrum*, 489.  
*Ricinus communis*, 250, 490.  
*Robinia*, 476, 512.  
     *pseudacacia*, 250, **355**, 395.  
     *viscosa*, 365, 395.  
*Rosa*, 119, 120, 146, 249, 401, 402, 413, 447, 457.  
     *carolina*, 488.  
*Rose*, 192, 195, 249, 269, 299, 371.  
*Rubus*, 119, 124, 249, 402, 494, 495, 511.  
     *canadensis*, 395.  
     *villosus*, 312, 395.  
*Rumex obtusifolius*, 271.  
*Salix*, 249, 300, 395, 401, 402, 406, 447, 489, 490, 494,  
**557**.  
     *alba*, 401, 488, 592.  
     *babylonica*, 488, 592.  
     *cordata*, 488, 583, 595.  
     *fragilis*, 488.  
     *humilis*, 401, 596.  
     *inornata*, 596.  
     *longifolia*, **578**, 595.

- Salix*, *lucida*, 488, 592.  
     *nigra*, 565 593.  
     *vitellina*, 579.  
*Sambucus*, 402.  
     *canadensis*, 248.  
*Sassafras*, 172, 219, 395, 396.  
     *officinale*, 249, 396, 525, 609, **646**, **649**.  
*Service berry*, 531.  
*Sequoia gigantea*, 922.  
     *sempervirens*, 732, 922.  
*Silver bell*, 525.  
     tree, 186.  
*Silver poplar*, 238.  
*Sloe*, 249.  
*Smilax laurifolia*, 187.  
     *rotundifolia*, 187.  
*Smoke tree*, 250.  
*Solanum nigrum*, 490.  
*Solidago*, 355.  
*Sorbus aucuparia*, 538.  
*Spice bush*, 396.  
*Spindle tree*, 413.  
*Spiræa*, 249, 313, 402.  
     *opulifolia*, 488.  
     *salicifolia*, 164.  
     *sorbifolia*, 406, 490.  
     ? *tomentosa*, 406.  
*Spruce*, 681, 708, 726, 756, 773, 780, 862, 867, 898.  
     black, 512.  
     Douglass, **855**, 857, 858.  
     Rocky Mountain, **855**.  
     Norway, 860.  
*Staphylea trifolia*, 249.  
*Stellaria*, 271.  
*Strawberry*, 182, 195, 274, 362.  
*Strombocarpus*, 669.  
*Sumach*, 282, 299, 301, 396, 413, **663**, 873.  
*Sweet gum*, 274, **656**.  
*Sycamore*, 249, 266, 268, 413, 484, 560, **642**.  
     American, 396.  
*Symphoricarpus*, 395.  
     *racemosus*, 249.  
*Syringa*, 402, 490, 525, 542, 549.  
     *persica*, 490.  
     *vulgaris*, 248, 345, 490.  
*Tamarack*, 299, **879**.  
*Taraxacum dens-leonis*, 489.  
*Taxodium distichum*, 396, 921.  
*Taxus*, 250.  
*Tecoma radicans*, 249.  
*Thorn*, 150, 171, 282, 447, 449, 457, 489, 522.  
     black, 534.  
     dwarf, 534.  
     wild, **532**, 564.  
*Thuja*, 525.  
     *occidentalis*, 905, 916, **917**.  
*Tilia*, 119, 402, 489, 494.  
     *alba*, 302.  
     *americana*, 249, 302, 401, 448, **474**, 476, 487.  
     *europæa*, 249, 302, 401.  
     *heterophylla*, 302.  
*Touch-me-not*, 347.  
*Trees*, diseases of, produced by insects, 24.  
*Tree of heaven*, **668**.  
*Trifolium*, 249, 489.  
     *pratense*, 395.  
*Tropæolum*, 490.  
     *majus*, 490.  
*Tulip tree*, 250, **662**.  
*Turnip*, 271.  
*Ulmus*, **224**, 395, 401, 402, 406, 447, 484, 497.  
     *alata*, 488.  
     *americana*, 224, 249, 396, 488, 490.  
     *fulva*, 224, 243, 249, 396, 488.  
     *uberosa*, 243, 396, 488.  
     *campestris*, 396.  
*Umbellularia californica*, 371, 372.  
*Vaccinium*, 401, 402, 457.  
*Verbena*, 490.  
*Viburnum*, 249, 497, 609.  
     *dentatum*, 490, 505.  
*Vitis*, 409, 789.  
     *labrusca*, 490.  
*Walnut*, 117, 130, 160, 167, 178, 286, 299, 494.  
     black, 301, 302, 312, **329**, 356.  
     English, 336.  
*Water locust*, 553.  
*Watermelon*, 271.  
*Whahoo*, 243.  
*Whortleberry*, winter, 650.  
*Willow*, 54, 64, 119, 128, 133, 138, 150, 165, 178, 217,  
     238, 248, 249, 257, 342, 371, 395, 401, 402,  
     403, 405, 406, 413, 427, 429, 434, 447, 450,  
     455, 456, 461, 464, 467, 487, 489, 524, **557**,  
     609, 628.  
     brittle, 488.  
     European, 2.  
     heart-leaved, 488.  
     shining, 488.  
     weeping, 488.  
     white, 488.  
*Willow oak*, 208.  
*Winterberry*, 269.  
*Wistaria*, Chinese, 488.  
     *frutescens*, 249.  
     *sinensis*, 249.  
*Witch hazel*, 282, **667**.  
*Woodbine*, 414.  
*Woodwax*, 782.  
*Yew*, 250.  
*Zanthoxylum americanum*, 250, **658**.  
*Zea mays*, 395, 489.

## INDEX OF NAMES OF AUTHORS.

- Abbot (John) and Smith (James Edward), 129,  
133, 137, 144, 152, 153, 156, 161, 165, 178, 181,  
182, 184, 185, 186, 187, 188, 218, 301, 424, 434,  
488, 489, 494, 531, 536, 550, 567, 636, 645, 646,  
649, 650, 768, 841, 921.
- Adler, H., 11, 12.
- Alexander, William, 831.
- Andrus, V. V., 450.
- Angus, James, 151, 298, 303, 304, 305, 333, 671.
- Ashmead, William H., 104, 208, 217, 806.
- Atkins, Charles G., 689, 881, 889, 890.
- Bailey, J. S., 54, 59, 442, 443.
- Bailey, T. P., 439, 442.
- Bailey, W. Whitman, 882.
- Balding, A., 507.
- Barnard, W. S., 31, 40, 44.
- Barth, J. B., 817.
- Bassett, H. F., 11, 12, 124.
- Bean, T. E., 403.
- Behr, H. H., 597, 773.
- Behrens, James, 123.
- Belfrage, G. W., 58.
- Beutenmüller, William, 200, 217, 218, 223, 243, 282,  
302, 328, 336, 342, 353, 396, 476, 481, 488, 514,  
520, 529, 641, 645, 649, 667, 921.
- Blanchard, F., 89, 641, 718.
- Bland, J. H. B., 543, 700.
- Boisduval, H., 767.
- Bolter, A., 421.
- Bowditch, F. C., 297, 685, 686.
- Bowles, J. G., 406, 445, 446.
- Bridgham, Joseph, 271.
- Brodie, W., 218, 400, 401, 402, 473, 481, 526, 536, 555,  
596, 599, 636, 648.
- Bruce, David, 405.
- Bruner, Lawrence, 214, 429, 586, 591, 652.
- Bumpus, Hermon Carey, 3, 4.
- Bundy, William, 211, 552.
- Bunker, Robert, 300, 450, 462, 500, 773.
- Burgess, Edward, 505.
- Burrill, T. J., 443.
- Butler, Arthur G., 123.
- Calder, Edwin C., 3, 74, 77, 682, 702.
- Carney, J. P. R., 330.
- Cassino, S. E., 421.
- Caulfield, F. B., 177, 337, 424, 536, 558.
- Chambers, Victor Tousey, 205, 219, 220, 282, 283, 349,  
354, 365, 373, 401, 410, 468, 473, 481, 507, 508,  
517, 519, 520, 536, 550, 577, 581, 584, 609, 636,  
645, 648, 650, 668, 672.
- Clark, Howard L., 240, 452, 524, 569, 597.
- Clarkson, F., 52, 89, 446, 447.
- Claypole, E. W., 124, 633, 655.
- Clemens, Brackenridge, 146, 196, 198, 219, 315, 334,  
349, 363, 365, 399, 410, 478, 505, 527, 528, 531,  
532, 534, 579, 580, 581, 582, 641, 643, 647, 648,  
667.
- Cockerell, Theodore D. A., 474.
- Coe, Eben S., 820.
- Coleman, N., 447, 490.
- Comstock, J. H., 5, 99, 100, 101, 102, 103, 158, 194, 201,  
307, 313, 335, 354, 359, 361, 362, 369, 371, 372,  
411, 415, 417, 418, 419, 537, 553, 593, 594, 600,  
651, 657, 660, 662, 665, 669, 742, 749, 752, 787,  
788, 792, 793, 797, 807, 808, 878, 915.
- Coquillett, D. W., 4, 37, 38, 168, 174, 179, 217, 218, 311,  
312, 328, 397, 467, 468, 470, 486, 495, 505, 510,  
530, 557, 575, 590, 591, 599, 637, 639, 640, 641.
- Couper, William, 726.
- Cramer, A. W. P., 406, 570.
- Devereaux, W. L., 276, 283, 341, 367, 389, 470, 480,  
521, 529, 540, 544, 591, 623, 668.
- Dimmock, Anna Katherine, 118, 124, 300, 394, 400,  
401, 406, 425, 447, 448, 449, 457, 476, 483, 484,  
485, 486, 487, 489, 490, 493, 494, 497, 500, 501,  
502, 503, 504, 505, 507, 509, 513, 525, 635.
- Dimmock, George, 485, 486, 493, 500, 502, 510, 514.
- Dix, Dorothy L., 536.
- Doll, Jacob, 175, 539, 570.
- Drury, D. M., 424, 425.
- Dyar, Harrison G., 328.
- Edwards, Henry, 3, 119, 121, 122, 123, 134, 147, 217,  
257, 282, 346, 360, 456, 459, 481, 497, 525, 570,  
625, 657, 733, 765, 922.
- Edwards, W. H., 241, 243, 525, 530, 546, 607, 625.
- Eichhoff, W., 5, 28, 29.
- Elliot, S. Lowell, 3, 144, 146, 147, 148, 218, 257, 272,  
282, 302, 346, 424, 450, 456, 457, 492, 493, 497,  
514, 525, 526, 529, 530, 565, 596, 599, 641, 656,  
657, 664.
- Emerson, George B., 752.
- Fairmaire, Léon, 64.
- Faxon, W., 282.
- Fernald, Charles H., 138, 192, 243, 282, 312, 326, 477,  
505, 547, 559, 575, 576, 630, 652, 744, 749, 753,  
754, 788, 790, 793, 830, 837, 845, 849, 850, 891.
- Fischer, P., 450, 481, 489.
- Fish, William C., 759.
- Fitch, Asa, 1, 5, 50, 54, 59, 65, 68, 71, 72, 73, 81, 82, 84,  
98, 111, 112, 118, 191, 224, 226, 287, 291, 298,  
322, 324, 325, 326, 338, 341, 342, 344, 367, 368,  
399, 406, 447, 471, 472, 511, 512, 513, 590, 675,  
677, 678, 679, 681, 684, 685, 686, 694, 696, 697,  
700, 704, 706, 710, 711, 713, 715, 719, 723, 724,  
734, 739, 741, 742, 757, 758, 767, 801, 802, 803,  
805, 853, 854, 871, 902, 903.

- Fletcher, James, 117, 152, 409, 438, 439, 450, 489, 890.  
 Forbes, S. A., 1, 5, 195, 280, 329, 370, 371, 408, 416, 419, 421, 422, 443, 522, 524, 567, 587, 588, 591, 596, 789, 903, 919, 920.  
 Foster, P. H., 911.  
 French, G. H., 116, 128, 129, 130, 159, 268, 329, 354, 402, 464, 465, 466, 526, 530, 562, 565, 566, 571, 596, 608, 652, 670, 731.  
 Fuller, A. J., 543.  
 Fuller, A. S., 704.  
 Fyles, T. W., 409, 509, 890.  
 Gage, Simon H., 754.  
 Gardiner, Robert H., 817.  
 Garman, H., 213, 281, 422, 480, 554, 595, 668, 920.  
 Gentry, Thomas G., 300, 400, 401, 909.  
 Gissler, Carl., 724.  
 Gilbert, A. R., 773.  
 Gillette, C. P., 469.  
 Gilman, Charles J., 879.  
 Goding, F. W., 756.  
 Goodale, George Lincoln, 752.  
 Goodell, Abner C., 686.  
 Goodell, L. W., 149, 186, 307, 345, 347, 395, 404, 406, 487, 489, 496, 497, 502, 571, 597, 638, 672, 782, 791.  
 Goodhue, C. F., 455.  
 Gosse, Philip H., 242.  
 Graef, H. A., 135, 232, 462.  
 Grote, Augustus Radcliff, 132, 143, 150, 156, 169, 170, 174, 395, 400, 401, 462, 463, 476, 497, 567, 596, 731, 787.  
 Guenée, A., 166, 172, 498.  
 Hagen, Hermann H., 387, 883, 901, 903.  
 Haldeman, S. S., 289, 350, 368, 486, 610.  
 Hall (Dr.), 50, 473, 474.  
 Hamilton, John, 88, 292, 296, 371, 536, 599, 700, 701, 860.  
 Harrington, W. Hague, 286, 291, 292, 293, 297, 298, 316, 327, 328, 337, 381, 383, 387, 388, 392, 394, 410, 424, 484, 510, 515, 521, 599, 674, 676, 677, 679, 682, 683, 720, 809, 810, 903.  
 Harris, D. S., 300, 330, 336.  
 Harris, Thaddeus William, 1, 54, 64, 65, 69, 71, 81, 98, 118, 124, 131, 133, 147, 155, 165, 226, 242, 268, 269, 270, 273, 274, 287, 299, 300, 301, 323, 330, 331, 340, 345, 356, 365, 367, 370, 375, 379, 380, 386, 394, 400, 401, 419, 437, 441, 447, 448, 449, 457, 474, 476, 484, 487, 488, 489, 490, 491, 493, 494, 495, 500, 511, 519, 525, 539, 550, 555, 588, 592, 597, 630, 646, 675, 676, 683, 700, 702, 715, 721, 724, 733, 757, 771, 774.  
 Harris, Thomas C., 693.  
 Hill, C., 403, 881.  
 Hodge, T., 286.  
 Holland, W. J., 131, 547.  
 Horn, George H., 1, 74, 77, 79, 89, 91, 93, 221, 222, 228, 352, 358, 712, 713, 720, 722, 723, 726, 824, 825, 826, 858, 873.  
 Hough, Franklin B., 813.  
 Howard, L. O., 3, 11, 99, 416, 906.  
 Howe, George Allen, 4.  
 Hubbard, H. G., 36, 50, 51, 140, 143, 146, 222, 224, 228, 229, 290, 293, 414, 415, 660.  
 Hulst, George D., 135, 175, 176, 178, 303, 304, 332, 370, 405, 463, 464, 465, 500, 514, 524, 533, 542, 570, 597, 636, 650, 663, 857, 893.  
 Hunt, George, 3, 75, 78, 82, 228, 344, 355, 387, 424, 436, 559, 680, 683, 684, 693, 701, 704, 818, 827, 871, 883, 889, 907.  
 Jack, John G., 535, 597, 598, 599, 890.  
 Jenett, H. S., 651.  
 Judeich, J. F., 5, 19, 20, 21, 23, 24.  
 Juulich, William, 599.  
 Kaltenbach, J. H., 2, 5, 48, 494, 502, 503, 557, 623, 673.  
 Kellicott, D. S., 304, 305, 306, 444, 445, 450, 463, 465, 473, 505, 597, 623, 667, 727, 729, 732.  
 Kellogg, Elijah, 833, 834, 835.  
 King, Mrs., 909.  
 Kite, William, 95.  
 Knaus, Warren, 427, 543, 905.  
 Koebele, Albert, 17, 37, 59, 155, 174, 180, 181, 491, 537, 571, 768.  
 Kollar, Vincent, 5.  
 Le Baron, William, 1, 229, 434, 592.  
 Le Conte, John E., 145, 525, 531, 599, 600.  
 Le Conte, John Lawrence, 1, 4, 90, 92, 93, 94, 291, 293, 294, 352, 387, 391, 536, 544, 552, 611, 669, 679, 680, 681, 685, 699, 701, 704, 711, 713, 714, 717, 718, 720, 721, 722, 724, 725, 726, 727, 824, 825, 826, 827, 857, 922.  
 Lee, Lester A., 835.  
 Leng, Charles W., 329.  
 Leonard, L. W., 375, 378.  
 Leubner, —, 403.  
 Lintner, J. A., 3, 5, 58, 59, 60, 124, 137, 140, 154, 164, 166, 222, 300, 328, 375, 380, 391, 399, 400, 401, 406, 425, 449, 450, 472, 480, 481, 485, 486, 487, 488, 489, 490, 491, 494, 495, 497, 507, 512, 525, 531, 546, 549, 551, 555, 597, 730, 768, 769, 770, 771, 773, 774, 830, 864, 893.  
 Lockwood, Samuel, 274.  
 Lugger, Otto, 13, 486, 551, 745.  
 Lyman, H. H., 494.  
 Mann, Benjamin Pickman, 277, 489, 490.  
 Marlatt, C. L., 268, 555, 645.  
 Marten, J., 608.  
 Marx, George, 4.  
 Matteson, F., 457.  
 McBride, A. S., 92, 293, 427, 599.  
 McNeil, J., 541.  
 Meske, O., 455.  
 Merriam, C. Hart, 389, 821.  
 Middleton, N., 609.  
 Minot, Charles Sedgwick, 300, 525.  
 Monell, J., 537.  
 Morris, John G., 124, 300, 395, 400, 401, 457, 487, 525.  
 Morris, Margaretta H., 49.  
 Morton, Emily L., 4, 135, 136, 146, 149, 156, 353, 366, 481, 526, 773.  
 Mundt, A. H., 442.  
 Murtfeldt, Mary, 173, 194, 196, 203, 218, 219, 314, 391, 399, 416, 420, 424, 477, 513, 524, 530, 543, 545, 597, 650, 869.  
 Mygatt, F. G., 56.  
 Nash, H. W., 459.  
 Neumcoegen, B., 402.  
 Newcomb, W. A., 880.  
 Nichols, Andrew, 882, 888.  
 Nitsche, H., 5, 19, 20, 21, 23, 24.  
 Norton, Edward, 205, 339, 484, 759, 862.  
 Nostrand, P. E., 596.  
 Noyes, Charles J., 832.

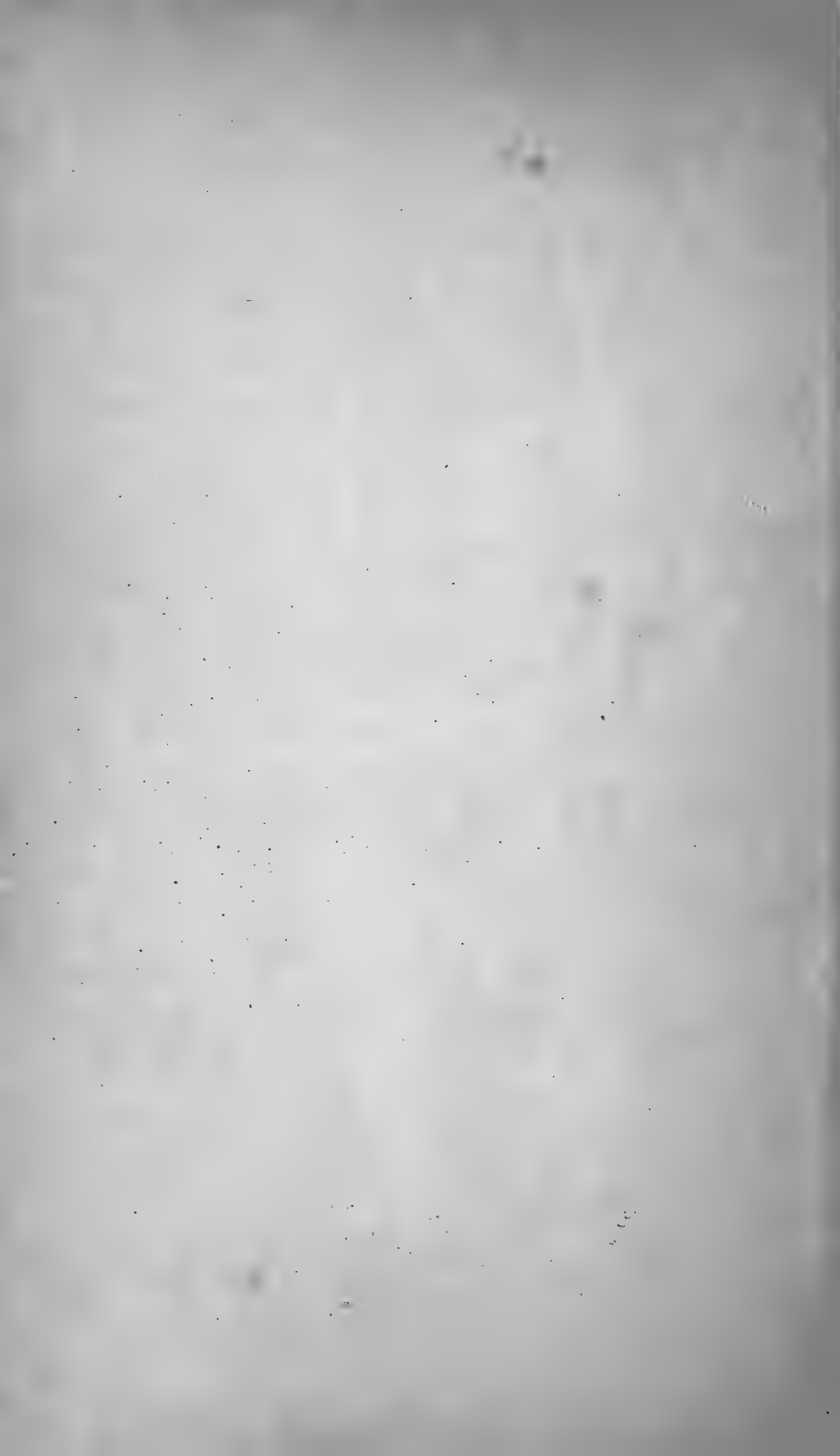


- Oestlund, O. W., 213, 283, 593.  
 Ormerod, Eleanor A., 28.  
 Osborn, H., 391, 542, 544, 957.  
 Osten-Sacken, Charles Robert von, 208, 358, 412, 482, 598, 636.  
 Packard, Charles Appleton, 832.  
 Patton, W. H., 483.  
 Payne, Emma, 491.  
 Peabody, Charles, 94.  
 Peck, C. H., 814, 821.  
 Peck, William Dandridge, 54, 83, 84, 231.  
 Pergande, Theodore, 514.  
 Perris, Edouard, 2, 5, 18, 61, 62, 674, 710, 718.  
 Pilate, G. R., 242, 282, 303, 329, 330, 384, 395, 406, 555, 596, 597, 643, 651.  
 Poulton, Edward Bagnall, 10, 15.  
 Putnam, J. D., 413, 415, 416.  
 Ragonot, E. L., 856.  
 Rathvon, J. S., 95, 419.  
 Ratzburg, J. T. C. 2, 5, 16, 20, 22, 61, 62, 735, 883.  
 Reakirt, T., 150, 482.  
 Reed, E. B., 282, 357, 375, 395, 400, 402, 434, 515.  
 Reed, Shelby, 543.  
 Reinecke, Ottomar, 81.  
 Reissig, Jacob, 62.  
 Richsecker, L. E., 859.  
 Riley, Charles Valentine, 1, 3, 11, 12, 17, 19, 31, 49, 50, 56, 69, 72, 77, 91, 94, 96, 100, 103, 111, 112, 116, 117, 119, 124, 125, 130, 131, 134, 137, 141, 142, 148, 150, 153, 154, 158, 160, 162, 171, 172, 179, 180, 182, 188, 189, 193, 195, 196, 197, 200, 202, 206, 210, 216, 218, 221, 222, 223, 226, 229, 234, 238, 244, 258, 265, 266, 267, 269, 277, 279, 280, 281, 288, 294, 300, 312, 317, 327, 391, 393, 395, 399, 400, 401, 402, 412, 414, 424, 426, 428, 433, 434, 435, 447, 457, 476, 480, 481, 489, 490, 492, 495, 511, 512, 513, 520, 524, 525, 530, 536, 542, 543, 556, 566, 569, 576, 584, 587, 601, 637, 638, 643, 654, 655, 656, 665, 669, 670, 671, 689, 730, 749, 755, 756, 805, 806, 840, 843, 910, 921.  
 Rivers, J. J., 119, 120, 121.  
 Robert, Eugène, 29.  
 Robinson, Coleman T., 192, 194, 195, 476.  
 Rogers, R. V., jr., 357, 596.  
 Russell, Henry G., 674, 736, 803.  
 Sage, D., 817.  
 Sanborn, Francis Gregory, 488.  
 Sanders, Julia E., 4.  
 Sargent, Charles E., 674.  
 Sargent, C. S., 882.  
 Saunders, S. H., 608.  
 Saunders, William, 119, 133, 171, 173, 176, 177, 183, 241, 301, 385, 400, 401, 404, 436, 447, 448, 457, 473, 487, 489, 495, 497, 501, 517, 520, 532, 533, 536, 570, 597, 668, 778, 863.  
 Say, Thomas, 419, 553, 589, 703, 827, 913.  
 Schaupp, F. G., 337, 481, 485, 519, 520, 873.  
 Schwarz, E. A., 4, 18, 19, 79, 91, 93, 94, 220, 221, 291, 296, 520, 544, 611, 697, 706, 710, 720, 824, 860.  
 Scudder, Samuel Hubbard, 128, 130, 131, 217, 308, 345, 448, 449, 487, 501, 514, 529, 537, 596, 602, 605, 616, 746, 609.  
 Sears, John H., 556, 816.  
 Seifert, Otto, 135, 561, 773.  
 Sharp, David, 17.  
 Sherman, John D., 93.  
 Shimer, Henry, 322, 326, 422, 423, 658, 659, 697, 734.  
 Shurtleff, C. A., 139.  
 Siewers, C. G., 490, 520.  
 Signoret, V., 418, 419.  
 Slosson, Anna Trumbull, 60, 138.  
 Smith, Gideon B., 49.  
 Smith, Emily, 418, 419.  
 Smith, Emma A., 192, 193, 194, 213, 414, 416, 592.  
 Smith, George D., 228.  
 Smith, John B., 4, 44, 169, 191, 217, 221, 282, 296, 473, 597, 642, 776, 859.  
 Smith, Sidney J., 437, 481, 890.  
 Snow, Frank H., 430, 681, 684, 693.  
 Soule, Caroline G., 472, 555.  
 Sprague, P. S., 401.  
 Stainton, H. T., 410.  
 Stretch, R. H., 119, 123, 134, 560, 762, 773.  
 Stuart, Joseph A., 164.  
 Sullivan, Lillie, 4.  
 Tenney, Albert G., 813.  
 Tepper, F. O., 445, 456, 566, 596.  
 Thaxter, Roland, 135, 136, 167, 168, 172, 218, 272, 273, 300, 302, 336, 460, 461, 462, 464, 494, 495, 497, 530, 556, 628, 640, 655, 669, 773.  
 Thomas, Cyrus, 209, 211, 212, 278, 425, 434, 482, 553, 804, 806.  
 Tiedemann, H., 29.  
 Tolman, Adams, 82.  
 Townsend, C. H. Tyler, 89, 298, 328, 481, 482, 537.  
 Trouvelot, L., 5, 138, 300, 401, 409, 525.  
 Uhler, Philip R., 3, 419, 421, 801, 803.  
 Verrill, Addison E., 437.  
 Vose, George L., 737.  
 Wailly, A., 400, 401, 402.  
 Walker, Charles A., 84.  
 Walker, James J., 186, 438, 455.  
 Walsh, Benjamin D., 1, 11, 14, 322, 328, 414, 427, 434, 491, 513, 531, 535, 583, 611.  
 Walsingham, Thomas Lord F., 192, 636, 844.  
 Watson, B. M., 96, 902.  
 Westcott, O. S., 489, 597.  
 Westwood, John Obediah, 61.  
 Wetherby, A. G., 144.  
 Wiebe, Edward, 232.  
 Wilder, H. H., 4, 563, 564, 568, 572.  
 Worthington, C. E., 401, 425, 434, 597.  
 Wright, W. G., 597.  
 Young, —, 401.  
 Zeller, P. C., 197.  
 Zesch, Frank, 81.  
 Zimmerman, C. D., 731, 844, 856.



## ADDITIONS AND CORRECTIONS.

- Page 154, line 14 from bottom, for *Larvæ* read *Larva*.  
Page 217, line 22, for Red read Bred.  
Page 224, line 7, for about 80, read over 90.  
Page 287, after line 13, add, See also H. Osborn, in Garden and Forest, May 23, 1888, with good figures.  
Page 500, transpose last paragraph and three first lines on next page (in brevier type) to end of description of No. 47.  
Page 336, add *Olygia versicolor*. See p. 840.  
Page 342, line 6 from bottom, for *angustatus* read *angustus*.  
Page 400, for Fig. 151, Maple slug worm, read Fig. 151. Larva of *Lisyrosea mornata*.  
Page 426, add to title POPLAR AND LINDEN.  
Page 471, line 1, from bottom, for observer read observed.  
Page 483, line 16, for 105 species read 117 species.  
Page 514, add *Olygia versicolor*. See p. 840.  
Page 535, last line, for *Melanoles* read *Melanotus*.  
Page 536, transpose No. 14, add also on *Fraxinus trifoliata* (Couper, Can. Ent. vi, 91.)  
Page 536, line 11, for Sanders read Saunders.  
Page 557, line 24, for 186 read 220.  
Page 584, line 13, for *siholata* read *striolata*.  
Page 597, add *Thyridopteryx ephemeriformis*, (Edwards' Cat.)  
Page 598, line 4, for *trilineatas* read *trilineatus*.  
Page 639, at end of descriptions of *Nepticula corylifoliella* and of *Coleophora coryli-foliella* add (Clemens).  
Page 641, line 2, for the Chambers read Mr. Chambers.  
Page 641, line 7, from bottom, for Lackawaren read Laxawaxen; also add the following: (Coquillet in letter). Hyphantria textor, Harris, p. 641; Apatela falcula, Grote; Apatela parallela, Grote; Hibernia tiliaria, Harris; Chytolitis morbidalis, Guen.; Loxotania rosaceana, Harris; Exartema permundana, Clem.; Depressaria gratella, Robs.; Gelechia tristrigella, Wlsm.  
Page 643, for Chapter XIII read Chapter XIV.  
Page 644, line 24, for Pilot read Pilate.  
Page 646, line 29, for (Horr.) read (Harr.)  
Page 650, to Hornbeam insects add *Datana ministra*. (Beutenmüller in Can. Ent. xx, 17.)  
Page 654, to Honey locust insects add *Parorgyia parallela*.  
Page 663, line 10, for *thæ* read *thoe*.  
Page 666, add to Poison ivy insects *Amorbia humerosana*. (Bred by L. W. Goodell.)  
Page 672, to Persimmon insects add *Parorgyia parallela*.  
Page 674, for Chapter XIV read Chapter XV.  
Page 7-5, the red and yellow striped pine spar-worm is represented on Pl. X, fig. 3, and Pl. XXXIII, fig. 2, 2a-2f.  
Page 810, add *Thyridopteryx ephemeriformis* (Edwards' Cat.)  
Page 811, for Chapter XIV read Chapter XVI.  
Page 840, line 5, for four read five.  
Page 858, line 3, for page 168 read page 713.  
Page 861, for *Xyloterus* read *Xyloteris*.  
Page 861, for *Xylebores*, read *Xyleborus*.









JUN 1961



SB Packard, Alpheus S.  
S 761 Fifth report of the United  
7 P3 States Entomological Commis-  
P Ent. sion : being a revised and  
I enlarged edition of Bulletin  
no. 7, on Insects injurious  
to forest and shade trees.

SMITHSONIAN INSTITUTION LIBRARIES



3 9088 00061 8967