

UC-NRLF



QB 32 143

FLAX
AND
ITS PRODUCTS

By

H. R. CARTER

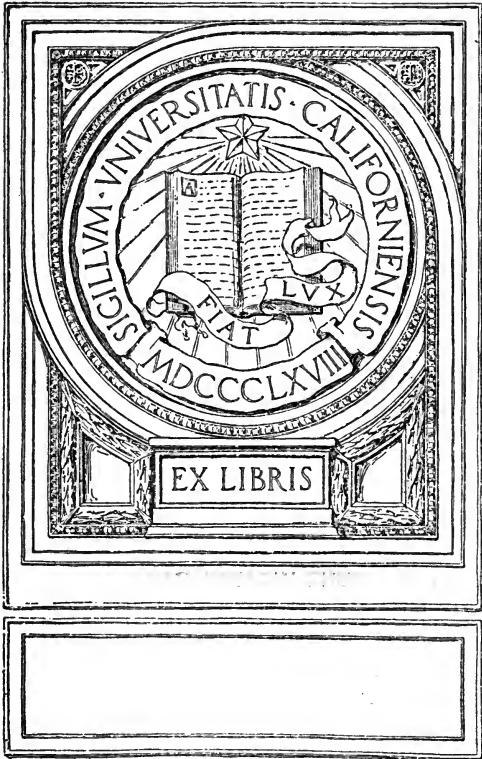

Rec'd 4/2/25 - at the office of the Secretary

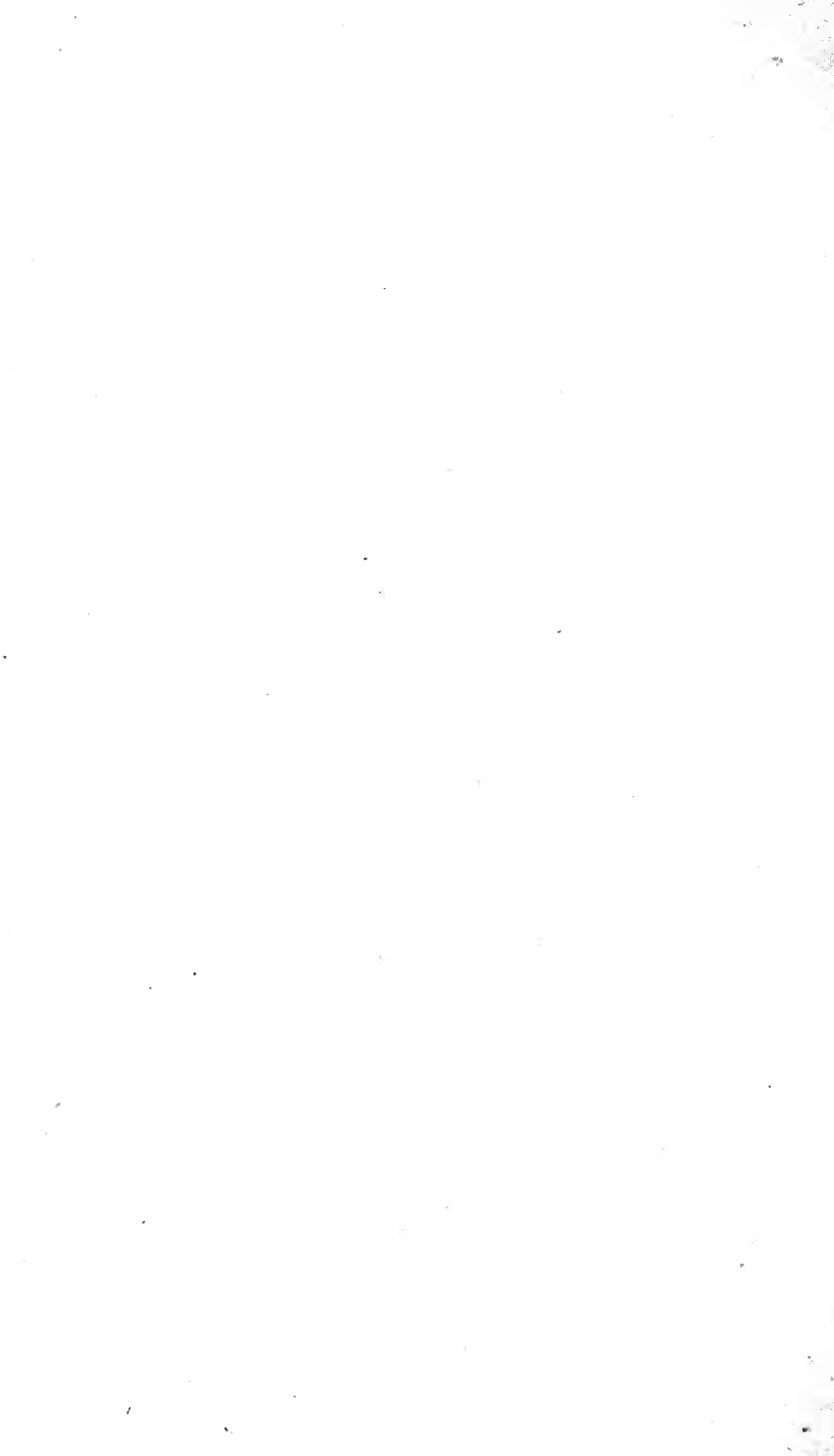

FLAX

AND

ITS PRODUCTS

BY

H. R. CARTER

Author of "Modern Flax, Hemp and Jute Spinning"; "Rope, Twine and Thread Making"; &c., &c.



LONDON

JOHN BALE, SONS & DANIELSSON, LTD.
OXFORD HOUSE

83-91, GREAT TITCHFIELD STREET, OXFORD STREET, W.1.

1920

TS110
C33

THE
AGRICULTURE

MAIN LIBRARY-AGRICULTURE DEPT.

PREFACE.

OUR last publication, "Flax, its Cultivation and Preparation for Market," having met with such approval and a demand which exhausted the issue in a comparatively short time, it has been decided to re-write it and to incorporate with it a concise description of the spinning, weaving and finishing of flax fabrics, the manufacture of linen threads, flax gaskin, linseed oil and cake, and other flax products.

It will also be found to form an up-to-date history of the Linen Trade, and in this and other respects will resemble an up-to-date edition of that admirable work, "Flax," by Charley—long since out of print.

It is hoped that it will, like our last, still further encourage the growth of flax at home and abroad. The Appendix puts on record the outstanding events of the flax booms of 1918, 1919, 1920, and the effects of war upon the industry.

H. R. CARTER.

25, *Donegall Street,*
Belfast.

March, 1920.

465110

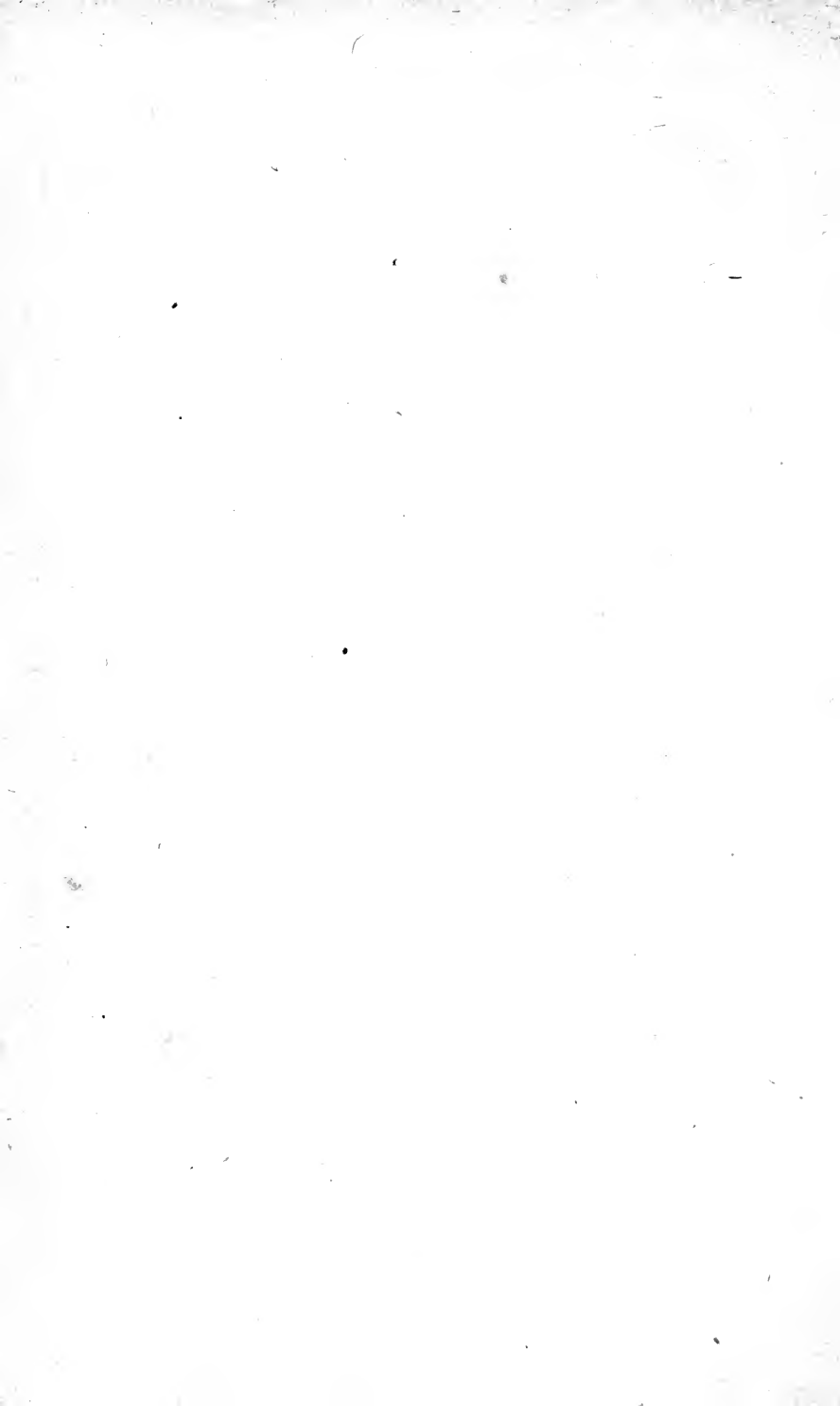

CONTENTS.

	PAGE
INTRODUCTION... ..	1
CHAPTER I.	
FLAX AND ITS CULTIVATION	4
CHAPTER II.	
PREPARING THE SOIL	7
CHAPTER III.	
FLAX SEED	11
CHAPTER IV.	
SOWING THE SEED	14
CHAPTER V.	
HARVESTING THE CROP	17
CHAPTER VI.	
SAVING FLAX SEED	23
CHAPTER VII.	
RETTING... ..	32
CHAPTER VIII.	
FLAX SCUTCHING	50
CHAPTER IX.	
FLAX HACKLING	72
CHAPTER X.	
FLAX AND TOW PREPARING	77
CHAPTER XI.	
FLAX AND TOW SPINNING	81

CHAPTER XII.		PAGE
THE YARN DEPARTMENT—RULING, DRYING, TREATING, WINDING, AND THREAD MAKING		84
CHAPTER XIII.		
LINEN WEAVING		90
CHAPTER XIV.		
FINISHING LINEN CLOTH		96
CHAPTER XV.		
LINSEED OIL AND CAKE MANUFACTURE, AND OTHER PRODUCTS OF FLAX		103
APPENDIX		108
INDEX		309

ILLUSTRATIONS.

	PAGE
Spinning Flax by Hand	I
Patent Linseed Dresser	12
Pulling Flax by Hand	18
Lifting and Drying Flax Straw	20
Flax Straw in Round Gaits	24
Flax Straw in Long Gaits	26
Carting the Flax Straw to Dam	28
Flax Straw in Stack	30
Flax Retting Dam	33
General View Legrand Rettery	41
Plan of Legrand Rettery	42
Section through Legrand Rettery	43
Drying Flax Straw after Retting	45
Spreading Flax Straw to Dew-ret	46
Dew-retting Flax	48
Modern Set of Flax Rollers	51
Flax Straw Butting Machine	52
Williamson's Patent Flax Rollers	54
Section in Irish Flax Scutch Mill	55
Continental Scutching Rims and Blades	56
Belgian Method of Flax Mill Ventilation	58
"Speedo" Automatic Flax Scutcher	66
Combined Automatic Spreader and Hackling Machine	75
Spread Board	78
Delette Tow Comb	80
Wet Spinning Frame	82
Patent Bundling Press	85
Hank Bleaching Reels	87
Damask Factory	94
An Irish Bleach Green	96
Linen Shirt Factory	100
Linseed Dressing Machine	103
Linseed Cleaning Plant	105



FLAX AND ITS PRODUCTS.

INTRODUCTION.

THE plant which yields flax fibre is unique in its history. Cultivated for the last 5,000 years or so, it has not been replaced by any modern fibre and recent events have shown that it is indispensable, at least in times of war. In the dawn of civilization, 4,000 or more years ago, the cultivation, spinning and weaving of flax was not unknown. Mention is made of flax and linen in one of the earliest books of the Bible. In the Book of the Exodus, speaking of the plague of hail, it says: "The flax and the barley were smitten." In the 1st Book of Kings it is recorded that linen yarn was brought out of Egypt, while in the Proverbs, a good wife is described "whose price is above rubies, who seeketh flax and worketh with her own hands the spindle and distaff and maketh fine linen." There is thus ample Biblical evidence of its manufacture by the Egyptians and also by the Children of Israel. Herodotus also mentions the export of linen yarn and cloth from Egypt. Solomon we are told brought linen yarn out of Egypt. Thence the knowledge of flax and its manufacture came first into Greece and Italy, thence travelled westward to France and Flanders and next into Germany and England. It is to a Roman factory, established at Winchester, that we probably owe our primary knowledge of linen weaving in Britain. After the Norman Conquest linen weaving acquired a new impetus from the weavers who accompanied William I and who subsequently settled in this country in the reign of his son. The

reign of Edward III, with its successive immigrations of Flemish refugees also greatly benefited British linen manufacture. The manufacture of linen can be traced in Irish records as far back as the 13th century, flax and linen yarns being exported. More Flemish refugees settled in Ireland in Elizabeth's reign and carried on the manufacture of linen. In the 16th century, Manchester was noted for its linen manufactures, the yarns used being principally spun in Ireland. About 1636, Stafford, Lord Lieutenant of Ireland, spent large



Spinning flax by hand with spindle and distaff.

sums of money in encouraging the Irish linen trade. Towards the end of the 16th century a further influx of Huguenots driven out of France, chief among whom were the Crommelins, started the Irish linen trade on its prosperous career.

Linen was made in Scotland in 1600, if not earlier. Dundee has always been the centre of linen manufacture in Scotland and was engaged in the export trade before the end of the 17th century. About 1727, Nicholas d'Assaville and a little colony of French weavers from St. Quentin were invited over

and the importation had a beneficial effect. The Scotch linen trade was in its prime early in the 18th century, when there were almost double the number of spindles at work on flax than there are to-day. In 1821, the first linen power loom factory ever erected was started in Kirkcaldy.

About the end of the 17th century Leeds became the centre of the English linen trade, John Marshall erecting a fine mill there. The invention of Arkwright of the principle of roller drawing, and forty years later the discovery by Philippe de Girard of the principle of the use of gills in the preparing process, and of the use of hot water as a macerating agent in the spinning of fine numbers, paved the way to the introduction of mill machinery. The introduction of the Jacquard machine in 1824 greatly simplified the manufacture of linen damask.

At the beginning of the last century the British linen thread was made entirely in Scotland and in Yorkshire. The Irish linen thread trade was established by a Paisley gentleman, named Barbour, near Lisburn.

CHAPTER I.

FLAX AND ITS CULTIVATION.

THE flax plant is a slender growing annual, 20 to 40 inches in height, with a stem about $1/16$ inch in diameter, with alternate sessile leaves, narrow and lance shaped. It starts from the ground or "comes abraid" with only its two seed leaves developed. It then rises with an upright hollow stem, which divides into branches when grown singly and exposed to light and air, but which runs up straight and slim without scarcely branching at all when it is crowded in its seed bed. It bears a cluster of blue or white flowers on its top, which in time produce capsules having five cells, each containing two flat oily seeds, of a tawny brown colour. In the flowers of the flax plant both stamens and pistils are present, and seed may be expected from every flower except in the case of accident or injury.

Each blossom of the flax plant contains five stamens or fructifying organs called the male part of the flower, and also five pistils or terminating points of the embryo fruit, forming the female organs. Each stamen is tipped with a little roundish head called an antler, which, when mature, sheds a fine dust called the "pollen." The pollen coming in contact with the pistils causes the seeds to grow and become reproductive.

The chemical composition of the flax plant, according to the late Professor Hodges, Queen's College, Belfast, is:—

Water	56.64	per cent.
Organic matters	41.97	„
Ash	1.39	„
				<hr/>	
Total	100.00	per cent.

One hundred parts of Irish flax straw give 0.53 per cent. of nitrogen and 3.20 per cent. of ash. This ash contains:—

Potash	20.32	per cent.
Soda	2.07	„
Chloride of soda	9.27	„
Lime	19.88	„
Magnesia	4.05	„
Oxide of iron	2.83	„
Sulphuric acid	7.13	„
Phosphoric acid	10.24	„
Carbonic acid	10.72	„
Silica	12.80	„

CHOICE OF SOIL.

A deep sandy loam with clay subsoil is the soil which best suits the flax plant. Maritime districts, especially those which first receive the evaporation of the ocean, such as the East Coast of Scotland, are those in which the flax plant is produced in the greatest perfection. Alluvial deposits of rivers furnish the best fibre. Bog, sandy and gravelly soils have been condemned; yet some of the best Irish lots have been grown on such soils. That flax has been grown successfully on medium or poorer soils is apparent from the fact that it is not in the best districts for land that it is grown most extensively, but rather in the poorer and medium districts. As a general rule, it is on the really good lands that flax growing has been entirely abandoned. Experience shows that an extra rich soil is not a necessity but rather a drawback, from the fact that the flax crop immediately following a manured green crop is seldom as successful as where the soil has been impoverished by an intervening oat or barley crop. Upon poor clays or dry gravelly soils flax will not thrive.

By attention and careful cultivation, good flax may be grown on various soils. It is very desirable that the land should be properly drained and subsoiled, as when it is saturated with either underground or surface water, good flax cannot be expected. An intelligent flax grower, who prepares and manures his land suitably to its nature and situation, will get good flax from almost every quality of soil, but especially from good light land and from clays that are sufficiently intermingled with sand. But soils which are fertile naturally are much better adapted for flax than those which are made so artificially by manure, because they insure a much more even growth.

Upon poor clays or dry gravelly soils flax will not thrive.

The land should be properly drained. Well prepared and manured, good flax may be had from almost every quality of soil, but especially from good light land and from clays that are sufficiently intermingled with sand. Where the soil is light and gravelly flax should be sown after oats, following potatoes or turnips, and where the ground is heavy with a clay subsoil after oats following lea. Flax may also be successfully grown on broken up pasture.

In Scotland, the best plan that has yet been discovered is to sow oats as a by-crop and flax after it. In 1920 therefore, Scotch farmers taking up flax for the first time, could not do better than sow it where they grew oats in 1919. Where the soil is light and gravelly, flax should be grown after oats following potatoes or turnips, where the ground is heavy with a clay subsoil, after oats following lea.

Flax may also be grown at pleasure and without limit on newly broken up pasture, also when there has been a great deal of trefoil or clover, on the roots of which, as they rot in the earth, it supports itself well.

Flax is sometimes sown first crop from lea, but is then very likely to be injured by grub and cannot withstand a prolonged drought as well as if it follows oats for instance. One thing in favour of this lay is that the crop will generally be more clear of weeds than on any other. In some districts flax is successfully grown after a potato crop. In the best soils of Flanders, flax is grown in the third year of a seven-course rotation, or the fifth year of a ten-course rotation. It then invariably follows a corn crop—generally oats—and in Scotland, where oats are a common crop, the same system might be profitably followed.

In Ireland flax is found to thrive best if sown after potatoes, wheat or oats, a good rotation being oats, turnips, wheat, clover grass and potatoes. Flax after potatoes and flax after barley or wheat—the latter crops should be produced after the ground has been manured for potatoes or turnips before flax is cultivated, as either crop will take up the over quantum of matter which would if left in the soil completely spoil all hope of the flax plant being produced either in quantity or fine quality. The wheat or barley stubble when turned down by the plough in October serves as manure for the flax the following year.

CHAPTER II.

PREPARING THE SOIL.

No crop requires the land to be better worked and more thoroughly cleaned than does flax. Light land should be deeply ploughed. On strong and wet land it is desirable to cross plough deeply, or even better to employ spade husbandry. The soil should be soft and well pulverized; the manure short and quite rotten. Many are fond of street sweepings for the culture of flax on moderate and sandy soils, but others dislike them, on the ground that street sweepings encourage a great deal of darnel to spring up. Careful farmers do not abstain from using them on that account however. They plough their land deeply as soon as the weather permits, then they lay on a liberal allowance of street sweepings and other town muck. They plough it in shallow and leave it so till the end of April; by that time the weeds have made their appearance, then they give the land a second ploughing, a little deeper than the former one. They give a top dressing of liquid manure, cross harrowing immediately afterwards. In this way they get the better of the weeds and their flax thrives well.

Others make, in autumn, dunghills of vegetable mould mingled with pig muck and farmyard manure. They turn and mix their dunghill well, and as soon as winter is over they plough it in at a slight depth as soon as possible, because the land will already have had a deep ploughing and top dressing either of light soil from the nearest town or of liquid manure from a farmyard tank. Then they pass the harrow over all and proceed with the work in the usual way.

Three points are requisite for success: The land must be thoroughly cleaned, well pulverized and uniformly rich.

A fine, clean, compact seed bed is required. This allows of the seed being covered to a uniform depth and also permits uniformly rapid germination, this being very important. In order to secure this, the land should be autumn ploughed to a depth of 7 or 8 inches. In spring, if the soil is of a heavy nature, a shallow ploughing of 3 or 4 inches may be neces-

sary; but grubbing and cultivation followed by harrowing and rolling will generally give the desired result. To prepare lea ground for flax, harrow well in the same direction as ploughed so that the furrows are all levelled and the soil made loose to a depth of two or three inches. If the soil is heavy, give it a double stroke of the harrow both in the direction of ploughing. If lumpy or if the furrows do not lie close, roll and harrow again before sowing. Compactness is an important feature of the ideal seed bed as it allows of the ascent of water from the lower strata to the somewhat shallow root system of the crop. The soil should be worked deeply and then consolidated, especially in the drier localities, in order that it may maintain all through the growing period a sufficiency of moisture and so allow of a full development of the seed. On no account should the seed bed be loose and friable. The land must not be in too high condition or the crop is liable to "lodge." Farnyard manure is most beneficial when applied to the crop preceding the flax. It should not be applied directly as it tends to encourage weeds, nor in too fresh a state lest it cause a too luxurious growth. Excellent results can be obtained by the judicious use of artificial manures. Potash is the chief artificial manure used for fibre production and it checks "yellowing," a disease which attacks the plant in the early stages of its growth. Its application is recommended in the form of 5 cwt. of kainit or $1\frac{1}{2}$ cwt. of muriate of potash per acre.

The following compound may be successfully used as a manure for flax:—

Bone dust	54 lb.
Sulphate of ammonia	56 "
Muriate of potash	30 "
Common salt	30 "
Burned gypsum	30 "

The above quantity is sufficient for a statute acre and should be sown broadcast on the land after the latter has been ploughed and well harrowed and before sowing the seed.

One of the points of the greatest importance in the cultivation of flax is, by thorough draining and by careful and repeated cleansing of the land from weeds, to render the tilth of the finest, deepest and cleanest nature. Room is made for the roots to penetrate, which they will often do to a depth equal to nearly one-half the length of the stem above ground. After wheat one ploughing is often sufficient, but two are generally safest on stiff soils—one in the autumn and one

before spring. After oats, when the land has not been thoroughly drained, plough early in autumn, throw it into high ridges, that it may receive the benefit of the frost and air, and make surface drains to carry off the rains of winter. This, however, will not be necessary where thorough draining has been attended to. Plough and harrow very early in spring, and again a month later, to bring the land into good tilth and clean it thoroughly from weeds and roots. Following the last harrowing it is necessary to roll so as to give an even surface and consolidate the loam, breaking this up again with a short-toothed or seed harrow, ere sowing. The ridges should be very little raised in the centre when the ground is ready for the seed, otherwise the crop will not ripen evenly. When land is properly drained there should be no ridges and the seed sown in flat, causing the crop to grow evenly.

The farmer who has had a lengthened practical experience of the characteristics of his soil should be the best judge of when and how to cultivate it. Opinions differ as to whether flax land should be ploughed once or twice. It is a matter which can best be determined by the grower. Ploughing early in autumn and again in spring is the most effectual method of eradicating such weeds as scutch grass, &c., but these weeds are not the most injurious to the crop. Red-shank, charlock and spurrey are much more injurious, and growers should study the best means of combating them. Their seed is chiefly introduced from plants grown among the previous oat crop, and it stands to reason that if the land is ploughed shortly after harvest those seeds are covered to such a depth as to completely preserve them through the winter, after which they are ploughed up again to the surface and grow along with the crop, whereas if the land is allowed to lie in stubble until about February before being ploughed, the action of frost, together with the multitude of wild birds which feed on these seeds, effectually dispose of the greater part of them. This method is now being practised to a greater extent than in former years, and the treatment is to be recommended in the case of land which is infested with such weeds.

On light soils plough shallow and on heavy soils deeper. 4 cwt. of kainit per statute acre, applied in the months of January or February, will be found a beneficial application. Muriate or sulphate of potash to the same money value may be substituted. Where seaweed is available and largely used the application of a potassic manure is unnecessary. The use of phosphate manures, i.e., super-phosphates, basic clay, bones

or bone compounds, is to be avoided, as these will have the effect of making weed plants, especially "spurrey," grow more luxuriantly and will have no beneficial effect whatever on the flax plant. An application of lime to previous crop in preparation for flax is advantageous, particularly if potash is applied. Sulphate of ammonia (about 56 lb. per acre) has been proved as advantageous on land which would not be likely to produce an overgrowth of straw. Potash should also be applied with this dressing.

Such fertilizers as nitrate of soda generally give a great increase in the bulk of straw, but a decrease in the yield and quality of fibre, consequently the Government will not at this juncture encourage its application.

Experience has proved the use of a potassic manure most beneficial, flax so treated being superior in quality and yield to bulk of straw. Yellowing, which will be referred to later, never occurs when potash has been applied.

CHAPTER III.

FLAX SEED.

FLAX seed is almost too well known to require description. Its skin is smooth and polished and is covered with a kind of mucilage which is readily soluble in hot water. This mucilage, dissolved in water, is popularly used, under the name of flax seed tea, as a soothing drink in various inflammatory diseases. The seeds contain a large quantity of oil and the plant is often cultivated for this product alone.

Sowing seed must be fully matured, heavy, plump and glossy, weighing 52 to 57 lb. per bushel, 1,000 pickles weighing 4.62 grammes. Good Dutch seed will germinate 97 to 100 per cent. Riga seed is lighter and of lower germinating power, being frequently kiln dried. If Riga seed, having a germinating power of not less than 80 per cent., be sown proportionately thicker than Dutch seed, it generally produces heavier flax fibre. Flax fibre produced from Dutch seed is generally of fine quality. Russian seed and Russian seed grown one year in Holland, called Riga child, give excellent results. Many record Irish yields have been produced from Russian seed. Some flax buyers prefer flax grown from Pernan seed to any other.

Russian seed, or rather seed properly matured on plants that grow at proper intervals, ought to be plump, heavy, bright, of a clear brown hue, shining with a greenish lustre and terminating at one end in a blunt little hook, which in fact is the dried-up umbilical cord of the seed, as is seen more clearly when observed under a magnifying glass. It should be smooth and slippery and should sink in water. It should taste sweet when chewed and being broken it should appear of a light greenish yellow colour and very oily.

A good means of testing various samples of seed is to weigh equal measured quantities against each other. Experienced persons examine the seed by taking a handful of it and letting it run out between the forefinger and thumb in order to be able to observe it closely sideways and to be better able to

judge of its plumpness and weight. Others moisten their forefinger and dip it into a sample of seed, which sticks to it; they are thus able to examine each grain separately and so form an opinion of its purity and goodness.

Home-grown seed—i.e., seed from drawn-up or not fully ripened plants—is flatter and broader in proportion to its thickness, extremely slippery, running between the fingers like so much quicksilver. Russian seed is not so soft to the touch and is more easily held in the hand. Good seed too should be very even in quality, and free from all mixture with the smaller seeds of weeds.

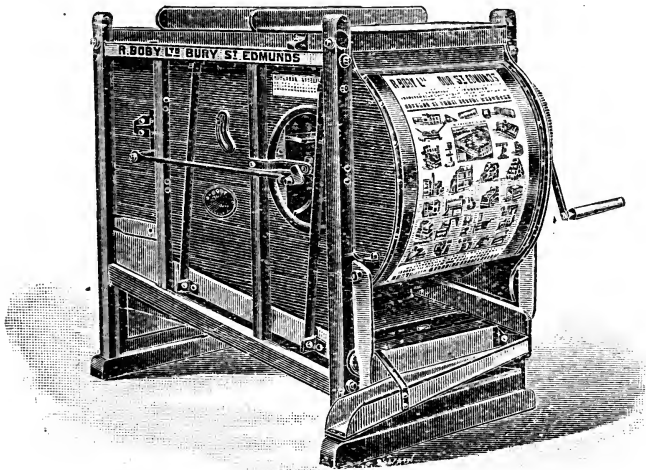

Boby's patent linseed dresser. Cleans up to 50 bushels of linseed per hour, separating weed seeds, rubbish and dust.

Most growers prefer to sow new seed, but flax seed preserves its vitality for several years. Indeed, French growers say that home-grown flax seed will grow just as well at the end of ten years as at the first. It is probable that the vital power of foreign seed is more liable to injury during the packing and the journey.

Dutch farmers to the south of Rotterdam make a specialty of producing good sowing seed, for which they obtain good prices on the Rotterdam market.

If Riga seed, having a germinating power of not less than 80 per cent., be sown proportionately thicker than Dutch

seed, it generally produces heavier flax fibre. However, the danger of sowing a low germinating seed lies in the fact that if the weather proves warm and seasonable the flax may grow too thick and may be "laid" if rough weather sets in, and the crop lost. If the season is unfavourable, on the other hand, the crop may be a failure owing to the seed not germinating in sufficient quantity, so that on the whole Dutch seed is to be preferred.

It is sold at so many pounds sterling per sack of 200 lb. containing, approximately, $3\frac{1}{2}$ bushels.

Sowing flax seed when bought should be stored in a dry place till sowing time, as no seed absorbs moisture more readily than flax seed, and moisture causes it to lose its vitality. Before sowing it is a good practice to use a wire sieve to take out about 20 per cent. of small seeds. These, if sown, produce a finer stalk, which does not rot so quickly as the bigger stalks, and consequently will not scutch out.

The question of proper sowing seed, whether to produce fibre or more seed, is one of the utmost importance to the farmer, and he should have the germinating power of the seed he proposes to sow tested before he uses it.

CHAPTER IV.

SOWING THE SEED.

In Ireland, and probably also in Scotland, the best time for sowing is from April 20 to May 10; but a few days earlier in sheltered situations. Clover and grass seed may be sown with it. The earlier sown crops are the best if the season is a favourable one. It is true there are greater risks with early sown flax, but if successful the result is a much more valuable and heavier crop with a longer fibre than the late sown, though not so fine in quality. Late sowing is the surer plan and is also adopted when fine fibre is required. Farmers might therefore follow the safer plan and sow fairly late.

In Ireland, where flax is grown for its fibre, the quantity of seed sown per statute acre is generally $1\frac{3}{4}$ bushels of Dutch seed or 2 to $2\frac{1}{2}$ bushels of Riga seed. In France they sow nearly 3 bushels of seed per English acre, for in the opinion of French flax growers any less is very false economy.

In Ireland the seed is sown broadcast by hand. In England it is often done by a horse machine, drills being made for the introduction of the seeds, which are embedded about half an inch below the surface. On the Continent, and especially in Belgium and Holland, sowing is performed by a small portable distributing apparatus, sometimes termed a "fiddle." (See Appendix.)

When a sufficient quantity of seed is sown the plants are thrown up close, delicate and lengthy, with but one linter on top, until nearly three feet high, just as young fir trees grow when thickly planted. Sown in this way a fine and valuable quality of fibre is produced, at least one-fourth heavier than thin sowing would produce.

On the Continent flax seed is always sown broadcast, never drilled. For sowing perfectly calm weather should be chosen, but if there is a slight breeze the sower should always work with the wind at his side, blowing alternately on his left hand

and on his right as he paces up and down the field and not at his back or in his face.

A fine, clean, compact seed bed is what is most necessary so as to allow of the seed being covered to a uniform depth, permitting a uniformly rapid germination, which is most important. Compactness is an important feature of the ideal seed bed, as it allows of the ascent of water from the lower strata to the somewhat shallow root system of the crop. The soil should be worked deeply and then consolidated, especially in the drier localities, in order that it may maintain all through the growing period a sufficiency of moisture, and so allow of full development of the seed. On no account must the seed bed be loose and friable.

When flax is grown principally for the seed it is sown thinly, when it has room to throw out a large number of branches in bush form. This renders the fibre coarse, but gives a large yield of seed. Branching spoils the quality of the flax for spinning purposes. It has been recommended to sow ashes over the sprouting seeds in order to put a stop to the ravages of slugs and grubs. A top dressing of soot would have an equally beneficial effect.

WEEDING.

When a "braird" appears and is a few inches long the field should be carefully weeded, as the value of the fibre will be much reduced if it be afterwards found that weeds are mixed with it. In weeding, every precaution must be taken not to crush the young plants. When feasible, and especially in dry weather, it is advantageous to cut the weeds in order to prevent the loosening of the flax plants. In weeding the weeders kneel upon straw mats and face the wind, so that as they pass the breeze may assist the young stems to regain their upright position. Rough weeds, such as docks and thistles, are easily pulled. The most difficult to get rid of and the most injurious are redshank, charlock, and spurrey. These sometimes grow so plentifully that it is almost impossible to pull them by hand. At the usual weeding time redshank has not made much growth, but it makes greater progress after flax has attained its length. If it cannot be got rid of at or before sowing time, there is practically no alternative but to let it grow, which it will not fail to do, often to the great injury of the crop. Charlock is very easily and effectively destroyed by spraying with a 3 per cent. solution of sulphate of copper when the flax is

from 3 to 6 inches long and before the weed plant comes into flower. This treatment has been proved to be most effectual and does not injure the flax in the slightest degree, with the exception of the damage which may be caused by pressure from the horses' feet and the wheels of the spraying machine. No one should hesitate to apply this solution where charlock is plentiful. As for spurrey, the best preventative is dry labour.

When large quantities of scutch grass are present with the flax a flock of sheep have sometimes been turned on to the field without any apparent injury being done to the crop, as sheep will not eat flax under any circumstances. However, this method is rather risky, and not to be recommended except in exceptional cases.

The plant is, under favourable circumstances, an extremely quick grower, and it has been observed to increase in height at the rate of $1\frac{1}{2}$ inches in 24 hours. A steady growth, however, to a maximum of, say, 40 inches, tends to produce the best fibre.

When you see a flax field in blossom you see one of nature's prettiest panoramas. The field appears a panel of soft and elegant pastel green, undulating in long waves when under the gentle pressure of the zephyr breezes. Approaching nearer, the modest plant is all around, with its dainty, small, bright blue flowers, reaching knee high. For delicate, artistic beauty there is no crop to compare with flax at this stage.

CHAPTER V.

HARVESTING THE FLAX CROP.

TOWARDS the middle or end of August, the plant should be ready for harvest.

In Ireland and on the Continent, where the best spinning flax is produced, the stems are pulled up by the root by hand. This is of course a tedious and laborious process, and will, it is hoped, soon be able to be accomplished by a satisfactory machine. While the quantity of fibre contained in the roots is very small, the cutting of the stems like corn leaves a square blunt end on the fibre which reduces its spinning qualities. The best fibre is obtained if the flax is pulled before it has quite reached maturity, or at the moment when the stems begin to get yellow at the base and the seed bolls become firm. The average flax grower knows well the proper stage at which to pull the crop. It is about the time when the stalk is cleared of leaves half way up. A more reliable guide is to cut a few average bolls straight across and squeeze out the seed. If sap oozes out it is still too green, but if the sap has all been absorbed in the seed, the crop is ready for pulling.

The best fibre is obtained if the flax is pulled before it has quite reached maturity. In pulling the long and the short stems should be kept separate as much as possible and the root ends even. The Flemish pullers pull the flax straw up in handfuls about one-half larger than they can grasp in one hand.

You can easily tell the experienced flax puller as he works forward along the side of the standing flax. With his regular and musical note of rip, rip, rip, the straw is plucked from the soil in large handfuls as he clears his way.

FLAX-PULLING MACHINES.

None have so far proved a practical success. Perhaps the most promising is an American invention (Whittaker and Previsto). This machine is said to pull a width of 3 ft., clean

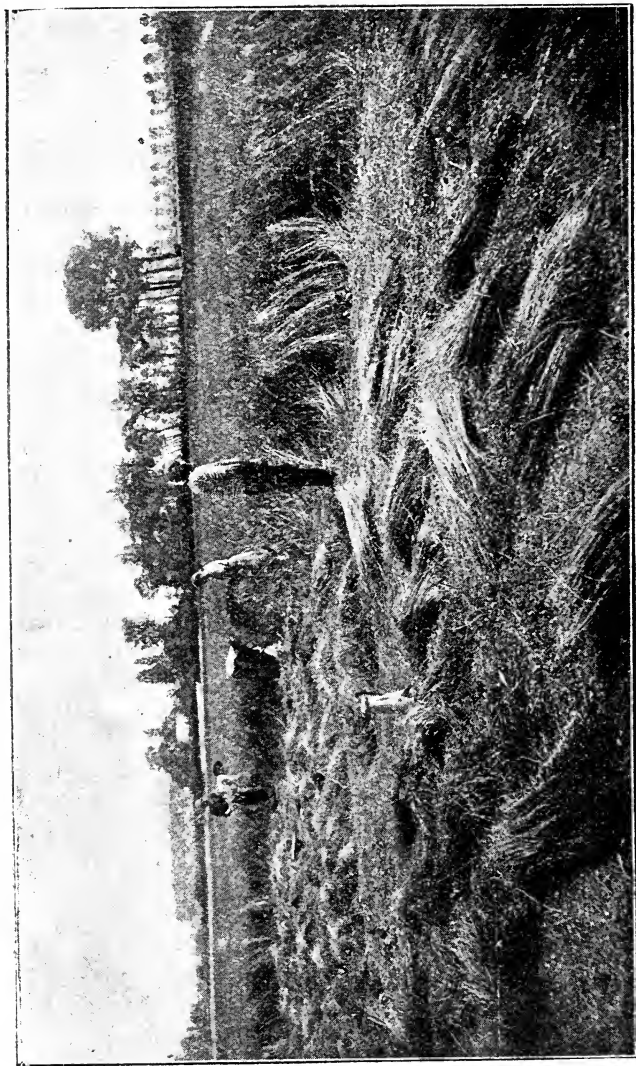

By the courtesy of Messrs. Wigglesworth & Co., London.]
Pulling flax by hand.

the roots, lay the stems parallel, tie them in bundles and throw these beets to one side. Its capacity is stated to be 10 acres a day, using one pair of horses and a man in addition to the small auxiliary oil engine there is on the machine.

Pull the flax when the fibre is in the best state for spinning and still take off the seed bolls, which under ordinary circumstances will amply repay the outlay. Flax seed, even if not quite matured, when pulled ripens sufficiently afterwards, provided it is not detached until dry from the parent stem, all the sap which this contains contributing towards further nourishment and perfecting the seed. The Dutch avail themselves of this fact, and after pulling the stems they stack them. The seed by this means becomes ripe, while the fibre is harvested at the most favourable period of its growth. They thus obtain both seed and fibre.

In Belgium, where the fine quality of the fibre is the first object in view, the seed is only a secondary consideration and the manner of saving it generally is less calculated to produce a good quality of sowing seed. In the first place the flax intended for Courtrai steeping is pulled much earlier than by the Dutch farmers and the seed is often not fully matured.

It has been stated that in normal times the difference in value in favour of flax when pulled green and when allowed to ripen is £4 per acre. Thus the produce of an acre, if pulled green, might realize £20, which when allowed to become ripe would be worth only £16, but the green bolls are only worth £3 per acre, while the ripe might amount to four barrels and be worth £2 each, equal to £8 per acre, thus leaving a balance of £1 in favour of the ripened flax.

However, when quality and yield of fibre is of paramount importance, farmers should pull the crop when rather on the green side and about the stage already indicated.

As the cultivation and harvesting, &c., of flax straw is a regular industry in Belgium, we will give a description of the method there employed as representing the best practice, at the same time noting the different modes of procedure in vogue elsewhere. The Flemish pullers pull the flax straw up in handfuls about one-half larger than they can grasp in one hand. Extra care in pulling is well repaid, as when flax is pulled neat and square it can be easily kept so in the after processes. In pulling, the long and short stems should be kept separate as far as possible. Ordinary green flax as pulled weighs 5 tons per acre. This is reduced about 55 per cent. by sun and air drying, leaving 2 to 2½ tons of dry straw

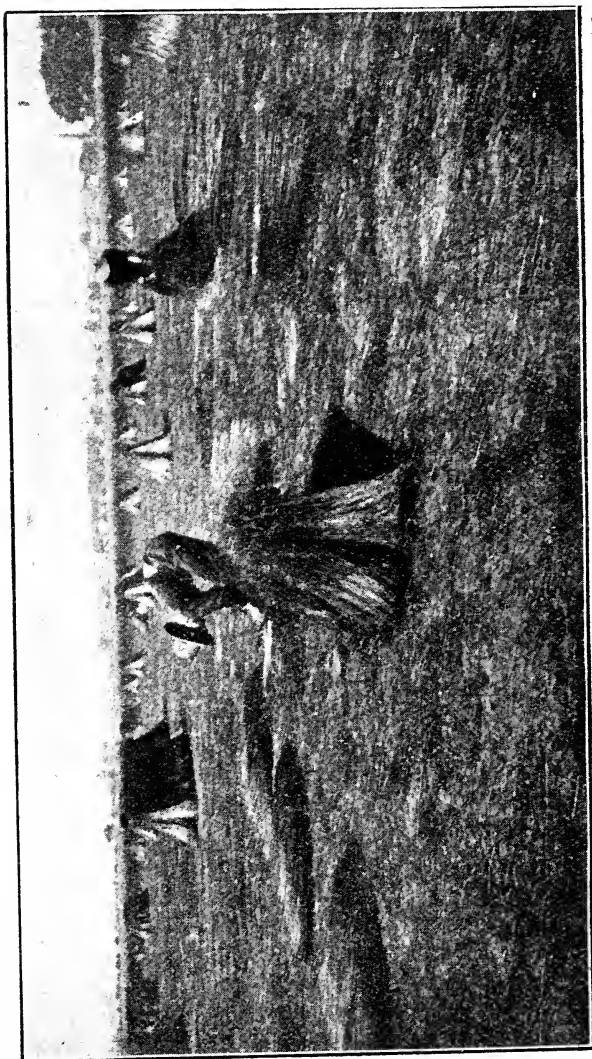

By the courtesy of Messrs. Wigglesworth & Co., London.]

Lifting and drying the flax straw.

per acre. From the latter amount seeding or rippling takes away about 20 per cent. or nearly 10 cwt., leaving 32 to 40 cwt. When pulled the Flemings spread out the straw a little as they lay the handfuls on the ground in rows, the bundles with the tops and roots alternating, which prevents the seed bolls from sticking to each other in lifting.

In Ireland and in the "blue" districts of Belgium on the contrary, where the flax is either rippled green or steeped with the seed on, the pulled flax is tied up by rush bands, or with bands taken from the crop itself, into beets (sheaves) of about 15 in. in circumference which are either carried to the "ripple" or to the steeping dam. For Courtrai steeping, however, the straw is stooked as soon after pulling as possible and never allowed to remain over-night unstooked, except in settled weather. The stooking goes on at the same time as pulling, as if rain comes on while on the ground the colour of the fibre is injured. A good stoker can put up the produce of an English acre per day with two girls or boys to hand him the bunches. The flax straw is handed with the tops to the stoker. The handfuls are set up resting against each other, the root ends will spread out and the tops joined like the letter A. The stooks are made 8 or 10 feet long and are very narrow at the top, and the straw is thinly put up so that it may dry.

In Ireland, if the weather is dull and dark, flax for green steeping will not be injured by being left in the stooks for a few days after it is pulled; on the contrary, this may improve it, but if sunny weather prevails the sooner it is put into the retting pond the better, as the sun will have the effect of making brown "scruffy" stripes in scutched flax which is difficult to scutch and reduces the quality of the bulk.

Under the Courtrai system, after a few days' winnowing in the stook, the straw is ready for tying into sheaves, like corn sheaves. It is then built into long rows or ricks, with the ends of the flax containing the seed exposed to the weather for perhaps a month, the long rows of straw, perhaps 5 ft. high and one sheaf deep, being covered with straw on top to keep off the rain until the seed is dry enough for stacking. In building a stack, two poles are laid parallel on the ground about 12 in. apart, with strong upright poles at each end. The straw is then built in, the length of the sheaf in thickness or breadth. The bottom poles are laid north and south, so that the sun gets at both sides of the rick during the day. In building, the sheaves are laid tops and roots alternately,

built 7 or 8 ft. high and finished on the top by laying a single row of sheaves lengthwise across the others and then another row as before, but with the tops all the same way, which gives a slope to throw off the rain. The stack is then finished by putting a little straw on the top and tying it down with a rope. In this way, if properly built, it stands secure for months or years without injury.

CHAPTER VI.

SAVING FLAX SEED.

WHEN the seed is to be matured upon the straw itself, the flax when pulled should be put into either long or round "gaits." A long gait consists of two rows of handfuls of flax set up against each other like an inverted V for about 7 or 8 ft. in length. A convenient method of making these gaits is as follows: Take two stumps or posts about 3 ft. long, push them into the ground to a depth of a few inches and 9 ft. apart. Place a round pole about $1\frac{1}{4}$ in. in diameter with the ends resting upon the top of each post. The tops of the stumps should have a notch or hollow to prevent the pole from falling off. The handfuls of flax can be placed leaning against the pole on opposite sides and should be shaken so as to leave the straw open when this is being done. The gait should be left with a sharp top. When the gait is built, the poles and stumps can be removed and used again. The round gait or cone is made in the following way: A handful of flax is spread out to a width of about 15 in.; another handful is placed on this and spread out also, and a third handful is then placed on top and spread out to the same width. The whole is then lifted with the roots towards the ground and is turned round the worker's leg. No tying should be used. Long gaits do not as a rule require turning, but round gaits should be turned to secure uniform drying.

While the ripple is the most practical way of removing green seed, ripened seed is more easily removed. It is recommended, however, that it should not be done for some months so that it may have plenty of time to mature. When the branches and seed have been removed together, as has been recommended, an ordinary thrashing machine may be used to effect their separation. The same machine may be and often is used for the same purpose when the seed and branches remain upon the stems, but in this case the latter must be firmly held so that they are not drawn in and tossed. As for fibre purposes, the utmost care must be exercised to keep the root ends level or square.

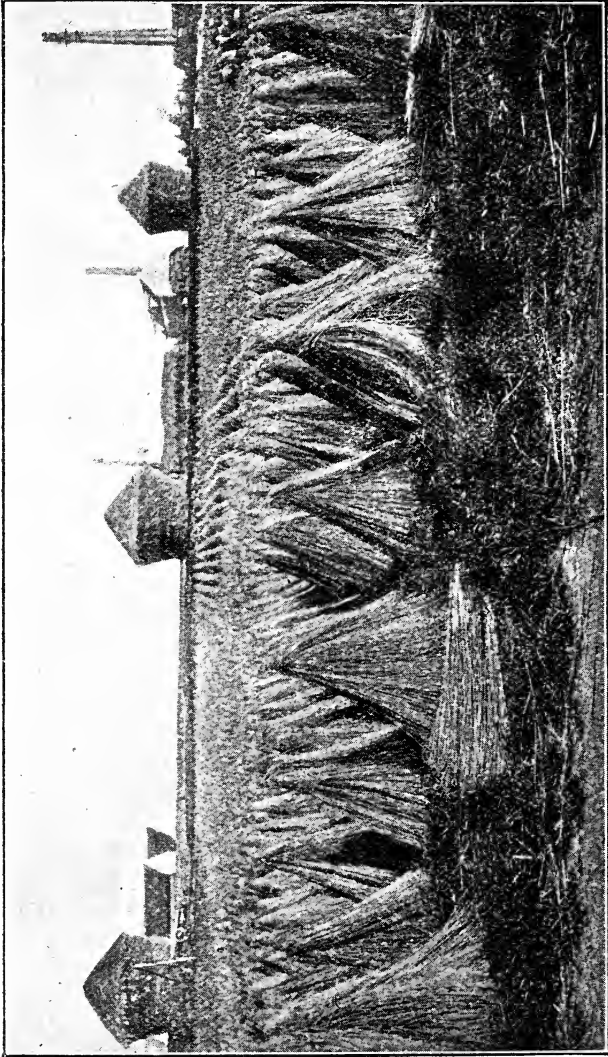

By the courtesy of Messrs. Wigglesworth & Co., London.

Flax straw in round gaits.

Several deseeding machines have been put upon the market within recent years.

The Haughton machine has a spiked drum about 30 in. in diameter which removes the seeds. Graves's deseeder has a pair of hollow cage rollers about 6 in. in diameter, composed of solid ends connected by bars which intersect with those upon the corresponding roller and pull off the seed bolls. The old Sibley machine consisted of a heavy iron framework carrying a pair of rollers, one of which was power driven by a belt running over a pulley in the centre, the two ends being thus available for use. The other roller was pressed against the former by spring pressure regulated by means of an adjusting screw. A man worked at either end of the machine and taking a handful of straw passed it repeatedly between the rollers without letting the root end go, until the seed had all disappeared. A later improvement in the same machine consisted in the insertion of a second pressing roller, thus giving two nips and thus reducing the number of passages by about one-half. The latest form of this machine has been largely adopted by the Department of Agriculture in its deseeding stations. The rollers are of metal and placed in pairs one over the other and used in sets of three, the straw being passed horizontally through the three nips in succession. Even so, as many as three passages are frequently necessary to effect complete separation.

Under the Courtrai system the seed is taken off the dried straw during the winter after it has matured in the stook and rick. To remove the seed, the sheaves are loosened and the straw spread flat upon the ground, the top ends being struck with a sort of long-handled wooden mallet which knocks off the bolls. The straw is then bound up again as before and restacked or stored under cover until the spring when it may be steeped or retted, &c.

Dutch farmers who save seed, intending it for sowing purposes, winnow the straw in the stook in the field until it is dry enough to stack, the seed bolls being then rippled off and the seed preserved in the boll till it is cleaned for the market and by that means kept perfectly dry and in good condition for sowing purposes. Dutch farmers always save the seed of the flax and value it as high as £8 or £9 per acre. They say that this is done without any injury whatever to the quality of the fibre. From 29 to 32 bushels of flax seed per acre have been produced in Norfolk.

Flax seed if not quite mature when pulled ripens sufficiently

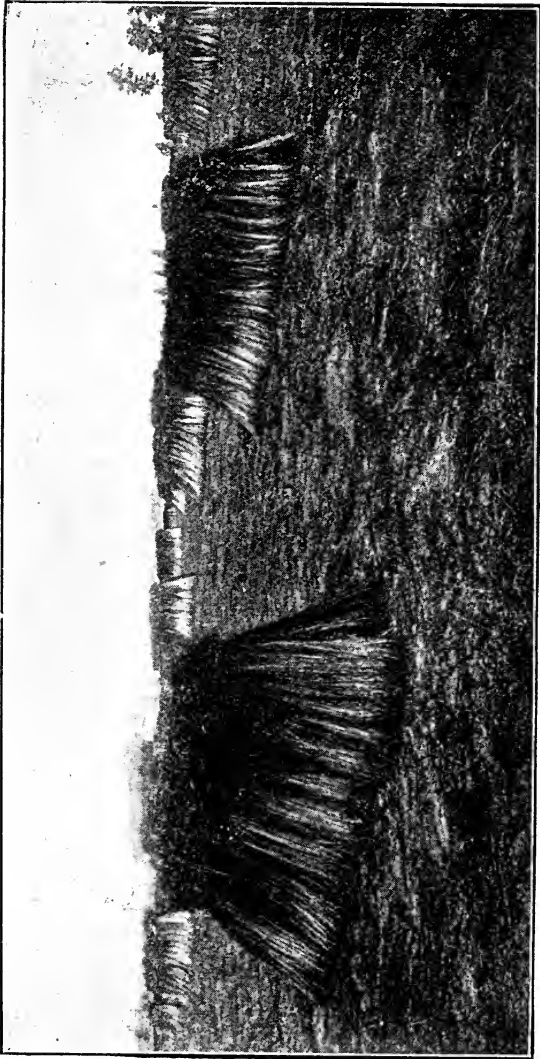

By the courtesy of Messrs. Wigglesworth & Co., London.]

Flax straw in long galls.

afterwards provided the bolls are not detached until dry from the parent plant, all the sap which this contains contributing further nourishment and perfecting the seed. The Dutch avail themselves of this fact and after pulling the stems they stack them. The seeds by this means become ripe while the fibre is harvested at the most favourable period of its growth. They thus obtain both seed and fibre.

Great importance is attached to the operation of gaiting flax straw in Belgium and Holland. As the flax is allowed to stand in the stook (standing straight up) in the field to mature, completely ripen or season, the sun completes the ripening by drawing up the juices, oil or sap of the unripened part of the seed. This operation of the sun is watched very carefully, and it is made sure that maturity has been completed before the flax is hauled off the field and stacked in barns or sheds with the seed on, where during the winter months it is deseeded and then put into bundles or beets from 8 to 12 in. in diameter, and again stacked ready for steeping. The weight of the seed runs from 6 to 12 per cent. of the total weight of the straw. This of course depends upon the season as does also the total yield of flax.

When it is intended to ripple flax it is pulled in the ordinary way and laid straight and evenly into beets. The rippling is done as follows: A rippling comb is attached to the end of a moderately broad plank, which is supported upon some convenient rest, such as a low barrel. The operator sits astride the plank facing the comb and splitting up the beets into small handfuls, strikes the seed over the comb, and draws them through the teeth towards him. This will remove the seed, after which the flax may be retied and put in the retting pond at once, care being taken to keep the butts of the beets as even as possible.

The ripple is a coarse comb composed of square section iron spikes set in a wooden stock.

The best ripples are made of $\frac{1}{2}$ in. square rods of iron, placed with the angles of the iron next to the rippers, $\frac{3}{16}$ in. asunder at the bottom, $\frac{1}{2}$ in. at the top, and 18 in. long to allow of sufficient spring and to save much breaking of flax. The points should begin to taper 3 in. from the top.

When the soft green seed bolls are rippled off, they must be thoroughly dried. The best way to do this, when the weather permits, is to do so either outside on sheets or indoors in airy lofts, over the floors of which they must be thinly spread; but for feeding purposes, if the weather is indifferent,

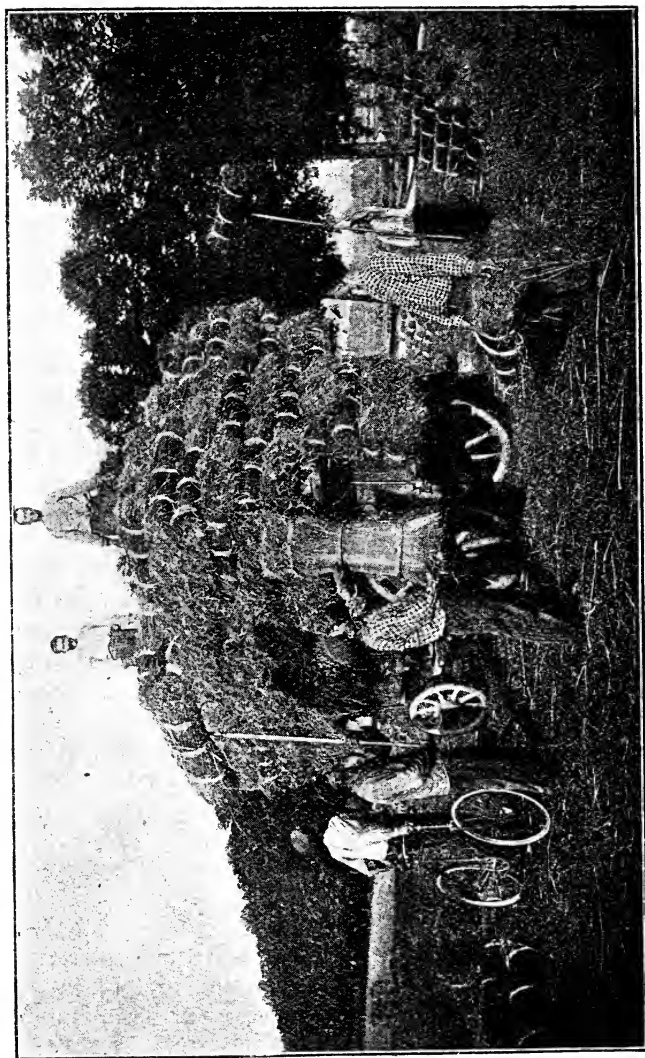

By the courtesy of Messrs. Wigglesworth & Co., London.

Carting the flax straw to the barn or retting dam.

they may be gently dried on the nearest corn kiln. Air drying is, however, the best system and leaves the rich juices of the seed more valuable and nourishing. When sufficiently dry, the bolls destined for crushing or for sowing must be thrashed to separate the seed from the husks, but this is not necessary when they are to be used for feeding.

Flax seed ripped off green flax straw makes a useful feeding stuff and will keep if spread a few inches deep on a dry wooden floor in an airy loft and frequently turned to prevent heating.

When grown for seed only, the flax straw is thrashed by machine as is oats.

For instance: When fibre is to be extracted from the straw, the greatest care must be taken to preserve the stems with root or butt ends even and to prevent them from being tossed and broken as they would be in a thrashing machine.

The method of deseeding flax fibre straw most suitable for large growers, and that used in Yorkshire, Dorset and Somerset, is by means of the machine here described.

This machine consists of a heavy iron framework carrying a pair of rollers, one of which is power-driven by a belt running over the pulley in the centre, the two ends being thus available for use. The other roller is pressed against the former by spring pressure, which may be regulated by means of the adjusting screw. A man works at either end of the machine, and taking a handful of straw spreads the crop end out fanways and passes it between the rollers without letting go the root end. He passes it through several times after rearranging the position of the stems until the bolls have been squeezed off the branches.

In the operation of deseeding care should be taken to prevent particles of soil from getting mixed with the seed, as they are very difficult to remove and their presence tends to make the seed heat.

For a like reason it is advisable to postpone the deseeding operation until as close to sowing time as possible, for seed will keep in the best possible condition by being allowed to remain on the straw until it is wanted for sowing.

As the proportion of moisture in Irish, English and Scotch home saved seed is relatively high, if the seed is removed from the bolls early and stored in bags or in heaps, it is very liable to heat and lose its germinating power. Small quantities of bolls are best broken by spreading them over a wooden floor and passing a light roller several times over them.

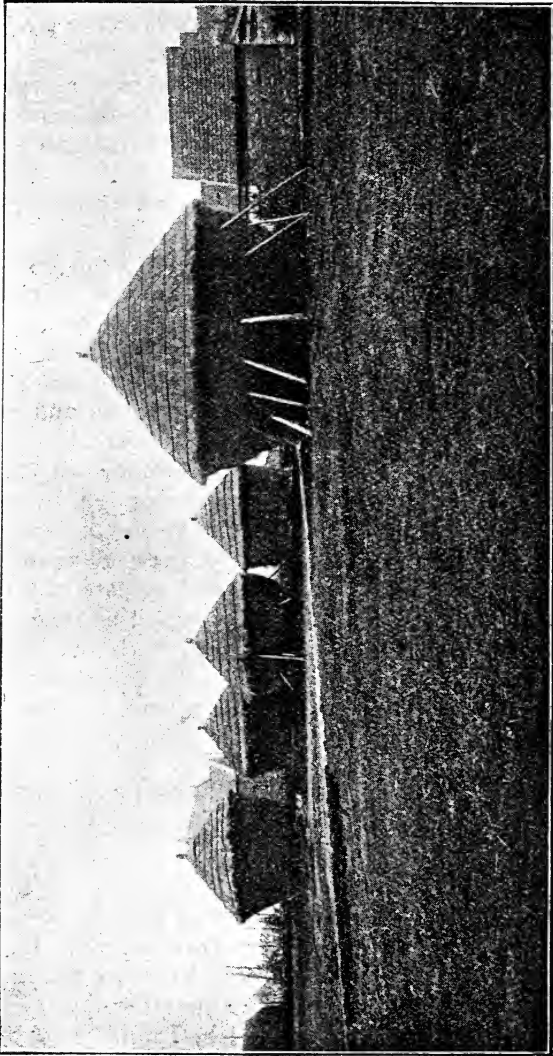

By the courtesy of Messrs. Wigglesworth & Co., London.]

Flax straw in stack.

When large quantities of seed have to be dealt with the bolls can be safely and quickly broken by passing them through a corn-crusher with plates set widely apart.

In Greeve's deseeding machine the bolls pass direct to a pair of crushing rollers.

With the multiple roller deseeder a conveyor band carries the bolls to crushing rollers whence they pass to the winnowing and screening machine.

Either a No. $7\frac{1}{2}$ perforated zinc sieve, a standard grass seed sieve with 12 meshes, or a wire sieve with 14 meshes per inch, will serve to remove small weed seeds and dust from the flax seed, and a wire sieve with 7 or 8 meshes per inch, which will allow the flax seed to pass freely through it, will enable a separation to be made of coarse materials, such as particles of straw and bolls.

Really good seed should weigh about 55 lb. per bushel.

CHAPTER VII.

RETTING.

THE retting of flax straw, either in the green or dried state, is undertaken with the object of rendering soluble the gummy matter which binds the fibre around the stem so that separation may be effected with the minimum breakage and loss of fibre. Mechanical decortication without retting has never proved a success, as the fibre produced remains coated with an insoluble gum which does not macerate in the hot water trough of the wet spinning frame and prevents the fibres being drawn apart.

Soft water is the best for flax retting and all waters having strong mineral qualities should be avoided. The action of the salts of iron upon the modification of tannic acid in the flax straw is very prejudicial.

It is known that—other conditions being equal—the speed of fermentation or retting increases with the rottenness of the water. It also increases with the temperature.

It has been established by biological study of the retting process that retting is primarily a process of fermentation brought about by the action of microbes developed in the straw itself.

The nature of the water and ponds for flax steeping has various peculiarities and characteristics with which it is necessary for the grower to be thoroughly acquainted. Soft water and a blue clay subsoil in ponds will invariably produce a clear “blue” colour and a superior quality of fibre. Hard spring water in ponds with a gravelly or sandy subsoil will generally produce fibre of a light colour and inferior quality. In many districts, no other ponds are available and these have to be used. When this is so, the best thing to do is to fill the dams early, say in the month of May, and allow them to remain so until required. There should always be a considerable quantity of mud left in such dams and they should never be entirely cleaned out. By following this treatment it will be found that even these inferior dams will give fairly satisfactory results. The water should always be stagnant, unless there is a very large body of flax confined in a small

space, when a very small run of fresh water may prove beneficial.

Newly made dams often fail to ret satisfactorily for the first year. When such are used, it is advisable to put in a few loads of mud from some previously used dam to supply the necessary bacteria.



By the courtesy of Messrs Wigglesworth & Co., London.

Flax retting dam.

In Ireland and in some parts of the Continent flax is steeped or retted in earthen dams or ponds of any convenient length and about 9 ft. wide and 4 ft. deep. The bundles of flax straw are packed in almost vertically with the top or crop end up. Mud or sods are then placed on top and the whole kept down by stones, so that the butts are covered by about 3 in. of

water. As fermentation proceeds, the beets tend to rise and more stones must be put on to keep them down. There should always be a sufficient depth of water in the retting pond to float the flax and the beets should never be packed so tightly as to prevent free circulation of the water, nor should the flax be weighted down so heavily that it will not rise in the pond when fermentation begins. The less weight upon it the better so long as it is kept under water. The practice of placing two rows deep in ponds is not to be recommended, as it will be found that one row will be considerably more retted than the other, and if both are mixed together the flax will not scutch satisfactorily and the yield and quality will probably be reduced. Where it is necessary, owing to scarcity of convenient ponds, to put in two rows, it is advisable to keep each row separate and have them scutched so.

In the Bruges and Lokeren districts of Belgium the beets of flax straw are put into the pond perfectly flat to the depth of about five rows, or as much as the water will cover. The water is usually collected from percolation after rain, and as the ponds are nearly full before steeping begins the worker stands in the water and builds the beets of flax straw in, row after row, to the requisite depth across the pond. In the Bruges district, when the pond is filled, the surface of the top layer of flax straw is covered with oat or wheat straw to keep off the sunlight, and on this again a quantity of sods are placed to press the flax evenly under water, much after the Irish method of stoning. In the Lokeren and other "blue" districts of Belgium, as well as in Holland, the mud which accumulates at the bottom of the pond year after year is employed to cover the top layer of flax. The worker engaged in putting the flax into the dams uses a spoon-shaped wooden shovel; with this he, in the first instance, throws a quantity of water over the top layer of each section as it is put in, until it is thoroughly saturated. He next gets a heap of mud scraped from the bottom of the pond and usually collected at intervals along the sides of the dam, and shovels it over each top layer of flax straw, effectually covering it with a layer from 4 to 6 in. thick. Each layer as put in is treated in the same way, so that when the filling of the dam is completed the top surface presents a level expanse of soft black mud. The main purposes served by this mud covering are: (1) To keep off light, and thus prevent discoloration; (2) to give the fibre the requisite blue or black colour; (3) to make the retting process take place more

uniformly throughout the entire mass; and (4) to serve in lieu of stones to keep the flax straw under water. Though the upper surface of mud is quite compact and continuous, that which adheres to the top of each beet is easily removed by giving the latter one or two plunges in the water before it is taken out. When sufficiently long in the steep, the flax is not thrown out by hand, as in this country, but is lifted out by means of a fork. The worker standing at the side of the dam detaches each beet from the heap, and after plunging it down once or twice in the water to remove the mud, places the fork underneath it and deftly lifts it out on to the bank.

It is worthy of remark that in these "blue" districts, the water in the ponds is entirely stagnant during the time the flax is being retted and no further water is allowed into the pond after the flax has been put in.

The farmers in the Lokeren district are of the opinion that the best results are obtained when the flax is pulled green and steeped immediately after rippling, as is the usual Irish custom.

In the Dordrecht district of Holland, the beets are placed in narrow dams in a sloping position and not more than two layers deep, the boll or top end of the flax being downwards—which is the reverse of the method adopted in the "blue" districts—and covered with mud.

In some Flemish retting dams sticks are placed along the sides of the dam to keep the flax from contact with the earth. Upon the top of the flax they lay a straw mat and upon this sticks and planks loaded with stones to keep the flax down.

Flax retting proceeds quite successfully in a running stream of fresh water or in a fresh-water lake. The best flax produced is retted in the River Lys in Belgium, while its substitute "white Dutch" is retted in the River Scheldt in Holland.

The effect of running water is to produce flax of a light yellow colour. This always fetches a higher price in the market. The same effect is produced in large ponds or lakes of fresh water.

In some parts of Ireland, notably on the upper Bann River, flax straw used to be tied up in large bundles attached to a stake by ropes and thrown into the running stream.

It is evident, therefore, that the process of fermentation must go on in the juices and gummy matter which connect the fibre to the woody stem, as the water itself has not time to become decomposed in passing through the bundle.

On the River Lys, where as we have said the finest flax procurable is produced, the flax is either steeped in September of the year it is grown, or in June the year after. The commoner qualities are steeped the same year and the better qualities held over.

The colour of flax generally is improved by a small stream of water continually passing through the ponds during the steeping, which water, even from a stream of comparative softness, should be exposed to the atmosphere in a pond for at least a week, before being used, but if from a spring of hard water a much longer time of exposure to the atmosphere is necessary.

The retting of flax straw is a regular industry around the town of Courtrai in Belgium, where flax is retted in the River Lys. The success achieved on the Lys is probably due in a great measure to the slow movement of the water and the exceptional bacterial development* resulting from continuous retting. Under the Courtrai system the seed is taken off the dried flax straw during the winter, when two sheaves are tied together with three bands of rye straw (one near each end and one in the middle) and are so arranged that the root ends of the sheaves are at opposite ends of the bundle. These bundles, about 12 in. in diameter, are then restacked or kept under cover until the spring, when they are sometimes retted. It is generally considered better, however, that the flax straw be kept for at least a year before steeping, and it is sometimes even kept for two years, a practice believed to increase the strength of the fibre. Much nicety is required in preparing the flax straw for steeping if the very best results as regards light colour and quality are desired. To obtain such results the sheaves should be untied and the flax shaken over, a few stalks at a time, in order to remove all dust, leaves and weeds.

For steeping, the parallel bundles, made as described, are packed either horizontally or vertically in large wooden crates or "ballons," about 10 ft. by 8 ft. by 3 ft. deep, lined with straw and sacking. The upright position is usually adopted, as it is said to be more favourable to the production of light coloured fibre, as no sediment or deposit can rest upon it at any stage of fermentation. Straw and boards are afterwards placed on top and the crate thus lined slid into the river, anchored in the stream, and weighted with stones, so that it is submerged a few inches below the surface. In a few days fermentation begins and as it proceeds additional stones are

added from time to time in order to prevent the rising of the crates through the evolution of gas. As a rule, after steeping for a few days, the flax is removed from the crates and set up in hollow sheaves to dry, the advantage of the interruption of the retting process at this stage being that exposure to the sun and air kills the microbes of putrefaction which have developed, so that the strength of the fibre remains unimpaired. When dry, or later, it is repacked in the crates and again steeped until retting is complete, in seven to twelve days, according to the temperature and quality of flax. When repacking the flax straw in the crates for second retting, care is taken to arrange the bundles so that the end at the bottom during the first retting is placed at the top in the second retting. The second retting does not take so long as the first retting, the exact period depending upon the extent of the first retting, quality of the straw, temperature, &c.

The total duration of steeping is about, say, six days in August, ten in May, and twelve in October, but occasionally as much as twenty-eight days when the temperature of the water is much lower. When the temperature of the water is high, retting proceeds much more rapidly than in colder weather. Fine thin stems require a longer time to ret than do stouter stems. The average time taken for retting in the North of Ireland, with water at 64° F., is about nine nights. In all cases Continental retters ret until the straw is considerably softer than is usual in Ireland.

The end of the process is accurately determined by occasionally examining the appearance of the stems and applying certain tests. The bundles of straw should feel soft and the stems be covered with a greenish slime, easily removed by passing them between the finger and thumb. When bent over the forefinger, the central woody portion should spring up readily from its fibrous envelope. If a portion of the fibre is separated from the stem and suddenly stretched it should draw asunder with a soft and not a sharp sound. A common test is to break a few average stalks at points from four to six inches apart, and if the woody part between pulls out clean and easy from the fibre, it is then about the proper stage for taking out of steep. The stems tested should be drawn from various parts of the retting pond.

It is said, on the authority of a Dutch Boer, that in steeping flax, when the bubbles of air disappear from the surface of the water and the flax seems to have settled to the bottom, it may then be concluded that the operation is nearly finished.

It is known that, other conditions being equal, the speed of fermentation increases with the rottenness of the water. Thus, in the Lys, retting proceeds much quicker and better the more flax is being steeped for the first time (in the second retting, fermentation being practically *nil*).

Flax should be taken out of the steep carefully, the use of forks being avoided where possible, as they are certain to injure the soft retted straw. The flax fibre is injured if the stems, as they are taken from the steeping dam or river while the gum is in a wet state, are handled or exposed to rain, for the removal of the gummy matter in spots leaves those places weaker.

On the Lys, when retting is complete, the crates or ballons are pulled ashore and the flax straw carefully removed and placed in an upright position on a light layer of straw, where it is allowed to drip and drain for about twenty-four hours. When all is removed from the crates, it is lightly covered with straw or sacking.

When a considerable quantity of water has thus been got rid of the flax is wheeled to the drying ground, where it is set up in sheaves to dry, this time in the shape of a hollow cone, or is "gaited" in close rows which are regularly turned.

TANK RETTING.

The retting of flax in tanks with water at a temperature above the normal with a view to reducing the time required to ret has frequently been done. The following is a description of one of the earliest of such processes, i.e., that of Schenk:—

"DESCRIPTION OF AN OLD IRISH FLAX RETTING ESTABLISHMENT.

"The following description of Schenk's flax rettery once established on the Newport River, Co. Mayo, is taken from a report by Mr. M'Adam, Secretary of the Old Royal Belfast Flax Society. He says: 'The tenements containing the retting vats and drying shelves are simple wooden sheds of cheap construction. In one end of the building are four vats, set parallel to each other, the length of the house. They are made of inch deal in the form of a parallelogram 50 feet long, 6 broad, and 4 deep. There are false bottoms perforated with holes; underneath these are introduced the steam pipes crossing the vats, and having stop-cocks at their entrance, by which

the steam can be let on from the main pipe as required. The steam is generated in a small boiler, which also serves to turn two hydro-contractors. The flax is packed into the empty vats on the butt ends, in a half-sloping position, precisely as in the case of the steep pool, only one layer being in depth. The water is then let in and a frame fastened over the top of the flax, answering the end of stones or straw in the steep pool—the prevention of the rising of the flax in the course of fermentation.

“The steam is then let into the pipes by turning the stop-cocks, and the water is some eighteen or twenty hours in becoming heated to the required point, 85° to 90° . The fermentation then commences and no further steam is required, the action going on till the flax is thoroughly retted, which is in forty hours afterwards, being sixty from the time of admission of the water. At the end of the sixty hours the flax is taken out, the water allowed to run off, and the vat permitted to cool. The same process is then repeated with fresh water and fresh flax.’”

By Watt's process boiling and crushing are substituted for fermentation, the flax straw being first steamed and then crushed between heavy metal rollers.

Buchanan's process was intended to be an improvement on Watt's. In it the solvent power was due to hot water occasioned by the condensation of steam, the steepings being effected by repeated immersions in a tank of heated water, kept at a temperature of about 160° F., only four hours being required for the operation.

In Germany, specially fine flax has been steeped four or five days in a warm mixture of milk and water. Sometimes an alkaline ley made from wood ashes or other chemical agents has been tried to hasten the retting process, but the action of soft water, and the production of fermentation in the ordinary way is, if rightly conducted, probably the best mode of accomplishing the desired object.

“As early as 1808 a Mr. O'Reilly proposed that instead of steeping flax straw in the usual way, the stalks should be boiled in water or in a caustic mineral alkaline ley. Alternately he proposed to suspend the flax straw in a steam-tight chamber with a boiler attached from which steam was to be introduced, that from a weak caustic alkali being thought best for the purpose.” Hence O'Reilly's idea clearly foreshadowed both Schenk's and Watt's patents.

Perhaps what might be termed the first modern attempt at

industrial tank retting was that of Jules Van Mullem, 1882, at Harlebeke. His object was to replace retting in the River Lys itself by retting in a series of tanks situated near to the river and supplied with water from it so as to produce better results by doing away with several disadvantages of the river for retting. His patent claimed a methodical and continuous system of retting in tanks by means of ordinary river water filtered and heated to get rid of matter likely to injure the flax. He employed a series of eight water-tight tanks communicating one with the other, and proceeding step by step with a feed and discharge pipe, both fitted with stop-cocks or valves. In each tank the opening into the preceding tank and into the feed conduit was near the top level, while that into the following tank and the discharge was at the lower level.

It was thus possible to produce through the flax straw in each tank a continuous water circulation in one direction. The pure water entering into the first tank flowed on successively into each of the other tanks unless one or more was skipped for cleaning or emptying, &c. Matters were arranged in such a way that the freshly entered flax straw was first treated with the water which had made the whole circuit, next by the water which had been through all the tanks but two, and so on until, the retting nearly finished, it got pure water. In this way fermentation was hastened at the start and retarded at the finish. Thus one inconvenience of retting in the Lys, where all the flax cannot have the best position, was done away with. The retardation of retting at the finish made it easier to determine the exact period when the flax had been sufficiently retted. A saving in water was also effected, the water discharged only being lost and no more being required for the series of tanks than for one. Neither was the water of the river contaminated by pectic acid. The water of the river, often charged with black matter, was first decanted in a tank, then filtered and the clean water passed to the retting tanks. The straw and sacking used in the Lys to protect the flax against dirt is thus not necessary to the production of a nice yellow colour, although it was found that the straw retted in the tanks lost less weight than it did in the river, and yielded better at the scutch mill; this system did not extend, we do not know why.

Mr. Foster, of Selby, Yorkshire, was at one time a large flax grower and cultivated up to 3,000 acres annually, the straw being retted and scutched under his own supervision.

His method consisted in first crushing the green straw between rollers and then retting it in vats of lukewarm water.

For several years before the outbreak of war hot water retting was being extensively carried out in central retteries in Holland, Friesland, Germany, Austria, Japan, &c., and even along the banks of the river Lys itself. The latter fact, which may seem strange, will be understood when we say that

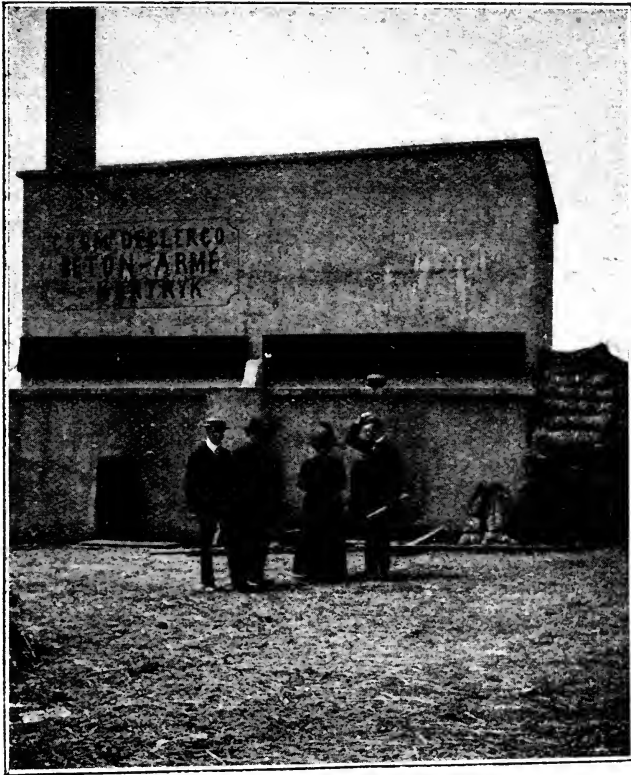

General view of a Legrand patent rettery on the Lys.

there is not sufficient retting accommodation along the Lys, the renting of a part of the bank being difficult and expensive. The shorter time required for hot water retting and the small quantity of water used are further advantages, the former meaning a greater turnover, and the latter rendering it possible to carry on such a retting anywhere.

The most successful hot water retteries have been con-

structed upon the Legrand van Steenkist principle and there are nine or ten such reterries along the Lys.

The following is a description of such a reterry. The retting tanks (*see* section and plan), measure approximately 33 ft. by 10 ft. They are simply constructed of reinforced concrete, four walls, a floor formed of inclinations towards the central points, *b*, connected up with the iron pipe T, which can be used either to fill or to empty the tank and which branch into the main ducts M which surround the tank.

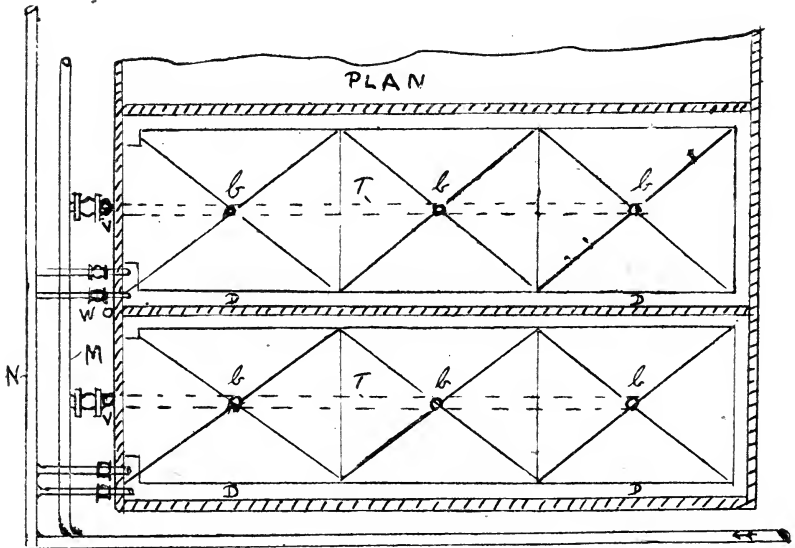

Plan of a Legrand patent reterry.

The latter is also surrounded by a pipe D of double square section (*see* plan), also made of cement. At equal distances along this pipe are oblique openings which give to the water entering the tank a circular motion. They are connected with the duct N, and serve in conjunction with the pipe in the bottom to fill the tank. They are also used for another purpose, as will be explained later on.

Two vertical pipes V, opening into the same cement gutter R which runs along the top of the tank, branch out from the pipe in the bottom. Between every two tanks is a down pipe W discharging the contents of the gutter into a ditch or pit. The combination of the pipes V, R and W thus serve as an overflow.

The cement ducts D serve as supports for an openwork floor upon which the bottles or sheaves of straw are built on end when the tank is empty just as the crates are filled upon the Lys. When the tank is filled with straw, water is admitted through the three pipes. Degumming begins and when finished the brown saturated water is run off by the discharge pipe and the tank is again filled to commence the second stage, or retting proper. When fermentation sets in the water becomes more and more acid and must be diluted. To do this water is admitted in the desired quantity by the double side duct. This water entering by the oblique openings O rises with a circular motion, and as it rises a corresponding descent of saturated water takes place, the latter escaping by the pipe

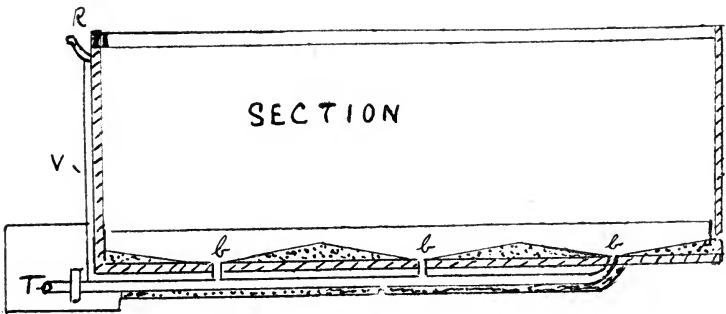

Section through a Legrand patent rettery.

in the bottom, rising by the vertical pipe V to the gutter R, and flowing off by the down pipe W.

Let us here remark that the water which thus runs off towards the end of the retting process can be used for degumming in a tank of fresh straw. Its utilization in this way is arranged for, it being only necessary to stop up the pipe W, when the water passes by the pipe T to fill the next tank.

Scutch mills are usually combined with these patent retteries. Above the latter, constructed of reinforced concrete with flat roof, are two water reservoirs side by side. The second is smaller than the first and at a lower level; water is pumped into the first tank, from thence it flows into a boiler of the water heater type, which raises it to a temperature of 95° F., as shown by a thermometer placed in the outlet pipe. The warm water rises and fills the second tank. From thence it can, simply by opening a valve, flow into the retting tanks.

The only fuel employed is the shove and waste from the scutch mill.

Such a rettery produces per season and per square yard of floor surface, 62 cwt. of flax straw retted twice.

The retting season is counted as six and a half months, i.e., March 15 to October 1.

The pre-war cost of such a retting was £5 per square yard, the ground and drying fields not included. The revenue of the rettery, let at the same rate as those on the Lys, i.e., 5d. per cwt., is 25 per cent. on capital. The building cost for a rettery one layer deep, 10s. 7d. per square yard, and for a rettery two layers deep, 12s. 3d. per square yard.

The quantity of water required per cwt. of straw to be retted either in one or in two operations, i.e., single or double retting, is 108 cubic feet. The heating of these 108 cubic feet, waste steam being utilized, costs 3 $\frac{3}{4}$ d.

The tanks are filled and emptied of flax straw through water-tight iron doors. Except for the difficulty of making the doors or gates water-tight it would be much more convenient were the door made big and wide enough to permit of a horse and cart backing in as into a silo.

The hot-water retteries built at Selby, Yeovil and Dromara are but poor imitations of the Legrand system. In the former the tank has to be filled and emptied over the top or edge.

The Feuillet process bears a striking resemblance to M. Legrand's old process which proved too costly.

For some years chemists have been studying the retting microbe with a view to employing a better knowledge of its action industrially in the more rapid, effective and economical retting of flax, &c.

The Rossi process is based on the alleged discovery that the use of a gas current through the liquor while retting is going on regulates and increases the retting effect of the pectic aerobic microbes. Professor Rossi uses several varieties of these retting microbes at Portici. A pipe fitted with a valve admits the retting microbes to the retting tank, while a pipe entering at the top passes down the centre to a level beneath the false bottom and is used to pump in a current of air or gas which bubbles up through the liquor and the fibre under treatment which is kept submerged mechanically.

The Americans have made many attempts to supersede retting by chemical action of acids, alcohol, petrol, soap, &c. Their latest involves the use of solvents to effect the release of the pectose from its association with the fibre and non-

fibrous elements of the flax straw. Kerosene, naphtha, benzine, carbon tetrachloride, ethyl trichloride, &c., are used with water at any ordinary temperature or in the form of steam, depending upon the specific gravity of the solvent used.

It seems as if any great increase in the cultivation of flax in Great Britain and Ireland can only come with the invention of a flax-pulling machine and with the establishment of central retteries and scutch mills.

Retting and scutching is a trade in itself and a farmer can never hope to attend to the retting of his straw with the results that can be achieved by the centralization of the process.

The advantage of central retteries are that instead of individual growers taking up the critical operation of steeping

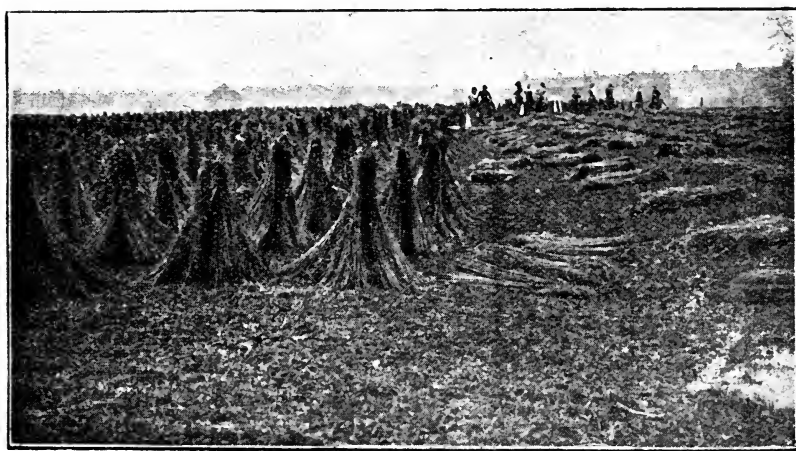

By the courtesy of Messrs. Wigglesworth & Co., London.]

Drying flax straw after retting.

once a year, there is a regularly organized establishment where this business is regularly carried on and the workers consequently become very expert.

Flax retting on the Lys is in fact a central rettery, flax straw being brought to it by canal from Holland and France, and other parts of Belgium. Thousands of hands are there employed in the industry and nearly £200,000 paid out in wages annually.

Dam-retted flax, when sufficiently long in the steep, is in Ireland thrown out on the bank by hand, but is on the Continent forked out. It should not, if possible, be allowed to

remain there for more than twenty-four hours. If the weather is very warm it may heat, and the fibre be considerably weakened. It is consequently taken and spread on the grass, where it is allowed to lie, in some instances, as long as six weeks. It should be spread rather thinly and well shaken. If thrown down in unshaken lumps the colour of the fibre will not be uniform but will be more or less striped.

On the Continent it is spread thicker than is the case with us. Very thin spreading is likely to become tossed and straggle very considerably, and will give no better result than thick spreading when well shaken. While on the grass the flax straw must be frequently turned, after every shower if possible. This operation may be performed by means of a



By the courtesy of Messrs. Wigglesworth & Co., London.]

Spreading flax straw to dew-ret.

long pole, the pole being pushed under the row of flax and a length of about 12 ft. being turned at each thrust. If weather conditions are favourable, spreading gives a more uniform colour than gaiting. However, if the weather is very showery, gaited flax will suffer less injury from the rain than that which is spread. Gaiting is quite as easy, if the seed has been ripped off, as it is hoped in the future it always will be before retting. Besides improving the colour grassing causes the fibre to contract and to leave the boon and render scutching much more easily accomplished.

The best Courtrai flax is sun-bleached after retting. Clean

pasture land is rented and the flax straw spread about $\frac{1}{4}$ in. thick in straight lines, root ends even as a brush, having a distance of about 4 in. between each line. In dry weather it remains twelve to fourteen days on the grass; in wet and warm weather about four to five days. In dry weather it is turned every three days and in wet weather every day, the object being to obtain a bright yellow colour. In very warm weather, a few hours too long on the grass may entirely spoil its colour. The moment therefore a few blue spots make their appearance on the fibre it is quite time to lift it from the grass and set it up in hollow cones to dry, as when it comes from the steep, but in dry weather it may be taken from the grass and tied up at once. In this case, however, it should be turned on the morning of the day on which it is to be lifted.

Flax intended for summer bleaching should be steeped a little more than that intended for March bleaching, because in summer it cannot remain long enough on the grass to soften without spoiling the colour, while in March it can remain on the grass sometimes seven or eight weeks without injury to the colour, and during that time flax steeped too little will become properly soft for scutching.

When sufficiently grassed and dry the flax straw is lifted and tied up in fairly large beets. If heavy rains are prevalent, it is advisable to lift the flax even when half dry, tie it rather slack in small beets and put it up in stooks or "gaits," in which it will soon dry satisfactorily. Heavy rains at any stage while the crop is spread are very injurious, but especially so when freshly put down, and it is safer, five times out of six, to lift the flax as soon as it is in proper condition. If the weather is favourable and there are dews at night, a few days on spread under such conditions may effect an improvement. After being a few days in stooks, the flax should be stacked for at least two weeks, preferably a month, before being taken to the scutch mill, and much better results will follow than if it was scutched direct off the spread field.

It often happens that when put in store at this stage, apparently perfectly dry, it will in a few days "come back" again and become so damp as to lead to considerable difficulty in the scutching, and consequently there will be more waste from the scutching handles. When the flax is scutched immediately after being taken off the spread field, most unsatisfactory results will be obtained. As a rule, the straw at that time will have one of two faults, and occasionally both combined. If sunny weather prevails, it will likely be too hot

and bristled—a condition which renders scutching easy but is detrimental to yield and quality; or it may be too dry on the outside of the beet and too damp on the inside, which condition will give even worse results. But when stacked for a few weeks the straw becomes of a uniform cool character, a condition which may be expected to give best results.

The dew-retting of flax is practised to a large extent in Russia, and combined with water retting in the Walloon district of Belgium and in Brittany. It is a most primitive method and consists in spreading the freshly pulled flax straw lightly over the field and allowing it to remain there until the combined action of the sun, rain and dew has accomplished the

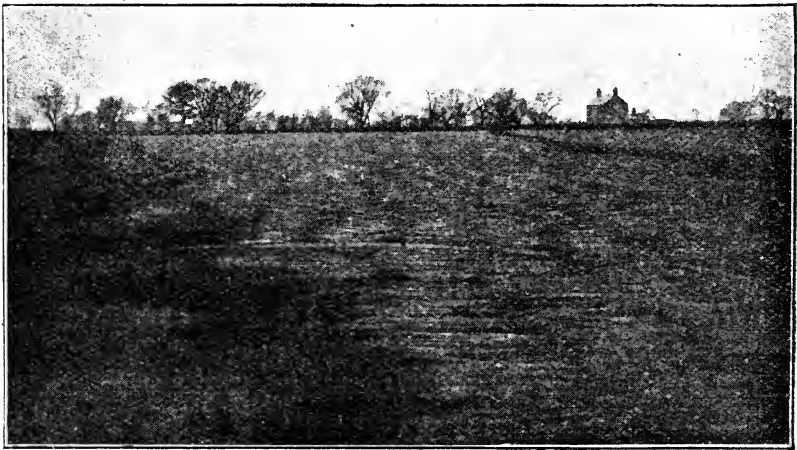

By the courtesy of Messes. Wigglesworth & Co., London.]

Dew-retting flax.

partial dissolution of the gummy matter which binds the fibre to the wood. Its only advantage is to save the disagreeable work of water-steeping, for which reason it is being advocated in certain quarters to-day. We do not recommend it, however, as against water-retting, to produce fine and strong spinning flax; besides in this country dews cannot be depended upon long enough to complete the operation, and there is a strong possibility of a storm of wind scattering the flax, or rain causing it to lose half its value. It can only be advocated for the purpose of saving expense and labour. The yield of fibre is perhaps somewhat greater than that produced by the usual method, but the quality is not so good. Most dew-retted flax

is, although coarse, of uniform colour and strong fibre. Russian dew-retted is fine, but soft and weak.

Russia is the largest producer of dew-retted or Slanetz flax, which is exported from Archangel and Petrograd by ship and rail. France has hitherto been the largest importer of dew-retted Russian flax. Continental spinners of eminence have always shown a preference for dew-retted flaxes, whereas Irish spinners before the war invariably fought shy of them, because the yarns when made would not boil a clear yellow colour as water-retted flax yarns will. Since the war broke out, however, both water-retted and dew-retted have been used without any objection being raised. A good deal of tow as well as flax comes from the dew-retting districts of Bijetsky, Kashin, Kama, Krasniholm and Ouglitch.

The chief centres for Flemish dew-retted or Walloon flax are Tournai, Namur, Ath, Leuse, Liège, and Gembloux.

French flax grown in Brittany and in the Bergues district is partly dew- and partly water-retted, being first partly dew-retted on the grass, and then finished in the dam.

Flax straw intended to be dew-retted should first be dried and then crushed in the flax rollers. January and February dew-retting gives the best coloured fibre and is called in Belgium "March flax." In France before grassing for dew-retting, the straw is sometimes wetted with a weak alkaline solution. In Holland it is sometimes watered with salt water or steeped for some time in a saline solution.

Ordinarily green flax as pulled weighs 5 tons or 11,200 lb. per acre. Drying takes away about 55 per cent., or 6,200 lb., leaving 5,000 lb. From the latter amount deseeding or rippling takes away about 20 per cent., or 1,000 lb., leaving 4,000 lb. Retting or steeping still further reduces the quantity about 20 per cent., or 800 lb., leaving 3,200 lb. to be scutched.

Some authorities reckon that flax straw loses only about 16 per cent. in weight by two rettings in the Lys, and that in still water or dam-retting the loss in weight is not so great—say 14 per cent. These discrepancies are no doubt due to the degree of dryness of the straw or the amount of sap left in it. No artificial method of retting has proved so efficacious as that practised from the earliest times. Some of the castings on the Egyptian tombs show the retting dam being filled with water, the laying of the flax therein, and the removal of it afterwards for drying purposes. The water in which flax is steeped, retted, or watered should be saved for use as liquid manure on account of its fertilizing properties.

CHAPTER VIII.

FLAX SCUTCHING.

THE word "scutch" is of doubtful origin, and is supposed to be another form of the word "scotch," when it is used to convey the meaning of separating by cutting, such as chopping off a piece of bark.

Modern scutch mill machinery consists first of all of a butting machine to equalize the root ends of the striks; next, of a breaker or set of crushing rollers, a series of pairs of fluted rollers which crush the straw and break up the "boon" into small pieces, which if the flax has been skilfully retted are easily separated from the fibre by the strokes of the beater, a series of revolving blades called "handles."

As we have already emphasized, in order that the maximum yield may be obtained in scutching and hackling flax, it is advisable that in pulling, the long and short stems be kept separate as much as possible and the root end even. The evenness of the root end must furthermore be maintained through all the stages of preparing the fibre for spinning. To ensure the evenness of the root end of the striks of flax straw presented to the scutcher, the ingenious machine shown in section has been devised, and is being successfully used in several large scutch mills both at home and on the Continent. The machine comprises a slightly sloping table *b*, with a back *h*, against which the flax straw is placed root end down on the table and leaning against the back. A vibratory motion is given to the table by the crank *e* and the connecting rod *f*, which motion causes the individual stems to settle down by gravity, being prevented from falling sideways by a horizontal bar *i*, fixed to the back and having projecting spikes *l*, which enter the bundles of flax straw. The table is mounted on springs and the spiked bar is vibrated by a crank or eccentric and connecting rod *k*, at the rate of about 450 per minute, the throw being about $\frac{3}{4}$ in.

Although in some parts of Ireland there are still vertical sets of three-fluted rollers at work giving two "nips," also at least one set of flax beetles, horizontal sets of four to eight pairs of fluted rollers giving four to eight nips are now almost

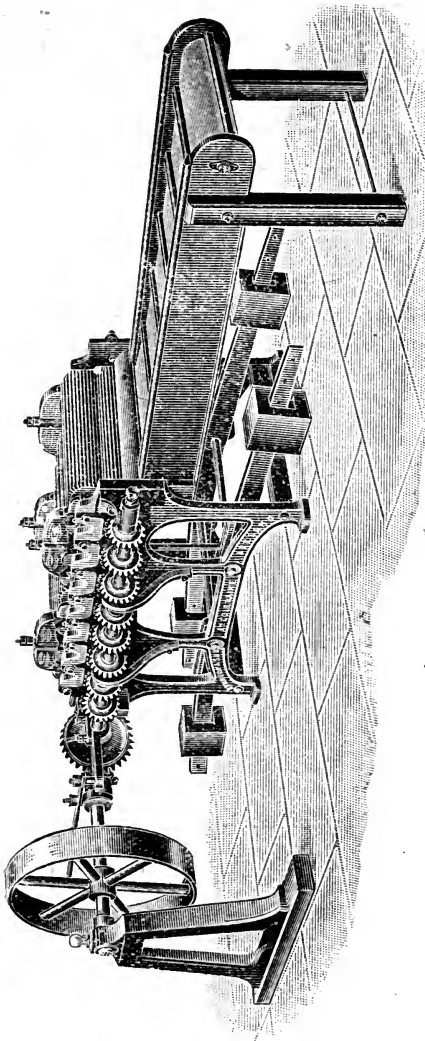

Modern horizontal set of flax straw crushing rollers.

universally employed, and such a set is illustrated herewith. The crushing rollers are heavily weighted either by levers and weights or by spring or rubber buffer pressure. In the old vertical and new Williamson machines the flax straw is guided into one nip, constrained by a guide to follow the centre roller or the end roller of a row, as the case may be, and passes out again to the attendant through the second or

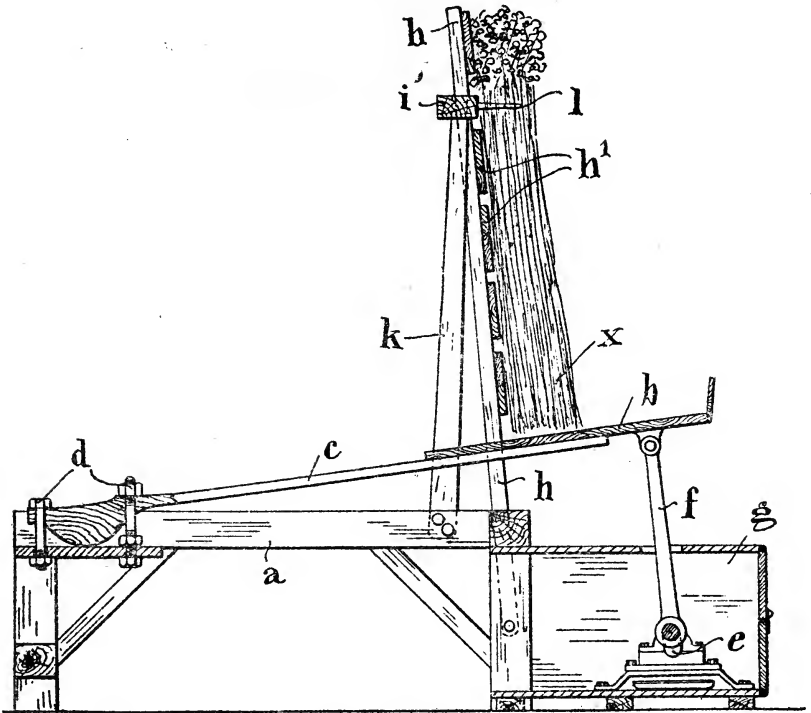

Butting or root levelling machine for flax straw.

last nip respectively. The old vertical machine is 6 ft. high, and occupies floor space 7 ft. by 5 ft., weighs approximately 13 cwt., and costs in normal times about £21. Its production is sufficient for a four-stock mill. It requires about two horse-power to drive it. A four-pair set of rollers usually suffices for a four to six-stock mill, but for over six stocks a six or eight-pair set is generally used. A four-pair set occupies floor space 7 ft. by 9 ft. 6 in., weighs about 23 cwt., and costs approximately £28 in normal times and requires $2\frac{1}{2}$ horse-power to drive it.

A six-pair set occupies floor space 7 ft. by 10 ft. 6 in., weighs about 31 cwt., costs £38 in normal times and requires three horse-power to drive it. An eight-pair set occupies floor space 7 ft. by 12 ft., weighs 40 cwt., and cost before the war £48. These machines are either belt driven with fast and loose pulleys or are driven direct from the wiper shaft by means of a clutch. They should be fitted with an automatic throw-off motion in case of accidents. The rollers are about 8 in. in diameter, and have from fourteen to twenty-four flutes, $\frac{1}{2}$ in. to 1 in. deep.

Flax breaking or crushing rollers are always fluted. As it is absolutely necessary that the fibre be not injured, the flutes should not bottom and thus run "hard to hard." The bottom rollers are positively driven while the upper ones turn by contact with the lower set. The positive drive of the bottom rollers usually consists of a side shaft and clutch.

Occasionally in addition to the set of fluted crushing rollers there is a pair of plain or scratch-fluted delivery rollers and sometimes two such pairs, between which a pair of winged cleaning or scraping rollers may be run at a comparatively high rate of speed—say, 250 revolutions per minute—to scrape off adhering woody matter or "shove," the rollers being so geared that the wings in one intersect between the wings of the other. In order that these rollers may not lap, they are frequently perforated and hollow, and a stream of air is pumped through them. The crushing rollers make about twenty-eight revolutions per minute. Their surface speed is thus only about one-ninth that of the scraping rollers.

In such horizontal sets of rollers the fluting of the succeeding pairs of rollers becomes progressively finer, with the object of breaking the straw in a large number of places, or making the particles of woody matter to be knocked out smaller.

With the vertical 3-roller set of rollers this of course cannot be done, nor can it be with the latest form of horizontal set, which being little more than an enlargement of the 3-roller type gives twelve nips with four rows of four rollers, or sixteen rollers in all. The main advantage of this latter machine is a saving in floor space, as a machine to give twelve nips occupies no more space than a four-pair horizontal machine of the usual type, which gives only four nips. Furthermore the fact that the pitch of the flutes on the rollers is the same from one end to the other does not of necessity mean that at each nip the straw is caught and

broken again at the same spot. The centre to centre distance of the rollers should be so calculated with relation to the pitch of the flutes that the straw is each time broken in a different place. We repeat, the more completely the straw is broken up without injuring the fibre, before being submitted to the operation of scutching proper, the greater the yield of long fibre and the better the quality of the product. Even the best scutchers cannot take the greatest possible yield of long fibre out of the flax straw unless the woody part is thoroughly crushed and broken by the rollers, so that the piece being scutched falls slack and supple over the scutching stock. If the straw is so prepared and the stocks and handles properly adjusted, the handles scutch right into the heart of the piece at first contact. If not sufficiently "rolled" the mill will hammer and waste the ends before the middle of

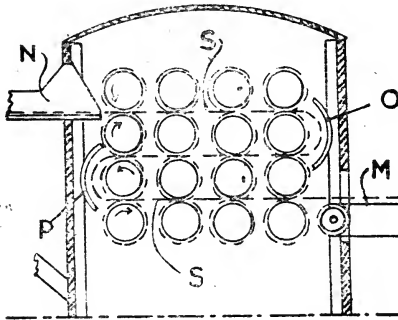

Diagram showing the principle of Williamson's patent flax rollers.

the piece is broken, consequently when clean of shives, the fibre is reduced very much both in quantity and quality.

An end section of the central part of an Irish scutch mill is shown in the figure. AA are the horizontal shafts upon which the "rims" or "circles" B are keyed. CC are the scutching blades or wipers of wood, screwed or bolted to the rims. The stocks D consist of an upright board or iron plate, in a slot E in the side of which the flax is held by the scutcher, who stands on one side while the revolving blades C strike the flax in rapid succession on the other. Irish scutch mill handles are fewer in number and much heavier than those used in Belgium. They are more severe on the flax and make more tow, but until retting becomes a science, as it is on the Lys, they must be preserved. Six-point rims give

very satisfactory results. There are two sets of handles—one for doing the rough work or cleaning, and the other for finishing or buffing. The buffing handles are bevelled on both sides of their face, while the cleaning handles are rounded off on the side away from the scutcher only.

The number of blades on the rim of the Belgian circles is ten or twelve. The rims are about 4 ft. in diameter and the blades $\frac{3}{8}$ in thick. They are of walnut wood, 27 in. long, projecting 10 to 12 in. beyond the rings or circles, $5\frac{1}{2}$ in. wide, tapering to $4\frac{1}{2}$ in. at the point. These blades are held in

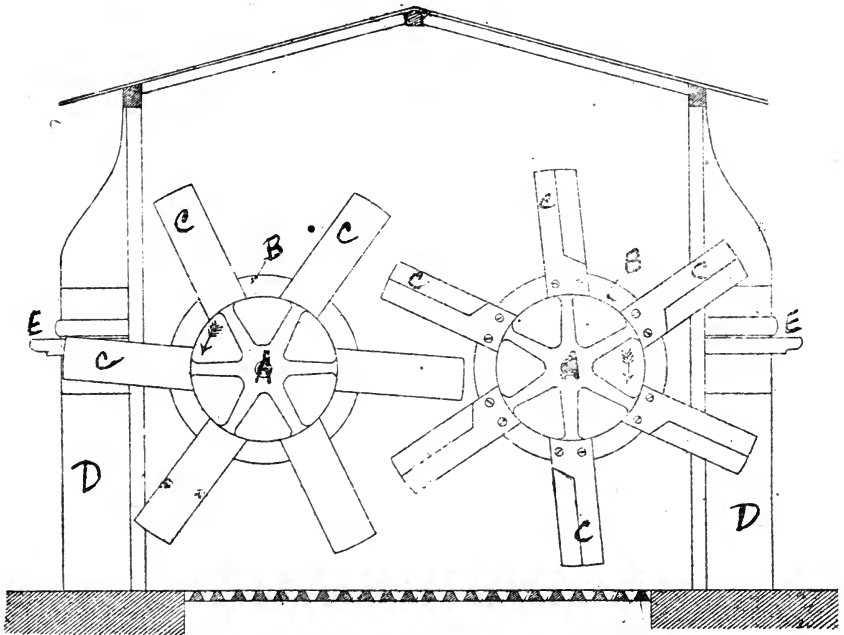

Section showing stocks and handles of an Irish scutch mill.

position by two steel rings, which are riveted to an iron boss, keyed upon the driving shaft.

In Irish mills the diameter of the wiper rims varies from 3 to 4 ft. Three-foot rims are now generally considered too small, although the Department of Agriculture recommend them. Rims 3 ft. 6 in. in diameter are now more general. In normal times, including shafting, pedestals and cast-iron stands, they work out at about £5 per stock. Continental

rims are quoted at 16s. each; walnut blades at 4s. 6d. per set, and stocks 6s. each.

The hand-board or stock should be in line with the centre of the scutching shaft and the back of the handles 4 or 5 in. above the hand-boards.

NUMBER OF HANDLES ON THE ROUND.

“The number of handles on the round which is to be most recommended has always been a debatable question: the

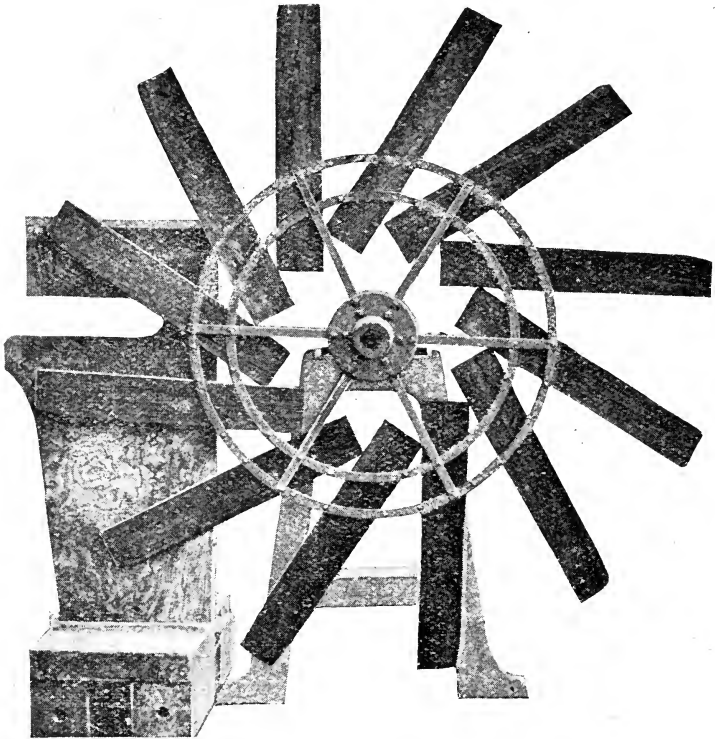

By the courtesy of Messrs. Wigglesworth & Co., London.]

Continental scutching rims and blades.

general rule being that whatever number happened to be on a particular mill, that number, of course, was bound to be the best. There are strong advocates for all styles—5, 6, 7 and 8 on the round—and for so far nothing has been definitely proved. I think that in considering the merits of a mill it

is necessary to consider the diameter of the scutching circle equally as much as the number of handles. Take a mill measuring 6 ft. diameter from point to point of scutching handles. You have a circumference of 18 ft. (it is not necessary to go into fractions), and with six handles on the round there will be 36 in. between each scutching edge. Take another mill, measuring 7 ft. diameter, with seven handles on the round, and you have the same 36 in. between each scutching edge, and practically the same mill. But take a 6 ft. diameter with seven handles—the same diameter with eight handles—and you will have only a distance between each scutching edge of about 31 and 27 in. respectively. It seems to me that 36 in. between scutching edges is about the proper standard, as this space allows the scutched piece to 'rise,' or, as I might say, shake itself out in preparation for the next 'bat,' which is consequently much more effective. With the smaller space between the scutching edges the flax is covered continually by the handles. It has not got room to 'rise.' The handles are not as effective as they should be, and it is more of a 'rubbing' than a 'scutching' business. Every stalk has to be in direct contact with the handles, requiring much more handling by the operator, and the finished piece, instead of being whole in the fibre and well 'closed,' will be considerably broken and 'spongy.'

"Apart from the number of handles on the scutching rim, a most important thing is the proper setting of both stocks and handles."

THE VENTILATION OF FLAX SCUTCH MILLS.

The ventilation of flax scutch mills is usually effected by fans placed in the walls of the partitioned-off shove chamber behind the stocks and handles.

A centrifugal fan (blower type) connected up with a collecting tube is, however, much more effective than extracting fans of the Blackman type placed in the walls or roof.

The figure shows the Courtrai plan of scutch mill ventilation which has been found to be both cheap and effective. A is the circular path of the tips of the fan blades F and K, pieces of board attached to the forked arms projecting from the boss G keyed upon the rim or circle shaft. These blades revolving clockwise draw in the dust through the circular intakes at each side around the shaft and 16 in. in diameter, and expel it through the outlet pipe E, 14 in. in diameter,

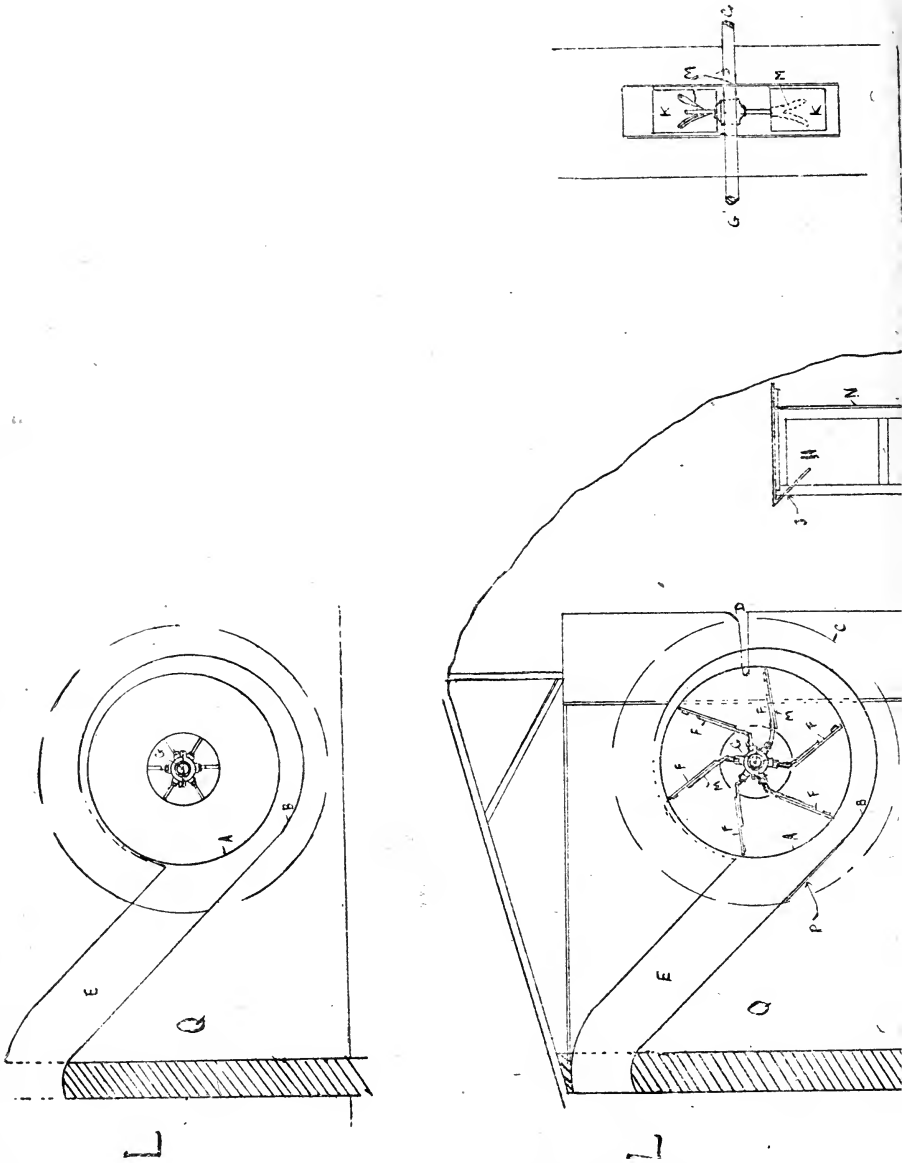

Belgian method of flax scutch mill ventilation.

which must be smooth. The tips of the fan blades should pass as close as possible without touching to the upper junction of the outlet pipe and the circular casing, which is slightly eccentric, to the revolving shaft and fan. There is a passage at Q underneath the outlet pipes to remove tow and an inspection door at the lower junction of the outlet pipe and fan casing. The fan blades may conveniently be of seasoned beech, $12\frac{1}{2}$ in. wide and 17 in. long. The casing is of $\frac{1}{8}$ in. sheet steel and $13\frac{3}{4}$ in. wide. The distance apart or pitch of each set of scutching blades is 33 in. and the fan is placed on the shaft exactly between two of them, there being one fan for every three handles. The shaft and the fan make 230 revolutions per minute. S is a baffle-board attached to the flax table to keep the draught produced by the handles down; while N is sheeting hinged on sliding doors which may be fitted at the back side of the flax table. The fan casing and outlet pipe may be of $\frac{1}{2}$ in. wood sheeting tongued and grooved, in which case the outlet pipe may be of square section.

The removal of the dust produced in rolling or crushing the flax straw by means of fluted rollers is best secured by filling in the framing of the machine with wood or sheet iron so as to make it air-tight; the only places where air can enter being between the pairs of rollers, i.e., just where the dust would issue were the machine not connected up with an extracting fan. Occasionally the dust is removed by suction, operating through a hood or hoods placed over the top of the rollers, but the downward draught is to be preferred.

In country mills, the dust may usually be discharged directly into the atmosphere, as it does little harm if the mill is not in close proximity to a dwelling house. If discharged in this way, the fan outlet should not face the direction whence comes the prevailing wind lest free discharge of the fan should thereby be obstructed, the usual fan being incapable of overcoming much resistance of that sort.

Should the position of the mill be such as to render the dust blown out by the fans a source of nuisance, a cyclone dust separator and settling chamber must be provided, or other means adopted to smother the dust at once, such as the projection of the dusty air into a stream of water. If blown into the open air it must be carried well away from any inlets lest it be again carried into the building.

The cyclone separator, above referred to, is constructed in such a way that the heavy waste falls downwards into a chamber, while the air escapes from the upper portion.

It is probable that a cyclone separator would pay for itself sooner or later in saving saleable fibre which would be lost were it blown out into the open air.

Turning now to the working of a flax scutch mill. Nothing is of more importance in obtaining maximum yield of long fibre from the flax straw than careful streaking or "stricking" and especially in keeping the butt or root end level, i.e., long or short stems if such are present, or all stems, on the same level as they grew in the field. This squaring of the root end may be done either by hand or by the "butting" machine already described. If done by hand, the handfuls or beets of uncrushed straw must be "chopped" or knocked on the ground and the root end squared as well as possible in this way, protruding stems being pushed upwards and receding stems given a chance of dropping down to the same level. The butting machine, already referred to, does this work, and in a very superior manner, and furthermore straightens out the straw or parallelizes the stems so that the bulk is much more easily separated into handfuls by the feeder of the crushing rollers without producing loose and displaced stems. When the straw has not been prepared in this way the streeker, who separates the beets into handfuls for the rollers, finds some difficulty in separating these handfuls, the stems not being perfectly parallel. Loose and straggling stems are consequently produced, which being displaced are often lost in the tow and go to diminish the yield of long flax. To minimize this, streakers ought to pull out these loose stems by hand and replace them in the proper position.

If properly streaked the crushed straw or fibre comes out of the rollers perfectly square. The attendant gives the handful a twist and builds the pieces into a bunch for the scutcher.

An up-to-date set of rollers is an absolute necessity if best results are to be obtained both in quality and quantity of fibre. If the straw has been properly crushed and in fairly small pieces, the scutcher requires no more than the average strength and muscle to hold the piece against the stroke of the blades and prevent the fibres slipping and the piece getting out of shape.

In spite of care, however, it must be emphasized that the best scutchers in the world cannot repair the damage done by bad pulling, unskilful retting, careless spreading, drying and gathering.

We repeat that rolling is one of the most important

operations of the scutch mill. The flax must be kept and given to the rollers in good shape, butt end square and even, if the best results are to be obtained. If not sufficiently rolled, the scutching blades hammer and waste the ends before the middle of the piece is broken. Consequently when clean of "shows" or "shive" in the centre, the fibre is reduced very materially both in quantity and quality. This matter can be easily tested in a very practical way. Take two beets of the same quality out of the same lot. Put one through the rollers and scutch it. Then scutch the other without any rolling. Note the results both in quantity and quality of fibre. A somewhat similar result will be obtained by testing an up-to-date set of flax rollers against an inferior and worn-out set.

Flax should not be scutched immediately after grassing, for the straw is then hasky and fresh, and much of the fibre will be carried away by the handles and the yield much deteriorated both in quantity and quality. By keeping the straw in stack at least a month before scutching, the fibre is much improved both in strength and spinning quality. It is also improved by merely buffing it at the first operation and holding it over for twelve or fifteen days before finishing it.

In scutching, the scutcher takes the handfuls of crushed or rolled straw from the bunch made up from the rollers and holds them one at a time in the notch E of the upright stock. First the root end is operated upon by the revolving beaters C, and then the piece is turned and the top end scutched, the piece being opened out and exposed to the action of the handles by the fingers of the right hand while firmly held by the left. When the scutcher has thoroughly cleaned his piece or strick, he pulls out loose fibres from the ends, gives the piece a turn to keep it together, and builds it with others into a bundle of given weight, usually a stone of 14 lb., which is bound with flax bands ready for the market. Courtrai and Hasnon flax is made up into bottes, of which seventy-two go to make up a 2-cwt. bale. Bruges flax is put up into Flemish stones, of which there are twenty-seven in a 2-cwt. bale. Unfortunately the weight of a Flemish stone is not at all regular, for 33½ Waereghem stones, 34 Ghent, Wetteren or Welle stones, 36 St. Nicholas, Malines, and Lokeren stones are required to make up a 2-cwt. bale. Dutch flax is put up into stones of which thirty-six make up a 2-cwt. bale.

In the flax scutch mills around Courtrai, the ends of the cleaned strick are combed out on a little hackle, and the

loose fibres pulled out by means of a touch pin. The strick is furthermore so handled and rubbed up that it presents a very sightly appearance. There being twelve point rims in a Flemish mill or twelve blades to the round, the effective diameter of the circle being 4 ft. 6 in., and the shaft making 175 revolutions per minute, about 2,100 strokes are given per minute by the blades, the speed of which is nearly 2,500 ft. per minute. In Ireland, although the shaft runs faster, a fewer number of heavier strokes are given as there are only approximately half the number of blades to the round.

The yield of scutched flax is approximately 22 per cent. of the weight of the dried and retted straw, although only about 4 per cent. of the weight of the green stems, or 9 per cent. of the weight if the same are dried.

The relative average yield of scutched flax and tow produced in an Irish scutch mill may be taken to be as follows:—

Retted and dried flax straw	100'00
Scutched flax therefrom	14'84
Fine tow	3'32
Coarse tow	12'33
Waste or shive	69'51

A scutcher in an Irish mill turns out about 1,000 stoncs of flax in a season of twenty-six weeks. His wages average about 1s. 3d. per stone of scutched flax.

SCUTCHING.

Mill scutching, so called because the operation is effected in a scutch mill employing four or more scutchers, besides the roller man and strickers, &c. The mill is usually driven by water power, oil or gas engine.

Wooden or sheet-iron covering surrounds the revolving handles like a drum, except at that point left open to introduce the strick into the notch of the stock. The sheeting in of the handles protects the worker from injury and keeps in the dust to some extent.

The scutcher holds the handful of rolled straw in his left hand, supported against the back of the stock. With the fingers of his right hand he constantly opens and turns over the fibres of the piece so that the beaters or scutching blades clean every portion of it.

A *treadle scutch mill* is often used in Belgium. The machine works on the same principle as in a scutch mill, but instead

of being in series the machines are single, and the revolving blades, turned by one or two cranks and pedals, actuated by the feet of the scutcher himself. The operation is a tiring one, as both hands and feet are occupied at the same time, while the production is not up to that of the scutch mill.

Hand scutching requires only two tools—i.e., a vertical plank or board firmly fixed in a stand and a hand scutching blade of special form and consisting of a handle, a wooden knife blade and a heavy back portion to balance the blade and lend weight to the blow. The scutching blade itself is generally made of walnut. The hand scutcher holds a handful of the crushed or broken straw by one end with his left hand. He passes the other end of the piece into the notch in the vertical board and strikes this end with the scutching blade, which he wields with his right hand. The flat surface of the stock or stand guides the blade, which is thus forced to slide along the whole length of the exposed fibres. The scutcher should frequently turn the handful over and inside out, so that every portion of it may be cleaned. Now and then he should stop, lay down his blade, and open out the fibres with the fingers of his right hand, so as to bring to the surface those reeds of fibre which have not been touched, so that they may be struck in turn. The more frequently the flax is opened in this way the better it is cleaned. When one end of the handful has been cleaned he turns the piece and treats the other end in a similar fashion.

The first scutching or buffing having considerably reduced the bulk of the handful, the scutcher combines two or more of the small stricks, thus produced, together into one handful for a final cleaning.

NEW METHODS OF SCUTCHING.

Numerous attempts have been made from time to time to improve on existing methods of scutching but have failed to find favour. The only part of the scutching process which has really been improved upon is the rolling or crushing of the straw preparatory to scutching it. No doubt this is better done now than it used to be, and more yield obtained from the handles.

In spite of improved ventilation the occupation of a flax scutcher is a dirty and dusty one, and difficulty is experienced in getting young men, the sons of farmers, &c., to learn the trade.

It looks, therefore, as if some more mechanical and automatic methods would have to be devised if the cultivation of flax is to be extended.

SOME RECENT ATTEMPTS AT IMPROVEMENT.

The following brief description of attempts at improved scutching methods may give someone an idea or save his time in unknowingly going over old ground.

In the early nineties there was exhibited under the agency of Mr. Hyndman at an exhibition held in the old White Linen Hall, Belfast, now the site of the City Hall, a flax scutching machine of particular merit. After being submitted to the crushing action of a set of rollers of rather finer flutes than usual, the handfuls of crushed straw were fed by hand between two endless steel holding and conveying bands. These bands resembled the steel blades of a band-saw, but were carried around flanged pulleys lying horizontally. One side of each endless band travelled in the same direction along parallel lines about three inches apart. Between them lay on edge a fixed and smooth bar. As the upper edges of the steel bands were serrated and the piece passed over one serrated edge, under the fixed bar and over the other serrated edge, it was held quite tightly against a longitudinal pull. Hanging down from the grip of these holding and conveying bands the flax straw was struck by longitudinal beater bars carried on radial spokes like the barrel of a reel; these struck close up to the point where the straw was held, and the stems being thinly fed in, spread it out, and pretty thoroughly cleaned one side of the half of the piece. After travelling a distance of six or eight feet, the circular beater came to an end, while fixed guiding plates caused the depending fibre to pass on to another similar beating barrel turning in the opposite direction, which cleaned the other side of the same root end of the piece. The half-scutched piece was then passed out of the machine and was placed by hand by the turner or changer between another similar pair of conveyor bands which held the scutched portion of the piece while the top end was being scutched in two operations like the other end. The fully scutched fibre then passed out of the machine and was bundled up in suitably sized stricks.

We believe that the objection of spinners to the product of this machine was that the reed was left too whole, like hand-scutched flax. They like the reeds to be split up or the flax

"milled" as it is by the heavy Irish blades operating upon often under-retted fibre.

In the writer's opinion the system did not get fair treatment, and would be worth trying again now that spinners are, it is hoped, more broad-minded and not so conservative as they used to be. Perhaps the next notable attempt at improvement was Crawford's, which the writer inspected in operation at Willowbank, Belfast. Mr. Crawford, after thoroughly crushing his straw, held the handfuls by hand, one end at a time, over a horizontal edge, while each end in turn was operated upon by a pair of rapidly revolving and intermeshed winged rollers. Combined with automatic feeding and conveying this system may yet prove a success.

McAdam's old scutching drums are nothing more nor less than the "Raspador" used in cleaning hard fibres (see Carter's "Decortication of Fibrous Plants"). Another system, tried both at home and on the Continent, is analogous to Crawford's, the scutching blades being attached to the bars of a vertical sheet hackling machine, the fibre being either carried in screwed holders or carried through by conveyor bands or ropes. As conveyor or holder bands, chains and ropes are in general use for holding fibre in all modern hard fibre decorticating machines, intending inventors would do well to study what is being done in this class of machine.

In the late nineties, M. Vallet-Rogez, of Lille, put on the market his combined system of flax scutching and hackling, and claimed an improved yield of fibre from the straw. His machine resembled a vertical sheet hackling machine and the speed and setting of the beaters could be changed to suit the nature of the flax straw being operated upon. Several rounds of hackles at the finishing end combed out the scutched flax, which was delivered in the form of dressed line. The first round of this part of the machine was fitted with notched hardwood scrapers to clean off sticky shove, instead of hackles.

The high state of efficiency which has since been reached by automatic screwing attachments for machines of this class should add considerably to the success of such machines to-day, but it is possible that a much less costly system of conveying and holding bands, chains or ropes will be found equally efficient. M. Vallet-Rogez claimed that his yield of *hackled* flax was equal if not superior to that of simply *scutched* flax from the ordinary scutch mill. Hence he argued that as flax scutched in the ordinary way only yields, say, 50 per cent. of dressed line from the hackling machine, his process

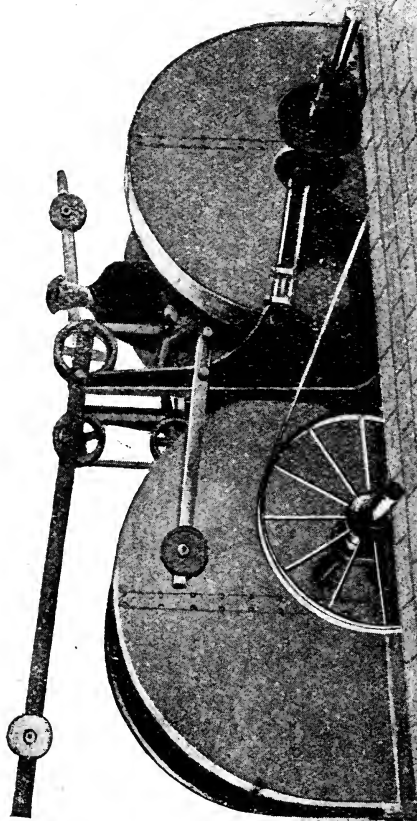

“Speedo” automatic scutching machine.

resulted in a yield exactly double that obtained in the usual way. This result he claimed was due to the parallelism of the fibres being maintained all through and not destroyed by handling. There is no doubt a great deal in this point, which has been carried a step further by the inventor of the automatic spreader.

A recent Continental scutching machine of the Crawford type has its co-operating scutching drums provided with a radial and outwardly directed air blast to prevent the fibre from lapping round the drums, the shafts of which are made hollow and provided with radial perforations which are arranged so as to give the desired distribution of the blast, which is produced by an air pump or fan.

The Helsing machine now on the market combines Crawford's roller with his scutching blades or drums. The crushing rollers are reversible at will, and the scutching rollers situated immediately in front make about 1,000 r.p.m. and turn continuously in the same direction. The operative spreads a strick of straw upon the table while at rest and first passes the root end into the rollers which hold the top while the root is scutched. The crushing rollers are then reversed and the strick run out again and turned and the top end treated in a like fashion. If the straw has been well retted very good results are thus obtained. If not really well retted, a saleable half-scutched flax is the result. As this machine is comparatively cheap and easily run by an oil engine, the writer recommends it to large farmers at home and in the Colonies for winter work.

Flax scutching in Japan is carried out in a much more business-like way than it is in Ireland. The retted straw is weighed out to the scutcher in parcels of 40 lb. Each parcel is passed through the rollers separately and delivered to the scutcher, who when he has scutched it weighs in the scutched flax. If it is found that his yield is above the average, i.e., 20 per cent., he receives a bonus of $\frac{1}{2}$ d. for each per cent. above 20. On the other hand, if he makes too much tow and has, say, only 18 per cent. yield, his rate is reduced by a like amount. In Japan the scutch mills have thirty to forty stocks, and a spirit of healthy rivalry exists among the scutchers.

In the larger Continental scutch mills about 150 hands are employed. The system of weighing out the rolled flax straw to the scutcher is frequently practised, and serves as a check on the man's work. The average output of cleaned fibre by each scutcher per day is about 3 stones.

Co-operative scutch mills are common in Belgium, and fitted up with up-to-date machinery. Each shareholder owns one or more stocks, and usually scutches his own flax. The tow is forfeited to the society for the repair of the machinery, rent, &c., and the profits, if any, are divided among the shareholders at the end of the year. The price charged for scutching is about 1d. per lb. if the tow is taken away. If the tow is left, the use of the mill is given free to the member who is having his flax cleaned, but during this period he is responsible for payment of the scutchers employed.

Under pre-war conditions scutching of Irish flax cost 20 per cent. of its market price. Under war conditions, even at a cost of 2s. 6d. per stone with the tow, or 3s. per stone without the tow, the cost of scutching represents less than 10 per cent. of the value of the scutched flax.

In Holland and Belgium the pre-war cost of all operations, from the rippling of the seed to the baling of the finished flax and tow ready for the spinningmill—viz., rippling, bundling, retting, drying, breaking and scutching—is £3 10s. per ton of straw (basis two steepings).

Some Irish farmers want their flax to weigh heavy, and so do not encourage the scutcher to clean it properly. They evidently have not considered how light "shives" weigh, and how much they lose by keeping them in the flax. In 100 stones of flax, if the shives are left, there would not be more than 14 lb. of shives. Say, for instance, they get 20s. per stone, bringing in £100, if the shives were removed they would have 99 stones selling at 24s. per stone. In the one case they receive £100 and in the second £118 16s. Have they not sold their shives dear?

Although hand scutching has practically died out in Ireland, in the "blue" districts of Holland and Belgium where the farms are small, hand scutching is still pretty general. One man working with a hand roller and a hand scutching blade can clean about 1½ stone of flax per day.

The by-products of scutching are rug, tow and shives. Rug is the coarse dirty tow made in the first cleaning of the flax, tow the short fibres cut away by the finishing handles, and comparatively clean and fine, while the shives are of course the broken-up woody matter of the stem, which may be burned or returned to the soil as manure.

Until recently scutch mill owners charged a comparatively low price for scutching and kept the rug and tow produced, rescutching and selling the rug and tow at the end of the

season, and thus making a considerable profit. Now that tow is so valuable, farmers are paying a higher price for flax scutching and demanding possession of the rug and tow, for which the millowner charges 20s. per cwt. for rescutching, the product "targed tow" being now worth 80s. per cwt. in the market. In its rough state the market value of rug is now about 20s. per cwt., and of fine tow 45s. per cwt. Rug is rescutched or targed in wads or mats in a somewhat similar fashion to flax, over the same handles set rather wider.

The mechanical decortication of flax without retting is, as we have previously said, useless in our opinion, for the reason that the pectic matter remains insoluble and in excessive quantity upon the fibre and prevents it from being subdivided by hackling, and also from being spun to fine numbers, as the gum cannot without fermentation be softened by maceration in hot water and the ultimate fibres drawn out and separated.

The most successful machine for the purpose is, we believe, that of Mr. Gray, of Glenanne, Co. Armagh, and made by Messrs. Combe Barbour, Belfast. In principle it is an ordinary set of flax rollers, combined with which are rapidly vibrating or vertically reciprocating frames placed in juxtaposition, between which the broken-up boon is rubbed off the fibre more or less completely.

IRISH FLAX SCUTCHING.

Evidence given before the Committee appointed in 1917 by the Irish Department of Agriculture to inquire into the charges for scutching and the disposal of tow affords some interesting reading. It appears that the scutch mill-owner either charges the farmer a comparatively large fee, say, 3s. 6d. per stone, for scutching his flax and allows him to take the tow produced away and sell it, or else he charges a much smaller fee, say, 1s. 9d. per stone for scutching and keeps the tow. When the farmer pays the larger sum he can often sell the tow to the mill-owner at from 4d. to 8d. per stone to 10s. per cwt. for rough tow, and £1 per cwt. for fine tow.

Mr. Alex. Cromie handed in a return made out on the basis of scutching 8,000 stones in a season of twenty-six weeks. That return showed the actual cost of scutching to be 3s. per stone, allowing for interest on invested capital and 2½ per cent. depreciation.

Mr. F. B. Small considered that every stone of flax now

cost him 3s. 8d. per stone for scutching, and produced a return in support of that statement.

Mr. Samuel Cupples produced a return showing that the scutching of 7,000 stones of flax in the season cost him 3s. 2d. per stone.

Mr. J. M'Kean said that without getting the tow he could not scutch flax for less than 3s. 6d. per stone.

Mr. Carville gave a detailed account of the working expenses of his mill, in which he invested £1,200. He had nine scutchers and they turned out 9,000 stones of flax in the season. He paid them 1s. 3d. per stone as wages. With £100 for himself as manager, and insurance, fire, light, &c., this left the total expenses at £1,105 16s. 5d. per year.

Mr. Ewart, Ards, said that in order to get a fair profit, owners could not scutch for less than 3s. 6d. per stone and let the farmer have his tow.

Mr. Jas. Boyd said that at present in the Kirkcubbin district of the County Down, 2s. 3d. per stone was charged for scutching and the mill-owner retained the tow.

Mr. Small, representing Loughbrickland Farmers' Association, said that they had established a mill and were going to scutch the flax at 3s. per stone, and scutch the tow for the farmer as well.

Mr. Dolohan stated that in Sir Robert Liddell's new mill at Donaconey, the charge was 2s. 9d. per stone and the farmer got his tow.

Sometimes the charge for scutching includes, say, 2d. for insurance.

Several co-operative scutch mills have been established by bodies of growers who were dissatisfied with the system of letting the scutchers keep the tow.

Farmers would like to have their tow scutched directly after the flax; mill-owners, however, would prefer to keep it until the end of the season and then scutch it.

Mr. John Jeffers believed that if there were better streaking and rolling in mills there would not be so much tow.

SCUTCHING TOW QUESTION.

In the olden days when flax scutching tow was only worth £12 to £18 per ton, the scutch mill-owner charged the farmer only a small fee, say, 1s. 6d. to 1s. 9d. per stone, for scutching and kept the tow produced. At the present time, however, when tow is worth from £80 to £100 per ton, the grower is

naturally anxious to realize all he can on his own produce and refuses to be put off with the tow allowance made in the years when scutched flax only fetched 6s. to 7s. per stone in the market.

From evidence given before a committee appointed by the Department of Agriculture to inquire into the charges for scutching and the disposal of tow it would seem that the actual cost of scutching was in 1917 approximately 3s. 3d. per stone, of which the operative scutcher got 1s. 3d. as wages. The charge made for scutching the rug is approximately 20s. per cwt. In 1917 the market value of rug was 20s. per cwt., and fine tow 45s. per cwt., and targe rug 75s. per cwt.

LINEN MANUFACTURE.

In the manufacture of flax distinction is made between the mill, the factory and the warehouse. Flax is spun into yarn in the mill; yarn is manufactured into cloth in the factory; while subsequent processes, such as embroidering or otherwise ornamenting, making up into handkerchiefs, &c., folding, boxing, &c., are carried on in the warehouse.

A weaver would never refer to herself as a millhand, nor would a hackler or a spinner be called a factory operative.

The average flax spinning mill in Ireland contains approximately 20,000 spindles and employs some 750 workers, of whom about three-fourths are women and girls. The management of such a mill consists of the following: (1) The owners of the mill or the directors of the company owning it. (2) A mill manager. (3) A head sorting master. (4) A head preparing master. (5) A head spinning master. (6) A flax buyer, and (7) a yarn salesman.

The usual processes in an Irish flax-spinning mill are as follows:—

Hackling-room.—Roughing or piecing out; machine hackling; sorting by hand.

Preparing-room.—Spreading; drawing and doubling (3 to 5 processes), and roving.

Spinning-room.—Wet spinning.

Yarn Department.—Reeling; yarn drying; yarn bundling and baling.

CHAPTER IX.

FLAX HACKLING.

THE Irish scutcher usually makes up the handfuls of cleaned fibre into bundles of one stone weight, but sometimes into larger bundles or double stones, in which case it is sold by the hundredweight instead of at so many shillings per stone.

The Flemish and Dutch scutcher cleans his flax better and makes it into a smaller and differently shaped bundle, "head" or botte, weighing from 6 to 9 lb. in different markets.

Russian flax is put up in bundles somewhat like the Irish stone and up to 20 lb. in weight. It is roughly graded into several qualities according to colour and spinning quality, each quality having its own mark, such as K, PK, SPK, &c., which have well-known relative market values.

Received at the mill, each lot of flax is given a number and stored away until required, a note being taken of the characteristics of each.

The first operation to which it is subjected when required is called piecing-out and roughing.

"Piecing-out" is the separation of the "stricks" and "fingures" or small handfuls of which the bundles are made up, into pieces of suitable size, say, 4 to 8 per lb., for roughing, hand-dressing or machine hackling.

"Roughing" is the operation of combing these pieces by hand through a coarse hackle in order to separate short and irregular fibres and level the ends. This operation is only necessary when the flax has been badly handled by the puller and scutcher. It may be usually dispensed with in dealing with Dutch and Flemish flaxes, or with flaxes of comparatively small value when the difference in value of long line and tow is small. It is usually almost a necessity in dealing with Irish flax and may also be applied in dealing with very expensive flax, so that the greatest possible yield of dressed line may be obtained, for the longest fibres left in the hackle are replaced in the piece.

Hand-dressing or hand-hackling is the complete combing out and splitting of the fibres upon hand tools or hackles. Since the flax plant ripens first at the root and bears branches

at the top, the central portion of the stem contains the best spinning fibre. When such is required for specially fine or superior yarns, the flax may be cut, the roots and tops being removed and the "cut line" middles separated 14, 16 or 18 inches in length.

This cutting is done upon a special machine while the flax is in large stricks, i.e., before it is pieced out.

From the roughing shop, the material goes to the hackling machine. Hackling is a combing process and the work of the machine may be quickly understood if one imagines a man holding up a bunch of flax in one hand while he combs it with the fingers of the other, then reversing the piece end for end and again combing. The hackling machine consists essentially of two long endless sheets of hackles revolving vertically side by side. Each of the sheets is some 70 inches in circumference and is made up of 24 to 30 hackles per round, each from 10 to 13 inches long and formed usually of but one row of steel pins about 1 inch out of the wooden stock in which they are set. The machine boy or filler who stands at the end of the machine lays a piece or two of the roughed flax in a clamp, or holder, which lies open before him and screws together the two flat sides of the clamp. He places this holder with its suspended root end in the groove of a long iron channel or "head" which extends the length of the machine above the double line of revolving hackles. The head is automatically lowered and the piece of flax subjected to the action of the hackles which comb it from both sides. The head then rises again and the holder is slid forward over the next row of finer hackles. The head then descends again and the piece is combed out by the next round of hackles, and this process is continued to the end of the machine, the flax being subjected to the action of finer and finer hackles. When it reaches the end, the holder is taken out and unscrewed by a boy who first screws the hackled end of the piece in another holder, which is then passed to the other machine (for these machines are worked in pairs) through which it makes its return journey and in which the top end is thoroughly combed out or hackled as was the root end. It is finally received by a fourth boy, who unclamps it and lays it crosswise over other pieces until he has enough to make a bundle or tippel, because the ends are tipped or tied together like a top knot. These bundles are then sent to the preparing room or to the sorting room if the flax is of very superior quality.

In recent years the hackling machine has been improved and made so automatic in action that one boy takes the place of four, the two separate machines being coupled together and tended by one boy at the front end, his work being simply to lay the pieces of roughed flax in the open holders, and then to take out the hackled flax when the holders have returned after making a circuit of the machine. The machine automatically screws up the holders, places them in the channel of one machine, unscrews them at the far end, and draws the flax through so that the part in the holder itself may be hackled with the top end, screws up the holders again, and places them in the channel of the second machine. When they reach the other end they are again unscrewed and the covers lifted ready for the machine boy to take out the finished piece and insert another. This improved machine, which is now largely used, not only saves in the cost of labour by one boy doing the work of four, but also makes less and more uniform tow by reason of its screwing up all holders to exactly the same holding power.

For very coarse flax the machine is arranged with as few as nine tools or rounds of hackles with pins spaced from four inches apart up to six pins per inch, while for fine Courtrai flax it may have as many as twenty tools, with pins successively spaced from two inches apart up to as many as fifty-six per inch. The closer the spacing the finer the pins, which are usually one inch long. With hand screwing the hackle sheets usually make from four to twelve revolutions per minute and the head raises and lowers the flax four to six times, throwing out four to six holders in the same period of time. With automatic screwing as many as ten lifts of the head per minute may be made, the speed of the hackling sheets being increased in like proportion. According to the size of the pieces and the number of lifts per minute, the production of the combined machine varies from 500 to 1,000 lb. per day of hackled fibre. The finest fibre is hackled in the smallest pieces and with the slowest speed so as to secure the best results.

A still further improvement has recently been made whereby the labour on the ordinary spreader is eliminated by combining its operations with those of the hackling machine, so that one boy runs a combined pair of machines that takes in roughed flax and delivers it, after hackling, in the form of sliver or broad ribbon ready for the drawing frames. The specially designed single sliver spread board attached to a

pair of hackling machines draws the flax from the holder and lays it down on the feed sheet with greater regularity than hand spreading and with much less displacement of the fibres. The resultant sliver is exceptionally level. With this machine

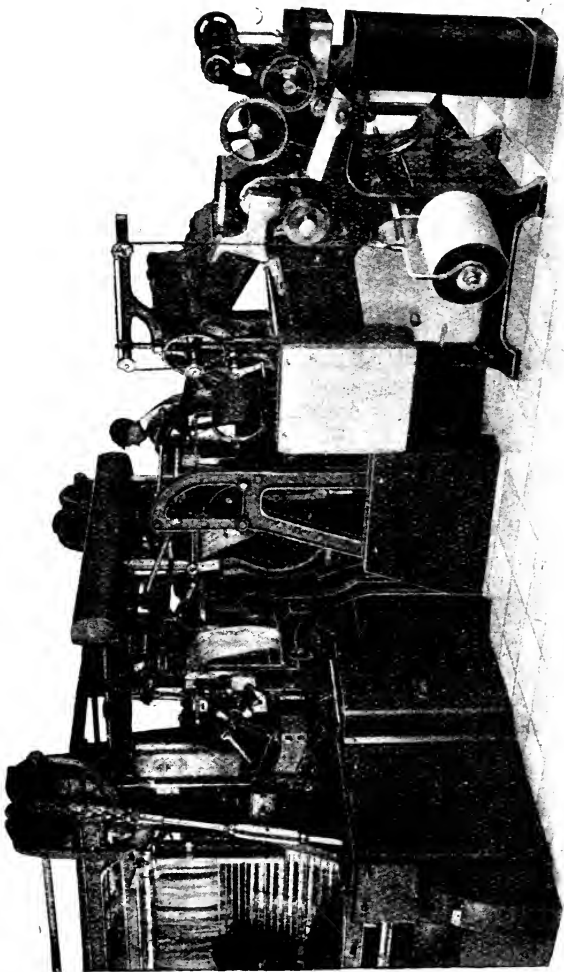

Combined automatic spreader and hackling machine.

the number of lifts per minute can be still further increased as the boy has time to spread the flax carefully in the holder and does not have to pull out and lay down the finished piece. Unfilled holders automatically stop the feed sheet which

starts again when the next full holder is presented. The automatic sliver can-packer attached to this spreader without any attention presses over 50 lb. of sliver into a can 38 inches high by 16 inches by 13 inches. A stop motion acts on the belt if a lump passes through the delivery rollers and when the required number of yards has been packed in the can. This combined patent automatic spreader and hackling machine is the very latest improvement in flax preparing machinery, and is being rapidly adopted by the larger mills both in Ireland and on the Continent.

While in modern practice the bundles or "tipples" of hackled flax usually go direct to the preparing room spreader, valuable flaxes intended for the best and finest yarns are usually sorted or picked over after machine hackling. This is done in the "sorting shop." Sorting proper consists in the careful classification of the fibre combined with the removal of inferior ends by breaking on the touch-pin, the straightening of the fibre over hand hackles, the putting of a "lap" upon the pieces and the building of them into bunches, according to the quality and cleanliness of the fibre.

There are two common bases of dressed line numbering. That usually adopted in fine mills is generally known as "warp numbers," because the line thus classed is supposed to be capable of spinning a fair warp yarn of the lea indicated by the number. Thus we have the numbers 25 to 100 ranging from a coarse dirty flax to the finest Courtrai line.

Another system in vogue in coarse mills has its origin in the Scotch trade, in which the pounds per spangle or spyndle of 14,400 yards indicates the number of the yarn. The line is then classed as No. 1, 2, 3, 4, 5, &c., according as it is supposed to be equal to spinning 1 lb., 2 lb., 5 lb., yarn, &c.

CHAPTER X.

FLAX AND TOW PREPARING.

FLAX is prepared and spun into two general classes of linen yarn: (1) Line yarn; and (2) Tow yarn. We have described the production of long line. Tow is a by-product of the hackling and scutching process, being the short fibres which break away from the long during these operations and are collected in a tangled mass of fibres unlike those of the line which are in parallel order.

The first stage in the production of yarn from either is the formation of an endless sliver or ribbon. We have described how this is done by the automatic spreader. When this machine is not available, or when the flax has been sorted after machine hackling, an ordinary hand-fed spread-board is used. This machine consists of a table over the surface of which four, six or eight endless leathers are carried by means of rollers at either end. The pieces of flax are spread lengthwise upon these travelling straps, one piece overlapping the end of another in such a way that a continuous ribbon is formed.

The straps deliver the fibre through conductors to the feed rollers and thence into the gill box, which is rectangular in form and contains fallers or gill bars upon which "gills," like combs, are fixed. When the fallers rise close to the feed rollers the pins of the gills penetrate the fibre, which is conducted forward by them to the boss or drawing roller. This roller has a surface speed ten to thirty times that of the feed or retaining rollers. The fibre is consequently drawn through the gills, further split up and parallelized. While being drawn through the gill the fibre passes through a conductor slightly narrower than the gill so that a sliver of uniform width is formed. Each of the four, six or eight slivers issuing from the drawing roller is passed through a separate slot in a doubling plate and then all out again through another slot, the tension being maintained by means of a pair of delivery rollers having a slight lead which, drawing the sliver through a conductor, deposits it in a can.

The fallers are thin, but deep bars extending parallel with the feed rollers and resting at the ends upon top and bottom slides, the ends themselves being formed to work in the square threads of revolving screws, by means of which those upon the top slide are moved forward from the feed rollers and those upon the bottom slide in the opposite direction.

This brief description of screw gill faller mechanism and roller drafting applies equally to the doublers, drawings and rovings afterwards used to reduce and equalize the sliver thus formed whether line or tow.

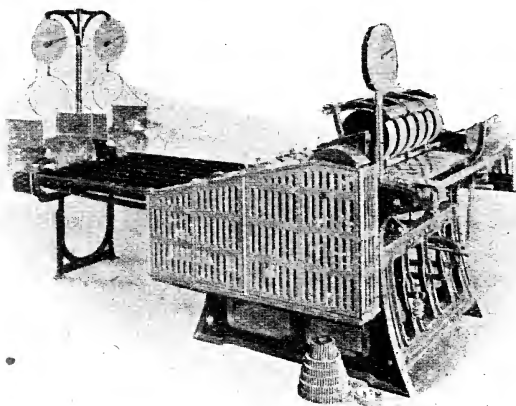

Spread-board, as made by Messrs. Fairbairns, Ltd., Leeds.

The shorter matted and entangled fibres of tow are slivered or made into a ribbon upon a machine called a card, which has held its own as a sliver former and tow hackler, although it is difficult to prevent the loss of some fibre which might, without injury to the quality of the yarn, be retained.

The tow card consists of a pinned cylinder 72 inches wide and 60 inches in diameter, five or more pairs of rollers, 4 to 8 inches in diameter, called workers and strippers, a pair of feed rollers, and two doffers about 15 inches in diameter. The tow to be carded is spread either by hand or by an automatic feeder upon a feed sheet, passes between the feed rollers, is hackled and carried away by the pinned cylinder, which revolves at a surface speed of about 3,000 feet per minute. The five or more pairs of rollers spaced around the cylinder open and work the material still further before it reaches the doffers upon which it is deposited and from which it is stripped by rapidly vibrating knives. The fleeces from

the doffers separate themselves between three drawing-off or calender rollers, which pass the sliver on along a sliver-plate to a side delivery or drawing head, which has as its object the parallelizing of the fibres and the production of a lighter but stronger sliver. It has feed and drawing rollers and gill bars, and is in fact a single-headed drawing frame.

A bell mechanism is generally used in connection with the sliver former, with the object of measuring off a certain length of sliver, say, from 400 to 1,000 yards, into the can. The object of doing so is to prepare a "sett" of cans of fixed length and collective weight, the slivers from which are all doubled together and elongated on the doubler or first drawing frame so that sliver of known length per unit weight or vice versa may be obtained.

The successive drawing frames and roving frame which follow the sliver former, to attenuate and equalize the sliver, are similar in principle to the spreader, but are fed with slivers instead of loose flax or tow. The number of drawing frames to be used, the drafts, the doublings, the pins per inch in the gills and other details vary according to the length of the staple, the fineness and quality of the yarn to be spun. For long line the draft, or number of inches of sliver delivered for every inch fed in, will give good results with an average of 12 per machine for the system or set, but may vary from 10 to 15 and sometimes higher. The doublings per frame may vary from 4 to 16. For instance, in a three-drawing system for making 10 to 16 feet lea = 3 lb. yarn from long line, there may be successive doublings of 8, 6 and 4, while in a five-drawing system for making 120 to 250 lea there may be successive doublings of 16, 16, 8, 8 and 4. The drafting arrangements of the roving frame are practically the same as the drawing frame. When the sliver reaches this frame it has been drawn out to such an extent that if it has to be drawn out still further it must be given a little twist and wound upon a bobbin. For this reason the roving frame is provided with spindles and flyers, which are placed vertically in front of the delivery roller. Additional mechanism is provided to prevent excessive strain being put upon the roving as it is being wound upon the bobbin. No doubling takes place on the roving frame, which may have from 56 up to as many as 112 spindles.

Tow slivers are sometimes combed after they have been produced on the card and once doubled and drawn to straighten out the fibres. The tow combing machine is

wonderfully complex, yet simple when its actions are followed and understood. In reality it separates the slivers into tufts of fibre. The front end of the tuft is combed out by a

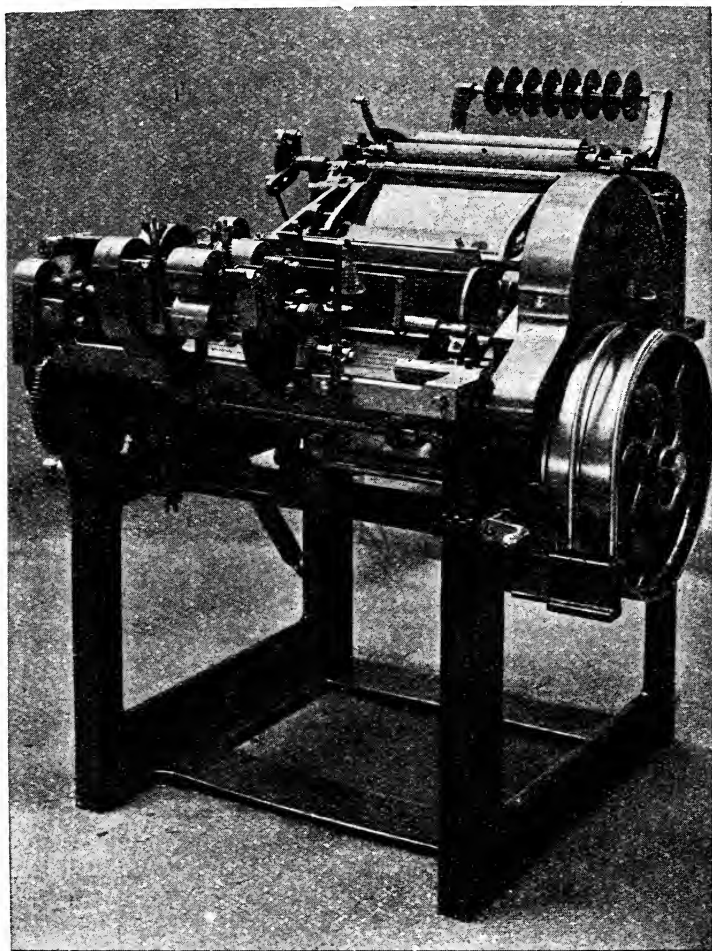

circular comb and the tail end by being pulled through a fixed comb. The combed tufts are caused to overlap and again formed into a continuous sliver, which is again drawn and doubled and turned into rove as before.

CHAPTER XI.

FLAX AND TOW SPINNING.

THERE are two methods of spinning flax and tow yarns, i.e., the wet process and the dry process. While wet spinning is but little practised in Scotland, dry spinning is seldom met with in Ireland. In wet spinning the rove is first passed through a trough of hot water which softens the pectic matter of the fibre rendered soluble by the retting process, so that the individual or ultimate fibres may be drawn over each other and a much finer yarn produced than is possible in dry spinning, in which the ultimate fibres remain bound together forming composite fibres of considerable length.

In the wet spinning of flax the bobbins of rove are carried to the spinning room and set on skewers in the creel of the spinning frame. The rove from the bobbins is then passed over guides and submerged in the hot water trough whence it passes to the feed and drawing rollers, which in this frame are comparatively close together (say, 2 inches centre to centre). The spindles are arranged in one row underneath the point of delivery of the wet and attenuated rove as it issues from the drawing rollers. Flyers screwed upon the spindle tops put in the necessary twist to make a strong yarn, which the flyer winds upon the bobbins which are threaded upon the spindles.

In flyer spinning the bobbin is loose upon the spindle and is pulled round by the yarn and flyer, which leads and wraps the yarn upon the bobbin, which is dragged or retarded in its motion by weighted drag bands.

Flax spinning spindles rarely run at more than 6,000 revolutions per minute. The production per spindle varies with the speed, the degree of twist inserted and the quality of the material.

In the wet spinning room the air is hot and damp, as steam escapes from the troughs and the rove carries water over the lip of the trough, which water is thrown off by the rapidly revolving flyers. The law consequently requires spinners to be provided with waterproof bibs and aprons and

has made rules as regards ventilation. In the most modern mills the spinning room floor is laid with cream-coloured tiles and is sloped in such a way that the water is drained off.

DRY SPINNING.

Gill spinning is sometimes resorted to by flax spinners in the production of special shoe threads up to 16 or 18 lea, the object being to get a strong level thread. The gill spinning frame is of similar build to the roving frame but simpler, the complicated bobbin winding gear of the roving frame being usually dispensed with and the bobbin dragged

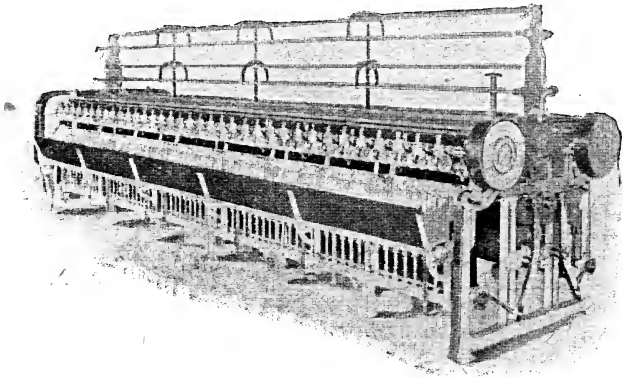

Wet spinning frame, as made by Messrs. Fairbairns, Leeds.

as in the wet spinning frame. However, a spinning roving frame or regulated gill spinner is sometimes used for shoe threads with the object of using a comparatively large bobbin upon which a long length of thread-free from knots may be wound.

Ordinary dry spinning is practised to a considerable extent in the Scotch trade in order to produce a soft full yarn which will cover well in certain cloths or give the fabric a softer and more absorbent feel.

In the dry spinning frame the bobbins of rove produced upon the roving frame are placed upon stationary pins ranged above the feed rollers. The feed rollers are of steel and fluted. The drawing rollers are likewise of steel. The drawing pressing rollers are of wood, about 8 inches in diameter, and tapered to a narrow face. Unlike those of the wet spinning frame, they are placed behind the metal drawing roller, against which they are pressed. In passing between

the feed and drawing rollers the rove is guided and controlled by a breast-plate supplemented by bearing rollers if the reach is very long. The length of reach being equal to that of the longest fibres, the breast-plate takes the place of gills in controlling the delivery of material to the drawing rollers. A small funnel-shaped tin conductor is used to guide the material to the narrow-faced drawing roller. The flyers are screwed upon the spindle tops.

Unlike the wet spinning flyer, which has a wire curl at the extremity of one leg, the dry spinning flyer is made with a fish-tail at the extremity of its leg. The yarn is lapped once or twice around the leg of the flyer and passed through the semi-circular nick in its flattened end to the bobbin. The bobbin rests upon the builder to which, as in the roving frame, is given an up and down motion, so that the yarn is evenly lapped upon the barrel of the bobbin.

The demi-sec or half-dry frame is identical with the ordinary dry frame, but is provided with a brass damping roller running parallel to and just behind and above the thread plate. The thread, while being twisted, rubs against the wet roller, the fibres are laid and a smoother yarn produced.

CHAPTER XII.

THE YARN DEPARTMENT—REELING, DRYING, TREATING, WINDING, AND THREAD MAKING.

WHEN the yarn has been spun, it must be reeled or hanked if it requires to be dried, bleached or dyed. Dry spun yarns which are to be used in the grey state may be cop wound for weft or cheese wound for warp from the spinning bobbin. Fine wet spun yarns, wound in cop form on paper tubes as spun, may be dried upon these tubes and directly used as grey weft. Gill spun shoe threads may be balled from the spinning bobbin. Unbleached yarns are known as grey or green yarns, and in the weaving trade cloth made from such yarns is known as green linen, while that made from boiled yarn is known as boiled linen.

The reel or hanking machine has a collapsible swive 90 inches or $2\frac{1}{2}$ yards in circumference, upon which the yarn is wound into cuts of 300 yards, or 120 threads, and into hanks each containing 12 cuts, or 3,600 yards. Two hundred cuts, or $16\frac{2}{3}$ hanks, form what is known as a bundle or the usual selling unit, yarns being quoted at so many shillings and pence per bundle. When a rise or fall in price takes place it progresses by $1\frac{1}{2}$ d. per bundle.

Very fine linen yarns are sometimes reeled into 54-inch hanks, as is cotton.

A Belgian paquet of linen yarn is equal to three Irish bundles and a French paquet to six.

The number or fineness of linen yarn is gauged by the number of leas or cuts per lb. Forty-lea yarn has 40 cuts per lb. and so on. There being 200 cuts in a bundle of linen yarn, the weight of a bundle of 1-lea yarn is 200 lb. The weight of a bundle of any other lea is easily obtained by dividing 200 by the lea. Thus the weight of a bundle of 40-lea yarn is $200 \div 40 = 5$ lb.

A different system is followed in connection with dry-spun linen yarns, chiefly produced in Scotland. In that trade 48 cuts make a spangle or spyndle, and the weight of a spangle in pounds gives the Scotch number, which is also equal to 48

divided by the lea of the yarn. Thus 3-lb. yarn equals $48 \div 3 = 16$ -lea yarn, or 4-lea yarn equals $48 \div 4 = 12$ -lea yarn.

The Dorset and Somerset system of yarn numbering is based upon the weight in pounds of a "dozen," containing 21,600 yards or 12 half-hanks.

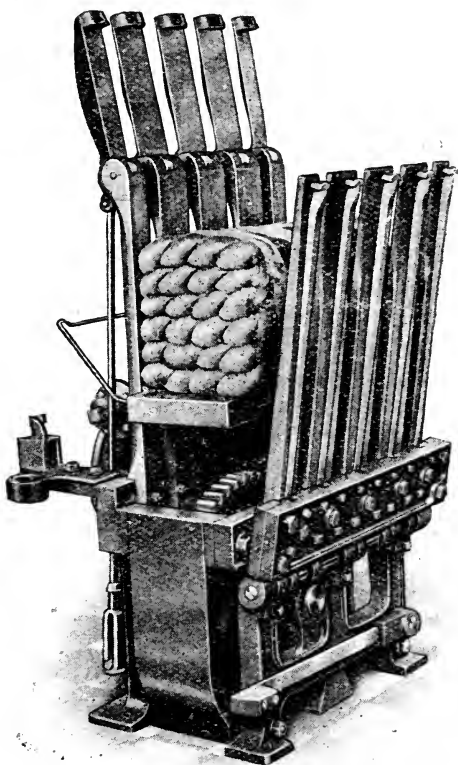

The rapid long stroke power bundling press.

Scotch counts may be reduced to Somerset numbers by multiplying by 3 and dividing by 2, and vice versa.

Irish counts may be reduced to Somerset counts by dividing into 72. Thus 12-lea Irish is equal to $72 \div 12 = 6$ lb. Somerset, or $48 \div 12 = 4$ lb. Scotch.

Wet-spun, dyed or bleached yarn is hung on poles in a drying loft over the boilers or heated by steam, where it

quickly dries; or it may be passed through a continuous drying machine or over heated copper cylinders.

When bone-dry, flax yarn will naturally absorb from 5 to 8 per cent. of moisture under atmospheric conditions and should be allowed to do so, else the yarn will be harsh and brittle in weaving.

Irish yarns are subject to a 9 per cent. discount when sold to weavers, and to 11 per cent. discount when sold through a commission house.

Wet-spun yarns are generally made up for market in short press bundles about 20 inches long. Scotch D.S. yarns are generally stood bundled in the full length of the hank.

Up to 20's lea a press bunch may conveniently contain $1\frac{1}{2}$ bundles or 25 hanks, while 100's lea and finer may be made into 12-bundle bunches containing 200 hanks.

While the average price per bundle of 100's lea line weft was in pre-war days 4s. 7 $\frac{1}{2}$ d., and of 25's tow 6s. 3d., to-day's abnormal price is 28s. and 50s. respectively.

The weight in kilos of a Belgian paquet is found approximately by dividing 270 by the lea, and of a French paquet by dividing 540 by the lea.

Some first-grade flax yarns, spun dry or half-dry from good long line, for shoemakers' or saddlers' use, are balled direct from the spinning bobbin into from 1 to 16 oz. balls upon a hand or automatic baller. Dry-spun yarns intended for weft may be wound direct from the spinning bobbin into a form called a cop, which is put direct into the weaver's shuttle.

Dry-spun or D.S. flax yarns intended for warp may be wound from the spinning bobbin into the form of a cross-wound cheese upon a quick traverse drum winder, which cheeses or rolls go to the bank of the warping machine or to the twisting frame.

Buyers of flax yarns sometimes require them formed into warps or chains upon the warping mill. In this form they may be utilized as weaving warps, but more usually by the hand twine-maker for the manufacture of fishing lines, &c.

The bleaching, dyeing or otherwise treating of linen yarns is done in the hank when required. There are four different recognized degrees of bleaching, viz.: quarter-bleach, half-white or cream, three-quarter and full-white. The treatment consists (1) in boiling in alkaline liquor, (2) reeling in solution of bleaching powder, (3) souring in weak acid solution, with intermediate washings and repetitions of these operations until the desired result is obtained.

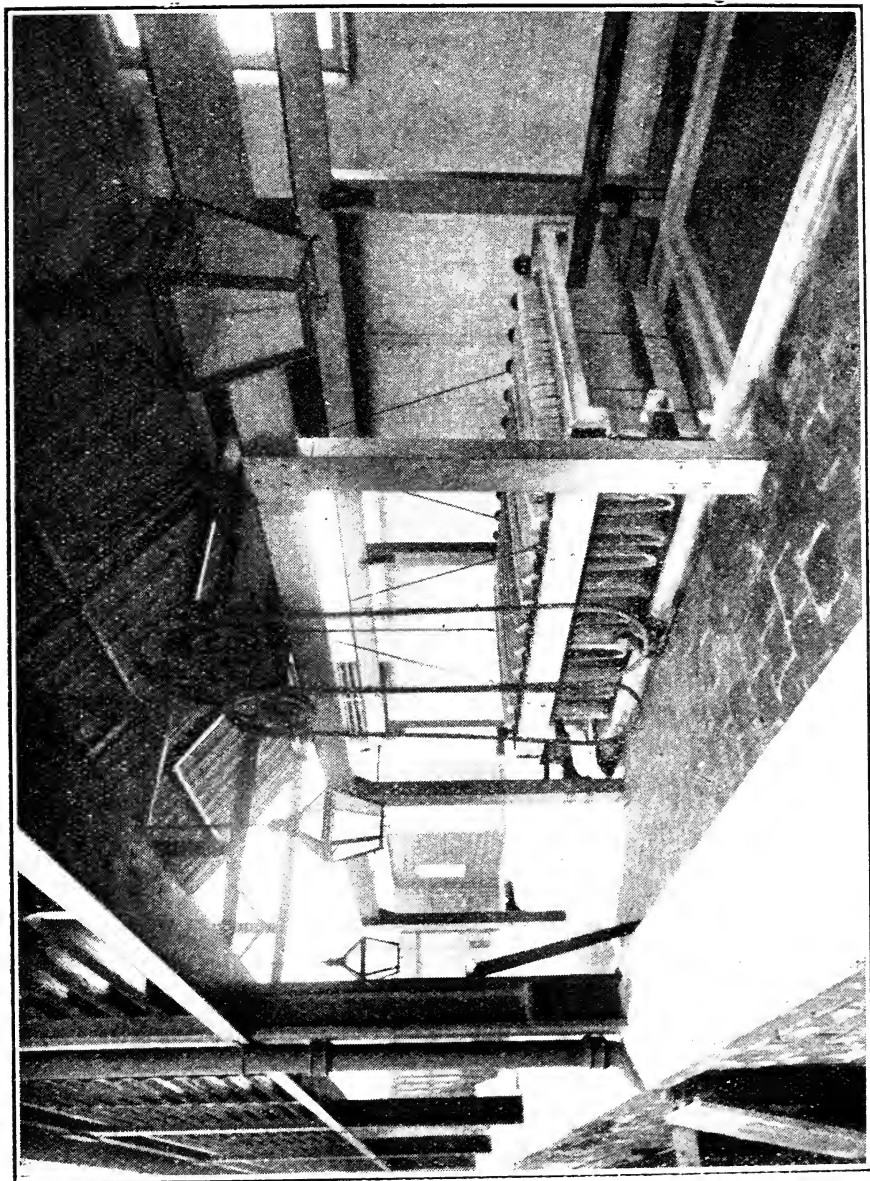

Sometimes the yarn is spread on the grass or hung on poles for a week after the boil.

Lye boiling gets rid of so much of the pectic matter that a loss in weight of from 15 to 25 per cent. frequently occurs.

As a rule yarns that are bleached are those intended for glass-cloths, cream damasks, apron dowlas, huckabacks, towels, &c., which are not bleached after weaving. Yarns intended for fine white linens are usually boiled to reduce their bulk and make them softer and more workable so that a tighter and firmer cloth may be produced, which will not look open and bare when fully bleached later in the piece.

Linen yarn must be bleached to a sufficient degree to take light shades. Dark colours can usually be obtained from the grey yarn, but a half or full bleach is required for lighter shades. Unbleached linen yarn should be well boiled in soda lye before dyeing. Blacks are produced with hot logwood liquor, and other shades with sulphur and other cotton colours.

LINEN THREAD MAKING.

The linen thread trade was first established in Scotland by Christian Shaw about 1722. She excelled in spinning flax by hand. The idea occurred to her to twist the yarn into threads for sewing and lace-making, and Bargarren thread soon became famous. Thus the British thread industry began, and factories were established at Johnstone, Kilbirnie, Beith, &c., and there trade has continued until the present time.

A Paisley gentleman named Barbour established the industry in Ireland, near Lisburn, a few years later.

Threads are produced by doubling two or more strands of yarn together with the object of producing uniformity and strength. Flax threads are used for sewing purposes by tailors and bootmakers where great strength is required, also for embroidery, lace, &c.

The counts of doubled yarn are expressed according to the number of threads twisted together. Thus three threads of 20's lea yarn twisted together constitute 20's threefold, expressed 20/3. The counts of the single yarn are invariably named.

The process of manufacture may be divided as follows: (1) Doubling and twisting. (2) Reeling or hanking. (3) Dyeing or bleaching. (4) Hank winding. (5) Finishing and polishing. (6) Spooling, balling or hanking. (7) Labelling and packing.

When a thread is made up of three strands each containing two or more yarns twisted together, that thread is said to have been cabled. Cabling gives the thread a very hard surface and enables it to resist wear, as for button-holing, &c. In twisting threads and strands for cabling the twist is put in in the opposite direction to that in which the yarns were spun. When the strands are being laid into a cabled thread they are again twisted together in the opposite direction to that in which the strands were formed, or in the same direction to that in which the yarn was spun.

Brownell and similar threads for sole-sewing are twisted together upon a tubing-twister. When hanked they are softened upon the hooks of the iron man or pinning machine, which also gives the thread a frictional gloss after it has been batched with soap and water.

Sewing threads are polished either in the hank or while running bobbin to bobbin, in both cases by friction after starch and wax have been applied. The finished thread is either wound in rolls or cops or on to wooden reels or spools for the sewing-machine, &c., or skeined or plaited for tailors' hand use. The automatic spooling-machine is highly ingenious. It cuts a nick in the edge of the wound spool, inserts the thread and cuts it off, pushes off the full spool into a receptacle and replaces it by an empty one from a magazine, the same being even automatically stamped and labelled in its passage through the machine.

CHAPTER XIII.

LINEN WEAVING.

LINEN.

LINEN is the king of vegetable textiles, worn at birth and at death. Transformed into cloth the brilliancy of flax is beyond compare. Time shows that it is better than cotton. The dress, handkerchief, or tablecloth of cotton once washed gives the impression of being worn out and of poor quality, while one of linen is as new. Nothing but the inherent beauty and excellence of the flax fibre has permitted its survival in the face of the formidable competition of cotton.

The use of linen as an article of clothing is veiled in the mists of antiquity. It is mentioned in the Book of Genesis as in use for robing the royal princes of Egypt, and in the Bible is frequently referred to in terms of appreciation and as a symbol of purity and excellence. Irish linen has a world-wide fame. The moist climate of Ireland is admirably suited to the growth of flax and the processes of its manufacture up to and including that of bleaching.

Bleached linens take a natural silky finish owing to the straightness of the fibres. To obtain anything like the same finish on fabric made from curled cotton fibres, the application of starch, wax, &c., is necessary.

Linen, like other woven fabrics, is built up of two sets of threads called warp and weft. The warp is arranged longitudinally, while the weft crosses it at right-angles and passes under and over certain warp threads. The appearance and texture of the cloth almost entirely depends upon the manner in which these interlacings take place.

The first operation in weaving is the preparation of the warp for the loom. If the yarn is in the hank it must first be wound on to spools or cross-wound rolls, which are put direct into the creel of the beam warping machine to the number of $\frac{1}{4}$, $\frac{1}{6}$ or $\frac{1}{8}$ the number of warp threads which will eventually be required upon the weaver's beam, and wound in parallel order upon the warper's beam. Four, six or eight of these beams are afterwards run together upon the weaver's

beam in the beaming or dressing machine. The beaming machine is used when the warps are to be woven undressed.

Dressing the Warp has as its object the laying of any loose fibres on the surface of the thread, the production of a harder surface on the thread so that it may not be frayed by the friction of the loom, and, the most important of all, the giving of increased strength to the thread, so that fewer breakages may be produced or inferior yarn used.

The warp dressing machine is not unlike the beaming machine, but the yarn in passing to the weaver's beam runs through a trough of starch and is then brushed clean and dried by steam-heated cylinders or radiators.

Drawing in the Warp.—When the warp has been dressed or beamed, the beam is put into a drawing-in frame and a set of rods put through the threads where the lease cords are. Then a set of healds or heddles are hung down from the beam and the ends drawn through the heddle eyes in a manner required by the sort of fabric to be woven, plain, twill, diaper, &c. The yarn is then drawn through the splits of the reed by means of a reed hook, two ends usually passing through each dent.

The loom forms a fabric by interlacing warp and weft threads. It contains parts for the performance of three essential movements, i.e., shedding, shottng or picking, and beating up, also for controlling the tension and delivery of the warp, for drawing forward or rolling up the cloth as produced, and for stopping the loom when the weft runs out or breaks.

Shedding is the operation of dividing the warp into two portions for the passage of the shuttle and the insertion of the weft. In plain cloth, twills, huckabacks, dimities and diapers, it is performed by heddles, controlled by tappets or dobby machines; in damasks by harness cords controlled by Jacquard machines.

Picking is the operation of passing the shuttle through the opening or "shed" formed in the warp by the raising and lowering of the heddles or harness cords.

Beating up or pushing up the weft threads close and parallel to one another is performed by the reed and sley which, through the action of cranks and connecting rods, are caused to advance towards and recede from the cloth after each passage of the shuttle and weft.

Plain Cloth is formed by the warp and weft threads crossing each other at right-angles and passing under and over each other alternately.

Linen Duck is a plain single cloth made of coarse two-ply yarn and of plain weave.

Twilled Cloth.—In one form of twill (the 2 and 2 twill) the warp and weft threads each pass alternately over and under two threads. In another form, the warp and weft threads each pass first under one and over two threads. Another is a combination of the figure and the plain principle, for alongside a "float" three threads in length there are four ends which work plain—that is, the warp and the weft threads pass under and over each other alternately. In twills the weft does not pass over and under the same set of threads every time, but moves one thread to the right or left at every pick, thus forming a regular and continuous twill.

In Gauze or Doup-Weaving, between every pick of weft, the warp threads are made to cross each other, or to twist half round each other, so that the weft threads are held separately and a light transparent fabric produced.

Irish-Eye Diaper is a three-leaved diaper, with two-thirds of the weft thrown to one side of the cloth and two-thirds of the warp to the other.

Bird's-Eye Diaper is best if made with four leaves of heddles, with warp and weft equal on both sides of the cloth.

Diamond Draught Diaper requires eight different threads to complete the pattern.

Four-leaved diaper has the warp and weft equal on both sides, which makes by far the best bird's-eye diaper, although the three-leaved one looks much finer, if they are both woven in the same set of reed and both have the same quantity of shots per inch.

The form of diaper which is called diamond draught requires eight different threads to complete the pattern. For high-class linen towelling, where a large diaper pattern is required a seven-leaved diaper with twelve threads or an eight-leaved diaper with fourteen threads, may be employed.

A pattern or figures are produced on damasks by bringing the warp and weft to the surface as desired, the figure effect on the surface of the fabric being produced by a combination of masses of warp predominating, contrasted with masses of weft predominating. The figure is produced by masses of weft floating on the surface of the cloth, and is visible because of the different reflecting properties which this mass of threads has as contrasted with those of the masses of warp floats in the ground as they lie at right-angles to each other. These floats of warp and weft are usually produced in the form of

a five- or eight-leaf twill by heddles, the pattern being controlled by Jacquard mechanism.

If the ground of the damask is eight-leaf twill, the fabric is termed double damask.

The Jacquard Machine consists essentially of a number of upright wires held in a frame at equal distances. Each wire corresponds to an eye of the heddle, and the object of the mechanism is to ensure the independent raising of any of these wires as they may be required to form the pattern. The wires are made with a hook at the top and a long flat loop at the bottom. They are arranged in rows, and through the bottom loop of each row a rod is passed so as to keep the open side of the hook turned in the same direction. To the bottom loops cords are attached, leading down to corresponding threads in the warp, and the top hooks are so placed as to be acted upon by a frame containing a series of bars or knife blades, one blade to each row of wires, and they may thus be raised at any time by raising this grid frame. By the use of cards and selecting needles any desired wires are removed from proximity to the raising blades, so that they are not lifted as the grid frame rises.

Full Harness Damask Weaving is effected with the Jacquard only, and one thread through each mail. Common or *Pressure Harness* weaving is effected with the Jacquard and leaves of heddles combined. It may have two, three, or four threads per mail, but in drawing it through the leaves of heddles it has a thread for each heddle.

The Sett of the Cloth.—The sett of the warp threads in linen manufacture is variously stated, but for the Irish linen trade the scale most usually adopted is based on the number of hundred splits in a 40-inch reed, sleyed two ends in a split. Thus an 8⁰⁰ linen fabric means that there are 800 splits or 1,600 threads in 40 inches of the reed, and so on; this is irrespective of the actual width of the cloth. In finer setts, in which there may be actually 3, 4, or more threads through each dent or split of the reed, the sett would increase pro rata. Thus the sett of a fabric woven in a 10⁰⁰ reed, 3 threads to the dent, would be $\frac{1000 \times 3}{2} = 1500$ sett.

The shots or picks put into the cloth in Ireland is reckoned on the number of picks of shots under a 37-in. glass, by which is meant a shot glass having an aperture $37/200$ th, or 0.185 in. in diameter.

Shot or Web Glass.—To find the sett or fineness of any

cloth it must be counted with a web glass. These glasses may be made $\frac{1}{4}$ -in. or $\frac{1}{2}$ -in. in diameter, so that if the number of threads shown under them be counted the threads per inch are easily calculated. For Excise purposes the fineness of

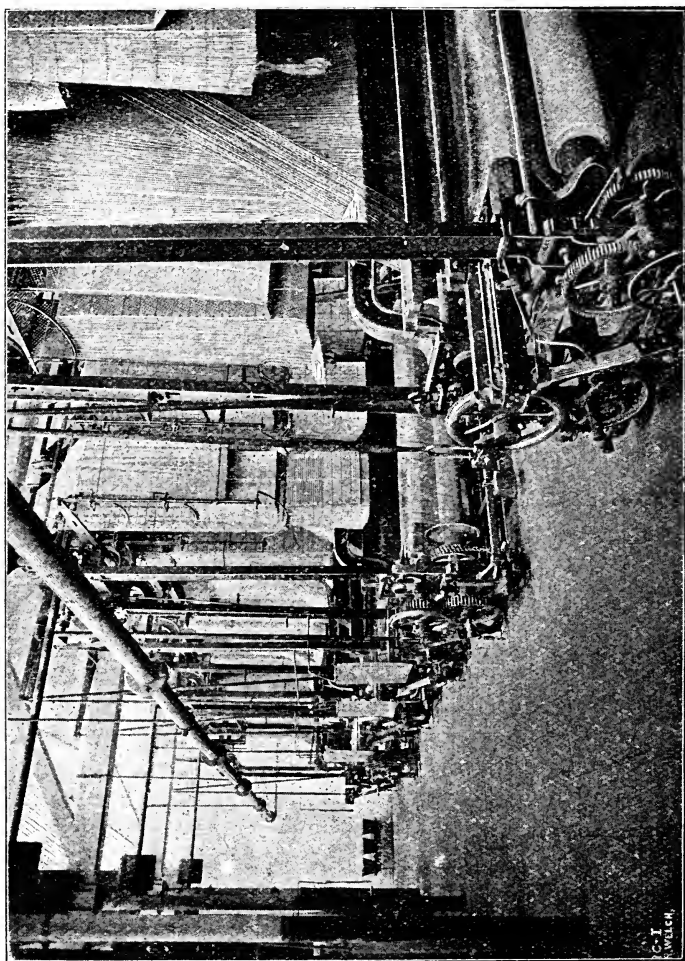

By the courtesy of Messrs. Robinson & Cleaver, Belfast.]
Messrs. Robinson & Cleaver's damask factory at Banbridge, Ireland.

linens exported to the Continent is reckoned in threads per centimetre. The French and Belgian glass has a 5 mm. aperture, and the Spanish glass a 6 mm. aperture. The latter is also used in South America and Cuba.

English glasses are also made 40/200, 38/200 and 36/200 of an inch diameter. If a 38-inch glass is used for brown linen and a 36-inch for bleached, the number of threads shown under them will give the sett of the cloth made on the 40-inch reed system, for the sett is 1/200th part of the number of threads, there being two threads per split in the reed. The number of hundreds of threads in the reed multiplied by 5 equals the threads per inch and also the beers on 40 inches. In Scotland, the Scotch ell of 37 inches is the standard breadth of linen fabrics, and in Dundee, Arbroath and Kirkcaldy the number of hundreds of splits in 37 inches of the reed is divided into five parts, called "porters," and the sett of the warp in the reed is indicated by the number of porters of 20 splits or 40 ends in the standard width of 37 inches.

Light Power Loom Linens are considered as those from 15⁰⁰ to 20⁰⁰ inclusive, and weighing from 29½ to 27 lb. per 100 square yards respectively.

Light Medium Linens vary from 9⁰⁰ to 14⁰⁰ and from 36 lb. to 28 lb. respectively per 100 square yards.

Lawn is a fine plain woven soft-finished linen fabric, varying in weight between 1½ and 2½ oz. per yard. It is consequently coarser than cambric.

Medium Linens vary from 9⁰⁰ to 20⁰⁰ and from 41 lb. to 30 lb. respectively per 100 square yards.

Heavy Medium Linens vary from 10⁰⁰ to 20⁰⁰ and from 44 lb. to 32½ lb. respectively per 100 square yards.

CHAPTER XIV.

FINISHING LINEN CLOTH.

Cropping Machine.—Before leaving the factory linen cloth is first looked over by the “cloth passer,” and then run through the cropping machine, in which spiral knives or revolving cutters, which work against “ledger plates,” shear any knots and loose threads from the surface of the cloth.

Bleaching Linen.—There are two systems of bleaching, the old and the new, the distinguishing feature of the first being



By the courtesy of Messrs. Robinson & Cleaver, Belfast.]

An Irish bleach green.

crofting and of the latter chemicking. In both systems “buck-
ing” and souring are employed.

Crofting is a tedious process, consisting of exposing the linen for two or three days at a time to the action of the atmosphere, spread upon the grass of the bleachfield. The crofting is repeated at frequent intervals, about half the time employed in bleaching being devoted to it.

Chemicking consists in steeping the cloth in a solution of chloride of lime. The cloth is placed in stone vats over the centre of which a perforated trough is suspended. Into this the solution is pumped, and from it pours down upon the cloth.

The process is continued for about four hours. The bleaching powder, in order to be applied to the cloth, must be dissolved in water in the proportion of about $\frac{1}{2}$ lb. chloride of lime to three gallons of water. This quantity of chloride of lime or chemick will bleach 1 lb. of linen.

Boiling consists in boiling the cloth in alkaline lye, or in slaked lime first and alkali afterwards, in large iron kiers or boiling pots for eight or ten hours at a time. This operation is repeated very frequently in the open-air method of bleaching, and is always followed by crofting or grassing.

Souring is the process of steeping the cloth in water, mixed with sulphuric acid in the proportion of eight gallons of the latter to 200 of the former. The cloth is allowed to remain in the sour about ten hours. As many as twenty-two operations, or, including the intermediate washings, forty-four operations, have been employed under the old system for bleaching a parcel of linens. Thirty-one days were required to complete the process, thirteen of them being devoted to crofting. The new method consists of only about thirteen operations, and occupies a much shorter time, but is apt to tender the cloth unless the greatest care is exercised.

If bleached cloth is to be dyed or printed it is sent to the dye and print works in an unfinished state. The dyeing of linen piece goods is usually done on the dye jig by means of which the cloth in its full width is reeled through boiling dye liquor as used for yarn.

PRINTING.

Linen goods must be bleached rough for printing.

The object of printing is to impress a coloured pattern upon the cloth. Printing by rollers has almost entirely superseded the old hand block method.

The pattern is cut out of copper rollers like a seal. As many as six or eight colours can be put on in one operation upon these machines, each colour requiring simply a separate roller. Printing in one uniform colour is called *padding*. The mordant is mixed with starch and gum to give consistency and applied mechanically to the rollers. The mordants most used are iron liquor, alumina and indigo, varying according to the colours to be used. The cloth is then run through the machine to impress the pattern, the goods being then taken to the dry room, called the "ageing room," where they are kept for from two to five days to ripen and set the mordant; black and

chocolate requiring double the time of the reds and pinks. From this room the goods descend to a lower one containing vats in which is a weak souring solution. After passing through these vats over the rollers the cloth is well washed to extract the gum or starch of the mordant. The cloth is then ready for the dyebath, where it is detained about $2\frac{1}{4}$ hours, revolving on rollers. It is next washed in the washing machine, then twice soaped and washed again; plunged in a weak bath of chloride of soda, washed, starched, dried, and finished either by beetles or calender.

If the linen is to be finished by the bleacher he first starches it. The starch is made from wheat flour and mixed with a little indigo to give it a blue shade, and with sufficient water to give it the desired consistency.

The starch may be applied in the stiffening mangle, in which the cloth passes through a starch trough and then between squeezing rollers which remove superfluous starch. The cloth is then dried upon steam-heated cylinders or by a current of heated air blown upon it as it is stretched upon the stentering machine.

Beetling and Calendering.—The object of both beetling and calendering is to impart a soft gloss to the cloth. Beetling gives the best effect, but the calender a cheaper finish. In the calender the bowls or rollers to the number of four, five or six are placed one above the other in a massive iron framework. The bowls are of cast iron, wood, and compressed paper. The cloth is first wound upon the wooden bowl near the ground, it is then passed round a hollow iron bowl, then round a paper one, and then under a very lieavy cast-iron bowl, to be finally wound upon a wooden roller. The cast-iron bowls can be heated by steam. Pressure is applied to the bowls by means of hand wheels, screws and levers. The calendering process slightly increases the length of the piece, and contracts its width.

Beetling Machine or Engine.—The cloth having been wound upon C.I. or wooden beams, it is subjected on this machine to a rapid succession of elastic blows from a series of hammers or stocks. The hammers work vertically and the roller upon which the cloth is wound revolves very slowly. The beetling engine as used in the North of Ireland consists of a number of wooden stocks which fall upon the cloth. The beetles are lifted and then allowed to fall by pieces of wood which project from a revolving beam behind the machine, and engage with corresponding pieces on the stocks. In the *Patent Beetle* each

hammer head is suspended on belts tightly stretched round C springs. The patent or Lancashire beetle does more work, but cannot give the same finish.

In the Belfast warehouses the cloth from the bleach-green is inspected and defects remedied. Cloth to be shipped in the piece is lapped or folded, with or without coloured tissue paper interlining, stamped or ticketed, each piece wrapped in glazed paper and cased and marked for shipment. Valuable goods for long voyages should be packed in strong zinc-lined boxes. A lining of coarse cheap cloth or other substance is placed inside in order to keep the goods from being damaged by rubbing or chafing. The goods are then packed in firmly, each piece being wrapped in paper, and each alternate layer being placed crosswise of the other until the box is full, when a like protection of cloth or other lining is placed over the top of the goods. Then the tin cover is put on and carefully soldered at the seams where the tin is joined, making the whole perfectly watertight. The top of the wooden box is then put on and the goods are ready for shipment. Goods packed in this manner may be shipped to the most distant countries without danger of damage, even if quite immersed in water during a storm, &c.

Linen for the home trade is generally folded in thick pieces, each containing 25 to 30 yards, and plainly ornamented with fancy ribbons and devices. Linen for export is much more profusely ornamented with tickets, with devices in gold and bronze upon a blue or red ground. Almost every country has its special "fold" peculiar to itself. Cambric handkerchiefs and other high-class goods are often put in elaborately made boxes. When the pieces have been folded and ticketed, they are placed in a hydraulic press with a piece of pasteboard between each.

Cloth for handkerchiefs, centrepieces, table-covers, &c., are torn into the correct sizes and hemstitched, threads drawn, embroidered with initials or designs in white or colours, or ornamented in various ways. In the large warehouses there are rooms full of girls working sewing machines of various types—spoke, shire, scallop, embroidery, &c. Some of the warehouses also have hand embroidery machines worked by pantograph on the Swiss system. There are now also thread-pulling machines, which do the work of a number of girls. The principal processes in the making-up work are as follows: Broad and narrow hemming, thread drawing, top sewing and overseaming, thread clipping, lace attaching, lace undercutting

or clipping, scalloping, nickeling, embroidering, spoking, fancy sewing (drawn threadwork), machine stitching of linen apparel and household articles, button-holing, sewing on buttons, collar running and twining, &c.

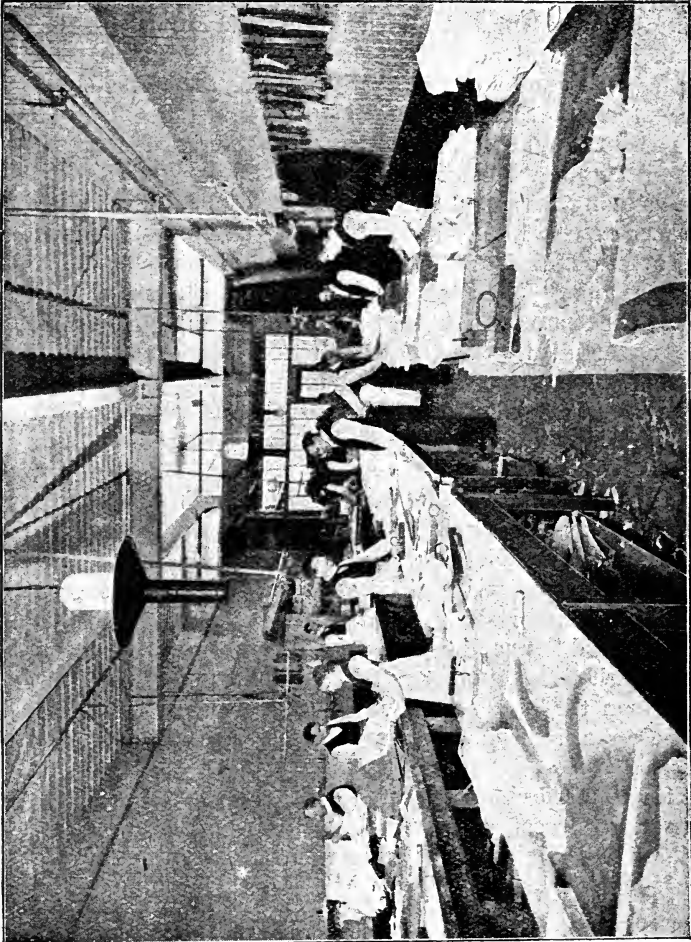

By the courtesy of Messrs. Robinson & Cleaver, Belfast.
Messrs. Robinson & Cleaver's shirt factory, Belfast.

Irish hand embroidery work is known the world over, but has to face keen competition from machine embroidery made in Irish factories, and in Switzerland, as well as from Japanese hand embroidery and Belgian and Japanese drawn threadwork.

To distinguish between Linen and Union Cloth, and to ascer-

tain the Amount of Cotton and Linen in Union Goods.—Use Carter's Linen Proving Liquor or steep a sample of the cloth in a strong solution of potash. The linen threads will be coloured a deep yellow, whilst the cotton will be coloured a faint yellow. Union goods will have a spotted appearance. If a sample of linen is dipped in olive oil, the oil is quickly absorbed and the linen threads become transparent. Under the same treatment cotton threads remain opaque, so that a union fabric will appear striped, and if placed upon a dark substance the linen threads will appear much darker than the cotton threads. In order to ascertain the percentage of cotton and linen threads in a union fabric, weigh and place the sample of cloth in a mixture of three-parts of sulphuric acid and two parts of saltpetre for ten minutes; then wash and dry the sample thoroughly, and afterwards treat it with ether containing alcohol. By this method the cotton fibres are dissolved and washed away, leaving the linen fibres, which when weighed and deducted from the original weight gives the weight of the respective fibres of the sample.

A good test of the component fibres of a fabric can be made by the use of a powerful microscope. To test effectually, draw several threads out of the fabric (an operation best performed under water) and subject them to an examination with a power of 200 to 300 diameters. Cotton fibres will show themselves as flat ribbons. Linen fibres appear cylindrical with nodular swellings and will sometimes split into finer filaments. Cotton and linen unions can be examined best by opening a small strip of the material and putting it into a dilute alcoholic solution of aniline red (fuchaine) for a short time, well washing it afterwards, and then immersing it in caustic ammonia for two hours. In this operation the linen fibres are dyed rose red, whilst cotton takes no trace of colour, and their examination is greatly facilitated afterwards.

Dextrine or Starch Finish.—If dextrine has been used a little iodine dropped on the sample will show a red colour. If starch has been used the colour produced will be blue.

Waterproofing Canvas, &c.—Canvas may be waterproofed by steeping it for twenty-four hours in a decoction of 1 lb. of oak bark with 14 lb. of boiling water. It is then taken out, rinsed in water and hung up to dry. Seamen's oilskins are made by dipping the linen in bullock's blood, then drying in the wind, and then giving two or three coats of raw linseed oil with a little gold size or litharge in it.

Canvas is also sometimes waterproofed by coating it with

plain gelatine solution, until quite impervious to water and then soaking it for twenty-four hours in a strong solution of chrome alum.

To waterproof cart covers, &c. Take two parts of Stockholm tar and one part of Neatsfoot oil. Heat the oil by itself to boiling point, add the tar and stir well. Apply while hot with a soft rag. A little lamp-black may be added if desired.

Waggon covers, tents, awnings, &c., may also be waterproofed with the following mixture: Soft soap is dissolved in hot water and a solution of iron sulphate added. The sulphuric acid combines with the potash of the soap and the iron oxide is precipitated with the fatty acid as insoluble iron soap. This is washed and dried and mixed with linseed oil. The soap prevents the oil from getting hard and cracking.

Among the many preparations used in the production of tarpaulin are the following: Five parts Stockholm tar pitch, melted with four of rosin and one of Stockholm tar; forty-eight parts Stockholm tar pitch, ten Stockholm tar, thirty-two rosin, and one tallow.

Willesden Finish for Flax, &c., Goods, makes them waterproof and free from liability to mildew and rot, and possesses many advantages over protection by tarring or dipping in the bark vat. Canvas or scrim are treated by unwinding from one roller and re-rolling upon another, after passing successively through a bath of cuprammonium solution and a series of drying cylinders. They are then found to be coated and impregnated with cuprocellulose, which not merely forms a kind of varnish-like surface dressing, but further adds strength to the fibres by more or less intimately cementing them together.

For more detailed information see "Bleaching, Dyeing and Finishing Linen Fabrics."

CHAPTER XV.

LINSEED OIL AND CAKE MANUFACTURE AND
OTHER PRODUCTS OF FLAX.

THE flax seed encloses a pair of large oily cotyledons which contain that valuable product—linseed oil—of commerce. Linseed grown in tropical countries is much larger and plumper

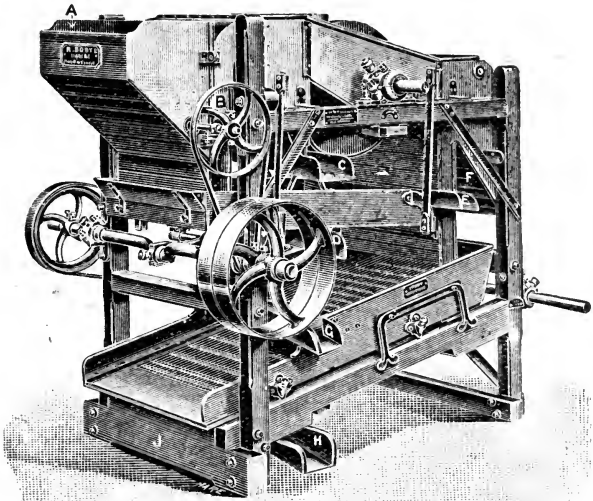

Boby's patent linseed dresser (belt driven). Cleans up to 80 bushels of linseed per hour, separating weed seeds, rubbish and dust.

than that grown in Europe, but the seeds from colder countries yield a finer quality of oil. This oil is to some extent used as food in Russia and in parts of Poland and Hungary. Flax intended for oil production is grown principally in India, the United States, Southern Russia, Brazil and the Argentine. As the quality of the oil is seriously affected by the admixture of the seeds of other plants, to obtain pure oil, the seed should be cleaned of the seeds of the flax dodder and other weed upon a Boby machine.

Linseed cake is the marc left after the expression of the oil and is the most popular of all stock foods for cattle. Linseed oil is obtained by pressing the seeds with or without the aid of heat. The percentage of oil present ranges from 28 to 35 per cent. by weight. A good average quality of seed weighing 392 lb. per quarter gives about 109 lb. of oil. The hydraulic press is employed to press the oil from the seeds. Preliminary to the operation of pressing, the seeds are crushed and ground fine. Cold pressing yields a golden yellow oil. A greater yield of oil is obtained by crushing at a temperature of 160° F. So obtained it is turbid and brownish in colour.

The crushed seeds, in the form of meal, is placed in the hydraulic press in bags and pressed in the cold at a pressure of about 2 tons per square inch. The pressed cake still contains a considerable proportion of oil, the bulk of which is removed—as a product of lower quality—by disintegrating the cake and pressing it hot. When the maximum yield of oil is the main object in view, the meal which is meanwhile kept moist by steam, is heated to about 170° F. in a steam-jacketed vessel provided with a mechanical stirrer. It is delivered into a measuring box, then placed in cloths in a moulding machine and gently pressed into shape. The cakes thus formed are then subjected to high pressure and the expressed oil collected. The cakes are removed and the oily edges trimmed off to be ground and repressed. The cake still contains about 10 per cent. of oil.

Another process known as “extraction” consists in the use of such solvents as naphtha, petroleum spirit and carbon bisulphide. If the extraction is carried out in the cold, the solvent is made to percolate through the ground seeds contained in a series of closed vessels. In the Soxhlet apparatus, with a connected condenser, continuous extraction with a reduced quantity of the solvent is possible. When the mass has been completely extracted, the solution is withdrawn, the solvent distilled off and condensed to be used over again, while the extracted oil remains. Under this process the residue contains but a small percentage of oil, say $3\frac{1}{2}$ per cent., but rather more albuminoids and carbohydrates. For cattle food, therefore, the old process cake is better, as it provides more digestible nutritious matter. Linseed cake is essentially a fattening food for cattle and sheep. In very small quantities it is useful for horses when it is desired to put on flesh and add to the brilliance of their coats.

After storing several years linseed oil is known as tanked oil

and is much valued by varnish makers. The crude oil is, however, generally refined by treatment with 1 to 2 per cent. of strong sulphuric acid, as much less time is required. Artists' oil is prepared by placing linseed oil in trays in the sun where it is oxidized by the ozone.

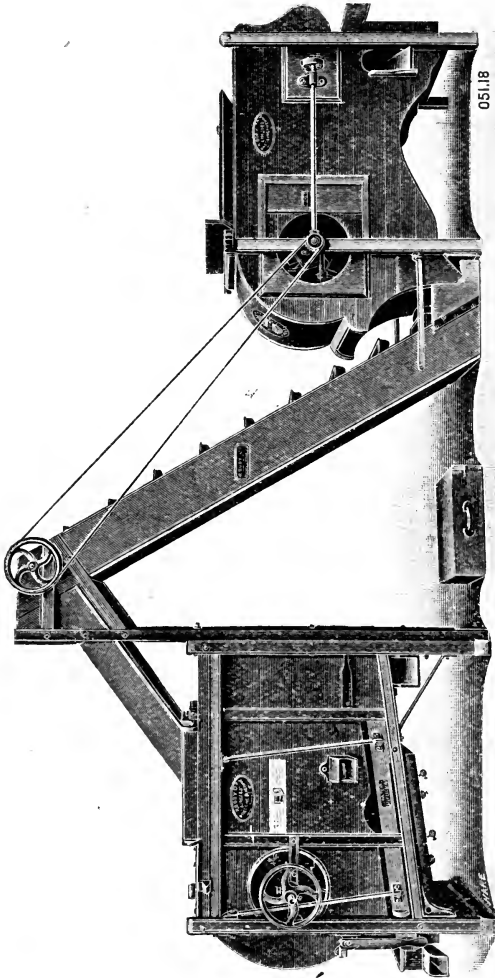

Boby's linseed cleaning plant, as supplied to over fifty Government English and Scotch flax factories.

The chemical composition of linseed oil is not definitely known, but the glycerides of linolic acid $C_{18}H_{32}O_2$ and linolinic acid $C_{18}H_{32}O_2$ predominate. Commercial linseed

oil has a sharp taste and smell. Its specific gravity varies from 0.928 to 0.953. It freezes at 37° F. Exposed to the air it oxidizes and forms linoxyn, a resinous matter.

Linseed oil is the most important of the drying oils, as it combines readily with oxygen, drying on exposure to the air, and it is to this property that its extensive use in the manufacture of paints and varnishes and of linoleum is due, the "boiled" or partly oxidized oil being generally employed. Linseed oil is also largely employed in the making of soft soap. Its most important use is, however, the preparation of oil paints and varnish. For oil painting the oil is boiled for a couple of hours and about 3 per cent. of dryers added. It is then boiled for a further three hours and allowed to cool slowly. It is then stored for some weeks before use. Linseed oil is also largely used in printing and lithographic ink. Bird-lime is made by boiling linseed oil until it is of the desired sticky consistency.

Linseed oil enters largely into the manufacture of linoleum, which name is indeed derived from the Latin words *linum*, flax, and *oleum* oil. In making linoleum, the backing, usually a fine jute plain cloth, is coated back and front with a paint made by boiling raw linseed oil with a little litharge (monoxide of lead) and red lead. Additional coats as required are applied to one side of the cloth. In the manufacture of cork lino the oil is used to form a cement to hold together particles of cork which are then laid upon the canvas. The oil is first boiled to the consistency of bird-lime and then re-heated with the addition of rosin and kauri gum. The mixture is then run into pans where it cools into flat cakes of "cement." To use the cement it is cut into portions and heated and fed through a series of heated rollers. As it comes from the rollers the cork dust is dropped upon it and a flat strip with cork surface is produced. The cement is next mixed in a mixer with the desired colour, then again heated by steam and passed through a pair of rollers, one of which is steam heated and the other water cooled. The material adheres to the cold roller and is scraped off it in a thin film by a stationary knife. Entering a fourth machine with similar rollers the material is granulated as it is scraped from the cold roller by teeth set in the surface of a cylinder. It is in this state that it is pressed upon the surface of the canvas, which, rolled in a continuous length, is fed between a series of squeezing rollers, some heated and some water-cooled. A wire lattice conveys the cork and cement to the canvas into the interstices of which it is pressed.

Care should be taken not to leave any cotton waste saturated with linseed oil lying about, as combining with oxygen it generates heat which may bring about spontaneous combustion.

OTHER FLAX PRODUCTS.

When flax is grown for seed only the straw is frequently used for stable bedding, to thatch a roof, or sometimes for forage when hay is scarce. A small portion of the flax straw produced in America is used for paper stock and in a few localities it is made into upholstery tow. The tow wastes made in the spinning mills are used to produce felt and paper, the best qualities fetching a comparatively good price and proving most useful in the production of cigarette and grease-proof butter papers.

A product resembling cotton wool may also be made from flax tow and waste by thoroughly bleaching the fibre and reducing it to pure cellulose and then carding it. It is said to be cooler and more antiseptic when applied to wounds than cotton wool.

During the late war flax tow was bought by the belligerent Governments not only to stop the flow of blood from wounds, but also to clean guns. To render it antiseptic it may be carbolized before carding by the application of carbolized oil.

The woody part of the flax straw, which should all be removed in the scutch mill, may be burned in the furnace to produce steam and save coal.

Short waste flax fibres are also useful in fibrous plaster and as a binder in boiler covering compositions. As flax gaskin, thick, soft twisted flax yarns are most useful to the plumber and hydraulic engineer for packing the joints of water mains, &c. Flax is also a most useful material for the manufacture of "grummets" as used by engineers and ship builders to encircle bolts, lying like a ring underneath the washer, and producing a water- or steam-tight joint. Soft dry spun yarns are also largely used in the manufacture of plaited engine and pump packings, being usually saturated with tallow, plumbago, &c.

Pure flax cellulose can also be used in the production of artificial silk, celluloid, xylonite and similar products, either by the cupra-ammonia or viscose process.

APPENDIX.

EARLY in 1918 British and French flax spinners began to debate among themselves as to what the effect on the supply of flax would be owing to the secession from hostilities and the consummation of a separate peace by Russia.

Every flax-spinning country has hitherto been dependent to a greater or less extent upon Russia, which exported before the War about one-half of her production. The following were approximately the pre-war figures of supply:—

Russia	400,000 tons
France and Belgium	50,000 ,,
Ireland	10,000 ,,
Holland	10,000 ,,
Germany and Austria	30,000 ,,
					<hr/>
Total	500,000 tons

The Scotch linen trade took practically its whole supply of raw material from Russia, and bought yarns made from Russian flax in Belgium and France.

In the Irish linen trade about one-fifth of the flax used was Irish grown, over three-fifths came from Russia, and the remainder from Belgium and Holland.

The advance of the Germans into Russia and particularly the capture of Reval hence naturally give cause of alarm. It had at this time been realized by the trade that the Germans had grabbed the white flax, Motchinetz, or water-retting districts of Livonia, Esthonia, Courland, Fellin, &c., and the precious fibre which they grew. Once in Petrograd they would have control of the railway to Archangel, and could put a stop to the possibility of export from that northern seaport.

Early in 1918 saw a largely attended meeting representative of all branches of the Irish linen trade, summoned to Belfast to consider a scheme to grapple with the problem of providing the coming season's flax supplies. The trade was with this object organized on the lines of a representative limited liability syndicate to be responsible for a guarantee of £200,000, subject to obtaining £600,000 guaranteed by the Government, the money to be expended in renting land and cultivation of a quantity of flax over and above the expected

increased acreage of farmers and sowing Canadian common seed. For this land the rent was to be £20 per acre for the six months, together with an additional £4 per acre for labour of sowing, &c. It was estimated that this amount would be sufficient to cultivate 20,000 acres, harvest, ret, scutch, and deliver the fibre to the Control Board.

Even if this scheme was successful, which was by no means certain, it only means a supply of a further 4,000 tons, still leaving a deficit of over 30,000 tons if the supply of Russian flax was entirely cut off. If the worst takes place Scotch spinners would be in a desperate plight, and Irish spinners little better off.

An ample supply of *cheap* raw material is essential to the prosperity of the linen trade. It is an abundance of cheap labour that makes Russian flax comparatively cheap. Owing to the climate home-grown flax will always be *better* than Russian, but it can never be produced so cheaply. Two possible fields for flax cultivation on a large scale are Canada and India. Experiments are still being made in the Province of Ontario, Canada, but the cost of production proves to be about the same as in Ireland. Perhaps the most promising opening lies in India, where native labour is cheap and plentiful.

Mr. W. H. Webb, President of the Ulster Linen Merchants' Association, insisting recently on the necessity for a larger supply of Irish flax, said that this could only be accomplished through an organized scheme, for under present conditions its production had about reached a maximum.

Another merchant pleaded for a really scientific treatment of the flax after being pulled, believing that farmers should not be asked to become experts on the after treatment of flax, but should specialize in the growing of the crop both in quality and quantity.

MR. H. R. CARTER'S SCHEME.

Writing to the editor of the *Belfast News-Letter* on January 14, 1918, Mr. Carter says:—

“ Sir,—Mr. W. H. Webb, President of the Ulster Linen Merchants' Association, in a recent letter to the press, rightly insisted on the necessity for a large supply of Irish flax. This, he said, could only be accomplished through an organized scheme, for under present conditions its production has about reached a maximum. As one who has studied the question closely for the past twenty-five years, and been in close touch with the raw flax industry both at home and on the Continent during that time, I venture to submit the following scheme to relieve flax growers of the labour of retting and grassing,

which are not strictly agricultural operations, and at the same time to greatly improve the colour, handling and scutching of Irish flax. Spinners and other interested parties of intelligence are now agreed that the waters of the River Lys, which produces the world's best flax, possess no hidden virtue of their own, their efficiency being due to their softness and slow rate of flow, but more particularly to the quantity of flax which is steeped in the river, and to the cultivation therein of the retting microbe, which attains its maximum activity in the neighbourhood of Courtrai. Spinners are, further, unanimously of the opinion that hot-water retting in tanks, although a saving in time, produces fibre of inferior yielding and spinning quality, and is not to be advocated. Taking these two points for granted, therefore, why not convert one of our disused canals into an Irish 'golden river'? It could easily be done, just as at Selby a branch of the river is being successfully utilized. Select a stretch between two or more locks in a part of the country where flax is largely grown and where the fields on either side are suitable for drying and grassing the straw. If not already closed, close the canal to all traffic between April and October. Make the locks quite watertight; produce a current by means of syphons, ball-cocks, and overflows, the rate of flow being that known to produce the best results (of which I have data) and under strict control. Build jetties provided with lifting gear to launch and land crates containing the flax straw, after the Courtrai fashion, and a towpath, so that they may be hauled to their proper position in the stream. Erect scutch mills at the other side of the drying-fields. Encourage neighbouring farmers to grow flax, and buy it on foot from them if necessary; also, buy up all the best straw from all parts of Ireland, and convey it to this central rettery by those parts of the canal on either side of the stretch being utilized as a rettery. Bring together scutchers from all parts of Ulster, and supplement their number by skilled Belgians and Dutchmen. Employ them on the canal and in the drying and pulling fields during the summer months, and in deseeding and scutching during the remainder of the year. If this scheme were skillfully carried out we would have no need to send hundreds of thousands of pounds annually to Belgium and Holland, and it would be spent in our-own country, to the immense advantage of the workers. To get over the difficulty of pulling an increased acreage of flax in a limited time, if a successful pulling machine has not yet been invented, I would suggest the complete or partial closing down of the flax-spinning mills during the pulling season and the turning out of the dust-choked workers into the healthy country air of the flax fields at a usually agreeable time of the year. They could be set to work in gangs under their own foremen.

who might be given a short preliminary training. In any case I know by practical experience that those who have been trained to handle flax fibre carefully in the mills naturally handle the flax straw much more carefully and skilfully than the farmyard hand."

Mr. J. A. Campbell, of Furze-field, Donaghadee, writing early in 1918, said: "I am prepared during the coming season if I can obtain proper seed (and I know a good many farmers who will increase their acreage also if the Government state they require it) to sow anything between 15 and 50 acres, provided some guarantee is given that the flax, when properly grown and pulled, will be purchased by the spinners or some responsible syndicate on their behalf."

Mr. James Davidson, Linwood, Donaghadee, wrote: "This is a very sensible proposal, and coming as it does from a practical farmer, it is one that should commend itself to everyone interested in the extended cultivation of flax. The farmers' part of the work should cease when he has cultivated the ground, sown the seed, weeded and pulled the flax, and the after processes of retting and scutching should be scientifically treated by some such means as suggested by Mr. Campbell. If such a company could buy the flax from the farmer and pay for it the day it was pulled, it would do more to extend the acreage than any Government grant."

"Owen Varna suggested that retting should be done in tanks which could be kept at an even temperature, somewhat higher than our mean summer temperature: He said that most farmers agree that the temperature has an effect, and it is not unlikely that the warmer summer climate of Belgium has contributed a share in making the River Lys famous as a flax-retting centre. If these factories were established on the sites of disused mills now so common throughout the country, there would be no difficulty in having a regulated flow of water throughout the ponds as suggested by Mr. Carter. It would require such a factory in every district, so as to save cartage and handling expenses. I am afraid that the suggestion of using the canals is not workable, as in addition to having to cart the flax straw for a long way traffic could not be stopped without an Act of Parliament. I believe modern methods of drying would be more economical than spreading on grass, and there would be no risk of a wet season spoiling the flax, but practical experience only could prove it to give as good results as grass drying."

Mr. Thos. M'Connell, Ballinderry, writing early in 1918: "Mr. Campbell's suggestion in your paper appeals to all intending flax growers. There are so many new growers of flax in all parts of the country that the want of scientific knowledge hinders the production of the proper quality of fibre amongst the inexperienced. Surely there is great need

that the spinners should change their tactics and give encouragement to the farmers and buy the crop as grown, and take the responsibility of all subsequent labour. The spinners have plenty of help, and, as Mr. Carter suggests in his letter of 14th inst., the dust-choked workers would benefit in the healthy work of pulling, steeping, spreading and lifting the crop. The old stubble land of last year lends itself as most suitable for growing a good strong crop of flax, which will be so necessary and so much required for the making of aeroplane linen, as well as to keep our mills and factories working. The possibility of any imported flax this year may be very remote, and for this reason and the present scarcity it is surely up to the spinners to give a helping hand. Many farmers are anxious to know how many owners of spinning mills and others engaged in the linen industry have in the past been in the habit of growing and producing flax on their own land. It is interesting to note that the Government have decided to make an effort to grow 10,000 acres of flax this season in England, and to assure the successful growing of this quantity farmers are guaranteed a minimum of £14 per acre. In the year 1864 Ireland grew over 300,000 acres, which is the highest record for the past fifty years. In the years 1898 and 1899 we have the lowest record, viz., a little over 34,000 acres. Last year we had somewhat over 107,000 acres, and there is no reason, with a substantial bonus per acre, that we should not grow over 200,000 acres this season."

On January 25, Mr. Carter replied:—

"Sir,—Referring to recent correspondence re flax, 'Owen Varna' is quite right. The time required to ret flax depends upon the temperature: the higher the temperature the shorter the time required. It is when the temperature is raised to such a degree that retting is accomplished in about four days that damage is done to the fibre. The maintenance of an even temperature, somewhat higher than our mean summer temperature, would make the time required for retting approximate to seven to ten days, and give a good spinning and yielding fibre. This could easily be done through the feed water required to produce the regulated current, which I have proposed should be given to a section of one of our canals, some of which, I believe, are very little used indeed; in fact, my idea originated through reading in the paper not so very long ago that it was proposed to pass an Act of Parliament to close down a certain Irish canal—I forget which—as it was so little used. 'Owen Varna's' suggestion of smaller and scattered reterries does away with all the benefits of a central reterry and a centralized flax industry which has made Courtrai so rich and famous. As I pointed

out, the quantity of flax retted in a certain stretch of water has not a little to do with the success of Courtrai retting. Cartage, handling expenses, and carriage on straw would be reduced to a minimum by carrying out my suggestion of utilizing the canal to bring up the dried straw to the central rettery, and of encouraging farmers within easy reach of that canal, which would probably communicate with the Midland, Southern, and Western counties of Ireland, to grow flax. This industry would then create traffic for a canal about to be closed for want of traffic. In any case, it would be well worth the Government's while to stop through communication for three months in the year to encourage the industry and to provide material for aeroplanes, &c. To Mr. M'Connell I would say that I only suggested that mills should arrange to let certain sections of their hands assist farmers in pulling the crop. They could hardly be spared for more than two or three weeks at the outside. I would also ask him where he can find the seed to sow 200,000 acres this season? To Mr. James Davidson I would say that the Fibre Corporation, Dromara and Newry, has been in a comparatively small way for some years past buying flax straw from the farmer.—

Yours,

H. R. CARTER.

"25, Donegall Street, Belfast, January 25."

An entirely new departure was made by linen manufacturers, in 1918, renting suitable ground from the farmers for flax cultivation. About 4,000 acres were thus rented by the trade in the province of Ulster and another 1,000 acres in other parts of Ireland. For this land the rent paid was £20 per acre for the six months, together with an additional £4 per acre for labour. Canadian common seed was used.

THE ARTIFICIAL DRYING OF RETTED FLAX STRAW.

An artificial method of drying retted flax straw is a necessity if the operation of retting is to be carried out all the year round. The drying plant hitherto adopted in Continental centres consists of a long passage way in brick and cement lined, this being entirely closed except at the two ends and being approximately 30 yards in length. A narrow gauge line runs through the passage in order to carry the trucks laden with wet straw. These trucks are constantly being loaded in the room containing the dryer, each being made up of a wooden frame about 7 feet high by 28 inches wide and 10 feet long, in which twenty shelves or wooden racks with wire bottoms are placed. The drying passage is kept heated by the use of a set of gilled steam pipes laid along the floor and hot air is blown along the passage by a fan, the air being

first heated by a passage through economizer pipes or an aerocondenser. The wet straw is spread upon the racks, and these latter are run in upon the side cleats of the truck frame as fast as they are filled. A frame of this sort will hold about 22 lb. of straw.

A modification of this apparatus has recently been installed in a leading Scotch flax factory. The straw is spread in metal trays which are pushed into a metal framework upon wheels, this truck and framework being a good fit for the tunnel through which it is pushed as each succeeding carriage is inserted. The air is heated in side-heating chambers and blown or drawn through the trays by means of fans.

FLAX-GROWING IN ENGLAND.

According to the *Yorkshire Post*, in 1918 12,363 acres of flax were grown in England under contract with the Board of Agriculture, and in 1919 the acreage under cultivation was 12,568. The flax is grown for fibre, and should not be confused with the La Plata variety, which is raised entirely for seed purposes. A large number of farmers and landowners grew linseed during last summer for feeding purposes, and this crop is becoming more and more popular every year.

Flax-growing is likely to remain a rural industry of great importance for some years to come. It is improbable that any large quantities of flax will be procurable from Russia for a long time; indeed it is stated that in many parts of Russia the peasants have eaten all the flax-seed. The flax factories of the Board of Agriculture are now turning out a considerable quantity of seed and fibre, but their output remains restricted owing to the delay in the completion of the necessary machinery.

FLAX PRODUCTION IN FRANCE.

(*Irish Farmer.*)

In 1862, the area under flax in France was 262,500 acres. In 1914 the area had decreased to a little over 62,500 acres, an area totally inadequate for the requirements of the spinning and weaving industries of the country. This decrease is attributed by the *Journal d'Agriculture* partly to the competition of cotton fabrics with linen, but to a greater extent to the low freights and transport facilities for imported flax particularly from Russia—where, in 1896, 3,250,000 acres were devoted to its cultivation. Not only did French manufacturers draw their largest supply of flax, whether scutched, combed, or in the

rough form from external sources, but French flax-growers were to a still greater extent dependent on Russia for their seed supply. It was estimated that formerly from 8,000 to 10,000 tons of flax seed were brought each year from Riga to Brittany. Taking the amount of seed sown at 160 lb. per acre, from 100,000 to 125,000 acres would be sown with this seed alone. The area under flax in five Breton departments does not, at the present day, reach 17,500 acres.

The flax situation in France, the *Journal* proceeds, is therefore extremely serious. Many of the flax-growing areas have been devastated during the war, and neither fibre nor seed can now be obtained from Russia. It is suggested that it may be possible to obtain seed from Holland, but the quality will not be so good as that of Russian seed. The entire crop in Belgium, where it is expected flax production will soon resume its past importance, will be required for use in that country. Even if seed from Holland is available, and the high prices for fibre continue for some years, it cannot be hoped that flax production in France will increase sufficiently to supply the needs of the linen industry in that country.

NEW FLAX STRAW MACHINERY.

A feature of at least two recent Ulster agricultural shows has been the exhibition of flax straw deseeding machines, patent flax straw crushing and crimping rollers, and a flax straw butting machine. Although on its way to Ireland a flax straw pulling machine has not yet been shown.

Williamson's patent flax rollers and Stewart's flax straw butting machines have already been illustrated and described in this book. The Greeves' patent deseeding machine is the newest thing in this line. Of comparatively cheap and simple construction it is wonderfully efficient. The crop end of the straw is passed in by hand between a pair of openwork and slightly intersecting rollers about 6 inches in diameter composed of solid ends between which W.I. rails are bolted after the fashion of the rails of a reel swift. These scrape and beat off the bolls which pass on to a pair of plain or scored rollers which crack the bolls and release the seed which may then be winnowed and sieved.

RECENT GOVERNMENT CONTROL IN LINEN TRADE.

Mr. J. H. Stirling, of the York Street Flax Spinning Co., Belfast, has, it is reported, been recently criticizing Government control somewhat as follows: He is reported to have said "that during 1917 and 1918 the linen trade in all branches of manufacture was closely controlled by the Government.

That this control became absolutely rigid during 1918. The price of raw flax was fixed by the Government. This flax was distributed to the spinners, who were allowed to spin only such yarns as were required for Government work. Their costs were checked at every stage by Government accountants and the prices they were to get for their yarns were fixed by the Government. The weaving was similarly controlled and had to take such yarns and weave such cloth as the Government ordered. Their costs were also checked at every stage and the price of every make of aeroplane or other cloth for the Government was fixed by the Government and not by the linen trade..

“When a Government representative was fixing the prices for certain stocks of cambrics which the Government proposed to take over, trade representatives demurred to the very old and low basis of cost on which the Government valued these stocks, and were peremptorily informed that if they did not care to accept these values, their stocks would be commandeered under D.O.R.A. without any payment.

“The Government were left with a stock of over 40 million yards of aeroplane cloth, covering a large range of widths and counts all much too light for ordinary household purposes. It was then suggested that the linen trade, having extorted fabulous prices from the Government for these aeroplane linens, sought to buy back the Government surplus stocks at absurdly low prices in order to profiteer again at the expense of the private buyer and consumer. This stock, it is stated, might have been much less, say one half, if the Government had acted on the suggestions made to them by representatives of the trade in 1918, but which were turned down by the Aircraft Department. Soon after the armistice the Government tried to insist on the reductions previously proposed by the trade, but were told it was too late and that the goods were too far advanced in manufacture to allow of such reduction. The Government threatened and blustered, but the trade was sure of its ground, and finally the Government had to admit liability and agree to accept delivery. The Government then disposed of these goods at varying prices without the slightest regard to the stability of the market.

“The finest of these aeroplane linens will bleach into light fronting linens, suitable for shirt and collar makers. The coarse goods are only suitable for use in the natural state and colour. The linen trade, we understand, offered to take over and pay cash for the whole quantity at about 55 per cent. on pre-war cost, or else to sell the stocks for account of the Government on a profit-sharing basis—75 per cent. to the Government and 25 per cent. to the trade. Both offers were declined.”

THE FLAX INDUSTRY.

(Fife Free Press.)

INTRODUCTION.

When this dreadful war was forced upon the nations by Germany, and Northern France and Belgium became the venue of operations, considerable inconvenience was caused to the British linen trade. The choicest flax fibre producing areas became bloody battlefields, or were under German occupation, and in consequence the finest lines of our linen industry were bereft of their accustomed supplies of raw material. A greater disaster overtook us when the counter revolutionary disorders, coupled with the German occupation of the Baltic provinces, utterly prostrated Russia, our chief source of supplies. The British Government, along with our textile manufacturers and agriculturists, were compelled to focus their attention upon the feasibility of resuscitating flax growing on our own soil to augment the limited stocks available. Therefore, flax fibre production in Britain has become a question of great national importance, and it is consequently absorbing considerable public interest at the moment. It is proposed to deal in a series of articles with the cultivation and various processes of preparation flax undergoes before the fibre becomes a marketable commodity.

Our forebears knew the plant well, and were conversant with its treatment. To the present generation a field of growing flax is an unusual sight, and it does seem wondrous how the slender green and yellow stalks at present being harvested should before the end of the year be transformed into "vestures of fine linen," or into important articles of war equipment. Yet it is an industry of great antiquity, the flax fibre having been grown, spun, and woven thousands of years before the Christian era by the Egyptians and Chinese into fabrics, the texture of which cannot be excelled to-day.

The botanical name of the plant is *Linum usitatissimum*. In Egypt, where it is indigenous, the ancient inhabitants on the banks of the Nile called it by the name of Shenu. The generic term in Latin is *Linum*, and in Greek *Linon*. The Scottish name is *Lint*, and our forefathers seldom referred to it as flax, but the old Scottish word *Lint* fell very much into disuse after we ceased to cultivate the plant. The poet Burns, and other Scottish writers in the past, made frequent references to *Lint*.

In some parts of Asia, and also in Egypt, the flax plant grows wild, but is diminutive and weedy. Under the most favourable conditions of cultivation it has been known to reach

a height of four feet. The average height, however, of a good flax crop is between two and three feet. The stem is erect and slender, with alternate lanceolate leaves. It is crowned by panicles of flowers, the petals being of a purple blue colour. There is also a rare variety bearing white flowers. The blooms give place to rough brown capsules containing the dark brown smooth-skinned oval seeds so well known as linseed. The stalk is curiously constructed, the major portion being a central woody core or boon, which, when pulverized, becomes shive, which is a residual product of small commercial value. Around this cylindrical centre clings the valuable fibre in layers from root end to crop end of the stalk. The whole structure is encased in an envelope of fine skin, and all are firmly bound together by a natural gum.

When the stem is subjected to the necessary process, to be afterwards described, the long fibres are detached from the woody core. These long fibres are not really intact, but made up of short lengths. Microscopic study of these long fibres is highly instructive. It discloses the fact that the long fibre is constructed of fine filaments from one inch to one and a quarter inches long, and all ingeniously interlarded, or jointed by nature to constitute one long compound fibre. These ultimate fibres are all wedge shaped, and are laid together in such a manner that they give the completed fibre flexibility and tenacity. It is this peculiar construction of the fibre which enables us to accomplish our fine wet spinning for delicate linens, because, through the action of the hot water, the native gum is softened, and a process of maceration induced whereby the ultimate fibres become partially separated. The microscope also reveals a hollow channel of exceedingly minute dimensions in the centre, and grouped around it in successive linear wedges are the filaments described. Viewed in transverse section the filaments appear in hexagonal contour with great power of combination. When subjected to chemical test with iodine and sulphuric acid the small centre core betrays a faint yellowish line, but the fibres assume a blue colour, and become almost transparent. No doubt this clearness and purity of the fibre explains the snow white bleaching capacity of linen. Chemical analysis shows the fibre to be composed as follows: Water, 56 per cent.; organic matters, 42 per cent.; and ash, 2 per cent.

Russia is the most extensive grower of flax, and the pre-war production of fibre annually amounted to 500,000 tons. The chief ports are Riga and Archangel, but the flax growing areas are widely scattered throughout this vast country. The Russians' culture of flax is undoubtedly of a rather primitive character, while the after-treatment is not conducted on the most scientific lines. For half a century nearly the British spinner has been a long-suffering mortal at the mercy of the

Muscovite, and to-day his cup of woe is surely filled to the brim. Hopes run high that in the years to come we shall not be so dependent upon Russia for our flax supplies. It is a matter for much wonderment that long ere this Canada has not done a great deal more to supply the markets of the world with flax. The writer has handled small samples of Canadian flax generally of rather mediocre quality, and evidently grown for the seed and not for the fibre. For years flax users have turned their eyes expectantly to the Dominion hoping for signs that Canada might become Russia's rival, but as yet flax cultivation for fibre in Canada is only in its infancy.

Ireland has always ranked high as a flax-growing country, its soil and climate being excellently suited for the purpose. Indeed, it may well be said that Ulster owes its prosperity to flax; at least, without flax it would doubtless have been a less thriving province. It is regrettable, however, that during the past quarter of a century the acreage under cultivation in Ireland has declined. From time to time efforts have been put forth to promote and energize the industry, but with somewhat indifferent success. Now, however, signs are not wanting that the Irish agriculturist will rise to the occasion when every encouragement is being given to the grower, and new methods of dealing with the straw make the cultivation of flax more advantageous to the farmer.

England, Scotland and Wales have grown very little flax for many years, and during the lifetime of the present generation the crop has been practically unknown, except in some southern districts where a small acreage has been grown. It has been persistently asserted that the crop unduly impoverishes the soil. No doubt the method of reaping will have a tendency to make the crop an exacting one, because the entire growth is removed from the ground. There are also other little difficulties in the way of the agriculturist, some real and some fancied, which need not be enumerated here. At all events, the real causes of the decline may be said to have been mainly economic, and who knows but economic changes are now to reverse the present order of things? In the United Kingdom there are over one million flax spinning spindles in operation, and we require to import nearly 100,000 tons of flax, flax tow, and flax codilla annually, therefore we are practically dependent upon the foreigner for our supplies of raw material in the linen industry. Those directly interested are building high hopes upon the present efforts of our farmers to augment the supply. To the Scottish agriculturist of to-day the crop is a new one. He will require every encouragement to persevere with its cultivation, but it must be a profitable enterprise for the farmer before we can be guaranteed continuity. Much will depend upon the co-operation given by the Chamber of Commerce and

those directly concerned with the trade. Still further, we must have the best methods of cultivation and treatment. The Scottish soil is capable of producing a most excellent flax, and the writer sees no reason why this crop should not continue in every farmer's rotation during the years to come.

It is proposed in future articles to deal with flax cultivation, de-seeding, retting, breaking, scutching, and assorting. It must be remembered that flax is unlike other cereals in respect to the treatment required after harvesting. As it is not cultivated for the grain alone, but mainly for a certain portion of the delicate stalk, it must be quite obvious to readers that there is much to be explained, and much to be learned by those who are yet imperfectly informed on the subject of flax culture and cleaning.

CULTIVATION OF THE PLANT.

Writers on flax culture are seldom practical agriculturists. More frequently they are connected with the manufacturing end of the trade, and can only record the experiences of expert growers at second hand, and blend it with the results of their own personal observation and amateur study. Nevertheless some of these writers are prone to lay down to the man on the spot certain fixed rules which are more or less impracticable. Such is the case with the question of which is the best soil for flax growing. That is a subject on which the practical farmer himself need hardly dogmatize. The individual agriculturist cannot make his land other than what it is, therefore his choice of ground is limited. Some confidently assert that a deep loam is most productive, other opinions vary. It is quite obvious, however, that very light soils cannot yield strong fibres, though very light soils stimulated by judicious fertilizing will produce a fine soft texture somewhat lacking in tensile strength. Heavy soils, well tilled and properly drained, are capable of yielding a large return, but often the fibre is not of the finest quality, and inclined to be rank and possessing considerable strength. However, judging from the character of the soils in the foremost high-class flax producing quarters of Europe it is perfectly evident that alluvial deposits constitute the best ground for this purpose. An ideal flax-growing soil would show a percentage composition something like the following: Silica and sand, 65; oxide of iron, 5; alumina, 7; carbonate of lime, 2; magnesia, 1; phosphate of iron, 1; organic matter, 7; and water, 12. Flat ground, or a gently undulating surface, suits the crop admirably, but hilly ground is generally considered unsatisfactory, and land shaded by large plantations should be avoided. The average farmer may find it impracticable to give his flax crop a seven years' rotation, but the period ought to be not less than five years. Although some advocate sowing

flax after wheat, this practice is not to be countenanced, because it is hardly advisable to do so in succession to any cereal crop. Potatoes, turnips, and other non-stubble crops are to be recommended to precede flax.

The judicious flax grower is cognizant of the fact that perfect tillage and thorough cleaning of the ground is essential to his success. Though deeply ploughed in early winter a light ploughing in spring will not suffice, because to give the crop justice a second deep ploughing must be administered to the flax field. The vast importance of cleaning cannot be over-estimated. Not only is the plant fickle and delicate, but we must always keep in view the fact that we grow the crop chiefly for the straw. Therefore, rank obnoxious weeds, always impossible to eradicate when in full growth, are certain to mingle with the flax straw, and being a foreign body and mere refuse, certainly involves serious deterioration of the main product.

Artificial manuring is not favoured by many flax growers for reasons somewhat obscure to the writer. There are French cultivators of long-standing who, by the scientific use of fertilizers, have raised prolific crops of splendid flax. These men are not only experienced growers, but also men with good business ability, and they claim to have obtained ample compensation for the expenses incurred by artificial manuring. The approved recipe of one noted grower is as follows: $1\frac{1}{2}$ cwt. of nitrate of potash, 3 cwt. of superphosphate of lime, and 3 cwt. of gypsum per acre. At all events the law may be laid down that the exhausting nature of the flax crop demands a liberal supply of manure to the ground.

The selection of seed is a matter of prime importance. It has long been the practice of the Irish farmer to use foreign seed, chiefly the Dutch and Riga varieties. Such conservative methods are absurd. There are enterprising Irish growers producing home-grown seed for sowing purposes, which will compare favourably with the choicest continental product. The highest germinating power of flax seed is about 95 per cent., and good Riga seed will germinate about 85 per cent., while the best Dutch, Irish, Flemish, or French all reach a higher mark of germinating power than Riga. It has always been recognized that Dutch seed grows the finest qualities of flax, while the Riga seed gives us the spanking ribbony flax so much in request by the Scottish spinner. There is no doubt, however, that good Irish seed provides the strongest flax fibre grown, and in point of fineness and spinable qualities often outrivals much of the continental flax generally supposed to be superior. It is folly at any time to sow flax seed that is not plump and glossy, and weighing something like 56 lb. per bushel. Scraggy, lustreless seed must be avoided, so also

must be the kiln-dried sorts that are so common, and must be banned for sowing purposes. The quantity required per acre has been much debated, and considerable diversity of opinion exists. There are various determining factors, such as the quality of the seed, the nature of the soil, and the climate. It must be observed that when the crop is grown for the seed alone thin sowing is imperative. The plants require room to expand, and to throw out branches which induces prolific seed bearing. In this case the fibre is coarse and of low value. This is an exceedingly remote contingency in Britain, unless where a special patch is specially nurtured to obtain seed for sowing purposes. Our prime object is to obtain fibre.

It is proposed in future articles to deal with flax cultivation, de-seeding, retting, breaking, scutching, and assorting. It must be remembered that flax is unlike other cereals in respect to the treatment required after harvesting. As it is not cultivated for the grain alone, but mainly for a certain portion of the delicate stalk, it must be quite obvious to readers that there is much to be explained, and much to be learned by those who are yet imperfectly informed on the subject of flax culture and cleaning.

To this is attributable much of the inferior flax grown by the Russians. All things considered it is advisable for the Scottish agriculturist to commence with $2\frac{1}{2}$ bushels of seed per acre. His experience of the crop with his knowledge of his ground will enable him to determine when this quantity can be reduced with advantage. At all times it is most imperative that after the seed is sown in broadcast fashion and the ground harrowed the surface should be well rolled. Furthermore, no matter how clean the land may have been prior to sowing, weeds will quickly assert themselves, and compete with the young flax for existence. A good flax crop is impossible if these are not removed.

When the blue flowers, which gives the flax field such a picturesque appearance, begin to fade, it is time to be on the alert. The leaves drop from the lower half of the stems, and a yellowish tinge of colour slowly creeps upwards. Careful judgment is required for the selection of the best moment of harvesting. If too soon the fibre will be soft, flabby and tender. If too late the fibre will be dry and brittle. When the yellow colour has crept up the stalk fully half way, or roughly speaking has reached upwards two-thirds of the entire height of the plant, and the seed balls turning brown, then is really the time to commence harvesting operations. We do not cut the flax crop, because by so doing we should leave a valuable part of the stalk in the ground as stubble, and further the shearing process would in some respects prove detrimental to the delicate

stalk. The flax is pulled by hand, which is a tedious process. It is extremely doubtful if those who engage in this work fully realize how much depends upon the manner in which they perform their work. The evils of defective handling during the pulling are never wholly removed in the after processes. Very little experience is necessary, but constant care must be exercised to preserve the level laying out of the straw. With the reaping and gathering in the farmer's part of the work should terminate, all further operations taking place at the flax scutching mill.

It will be evident to everyone who has read the foregoing that flax growing entails more labour than the ordinary grain crops. We cannot trade upon the farmer's patriotism; on the other hand, flax growing must be made a remunerative crop. The country needs the fibre, and must procure it at any cost. Russia is hopeless this year, and we cannot build any high hopes on her for next year. Our fondest hope lies in the efforts of our own agriculturists, but they must receive ample encouragement to persevere with flax growing, or the country will suffer.

BREAKING.

After steeping, grassing, and drying the final operation of separating the fibre from the stems remains to be accomplished. The dissolution of the pectose or gum having been effected by retting, the fibres no longer adhere to the central core, and also become disengaged from one another. The bone or boon is still encased in the fibrous envelope, and must be expelled by scutching. In the case of larger fibre plants, such as jute, the outside layers can be stripped off by hand similar to bark peeling, but the flax stalk is too small and too tender for this tedious method. The dry brittle boon is crushed and broken into fragments as a preliminary to scutching. The straw is passed through a series of "fluted" rollers arranged in pairs one above the other. Many and varied in detail are the different designs of breaking machines, but all conform to the general principle of corrugated faced rollers with the teeth or flutes intersecting. The machine resembles the well-known jute softener, except that the roller flutes are straight and run parallel to the axis instead of running spirally around the surface, as in the case of the latter. It may be suggested that a jute softener could be improvised for flax straw breaking if the fibre did not sustain injury through the spiral flutes possessing a sharp surface action. However, there are already many machines specially constructed for the purpose, and the most modern of these is fitted with what the textile mechanic terms a "reciprocating roller motion." This appliance is closely allied to the up-to-date Hemp Tow Softener, and it is un-

questionably an improvement on the old style of breaking machine. The obvious advantage lies in the gradual rolling imparted to the straw with a tendency towards softening the fibres. At all events, by running the straw through a breaking machine the woody core is crimped, crushed, and broken into small particles, and much of it reduced to dust. It is quite a common practice to use two machines, one with coarse pitched rollers and one with fine pitched rollers. There is no doubt that the breaking, simple though it may be, cannot be scamped. "Fast shive," which escapes the breaker, cannot be thrown off by the scutcher, therefore, to pulverize the wood is the great object to be attained, and whatever is calculated to enhance the spinning, bleaching, and weaving properties of the flax demands attention. Unequal retting will leave patches of "fast shive," and much Russian, and no little of the poorest Irish brands are notorious in this respect. This fault is practically inexcusable, but where it does occur a perfect system of rolling would undoubtedly mitigate the evils of faulty and irregular retting in parts. Very heavily weighted fluted rollers must be condemned as dangerous to the integrity of the fibre, but it might be suggested that the breaking machine possesses finishing rollers with plain surfaces and working under heavy pressure so as to aid in the pulverization of any "fast shive" that may abound.

SCUTCHING.

A very considerable quantity of the finest Continental flax is scutched by hand. The scutcher beats out the broken and bruised woody tissue with a flat wooden implement known as a sword. An expert manipulator of the hand wielded scutching blade will undoubtedly clean his flax with a minimum of waste fibre. The process is slow however, and cannot be entertained. Manual labour must be superseded by mechanical power wherever possible, and by mill scutching only will flax production become a profitable enterprise in Scotland. The ordinary scutching machine is a simple contrivance. The scutching mills in Fifeshire and in other parts of Scotland were equipped with this machine when the industry was so common during last century, and the use of the same power-driven appliance is prevalent throughout Ulster to-day. It consists of a long horizontal shaft enclosed by an iron or timber canopy. On this shaft are keyed a number of cast iron bosses regularly spaced along the shaft. From each boss project radial arms to the number of three, five, or upwards. At the extremity of each arm a wooden blade is bolted, and fashioned with a bevelled edge. Directly in front of each set of arms and blades there is an opening in the covering which encases the shaft. At each opening an upright metal or wood stock is fixed. The

flat sides of the wood blades revolve in close proximity to the stock. Each opening in the shroud with its set of blades and upright stock forms a berth for a workman. The latter grasps a large handful of straw near to the root end, and suspending the crop end over the stock allows the rapidly revolving blades to play upon the straw. By working the straw up and down and around according to his judgment, the rotating blades, running from 500 to 600 blades per minute, beat out the bruised woody tissue. When the scutcher judges this to be sufficiently done he reverses the straw, and repeats the same operation with the root end half of the straw. Invariably the men work in pairs, one man "roughing" the straw with a wide stock, and the other "finishing" with a closely adjusted stock, and he is ultimately left with a wisp of flax fibre from which has been ejected all refuse.

The mechanical equipment of the flax scutching mill has passed now beyond the old-fashioned contrivance already described. There are various types of machines in vogue, all invented with the main object of saving labour, and to secure more rapid production. One deserving special notice is the drum scutcher. On the face of a revolving cylinder are fixed eight sets of "tools." Each of these tools, and they are all identically similar, forms an ingenious triple combination. The so-called "tool" consists of three separate parts, each performing its allotted function. First, there is a flat hard wood blade fixed across the face of the cylinder. This blade has a bevelled edge, and it is so placed that the edge points exactly in the direction of the revolution of the drum. On the top of the blade, and behind the operating edge a row of short stumpy metallic teeth stand upright at right angles to the flat outer side of the blade. Then behind these teeth is fixed a metal plate also in an upright position from the face of the drum. The wooden blade first beats the straw, the teeth follow with a combing or opening out movement, and lastly the iron blade or scraper engages the flax. The material under treatment is reversed, and the other half of its length brought under the action of the tools. The work performed by this machine is very good, and like the old-fashioned machine two separate buffings are considered indispensable, which means two machines with coarse and fine adjustment respectively.

It would be a mere waste of space, and quite superfluous, to go any further in descriptive writing of scutching and the various machines employed. The reader, though not formerly conversant with the work, will now understand that scutching means beating out the broken inside core of the flax stock after it has been loosened by retting. To those who do know the work, and who may be at present interested in the resuscitation of the industry in Scotland, the writer would advise a new mechanical device for scutching. An immense amount of

raw material is passed through hands for quite a small return of fibre, therefore the need to further lessen the labour involved is quite patent to anyone. An acre of ground produces from 2 to 2½ tons of straw, and this is dealt with in handfuls, therefore it must be quite obvious that increased celerity in handling is a necessity, and likewise the elimination as far as possible of the skilled element in labour. Like flax hackling the scutching demands the introduction of a perfect automatic machine. This has practically been achieved with the former, and if flax growing is to be successfully carried on in this country it is now that the attention of British textile machine makers should be fixed upon the subject.

It must now be explained that the woody fragments thrown off by the scutcher's blades is not the only waste made in scutching. There is always a certain quantity of fibre becomes disengaged and deposited among the refuse. A small proportion of short fibres occasioned by stunted or unequal growth fail to resist the action of the scutcher's wheel. A more fruitful source of trouble is the careless pulling of the crop, and defective handling prior to and during scutching. The fibre thus thrown off is not really waste, but it becomes an article of less value than the long flax. Such fibre, when willowed from refuse, is known as codilla, and consists of short staple, and broken uneven material. Codilla, resultant from scutching, must not be confounded with tow, which is the combings of the hackling process. It is longer in fibre than tow, and the spinner values it as an important constituent in his tow batch when tensile strength of the tow yarn is urgently required. The coarser and rankest of codillas are mainly used by our rope makers. We hear frequently of re-scutching being resorted to, and the practice is common in Ireland. It is perfectly evident that codilla, which will stand re-scutching, has been produced by the incompetency of the operations in the scutching mill, or the rough methods of the growers when engaged in reaping the crop. No doubt when flax growing and scutching has resumed its rightful place as a Scottish industry every possible means will be adopted to eliminate undue waste. We want no excessive residual product given off at the expense of the chief article. At this juncture we are engaged on a clamant emergency enterprise of national necessity, and choice of method is limited, therefore, those entrusted with the work in connection with our home flax production must make the best of the means at their disposal this year.

When the decortication of any particular farmer's flax is completed and the cleaned flax stored it will be found that though grown from the same brand of seed, and generally under like conditions, the quality and consequently the value of the material will vary throughout the parcel. A practised flax selector will have no difficulty in separating the product

into different grades if it is not to be disposed of overhead. What is technically recognized as "quality" does not embrace all the merits the flax may possess. "Quality" really denotes the measure in which the fibre is endowed with its natural sap, and which may be lacking in long strong flax. It necessitates no special experience to determine the absence or presence of "quality," while on the other hand it is exceedingly difficult even for an expert to judge accurately the probable yield of long line the spinner may expect out of his purchase from his hackling process. However, in selecting flax the various points to be noted are as follows: 1st, quality; 2nd, texture; 3rd, strength; 4th, probable yield of long line; 5th, cleanness; 6th, length; 7th, lustre; and 8th, colour. The present and the preceding generations of British flax spinners have been chronic sufferers from the very slipshod methods of selecting employed by the Muscovite "brackers" or selectors. Adding to that the vile Russian practice of stuffing rubbish in the hearts of bundles and the "wet hand" device so frequently practised to increase the weight, one can readily comprehend how the British spinner has been systematically victimized by the Russian peasantry and the conniving flax factors who purchase from the growers. Strong representations have been from time to time addressed to the Russian Government on the subject. In response to repeated protests feeble efforts have been made to disseminate a better knowledge of the work, and also to checkmate cheating. The improvements secured still leave much to be desired. The outstanding causes for complaint have never been thoroughly eradicated. Careless handling, improper retting and nefarious tricks in the baling of the goods are still characteristic of shipments hailing from certain districts in Russia, and it may be said that there is practically no redress for the British buyer. In these times when the price of the article is so extraordinarily high, such irregularities tell heavily upon the mill spinner, and inevitably affect the linen manufacturer. Such a condition of matters is unthinkable with the British-grown article, therefore, the revival of flax growing in this country would afford welcome relief to our linen trade.

In the minds of many people conversant with the trade there arises the question of how far Scotch-grown lint can be used in Scotland at the present time, when we take into consideration how our spinning plant is constituted nowadays. To the outsider this may appear a rather odd query, but to those practically acquainted with the business the question is a legitimate one, and of considerable importance. It must be distinctly understood that the reputation of Scotch lint stood high in the old days. We had much fine wet spinning then in Scotland for which the best of the native-grown lint was eminently suitable. The making of very fine linen yarns dis-

appeared almost contemporary with the cessation of flax growing. To-day fine wet spinning is extinct in the eastern counties of Scotland, but we do a very considerable trade in fine dry spinning for which the higher class Russian flax is required. No doubt a goodly proportion of our one hundred thousand spinning spindles are engaged on heavy canvas yarns made from medium and low or coarse grades of flax, but that does not justify the assumption that we are the scavengers of the flax markets of the world. A very large quantity of prime flax is used in Scotland. Should our soil produce an article this year similar to that of sixty or seventy years ago perchance the choicest parcels may find their way to Ulster. It is not unreasonable to expect that this should release good Irish flax suitable to the Scotch trade. But a careful scrutiny of the amount of high-class dry spun yarn made in Scotland, together with a knowledge of the requirements of the Scottish linen manufacturers, should convince anyone that there is ample scope for all our flax-growing resources, no matter whether the higher marks be spun in Ireland or Scotland. Furthermore, it is not unreasonable to hope for the re-introduction of the spinning of fine wet spun numbers when we have the raw material raised at our own doors. In the meantime it is flax we want to avert the partial cessation of an industry of great national importance. There is every reason to believe that we are to accomplish our object, and a ready market will be found for every pound of fibre produced on British soil. We cannot, however, regard the present effort as a mere temporary expedient for the conventional duration of the war. Our dearly bought experience ought to convince us that now is the time to establish flax cultivation on a permanent basis, and if we consult the best interests of the country we ought not to fail in doing so.

Reliable statistics prove that our land is quite as prolific in flax rearing as can be found in Continental countries. One ton of straw yields about 200 lb. of fibre. From an acre of ground we obtain from 2 tons to 2½ tons of straw, the former figure being a mean short crop and the latter a desirable average yield. With good seeds, proper husbandry, and an ordinary season we are justified in expecting 4 cwt. of flax fibre per acre, with almost 1 cwt. of codilla in addition, and roughly about 6 cwt. of linseed. One ton of straw in the stackyard will resolve itself approximately into a percentage calculation as follows: Refuse, 70 per cent.; seed, 12 per cent.; long fibre, 9 per cent.; codilla, 2 per cent.; dissolved gum, 4 per cent.; and earthy matter, 3 per cent. The refuse, which is readily combustible, can be consumed as fuel in steam raising or water heating. It can also be used as cattle bedding, in fact of late years the farmers' demand for mill dust has often exceeded the supply. It will thus be seen that by

utilizing the scutching mill refuse the absolute waste is very small indeed.

It has been left on record that the greatest area under flax cultivation in Scotland reached nearly 7,000 acres when the industry was at its height about the middle of last century. Imagine such an area being hand pulled, and one can see the urgent need for a reaping machine. It is confidently expected that such a machine will be in operation soon. We cannot expect emergency pullers in normal times, and besides that the hand pulling is slow and expensive. We may have more than 7,000 acres to operate upon in Scotland. An exhaustive study of the question of ground available at the present day is hardly possible within the limits of an article such as this. We cannot ignore the great outstanding problem of the country's food supply. While giving due consideration to this vital matter we are reminded that all arable land at our disposal is not under tillage. Competent authorities assure us that there are vast tracts of ground lying in a permanently non-productive state throughout England, Scotland, and Wales. If we take Scotland alone, the facts are astounding. The crofter was gradually expelled, and sheep farming installed. Eventually sheep were largely displaced by deer. Let us ponder over the fact that out of Scotland's nineteen millions of acres there are three and a half millions of acres devoted to deer forests, and this vast area embraces many straths formerly under cultivation. The land question will inevitably become a great post-war problem. There is ample scope for a Ministry of Agriculture endowed with extensive powers which, judiciously exercised, could extend the cultivated area. Having due regard to all the nation's needs it is quite reasonable to expect a definite place for flax growing, and it is not too ambitious to suggest 40,000 acres in Britain, exclusive of Ireland, Favoured with an acreage approximating to 40,000, and the prospects of the industry developing in Canada we could look forward to enjoying an independence of Russian supplies to a degree unknown to the present generation. No one expects to oust Russia with its immense territorial resources and established trade. But Russia in normal times is an autocratic flax monopolist. If the present movement to produce British flax should fail the position of the British spinners will be intolerable, simply because they will be still absolutely dependent upon the foreigner for supplies. During the last quarter of a century we have not spun sufficient yarn for our own looms. No doubt our fiscal system stimulates the purchase of foreign yarns, but the lack of any home-grown raw material stultifies our flax spinning trade beyond the possibility of dispute.

We must keep in view the fact that at present the agricultural question is primary. This year's result is awaited with intense

interest, though it will not be a true test. The extreme urgency of the situation occasioned a hurried effort which did not admit of perfect organization. Great credit is due to the farmers for the alacrity they displayed in responding to the call for flax. They have not had a fair chance this year to produce the results that may be expected from greater preparedness and more deliberation. We shall doubtless discover difficulties of more or less import. Not the least perchance will be the well-known objection to the exhausting nature of the crop. It must be remembered that no experiments have yet been made, say, of the relative efficacy of the different phosphatic manures. Before accurate and perfectly reliable tests are made with chemical manures the farmer cannot veto flax rearing. Scientific investigations are being systematically carried through with other crops, as for instance the present tests with potatoes at the West of Scotland College Farm, Kilmarnock, and it is reasonable to hope for experiments with flax on similar lines. The laboratory and the farm have been comparative strangers too long. After the war terminates the release of high explosive factories from their present occupation should easily provide the nations with ample means to manufacture chemical manures. Sentimentally this would be equivalent to "beating swords into ploughshares," and practically it would be a big advance in the realms of scientific cultivation. Depend upon it other nations will be up and doing to secure their places in the sun, or to put it correctly, to obtain a standing in a world dominated by universal competition. Should the present project share the fate of the futile attempt made thirty years ago very many connected with the textile trade will be keenly disappointed. Those who are pessimistic profess to see failure stamped across the venture because they fear flax will not be a sufficiently lucrative crop for the British farmer. If their fears be well grounded the fact will sooner or later be disclosed. The farmer will not hesitate to enlighten us on the subject. If we are to obtain what we desire to stimulate our linen industry, the financial aspect of the cultivation of flax must be favourable to the agriculturist; in these days of industrial and commercial chaos everything is uncertain, but when normal times return surely there will be no reason why flax rearing should not be a paying concern. Granted flax straw the British flax spinner will find it to his advantage to insist on retting and scutching plant being perfected to the highest degree.

ULSTER'S STAPLE INDUSTRY.

In a recent article the *Belfast Evening Telegraph* says:—
"While we are justly proud of the world-wide fame of Irish linen, yet we must ever turn to a consideration of the

position and future prospects of this vital economic asset, particularly at a time like the present when there has been an absolute upheaval in commercial matters throughout the world. The war has not so far affected the prosperity of the linen trade. The great advance in aeroplane activity made tremendous demands on linen supplies and furnished abundant work for those engaged in linen manufacture. But now the truly terrible condition of affairs in Russia constitutes a very real danger to the linen industry of Belfast, and, unfortunately, there is little real hope of immediate peace for that wretched country. How it affects us will be understood when we reflect that we grow in Ireland hardly one-seventh of the flax we use in the manufacture of linen. We have to import six times as much flax as we grow, and of this imported flax Russia used to supply us with something near 80 per cent.; and we were able to buy it cheaply, because labour was plentiful and cheap in Russia. We also imported more from Belgium than we produced ourselves. These two sources may be accurately described as the only sources of our raw supplies; though, of course, there was a very trifling—substantially negligible—quantity imported from other sources—France and Holland, for example. Now that condition of affairs is all changed. For the present, at all events, Russia cannot be looked to for any assistance in the way of flax supplies, though probably if peace were restored within her territories she would speedily be in the market again. And as for Belgium, it will, in the nature of things, be some time before she is in a position to export an ounce of flax. It, therefore would appear that our entire linen industry is in very real jeopardy through the failure of our supplies, and until something can be done, and done speedily, to bridge the gap and so prevent anything in the nature of a sudden collapse when the supplies at present in existence become exhausted, it is difficult to see how idleness can be avoided. The magnitude of the danger will be easily realized when it is remembered that close on 85,000 persons are calculated to be engaged in the linen industry in Ireland, and that some 52 million pounds are sunk in it as capital. The problem is a serious and anxious one, demanding the earnest attention of the best brains in the trade. Probably more flax could be produced at home; but it is hardly possible that Ireland could produce anything like the quantity required for our needs, for it must be borne in mind that the world's linen manufacture is carried on in North-East Ulster in a comparatively small area, with Belfast as a centre. And in any case it is a curious commentary on our position that the acreage under flax this year is only four-fifths of what it was last year. Where, then, may one look for supplies to take the

place of the lost Russian and Belgian ones? There are two countries within our own Empire that could give most useful aid, Canada and British East Africa, and it is comforting to note from recent reports to hand that Canada is making really big efforts to increase her flax-growing acreage. There are also two foreign countries that could similarly assist, Japan and Holland; but the unfortunate thing is that all these countries combined could not, in the opinion of experts, produce in the immediate future more than half the amount of our pre-war and normal import, which was close on 90,000 tons. And in this connection it must not be forgotten that our exports of linen to the Continent—notably to Denmark, Switzerland, and Belgium—rose enormously during the first six months of 1918, though in the same period our exports to the United States sank to about half their normal standard; this, however, was partly due to want of transit facilities. The problem is already occupying the attention of the leading men of the linen industry, and all can only hope that they will be able to devise an effective solution for so imminent and serious a danger. The problem is a big one, demanding the most active attention of big minds and the performance of big acts for its successful solution, and beyond a doubt not only Belfast and Ireland generally, but the whole Empire, will watch with deep interest, not to say anxiety, the activities of those who take part in the efforts to solve it, for there are involved in its solution two of the most difficult factors in modern economic enterprise—the discovery of sources of supply and the providing of shipping.”

WHAT CO-OPERATION CAN DO TO INCREASE THE GROWTH AND IMPROVE THE CULTURE, HANDLING, AND SALE OF FLAX.

(By A. A. Anderson, Secretary to the Irish Organization Agricultural Society. Reprinted from his leaflet published in 1900.)

The flax-growing industry lends itself peculiarly to co-operation, and therefore the thought at once suggests itself that in any locality where a sufficient quantity of land is cultivated for this purpose a co-operative society should be formed, somewhat on the lines of a co-operative dairy society, with the following objects:—

- (1) To own and work a scutching mill for the benefit of its members.
- (2) To provide them with the means whereby they can benefit from expert instruction in the growth and treatment of the crop.
- (3) To procure them seed of the best and most suitable

quality on the best terms, and also such artificial manures as are found most beneficial to the land of the district and to the crop.

- (4) To carry out such experiments, under the direction and advice of the Department of Agriculture, as would be best calculated to afford the members of the society useful information, and to publish and circulate results of these experiments amongst them.
- (5) To provide a better means of disposing of the fibre than exists at present.

Other objects would doubtless suggest themselves to an intelligent committee, such as would be easy to find in the North of Ireland, but these would be sufficient to begin with.

Unlike creameries, the capital required for a flax-scutching mill would not be very large, particularly having regard to the fact that the society would not purchase the flax from its members as a dairy society purchases milk, but would merely make a charge of so much per stone for scutching. The equipment of a flax scutching mill is not a costly undertaking, and in all probability £250 to £400 would be sufficient capital in most cases. Moreover, generally speaking, it would be possible to secure the use of an existing mill on favourable terms, either by renting it or purchasing it from the present owner, who might be employed as manager of the business. I found that farmers were unwilling to pay more than 1s. per stone for having their flax scutched, but it is pretty certain that to secure good results they ought to pay more, say 1s. 6d. They would object to pay this sum to the mill owners, but this objection would be completely removed if the scutch mill were owned co-operatively, as the surplus, if any, would go to swell the profits of the society for the benefit of its members. This charge would enable them to employ really skilled hands, and in every mill the foreman scutcher ought to be a thoroughly qualified man, able to supervise the work of his subordinates. The flax dealt with by each mill-hand should not only be marked with the name of the society, but it should also bear a number to identify the worker through whose hands it has passed. This would prevent careless work.

The tow would be retained at the mill until the slack season of the year, when it would be scutched and sold to the best advantage and the amount thus realized distributed among the members in proportion to the quantity of flax fibre produced from each man's straw. This would give a distinct advantage to the careful grower, which members would not be slow to appreciate. Any surplus of net profit would be divisible among the members in the same manner.

Flax-growers and spinners alike complain that a result of

the present system is to glut the market with flax early in the season. The farmers, as has been said before, allege that owing to the quantity of straw dealt with at the scutch mills they suffer serious loss owing to imperfect scutching, and the flax-spinners on their part complain that, owing to the great quantity of flax put on the market at once, they are forced to make arrangements to finance the bulk of their business within a very short time. It seems desirable, therefore, on account of both growers and manufacturers, that the sale of flax should be more evenly distributed over a longer period. This can only be done by affording the farmers the means of holding over their straw until there is an opportunity to do it justice at the scutch mill. At present if they are pressed for money they cannot do so, but by the introduction of Raiffeisen banks they would be able to obtain an advance on the security of their straw, and having had a small quantity scutched, as a sample of their crop, could dispose of the bulk to the spinners at a price for delivery as it was turned out of the mill, the price being fixed on the value of their samples. This would probably remove one of the most serious difficulties which now hampers the development of the industry. There is another very great disadvantage in the present system of scutching. Owing to the anxiety of each grower to get his flax to market early, so as to secure the high prices which usually then rule, the scutchers open their mills for work at a time when harvest work demands the whole time of the people, and close them earlier in the year than would be necessary were the flax to be supplied continuously instead of practically being all sent in within the space of a few weeks. This intensifies the scarcity and dearness of labour. It also seems to be generally admitted that flax ought not to be scutched for some weeks after pulling.

FLAX CULTIVATION IN IRELAND.

The following notes on "Flax Culture and Handling," by Mr. David M'Mordie, Crossgar, are interesting:—

KIND OF SOIL.

It is generally admitted that the best kind of soil to sow on is that having only a clay sub-soil, with a friable top, or surface soil. The best place to sow on is after a crop of lea oats, and the older the lea before it is ploughed the better.

PREPARATION OF THE SOIL.

There is a difference of opinion about this. My own view is, to plough early, that is, in the autumn, then cross-plough,

but not too deep, in February. If the ground is dry, spring-harrow again in March; if March is wet, it is better not to touch the ground until sowing time. If there is a friable soil having a gravelly or sandy sub-soil, that will not suit to loosen too much, the spring harrow will be sufficient.

An instance or two to prove that this is the best way to prepare ground for flax: A neighbour, who had a field in a poor or low state of cultivation filled with weeds and roots of different grasses, prepared his fields in the way I have stated. In the month of April, in dry weather, the ground was cleaned of weeds and seed sown. A fine crop followed, which, when cleaned in the mill and sold, gave 9s. per stone—2s. more than any other neighbour that had flax that year.

Another instance will suffice—the result of two bags of seed, sown in ground prepared in the way I have described: One bag realized 99 stones of flax at 8s. per stone; the other bag of seed, sown on the ground prepared in the customary way, that is, ploughing in February, harrowing well in March with ordinary harrow, then sowing in April, realized, when scutched, 48 stones at 7s. per stone. Both of these bags of seed were sown at the same time, and both beside each other.

PREPARATION OF SEED BED.

It is most important to have the mould very fine on the surface. When mould is fine and free from clods or lumps it is more likely, if the weather keeps dry, after seed is sown, to absorb the dew at night. When rolled all of the seed will then most likely germinate at the same time, whereas, if lumps or clods on the surface are left, the dew will not be taken into the ground in the same way, and the longer those lumps lie there before they get rain they become harder and drier, causing after growth. Some seed may almost die under these clods, and will not germinate until the rain comes at the end of, perhaps, eight or ten days. This is a great loss to the grower as these stalks of flax at pulling time will most likely be only in the flower, necessitating them to be handled all through the different processes, and of no value only to increase the tow pile. They are liable, too, to mislead the person who judges the flax in steep when it is sufficiently retted. In this way the woody part of those stalks will free itself of the fibre before the matured flax. As the winter may have been extremely wet, and from an absence of frost the ground in spring may be very hard to get pulverized, there is an article used in this neighbourhood for pulverizing the ground. It is far superior to rolling for breaking lumps. It is used by small farmers and farmers cultivating some hundreds of acres. Rolling is not necessary only to close the

ground after the seed is sown. I shall try and give a description of it: Get five or six larch poles, about seven feet long, with a circumference of fifteen or eighteen inches. Have a cut put down the centre. Lay them on the ground with the round side down, leaving them a quarter or three-eighths of an inch apart. Bolt two pieces of wood about one foot from the end to those on the ground. Attach to the ends of those two pieces the ends of a three or four foot chain, with a hook in centre for putting the horse to. You will then have one of the best articles for breaking and grinding lumps ever invented. It is excellent for preparing the surface before sowing clover and grass seed, and the ground, too, for an early braid of turnips.

TIME TO SOW.

It would be hard to settle exactly the best time for sowing. Some farmers are in an earlier district, others later; but, taking the whole together, the best time for sowing is between April 1 and May 1; but care should be taken that the ground is worked when dry and the seed sown in good order and on a calm day. After harrowing in the seed the ground should be rolled immediately. The young braids will not suffer so much from the frost which sometimes comes in May if the seed is sown when the ground is dry.

KIND OF SEED.

Each farmer should know the best brand of seed that suits his own land, but the Dutch seed is usually the best, and therefore most reliable; but the best seed may be thrown away in ground not prepared properly, or when sown at a wrong time. We hear sometimes about bad seed. An instance to show that the seed is not so bad as some people try to make it: My father and a neighbouring farmer, meeting in Belfast, purchased each a bag of the same Dutch brand on the same day. The produce on the bag my father sowed was between 80 and 90 stones of cleaned flax, whereas the other seed got up in weeds and became so choked that it had to be cut down with the scythe and burned. The fault, evidently, did not lie in the quality of the seed.

QUANTITY OF SEED TO THE ACRE.

There is a great difference of opinion, too, about this. If the season is favourable for sowing, the ground well prepared, mould fine, and the seed good, less seed per acre will do. Two bushels to the statute acre should be sufficient.

If the farmer wants a coarser or bigger flax he would sow less. Less is usually sown where the soil is very rich or low-

lying, to prevent lodgment. Again, where the soil is in a low state of cultivation, the quantity of seed should be increased, as some may not come to perfection, or may not all germinate.

WEEDING TIME.

The weeding time usually starts when the flax is two or three inches long. Most farmers understand this, and commence as soon as opportunity offers.

PULLING TIME.

The proper time to pull is when the leaves on most of the stalks of flax are withered halfway from the root. Farmers require to judge this for themselves, as the leaves on some stalks might be withered more than halfway up, while the blue flower may be on other stalks, or a short time off, the leaves on these stalks showing no sign of withering.

THE STEEP.

If the culture of flax is to be a success in this country, the matter of steeping must be carefully considered. I would suggest the desirability of combination for the purpose of getting this brought about, viz.: If the Agricultural Department, spinner, and farmer combine in a small way at first and purchase some low-lying moor near a lake or stream where the steep is known to be good, it would be a step in the right direction. I know a moor, or peaty bog, of, say, four or five acres, near a lake which, if sunk into dams, would water some thousand stones of flax. A place like this could be bought out very reasonably from the farmer, as a swamp or bog is nearly worthless to him. Dams in a bog would be very easily sunk.

I know the quality of flax produced from dams in this bog, having scutched the flax often. The price is usually two or three shillings a stone more than the average price of flax from most other steeps. We cannot have a general good steep for flax from the system that obtains at present, because the nature of most farmers' land will not produce a good steep. If the combine can be brought about, the flax could be bought from farmers on foot by an expert who shall have little companies of men under him for pulling, boling and taking out of steep. Farmers then, I believe, would be getting as much for their flax on foot as they now do after it is cleaned in the mill and sold in the market. (I don't believe in selling flax at the mill. It is, as a rule, only the best that is sold there, and sometimes under value.) Under this new plan then, all that the farmers would have to do would be to cart it to the place of steeping. The mill dis-

closes whether or not the flax has been sufficiently retted, but it is then too late to remedy an error.

SPREADING FLAX.

This is a most expensive and ruinous system.

Flax spread on the grass sometimes lies eight days or more before being lifted. If the time is very wet it suffers tremendously in the mill, and the loss is very great, as well as a bad price when sold. Flax lying in this way for eight days or so, though there be no rain, only dew at night, suffers. The part that is uppermost catches the dew, the underpart does not; therefore the flax that is uppermost will free itself in the mill of the wood before the underpart to follow it up in the mill until all the broken wood is out of it, that part of the fibre which was exposed to the dew at night has got too much work, the fibre is broken, and has a tendency to waste on the hackles. Spreading of flax is ruinous in another way—there are reeds pulled across the rows in spreading. When the flax is lifted into bundles these reeds are woven through the bundles; when it goes to the mill to be separated for rolling it has to be torn from one another, injuring and damaging the fibre. It goes through the same tearing in the streaking before given to the scutchers—hence the great amount of tow at most mills that might have been avoided. I shall suggest another plan that will avoid all this waste, be less expensive, and much more profitable. The plan is that the flax should be sufficiently retted. This is known when the woody part draws freely away from the fibre. The flax should then be taken out of the hole and left on the bank in a sloping position, with the root end down, to drip. The next day it should be left in rows, every three bundles almost touching. An hour or two after a person goes along and lifts these rows, placing every three bundles on their root end and meeting together at the top. On the following day, when the fibre becomes so firm as not to peel off by handling, these bundles should be opened separately, kept on their ends still, and shaken out in the shape of a cone. After two days or so, turn inside out, keeping it in the same position. At the end of two days more, when flax is thoroughly dry, it should be tied up and stacked. I prefer stacking to housing so as to prevent mildew. In a short time it is ready for scutching.

When flax treated in this way goes to the mill it divides freely at the rolling, the same in the streaking or handfulling. There are no broken or damaged reeds when it goes into the mill to be scutched, and there is almost no tow when finished. The flax itself is better, it cleans evenly in the mill, is of one

colour, less of it will make a stone, is squarer in the ends, and consequently more money is obtained when sold by the stone or cwt.

OTHER ITEMS.

Some of these I shall not touch now, such as rolling, setting of the stocks, position of the handles or wipers.

I shall deal with the streaker first. In lifting the handful the streaker should lift it as evenly at the root end as possible, the handful should then be caught about two-thirds of the length from the root but with the right hand, the left hand passing down the handful toward the root, and with the left foot placed firmly on any loose stalks or reeds, then draw with the right hand, holding the handful tightly. These reeds should be lifted, keeping them straight in the next handful, or placed by themselves until a handful is gathered. Any reeds in the top end of handful should be done in the same way; the root end then should get a chop on the ground, a slight twist is put in the handful; they can then be tied in bundles for scutching. As a rule the streaking is very badly done in most mills, the mill owners are not paid for the care that should be taken with the streaking and scutching, because the charge for scutching flax now is no higher, or very little higher, than it was forty years ago. The scutcher and streaker, with other attendants, have to get more wages than they got forty years ago, eating up the whole charge, leaving perhaps nothing but the tow for the mill owner as his profit.

THE SCUTCHER.

Some of these are very bad. They have learned, or have tried to learn, but in a bad way. The scutcher should be a healthy man, the muscles of his wrist must be strong and active; he must be able to keep a good hold of his flax on the stock, not to let any of it slide or get out of shape. The buffer should catch his handful of flax two-thirds of the length from the root when giving it to the mill. Some catch the handful too near the centre, thereby leaving a bit in the heart unbroken. This is not a proper workman, and should be rejected. The buffer should be able to break the woody part of all his handful on the stock before leaving his hand, and should leave it to the cleaner with the root end next him. The cleaner can then lift it square in the end, and if a good workman will keep it square until finished. Should he let it slide on the stock even he is not a proper workman.

The present system of scutching, which is pretty general, paying workers by piece instead of time, should be abandoned. Flax is usually roughly handled by piecework; paying by time would be better.

I have now given a brief outline of the whole flax system, from the best time to sow until finished in the mill. There may be some points here and there I might have gone into more fully, but if the substance of this is taken up and acted upon I believe it will establish the linen industry in Ireland on a basis that will not be surpassed.

VISIT TO THE SELBY FLAX STATION.

The ground around the works is used for drying the retted straw in steeple form.

Entering the works we found a number of men and girls deseeding dry straw, and bundling it up again for retting in hand presses. The deseeding machine used was of the roller type, as elsewhere described. The crushing, sieving and winnowing of the bolls followed, the clean seed being bagged up and the husks burned.

The treatment of the retted and dried straw was next witnessed. An eight-pair set of flax rollers of continental make was used, chiefly differing from Irish rollers in the application of thrust screws to the roller ends. The rolling, striking and scutching was done by girls, who, wearing a glove on the holding hand, seemed to have been well taught and to be skilful. The straw being well retted was easily cleaned by blades or handles of the light Belgian type, that part of the mill fitted with Irish handles and stock being seemingly unused. Loose fibres were pulled from the ends of the strick by hand, end combs and touch pins being conspicuous by their absence. The scutch mill was ventilated, apparently satisfactorily, by blower fans of the Belgian type, fixed upon the rim shaft and arranged as elsewhere described.

We were next taken to the retting dam and tanks, the former a branch of the River Ouse, or adjoining canal in which the rate of current was regulated to $\frac{1}{2}$ in. per minute or less than one yard per hour, a very much slower current than that of the Lys. Otherwise Lys methods were followed, the straw being built into openwork crates which were lowered into and raised from the river by well-arranged rack and pinion lifting gear, being floated to and from their retting positions in the pond.

The retting tanks were of cemented concrete and in depth equal to one layer of straw on end only, which was just as well, seeing that the heavy beets of wet straw had to be pitchforked out over the edge. The straw rested upon a false bottom over channels communicating with hollow outside buttresses serving as overflows and which carried off the heavy brown acid juices of fermentation. Downward currents were produced by intermittent flushes of water evenly distributed by

means of perforated wooden gutters. The water was intermittently supplied in flushes so as to ensure the equal filling of the gutters, which could not be produced by the same amount of water flowing constantly. The flush was produced by an ordinary sanitary cistern. The water was heated to a temperature of about 70° F., and pumped into an overhead storage tank, whence it ran to the flush cistern through a hole of adjustable size, according to the rate of flow required. A uniform temperature was maintained during the night by a gas heater through which the water passed, the gas being turned on and off by the action of a thermostatic valve.

We were led to suppose that the cost of retting and drying thus carried out amounted to 16s. per ton of retted straw.

We next witnessed a demonstration of Mr. Wilkinson's impact testing machine, specially designed to replace the experience necessary to successfully judge the comparative strength of flaxes and the results of various methods of retting and season's growths. In this machine a bundle of untwisted fibres, say $\frac{1}{4}$ to $\frac{1}{2}$ in. diameter, but of the exact section of the opening in the clamps provided to hold it, is clamped so as to leave a few inches tightly held between the clamps. A heavy lead-loaded pendulum-hammer was swung directly overhead and raised to a given height and allowed to swing downwards in the arc of a circle, striking and breaking through the bunch of fibres on its way. The motion which it loses represents the force required to break this bunch of fibres, and is measured by the difference in the length of the arc swung through on each side of the vertical line passing through the point of suspension of the hammer and the bunch of fibres below. If no resistance was offered, the length of the arc would practically be the same, and the difference in their lengths is directly as the resistance offered or the strength of the fibre. The height to which the hammer swings after passing through the fibre is indicated by a pencil or point upon a piece of indicator paper suitably placed.

We were also interested in samples showing the resultant quality of the same flax pulled green, half ripe, and fully ripe, also in the increased length, say 9 in., of flax grown from Professor Bateson's selected seed as compared with that grown from the best ordinary seed.

FLAX DESEEDING AND DEW RETTING.

Mr. Lewis C. Gray, Administrator of the Flax Supplies Committee, Belfast, communicated the following letter to the Press early in 1918:—

"SIR,—As the question of dew-retting flax grown in Ireland is at the present moment of considerable interest to farmers in

Ireland, and of great importance, looking to the necessity that all owners of 1917 flax or previous years require, in terms of the Order in Council recently published, to have same scutched and marketed by July 1, including the proportion of their crop saved for seed, I am directed by my committee to bring the following facts of an actual test that has been made before you, in order that the general body of farmers may be made aware of these and adopt the procedure outlined: A flax-grower in County Down recently delivered to this committee 9 stone 9 lb. of flax scutched from straw from which his regulation amount of seed had been saved. The straw in question had been dew-retted by the farmer, and the procedure adopted by him in doing so was practically that as outlined in the leaflet (No. 29) issued by the Department of Agriculture and Technical Instruction for Ireland in which retting of de-seeded flax straw is strongly recommended, and the procedure to be adopted is laid down as follows:—

“The retting process takes about six weeks. Flax is placed on grass in the same manner as when spread after being taken out of the steeping pond, except that it must be more thinly spread. Every few days, according to weather, the straw should be turned over to allow of even exposure to the air and prevent discoloration. There is more danger of under-retting than of over-retting in this process, and the flax straw should be left on the spread ground until the straw can be quite easily rubbed away from the fibre. When taken to the scutch mill the scutching handles should be driven very slowly, as dew-retted flax requires very little beating to remove the shoves.’

“On receipt of the flax in question, the committee, in order that they might be in a position to judge and advise as to the suitability of this method of disposing of the de-seeded straw, asked the firm of spinners to whom this special consignment was allocated to make a special report thereon. The firm reported that this particular lot of flax yielded as well in hackling as the average of water-retted flax, and cleaned up well. It turned out quite up to grade 2, at which it had been bought. The firm in question also reported that flax of this type would be quite satisfactory for the manufacture of aeroplane yarns. The committee are quite satisfied that there would be no comparison between flax dew-retted as above and fibre that had been scutched green without retting of any sort, and hope that farmers will adopt the ‘dew-retting’ method as outlined.”

Later Mr. George R. Begley, who has had considerable mill experience in Russia, wrote to the Editor of the *Belfast News-Letter* as follows:—

“SIR,—I have followed with interest the correspondence in

your columns on the question of dew-retting flax grown in Ireland, more especially a letter from the pen of Mr. Lewis C. Gray, Administrator, Flax Supplies Committee, in your issue of the 8th inst., wherein a report is given of an actual spinning test made recently with Irish dew-retted flax. I have always been of the opinion that great use could be made of this mode of retting in Ireland. The peasants in Russia have little difficulty in turning out a very good dew-retted flax, and as the average Irish flax is superior to the average Russian flax, the difference in quality should still hold good between Irish and Russian flax treated in the above manner. In certain districts in Russia, particularly Jaroslav, dew-retting has been brought to such a high point of efficiency by the peasants that there is no trouble at all in spinning to numbers as high as 130's weft; in fact, for a number of years it was spun to the same number against water-retted Courtrai line, with better results both as regards production and spin. From the standpoint of the spinner, and taking into account the handling the fibre would get in the home mills compared with what it receives in the Russian mills, I have no hesitation in saying that carefully dew-retted Irish-grown flax should be even a greater success than the water-retted Irish flax."

Under date March 12, 1918, Mr. H. R. Carter, of 25, Donegall Street, Belfast, wrote the Editor of the *Belfast News-Letter* as follows:—

"SIR,—Referring to letters on the above subject which have appeared recently in your valuable paper over the names of Mr. Lewis C. Gray and Mr. Geo. R. Begley—without in the least degree wishing to throw cold water on the scheme, if for the benefit of the trade, I would remark that my experience of dew-retted flaxes, gained in Continental mills, and the French have always been the largest users of such flax, is that wholly dew-retted flaxes are soft and weak. I say wholly dew-retted because some such flax, supposedly dew-retted, has been partly water-retted. My opinion on the subject is borne out both by Mr. Gray and by Mr. Begley, if one reads between the lines with technical knowledge. Mr. Gray says: 'The scutching handle should be driven very slowly,' in fact the flax is so soft that Irish blades run at the usual speed would knock it all into tow. Mr. Begley says that there is no trouble in spinning the best Russian dew-retted flax as high as 130's weft. Mark the word weft! Will dew-retted Irish flax, if fine enough for aeroplane yarns, stand the strength test?"

SIX WEEKS' FLAX PULLING.

EXPERIENCES OF A COLLEGE GIRL IN THE SOMERSET FLAX FIELDS.

The following extract from an article which appeared in a

recent number of *The Englishwoman* may interest and amuse. Miss Goss, a London University student, there recounts her experience of flax pulling in Somerset. Eager "to do her bit" and "incidentally to consummate" visions of green fields and juicy apples and friendly cows and horses, and breeches and leggings, she interviewed the Secretary of the Women's Land Union in London one summer.

"How about flax pulling for aeroplanes in Somerset?" the latter said. "The Government has commandeered all the flax grown in the district, and we are sending down one hundred workers (mostly college girls). It's hard work, you know."

"Oh, I don't mind that," Miss Goss replied airily.

"Well, sign here, and pay 12s. 6d. for your enrolment fee and the return ticket to Waterloo, please."

Leaving a few minutes later plus a khaki armlet with the inscription "Women's National Land Service Corps," the rest of the afternoon was spent in buying khaki overalls, gaiters, sun-bonnet, &c. The following Monday she left for Yeovil. It was a nasty wet day, and, arrived there, there was no one to meet her, and she had not the faintest idea how to get to Barwick House, the "empty country mansion" where the War Office was to billet the girls. Directed by the station-master, however, she set out in torrents of rain along a very muddy lane, and after half an hour's brisk walking came to the house and walked through the open door into a hall full of tin cans and cups and trestle tables. A battered piano stood by the door, and facing it was the large blue triangle of the Y.W.C.A. who ran the canteen.

Some one in a blue overall emerged and led her up some very noisy stairs on to a wide landing. Here she was confronted with a medley of suit cases and battered trunks and mattresses.

"All the rooms are called by different names," said Blue Overall. "This landing is 'Pandemonium.'" We passed The Sardine Tin, Olympus, Valhalla, Arcadia, and finally arrived at The Hotel Cecil, a small room in which eleven slept on straw mattresses and covered with an army blanket.

"In the morning, after hurriedly dressing, I got down to breakfast. Soon after breakfast, some small cars, two large motor lorries, and a shut-up affair known as the 'Black Maria' rolled up, and we packed in. By 8 o'clock I found myself in a flax field, pulling for dear life. We worked in gangs, each under a gang-leader. The flax had to be pulled up by the roots. This naturally involved much stooping, and resulted in backaches of the most fiendish description. My gang-leader hovered near me for a time, showing me how to pull the flax by a series of small jerks, instead of the herculean efforts I first expended on it. We each had a strip of some 2 yards

width. When on each occasion I straightened up and looked hopefully across the field I found I seemed to remain in exactly the same position; and on looking back I found I had left heaps unpulled. Talk about dragons' teeth! I am sure that flax could beat any dragon's teeth to fits. It grew by magic before and behind the desperate puller. At 11 a.m. we stopped and each ate an enormous sandwich. At 11.30 we were back at work. At 1.30 p.m. we were given half an hour's rest. At 3.30 a girl fetched tea in a bucket for the gang. After tea, we worked again till 6.30 p.m., when the motors came to fetch us home. The after-tea work was a little better than the pulling, for we 'gaited' or stood up the pulled bundles in stooks or 'gaits.' Two girls did the gaiting and the others 'served' or carried the bundles to them.

"On Saturday we went off after work to visit the Westlands Aircraft Factory, where the linen from our flax was used for aeroplane wings. The finer the linen the greater is the speed of the machine, I believe.

"The very worst remembrance I have of flax work is that of laboriously 'turning' acres of mouldy, wet flax, festooned with fat worms, through an entire day.

"Later on the work became easier. We 'tied' the gaited flax into sheaves ready to be loaded and carted away to the factories. If they were not carted the same day they had to be piled up in little pagodas, known as wind-mows. At first our earnings were very small—7s. to 12s. weekly—and our canteen charge was 13s. weekly. Later, when we 'tied,' we got more—16s. to 25s. Those were great days.

"Our numbers gradually dwindled down until September 8 found two solitary people finishing a field together after the departure of the others. On the night of the 7th the chief farmer of the district and local secretary of the Flax Growers' Association had us all to supper and gave us a good time. We arrived in town on September 10, very brown, very fit, and absolutely uncivilized."

FLAX CULTIVATION IN ENGLAND.

The general method of cultivation in England is as under-mentioned:—

The land for flax cultivation is rented from the farmers by either a company or privately. There is a contract made between the two parties: that the farmer who offers the land has to plough and cultivate the ground in preparation of the seed-bed, and when the crop is harvested it is delivered at the nearest railway station or at the rettery belonging to the parties connected. The party renting the land, enabling him to get in the flax crop, supplies the seed for sowing, so the

weeding and pulling, and finally takes delivery of the straw when harvested. Afterwards the seed is taken off the straw during winter, and the straw retted the following summer, which results in the fibre being held a year over.

The farmers not having accommodation or retting facilities, a rettery is established. Where the flax is grown in the district very often the straw is artificially retted, as the water supply for natural retting is not available.

The handling and scutching of the flax is carried on much after the same principle as in Ireland.

In Ireland the flax grower remains generally the owner of his product through all its stages, and having full knowledge of the suitability of his land for flax cultivation and careful treatment of the crop throughout, such as cultivating while the ground is dry, weeding, proper stage of pulling, retting, &c., he gains the full advantage of his crop, whereas in England the middleman comes in for his share between producer and consumer.

AN APPEAL TO THE FARMERS OF IRELAND TO GROW MORE FLAX.

PARTICULARLY THOSE IN MUNSTER, LEINSTER AND CONNAUGHT.

The soil and climate of Ireland are the best in the world for the growing of flax.

Before the Irish started the cultivation, Belgium and France had supplied the markets of the world. But after we commenced, we were able, I understand, to export large quantities to Great Britain. So prosperous and well-established had it become that in 1828 the Government withdrew its annual grant.

In 1809 the flax grown in Munster, Leinster and Connaught was nearly 15,000 Irish acres, which in 1823 had increased to nearly 50,000 acres. Now it is almost nil.

Why has there been such a decline? Several reasons might be given, viz., low prices, scarcity of labour, &c. The farmers of those provinces, I daresay, are as anxious to make money as are the farmers in Ulster. I am sure I need only have to call attention to the splendid return from last season's crop and the present one in this province.

In the Journal of the Department of Agriculture, I understand, numerous instances appeared where farmers, scattered over Ulster, had last season realized, even with the low yield, over £30 an acre; while this year this will easily be surpassed. In some cases nearly £40 have been already received. Are not these tempting prices to any farmer? From what other crop could he obtain anything to equal it? Would cattle give such a return?

The sowing of this crop has many material advantages. Let me enumerate a few:—

(1) It will increase the wealth of the farmer more quickly than any other crop.

(2) It gives employment to a far larger number of workers than does the produce of any other crop.

(3) It retains more labour in a district available for the farmer in the spring, summer, and autumn, as in the winter the same hands can be employed in scutching; then they get a whole year's continuous employment.

(4) The scutchers' wages range from 18s. to 24s. a week; while streakers, with rolling man, or woman, are paid less in proportion. Women and girls as a rule do the streaking or handfulling, so that both male and female labour is employed.

(5) The erection of scutch mills would help to raise more revenue for rates and taxes.

(6) A reasonably extensive sowing of flax in a district would open up new markets for its sale. Flax buyers would attend these markets, and thereby create a large circulation of money.

In Coleraine market, held on November 2 of the year 1916, there were over £6,000 paid for scutched flax; this is going on every week for several months. Is it any wonder the Derry farmers are so comfortable and well-to-do!

(7) Flax, not having been sown outside Ulster for practically half a century, would be grown on virgin soil in the other provinces, which is needed to produce flax of a superior quality.

(8) The bows or seed pods make an invaluable feed for cattle, if not otherwise preserved for sowing.

These are only a few of the many advantages to be derived from the growing and handling of this crop. When extensively grown, spinning mills, weaving factories, and bleach works, with kindred other industries will spring up into existence, bringing in their train a new era of contentment to our land.

Belgium was a wealthy country before the devastating war. What made it so? When flax here was selling at 5s. to 10s. a stone, it was selling on the Continent from 30s. to 40s. a stone. Why is this? The Belgians used their intelligence, and turned out an article superior to ours. What a splendid example of what can be done when enterprise and skill is properly directed!

I, therefore, hope to hear in a short time that all our farmers in Ireland have become growers of flax. There are said to be about 500,000 farmers in Ireland, and if each only sowed one acre we should increase our present area tenfold. What a splendid opportunity for the South and the West!

DAVID M'MORDIE.

RUSSIA'S LINEN TRADE.

Russia is the great flax-producing country of Europe. There it is grown to some extent in almost every government of that great Empire both in Europe and in Asia and more particularly in Pskoff, Smolensk, Vologda, Kostroma, Livonia, Vladimir, Vitebsk and Viatka.

The various branches of the linen trade, from raising the plant to weaving the linen, occupy the first rank among the textile industries of Russia. On the banks of the Volga and in Yaroslav and Kostroma many flax spinning mills have been erected, while power loom weaving has made great progress in Vologda, Vladimir, Kostroma, Yaroslav, Novgorod, Tiver and Archangel. Yaroslav is famed for its fine linen made in imitation of Irish goods; Kostroma for fine linen and damask and Vladimir and Novgorod for duck and sheeting.

The surface of Russia, though mainly made up of one vast plain, offers natural difficulties which have prevented Russia from acquiring adequate transport facilities, especially by land. The marshy character of a large part of the surface and the want of road-making materials, both stone and wood, stand in the way of road construction. Hence the roads are often mere tracks, impassable in wet weather, and at their best when snow and frost make the use of sledges possible.

The deficiency of roads is, however, to some extent made up for by the abundance of natural water-ways, the greater number of the rivers being navigable nearly to their source. No Russian river port, however, is on an average free from ice for more than ten months in the year, Archangel for only 177 days.

The extent of Russian water communications helped to delay the laying of railways. Down to the close of the Crimean War there were only four railway lines in the country.

As regards climate, Russia lies in that part of Europe where the extremes of temperature are greatest and the rainfall least on the whole. The nature of the climate puts a limit to cultivation both in the north and the south-east. The region of black earth, a soil of unsurpassed fertility which is spread over Southern Russia in patches from the frontier on the south-west to the hills west of the Volga, is that on which the best corn crops are grown.

Flax is chiefly cultivated in the northern departments. In two of these, namely, in the Governments of Pskoff and Jaroslav—it is the chief crop and source of revenue to farmers and peasants. These two Governments, together with the Governments of Kovno, Vilna, Witebsk, Smolensk, Novgorod, Kostroma, Viatka, Vladimir, Moscow, Tiver and Kaluga, where flax culture holds sway, extend from west to east and

pass just north of Moscow. It is in this huge region that practically all the flax which is exported is produced.

Agriculture is practised under conditions in some respects peculiar in Russia. Down to 1861 the majority of the peasants were serfs attached to the properties of large land owners, but since the emancipation of the serfs in that year the land has become in a great measure the property of the peasants and especially so in the arable districts.

In connection with Russian flax, *Gospodsky* means a Russian noble who may take flax from the peasants as a toll, or who may grow considerable areas of flax and have it more carefully cultivated, retted and scutched than is the general rule among the peasants. *Zins* = tax-money. In levying this tax the officers of the Church take the best flax, called *Zins*.

The linen industry of Russia, nourished by abundant local supplies of flax, furnished till about 1820 an important export, but only slowly recovered from the blows inflicted upon it by the introduction of machine-made linens of other countries. Russian linen, formerly coarse though strong, is now not to be distinguished from that of western manufacture.

The principal seaports on the Baltic and its arms are St. Petersburg, with Kronstadt, Reval and Riga, the first three on the Gulf of Finland, the last on a river entering the gulf to which Riga gives name. The harbour of Reval has within recent years been deepened and extended, and imports large quantities of American cotton. The port of Riga, population 280,000, has also had its shipping accommodation improved by the regulation of the Drina of Western Dwina. Its port for large shipping is Dunamunde or Dwinsk, at the mouth of the river. The minor Baltic ports (exclusive of those of Finland) are Libau, Pernau and Windau, the first of which (the furthest south) has a very considerable trade.

Russian flax is principally grown in the north, and it is the chief crop and source of revenue to farmers and peasants. Russia is the largest flax producer in the world, nearly 41,000,000 acres being sown.

Two processes of retting are carried out, namely, dew-retting and water-retting. That coming from Archangel is dew-retted, and is usually of a silver-blay or reddish foxy colour.

Water-retting is practised in the west and north-west districts. Dew-retted is produced in larger quantities than water-retted. France is the largest importer of dew-retted fibre.

Russian spinners use home-grown flax almost entirely, their consumption being about 40,000 tons, or one-fifth of the total output of the country, which exceeds 200,000 tons annually.

The Russian Government takes the keenest interest to promote the prosperity of the flax industry. It has established experimental farms and propagates the best brands of seed,

and gives instruction in the most modern methods of flax culture.

Their peasants bring their flax to market in the winter time when the roads are covered with snow and in good order for the sledges. Since the lots are rather irregular in quality, classers attached to the market separate the various qualities and put a price upon the lot. It is then sold to small agents, often Russian Jews, who resell it to export houses.

FLAX GROWING AND FLAX PRICES.

According to the first annual report of the Flax Production Branch of the Board of Agriculture and Fisheries recently published, the Branch was formed in December, 1917, owing to war conditions and the cessation of the arrival of raw material from Russian ports rendering it imperative that urgent steps should be taken to conserve our seed supply for future sowing and to increase the production of fibre within the Empire. The task submitted to the Board was to arrange for the growth of at least 10,000 acres of flax in Great Britain, to deal with the resultant crop in such a manner that seed should be available for sowing in the spring of 1919, and to manufacture straw into fibre suitable for aeroplane cloth and other military requirements.

The terms offered to growers were £8 10s. per ton of the total crop (straw with seed on), with free seed and a minimum payment of £14 per acre whatever the crop. The total area of land finally contracted for was approximately 12,352 acres. The whole of this acreage was contracted for directly by the Branch for treatment in its own factories, and an additional 1,140 acres were arranged for in Yorkshire by private firms. The total quantity of seed used was 26,290 bushels. After making due allowance for short crops on which the guarantee minimum of £14 per acre will be paid, it is estimated that the weight of straw and seed will be approximately 26,500 tons. The total cost of the guaranteed minimum payment per acre was £5,341.

The report points out that it is obvious, in regard to future developments, that no satisfactory conclusions as to the possibility of working the enterprise as a sound commercial business can be deduced from the experience of the past year. The high prices obtainable for the products of industry have clearly been more than discounted by the heavy cost of production. That the flax industry can be made to pay in Great Britain on a small scale has been demonstrated by the results achieved by the experimental stations established before the war. The maintenance of the industry on the present scale, however, it is stated, must depend on the unknown future of foreign

imports and prices, and the development of flax growing in the new countries.

The Flax Supplies Committee, who have their offices in Whitehall Buildings, Ann Street, Belfast, will administer the Flax (Irish Crop) Order, 1919, and they have issued a notice stating that the flax will be divided into six grades, as follows: first grade, 35s. per stone, delivered at the appointed centre; second grade, 33s.; third grade, 31s.; fourth grade, 29s.; fifth grade, 27s.; sixth grade, 25s.* Flax which is inferior in quality to that of the sixth grade will be taken over and paid for according to its relative value. Flax brought to market not properly scutched will be sent back for re-cleaning. All flax will be graded and paid for at the various markets, and there will be no buying at the scutch mills. The committee's staff of graders will attend the markets according to the requirements of those markets. Flax once brought to a market or any other centre as directed by the Committee may not be withdrawn. Any person committing or attempting to commit such action will be guilty of an offence against the Defence of the Realm Regulations, as stated in clause 6 of the Flax (Irish Crop) Order, 1919, and will be proceeded against. The allocation or sale of the flax bought by the committee will be in the hands of the Allocation Committee of the Flax Control Board (Irish Sub-Committee) who will instruct the Flax Supplies Committee of the quantities of flax to be allocated or sold to each spinner. The terms of payment by spinners for flax will be intimated direct to spinners in due course.

A market for the grading and purchase of flax will be held every Friday in Belfast, and markets will also be held in many towns in Ulster. All flax must be in each market before 9 a.m., otherwise it will not be graded on that particular day.

At a meeting of the Ulster Farmers' Union, held on October 10, 1919, Mr. S. Haughton (representing the spinners), at the request of the chairman, addressed the council in regard to the flax question. He pointed out that he had explained at a meeting in the Ulster Hall that he believed 85 per cent. of the linen trade was with them in that movement for a better price for 1919 flax. (Hear, hear.) He believed that statement then, and it was true still. (Applause.) The Government had been blamed for many things, but the position so far as flax was concerned lay with the farmers and the flax growers on the one hand and the linen trade on the other. He had looked at every side of the question, and had been privileged with a certain amount of confidence on one side and the other. Farmers had the matter in their own hands, and let them go

* These prices were afterwards increased by 10s. per stone.

about it in a cool business-like way. A deputation from that council was to meet a deputation of the linen trade on the question, and it did not matter twopence what hall they met in. When the council proceeded to appoint their deputation to meet the spinners, let them appoint the best men, and do not quibble about where they would meet. (Hear, hear.)

A deputation was appointed to meet the spinners at a conference in the Belfast Chamber of Commerce in the afternoon.

The price the farmers' deputation was to insist upon was spoken to by several members, and most advocated £3 per stone for first grade.

Mr. David Johnston, J.P. (president), said he would be in favour of the control being taken off, believing if it were prices would reach even £5 per stone, and certainly not less than £4.

Mr. Neill said he had examined two samples of flax grown in Ulster, and each was worth about £400 per ton. It was superior to French flax, which was bringing in between £560 and £600 per ton.

Subsequently the deputation met the representatives of the Spinners, Power-loom Weavers, Flax-mill Owners, and Flax Society, Ltd., in the Chamber of Commerce. After a discussion lasting several hours it was decided to ask the Control Board that the same price, 35s. to 45s. per stone, be paid for the 1919 crop as for the previous years' growth. Failing compliance, spinners were to join in a deputation to the Control Board, and failing satisfaction to appeal to the Prime Minister.

In a leading article the *Belfast News-Letter* said: We are glad to observe that representatives of the Farmers' Union and of the Flax Trade have at last met in friendly conference in the hope of amicably adjusting the acute controversy that has been waged concerning the prices for flax. There has been a good deal of shouting at each other from rival platforms, with the result probably that needless warmth has been engendered. This is a pure matter of business, and the negotiations should, therefore, be carried on in a calm and business-like spirit. Such a disposition is far more likely to eventuate in agreement than is the manifestation of irritation. Above all, let there be no indulgence in threats as to what may or may not be done in certain eventualities. It will be time enough to resort to that sort of thing when all pacific measures have failed. The quarrel really is not between the spinners and flax growers. There are third party interests that profoundly affect the argument. Let it not be forgotten either, that in one way or another it is the public who will be the ultimate payers of any increased prices which may be arranged. The threat to cease growing flax if certain demands are not conceded is of more than doubtful wisdom. No one has or can have any moral right to insist upon a farmer grow-

ing a crop which must inevitably involve him in loss. But is it really true that flax-growing generally involves such consequences? Flax-growing, we know, is precarious. Here and there individual examples of loss can be quoted due to special circumstances. The same is probably true of nearly every kind of crop. But it is undoubtedly true that in the main flax-growing at present rates pays, and pays well. The farmer thinks it should pay him better; that really is the essence of the present agitation. It is a difficult crop to raise; the risks of losses in one season must be offset against the gains of another; the cost of labour is high and flax requires a good deal of handling. These are all questions that enter into the consideration of what constitutes a fair and reasonable price, and they show that the answer to the question is not easily ascertainable. Even amongst the farmers themselves there is diversity of opinion. Some want the present system of control entirely withdrawn, and the law of supply and demand permitted to operate in an open market. It is well to remember that at no distant date foreign flax may be a formidable competitor with consequences that are obvious. There are others who suggest that a minimum price for the various grades represents the more prudent line of policy. These views can all be threshed out in the negotiations that have been begun, and with mutual goodwill and consideration for the various interests involved. We have little doubt that a satisfactory arrangement will be evolved.

About October 20 deputations from the Ulster Farmers' Union and Flax Spinners' Association went to London and called upon the Flax Control Board. The deputations were well received and the whole question was carefully considered. As a result, and in view of the willingness expressed by the spinners to relieve the Government of all liability for any increase in the purchase price the Board decided to recommend an increase on the scale of prices prevailing in 1918, provided (1) that spinners place with the Flax Supplies Committee firm orders for 16,000 tons at 45s. per stone (or less according to grade) with the addition of a charge of 8d. per stone or such other sum as may be necessary to cover expenses; delivery to be made in such assortment and at such time not later than October 1, 1920, as may be decided by the Allocation Committee, Flax Control Board; and (2) that such increase of price will operate retrospectively.

ARBROATH SIXTY YEARS AGO.

The *Arbroath Guide* recently published an article on the above subject from which we cull the following items of interest to our trade:—

“The first power-loom factory in Arbroath was Spring

Garden, belonging to Messrs. David Corsar and Sons. It is now a big business, the 'Reliance' trade mark being known all over the world in connection with sail cloth and heavy canvas.

"Ramsay, the reed-maker, was early established in Arbroath. Seventy years ago George Ramsay was in business as a reed-maker in Panmur Street. Since then successive generations of the family have carried on the business of reed and camb (heddle) makers in the town.

"Old Hume Street Mill, now a heap of rubbish, was one of the oldest of the Arbroath spinning mills and was carried on from time to time by different owners. At one time the owner was John Finlay, who was in business there in 1857. From him the mill passed to the Raitts and they were succeeded by the Scrymgeours, who were the last to keep the mill running. Mr. Peter R. K. Leslie, the locally famous cricketer, was long the solitary mechanic-manager at the place.

"The old Inch Mill dates back to 1808. In that year a 16 h.p. steam engine was introduced for the purpose of driving the spinning machinery. Until about the late 'forties the Inch Mill was carried on by a Mr. Canning, who was a native of Kirkcudbright, but had been long resident in Arbroath. He was followed in the ownership of the mill by Messrs. William Curr and Co. The old Inch Mill, or No. 1 as it was fondly called by the workers, was about the year 1863 taken over by the late Mr. Andrew Lowson of the Green's Mill and was turned into a machine hackling shop. Shortly afterwards Nos. 2 and 3 Inch Mills were built. No. 2 Mill, next the burn at Stobcross Bridge, is now incorporated in Messrs. Douglas Fraser and Sons, Westburn Foundry.

"In 1744 Mr. John Gardiner built a mill for washing and 'knocking' cloth and yarn at the corner of his bleachfield. David Corsar's washing or beating mill adjoined alongside the mill-lade. The bleaching green referred to covered most of the ground extending from Milgait to what is now North Grimsby. In 1750 the firm extended their bleaching green by four or five acres by taking in the adjoining crofts belonging to Mr. James Ritchie, afterwards Hampton's, and the croft of Mr. David Milne.

"The Nether Mill was long in use as a 'Pashie' or yarn washing premises.

"There was little or no division of labour, all the processes from the dressing or hackling of the newly imported flax to the disposal in the market of the woven cloth being undertaken or directly superintended by the manufacturer himself. The master attended personally to the cleaning of his yarns in the tubs or 'caves' of the plashmill where he had often to wait his turn among other masters who were there on the same errand as himself. The place was in constant motion

with the thud, thud, of the wet and the clatter, clatter, of the dry beaters which appeared to be in perpetual motion, never ceasing their din day or night. About 1863, the yarn washing was transferred to the Green's Bleachfield, now the Cattle Market.

"When Captain Falls, of the French privateer 'Fearnought,' bombarded Arbroath in 1781, Millhead House was occupied by Bailie James Renny, one of the partners in the firm of Messrs. Fitchett and Sons, then the leading firm of flax spinners in the town, and a cannon ball which struck the house is still in the possession of a descendant. Messrs. Fitchett and Sons were the builders of the Brothock Mill in 1806, the first spinning mill in Arbroath to be driven by a steam engine by Boulton and Watt, Soho Works, Birmingham.

"Not long after steam engines were introduced into the old Burnside Mill and the old Inch Mill No. 1. During its long history, the Brothock Mill has repeatedly changed hands. The Rennys of Fitchett and Sons were followed by Mr. John Muir, who in 1860 sold it to Mr. David Corsar, of Applegate Factory. On the death of Mr. Corsar, the mill was closed down for a time and was then taken over by the firm of Anderson and Chalmers, St. Rollox Works, who still continue to carry on this historic mill.

The following Arbroath Weavers' Toast is redolent of the East Coast and points to the elements of fishing, industry and agriculture.

"The life o' man, the death o' fish;
The shuttle, soil and plough;
Corn, horn, linen, yarn;
Lint and tarry woo'."

PRODUCTION OF RUSSIAN FLAX.

According to a recent report, the production of the various Russian Governments of flax is as follows:—

				Flax, poods.
Livonia	1,629,500
Kovno	1,404,600
Witebsk	1,304,500
Pskov	2,250,800
Vilna	512,300
Courland	404,100
Esthonia	81,100
Petrograd	211,300
				<hr/>
Toal	7,798,200

FLAX FIBRE DEVELOPMENTS IN SASKATCHEWAN.

(*Board of Trade Journal.*)

A new linen, or bastard linen, has been produced from ordinary flax straw grown on farms in Saskatchewan for seed purposes, the Public Service Bulletin of the Saskatchewan Government states.

Some fifty articles made from this new material were recently on exhibition at the Parliament Buildings, Regina, and they comprised the following:—

Yarns, drawn and spun up to 4,500 feet to the pound, ready for weaving into heavy sacking, burlaps, or heavy towelling.

Commercial twines, heavy qualities with glazed surfaces, and fine qualities with waxed surfaces, having a wholesale value ranging from 50 to 83 cents per pound.

Binder twines of a soft even surface, being three-ply spun, giving 750 feet and 900 feet to the pound, with a breaking strain at 60 and 50 pounds respectively, not varying more than 2½ pounds either way. Tests of this binder twine in the field gave 99 per cent. of well-bound sheaves, a better result than when sisal twine was used with the same binder.

The preparation and treatment of raw flax fibre is simple and cheap, and can be carried on under cover at all seasons of the year. The treatment gives a spinning value of 4,500 feet to the pound, with the permanent qualities of linen, and is believed to be immune from the activities of gophers, mice or crickets.

FLAX GROWING IN RUSSIA.

That Russia is the chief flax-growing country in Europe is clearly shown by the following figures for the years 1903-1914:—

Countries.	Acres under flax,		Total yield,		Average yield
	acres	%	tons	%	in stones per acre
Holland ...	34,566	1·1	8,361·4	1·7	39
Hungary ...	64,440	1·5	12,704·8	2·6	31½
Ireland ...	48,600	1·5	9,667·8	2·0	31½
Belgium ...	49,140	1·6	9,833·9	2·1	32
Germany ...	57,570	1·9	10,477·4	2·2	29
France ...	61,290	2·0	28,869·3	4·3	75
Austria ...	149,850	4·8	44,325·8	9·2	47
Totals...	447,451	14·4	116,250·4	24·1	42
Russia	2,676,810	85·6	363,659·7	75·9	22

WORLD FLAX AREAS.

The following figures recently published show the number of statute acres under flax in 1919, Russia excepted:—

Ireland	112,000
Belgium	87,000
Japan	70,000
France...	35,000
Holland	25,000
Canada	22,000
England	13,000
British East Africa	5,000
Egypt	2,000
Scotland	1,350

Total in statute acres ... 342,350

The last Board of Trade returns give the total imports of flax and tow into the United Kingdom at 8,554 tons, value £2,148,370, and 844 tons, value £102,033 respectively, against 21,272 and 2,027 for 1918.

LINEN YARN VALUES, 1919.

	Line Weft		Sheer Warps		Light Warps	
	Feb.-Sep.	Dec.	Feb.-Sep.	Dec.	Feb.-Sep.	Dec.
20	49/-	72/-
22	45/6	68/-
25	41/6	62/-
28	38/3	58/-
30	36/3	56/-
32	35/3	54/-
35	32/9	52/-
40	30/6	50/-
45	28/3	45/-
50	26/9	42/-
55	25/9	40/-
60	24/9	37/-
65	22/-	33/-	24/-	35/-
70	21/-	31/-	23/6	33/-
75	20/3	30/6	23/-	32/6
80	19/6	30/-	22/6	32/-
85	18/9	30/-	22/3	32/-
90	18/-	29/-	22/-	32/-
95	18/-	29/-	21/9	32/6
100	18/-	29/-	20/-	31/-	21/6	33/-
110	18/-	29/6	20/-	31/6

	LineWeft		Sheer Warps		Light Warps	
	Feb.-Sep.	Dec.	Feb.-Sep.	Dec.	Feb.-Sep.	Dec.
120	18/-	31/-	20/-	33/-
130	18/3	32/-	20/3	34/-
140	18/9	33/-	20/6	35/-
150	19/6	35/-	21/-
160	20/3	37/-	21/6
180	21/9	40/-	23/-

	Tow Wefts		Combed Rescutched		Combed Russian	
	Feb.-Sep.	Dec.	Feb.-Sep.	Dec.	Feb.-Sep.	Dec.
14	45/6	62/-
16	40/6	60/-	49/6	56/-
18	36/6	58/-	45/-	54/-
20	33/-	56/-	41/-	52/-
22	30/6	54/-	36/-	50/-
25	28/-	52/-	34/-	48/-
28	27/6	57/-	32/6	46/6
30	27/-	50/-	29/9	45/-	34/-	52/-
35	26/-	47/-	30/6	48/6
40	25/-	44/-	27/6	45/-
45	24/-	41/-	25/-	43/-
50	23/-	38/-	23/9	40/-
60	21/-	34/-

SUPERIOR COMBED TOWS.

Lea	Feb.-Sep.	Dec.	Lea	Feb.-Sep.	Dec.
20	49/-	72/-	35	32/9	52/-
22	44/6	67/-	40	30/-	49/-
25	41/6	62/-	45	27/6	46/-
28	39/6	59/-	50	26/-	41/-
30	36/6	56/-			

MIXED FLAX AND HEMP TOWS.

	Feb.-Sep.	Dec.		Feb.-Sep.	Dec.
14	44/6	60/-	18	35/6	56/-
16	39/6	58/-	20	32/-	54/-

RESCUTCHED CARDED TOW YARNS.

	Feb.-Sep.	Dec.		Feb.-Sep.	Dec.
14	39/-	59/-	20	30/6	53/-
16	34/-	57/-	22	29/-	51/-
18	32/-	55/-	25	26/9	49/-

Linen yarn values in 1914 were approximately as follows:—

Line wefts: 20's, 9/4½; 22's, 8/10½; 25's, 8/-; 28's, 7/4½; 30's, 6/10½; 35's, 6/3; 40's, 5/10½; 45's, 5/6; 50's, 5/3; 60's, 4/10½; the range 65's to 90's, 4/8; 100's, 4/10; 110's, 4/11; 120's, 5/3; 130's, 5/6; 140's, 5/9; 150's, 6/-; 160's 6/3.

Tow wefts: 20's, 8/4½; 25's, 7/1½; 30's, 6/9; 35's, 6/3; 40's, 5/9; 50's, 5/3; 60's, 4/9.

LINEN VALUES, 1914-1919.

Pre-war. 1919.

	1914.	Jan. 1919.	Dec. 1919.
95 in. 9 ⁰⁰ linen sheeting	17 ³ / ₄	78 ³ / ₈	120d. per yd.
48 in. 14 ⁰⁰ pillow linen	11 ¹ / ₂	49 ¹ / ₄	68 ³ / ₄
38 in. 15 ⁰⁰ green yarn linen	8 ³ / ₄	37	44 ⁷ / ₈
38 in. 18 ⁰⁰ boiled yarn linen	12 ¹ / ₂	46 ¹ / ₂	56 ¹ / ₄
25 in. 10 × 7 linen rough, 25/30 tow	3 ³ / ₄	16 ¹ / ₂	28 ¹ / ₄
40½ in. 16 ⁰⁰ linen cambric	10 ¹ / ₄	39 ³ / ₄	54 ³ / ₄
Men's linen h.s. hkfs. 21 in. 16 ⁰⁰ shire h.s.	5/-	15/11	23/- doz.

THE CENTRAL ASSOCIATION OF RUSSIAN FLAX GROWERS.

The aim of this recently formed Association is to market the produce of its members and by supplying them with seed, up-to-date machinery, &c., to improve the standard of Russian flax.

The Association comprises about 3,500 societies of farmers, with an aggregate membership of about 350,000.

TEXTILE WAGES IN BELGIUM.

Belgian textile industries have had many difficulties to overcome, of which provision of new machinery and raw material were possibly not the more important. Before the war the average working day was of nine to ten hours. Efforts are being made to have this reduced to eight hours; nine hours is now the limit and a reduction to eight and a half hours is shortly expected. An eight-hour day is expected to commence in April, 1920. There have been numerous strikes for increase in wages and these are now 150-200 per cent. above the rates of 1914. Wages now paid in the principal textile industries are as follow:—

Linen industry:—

Hacklers	7d. to 9½d. per hour.
Driers	8½d. to 9½d. ..
Packers	9½d. to 10½d. ..
Children	3½d. per hour.
Bleachers, dyers and finishers	9d. ..

RESEARCH IN THE LINEN TRADE.

The first general meeting of the Linen Industry Research Association was held on September 16, 1919, in Belfast, under the chairmanship of Mr. J. G. Crawford. There was a good attendance of those directly interested in the Irish linen trade. Upon the platform were also Mr. Norman Boase, chairman of the Scottish Provisional Committee; Professor J. A. M'Clelland, F.R.S., a member of the Council of Scientific and Industrial Research in London; and Dr. Vargus Eyre, the newly appointed director of linen trade research.

Mr. J. G. Crawford, in opening this meeting, said that the formation of the Linen Industry Research Association marked an epoch in the history of the trade. If they were to look diligently into the early history of the linen trade in the country most of them would be surprised how well and truly the foundations were laid, how sound was the economic theory to which the builders were working. On those foundations were built up the world-wide reputation of Irish linen, and on that reputation they were too long content to live, with little or no concern beyond their next balance sheet, without an idea of the wider vision of those who had gone before, without taking time to look ahead or to consider the questions which lay at the very basis of the manufacture and commerce. A desire for common action, for co-operation, gradually dispelling the feeling of mutual distrust, more noticeable at first perhaps among the spinners, but eventually equally evident in all branches of the trade, began to put new life into the industry. Various factors came in; the new scientific spirit abroad in the world was one. It often had its earliest manifestations in the British Empire, but, awakening no response among their inappreciative manufacturers, the discoveries of their chemists were taken up in Germany, and there, as the fruit of plodding research, revealed their power and possibilities. The scientific research had been ours; the industrial research, which had taken advantage of the first, was theirs, and was giving their industry such a pull over ours as compelled our people to reconsider their attitude.

Another factor, the speaker said, was the new spirit with regard to labour. Here and there an enlightened employer made improvements in the conditions under which work was carried on at great cost, and with no idea but that of benefiting the workers, only to find subsequently that in many cases the money spent was a sound investment. Official action, through the factory rules of the Home Office, compelled more slow-moving employers to adopt these and other ameliorations. Labour began to demand a larger share of the good things of this life. No right-minded person would dispute that claim, but the goal cannot be reached by merely shortening hours

and raising wages. The effect of both is to raise the cost of product, and if carried out all round everything goes up simultaneously. The raising of wages is of no advantage whatever if prices of all commodities rise in the same proportion. But if we can increase the yield of flax per acre, and save the seed, we may possibly reduce the price of flax below its pre-war level, or at any rate get it back to that point, and at the same time make it a more profitable crop to the farmer, then one factor in the cost of our goods remains the same. If we can eliminate waste in manufacture, if we can derive a revenue from the better utilization of by-products, if by co-operation with our wage-earners we can increase our production per hour, we have an offset against the increased cost of production, and we can afford to pay high wages without raising the price of our product correspondingly, and then the wage-earners will profit in proportion.

The war with its alternatives of life or death, revealing as by a lightning flash so many and so serious deficiencies in our industrial equipment, enabled us to close our ranks and showed us how it is possible to standardize our products. At its close the war has given us a practical monopoly of means of production for a year or possibly two, and an unparalleled opportunity of remodelling our industry, and placing us in a very strong position to meet the renewed competition which is bound to come. The formation by the Government of the Scientific and Industrial Research Department supplied the suggestion necessary to make us see that organized research was the logical and natural outcome of all these diverse influences. The present condition of the linen industry and the outlook are most interesting and stimulating, and I feel it advantageous to turn aside from immediate commercial concerns, and make a short and very summary survey of past and present conditions, and forecast the possible developments. What are our present conditions? We have a linen trade, no longer a number of entirely independent and jealous firms, but formed into a series of associations working in co-operation in the interests of our industry. Further, practically all the members of these different associations have joined in the support of the Flax Society, Ltd., at one end of our operations, and of the Irish Linen Society at the other. The one has for its aim the direct improvement in our supply of raw material, both as to quantity and method, while the other seeks to develop the market for our finished goods, and find new ones, tending to prevent violent fluctuations in price which are so disastrous to commerce. It seeks to establish standards of quality for our products and eliminate the ruinous cutting of prices, and manufacturing to price, which has done us so much harm in the past.

Research may be broadly classified under two heads, pure

or scientific research and industrial research. The first is concerned chiefly to increase the sum of knowledge, the latter with making such acquired knowledge useful to a particular industry. The dividing line between the two is possibly imaginary, but the distinction is nevertheless useful and must be borne in mind. Pure research may prove valuable anywhere, sometimes in the most unexpected quarters, industrial research is that from which we derive direct benefits. At first sight it might appear that we should be spending our money to better advantage by confining ourselves to industrial research. The returns are likely to be more easily ascertained and more quickly realized. But I believe that without pure research we shall miss something equally certain, if longer delayed, and of incomparably greater value. Let me now elaborate a little the case for the Linen Industry Research Association. The basis of our manufacture is the flax plant—what do we know about it? Appallingly little, nor have we taken any trouble either to study it or to improve it. There is as much difference between a cambric and a tent duck as between a thoroughbred and a shire horse, yet we expect to grow flax crops to manufacture both fine and coarse goods from seed derived from one haphazard source, namely Russia. It is not reasonable. Plants will respond to selection as readily as animals. There is a whole range of different wheats to suit climates or season, and so on for potatoes or cabbages or lettuces, but so far there is nothing of the sort for fibre flax. At present the position of fibre flax-seed is one of the greatest confusion—long fibred and short, coarse and fine, early maturing and late, blue and white blossom are hopelessly mixed together, and from this nice mixture we are asked to produce the whole range of cloths from the finest cambrics to the heaviest canvases. From what I have seen I believe it should be quite possible to have one variety of flax producing fine weft, another medium warp, another heavy warp. This branch of work, seed selection, we may find ourselves compelled to take up immediately. It has been carried out hitherto by Dr. Eyre, financed by a grant from the Development Commissioners. These Commissioners now say that as the Linen Industry Research Association is formed and is receiving a grant from the Government through the Research Council, they can no longer furnish funds for such work. Therefore, we shall have to make provision for continuing and probably developing the work which Dr. Eyre has conducted with such ability up to this point. There are dozens, nay hundreds, of other questions awaiting investigation—for instance the utilization of waste products such as pouce, or the elimination of others, such as scutching tow or spinning waste. There is again the very important and complex question of dressing warps. Many others will occur to you. And as we get started

the number of questions requiring an answer will increase in arithmetical, if not in geometrical, progression.

A preliminary selection of seed has been made by Dr. Eyre, working under the auspices of the British Flax and Hemp Growers' Society, and by Captain Hunter, on behalf of the Department of Agriculture and Technical Instruction for Ireland. Next year, or the year after, we may hope to have enough of the selected seeds to grow a quantity of flax sufficient to furnish trials in spinning and weaving on a considerable scale.

I think it reasonable to suppose that in three years there might be something tangible to show somewhere, and pretty certainly in five, but it might take longer. Therefore it is that we are asking for an undertaking from you to support this scheme for five years certain, believing that by that time we will have sufficiently demonstrated the possibilities to have you eager to carry it on permanently.

The principal officer of a research association is the director of research. This man must have very exceptional qualifications. To mention merely his scientific qualifications, he must certainly be a chemist; but he must not be a chemist to the exclusion of all other branches of science. The more knowledge he has of botany, bacteriology, physics, and I know not how many more sciences, the better. Such a man is difficult to find, and we took advantage of the best assistance we could get in selecting him. Mr. Eyre is our choice, and I believe we have the right man. When he gets past the purely preliminary work, which will necessarily occupy some months, we will probably have under him specialists in as many different branches of science as we may determine to take up, with assistants, where necessary, to carry on the routine work. The work may be carried on in any centre found suitable—it may be Belfast, Dundee, Leeds, or any other place.

Professor M'Clelland said that the Research Association, of which those present were members, was not an association set up and controlled from London. It was true the State was taking some part in the work, and the justification of the State taking an interest was quite obvious, as it was clear the success of the linen industries was not only of importance to individuals, but concerned the whole community. The members of the Association would make their own appointments. The Department would contribute pound for pound up to £5,000 contributed by the Association. If the work of the Association developed, and it was necessary to spend more than £5,000, the Government would contribute a sum more than £5,000, but he would not say the contribution would then be pound for pound. One million pounds had been set aside by the State for the work. If the Research Association was going to secure the results they all hoped it would, education,

from the university down to the primary school, would have to be improved. The education of the worker would have to be improved; because in the future employers would be looking for a higher standard of excellence—a standard never experienced in the past. If the workers were to attain that proficiency education down to the lowest grade must be improved.

Dr. J. de Vargus Eyre gave an account of the programme of research which it was proposed to take up. He was not unused to research work, he said, and therefore he believed he would be able to bring something of value before the Association. When once a promising line had been made, and one became more familiar with the details of the several operations, fresh problems would present themselves and their full significance be appreciated. There was, however, clear evidence that inequality in the raw material for spinning was largely responsible for much of the trouble experienced in the after processes. He thought a careful study of the problems associated with the artificial drying of yarns would be of great value, also a study of the sizing and finishing of threads and twines. A very careful examination should be made of all the literature bearing upon the linen industry, including all relevant patents. He felt sure that the classification of such literature would serve a very useful purpose, not only for those actually engaged upon research work, but for those occupied in the several branches of the industry.

A vote of thanks to Professor M'Clelland was proposed by Mr. R. Garrett Campbell, O.B.E., chairman of the Irish Committee of the Flax Control Board, seconded by Mr. Frank Anderson, and passed by acclamation.

[EDITORIAL NOTE.—Anent Mr. Crawford's words: "There is as much difference between a cambric and a tent duck as between a thoroughbred and a shire horse, yet we expect to grow flax crops to manufacture both fine and coarse goods from seed derived from one haphazard source. It is not reasonable. From what I have seen, I believe it should be quite possible to have one variety of flax producing fine weft, another medium warp, and another heavy warp." If this is so, what spinner is going to pay as much for canvas flax as for cambric flax, and if this is not done, what farmer will produce the cheaper article if it is only a question of selection of seed? We are convinced, however, that the facts are not quite as stated and are rather inclined to pin our faith on Carter's theory, *i.e.*: (1) That any flax seed sown thin will produce coarse fibre. (2) That under like conditions certain soils will always produce weft flax and others warp flax; Strabane and Cookstown, for instance. (3) That if the seed be thickly sown fine stems and fine spinning fibre will be produced, and vice versa. (4) That if seed be thinly sown year after year it con-

tinually deteriorates for fibre producing purposes, but will again become a good fibre producer if it be sown thickly for a number of years. (5) That the poor results obtained in Ireland during the past few years is largely due to the forced use of Canadian and other seed which had been sown too thin for years. (6) That the production of coarse or fine warp or weft flax depends more upon climate and soil, thick and thin sowing, than it does upon seed selection. (7) That by the process of seed selection and continued thick sowing a longer flax may be at length obtained, but that if carried to excess the result will be stems which will not stand upright under rain or which if allowed room to grow robust enough to stand, will produce fibre more like hemp than flax.

THE WORLD'S FLAX SUPPLY.

A correspondent of the *Northern Whig*, Belfast, recently wrote: Few people seem to realize exactly what is meant by the words "the flax shortage." They are so accustomed to hear about there being a shortage of everything that they are apt to lump flax along with the other articles or materials in daily use. The flax situation is, however, something by itself. What the world is faced with is not a shortage but an actual famine of flax, and the results of the famine are seen in the famine prices that prevail for linen and linen goods. These prices are already about seven times as high as in pre-war times, and they will certainly go higher still before the year is far advanced.

This enormous increase in price is not the result of any ring, trust, or combine. It is the natural and inevitable result of economic causes. It has come about because while the world demand for linen is as great as ever—indeed much greater than ever—the supply of the flax from which the linen is spun and manufactured amounts at present to a third of the pre-war supply at most, and (as I shall show) probably only to a fourth of the old annual total. And this flax famine, I repeat again, is not a phenomenon confined to the British linen industry. It is universal, world-wide. There is not a country in the world which has its normal flax output or anything approaching it.

The prime factor in creating this situation is the disappearance of Russia for the time being as a flax-growing country. Russia occupied in pre-war days the same position practically as the United States does in cotton-growing. We know the effect on the cotton industry in the 'sixties when the American Civil War shut off the cotton crop of the Southern American States from the world's markets. Cotton prices rose to fabulous heights. The linen industry to-day, owing to the collapse of Russia, is in just the same position as the cotton trade in the 'sixties, and history is repeating itself.

RUSSIA'S IMPORTANCE.

Let us glance at a few facts bearing upon Russia's importance to the linen industry of the world as a whole. Before the war Russia was responsible for growing more than 60 per cent. of the entire flax crop of the globe. The average world crop was from 600,000 tons to 650,000 tons per annum. Of this total Russia produced from 400,000 tons to 450,000 tons. In 1913 there were 3,429,121 acres under flax in European Russia. The statistics of her exports of flax during the ten years preceding the war carry their own moral. They were as follow:—

RUSSIAN FLAX EXPORTS.

Year	Tons	Year	Tons
1904	146,459	1909'	230,769
1905	237,166	1910	216,080
1906	222,183	1911	191,330
1907	218,169	1912	310,692
1908	233,614	1913	267,814

These exports were made to all the principal European countries—to Germany, France, and Belgium as well as to Great Britain. All these countries depended on Russia to supplement their own stocks. Great Britain was more dependent on Russia than the others, but all imported heavily from Russia. These immense exports ceased almost entirely during 1919, and nobody can say when they will be resumed. Until they are resumed the flax famine will continue, and linen prices will remain famine prices universally.

So much for the world situation. How the British (which means mainly the Irish) linen industry is affected may be seen by a comparison of our total flax supply in 1913 and that in 1919, as far as the latter can be calculated.

1913 AND 1919.

The net flax supply in Great Britain in 1913, including home crop and imports from abroad, was 107,258 tons. It was made up as shown in the following table:—

Country of origin	Flax, tons	Tow, tons
Russia	68,161	13,416
Belgium	14,194	3,812
Holland	1,442	226
Other countries	473	729
	<hr/>	<hr/>
	84,270	18,183

Total imported supply	102,453 tons.
Irish flax	13,439 "
British crop	153 "
			<hr/>
			116,045 tons.
Less exports	8,787 "
			<hr/>
Net supply	107,258 tons.

The average annual net supply of flax and tow for the British industry during the four years 1910-1913 was 99,000 tons.

Contrast these figures with the 1919 estimates. In the table given below the statistics of imports are taken from the Board of Trade returns. The estimates of the home production were made as will be explained immediately.

NET BRITISH SUPPLY IN 1919.

Country of origin	Flax, tons	Tow, tons
Russia	3,868	27
Belgium	373	172
Holland	2,880	—
Other countries	2,876	912
	<hr/>	<hr/>
	9,997	1,111
Total imported supply	...	11,108 tons.
Irish flax	...	17,900 "
British crop	...	3,000 "
		<hr/>
		32,008 tons.
Less exports	...	983 "
		<hr/>
		31,025 tons.

Thus the 1919 net supply was less than a third of the normal pre-war quantity. The man in the street can understand what happens in an industry with a booming demand for its goods when two-thirds of the supply of raw material is suddenly stopped.

As a matter of fact, however, the figures in this table err on the side of over-estimate. As far as the English and Scottish crop is concerned they have been put intentionally high, even while reckoning in two years' harvests. Very little of the cross-Channel flax has been scutched, and it is not likely that a large proportion of it will be scutched this year. The Irish flax crop in the above table is calculated on an acreage of 95,600 acres. The Flax Supplies Association, I understand,

put the acreage at 114,000, but 95,600 acres is the estimate of the Irish Department of Agriculture, which was made last year with more than usual care and minuteness. The yield is taken at an average of 30 stone per acre. But it is extremely unlikely that the average yield was as heavy as 30 stone. A more probable figure is 23 stone per acre. In this case the total yield of the crop would be some 4,000 tons less than is given above, and the net supply in 1919 would be 27,000 tons as against 107,000 tons in 1913, and an average of 99,000 tons in the last four complete years before the outbreak of war—that is to say, less than a quarter.

The situation of the linen weaving industry is even worse than these figures would indicate, for in 1913 linen yarns came into this country from abroad (largely from Belgium) to the extent of 27,863,154 lb. Last year these imports were only 838,158 lb., so that at present the manufactures are entirely dependent on home-spun yarns. But this is a matter which will partially remedy itself when the Belgium and French mills get going.

In my previous article I dealt with the total flax supply of 1919, and showed that it was from a fourth to a third of the pre-war average. What are the prospects for the present year? The British industry, of course, depends to a large extent on Belgium as well as on Russia for an important portion of its material. Belgian or Courtrai flax is essential to the finer end of the linen industry. But Belgian imports will probably reach us in sufficient quantities to tide over the worst of our difficulties. Last year's import of 373 tons was all sent in during the two final months of the year, evidently under an agreement by which the British Government undertook to exchange three tons of Irish or Russian flax for one ton of Belgian. It will be noted that while we imported 373 tons of Belgian flax we exported 983 tons of our own flax—that is to say, roughly, three tons for one. The Board of Trade returns do not state where our exports of flax went, but it is pretty obvious that they went to Belgium. But while we may secure by a bargain, which is advantageous to Belgium, but equally advantageous under present circumstances to ourselves, something approaching the quantity of Courtrai flax which is absolutely necessary to us, we need not reckon on receiving this year or for a year or two to come the old complement of Belgian flax. Belgium is sowing a large acreage, but she is limiting export severely, and is not likely to send out more than suits herself. The same remark applies to France also. The French acreage under flax will probably expand very largely this year; in fact, it is certain to do so. But it is not probable that France will export more than she can help. It is more profitable for her to export the manufactured article, whether in the shape of yarns or linens, and the urgent need of putting her foreign exchange on a

sound footing will force this procedure on her. It is safe to say that during the present year and next year we shall receive a certain amount of flax from France and Belgium, but it would be very unsafe to build upon this factor as contributing in any material degree to relieve the situation here.

LITHUANIA.

As to Russia opinions seem to be sharply divided. A month or two ago everybody in the linen trade was exceedingly pessimistic about Russia. Recently there seems to have been a revival of optimism. This change of temper appears to have been largely influenced by a recent speech of Mr. Roberts, the Food Minister, and by the announcement of the British Government's plan for buying up the flax remaining in Lithuania on a commission basis. That there is some remaining flax in Russia has never been doubted. How much it amounts to nobody seems to know. But it appears at all events certain that what exists is only the remainder of earlier crops. There are very great transport difficulties in getting it together. The flax that is in Russia proper is not in the slightest degree likely to reach us for years to come. We may get a part of what is in Lithuania, but even the Lithuanian stores can only be partially secured, because the railway system is in a state of absolute breakdown. Besides, the Lithuanians cannot export the whole, for they need a large portion to clothe themselves.

In any event neither in Lithuania nor elsewhere does there appear to have been any sowing of flax in 1919, or any seed with which to sow this year's crop. Besides, the pressing question in every part of what was formerly Russia is the food question. Even if it were possible to have peace in Russia to-morrow, entire and absolute peace, and the seed was forthcoming (which it will not be) to sow out those millions of acres formerly under flax, the peasant would find it more essential and more profitable to grow food and forage crops for man and beast. Flax is, after all, a luxury crop which can be grown only where food is otherwise plentiful. No man will sow flax for export if he is hungry and has no means of satisfying his hunger except by the produce of his own fields.

On the whole there seems no ground to anticipate much relief from those Lithuanian flax stores. Some thousands of tons may be got, which may ease the situation to a certain extent this year. That is the most that even an optimist is entitled legitimately to hope for. But the ease so obtained will be at the expense of the following year. In any case, Lithuanian flax or not, the shortage is going to exist for more than one year, and flax prices will remain at a high level. The unknown, unestimated and unestimable Lithuanian flax

does not in any appreciable degree diminish the urgent necessity for encouraging by every means the development of other sources of supply to take the place of the Russian sources.

IRELAND AND PRODUCTION.

Now, where are these additional sources of supply to be found? Efforts have been made, and in a way are still being made, to stimulate new foreign sources. We hear of Canadian flax, Egyptian flax, East African flax, &c. More energy appears to have been devoted to scouring the corners of the globe for odds and ends of flax than has been displayed in fostering production at home. With what result? The success of these efforts may be judged by the growth in imports under the heading "Other Countries" in the tables given in my previous article. An increase in flax and tow imports under this head from 1,202 tons in 1913 to 3,788 tons in 1919 does not look like success. It does not carry us very far. The only part of the world accessible to the British linen industry which has responded to the need is Ireland—and Ireland in this connection means Ulster. The Irish record of acreage is quite creditable to the growers, and one trembles to think what would be the situation to-day if the Ulster growers had not risen to the occasion.

IRISH FLAX ACREAGE, 1913-1919.

Year	Acreage	Year	Acreage
1913	59,305	1917	107,705
1914	49,253	1918	143,355
1915	53,143	1919	95,610
1916	91,454		

The first thing that strikes one about these figures is the connection between acreage and price. The large 1918 acreage was due to the announcement of the guaranteed price of from 45s. to 35s. per stone, which was then a good market price. When the price was reduced by 10s. a stone at the beginning of 1919 it will be observed that the acreage fell by 50,000 acres. It went back at one step to the 1916 level, three years' progress being thus lost. For this fact no blame attaches to the Control Board, because most people anticipated then that there was to be a slump in prices. But it is not to the credit of the Control authorities that they seem entirely to have failed to read the lesson of the acreage fluctuations. That lesson is that if you want increased acreage you must pay for it in increased prices, and if you pay the price you will get the acreage. Now it is evident enough that we want every acre we can get, and we have not yet reached the limit we can

obtain from the Ulster farmer by applying a sufficient stimulus in the shape of price.

In the decade 1861-1870 the average acreage under flax in Ireland was 221,266 acres, and in 1864 the area under crop reached 301,693 acres. This was the period of the American Civil War and the cotton famine, and flax-growing had not then practically died out, as to-day, in three out of the four Irish provinces. But the figures indicate clearly enough that the 143,355 acres sown in 1918 is far from being the maximum that Ireland (or even Ulster alone) could furnish to-day, if the stimulus is forthcoming.

THE CONTROL QUESTION.

The only thing that will stimulate the farmer to this extra effort is an open market. But the Flax Control Board so far has kept its mouth tightly shut on this subject. One might be tempted to think that it imagined its primary duty was to keep down cultivation. The sowing season is at hand. The farmer is at the time of year he has got to make up his mind how he is to arrange his crops for the year. But the Control Board sits still in London in lordly and lonely isolation indifferent to times and seasons, and remains silent when it should be declaring its policy for the year.

There are a good many of the optimists—basing upon Lithuania and its prospects—who maintain that the farmers are building exaggerated hopes on what a free market will bring them next harvest. If that is so, surely from the point of view of these people it is an additional argument for the removal of control and the installation of a free market. To the ordinary unbiassed observer it seems pretty obvious that whether the rosiest dreams of the farmers are realized or not, they will get a price in the open market which will make cultivation worth their while. The flax shortage is too great to be suddenly ended. It will not be ended for some years yet, though after a year or two there may possibly be a gradual reduction in price. I offer this, of course, only as my own opinion, but it is a disinterested opinion.

From the public point of view the important part of the situation is that unless more flax can be got the linen operatives may be working only 15 or 20 hours per week before the end of the year. That is a situation which cannot be contemplated with equanimity, and it is a situation which the majority of the leaders of the linen trade do not contemplate without disquiet. I would add a final word which I think is necessary. The discussion of the flax control too often degenerates into an attack on the spinners. Now the present writer can say from his own knowledge that the majority of the spinners are not opposed to the removal of control.

DISSATISFIED IRISH FLAX GROWERS.

During the past few months public meetings have been held in various parts of the country to protest against the present system of flax grading in the markets. The following resolution adopted by the Dungannon branch of the Farmers' Union is in keeping with the feeling all round: "We call upon the Government to make the following concessions as regards the grading to be done during the coming season: (1) That a representative of the farmers be allowed to attend each market. (2) That two referees be appointed who should be good judges of flax and unconnected with the Government or the linen trade; (3) that farmers, if dissatisfied with the grading, should have the option of removing their flax to another market; and (4) that until the flax workers get reduced wages the price for flax should be from 27s. to 40s. per stone according to grade, and that the minimum should be 27s. per stone."

Lacking in initiative and confidence in their own judgment as some flax buyers are, it is but fair to state that the farmer can have little knowledge of the value of his flax to the spinner, while it might be rather difficult to find two good judges of flax unconnected with the linen trade.

A "Flax Grower" writes: "Sir,—Is it not time the present unsatisfactory system was ended or mended? In our flax market last week a grader graded my flax at 35s. When I objected the inspector increased it to 37s. In a neighbour's case he was reduced 2s. In another, after his flax was graded, he told the grader he had kept a stone at home and would have it tested, and when the former heard that he at once marked up the ticket 2s. After all these months' training, are the graders not to be relied upon? I am sure they are not all qualified, or if they are they are belying their qualifications. My opinion is the grading system should be ended. Flax-growers have lost thousands of pounds on account of the way they have been treated, and there appears no way of obtaining satisfaction. When we complain we are only laughed at by the graders, who have too much power."

"Scutcher" writes: "I wonder would the opinion of a prominent scutch-mill owner of Ulster be considered by 'Flax Grower'? It is quite in order for a farmer to appeal to the inspector in charge of the market. It is rather difficult for a grader to grade flax from the cart. Flax is always seen to better advantage when being taken into store. Some farmers have the habit of placing their best flax on top of the cart and the bad flax is not seen until taken off a few minutes later. The graders, as far as I know, are all experienced men, and could not and would not raise or reduce the price of graded flax without being ordered to do so by the inspector. 'Flax

Grower' states that the farmers have lost thousands of pounds sterling. I say they cannot lose what they never had to lose. He seems to blame the Government for the very bad yield this year. How so?"

In view of the increased scarcity of flax and the great demand for it not only by Irish but also by Continental spinners, Irish farmers have been agitating for the de-control of the market. Numerous meetings of the Ulster Farmers' Union have been held and letters on the subject have repeatedly appeared in the Belfast press. For instance, a "Flax Grower" wrote:—

"SIR,—Is the time not ripe now, in view of the very large increase in the price of yarn, and as an encouragement to all flax-growers, that the control should come off flax? Why should the spinners get our flax below its proper value? There is really no fair-play in it, to say the very least, and flax-growers must make up their minds to ask for the last penny that their crop is worth. The spinners would not sell their yarn a halfpenny below what was the commercial value. As the market has risen since the prices were fixed by at least £100 a ton more for years, the farmer is clearly entitled to move along with this rise. The spinner cannot be hurt; he is obtaining a splendid, in fact an abnormal, profit. Were he selling his yarns at the current value of flax there might not be the same case for an increase, but when his prices are increasing daily why should not the farmer's also improve. There can be no loss to the Government in de-control of the flax, because I am sure they would gladly go out of it."

"Farmer's Friend" also wrote:—

"SIR,—From the correspondence appearing in your columns, the time has now surely arrived when the Ulster Farmers' Union should fight for immediate de-control of the 1919 flax crop. This is a matter which admits of no delay: it is imperative, and it is clamant. Gross injustice is being done to the flax-grower, which can only be remedied by relieving him of a heavy loss, and I hope the Council of the Ulster Farmers' Union will show their earnestness and the object for which they were established by immediately and unanimously passing a resolution to this effect. No injustice is done to the spinner: in fact, he is doing a gross injustice to the flax-grower, and hurting himself by the action he is pursuing. It is a 'penny-wise, pound-foolish' policy, and he is 'trying to save the ship for the ha-porth of tar.' For 1920 the Farmers' Union ought to pass a resolution stating that they do not want control or licensed buyers. Surely the farmers now are quite fit to hold their own. They think the spinners may try to crush them as they did in former years; but they do not fully understand the situation. Previously they supplied only one-fourth of the flax that the mills required; now four-fifths are

supplied by the Irish farmer. He has the control of the market, and he must obtain the very best price that his flax will bring him."

At a largely attended meeting of Armagh farmers a demand for an open market was made.

Mr. John C. Nixon, Belfast, said he stood for de-control, which meant freedom from any interference with the farmer in the production and the sale of his crop. It was not generally understood, but it might be said, that the French Government had decided not to allow any more export of French flax until they were free to import Irish flax from Ireland. (Applause.) What was the present position of flax? At present there was not 25 per cent. in relation to the demand for flax anywhere in existence. Of all commodities in the world, flax was practically the only one that could not be produced in a hurry. It was the only crop probably that required a very great percentage of expert labour. The prospects of next year were not a bit better than they were at present. There would probably be a certain amount of flax grown extra on the Continent, and there would probably be a certain percentage grown extra in Ireland. But if there was to be increased cultivation, the spinners would have to come to the farmers and say that there would be no more control—that they would buy the flax at market value. If Continental flax had doubled in value since July last, it was not unreasonable to assume that Irish flax should have gone up in the same proportion. He (the speaker) stood up for de-control in every shape and form, and he advised those present to have nothing whatever to do with any bargain with the spinners. The spinners were comparatively few and clever men, and the farmers were not a match for them. Mr. Nixon did not think they could have a price of any sort fixed unless by Act of Parliament. There was no physical probability of flax being produced in sufficient quantities to meet the demand for a minimum period of five years, and the probabilities were it would be at least ten years. There was not enough seed in the world to-day to give 50 per cent. of the supply required next year. There were enormous holes to be filled up in the question of linen supplies of all sorts. He contended that they would not have the prices of Irish flax as low as they were to-day for five or six years at the very least. They wanted nothing from the spinners whatever except to have them "tripping over one another to buy your flax."

The following resolutions were passed: (1) "That we are of opinion that all control should be taken off flax for 1920, and we demand an open market." (2) "That in the opinion of this meeting the spinners could best serve their own interests by joining with the farmers to secure immediate

de-control, so that flax-growers could get the benefit of the present open market value of £200 per ton over the present controlled rates, and thus be encouraged to double or treble their acreage under flax next year."

Mr. J. Small, Loughbrickland, also wrote:—

"SIR,—Much credit is due to the untiring efforts of Mr. J. C. Nixon in bringing before the public in his speech at Armagh on the 19th ult. the present position of yarn values and Irish flax prices. He is reported to have said on the same occasion: 'As a matter of fact, although the fact had not been officially published, the French Government had decided not to allow any further exports of French flax until they were free to import Irish flax. Therefore it was probable that foreign buyers would soon provide a market for Irish flax. Now this brings the matter on behalf of Irish flax-growers to a crisis. It is now as plain as the British language can make it that the only solution to the whole question is immediate de-control. As a member of the deputation that appeared before the spinners in October last, I put the following question to them: "Is your association in favour of de-control; and, if so, will they support the demands of this Union that the Flax Control Board be dissolved, and a free market for Irish flax allowed? If not in favour of de-control, will you be good enough to explain for what reason?" The only answer was "De-control, never. No de-control." We farmers believe there is a limit to human endurance, and that the present conditions cannot last any longer. Of all the flax-growers in the world the only one that is controlled is the Irish flax-grower. While the spinner is allowed to buy his flax at £2 per stone below its market value, and there is no control on him to export the yarns and get whatever price he asks in reason, must not the Spinners' Association feel they have not an inch of ground to stand upon, and even that is crumbling under their feet; and if they try to retain it any longer they will be hurled from it by the Ulster Farmers' Union without mercy or help.'"

Later "Constant Reader," writing in the *Northern Whig*, said:—

"SIR,—As I anticipated, a vigorous effort is being made by the Farmers' Union to get 50s. per stone for flax. With other writers in your paper I look upon such a demand as scandalous in the extreme. One farmer, I notice, says the flax crop this year will not pay. I most emphatically deny that statement. I admit in some cases that the crop is not as good as one could wish, but in the large majority of cases the average crop is much better than last year, and if it is such a bad paying crop why has £9 to £10 per statute acre been given for lea ground to sow flax, and why has up to

£20 been given for more suitable ground? It is a well-known fact that more flax will be sown next year than this year, especially as home-grown seed has been such a success and the price for handling flax has decreased. I hope a general protest will be made against such an uncalled-for and unnecessary demand made by the Farmers' Union. If the demand is granted a greater instance of profiteering has not publicly taken place since the war began."

Next a Co. Derry farmer wrote:—

"SIR,—I notice that there are still a few correspondents writing in your paper against any increase in the price of flax being granted. Those letters seem to emanate from one source. Their writer quite evidently knows nothing whatever of the subject. He looks upon an increase to 50s. per stone as 'scandalous in the extreme,' argues that 'the average crop is much better than last year,' that 'it is a well-known fact that more flax will be sown next year than this year, especially as home-grown seed has been such a success and the price for handling has decreased,' and that 'if the demand be granted a greater instance of profiteering has not publicly taken place since the war began.' Such are the 'arguments' used. It might be well to look at another aspect of the situation. The farmers at the present time are not keen on sowing flax at the prices fixed—25s. to 35s. per stone—as proved by the fact that the acreage under flax has dropped this year by one-third; and there is nothing more certain than that if there is not a very substantial increase in price there will be a further falling away in the acreage under flax next year. Is it desirable in the national interest that such should take place? Will it be to the interest of Belfast if the spinning mills have only raw material to keep their mills going a few hours per week for the next few years?—a condition that is certain to continue if the acreage under flax in Ireland is not very largely increased. If the powers that be take the advice of your correspondent it will be the spinning trade and the trade of Belfast generally that will suffer, and not the farmers, who are independent of flax-growing to a great extent; in fact many of them intend to give it up altogether, and I believe your correspondent's letters on the matter will decide many waverers against flax-growing. Why does your correspondent not state the actual reduction in flax wages? I have not experienced any. And why, if home-saved seed is such a success, have few growers, if any, saved any seed this year, now that seed-saving is not compulsory? Further, if the demand made by the Ulster Farmers' Union is the greatest instance of 'profiteering' since the war began, how will he describe the position of spinners, who under existing circumstances are to obtain Irish flax at a possible average of £240 per ton, while they are willing to pay, and have

paid, from £400 to £450 per ton for French flax not any better than our Irish—a price which the Continental spinners would be glad to pay for the Irish crop if only they had the opportunity of procuring it? Such a position would be intolerable. It is one that Irish growers will not submit to, and rightly so. If your correspondent has the real welfare of the City of Belfast at heart he should change his tactics and agitate for the price of Irish flax to be raised to at least 50s. per stone, as anything less will not secure such a substantial increase in the acreage as will meet anything like the requirements of the trade during the next few years.”

On September 1, J. Crawford wrote:—

“SIR,—In to-day’s issue ‘Constant Reader’ states the farmers’ claim to an increased price for flax as ‘scandalous in the extreme.’ Would ‘Constant Reader’ kindly give us figures to prove that such a claim should be so characterized? Has he tried to grow flax and make it a paying venture? If he has then let him give your readers the benefit of his experience. If not he might tell us how he acquired his information. Does he reason from a particular case or has he general information? If he gives us these facts I believe I can give him many figures to prove that to ‘emphatically deny’ the statement that the flax crop has not paid in the past is absurd. To ‘emphatically deny’ that ‘the flax crop of this year will not pay’ is still more absurd, for the simple reason that no one can tell yet whether it will pay or not. That has all to come on trial. Reasoning from facts that are known it can be shown that there is justice in the farmers’ claim. The farmer is out only to get a paying wage. He does not want any more. Unfortunately in the past he has often had to do with less, and had very scanty remedy. To say that there is profiteering in a case where the producer of an article gets less than what it is worth to the manufacturer does not prove anything. It is simply nonsense. In this district the price for handling flax has not decreased, and is not likely to decrease in the near future. The figures which ‘Constant Reader’ gives about the rent of land to produce flax may be admitted, but they do not affect the question much, if anything. What really does affect the general question of flax-growing is (a) the amount of labour necessary to produce a crop of flax, (b) the general riskiness of the crop in any season, and (c) the risk of a comparative or complete failure in a bad season, together with the risk of bad market. Other causes affect the crop which no man can control.”

On the same day “Short Flax” wrote:—

“SIR,—I observe that a correspondent to your paper, who signs himself ‘Constant Reader,’ protests against the Irish farmers getting an increase in price for flax this year. I would expect more from a ‘Constant Reader’ of your paper

than the ignorance displayed in his letter. One of the arguments he puts forth is that flax cannot be a bad-paying crop when from £9 to £20 an acre has to be given for land to grow it. I would say this is one of the reasons why the market price of flax should be increased. I am a flax-grower myself, and had to pay very dear for the land. The crop is very light and far below my expectations. Owing to my flax dams being dried up I have had to take my flax three miles to a flax dam, which took extra labour. I have paid 15s. per day to flax-pullers this year, which is above last year's wages. The scarcity of mills in the country leaves the farmer's flax on the shelf for many months perhaps, so that before he touches coin he has to pay for the land if taken in conacre, pay for the seed, even should he have got credit to November, pay for the labour, pay for the sowing, pulling and handling, and be at the mercy of the weather and the goodwill of the labourer. On the whole I say the flax-grower has something at stake when he ventures to sow flax under the present circumstances. I wish success to the Irish Farmers' Union in this cause. It is not with the poor farmer the profiteering lies; it is at the other end of the business, as any intelligent person can easily see."

At a meeting of Comber farmers held early in September, the question of the price of flax was discussed. The Chairman said that the price of flax—35s. for first-grade flax—was 10s. below that of last year. That was a very serious question for farmers, because it brought to their minds the poorness of the crop, the increased cost and the scarcity of labour. These things had made the cost of production so great that there was very little margin left for the grower.

Mr. Joseph Berkley moved the following resolution: "That having observed the new scale of flax prices as fixed for this season's crops, and which is a source of great disappointment to us, as the price should have been greatly increased instead of decreased, we are more convinced than ever of the utter incompetence of the Flax Control Board to deal with the problem of flax production, particularly with the fostering and encouraging of the growth of the fibre, which is the most important branch of production in view of a universal shortage, and we are further convinced that the sooner the personnel of the Board is changed for men who know their business the better it will be for the flax industry; we hereby resolve not to market our flax until the control is removed, when, with the present market price, the return to the grower would be nearer £500 per ton than £280, as fixed by the Board, or, failing the re-establishment of the free market, the price of top quality to be increased to 60s. per stone, so as to compensate us in some degree for the poor crop on account of the dry season, the scarcity and dearness

of labour, and as an incentive to farmers to sow next year, for there is a universal determination to sow none in the coming season." Proceeding, Mr. Berkley said there was no foreign flax being imported at present, and the farmers should realize that they had the whole matter in their own hands. They were in a position to dictate to the Government and to the flax spinners, and they should let it be known that they would use that power. They were only asking for what they had a right to get, and they should adopt an attitude that would make the Government get up and show them the proper course to follow in the matter.

Mr. Alex. Orr, who seconded, said as regards the flax, the Central Committee of the Union had decided that the plan indicated in the resolution was the most practical one to adopt. He did not see why they should not have urged for the abolition of control; he did not know why control was instituted now. A different state of affairs prevailed last year, but now there was no necessity. Flax was being controlled in the interest of the spinners, who were getting enormous prices for their produce. (Applause.)

The resolutions were unanimously adopted.

Mr. D. R. Martin, Secretary of the Union, was delighted to find that they had a thorough grasp of the questions which were of vital interest to farmers. The question of flax was the burning question of the hour. Any man who grew flax started the year with an assurance that a certain price would be fixed. They asked for a price for next year's crop, and the Government, in reducing it to and fixing it at 35s. had thought there would be a fall in the price of other stuffs. Labour, however, was dearer, and feeding stuffs were rising in cost, and now the time had come when farmers should ask for a better price. The question of control was a critical one. When control was taken off into whose hands did the farmers fall? Into the hands of twenty-five or twenty-six spinners. The flax industry round Armagh was practically crushed out by spinners, who gave the growers no assistance at all to further the industry. The farmers should fight for a higher price and not allow themselves to be crushed between the upper and the nether millstones. Nothing short of a larger representation upon the Flax Supply Committee would ensure fair grading and proper treatment for the farmer who produced the flax crop.

On September 9 a letter appeared over the signature of Mr. F. G. Foster, of Selby and Staddlethorpe, on the subject of Flax Control. It read as follows:—

"SIR,—In view of the recent report of the Empire Flax-Growing Committee recommending that the support of the Government should be given to flax-growing within the United Kingdom, I should be glad if you could throw any

light upon the present policy of the Flax Control Board, which is discouraging the production of flax by making it more unprofitable. I am a partner in the largest private firm of flax-growers in Great Britain and Chairman of Yorkshire Flax, Ltd., the only private enterprise which has established (at a cost of £20,000) mills for deseeding, retting and scutching flax in England, and am therefore very much interested in this matter. The facts are as follows: In 1917, when the flax shortage for military purposes (especially aeroplane wings) became very serious, the Flax Control Board fixed a price to be paid for flax produced in the United Kingdom according to six grades of quality as valued by their inspectors. The prices fixed by them were slightly below the open market prices of flax on the Continent. In 1918 wages and all working expenses having increased, the Control Board fixed a higher price for flax. This price was still slightly below the open market price, but was sufficiently encouraging to cause a large increase in the acreage of flax grown, over 140,000 acres being grown in Ireland alone, and a considerable extension being made in England, where our Company increased its acreage from 140 in 1917 to 1,100 in 1918. In 1919, when the shortage of flax was greater than at any time within living memory and when the wages and working expenses of producing flax had further increased since 1918, the Flax Control Board is transferred from the War Office to the Board of Trade with the specific object of encouraging the revival of flax production in the British Isles. They proceed to do this by lowering the price of flax £80 per ton. The result is, of course, to make flax production less profitable in the United Kingdom than in any other country in the world, and the natural consequence was a heavy drop in the acreage grown—40,000 acres less being sown in Ireland in 1919 than in 1918, whilst we reduced our acreage from 1,100 to 510. This is what a Government Department calls encouraging flax production in the United Kingdom. Since 1917 our cost of labour has increased over 50 per cent., we have to pay farmers 75 per cent. more for land for growing flax, and the cost of machinery, fuel, and other working expenses has increased an average of 50 per cent.

“How, then, can we be ‘encouraged’ by the Government commandeering the flax we produce at the same price as they paid us in 1917; and, if the prices fixed by the Control Board in 1917 and 1918 were reasonable why should they, when the cost of production has increased so enormously, drop the price in 1919 to a figure which is only 60 per cent. of the open market value of flax? If we could send our flax to the Continent we could get at least £100 per ton more for it on the open market, or if we could change the label and export it to Belfast or Dundee as French or Belgian flax the spinners

would buy it at £100 per ton more than we are now receiving for it. During the war, when the whole production of the flax-spinning mills was for Government account, the Government and the public got the benefit if the price of flax was lower in the United Kingdom than abroad; now the whole of this difference goes into the pockets of the flax-spinners at the expense of the producers of this essential fibre. Although we as producers of flax are denied an open market at home and prohibited from exporting our flax, the spinner is free to export his yarns to the Continent and there obtain the same price as the Continental spinner who is paying nearly twice as much for his flax. The Flax Control Board is dominated by the flax-spinners, who are therefore in a position to buy their flax at far below market value, and after spinning it to sell their linen yarns at ever-increasing prices. Is there any wonder that flax-growers and producers have no confidence in the present Control?

“Few businesses are so risky as flax-growing when the crop is harvested and dried to obtain the seed as well as the fibre. The business has a bad past history in this country. My grandfather, who was fifty years ago the largest flax-grower and flax millowner in the United Kingdom, lost all his money during the closing years of the last century, when Russia was producing four-fifths of the world's flax and was flooding the market with flax produced by peasant labour at a price with which this country could not possibly compete. He was a wealthy man, and he kept his flag flying and his workpeople employed until he died penniless. The same fate overtook the industry throughout the whole of England and Scotland. A far-seeing Government gave no assistance, and the reply of the flax-spinners in those days, when they bought English and Irish flax produced at a loss, was that ‘the law of supply and demand must rule the market.’ It does so now all over the world except in the United Kingdom, where the descendants of the men who were ruined in this business are denied the benefit of an open market which would enable them to wipe out past losses and re-establish this business on a firm foundation. Few crops are more liable to damage by unfavourable weather than flax. In a disastrous season the flax-grower may lose the whole of his capital. Last year when the weather broke in the middle of harvest and continued wet for months we lost more than one-third of the value of our crop through damage by rain. This year we have 450 acres of flax crops stacked in the fields, which were not dry enough to stack when the weather broke seventeen days ago, and during the last ten days we have had nine wet days and an average of eight hours’ rain per twenty-four hours. Our bankers will not advance us any money on the security of flax crops because there is no market value for our product, which can be commandeered by

the Government at any price they may choose to fix. What is the position of a business man who has £25,000 worth of crops and cannot borrow £2,000 for working expenses without giving collateral security for the whole amount?

“The time has now come when we must begin to secure land from the farmers for flax-growing in 1920. To obtain suitable land we must offer the farmers an average of £17 per acre for the cultivation and use of their land for the season. The Flax Control Board can give us no decision as to the price we shall receive for the 1920 flax, and in spite of repeated requests they have not yet decided certain important points respecting our 1918 and 1919 crops. How can we decide whether to reduce or increase our acreage next year? If we had the same open market as our competitors in France, Belgium, Holland, Canada and British East Africa we should be prepared to treble our growing and production next year. There is not sufficient flax to keep the spinning mills running for more than 50 per cent. of a normal working week during the next twelve months. What blindness afflicts these Government Departments who talk of continuing their ‘supporting’ an industry they are hampering in the most absurd fashion? How can flax-spinners expect the United Kingdom to provide them with the raw material which they cannot now obtain from Russia when they offer home producers 60 per cent. of the price which they are prepared to pay the producers on the Continent and in the Colonies? The best flax in the open market is now fetching up to £500 per ton, the maximum price fixed for the same article produced in the United Kingdom in 1919 is £280 per ton. The flax-spinners are magnificently organized and well able to look after themselves even if the control were removed. Let the Flax Control Board demobilize and allow business men to conduct their enterprise on business lines, and the home production of flax will be doubled within twelve months.”

On September 11 Mr. S. A. Johnston, of Messrs. Philip Johnston and Sons, Ltd., Jennymount Mills, Belfast, and of John Barbour and Co., Ltd., Whitehouse, wrote to the *Belfast Press*:—

“SIR,—Regarding the agitation now going on amongst farmers to do away with the Flax Control Board, we respectfully suggest it would be a mistake to do so, both in the interests of the farmers, the scutch mill owners, and the flax spinners. Farmers frequently attend the scutch mill when their flax is being scutched, and are so intent on quantity that it is with difficulty the scutcher can get cleaning the fibre properly, and the consequence is a lower price obtained for the flax when marketed. The scutch mill owner can explain to the farmer if his flax is properly cleaned it will sell in a higher grade, and if not properly cleaned the Control Board will send it back to

the scutch mill, thereby incurring heavy expense and loss to the owner of the flax. Since the Board took control the scutching has been greatly improved, although there is much still to be desired in this respect, and if the Control Board were abolished the scutching would certainly revert back to what it was formerly, and so cause most of the Irish flax to be useless for the higher grades essential to the finer class of yarns and linens, and so drive the spinners more and more to Continental flax, where these details are more carefully carried out. We grow a considerable acreage of flax ourselves, and so have a practical experience of the risks and difficulties the farmers have to encounter from inferior seed, unfavourable seasons, difficulty of getting labour to pull and water the flax, risks from which other crops are comparatively free. It is admitted on all hands that the cultivation of flax should be extended in Ireland and the quality improved by better scutching and more careful handling. None of these desirable aims can be attained by reducing the prices, and we would respectfully urge the Control Board to go back to the 45s. instead of the 35s. limit now proposed. We would even go further and advocate a 50s. per stone grade in exceptional cases of superior lots of flax, so that the scutch mill owner could, in special cases, give the scutcher an extra bonus to take extra care in the manipulation and in time work the Irish flax into competition with Continental flax now commanding such high prices from its cleanness, quality, and superior handling. No flax fibre in the world is superior to the Irish if it gets proper handling at the various stages. We are employing over 50,000 spindles all on high-class yarns, and requiring high-grade flax. To keep these going we are sending about £250,000 a year to the Continent for high-grade flax, and two-thirds of this could easily be kept in Ireland if we could only get the better grades in quantity. We would far rather be paying 50s. per stone for the better grade than 25s. per stone for the lower. The time is now for farmers to be arranging for next year's crop, and as it is urgent that the area should be extended, we hope the Department will revise without delay the advertised prices for 1919 flax crop—45s. per stone instead of 35s., and for superior lots, where the growing, watering, and scutching have been exceptionally well carried out, 50s. per stone, so as to encourage farmers, scutchers, and all concerned to aim at competing with the Continental flax growers, instead of producing the lower grades which only come into competition with Russian."

On the same day "X. Y." wrote: "None of your correspondents on this subject have mentioned the great advantage that accrues to the flax-grower from sowing his own seed, which has been such a great success."

"W. M. C." writing later to the *Northern Whig*, said:—"The letters of Mr. D. P. Martin, Secretary of the Ulster

Farmers' Association, afford somewhat amusing reading and illustrate the couplet so often quoted: 'When self the quivering balance shake, 'tis rarely right adjusted.' In to-day's paper he calls upon the Government to take off the restriction on the price of pork, while a short time ago he was as energetically urging a fixed price for flax. Would it not be much more consistent for farmers here and in Great Britain to call for the removal of all restrictions. The experience of the last few years has amply proved that Government interference in trade and commerce is at the best but muddle and confusion and benefits no one."

On September 19 "Flax Weft" wrote:—

"SIR,—In common, doubtless, with most of your readers who are growers of flax, I have read with much interest the letter from Mr. S. A. Johnston in your issue of 12th inst. It is with great pleasure that I note that he advocates an increase in the price of the 1919 crop flax, but I would like to join issue with him on the question of control, which I cannot help thinking he has not sufficiently considered. During the war control was both possible and perhaps desirable, as the Government were the buyers of flax, yarn, and cloth. Prices could be regulated accordingly, and if injustice occurred in the grading of the flax, they were submitted to with resignation. To-day the situation is quite different, as each flax producer, spinner or manufacturer is working for his own profit, and the same 'resignation' certainly cannot be expected, and will not be displayed. A flax grader is only human, and, if he has been brought up in a mill making for most part threads or heavy warps, he will naturally 'grade' flax accordingly. The same argument would apply to a grader who had bought, say, for a mill making exclusively fine weft yarns. From another point of view, let me ask, on what basis are the grades to be established? We will suppose, for example, that to-day coarse yarns are a drug, warp yarns a good market, and fine wefts in demand at 'any price.' Will the grades be established on this basis? If so, what will happen if the market changes and fine wefts go down in price? Is there any control which can compete with the ordinary laws of 'supply and demand' (as referred to by a previous correspondent), under which our trade has successfully worked in the past, and that automatically places different grades of flax at their correct market value? Mr. Johnston suggests that control encourages the production of the better sorts. Would this not evidently depend on the relative prices offered and paid for coarse or fine flax, and would not the same result be attained by the ordinary laws of supply and demand—the farmer and scutcher—working the flax in the way that will yield most profit? It may here possibly be answered that the removal of control will tend to raise prices unduly, but will this be a great hardship? Can any

better method be suggested for attaining an immediate increase in production? Would it not be better to pay very high prices to-day when they can well be afforded, and so secure by increased production lower prices in two or three years' time, when perhaps prices for yarns may not be quite so high as those readily obtainable at present. The obvious and logical sequel is evidently a return to the pre-war free trade condition in flax as between the three countries which both spin and grow that fibre—i.e., France, Belgium, and the United Kingdom—thus allowing each country to secure the flax best suited to its needs. Can any better method be devised to obtain in all three countries the immediate increase in production so urgently necessary, and which would be for the benefit of each alike? Mr. Johnston suggests that the production of fine flax in Ireland would enable his firms to do without the importation of £250,000 of foreign fine flax. In this case what is to happen to the foreign flax? Would the foreign spinners not set themselves to use it and make similar yarns to those spun here, with a result which might not altogether be to the satisfaction of our own spinners? What will happen when the Irish crop is bad? At the present moment the export of French flax is allowed, but the French spinners, I hear, are agitating to get this export stopped, the argument they use in support of their demand being that Great Britain denies them equal rights to purchase and import Irish flax. One must admit that the situation is somewhat anomalous, as the French spinners have as much need of flax as we have. Is it not somewhat galling to find a foreign country showing a higher respect than we for those principles of freedom and justice which we have in the past been, justly, so proud of. If the French spinners get their way, and export from France is stopped, what will be the position of spinners of the yarns in Ireland during the next few years? The F.C.B. may not pause to consider this point of view, but surely that section of the trade concerned will not see their interests jeopardized without protest."

On the same date the Editor of the *Belfast News-Letter* wrote:—

"Our correspondence columns have, within the past few weeks, offered evidence of a strong opinion antagonistic to the announcement by the Flax Control Board reducing the grade prices of flax fibre to 35s. limit. We have published letters on the subject from all sides interested—farmers, linen manufacturers, and flax merchants. And so far the consensus of opinion is that the new grade price list is a mistake, that the effect of it, if it is persisted in, will be to reduce seriously the acreage put down in flax next year, and that that would be highly injurious to the industry. There can be no doubt about the extent of the dissatisfaction created among the farmers.

The Ulster Farmers' Union has taken up the question, and its attitude is unequivocal. Its contention is that the new grade prices have no justification; the reduction, it is argued, is unwarranted by any condition attending the cultivation of the crop. Instead of the cost of cultivation decreasing, the prospect is that it will go up, and that in consequence farmers will be compelled to give up sowing flax if they are not to incur loss. Yet the declared policy of the Control Board is to encourage the increase of flax cultivation in Ireland. The question of the fixing of flax prices is a highly technical matter on which we cannot pretend to speak with any certainty. But we are driven to the conclusion that there is no substance in the farmers' complaint when we find an authority like Mr. S. A. Johnston, in a letter which we published last week, not only urging that the grade limit price of 45s. be retained, but advocating a 50s. per stone grade for exceptional cases of superior lots of flax. To-day we publish another letter from a correspondent whose *nom-de-plume* covers an equal authority in the flax buying end of the trade. 'Fine Weft' differs with Mr. Johnston as to the retention of the Control Board. Mr. Johnston is in favour of its continuance. 'Fine Weft' thinks it is time to return to free dealing in the market, when supply and demand would regulate prices. But he notes with pleasure Mr. Johnston's advocacy of an increase in the price of the 1919 flax crop. Here, then, we have a flax buyer and a flax consumer at one with the flax grower that the reduction of the grade price list is a mistake, that if any change in the list is made it should be in the opposite direction. It has been stated with more or less show of authority that the decision of the Control Board is not to be taken as final. If this is so, then the Board should issue an official announcement at once. For it is highly desirable that the flax acreage next year should be increased, and that the farmer should be encouraged in whatever way lies open to the Control Board to do so."

On September 23, Mr. J. C. Nixon wrote:—

"SIR,—During the past seven or ten days the Flax Control Board, London, arrived at two decisions which have caused some surprise and considerable comment in trade circles. First, they have finally declined to reconsider the question of prices payable for 1919 flax crop in Ireland, and are resolved to enforce purchase of said crop at a reduction of £80 per ton on 1918 rates, namely, £200 to £280 per ton. Secondly, they have advised spinners that so far as they are concerned they will be called on to pay for Irish flax allotted them at 1918 schedule prices—viz., £280 to £360 per ton.

"Let us examine the position as it now exists. Continental water-retted flaxes are selling at £200 in advance of prices prevailing early this year. Sales have recently been recorded at £600 per ton for Normandy flax, and £650 to £700 is being.

quoted for finer sorts. Dew-retted flaxes have also advanced in like proportion.

“Then, as to linen yarns, line and tow yarns most commonly in use here, since July 1, advanced 3s. to 10s. (say 20 per cent. to 25 per cent.) per bundle on top of prices in force since September, 1918.

“Irish flax prices, owing to control, have remained unaltered. It is safe to say, however, that had there been an open market, 60s. per stone, or £480 per ton, for first grade would have been freely paid. Yet in face of this the F.C.B. propose to pay Irish flax growers no more than £200 to £280 per ton for 1919 flax crop (according to grades arbitrarily fixed by their own officially appointed graders). Further, and notwithstanding the recent Profiteering Bill, they (the F.C.B.) propose to add a profit of £80 per ton before passing on the flax so purchased to spinners, and the latter are to be subsidized (inferentially) to the extent of over £100 per ton. To put it plainly, the Irish flax grower will, if the F.C.B. proposals can be enforced, get £200 per ton less than to-day's market value of his flax. The gross loss to Irish flax growers will, according to the yield of fibre per acre, amount to between two and three million pounds sterling, possibly even more.

“If any of the statements made in this letter can be refuted, I hope such will not be allowed to remain unchallenged.

“A very serious position—almost a crisis, indeed—has arisen, as Irish farmers, I am informed, do not intend to take the matter lying down. They will demand a thorough investigation of all the facts. Their case, which is that they are being most unjustly and unfairly treated, is so strong that public opinion will be with them all the way, and in the end they will win, even without having to retire on their last line of defence, which is that of holding up supplies.

“Spinners should openly declare whether they are or are not in favour of an open market (and open market prices) for Irish flax growers. The latter are entitled to it even more so than English and Scotch flax growers, who have been subsidized and assisted already by the Government, and who, furthermore, do not come within the scope of the recent Order, and are free to sell their fibre at the best prices they can get. Why the linen trade generally is so apathetic about a ‘key’ industry, so much a matter of life and death to them, it is difficult to conceive. Costly advertisement schemes for assisting the sale of linen goods are right enough in their own way and may bear fruit later, but at present every yard of linen which can be produced does, or will, find plenty of buyers. ‘Scientific research’ also may prove beneficial in future, but what of the present? Supplies of raw material are urgently needed, and instead of making it possible to have 100 per cent. increase in next year's sowings, agencies seem to be at work unhindered

to prevent even 1919 average being repeated. As has previously been stated, control of flax, flaxseed, yarns, and cloth was desirable during the period of the war. Now, however, yarns, cloth, and flaxseed are entirely free from control, and can any valid reason be advanced in support of retaining control of flax only and for the benefit of one section of the trade at the expense of a very widely-scattered, hard-working, and deserving part of the community, who are the actual producers of the raw material, and entitled to consideration."

On the same day "Flax" wrote:—

"SIR,—With reference to correspondence in your columns *re* price of Irish flax, it appears that the Government have arranged to pay the farmers a maximum of 35s. per stone for their flax, and to charge the spinners 45s. per stone for the same material—a profit to the Government of 10s. per stone, or £80 per ton. And very nice, too!"

On September 22, Mr. H. R. Carter wrote:—

"SIR,—In view of the statements of flax growers which have recently appeared in the public Press, to the detriment of the Flax Control Board and of Irish flax spinners, it seems to me that the time has come either to lay the facts of the case before an impartial arbitrator and hear what the maximum price of flax should really be, or else abolish control, and let the laws of supply and demand fix the price of flax. It seems to me that the former would be the safer plan, as one of the benefits of Government control is to prevent the formation of a corner in flax, which should not be allowed. Were control abolished growers might, and probably would, withhold supplies in order to force up prices. Spinners would probably resist, and the result would be more unemployment in the linen trade, possibly without unemployment benefit. Neither side, if they really believe in their own cause, should object to a settlement by arbitration. If their side of the case is not properly put before the arbitrator they have themselves alone to blame. Things cannot remain as they are. Something must be done or Ulster farmers will in many cases stock this season's flax and refuse to grow any next season. Show them that their suspicions as regards the spinners are unfounded, and they will continue to grow it if an average crop offers them fair remuneration and a bumper crop, a little gold mine—for they all like to gamble when there is a fair chance of winning. It is always the hope of a 60-stone yield of prime quality flax which makes them persevere in the cultivation of a risky and troublesome crop. In conclusion, I would re-echo Mr. Lloyd George's words as to the necessity for a spirit of brotherhood at the present time, and appeal for a co-operation to secure fair play for all classes in the endeavour to build up a new and better Ireland."

“ Flax Grower ” followed with :—

“ SIR,—Reading over a letter in the *Northern Whig* by “ Constant Reader ” on flax matters, I thought that it was my duty as a farmer and flax grower to make some comment on same. I believe that farmers ought to demand a much higher price than the present fixed price. (1) Because the seed for sowing was dearer; (2) the cost of artificial manures was considerably higher; (3) the cultivation was more expensive owing to the higher price of oats and hay for horse feeding; (4) the labour for pulling and handling was dearer. Anyone who knows anything at all about this year’s flax in Antrim will admit that the yield of flax straw was, generally speaking, little more than the half of last year’s yield. County Down was even less favoured, the lighter soil being less able to withstand the drought. During the past fifteen years the poorest yield of flax straw was in 1911. The yield this year is much lower. ‘ Constant Reader ’ refers to the prices paid for land on the conacre system. The land is generally let either for corn or flax at the same price, and the grower uses his own judgment as to which crop will give the best returns. I assure him that the prices fixed by the Government leave no room for profiteering on either of these two crops. I think it is too soon to predict whether or not there will be an increase in the acreage of flax next year. It depends mainly on this year’s price and yield of scutched flax. I hope that every farmer and every one connected with flax-growing or any branch of the linen industry will do all in his power to have this year’s price of flax increased. A fair return for the crop will increase production, while a bad price will discourage the farmers and seriously affect the acreage next year. The Farmers’ Union is now a strong body, and has not been formed to raise unduly the price of any product, but to prevent ruin to the most important industry in Ireland.

Another wrote :—

“ SIR,—I have read some of the letters that have appeared in the Press regarding the price of flax, and with your permission I would like to make one or two suggestions. Several correspondents say there is a very poor crop of flax this year, and that the price fixed would not compensate them for it. I think this cannot be universal, as I know a large district in which growers say they have a better crop this year than they have had for many years; that the bulk is very large when pulled, in many cases from 200 to 250 stooks per bag of seed sown; and the beets are by no means small, but rather large. It may be that the crop is not good in some districts, and I would suggest if there should be any change made in the price fixed, it might be better to fix it on the basis of the acreage sown, that would protect those where the crop may be poor, and

as the oat crop is guaranteed on the acreage sown, it surely would not be unfair for flax.

“I understand a guaranteed price was asked for at the beginning of the season, and seeing that has been fixed, is it honourable for one of the parties thereto to try to get the arrangement broken? Let us suppose the Government considered the crop extra good, and the price fixed too high, and wanted to reduce it, would the growers like it? I am aware the working expenses are high, but has that not been caused to a certain extent by the high prices obtained for flax? and if the price is now further advanced will not the flax mill owners and scutchers want more, and also the farm labourers next year? I would, therefore, also suggest it might be better for the growers not to press their demand for a higher price too far, as prices are not likely to remain always so high as at present, and they may find it difficult to get the working expenses reduced accordingly. If the fixed price is unremunerative, as stated by some correspondents, how is it some flax mill owners and others interested in flax have been buying large quantities of it from the growers before it is scutched? They cannot think the fixed price will not compensate them, and they ought to know.

“Perhaps some growers or the Farmers' Union would say how much per acre would compensate them for the crop. There is a general outcry against the high prices prevailing for most goods, but if everyone is dissatisfied with what they are getting for their goods, and wanting more, how are prices ever to come down.

“Mr. Small, of Loughbrickland, at a recent meeting of Comber farmers traced the history of the controversy over the flax prices, and expressed surprise at the fact that of flax growers the world over the Irish were the only ones under control. The best customers they had, he said, were always the Americans, and as the United States Government had now a great deal of money why should they not pay extra for the linen and so help the rate of money exchange? Spinners had agreed to take the crop at the old price, but the producers would not accept that because, owing to the greatly increased demand, the market value of the flax had greatly advanced. French flax had gone up £200 a ton, and yet Irish flax was down £80 a ton. That Irish growers were not satisfied and that the prices were insufficient were shown by the fact that the present year's crop was one-third less than last year's. If a remunerative price was not agreed upon the farmers would cease growing flax altogether. They wanted an open market and decontrol.”

Mr. J. H. Stirling recently wrote: “It is evident that the farmers' trump card now is that there was no contract between them and the Government. Let us suppose that the market

price of flax had fallen during this summer as the result of foreign supplies coming in, and that the Government had then announced that there was no guarantee of 25s. minimum. There is not a flax grower in Ireland that would not have taken his 'Bible oath' that he had sown his flax on the strength of the Government guarantee, and that any evasion by the Government of its responsibility to take the 1919 crop at the 25s. or 35s. grading would be a breach of faith of the grossest description. The Government made a bargain with the farmers, none the less binding though not on stamped paper. If flax prices had fallen the farmers would have held the Government to the last penny; but because flax prices had gone up the public are asked to believe that there was no bargain."

In reply to this a County Derry farmer replied: "As to the alleged contract does anyone contend seriously that the farmers or their unions actually agreed to the prices fixed, in view of the fact that the acreage under flax in Ireland was reduced by one-third this year because of the fixed prices—in other words, roughly 30 per cent. of the Irish flax growers refused to grow the crop for sale at the rates guaranteed. Did the farmers concerned, or the Farmers' Unions, authorize any single individual to make the contract on their behalf? Certainly not. Possibly the Government may be indifferent as to the prosperity or otherwise of the Irish flax industry—an inference which appears to be justified by the fact that there is lavish expenditure incurred for the subsidizing and fostering of English and Scottish flax-growing, whereas the kindred industry on this side of the Channel is being totally neglected and starved for want of Government aid."

A "Flax Grower" also replied: "There is not the slightest doubt the farmers insisted on the Government fixing a price for this season's crop. The Farmers' Union may not have had anything to do with it officially, but every farmer knew of the fixed price, and sowed his flax on that understanding, and I agree with Mr. Stirling that if the linen trade had remained stagnant as it was in the first few months of this year, and no demand for flax, the farmers would certainly have expected the Government to buy their flax at the fixed price. This is one side of the question. On the other hand, farmers naturally thought when they were sowing their flax this year that, the war being over, the cost of labour would be reduced. As I am interested in farming myself I can say, without fear of contradiction, that instead of being reduced the cost of labour and handling of flax has been largely increased this year, and yet the farmers are expected to accept 10s. a stone less, and say nothing. I ask Mr. Stirling a straight question. At the present price his firm is getting for linen yarns is he not profiteering at the expense of the farmer? As a matter of fact

could his firm not pay 5s. to 10s. per stone above last season's price and still have a substantial profit on present yarn prices? A straight answer to these two questions would be very interesting.—Yours, &c."

Mr. S. A. Johnston recently wrote: "The importance of the flax crop to the linen trade of Ulster cannot be exaggerated. No flax fibre in the world equals it for important branches of the linen trade, such as damask, sheetings, heavy linens, and superior linen threads. It was on the superiority of Irish flax that the high reputation of Irish linen was established, and it is of vital importance to the whole trade that the cultivation should be extended instead of being discouraged and curtailed."

Later, on December 8, Mr. Alex Proctor, flax spinner, Blairgowrie, Scotland, wrote the editor of the *Belfast News-Letter*: "SIR,—Referring to the letter signed by J. C. Nixon, Belfast, in your paper dated 26th ult., to which my attention has been drawn, I may say that the view of all competent unbiased observers of the flax supply position fully coincides with that of Mr. Nixon. In order to independently refute Major M'Cormack's ludicrous assertions regarding the effect of the withdrawal of control of flax prices in Ireland, I am prepared to back Mr. Nixon's contention, and am likewise agreeable to forfeit to Irish charities the sum of £250 if Irish flax values are not considerably higher at this time next year than they are to-day. Having had an intimate and extensive experience of Russia and the Russian Revolution, I endeavoured six months ago to interest the British linen trade in a scheme for increasing the flax supply within the British Empire to partially replace the vanished Russian supply, which in pre-war times was 80 per cent. to 90 per cent. of the world's production, and which cannot possibly substantially recover during the next five years. The linen trade and a semi-official organization called the Empire Flax Culture Association have done practically nothing either to encourage or stimulate flax production within the Empire. At the present moment thousands of ex-service men have secured grants of exceptionally suitable land for the development of flax production in British East Africa, where two crops per year can be secured. Nothing, however, has been done to help those young settlers to establish a large and organized flax production, which would be highly profitable to them as well as to the linen trade, preventing at least to some extent both capital and labour in this country from becoming idle, as it certainly will do with the foreign flax supply drifting to almost vanishing point. Flax culture and preparation could be developed in most parts of Ireland, wherever there are large rural populations. In order to encourage and foster this industry, which would be most desirable from all points of view, particularly that of the labouring classes of rural Ireland, it is essential to retain the

Irish Tillage Act in force for an indefinite period, and likewise withdraw all flax control so far as price is concerned, removing the arbitrary grading of official graders of flax, who, in most cases, grade flax simply as it suits themselves, more or less ignoring the interests of the producer. The linen trade operatives have drawn very substantial sums during the last year from Government as unemployment allowances. Something will have to be done for them on a large scale in the coming years, and it is my belief a great deal could be done to utilize these idle people in connection with organized linen trade flax production work, thus, to some extent, avoiding this most ruinous and pernicious form of national expenditure."

Again, "One Who Knows" wrote: "Sir,—The Farmers' Union, encouraged by Mr. Nixon's letters, deserve credit for getting the price of first grade flax fixed at 45s. per stone; but it is well known by those in the spinning and weaving end of the trade that the farmer is not getting the price that today's price of yarns would warrant, and I believe my argument for this statement is uncontrovertible, and it is this: While aeroplane cloth was being woven the price of all yarns was fixed by a Government auditor in consultation with the Spinners' Association. For the sake of brevity I will confine my figures to what is known as 'the range.' On December 11, 1918, the price of 'the range'—90's, 95's, 100's, 110's, and 120's—was then fixed at 17s. per bundle for common weft up to 18s. 7½d. per bundle for superior weft. During the past few days these numbers have been sold at double, and more than double, these figures, and still the flax is only 45s. per stone. In view of these figures, which any yarn merchant or weaver can substantiate, I would ask the Farmers' Union not to allow their members to sell a stone of flax till the price obtained bears a fair ratio to the price of the yarn spun from it. I believe that on the whole the controlling of the flax has been a benefit to the farmer, and I hold that the price should be controlled for a few years longer, but controlled so that the spinner would pay a fair price. I quote from the *Linen Trade Circular* of January 3, 1920: 'Farmers are now inclined to agitate for the decontrol of the 1920 crop, believing that a free market would ensure them higher prices. This might be so, and it might not be. Farmers would be well advised not to overdo things, and to be satisfied with some form of a reserved market which would make them certain of a satisfactory price without driving the spinning trade into the hands of foreign competitors who, when they could get supplies from the usual growing countries, would very soon cold-shoulder the Irish farmer.' I entirely believe in this extract, but, at the same time, the exceptional price of yarn now fully warrants Irish flax being sold for at least 80s. per stone for first grade."

SOME REMARKABLE RESULTS.

By F. J. LEITCH.

(Time's Irish Number.)

At the time when England declared war against Germany, in August, 1914, the flax-spinning mills in the United Kingdom consumed about 95,000 tons of flax fibre. Of this quantity about 60,000 tons were imported from Russia, the balance being made up with imports from Belgium, Holland and France, *plus* the flax grown in Ireland. At that time practically no flax was grown in Ireland outside of Ulster. Not only is there no immediate prospect of any flax supplies coming from Russia, but, in the opinion of those best qualified to judge, it will be at least three years before Russia will again export flax fibre in tens of thousands of tons. How is the deficiency to be made good, and what are the prospects of Ireland filling all or a substantial portion of that deficit? At the outbreak of hostilities Ireland put under flax cultivation about 50,000 statute acres, all of which were in Ulster with the exception of about 1,000 acres in Munster. The price at that time did not average over £45 per ton, and the farmer made no attempt to save the linseed, so that he was entirely dependent upon foreign linseed wherewith to sow his future crop.

Previous to the spring of 1918—with the exception of a few acres which my firm had planted in 1917 with the object of testing certain varieties of linseed—I had never cultivated flax; but I was led to do so by the consideration that, notwithstanding the scarcity of linseed for (a) fibre cultivation purposes, (b) for oil, (c) for feeding purposes, farmers in Ulster were deliberately destroying over 65,000 tons of linseed. The reasons advanced were that climatic conditions in Ireland were such that it would be impossible to save the linseed, and even if it could be done it would be more or less at the expense of the fibre.

The following problem, therefore, presented itself: If in pre-war times an Ulster farmer could cultivate flax to his pecuniary advantage although he destroyed the linseed and only received £56 per ton for the scutched flax and £12 per ton for the re-scutched tow, how much more could he make if he saved the linseed and obtained £250 per ton for the scutched flax, £80 per ton for the re-scutched tow, and £100 per ton for the cleaned linseed?

LARGE-SCALE ENTERPRISE.

In the spring of 1918 my firm put 500 acres under flax—100 acres in Ulster, 100 in Connaught, and 300 in Leinster, where full advantage could be obtained from the use of tractors. The climatic conditions which prevailed during the

growing and harvesting seasons could hardly have been worse. No rain fell during the early stages, whilst during harvesting operations it scarcely ceased to pour. It is conceded that the 1918 crop of flax, both in point of yield and in quality, was the worst that Ireland had produced for over fifty years. The 100 acres put under cultivation in the province of Connaught resulted in a loss. This was due to the absence of rain during the growing season. The 100 acres in Ulster were harvested with the greatest difficulty on account of incessant rain, with the result that a profit was made, but only through the saving of the linseed. The 300 acres put under cultivation in Leinster turned out very successfully, with the exception of about 30 acres in Co. Wicklow, where flax was grown on land at a high elevation and suffered on account of drought. All the land that had been put under cultivation in the counties of Meath and Kildare produced magnificent crops, particularly of linseed. In every instance the linseed was saved, and what was not suitable for fibre cultivation was sold for crushing purposes at about £43 per ton. Of fibre linseed we had ready for sowing this spring over 1,100 bags of 182 lb., which realized 1s. per lb., and as a result about 2,200 additional statute acres were sown down this spring in Ireland with home-saved Irish linseed.

· GOOD RESULTS.

Notwithstanding the severe test and trying conditions experienced with the 1918 crop, we put under flax cultivation this spring about 1,500 statute acres, and confined our attention to the counties of Meath, Kildare and Dublin. Of this amount about 1,000 statute acres were sowed with the linseed saved from the previous crop. The results have far exceeded expectations, as it is admitted that our production of flax straw and bols is as good a crop as was ever grown in Ireland, and that in a year when the flax crop in Ulster pulled on the light side, whilst the flax crops in Holland, France and Belgium will not realize more than one-half of a normal yield to the acre. Local labour was entirely relied upon for pulling and harvesting this year's crop; and when it is borne in mind that the majority of the workers had never previously seen flax growing; it was a remarkable achievement.

From experience thus gained it is confidently asserted that Ireland, south of the Boyne, is the best flax-growing country in the world; and the opinion is hazarded that in course of time Ireland could grow all the flax required by spinners in the United Kingdom—that is to say, from 400,000 acres worked on a commercial basis. Irish flax is not only superior in quality to flax grown in Russia, but possesses considerably more strength, thus giving a higher yield to the spinner, with

the result that spinners can afford to pay a far higher price for Irish-grown flax and still have not only as cheap, but a better and stronger pound of dressed line. Furthermore, Russian flax fibre is generally utilized for the production of coarse and heavy spun yarn, whereas Irish flax is spun into finer yarn and utilized for a different class of trade, thus commanding much higher prices.

A landowner can cultivate flax and pay present wages, and his enterprise will repay him threefold from a pecuniary standpoint as compared with a corresponding crop of grain. In addition to this, it will enable him to give employment to the peasantry at attractive wages, and thus help to stem the tide of emigration which is so certain to resume its flow under normal conditions of Irish life.

FINISHING LINEN TOWELS.

Linen towels may be finished either upon a heavy hydraulic mangle or upon a beetling engine. Such towels may be made out of all linen yarns which have been three-quarter bleached before weaving.

In a hydraulic mangle the goods are run through the mangle under heavy pressure. It is not necessary to use a softening or finishing oil to get a fine lustrous finish. To get the gloss it is a question of running the goods through the mangle a sufficient number of times with the proper amount of water in them. A high gloss is natural to linen when bleached and properly finished and neither need a softener be used for a better finish. The cloth is passed through a weak sizing solution, say, about $\frac{1}{2}$ lb. of starch to 1 gallon of water, with about 10 lb. of Epsom salts to 5 gallons of solution, then boiling up. After passing through this the cloth is dried. The goods are then run through a damper or conditioning machine and got to a nice percentage of moisture, then run on the beam of the beetles and given about forty-five minutes to one hour, then changed and given another forty-five minutes. The treatment softens the goods up and emphasizes the linen appearance.

The nearest approach to a beetle finish is a chased finish off the calender. Thousands of yards are given the chased finish and sold for beetle finish. It is obtained on a calender by passing the cloth through all the nips, taking it over rollers behind the machine and then passing it through the machine again. The pressure of the calender rollers upon the bowls or their layers of cloth presses the yarns of one layer into the yarns of the layer underneath, thus giving a thready appearance. This process may require a softener in the sizing solution, as it has a tendency to harden. For such a solution soluble oil, cocoa oil, oleine oil, or glycerine substitute may be used.

LINEN TRADE POSITION IN 1919.

Mr. J. Milne Barbour, D.L., at a recent meeting of the Linen Thread Co., Ltd., made rather a lucid statement on the above subject. The summary herewith is consequently interesting.

The outlook for supplies of raw material is causing considerable concern. This year the sowing of flax in Belgium, in spite of all that country has gone through, will be on a considerable scale, but some of that crop may not come on the market until the winter of 1920. The conditions in Russia, whence the greater amount of the United Kingdom's supplies have always been drawn, have prevented information either as to what supplies may be available there or as to what effect the increased cultivation of foodstuffs may have had on the acreage sown to flax. So far as the cultivation of flax in Ireland is concerned, the Government has been working in close conjunction with the flax-spinning trade, and its operations in providing seed and controlling the marketing and distribution of flax have been very capably conducted, with the result that the trade has been saved from much disorganization and unsettlement which might have resulted had the situation been either allowed to drift or been less ably handled. The high prices fixed for the crop, and, I hope, a certain measure of patriotism, have had the effect of raising the acreage under flax in Ireland.

Mr. Norman Boase, speaking in London recently, is reported to have said: "Now that war demands have ceased, the present position of the linen industry is lamentable. Nobody appears to require flax goods of any kind. Doubtless the high price of raw material, about five times pre-war value, has decreased in volume of business. Certainly the industrial unrest, the general want of confidence due to after-war reaction and the non-settlement of peace terms, deters buyers from entering into fresh obligations, but with the certainty that the law of supply and demand would level prices of raw materials and goods, and with the knowledge that flax is the greatest and best of all vegetable fibres, we need not fear that the linen industry will not maintain its prestige of the past."

The following extract from the Belfast *News-Letter* is also of interest in this connection. It reads: "The policy pursued by the Government in taking entire control of the linen industry from the growing of the flax to the finished linen left nothing to complain of had they strictly confined their demands to something like probable requirements, but from first to last their chief endeavour seemed to aim at the complete stoppage of any linen goods being manufactured for civilian purposes. No flax yarns were permitted to be used

up for any but Government purposes, although there were supplies of extreme fine numbers lying in stock which could not by any known means have been worked up for aeroplane linen. Now that the restrictions have been removed such yarns will have to be used up for their original purpose, but unfortunately the trade for the goods has to be brought back again. The enormous accumulation of aeroplane linen fully testifies to the insensate manner in which those acting for the Government conducted their business, and while there is no chance of these goods being put to anything but a proper use, the effect of such a vast quantity of linen being on the market is bound to act as a drag upon the sale of analogous goods until it is known that they have been entirely wiped out of existence.

“So far as spinners are concerned there has been really nothing done to relieve them of anything produced, merchants still holding stocks sufficient to accommodate consumers with small sorting-up lots required, and while manufacturers succeeded in getting some few orders for mixed goods there was a great deal more waiting to take the place of the Government orders due to run out at the end of this week. The factories are now all noticed to run at a maximum of thirty hours weekly from this forward, and to stop work for ten days at Easter, and no doubt the spinning mills will adopt a similar policy, because they have no inducement to act otherwise.

“The return published by the Department of Agriculture with regard to the extent and produce of the flax crop in Ireland in 1918 is the reverse of being satisfactory. The acreage shows an increase of 33 per cent. over that for the previous year, and yet the produce is only 2 per cent. more. The yield given as 17.5 stones per acre is almost 2 stones below that of the lowest in 1868, when only 19 stones resulted. Weak seed accompanied by atrociously bad weather at a critical time will account for a great deal of this, but certainly the results will cause much amazement to all in the trade not actually concerned in the growing of the article. On the principle that two entirely bad seasons seldom follow each other, it is just possible that with such a late spring this year will do much to make amends for the disappointments and losses of last year.”

EXTRACTS FROM ANCIENT AND MODERN WRITERS ON FLAX.

“Land reclaimed from the sea is often very suitable for flax production, containing as it does a large percentage of silica and siliceous sand and organic matter rich in nitrogen.”

The chemical composition of the flax plant, according to the late Professor Hodges, Queen's College, Belfast, is:—

Water	56.64	per cent.	
Organic matters	41.97	„	
Ash	1.39	„	
Total				...	100.00	per cent.

One hundred parts of Irish flax straw give 0.53 per cent. of nitrogen and 3.20 per cent. of ash. This ash contains:—

Potash	20.32	per cent.
Soda	2.07	„
Chloride of soda	9.27	„
Lime	19.88	„
Magnesia	4.05	„
Oxide of iron	2.83	„
Sulphuric acid	7.13	„
Phosphoric acid	10.24	„
Carbonic acid	10.72	„
Silica	12.80	„

“Canada has both a suitable soil and climate for flax.”

“The total number of known acres under flax cultivation is approximately 15,000,000, but out of this number only about 5,000,000 acres are cultivated for fibre.”

“In normal times the relative values of Russian, Irish and Courtrai flaxes are approximately:—

- (1) Courtrai flax £80 to £100 per ton.
- (2) Irish flax £60 per ton.
- (3) Russian flax £40 per ton.

“Dutch flax is intermediate between Courtrai and Irish. The fine flaxes are used for damasks and fine linens; the coarser qualities, from Russian flax, for heavy canvas and sail-cloth.”

In 1857 Brown wrote: “I ask if it would not be a great national object to increase the culture of flax in the United Kingdom, and that to such a degree which would supersede, in some measure, the importation, or at least reduce the price, of foreign flax and flax seed to the extent of one-fourth of the value and quantity, say, to the extent of £5,000,000 or £6,000,000 yearly, whereby a great increase would be profitably made at home to the value of land. In short, all the advantages incident to the augmentation of home produce and manufactures would be secured to our own country, instead of going to foreigners.”

“When the flax is pulled it should be made up into small sheaves or bundles tied slack to let the air have free action

through them. These should be set up in stooks of twelve sheaves with the bolls up and allowed to remain from two to four days to ripen and firm. In very sunny weather little time is required for this purpose, but if the crop has been heavy and lodged it will require a little extra time, as it should under such circumstances be pulled a little sooner than if it had been standing."

"Pull the flax when the fibre is in the best state for your purpose, and still take off the seed bolls, which under ordinary circumstances will amply repay the outlay."

The Dutch method of pulling consists in catching the flax close to the bolls. This allows the shortest of the flax to escape with the next handful. The puller draws the short flax and so keeps the long and the short separate to be steeped separately.

Flax retting requires water of at least 64° to 68° F. and also dry warm weather for the drying of the straw on the fields. On the other hand, the scutching is done inside a building and requires a certain amount of moisture so that the fibre may remain supple. The retters and scutchers of the Lys are specialists, for they work at nothing else.

The waters of the Lys are even better suited to the retting of the previous year's straw, even for straw two or three years old, than for green straw. Retting is there carried out on comparatively large quantities of flax, with the result that each merchant can get his lot of straw sorted and prepare for the filling of his "ballons" lots of flax which require the same duration of immersion. The flax thus handled supplies lots which ret in a regular manner and are easily scutched with small loss.

The scutching is generally done in four successive operations by two workmen.

Water which has been used for retting flax is very rich and favourable for bacilli culture. Wolff's book on "Manures" sets down approximately 7½ lb. of phosphoric acid and 20 lb. of potash as remaining in the water per ton of dry flax straw retted in stagnant water.

The average composition of flax straw includes 10½ lb. of azote, 9 lb. of phosphoric acid, and 20½ lb. of potash per ton.

When the farmer rets his flax straw himself a large proportion of the stems are too much or too little retted, the over-retted stems going to tow in the scutching and the under-retted ones giving dirty fibre of comparatively little value.

Retted in the Lys, dry flax loses approximately 29 per cent. in weight. The percentage of fibre obtained is only 12 to 14 per cent. on the weight of the unretted straw, or, say, 17 to 18 per cent. on the weight of the dried retted straw.

The natural fermentation of flax straw in running water is

distinguished (1) during the retting by the smell given off by the straw, (2) after the retting and drying by a characteristic fresh smell, a clear yellow colour, the extreme brittleness of the wood, and the slight adhesion of the fibre to the wood.

“Water slain fibres” are those wholly deprived of their gum and thus of all strength. It is produced after retting which has reduced the pectic matter to a mucilaginous state, soluble, very soft and easily removed by a too strong flow of water or by friction of the workman’s hands or fork when in a wet state.

Each blossom of the flax plant contains five stamens or fructifying organs called the male part of the flower, and also five pistils or terminating points of the embryo fruit, forming the female organs. Each stamen is tipped with a little roundish head called an antler, which, when mature, sheds a fine dust called the “pollen.” The pollen coming in contact with the pistils causes the seeds to grow and become reproductive.

Some thirty years ago one witnessed the cultivation of flax upon almost every little farm throughout Ulster. At that time in Monaghan the country seemed dotted with little smokes arising from the flax kilns throughout the country in the autumn months. The flax was then dried over a turf fire in those kilns, and beetled with hand-beetles, or rolled in preparation for the scutching. The latter was usually done by girls with the aid of a flat board containing a handle, and with which they scutched the flax on an upright strong board secured to the ground by a sole, and known as a stock. Sometimes as far as twenty girls would be engaged, with as many stocks and handles, at one farmer’s house. Each girl could scutch about one stone per day of finished flax on an average. The house was known for the time being as a scutch house, and the girls’ sweethearts, and all the boys for miles around, would turn up at night for the purpose of having dances, songs and enjoyment. This process of handling flax was slow, but neat, and always capable of taking out without loss every available piece of the fibre for sale. The prices per stone averaged from 5s. to 7s. in the market, and the yield, I believe, exceeded our present-day yield on the average.

In a normal year—and 1913 is a good average—the entire flax supply used in Irish manufactures is 55,000 tons; of this total, somewhere over one-fifth is Irish grown, much over three-fifths comes from Russia, and the remainder from Belgium and Holland.

Early ploughing should be done in January. Then as soon as the weather in March permitted, to plough again lightly, clean thoroughly, roll often and make a firm seed-bed. I was over this summer a good field of land, but which

bore a bad crop of flax, and it was almost like a bog, not having been properly rolled.

Flax will not grow successfully in such land. The farmers' motto should be: "A firm seed-bed, for your life." Good rolling is as good as good harrowing.

The ground should be got ready two or three weeks before sowing, and it should be well cross-harrowed.

From April 20 to May 8 is our best time for sowing. Sow not too thickly, say, from 9 to 10 pecks to the Irish acre.

"Bursting" the fibres is a process supplementary to scutching and consists in smoothing and polishing it by a hand-scraper or blade, which also removes some of the remaining shive.

Flax does not necessarily stop growing when the flowers appear. When the weather is moist and warm after flowering it has been known to increase another twelve inches in length. You may take it that flax is still growing as long as the tops of the stems bend downwards or are "obesant." When the plant ceases to grow and starts to ripen the stem and branches become firmer and stiffer.

"If soil, at or near the surface, is all pure clay it is termed cold."

"Heavy soil contains over 50 per cent of pure clay."

"A loamy soil is free and open. It contains from 25 to 30 per cent. of pure clay."

"A sandy loam contains 10 to 24 per cent. of clay and a sandy soil about 6 to 9 per cent. of clay."

"Calcareous soil contains 20 per cent. or more of chalk or lime."

"A good flax soil contains 70 to 75 per cent. of clay and sand in approximately equal proportions and the balance in calcareous substances and humus of approximately equal quantities."

"Occasionally lime is applied to heavy soils as a developer of the natural plant food contained therein. 'Fallen' lime is a deliquescent. It readily absorbs moisture, dissolves acids, opens up the soil and improves its texture; it decomposes decaying vegetable matter, which in the process generates heat to the soil and simultaneously produces carbonic acid and ammonia, both important plant foods."

"Generally the flax plant reaches the limit of its growth in about nine or ten weeks, at which stage 'the lint is in the bell.'"

"Details of the Fiddle' for Machine Sowing of Flax, &c.

"The apparatus consists of a distributing wheel, a seed box and supporting framework, the iron feed plate with portions

cut away and pivoted on a small stud fixed in the base of the seed box. The cut away portions with their intersecting projections are designed to allow the seed to fall by gravity but under control from the aperture in the base of the seed box on to the oscillating hexagonal ribbed wheel, secured to a small wooden pulley compounded with a vertical spindle upon the upper end of which a small brass pulley or collar is eccentrically fixed. This pulley loosely fits into a recess on the underside of the feed plate. The spindle passes freely through the wooden base and oscillates freely on an iron plate fixed to the underside of the wooden base. A second plate, styled the *shut-off plate*, is adjustably supported on the underside of the seed box by set-screws which pass through slots in the shut-off plate. By this arrangement the shut-off plate is free to reciprocate in a direction parallel to the base of the feed box so as to partially or wholly cover the aperture of the vibrating lever and feed plate.

“A small iron lever is pivoted to the underside of the seed box by a set-screw and may be adjusted to any desired position about its pivot stud. The nearer it is moved towards the front of the feed box the more completely it moves in sympathy with the shut-off plate and closes over the aperture, thereby regulates or entirely shuts off the supply of the seed in the box. The limit of the backward traverse of the lever and the shut-off plate and consequently the flow of seed from the box is controlled by a small bracket adjusted on the fixed stud to the underside of the feed box by a thumb-screw. A fiddle stick is provided with a detachable knob to which is securely fastened a narrow leather strap or cord. When the knob is detached, the stick is passed through perforations in the base board and spiral springs. The knob is then fastened on to the end of the stick and the leather strap is coiled once around the wooden pulley, then the free end of the cord is securely but temporarily fastened to the handle of the stick. The fiddle stick is free to be reciprocated to the right and left, by which means the pulley and its connections are oscillated. Two spiral springs are fastened to the base board and serve as buffers against the shoulder of the knob, alternately with the shoulder of the handle of the stick.

“The sower carries the fiddle and seed box suspended from his shoulder by a strap. When ready to commence sowing, he moves the feed plate and the adjustable bracket so as to cover as much of the aperture as is necessary to regulate or limit the amount of seed which is to continuously fall from the seed box through the aperture of the vibrating feed plate and on to the oscillating and distributing fan wheel. Then as the sower strikes out with his left foot, he moves the fiddle stick inwards to the left, and alternately outwards to the right, with each forward stride of the right foot.

“The constant reciprocation of the fiddle stick oscillates the pulley, spindle and eccentric brass collar and causes the feed plate to slightly vibrate so that the seed as it falls through the apertures in the base of the seed box is prevented by the constant vibration of the “fingers” of the feed plate from assuming any tendency to accumulate and jamb in the apertures of the feeding part. As the controlled seed drops through the apertures in the food plate and on to the oscillating hexagonal fan-shaped wheel it is scattered broadcast to the right, left and front reciprocating bar. The reciprocation of this bar causes the washer to oscillate and turn the flax seed on to its edge, thus allowing it to pass through the fine sieve of about 1/16 inch mesh, but the round weed seeds and small lumps of earth and other foreign matter are shaken forward into another receptacle. A blast of air separates the seed into different weights, the heavy seed falling first and the chaff, dust and light weed seeds being blown further.”

“Micro-organisms or bacteria are of various shapes.”

“Bacilli is the special term used to denote the group which are rod-shaped. These bacilli may be either aerobic or anaerobic.

“The retting microbe remains alive or in suspended animation in the dry flax straw for very long periods.

“In the ordinary flax dam it is the anaerobic bacilli which multiply and carry on the work of decomposition of the pectic matter of the straw.”

“The yield of scutched flax fibre should vary from 32 to 40 stones per acre. In 1917, a Co. Down farmer got nine bags of excellent seed from one bag of seed sown. In the same year and county a farmer divided his crop into two parts, one of which he harvested for fibre only, the other he pulled, stooked, dried, stacked, deseeded and retted in the spring of 1918. The total receipts for the latter were exactly twice those of the former.”

“Many flax growers who stack their flax and defer the retting until the following summer, assert that the resultant fibre is approximately 10 per cent. better in yield and quality.”

A “windrow” is a pile of beets of flax straw, not closely packed together as in normal stacking, but in open order, so that the air and wind can freely circulate among them. A windrow may be built up as follows: Form a gait of any convenient length by first adjusting two rows of beets with their root ends apart and their heads leaning against each other. Three additional rows may be added to each side, making eight rows in all. Further additions may be added to the top and built in such a way as to form a slanting roof so as to facilitate, if necessary, rapid covering in very wet weather and induce the water to freely run off and clear of the lower row of butts.

Boby's flax seed cleaning machine comprises a fan, three sieves and a duct, through which the dust and small light leaves are blown. The chaff is carried forward to a separate exit, while partially cleaned seed falls to the ground or into a receptacle placed to receive it. Charlock and other weed seeds are separated from the flax by an ingenious arrangement consisting of a series of small washers upon a series of stationary cross rods.

"In 1816, a Linen Board Inspector, after a tour through the flax-growing districts of Scotland and Yorkshire, reported very favourably upon the great care taken by the Scotch cultivator and especially by the scutcher, resulting in over 25 per cent. increased yield of hackled flax as compared with Irish. The reason of this difference was attributed in part to the fire drying of the Irish flax, by which it lost the oil, becoming hard, and the fibre easily broke. In Scotland the flax was air dried in the field."

"Flax seed is highly valuable, for it is most nutritious and has life-sustaining property; as could be vouched for by many of our troops, who were more than thankful for an accidental discovery of several barrels of linseed found during the siege of Coomassie."

"In Canada the early settlers considered that flax was one of the best crops for clearing the land as it reduced the super-fertility of the soil, and after three flax crops in succession they obtained the best crops of grain, the land being as productive as ever."

"On light soils plough shallow (four inches), and on heavy soils deeper, say seven inches.

"A fine, clean, compact seed-bed is required, which allows of the seed being covered to a uniform depth and also permits uniformly rapid germination, this being very important. In order to secure this, the land should be autumn ploughed to a depth of seven or eight inches, and in spring, if the soil is of a heavy nature, a shallow cross-ploughing of three or four inches may be necessary, but grubbing and cultivation followed by harrowing and rolling will generally give the desired result.

"If fibre is the chief object, then the seed must be thickly sown; in some cases $3\frac{1}{2}$ bushels per acre being sown, the result being the drawing up of the stalks with little or no tendency to branch. The object to be gained is to get the longest and finest straw possible, consistent with strength sufficient to keep it upright and bring it to maturity."

"In 1911 Russia had 1,785,640 acres under flax, of which she produced 459,000 tons, of which she exported 222,387 tons, of which 60,450 tons came to the United Kingdom."

(According to the above figures, it would seem that Great Britain must cultivate at home or in her colonies at least an extra 240,000 acres.—ED.)

"The root itself has no fibrous tissues at all, and not until the stalk is above the ground does it show signs of fibre.

"The resulting crop has all the characteristics and deficiencies of the parent, seed from long stalks producing similar long and sound stalks, while seed from short stalks produce similar shorter, inferior stalks. It is therefore evident that a real improvement in the crop can be found from breeding from the long and sound stalks."

A bushel of seed sown will produce six or seven bushels of seed the following year.

(ED. NOTE.—If each grain of seed produces a stem and each stem bears twelve bolls, since each boll contains ten seeds, how many grains of seed should one grain produce if every care is taken?)

In Belgium, flax is grown mainly in the district drained by the Lys, a left-bank tributary of the Escant, and the fibre obtained from it has long been known for its excellent quality, which is due to the circumstances that the district named is remarkably free from lime salts, in consequence of which the water of the Lys is particularly well suited for retting. The centre of the Belgian raw flax trade in Courtrai.

The green ends on Pernau flax is caused by tying the end and hanging it over a rope or pole in drying or sun bleaching.

The value of the sowing and crushing flax seed and of the hemp seed annually exported from Russia may be estimated at about one million sterling.

The dew-retting process takes about six weeks. Flax is placed on grass in the same manner as when spread after being taken out of the steeping pond, except that it must be more thinly spread. Every few days, according to weather, the straw should be turned over to allow of even exposure to the air and prevent discolouration. There is more danger of under-retting than of over-retting in this process, and the flax straw should be left on the spread ground until the straw can be quite easily rubbed away from the fibre. When taken to the scutch mill the scutching handles should be driven very slowly, as dew-retted flax requires very little beating to remove the shoves.

"Goods made from flax are characterized by their relative great strength and power to absorb and give off moisture more readily than cotton. Linen fabrics are easy to wash and possess a characteristic gloss which is unequalled. Some types of linen towels possess exceptional drying properties."

"The weight of flax fibre seed should not be less than 4.2 grammes or 65 grains (avoirdupois) per 1,000 pickles. This weight corresponds with 54 lb. per bushel, or 189 lb. per bag of $3\frac{1}{2}$ bushels."

"The weight of small seed per unit volume is relatively greater than large seed."

"If flax straw is cut instead of pulled it tends to become sour and deteriorate about the point of severance."

"The operation of hand-pulling flax is simple and easy to learn. The experienced puller usually lays hold of as many standing stems with his left hand as the reach of his fingers will permit. Simultaneously, with his right hand he gathers as many of the adjacent stems and continually adds them to those in his left until he has a sufficient number of stalks to make a reasonably good-sized handful; these he then grips with both hands and together with a peculiar twitch of the knee and movement of the arms he pulls the complete handful of stalks up by the roots, as free as possible from soil and weeds. About six such handfuls form a round, beet or sheaf."

"The beets should weigh from 7 to 10 lb. each. Eight flax-pullers of average ability will pull a statute acre of flax per day. A stook contains twelve beets each, 24 to 27 inches in circumference. Eighty or ninety stooks should be harvested per acre; or forty to fifty stooks per bushel of seed."

Gray's flax decorticating machine, which has been used in Canada to clean unretted flax straw, consists of five pairs of rollers and two beating blades arranged as follows: First a pair of rollers to seize the material as it passes in from the feed tables; then a beating blade, which works between two fixed blades and which crushes the straw and breaks away the hard roots and tops. Then three more pairs of rollers, a beating blade similar to that already mentioned, and finally a pair of rollers to deliver the material on to the floor.

The first beating blade is adjustable and can be set so as to give more or less cleaning to the fibre. This adjustment applies both to the up and down motion of the blades and also to their position in relation to the fixed blades and by arranging either of these motions or both, the requisite amount of work deemed necessary can be given to the material.

The second beating blade is similarly adjustable and requires rather different setting from the first blade owing to the fact that so much of the straw has been removed from the fibre by the first blade that the bulk is reduced. The fluted rollers assist the beating blades by crushing the straw, thus rendering it more easily worked and cleaned.

MORE ABOUT THE ROSSI PROCESS.

It is claimed that the Rossi method is of a micro-biological nature. It aims at supplying a microbe to consume, so to speak, the pectic matter and leave the cellulose untouched. Up to the present time Professor Rossi maintains all the researches made in this direction by micro-biologists led to the use of anærobic bacilli, i.e., those exerting their action in an absence of free air and necessitating the employment of

hermetically sealed vats into which the entrance of even the most minute quantity of air, which would have the effect of stopping the action of the bacillus while employed in the process is prevented. Professor Rossi states that he has discovered a ferment of an aerobic nature for which the presence of air is indispensable for life. This organic ferment, he states, consumes pectic matter as food, being indifferent to cellulose. He claims, therefore, that there is no danger of over-retting.

The process may be divided up into three operations:—

(1) Immersion of the flax, hemp or ramie in water at, say, 85° F., in suitable vats.

(2) Addition of a suitable quantity of culture bouillon, prepared by means of the ferments discovered by Professor Rossi.

(3) The use of a current of air during the whole time of the operation, which is introduced through the bottom of the vats and passes through the volume of water.

We agree that the employment of this current of air intensifies greatly the power of the retting microbe, but we do not agree that the success of the operation depends upon the use of microbes supplied by Professor Rossi in sealed tubes ready for use and employed in the production of a culture bouillon. We are advised that it makes no difference if the tube of culture is forgotten, the undisputed saving in time of the retting operation being due to the old, if little known, principles which we have frequently set forth: (1) That the speed of retting increases with the temperature. (2) That the introduction of air during the retting process also hastens the operation. This latter fact is known to the retters, of the Lys valley, and is the secret of the virtue of the doubly retting process. It was also known to Legrand when he went to the expense of raising his crates out of the tank periodically in order to aerate them. It is also known to the Japanese, who, as we have pointed out before, run off the water from the tanks at half-time, aerate and refill.

Professor Rossi's vats are made of reinforced concrete, open to the air, and having an average capacity of nearly 1,800 cubic feet. At the Bonnetable works it is reported that there are four vats in use, placed in line and mounted on a brick foundation, being contained in a closed shed provided with doors in order to keep the vats well sheltered against the weather. Each vat contains 5 to 5½ tons of flax straw. On the bottom of the vat and on each side is a perforated branch pipe or bouilleur through which the air is supplied. Along the bottom and down the middle of the vat is a perforated pipe of larger diameter which serves for the introduction of steam, employed to keep the water in the vat up to the desired temperature. This water enters the vat through a feed pipe. Thus each vat has three sets of pipes, each set

controlled by a separate valve, i.e., one for air, one for steam, and one for water.

The bundles of flax straw are laid flat in the tanks and are placed side by side until the vat is entirely filled up. When the vats are filled up water is introduced, the flax being held down in place by wooden beams, as, of course, it has a tendency to rise when fermentation sets in. The temperature of the water is next raised. The culture bouillon is then brought in a bucket and its contents poured upon the surface. After this the air-pump is started and a current of air sent into the vat. The Bonnetable plant makes use of an air compressor for the four sets of vats which supplies 7 cubic feet of air per minute to each vat. This delivery of air produces considerable ebullition, and sometimes produces a thick coating of white foam on the surface.

Magnified to 12,000 diameters the microbes are seen to be rod-shaped bodies which moved to and fro in all directions in the liquid, and these movements are seen to be more rapid as the operation goes on.

At Bonnetable the retting water is run off into an adjacent river. Professor Rossi claims that the stream is not polluted thereby, for he says, as the microbes which it contains is of the aerobic nature it does not kill the fish by asphyxiation by withdrawing the oxygen from the water as flax water usually does. He also claims that most of the unpleasant odour usually associated with flax retting is absent and that the water is only rendered slightly yellow.

EFFECTS OF AMERICAN CIVIL WAR ON IRISH FLAX INDUSTRY.

The Civil War in America caused great excitement in the linen trade. For a time it almost completely prevented the cultivation of cotton and led to the destruction of large quantities already harvested in the Southern States.

The area under flax in Ireland, which was 128,595 in 1860, rose in 1864 to 301,693 acres, an increase of 134 per cent. As might be expected, this enormous increase had a tendency to check the inflation of prices which had taken place in 1862 and 1863 owing to the scarcity of American cotton.

In 1860 Ireland had about 600,000 spindles, consuming roughly 32,000 tons of flax, of this the home supply was 24,000 tons, or about three-quarters between that year and 1864. However, spindles had increased by 50,000, or, say, $8\frac{1}{2}$ per cent., whereas the area under flax had gone up to 301,693 acres, with a total production of 64,500 tons, an increase, compared with 1860, of 170 per cent., or, otherwise expressed, the supply in 1860 was about 6.4 stones per spindle,

and in 1864 about 15·8 stones. Assuming for the moment that Irish flax only was used, the consumption could not exceed 34,500 tons, leaving a nominal surplus of 30,000 tons. But as the quantity of foreign flax which was used at that time and estimated at about one-fourth of the total consumption, must be taken into account, the surplus would approach 40,000 tons.

The mills, however, could not procure extra machinery and organize plans to keep pace with the rapid increase in production. So the inevitable occurred and the price of raw material, which had been high in 1862 and 1863, began to show weakness, and at the end of 1864 prices went down with a rush by about 20 per cent.

This is perhaps one of the most unfortunate events in connection with the Irish flax industry which we will have to record. The flax-grower did not repeat his mistake in 1865, for the area under flax that year fell by 16 per cent., and in addition, the season being unfavourable, the total yield was 23 per cent. smaller than in 1864. The effect of this was that prices again rose and remained exceptionally high during 1866 and 1867, notwithstanding that supply was equal to demand. The export of linen and linen thread from the United Kingdom, which steadily increased from 1861 till 1866 by 148 per cent., began to flag. In 1867 it fell off by over two million sterling.

The results recorded led up to the formation of the Flax Extension Committee.

LINEN EXPORTS.

South America takes about 10 per cent. of our exports of linen manufactures. Among our customers the Argentine ranks fourth—after the U.S.A., Australia and Canada—and Brazil is sixth in order of importance. These two countries together took in 1913 linens to the value of over half a million. Flax is grown locally and Brazil is endeavouring with the assistance of tariffs to build up a linen industry, but it is still of slight dimensions. We may expect very little competition in linens in South America for a very considerable time. Germany and Austria used to be the “bogies” of our linen manufacturers, and in the finer linens perhaps the fear was to some extent justified. We never did like anyone else to even offer to supply “our” customers. The competition of these countries was not really a serious one when broadly considered, as even in our best market the United States, Germany and Austria together supplied only about one-fifth of what we did. Our real competitors in South America are Spain and Italy, and this competition is due largely to the fact that so large a proportion of South Americans being of

Latin descent, the taste in textiles is similar to those of the Spanish and Italians.

ULSTER INDUSTRIES.

In an article which he contributes to the *Times* special Irish number, Mr. H. M. Pollock makes a brief survey of Ulster's industries, especially those concerned in the manufacture of textiles, recalling the interesting fact that the first steam engine in Ireland—about 1800—was erected near Belfast, and was used to drive the spindles of a large cotton mill. At this period the cotton industry in Ulster greatly exceeded the linen trade in importance, but after thirty years of comparative prosperity it began to decline, and when the spinning of flax by machinery was introduced it fell rapidly into decay, the American Civil War in the late 'sixties being one of the determining factors in its final extinction. In view of the practical non-existence of coal and iron in Ireland Mr. Pollock considers it amongst the most extraordinary of economic phenomena that Ulster manufacturers have been able, not merely to exist, but to maintain their position of relative equality with those of the more favoured island.

“Ulster,” he says, “is rightly regarded as the natural home of the linen industry. It greatly transcends all other linen centres in the volume of its products, and has proved its value to the country and Empire at the time of their direst need. Yet six-sevenths of the flax normally used in the manufacture of Ulster linen is grown elsewhere than in Ireland. It is also noteworthy that in all the other great industries in which Belfast and the surrounding country are pre-eminent the dependence on the predominant partner for their component materials is absolute. Shipbuilding and engineering, rope-making, tobacco manufacture, distilling, cotton printing and dyeing, and the making-up trades (which include ready-made clothing of various kinds) may all be regarded as exotic industries, but notwithstanding great natural disadvantages have all been developed with remarkable success.”

Later on, in a reference to the important and gradually expanding trades of cotton spinning and weaving in Ulster, he remarks: In the flourishing days of cotton spinning and weaving in Ulster, colour-printing formed a natural adjunct of the industry; but to-day, in the absence of any material manufacture of cotton fabrics in the province, it seems worthy of more than a passing comment that Lancashire merchants can profitably ship their piece goods to Belfast for bleaching, printing, and finishing, to be returned after treatment to their Manchester headquarters. This successful competition with British printworks furnishes a remarkable testimony to the character and efficiency of the Ulster work which is regarded

as superior to that of most British printers, both in the delicacy and "fastness" of the colourings.

THE THEORY OF LINEN BLEACHING.

In a recent article in the *Textile Colorist* Mr. S. H. Higgins refers to the belief that the action of bleaching is a case of oxidation, and to the differing opinions as to whether chlorine is first generated and afterwards reacts with the water to produce nascent oxygen. Experiments are detailed that were carried out in observing the bleaching actions of bleaching powder solution and of sodium peroxide, an analogy existing between the two actions. The results go to support the contention that bleaching is due to oxygen directly produced from hypochlorites. Tests were next made on the action of bleaching powder solution on the colouring matter of vegetable fibres and on fibres dyed with indigo. In the case of indigo it is shown that the action of the hypochlorite is a case of direct oxidation. All the experiments described point to the conclusion that bleaching is due to the direct production of oxygen by the free hypochlorous acid present in hypochlorite solutions. Sometimes the hypochlorous acid reacts with chlorides present in solution to produce nascent chlorine, which has energetic bleaching properties, but this reaction is only a secondary one, being quite distinct from the main one.

RETTING BAST FIBRES.

According to recently recorded investigations of Mr. P. Kraus on retting with solutions of bicarbonates, steeping the air-dried stems in ten times their weight of water containing $\frac{1}{2}$ to 1 per cent. of sodium bicarbonate for about three to four days at about 95 deg. F. produces an effective retting. When retting is finished as shown by complete separation of the fibres from the wood when hot water is poured on a sample, the liquid is drained off. Sodium carbonate may be replaced by potassium, ammonium or magnesium bicarbonate. Sodium carbonate and magnesium hydroxide are not so effective, while the hydroxides of calcium, potassium and sodium are unsuitable. Water of 9 degrees of hardness may be used if a little urine is added.

It appears that the principal agent in retarding retting is acidity. In the water retting of plants this acidity is removed by the continuous flow of a slow stream of water. A more certain and effective result is obtained, however, by neutralizing the acidity with bicarbonates.

LEE'S PATENT PROCESS, 1816.

- (1) A breaking machine for the unretted flax straw.
- (2) A cleaning machine for the unretted flax straw.

(3) A refining machine for the unretted flax straw.

After passing through the refining machine the fibre was washed in cold water and then made nearly white by boiling in soap and warm water for twenty minutes.

This patent created great interest in the trade and thousands of pounds were spent in testing its utility. A committee of linen trade men at length decided that Mr. Lee's patent machines were of no use.

In 1851, Chevalier Claussen's patent process was much talked about. His object was to cottonize flax. In 1775, Des Charmes, a Swede, had a like idea. Claussen's process consisted in first steeping the flax or tow fibre in a weak solution of caustic soda, cold, for twenty-four hours; secondly, to boil it in a similar solution for two hours; thirdly, to saturate it for one hour in a vat containing 5 per cent. of carbonate of soda, and fourthly to immerse it in a $\frac{1}{2}$ per cent. sulphuric acid solution.

“SYSTEM LOPPENS AND DESWARTE” FOR FLAX RETTING AS IN THE LYS IN RUNNING WATER.

Their retting tanks were made up of two principal parts. The upper part which contained the flax straw to be retted was separated from the lower part by an open floor. Its walls were vertical and means were provided to keep the straw suitably immersed by means of cross beams working in vertical slides and adjustable to any required height. The lower part, in which the renewal of water took place, was situate between the bottom of the tank and the open floor. Fresh water was admitted by an inlet in the upper part just beneath the open floor, and the outlet for the used water was made through the bottom. Boards were placed on top of the beets of straw to equalize the pressure of the cross beams. The inlet and outlet taps were so regulated as to ensure of the water being suitably renewed and its level maintained at the same level.

The changes which occurred in the retting mass were set down as follows: The water surrounding the stalks dissolved the various vegetable substances, some of which were naturally soluble, while others became so successively under the action of fermentation. Their streamlets of heavy juices were thus formed, which flowed down the stalks and slowly crossed the layer of fresh water below the retting mass, and this without mixing with it owing to the extreme slowness of their motion. On the bottom of the tank these then formed a layer of dirty and denser water, while at the same time the fresh water of the upper layer worked its way up into the retting straw, also in the shape of thin streamlets, which took the place of the descending one. Owing to the vertical position

of the stems and the equal pressure all over the tank these movements took place with equal facility all over.

From the preceding it will be seen that the complete circulation of the water took place as follows:—

(1) The water was admitted by the inlet situated in the upper part of the space between the bottom and the open floor.

(2) It spread slowly in a layer of fresh water immediately under the retting mass.

(3) It rose in fine streamlets of fresh water in the spaces between the vertical flax stems.

(4) It fell again, as saturated streamlets, having dissolved the vegetable matters.

(5) It crossed, still in the form of a heavy juice, the above-mentioned fresh water layer.

(6) It settled below the fresh water layer, forming a dirty layer on the bottom of the tank.

(7) Lastly, it flowed off by the outlet, placed at the lower part of the space between the bottom and the open floor.

The system was characterized by the vertical circulation of the water under the influence of gravity alone. This circulation, consisting in the natural fall of heavy juices and the corresponding rise of fresh water, took place uniformly and to the exclusion of every other motion in all parts of the retting mass.

The inventors claimed for this system a large yield of fibre owing to the uniformity of retting.

Flax only succeeds in a rather low mean temperature and upon a rather cold soil with a very regular moisture supply. Flax fibres appear under the microscope as a greatly elongated cylinder, with a cavity sometimes well marked, sometimes scarcely visible, at other times wanting. The diameter of the fibre averages about 0.0005 inch.

RECENT GOVERNMENT CONTROL IN LINEN TRADE.

Mr. J. H. Stirling, of the York Street Flax Spinning Co., Belfast, has, it is reported, been recently criticizing Government control somewhat as follows: He is reported to have said "that during 1917 and 1918 the linen trade in all branches of manufacture was closely controlled by the Government. That this control became absolutely rigid during 1918. The price of raw flax was fixed by the Government. This flax was distributed to the spinners, who were allowed to spin only such yarns as were required for Government work. Their costs were checked at every stage by Government accountants and the prices they were to get for their yarns were fixed by the Government. The weaving was similarly controlled and had to take such yarns and weave such cloth as the Government

ordered. Their costs were also checked at every stage and the price of every make of aeroplane or other cloth for the Government was fixed by the Government and not by the linen trade.

When a Government representative was fixing the prices for certain stocks of cambrics which the Government proposed to take over, trade representatives demurred to the very old and low basis of cost on which the Government valued these stocks, and were peremptorily informed that if they did not care to accept these values, their stocks would be commandeered under D.O.R.A. without any payment.

The Government are now left with a stock of over 40 million yards of aeroplane cloth, covering a large range of widths and counts all much too light for ordinary household purposes. It is now suggested that the linen trade, having extorted fabulous prices from the Government for these aeroplane linens sought to buy back the Government surplus stocks at absurdly low prices in order to profiteer again at the expense of the private buyer and consumer. This stock, it is stated, might have been much less, say one half, if the Government had acted on the suggestions made to them by representatives of the trade in 1918, but which were turned down by the Aircraft Department. Soon after the Armistice the Government tried to insist on the reductions previously proposed by the trade, but were told it was too late and that the goods were too far advanced in manufacture to allow of such reduction. The Government threatened and blustered, but the trade was sure of its ground, and finally the Government had to admit liability and agree to accept delivery. The Government are now disposing of these goods at varying prices without the slightest regard to the stability of the market.

The finest of these aeroplane linens will bleach into light fronting linens, suitable for shirt and collar makers. The coarse goods are only suitable for use in the natural state and colour. The linen trade, we understand, offered to take over and pay cash for the whole quantity at about 55 per cent. on pre-war cost, or else to sell the stocks for account of the Government on a profit-sharing basis—75 per cent. to the Government and 25 per cent. to the trade. Both offers were declined.

YPRES.

Ypres was formerly the capital of Western Flanders, and a city of great commercial importance. When William the Conqueror was preparing to land in Britain to redeem the English from semi-savagery, Ypres was already a civilized centre of trade, making the finest cloths on the Continent, and a little later in history we read there were upwards of 4,000 looms in constant activity. A dozen causes contributed to its

fall. It was the subject of never-ceasing strife between several Flemish factions for two centuries; the burghers of Ghent raided it more than once; the Iconoclasts and the cruel soldiers of Alva devastated it; the Great Plague which swept the Low Countries in 1574, and which is recorded in a curious inscription and chronogram in the Town Hall of Leyden, left it a wreck; its linen weavers migrated, many of them to England and Ireland, and some of them carried with them the secret of the weaving of diaper (that is, d'Ypres), which took its name from the old city. In the days before the war the name of the city was either Ypres or Yperen (both names were on the railway station) according as it was pronounced by French-speaking or Flemish-speaking people. To-day, it has added to itself a host of different pronunciations, of which the most popular is "Wipers," and the most extraordinary is "Yerps," but by whatever name it is called it will be the memorial of a city whose grandeur was dethroned and impoverished by war in olden days, and whose very existence has now been annihilated by the same dread agency.

CAMBRAI.

Cambrai is a very ancient cathedral city, dating back to the eighth century at least, and situated thirty-seven miles south-south-east of Lille on the Scheldt. Before the war its population was 21,000. Among its industries is the weaving of fine linen and cotton fabrics. It is from Cambrai that we get the word "cambric," for it was here that the cloth of that name was said to have been first made. Batiste, said to be called after Baptiste, a linen weaver of Cambrai, is a kind of cambric frequently dyed and printed.

FLAX RETTING.

The proper time to take flax out of steep depends considerably on various circumstances. A common test is to break a few average stalks about four or six inches long apart; should the wood of these parts pull out clean without tearing the fibre it is then about the right stage for removing from steep. This remark is quite right to my mind, but too indefinite, inasmuch as it won't do to let the flax remain in the steep until the wood free itself from fibre of the whole of the flax in the hole. If that was so, the flax would be over-retted. Another very good test is, if the flax should grow big and coarse, about one-third of the flax freeing itself from the fibre. On the other hand, if the flax should grow fine of the reed, one-half of wood freeing itself from fibre should be sufficient, the other half still having a slight catch of fibre.

FLAX AND ITS WAR SERVICE.

It is said that a slogan of the new Linen Corporation's advertising campaign in the States is to be that "the war was won on Belfast wings," i.e., Belfast provided the bulk of the aeroplane linen for those machines which proved of such service to us in maintaining mastery in the air.

Speaking recently at the annual meeting of the Linen Thread Co., Ltd., the chairman, Mr. J. Milne Barbour, D.L., gave some instances of further war services rendered by flax. He is reported to have said: "While not so obvious or spectacular as the construction of battleships, guns or explosives, the services to which we have catered are of an indispensable character—namely, the clothing and footwear of our soldiers and sailors, tents, aeroplane yarns and threads, and the infinite uses for which thread is required. Government requirements absorbed a large proportion of our production. In this we have shared the same experience as the linen trade generally as owing to the almost unlimited demand for aeroplane cloth, tent duck, and other articles for aeronautical, naval and military equipment, the utilization of flax has been strictly controlled under licence to the extending exclusion of export and civil trade, so much so that in some instances firms were working exclusively on Government work."

PREVENTION OF MILDEW ON LINEN GOODS.

All places where linen goods are stored should be kept very clean and the walls well washed with lime wash into which some antiseptic has been put. The floors should be kept well washed with water containing a little carbolic acid or formaldehyde and all decaying or rotten wood removed. The windows should be kept free of slime and fungoid growths.

Many organic acids, such as tartaric for example, favour the growth of mildew but the lactates seem to offer the best feeding ground.

On the other hand, it has now been well-established that soda and other alkalies have just the opposite effect. Indeed, comparatively weak solutions completely inhibit the growth of all the lower forms of life.

A fairly alkaline starch or gum, to which a little formaldehyde has been added, has been recommended as a good preservative to use in finishing linen cloths. Of course, care must be taken to see that the paste is not sufficiently alkaline to modify any colour present.

Common salt is said to be a much better preventative than Glauber's salt, but formaldehyde seems to give the best results, because even when dried on the cloth, it does not lose its properties, but remains in one of its polymeric forms.

NEW PROCESS FOR RETTING FLAX.

Experiments are being made at the flax spinning mill at Forsa (the largest mill of its kind in Scandinavia) with a new process for the retting of flax, in which valuable by-products, such as acetone, wax, paraffin, &c., are obtained.

The value of these by-products is stated in the press to be so great that it more than covers the cost of retting.

WORK OF THE IRISH LINEN SOCIETY.

At a general meeting of the Irish Linen Society held recently in Belfast, Mr. Sam G. Haughton, administrator, read his report upon the work of this Society in the U.S.A. since the start of their publicity campaign in February last. Among other things, Mr. Haughton said: "I would like briefly to review the situation in the Irish linen trade at the time I was sent to America on behalf of the I.L.S. The contract with the Textile Publishing Co. had been signed on January 6, and during February a policy of stabilization of prices had been brought about and the first work of the I.L.S. was to give publicity to the fact that prices would be maintained and that there were sound economic reasons for such a maintenance. At the time the advertising started the name of the Irish Linen Society had not been registered, and the first advertisements appeared without any name, which led to a certain amount of misunderstanding.

It is obvious that since the I.L.S. is not a trading organization that distributors must be provided with every means of obtaining the advertised merchandise, and at a very early date it is suggested that all the names of merchant members of the society should be published in the trade journals which we are at present using. The only reason for refraining from inserting these lists now is to first give those firms who have not yet joined an opportunity of becoming members of the society.

In May the question of price was under keen discussion, and opinions were expressed that business could not be done unless prices were very greatly lowered. All these things tended to a very unsettling feeling amongst the members of the linen trade in New York, and especially amongst those who had come together as a committee to consider the advertising campaign.

At a series of meetings held in Chicago, St. Louis and New York, a large number of linen buyers were brought together and the aims and objects of the Society explained to them, after which questions were answered. There are indications that these meetings established a very considerable confidence in the whole scheme and the explanation of the stability of price policy brought home to these linen men the fact that

they had been saved an enormous amount of money owing to the fact that no demoralization has been allowed to set in and consequently no drop in values which would have considerably injured their stocks.

Mr. Haughton pointed out that at these meetings he took the opportunity of explaining to the linen buyers that the London trade did not intend to rest satisfied when they were faced with serious economic conditions, but that by means of the Flax Society, Ltd., and the new London Industrial Research Association, they hoped eventually to solve the problems of supply of raw material, and to eliminate waste in production with a view to eventually bringing down the costs. He also explained that the Flax Society, Ltd., were laying the foundation stone for a central retting system in Ireland, which would undoubtedly be developed in the future so that those interested in the raw material in Ireland could no longer be blamed with relying on the old rule of thumb methods.

One firm put before me the publicity which can be obtained through cinematograph films. In order that the Irish linen trade may see the lengths to which individual firms have gone in this matter, I have brought home a film, which was prepared for a silk manufacturer, showing the process from beginning to end. It is particularly interesting because it demonstrates very clearly how advertising matter is introduced by means of a story, and it also shows how interest is maintained because otherwise managers of picture houses would not be prepared to allow such films to go on their programmes.

One of the most interesting aspects of the work of the Society is the undoubted possibility of promoting all kinds of co-operation with manufacturers who can use pure Irish linen. Without further consultation with the trade I did not feel prepared to go a great length in this matter; but in order to have one concrete example of what could be done I entered into co-operation with the Pollyanna Manufacturers—Messrs. Charles E. Shedaker and Sons, Philadelphia—and they immediately sampled out to their salesmen a new line of pure Irish linen underwear, and introduced this new element into their advertising. I have on file their complete advertising programme for 1919-1920, with a complete set of their illustrations. The same thing could undoubtedly be done with manufacturers of clothing, collar manufacturers, &c., and I strongly advocate the very serious consideration of such promotion if and when the conditions of production make such things possible.

The need for a really good bureau for information for linen buyers to help them with their work should be considered. It is not suggested that the older buyers who have visited this market for years and years do not know exactly where

to turn for the goods they need, but the smaller buyers and the newer men would value any assistance we could give. The programme for the immediate future has been laid down in a general way. Trade advertising will continue in several of the journals; but the most important feature is that a certain amount of consumer advertising will be done in order to keep good faith with the distributors, who undoubtedly expect us to help them in selling the stocks they have bought or which they hold. This consumer advertising will be directed to that class which can undoubtedly buy linen even at to-day's price, and the fact has been made widely known that we are doing this, and that there are many reasons for believing that retailers appreciate the fact. Generally speaking, however, in view of the shortage of raw material the advertising funds are being greatly conserved, so that when a more plentiful supply of linens are available special promotion will be possible.

THE PORT OF RIGA.

At the beginning of the seventeenth century Riga possessed 30,000 inhabitants, and more than 500 trading vessels per annum arrived at the port and trade was beginning to develop rapidly, but the war which broke out immediately after this interfered with the trade development to such an extent that in 1700 only 44 vessels arrived at Riga and in 1710 only 10 foreign vessels. Within fifteen years, however, development began to take its natural course, so that in this period the number of boats which arrived at Riga amounted to 388, but the population remained low and in fact in 1765 only numbered 14,000, which is less than one-half of what it was a century earlier.

The nineteenth century witnessed a rapid growth of the town, and in 1850 the population had increased to 60,000 and the number of arrivals at the port was 1,400. In the latter year the exports from Riga amounted to Rs. 13,000,000, and were largely composed of flax, flax-seed and hemp.

If we take the figures for the last normal period before the war, that is, for 1913, it will be seen that in this particular year Riga possessed the biggest turnover and was followed closely by Petrograd and Kronstadt, after which there is a considerable drop to Reval, Windau and Libau.

Great Britain took 40 per cent. of the total exports from Riga, while Germany only took 20 per cent. In the case of imports Great Britain supplied 44 per cent. of the goods which reached Riga, Germany following with 35 per cent.

CHARGES FOR SCUTCHING FLAX AND THE DISPOSAL OF TOW.

The *Mid-Ulster Mail* takes the following extract from the

1918 report of Messrs. W. J. Megaw, James Stewart and John W. Stewart, the Committee appointed to inquire into the charges made for scutching flax and the disposal of tow, and to make recommendations. Eleven public sittings for the purpose of hearing evidence were held. Two hundred and three witnesses were examined. Much interest was manifested in the proceedings, a considerable number of persons attending at each sitting in addition to those who gave evidence.

(I) ORIGIN OF THE SYSTEM OF RETAINING TOW BY THE
SCUTCH MILL OWNER.

Up to about thirty years ago tow was not utilized to any appreciable extent by the owners of flax scutch-mills. In districts where mills for scutching tow existed, the farmer sold it at a low rate to the owners of such mills, who scutched it for manufacture into bags, ropes, twines, &c. In other cases it was purchased by tow jobbers, who gathered it at the flax mills. Very frequently rough tow was allowed to go entirely to waste. At that time the flax-growing industry, and with it the flax-scutching industry, began to experience a period of depression and the flax-mill owners consequently turned their attention to tow as a source of profit. The result was that a system sprang up under which the flax-mill owners purchased the tow or allowed a small deduction therefor in their charge for scutching flax. They, however, exercised no absolute claim to the tow, but as the growers generally took no great interest in it and could only obtain a small sum for it from jobbers or at tow mills, the practice of selling it to the millowners for a nominal sum, allowing it to be retained in part payment for scutching, or in some cases making no claim whatever to it, became established, so that eventually in most districts all the tow at the mill was left to the mill-owners, who scutched it and disposed of the product in bulk more advantageously than it otherwise could have been. This system, once established, gave the millowners complete control of the tow.

With regard to the charges made for scutching when the millowner retains the tow we have not been furnished, nor could be obtain actual figures from proprietary mill-owners as to the amount of tow produced at their mills, so that we could form no accurate idea from their evidence as to the amount of profit which they make.

From figures obtained from a reliable source it appears that the variations in the price of scutched tow during the decades 1884-1893, 1894-1903, 1904-1913, inclusive, were as follows:—

Period	Period	Period
1884-1893.	1894-1903.	1904-1913.
£8 to £23	£8 to £24	£9 to £28
per ton.	per ton.	per ton.

The variations in the price for each of the years 1914 to 1917, inclusive, were as follows:—

Year	Variations in price
1914	£15 to £40 per ton.
1915	£40 to £50 per ton.
1916	£45 to £62 per ton.
1917	£51 to £82 per ton.

Informative returns in this connection have also been furnished by the Swilly Valley Co-operative Flax Society, and a table compiled from these returns is appended, showing the amount of scutched flax and scutched tow produced at the Society's mill during the seasons 1907-8 to 1916-17, inclusive; the quantity of scutched tow produced for each ton of scutched flax; and the approximate amount per ton obtained for the scutched tow:—

I.	II.	III.	IV.	V.	VI.
Working season	Output of scutched flax	Output of scutched tow	Quantity of scutched tow produced for each ton of scutched flax	Total amount received for scutched tow	Average value of scutched tow per ton
	T. C. Q.	T. C. Q.	C. Q. LB.	£. s. d.	£. s. d.
1907-8	39 18 2	13 7 0	6 2 21	132 3 5	9 18 0
1908-9	35 11 1	11 8 0	6 1 18	136 11 11	11 19 7
1909-10	31 10 3	5 13 2	3 2 11	107 12 6	18 18 5
1910-11	52 12 2	12 12 2	4 3 5	303 1 6	24 0 0
1911-12	83 9 1	15 3 2	3 2 15	367 19 10	24 5 0
1912-13	78 11 0	14 2 0	3 2 10	323 8 9	22 18 9
1913-14	74 0 9	13 12 3	3 2 18	259 2 3	19 0 0
1914-15	37 7 1	9 4 1	4 3 20	355 11 10	38 12 0
1915-16	45 10 2	8 8 0	3 2 21	505 6 0	60 3 1
1916-17	50 11 3	11 9 0	4 2 3	785 5 7	68 11 8
Totals ...	529 11 3	115 0 2	—	3,276 3 7	—
Average	52 12 0	11 14 2	4 1 23	327 12 4	27 18 10

(Note.—In connection with the returns, it should be noted that the ratio of scutched tow to scutched flax in any particular year may vary within very wide limits. In cases where the flax straw is very weak or badly handled by the grower, the amount of scutched tow produced may be almost equal to the amount of scutched flax, even though the straw may have received the most careful handling at the mill. On the other hand, when the straw is of particularly good quality and is well handled, the ratio of scutched tow to scutched flax may be as low as 1 to 8 or even lower.)

The figures given in column 4 appear to us to indicate that the flax was scutched economically. In view of this and other

evidence received from growers we are of opinion that the money charges for scutching in mills, where, in addition, tow is retained in part payment of scutching, are excessive, having regard to the current prices for tow.

With regard to the charges for scutching in the relatively small number of cases in which growers are in a position to exercise advantageously the option of disposing of their tow, we have carefully gone into the large volume of evidence, including detailed financial accounts, given by the millowners regarding initial expenditure, working costs, &c., and we consider that their current charges, averaging 3s. per stone, are, under existing circumstances, quite reasonable where the scutching is efficiently done.

It should be borne in mind that owing to fluctuations in the area under flax the millowner runs the risk of finding, at any time, that the quantity of flax grown in his district will not be sufficient to provide work for his mill over any considerable period, or it may even occur that his mill may become entirely idle for want of raw material. On this account we are of opinion that when a millowner incurs a capital outlay on a venture of this kind he is entitled to more than an ordinary rate of profit.

The variation in the charges made at different mills is warranted by the following facts: (1) Scutching is carried out more carefully and is better supervised in some mills than in others; (2) more expenditure is incurred in the preparation of flax for scutching, i.e., in straightening the flax and squaring the root ends by hand labour or by passing it over a special machine for the purpose; and (3) better machinery and equipment are provided.

We were disappointed to find from the evidence given that many growers, although alive to the serious loss they sustain from careless or inefficient scutching, fail to recognize that millowners who take extra care and incur extra expense in doing good work are entitled to a relatively high charge. We are of opinion that this attitude seriously retards millowners from adopting the most improved methods.

(2) DISSATISFACTION OF FARMERS WITH THE SYSTEM OF RETAINING TOW AT THE MILLS.

For a considerable time previous to the war farmers had become dissatisfied with the system under which the tow was retained by the millowners. They were unable to ascertain the amount of tow scutched from their flax and had no means of finding out its actual value. Suspicion, consequently, existed that not only were the millowners making undue profits out of tow, but also that due care was not taken by them to prevent wasteful scutching. Further, it was believed

that the system tended to affect adversely their interest in the provision of improved machinery for the production of the maximum of scutched flax. The irritation thus caused spread widely amongst the growers when the price of tow rose to an unprecedented figure, owing to war conditions, and was further intensified when the millowners raised their money charges for scutching. The growers who gave evidence were practically unanimous in condemning the system, and strongly insisted on the necessity for their being placed in a position to dispose of their tow at competitive prices.

(3) EFFORTS MADE BY THE FARMERS TO HAVE THE SYSTEM OF RETAINING TOW ABOLISHED.

In the past season organized efforts were made by the farmers in many districts to have the system abolished, and in a few instances co-operative mills and tow markets were started to this end. A number of millowners refused to scutch for growers unless they were allowed to keep the tow in part payment for scutching. A large number, however, agreed to scutch for an increased money charge without claiming any option as to the disposal of the tow. In the remaining cases no organized action on the part of farmers appears to have been taken.

(4) WHY FARMERS DID NOT SUCCEED.

In most of the districts where farmers had the option of removing their tow, the system under which they could do so was not generally availed of for the following reasons:—

(1) The absence of local markets or other facilities for disposing of it; (2) the fear existing amongst them that their adoption of the system would render them unpopular at the mills and that they would not be accorded due priority for scutching or rendered the maximum amount of service; (3) the trouble of collecting and marketing it; and (4) the disinclination of many of them to pay an increased money charge for scutching.

In a limited number of districts, however, farmers have been in a position to dispose of their tow at competitive prices, owing to the existence of markets or other facilities for sale at (1) tow mills, or (2) flax mills where the market value of unscutched tow brought to them from other mills was given.

(5) WORKING COSTS OF MILLS.

It appeared from the evidence that farmers in general had but little idea of the legitimate costs, other than wages, involved in the running of a scutch-mill. In very many cases the margin which they were willing to allow the millowner after rent and the wages of hands immediately employed in

connection with the scutching operation had been provided for was entirely insufficient to cover other legitimate charges, not to speak of giving the millowners reasonable remuneration for his services. We consider that every millowner who works his mill as a business proposition must be allowed to provide for items such as interest on invested capital; depreciation on building and machinery; repairs, fire, accident and National Health insurances; and cost of employment of extra hands needed for operations about the mill.

(6) CHARGES FOR SCUTCHING.

From the evidence given by millowners, supported by the experience of co-operative flax societies, it appears conclusive that from the time at which the system of utilizing the tow by the flax millowners became general to the period immediately previous to the war a very large number of the millowners could not run their mills without loss if they made no profit out of the sale of tow. The general charge was from 10d. to 1s. per stone, but in some mills where an improved system of scutching existed the charge of 1s. 3d. per stone was made.

Since the beginning of the war the terms on which flax has been scutched have generally been very variable. At the time of the Inquiry the charges generally in force ranged from 1s. 6d. to 3s. per stone, if the millowner retained the tow, and from 2s. 6d. to 3s. 6d. per stone if the farmer desired to take the tow away. Under the latter arrangement, however, some millowners fixed a charge of from 4s. to 5s. per stone, but this was regarded as unreasonable by their customers and does not appear to have been accepted. The variation in the money charges has also been a source of irritation amongst the growers.

Millowners who gave evidence, with few exceptions, agreed as to the desirability of abolishing the system under which they have to depend on tow for profit, with a view to obviating friction with the growers. They would prefer to be paid a money charge for scutching which would be remunerative. In connection with their increased money charges for scutching, they point out that their working expenses have increased very considerably during the war. The wages of scutchers and other hands and the cost of new machinery, or of repairs to old machinery, have risen enormously, as has the cost of oil and lubricants; fire and accident insurances not hitherto provided for have been taken out; a greater interest on the amount invested has to be allowed; and in some mills additional time and care has been taken to reach a superior standard of scutching with a view to securing increased returns to the grower.

my committee to farmers to dew-ret their flax rather than water-ret it. If your readers will again refer to my letter they will see that there is no such recommendation contained in it. My committee only desire to point out that, in the interests of the country and also of the farmers, that portion of the crop which has been de-seeded should be dew-retted this year prior to scutching, as flax which has been scutched green can only be taken over and paid for by my committee at a very low value. The Flax Order of 1918 makes it incumbent upon all owners of flax of the 1917 crop or previous years to have same scutched and delivered to my committee by July 1, 1918, and it is only if the de-seeded portion of each farmer's crop has been retted that it can be delivered to my committee by that date with any prospect of it being taken over and paid for under one of the specific grades set out in the 1917 Flax Order. It is, of course, preferable for farmers to water-ret such de-seeded flax if they can do so; but this cannot easily be done in Ireland in the early part of the season."

IRISH FLAX.

The possibilities of flax-growing in the South of Ireland were dealt with in an interview given a Press representative by Mr. F. J. Leitch, one of the Northern growers, who has taken up cultivation in the Midland counties this year. Mr. Leitch is one of the largest individual flax fibre growers in the world. His firm are the largest importers of flax fibre seeds in the Kingdom. His firm has raised about 400 acres of flax in the South this year, and he proposes to extend the acreage to at least 1,000 next year. He has acquired the corn mills at Slane for scutching, and proposes in connection with all work involved to employ local labour. He is an enthusiastic believer in the future of the flax industry in the South. He pays tribute to the adaptability of local workers, the spirit of willingness with which they have entered into the success of the industry, and the kindness and courtesy of the people as a whole.

Discussing the position and prospects of the flax industry, Mr. Leitch pointed out that the total consumption of flax fibre in the United Kingdom was 100,000 tons, of which for the year ended November, 1917, Russia sent 75,000 tons. The Russian supply of fibre is now cut off, the Belgian supplies are in the hands of the Germans; flax-growing has fallen off in France as a result of the war, and in Holland the acreage under the crop has fallen from 30,000 last year to 13,000 this year.

The deficiency thus created in the United Kingdom's supplies alone must be made good, and Ireland, he holds, has a magnificent opportunity of supplying the deficiency. The

demands for aeroplane manufacture are at present abnormal, but he believes that the demand will continue to be heavy in that connection even after the war. He sees no reason why Ireland as a whole should not become a great flax-growing country with a great export trade. The world's stocks of linen are depleted and they must be built up again, and the demand for Irish supplies will, in his opinion, be world-wide if Ireland rises to its opportunities.

"The demand," Mr. Leitch proceeded, "will naturally exercise a controlling influence over prices, and remunerative prices will in turn govern the success of flax-growing developments in the South. Growing is not the business of the Northern firms who have taken it up here. They require the fibre, and would prefer to purchase it from the farmers. There are great areas of suitable land available; flax is not a difficult crop to cultivate, and with a proper rotation system it will always do well. Generally speaking, any land that will grow good oats will grow good flax, and the crops (flax following oats) succeed each other with advantage. A fair field of flax is at present worth £40 per acre, and farmers will be able to sell the crop 'on foot,' thus avoiding what they may regard as the dangers of the pulling, retting, and other more or less technical processes with which at present most of them are not familiar.

"About 400,000 acres of flax in Ireland would keep the whole of the mills of the United Kingdom running full time. That is to say, the acreage under flax in Ireland would have to be nearly trebled. The immense benefits in national prosperity, and particularly in the return to growers and the distribution of wages, need not be elaborated. In the South especially, the farmers would have a double advantage, inasmuch as rural labour would be retained in the countryside.

"During the war, and for some years, the present high prices of flax will be maintained. It may be accepted as pretty certain that remunerative prices will rule for ten years, during which the Southern farmers will have every inducement and opportunity to establish the industry on a permanent and successfully competitive basis. Since the outbreak of war the stocks of linen throughout the world have been depleted, and supplies of household linen have reached vanishing point. All these stocks will have to be replenished, a task that will take years; but in addition there will be a big demand for aeroplane sheetings for commercial and other purposes. In this connection it is important to remember that Russia's flax, which in pre-war times formed four-fifths of the flax sent to the United Kingdom, is not suitable for aeroplane sheetings, while Irish-grown flax is ideal for the purpose.

"A wide industrial vision is necessary to appreciate the greatness of the possibilities. If the Southern farmers and

landowners are prepared to take up flax cultivation there must be no petty spirit about labour and wages. Parochialism in this thing will kill all possibilities of development. Labour must have its rightful share of the success of the industry. There is national wealth in it, and I, among others, have shown faith in its future by embarking on the development schemes in the South.

“ Taking 400,000 acres of flax as the maximum of Ireland’s cultivation, within the next few years we get 80,000 tons, a quantity sufficient to keep all mills going full time, and perhaps to justify the creation of new spinning establishments near the sources of supply. Taking this flax at the low average value of £200 per ton, it yields a revenue of £16,000,000. This year’s crop of Irish flax is estimated to produce 30,000 tons, and at same value it will be worth £6,000,000. If the seed is saved, as it ought to be, and can be with very little trouble, it means keeping more of the profits in the country. It has been one of the faults of flax cultivation in the North that the seed was not saved. The order requiring growers to save the seed of one-eighth of the crop is wholly inadequate to meet the situation. At least a third of the seed should be saved to make the country independent of supplies from abroad. The seed supply question is vital, and we are saving all the seed of our crop this year. At present it costs a grower about £6 per acre to seed his land, and taking 150,000 acres as the area under cultivation in Ireland, we get an expenditure of nearly a million pounds on seed, the greater part of which money goes out of Ireland.

“ A point which is of importance in considering the future of the flax industry is the fact that the shortage of tonnage after the war must affect supplies of flax from abroad, even in the quantities in which they will be available. The United Kingdom will therefore have to rely for its supplies on the home crops.

“ Reverting again to the financial aspect of flax cultivation, I may mention, as showing the way in which this money becomes distributed among the people, that on 400 acres in Kildare and Meath districts this year meant an expenditure of between three thousand and four thousand pounds locally.

“ The future of the flax industry in the South depends upon the continual support of the peasantry in showing a desire to continue the work at a reasonable wage. In our case, we employ all local labour and have imported no workers from the North except a few skilled men to give instructions. The results, both as regards crop and labour have exceeded our best anticipations. With the labour, despite pessimistic prophecies we had no trouble whatever. We have grown better flax than in the North, and have found both the land and the labour in every way suitable.

“I may mention that where we take land for flax growing the owners have the right to sow grass seeds along with the flax. Our operations here are under the supervision of Mr. James Gardner, an expert, who has had years of experience in Holland and Belgium. He is as well satisfied as I am of the absolute success of the industry if it is taken up on the right lines and with the necessary amount of energy and enterprise.”

PROGRESS IN THE LINEN TRADE.

Mr. H. R. Carter wrote the editor of the *Belfast News-Letter* recently as follows:—

“SIR,—The following comments upon recent letters connected with our staple trade which you have received and published may be of interest and help to make manifest the true facts of the cases in point. On the question of holding our own against foreign competition in the world’s markets I would say that as a matter of fact it is probable that the Irish linen trade, in any case probably on account of its many Yankee associations, is in advance of many other British trades in enterprise, salesmanship, &c. As regards ‘Spinner’s’ letter, I have already refuted ‘Crash’s’ assertion that ‘there has been practically no great invention in the whole of the linen trade for the past half century.’ ‘Spinner’s’ assertion that the introduction of the double-threaded screw (from the worsted trade, by the way) for preparing enables a 25’s weft to be spun to 30’s warp is to my mind rather far-fetched. I think I am right in saying that the device is not in general use and that just as short a nip and draft can be obtained with a single-threaded screw. What ‘Spinner’ no doubt means is that with the maximum rate of delivery shorter drafts are obtainable, double the number of drops of the faller being possible when running the screws at the same speed. Thus, while maintaining high production, drawing and roving drafts may be reduced in length and a leveller thread or yarn made from the same material. His 25’s weft must have been very badly prepared and spun, if, on the adoption of the double-threaded screw principle, he succeeded in producing 30’s warp from the same material; in fact, he was probably unconsciously induced by the astute machine maker to adopt more up-to-date methods learnt from Continental spinners, for which the machine maker’s double-threaded screws got the credit. The improvements in thread and twine machinery to which ‘Spinner’ refers, affect production more than quality and are mostly or wholly of American origin.”

In reply to this, “Spinner” wrote on March 27:—

“SIR,—I am sure you do not wish to prolong unduly the correspondence *re* linen trade inventions. But it is only fair to point out that Mr. Carter’s letter published on Monday

omits all reference to the automatic hackling machine as an important development. Then, in reference to the double-threaded screw, I have obtained the results claimed by shortening drafts on old machinery to 4, 5 and 6 instead of 8, 9 and 10, and have made a common 30 warp out of 25 weft mix in tow yarns. Certainly I lost in turn-off, but one has to limit turn-off in these times. I am not, therefore, the victim of an 'astute machine maker.' P.S.—I have given Mr. Carter my name privately, as it is but fair in view of his signed letters."

In reply, Mr. Carter wrote:—

"SIR,—Referring to 'Spinner's' letter which appeared in your issue of March 27, if 'Spinner' had read his paper regularly he would know that I entered the lists as an upholder of progress in the linen trade, and refuted the assertion of another that no improvement had been made in its machinery for the past fifty years. My chief piece of evidence was the automatic hackling machine. I considered it unnecessary to refer further to it and take up your valuable space. In the latter part of his letter, 'Spinner' confirms what I have said about the single and double-threaded screw, and admitted that the old method of preparing 25's tow weft left room for improvement. I never suggested that he was a victim of the astute machine maker. He was undoubtedly a gainer by the transaction. Now that I know who he is, I can testify that he is one of the best of our young mill managers. As regards 'dew-retting' of Irish flax, it now appears that Mr. Gray's object in advocating the system is to get the Flax Order of 1918 carried out, and the straw which was kept to mature for the sake of the seed scutched before July 1 next. It is a pity that this date has been fixed, as had it been put off a month or six weeks later farmers might have dam-retted it in July, and, incidentally, in doing so have rendered the water better for dealing with the new crop in August. Scotch mills will probably be closed down in June, but might start work a week or two earlier in the new season and scutch all this straw which has been carried over before starting on the new season's straw. If it is the Administrator's idea to get hold of all last season's crop before the new season's comes forward, he can prevent a farmer from having his new straw scutched until the old has been cleaned and sold."

EFFECT OF THE WITHDRAWAL OF THE IRISH LINEN BOUNTIES.

Mr. J. H. Stirling, of the York Street Flax Spinning Co., speaking recently in Belfast, is reported to have remarked "that premiums formerly given to the linen trade were only awarded for excellence of manufacture and that they were distributed all over Ireland. Ulster during that period had no monopoly in the linen trade which was just as firmly rooted

in the other provinces. It was a curious fact that coincident with the withdrawal of the linen bounties and the introduction of power loom weaving, the industry died down in the other provinces and developed in Ulster only. There was no reason whatever, he argued, why Dublin should not have retained her position as a linen trade centre."

CAMBRIC.

A fine fabric invented in the 15th century by Baptiste Containg, of Cambrai, in the North of France, a town which recently figured prominently in our war news.

Widow's Lawn is a high quality linen lawn, or fine, even, plain woven linen fabric. Lawn has a soft, smooth feel due to the absence of size or starch and to the process of brushing or calendering. Its weight varies between 1½ and 2½ oz. per yard. It is consequently coarser than cambric.

Irish Cambric is an all linen fabric, plain woven, and often without a selvedge.

FLAX PULLERS' WAGES.

The July, 1918, award under the M.O.W. Act came as a shock to farmers and other flax growers. It read as follows:—

	Men.	Women.
Time rates ...	1/1 per hour ...	9½d. per hour.
Piece rates ...	1/6 per stook, or £4 5s. per acre.	1/1 per stook, or £4 5s. per acre.

Fixed scale of deductions from wages for board and lodging, and for meals provided by the farmer: Breakfast, 4d.; dinner, 1/-; tea or supper, 4d.

Protests from Northern Boards, &c., were numerous. At a meeting of the Ballymena Guardians, Mr. Joseph Maybin is reported to have said that he did not think there was any need for such interference. Heretofore a puller of flax at 7d. per stook, commencing at 9 a.m. and working till 4.30 p.m. had been able to earn 13s. per day. At the present rate the same man would be able to make about 26s. a day. He concluded by moving a resolution protesting against the action of the Government in fixing a scale of wages for pulling and handling the flax crop and expressing the opinion that it would have most disastrous results.

FLAX AND SPINNING.

Lecturing recently in Belfast on the above subject, Mr. J. Milne Barbour, M.A., said he should confine his remarks to the cultivation of flax and the spinning of the fibre. The best soil for flax was a nice dry sandy loam, or an alluvial soil, not too light, but of medium weight, with a strong subsoil, but not of a clayey nature. It was often stated that flax was very exhausting to the ground, but there was little justification

for this if it was grown in a well-considered rotation of crops with suitable manuring. The best flax fibre in the world was produced in Belgium where the flax was packed in crates and submerged in the river Lys, which was a sluggish-flowing river, with just sufficient movement to clear away the products of decomposition without interfering with the process of fermentation; but in Ireland, which also produced a high quality of flax, it was steeped in stagnant pools without any change of water. During the steeping an even temperature was very desirable, as any chilling or arrestment of fermentation caused the products of fermentation to be redeposited upon the fibre in insoluble form. Lime water was inimical to the process of fermentation. In Belgium it was the practice in the case of superior straw to repeat the steeping process, drying the flax between the steeps, but in Ireland one steep was made to suffice. The length of time in the steep depended on the state of the weather. In fine warm weather ten days might be enough and in cooler weather fourteen days might be necessary. In the matter of retting Mr. Barbour said a great deal of time and thought had been given to improving prevailing methods by constructing tanks and slowly circulating the water in them and controlling the temperature, or by bacteriological treatment, but these had not succeeded in producing better fibre than that produced in the River Lys, and, generally speaking, spinners preferred fibre produced by the old troublesome method. But he believed there were great possibilities in the way of conducting this retting process by factory methods. If central retting establishments were organized with suitable storage facilities, with retting tanks under cover and the temperature of the water under proper control, and with suitable methods of drying, and a staff of men employed constantly on this work a great advantage would be derived by being able to conduct operations continuously throughout the year instead of having to do this work, which had such an important bearing on the quality of fibre produced, during the few weeks between the pulling of the crop and the setting in of winter weather conditions. Mr. Barbour gave an account in brief of the history of the flax industry, mentioning its introduction into these countries, and pointed out that statistics showed that one-third of the power-driven spindles of the world were situated in the United Kingdom. He then dwelt upon the process of manufacture in its various departments. It was imperative that when once again they were able to devote their energies to the development of their industries that steps should be taken for the extension of flax growing within the United Kingdom and the maintenance of flax-spinning on a stable basis, so that the trade would be in a position to make an adequate response to all demands. Prior to the war only about one-eighth of the flax required by their spinners was

grown in the United Kingdom, and hitherto the entire production of seed off the crop of fibre had been destroyed owing to no satisfactory scheme for seed-saving having been thought out and put into operation. The seed was saved off the fibre crop in nearly all countries except the United Kingdom. Fortunately during the past season this matter had had attention, and let them hope that this might lead to suitable methods being devised to obviate this waste in future. Owing to their neglect in the past in addition to occupying valuable shipping room in importing seed the cost of the seed imported to grow this year's crop amounted to close on £350,000, which might have been saved to the country. For many years now British linens had held first place both in volume and quality, but their output had been remaining stationary while that of other countries had been creeping up; and to continue to hold their own in the commercial struggle which would succeed the conflict of arms now raging there must be very thorough organization among all their manufacturers. Research must be followed up to improve the efficiency where possible, and he for one hoped that university training in business methods and economic service, and by training the minds of their young men to systematic observation and experiment, and to the logical deduction of cause and effect these might play a very important part in enabling the commerce of their country to occupy in the markets of the world that position which they all desired for her. (Applause.)

A member of the meeting suggested that the mill owners should take over the flax in its green state, buying direct from the farmers, and retting it themselves, and also intimated that the seed saved during the past season would be of little avail next year. He asked if any remedy could be proposed for that contingency.

Regarding the first point, Mr. Barbour said spinners did not want to monopolize the entire industry. They found a good deal to be done in the mere spinning of the fibre after it came to them. As to the second point, he was glad it had been raised. It was their duty to whole-heartedly support the Government in every effort to win the war. It was the farmers who saved their own flax seed abroad, and if the agriculturists in these countries had been able to save their seed properly the large sum of money he had mentioned in his lecture would have been saved. The farmers required to take advantage of the educational facilities now available for their highly-scientific employment. In that connection he might mention that the late Mr. Gibson had placed £10,000 at the disposal of the University to be applied to the education of farmers' sons in practical agriculture, while there was also an agricultural college in Antrim. The saving of flax seed lay more in the farmers' hands than in the hands of the spinner.

SALT AS A MANURE FOR FLAX.

Mr. T. P. O'Hare, of Ballymena, wrote a few years ago: "Sulphate of ammonia and salt mixed in proportion $\frac{1}{2}$ cwt. of former to 3 cwt. latter, is said to be a splendid dressing for flax in the absence of potash."

I would like to draw the attention of growers of flax to a few points regarding the use of salt for the flax crop:—

In field trials, conducted by the Department of Agriculture in 1902 and 1903, the use of salt was found to be unprofitable. As a matter of fact the loss due to the application of salt in 1902 was £1 9s. 3d., and in 1903 2s. 9d. per statute acre. The quality of the fibre was also somewhat inferior.

On account of the scarcity of potassic manures in the spring of 1915 many farmers decided to use salt in order to replace the kainit, which was unobtainable. The results in many cases were very striking (particularly where the salt had been applied at the time of sowing the seed), large patches of ground were totally devoid of a braird of flax. Where the bag of salt has been allowed to stand in the middle of the field while sowing was in progress, the ground was also quite bare. The above is due to the fact that the salt has the effect of retarding and in many cases destroying germination. In view of the above, I believe it would be well to draw the attention of farmers to the loss which is caused by an application of salt to the flax crop.

Whilst on the subject of flax, I might mention the fact that many flax growers who used Spanish potash material ("Dust Potash Salts") on their crop last year all speak in the highest terms of it. Unfortunately the Spanish Government has prohibited export of this material for the present.

HINTS FOR FLAX GROWERS.

Grow flax only in land that is well drained.

Prepare well if you want to reap well.

The finer the seed top the more seed will grow.

Fine quality of fibre can only be obtained by diligently preparing the soil for seeding.

In the States they consider the early sown seed grows the best fibre.

Select a gently sloping field having a loamy soil with a clay subsoil, in a good state of fertility, and free from weeds.

SCIENTIFIC RESEARCH AND THE LINEN TRADE.

"It is needless," says the *Belfast News-Letter*, "to dwell on the importance of the linen trade to Ulster or upon the necessity of doing everything possible to maintain and improve it. Our linen manufacturers and merchants have never trusted much to State assistance and they are not going to depend

upon it now. They know that the future of the trade will depend upon their ability, foresight and enterprise more than on anything else, and although they are now confronted with great difficulties they are confident that they will surmount them.

“Believing that in the linen industry, as in the other great industries of the country, there is room for scientific research and that it is reasonable to look for valuable improvements, the Provisional Committee of Research have secured the services of Mr. John C. Curtiss, who is said to have a wide commercial experience and a scientific training in Chicago University. This gentleman is convinced that organized research will make great discoveries in flax growing, as well as in the manufacturing and finishing processes and that a large extension of the market for linen is possible. He has written a series of articles for the Belfast press from which we make the following notes and comment upon them.”

In Article I, after eulogizing perfection and instancing the many great discoveries made in the realms of iron, steel, coal tar, chemicals and electricity during the past century, he says:—

“The great war to come for commercial supremacy demands broad mental vision on the part of your manufacturers: yes, even of the flax growers. The leaders of the linen industry see clearly ahead, and are laying down the road on which the others may travel. But why should any hold back; why can they not eliminate from their minds those petty narrow views towards progress which retard industry and give their enemies a chance to forge ahead? Why should man allow jealousy to make him miserable and stand in the way of success? Why should he hold his eyes so close to the surface that he cannot take a broad survey of what is ahead of him? Why should new methods frighten him, and ultra-conservatism become bonds which hold him fast to the starting post? These must be severed, or else he cannot run in the race for the great. Why do some men hold back when the rest want to go forward?”

“Some men do not like changes, but they will come whether or no; but if they do come too late for your own good, you have only yourselves to blame. Are the discoveries which lead to progress to be all developed in Germany and America? And when they have been made, are the men of the linen trade going to see them exploited by the Germans in the same old way that so many of our good British inventions have been exploited abroad because your own people lacked the imagination to exploit them themselves?”

“It is quite certain that very little of the progress in the linen or other industries was made by mere chance, nor by the untrained men working casually, or without co-operation.

It has been made only by patient investigation, working systematically and taking advantage of such knowledge as has been gathered by others."

In Article III, Mr. Curtiss discusses the development of industries. He quotes Mr. J. H. Stirling's recent statement as follows: "It is cheerful to find that, even in that stronghold of individualism, of go-as-you-pleaseism—the Belfast linen trade—the producers are finding out the value of combination. One after another of the various branches of the trade are closing their ranks and all experiencing the strength and value of being able to present an unbroken front to the enemy from whatever side he may come. Even the least hopeful section—the merchants—are at present considering a huge combined advertising scheme."

He stated further: "That the formation of an Association of Scientific Research has already been born is now common knowledge. Germans have been able to fight the strong vested interests of England, even though they were late arrivals in the industrial field, because they have neglected nothing in order to win supremacy. Applied science has been to them merely one of the weapons in their industrial war." Mr. Stirling further called attention to the fact that German scientists were no better than ours, but that German manufacturers had been more wideawake and far-seeing. The pre-war attitude of the average British manufacturer towards applied science might have been described as a sort of amused tolerance.

Mr. Curtiss then states that the need of increasing output in all British industry is being realized, and the necessary conditions to that end are being explored by the Government Committee appointed to inquire into the position of national science in the educational system of Great Britain.

The report just published by that Committee (Cd. 9.001) states that: "Rule of thumb methods are seen to be inadequate if industry in this country is to hold its own.

"The individualism which has heretofore characterized British industry is gradually giving way before serious efforts towards combination. With all these there is a growing consciousness of the need for organized research into the process of manufacture. Lately the community has come to realize as never before that the development of industry is the concern not only of individual employers, or groups of employers, but of the nation as a whole."

Sir George Beilby pointed out that one-fifth to one-half of the 100 millions sterling which represents the national bill for raw coal is being wastefully expended and might be saved, and that the saving can only be effected by the co-operation of a large body of trained fuels experts to carry out the necessary

research and to introduce and supervise improved methods wherever fuel is consumed.

Before the war there were not more than half a dozen firms in non-ferrous trades which had laboratories of their own, but in the near future there will likely be fifty. This is not my statement, but that of Sir Gerald Muntz.

That the linen industry, with its vested millions, has not already had an association of research is of course unfortunate, and one which must quickly be changed.

As early as 1900 the British Government recognized the importance of the Government lending its endorsement to scientific research, and they then established the National Physical Laboratory, which was the first instance of official recognition of this subject. The object was to bring scientific knowledge to bear practically upon our everyday industrial and commercial life, to break down the barrier between theory and practice, and to effect a union between science and commerce.

The original objects as stated were very academic, and not nearly thorough enough if Britain expected to acquire commercial supremacy for its industries. At that time the Government gave an annual allowance of £4,000 per annum for five years; this in 1908-9 was increased to £7,000, and in 1916-17 the grant for aeronautical research alone was £10,400. The United States Government had endowed its Research Department with £100,000 per annum long before the outbreak of the war.

We cannot escape from the conclusion that scientific research can do much for the linen industry, both in the cultivation of the flax, its treatment, the extraction of valuable by-products which are now going to waste, also in its handling and manufacture, and the production of special machinery which will be evolved to meet new requirements of the trade.

In Article IV, Mr. Curtiss continues:—

America has shown the marked advantage to be derived from applied research work in her industries. Practically every industry and most large concerns have their laboratories where constant work goes on, week in and out, solving the problems of manufacture and discovering occasionally new secrets which earn for the commodity a place in the sun of the world's commerce. In promoting scientific research for industrial purposes we must take big views; we must not be disappointed because immediate results of value are not forthcoming. Over and over again in the history of research discoveries of great value have been stumbled on, as it were, in the course of some inquiry which was primarily directed to quite a different object. Faraday did not dream of the vast applications of electro-motive force when he first made a magnet revolve round an electric coil, and its possibilities are not yet fathomed,

scientific research proved its value in the early days of the war, and the practical man of business, the manufacturer, and the trader soon discovered that without the help of the scientists they would not be able to continue because of the lack of certain essentials necessary to the production of their wares.

Mr. Curtiss then goes on to give examples of how research has established industries and supplied essential material thought to be no longer available. He repeats a few of the slogans of one to whom scientific research leading to invention has brought fortune, as follows: "Imagination seeks to fecundate dormant fancy." "Lack of imagination is the loadstone of the average man." "Imagination leads to team work." "Success comes to him who can see beyond the so-called boundaries of the trade, and has the strength to assume responsibility." "I want men eager to shoulder loads involving great issues." "I would rather have ten men with enthusiasm germinated by imagination than a hundred men of the same abilities who have lacked the master trait."

By some extraordinary converse the manufacturers of the old world shun changes, says Mr. Curtiss; and even with the lessons of the war before them think that their own particular industry is safe enough.

The report of the Committee of the Privy Council found that "manufacturers generally were unwilling to try new developments because they appeared to lack imagination or ambition for extension so long as their existing plants were fully occupied."

Broadly speaking, it is evident that the difficulties of tradition, national temperament, and lack of trade organization are responsible for the inertia which British manufacturers have shown towards research, and which stand in the way of proper co-operative effort, except in certain industries where the leaders are endowed with sufficient imagination to see far ahead (years in advance) and are strong enough to swing the others into line. It is incumbent on the leaders of British industry to accept advanced thought and to face their post-war problems squarely, with the realization that only by so doing can the progress of the whole industry be assured. What will be the position of the linen industry ten or twenty years hence?

In Article V, Mr. Curtiss continues:—

You rightly flatter yourselves that in the linen trade you hold the premier position in the world. It is because you wish to hold this position that it is imperative to apply scientific research to each process of manufacture in order to reduce cost to the minimum by making it possible to get the maximum of production from looms and spindles.

Where have you acquired the knowledge and experience to put you on the high level on which you now stand? For the

greater part it was handed down to you. The fact that a high degree of perfection was practically attained years ago is the real reason why you should now turn the searchlight of research on your present process of manufacture to discover new phases of development. Perhaps you cannot improve, maybe. But you ought to know.

You ought to know if there is any existing improvement of method; you ought to know if you are utilizing all possible waste; you ought to know all the possible facts regarding flax and its by-products. You ought to know if there can be any new methods or inventions that will help the industry, or any new powers of application or outlets for linen which will assist in maintaining its commercial supremacy. You cannot know these things in the routine of your busy lives unless you have men of trained scientific minds in bacteriology, biology, botany, chemistry, geology, physics, mechanics, and psychology. These men have acquired inquisitive minds; they think in an analytical way; they are for ever asking the questions, "Why?" "Why is this?" and "Why is that?" and they work for a day, a month, or years solving these questions. The answer may be simple, but it may be very important to the trade.

I was shown a lump of hard wax the other day. It was a rich, dark-brown colour, almost identical with beeswax; it had been extracted from flax dust, of which it constitutes 10 per cent. For generations this wax has been thrown away, enough wax per annum, more than enough to pay the bill of the Research Association each year. Extracted it has a commercial value; left in the yarn it makes bleaching more difficult; blown into the atmosphere it is a nuisance.

You want to know the "why" of the bleaching action of bleaching powder.

You want to know the "why" of lime and soda boiling.

You want to know "why" lime-boiled cloth has a different physical appearance when bleached and finished than that which has been boiled in soda.

You want to know what is the exact cause of the brightening action produced in the final white sour (sulphuric acid), or in fact each time the cloth enters this.

You want to know the "why" of retting, with reference to its effect on the cloth produced from the flax, from the bleachers' point of view.

You want to know what it is that makes linen so expensive to produce, and what it is that at the same time makes it worth producing even at its high cost. The pectine bodies contained in the flax plant have undoubtedly a very great deal to do with both questions.

Just what are pectines? You know that in a general way pectine is the gummy substance that binds together the ulti-

mate fibres of the flax into long continuous ribbons which extend practically the length of the plant, and that connects these ribbons to the structure of the plant.

To say that that gummy substance is pectine does not get us any further. There is a great lack of knowledge of what it is exactly. Yet the manner in which it is acted upon in the retting process is the chief factor in determining the value of the marketable fibre.

The behaviour of the pectine bodies when passing through the hot water of the troughs is what makes wet-spinning possible.

Again, the modifications which these same bodies have undergone are no doubt largely responsible for making yarn or cloth easy to boil or bleach, or the reverse.

Here, then, is a substance, or group of substances, which directly affects the grower, the spinner, the weaver, the bleacher, and the merchant, and there is very little exact knowledge concerning it. Is it not worth some investigations?

How is pectine affected by the various industrial operations? To what extent does it hamper or facilitate them? How does its nature vary from crop to crop, from soil to soil, or from any other reason? It is hardly possible to conceive that thorough and patient investigations into these and similar questions would not be of incalculable value to the linen trade, and by solving a few of the problems they present we should bequeath a richer heritage to our sons.

Not only physics and chemistry but botany has been neglected. The very basis of the whole of the linen trade is a vegetable product, yet how little has botanical research contributed to the problems of flax growing. Naturally the flax grower has studied to some extent matters of immediate concern, especially the problems of yield, but even this study has been of necessity rather superficial investigation than deep-seeking research. Further, they have been hampered at all stages by lack of facilities for interchange of ideas with spinners, to whom quality is of equal concern to quantity.

The flax trade has made little use of the science of physics and the knowledge of exact measurements. The methods of treating textile materials, yarns, and fabrics have remained to a great extent undeveloped. To illustrate: It is usual to test only the tensile strength of yarn before using it, but are there no methods available for testing the two equally important properties of resistance to friction and elasticity, both of which are of importance in the operation of weaving? What is termed elasticity in yarn is difficult to define. It exists in some yarns and not in others, although the flax fibre is almost devoid of this property. How, then, can yarns be spun to give this most necessary quality?

Any successful methods that have been discovered are mainly on the "hit or miss" principle, and your store of experience and knowledge has been derived from the accumulations of countless generations. The present generation has added little to that store compared with what might have resulted from a well-thought-out scheme of scientific research such as is now being proposed.

There seems to have been an established idea that some things can only be determined by practice, but we must remember that there is no change that takes place in any material fabric that does not fall under some natural law and is capable of being expressed by a formula.

The linen industry should never again be dependent for its main supply of raw material on outside sources. The question of an adequate supply of flax is of primary importance. Enough should be grown in the United Kingdom after the war to meet all needs, and this could be brought about by intensive methods, by seed selection, by proper use of fertilizers, and by elaborating the flax extension scheme to cover the United Kingdom.

No keen man really thinks that the linen trade has reached the millennium of achievement, and that there is nothing further to be known about flax and its manipulation. Organized research can and will make great discoveries still in flax growing, in mill process, such as spinning and the manufacture of fabrics; in the finishing processes, as bleaching, dyeing, &c. Linen has been the aristocrat of fabrics, but its uses have been too limited. The market can be increased manifold by scientific, organized effort.

One of the fundamentals of scientific research will be the study of flax. We do not yet begin to know what can be produced by intensive scientific cultivation.

Mr. Hudson Maxim told of a New Jersey farmer who went to China, studied the art of fertilizing and intensive cultivation from the Chinese, then returned to his farm in New Jersey, applied the principles to his land which he considered worn out, and sold the year's produce of his 150 acres in New York City at the stupendous figure of £30,000.

It is undoubtedly true, and to our shame, that we have much to learn from the Chinese, Japanese, and unfortunately from the Germans, in the use of fertilizers.

During the last thirty years the general yield in agriculture per acre in the United Kingdom has remained practically stationary, while that of Germany during the same period has gone up 40 per cent.—the result of applied science.

Germany has used artificial fertilizers to the extent of 105 lb. to the acre, while the farmers of the United Kingdom have been content with 48 lb. to the acre. Agriculture in Germany has not been allowed to stagnate or decay.

A more thorough knowledge of fertilizers by the farmer would surely lead to an enormously increased yield per acre.

You should endeavour in your Association of Research to bring about a revolution of flax production and quality of fibre. It is high time something was done.

As an example of the necessity for such research I will quote from the report of M. Alcan on the state of linen manufacture at the London Exhibition, 1862, fifty-six years ago: "The lack of development of the flax industry between the Exhibitions of 1851 and 1862 so impressed the jurors at the latter exposition that they asked for a special report on it. This was so important that it was published in full, but it is too long for me to quote. It stated that inferior seed had been used, with result, poor crop, &c."; and also "that the quantity of goods actually produced is far from having made the same active progress as several other branches of textile manufacture. It has even remained almost stationary." This, bear in mind, was said fifty-six years ago.

Flax-growing has rapidly decreased since 1864, although it has been proved that superior flax can be grown in Ireland and the United Kingdom if the crop is made profitable for the farmers and they are properly assisted in getting the best results. Mr. F. K. Jackson, Director of the Flax Experimental Station at Selby, says in regard to flax: "One of the most striking results has been given with some seed which has been selected for length of straw by Professor Bateson, of the John Innes Horticultural Institute, and sent to me for trial. For two years the straw has grown at least nine inches longer than that from imported Dutch seed alongside of it."

You cannot afford to leave yourselves in the dangerous position of depending on such an uncertain source for your main supply of raw material. The modern tendency in industry is to control that supply. You have now the opportunity of developing your own good home-grown flax, and by science and organization inducing such economical production that, while surpassing in quality, you will also be unassailable in price and value throughout the markets of the world.

When these pure strains of seed come on the market every farmer should be encouraged to use them, aiming at the production of a given quality of fibre, which if scientifically handled in the subsequent intermediate processes would lead to the solution of many difficulties which at present confront the spinner and the manufacturer. More scientific knowledge of the saving of flax seed is undoubtedly another field for research, so that perfect seed and uninjured fibre may be the grower's reward for his labour.

No farmer who has any imagination would rest satisfied

with the yield of $31\frac{1}{2}$ stone per statute acre (which was the average Irish yield for the last thirty years). If shown the way to obtain an increase he would gladly co-operate with the other members of the linen industry in undertaking the research of problems which are primarily his own, but also in reality the problems of those who pick up the threads where he lays them down.

One could hardly over-estimate the possibilities of the introduction and development of a system whereby flax would be bought on foot from the farmer and subsequently handled by scientific methods in co-operative reterries. In this way the farmer would be relieved of a responsibility which never should have fallen upon him, and would then be able to direct his energy and skill to the production of a large and better crop.

I am told 400,000 acres would meet the present requirements of the linen trade, and that this could easily be grown by your farmers if freed from the intolerable burden of pulling, retting, and subsequent operations.

"A Farmer," writing to the Editor of the *Belfast News-Letter* on July 6 last, says:—

"SIR,—I have read with interest the article on 'Science and Flax Cultivation,' in your issue of yesterday. I do not know where Mr. John Curtiss gets his information, but if he really wants to know why 'Flax-growing has rapidly decreased since 1864, although it has been proved that superior flax can be grown in Ireland,' I would advise him to spend a day in one of our country flax markets. The first farmer he meets will tell him the reason. In the past flax-growers have done their best. They shouldered 'the intolerable burden of pulling, retting and subsequent operations.' But what was their reward? A few shillings a stone, and a none too polite intimation from the flax-buyer that if they did not like the price they could keep their flax!

"All this happened but a few years ago, and a farmer has a wonderful memory. But now everything has changed. Prices are high because the linen trade finds itself unexpectedly dependent upon Irish flax, and there is great talk of co-operation with the farmer—scientific methods, seed selection, central reterries, flax extension schemes and the like.

"Far be it from me to discourage all this enterprise, but I can tell Mr. Curtiss' that if the linen trade really wants the 400,000 acres of flax which are spoken of, it must first convince the farmers that history will not repeat itself, and that in years to come, even though other supplies can be imported, the trade will still encourage and foster home-grown flax.

"Undoubtedly the investment of capital in reterries would be the surest proof of this intention."

But 30,000 tons is not one-third of your normal requirements, so that were you to grow, say, two-thirds of your fibre in Ireland the reduction in cost would be enormous, amounting to somewhere around 20 per cent. on the finished cost of your linen.

We have dealt in this article only with the waste in the preliminary processes: the waste in spinning, I understand, is almost as large, and while the percentage of waste made in the subsequent processes is a gradually diminishing one, it is the waste of a material increasing in value with every process.

You will be asked as an industry to put up £5,000 a year for scientific research, and one single problem out of the many to be investigated represents a preventable annual waste of millions of pounds.

Might I, as an outsider, suggest that you are not aiming high enough, and that an elimination of waste representing a figure so large as this is in itself worth a far greater expenditure on an immediate scientific investigation.

Again, from the outside point of view, I cannot help remarking that along these lines lies the future prosperity of the linen trade.

It was your own beautiful flax that made your linens celebrated in the past, but before the war flax-growing had almost become a lost industry to Ireland. Revive it, nourish it by systematic and thorough research and scientific control, improve its quality and reduce its cost of production; then you will place yourselves in a position unassailable in the linen markets of the world.

I am not surprised, however, that these problems, glaring though they may be, have never been taken up. It was too big a problem for individualistic treatment—the risk was too great. But you are now an organized industry, beginning to appreciate the big things a combined trade can carry out co-operatively at small financial risk to the individual firm.

But waste does not end here; your marketing methods also require the application of scientific research. There is even more preventable waste evident there than in your wasteful scutching process.

Selling also can be carried out on scientific lines nourished and stimulated and increased.

In Article VIII, Mr. Curtiss continues his soliloquy on "Research." He quotes an ancient writer as saying: "Where there is no vision the people perish." This thought embodies not only the power of foresight and imagination, but the power to comprehend our faults and failures of the present.

Owing to the keen race for life the majority of people have their time so fully occupied that there is little inclina-

tion to study the pros and cons of the daily routine. To the more thoughtful the "whys" and "wherefores" do occasionally present problems, but the want of time and opportunity often raises barriers that are insurmountable; therefore many valuable and brilliant thoughts are lost to the world. Had the linen trade a research department these thoughts could be put before a staff scientifically trained whose minds were free from the ruts of commercial routine, and thus they might form the basis for investigation of great value to the trade. This is what the Association aims at by putting this opportunity for investigation within the reach of all.

Having scientifically controlled the details required for the production of linen goods the research could be carried further, and the whole question of standard cloths should be reconsidered and rebuilt on such lines as would best suit the finish and purpose for which these goods are intended. It is well known by bleachers that some manufacturers' goods are more easily finished than others, and therefore their goods are always better in appearance and handle owing to the finish being arrived at by the first trial or intention, as subsequent treatment invariably reduces the appearance and destroys the handle and lustre. But owing to the divisions of the expert processes many difficulties remain mysteries, which could be elucidated if only it were possible for one individual to possess the necessary knowledge to control scientifically the whole system and process, from the selection of the flax seed to the bleaching and finishing of the goods. As this is impossible it has rendered more necessary a thorough research in the different departments so that the knowledge acquired should become the common property of the trade, which even if only theoretically understood would tend to raise the standard of quality, style, appearance and lustre, and so enhance if possible the beauty of texture and appearance which makes high-class linen goods so much appreciated and valued. Merchants and others should therefore have a theoretical knowledge of the kindred branches of their trade, which can be acquired by the younger members of the trade at any rate through a course of study in our technical schools. This would enable them to discuss and describe their requirements to the various experts with whom they do business, as well as being in a position to appreciate the requirements of their customers in the world's markets, and so attain a still higher position for our staple trade throughout the world."

All the above questions depend largely on chemistry, and it is important that chemical research be developed as it affects the various operations. The sizing of the warps is universally based on the use of starch in one or other of its forms, but practically nothing is known of the chemistry of starch and reasons why one form is more suitable than another for a particular purpose.

It is important to have a complete knowledge of starches and their relations to one another and of their action under varying conditions. Such knowledge would be of great value to the manufacturer.

Then, again, the bleacher, dyer, and finisher not only needs a knowledge of sizing materials but of other chemical substances used for imparting specific characteristics to the fabric before it goes to the market. Only laboratory tests as to the bleaching of yarns will prove whether this might not be an advantage to the manufacturer. It should be possible to discover a process of treating the yarns so that they would not readily crease when woven. There is a growing demand in the States for dress linens and suitings which do not crease. Will it ever be possible to discover a process for treating the yarns so that the linen when woven would be free from creasing? This would be a great advantage in the use of linen for dress materials, and a tremendously increased demand for such goods would thereby immediately ensue.

Thoughtful men of business who have tested it out will tell you that directly scientific knowledge is applied to the problems of production and organization, so surely are all previous estimates of possible earnings out-distanced to such a degree as would seem fabulous to the uninstructed mind.

Many industries in the United States came to the realization years ago that it was the systematic application of science which has played for the rapid progress of German trade.

During the past twenty years large American companies have been setting up their own research laboratories so as to keep the lead in their respective lines.

The research laboratory would formulate the underlying theories of the entire industry. It would need to be elaborately equipped and a proper staff employed, with a thorough understanding at the outset that they were to be absolutely free from outside pressure or annoyance, with a knowledge that they would not be subject to destructive criticism even if their work were unremunerative for several years. It must be understood that for a considerable time after its foundation no results of a serious nature may be expected by the industry.

A member of the Provisional Committee told me that the linen trade work with a balance-sheet in one hand and a knife in the other, and if at the end of six months a department does not pay it is cut off.

You collect a great deal of dust by the ventilating parts of your mill, and then you either blow it away and pollute the atmosphere or you have considerable difficulty in disposing of it. So far this dust has been an unmitigated nuisance, and yet in this dust you are throwing away probably £400 a week: Scientific research not conducted on behalf of the linen trade, has demonstrated that 10 per cent. of this dust is a wax

almost identical with beeswax, and those responsible for this work will be prepared to hand over the required results to be worked out by industrial research. Why should not the linen trade get this department of industrial research going, and so test out the possibility of eliminating this source of trouble and transforming it into a source of revenue?

In the linen industry, as in every other, progress is the result of continual acquisition and application of new knowledge. In a competitive market progress is indispensable to success. Competitors, therefore, are successful according to the extent to which they are able to usefully employ new knowledge as compared with their less progressive rivals.

After the war you will require to compete as an industry, and not with one another.

In the contemplation of research for the Linen Association it will be important first of all to ascertain what scientific work has already been accomplished in similar trades elsewhere. This necessitates a varied collection of scientific data. You would need (and it would be an important part of your laboratory) to have extensive library facilities, of text-books, authoritative reports, current scientific magazines, and scientific literature. You would need also to educate your own industry along advanced lines of thought, to encourage an interchange of ideas and discoveries in and out of the linen trade, which could be done by means of a monthly industrial organ for the linen trade that would discuss and report findings of the department, and give a digest of current scientific news bearing on the production and distribution in your own and competitive trades, &c.

Probably because the trade is not at present sufficiently appreciative of the need of scientific knowledge this suggestion may be thought useless. However, much valuable information which would be available could not be utilized without the industrial organ. Indeed, this industrial organ outside the question of the research department will be a necessity in your trade now that you have become organized.

The democratic grouping together in industries has been going on in America for some time, and one of the greatest difficulties they have had to contend with was that their councils or committees were always possessed, or supposed to be possessed of, information not known to the rank and file. It was, therefore, found necessary to methodically supply information concerning the business transacted at these meetings to the ordinary members, otherwise sooner or later there was trouble due to uninformed gossip and inaccurate rumours.

Where any mystery existed it was found that the ordinary members were dissatisfied, and were convinced they were being run by a clique. It is a psychological question, but psychology is a scientific force that cannot be ignored with impunity. You

have either to give away a certain amount of information or else break up the harmonious working of your associations.

The former is the lesser evil, and it is only by means of an industrial organ that information can be methodically supplied to the trade.

The California Fruit Growers' Association—the most successful grouped industry in America—is so particular on this point, and also that the cards should always be played face upwards on the table, that not only does it circulate all information to its members and opens its books for their inspection at any time, but at all meetings of the directors it is free for ordinary members to come into the room whenever they please to hear how their business is being transacted.

It is important that all the results from investigation should be given to flax-growers, and that the farmers be assisted and encouraged to grow better qualities.

You have in your community those who have been experimenting for a number of years in the use of seed specially selected from picked stalks of flax. The remarkable results produced by seed selection as shown in the recent illustrated address of Dr. J. V. Eyre, M.A., Ph.D., should be published for the benefit of the whole trade.

It is not the one lecture, the one article, the one number of an industrial organ, or the one advertisement, that does the work. The value comes in the cumulative effect of getting people to think along new lines; little by little their ideas change, their outlook broadens, and they move forward.

Efficiency is a matter of comparison, and comparison of industrial production per wage-earner per year in the U.S.A. and the United Kingdom shows that in most cases production per head is from two or three times greater in the States than it is here, where they are less efficient. In the production of cotton goods, which is fairly efficient in England, the difference is only 40 per cent. greater in the States than in England.

In the cotton industry, for instance, in which the American worker produces 40 per cent. more per year than the British workers, there is 2,214 horse-power per 1,000 workers in the United Kingdom and 3,423 horse-power in the United States. A superiority of 40 per cent. in American production is accompanied by a superiority of about 60 per cent. in horse-power.

The explanation of the curious phenomena that American workers produce 40 per cent. more per year than the British workers engaged in the same industries is very simple. It is due to greater employment of machinery, greater mechanical efficiency, and by a more intensive use of science.

The spinners' and growers' interests are identical, and there should be no real antagonism between them. They approach the problems from different angles: that is all. The grower thinks of the value of his crop. The spinner is interested more

in the quality of the flax which will give him best spinning results. Different kinds of material and different ways of finishing require different classes of flax fibre. The trouble is to say exactly in what way they differ. Only research can provide a language comprehensible to both.

Prior to the war everything was cheap, wages were low, and flax cost a fraction of what it does to-day, and we shall never again return to the old low level of values. Linen is the strongest and the most beautiful among vegetable fibres, and but for its price nothing could compete with it. Everything is in its favour except its comparatively high cost of production.

It is obvious, therefore, that the linen industry should concentrate on this "high cost of production" and see what can be done to reduce it.

I do not suggest making cheap linens out of the lowest class fibre obtainable—quite the reverse; in order to serve the public best you need to give them value, not mere cheapness.

"Value" is made up of three elements—"quality, usefulness, and price." The worship of mere "cheapness" is suicidal; it is usually accompanied by price cutting, and has led many an industry white. Some sections of your industry, I am informed, have suffered from this in the past.

It is, therefore, the high cost of production in particular you want to get after. Waste is one of the chief factors in high cost of producing, and one of the principal functions of research is the "elimination of waste."

Strength, quality, and lustre are what you require in your linens. Your own good home-grown flax is rich in these properties; the coarser Russian flax, on the other hand, is deficient.

Shipping will be scarce and freights high for several years after the war, and will not Germany control commercially the Russian flax districts?

It would be dangerous to allow your industry to depend on this source for its main supply of raw material.

You are all agreed now, I am sure, on the value of encouraging home-grown flax from selected seeds. In this you have everything to gain, and your Research Department will help you enormously, both in the matter of reducing the cost of production and also in still further improving the quality and uniformity of the fibre.

WASTE IN GROWING.

Dr. Eyre has shown us very clearly in his recent lecture the great future that lies in the production and refinement of pure strains of seed, as dealt with in article No. 6. His experiments have reached a point where it is possible to say that

a largely increased yield can be obtained with a definite gain in quality; he also leads us to expect that eventually quality can be controlled.

The first step forward has been brought by scientific research. It took a period of over five years to reach this point, and incidentally I would suggest you make a mental note of the time involved.

That research on flax seed will eventually reduce the cost of fibre production considerably has been clearly foreshadowed, yet this is only the first in the many processes which go to make up the linen industry.

WASTE IN SEED.

In addition to the unnecessarily low yield per acre, which is quite preventable, the first great source of waste is the destruction of flax seed, which would, I am informed on the best authority, be equivalent on last year's acreage to £500,000 sterling at crushing price. There is also the waste of the bolls, which are used in Belgium and Holland for feeding purposes.

WASTE IN PULLING.

Every farmer knows the enormous expense entailed in the pulling of flax, not to speak of the loss in yield which may result from careless work. I understand there may be several stones per acre saved in good pulling. Experiments in mechanical pulling have been made during the last year or two with increasing success, and when this machinery is perfected an enormous saving will be effected in cost and yield.

WASTE IN RETTING.

This process has proceeded on more or less the same principles for 4,000 years, and has never yet been systematically researched. Retting is a bacterial process, and therefore lends itself to scientific treatment, and it is not unreasonable to expect, as in the case of the seed, a similar new world of opportunity will reveal itself once this problem has been scientifically tackled.

We know vaguely that a great deal depends on the retting, and that this process to a considerable extent governs the yield in scutching, the spinning and bleaching properties, the lustre and character of the flax; yet few attempts have ever been made to get it under scientific control.

It will surely be worth considerable expense, time and trouble to thoroughly research this most important process, and one would be safe in prophesying that improved quality and reduced cost would be the result.

Upon investigation I find that flax as it is brought to the scutch mill is, as a rule, tossed and either over or under

retted, each of which entails considerable loss of valuable fibre; but on this subject no one seems to be able to give me the definite data on which to base an estimated loss.

WASTE IN SCUTCHING.

The scutching process comes next in order, and from the information and data at my disposal the deliveries of Irish fibre of the last season's crop are almost exactly in the proportion of two parts scutched flax to one part unscutched tow; one-third of your good flax has therefore been broken up into tow. It also seems that the loss does not end here, and that a considerable quantity of fibre is thrown away with the shive, so crude are the retting and scutching processes.

I have gone into the figures for the 1918 crop, based on 150,000 acres, and taking an estimated yield of 30,000 tons of flax and 15,000 tons of tow at the average prices of £280 per ton (35s. per stone) for flax and £85 per ton for tow:—

Scutched flax, 30,000 tons at £280	£8,400,000
Tow scutched, 15,000 tons at £85	1,275,000
	<hr/>
	£9,675,000

Now, had this process been systematically researched, the retting been improved and machinery devised to give you all your fibre as scutched flax, eliminating all the scutching tow, the figures would read:—

Scutched flax, 45,000 tons at £280	£12,600,000
---	-------------

This indicates a waste of approximately £3,000,000 on the 1918 crop. The loss which is made apparent here is absolutely appalling. This represents a colossal waste to the industry; what possibilities lie here for reducing the cost of linen and improving the quality.

It is therefore with considerable interest I give the thoughts and suggestions of a member of the linen trade upon the research and standardization of yarns and weaving.

The full force of the competition which is developing will not be felt for several years, and if you wait till then it will be "too late."

Germany is aiming at a large export trade which will compete against you with all the force of a combined scientifically organized industry. Japan is steadily developing a linen trade. Indeed, I am informed that there are Japanese students studying in your Technical College here. I spent some time researching the markets and commercial system in Japan a few years ago, and would warn you that competition from this quarter is not to be despised, as their methods are advanced and scientific. What you require is a strong far-seeing policy.

You, yourselves, alone, can frame this policy, and it is only for me to point out its importance and make a few suggestions.

I can best convey what I mean by describing the sales policy of an industry which is famous over the world for the way it has handled this particular problem. It is the California Fruit Growers' Association. You have heard of it before, but its sales methods will repay close analysis and study. Mr. Hamilton Wickes, the Board of Trade expert on commercial matters, referred to it when he was in Belfast recently as a pattern that any industry might profitably follow. This industry was even more finely divided than yours—the cost of marketing its product was enormous, and the individual growers were at the mercy of the wholesalers, just as you have been. Everything was carried out in an individualistic and unscientific way from growing the fruit to selling the product. Waste was rampant, and the quality of the fruit under these conditions had fallen to a low ebb. The orange crop was greater than the demand. There was no co-ordination; one market would have a glut, while another was experiencing a famine.

The fruit distribution was handled from one centre by a number of competing wholesalers, this unscientific method being, of course, wasteful in the extreme, and entirely inadequate for a country as large as the United States. The growers first tried an association for fixing minimum prices, but though this for a time improved matters, it had no effect in remedying faulty, wasteful distribution, which seems to me to be a weak spot in the linen trade also.

They analysed the problem carefully, and came to the conclusion that the only cure was to act together co-operatively as their own wholesalers, and to organize the country for scientific distribution. The result was the California Fruit Growers' Exchange, which handled all the fruit for the association. The country was divided into seven areas, each area having its own headquarters, where stocks were held, and from where they were distributed. Scientific market investigators were employed, and the country was subjected to a continuous research, so that the Board of Management in Los Angeles had accurate information and were able to replenish the stocks at the seven headquarters, in just the correct quantity and proportion.

Before the Exchange was formed selling costs amounted to between 7 and 10 per cent., whereas in 1917 they amounted to only $1\frac{2}{3}$ per cent.

A selling organization as scientific as this, of course, quickly developed in other directions—their combined advertising campaign—which has increased their turnover 81 per cent., being one of these developments, and this is run on most scientific lines. Last year, with a turnover of £12,000,000, they spent £80,000 on advertising—0·85 of 1 per cent. on their turnover.

Mr. G. Harold Powell, their expert manager, states that this small percentage expended co-operatively brings as great a return as would 10 per cent. expended individually by each grower. In advertising, as in other things, it is the weight, the concentration, that spells results. This industry affords an interesting object lesson in how scientifically organized industry can plan ahead for its future expansion.

An unscientific industry waits till there is a suction in demand—in other words, a wave of good trade—when it hurriedly rushes up buildings and orders in machinery at breakneck speed. When the buildings are completed and the machinery ready, oftener than not the wave of good trade has passed.

The orange growers plan their trade expansion years ahead. By means of their scientific market investigations and records they know what the normal expansion due to selling a genuine commodity will be; they know also from their carefully kept statistics what additional sales they may count on from a specified amount spent on advertising, and they know exactly what additional acreage in orange trees it is possible for their association to conveniently handle, and they arrange accordingly.

With this scientific knowledge to work on it becomes possible to lay their plans for several years ahead with confidence and accuracy, and to make their preparations in harmony with those plans. You can control an industry organized on scientific lines, otherwise the industry controls you.

In 1916 changes due to the war threatened to upset their arrangements. Exports were restricted, but to meet this crisis they increased their advertising appropriation to the figure necessary to force their own country to consume the whole crop, which it did.

This year a large additional acreage will come into bearing, some of which was intended for export, but it has been arranged that advertising will take care of it, and the industry continues quietly and confidently on its way without panic or fears for the future.

Another general development has been that the industry has introduced science and scientific method throughout its whole fabrics, and the orange growers have made high profits without increasing the cost to the consumers. I understand that a pamphlet is being printed for distribution to the members of the linen trade, giving the history of this unique and interesting industry, with the annual reports for 1917 of their Exchange and Co-operative Supply Association.

Though industries differ in detail, the underlying principles are the same for all, and I would recommend the linen trade to carefully study this pamphlet, as it affords an excellent pattern for other industries to follow, of course adapting the details to their own particular needs.

To return to your own industry. It would take time to

organize it in its entirety to this pattern, but there are some clearly defined, more or less standardized sections, such as the Cambric and the Canvas Holland and Buckram Associations, which could with little trouble and with great profit to themselves adopt this principle in their selling and distribution. Great benefit would result from the thorough working of the whole country with the scientific handling of stocks and economical distribution.

In Article IX, under the heading "Need for a New Outlook," Mr. Curtiss writes:—

A century ago all British industries held a commanding position in the world. This created a deeply-rooted feeling of security among most British manufacturers, which together with a natural conservatism has acted against the ready adoption of new proposals which called for investment to develop along new and original lines, either in methods of marketing or in production of the goods. This is especially true where the immediate financial returns are not positively assured. Aside from this, many of the heads of British industries have not been educated in a manner which gives them a keen appreciation of scientific knowledge.

I would suggest that every concern of any importance should select from its staff one of their younger men possessing sufficient preparatory education, known loyalty and ambition, who could be given a special science course in the Technical Institute. This man would become the contact point between his concern and the Research Department, he could understand the common language of science, and take up and apply the discoveries and suggestions of the laboratory. Even without a research department such a man would be valuable in a concern. There would be enough to do to more than earn his salt. There are the gases, oils, coal, &c., which, if analysed constantly, can be made to produce great efficiency. There is the testing of water and watching the spinning troughs, by which he will be able to improve the bleaching properties of the yarn. By close analysis of all supplies he will save his concern money. One linen manufacturer saved £2,000 on his coal bill by watching the draughts and gases in their furnaces. He could also save his concern money in minor ways, as, for instance, the elimination of troublesome stains.

Scientific research is a paying proposition, for it attacks the problems most pressing to the trade which arise in the course of ordinary routine, problems which ought no doubt to be solved by means of their own scientific staffs, but are not solved, as few have men trained for such work or laboratories equipped to carry out the experiments.

If from no other motive the linen trade should look upon efficiency as a weapon against the competition that awaits them in the future.

Those who have followed the papers know that the German Government has not been asleep in its preparations for activities after the war. Early in the war she formed a Board of industrial magnates, which has been operating ever since with the whole power of the State and the German banks behind it, acquiring huge quantities of raw materials in South America and elsewhere ready to ship immediately peace is declared. As they have provided for raw materials, so they have for their producing and selling organizations. You may depend on it every available opportunity will be taken to get ahead of British goods in the markets of the world. To ignore that fact, and continue in the belief that conditions will after the war adjust themselves as before is playing into Germany's hands.

You may have held the premier position in the linen markets of the world; but even as a preponderance of man-power and of wealth will not bring victory against superior directing power and organization; so your supposedly safe position will not secure your pre-eminence if you neglect any of the means for advancing the efficiency of the industry by research, or neglect your markets.

The use of statistics is in reality a psychological question. Year by year you have been in the habit of comparing your figures with those of the previous year, and for that reason your exports have for years remained at approximately the same figure.

Aim higher, set yourselves standards after careful analysis, and in time you will as surely attain them.

This will project the mentality of the industry forwards instead of eternally dwelling on the past. It will automatically stimulate effort, and steady progress will result. All these things can be accomplished. I am building no castles in the air, but I would warn you that this is not the age of miracles. All development is gradual if it is to be permanent; it will take some years of concentration and effort before really great results can be looked for.

Without a scientific statistical system to measure progress and wherewith to direct its activities you will not get 30 per cent. efficiency out of your Research Department. Without this control research would be applied in a haphazard and un-systematic manner. It is the first function you would require to establish as a department in your scheme of reconstruction. It should direct and "control" all the activities throughout the whole industry, and it is the only means whereby satisfactory standardized conditions can be attained. It is an essential in the systematic handling of your markets, and great care should be taken that the accurate information it mobilizes is so assembled and shown up that the whole trade can easily assimilate it. You want to take each one of your markets,

and at the end of every season the results should be shown up graphically on charts in comparison with:—

- (1) The previous season's figures.
- (2) The average over, say, ten periods.
- (3) The standard or potential of that market based on its wealth plus population.

The selling of your finished product is the most important function in your whole industry; to this everything else is subsidiary. On the condition of your markets depends the prosperity of every branch of the trade. It is as important to spinners, weavers, bleachers, and finishers as to merchants. To them also should be circulated your sales statistics, so that all should have the fullest possible knowledge of the actual position of the industry from this point of view, and also of the possibilities of expansion calculated on your scientifically prepared data. This would overcome that paralysing subconscious feeling of "finality" which I could not help noticing when I first came in contact with the industry three years ago, and would stimulate to more scientific handling of your markets.

I can assure on the experience I have had of the American textile markets that there you have as yet only scratched the surface, that the possibilities of expansion are far greater than anyone in the linen trade imagines, and it is reasonable to assume that this will equally apply to your other markets also.

One cannot help realizing that, after the long years of working to an ideal of individualism, it will be a wrench to begin to supply detailed figures of the sales in your various markets—that information which has been always considered most secret and most sacred.

But, in the first place, your statistical department should and would be run on as confidential lines as a chartered accountant's business; secondly, it will be the same for everyone.

When you have taken the necessary steps, and your trade is in such a position that demand is always ahead of your power of production, you will find that all these old barriers will automatically break down.

In Ireland the linen industry is now completely organized into associations, and Scotland, no doubt, in self-defence, will have to follow suit. That action is the outward and visible sign that you have given up for ever the old principle of unbridled individualism, and have in its place accepted the principle of co-operation. Having accepted the principle of co-operation, for heaven's sake play it up for all it is worth; take all the value you can get out of it; it holds a rich store of prosperity for you if you will only avail yourselves of the opportunity. It will remove much of the harassing worry which characterizes the all individualistic business, and together you can with ease accomplish the big things which

individually you could never have attempted. You people in the linen trade, both Scotch and Irish, are very intense. You have carried on your trade on the individualistic principle with such intensity that to a stranger coming in and analysing your problem it seems wonderful that it has ever survived, as he can only attribute its present condition to the great ability and industry of all those concerned. Apply these gifts, this ability, this industry, with the same intensity, the same thoroughness. Break away completely from the old secrecy, jealousy, and petty narrowness of the individualistic idea. Accept the co-operative principle whole-heartedly in your manufacturing, in your marketing, your scientific research, your statistical department, in everything; and together your progress will be rapid and profitable, and the position of everyone in the industry, large or small, employer and employee, will vastly improve. Having accepted the principle of co-operation, carry it through in an understanding and methodical manner. For this purpose a statistical department or control is your first necessity. You require uniformity in conditions and practice, and only by this means can you bring it about.

An effective knowledge, grasp, control over every function and activity in the industry are essential.

Only by means of a scientifically organized statistical department can you bring this about.

In Article No. X, Mr. Curtiss treats of the waste in marketing linen owing to its passage through the hands of so many middlemen, and analyses the pre-war system. "The farmer in Russia or Holland," he says, "sold the seed to the merchant there; he in turn sold it to the retail seedsman, who sold it to the growers in Ireland. It's like 'the house that Jack built.'" Here are four sales and four movements, each carrying a profit and the cost of movement, interest, overhead charges, accounting, &c., before the seed ever reaches the ground.

The Irish farmer may sell to the flax merchant, the flax merchant to the spinner, the spinner to the commission house, the commission house to the weaver, the weaver to the merchant, the merchant to the wholesaler, the wholesaler to the retailer, and the retailer to the public, the ultimate consumer. Altogether there are twelve different sales, accompanied by movement, before the merchandise ever reaches the ultimate consumer. All sales and movements cost money; they total an enormous sum. They may all be necessary, but it is well to know about them, and the problem is well worth researching.

What I particularly wish to deal with, however, are the last two of the series, "the marketing of the finished goods," for it is here my personal experience chiefly lies.

Let us again analyse the pre-war conditions in your industry

from this point of view, taking the United States for our field. This was your largest market, and was centralized in New York. Practically every merchanting concern had in this centre its own house, or else worked through an agency. The Linen Colony was located down town as far away as it could get from the neighbourhood of the hotels, railway centres and large New York stores. In this unfavourable location a form of civil war was carried on among the members of the trade; they were so intent on getting the better of each other that they had almost lost sight of the main factor in the situation—the reason for their existence—which was to produce and distribute linen in the most efficient and economical manner. They were all centred in New York, overworking this district, and underworking the balance of the country. Many carried stocks, and owing to the division of the industry into so many small units or firms, the overlapping in stocks of each particular class is bound to have been considerable and far in excess of the amount necessary for the volume of trade the industry was doing. This means waste to the industry as a whole—not alone in the extra cost of carrying stock, but also in the interest on the capital involved. Here would be found a large waste if it were possible to obtain the necessary data.

There is another waste that is bound to exist in a highly divided industry, is that it is impossible to gauge market requirements. You would be in a perpetual condition of having too much of one thing and too little of another; the former means an expensive carry over, the latter lost sales. It is impossible to obtain figures to arrive at an estimate on this, but anyone can realize that the loss to the industry as a whole must be considerable, and the working capital necessary to finance it excessive.

There are other wastes caused by overkeen competitive selling in addition to the very obvious one of "dissipated profits." Every house of any size tries to carry something of everything, and in addition the ranges become unduly multiplied in each variety in trying to get behind the other fellow. This means carrying much larger, more unwieldy stocks than are really essential, and the unnecessary variety makes manufacturing more expensive, besides holding up so much capital. Furthermore, the wholesalers you sell to are competing among themselves, they are also playing you one against the other, and the quality of the linen consequently gets needlessly beaten down with the price, for the working expenses on "cheap goods" are just as much as on quality goods, and your profits are usually based on a percentage of the turnover.

Those who possess analytical minds will therefore clearly see that scientific organization and distribution will eliminate these unnecessary expenses, and at the same time will provide better value for the public whom you serve. This will add greatly to the status of your industry.

From personal experience, Mr. Curtiss says, I can assure you that the economics that can be effected, the smooth and rapid way in which a business can expand working with scientific knowledge along scientific lines, is almost incredible.

The question of "distribution" does not appear to have received the attention that it requires. Manufacturing has, as a matter of fact, developed ahead of selling, distribution and finance, because the latter functions are not so obvious and have not attracted the same concentration of thought. To this weak spot is due the evil of "restriction of output" by the trade unions, and this policy, owing to the existing methods of selling and distribution, is not so illogical as some people think.

No one who does not carefully analyse the problem can realize the high cost of marketing, of buying, selling, and distribution. Indeed, in almost every instance the cumulative cost of these three items exceeds the actual cost of manufacturing. Did you ever realize this?

In Article XI, Mr. Curtiss suggests some improvements on these conditions based on his own personal experience in researching the American markets. The conclusions that one cannot help drawing from the analysis contained in Article X are that our pre-war methods of selling and distribution lack point and method and are the reverse of scientific—consequently there have existed considerable wastes of long standing which have acted detrimentally to the prosperity of everyone concerned in the trade. This is no reflection on the individual ability of the members of the industry, which is of a high order. It is the system, or rather the lack of system, that is at fault. You require a "definite selling policy" if your sales are to expand, but hitherto, owing to the individualistic nature of the industry, you have had no policy at all.

If you are to successfully meet competition under the changed order of things after the war you must have a "policy," and in framing this policy you will require to look years ahead, for to confine it to a few years after the war would be fatal.

In Article XI, Mr. Curtiss deals with after the war preparedness. He says:—

"The fact that there have been two misconceptions regarding a scientific research is as interesting as they are erroneous, though it is easily understood why some people might hold to such views. The first notion is that research work is not necessary in the face of the present finality of achievement, and consequently would be a waste of money; the second is that it is something subtle, mysterious and difficult to understand, therefore should be left alone.

"It is true that your linen trade has reached a high level of production, and that the machinery used is the most scientific

that can be had; but this is only the evolution of old ideas conceived years ago, since which time other industries have been swiftly moving along newer paths of progress. They have reduced costs by the discovery and use of by-products in some cases have revolutionized the whole industry, and often have increased the material wealth immensely. There should be nothing mysterious about scientific investigation which will result in greater preparedness for the linen trade.

“ But preparedness for what ?

“ Not for war. For peace, of course. Never before has a lesson been more thoroughly taught than the lesson of preparedness as an essential to victory in any international undertaking.

“ Flax growing, retting, scutching, spinning, weaving, bleaching and selling are the fundamental principles of the industry; to each in turn the X-ray of research wants to be applied to discover its greatest efficiency if this trade is to hold its own the next fifty years. The present war is nothing more than a war of commercial competition. Such expression as ‘ a place in the sun,’ ‘ the freedom of the seas,’ &c., refer to unrestricted commercial activity.

“ It is obvious, therefore, that the war of artillery and torpedoes on, under, and over, land and sea is but a prelude for a more intensive and extensive contest for the commercial supremacy of the world.

“ Volumes have been written on the military unpreparedness of both England and America, a condition chiefly due to our imagined security against foreign attack. I have heard expressions of security from men in Belfast who really believe that after the war conditions will be the same, and that no special effort on their part is necessary to contest for the place of commercial leadership in the world’s linen markets.”

For forty years Germany has been preparing to attain political and commercial supremacy. Because of our lack of preparation we have paid a terrible price to hold our own against her; but we will win this war if it takes forty years more to do so.

Have we learned anything? What preparation are we making? What foresight are we showing against the next stage of the war with Germany—the war of commerce for industrial supremacy? Unless we win the next stage the advantages of the first victory will be negligible. It is well known that Germany has thoroughly organized her industries and centralized them to recoup her war costs through world commerce. Whether this war proves the death-knell of Prussianism or not all the ingenuity, research, and efficiency of Germany will be concentrated exclusively on commercial conquest later.

HAPHAZARD METHODS.

What chance will haphazard methods have against organized rivals admitted to be the most efficient in the world? You as a nation, perhaps as a country, are far too conservative and slow. Even if the war has taught nothing else, every man should by now have realized the meaning of preparedness. Now is the time for a complete reconstruction, from flax growing to the doubling of your markets. After the war, perhaps sooner than we realize, international competition will be upon us again keener than anything we have hitherto experienced, and the question is, How can this be met? Germany's policy for industrial expansion includes getting control of raw material, and already she has penetrated the Russian flax districts. Therefore better methods with more economical production, is of first importance if you are to retain your lead in the linen industry and be in a position to maintain a high standard of wages. Increased capital alone will not suffice, for capital without life-giving ideas is a dead thing. There are two factors which will accomplish all that is necessary, and the linen industry is going to carry them out.

In Article XII, Mr. Curtiss deals with Science and Education and maintains that "this is the age of science. If that is so it is no less true that science will play a most important part in industry after the war."

Lord Montague states: "I do not think the attitude of the nation towards science is one of dislike or hostility. It is one simply of contemptuous neglect. We can only remedy that by beginning to teach the youth in the country the use of science and respect of science until they in turn rise to the top."

In Article XIII, Mr. Curtiss deals with statistics, and says that: "The importance of accurate statistics scientifically assembled and shown up cannot be over-rated. In America, the scientific assembling of statistics has developed into practically a new function and one of the greatest importance. The value of statistics lies in the lessons they carry for the future, and on the way they are assembled and shown up. You should set a standard for each important function and each important waste industry. The standard set should be as nearly as possible 100 per cent. perfection.

"Take, for instance, the waste of fibre that takes place in scutching. The graphic system would measure your progress against the previous year, against the average over a period; but—and this is the most important point—it will also measure and show up vividly the amount of waste that is 'still going on' in this particular process as compared with the standard set.

"Had the trade systematically collected and tabulated

statistics by this process they would never have allowed such a colossal waste—the chief cause of the comparatively high cost of linen—to go unchecked for years.

“But they had nothing to make them conscious and remind them that such a waste was going on steadily from year to year, and it consequently escaped their notice.

“There is waste in spinning. I am told that this is considerable. This should be treated statistically in the same manner, and many other places where waste is occurring will be shown up when you settle down in a systematic way to analyse your industry from this point of view.

“The important advantage about handling statistics in comparison with standards is that the accent is always on the future, and at the same time the wastes that are still going on, the money and possibilities of expansion which are being steadily lost year by year, will be brought strikingly before the whole trade at regular intervals and can never be lost sight of.

“By circulating statistics, scientifically assembled by this idea, it will be quite impossible for the industry to get into a rut and remain there. Instead of dwelling ever on the past the possibilities of development and the elimination of waste are kept in the foreground. The mentality of the trade is kept dissatisfied with existing conditions and progress follows automatically.

“In your Research Department you organize and departmentalize ‘progress.’ It is the dump for the ideas of the whole trade where they will be worked out by minds scientifically trained for this purpose. The factory should be for production only.

“In the ordinary way, statistics are a ‘post mortem’ only; used scientifically, they become a ‘guiding star,’ an irresistible force, compelling you to effort, and rendering progress automatic. All this means considerable thought; you cannot simply apply statistics to your industry as it is. You would require uniformity of practice, and to organize the whole industry, for a scientific statistical or control system. You would be well advised for this purpose to employ an expert, as it is no simple job, and requires skilled knowledge and experience. There are many functions in the industry that urgently require analysis and the application of statistics. It all comes down to the elimination of waste, and all waste comes under one of the three headings: ‘Time,’ ‘Effort’ or ‘Material.’ To mention a few instances of functions requiring specific treatment—wages costings, loom and spindle efficiency, waste in all processes; labour conditions can also be treated statistically with much benefit. You require an annual balance-sheet for the whole industry, and your markets are crying out to be properly handled.

“Take the latter. You have figures showing your annual exports of linens and unions to all foreign countries, but this is all you have. You do not even know how much of this is pure linen, a most important matter; again, you do not know what your home market consumes. All the figures you have are ‘post mortem’ only; it is just as important to know what your potential markets are as to know what your past year’s sales amount to. You require to carefully analyse all your markets on a population basis and also on the basis of wealth. This will show an amazing variation, and it is at this point that market research will come in to find out ‘why.’ In one market you may find that the wealth is in too few hands, and this will indicate an opening for fine high-priced goods. In another market you may find that the figures do not come up to the average, because the wealth has been made rapidly, and the population have not the education or the refined tastes which lead them to buy a commodity such as linen. A condition such as this, at once suggests advertising, as the *nouveau riche* are most susceptible to this treatment. They desire to ‘do the right thing’; they don’t know how, they want to be told, and you should tell them that smart people use good linen.

“But only analysis with statistics and market research can give you this valuable information. In all these cases you must keep careful statistics, and regularly compare results with standards of what each particular market should be capable of doing. You will then know how to concentrate on those which are not doing their duty and where there exist the greatest possibilities for expansion.

“You require a statistical or control department for the industry, and the statistics for the whole industry should be handled by the one department. This should be properly staffed and should have the most up-to-date machines for automatically sorting and tabulating statistics, such as Powers or Hollerith. I used these in Messrs. Butler Bros., and for this sort of work they are essential. Their advantages are speed, economy, and headings. One machine will do the work of fifteen clerks. A department such as this would not be an additional expense; it would be an additional economy.

“Supposing, for instance, some machine were invented by which the spinners were able to get such an increased production that they were enabled to put their yarn on the market at a lower price, and a merchant commenting on this held that it did not concern him in the least, as the only section who benefited was the spinners, because they spun the yarn, would he not be reasoning illogically and erroneously?

“It does not, therefore, matter to the individual firm or section in an industry like yours in what section betterments are effected. One section is bound to benefit directly, but

all the others* must also benefit indirectly—the merchant probably just as much as the spinner—for increased economy in production tends to increase the demand for the goods.

“On the other hand, if the merchants through some scientific method of selling and distribution create an increased demand for linen and handle and place their stocks of linen so that increased consumption results, the spinners also are gainers, for the demand on them for yarn will be greater.

“There need, therefore, be no jealousy in the trade as to which section received most benefit from the Research Department. Every section will benefit equally, and all, without exception, should bear their proportion of the cost.

“Economical production is brought about by the elimination of waste.

“In commerce waste comes under three headings—time, effort and material. It is the mission of research and science to wage eternal warfare against ‘waste,’ and in your case it does not matter where the waste lies—if research locates it, and science eliminates it, you will all benefit.

“Before dealing directly with the financing of your Research Association, I would remind you that there are individual firms in Germany spending as much as £300,000 per annum on research, and in America practically all the large concerns find it necessary to have research laboratories, some of them—notably the Westinghouse, Kodak, and Goodyear Tyre Companies—spending up to and over £100,000 yearly in this way.

“These firms are managed by far-seeing business men, who do not throw their money away for nothing. They put their money in research, because they find it pays them and has been an outstanding factor in their rapid success.

“Besides these huge sums, the £8,000 per annum for five years which is expected from the linen industry looks small. This is, however, a beginning, and no doubt before the five years are run a much more comprehensive scheme will be demanded by the trade.

“A sum so small as £8,000 divided proportionally over the whole industry, will fall lightly on the individual firm. It is therefore confidently expected that every firm without a single exception will agree to contribute their proportionate amount.

“In other industries some of the larger firms, in addition to their annual payment, have donated money to create a foundation fund in order that their association may start off with sufficient funds to provide buildings and equipment without having to draw on their income for this purpose. Already in the linen industry several donations have been promised. In the cotton industry one donation promised amounts to £10,000.

“By arrangement between the Government and the Privy

Council Committee on Research all payments of whatsoever nature to recognized research associations are definitely exempted from income and excess profits taxation. This is because the Government believe that the future commercial prosperity of the country depends to a great extent on the application of the science to industry.

"In making up your annual income-tax returns think of your contributions as an 'expense'; at all other times think of it as an investment, and one that will pay a handsome dividend in the future.

"In addition to this the Government have voted a grant in aid of industrial research, which is allocated *pro rata* on the amount contributed by the industry. This is made conditional on the firms in the industry entering into an agreement to contribute annually for five years a fixed sum to be assessed on some equitable basis arranged among themselves, so that an annual income for the Research Association for at least five years shall be assured.

"It is suggested that the annual assessment in the Linen Research Association shall be based on 'working capital'; the working capital as returned to the Inland Revenue for income-tax purposes for the year 1918 to be the standard for assessment for the first five years.

"It is suggested to deal with the capital amounts as under, so that no firm will require to disclose the exact amount of its working capital, and a certificate from its chartered accountant that the working capital comes within any of the eleven classes will be accepted as proof.

CAPITAL.		ASSESSMENT Per annum for five years.				
Under	£17,000	£10				
Between	£17,000 and £26,000	£15				
„	£26,000 „ £40,000	£20				
„	£40,000 „ £60,000	£30				
„	£60,000 „ £90,000	£45				
„	£90,000 „ £140,000	£70				
„	£140,000 „ £200,000	£100				
„	£200,000 „ £300,000	£150				
„	£300,000 „ £500,000	£250				
„	£500,000 „ £700,000	£350				
„	£700,000 „ £1,000,000	£500				

"Against the first £5,000 subscribed by the industry the Government will contribute £5,000, and on any sum subscribed over and above £5,000 they will also contribute, but at a reduced rate to be agreed upon later.

"From the above it will be seen that the call on each

individual firm would be comparatively small, and that from the financial point of view there is nothing to prevent any firm, large or small, from taking its part in what will ultimately prove a paying investment, but which at the same time should be considered from the patriotic point of view as a national duty.

"All these articles have been suggesting an ideal for the scientific development of your industry. Everything cannot be done in a day, and all development is gradual if it is to be permanent. You cannot slate the house before the foundations are laid and the structure has reached the appropriate stage.

"But whether it be the building of a house or the scientific rebuilding of an industry, you require in the first place a policy—a plan to work to—or otherwise you will drift, progress will be slow, and many mistakes will be made.

"Science touches your industry at every point. To get the best out of it your selling and the distribution of your merchandise must be just as scientific as your specialized machinery. If all industry were run on scientific lines throughout there would be no poverty, want, or labour troubles to-day. Science might well be described as the 'best, easiest, and quickest way to the desirable things of life.'"

In conclusion, I would quote from the Report of the Committee on Commercial and Industrial Policy after the war, Referring to linen, it states:—

"The chief difficulties of the British industry have been due to over-production resulting from internal competition, and it appears desirable that all sections of the trade should recognize the advantage to be derived from common action to meet foreign competition after the war."

Were I permitted to criticise this I would alter the words "over-production" to "under-selling."

You want a strong aggressive sales policy. This as it stands suggests that "restrictions of output" is not peculiar to the trade unions only.

When hours have to be shortened and machinery stopped from lack of sales, the workers have a good right to ask, "Have you done everything possible to sell the product?"

In Article XVI, Mr. Curtiss gives some compelling reasons for science in the linen industry. He says:—

"Nothing of marked achievement was ever accomplished except it was first a dream, which stimulated imagination far ahead to see a vision of final result, and then having had the inspiration the result has been achieved by systematic, intelligent following of a policy.

"Your Provisional Research Committee has by means of these articles striven to create an atmosphere for the linen trade from which it will draw in new life and inspiration—

to will, to mobilize to the full for the opportunity which will arise after the war.

" In this war with profound repugnance we have been forced to fight Germany with her own weapons, liquid fire, gas, &c. To fight her in the realms of commerce we are forced to abandon our traditions of individual freedom in trade and submit our trade destinies to a centralized command in the handling of our commerce. Railways, shipping, banking, materials, and industries have been mobilized to a greater or less extent for the duration of the war. Some of us do not even now realize the powerful economic grip in which Germany held the world during the past two decades. While we were slighting her efforts she fastened on the world's markets. Even a conquered Germany will be relentless and a powerful enemy in the field of trade. If Germany is allowed to continue the process of peaceful penetration after the war she will again become a world menace in commerce no less than in the field.

" It is not generally known that Germany, having ruined Russia commercially by organized Bolshevism, is now buying up at their depreciated value interests in Russian industrial concerns which will leave her at the end of the war in control of Russian commerce.

" This series of articles has been written for the purpose of leading the trade along to new lines of thought, broader vision for the future, so that it may pull itself together, reorganize on modern lines, and be in a position by employing science through research to eliminate waste, reduce costs, and largely increase its markets.

" No longer will it be possible to continue, as in the past, competing madly against each other in the manufacture of the goods at home, and again as madly by your agents in the linen colony of New York City. Big lasting success is not the result of conquest but of co-operation.

" Why is it necessary to get together as an industry? The answer is simple—Because you will have to meet in German and Austrian competition what many business men in America have come to regard as the bugbear, the root of the German cancer in commerce, viz., the cartel.

" There seems to be a great lack of knowledge concerning the cartel. This is doubtless due to the fact that there may be several cartels in the same industry, and each industry handles its cartels in accordance with its requirements. Then, again, there are various forms of commercial combination in Germany known by different names.

" The 'monopoly' implies State control. The 'consortium' is a union of banks, which finances the sales of the monopoly. Or it may be a union of commercial, industrial, or agricultural concerns to underwrite or handle a given enter-

prise. Community of interests is another form, and really is an agreement or trust for the detriment of outside trade. But the real cartel, *kartell*, *syndikat*, *verband*, is different from the others, and is the evolution of a system begun in the middle of the last century. It is the cartel system still more highly developed which you must meet after the war.

"The cartel has at its head the German State, and its aims are not commercial alone, but political to a high degree. No commercial contracts into which it enters are sacred or binding beyond the rule of expediency; it can always break faith on the pretext of the State's monopolistic rights.

"So rapid was the growth of German trade under the new system, irrespective of supply and demand, that the German system of 'dumping' came into being. The cartel at the time was a combine within an industry to safeguard the home market by throwing excess production on foreign markets. As the general staff were working out plans for world domination, so the trade colleges, the Handelsakademien, were scientifically working out commercial campaigns for the domination of the world's markets. The cartel became the most efficient means of crushing ruthlessly, relentlessly, brutally the competition of rival commercial Powers. The system was a complex interweaving of banks and of interests co-related.

"Their scheme succeeded and crushed out all opposition in the lines they attacked. Their approach to a market was no less methodical and thoroughly organized than the advance of their troops in the field. Suppose a German linen cartel should attack you in North America, and decided on cutting prices considerably below yours, as they probably would, they would notify all the co-ordinated cartels, those of growers, spinners, weavers, dyers, bleachers, finishers, coal producers, &c., who would make the allowance of price necessary to cut you out of the New York market. Allowances would be arranged by the Abrechnungstelle, a special accounting bureau for the cartels. The German banks would finance the deal, and the German Ambassador at Washington would lend his assistance. The Government would carry the goods to Hamburg free on the State railways, and could pay a special export bounty far in excess of the usual two marks per 100 kilograms which is allowed manufacturers on goods sent abroad. The whole German Empire is taxed to further the economic invasion of foreign markets through dumping by cartels. As soon as you were beaten out prices would again rise.

"Before the war the United States, through the Sherman Anti-Trust Law, was endeavouring to stamp out trade combinations; to-day she is encouraging them, and the Sherman Act is to be repealed. This is because it has been recognized, none too soon, that only by combination can the commercial menace of the cartel be defeated.

“ But these are not all the German methods that will be employed against you. They still have that most powerful weapon—propaganda; and when it is insidious, subtle and cunning, it is most dangerous.

“ These are the reasons, and very compelling reasons, why the linen trade requires to-day to take stock of its position.

“ Everyone must now be aware that Germany, whether she wins or whether she loses, has ready for after the war a plan of concentrated industrial organization far in advance of anything she has previously attempted, and in this education, finance, propaganda, science, research, scientific business methods, co-operative buying and marketing will be employed with an intensity hitherto unknown.

“ In spite of their pre-occupation with the war they have been systematically preparing and organizing their post-bellum markets so that they may catch you napping—they have even been doing this in your own country, so Mr. Hughes tells us, and their underground influence has kept the Deutsche Bank alive for four years, and has made it difficult for the Governments of the Allies to come out with a strong commercial policy.

“ ‘ Stocks are depleted,’ says the mentally lazy business man; ‘ we will have a high old time filling in these depleted stocks after the war. Why worry about organization, scientific research, developing markets? There is no need; we are quite safe.’ Do these short-sighted stock-fillers really imagine that the game of stock-filling is going on for time and eternity? It will only go for a space, a much shorter interval than most people imagine. These will be the precious moments, and just on how you use them depends the future of the linen industry. International competition will follow such as none of us have ever experienced.

“ We were totally unprepared for war. Are we going to be equally unprepared for peace? Can the linen industry afford to wait complacently until competition such as this overtakes it? The time to prepare is ‘ now.’ ”

In Article XVII, Mr. Curtiss sets forth the proposed scheme for Science in the Linen Industry, and defines his position in connection with the Provisional Committee on Research. It appears that at the first meeting of the Committee it was decided to ask Mr. Curtiss to undertake the necessary propaganda work, and to pay him a fee for so doing.

In order to carry out the work, and to secure the financial assistance which the Government is affording to aid industrial research, it is necessary to form an Incorporated Research Association, and for the formation of this association the preliminaries are well in hand.

Those firms or individuals concerned in the linen industry who contribute financially will constitute the ordinary mem-

bers, and from them will be elected the governing body or council, who will direct the operations of the research department.

It is suggested that the representation on the council shall be apportioned in an equitable manner over the various sections and interests in the industry.

The headquarters will be in Belfast, that being the largest centre.

At first, on account of the war, it would be impossible to have your own laboratories and experimental stations, but as soon as circumstances permit these, with the necessary equipment, should be provided for as and when required.

In the meantime it is recommended that if possible arrangements should be made for the use of such facilities for research as already exist in the district.

It is of the utmost importance to have at the head of the staff a thoroughly competent director of research. This is a difficult and exacting post, as it requires, in addition to executive ability, a broad knowledge of science in its various branches, and the best man obtainable should be selected, as the success of the research department depends to a great extent on the ability of the director.

All the men qualified for this position are at present engaged on war work, but it is suggested that a selection should be made at the earliest date, and someone appointed who could take up the work immediately on the conclusion of the war.

The scientists employed should also be the best obtainable, as unless an undertaking of this sort is carried out in a thorough manner it would be better not to attempt it at all. It cannot be successfully run "on the cheap."

The Committee, says Mr. Curtiss, have asked me to make it very clear that no results of importance can possibly be expected for some considerable time, though probably in small matters improvements may be effected in a shorter period. To expect revolutionary results after a year or two would not be reasonable, and it would be most disastrous to the work carried on in the research department if because it did not show immediate results it were to be snowed under by destructive criticism.

When the research department is established and in working order it is anticipated that each firm subscribing will enjoy the following privileges:—

(1) It will receive a regular service of summarized technical information which will keep it abreast of the technical developments in the industry at home and abroad. To do as much for itself any firm would have to employ more than one man on its staff reading and translating the technical press.

(2) It will be able to obtain a translated copy of any foreign article in which it may be specially interested and to which its attention will have been drawn by the periodical bulletin.

(3) It will have the right to put technical questions and to have them answered as fully as possible within the scope of the research organization and its allied associations.

(4) It will have the right to recommend specific subjects for research, and if the Committee or Board of the research organization of that industry consider the recommendation of sufficient general interest and importance the research will be carried out without further cost to the firm making the recommendation, and the results will be available to all firms in the organization.

(5) It will have the right to the use of any patents or secret processes resulting from all researches undertaken.

(6) It will have the right to ask for a specific piece of research to be undertaken for its sole benefit at cost price, and if the governing committee or Board approve the research will be undertaken.

In Article XVIII, Mr. Curtiss deals with financing the scheme, and says:—

When a man is asked to pay out money the first thing he generally wants to know is what benefit he is going to derive from his outlay.

There are two ways in which a man can derive benefit—(1) directly, (2) indirectly.

When the scientists in your Research Department invent a scutching machine which will give you 90 per cent. of the fibre on the flax crop as scutched flax and only 10 per cent. as tow, instead of losing 50 per cent. of its value, as you are doing at present, the farmer and the scutch mill owner will benefit directly, but every section of the trade all along the line will also benefit indirectly. The farmer will have a larger yield of fibre per acre for the same outlay, and he will be able to sell his flax at a lower figure to the spinner; the spinner in turn will be able to reduce the price of his yarn; the weaver will be able to sell the cloth cheaper to the merchant, and the finished cloth will eventually reach the consumer at a lower price than before. The finished product is produced more economically, it will carry better wages and profit, and the lower price tends to make it saleable in larger quantity. Everyone concerned, therefore, derives a benefit either directly or indirectly: the farmer who grows the flax, the spinner, the weaver, the bleacher, the merchant, the whole district are benefited; the distributor is also a gainer; the consumer, too, gets a share through obtaining linen at a lower price.

SCIENTIFIC RESEARCH AND THE LINEN INDUSTRY.

CRITIQUE AND SUPPLEMENT.

The following notes by one of wider experience and broader outlook than the majority of those engaged in the linen trade is intended to supplement that inspiring series of articles which

have been appearing in this paper from the pen of Mr. J. C. Curtiss, an American university man, who has made a study of industrial research, and whose services have been secured by the Linen Trade Research Association. We admire his enthusiasm, commend his ideals, and trust that the war has opened up a new era in the history of the trade and killed the conservatism and lack of initiative of mill-owners, &c., which has been a stumbling-block to progress in the past. We do not know if Mr. Curtiss is capable of, or intends to carry on, research work for the trade himself. Whether he is among them or not, the following notes may prove suggestive and provide food for thought among progressive men, and save their time, without, we hope, tending to keep them in the old rut; for any great progressive step must be revolutionary and off the beaten track.

Perfection.—While existing methods of flax decortication, spinning, weaving, and cloth finishing may not be economically perfect, yet none can deny that the finished product, be it linen thread (which may be described as sinews of flax) or snow-white and lustrous damask, stands head and shoulders above any other vegetable textile. The very properties which render it superior to its rival, cotton, are those which increase the cost of its manufacture. Practically all ancient and modern attempts to revolutionize the trade from the time of Lee to this date, mostly American, have been in the direction of cottonizing the flax fibre—a most mistaken idea, resulting in the destruction of the valuable qualities of the flax fibre, without even producing good cotton. Researchers, therefore, need not waste their time in this direction.

It seems to me that the most promising field for development lies in the direction of cheapening production, will be at the expense of the cotton industry, and will necessitate the cultivation of more flax. In spite of what anyone says, we have advanced considerably on these lines in the mechanical department during the past thirty years, notably through the adoption, first, of the heavy spreader system, followed by the automatic hackling machine and automatic spreader.

Mr. Curtiss instances many revolutionary discoveries made in the province of steel, viscose, high explosives, dyes, electricity, pottery, pneumatic tyres, leather substitutes, aeroplanes, turbine engines, &c.; but gradually, as his articles proceed, he seems to work round to our own way of thinking—that it is on the lines of cheaper production that advance must be made. The finished flax produced must eventually become pure cellulose, and there is no possibility of chemically combining it with other substances for textile purposes, as in the manufacture of steel, explosives, dyewares, &c. In his seventh article, therefore, Mr. Curtiss has to admit that “It is obvious, therefore, that the linen industry should concentrate on this high

cost of production and see what can be done to reduce it." He tells us nothing we do not know when he says that "Waste is one of the chief factors in high cost of producing." We are afraid that one thing that is wrong to-day is that spinners do not realize how much spinnable fibre they throw away or sell for "a mere song." It is an open secret that others thrive on their rejections, and that spinning mills could be kept going with fibre sent to the felt and paper-maker; and, while the spinning of cotton, woollen and jute wastes have become important industries, there is no corresponding branch of the linen trade. It is not that it cannot be done; all that is required is capital and enterprise.

Regarding what Mr. Curtiss says in Articles VI and VII about flax seed selection, pure strains of seed, &c., we are under the impression that Dr. Eyre is only covering ground already dug by Professor Bateson, and that the Japanese are years ahead of us in this branch of the industry. Mr. Curtiss writes of producing flax stems of double the present length, and thus doubling the yield of fibre per acre. This sounds or reads very well, but will probably prove impracticable. In the first place, stems of this length would not remain upright under a shower of rain unless the stems were correspondingly robust, and such stems do not produce fine spinning fibre, and the product would probably only be a substitute for European hemp. As regards the mechanical pulling of the flax crop, if Mr. Curtiss were of a mechanical turn of mind, and had studied the problem of flax-pulling by machinery as I have done I do not think that he would be so sanguine about the "enormous saving in yield" to be effected by this means. Mr. Curtiss, when he says that the principles of flax retting "have never yet been systematically researched" ignores the labours of such men as Schenck, Van Steenkist, Legrand, Feuillette, Blitz, Rossi, and others whose names my memory fails to recall at the moment. Carried out as it has been for the past 4,000 years, scientists fail to improve upon results achieved by practical men to-day. What is wrong, as Mr. Curtiss points out, is that the flax as brought to the scutch mill is, as a rule, tossed and either over or under retted, owing to the unskilful treatment it has received at the hands of the farmer and his hands, who have done this part of the work with what skill they have, and more or less patience and care.

Mr. Curtiss is merely echoing my words and opinions expressed in public and in the technical and daily press during the past ten or more years when he says, in Article VI, "One could hardly over-estimate the possibilities of the introduction and development of a system whereby the flax would be bought on foot from the farmer and subsequently handled by scientific methods in co-operative reterries. In this way the

farmer would be relieved of a responsibility which never should have fallen upon him, and would then be able to direct his energy and skill to the production of a larger and better crop."

We know more than "vaguely" that a great deal depends on the retting, and that this process to more than "a considerable extent" governs the yield of scutching, the spinning and bleaching properties, the lustre and character of the flax.

Mr. Curtiss is quite right when he says that "it will surely be worth considerable expense, time and trouble to thoroughly research this most important process, and would be quite safe in prophesying that improved quality and reduced cost would be the result."

The word quality brings us to another important point and into debatable ground, and what we are about to say may lead to a controversy unpalatable to some, but which we do not shirk, believing that it will result in the ultimate good of the trade. Up to the present spinners have welcomed large supplies of cheap but inferior Russian and Irish flax fibre, using it to produce the coarse yarns required for sailcloth, crashes, and other cheap linen fabrics. In years gone by they found medium grade Irish—badly scutched and handled, but cheap—almost a necessity in the production of medium grade yarns, and although professedly advocating drastic improvement in the handling, retting and scutching of Irish flax, would have been at a loss if this medium grade flax had disappeared and been replaced by an article equal to the best Courtrai, Dutch, and Flemish flaxes. His refusal to pay equivalent prices for really good Irish flax forced the Irish farmer and scutcher to the conclusion that it did not pay to produce this class of fibre, and that a half-scutched article giving a high yield at the mill was far more profitable as far as they were concerned, as in reality it was in view of the price paid per stone as compared with the maximum price of the Irish flax buyer. The letter from "A Farmer" which appeared in the correspondence column of the *Belfast News-Letter* on July 7 or 8 last has also some bearing on this matter.

IRISH FLAX HARVEST, 1918.

Flax pulling commenced in the Newry District on Saturday, July 20, in connection with the flax extension scheme, Mr. Robert Kerr, J.P., Newry; Mr. Frank Wilson, Newry; and Mr. Samuel Pink (Bessbrook Spinning Company) were the Committee representing the local mills, whose workers volunteered to pull the flax in the Newry district—between 400 and 500 acres. The first lot ready in the district was that belonging to Mr. W. H. B. Moorhead, J.P., Carnmeen—21 acres—and 100 hands, about one-half of whom had pulled flax before,

started to the work. All hands entered with enthusiasm into the work. During the day Mr. Kerr, Mr. Wilson, Mr. Pink and Mr. J. N. Richardson visited the field of operations, and expressed themselves greatly pleased with the way the work was being done. Mr. Heber A. Magenis, J.P., Poyntzpass, was in charge of the operations in the field. In another week most of the lots were ready for pulling, and 300 workers who had volunteered were then engaged.

The last week of July saw flax pulling in full swing among the 650 acre crop grown for the syndicate in the Co. Kildare, West Meath, and surrounding districts. The operations were under the general supervision of Mr. Craig Houston, the energetic manager of Messrs. The York St. Flax Spinning Co.'s York Road Mills.

The acreage under flax this year in the North-west far exceeded any previous year in the life of the present generation, and the farmer had some difficulty in procuring sufficient help to save the crops. The increase was urged by the Government, and practically every farm of reasonable size in North and South Derry had got at least one field of flax, and the handling of this was a most serious matter. The Department, to give encouragement to farmers, rented from the Donneybrewer Land Co., Eglinton, four large fields, in all about 85 acres, and sowed them out in flax. These fields are situated near the sea, flax and heavy soil, but capable when well laboured of producing satisfactory crops, and Mr. John W. Stewart, the well-known flax expert, judged aright when consulted about the productive power of this land. Some of the flax, of course, is good and very good, some bad and very bad, but it is a decent average.

Labour was not easily obtained, for the corn harvest was also ready, and passing through the country one found every rural resident in the fields. The pulling of the eighty-five acres already mentioned was no easy task, particularly in the face of a big labour strike in the district.

The strike was fortunately settled in good time, and master and man were soon on friendly terms once again. All round this part of the country these eighty-five acres were called the "Department flax," and fifty of the "Department" men were sent down by the Flax Extension Committee to help at the pulling.

These "Department men" so-called were in reality the school Cadet Corps from Belfast R. A. Institution, under a number of instructors, including Mr. Dunn, of Messrs. Lindsay, Thompson, and Co., and in charge of Captain Harriman, assisted by Lieutenants Manning and Beattie. There was no friction between the boys and local labourers, for many of the latter assisted and had to teach the boys, whose hands at the beginning succumbed for a time.

It was an interesting sight to witness these cadets at work, to which they soon settled down and looked like labourers of long standing. They were not the nice tunic-uniformed lads of Belfast now. Their nearest relatives would scarcely have recognized them with their old boots and ragged garments. Dressed, too, in agricultural garb, and as busy as any of the boys, was Captain Harriman, with his white sun hat, rejoicing in the delightful weather. The captain is a most social and agreeable officer, and the boys don't hesitate to do his bidding. "I have no trouble with these boys," he is reported to have said. "After the first day they got right into the spirit of the work, and they have not lost their time. We cannot expect to turn out the work as neat as the old-timers. The weather since we started has been bad, and was much against us." The boys had their amusements in their holidays, and were having a really good holiday of hard work and recreation. Bathing parades, singing parties, &c., were formed, and one evening in the village they gave a concert for the benefit of the Red Cross, and realized £5.

Flax pulling in the Kentstown District of the Co. Meath ended during the last week in August, some 100 acres being pulled in this district by 250 workers—men, women and children, who found the work most remunerative. The crop was an excellent one, and yielded results which more than justified the enterprise of Mr. J. F. Litch. The crop at Sicily was not such a heavy one as on Mr. R. J. Butler's land at Staffords-town, where 156 single stooks or $156 \times 12 = 1,872$ beets each 7 inches diameter, or 22 inches in circumference, were harvested per acre.

Where mill and factory hands were employed in pulling, as in the Co. Kildare and around Belfast, Lisburn, Lurgan and Newry, as anticipated by us, but contrary to the expectations of some, the girls after a little practice proved themselves capable pullers.

After the first wet Monday, the weather remained fine and favourable and many came home without a drop of rain.

As far as we are aware, only one flax-pulling machine made its appearance in Ireland this year and proved defective, leaving behind as many stems as it pulled.

It is reported that Sir John Dillon, of Lismullen, Navan, followed the same practice as last year and cut his crop of seed flax with a reaping machine.

THE IMPORTANCE OF GOOD FLAX SEED.

Lecturing in Belfast recently on "Flax Seed Selection," Dr. J. Vargas Eyre, of the South East Agricultural College, Wye, Kent, is reported to have stated that: "There are a host of influences at work, all playing an important part in

determining the character of the ultimate fibre. Primarily, the breeding of the seed itself is of very great import. There are immense and far-reaching potentialities to be realized in producing pure strains of seed both from the point of view of length and plant perfection and also from the aspect of uniformity of fibre and its quantity. The fibre produced from the pure strain is quite remarkable and when this has been propagated more extensively it is certain that a larger crop of fibre per acre as well as a more even quality will be achieved.

“In producing a pure strain on the Mendellian system a period of four years at least is necessary before the strain becomes constant. In this research the first stage has been achieved of producing a long stalked plant without any tendency to branch. Next stages, quite achievable, no doubt, in similar fashion, will be to produce plants considerably improved in quantity and quality of fibre, as well as in an attempt at isolation of particular fibre for specific purposes.

“Upon making a comparison of the crop raised from the originally imported seed and the corresponding crop raised from the selected seed, it was at once apparent that an increase in the height had been brought about by selecting for tallness and the crops from the selected seed also presented a greater degree of uniformity. In one case an increase of nearly ten inches was manifest.”

Mr. F. K. Jackson, of the Flax Experimental Station, Selby, is able to declare that for two years he has been able to obtain by care straw nine inches longer than that from imported Dutch seed grown beside it. This seed, which had been selected for length of straw, was sent to Selby by Professor Bateman, of the John Innes Horticultural Institute.

At present there is an utter lack of uniformity in the stalks of flax, so every effort should be made to avoid this dissimilarity in the evolution of a pure strain of seed which may be relied on to produce a longer flax with greater yield, almost uniformity in height and altogether uniformity even in quality of its fibre.

When these pure strains of seed come on the market every farmer should be encouraged to use them, aiming at the production of a given quality of fibre. This if scientifically handled in the subsequent intermediate processes, will lead to the solution of many of the difficulties which now confront the spinner and the manufacturer. When attempting to grow good flax on the basis of fibre per acre, it also becomes a matter of importance to know whether the flax stems are likely to carry the maximum quantity of fibre distributed around the stem equally, or whether they carry the maximum amount of fibre by virtue of their length. Whether the variation in fibre distribution in the stems leads itself to

plant selection is a matter which should be determined at an early date.

The value of the flax crop depends not only upon quantity of fibre per acre and uniformity of straw length, but also upon the character of the individual fibres making up the bundles which a microscopic examination of the cross section of a stem reveals. The variations shown in these cross-sections of the fibres are very considerable. It is found in some cases that the bundles are composed of large irregular fibres associated with small compact fibres, whereas in other cases the presence of small compact fibres characterise the bundles. Then, also, the prevalence of larger irregular thin-walled fibres show as a characteristic feature.

More scientific knowledge of the saving of flax seed is a still further field for research, so that perfect seed and unimpaired fibre may be the reward to the grower for his labours.

A more thorough knowledge of fertilizers by the growers would assuredly be conducive to a greatly increased yield of flax per acre.

In conclusion Dr. Eyre maintained that there was pressing need for systematic research on the manner in which the ultimate fibres respond to cultural treatment and the possibilities of improving flax by methods of plant selection and by plant breeding—both as regards uniformity of length and uniformity of fibre.

FLAX-GROWING IN RUSSIA.

According to a recently published booklet issued by the Central Association of Russian Flax-growers, Russia is a country of small peasant holdings. As a rule the peasant's household carries on the farm work without resorting to hired labour.

In the north and north-west of European Russia flax-growing and butter making occupy the farmers' attention almost exclusively. As far as the former is concerned, it forms the principal occupation of the peasants in over one-third of all the provinces of European Russia. Before the war the area under flax in twenty-seven provinces exceeded 2,786,400 acres, there being over 3,500,000 small farmers engaged.

In some parts of Russia the acreage under flax approximated from 25 to 30 per cent. of the whole area under crops. In such localities the return from flax-growing formed a considerable part, extending to 50 per cent. and over of the whole revenue of the household.

Russia occupies a prominent position in the world's production of flax, as evident from the fact that out of 15,298,200 acres, representing the average yearly world acreage under

flax in the decade immediately preceding the war, 2,786,400 acres, or about one-fifth of the whole, were cultivated in Russia. As far as the products of flax-growing are concerned, Russia's position is somewhat peculiar. Her share is a very small one in the world's production of linseed, but she predominates in the production of flax fibre. Out of the total quantity of linseed, amounting to 2,825,000 tons, produced all over the world, Russia's share is limited to 394,000 tons, or to 14 per cent. of the whole; whereas from the total world's production of flax fibre of 662,000 tons, Russia supplied 412,700 tons, or 62·3 per cent.

Notwithstanding the low productivity of flax-growing in Russia, being as it is twice lower than in Hungary and Austria and two and a half times lower than in France, Russia yet occupies the first and foremost place in the world's production of flax fibre. She grows flax over an area six times larger than all the other countries combined and gathers, as compared with them, three times as much flax.

Holland has 34,560 acres under flax, produces 8,361 tons, or 543 lb. per acre.

Hungary cultivates 46,440 acres and produces 12,705 tons, or 613 lb. per acre.

Ireland averages 48,600 acres, yielding 9,668 tons, or 445 lb. per acre.

Belgium has 49,140 acres under flax on an average yielding 9,834 tons, or 448 lb. per acre.

Germany cultivates 57,510 acres yielding 10,477 tons, or 408 lb. per acre.

France sows 61,200 acres on the average yielding 20,869 tons, or 761 lb. per acre.

Austria has 14,985 acres under flax, yielding 443,326 tons, or 661 lb. per acre.

The total for all countries, Russia excepted, is thus 447,330 acres, yielding 116,250 tons, or 554 lb. per acre.

The production of Russia averaged 2,646,810 acres, yielding 363,660 tons, or only 308 lb. per acre.

Beginning with the second half of the nineteenth century flax-growing in practically all countries of the world suffered a setback and began gradually to decrease. In Russia, on the contrary, it continued to grow and develop. However, the inner structure of Russian flax-growing has undergone radical changes during this time. The big estates employing hired labour followed the example set by the process of the reduction of flax-growing which went on in other countries. They were forced to adopt this course by two different circumstances: on the one side, by the increased cost of flax cultivation when carried on by means of hired labour owing to the rising wages of farm labourers; and on the other side, by the falling prices for flax, due to the appearance on the world's

markets of the cotton fibre. Only the small peasant farmer, who dispensed with hired labour, was in a position to continue the cultivation of flax as before. In this he was further assisted by a number of factors, such as that flax-growing was carried on on newly-broken-up land; that when growing flax the family of the peasant were provided with a winter occupation in hand-scutching, instead of having to migrate to the towns in search of work, a very common procedure in Russia.

Taking man hand-power as 1, juvenile hand-power as $\frac{1}{2}$, woman's work as $\frac{3}{4}$, and horse-power as $1\frac{1}{2}$, and expressing all this in man-power, the amount of labour required for the production of 1 desiatina (= 2.77 acres) of flax in Russia is approximately as follows: The quantity of horse-power required for flax-growing in Russia, if converted to man-power, amounts to only 16 per cent. of the total number of days, whereas 84 per cent. is spent in manual labour by the members of the peasant's family and especially by female labour, as of the total number of days, the part of juvenile labour is only 4 per cent., of man labour 19 per cent., and of female labour 61 per cent. But the hand treatment of flax naturally produced effects detrimental to the interests of the producers. Being carried on in a very primitive way it yielded a fibre of very low quality, which fetched but a low price on the market. Eventually the falling price of flax threatened to affect the production of this commodity even by the small farmer. The greater part of the flax produced in Russia has always been exported. The peasant producers, being unorganized and isolated, did not and could not take part in the foreign trade in flax. It was natural, therefore, that a whole string of middlemen appeared, through whose hands the flax had to pass from the peasant producer to the consumer in the person of the spinner abroad. In some cases, before reaching the spinner, the flax had to pass through five to seven different middlemen, who each made as much profit as they could out of it and sometimes adulterated it.

The attention of the Russian community was at last directed to this branch of the national trade and to the circumstances under which it was carried on. An All-Russian Congress of representatives of flax-growers was called together in 1912, to which, in addition to the actual producers and manufacturers, a number of experts and professors were invited. This Congress indicated the measures required for the advancement and progress of Russian flax-growing, and recommended the conduct of the trade in flax on co-operative lines.

The first experiments in co-operative marketing of flax were undertaken in 1912, and within a period of five years the number of credit co-operative societies operating in this branch of Russian agriculture has grown to over 20,000. At

the end of 1917 there were 247 Co-operative Credit Unions in the sixteen flax-growing provinces of Russia. The further idea of cementing more closely the work of the individual unions was also gaining ground and was finally realized in the autumn of 1917, when the Central Association of Flax-growers was formed.

In this way the unification of the co-operative societies engaged in handling flax was set upon a firm basis. From this moment the co-operative organization of flax-growing in Russia attained its harmonious and uniform structure, composed of local individual co-operative societies, joined in district or provincial unions, the latter combining in the central organization.

As to the activities of the Association, those appertaining to the marketing of the flax and the supply to the members of seed and materials required for the flax harvest have been attended with the greatest success. Of late, some co-operative societies have organized to hackle flax by machinery and to manufacture oil from the seed.

Before the war, the provinces covered by the Central Association of Flax-growers provided yearly over 300,000 tons of flax. During the war, principally owing to the scarcity of labour, the sowings of flax noticeably decreased, the rate of decrease being 8 per cent. in 1915, 7 per cent. in 1916, 9 per cent. in 1917, and from 9 to 15 per cent. in 1918.

The total yield of the flax harvest season 1917-18 over the whole of the flax-growing area in Russia amounted to about 250,000 tons. Towards this last figure the co-operative societies contributed 19 per cent. Of the remainder, the peasants used in their home spinning about 84,000 tons. Russian spinning mills took about 50,000 tons, while 38,000 tons remained in the hands of the peasants owing to the total absence of demand from private traders.

The flax produced in Russia is sold chiefly abroad, the normal export of flax amounting to about 300,000 tons.

The gathering of flax by the co-operative unions is carried out in two ways. In one case the Credit Co-operative Association maintain special collecting depots in the respective localities, where the peasants arriving from the surrounding districts deliver their flax. Before the flax is taken over by the Association it is subjected to valuation by a special valuer from the local Co-operative Union. After this, the local Credit Association issues to the peasant a receipt showing the amount, quality and market price of the flax received from him. On the security of this receipt the producer is entitled to an advance amounting to 90 per cent. of the market value of the consignment. The flax thus collected is forwarded to the storehouses of the district unions.

Another way of handling the flax is carried out by the

District Co-operative Unions, which themselves collect the flax at central points where flax markets are usually held. The flax received by the union is credited to the account of the associations working in the locality of the respective producers, so that this Association conducts all further settlements with the latter.

Finally, the flax collected in one way or another is delivered to the Central Association of Flax-growers, which thus controls and unites the whole of the marketing of the co-operative flax.

As soon as a consignment of flax is sold the Central Association allots the amount derived from the sale amongst the Co-operative Unions, *pro-rata* to the quantity of the flax delivered by them; the unions distribute the sum received by them amongst the individual societies, and the latter amongst the individual member producers.

On the strength of the axiom, that the successful marketing of flax, ensuring the fullest possible return of the labour of the producer, depends to a large extent on the quality of the product, the Russian Flax-growing Co-operation insists that the local co-operative societies should pay special attention to the quality of the consignments of flax delivered by them for sale and to their proper packing.

However, the young co-operative organizations could not at once accomplish the task of establishing a uniform standard of flax. Owing to the historical conditions which led to the concentration of flax-growing in small husbandries they had to put up with the usual grading of flax according to "kriazh" or district local quality, such as Bejetsky, &c. In course of time, however, they succeeded in introducing a certain degree of uniformity within the limits of each locality and early adopted the following resolution:—

"It is imperative to introduce common methods of grading and to reduce the numerous local methods to a simpler and broader system, and to establish the standard of the Central Association, which must be checked from time to time by experimental hackling and other methods."

As a result of the Association's efforts, the Franco-British Committee, who purchased their flax in 1917, found the co-operative plan to be of a higher standard than that of private firms.

The net weight of the flax in a bale is usually $12\frac{1}{2}$ poods = 451.3 lb.

In some districts, however, other weights are still used and the flax packed in small bales weighing about $3\frac{1}{2}$ poods, or 126.4 lb. each.

In 1917-18 the co-operative flax was sold at Archangel to the British War Office, which acted on behalf of its Allies and distributed the flax bought among them. Great Britain re-

ceived about 60 per cent., France about 25 per cent., America about 15 per cent. of the whole lot.

Before the war the provinces of Pskov and Latland were the chief sources of the supply of Russian flax sowing seed, but of late much smaller quantities have been available owing to these provinces having become the theatre of military operations.

TO DISTINGUISH LINEN FROM COTTON CLOTH.

Since linen yarn is of more irregular thickness than cotton yarn, linen threads are easily recognized when the fabric is held up to the light. Linen threads snap sharper and clearer than do cotton threads, hence the difference in sound when the fabric is torn.

The oil test for linen is based upon the property which linen has of more readily absorbing oil than cotton does. When a union fabric which has been freed from dressing by washing and boiling is dipped in oil and then held up to the light it will be seen that the linen fibres look transparent, whereas the cotton remains more nearly opaque. This is due to the linen having absorbed the oil more readily than the cotton.

“THE LINEN FABRIC.”

- “ And this is the fabric whose fibre strong
 Will last through years of space,
 Which once through the fruit of the field among
 Its origin we trace.
 Yes, this is the fabric, all pure and white,
 Our Irish nation’s dower,
 Which owes its birth to the tendrils light
 Which bore the soft blue flower.
- “ ’Tis a free-born fabric! the sun in heaven
 Looks not with a burning eye
 O’er plantations vast where the slave is driven
 In hopeless toil to die!
 No, it springs from the lap of fair Erin’s land,
 And the sons of her fertile soil,
 With a willing heart and a willing hand,
 Secure the wealthy spoil.
- “ ’Tis a royal fabric! the ancient kings
 Of glorious realms of old,
 Where the Persian eagle spread its wings,
 Or the Nile’s proud waters rolled,
 As they sat in the halls of their princely line,
 In their purple robes arrayed,
 The snowy folds of their linen fine
 A contrast well displayed.

“ Not alone, in the ages long passed away,
 Doth it kingly favour claim,
 For as nations swept on with resistless sway,
 Their monarchs avowed its fame.
 Though no more enthroned in the palace hall
 As a vesture of Royal State,
 Its substantial worth is enjoyed by all,
 'Mid the high-born and the great.”

Irish linen has a world-wide fame. The moist climate of Ireland is admirably suited to the growth of flax and the processes of its manufacture up to and including that of bleaching.

Aided by its climate, the North of Ireland more than maintains its pre-eminence for producing that dazzling whiteness which can only be found in Irish linen, bleached on the lovely verdant fields of the Emerald Isle.

The use of linen as an article of clothing is veiled in the mists of antiquity. It is mentioned in the Book of Genesis as in use for robing the royal princes of Egypt, and in the Bible is frequently referred to in terms of appreciation and as a symbol of purity and excellence.

Nothing but the inherent beauty and excellence of the flax fibre has permitted its survival in the face of the formidable competition of cotton.

Transformed into cloth the brilliance and durability of flax is beyond compare. Time shows that it is better than cotton. The dress, handkerchief or tablecloth of cotton, once washed, give the impression of being worn out and of poor quality, while one of linen is as new.

Bleached linen takes a natural silky finish owing to the straightness of the fibres. To obtain anything like the same finish on fabrics made from curled cotton fibres, the application of starch wax, &c., is necessary.

Brazil furnishes the largest market for linens in South America.

The capital employed in the Irish linen trade may be roughly estimated at £7,000,000 in plant alone, or £13,000,000 all together, i.e., including stocks, &c.

RECENT INVENTIONS RELATING TO FLAX.

Patent No. 123710. PREPARING FIBRE FOR SPINNING. Etablissements E. Feuillette.

Breaking and Scutching Apparatus.—The flax, &c., is fed from an apron through a series of feed rollers arranged around semi-circular plates supported on side cheeks connected by cross bars. The rollers are supported on brackets and alter-

nately with the rollers are arranged jaws comprising three bars and two laths. The jaws are supported on radial rods and acted on by springs. The laths slide between the bars against the action of weaker springs. The material is nipped and bent against the jaws by a series of rotary beaters carrying ribbed bars. The beaters are mounted on a driven drum and are at the same time rotated on their own axes by gears engaging with a stationary gear on the main shaft. The drum and beaters are mounted on ball bearings. The lower feed rollers are all driven by a chain. The arrangement of beaters and jaws is such that no stalk is nipped simultaneously by two beaters but is acted on by them successively.

No. 115,547. PREPARING FIBRES FOR SPINNING. J. A. Williamson.

Breaking and Scutching Apparatus: Holders for Flax, &c.—In an apparatus for scutching flax, &c., the material in bundles is carried by a revolving stock of cylindrical or polygonal shape moving continuously or intermittently and at a uniform or variable speed, which can be adjusted to suit the material being treated. The stock comprises two concentric cylinders with registering notches in their upper edges in which the bundles of flax are laid. Clamping bars are situated between the cylinders and raised by a cam to free the flax to be reversed or withdrawn. The flax is secured also by holders comprising jaws, the latter of which is withdrawn, to allow the flax to be inserted, against the action of a weight, by a fixed cam engaging a projection on the sliding spindle of the jaw. The rotation of the stock carries the flax past the beater arms which treat one side of the bundle. After passing the arms the clamping bars are raised by a cam and the bundle turned over to expose the other side of the bundle to the action of a set of beaters. This turning is accomplished by the rotation of the holder by racks which engage a toothed wheel on the hollow spindle of the holder. The racks are depressed by cams on the plate. The second set of beaters may beat the flax upwards against a fixed stock, in which case the holders may be dispensed with. Additional beaters may work across the face of the stock.

No. 28560, 1919. H. R. Carter.

A method of slivering tow without carding and practically without waste, whereby a given quantity of tangled fibres are drawn parallel through a porcupine feed roller and laid on the drum of a filling engine. This known length of fleece of given weight is then cut off and used to feed a wide-gilled drawer, the fibres being still further parallelized by being drawn through the pins of the gill by the higher surface speed of the drawing roller. The fleece from this machine may be condensed into a sliver which is afterwards doubled and drafted with others or combed in the usual way.

OLD WHITE LINEN HALL, BELFAST.

The following ode, culled from a Belfast local paper and published at the time when the White Linen Hall was demolished to make room for the present City Hall, may be of interest to lovers of old Belfast:—

“ And so I’m out of fashion—said to be old and worn,
And strangers shrug their shoulders and want me downward
torn.

I’m grey, and so unsightly too! fast moulding to decay—
Well, well! Perhaps Belfast is right—and I have had my day.
Men thought me, in the olden time, a model of delight;
I was pointed out to visitors as a noble, worthy sight.
Alas! that generation’s gone, and I am left alone,
Without one hand to shield me from being overthrown.
Belfast was not a city then, but just a dear old town,
And I was as its pivot—that commerce went around
I made the town a city, too—I mean its staple trade:
Then woe to him who spurns me and want me in the shade.
No tramcars then did grace our streets, for people once
could walk,

No trains kept shrieking loudly to give us all a shock.
No telegrams, no telephones, nor yet Westminster chimes,
O yes, dear me, ’tis sadly true, I’m far behind the times.
Well, well! perhaps the world is right, ’tis true I’m getting
sere;

But all the same I cannot help brushing away a tear.
Old buildings, like old friends, are often in the way:
Well, well, perhaps Belfast is right, and I have had my day.”

THE FLAX SOCIETY, LTD.

Mr. Austen Chamberlain writes, in answer to a question by Major Barnes (R.) respecting advances made out of public moneys in connection with the growth of flax, &c., that in 1918 the War Department guaranteed a sum not exceeding £600,000 in respect of the administration by the Flax Society, Ltd., of a scheme for additional flax production in Ireland in 1918, in respect of which a guarantee of £200,000 had already been given by the leading firms and companies engaged in the linen trade. Two nominees of the War Department were appointed to the Society, with a right to veto any proceedings to which they objected. The profit or loss accruing in the Society’s administration of the scheme will be shared to the extent of three-fourths and one-fourth respectively by the War Department and the guarantors. The operations of the Society had, in fact, been much less extensive than was originally contemplated, and the maximum amount for which the Government can be called on under the guarantee has in

consequence been reduced to £300,000. The Board of Trade renewed this guarantee to the Society in respect of the year 1919 on a reduced scale. Under the guarantee for the year the Government guaranteed only half of the total sum (£400,000) guaranteed by the Government and the linen trade jointly, and the profit or loss accruing on the administration of the scheme for 1919 will be shared equally by the Government and the linen trade. As in 1918, the scheme administered by the Society has proved to be less extensive than was contemplated and the maximum for which the Government can be called upon in respect of the scheme in 1919 has consequently been reduced to £100,000. The names of the directors of the Flax Society are Messrs. J. G. Crawford, Frank Barbour, John Morrison, James W. Murland, James L. M'Ferran, T. Jackson Greeves, Samuel C. Haughton, and J. A. Cooper and R. Garrett Campbell (Government directors). Grants from the Development Fund for experiments in the cultivation and preparation of flax had been made up to September 30, 1917, to the University of Leeds and the British Flax and Hemp Growers' Society, a Society registered under the Industrial and Provident Societies Act as an association not trading for profit. The totals advanced to these bodies were £5,829 to the University and £22,463 to the Society, up to September 30, 1917. In the two years subsequent to that date further grants amounting to £1,130 have been made to the Society for seed trials.

LINEN EXPORTS, 1913-1918.

	1913.	1918.
Linen yarn to Holland	1,766,200	578,000
„ „ Germany	3,827,000	nil
„ „ Belgium	2,301,500	nil
„ „ France	407,800	526,900
„ „ Spain and Canaries	1,237,100	nil
„ „ Italy	54,800	231,000
„ „ United States	2,194,600	137,600
„ „ Other countries	4,516,700	204,800
	<hr/>	<hr/>
Totals	16,306,100	1,678,300
Total declared values	£1,215,744	£277,457

DUNDEE'S FLAX TRADE.

A large amount of flax spinning and manufacturing is carried on in the city, the output consisting principally of flax and tow yarn, linen and canvas of various qualities. The special products are tent duck, aeroplane cloth, double double and double single canvas and flaxens. There are about 5,000 workers engaged in the trade.

FLAX IMPORTS, 1913-1918.

	1913. Tons.	1918. Tons.
Russian flax	68,161	21,790
Dutch flax	1,442	597
Flemish flax (direct)	14,194	nil
Flax from other countries	473	563
Russian flax tow	13,416	1,906
Flemish codillas direct	3,812	nil
Other flax tow	955	179

INDIAN FLAX.

In February, 1918, the Empire Flax Growing Committee was appointed by the President of the Board of Trade, London, to investigate in all its bearings the question of increasing the supply of flax in the British Empire.

In the Committee's report with regard to India, it is stated that evidence regarding experiments in flax growing which were made some years ago in Behar and elsewhere show that flax can be successfully grown. There is, it says, little doubt that the system of central retting would be necessary to obtain the best results. This, however, necessitates skilled labour and supervision. Unquestionably, the successful development of the industry would also depend upon the services of an expert who would supervise the handling of the crop after it has been harvested and its proper preparation and grading for market. The Committee made the following recommendations: (1) It is undesirable that an industry so important as the British linen trade should remain largely dependent upon external sources of supply for its raw material, especially as the industry has proved to be indispensable in war time. (2) The efforts made by the Government under the necessity of abnormal war conditions to foster the revival of flax growing in the United Kingdom and to extend its cultivation within the Empire, have achieved a considerable measure of success, and it is essential that these efforts should be continued until full value has been derived from them.

THE FLAX PROBLEM.

(The Financier.)

It is an old and homely proverb that we never know the real value of water until the well runs dry. Similarly we only appreciate to the full our dependence on raw materials for our clothing when we find these approaching poverty point. The present climax in the linen industry is undoubtedly the most astonishing in its long history. Forced to exist on merely one-fifth of its normal supplies at a time when linen stocks every-

where throughout the globe are so far attenuated that their replenishment would keep the means of production, working both day and night were fibre obtainable, the British linen trade—the third of our great national textile industries in magnitude and the second in the value of its output—can only preserve its existence by working twenty-five hours weekly, i.e., two-fifths of the normal working hours' period. Moreover, there are the gloomiest of anticipations based on undeniable facts that affairs will become vastly worse before they become better.

DIRE SCARCITY.

The root problem of all is the dire scarcity of flax, which is, of course, linen's raw material. Further, it is certain that no great augmentation of stocks can be expected for probably four or five years to come.

Belfast, the centre of the British linen trade, owes its prosperity to the fact that economically it does not put its eggs into one basket, to adopt an apt simile. Thus while ship-building provides occupation for the male section of the population, spinning, weaving and the associated trades give employment simultaneously to their feminine folk. Albeit, in the past, had it pursued a similar policy in depending more on the broad realms of the British Empire than on one country—ill-fated and illusory Russia—the linen industry would not now have found itself in so precarious a position. However, there is no good from repining, and it is possible that the present predicament will drive home more forcibly than a decade of beaming prosperity the vital urgency of making the British Empire as self-supporting in regard to flax as it should be for its cotton and other material necessities.

Russia in pre-war days occupied even more pronouncedly the position as the great source of our raw material for linen than the United States did for cotton. Of the total supplies necessary 80 per cent. of the fibre was derived from that country and now its collapse has left an important industry unprovided for. Moreover, it has been made definite that, although hopes were cherished until very recently that some supplies might still be possible, that anticipation is baseless.

RAVAGED RUSSIAN AREAS.

As a matter of fact, the Russian flax-growing areas are mainly in the Baltic Littoral and the whole of that region has been ravaged not once but repeatedly by both German and Russian armies. So if there had been any stores accumulated they would have been pillaged long ago just as the fibre was stolen by the Huns from Belgium and Northern France. Further, it is quite safe to presume that there was practically little

flax grown there during the past five years, and as regards future provision of such the dire straits of the people incline to the belief that for some years to come their greatest difficulty will be to mobilize sufficient labour to grow wheat for their home consumption rather than flax for export.

CANADIAN FLAX SEED.

The increasing trade with Ireland in flax seed grown in Canada gives interest to an interview which a *Telegraph* representative has had with Mr. R. J. Hutchinson, Chief of the Fibre Division, Department of Agriculture for Canada. Mr. Hutchinson, who is a native of the North of Ireland, has been on a tour of inspection and investigation in connection with his Department. He says that the Canadian fibre seed has given very high satisfaction to farmers in this country, and he instanced the Coleraine district as a case in point. One of the leading growers there put in nothing but Canadian fibre seed last year, and is more than satisfied with the results. Similar reports come from different parts of the country. It is stated that Department of Agriculture tests have shown that the Canadian variety will yield £2 to the acre net profit better than Dutch Blue Blossom, which is a favourite in Ireland.

Complaints have been brought to the notice of the Association of Flax Growers in Canada of the changing of seed from bags and the substitution of oil seed, the matter was taken up by the Canadian Department of Agriculture, which has taken steps to guarantee that all imported seed from Ontario shall be protected against adulteration and misrepresentation. The seed is inspected at its source and exported in bags specially branded and sealed, ensuring the purchaser gets a pure fibre seed germinating 90 per cent. or better.

Discussing flax-growing in Canada generally, Mr. Hutchinson said: "There are two areas in Canada in which flax is grown. The first is the Western provinces ('Canada West'), which are commonly described prairie, with a 'semi-arid' climate, in which flax, of oil and feed character, and wheat, oats and barley are common and successful products. Efforts costing millions of dollars have been made to produce fibre flax there but with no result, as fibre seed, Dutch or other, has failed to produce fibre in that climate of value to commerce. Second, Ontario. No common or oil seed is grown in Ontario. Its flax-growth is entirely from fibre seed for fibre purposes. The climate in this flax district is very similar to that of Northern France or Southern England throughout the growing season. There is plenty of rainfall for fibre growth, as it lies nearly surrounded by the tremendous Great Lakes, and is abundantly watered by streams as well.

“For over seventy years flax fibre has been continuously produced in Ontario. At one time about 100,000 acres were produced. The fibre has mostly been sold to the spinners of the United States. The straw has been dew-retted for the most part.

“Dutch seed has always been regularly imported to renew the sowing seed, but all seed has always been saved, and better results in fibre have been obtained from Ontario seed grown from Dutch seed for several years successive sowings than from the imported Dutch. Where seed thus saved has been well selected, it has always been found superior, regardless of the number of years grown after Dutch.

“Irish farmers have for several years sown all surplus Ontario fibre seed, purchasing it through the ordinary trade channels as Canadian fibre flax seed, and reports of highly satisfactory results are everywhere obtained.

“A distinctive feature of Ontario flax-growing,” Mr. Hutchinson explained, “is that the grower usually farms 200 to 300 acres of flax, owns his own flax-scutching mill, and carries on nearly all operations under his own management. This has made it easy to develop a high standard of improvement in growing, retting and handling, and particularly in the harvesting and saving of seed; likewise, of course, in the control of seed sown. The flax-growers are organized in an Association which promotes intelligent and uniform action in respect of all matters of common concern. One result is a universal sentiment in favour of jealously conserving the good repute of Ontario fibre sowing seed in Ireland as well as at home.

“The Canadian Government has for some years maintained a Fibre Division of its Department of Agriculture, which has actively co-operated with the growers, individually as well as in collective action. This division has carried on a close supervision of crop growths, seed selection, including departmental choice and importation of Dutch seed for the growers and other matters. Owing to reports that Canada Western oil seed and other unsatisfactory sorts had been sold to Irish farmers and dealers as Canadian fibre seed, the Department has taken action to ensure that true Ontario fibre seed can be obtained with certainty. It has brought about the thorough inspection, grading and branding of sowing seed exported from Ontario this year, on request of the growers, and with the utilization of the efficient organization of seed inspectors of the Canadian Government’s Seed Branch.

“This inspection begins with the growing fibre crops, continuing through the saving and cleaning of seed, and effectually insures that none but true fibre seed is issued in banded bags for export. A germination of 90 per cent. or higher (inclusive of broken seeds) is required, and a purity of 98 per

cent. (exclusive of broken seeds), or not more than one noxious weed seed per ounce. Bags to contain this inspected seed are supplied through the Department, printed to show clearly to anyone that the contents are inspected as described, and these bags are shipped on certificates showing actual germination and purity. The bags are also sealed by the Department."

Last year 28,000 sacks of Canadian fibre seed were exported and sold throughout Ireland.

There is also at present in the North of Ireland a gentleman who is an extensive flax-grower at St. Mary's, Ontario—Mr. A. L. M'Credie. He grows nearly 1,000 acres of flax, and the reason of his visit is that he has had a quantity of his own produce of fibre seed Government inspected, which has been produced from selected Dutch seed origin, following the principles of the experimental farms as closely as possible to secure improved quality. "I feel that it is worth the expense," he said, "to make a trip over here to introduce my seed at a premium."

Mr. M'Credie has been a graduate on the staff of the Agricultural College at Guelph, which gives teaching in the principles of scientific production. He is aiming at scientific seed improvement, just as Professor Ayre is doing here. He is satisfied that the vigilance of the Canadian authorities will ensure that the Irish farmer will get what he asks for when he is out to purchase fibre seed.

EFFECT OF FLAX SHORTAGE.

The *Times* Trade Supplement prints the following message from its Brussels correspondent: "In 1914 twenty-eight flax-spinning mills were at work in Belgium. During the war four of these mills were completely destroyed. Of these three are to be rebuilt. Work in this industry restarted in March, 1919, and by August all the mills, with the exception of those destroyed, were in operation.

Activity is limited by the lack of raw material. In 1895, according to a Ministry of Agriculture census, 76,250 acres were devoted to the cultivation of flax; in 1919 this figure had fallen to 62,500 acres. This decrease is due chiefly to the results of the war in Western Flanders, the chief centre of production. Further, most of the flax used in Belgium before the war came from Russia. To-day no Russian flax can be obtained, and supplies from Russia will probably not be obtainable for some years. Foreign buyers, too, owing to the Belgian exchange rate, have been able to compete with Belgian spinners in the purchase of Belgian flax, and now that the frontier is closed to flax, smuggling is practised on a huge scale.

The output of the Belgian mills before the war was 3,300,000

packets (of three bundles). It is very difficult to calculate the present figure, as in the same factory the production varies from week to week, according to the supply of raw material and the working hours.

The number of operatives employed before the war in the flax-spinning mills was about 16,000; to-day there are only 9,500.

EFFECT OF THE WAR UPON THE LINEN TRADE.

The year 1914 was an epoch-making one in practically all branches of trade and a vexatious one in most. Early in August the outbreak of war created a financial panic of widespread proportions. Flax values rose rapidly through the difficulty of obtaining supplies from Russia, upon which country so many flax-spinners depend. Stocks were, however, such that the year closed without any stoppage of machinery or serious shortening of working hours in either mills or factories. Government orders were freely placed and the price of linen goods went up so high that the public turned to cotton. Early in August Flemish flax, and especially Courtrai, was largely bought by Irish spinners at an extremely reasonable figure, holders being eager to realize while they could. Early in 1915 the same flax was worth double the money. Irish buyers had to flee from Courtrai for their lives and the Germans carried off a lot of flax to supply their own mills. For a time a considerable quantity of Flemish flax was carted over the Dutch frontier for dispatch to Ireland, but towards the end of 1914 the Germans trebled the guard and practically stopped the traffic. Irish farmers obtained up to 20s. per stone for their produce. Government orders for coarse linens brought about an enormous demand for all numbers of coarse line and tow yarns, the production of which, being beyond the capacity of the Belfast mills, caused the requisition of Belgian yarns to an abnormal extent, and until the end of September, when the Germans got control of Ghent, large shipments were made to Belfast yarn houses, who reaped a golden harvest through the eagerness of the Belgian spinner to sell and the Irish weaver to buy. Before the end of 1914, 25's tow yarn rose from 7s. per bundle to 11s. 6d. per bundle.

Dunfermline damask manufacturers were soon in a very awkward position. Relying almost entirely upon foreign yarn, they soon found their supplies practically cut off. Turning to Belfast, neglected in times of plenty, they found themselves given the cold shoulder. They had consequently to turn on to union and cotton damasks.

On the outbreak of war Belgian and French spinners made haste to clear out their stocks and spin up their raw material

while they could, but before their designs were accomplished Ghent, Courtrai and Lille were in the enemy's hands. By desire of the Germans and to keep their hands from starvation they continued to work shortened hours. Their products, however, being taken by the Germans and paid for in bonds of problematic value, they at length ceased work altogether, and their remaining stocks of flax were sent off to Germany, being paid for in a similar manner at a valuation arrived at by German experts. German spinners, whose supply of Russian flax had been cut off, continued to spin up the German crop, the remainder of their stocks and what flax they could get from France and Belgium.

Towards the end of 1914 Russian spinners bought largely of the new Russian crop at reasonable prices. Their weavers got very busy on Government work.

Abnormal values of flax were maintained and increased throughout 1915. While always nominal the value of Riga-K increased nearly £10 per ton during the course of the year, while the price of the finest flax nearly doubled itself, i.e., reached £300 per ton.

The acreage under flax in Ireland was 50,000 acres, an advance of only 7 per cent. on 1914. No embargo was put upon the transit of Russian flax through Sweden during the early months of the year, so thousands of tons reached Belfast and Dundee, while much larger quantities were shipped from Archangel. The value of 25's tow yarn advanced 4s. per bundle during the year. The advance on line wefts was comparatively small, say, 1s. 9d. per bundle.

Makers of boiled power loom linens were called upon to supply aeroplane linen, weight $3\frac{1}{2}$ to 4 oz.; while weavers able to make canvas, such as $10\frac{1}{2}$ oz., were kept busy on Government work. Short time (thirty-five hours per week) was almost universal. Twenty-five and a quarter inch roughs, normally $2\frac{1}{8}$ d. per yard, advanced from $3\frac{3}{8}$ d. to $5\frac{1}{8}$ d. during the course of the year, while $41\frac{1}{2}$ inch cambrics 16/16, normally $10\frac{1}{4}$ d., advanced from 1s. to $15\frac{3}{8}$ d. per yard.

The year 1916 was another eventful year. Towards the end of January the War Trade Department found it necessary to issue an order forbidding anyone to buy or sell Russian flax or tow in the United Kingdom without a permit. In May flax bought by spinners in Russia began to arrive from Archangel, much to the relief of spinners, who had been in some cases stopped for want of it.

The area under flax in Ireland was 91,500 acres. Fine spinners received small quantities of Courtrai flax through Holland during the early months of the year by paying three prices for it. Only one-third of the usual quantity of flax was grown in France this year. Nearly 900,000 acres were sown with flax in Canada. Record prices were again paid for

flax, up to 26s. 6d. per stone, or £212 per ton, being paid for Irish, £84 for best Livonian, £255 for Dutch, and £325 f.o.b. Rotterdam for Courtrai.

The price of linen yarns continued to advance during the early months of the year, 25's tow reaching 16s. 3d. and 120's line weft 8s. per bundle. Government canvas and aeroplane linens kept weavers busy.

The year 1917 saw the linen trade pass almost completely under Government control, so that supplies of both raw material and finished products might be utilized to the best advantage for war purposes. As much as 30s. per stone was paid early in the year for Irish flax; later the maximum price for Irish flax was fixed at 27s. 6d. In March, Livonian cost £130 c.i.f. and Bejetsky £181. In April the Army Council requisitioned all flax and tow in the United Kingdom, and decreed that all flax suitable for aeroplane cloth must not be used for any other purpose. In this year the Irish Department of Agriculture notified Irish farmers that they would have to dry, stack and save one-eighth of their flax crop for seed purposes. The acreage put under flax in Ireland in 1917 was 107,400 acres. The Minister of Munitions issued an order taking possession of all flax grown in the United Kingdom and agreed to pay from 25s. to 35s. per stone according to quality. It soon became necessary for a spinner to obtain a permit to spin wet-spun flax line yarns. In September the fall of Riga brought business in Russian flax almost to a standstill. Increased areas were sown with flax in Yorkshire, Somerset and Dorset and treated in Government factories established in various centres. Later in the year spinners were forbidden to make goods for civil use as enormous quantities of canvas and aeroplane linens were required for the British and Allied armies.

In February, 1917, 3-lb. D.S. tow weft cost 4s. 6d. per spangle, in July 6s. and in December 8s. 2d. Early in the year 25's tow cost 16s. per bundle and in December 28s. In January 120's line weft was 8s. 6d. and in December 13s.

The American demand for linens was active in spite of abnormal prices. The finest class of linen goods became practically unobtainable.

Italian hemp and tow came into increased use as flax substitutes.

The flax shortage, brought about by the German occupation of the Baltic Provinces, shortage of freights and difficulties of safely navigating the Baltic and North Sea, continued throughout 1918 in spite of increased areas put under flax in various parts of the U.K., Canada and the British Colonies.

The distribution of raw material remained in Government hands. Urged by Irish farmers, Government agreed to pay still higher prices for home-grown flax. The production of

flax-spinners had to be still further curtailed. There was no free yarn market. Licences to spin were necessary. In order to conserve linen yarns for aeroplane cloth the manufacture of linen damask was forbidden. All stocks of plain linens and cambrics 14^{oo} to 19^{oo} were requisitioned for aeroplane purposes and the export of linen fabrics practically stopped. Victory and the imminence of peace made business very quiet. Government contracts were cancelled, as was also the Linen Export Order.

Early in 1919 a Committee of Flax-spinners fixed the prices of warp and weft yarns for six months. Arrivals of flax from the Baltic were few and far between during the year 1919. In January the Flax Restriction of Consumption Order was cancelled and the Imported Flax Dealing Order of 1918 amended so as to permit the free purchase for importation of Dutch flax and tow by merchants. Permits were fully granted by the Flax Control Board to spinners for the direct purchase of all imported flax other than Russian flax. Some small parcels of French flax arrived from Normandy and Brittany and sold at over £500 per ton in Belfast, and the Government doled out their stocks of Russian flax to spinners at £110 to £115 per ton.

The Irish crop of 1918 proved most disappointing. Although the acreage showed an increase of 33 per cent. over 1917 only 2 per cent. more scutched flax was produced, the yield being only 17½ stones per acre, or almost 2 stones below the lowest yield on record, viz., that of 1868.

In April, Irish rescutched or milled tow was selling at £135 per ton for first quality.

In January the Flax Control Board announced that they would pay from 25s. to 35s. per stone for Irish flax according to grade, but when exception was taken to this the Board said that a mistake had been made and that 30s. to 40s. per stone was meant.

The Compulsory Seed Saving Order was abandoned. Early in the year the Esthonian Government took the flax business of their part of Russia into their own hands and refused to allow British buyers to deal direct with producers or merchants. Large areas were sown with flax in Belgium, but the crop was very short. In August the Flax Control Board authorized dealings in Russian flax and tow on the same terms as those already in force in the case of Dutch and other imported flaxes. Owing to the reduced price offered by the Government for 1919 flax, and also the poor yield of 1918, there was a falling off in the acreage sown with flax in Ireland, England and Scotland.

The Government helped and encouraged several hundreds of young ex-officers to study the cultivation and preparation of flax for market, with a view to extending cultivation at Nairobi, East Africa.

In October an arrangement was arrived at by which a sort of exchange of flax was made with Belgium, we giving coarse flax in exchange for fine. At this date the approximate value of Hoff's Riga P.K. was £217 per ton.

As a result of a campaign carried out by the Ulster Farmers' Union the Government agreed to pay up to 45s. per stone for Irish flax.

Although in the early part of the year there was little demand for yarn prices remained firm. A feature of the year was the scarcity of tow. Several D.S. Scotch mills were temporarily closed down and the hours of wet spinning mills were reduced to twenty-four per week. A Yarn Costing Committee arranged that all tow yarns up to 20's lea were temporarily to contain 50 per cent. of hemp tow, and that prices were to range from 44s 6d. per bundle for 14's lea to 32s. for 20's lea. In July spinners experienced a much larger demand for yarn and large quantities were shipped to France and Belgium, where the weaving factories were got to work in advance of the spinning mills. In August 25's tow fetched 35s. per bundle, a rise of 7s. for the month of July. In September yarn prices reached the top, say 30s. per bundle. for 40's tow weft.

Belgian flax-spinning mills began to make shipments of yarn for the first time since 1914. In October 25's tow weft had gone up to 37s. 6d. per bundle, while line wefts offered in June at 18s. sold at 24s. Until the end of the year the general tendency of prices was upwards, demand continuing active.

Business in cloth continued quiet in January. Orders for aeroplane linens were cancelled and large Government stocks sold for civil purposes. In March the stoppage of looms continued, while in Dunfermline only one-third were working. In April, Belfast factories were only working thirty hours per week. In May inquiries for cloth became more numerous. In July the demand for linens had still further increased. Owing to a sharp advance in the price of cotton goods the difference between pure linen and its substitutes diminished and business improved. In August, America seemed willing to pay unheard of prices for pure linen goods and manufacturers got quite busy, their working week being increased to thirty-six hours. These conditions prevailed until the end of the year, the difficulty being to get the yarns to weave the cloth required.

In 1920 the uncontrolled portion of the flax market still advanced, while the controlled Irish growers were sorry they had asked for control and grew rebellious. Irish spinners paid up to £1,500 per ton for the best foreign flax and £170 per ton for rescutched tow. Eighty shillings per bundle was paid for 25's tow and 52s. for 140's line weft, the price of which in 1919 was only 27s.

At the time of writing a large sowing is anticipated not only in Ireland but in Holland, France, Belgium and elsewhere. Livonean Crowns fetch £360 per ton and Hoff's £348. Flax-spinners are forced to use more and more Italian hemp and linen weavers more and more cotton. A few small cargoes of Russian flax arrive and prospects of further supplies are rather more hopeful. Linens are likely to go dearer.

The following figures show our flax imports during the past three years:—

	Quantity.		
	1917. Tons	1918. Tons	1919. Tons
Flax, dressed or undressed:			
From Russia	63,891	21,790	3,868
„ Netherlands	2,868	597	2,880
„ Belgium	—	—	373
„ Other countries	3,587	563	2,876
Total	70,346	22,950	9,997
Tow or Codilla:			
From Russia	13,390	1,906	27
„ Belgium	—	—	172
„ Other countries	601	179	912
Total	13,991	2,085	1,111

ALL ABOUT THE £4,000,000 LINEN DEAL.

When the Government contracts for aeroplane linen were finished in March, 1919, the total stock of such linen amounted to about 40,000,000 yards. In view of the fact that even under the most optimistic forecasts as to the development of the aeroplane for postal and commercial purposes only a small portion of the total named would be required for years to come, the Government resolved to sell their huge stocks covering a large range of widths and counts from 31 to 50 inches wide 14⁰⁰ to 22⁰⁰. The prices paid by the Government for it ranged from 1s. to 1s. 3d. per yard.

When the Disposal Board was formed they offered the whole stock to the linen manufacturers; the best offer the latter made was 1s. per yard, which was declined. A profit-sharing proposal was then put forward, under which the trade would have borne 25 per cent. of any loss below 1s. 1d. per yard and would have received 25 per cent. of any profit over that figure. This offer was also declined by the Board. The Board then endeavoured to dispose of the linen in small quantities. About three-quarters of a million yards was sold in this way at an average price of 2s. 3d. per yard. In view of

the heavy storage charges and loss of interest the Board was anxious to effect a quicker sale. After prolonged consideration it was decided to sell the linen to a Mr. Martin at 1s. 8d. per lineal yard.

Had the linen merchants' offer been accepted and the linen ultimately sold at the price the Government actually received, the manufacturers would have made a profit of over £300,000.

Mr. Martin was promptly dubbed the Linen King. He was described as an alert young man who looked younger than his 37 years. According to Mr. Martin, on examination a considerable quantity of the linen supposed to be 36 inches wide was in reality double width or 72 inches wide.

Sir Edward Carson in the House of Commons reminded the House that the linen trade was as closely controlled as shell-making. The price to be paid for flax, the rate of wages, the cost of production, and the margin of profit were all fixed, not by the trade but by the Government, so that the story of exorbitant profits upon manufacturing was an absolute myth. It was from the linen trade, and not the Ministry, that the idea had come of slowing down output.

In September last the linen trade, seeing the end of the war clearly in sight, were desirous of preparing for a return to their pre-war trade. They proposed to diminish the aeroplane cloth output by one-sixth immediately, and switch on to ordinary trade production in an increasing degree, as the old commercial channels opened up.

The Government peremptorily refused this, and ordered a continuance of operations, but in December the Ministry asked that the output should be stopped. The trade had then on hands a floating stock of six million yards, and a further twenty-one million yards in process of manufacture, it being so far advanced that it could not be changed into something else. They had as well been precluded from looking for ordinary commercial orders, because the Government had refused permission to manufacture such goods, and to have shut down on Government work without having other work to keep machines going would have meant paralysis of the whole industry, and the turning out of nearly fifty thousand workers in Ulster. "The trade refused, and rightly refused, to be so treated," said Sir Edward in a statement which the House cheered, "and the Government had held them to a bargain. They had a right to expect the Government to adhere to its own bargain."

TEXT OF THE OFFER READ.

Sir Edward read to the House the actual text of the offer which the linen trade had made to the Government by letter in March last, a document not disclosed. By this letter the

trade undertook to market the whole stocks for the Government against loss should the average price fall below 1s. 1d. per yard, and proposing to hand over 75 per cent. of all profit based upon the same figure, the Government to have at all times an absolute right of veto over all matters and to appoint special representatives to act as a committee for the purpose of sale with representatives of the linen trade.

The whole linen trade thought the Ministry had made an extremely good sale to Mr. Martin. Whether Mr. Martin had made a good bargain remained to be seen, but at any rate not one man in Belfast envied him in the purchase he had made, nor would it in the smallest degree affect the output. The Minister had admitted that not one of the great warehousing concerns could be induced to make an offer for these goods at all. That was one of the most significant things in the whole business.

Colonel Cleaver, a member of the well-known Belfast firm of Robinson and Cleaver, referring to Mr. Leonard Martin's purchase of 40,000,000 yards of unbleached linen, is reported to have said: "The Government has made an extraordinary deal and an exceptionally good bargain. I cannot believe that Mr. Martin is alone in this matter. The Government must be behind him. Otherwise he stands to lose, in my opinion, at least £1,000,000. I'd give half a million to get out of a bargain like that," says Colonel Cleaver. "It will cost 6d. a yard to bleach it, and, unbleached, I cannot see how it is to be sold. Mr. Martin need not fear the competition of Belfast trade. We are busy making special lines of damask linens, tablecloths, linen sheets, and dress material."

Another prominent Belfast manufacturer in an interview declared: "There will not be one spindle or one loom running less in Belfast because Mr. Martin has made this deal. We will not lose one wink of sleep over it. The statement that mills in Belfast will be liable to be closed for three years while Mr. Martin is selling his stock is rubbish." All the talk about the "terroristic ring" of Belfast manufacturers was, he said, the most utter nonsense. There was to-day more organization in the trade than there used to be, but the idea that the Belfast manufacturers had been trying to take the Government by the throat by offering them a low price knowing all the time that the goods were worth much more was absolutely without foundation. The truth was that the linen trade had every reason to complain of the stiff and unbending attitude of the Government towards it. Some people seemed to forget that during 1917 and 1918 the linen trade in all its stages of manufacture was controlled like shipping or munition works. That control became absolutely rigid during 1918. The price of raw flax was fixed by the Government. The flax was distributed to the spinners, who were allowed to spin only

such yarns as were required for Government work. Their costs were checked at every stage by Government.

"The sale of 40 million yards of linen affects seriously a great many interests, states the *Morning Post*. Mr. Martin himself acknowledges that it is a corner in linen. The history of the Government dealing in linen is an interesting one. Linen and war had previously been associated only in the shape of bandages, but the development of the aeroplane changed all that. Not even after the war had gone on for some time did the authorities of any country realize that linen was an essential fabric in the turning out of efficient air machines. The Royal Flying Corps—both of the Navy and Army—were the first to discover that linen was the best material for aeroplane wings, and in 1915 the whole produce of the Irish factories was commandeered. The demand grew enormously as aircraft production expanded, and millions of yards were called for, practically unlimited orders going to Ireland, all weaving for other purposes being stopped. The result is that outside of Great Britain there is practically no linen cloth at all. France and Italy are clamouring for it, and Germany presents a vast market. She has no linen. Last year the Government took the further step of buying up for £12,000,000 the whole Irish crop of flax, the acreage of which had been greatly extended, as no flax was coming from Russia. This price worked out at about £40 per acre, whereas the normal figure was £2 10s. The British Government, in fact, had a monopoly of the world's flax, for Russia having gone Bolshevist, did not count. They also spent over £1,500,000 on trying to cultivate flax in Yorkshire, but the experiment was not a success.

"Mr. Martin is now in possession of the whole woven output of the Irish mills and stuffs produced elsewhere. It was made to certain specifications, and is probably the strongest fabric made, capable, as one of the leading manufacturers told a representative of the *Morning Post*, if taken from the loom and used as a cable for holding a battleship. It is unbleached, but can be used for ladies' dresses, sheets, table linen, and underclothes, and is more enduring than cotton. In an announcement in the press last year, the Government said it had great quantities of linen on sale, but limited the unit to 1,500 yards at 7s. per yard. Mr. Martin has been enabled to buy 40 million yards for £4,000,000—2s. a yard. If he sold to-day at 3s. a yard he makes a gross profit of £2,000,000. What the cloth has cost the Government is not known. A Belfast manufacturer put it at nearly 4s. per yard at the very lowest, because all prices were enhanced, the women and children who gathered the crop last year getting over £1 per day. Formerly they were paid 15s. a week. The difference between 2s. a yard and 7s. a yard is £10,000,000.

"Belfast will be seriously affected by this deal. Till Mr.

Martin has disposed of it they will probably have to shut down their mills. He makes no disguise of the fact that he can undersell them in any market. It will also prove disastrous to the cotton trade, for the finer counts cannot be sold owing to the present price of cotton. The situation caused the utmost consternation among all England in what the Americans call the dry goods trade."

We know nothing against Mr. Martin (says the *Times*), and we certainly have no sympathy with the Belfast firms, who have made a profit by selling this linen to the Government at prices up to 3s. a yard.

Reviewing the linen trade of 1919, the *Belfast News-Letter* wrote:—

In March, 1919, the man would have been called a crazy optimist who would have advised purchasing Government linen on any higher basis than the prospects of the day justified. What were the conditions?—buyers holding off, many lines of the goods not exactly suitable for regular requirements, the possibility of the import of Russian flax, entailing cheaper yarns and lower manufacturing costs for popular-priced goods. These and several other considerations tied the hands of the Belfast trade and prevented a deal which at best always was being hampered by arbitrary Government restrictions and a very obvious determination on the part of the Government officials concerned to make it as difficult as possible for the linen trade to purchase the stock, thus carrying out the policy which had been clearly hinted at when the cancellation of contracts had been under consideration in the previous December. Meanwhile, the local trade held firm. Orders were being placed as time went on—at first cautiously, as the need for replenishing stocks became imperative. The world shortage of textiles was beyond question. Wide looms were gradually filling up; damask looms, which had been turned to make plain cloths, were re-mounted; far-seeing merchants began to feel more confidence in the future, and then arose above the horizon a new luminary with whose name the world is now familiar, who ended the doubt and settled the fate of the Government stock in a bold and dramatic purchase of the lot. Much has been written and many hard things said about what Belfast merchants missed and all the rest of it, but probably the very best thing happened after all. Some men are born lucky, and Mr. L. J. Martin is among the number; for the stars in their courses have fought on his side. From almost the very day of the "deal" there has been an improvement. At first it was gradual, but later it came by leaps and bounds, till by the end of the year all previous records in prices have been passed, and the veterans who used to tell us about the exciting days of the American War have been forced to admit that this is "some" boom. The Govern-

ment stock was sold in June, and was quickly put on the market by Mr. Martin in a business-like and capable manner. His methods are thoroughly up-to-date, and his advertisements have undoubtedly helped the sale of linens. The Belfast opinion that the stock as it stood was not exactly suitable for staple business was perfectly correct. What has made it good property is the fact that it is much cheaper than regular counts and weights of standard makes. War conditions have taught the world the habit of making the best use of substitutes. Old conservative methods have had to give way to the strain and stress of shortages in raw materials. Customers accordingly are willing to buy the next best thing, and merchants have had to exercise their ingenuity to provide goods which the shortage of flax has rendered it impossible to procure in the regular way. It is not surprising, then, to find that a light-weight cloth, which made an ideal aero fabric, can be bleached to sell as a shirting linen, or a light pillow linen, or an embroidery cloth, or even for stitching and finishing as a handkerchief. It is the shortage and absolute impossibility of providing the usual linens which give the key to the situation, and which have found for Mr. Martin his best customers on the banks of the Lagan.

TRADERS' VIEWS.

Mr. Gordon Selfridge, in an interview with the Press Association, said, "It is an eminently wise course on the part of the Government to sell, and thus clean up the transaction and accept the loss, if there has been any loss, on its manufacture. How Mr. Martin intends to dispose of the material I am not informed, but for the courage and enterprise which inspired him to make the deal he is entitled to any profit which may accrue to him. Without knowing him, I congratulate him on the nerve displayed, and wish him good luck in the outcome."

Mr. Selfridge said if he had been asked to advise the Government in the matter he would certainly have recommended some such course. There was no reason for assuming that any hardship has been placed upon any members of the community by giving Mr. Martin a monopoly in this linen, and no burden would fall upon buyers or consumer.

Doubt has been expressed by a large West End firm as to whether Mr. Martin will find a ready market for his linen, for the reason that the uses to which it can be put are limited.

Among the agents of the Belfast linen industry the opinion is expressed that an average wholesale purchasing price of 2s. per yard would have been too great to ensure a profit being made which would repay Mr. Martin for his trouble. Bleaching is said to be out of the question, the cost of this process being something like 6d. per yard.

To the suggestion that the whole question should be raised in the House of Commons as soon as Parliament re-assembles, Mr. Martin says: "I have nothing to fear in that direction. The fullest investigation will only show that the transaction has been a very advantageous one for the Government and the general public."

The *Daily Mail* says: "The Government sale of 40,000,000 yards of linen for nearly £4,000,000 to a single man, Mr. Martin, is a transaction which obviously requires attention. This linen was acquired as a result of a "corner" of the linen market by the Government during the war. The "corner" was necessary and legitimate as a war measure. Two years ago the Government was confronted with a dangerous shortage of linen for aeroplanes. It, therefore, did what it was obliged to do in the interest of national security. It set every loom to work, and bought up all the linen available. It created a complete monopoly. It has now transferred this monopoly to Mr. Martin. We have nothing to say about Mr. Martin, except that we presume that he has bought the linen to sell it again at a profit. But to the Government this question must be put. Has it fixed his profit, or has it handed the material over to him to make what he likes out of it? If it has not done this, then it has taken a course which needs some explanation. It has not only omitted to protect the public in peace against the "corner" which it made during the war, but it has also forgotten its pledges to give small buyers a fair chance of purchasing surplus stores.

MR. MARTIN DESCRIBED.

He talks rapidly and volubly with much animation. He has a humorous outlook and laughs frequently. He was wearing a light tweed suit minus a waistcoat, a black tie and a soft collar. In other words, he looks exactly like thousands of other people who have not spent 4 millions on linen. To a representative of the *Star* he is reported to have said:—

I have jumped into this thing without any first-hand knowledge of the linen business.

My line is agricultural machinery, but my concern runs itself now, and I have come into this line mainly because I had nothing else to do. I was in California for two months' holiday when I saw the possibilities of this deal, and returned to jump into it.

I bought over the heads of everybody else simply by offering a higher price than anybody else would pay. The negotiations have taken only a few weeks, for everybody seemed scared at the size of the deal.

I am fascinated by the possibilities of this thing. I have never seen a proposition with so much scope in the markets.

of the world. There are no stocks of linen anywhere, and very little raw material available. The ordinary traders in linen have shown themselves pig-headed.

Then you have a sufficient amount of stuff to make it well worth while to run a big propaganda?—Why, if I spend a quarter of a million in placing the stuff on the world's markets it is nothing in comparison with the probable turnover.

There is going to be no profiteering as far as I am concerned. I see that it is already suggested that the Government should not have handed the whole stock over to one man; but look at the other side of the picture. It may surprise the public to know that the bulk of this linen was manufactured after the Armistice was signed.

The Belfast manufacturers declined to allow the Government to back down from their contract. What they wanted to do was to buy it all for 1s. a yard. [Mr. Martin's price works out at round figures about 2s.] They had previously declared that it was no good for commercial purposes, and had advised the Government to burn it. The purchase represented three years' normal supply of this class of linen. For two years the linen mills have been making nothing but this stuff. It is absurd to say that it is no good for commercial use. For men's linen suits, which are worn universally in warm climates, it is both lighter and better looking than that usually used. For handkerchiefs it is a hundred per cent. more durable than the linen handkerchiefs. The linen had to be of the highest quality that could be made for the purpose for which it was designed—the covering of aeroplane wings. They had to get strength and light weight in combination, and that could only be done with the best material. The Belfast manufacturers have been waiting until the Government would accept their price. As the Government has instead sold to one man you can stake your last dollar that the Treasury will see to it that I pay out all right for all the duties and taxes that are payable. They can check me as an individual more readily than they could check a combine of manufacturers. If I should make a million of profit there will be £400,000 to go back to the Treasury in excess profits, and another £250,000 in super-tax, so that the Government will gain £650,000 out of the deal.

Before the end of 1919 Mr. Martin had disposed of one half of his purchase to buyers in all parts of the world except Germany and her allies. The Belfast making-up trade bought largely and Irish bleachers are still very busy over it.

One New York store is reported to have disposed of 2,000,000 yards in one day at over 8s. a yard.

The *Daily Mail* says that Mr. Leonard J. Martin, who bought some 43,000,000 yards of aeroplane linen from the Disposal Board for £4,000,000, announced recently that he had sold his last yard. The purchase was made last June, so that this

transaction, which Belfast experts said would occupy years, is completed in little more than six months.

An echo of the purchase was brought about by an action brought by Mr. W. H. Sheppy against Mr. Martin recently. Mr. Sheppy claimed a percentage (one third) of the profit made by Mr. Martin on the purchase and sale of the linen and was given a verdict for £4,000. Mr. Martin agreed that he had made a good profit out of the transaction.

FLAX COSTS AND YARN AND CLOTH PRICES, &c.

The following figures, taken from a recent Russian report, may prove of interest:—

	Average, pre-war, 1910-1914	Average, war, 1914-1918	After war, 1919-1920
	£ s. d.	£ s. d.	£ s. d.
Cost of flax seed per acre	1 5 0	7 0 0	8 0 0
Cost of producing an acre of flax	8 4 0	15 0 0	20 10 0
Farm workers' wages per acre	3 6 0	6 0 0	7 0 0
Cost of scutching per acre	1 13 0	4 0 0	5 10 0
Cost per stone of scutching	1 0	2 0	3 3
Cost of producing a bundle of 40s	1 5	2 8	3 9
Coal per ton	15 0	1 8 0	2 8 0
Weekly wages of preparing room hands	11 0	1 0 0	1 10 0
" " spinners and reelers	12 0	1 0 0	1 10 0
" " roughers (maximum)... ..	1 5 0	1 11 0	2 7 6
" " sorters "	1 10 0	2 2 0	2 15 6
Average cost of Irish flax per stone	7 0	1 1 0	1 15 0
" " Bajetsky flax per ton	43 0 0	150 0 0	260 10 0
" " hackling flax per cwt.... ..	5 0	7 0	8 8
" " per lb. of Irish line for 40s	10	3 0	4 0
" " Russian line 40s	6½	2 6	3 0
Average price of range of line wefts	4 8	8 0	1 8 0
" " 25s tow weft	7 3	15 0	2 10 0
" " 95" 9 ⁰⁰ linen sheeting per yard	1 6	6 6	10 0
" " 48" 14 ⁰⁰ pillow linen	11½	4 1	5 9
" " 38" 15 ⁰⁰ green yarn linen	9	3 1	3 9
" " 25" 10 × 7 linen rough out of			
25/30 tow	4	1 4½	2 5
" " 40½" 16 ⁰⁰ linen cambric	10	3 4	4 7

RESULTS OF HACKLING RUSSIAN AND IRISH FLAXES. (PRE-WAR.)

	Cost of flax per ton	Yield of line per cent.	Waste per cent	Average lea
	£ s. d.			
Baltic P. K. Riga	25 0 0	42·5	13·4	40
Irish	48 10 0	55·0	8·0	39
Bruges	59 0 0	65·0	5·0	42
Dutch	60 0 0	66·0	5·0	42½

INDEX.

A

- Acreage under flax in Ireland, 112
- All about the £4,000,000 linen deal, 300
- Appeal to grow more flax, 146
- Arbroath 60 years ago, 153
- Artificial drying of flax straw, 113
- Automatic spreader and hackler, 75

B

- Beetling linen, 98
- Bleaching linen, 96
- Boiling linen, 97
- Breaking flax straw, 123
- Butting machine, 52

C

- Calendering linen, 98
- Cambrai, 216
- Cambric, 233
- Canadian flax seed, 292
- Carbolized flax tow, 107
- Central Association of Russian Flax Growers, 159
- Central flax retteries, 110-111
- Charges for scutching flax, 220-225
- Chemical composition of flax, 190
- Choice of soil, 198
- Cloth prices, 308
- Co-operative flax scutch mills, 68
- Cost of scutching, 68, 69, 70
- Crofting, 96
- Cropping machine, 96

D

- Dew retting, 48, 141, 206
- Dissatisfied flax growers, 172
- Drawing and doubling, 79
- Dressed line numbering, 76
- Dry spinning, 82

- Dundee's flax trade, 289
- Dyeing linen cloth, 97

E

- Effect of flax shortage, 294
- Effect of the American Civil War on linen trade, 209
- Effect of the war upon the linen trade, 295
- Effect of the withdrawal of the linen bounties, 232
- Embroidered linen, 100
- English flax harvest, 1918, 226
- Extraction of linseed, 104
- Extracts from ancient and modern writers on flax, 198

F

- Fineness of linen cloth, 93
- Finishing linen cloth, 97
- " " towels, 196
- Flax, 1-4
- " cellulose, 107
- " costs, 308
- " cultivation, 132
- " " in England, 145
- " " in Ireland, 134
- " descèding, 141
- " fibre developments in Saskatchewan, 156
- " growing and flax prices, 150
- " " in England, 114
- " " in France, 114
- " " in Russia, 156-280
- " and its war service, 217
- " imports, 1913-1918, 290
- " gaskin, 107
- " grummets, 107
- " engine packing, 107
- " hackling, 72
- " and spinning, 233
- " and tow preparing, 77

Flax pullers' wages, 233
 ,, pulling machine, 17
 ,, retting, 112, 216, 218
 ,, scutching, 50
 ,, ,, in Japan, 67
 ,, seed, 11
 ,, supply, 108
 ,, water, 200

G

Grassing flax straw, 47
 Gray's flax decorticating machine,
 207

H

Harvesting the flax crop, 17
 Hints for flax growers, 236

I

Importance of good flax seed, 278
 Indian flax, 290
 Irish flax, 228
 ,, ,, harvest, 1918, 276
 ,, ,, industry, 209
 ,, ,, Society, 288
 ,, ,, scutching, 55-69

J

Jacquard machine, 93

K

Kind of seed, 136

L

Lee's patent process, 212
 Legrand retery, 42
 Lime for flax land, 202
 Linen exports, 210, 289
 ,, manufacture, 71-90
 ,, trade position in 1919, 197
 ,, thread making, 88
 ,, values, 1914-1919, 159
 ,, yarn values, 1919, 157
 Linoleum, 106
 Linseed, 103
 ,, cake, 104
 ,, dresser, 103
 ,, oil manufacture, 104-105

N

New flax straw machinery, 115
 ,, method of scutching, 63
 ,, process for retting flax, 218
 Number of handles in the round,
 56

O

Old White Linen Hall, Belfast,
 288

P

Packing linens, 99
 Percentage of fibre in flax straw,
 200
 Pernau flax, 206
 Preparing the seed bed, 135
 ,, ,, soil, 7, 205
 Prevention of mildew on linen
 goods, 217
 Printing linen cloth, 97
 Production of Russian flax, 155
 Progress in the linen trade, 231
 Port of Riga, 220
 Pulling flax, 200-207
 ,, time, 137

Q

Quantity of seed per acre, 136

R

Recent Government control in
 linen trade, 115, 214
 Recent improvements, 64
 ,, inventions relating to flax,
 286
 Reeling, 84
 Research in the linen trade, 160
 Results for flax hackling, 308
 Retting, 32, 204, 207, 212
 Rossi process, 207
 Russian flax exports, 166
 ,, linen trade, 148
 Russia's importance, 166

S

Salt as a manure for flax, 236
 Saving flax seed, 23
 Schenk's retery, 38

Scientific research in linen trade,
236

Scutching, 62, 124

„ machines, 65, 66, 67

„ tow production, 222

„ tow question, 70

Six weeks' flax pulling, 143

Sliver formation, 77

Soils, 202

Some remarkable results, 194

Souring linen cloth, 97

Sowing fiddle, 202

„ the seed, 14, 202

Spreading flax, 138

Streaking flax straw, 139

System, Lopper's and Deschwart,
213

T

Tank retting, 38

Textile wages in Belfast, 159

The flax industry, 117

„ „ problem, 290

„ Flax Society, Ltd., 288

„ linen fabric, 285

„ Port of Riga, 220

„ Rossi process, 44

„ scutcher, 139

„ steep, 137

Theory of linen bleaching, 212

Time to sow, 136

To distinguish linen and cotton
finish, 101

To distinguish linen and cotton
cloth, 101, 285

Tow carding, 78

„ combing, 80

U

Ulster's staple industry, 130, 211

Uses of flax wastes, 107

V

Ventilation of flax scutch mills, 58

Visit to Selby flax station, 140

W

Waste in growing, 251

Water-retted v. dew-retted flax,
226

Waterproofing canvas, 101

Weeding flax, 15

„ time, 137

Weight of flax straw, 206

Wet spinning, 81

What co-operation can do to in-
crease flax cultivation, 132

Willesden finish, 102

Williamson's flax rollers, 54

Windrow, 204

Work of the Irish Linen Society,
218

Working cost of flax scutch mills,
224

World's flax areas, 157

„ „ supply, 165

Y

Yarn bleaching, 86-87

„ bundling, 84

„ Dyeing, 86

„ numbering, 84-85

„ prices, 308

Ypres, 215

The "Economic" TOW SCUTCHER

CLEANS Flax Scutching Tow better and more cheaply than by the usual method.

One boy will do the work of three Scutchers.

Opener, Cleaner and less Nappy Tow.

Cost of Scutching only 4d. per stone, as against the old 1/9.

A Machine working constantly will save over £500 per annum.

For further particulars apply—

H. R. CARTER,
25, Donegal Street, Belfast.



FOR EVERYTHING
FOR AND ABOUT

FLAX



WRITE TO

H. R. CARTER,

TEXTILE ENGINEER.

25, DONEGAL STREET, BELFAST,

Who having had many years practical experience in all branches of the Linen Trade, both at home and abroad, can supply any information or offer any Article required.

Flax Scutch Mills fitted out in all parts of the World.

Specifications Prepared for the Machinery necessary to

Scutch, Hackle, Card, Spin, and Weave Flax and Hemp.

(Mills re-organised and brought up to date.)

**Agent for the Legrand System of Patent
Central Co-operative Retteries and Scutch Mills.**

AUTHOR of

**Spinning and Twisting the Long
Vegetable Fibres**

Generally recognised as the Standard
Work upon Flax, Hemp, Jute and
Ramie Spinning, Rope and Twine
Making.

(Second Edition shortly ready).

Price 25/- Post Free.

**Modern Flax, Hemp and Jute Spinning
and Twisting**

Price 8/6 Post Free.

Rope, Twine and Thread Making

Price 6/- Post Free.

**The Manufacture of Linen, Hemp and
Jute Fabrics**

Price 4/6 Post Free.

**Bleaching, Dyeing and Finishing Flax
and Jute Yarns and Fabrics**

Price 3/6 Post Free.

Flax, Hemp and Jute Spinners' Catechism

Price 8/6 Post Free.

Practical Mill and Factory Arithmetic

Price 4/- Post Free.

Cordage Fibres

Price 3/6 Post Free.

Publisher and Compiler of

The Flax, Hemp and Jute Year Book

Price 4/- Post Free.

**Linen, Hemp and Jute Trades Directory
of the World**

Containing the Names and Addresses
of the Leading Firms in every Branch
of the Trade.

Price 5/6 Post Free.

Flax, Hemp and Jute Yarn

Length and Weight Tables.. 16 x 12

Flax Spinners' Draft and Twist

Tables 24 x 20

Russian and Continental Flax

Tables 24 x 20

Linen Weavers' Warping Tables 24 x 20

Rope and Twine Makers' Tables 24 x 20

Price 2/6 Post Free.

Linen Trade Picture Cards

Illustrating the production of Irish
Linen from field to fabric.

Set of 18, Price 1/6 Post Free.

Flax Market Ready Reckoner

Price 1/6 Post Free.

WILLIAMSON'S Patent Flax Straw Rolling and Crushing Machine

MADE IN 5, 6, 7, AND 8 PAIR SETS.

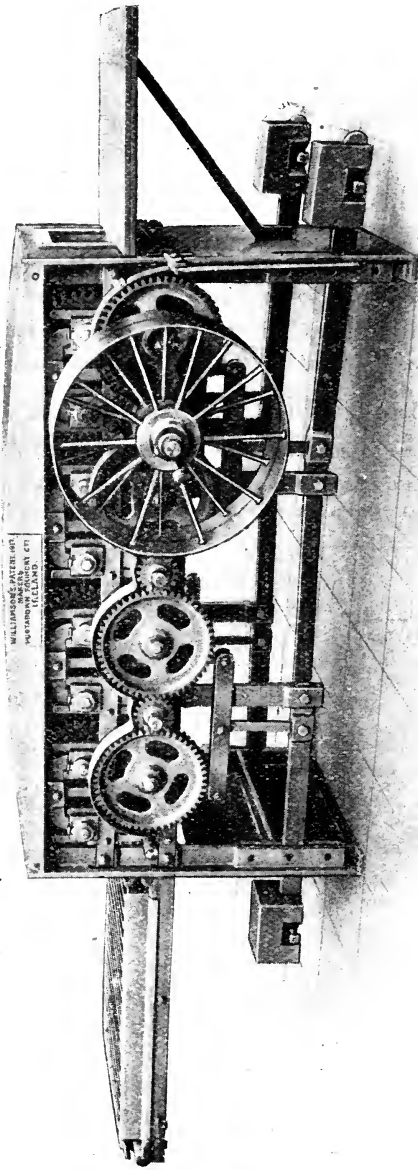

PORTADOWN FOUNDRY Ltd., PORTADOWN, IRELAND.

(Late BRIGHT'S PATENT PULLEY Co. Ltd.)

Agents in British East Africa.—LAMBERTS LTD., NAIROBI, E.E.A.
London Address—121, VICTORIA STREET, WESTMINSTER, S.W. 1.

The "Williamson" Patent Flax Rolling & Crushing Machine

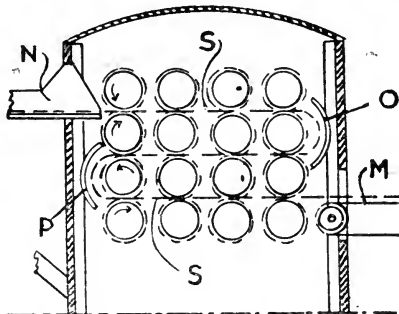

You want the VERY BEST, the most EFFICIENT, and the most Economical Machine.

You want the BEST RESULTS.

YOU want the "WILLIAMSON."

No other Machine will give you the maximum of "nips" with the minimum of rollers and the maximum of output.

No other Machine gives you the progressive and essential change in action on the flax as it passes from the inlet opening to the outlet opening of the Machine

The "WILLIAMSON" Machine combines Simplicity of Construction, Simplicity of Drive and the minimum of space occupied. In other words—

STRENGTH, ECONOMY, SERVICE.

PORTADOWN FOUNDRY Ltd.

(Late BRIGHT'S PATENT PULLEY Co. Ltd.),

FOUNDRY STREET, PORTADOWN, IRELAND.

Agents in British East Africa—LAMBERT, Ltd., Nairobi, B.E.A., who stock all types of our Machinery, also spare parts.

D. D. LEITCH & SON

HEAD OFFICE—

20, Church Street, BELFAST.

Flax Cultivation and
Scutching Department,
SLANE, Co. MEATH

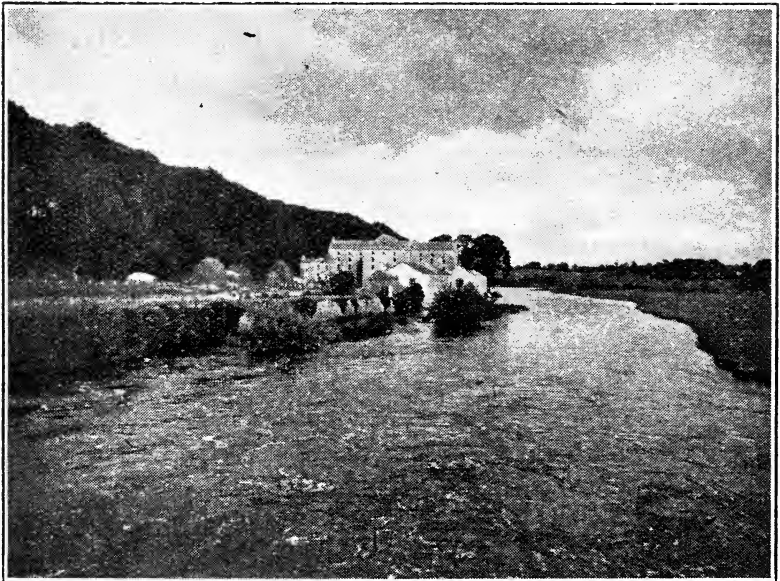

VIEW OF SLANE SCUTCH MILLS, CO. MEATH.

D. D. LEITCH & SON

20, Church Street,
BELFAST.

IMPORTERS OF

Canadian, Dutch, Japanese and Russian

FLAXSEED,

Russian and Continental

FLAXES,

MACHINE HACKLERS

(Automatic Attachments).

Telephones—3574 & 3575.

Telegrams—"Leitchcom" Belfast.

Codes—A.B.C., Marconi and Private.

FAIRBAIRN LAWSON COMBE BARBOUR
LIMITED.

LAWSON

BRANCH,

HOPE FOUNDRY,

LEEDS.

MAKERS OF

PREPARING & SPINNING MACHINERY FOR

FLAX, HEMP, TOW AND JUTE.

MACHINERY FOR THE MANUFACTURE OF

TWINES AND SHOE THREADS.

BROWNELL'S PATENT TUBING TWISTERS.

PREPARING & SPINNING MACHINERY FOR

**MANILA, SISAL,
NEW ZEALAND HEMP;**

And other similar FIBRES.

For the Manufacture of

**ROPE YARNS, BINDER TWINE,
TRAWL TWINE, &c.**

SOLE AGENTS FOR

HASKELL DAWES' Vertical and Horizontal

ROPE MAKING MACHINES

and TUBING TWISTERS.

FAIRBAIRN LAWSON COMBE BARBOUR,
LIMITED.

FAIRBAIRNS BRANCH.

WELLINGTON FOUNDRY, LEEDS, ENGLAND.

MAKERS OF

**Machinery for Preparing & Spinning
Flax, Tow, Hemp and Jute,**

AND FOR THE

**Manufacture of Twine and
Rope Yarns,**

AND FOR

**Stranding and Laying Hemp
or Manilla Ropes,**

Also Makers of

**Engineers' General Tools for Railway and
Ordnance purposes.**

**COMPLETE PLANS AND ESTIMATES FOR
SPINNING & WEAVING MILLS SUPPLIED.**

Telegraphic Address: "FAIRBAIRNS, LEEDS."

COMBE BARBOUR,

BRANCH OF

FAIRBAIRN LAWSON COMBE BARBOUR, Ltd.,
BELFAST, IRELAND.

Telegraphic Address: "COMBE, BELFAST."
Codes: A 1, ABC1, ABC5, BENTLEYS.

On Admiralty List.

Machinists, Engineers, Millwrights.

Makers of all kinds of Machinery for

FLAX

HACKLINGS, CARDS, SPREADERS, DRAWINGS, ROVINGS, GILL SPINNINGS, DRY SPINNINGS, WET SPINNINGS, TWISTINGS, REELS, THREAD POLISHERS, BALLING AND BUNDLING MACHINES; ALSO FLUTING MACHINES, LATHES, AND ALL ACCESSORY MACHINES.

HEMP

SOFTENING MACHINES, BREAKING MACHINES, CUTTING MACHINES, HACKLINGS, CARDS, SPREADERS, DRAWINGS, ROVINGS, GILL SPINNINGS, DRY SPINNINGS, WET SPINNINGS, TWISTINGS, TWINE LAYERS, POLISHING MACHINES, BALLING MACHINES, ROPE YARN SPINNING AND TARRING MACHINES, ROPE LAYING MACHINERY.

JUTE

BREAKER CARDS, FINISHER CARDS, PATENT PUSH-BAR DRAWING FRAMES, SPIRAL DRAWING FRAMES, ROVINGS, GILL SPINNINGS, DRY SPINNINGS, TWISTINGS, REELS, COP WINDERS, ROLL WINDERS, AND ALL ACCESSORY MACHINES.

MANILA

and

SISAL.

DUPLEX SPREADERS FOR CONVERTING FIBRE INTO SLIVER AT ONE OPERATION, SCREW AND CHAIN GILL DRAWING FRAMES, VERTICAL AND HORIZONTAL SPINNERS FOR BINDER TWINE AND ROPE YARNS, ROPE LAYERS, FOREBOARDS AND TRAVELLERS, AND ALL KINDS OF ROPE-WALK FITTINGS.

BINDER TWINE MACHINERY.

Largest Makers of Twine and Rope Machinery.

Steam Engines, Shafting, Pulleys, Hangers, &c.

ORIGINATORS OF GROOVED ROPE PULLEYS FOR TRANSMISSION OF POWER BY ROPES.

KENNEDY'S FLAX MACHINERY.

SOWERS

RIPPLERS

DE-SEEDERS

WINNERS

CLEANERS

BUTTERS

BREAKERS

SCUTCHERS

*USED BY ALL THE PRINCIPAL
FLAX MILL OWNERS AND GROWERS.*

SEND FOR PARTICULARS :

H. KENNEDY & SON, Ltd.

Engineers and Ironfounders,
COLERAINE, IRELAND.

SOLE MAKERS of the "EMPRESS" TURBINE.

RITCHIE, HART & CO.,

LIMITED.

Mountpottinger Foundry,
BELFAST,

Engineers, Iron & Brass Founders.

SPECIALISTS IN

FLAX SCUTCHING MACHINERY.
SOLE MAKERS OF HAUGHTON'S
PATENT SECTIONAL STANDS AND
STOCKS, YARN AND CLOTH
BLEACHING MACHINERY,
DISTILLERY PLANT AND PUMPS,
ROOFING FELT MACHINES, SHEET
ASPHALTE PLANTS.

SHAFTING AND GEARING. ∴ ROPE PULLEYS.

Makers of "Allibon-Goulding" Patent Mechanical Den,
for use in Chemical Manure Works.

**SPECIAL ATTENTION TO REPAIRS AND
BREAKDOWNS.**

8 Technical Handbooks

Indispensable to all interested in the subjects of which they treat.

By H. R. CARTER.

Author of "Modern Flax, Hemp and Jute Spinning."

Demy 8vo, strongly bound in paper covers.

1. **CORDAGE FIBRES: Their Cultivation, Extraction and Preparation for the Market.** (ILLUSTRATED.) Price 3/- net. Postage 6d.
2. **THE MANUFACTURE OF LINEN, HEMP AND JUTE FABRICS.** (ILLUSTRATED.) Price 4/- net. Postage 6d.
3. **ROPE, TWINE AND THREAD MAKING.** (ILLUSTRATED WITH FULL PAGE PLATES.) Price 5/6 net. Postage 6d.
4. **FLAX, HEMP AND JUTE SPINNERS' GATECHISM.** (ILLUSTRATED.) Price 8/- net. Postage 9d.
5. **PRACTICAL MILL AND FACTORY ARITHMETIC.** Price 3/6 net. Postage 6d.
6. **BLEACHING AND DYEING OF FLAX, HEMP AND JUTE YARNS AND FABRICS.** Price 3/- net. Postage 6d.
7. **COMBERS AND COMBING: Their Setting and Principles of their Working.** (ILLUSTRATED.) Price 5/- net. Postage 6d.
8. **FLAX AND ITS PRODUCTS.** (ILLUSTRATED.) Price 10/6 net. Postage 9d.

JOHN BALE, SONS & DANIELSSON, Ltd.,
83-91, Gt. Titchfield St., Oxford St., London, W.I.

R. BOBY, L^{TD.} Bury-St.-Edmunds,
SUFFOLK, ENGLAND.

(Associated with VICKERS, Ltd.) London Office: 63, Queen Victoria Street, E.C

Manufacturers of Latest Improved

LINSEED CLEANING MACHINES

for separating weed seeds, all rubbish and dust, as used in all the Government Flax Factories and by all the leading Merchants in England, Ireland, Scotland, British East Africa, &c.

New Combined De-SEEDERS & CLEANERS

Also Sole Manufacturers of

NEW PATENT FLAX SCUTCHING MACHINES

giving many **ADVANTAGES** over the Wheel system.

One* machine of the new design will do as much work as five wheels.

15 % increase in Flax Fibre from the Straw.

Fibre delivered in clean, straight lengths.

Absolutely safe for Operator and easy to manage. Takes little power.

WRITE FOR FULL PARTICULARS.

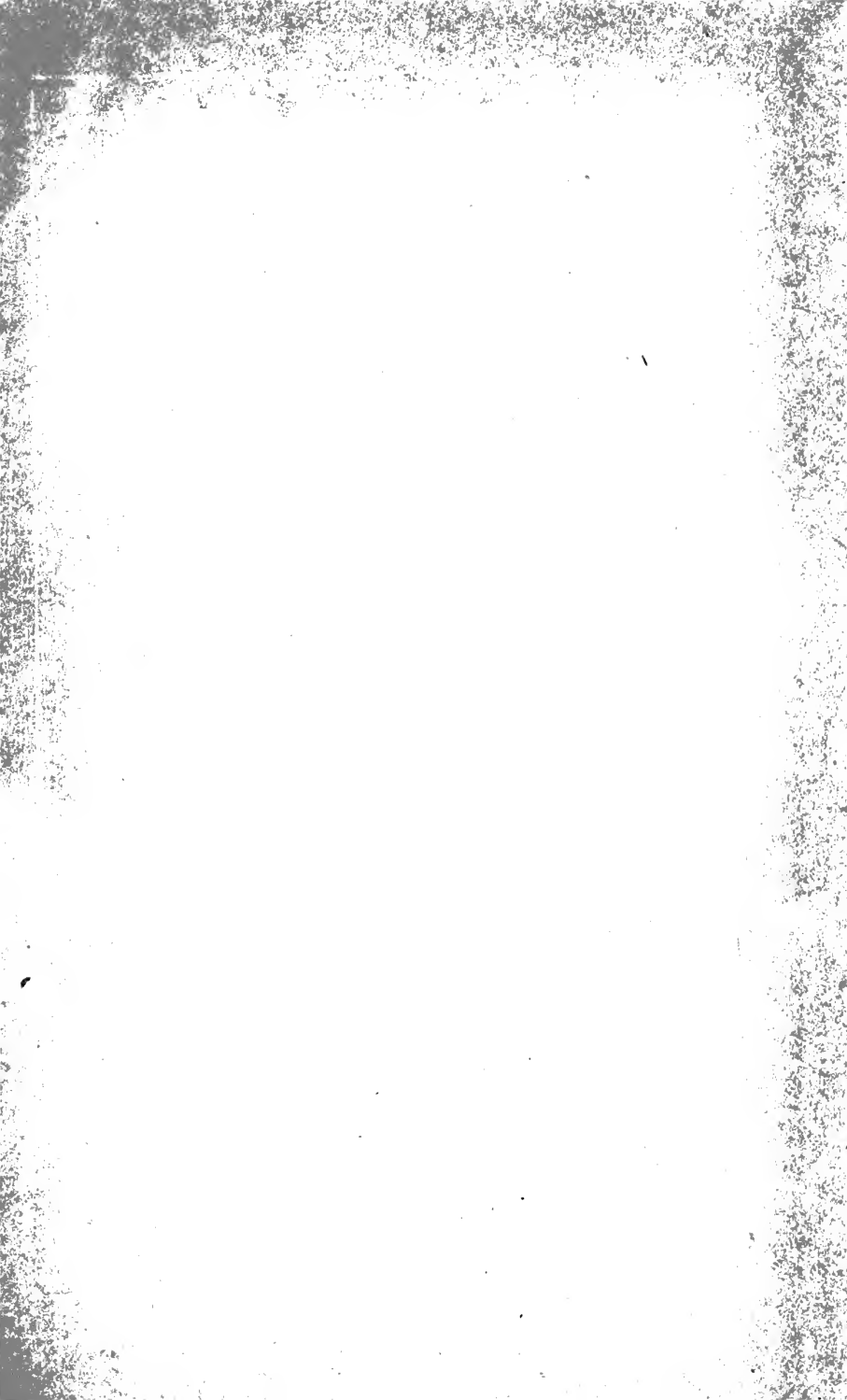

**THIS BOOK IS DUE ON THE LAST DATE
STAMPED BELOW**

AN INITIAL FINE OF 25 CENTS

**WILL BE ASSESSED FOR FAILURE TO RETURN
THIS BOOK ON THE DATE DUE. THE PENALTY
WILL INCREASE TO 50 CENTS ON THE FOURTH
DAY AND TO \$1.00 ON THE SEVENTH DAY
OVERDUE.**

MAY 20 1946

MAR 24 1947

6 Dec 50 CD

17 Jul 51 PY

10 Jul 51 LL

DEC 11 1982

REC. CIR. DEC 06 '82

DEC 10 2002

TS1705

C33

465110

UNIVERSITY OF CALIFORNIA LIBRARY

