

UC-NRLF



φB 32 934

THE GREAT WITHOUT
TOPIC

1960

THE GREAT WITHOUT
TOPIC

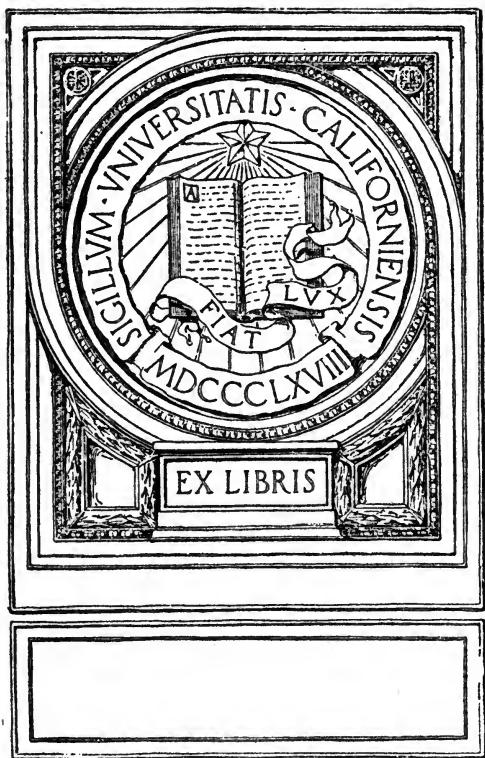

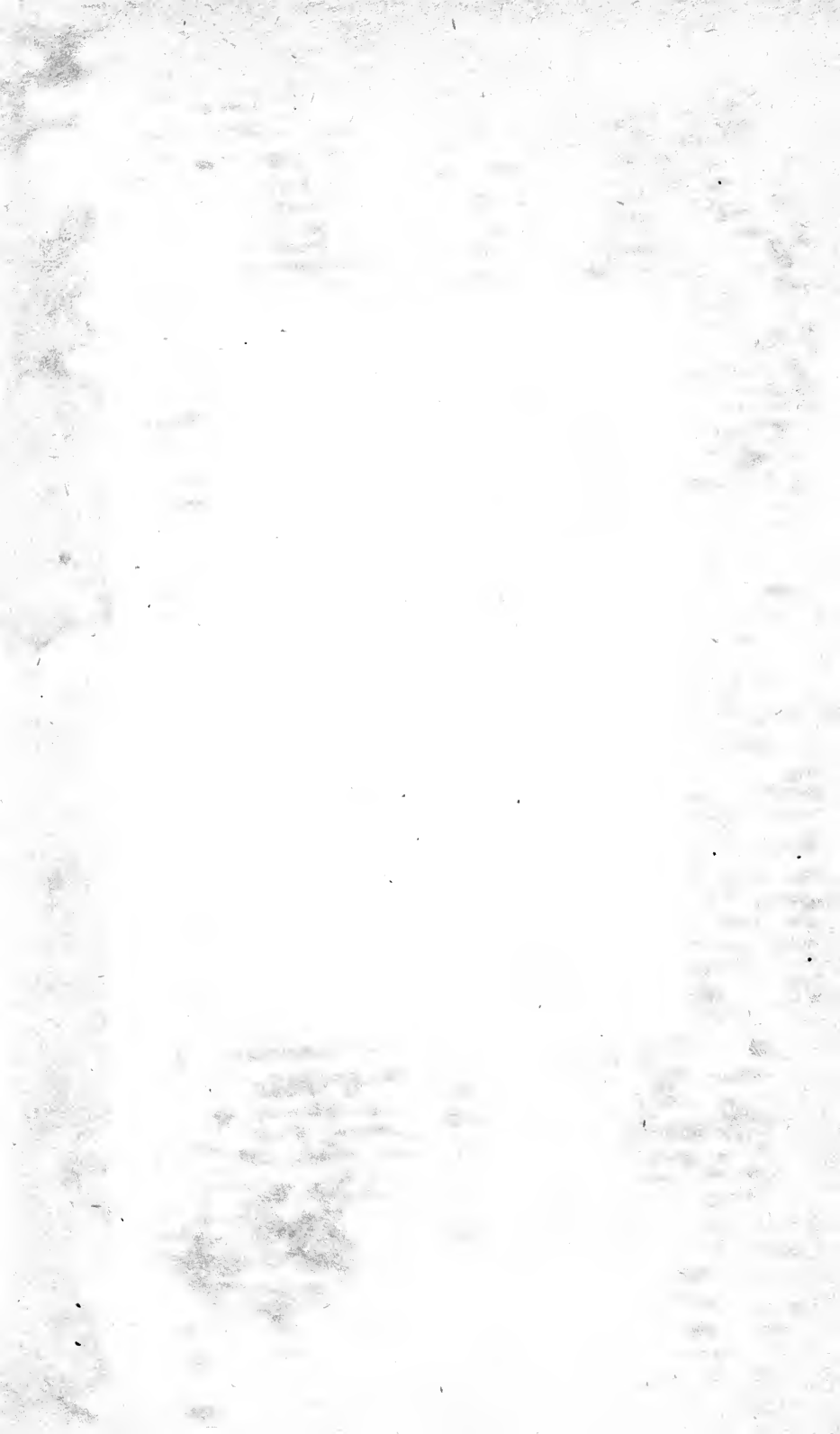

FLIGHT WITHOUT FORMULÆ

THE MECHANICS OF THE AERO-
PLANE. A Study of the Principles of
Flight. By COMMANDANT DUCHÊNE.
Translated from the French by JOHN H.
LEDEBOER, B.A., and T. O'B. HUBBARD.
With 98 Illustrations and Diagrams.
8vo. 7s. 6d. net.

THE AEROPLANE: An Elementary Text-
Book of the Principles of Dynamic
Flight. By T. O'B. HUBBARD, JOHN H.
LEDEBOER, B.A., and C. C. TURNER.
With 4 Plates and 35 Diagrams. Crown
8vo. 2s. 6d. net.

FLYING: Some Practical Experiences.
By GUSTAV HAMEL and CHARLES C.
TURNER. With 72 Illustrations 8vo.
12s. 6d. net.

LONGMANS, GREEN, AND CO.,
LONDON, NEW YORK, BOMBAY, CALCUTTA, AND
MADRAS.

FLIGHT WITHOUT FORMULÆ

SIMPLE DISCUSSIONS ON THE
MECHANICS OF THE AEROPLANE

BY

COMMANDANT DUCHÊNE

OF THE FRENCH GÉNIE
AUTHOR OF "THE MECHANICS OF THE AEROPLANE"

TRANSLATED FROM THE FRENCH BY

JOHN H. LEDEBOER, B.A.

ASSOCIATE FELLOW, AERONAUTICAL SOCIETY; EDITOR
"AERONAUTICS"; JOINT-AUTHOR OF "THE AEROPLANE"
TRANSLATOR OF "THE MECHANICS OF THE AEROPLANE"



LONGMANS, GREEN, AND CO.
39 PATERNOSTER ROW, LONDON
FOURTH AVENUE & 30TH STREET, NEW YORK
BOMBAY, CALCUTTA, AND MADRAS

1914

All rights reserved

TL670
II 77

TO WHOM IT MAY CONCERN
I HEREBY CERTIFY THAT

TRANSLATOR'S PREFACE

FORMULÆ and equations are necessary evils; they represent, as it were, the shorthand of the mathematician and the engineer, forming as they do the simplest and most convenient method of expressing certain relations between facts and phenomena which appear complicated when dressed in everyday garb. Nevertheless, it is to be feared that their very appearance is forbidding and strikes terror to the hearts of many readers not possessed of a mathematical turn of mind. However baseless this prejudice may be—as indeed it is—the fact remains that it exists, and has in the past deterred many from the study of the principles of the aeroplane, which is playing a part of ever-increasing importance in the life of the community.

The present work forms an attempt to cater for this class of reader. It has throughout been written in the simplest possible language, and contains in its whole extent not a single formula. It treats of every one of the principles of flight and of every one of the problems involved in the mechanics of the aeroplane, and this without demanding from the reader more than the most elementary knowledge of arithmetic. The chapters on stability should prove of particular interest to the pilot and the student, containing as they do several new theories of the highest importance here fully set out for the first time.

In conclusion, I have to thank Lieutenant T. O'B. Hubbard, my collaborator for many years, for his kind and diligent perusal of the proofs and for many helpful suggestions.

J. H. L.

v

CONTENTS

	PAGE
CHAPTER I	
FLIGHT IN STILL AIR—SPEED	1
CHAPTER II	
FLIGHT IN STILL AIR—POWER	16
CHAPTER III	
FLIGHT IN STILL AIR—POWER (<i>concluded</i>)	35
CHAPTER IV	
FLIGHT IN STILL AIR—THE POWER-PLANT	53
CHAPTER V	
FLIGHT IN STILL AIR—THE POWER-PLANT (<i>concluded</i>)	70
CHAPTER VI	
STABILITY IN STILL AIR—LONGITUDINAL STABILITY	90
CHAPTER VII	
STABILITY IN STILL AIR—LONGITUDINAL STABILITY (<i>concluded</i>)	115
CHAPTER VIII	
STABILITY IN STILL AIR—LATERAL STABILITY	142
CHAPTER IX	
STABILITY IN STILL AIR—LATERAL STABILITY (<i>concluded</i>), DIRECTIONAL STABILITY, TURNING	161
CHAPTER X	
THE EFFECT OF WIND ON AEROPLANES	183

Flight without Formulæ

Simple Discussions on the Mechanics of the Aeroplane

CHAPTER I

FLIGHT IN STILL AIR

SPEED

NOWADAYS everyone understands something of the main principles of aeroplane flight. It may be demonstrated in the simplest possible way by plunging the hand in water and trying to move it at some speed horizontally, after first slightly inclining the palm, so as to meet or "attack" the fluid at a small "angle of incidence." It will be noticed at once that, although the hand remains very nearly horizontal, and though it is moved *horizontally*, the water exerts upon it a certain amount of pressure directed nearly *vertically upwards* and tending to lift the hand.

This, in effect, is the principle underlying the flight of an aeroplane, which consists in drawing through the air wings or planes in a position nearly horizontal, and thus employing, for sustaining the weight of the whole machine, the vertically upward pressure exerted by the air on these wings, a pressure which is caused by the very forward movement of the wings.

Hence, the sustentation and the forward movement of an aeroplane are absolutely interdependent, and the former

can only be produced, in still air, by the latter, out of which it arises.

But the entire problem of aeroplane flight is not solved merely by obtaining from the "relative" air current which meets the wings, owing to their forward speed, sufficient *lift* to sustain the weight of the machine; an aeroplane, in addition, must always encounter the relative air current in the same attitude, and must neither upset nor be thrown out of its path by even a slight aerial disturbance. In other words, it is essential for an aeroplane to remain in equilibrium—more, *in stable equilibrium*.

This consideration clearly divides the study of aeroplane flight in calm air into two broad, natural parts:

The study of lift and the study of stability.

These two aspects will be dealt with successively, and will be followed by a consideration of flight in disturbed air.

First we will proceed to examine the lift of an aeroplane in still air.

Following the example of a bird, and in accordance with the results obtained by experiments with models, the wings of an aeroplane are given a span five or six times greater than their fore-and-aft dimension, or "chord," while they are also curved, so that their lower surface is concave.* It is desirable to give the wings a large span as compared to the chord, in order to reduce as far as possible the escape or leakage of the air along the sides; while it has the further advantage of playing an important part in stability. Again, the camber of the wings increases their lift and at the same time reduces their head-resistance or "drag."

The *angle of incidence* of a wing or plane is the angle,

* In English this curvature of the wing is generally known as the "camber." On the whole, it would perhaps be more accurate to describe the upper surface as being convex, since highly efficient wings have been designed in which the camber is confined to the upper surface, the lower surface being perfectly flat.—TRANSLATOR.

expressed in degrees, made by the chord of the curve in profile with the direction of the aeroplane's flight.

As stated above, the pressure of the air on a wing moving horizontally is nearly vertical, but only nearly. For, though it lifts, a wing at the same time offers a certain amount of resistance—known either as *head-resistance* or *drag**—which may well be described as the price paid for the lift.

As the result of the research work of several scientists, and of M. Eiffel in particular, with scale models, unit figures, or "coefficients," have been determined which enable us to calculate the amount of lift possessed by a given surface and its drag, when moving through the air at certain angles and at certain speeds.

Hereafter the coefficient which serves to calculate the lifting-power of a plane will be simply termed the *lift*, while that whereon the calculation of its drag is based will be known as the *drag*.

M. Eiffel has plotted the results of his experiments in diagrams or curves, which give, for each type of wing, the values of the lift and drag corresponding to the various angles of incidence.

The following curves are here reproduced from M. Eiffel's work, and relate to:

A flat plane (fig. 1).

A slightly cambered plane, a type used by Maurice Farman (fig. 2).

A plane of medium camber, adopted by Bréguet (fig. 3).

A deeply cambered plane, used by Bleriot on his No. XI. monoplanes, cross-Channel type (fig. 4.)

* The word "drag" is here adopted, in accordance with Mr Archibald Low's suggestion, in preference to the more usual "drift," in order to prevent confusion, and so as to preserve for the latter term its more general, and certainly more appropriate meaning, illustrated in the expression "the drift of an aeroplane from its course in a side-wind," or "drifting before a current."—TRANSLATOR.

These diagrams are so simple as to render further explanation superfluous.

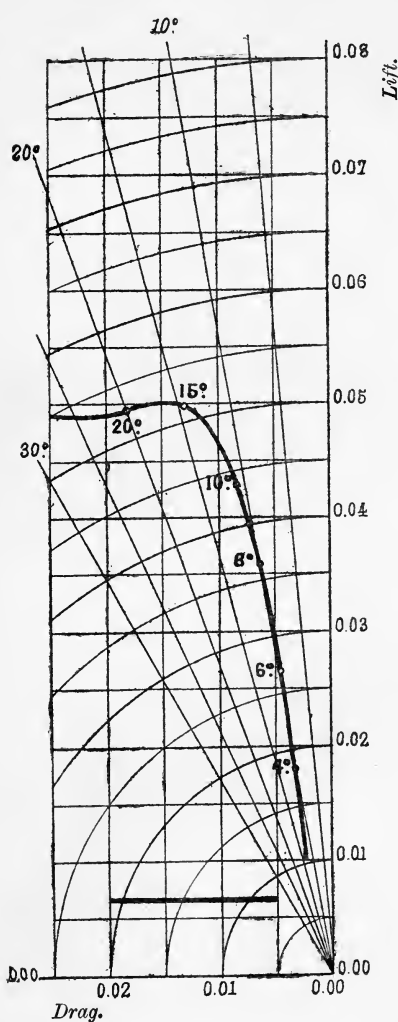

FIG. 1.—Flat plane.

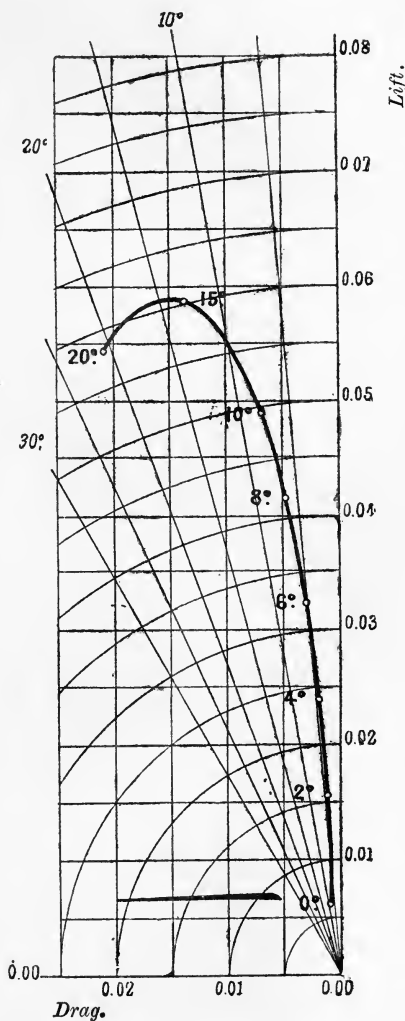

FIG. 2.—Maurice Farman plane.

The calculation of the lifting-power and the head-resistance produced by a given type of plane, moving through

the air at a given angle of incidence and at a given speed, is exceedingly simple. To obtain the desired result all that

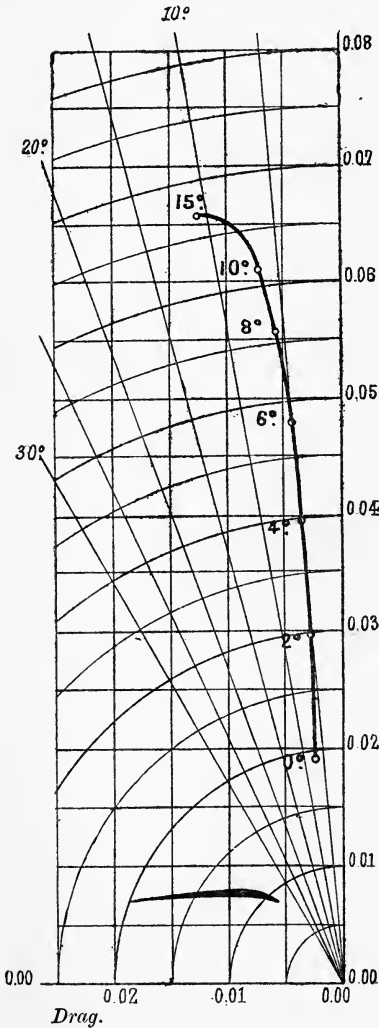

FIG. 3.—Bréguet plane.

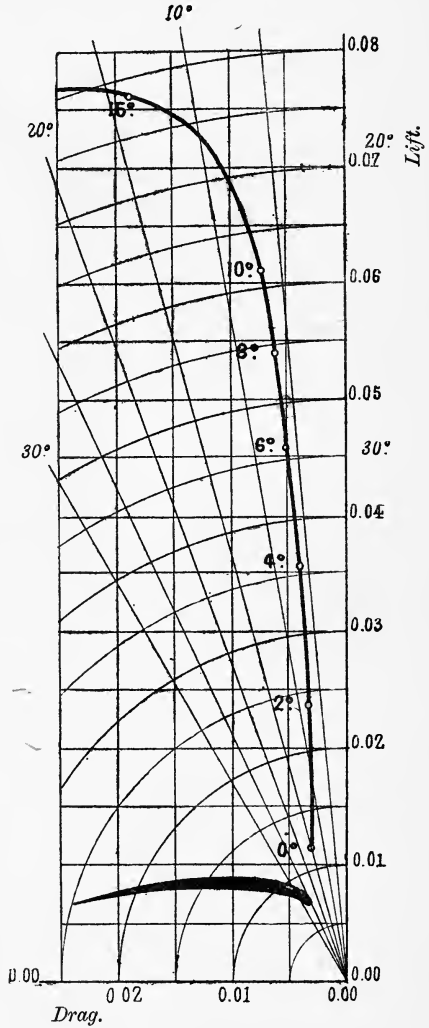

FIG. 4.—Bleriot XI. plane.

is needed is to multiply either the lift or the drag coefficients, corresponding to the particular angle of incidence,

by the area of the plane (in square metres, or, if English measurements are adopted, in square feet) and by the square of the speed, in metres per second (or miles per hour).*

EXAMPLE.—A *Bleriot monoplane, type No. XI.*, has an area of 15 sq. m., and flies at 20 m. per second at an angle of incidence of 7° . (1) What weight can its wings lift, and (2) what is the power required to propel the machine?

Referring to the curve in fig. 4, the lift of this particular type of wing at an angle of 7° is 0.05, and its drag 0.0055.

Hence

$$\begin{array}{rcc} \text{Lift.} & & \text{Area.} & & \text{Square of} \\ & & & & \text{the Speed.} \\ 0.05 & \times & 15 & \times & 400 \end{array}$$

gives the required value of the lifting-power, *i.e.* 300 kg.

Again

$$\begin{array}{rcc} \text{Drag.} & & \text{Area.} & & \text{Square of} \\ & & & & \text{the Speed.} \\ 0.0055 & \times & 15 & \times & 400 \end{array}$$

gives the value of the resistance of the wings, *i.e.* 33 kg.

Let us for the present only consider the question of lift, leaving that of drag on one side.

From the method of calculation shown above we may immediately proceed to draw some highly important deductions regarding the speed of an aeroplane. The fore-and-aft equilibrium of an aeroplane, in fact, as will be shown subsequently, is so adjusted that the aeroplane can only fly at one fixed angle of incidence, *so long as the elevator or stabiliser remains untouched*. By means of the elevator, however, the angle of incidence can be varied within certain limits.

In the previous example, let the Bleriot monoplane be taken to have been designed to fly at 7° . It has already been shown that this machine, with its area of 15 sq. m. and its speed of 72 km. per hour, will give a lifting-power equal to 300 kg. Now, if this lifting-power be greater than

* Throughout this work the metric system will henceforward be strictly adhered to.—TRANSLATOR.

the weight of the machine, the latter will tend to rise; if the weight be less, it will tend to descend. Perfectly horizontal flight at a speed of 72 km. per hour is only possible if the aeroplane weighs just 300 kg.

In other words, an aeroplane of a given weight and a given plane-area can only fly horizontally at a given angle of incidence at one single speed, which must be that at which the lifting-power it produces is precisely equal to the weight of the aeroplane.

Now it has already been shown that the lifting-power for a given angle of incidence is obtained by multiplying the lift coefficient corresponding to this angle by the plane area and by the square of the speed. This, therefore, must also give us the weight of the aeroplane. It is clear that this is only possible for one definite speed, *i.e.* when the square of the speed is equal to the weight, divided by the area multiplied by the inverse of the lift. And since the weight of the aeroplane divided by its area gives the loading on the planes per sq. m., the following most important and practical rule may be laid down:

The speed (in metres per second) of an aeroplane, flying at a given angle of incidence, is obtained by multiplying the square root of its loading (in kg. per sq. m.) by the square root of the inverse of the lift corresponding to the given angle.

At first sight the rule may appear complicated. Actually it is exceedingly simple when applied.

EXAMPLE.—A Bréguet aeroplane, with an area of 30 sq. m. and weighing 600 kg., flies with a lift of 0·04, equivalent (according to the curve in fig. 3) to an angle of incidence of about 4°. What is its speed?

The loading is $\frac{600}{30} = 20$ kg. per sq. m.

Square root of the loading = 4·47.

Inverse of the lift is $\frac{1}{0\cdot04} = 25$.

Square root of inverse of the lift = 5.

The speed required, therefore, in metres per second = $4.47 \times 5 = 22.3$ m. per second, or about 80 km. per hour. But if a different angle of incidence, or a different figure for the lift—which is equivalent, and, as will be seen hereafter, more usual—be taken, a different speed will be obtained.

Hence each angle of incidence has its own definite speed.

For instance, if we take the Bréguet aeroplane already considered, and calculate its speed for a whole series of angles of incidence, we obtain the results shown in Table I. But before examining these results in greater detail, so far as the relation between the angles of incidence, or the lift, and the speed is concerned, a few preliminary observations may be useful.

TABLE I.

Lift.	Corresponding Angle of Incidence.	Inverse of Lift.	Square Root of Inverse of Lift.	Speed.	
				In m. p. s.	In km. p. h.
				Product of figures in col. 4 multiplied by the square root of the loading, 4.47.	Product of figures in col. 5 multiplied by 8.6.
1	2	3	4	5	6
0.020	0° (about)	50	7.07	31.6	113.6
0.030	2° ,,	33.3	5.77	25.8	92.8
0.040	4° ,,	25	5.00	22.3	80.3
0.050	6½° ,,	20	4.47	20.0	72.0
0.060	10° ,,	16.6	4.08	18.2	65.6
0.066	15° ,,	15.2	3.90	17.4	62.6

In the first place, it should be noted that when the Bréguet wing has no angle of incidence, when, that is, the wind meets it parallel to the chord, it still has a certain lift. This constitutes one of the interesting properties of

a cambered plane. While a flat plane meeting the air edge-on has no lift whatever, as is evident, a cambered plane striking the air in a direction parallel to its chord still retains a certain lifting-power which varies according to the plane section.

Thus, in those conditions a Bréguet wing still has a lift of 0.019, and if figs. 4 and 2 are examined it will be seen that at zero incidence the Bleriot No. XI. would similarly have a lift of 0.012, but the Maurice Farman of only 0.006. It follows that a cambered plane exerts no lift whatever only when the wind strikes it slightly on the upper surface. In other words, by virtue of this property, a cambered plane may be regarded as possessing an imaginary chord—if the expression be allowed—inclined at a negative angle (that is, in the direction opposed to the ordinary angle of incidence) to the chord of the profile of the plane viewed in section.

If the necessary experiments were made and the curves on the diagrams were continued to the horizontal axis, it would be found that the angle between this “imaginary chord” and the actual chord is, for the Maurice Farman plane section about 1° , for that of the Bleriot XI. some 2° , and for that of the Bréguet 4° .

Let it be noted in passing that in the case of nearly every plane section a variation of 1° in the angle of incidence is roughly equivalent to a variation in lift of 0.005, at any rate for the smaller angles. One may therefore generalise and say that for any ordinary plane section a lift of 0.015 corresponds to an angle of incidence of 3° relatively to the “imaginary chord,” a lift of 0.020 to an angle of 4° , a lift of 0.025 to 5° , and so forth.

Turning now to the upper portion of the curves in the diagrams, it will be seen that, beginning with a definite angle of incidence, usually in the neighbourhood of 15° , the lift of a plane no longer increases. The curves relating to the Bréguet and the Bleriot cease at 15° , but the Maurice Farman curve clearly shows that for angles of incidence greater than 15° the lift gradually diminishes. Such coarse

angles, however, are never used in practice, for a reason shown in the diagrams, which is the excessive increase in the drag when the angle of incidence is greater than 10° . In aviation the angles of incidence that are employed therefore only vary within narrow limits, the variation certainly not surpassing 10° .

We may now return to the main object for which Table I. was compiled, namely, the variation in the speed of an aeroplane according to the angle of incidence of its planes.

First, it is seen that speed and angle of incidence vary inversely, which is obvious enough when it is remembered that in order to support its own weight, which necessarily remains constant, an aeroplane must fly the faster the smaller the angle at which its planes meet the air.

Secondly, it will be seen that the variation in speed is more pronounced for the smaller angles of incidence; hence, by utilising a small lift coefficient great speeds can be attained. Thus, for a lift equal to 0.02, at which the Bréguet wing would meet the air along its geometrical chord, the speed of the aeroplane, according to Table I., would exceed 113 km. an hour.

If an aeroplane could fly with a lift coefficient of 0.01, that is, if the planes met the air with their upper surface—the imaginary chord would then have an angle of incidence of no more than 2° —the same method of calculation would give a speed of over 160 km. per hour.

The chief reason which in practice places a limit on the reduction of the lift is, as will be shown subsequently, the rapid increase in the motive-power required to obtain high speeds with small angles of incidence. And further, there is a considerable element of danger in unduly small angles. For instance, if an aeroplane were to fly with a lift of 0.01—so that the imaginary chord met the air at an angle of only 2° —a slight longitudinal oscillation, only just exceeding this very small angle, would be enough to convert the fierce air current striking the aeroplane moving at an enormous speed from a lifting force into one provoking a fall. It is

true that the machine would for an instant preserve its speed owing to inertia, but the least that could happen would be a violent dive, which could only end in disaster if the machine was flying near the ground.

Nevertheless there are certain pilots, to whom the word intrepid may be justly applied, who deny the danger and argue that the disturbing oscillation is the less likely to occur the smaller the angle of incidence, for it is true, as will be seen hereafter, that a small angle of incidence is an important condition of stability. However this may be, there can be no question but that flying at a very small angle of incidence may set up excessive strains in the framework, which, in consequence, would have to be given enormous strength. Thus, if it were possible for an aeroplane to fly with a lift coefficient of 0·01, and if, owing to a wind gust or to a manœuvre corresponding to the sudden "flattening out" practised by birds of prey and by aviators at the conclusion of a dive, the plane suddenly met the air at an angle of incidence at which the lift reaches a maximum—that is, from 0·06 to 0·07 according to the type of plane—the machine would have to support, the speed remaining constant for the time being by reason of inertia, a pressure six or seven times greater than that encountered in normal flight, or than its own weight.

In practice, therefore, various considerations place a limit on the decrease of the angle of incidence, and it would accordingly appear doubtful whether hitherto an aeroplane has flown with a lift coefficient smaller than 0·02.*

It is easy enough to find out the value of the lift coefficient at which exceptionally high speeds have been attained from a few known particulars relating to the machine in question. The particulars required are:

The velocity of the aeroplane, which must have been carefully timed and corrected for the speed of the wind;

The total weight of the aeroplane fully loaded;

The supporting area.

* See footnote on p. 12.

The lift may then be found by dividing the loading of the planes by the square of the speed in metres per second.

EXAMPLE.—*An aeroplane with a plane area of 12 sq. m. and weighing, fully loaded, 360 kg. has flown at a speed of 130 km. or 36·1 m. per second. What was its lift coefficient?*

$$\text{The loading} = \frac{360}{12} = 30 \text{ kg. per sq. m.}$$

$$\text{Square of the speed} = 1300.$$

$$\text{Required lift} = \frac{30}{1300} = \text{about } 0\cdot023.*$$

Table I. further shows that when the angle of incidence reaches the neighbourhood of 15° (which cannot, as has been seen, be employed in practical flight) the lift reaches its maximum value, and the speed consequently its minimum.

* At the time of writing (August 1913) the speed record, 171·7 km. per hour or 47·6 m. per second, is held by the Deperdussin monocoque with a 140-h.p. motor, weighing 525 kg. with full load, and with a plane area of about 12 sq. m. (loading, 43·7 kg. per sq. m.). Another machine of the same type, but with a 100-h.p. engine, weighing 470 kg. in all, and with an area of 11 sq. m., has attained a speed of 168 km. per hour or 46·8 m. per second. According to the above method of calculation, the flight in both cases was made with a lift coefficient of about 0·0195.—AUTHOR.

Since the above was written, all speed records were broken during the last Gordon-Bennett race in September 1913. The winner was Prévost, on a 160-h.p. Gnome Deperdussin monoplane, who attained a speed of a fraction under 204 km. per hour; while Védrières, on a 160-h.p. Gnome-Ponnier monoplane, achieved close upon 201 km. per hour. The Deperdussin monoplane, with an area of 10 sq. m., weighed, fully loaded, about 680 kg.; the Ponnier, measuring 8 sq. m., weighed approximately 500 kg. Adopting the same method of calculation, it is easily shown that the lift coefficients worked out at 0·021 and 0·020 respectively. It is just possible that these figures were actually slightly smaller, since it is difficult to determine the weights with any considerable degree of accuracy. However, the error, if there be any, is only slight, and the result only confirms the author's conclusions. Since that time Emile Védrières is stated to have attained, during an official trial, a speed of 212 km. per hour, on a still smaller Ponnier monoplane, measuring only 7 sq. m. in area and weighing only 450 kg. in flight. This would imply a lift coefficient of 0·0185, a figure which cannot be accepted without reserve.—TRANSLATOR.

If the angle surpassed 15° the lift would diminish and the speed again increase.

A given aeroplane, therefore, cannot in fact fly below a certain limit speed, which in the case of the Bréguet already considered, for instance, is about 63 km. per hour.

It will be further noticed that in Table I. one of the columns, the second one, contains particulars relating only to the Bréguet type of plane. If this column were omitted, the whole table would give the speed variation of *any* aeroplane with a loading of 20 kg. per sq. m. on its planes, for a variation in the lift coefficient of the planes. It was this that led to the above remark, made in passing, that it was more usual to take the lift coefficient than the angle of incidence; for the former is independent of the shape of the plane.

The speed variation of an aeroplane for a variation in its lift coefficient can easily be plotted in a curve, which would have the shape shown in fig. 5, which is based on the figures in Table I.

The previous considerations relate more especially to a study of the speeds at which a *given* type of aeroplane can fly. In order to compare the speeds at which *different* types of aeroplanes can fly *at the same lift coefficient*, we need only return to the basic rule already set forth (p. 7). It then becomes evident that these speeds are to one another as the square roots of the loading.

The fact that only the loading comes into consideration in calculating the speed of an aeroplane shows that the speed, *for a given lift coefficient*, of a machine does not depend on the absolute values of its weight and its plane area, but only on the ratio of these latter. The most heavily loaded aeroplanes yet built (those of the French military trials in 1911) were loaded to the extent of 40 kg. per sq. m. of plane area.* The square root of this number being 6.32, an aeroplane of this type, driven by a sufficiently

* The 140-h.p. Deperdussin monocoque had a loading of 43.8 kg. per sq. m.

powerful engine to enable it to fly at a lift coefficient of 0·02 (the square root of whose inverse is 7·07), could have attained a speed equal to $6\cdot32 \times 7\cdot07$, that is, it could have exceeded 44·5 m. per second or 160 km. per hour.

It is therefore evident that there are only two means for increasing the speed of an aeroplane—either to reduce the

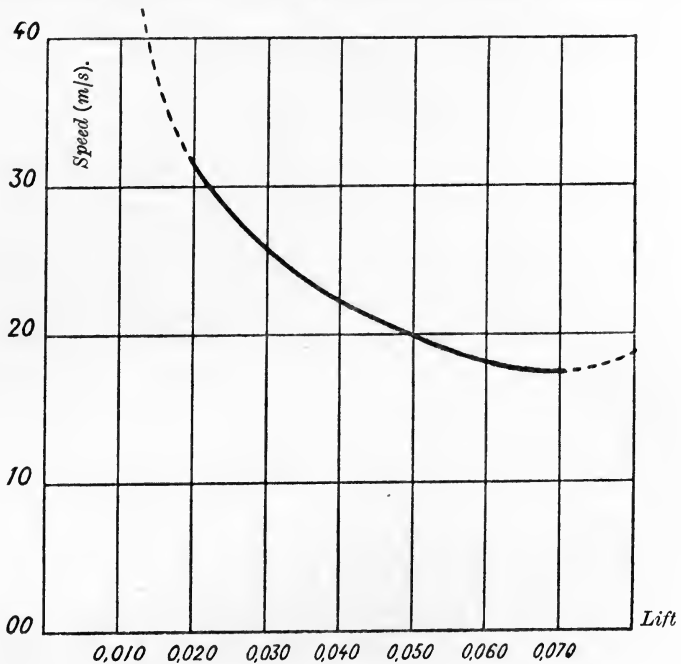

FIG. 5.

lift coefficient or to increase the loading. Both methods require power; we shall see further on which of the two is the more economical in this respect.

The former has the disadvantages—contested, it is true—which have already been stated. The latter requires exceptionally strong planes.

In any case, it would appear that, in the present stage of aeroplane construction, the speed of machines will scarcely exceed 150 to 160 km. per hour; and even so, this result

could only have been achieved with the aid of good engines developing from 120 to 130 h.p.* So that we are still far removed from the speeds of 200 and even 300 km. per hour which were prophesied on the morrow of the first advent of the aeroplane.†

In concluding these observations on the speed of aeroplanes, attention may be drawn to a rule already laid down in a previous work,‡ which gives a rapid method of calculating with fair accuracy the speed of an average machine whose weight and plane area are known.

The speed of an average aeroplane, in metres per second, is equal to five times the square root of its loading, in kg. per sq. m.

This rule simply presupposes that the average aeroplane flies with a lift coefficient of 0·04, the inverse of whose square root is 5. The rule, of course, is not absolutely accurate, but has the merit of being easy to remember and to apply.

EXAMPLE.—*What is the speed of an aeroplane weighing 900 kg., and having an area of 36 sq. m.?*

$$\text{Loading} = \frac{900}{36} = 25 \text{ kg. per sq. m.}$$

$$\text{Square root of the loading} = 5.$$

$$\text{Speed required} = 5 \times 5 = 25 \text{ m. per second or 90 km. per hour.}$$

* In previous footnotes it has already been stated that the Deperdussin monocoques, a 140-h.p. and a 100-h.p., have already flown at about 170 km. per hour. But these were exceptions, and, on the whole, the author's contention remains perfectly accurate even to-day.—TRANSLATOR.

† The reference, of course, is only to aeroplanes designed for everyday use, and not to racing machines.—TRANSLATOR.

‡ *The Mechanics of the Aeroplane* (Longmans, Green & Co.).

CHAPTER II

FLIGHT IN STILL AIR

POWER

IN the first chapter the speed of the aeroplane was dealt with in its relation to the constructional features of the machine, or its *characteristics* (*i.e.* the weight and plane area), and to its angle of incidence. It may seem strange that, in considering the speed of a motor-driven vehicle, no account should have been taken of the one element which usually determines the speed of such vehicles, that is, of the *motive-power*. But the anomaly is only apparent, and wholly due to the unique nature of the aeroplane, which alone possesses the faculty—denied to terrestrial vehicles which are compelled to crawl along the surface of the earth, or, in other words, to move in but two dimensions—of being free to move upwards and downwards, in all three dimensions, that is, of space.

The subject of this chapter and the next will be to examine the part played by the motive-power in aeroplane flight, and its effect on the value of the speed.

In all that has gone before it has been assumed that, in order to achieve horizontal flight, an aeroplane must be drawn forward at a speed sufficient to cause the weight of the whole machine to be balanced by the lifting-power exerted by the planes. But hitherto we have left out of consideration the means whereby the aeroplane is endowed with the speed essential for the production of the necessary lifting-power, and we purposely omitted, at the time, to

deal with the head-resistance or drag, which constitutes, as already stated, the price to be paid for the lift.

This point will now be considered.

Reverting to the concrete case first examined, that of the horizontal flight at an angle of incidence of 7° of a Bleriot monoplane weighing 300 kg. and possessing a wing area of 15 sq. m., it has been seen that the speed of this machine flying at this angle would be 20 m. per second or 72 km. per hour, and that the drag of the wings at the speed mentioned would amount to 33 kg.

Unfortunately, though alone producing lift in an aeroplane, the planes are not the only portions productive of drag, for they have to draw along the fuselage, or interplane connections, the landing chassis, the motor, the occupants, etc.

For reasons of simplicity, it may be assumed that all these together exert the same amount of resistance or drag as that offered by an imaginary plate placed at right angles to the wind, so as to be struck full in the face, whose area is termed the *detrimental surface* of the aeroplane.

M. Eiffel has calculated from experiments with scale models that the detrimental surface of the average single-seater monoplane amounted to between $\frac{2}{3}$ and 1 sq. m., and that of an average large biplane to about $1\frac{1}{2}$ sq. m.* But it is clear that these calculations can only have an approximate value, and that the detrimental surface of an aeroplane must always be an uncertain quantity.

But in any case it is evident that this parasitical effect should be reduced to the lowest possible limits by streamlining every part offering head-resistance, by diminishing exterior stay wires to the utmost extent compatible with safety, etc. And it will be shown hereafter that these measures become the more important the greater the speed of flight.

The drag or *passive resistance* can be easily calculated

* These figures have since been undoubtedly reduced.

for a given detrimental surface by multiplying its area in square metres by the coefficient 0.08 (found to be the average from experiments with plates placed normally), and by the square of the speed in metres per second.

Thus, taking once again the Bleriot monoplane, let us suppose it to possess a detrimental surface of 0.8 sq. m.; its drag at a speed of 72 km. per hour or 20 m. per second will be:

Coefficient.	Detrimental Surface.	Square of the Speed.		
0.08	× 0.8	× 400	=	26 kg. (about).

As the drag of the planes alone at the above speed amounts to 33 kg., it is necessary to add this figure of 26 kg., in order to find the total resistance, which is therefore equal to 59 kg. The principles of mechanics teach that to overcome a resistance of 59 kg. at a speed of 20 m. per second, *power* must be exerted whose amount, expressed in horse-power, is found by dividing the product of the resistance (59 kg.) and the speed (20 m. per second) by 75.* We thus obtain 16 h.p. But a motor of 16 h.p. would be insufficient to meet the requirements.

For the *propelling plant*, consisting of motor and propeller, designed to overcome the drag or air resistance of the aeroplane, is like every other piece of machinery subject to losses of energy. Its efficiency, therefore, is only a portion of the power actually developed by the motor. The *efficiency* of the power-plant is the ratio of *useful power*—that is, the power capable of being turned to effect after transmission—to the *motive power*.

Thus, in order to produce the 16 h.p. required for horizontal flight in the above case of the Bleriot mono-

* This is easily understood. The unit of power, or horse-power, is the power required to raise a weight of 75 kg. to a height of 1 m. in 1 second, so that, to raise in this time a weight of 59 kg. to a height of 20 m., we require $\frac{59 \times 20}{75}$ h.p. Exactly the same holds good if, instead of overcoming the vertical force of gravity, we have to overcome the horizontal resistance of the air.

plane, it would be necessary to possess an engine developing 32 h.p. if the efficiency is only 50 per cent., 26.6 h.p. for an efficiency of 60 per cent., etc.

But if the aeroplane were to fly at an angle of incidence other than 7° —which, as already stated, would depend on the position of the elevator—the speed would *necessarily* be altered. If this primary condition were modified, the immediate result would be a variation in the drag of the planes, in the head-resistance of the aeroplane, in the propeller-thrust, which is equal to the total drag, and lastly, in the useful power required for flight.

Each value of the angle of incidence—and consequently of the speed—therefore has only one corresponding value of the useful power necessary for horizontal flight.

Returning to the Bréguet aeroplane weighing 600 kg. with a plane area of 30 sq. m., on which Table I. was based, we may calculate the values of the useful powers required to enable it to fly along a horizontal path for different angles of incidence and for different lifts. The detrimental surface may be assumed, for the sake of simplicity, to be 1.2 sq. m.

The values of the drag corresponding to those of the lift will be obtained from the polar diagram shown in fig. 3.

Table II., p. 20, summarises the results of the calculation required to find the values of the useful powers for horizontal flight at different lift coefficients.

Various and interesting conclusions may be drawn from the figures in columns 8 and 9 of this Table.

In the first place, it will be noticed from the figures in column 8 that the propeller-thrust (equivalent to the drag of the planes added to the head-resistance of the machine, *i.e.* column 6 and column 7) has a minimum value of 91 kg., corresponding to a lift coefficient of 0.05, and to the angle $6\frac{1}{2}^\circ$. This angle, which, in the case under consideration, is that corresponding to the smallest propeller-thrust, is usually known as the *optimum angle of the aeroplane*.

TABLE II.

Lift.	Corresponding Angle of Incidence.	Speed Values.		Drag Coefficient, according to Eiffel.	Drag of Planes (drag \times area, 30 sq. m., \times square of speed).	Head-Resistance (0.08 \times detrimental surface, 1.2 sq. m., \times square of speed).	Propeller-Thrust.	Useful Power for Horizontal Flight (in h.p.), product of figs. in cols. 3 and 8 divided by 75.
		m. p. s.	km. p. h.					
1	2	3	4	5	6	7	8	9
0.020	0°	31.6	113.6	0.0022	66 kg.	96 kg.	162 kg.	68
0.030	2°	25.8	92.8	0.0024	48	64	112	38
0.040	4°	22.3	80.3	0.0032	48	48	96	29
0.050	6½°	20.0	72.0	0.0044	53	38	91	24
0.060	10°	18.2	65.6	0.0063	63	32	95	23
0.066	15°	17.4	62.6	0.0118	107	29	136	31

When the lift coefficient is small, the requisite thrust, it will be seen, increases very rapidly, and the same holds good for high lift coefficients.

Secondly, the figures in column 9 show that, together with the thrust, the useful power required for flight reaches a minimum of 23 h.p., corresponding to a lift value of 0.06. The angle of incidence at which this minimum of useful power can be achieved, about 10° in the present case, can be termed the *economical angle*.

This angle is greater than the optimum angle, which can be explained by the fact that, though the thrust begins to increase again, albeit very slowly, when the angle of incidence is raised above the optimum angle, the speed still continues to decrease to an appreciable extent, and for the time being this decrease in speed affects the useful power more strongly than the increasing thrust; and the minimum value of the useful power is, consequently, not attained until, as the angle of incidence continues to grow, the

increase in the thrust exactly balances the decrease in the speed.

The figures in column 9 again show the great expenditure of power required for flight at a low lift coefficient. Thus, the Bréguet aeroplane already referred to, driven by a propelling plant of 50 per cent. efficiency, flying at a lift of 0.05—that is, at a speed of 72 km. per hour—only requires an engine developing 46 h.p.; but it would need a 136-h.p. engine to fly with a lift of 0.02, or at about 113 km. per hour. It is mainly on this account that, as we have already stated, the use of low lift coefficients is strictly limited.

The variations in power corresponding to variations in speed (and in lift) can be plotted in a simple curve.

Fig. 6 is of exceptional importance, for it may be said to determine the character of the machine, and will hereafter be referred to as the *essential aeroplane curve*.

After these preliminary considerations on the power required for horizontal flight, we may now proceed to examine the precise nature of the effect of the motive-power on the speed, which will lead at the same time to certain conclusions relating to *gliding flight*.*

For this, recourse must be had to one of the most elementary principles of mechanics, known as the *composition and decomposition of forces*. The principle is one which is almost self-evident, and has, in fact, already been used in these pages, when at the beginning of Chapter I. it was shown that in the air pressure, which is almost vertical, on a plane moving horizontally, a clear distinction must be made between the principal part of this pressure, which is strictly vertical (the lift), and a secondary part, which is strictly horizontal (the drag).

And, conversely, it is evident that for the action of two forces working together at the same time may be substituted

* There is really no excuse for the importation into English of the French term "vol plané," and still less for the horrid anglicism "volplane," since "gliding flight" is a perfect English equivalent of the French.—TRANSLATOR.

that of a single force, termed the *resultant* of these two forces. This proceeding is known as the composition of forces. So, in compounding the vertical reaction constituting the lift, and the horizontal reaction which forms

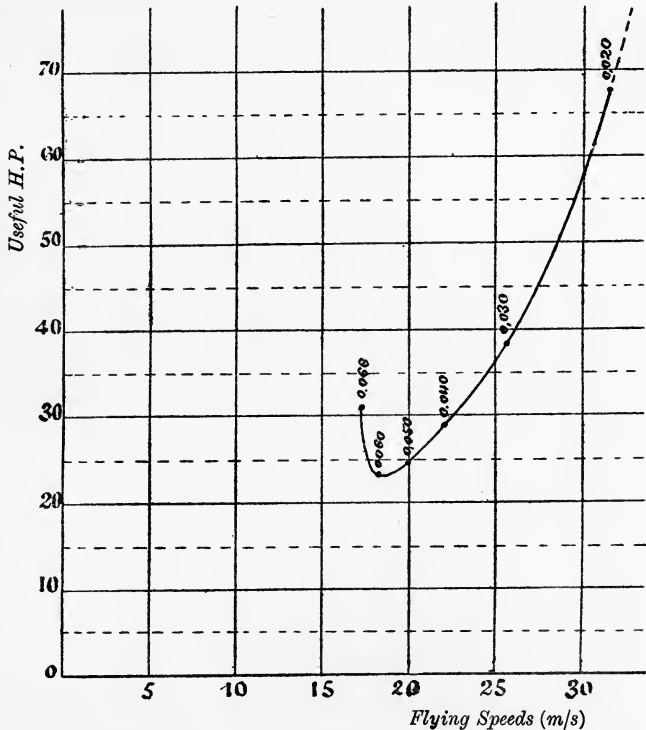

FIG. 6.

The figures on the curve indicate the lift.

the drift, one obtains the total air pressure, which is simply their resultant.

Both the composition and decomposition of forces is accomplished by way of projection. Thus (fig. 7), the force Q ,* which is inclined, can be decomposed into two forces,

* A force is represented by a straight line, drawn in the direction in which the force operates, and of a length just proportional to the magnitude of the force.

F and r , vertical and horizontal respectively, by projecting in the horizontal and vertical directions the end point A on two axes starting from the point O , where the forces are applied. Conversely, these two forces F and r may be

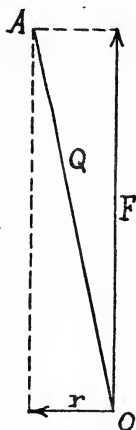

FIG. 7.

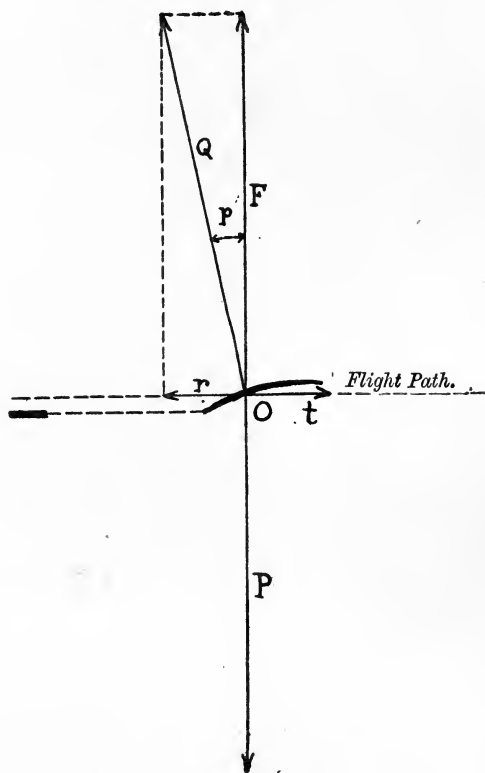

FIG. 8.

compounded into one resultant Q , by drawing the diagonal of the parallelogram or rectangle of which they form two of the sides. We may now return to the problem under consideration.

If we take the aeroplane as a whole, instead of dealing with the planes alone, it will be readily seen that the horizontal component of the air pressure on the whole

machine is equal to the drag of the planes added to the passive or head-resistance, the while the vertical component remains practically equal to the bare lift of the planes, since the remaining parts of the structure of an aeroplane exert but slight lift, if at all.* The entire pressure of the air on a complete aeroplane in flight is therefore farther inclined to the perpendicular than that exerted on the planes alone.

If (see fig. 8) the aeroplane is assumed to be represented by a single point O , in horizontal flight, the air pressure Q exerted upon it may be decomposed into two forces, of which the lift F is equal and directly opposite to the weight P , and the drag r , or total resistance to forward movement, which must be exactly balanced by the thrust t of the propeller.

But, supposing the engine be stopped and the propeller consequently to produce no thrust (fig. 9), the aeroplane will assume a descending flight-path such that the planes still retain the single angle of 7° , for instance, which we have assumed, so long as the elevator is not moved, and such that the air pressure Q on the planes becomes absolutely vertical, in order to balance the weight of the machine, instead of remaining inclined as heretofore. This is *gliding flight*.

Relatively to the direction of flight, the air pressure Q still retains its two components, of which r is simply the resistance of the air opposed to the forward movement of the glider. The second component F is identical to the lifting-power in horizontal flight, and its value is obtained by multiplying the lift coefficient corresponding to the angle 7° by the plane area, and by the square of the speed of the aeroplane on its downward flight path.

Fig. 9 shows that, by the very fact of being inclined, the force F is slightly less than the weight of the machine, but, since the gliding angle of an aeroplane is usually a slight

* For the sake of simplicity, we may consider that the tail plane, which will be hereinafter dealt with, exerts no lift.

one, the lifting-power F may still be deemed to be equal to the weight of the aeroplane.

Clearly, therefore, every consideration in the first chapter which related to the speed in horizontal flight is equally applicable to gliding flight, so that it may be said that

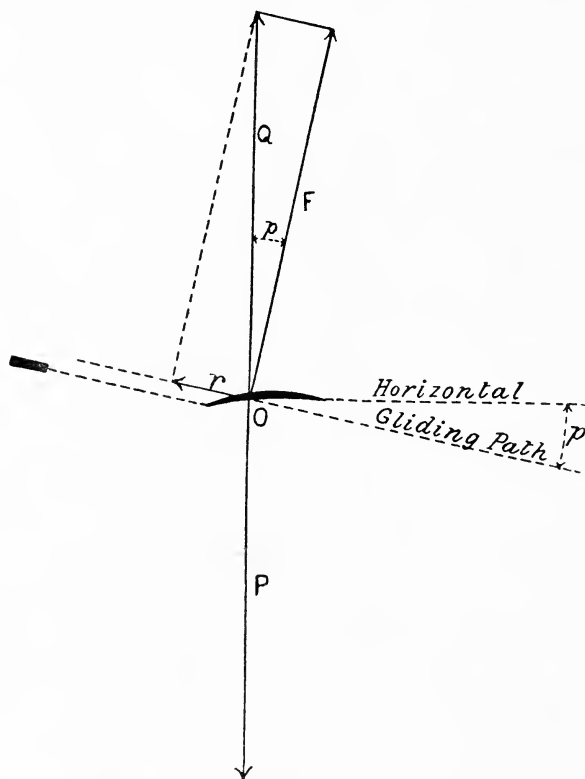

FIG. 9.

when an aeroplane begins to glide, *without changing its angle*, the speed remains the same as before.

In fact, horizontal flight is simply a glide in which the angle of the flight-path has been raised by mechanical means.

On comparing figs. 8 and 9 it will be seen that this angle is that which, in fig. 8, is marked by the letter p . If this

angle is represented, as in the case of any gradient, in terms of a decimal fraction, it will be found to depend on the ratio which the forces r and F bear to one another. Hence, the following rule may be stated:—

RULE.—*The gliding angle assumed at a given angle of incidence by any aeroplane is equal to the thrust required for its horizontal flight at the same angle, divided by the weight of the machine.*

Thus the Bleriot monoplane dealt with in the first instance, which requires for horizontal flight at an angle of 7° a thrust of 59 kg., and weighs 300 kg., would assume on its glide, at the same angle of incidence, a descending flight-path equal to $\frac{59}{300}$, or 0.197, which is equivalent to nearly 20 cm. in every metre (1 in 5). The Bréguet aeroplane on which Tables I. and II. were based, weighing 600 kg., would assume at different angles (or lift coefficients) the gliding angles shown in Table III.

TABLE III.

Lift.	Angle corresponding to the Lift.	Speed.		Propeller-Thrust in Horizontal Flight.	Gliding Angle. Weight (600 kg.) divided by figures in col. 5.
		m/s.	km/h.		
1	2	3	4	5	6
0.02	0°	31.6	113.6	162	0.270
0.03	2°	25.8	92.8	112	0.187
0.04	4°	22.3	80.3	96	0.160
0.05	$6\frac{1}{2}^\circ$	20.0	72.0	91	0.151
0.06	10°	18.2	65.6	95	0.158
0.066	15°	17.4	62.6	136	0.226

It will now be seen that the best gliding angle is obtained when the angle of incidence is the same as the optimum

angle of the aeroplane. The latter, therefore, is the best from the gliding point of view, so far as the length of the glide is concerned.

In fig. 10, starting from a point O, are drawn dotted lines corresponding to the gliding angle given in column 6 of Table III., and on these lines are marked off distances proportional to the speed values set out in columns 3 or 4; the diagram will then give, if the points are connected into a curve, the positions assumed, in unit time, by a glider, launched at the various angles from the point O.

It will be observed in the first place that any given gliding path, such as OA, for instance, cuts the curve at two points, A and B, thus showing that this gliding path could have been traversed by the aeroplane at two different speeds, OA and OB, corresponding to the two different angles of incidence, 1° and 15° in the present case.

Only for the single gliding path OM, corresponding to the smallest gliding slope and the optimum angle of incidence, do these two points coincide.

But it is not by following this gliding path that an aeroplane will descend best in the vertical sense during a given period of time; for this it will only do by following the path OE corresponding to the highest point on the curve, and the angle of incidence to be adopted to achieve this result is none other than the economical angle. But the difference in the rate of fall is only slight for the example in question.

It will be noted that as the angle of incidence diminishes, the gliding angle rapidly becomes steeper. If the curve were extended so as to take in very small angles of incidence, it would be found that at a lift coefficient of 0.015 the gliding path would already have become very steep, that this steepness would increase very rapidly for the coefficient 0.010, and that at 0.005 it approached a headlong fall. The fall, in fact, must become vertical when the lift disappears, that is, when the plane meets the air along its imaginary chord.

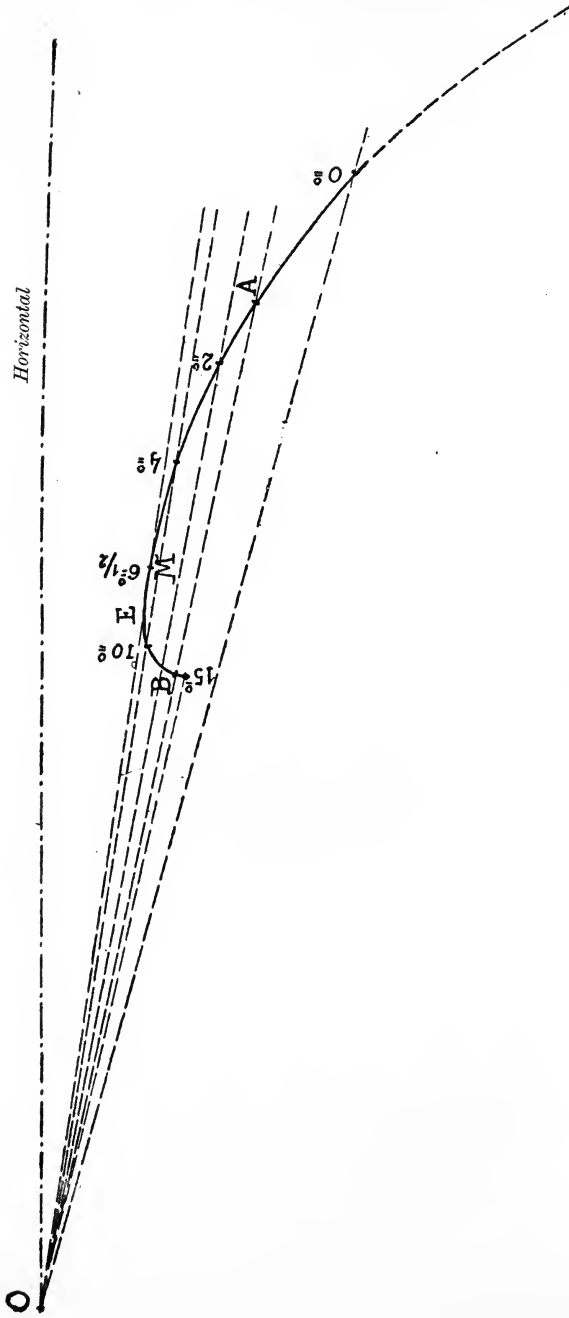

FIG. 10.

In these conditions, a slight variation in the lift therefore brings about a very large alteration in the gliding angle, and this effect is the more intense the smaller the lift coefficient. The *glide* becomes a *dive*. Hence it is clear that this is another danger of adopting a low lift coefficient.

This brief discussion on gliding flight, interesting enough in itself, was necessary to a proper understanding of the part played by power in the horizontal flight of an aeroplane, for we can now regard the latter in the light of a glide in which the gliding path has been artificially raised.

And this raising of the gliding path is due to the power derived from the propelling plant.

This will be better understood if we assume that, during the course of a glide, the pilot started up his engine again *without altering the position of the elevator*, so that the planes remained at the same angle as before; the gliding path would gradually be raised until it attained and even surpassed the horizontal, while the aeroplane (as has been seen) *would approximately maintain the same speed throughout*.

Hence it may be said that when the angle of incidence remains constant, *the speed of an aeroplane is not produced by its motive-power*, as in the case of all other existing vehicles, since, *when the motor is stopped, this speed is maintained*.

The function of the power-plant is simply *to overcome gravity*, to prevent the aeroplane from yielding, as it inevitably must do in calm air, to the attraction of the earth; in other words, to govern its vertical flight.

In the case now under consideration, the speed therefore is wholly independent of the power, since, as has been seen, it is entirely determined by the angle of incidence, and if this remains constant, as assumed, any excess of power will simply cause the aeroplane to climb, while a lack of power

will cause it to come down, *but without any variation in the speed.*

But this must not be taken to imply that the available motive-power cannot be transformed into speed, for such, happily, is not the case. Hitherto the elevator has been assumed to be immovable so that the incidence remained constant.

As a matter of fact, the incidence need only be diminished through the action of the elevator in order to enable the aeroplane to adopt the speed corresponding to the new angle of the planes, and in this way to absorb the excess of power without climbing.

Nevertheless—and the point should be insisted upon as it is one of the essential principles of aeroplane flight—*the angle of incidence alone determines the speed, which cannot be affected by the power save through the intermediary of the incidence.*

Hitherto we have constantly alluded to the different speeds at which an aeroplane can fly, as if, in practice, pilots were able to drive their machines at almost any speed they desired. In actual fact, a given aeroplane usually only flies at a single speed, so that we are in the habit of referring to the X biplane as a 70 km. per hour machine, or of stating that the Y monoplane does 100 km. per hour. This is simply because up to now, and with very few exceptions, pilots run their engines at their normal number of revolutions. In these conditions it is evident that the useful power furnished by the propelling plant determines the incidence, and hence the speed.

Thus, referring once again to Table II., it will be seen for example that, if the Bréguet biplane receives 29 h.p. in useful power from its propelling plant, the pilot, in order to maintain horizontal flight, will have to manipulate his elevator until the incidence of the planes is approximately 4° , which corresponds to the lift 0.040.

The speed, then, would only be about 80 km. per hour.

Experience teaches the pilot to find the correct position of the elevator to maintain horizontal flight. Should the engine run irregularly, and if the aeroplane is to maintain its horizontal flight, the elevator must be slightly actuated in order to correct this disturbing influence.

Horizontal flight, therefore, implies a constant maintenance of equilibrium, whence the designation *equilibrator* which is often applied to the elevator, derives full justification.

But if the engine is running normally, the incidence, and consequently the speed, of an aeroplane remain practically constant, and these constitute its *normal* incidence and speed.

Generally the engine is running at full power during flight, and so in the ordinary course of events the normal speed of an aeroplane is the highest it can attain.

But there is a growing tendency among pilots to reserve a portion of the power which the engine is capable of developing, and to throttle down in normal flight. In this case the reserve of power available may be saved for an emergency, and be used—the case will be dealt with hereafter—for climbing rapidly, or to assume a higher speed for the time being. In this case the normal speed is, of course, no longer the highest possible speed.

In the example already considered, the Bréguet biplane would fly at about 80 km. per hour, if it possessed useful power amounting to 29 h.p.

But by throttling down the engine so that it normally only produced a reduced useful power equivalent to 24 h.p., the normal speed of the machine, according to Table II., would only be 72 km. per hour (the normal incidence being $6\frac{1}{2}^\circ$ and the lift 0.050).

The pilot would therefore have at his disposal a surplus of power amounting to 5 h.p., which he could use, by opening the throttle, either for climbing or for temporarily increasing his speed to 80 km. per hour.

Although, therefore, an aeroplane usually only flies at one speed, which we call its normal speed, it can perfectly well fly at other speeds, as was shown in Chapter I. But, in order to obtain this result, it is essential that on each occasion the engine should be made to develop the precise amount of power required by the speed at which it is desired to fly.

Speed variation can therefore only be achieved by simultaneously varying the incidence and the power, or, in practice, by operating the elevator and the throttle together. This may be accomplished with greater or less ease according to the type of motor in use, but certain pilots practise it most cleverly and succeed in achieving a very notable speed variation, which is of great importance, especially in the case of high-speed aeroplanes, at the moment of alighting.

As has already been explained, the horizontal flight of an aeroplane may be considered in the light of gliding flight with the gliding angle artificially raised. From this point of view it is possible to calculate in another way the power required for horizontal flight.

For instance, if we know that an aeroplane of a given weight, such as 600 kg., has, for a given incidence, a gliding angle of 16 cm. per metre (approximately 1 in 6) at which its speed is 22·3 m. per second, we conclude that in 1 second it descended $0\cdot16 \times 22\cdot3 = 3\cdot58$ m. Hence, in order to overcome its descent and to preserve its horizontal flight, it would be necessary to expend the useful power required to raise a weight of 600 kg. to a height of 3·58 m. in 1 second. Since 1 h.p. is the unit required to raise a weight of 75 kg. to a height of 1 m. in 1 second, the desired useful power = $\frac{600 \times 3\cdot58}{75} =$ about 29 h.p. This, as a matter of fact, is the amount given by Table II. for the Bréguet biplane which complies with the conditions given.

In order to find the useful power required for the

horizontal flight of an aeroplane flying at a given incidence, and hence at a given speed, multiply the weight of the machine by this speed and by the gliding angle corresponding to the incidence, and divide by 75.

By a similar method one may easily calculate the useful power required to convert horizontal flight into a climb at any angle.

Thus, if the aeroplane already referred to had to climb, always at the same speed of 22·3 m. per second, at an angle of 5 cm. per metre (1 in 20), it would be necessary to expend the additional power

$$\frac{0\cdot05 \times 600 \times 22\cdot3}{75} = \text{about } 9 \text{ h.p.}$$

Of course, this expenditure of surplus power would be greater the smaller the efficiency of the propeller, and would be 12 h.p. for 75 per cent. efficiency, and 18 h.p. for 50 per cent. efficiency.

Clearly, this method of making an aeroplane climb—by increasing the motive-power—can only be resorted to if there is a surplus of power available, that is, if the engine is not normally running at full power, which until now is the exception.

For this reason, when, as is generally the case, the engine is running at full power, climbing is effected in a much simpler manner, which consists in increasing the angle of incidence of the planes by means of the elevator.

Let us once more take our Bréguet biplane which, with motor working at full power, flies at a normal speed of 22·3 m. per second (80·3 km. per hour) at 4° incidence (or a lift coefficient of 0·040). The useful power needed to achieve this speed (see Table II.) is 29 h.p.

Assume that, by means of his elevator, the pilot increases the angle of incidence to 10° (lift coefficient 0·060). Since horizontal flight at this incidence, which must *inevitably* reduce the speed to 18·2 m. per second or 65·6 km. per hour, would only require 23 h.p., there will be an

excess of power amounting to 6 h.p.,* and the aeroplane will rise.

The climbing angle can be calculated with great ease. The method is just the converse of the one we have just employed, and thus consists in dividing 6×75 (representing the surplus power) by 600×20 (weight multiplied by speed), which gives an angle of 3.75 cm. per metre (1 in 27 about).

This climbing rate may not appear very great; still, for a speed of 18.2 m. per second, it corresponds to a climb of 68 cm. per second = 41 m. per minute = 410 m. in 10 minutes, which is, at all events, appreciable.

The aeroplane, therefore, may be made to climb or to descend by the operation of the elevator by the pilot.

More especially is the elevator used for starting. In this case the elevator is placed in a position corresponding to a very slight incidence of the main planes, so that these offer very little resistance to forward motion when the motor is started and the machine begins to run along the ground. As soon as the rolling speed is deemed sufficient, the elevator is moved to a considerable angle, which causes the planes to assume a fairly high incidence, and the aeroplane rises from the ground.

* This is not strictly correct, since, as will be seen hereafter, the propeller efficiency varies to some extent with the speed of the aeroplane; still, we shall not make a grievous error in assuming that the efficiency remains the same.

CHAPTER III

FLIGHT IN STILL AIR

POWER (*concluded*)

THE second chapter was mainly devoted to explaining how one may calculate the useful power required for horizontal flight, at the various angles of incidence and at the different lift coefficients—in other words, at the various speeds of a given aeroplane.

In addition, gliding flight has been briefly touched on, and has served to show the precise manner in which the power employed affects the speed of the aeroplane.

In the present chapter this discussion will be completed; it will be devoted to finding the best way of employing the available power to obtain speed. Incidentally, we shall have occasion to deal briefly with the limits of speed which the aeroplane as we know it to-day seems capable of attaining.

It has been shown that the flight of a given aeroplane requires a minimum useful power, and that this is only possible when the angle of incidence is that which we have termed the *economical angle*.

The power would therefore be turned to the best account, having regard merely to the sustentation of the aeroplane, by making it fly normally at its economical angle.

But, on the other hand, this method is most defective from the point of view of speed, for as fig. 6 (Chapter II.) clearly shows, when the machine flies at its economical angle, a very slight increase in power will increase the

speed to a considerable extent. Besides, the method in question would be worthless from a practical point of view, since it is evident that an aeroplane flying under these conditions would be endangered by the slightest failure of its engine.

Such, in fact, was the case with the first aeroplanes which actually rose from the ground; they flew "without a margin," to use an expressive term. And even to-day the same is true of machines whose motor is running badly: in such a case the only thing to be done is to land as soon as possible, since the aeroplane will scarcely respond to the controls.

The other characteristic value of the angle of incidence referred to in Chapter II., there called the *optimum angle*, ^{of air} corresponds to the least value of the ratio between the propeller-thrust and the weight of the aeroplane, or to its equivalent—the best gliding angle.

For the best utilisation of the power in order to obtain speed, which alone concerns us for the moment, there is a distinct advantage attached to the use of the optimum angle for the normal incidence of the machine; Colonel Renard, indeed, long ago pointed out that by using the optimum angle for normal flight in preference to the economical angle, one obtained 32 per cent. increase in speed for an increase in power amounting to 13 per cent. only.

In any case, when the incidence is optimum the ratio between the speed and the useful power required to obtain it is largest. This is easily explained by reference to Chapter II., which showed that the useful power required for horizontal flight at a given incidence is proportional to the speed multiplied by the gliding angle of the aeroplane at the same incidence.

When the gliding angle is least (*i.e.* flattest), that is, when the incidence is that of the optimum angle, the ratio of power to speed is also smallest, and hence the ratio of speed to maximum power.

It would therefore appear that by using the optimum

angle as the normal incidence we would obtain the best results from the point of view with which we are at present concerned, which is that of the most profitable utilisation of the power to produce speed. This, in fact, is generally accepted as the truth, and in his scale model experiments M. Eiffel always recorded this important value of the angle of incidence, together with the corresponding flattest gliding angle.

Nevertheless we are not prepared to accept as inevitably true that the optimum angle is necessarily the most advantageous for flight, so far as the transmutation of power into speed is concerned. This will now be shown by approaching the question in a different manner, and by finding the best conditions under which a given speed can be attained.

The power required for flight is proportional, as has been shown, to the propeller-thrust multiplied by the speed. Hence, on comparing different aeroplanes flying at the same speed, it will be found that the values of the power expended to maintain flight will have the same relation to one another as the corresponding values of the propeller-thrust.

If we assume that the detrimental surface of each one of these aeroplanes is identical, the head-resistance will be the same in each case, since it is proportional to the detrimental surface multiplied by the square of the speed (which is identical in every case).

It follows that the speed in question will be attained most economically by the aeroplane whose planes exert the least drag. Now, it was shown in Chapter II. that the drag of the wings of an aeroplane is a fraction of the weight of the machine equal to the ratio between the drag coefficient and the lift coefficient corresponding to the incidence at which flight is made.

If we assume, therefore, that the weight of each aeroplane is identical, it follows that the best results are given by that machine whose planes in normal flight have the smallest drag-to-lift ratio.

Reference to the polar diagrams (Chapter I., figs. 1, 2, 3, and 4) shows that the minimum drag-to-lift ratio occurs at the angle of incidence corresponding to the point on the curve where a straight line rotated about the centre 0·00 comes into contact with the curve. This angle of incidence is beyond all question, for any aeroplane provided with planes of the types under consideration, the most profitable from our point of view; this angle, in other words, is that at which an aeroplane of given weight can fly at a given speed for the least expenditure of power, and this for any weight and speed. Hence this is the angle at which an aeroplane possessing one of these wing sections should always fly in theory. Accordingly, it may be termed the *best angle of incidence*, and the corresponding lift coefficient the *best lift coefficient*.

The value of the best incidence only depends on the wing section, but it is always smaller than the optimum angle, which in its turn depends not only on the wing section but also on the ratio of the detrimental surface to the plane area.

A straight line rotated from the centre 0·00 in figs. 2, 3, and 4 indicates that the best lift coefficients for M. Farman, Bréguet, and Bleriot XI. plane sections are respectively 0·017, 0·035, and 0·047, corresponding to the best angles of incidence $1\frac{1}{2}^\circ$, $2\frac{1}{2}^\circ$, and 6° . These values can only be determined with some difficulty, however, since the curves are so nearly straight at these points that the rotating line would come into contact with the curves for some distance and not at one precise point alone.

On the other hand, it is evident that the drag-to-lift ratio only varies very slightly for a series of angles of incidence, the range depending on the particular plane section, so that one is justified in saying that each type of wing possesses not only one *best incidence* and one *best lift*, but several *good incidences* and *good lifts*.

Thus, for the Maurice Farman section, the good lifts lie between 0·010 and 0·025 approximately, and the corre-

sponding good incidences extend from 1° to 4° , while the drag-to-lift ratio between these limits remains practically constant at 0.065.

For the Bréguet wing, the good lifts are between 0.030 and 0.045, the good incidences between 3° and 6° , and the drag-to-lift ratio remains about 0.08.

Lastly, for the Bleriot XI. the same values read as follows: 0.030 and 0.055, 3° and 6° , and about 0.105.

Even at this point it becomes evident that the use of slightly cambered wings is the more suitable for flight with a low lift coefficient, and that for a large lift a heavily cambered wing is preferable.

If the optimum angle of an aeroplane, which depends, as already shown, on the ratio between the detrimental surface and the plane area, is included within the limits of the good incidences, its use as the normal angle of incidence remains as advantageous as that of any other "good" incidence. But if it is not included,* flight at the optimum angle would require, in theory at all events, a greater expenditure of power than would be required under similar conditions if flight took place at any of the good incidences.

This shows that the optimum angle is not necessarily that at which an aeroplane should fly normally in order to use the power most advantageously.

To sum up: *the normal speed should always correspond to a "good" angle of incidence.*

Should this not be the case in fact, it would be possible to design an aeroplane which, for the same weight and detrimental surface as the one under consideration, could achieve an equal speed for a smaller expenditure of power.

A concrete example will render these considerations clearer.

In Table II. (Chapter II.) there was set out the variation

* This would be possible more particularly in the case of aeroplanes with very slightly cambered planes and small wing area and considerable detrimental surface.

of the useful power required for the horizontal flight of a Bréguet aeroplane weighing 600 kg., with a plane area of 30 sq. m. and a detrimental surface of 1.20 sq. m., according to its speed.

Let us assume that the useful power—24 h.p.—developed by the propeller makes the aeroplane fly normally at 0.050 lift, or at its optimum incidence. The speed will then be 72 km. per hour or 20 m. per second. This lift coefficient 0.050, be it noted, is slightly greater than the highest of the *good incidences* peculiar to the Bréguet section.

Now let us take another aeroplane of the same type, also weighing 600 kg. and with the same detrimental surface of 1.20 sq. m., but with 40 sq. m. plane area, which should still fly at the same speed of 20 m. per second.

The lift coefficient may be obtained (*cf.* Chapter I.) by dividing the loading of the planes (15 kg.) by the square of the speed in metres per second (400), which gives 0.0375. Now this is one of the good lift coefficients of the Bréguet plane. In these conditions, therefore, the drag-to-lift ratio will assume the constant value of about 0.08 common to all good incidences.

It follows that the drag of the planes will be equal to the weight, $600 \text{ kg.} \times 0.08 = 48 \text{ kg.}$

The head-resistance, on the other hand, will remain the same as in the original aeroplane whose speed was 72 km. per hour, since head-resistance is dependent simply on the amount of detrimental surface and on the speed (neither of which undergoes any change). The head-resistance, therefore (*cf.* Chapter II.), equals 38 kg.

The propeller-thrust, equal to the sum of head-resistance and drag of the planes, will be 86 kg., and the useful power required for flight =

$$\frac{\text{Thrust (86)} \times \text{speed (20)}}{75} = \text{about 23 h.p.}$$

The figure thus obtained is less than the 24 h.p. of useful

power required to make the aeroplane first considered fly at 72 km. per hour.

Therefore, in theory at all events, the optimum angle is not necessarily the most advantageous from the point of view of the least expenditure of power to obtain speed. But in practice the small saving in power would probably be neutralised owing to the difficulty of constructing two aeroplanes of the same type with a plane area of 30 and 40 sq. m. respectively without increasing the weight and the detrimental surface of the latter. Hence the advantage dealt with would appear to be purely a theoretical one in the present case.

But this would not be so with an aeroplane whose normal angle of incidence was smaller than the good incidences belonging to its particular plane section. For instance, let us assume that the propeller of the Bréguet aeroplane (*vide* Table II.) furnishes normally 68 useful h.p., which would give the machine a speed of 113·6 km. per hour or 31·6 m. per second, at the lift 0·020, which is less than the good lifts for this plane section.

Now take another Bréguet aeroplane of the same weight and detrimental surface, but with a plane area of only 20 sq. m. Calculating as before, it will be found that in order to achieve a speed of 113·6 km. per hour, this machine would have to fly with a lift of 0·030, which is one of the good lifts, and that useful power amounting to only 60 h.p. would be sufficient to effect the purpose. This time the advantage of using a good incidence as the normal angle is clearly apparent.

As a matter of fact, in practice the advantage would probably be even more considerable, since a machine with 20 sq. m. plane area would probably be lighter and have less detrimental surface than a 30 sq. m. machine.

Care should therefore be taken that the normal angle of an aeroplane is included among the good incidences belonging to its plane section, and, above all, that it is not smaller than the good incidences.

This manner of considering good incidences and lifts provides a solution of the following problem which was referred to in Chapter I.:

Since there are only two means of increasing the speed of an aeroplane—either by increasing the plane loading or by reducing the lift coefficient—which of these is the more economical?

To begin with, the question will be examined from a theoretical point of view, by assuming that the adoption of either means will have the same effect in each case on the weight and the detrimental surface, since the values of these must be supposed to remain the same in the various machines to enable our usual method of calculation to be applied.

This being so, it will be readily seen that as long as the normal lift remains one of the good lifts, both means of increasing the speed are equivalent as far as the expenditure of useful power is concerned.

On the one hand, since the drag-to-lift ratio retains approximately the same value for all good lifts, the drag of the planes will remain for every angle of incidence a constant fraction of the weight, which is assumed to be invariable. On the other hand, at the speed it is desired to attain, the head-resistance, proportional to the detrimental surface, which is also assumed to be invariable, will remain the same in both cases. Consequently, the propeller-thrust, equal to the sum of the two resistances (drag of the planes + head-resistance), and hence the useful power, will retain the same value by whichever of the two methods the increase in speed has been obtained.

But if the lift had already been reduced to the smallest of the good lift values, and it was still desired to increase the speed, the most profitable manner of doing this would be to increase the loading by reducing the plane area. So much for the theoretical aspect of the problem.

Purely practical considerations strengthen these theoretical conclusions, in so far as they clearly prove the ad-

vantage of increasing the speed by the reduction of plane area, even where the lift remains one of the good lift values.

Indeed, in practice the two methods are no longer equivalent in the latter case, since, as already mentioned, the reduction of the wing area is usually accompanied by a decrease in the weight and detrimental surface.

Generally speaking, it is therefore preferable to take the highest rather than the lowest of the good lifts as the normal angle of incidence, and this conclusion tallies, moreover, with that arising from the danger of flying at a very low lift. Finally, the normal angle would thus remain in the neighbourhood of the optimum angle, which is an excellent point so far as a flat gliding angle is concerned.*

Obviously, the advantage of the method of increasing the speed by reducing the plane area over that consisting in reducing the lift becomes greater still in the case where the latter method, if applied, would lead to the lift being less than any of the good lift values.

The disadvantage of greatly reducing the plane area to obtain fast machines is the heavy loading which it entails and the lessening of the gliding qualities. The best practical solution of the whole problem would therefore appear to consist in a judicious compromise between these two methods.

As usual, a concrete example will aid the explanation given above.

Let the Bréguet aeroplane already referred to be supposed to fly at a speed of 92·8 km. per hour with a lift of 0·030, which is the lowest of its good lift values. Table II. shows that this would require 38 h.p.

Another machine of the same type, and having the same weight and detrimental surface, but with an area of only 20 sq. m. (instead of 30), in order to attain the same speed

* Chapter X. will show that this conclusion is strengthened still further by the effect of wind on the aeroplane.

would have to fly at 0.040 lift, which is also one of the good lift values.

The necessary calculations would show that the latter machine, like the former, would also require 38 h.p. This is readily explicable on the score that the drag of the planes is 0.08 of the weight, or 48 kg., while the head-resistance also remains constant and equal to 64 kg. (Table II.).

In theory, therefore, there is nothing to choose between either solution. But in practice the latter is preferable, since the 20 sq. m. machine would in all likelihood be lighter and possess less detrimental surface.

But if a speed of 113.6 km. per hour were to be attained, the 20 sq. m. aeroplane has a distinct advantage both in theory, and even more in practice, for the machine with 30 sq. m. area would have to fly at 0.020 lift, which is lower than the good lift values belonging to the Bréguet plane section, which would, as already shown, require useful power amounting to 68 h.p., whereas 60 h.p. would suffice to maintain the smaller machine in flight at the same speed.

We have already set forth the good lift values belonging to the Maurice Farman, Bréguet, and Bleriot XI. plane sections, and the corresponding values of the drag-to-lift ratio or, its equivalent, the ratio of the drag of the planes to the weight of the machine.

Reference to these values has already shown that slightly cambered planes are undoubtedly more economical for low lift values, which are necessary for the attainment of high speeds, especially in the case of lightly loaded planes, as in some biplanes.

But the good lift values of very flat planes are usually very low—from 0.010 to 0.025 in the case of the Maurice Farman—which greatly restricts the use of these values, since, as already stated, it is doubtful whether hitherto an aeroplane has flown at a lower lift value than 0.020.

The advantages and disadvantages of these three wing sections, from the point of view at issue, will be more readily

seen by plotting their polar curves in one diagram, as shown in fig. 11.

The Bréguet and Maurice Farman curves intersect at a point corresponding to the lift value 0.030, whence we may conclude that for all lift values lower than this, the Maurice Farman section is the better,* but for all lift values higher than 0.032 (which at present are more usual), the Bréguet wing has a distinct advantage. In the same way, the Maurice Farman is better than the Bleriot XI. for lift values below 0.042, whereas the latter is better for all higher lift values.

Finally, the Bleriot XI. only becomes superior to the Bréguet for lift values in excess of 0.065, which are very high indeed, and little used owing to the fact that they correspond to angles in the neighbourhood of the economical angle.

To apply these various considerations, we will now proceed to fix the best conditions in which to obtain a speed of 160 km. per

hour or about 44.5 m. per second, which appears to be the highest speed which it seems at present possible to

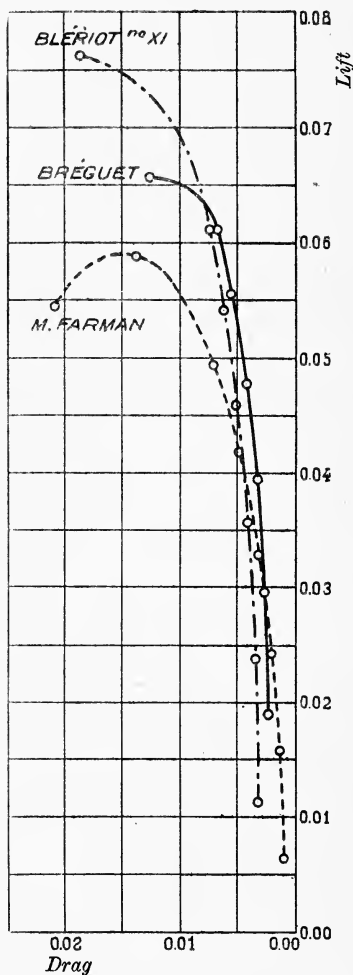

FIG. 11.

* Since it has a smaller drag for the same lift.

reach,* that is, by assuming it to be possible to have a loading of 40 kg. per sq. m. of surface and to fly at a lift value of 0·020.

In laying down this limit to the speed of flight we also stated our belief that, in order to enable it to be attained, engines developing from 120 to 130 effective h.p. would have to be employed.

This opinion was founded on the results of M. Eiffel's experiments, from which it was concluded that an aeroplane to attain this speed would have to possess a detrimental surface of no more than 0·75 sq. m.

Now, the last two Aeronautical Salons, those of 1911 and 1912, have shown a very clearly marked tendency among constructors to reduce all passive resistance to the lowest possible point, especially in high-speed machines, and it would appear that in this direction considerable progress has been and is being made.

One machine in particular, the Paulhan-Tatin "Torpille," specially designed with this point in view, is worthy of notice.

Its designer, the late M. Tatin, estimated the detrimental surface of this aeroplane at no more than 0·26 sq. m., and its resistance must in fact have been very low, since it had the fair-shaped lines of a bird, every part of the structure capable of setting up resistance being enclosed in a shell-like hull from which only the landing wheels, reduced to the utmost verge of simplicity, projected.

Taking into account the slightly less favourable figures obtained by M. Eiffel from experiments with a scale model, the detrimental surface of the "Torpille" may be estimated at 0·30 sq. m.

According to information given by M. Tatin himself, the weight of this monoplane was 450 kg., and its plane area 12·5 sq. m.

* It should, however, be remembered that this limit has actually been exceeded, with a loading of 44 kg. per sq. m. and a lift value of slightly less than 0·020. See also Translator's note on p. 12.

Let us assume that the planes, which were only very slightly cambered, were about equivalent to those of the Maurice Farman, and that they flew at a good lift coefficient. In that case the drag of the planes would be equal to 0.065 of the weight of the machine, or to 29.5 kg.

On the other hand, at the speed of 44.5 m. a second, the head-resistance =

$$\begin{array}{rcc} \text{Coefficient.} & \text{Detrimental} & \text{Square of} \\ & \text{Surface.} & \text{the Speed.} \\ 0.08 & \times 0.3 & \times 1980 = 47.5 \text{ kg.} \end{array}$$

The propeller-thrust, consequently, the sum of both resistances, would = 77 kg.

The useful power required would thus =

$$\frac{77 \times 44.5}{75} = \text{about } 45 \text{ h.p.}$$

Propeller efficiency in this case must have been exceptionally high (as will be seen hereafter), and was probably in the region of 80 per cent.

The engine-power required to give the "Aéro-Torpille" a speed of 160 km. per hour must therefore have been $\frac{46}{0.8} = 57$ h.p., or approximately 60 h.p.

M. Tatin considered that he could obtain the same result with even less motive-power, and that some 45 h.p. would suffice. If this proves to be the case, the detrimental surface of the aeroplane would have to be less than 0.30 sq. m. and the propeller efficiency even higher than 80 per cent., or else—and this was M. Tatin's own opinion—the coefficients derived from experiments with small scale models must be increased for full-size machines, their value possibly depending in some degree on the speed.*

* No proof, as a matter of fact, was possible owing to the short life of the machine. But the results obtained from other machines in which stream-lining had been carried out to an unusual degree, such as the Deperdussin "monocoque"—which, with an engine of 85-90 effective h.p., only achieved 163 km. per hour—would appear to show that the

It should also be noted that, in order to attain 160 km. per hour, the Tatin "Torpille" would have to fly at a lift coefficient equal to

$$\frac{36 \text{ (loading)}}{1980 \text{ (square of the speed)}} = 0.018.$$

Perhaps it will seem strange that simply by estimating the value of the detrimental surface at 0.30 instead of the previous estimate of 0.75, the motive-power required for flight at 160 km. per hour should have been reduced by one-half. Yet there is no need for surprise; for if the method for calculating the useful power necessary for horizontal flight (set forth in Chapter II., and since applied more than once) is carefully examined, it becomes evident that, whereas that portion of the power required only for lifting remains proportional to the speed, the remaining portion, used to overcome all passive resistance, is proportional to the *cube* of the speed.

For this reason it is of such great importance to cut down the detrimental surface in designing a high-speed machine.

Thus, in the present case, of the 46 h.p. available, only 18 h.p. are required to lift the machine. The remaining 28 h.p., therefore, are necessary to overcome passive resistance.

Had the detrimental surface been 0.75 sq. m. instead of 0.30, the useful power absorbed in overcoming passive resistance would have been

$$\frac{0.75 \times 28}{0.30} = 70 \text{ h.p. instead of } 28 \text{ h.p.}$$

To complete our examination of the high-speed aeroplane, Table IV. has been drawn up, and includes the values of the useful power required on the one hand for the flight of a Maurice Farman plane *at a good incidence*, and weighing estimate of 0.30 sq. m. for the detrimental surface was too low, a conclusion supported by M. Eiffel's experiments.

It is doubtful whether an aeroplane has yet been built with a detrimental surface of much less than half a square metre.

1 ton (metric), and on the other for driving through the air a detrimental surface of 1 sq. m. at speeds from 150 to 200 km. per hour.

TABLE IV.

Speed.		Drag of Planes (kg.) per aeroplane ton.	Useful Power (in h.p.) absorbed in Lifting (obtained by dividing by 75 the product of cols. 1 and 2).	Passive Resistance (kg.) for a Detrimental Surface of 1 sq. m. (by multiplying by 0.08 the square of the numbers in col. 2).	Useful power (in h.p.) absorbed by Passive Resistance (by dividing the figures in cols. 2 and 5 by 75).	
Km. per hr.	Metres per sec.					
1	2	3	4	5	6	
150	41.6	65	36	138	76	
160	44.4	Constant value = 1000 kg. divided by the minimum drag-to-lift ratio 0.065 of the Maurice Farman plane.	}	157	93	
170	47.2			41	178	112
180	50.0			43	200	132
190	52.8			46	232	157
200	55.6			48	248	184

According to this Table, an aeroplane weighing 500 kg., and possessing, as we supposed in the case of the Tatin "Torpille," a detrimental surface of 0.30 sq. m., would require a useful power of about 80 h.p. to attain a speed of 200 km. per hour. This high speed could therefore be achieved with a power-plant consisting of a 100-h.p. motor and a propeller of 80 per cent. efficiency. It could only be obtained—just as the "Torpille" could only achieve 160 km. per hour at a lift coefficient of 0.018—with a plane loading of about 56 kg. per sq. m. Consequently, the area of the planes would be only $\frac{500}{56} = 9$ sq. m.

If the theoretical qualities of design of machines of the "Torpille" type are borne out by practice* our present

* But, according to what has already been said, this does not seem to be the case. Hence, a speed of 200 km. per hour is not likely to be

motors would appear to be sufficient to give them a speed of 200 km. per hour. But this would necessitate a very heavy loading and a lift coefficient much lower than any hitherto employed—a proceeding which, as we have seen, is not without danger. Moreover, one cannot but be uneasy at the thought of a machine weighing perhaps 500 or 600 kg. alighting at this speed.

This, beyond all manner of doubt, is the main obstacle which the high-speed aeroplane will have to overcome, and this it can only do by possessing speed variation to an exceptional degree. We will return to this aspect of the matter subsequently.

To-day an aeroplane, weighing with full load a certain weight and equipped with an engine giving a certain power, in practice flies horizontally at a given speed.

These three factors, weight, speed, and power, are always met with whatever the vehicle of locomotion under consideration, and their combination enables us to determine as the most efficient from a mechanical point of view that vehicle or machine which requires the least power to attain, for a constant weight, the same speed.

Hence, what we may term *the mechanical efficiency* of an aeroplane may be measured through its weight multiplied by its normal speed and divided by the motive-power.

If the speed is given in metres per second and the power in h.p., this quotient must be divided by 75.

RULE.—*The mechanical efficiency of an aeroplane is obtained by dividing its weight multiplied by its normal speed (in metres per second) by 75 times the power, or, what is the same thing, by dividing by 270 times the power the product of the weight multiplied by the speed in kilometres per hour.*

EXAMPLE.—*An aeroplane weighing 950 kg., and driven attained with a 100-h.p. motor. Whether an engine developing 140 h.p. or more will succeed in this can only be shown by the future, and perhaps at no distant date. See footnote, p. 12.*

by a 100-h.p. engine, flies at a normal speed of 117 km. per hour. What is its mechanical efficiency?

$$\text{Efficiency} = \frac{950 \times 117}{270 \times 100} = 4.12.$$

Reference to what has already been said will show that mechanical efficiency is also expressed by the propeller efficiency divided by the gliding angle corresponding to normal incidence. This is due to the fact that, firstly, the useful power required for horizontal flight is the 75th part of the weight multiplied by the speed and the normal gliding angle, and, secondly, because the motive-power is obtained by dividing the useful power by the propeller efficiency. Accordingly, a machine with a propeller efficiency of 70 per cent., and with a normal gliding angle of 0.17, would have a mechanical efficiency = $\frac{0.7}{0.17} = 4.12$.

This conception of mechanical efficiency enables us to judge an aeroplane as a whole from its practical flying performances without having recourse to the propeller efficiency and the normal gliding angle, which are difficult to measure with any accuracy.

Even yesterday a machine possessing mechanical efficiency superior to 4 was still, aerodynamically considered, an excellent aeroplane. But the progress manifest in the last Salon entitles us, and with confidence, to be more exacting in the future.

Hence, the average mechanical efficiency of the ordinary run of aeroplanes enables us in some measure to fix definite periods in the history of aviation. In 1910, for instance, the mean mechanical efficiency was roughly 3.33, on which we based the statement contained in a previous work that, in practice, 1 h.p. transports 250 kg. in the case of an average aeroplane at 1 m. per second.

This rule, which obviously only yielded approximate results, could be applied both quickly and easily, and enabled one, for instance, to form a very fair idea of the results

that would be attained in the Military Trials of 1911. In fact, according to the rules of this competition, the aeroplanes would have to weigh on an average 900 kg. To give them a speed of 70 km. per hour or $\frac{70}{3.6}$ m. per second, for instance, the rule quoted gives $\frac{900}{250} \times \frac{70}{3.6}$.

But 250×3.6 remains the denominator *whatever the speed it is desired to attain*, and is exactly equal to 900, the weight of the aeroplane. From this, one deduced that in this case the power required in h.p. was equivalent to the speed in kilometres per hour:—

70 km. per hour	70 h.p.
80 „ 	80 h.p.
100 „ 	100 h.p.

If, on the other hand, certain machines during these trials, driven by engines developing less than 100 effective h.p., flew at over 100 km. per hour, this was due simply to their mechanical efficiency being better than the 3.33 which obtained in 1910, and was already too low for 1911.

At the present day, therefore, accepting 4 as the average mechanical efficiency, the practical rule given above should be modified as follows:—

RULE.—1 h.p. transports 300 kg. of an average aeroplane at 1 m. per second.

CHAPTER IV

FLIGHT IN STILL AIR

THE POWER-PLANT

BOTH this chapter and the next will be devoted to the power-plant of the aeroplane as it is in use at the present time. This will entail an even closer consideration of the part played by the motive-power in horizontal and oblique flight, and will finally lead to several important conclusions concerning the variable-speed aeroplane and the solution of the problem of speed variation.

The power-plant of an aeroplane consists in every case of an internal combustion motor and one or more propellers. Since the present work is mainly theoretical, no description of aviation motors will be attempted, and only those of their properties will be dealt with which affect the working of the propeller.

Besides, the motor works on principles which are beyond the realm of aerodynamics, so that from our point of view its study has only a minor interest. It forms, it is true, an essential auxiliary of the aeroplane, but only an auxiliary. If it is not yet perfectly reliable, there is no doubt that it will be in a few years, and this quite independently of any progress in the science of aerodynamics.

Deeply interesting, on the other hand, are the problems relating to the aeroplane itself, or to that mysterious contrivance which, as it were, screws itself into the air and transmutes into thrust the power developed by the engine.

The power developed by an internal combustion engine varies with the number of revolutions at which the resistance it encounters enables it to turn. There is a generally recognised ratio between the power developed and the speed of revolution.

Thus, if a motor, normally developing 50 h.p. at 1200 revolutions per minute, only turns at 960 revolutions per minute, it will develop no more than $\frac{50 \times 960}{1200} = 40$ h.p.

The rule, however, is not wholly accurate, and the variation of the power developed by a motor with the number of revolutions per minute is more accurately shown in the curve in fig. 12. It should be clearly understood that the curve only relates to a motor with the throttle fully open, and where the variation in its speed of rotation is only due to the resistance it has to overcome.

For the speed of rotation may be reduced in another manner—by shutting off a portion of the petrol mixture by means of the throttle. The engine then runs “throttled down,” which is the usual case with a motor car.

In such a case, if the petrol supply is constant, the curve in fig. 12 grows flatter, with its crest corresponding to a lower speed of rotation the more the throttle is closed and the explosive mixture reduced.

Fig. 13 shows a series of curves which were prepared at my request by the managing director of the Gnome Engine Company; these represent the variation in power with the speed of rotation of a 50-h.p. engine, normally running at 1200 revolutions per minute, with the throttle closed to a varying extent.

In practice, it is easier to throttle down certain engines than others; with some it is constantly done, with others it is more difficult.

Even to-day the working of a propeller remains one of the most difficult problems awaiting solution in the whole range of aerodynamics, and the motion, possibly whirling, of the air molecules as they are drawn into the revolving

R. P. M.

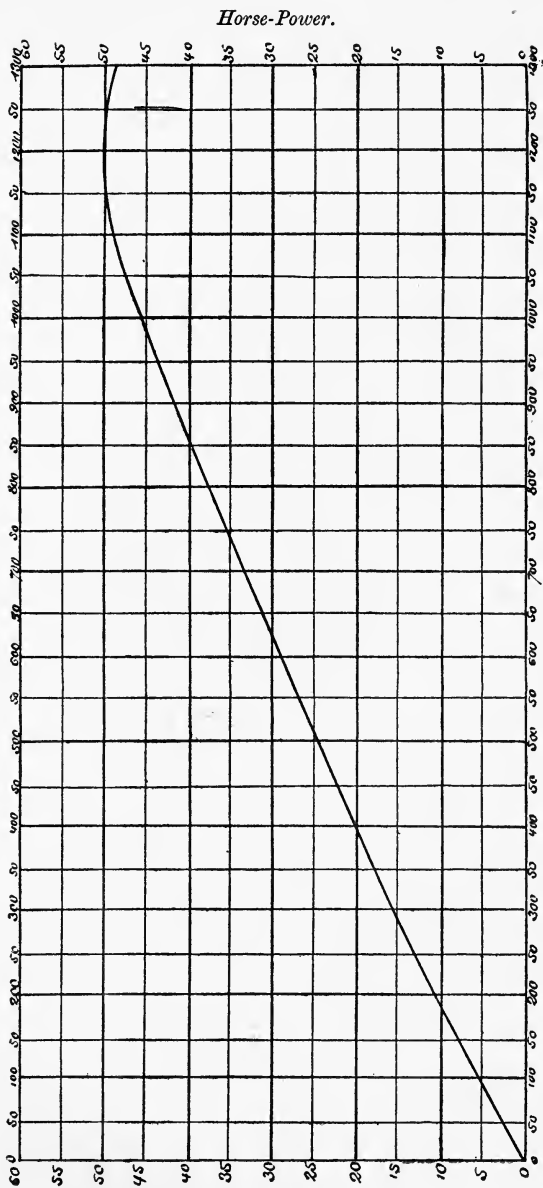

Fig. 12.

Horse-Power.

R. P. M.

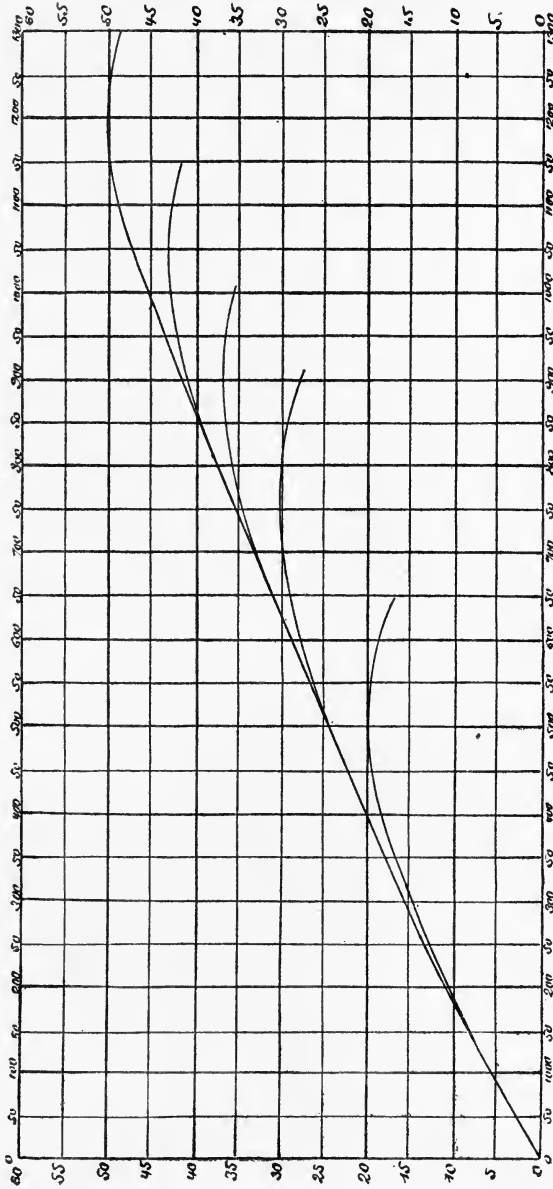

FIG. 13.

propeller has never yet been explained in a manner satisfactory to the dictates of science.

All said and done, the rough method of likening a propeller to a screw seems the most likely to explain the results obtained from experiments with propellers.

The *pitch* of a screw is the distance it advances in one revolution in a solid body. The term may be applied in a similar capacity to a propeller. The *pitch of a propeller*, therefore, is the distance it would travel forwards during one revolution if it could be made to penetrate a solid body. But a propeller obtains its thrust from the reaction of an elusive tenuous fluid. Clearly, therefore, it will not travel forward as great a distance for each revolution as it would if screwing itself into a solid.

The distance of its forward travel is consequently always smaller than the pitch, and the difference is known as *the slip*. But, contrary to an opinion which is often held, this slip should not be as small as possible, or even be altogether eliminated, for the propeller to work under the best conditions.

Without attempting to lay down precisely the phenomena produced in the working of this mysterious contrivance, we may readily assume that at every point the blade meets the air, or "bites" into it, at a certain angle depending, among other things, on the speed of rotation and of forward travel of the blade and of the distance of each point from the axis.

Just as the plane of an aeroplane meeting the air along its chord would produce no lift, so a propeller travelling forward at its pitch speed—that is, without any slip—would meet the air at each point of the blades at no angle of incidence, and consequently would produce no thrust.

The slip and angle of incidence are clearly connected together, and it will be easily understood that a given propeller running at a given number of revolutions will have a *best slip*, and hence a *best forward travel*, just as a given plane has a *best angle of incidence*.

When the propeller rotates without moving forward through the air, as when an aeroplane is held stationary on the ground, it simply acts as a ventilator, throwing the air backwards, and exerts a *thrust* on the machine to which it is attached. But it produces no useful power, for in mechanics power always connotes motion.

But if the machine were not fixed, as in the case of an aeroplane, and could yield to the thrust of the propeller, it would be driven forward at a certain speed, and the product of this speed multiplied by the thrust and divided by 75 represents the useful power produced by the propeller.

On the other hand, in order to make the propeller rotate it must be acted upon by a certain amount of motive power. The relation between the useful power actually developed and the motive power expended is the *efficiency* of the propeller.

But the conditions under which this is accomplished vary, firstly, with the number of revolutions per minute at which the propeller turns, and secondly, with the speed of its forward travel, so that it will be readily understood that the efficiency of a propeller may vary according to the conditions under which it is used.

Experiments lately conducted — notably by Major Dorand at the military laboratory of Chalais-Meudon and by M. Eiffel — have shown that the efficiency remains approximately constant so long as the ratio of the forward speed to its speed of revolution, *i.e.* the forward travel per revolution, remains constant.

For instance, if a propeller is travelling forward at 15 m. per second and revolving at 10 revolutions per second, its efficiency is the same as if it travelled forward at 30 m. per second and revolved at 20 revolutions per second, since in both cases its forward travel per revolution is 1.50 m.

But the propeller efficiency varies with the amount of its forward travel per revolution.

•

Hence, when the propeller revolves attached to a stationary point, as during a bench test, so that its forward travel is zero, its efficiency is also zero, for the only effect of the motive power expended to rotate the propeller is to produce a thrust, which in this instance is exerted upon an immovable body, and therefore is wasted so far as the production of useful power is concerned.

Similarly, when the forward travel of the propeller per revolution is equal to the pitch, and hence when there is no slip, it screws itself into the air like a screw into a solid; the blades have no angle of incidence, and therefore produce no thrust.*

Between the two values of the forward travel per revolution at which the thrust disappears, there is a value corresponding on the other hand to maximum thrust. This has already been pointed out, and has been termed *the best forward travel per revolution*.

This shows that the thrust of one and the same propeller may vary from zero to a maximum value obtained with a certain definite value of the forward travel. The variation of the thrust with the forward travel per revolution may be plotted in a curve. A single curve may be drawn to show this variation for a whole family of propellers, geometrically similar and only differing one from the other by their diameter.

Experiments, in fact, have shown that such propellers had approximately the same thrust when their forward travel per revolution remained proportional to their diameter.

Thus two propellers of similar type, with diameters measuring respectively 2 and 3 m., would give the same thrust if the former travelled 1.2 m. per revolution and

* This could never take place if the vehicle to which the propeller was attached derived its speed solely from the propeller; it could only occur in practice if motive power from some outside source imparted to the vehicle a greater speed than that obtained from the propeller-thrust alone.

the latter 1·8 m., since the ratio of forward travel to diameter = 0·60.

This has led M. Eiffel to adopt as his variable quantity not the forward travel per revolution, but the ratio of this advance to the diameter, which ratio may be termed *reduced forward travel or advance*.

Fig. 14, based on his researches, shows the variation in thrust of a family of propellers when the reduced advance assumes a series of gradually increasing values.*

The maximum thrust efficiency (about 65 per cent. in this case) corresponds to a reduced advance value of 0·6.

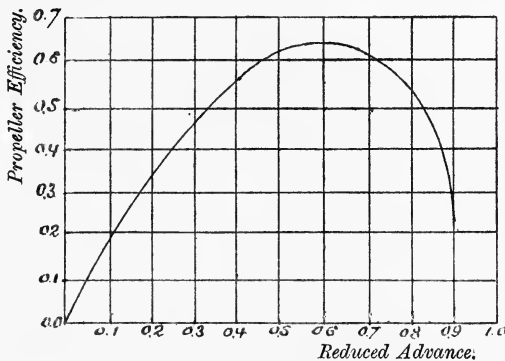

FIG. 14.

Hence a propeller of the type under consideration, with a diameter of 2·5 m., in order to give its highest thrust, would have to have a forward travel of $2\cdot5 \times 0\cdot6 = 1\cdot2$ m. Consequently, if in normal flight it turned at 1200 revolutions per minute, or 20 revolutions per second, the machine it propelled ought to fly at $1\cdot20 \times 20 = 24$ m. per second.

For all propellers belonging to the same family there exists, therefore, a definite reduced advance which is more

* Actually, M. Eiffel found that for the same value of the reduced advance the thrust was not absolutely constant, but rather that it tended to grow as the number of revolutions of the propeller increased. Accordingly, he drew up a series of curves, but these approximate very closely one to another.

favourable than any other, and may thence be termed the *best reduced advance*, which enables any of these propellers to produce their maximum thrust.

It has been shown that all geometrically similar propellers—in other words, belonging to the same family—give approximately the same maximum thrust efficiency.

But when the shape of the propeller is changed, this maximum thrust value also varies.

It depends more especially on the ratio between the pitch of the propeller and its diameter, which is known as the *pitch ratio*.

But, as the value of the highest thrust varies with the pitch ratio, so does that of the best reduced advance corresponding to this highest thrust.

In the following Table V., based on Commandant Dorand's researches at the military laboratory of Chalais-Meudon with a particular type of propeller, are shown the values of the maximum thrust and the best reduced advance corresponding to propellers of varying pitch ratio.

TABLE V.

Pitch ratio	0·5	0·6	0·7	0·8	0·9	1·0	1·15
Maximum thrust efficiency	0·45	0·53	0·61	0·70	0·76	0·80	0·84
Best reduced advance .	0·29	0·38	0·47	0·55	0·63	0·72	0·84

EXAMPLE.—A propeller of the Chalais-Meudon type with 2·5 m. diameter and 2 m. pitch turns at 1200 revolutions per minute.

1. What is the value of its highest thrust efficiency?
2. What should be the speed of the aeroplane it drives in order to obtain this highest thrust?

$$\text{The pitch ratio is } \frac{2\cdot0}{2\cdot5} = 0\cdot8.$$

Table V. immediately solves the first question: the

highest thrust efficiency is 0·7. Further, this table shows that to obtain this thrust the reduced advance should = 0·55. In other words, the speed of the machine divided by 50 (the number of revolutions per second, $50 \times$ diameter, 2·5) should = 0·55.

Hence the speed = $0·55 \times 50 = 27·5$ m. per second, or 99 km. per hour.

Again, Table V. proves, according to Commandant Dorand's experiments, that even at the present time it is possible to produce propellers giving the excellent efficiency of 84 per cent. under the most favourable running conditions, but only if the pitch ratio is greater than unity—that is, when the pitch is equal to or greater than the diameter.

It is further clear that, since the best reduced advance increases with the pitch ratio, the speed at which the machine should fly for the propeller (turning at a constant number of revolutions per minute) to give maximum efficiency is the higher the greater the pitch ratio. This is why propellers with a high pitch ratio, or the equivalent, a high maximum thrust, are more especially adaptable for high-speed aeroplanes. At the same time, they are equally efficient when fitted to slower machines, provided that the revolutions per minute are reduced by means of gearing.

These truths are only slowly gaining acceptance to-day—although the writer advocated them ardently long since,—and this notwithstanding the fact that the astonishing dynamic efficiency of the first motor-driven aeroplane which in 1903 enabled the Wrights, to their enduring glory, to make the first flight in history, was largely due to the use of propellers with a very high pitch ratio, that is, of high efficiency, excellently well adapted to the relatively low speed of the machine by the employment of a good gearing system.

The only thing that seemed to have been taught by this fine example was the use of large diameter propellers.

This soon became the fashion. But, instead of gearing

down these large propellers, as the Wrights cleverly did, they were usually driven direct by the motor, and so that the latter could revolve at its normal number of revolutions the pitch had perforce to be reduced.

As the pitch decreased, so the maximum efficiency and the best reduced advance—that is, the most suitable flying speed—fell off, while at the same time the development of the monoplane actually led to a considerable increase in flying speed.

The result was that fast machines had to be equipped with propellers of very low efficiency which, even so, they were unable to attain, as the flying speed of the aeroplane was too high for them. At most these propellers might have done for a dirigible, but they would have been poor even at that.

Fortunately, a few constructors were aware of these facts, and to this alone we may ascribe the extraordinary superiority shown towards the end of 1910 by a few types of aeroplanes, among which we may name, without fear of being accused of bias, those of M. Bréguet and the late M. Nieuport.

But, since then, progress has been on the right lines, and those who visited the last three Aero shows must have been struck with the general decrease in propeller diameter, which has been accompanied by an increase in efficiency and adaptability to the aeroplanes of to-day.

To take but one final example: the fast Paulhan-Tatin "Torpille," already referred to, had a pitch ratio greater than unity. For this reason its efficiency was estimated in the neighbourhood of 80 per cent.

The foregoing considerations may be summed up as follows:—

1. The same propeller gives an efficiency varying according to the conditions in which it is run, depending on its forward travel per revolution.
2. Each propeller has a speed of forward travel or advance enabling it to produce its highest efficiency.

3. For propellers of identical type but different diameters the various speeds of forward travel corresponding to the same thrust are proportional to the diameters, whence arises the factor of reduced advance, which, in other words, is the ratio between the forward travel per revolution and the diameter.

4. The maximum efficiency of a propeller and its best reduced advance depend on its shape, and more especially on its pitch ratio.

Hitherto the propeller has been considered as a separate entity, but in practice it works in conjunction with a petrol motor, whether by direct drive or gearing.

But the engine and propeller together constitute the *power-plant*, and this new entity possesses, by reason of the peculiar nature of the petrol motor, certain properties which, differing materially from those of the propeller by itself, must therefore be considered separately.

First, we will deal with the case of a propeller driven direct off the engine.

Let us assume that on a truck forming part of a railway train there has been installed a propelling plant (wholly insufficient to move the train) consisting of a 50-h.p. motor running at 1200 revolutions per minute, and of a propeller, while a dynamometer enables the thrust to be constantly measured and a revolution indicator shows the revolutions per minute.

The train being stationary, the motor is started.

The revolutions will then attain a certain number, 950 revolutions per minute for instance, at which the power developed by the motor is exactly absorbed by the propeller. The latter will exert a certain thrust upon the train (which, of course, remains stationary), indicated by the dynamometer and amounting to, say, 150 kg.

The power developed by the motor at 950 revolutions per minute is shown by the power curve of the motor, which we will assume to be that shown in fig. 12. This would give about 43 h.p. at 950 revolutions per minute.

The useful power, on the other hand, is zero, since no movement has taken place.

Now let the train be started and run at, say, 10 km. per hour or 5 m. per second, the motor still continuing to run.

The revolutions per minute of the propeller would immediately increase, and finally amount to, say, 1010 revolutions per minute.

The power developed by the motor would therefore have increased and would now amount, according to fig. 12, to 45.5 h.p.

But at the same time the dynamometer would show a smaller thrust—about 130 kg.

But this thrust would, though in only a slight degree, have assisted to propel the train forward and the useful power produced by the propeller would be $\frac{130 \times 5}{75} = 8.7$ h.p.

The acceleration in rotary velocity and the decrease in thrust which are thus experienced are to be explained on the score that the blades, travelling forward at the same time that they revolve, meet the air at a smaller angle than when revolving while the propeller is stationary. In these conditions, therefore, the propeller turns at a greater number of revolutions, though the thrust falls off.

If the speed of the train were successively increased to 10, 15 and 20 m. per second, the following values could be established each time:—

The normal number of revolutions of the power plant;

The corresponding power developed by the motor;

The useful power produced by the propeller.

We could then plot curves similar to that shown in fig. 15, giving for every speed of the train the corresponding motive-power (shown in the upper curve) and the useful-power (lower curve). The dotted lines and numbers give the number of revolutions.

The lower curve representing the variation in the useful-power produced by the propeller according to the forward

speed of travel is of capital importance, and will hereafter be referred to as the power-plant curve.

Usually the highest points of the two curves, L and M, do not correspond. This simply means that generally, and unless precautions have been taken to avoid this, the propeller gives its maximum thrust, and accordingly has its best reduced advance, at a forward speed which does not

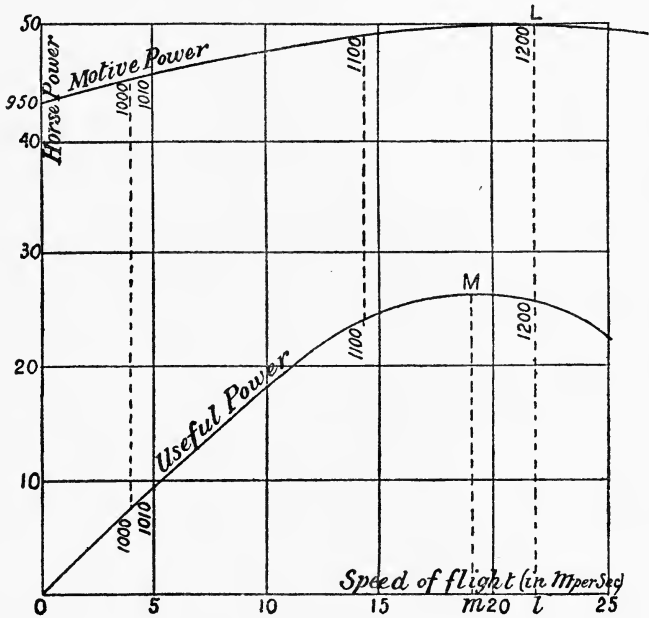

FIG. 15.

enable the motor to turn at its normal number of revolutions, 1200 in the present case, and consequently to develop its full power of 50 h.p.

It is even now apparent, therefore, that one cannot mount *any* propeller on *any* motor, if direct-driven, and that there exists, *apart altogether from the machine which they drive*, a mutual relation between the two parts constituting the power-plant, which we will term the *proper adaptation of the propeller to the motor*.

Its characteristic feature is that the highest points in the two curves representing the values of the motive-power and the useful-power at different speeds of flights lie in a perpendicular line (see fig. 16).

The highest thrust efficiency is then obtained from the propeller at such a speed that the motor can also develop its maximum power.

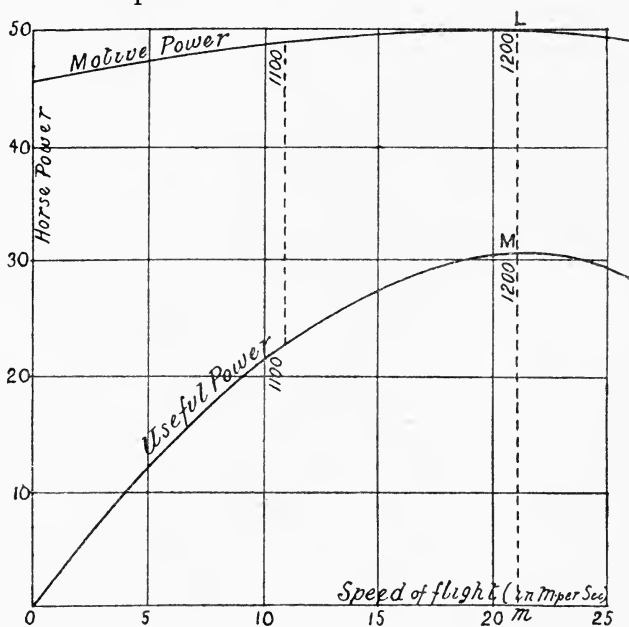

FIG. 16.

The expression *maximum power-plant efficiency* will be used to denote the ratio of maximum useful-power M_m (see fig. 15) developed at the maximum power L_l of which the motor is capable (50 h.p. in the case under consideration).

The maximum power-plant efficiency, it is clear, corresponds to a certain definite speed of flight O_m . This may be termed the *best speed* suited to the power-plant.

If the adaptation of the propeller to the motor is good (as in the case of fig. 16), the maximum power-plant efficiency is the highest that can be obtained by mounting

direct-driven propellers belonging to one and the same family and of different diameters on the motor.

Hence there is only one propeller in any family or series of propellers which is well adapted to a given motor.

We already know that in a family of propellers the characteristic feature is a common value of the pitch ratio—supposing, naturally, that the propellers are identical in other respects. The conclusion set down above can therefore also be expressed as follows:—

There can be only one propeller of given pitch ratio that is well adapted to a given motor. The diameter of the propeller depends on the pitch ratio, and vice versa.

Propellers well adapted to a given motor consequently form a single series such that each value of the diameter corresponds to a single value of the pitch, and *vice versa*.

According to the results of Commandant Dorand's experiments with the type of propellers which he employed, the series of propellers properly adapted to a 50-h.p. motor turning at 1200 revolutions per minute can be set out as in Table VI., which also gives the best speed suited to the power-plant in each case, and the maximum useful-powers developed obtained by multiplying the power of the motor, 50 h.p., by the maximum efficiency as given in Table V.

To summarise:

1. The useful-power developed by a given power-plant varies with the speed of the aeroplane on which it is mounted. The variation can be shown by a curve termed the characteristic power-plant curve.

2. To obtain from the motor its full power and from the propeller its maximum efficiency the propeller must be well adapted to the motor, and this altogether independently of the aeroplane on which they are mounted.

3. There is only a single series of propellers well adapted to a given motor.

4. For a power-plant to develop maximum efficiency the aeroplane must fly at a certain speed, known as the best speed suited to the power-plant under consideration.

TABLE VI.

Pitch Ratio.	Propeller Diameters (in metres).	Propeller Pitch (in metres ; product of cols. 1 and 2).	Best Suitable Speed.		Maximum Power-plant Efficiency (from Table V.)	Maximum Useful-Power developed (product of 50 h. p. and col. 6.)
			m. p. s.	km. p. h.		
1	2	3	4	5	6	7
0·5	2·46	1·23	14·2	51	0·45	22·5
0·6	2·33	1·40	17·7	64	0·53	26·5
0·7	2·24	1·57	21·1	76	0·61	30·5
0·8	2·16	1·73	23·8	86	0·70	35
0·9	2·09	1·88	26·4	95	0·76	38
1·0	2·04	2·04	29·5	106	0·80	40
1·15	1·98	2·28	33·3	126	0·84	42

In conclusion, it will be advisable to remember that the conclusions reached above should not be deemed to apply with rigorous accuracy. Fortunately, practice is more elastic than theory. Thus we have already seen in the case of the angle of incidence of a plane that there is, round about the value of the *best* incidence, a certain margin within whose limits the incidence remains *good*. Just so we have to admit that a given power-plant may yield good results not only when the aeroplane is flying at a single *best* speed, but also when its speed does not vary too widely from this value.

In other words, a certain elasticity is acquired in applying in practice purely theoretical deductions, though it should not be forgotten that the latter indicate highly valuable principles which can only be ignored or thrust aside with the most serious results, as experience has proved only too well.

CHAPTER V

FLIGHT IN STILL AIR

THE POWER-PLANT (*concluded*)

IN the last chapter we confined ourselves mainly to the working of the power-plant itself, and more particularly to the mutual relations between its parts, the motor and the propeller, without reference to the machine they are employed to propel. The present chapters, on the other hand, will be devoted to the adaptation of the power-plant to the aeroplane, and incidentally will lead to some consideration of the variable-speed aeroplane and of the greatest possible speed variation.

In Chapter II. particular stress was laid on the graph termed the *essential curve of the aeroplane*, which enables us to find the different values of the useful-power required to sustain in flight a given aeroplane at different speeds, that is, at different angles of incidence and lift coefficients.

In fig. 17 the thin curve (reproduced from fig. 6, Chapter II.) is the essential aeroplane curve of a Bréguet biplane weighing 600 kg., with an area of 30 sq. m. and a detrimental surface of 1.2 sq. m.

But in the last chapter particular attention was also drawn to the graph termed the *power-plant curve*, which gives the values of the useful-power developed by a given power-plant when the aeroplane it drives flies at different speeds.

In fig. 17 the thick curve is the power-plant curve, in the case of a motor of 50 h.p. turning at 1200 revolutions per

minute and a propeller of the Chalais-Meudon type, direct-driven, well adapted to the motor, and with a pitch ratio of 0.7.

Table VI. (p. 69) gives the diameter and pitch of the propeller as 2.24 m. and 1.57 m. respectively. The maximum power-plant efficiency corresponds to a speed of

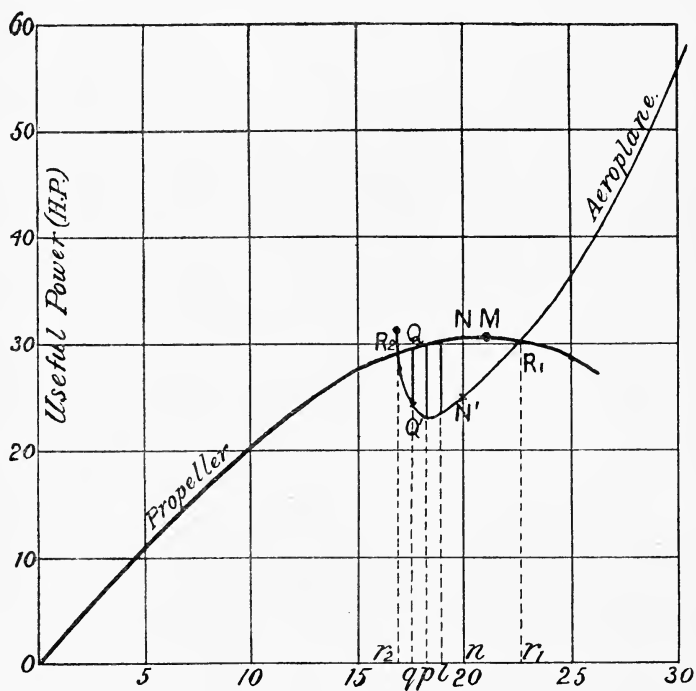

FIG. 17.

22.1 m. per second. The maximum useful-power is 30.5 h.p. These are the factors which enable us to fix M, the highest point of the curve.

It will be clear that, by superposing in one diagram (as in fig. 17, which relates to the specific case stated above) the two curves representing in both cases a correlation between useful-powers and speeds, and referring, in one case to the aeroplane, in the other to its power-plant, we should obtain

some highly interesting information concerning the adaptation of the power-plant to the aeroplane.

The curves intersect in two points, R_1 and R_2 , which means that there are two flight speeds, Or_1 and Or_2 , at which the useful-power developed by the power-plant is exactly that required for the horizontal flight of the aeroplane. These two speeds both, therefore, fulfil the definition (see Chapter II.) of the *normal flying speeds*.

From this we deduce that a power-plant capable of sustaining an aeroplane in level flight can do so at two different normal flying speeds. But in practice the machine flies at the higher of these two speeds, for reasons which will be explained later.

These two normal flying speeds will, however, crop up again whenever the relation between the motive-power and the speed of the aeroplane comes to be considered. Thus, when the motive-power is zero, that is, when the aeroplane glides with its engine stopped, the machine can, as already explained, follow the same gliding path at two different speeds. The same, of course, applies to horizontal flight, since, as has been seen, this is really nothing else than an ordinary glide in which the angle of the flight-path has been raised by mechanical means, through utilising the power of the engine.

Let us assume that the ordinary horizontal flight of the aeroplane is indicated by the point R_1 , which constitutes its *normal flight*.

The speed OR_1 will be roughly 23 m. per second, and the useful power required, actually developed by the propeller, about 30 h.p.

According to Table II. (Chapter II.), the normal angle of incidence will be about 4° , corresponding to a lift coefficient of 0.038.

Let it be agreed that in flight, which is strictly normal, the pilot suddenly actuates his elevator so as to increase the angle of incidence to $6\frac{1}{2}^\circ$ (lift coefficient 0.05), and hence *necessarily* alters the speed to 20 m. per second.

From the thin curve in fig. 17 (and from Table II., on which it is based) it is clear that the useful-power required to sustain the aeroplane at this speed will be 24 h.p.

On the other hand, according to the thick curve in the same figure, the power-plant at this same speed of 20 m. per second will develop a useful-power of 30·3 h.p., giving a surplus of 6·3 h.p. over and above that necessary to sustain the machine. The latter will therefore climb, and climb at a vertical speed such that the raising of its weight absorbs exactly the surplus, NN' or 6·3 h.p., useful-power developed by the power-plant, that is, at a speed of $\frac{6\cdot3 \times 75}{600}$ = about 0·79 m. per second.

Since this vertical speed must necessarily correspond to a horizontal speed of 20 m. per second, the angle of the climb, as a decimal fraction, will be the ratio of the two speeds, *i.e.*

$$\frac{0\cdot79}{20} = 0\cdot0395 = \text{about } 4 \text{ centimetres per metre} = 1 \text{ in } 25.$$

As a matter of fact, we have already seen that by using the elevator the pilot could make his machine climb or descend; but by considering the curves of the aeroplane and of the power-plant at one and the same time, we gain a still clearer idea of the process.

Should the pilot increase the incidence to more than $6\frac{1}{2}^\circ$ the speed would diminish still more, and fig. 17 shows that, in so doing, the surplus power, measured by the distance dividing the two curves along the perpendicular corresponding to the speed in question, would increase. And with it we note an increase both in the climbing speed and in the upward flight-path.

Yet is this increase limited, and the curves show that there is one definite speed, *Ol*, at which the surplus of useful-power exerted by the power-plant over and above that required for horizontal flight has a maximum value.

If, by still further increasing the angle of incidence, the speed were brought below the limit *Ol*, the climb-

ing speed of the aeroplane would diminish instead of increasing.

Nevertheless, the upward climbing angle would still increase, but ever more feebly, until the speed attained another limit, Op , such that the ratio between the climbing speed to the flying speed, which measures the angle of the flight-path, attained a maximum.

Thus, there is a certain angle of incidence at which an aeroplane climbs as steeply as it is possible for it to climb.

If, when the machine was following this flight-path, the angle of incidence were still further increased by the use of the elevator, in order to climb still more, the angle of the flight-path would diminish. Relatively to its flight path the aeroplane would actually come down, notwithstanding the fact that the elevator were set for climbing.

The same inversion of the effect usually produced from the use of the elevator would arise if the aeroplane were flying under the normal conditions represented by the point R_2 in fig. 17. For a decrease in the angle of incidence through the use of the elevator would have the immediate and inevitable result of increasing the speed of flight, which would pass from Or_2 to Og , for instance. But this would produce an increase QQ' in the useful-power developed by the power-plant over and above that required for horizontal flight, so that even though the elevator were set for descending, the aeroplane would actually climb.

This inversion of the normal effect produced by the elevator has sometimes caused this second condition of flight to be termed unstable.

For if a pilot flying in these conditions, and not aware of this peculiar effect, felt his machine ascending through some cause or other, he would work his elevator so as to come down. But the aeroplane would continue to ascend, gathering speed the while. The pilot, finding that his machine was still climbing, would set his elevator still further for descending until the speed exceeded the limit

Op , and the elevator effect returned to its usual state and the machine actually started to descend. The pilot, unaware of the existence of this condition and brought to fly under it by certain circumstances (which, be it added, are purely hypothetical), would therefore regain normal flight by using his controls in the ordinary manner.

Nevertheless, one is scarcely justified in applying to this second condition of horizontal flight the term "unstable" —if employed in the sense ordinarily accepted in mechanics, —for one may well believe that a pilot, aware of its existence, could perfectly well accomplish flight under this condition by reversing the usual operation of his elevator.

Still, it would be a difficult proposition for machines normally flying at a low speed, since the speed of flight under the second condition (indicated by the point R_2 , fig. 17) would be lower still.

But in the case of fast machines the solution is obvious enough. For instance, according to Table II., the minimum speed of the aeroplane represented by the thin curve in fig. 17 is about 63 km. per hour, whereas in the early days of aviation the normal flying speed of aeroplanes was less.

Now, note that by making an aeroplane fly under the second condition the angle of the planes would be quite considerable. In the case in question the angle would be in the neighbourhood of 15° , which is about 10° in excess of the normal flying angle.

The whole aeroplane would therefore be inclined at an angle equivalent to some ten degrees to the horizontal, with the result that the detrimental surface (which cannot be supposed constant for such large angles) would be increased, and with it the useful-power required for flight.

In practice, therefore, the power-plant would not enable the minimum speed Or_2 to be attained, and the second condition of flight would take place at a higher speed and at a smaller angle of incidence. Still, it would be practicable

by working the elevator in the reverse sense to the usual.*

Now let us just see how a pilot could make his aeroplane pass from normal flight to the second condition; although, no doubt, in so doing we anticipate, for it is highly improbable that any pilot hitherto has made such an attempt.

When the aeroplane is flying horizontally and normally, the pilot would simply have to set his elevator to climb, and continue this manoeuvre until the flight-path had attained its greatest possible angle. The aeroplane would then return (and very quickly too, if practice is in accordance with theory) to horizontal flight, and now, flying very slowly, it would have attained to the second condition of flight. At this stage it would be flying at a large angle to the flight-path, very *cabré*, almost like a kite.

The greater part of the useful-power would be absorbed in overcoming the large resistance opposed to forward motion by the planes. It will now be readily seen that, under these conditions, any decrease in the angle of incidence would cause the machine to climb, since, while it would have but little effect on the lift of the planes, it would greatly reduce their drag.

By the process outlined above, the aeroplane would successively assume every one of the series of speeds between the two speeds corresponding to normal and the second condition of flight (*i.e.* it would gradually pass from Or_1 to Or_2 , fig. 17), though it would have to begin with climbing and descend afterwards.

But we know that the pilot has a means of attaining these intermediary speeds while continuing to fly horizontally, namely, by throttling down his engine. This, at all events, is what he should do until the speed of the machine had

* At present we are only dealing with the sustentation of the aeroplane. From the point of view of stability, which will be dealt with in subsequent chapters, it seems highly probable that the necessity of being able to fly at a small and at a large angle of incidence will lead to the employment of special constructional devices.

reached a certain point Ol (fig. 18) corresponding to that degree of throttling at which the power-plant curve (much flatter now by reason of the throttling-down process) only continues to touch the aeroplane curve at a single point L . Below this speed, if the pilot continues to increase the angle of incidence by using the elevator, horizontal flight cannot be maintained except by quickly opening the throttle.

It would therefore seem feasible to pass from the normal to the second condition of flight, without rising or falling,

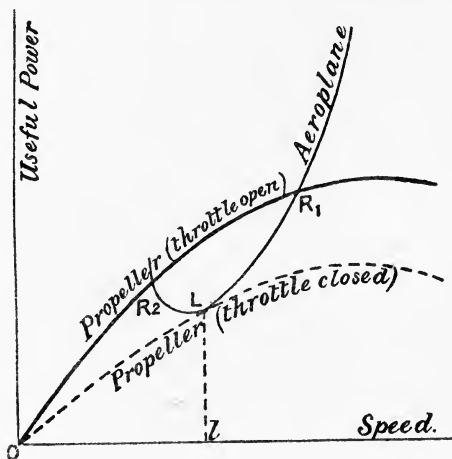

FIG. 18.

by the combined use of elevator and throttle. But up till now all this remains pure theory, for hitherto few pilots know how to vary their speed to any considerable extent, and probably not a single one has yet reduced this speed below the point Ol and ventured into the region of the second condition of flight, that wherein the elevator has to be operated in the inverse sense.

The reason for this view is that the aeroplane, when its speed approaches the point Ol , is flying without any margin, and consequently is then bound to descend. If therefore it obeys the impulse of descending given by the elevator, it no longer responds to the climbing manipulation.

As soon as the pilot perceives this,* he hastens to increase the speed of his machine again by reducing the angle of incidence and opening his throttle, whereas, in order to pass the critical point, he would in fact have to open the throttle *but still continue to set his elevator to climb.*

The possibility of achieving several different speeds by the combined use of elevator and throttle forms the solution to the problem of wide speed variation.

The greatest possible speed variation which any aeroplane is capable of attaining is measured by the difference between the normal and the second condition of flight. But, up to the present at any rate, the latter has not been reached, and the lowest speed of an aeroplane is that (indicated by *Ol*, fig. 18) corresponding to flight at the "limit of capacity."

This particular speed, not to be mistaken for one of the two essential conditions of flight, is usually very close to that corresponding to the economical angle of incidence (see Chapter II.). Hence the *economical speed* constitutes the lower limit of variation, which has probably never yet been attained.

In the future, if the second condition of flight is achieved in practice, one will be able to fly at the lowest possible speed an aeroplane can attain. This conclusion may prove of considerable interest in the case of fast machines, for any reduction of speed, however slight, is then important.

The highest speed is that of the normal flight of an aeroplane. In the example represented in fig. 17 this speed is 23 m. per second, or about 83 km. per hour. Since the economical speed of the machine in question is about 66 km. per hour, the absolute speed variation would be 17 km. per hour, or, relatively, about 20 per cent. This, however, is a maximum, since the economical speed, as we know, is never attained in practice.

The above leads to the conclusion that the way to obtain

* He is the more prone to do this owing to the fact that, with present methods of design and construction, stability decreases as the angle of incidence is increased.

a large speed variation is to increase the normal flying speed.

In the previous example we assumed that the 50-h.p. motor turning at 1200 revolutions per minute was equipped with a propeller with a 0.7 pitch ratio, well adapted, whose characteristic qualities are given in Table VI.

Now let us replace this propeller by another, equally well

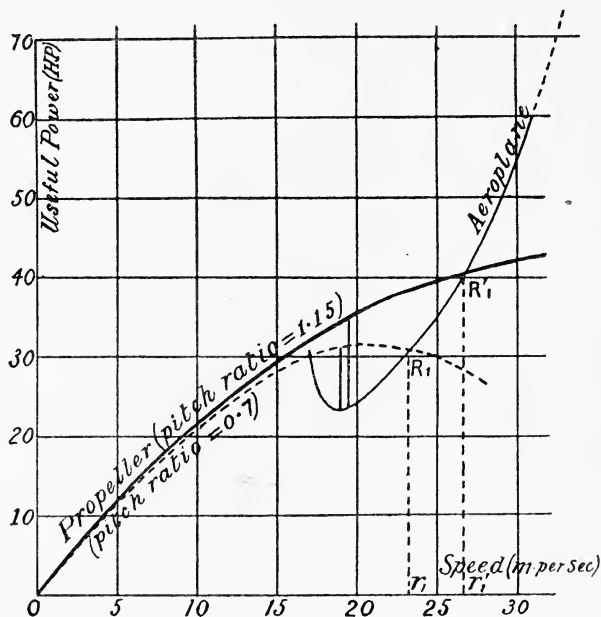

FIG. 19.

adapted, but with a pitch ratio of 1.15. According to Table VI. the diameter of this propeller would be 1.98 m. and its pitch 2.28 m. The best speed corresponding to the new propeller would be 33 m. per second, and the maximum useful-power developed at this speed 42 h.p.

Now let the new power-plant curve (thick line) be superposed on the previous aeroplane curve (see fig. 19). For the sake of comparison the previous power-plant curve is also reproduced in this diagram.

The advantage of the step is clear at a glance. In fact, the normal flying speed increases from Or_1 —equivalent to 23 m. per second or 83 km. per hour—to Or'_1 —equivalent to 26 m. per second, or about 93 km. per hour. This increases the speed variation from 17 to 27 km. per hour, or from 20 to 29 per cent.

Again, the maximum surplus power developed by the power-plant over and above that required merely for sustentation, amounting to about 7 h.p. with the former propeller, now becomes about 12 h.p. The quickest climbing speed therefore grows from $\frac{7 \times 75}{600} = 0.88$ m. per second to $\frac{12 \times 75}{600} = 1.5$ m. per second.

Hence, by simply changing the propeller, one obtains the double result of increasing the normal flying speed of the aeroplane together with its climbing powers. Nor is the fact surprising, but merely emphasises our contention that since highly efficient propellers can be constructed, it will be just as well to use them.

In order to gain an idea of the relative importance of increasing the pitch ratio when this ratio has already a certain value, we may superpose in a single diagram (fig. 20), on the aeroplane curve, all the power-plant curves representing the various propellers, well adapted, used with the same 50-h.p. motor turning at 1200 revolutions per minute, according to Table VI.

Firstly, it will be evident that a pitch ratio of 0.5 would not enable the aeroplane in question to maintain horizontal flight, since the two curves—that of the power-plant and of the aeroplane—do not meet. In fact, the pitch ratio must be between 0.5 and 0.6—0.54, to be exact—for the power-plant curve to touch the aeroplane curve at a single point. Horizontal flight would then be possible, but only at one speed and without a margin.

But as soon as the pitch ratio increases, the normal flying speed and the climbing speed increase very rapidly. On

the other hand, once the pitch ratio amounts to 0.9, the advantage of increasing it still further, though this still exists, becomes negligible. Beyond 1.0 a further increase of pitch ratio (in the specific case in question) need not be considered. All of which are, of course, theoretical considerations, although they point to certain definite principles which cannot be ignored in practice—a fact of which

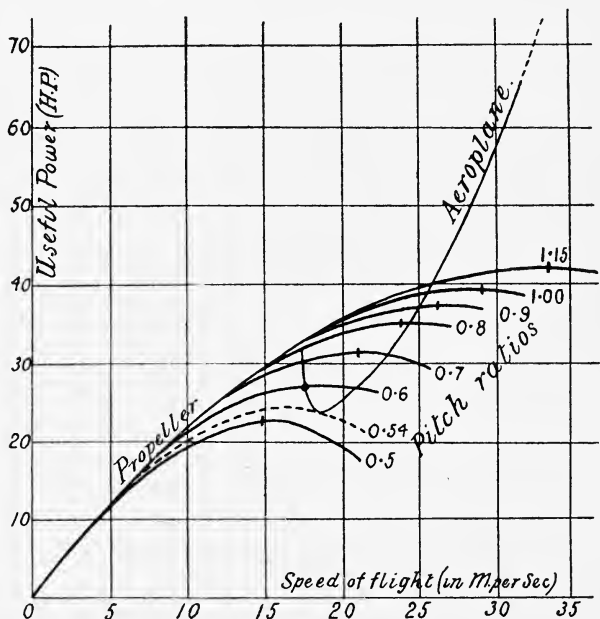

FIG. 20.

constructors, as already remarked, are now becoming cognisant.

At the same time, the reduction of the diameter necessitated by the use of propellers of great efficiency is not without its disadvantages, more especially in the case of monoplanes and tractor biplanes in which the propeller is situated in front. In these conditions, the propeller throws back on to the fuselage a column of air which becomes the more considerable as the propeller diameter is

reduced, since practically only the portions of the blades near the tips produce effective work.

It is on this ground that we may account for the fact that reduction in propeller diameter has not yet, up to a point, given the good results which theory led one to expect.

But when the propeller is placed in rear of the machine

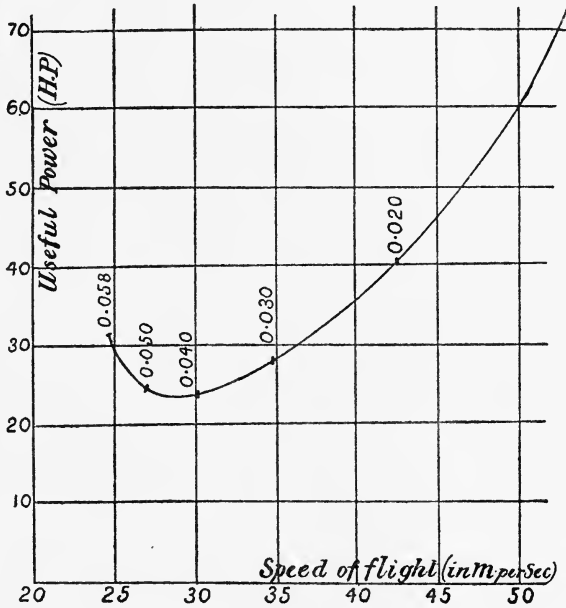

FIG. 21.

The figures at the side of the curve indicate the lift.

and the backward flowing air encounters no obstacle, there is every advantage in selecting a high pitch ratio, and we have already seen that M. Tatin, in consequence, on his Torpille fitted a propeller with a pitch exceeding the diameter.*

* It may also be noticed that the need for reducing the diameter gradually disappears as the power of the motor increases, because the diameter of propellers well adapted to a motor increases with the power of the latter.

The use of propellers of high efficiency, therefore, obviously increases the speed variation obtainable with any particular aeroplane.

The lower limit of this speed variation has already been seen to be the economical speed of the aeroplane.

Now, it should be noted that, in designing high-speed machines, the use of planes of small camber and with a very heavy loading has the result of increasing the value of the economical speed. Thus, the Torpille, already referred to, appeared to be capable of attaining a speed of 160 km. per hour;* but its economical speed would have been about 28 m. per second or 100 km. per hour. Fig. 21 shows, merely for the sake of comparison, the curve of an aeroplane of this type (weight, 450 kg.; area, 12.50 sq. m.; detrimental surface, 0.30 sq. m.) plotted from the following table.

TABLE VII.

Lift Coefficient.	Speed Value.		Drag, based on Eiffel's Results, with a M. Farman plane section.	Drag of Planes (drag coefficient \times area \times square of the speed).	Head Resistance (coefficient $0.08 \times$ area \times square of the speed).	Propeller-Thrust (col. 5 and col. 6).	Useful-Power required for Horizontal Flight (col. 2 \times col. 7 \div 76).
	m. p. s.	km. p. h.					
1	2	3	4	5	6	7	8
0.010	60	216	0.0007	31 kg.	87 kg.	118 kg.	94 h.p.
0.020	42.4	158	0.0013	29	43	72	40
0.030	34.6	125	0.0020	31	29	60	28
0.040	30	108	0.0034	38	22	60	24
0.050	26.8	97	0.0055	49	18	67	24
0.058	24.9	90	0.0100	77	16	93	31

* If we allow it a detrimental surface of 0.30 sq. metre, which is certainly not enough.

The speed variation of such a machine would be 60 km. per hour = 38 per cent.

If it could fly in the second condition of flight, *i.e.* at 90 km. per hour, the speed variation would be 70 km. per hour, or 44 per cent.

In a machine of similar type, able to attain a speed of 200 km. per hour (weight, 500 kg.; area, 9 sq. m.; detri-

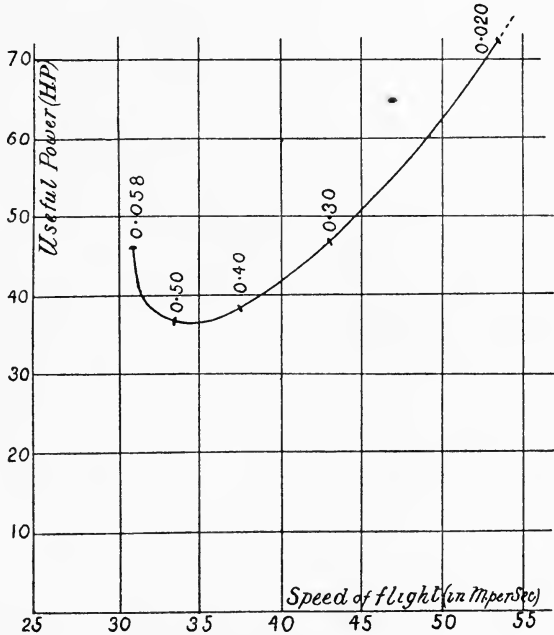

FIG. 22.

The figures by the side of the curve indicate the lift.

mental surface, 0.03 sq. m.), whose characteristic curve is plotted in fig. 22, according to Table VIII., the economical speed would be 34 m. per second, or 125 km. per hour, giving a speed variation of 75 km. per hour, or 38 per cent. If it could attain the second condition of flight, *i.e.* 110 km. per hour, the variation would be 90 km. per hour, or 45 per cent.

Fortunately, as may be seen, the high-speed machine of

the future should possess a high degree of speed variation. And in the case of really high speeds even the smallest advantage in this respect becomes of great importance. It may well be that the necessity for achieving the greatest

TABLE VIII.

Lift Coefficient.	Speed Value.		Drag, based on Eiffel's Results, with a M. Farman plane section.	Drag of Planes (drag coefficient \times area \times square of the speed).	Head Resistance (coefficient $0\cdot08 \times$ area \times square of the speed)	Propeller-Thrust (col. 5 and col. 6).	Useful Power required for Horizontal Flight (col. 2 \times col. 7 \div 75).
	m. p. s.	km. p. h.					
1	2	3	4	5	6	7	8
0·010	74·8	270	0·0007	35 kg.	134 kg.	169 kg.	168 h.p.
0·020	53	190	0·0013	33	68	101	72
0·030	43·1	155	0·0020	35	45	80	46
0·040	37·4	135	0·0034	43	34	77	39
0·050	33·4	120	0·0055	55	27	82	37
0·058	31	111	0·0100	86	24	110	46

possible speed variation will induce pilots of the extra high speed machines of the future to attempt, for alighting, to fly at the second condition of flight.* In this they will only imitate a bird, which, when about to alight, places its wings at a coarse angle and tilts up its body.

Fig. 20 further shows that when the pitch ratio is less than 0·8 the highest point of the power-plant curve lies to the left of the aeroplane curve. It only lies to the right of it when the pitch ratio is equal to or greater than 0·9. If the pitch ratio were 0·85, the highest point of the power-plant curve would just touch the aeroplane curve, and would hence correspond to normal flight.

* Attention is, however, drawn to the remarks at the bottom of p. 74.

In Chapter IV. it was shown that the highest point of the power-plant curve corresponds—the propeller being supposedly well adapted to the motor—to a rotational velocity of 1200 revolutions per minute, the normal number of revolutions at which it develops full power. If, therefore, this highest point lies to the left of the aeroplane curve, the motor is turning at over 1200 revolutions per minute when the aeroplane is flying at normal speed. On the other hand, if the highest point lies to the right of the aeroplane curve, in normal flight the motor will be running at under 1200 revolutions per minute.

In neither case will it develop full power. Moreover, there is danger in running the motor at too high a number of revolutions, particularly if it is of the rotary type. Only a propeller with a pitch ratio of 0·85 could enable the motor to develop its full power (in the special case in question).

This immediately suggests the expedient of keeping the motor running at 1200 revolutions per minute while allowing the propeller to turn at the speed productive of its maximum efficiency through some system of gearing. Thus we are brought by a logical chain of reasoning to the geared-down propeller, a solution adopted in very happy fashion in the first successful aeroplane—that of the brothers Wright.

Let us suppose that an aeroplane whose curve is shown by the thin line in fig. 23 has a power-plant curve represented by the thick line in the same figure, the propeller direct-driven, having a pitch ratio of 1·15, and hence possessing (according to Commandant Dorand's experiments) 84 per cent. maximum efficiency.

Evidently, however good this power-plant might be when considered by itself, it would be very badly adapted to the aeroplane in question, since, firstly, it would only enable the machine to obtain the low speed Or_1 ; and, secondly, the maximum surplus of useful-power, the measure of an aeroplane's climbing properties, would fall to a very

low figure. Hence, the machine would only leave the ground with difficulty, and would fly without any margin. And all this simply and solely because the *best speed*, Om , suited to the power-plant would be too high for the aeroplane.

Now let the direct-driven propeller be replaced by another of the same type, but of larger diameter, and geared down in such fashion that the best speed suited to this power-plant corresponds to the normal flying speed Or'_1 of the aeroplane (see fig. 23).

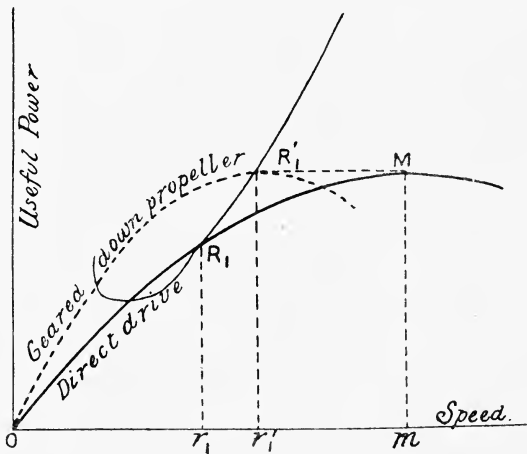

FIG. 23.

The maximum useful-power developed by this power-plant remains in theory the same as before, since the propeller, being of the same type, will still have a maximum efficiency of 84 per cent. The new power-plant curve will therefore be of the order shown by the dotted line in the figure.

It is clear that by gearing down we first of all obtain an increase of the normal flying speed, and secondly, a very large increase in the maximum surplus of useful-power—that is, in the machine's climbing capacity. In practice, however, this is not a perfectly correct representation of

the case, since gearing down results in a direct loss of efficiency and an increase in weight. Whether or not to adopt gearing, therefore, remains a question to be decided on the particular merits of each case. Speaking very generally, it can be said that this device, which always introduces some complication, should be mainly adopted in relatively slow machines designed to carry a heavy load.

In the case of high-speed machines it seems better to drive the propeller direct, though even here it may yet prove desirable to introduce gearing.

This study of the power-plant may now be rounded off with a few remarks on static propeller tests, or bench tests. These consist in measuring, with suitable apparatus, on the one hand, the thrust exerted by the propeller turning at a certain speed without forward motion, and, on the other, the power which has to be expended to obtain this result.

Experiment has shown that a propeller of given diameter, driven by a given expenditure of power, exerts the greatest static thrust if its pitch ratio is in the neighbourhood of 0.65.* On the other hand, we have seen that the highest thrust efficiency in flight is obtained with propellers of a pitch ratio slightly greater than unity. Hence one should not conclude that a propeller would give a greater thrust in flight simply from the fact that it does so on the bench. Thus, the propeller mounted on the Tatin Torpille, already referred to, which gave an excellent thrust in flight, would probably have given a smaller thrust on the bench than a propeller with a smaller pitch.

Consequently, a bench test is by no means a reliable indication of the thrust produced by a propeller in flight. Besides, it is usually made not only with the propeller alone but with the complete power-plant, in which case the result is even more unreliable owing to the fact that the power developed by an internal combustion engine varies with its speed of rotation.

For instance, suppose that a motor normally turning at

* From Commandant Dorand's experiments,

1200 revolutions per minute is fitted with a propeller of 1·15 pitch ratio which, when tested on the bench by itself, already develops a smaller thrust than a propeller of 0·65 pitch ratio ; the motor would then only turn at 900 revolutions per minute, whereas the propeller of 0·65 pitch ratio would let it turn at 1000 revolutions per minute, and hence give more power. The propeller with a high pitch ratio would therefore appear doubly inferior to the other, and this notwithstanding the fact that its thrust in flight would undoubtedly be greater.

A propeller exerting the highest thrust in a bench test must not for that reason be regarded as the best.

CHAPTER VI

STABILITY IN STILL AIR

LONGITUDINAL STABILITY

AT the very outset of the first chapter it was laid down that the entire problem of aeroplane flight is not solved merely by obtaining from the "relative" air current which meets the wings, owing to their forward speed, sufficient lift to sustain the weight of the machine; an aeroplane, in addition, must always encounter the relative air current in the same attitude, and must neither upset nor be thrown out of its path by a slight aerial disturbance. In other words, it is essential for an aeroplane to remain in equilibrium; more, *in stable equilibrium*.*

We may now proceed to study the equilibrium of an aeroplane in still air and the stability of this equilibrium.

Since a knowledge of some of the main elementary principles of mechanics is essential to a proper understanding of the problems to be dealt with, these may be briefly outlined here.

* The very fact that an aeroplane remains in flight presupposes, as we have seen, a first order of equilibrium, which has been termed the equilibrium of sustentation, which jointly results from the weight of the machine, the reaction of the air, and the propeller-thrust. The maintenance of this state of equilibrium, which is the first duty of the pilot, causes an aeroplane to move forward on a uniform and direct course.

We are now dealing with a second order of equilibrium, that of the aeroplane on its flight-path. Both orders of equilibrium are, of course, closely interconnected, for if in flight the machine went on turning and rolling about in every way, its direction of flight could clearly not be maintained uniformly.

The most important of these is that relating to the *centre of gravity*.

If any body, such as an aeroplane, for instance (fig. 24), is suspended at any one point, and a perpendicular is drawn from the point of suspension, it will always pass, *whatever the position of the body in question*, through the same point G, termed the centre of gravity of the body.

The effect of gravity on any body, in other words, the

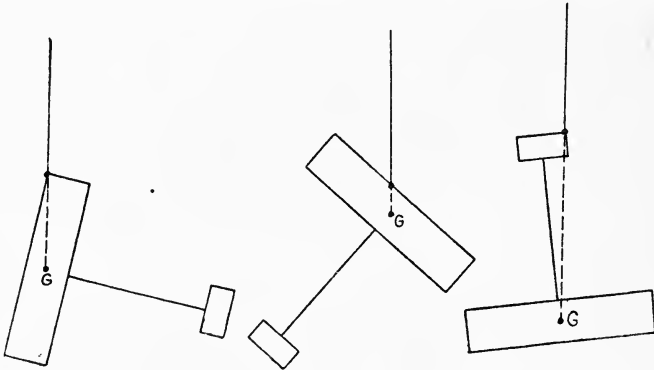

FIG. 24.

force termed the *weight* of the body, therefore always passes through its centre of gravity, whatever position the body may assume.

Another principle is also of the greatest importance in considering stability; namely, the *turning action* of forces.

When a force of magnitude F (fig. 25), exerted in the direction XX , tends to make a body turn about a fixed point G , its action is the stronger the greater the distance, Gx , between the point G and the line XX . In other words, the turning action of a force relatively to a point is the greater the farther away the force is from the point.

Further, it will be readily understood that a force F^1 , double the force F in magnitude but acting along a line YY separated from the fixed point G by a distance Gy ,

which is just half of Gx , would have a turning force equal to F . In short, it is the well-known principle of the lever.

The product of the magnitude of a force by the length of its lever arm from a point or axis therefore measures the turning action of the force. In mechanics this turning action is usually known as the *moment* or the *couple*.

When, as in fig. 25, two turning forces are exerted in inverse direction about a single point or axis, and their

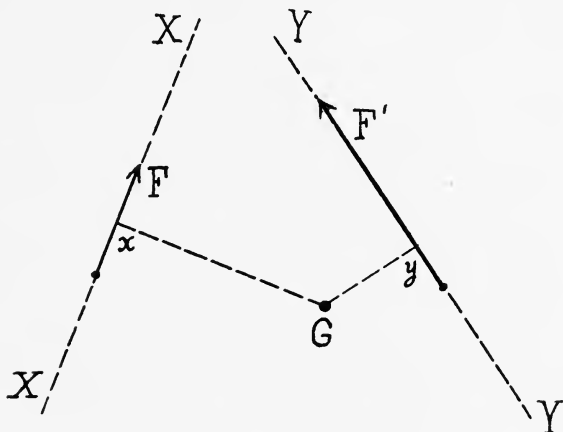

FIG. 25.

turning moment or couple is equal, the forces are said to be *in equilibrium* about the point or axis in question.

For a number of forces to be in equilibrium about a point or axis, the sum of the moments or couples of those acting in one direction must be equal to the sum of the couples of those acting in the opposite direction.

It should be noted that in measuring the moment of a force, only its magnitude, its direction, and its lever arm are taken into account. The position of the point of its application is a matter of indifference. And with reason, for the point of application of a force cannot in any way influence the effect of the force; if, for instance, an object

is pushed with a stick, it is immaterial which end of the stick is held in the hand, providing only that the force is exerted in the direction of the stick.

Before venturing upon the problem of aeroplane stability a fundamental principle, derived from the ordinary theory of mechanics, must be laid down.

FUNDAMENTAL PRINCIPLE.—*So far as the equilibrium of an aeroplane and the stability of its equilibrium are concerned, the aeroplane may be considered as being suspended from its centre of gravity and as encountering the relative wind produced by its own velocity.*

This principle is of the utmost importance and absolutely essential; by ignoring it grave errors are bound to ensue, such, for instance, as the idea that an aeroplane behaves in flight as if it were in some fashion suspended from a certain vaguely-defined point termed the "centre of lift," usually considered as situated on the wings. An idea of this sort leads to the supposition that a great stabilising effect is produced by lowering the centre of gravity, which is thus likened to a kind of pendulum.

Now, it will be seen hereafter that in certain cases the lowering of the centre of gravity may, in fact, produce a stabilising effect, but this for a very different reason.

The "centre of lift" does not exist. Or, if it exists, it is coincident with the centre of gravity, *which is the one and only centre of the aeroplane.*

The three phases of stability, which is understood to comprise equilibrium, to be considered are :

Longitudinal stability.

Lateral stability.

Directional stability.

First comes longitudinal stability, which will be dealt with in this chapter and the next.

Every aeroplane has a plane of symmetry which remains vertical in normal flight. The centre of gravity lies in this plane. The axis drawn through the centre of gravity at right angles to the plane of symmetry may be termed

the *pitching axis* and the equilibrium of the aeroplane about its pitching axis is its *longitudinal equilibrium*.

Hereafter, and until stated otherwise, it will be assumed that the direction of the propeller-thrust passes through the centre of gravity of the machine. Consequently, neither the propeller-thrust nor the weight of the aeroplane, which, of course, also passes through the centre of gravity, can have any effect on longitudinal equilibrium, for, in accordance with the fundamental principle set out above, the moments exerted by these two forces about the pitching axis are zero.

Hence, in order that an aeroplane may remain in longitudinal equilibrium on its flight-path, that is, so that it may always meet the air at the same angle of incidence, all that is required is that the reaction of the air on the various parts of the aeroplane should be in equilibrium about its centre of gravity.

Now, in normal flight all the reactions of the air must be forces situated in the plane of symmetry of the machine. These forces may be compounded into a single resultant (see Chapter II.), which, for the existence of longitudinal equilibrium, must pass through the centre of gravity.

We may therefore state that: *when an aeroplane is flying in equilibrium, the resultant of the reaction of the air on its various parts passes through the centre of gravity.*

This resultant will be called the *total pressure*.

Let us take any aeroplane, maintained in a fixed position, such, for instance, that the chord of its main plane were at an angle of incidence of 10° , and let us assume that a horizontal air current meets it at a certain speed.

The air current will act upon the various parts of the aeroplane and the resultant of this action will be a total pressure of a direction shown by, say, P_{10} (fig. 26). Without moving the aeroplane let us now alter the direction of the air current (blowing from left to right) so that it meets the planes at an ever-decreasing angle, passing successively

from 10° to 8° , 6° , 4° , etc. In each case the total pressure will take the directions indicated respectively by P_8 , P_6 , P_4 , etc. Let G be the centre of gravity of the aeroplane.

Only one of the above resultants— P_6 , for instance—will pass through the centre of gravity. From this it may be deduced that equilibrium is only possible in flight when the main plane is at an angle of incidence of 6° .

Thus, a perfectly rigid unalterable aeroplane could only in practice fly at a single angle of incidence.

If the centre of gravity could be shifted by some means or other, to the position P_4 , for instance, the one angle of incidence at which the machine could fly would change to 4° . But this method for varying the angle of incidence has not hitherto been successfully applied in practice.*

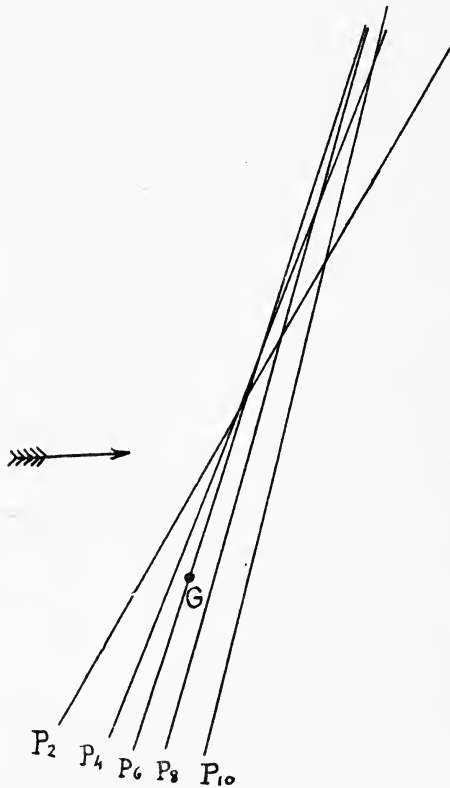

FIG. 26.

The same result, however, is obtained through an auxiliary movable plane called the *elevator*.

It is obvious that by altering the position of one of the

* It will be seen hereafter that, if the method can be applied, it would have considerable advantages.

planes of the machine the sheaf of total pressures is altered. Thus, figs. 27 and 28 represent the total pressures in the case of one aeroplane after altering the position of the

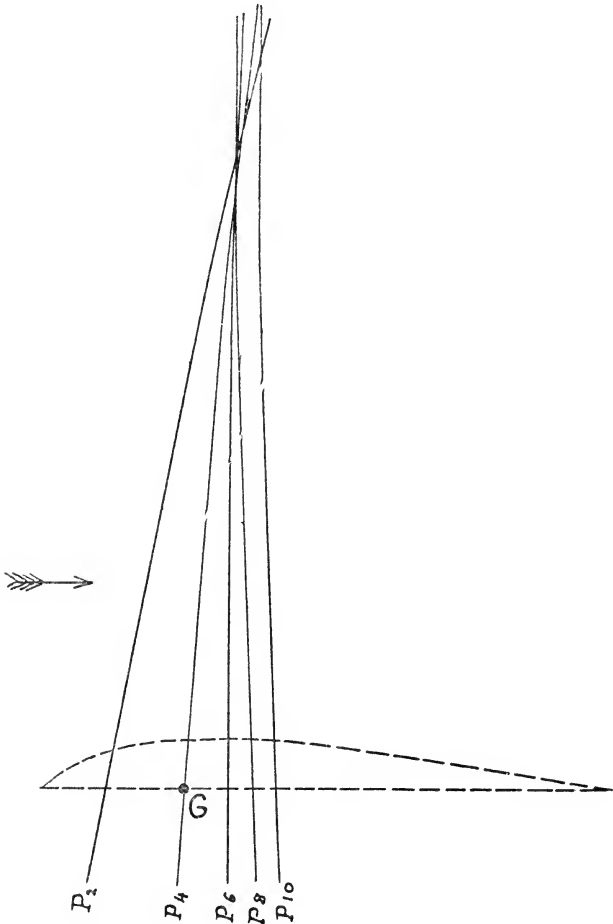

FIG. 27.

elevator (the dotted outline indicating the main plane). If G is the centre of gravity, the normal angle of incidence passes from the original 4° to 2° by actuating the elevator.

Therefore, as stated in Chapter I., *by means of the elevator the position of longitudinal equilibrium of an*

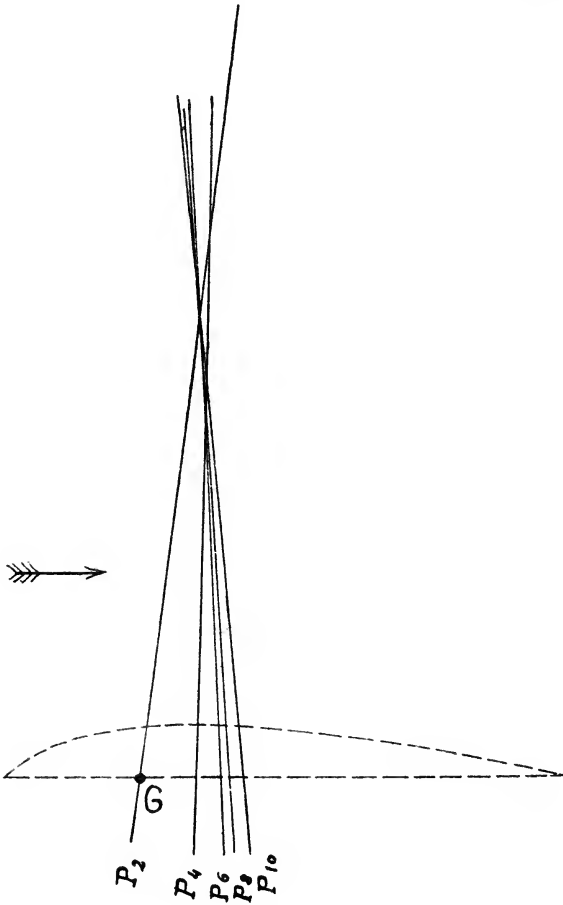

FIG. 28.

aeroplane, and hence its incidence, can be varied at will.

The action of the elevator will be further considered in the next chapter.

But the longitudinal equilibrium of an aeroplane must

also be *stable*; in other words, if it should accidentally lose its position of equilibrium, the action of the forces arising through the air current from the very fact of the change in its position should cause it to regain this position instead of the reverse.

If we examine once again the sheaf of total pressures we may be able to gain an idea of how this condition of affairs can be brought about.

Returning again to fig. 26, let us suppose that by an oscillation about its pitching axis—the movement being counter-clockwise—the angle of the planes, which is normally 6° since the total pressure P_6 passes through the centre of gravity, decreases to 4° , the resultant of pressure on the aeroplane in its new position will have the direction P_4 ; hence this resultant will have, relatively to the pitching axis, a moment acting clockwise, which will therefore be a *righting*

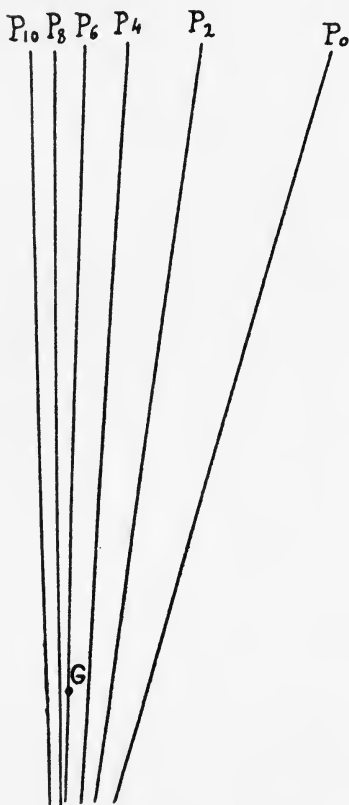

FIG. 29.

couple since it opposes the oscillation which called it into being.

The same thing would come to pass if the oscillation was in the opposite direction.

In this case, therefore, equilibrium is stable.

On the other hand, if the sheaf of pressures was arranged as in fig. 29, the pressure P_4 would exert an *upsetting*

couple relatively to the pitching axis, and equilibrium would be unstable.

The stability or instability of longitudinal equilibrium therefore depends on the relative positions of the sheaf of total pressures and of the centre of gravity, and it may be laid down that when the line of normal pressure is intersected by those of the neighbouring total pressures at a point about the centre of gravity, equilibrium is stable, whereas it is unstable in the reverse case.

Several experimenters, and among them notably M. Eiffel, have sought to determine by means of tests with scale models the position of the total pressures corresponding to ordinary angles of incidence. Hitherto M. Eiffel's researches have been confined to tests on model wings and not on complete machines, but the latter are now being employed. Moreover, the results do not indicate the actual position

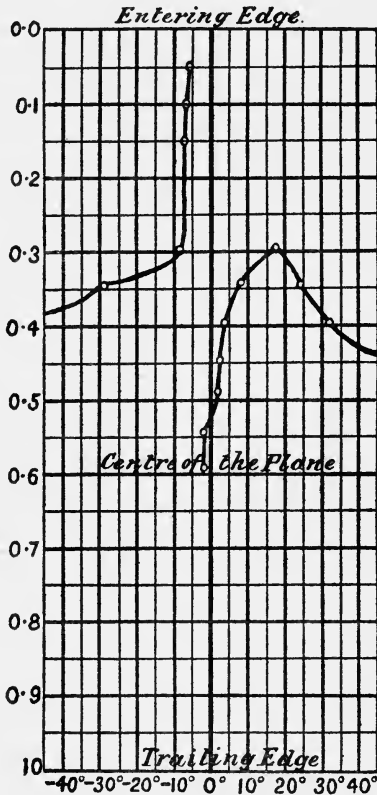

FIG. 30.—Angles i of the chord and the wind.

and distribution of the pressure itself, but only the point at which its effect is applied to the plane, this point being known as the *centre of pressure*.

The results of these tests have been plotted in two series of curves which give the position of the centre of pressure with a change in the angle of incidence. Figs. 30 and 31

reproduce, by way of indicating the system, the two series of curves relating to a Bleriot XI. wing.

It has already been remarked that the point from which a force is applied is of no importance; accordingly, a centre

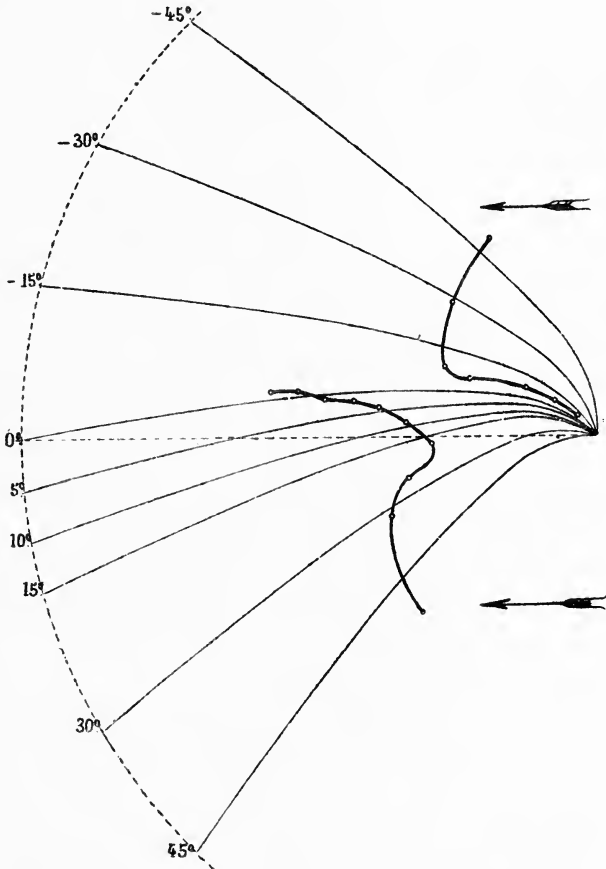

FIG. 31.

of pressure is of value only in so far as it enables the direction of the pressures themselves to be traced.

By comparing the curve shown in fig. 31 with the polar curves already referred to in previous chapters, one obtains

a means of reproducing both the position and the magnitude, relatively to the wing itself, of the pressures it receives at varying angles.*

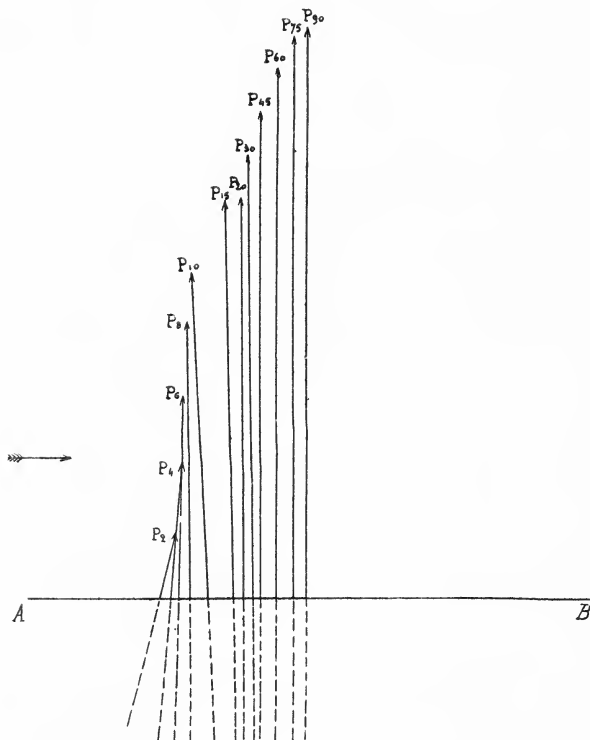

FIG. 32.—Sheaf of pressures on a flat plane.

Figs. 32, 33, and 34 show the sheaf of these pressures in the case, respectively, of:

A flat plane.

A slightly cambered plane (*e.g.* Maurice Farman).

A heavily cambered plane (Bleriot XI).

These diagrams, be it repeated, relate only to the plane by itself and not to complete machines.

* A description of the method may be found in an article published by the author in *La Technique Aéronautique* (January 15, 1912).

Comparison of these three diagrams brings out straight away a most important difference between the flat and the two cambered planes. That relating to the flat plane, in fact, is similar in its arrangement to that shown in

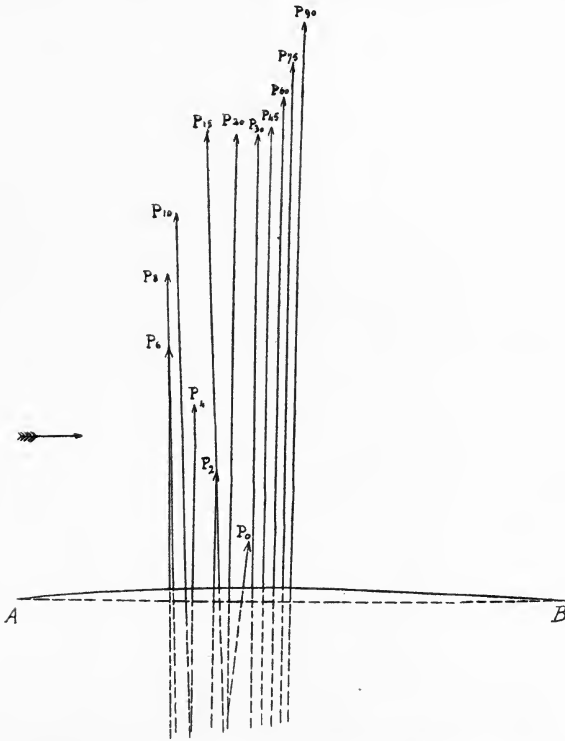

FIG. 33.—Sheaf of pressures on a Maurice Farman plane.

fig. 26, which served to illustrate a longitudinally stable aeroplane.

The diagrams relating to cambered planes, on the other hand, are analogous, so far as the usual flying angles are concerned, to fig. 29, which depicted the case of a longitudinally unstable aeroplane.

Thus we can state that, *considered by itself*, a flat plane is longitudinally stable, a cambered plane *unstable* (the

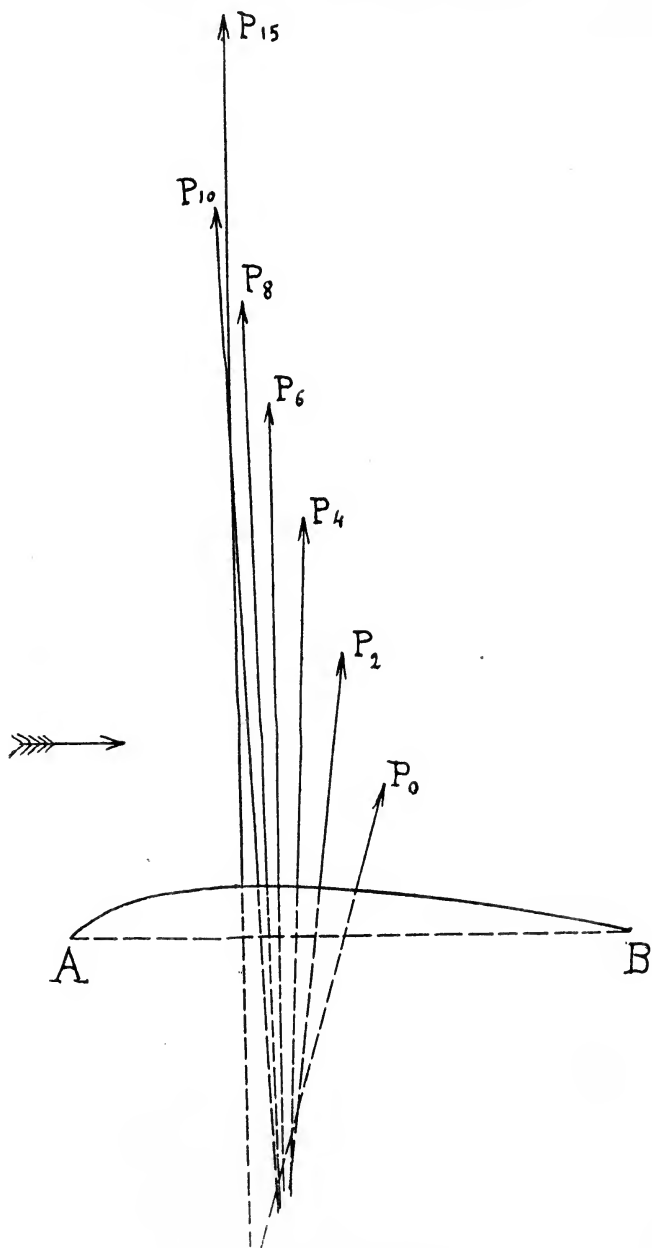

FIG. 34.—Sheaf of pressures on a Bleriot XI. plane.

latter statement, however, as will subsequently be seen, is not always absolutely correct). On the other hand, every one knows nowadays that flat planes are very inefficient, producing little lift with great drag.

Hence the necessity for finding means to preserve the valuable lifting properties of the cambered plane while counteracting its inherent instability. The bird, incidentally, showed that it is possible to fly with cambered wings. And it was by adopting this example and improving upon it that the problem was solved, by providing the aeroplane with a tail.

An auxiliary plane, of small area but placed at a considerable distance from the centre of gravity of the aeroplane, and therefore possessing a big lever arm relatively to the centre of gravity, receives from the air, when in flight the aeroplane comes to oscillate in either direction, a pressure tending to restore it to its original attitude. Since this pressure is exerted at the end of a long lever arm, the couples, which are always righting couples, are of considerably greater magnitude than the upsetting couples arising from the inherent instability of the cambered type itself.

The adoption of this device has rendered it possible to utilise the great advantage possessed by cambered planes. Of course it is true that a machine with perfectly flat planes would be doubly stable, by virtue both of its main planes and of its tail, but to propel a machine of this type would mean an extravagant waste of power.

Provided the tail is properly designed, there is nothing to fear even with an inherently unstable plane and the full lifting properties of the camber are nevertheless retained.

Subsequently it will be shown that the use of a tail entirely changes the nature of the sheaf of pressures, which, in an aeroplane provided with a tail, and even though its planes are cambered, assumes the stable form corresponding to a flat plane.

The aeroplane therefore really resolves itself into a main plane and a tail.*

Assuming, once and for all, that the propeller-thrust passes through the centre of gravity, the longitudinal equilibrium of an aeroplane about the centre of gravity can be represented diagrammatically by one of the three figs., 35, 36, and 37.

In fig. 35 the tail CD is normally subjected to no pressure and cuts the air with its forward edge. In this case, equilibrium exists if the pressure Q (in practice equal to the weight of the machine) on the main plane AB passes through the centre of gravity G.

In fig. 36 the tail CD is a lifting tail, that is, normally it meets the air at a positive angle and therefore is subjected to a pressure q directed upwards. For equilibrium to be possible in this case the pressure Q on the main plane AB must pass in front of the centre of gravity G of the aeroplane, so that its couple about the point G is equal to the opposite couple q of the tail.

The pressures Q and q must be inversely proportional to the length of their lever arms. When compounded they produce a resultant or total pressure equal to their sum (and to the weight of the aeroplane), which, as we know, would pass through the centre of gravity.

Lastly, in fig. 37 the tail CD is struck by the air on its top surface and receives a downward pressure q . To obtain equilibrium the pressure Q on the main plane AB must pass behind the centre of gravity G, the couples exerted about this point by the pressures Q and q being, as before, equal and opposite. Once again, the pressures Q and q must be inversely proportional to the length of their lever arms. If compounded they would produce a resultant total pressure equal to their difference (and to the weight

* In the case of a biplane both the planes will be considered as forming only a single plane, a proceeding which is quite permissible and could, if necessary, be easily justified.

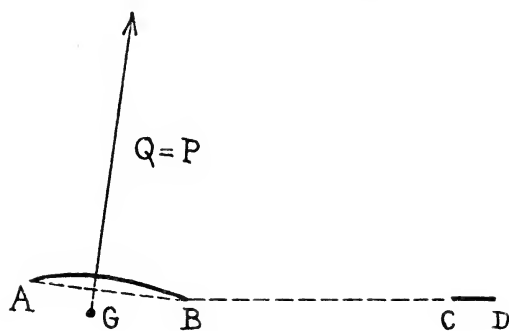

FIG. 35.

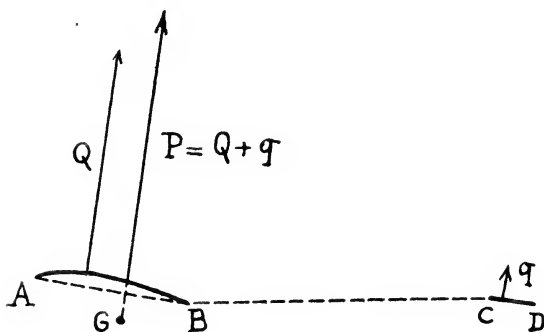

FIG. 36.

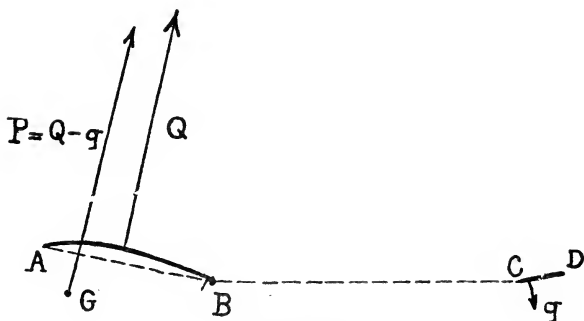

FIG. 37.

of the aeroplane), which would again pass through the centre of gravity.

A fourth arrangement (fig. 38), and the first to be adopted in practice—since the 1903 Wright and the 1906 Santos-Dumont machines were of this type—is also possible. It has lately been made use of again in machines of the “Canard” type (*e.g.* in the Voisin hydro-aeroplane), and consists in placing the tail, which must of course be a lifting tail, in front of the main plane. The conditions of equilibrium are the same as in fig. 36.

In an aeroplane, to whichever type it belongs, the term

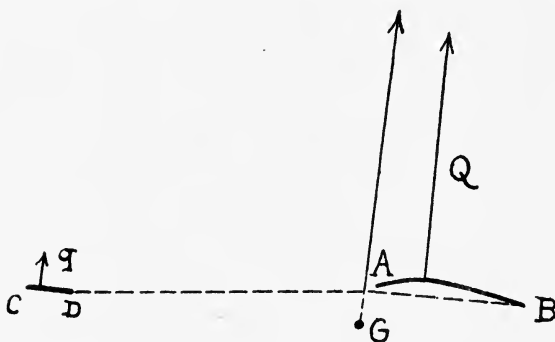

FIG. 38.

longitudinal dihedral, or Vee, is usually applied to the angle formed between the chords of the main and tail planes.

Hitherto the relative positions of the main plane and the tail have been considered only from the point of view of equilibrium. We have now to consider the stability of this equilibrium. For this purpose we must return to the sheaf of pressures exerted, not on the main plane alone, but on the whole machine, that is, we have to consider the sheaf of *total pressures*.

This is shown in fig. 39,* which relates to a Bleriot XI.

* At the time when this treatise was first published, no experiments had been made to determine the actual sheaf of pressures as it exists in practice. The accompanying diagrams were drawn up on the basis of the composition of forces.

tudinal Vee or dihedral of 6° , and placed at a distance behind the main plane equal to twice the chord of the latter.

Let it be assumed that the normal angle of incidence of the machine is 6° , which would be the case if its centre of gravity coincided with the pressure P_6 , at G_1 , for instance.

An idea of the longitudinal stability of the machine in these conditions may be guessed from calculating the couple caused by a small oscillation, such as 2° .

Since the normal incidence is 6° , the length of the pressure P_6 is equivalent to the weight of the machine. By measuring with a rule the length of P_4 and P_8 , it will be found to be equal respectively to $P_6 \times 0.74$ and to $P_6 \times 1.23$. The values of P_4 and P_8 therefore are the products of the weight of the aeroplane multiplied by 0.74 and 1.23 respectively.

Further, the lever arms of these pressures will, on measurement, be found to be respectively 0.043 and 0.025 times the chord of the main plane.

By multiplying and taking the mean of the results obtained, which only differ slightly, it will be found that an oscillation of 2° produces a couple equal to 0.031 times the weight of the aeroplane multiplied by its chord.

This couple produced by an oscillation of 2° can obviously be compared to the couple which would be produced by an oscillation of 2° imparted to the arm of a pendulum or balance of a weight equal to that of the aeroplane.

For these two couples to be equal, the pendulum arm must have a length of 0.88 of the chord, or, if the latter be 2 m., for instance, the arm would have to measure 1.76 m. Hence, the longitudinal stability of the machine under consideration could be compared to that of an imaginary pendulum consisting of a weight equal to that of the aeroplane placed at the end of a 1.76 m. arm. It is evident that the measure of stability possessed by such a pendulum is really considerable.

Having laid down this method of calculating the longitudinal stability of an aeroplane, fig. 39 may once again be considered.

To begin with, it is evident that if the centre of gravity is lowered, though still remaining on the pressure line P_6 , the longitudinal stability of the machine will be increased since, the pressure lines being spaced further apart, their lever arms will intersect. Therefore, under certain conditions, the lowering of the centre of gravity may increase longitudinal stability, though this has nothing whatsoever to do with a fictitious "centre of lift." Besides, in practice the centre of gravity can only be lowered to a very small extent, and the possible advantage derived therefrom is consequently slight, while, on the other hand, it entails disadvantages which will be dealt with in the next chapter.

Finally, the use of certain plane sections robs the lowering of the centre of gravity of any advantages which it may otherwise possess, a point which will be referred to in detail hereafter.

Returning to fig. 39—the normal angle of incidence being 6° , and the non-lifting tail forming this same angle with the chord of the main plane, the tail plane will normally be parallel with the wind (see fig. 35).

If the centre of gravity, instead of being at G_1 , were at G_2 on the pressure line P_6 , the tail would become a lifting tail (see fig. 36), having a normal angle of incidence of 2° . Calculating as before, the length of the arm of the imaginary equivalent pendulum is found to be only 0.63 of the chord, or 1.26 m. if the chord measures 2 m.

The aeroplane is therefore less stable than in the previous example.

On the contrary, if the centre of gravity were situated at G_3 , corresponding to a normal incidence of 4° , so that the tail is struck by the wind on its top surface at an angle of 2° (in other words, is placed at a "negative" angle of 2° , see fig. 37), the equivalent pendulum would have to have

an arm 3.50 m. long,* or about twice as long as when the normal incidence is 6° .

From this one would at first sight be tempted to conclude that the longitudinal stability of an aeroplane is the greater the smaller its normal flying angle, or, in other words, the higher its speed; but, although this may be true in certain cases, it is not so in others. Thus, if the alteration in the angle of incidence were obtained by shifting the centre of gravity, the conclusion would be true, since the sheaf of total pressures would remain unaltered.

But if the reduction of the angle is effected either by diminishing the longitudinal dihedral or, and this is really the same thing, by actuating the elevator, the conclusion no longer holds good, for the sheaf of total pressures does change, and in this case, as the following chapter will show, so far from increasing longitudinal stability, a reduction of the angle of incidence may diminish stability even to vanishing point.

It should further be noted that the arrangement shown diagrammatically in fig. 37, which consists in disposing the tail plane so that it meets the wind with its top surface in normal flight, is productive of better longitudinal stability than the use of a lifting tail.† This conclusion will be found to be borne out by fig. 40, showing the pressures exerted on the main plane by itself.

By measuring the couples, it is clear that if the centre of gravity is situated at G_1 , for instance, the plane is unstable, as we already knew; but if the centre of gravity were placed far enough forward relatively to the pressures, at G_2 , for instance, a variation in the angle may set up righting couples even with a cambered plane. The couple resulting from a variation of this kind is the difference between the

* Actually, the arm is longer if the oscillation is in the sense of a dive than in the case of stalling, which is quite in agreement with the conclusions which will be set out later.

† It will be seen later that this arrangement also seems to be excellent from the point of view of the behaviour of a machine in winds.

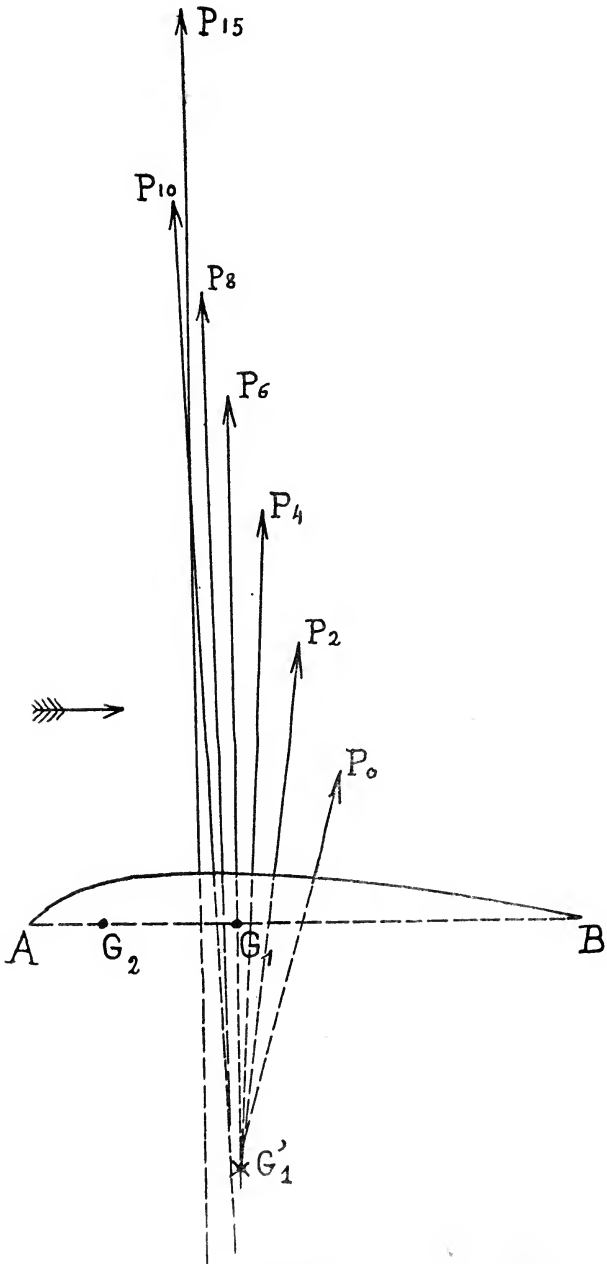

FIG. 40.

couples of the pressure, before and after the oscillation, about the centre of gravity.

Cambered planes in themselves may therefore be rendered stable by advancing the centre of gravity.

This is not difficult to understand; as a plane is further removed from the centre of gravity it begins to behave

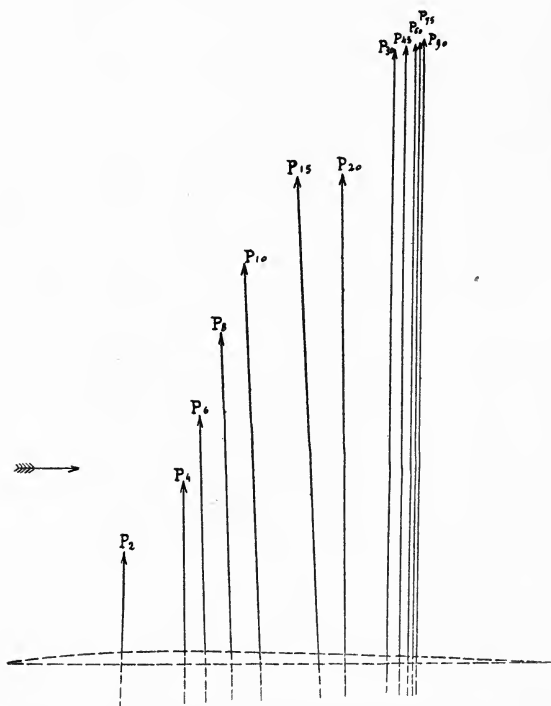

FIG. 41.—Sheaf of total pressures on a Maurice Farman aeroplane.

more and more like the usual tail plane. In these conditions the stability of an aeroplane becomes very good indeed, since it is assisted by main and tail planes alike.

This explains why the tail-foremost arrangement (see fig. 38) can be stable, for in this arrangement the tail, situated in front, really performs the function of an “un-stabiliser,” which is overcome by the inherent stability of

the main plane owing to the fact that the latter is situated far behind the centre of gravity.

Fig. 40 (which relates to the pressures on the main plane) further shows that if the centre of gravity is low enough, at G'_1 , for instance, a Bleriot XI. wing would become stable from being inherently unstable. This is the reason for the stabilising influence of a low centre of gravity, which the examination of the sheaf of total pressures already revealed.

For the sake of comparison, fig. 41 is reproduced, showing the sheaf of total pressures belonging to an aeroplane of the type previously considered, but with a Maurice Farman plane instead of a Bleriot XI. section.

The pressure lines are almost parallel.

Lowering the centre of gravity in a machine of this type would produce no appreciable advantage.

It will be seen that the pressure lines draw ever closer together as the incidence increases, and become almost coincident near 90° . This shows that if, by some means or other, flight could be achieved at these high angles—which could only be done by gliding down on an almost vertical path, the machine remaining practically horizontal, which may be termed “parachute” flight, or, more colloquially, a “pancake”—longitudinal stability would be precarious in the extreme, and that the machine would soon upset, probably sliding down on its tail. Parachute flight and “pancake” descents would therefore appear out of the question, failing the invention of special devices.

CHAPTER VII

STABILITY IN STILL AIR

LONGITUDINAL STABILITY (*concluded*)

IN the last chapter it was shown that the longitudinal stability of an aeroplane depends on the nature of the sheaf of total pressures exerted at various angles of incidence on the whole machine, and that stability could only exist if any variation of the incidence brought about a righting couple.

But this is not all, for the righting couple set up by an oscillation may not be strong enough to prevent the oscillation from gradually increasing, by a process similar to that of a pendulum, until it is sufficient to upset the aeroplane.

The whole question, indeed, is the relation between the effect of the tail and a mechanical factor, known as the *moment of inertia*, which measures in a way the sensitiveness of the machine to a turning force or couple.

A few explanations in regard to this point may here be useful.

A body at rest cannot start to move of its own accord. A body in motion cannot itself modify its motion.

When a body at rest starts to move, or when the motion of a body is modified, an extraneous cause or *force* must have intervened.

Thus a body moving at a certain speed will continue to move in a straight line at this same speed unless some force intervenes to modify the speed or deflect the trajectory.

The effect of a force on a body is smaller, the greater the *inertia* or the *mass* of the latter.

Similarly, if a body is turning round a fixed axis, it will continue to turn at the same speed unless a couple exerted about this axis comes to modify this speed.

This couple will have the smaller effect on the body, the more resistance the latter opposes to a turning action, that is, the more inertia of rotation it possesses. It is this inertia which is termed the *moment of inertia* of the body about its axis. The moment of inertia increases rapidly as the masses which constitute the body are spaced further apart, for, in calculating the moment of inertia, the distances of the masses from the axis of rotation figure, not

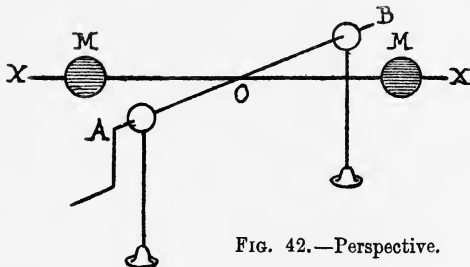

FIG. 42.—Perspective.

in simple proportion, but as their square. An example will make this principle, which enters into every problem concerning the oscillations of an aeroplane, more clear.

At O, on the axis AB (fig. 42) of a turning handle a rod XX is placed, along which two equal masses MM can slide, their respective distances from the point O always remaining equal. Clearly, if the rod, balanced horizontally, were forced out of this position by a shock, the effect of this disturbing influence would be the smaller, the further the masses MM were situated from the point O, in other words, the greater the moment of inertia of the system.

If the rod were drawn back to a horizontal position by means of a spring it would begin to oscillate; these oscillations will be slower the further apart the masses; but, on the other hand, they will die away more slowly, for the

system would persist longer in its motion the greater its moment of inertia.

These elementary principles of mechanics show that an aeroplane with a high moment of inertia about its pitching axis, that is, whose masses are spread over some distance longitudinally instead of being concentrated, will be more reluctant to oscillate, while its oscillations will be slow, thus giving the pilot time to correct them. On the other hand, they persist longer and have a tendency to increase if the tail plane is not sufficiently large.

This relation between the stabilising effect of the tail and the moment of inertia in the longitudinal sense has already been referred to at the beginning of this chapter. It may be termed the condition of oscillatory stability.

In practice most pilots prefer to fly sensitive machines responding to the slightest touch of the controls. Hence the majority of constructors aim at reducing the longitudinal moment of inertia by concentrating the masses.

It should be added that the lowering of the centre of gravity increases the moment of inertia of an aeroplane and hence tends to set up oscillation, one of the disadvantages of a low centre of gravity which was referred to in the last chapter.

By concentrating the masses the longitudinal oscillations of an aeroplane become quicker and, although not so easy to correct, present one great advantage arising from their greater rapidity.

For, apart from its double stabilising function, the tail damps out oscillations, forms as it were a brake in this respect, and the more effectively the quicker the oscillations. The reason for this is simple enough. Just as rain, though falling vertically, leaves an oblique trace on the windows of a railway-carriage, the trace being more oblique the quicker the speed of travel, so the relative wind caused by the speed of the aeroplane strikes the tail plane at a greater or smaller angle when the tail oscillates than when it does not, and this with all the greater effect the quicker

the oscillation. It is a question of component speeds similar to that which will be considered when we come to deal with the effect of wind on an aeroplane.

The oscillation of the tail therefore sets up additional resistance, which has to be added to the righting couple due to the stability of the machine, as if the tail had to move through a viscous, sticky fluid, and this effect is the more intense the quicker the oscillation. It is a true *brake effect*.

In this respect the concentration of the masses possesses a real practical advantage.

According to the last chapter, an entirely rigid aeroplane, none of whose parts could be moved, could only fly at a single angle, that at which the reactions of the air on its various parts are in equilibrium about the centre of gravity. In order to enable flight to be made at varying angles the aeroplane must possess some movable part—a controlling surface.

Leaving aside for the moment the device of shifting the centre of gravity (never hitherto employed), the easiest method would be to vary the angle formed by the main plane and the tail; *i.e.* the longitudinal dihedral.

The method was first adopted by the brothers Wright, and is even at the present time employed in several machines. Very powerful in its effect, the variations in the angle of the tail plane affect the angle of incidence by more than their own amount, and this in greater measure the bigger the angle of incidence.

Figs. 43 and 44 represent two different positions of the sheaf of total pressures on an aeroplane with a Bleriot XI. plane, and a non-lifting tail of an area one-tenth that of the main plane and situated in rear of it at a distance equal to twice the chord. In fig. 43 the tail plane forms an angle of 8° with the chord of the main plane; in fig. 44 this angle is only 6° .

If the centre of gravity is situated at G_1 , the normal angle of incidence passes from 4° in the first case to 2° in the second. This variation in the angle of incidence is

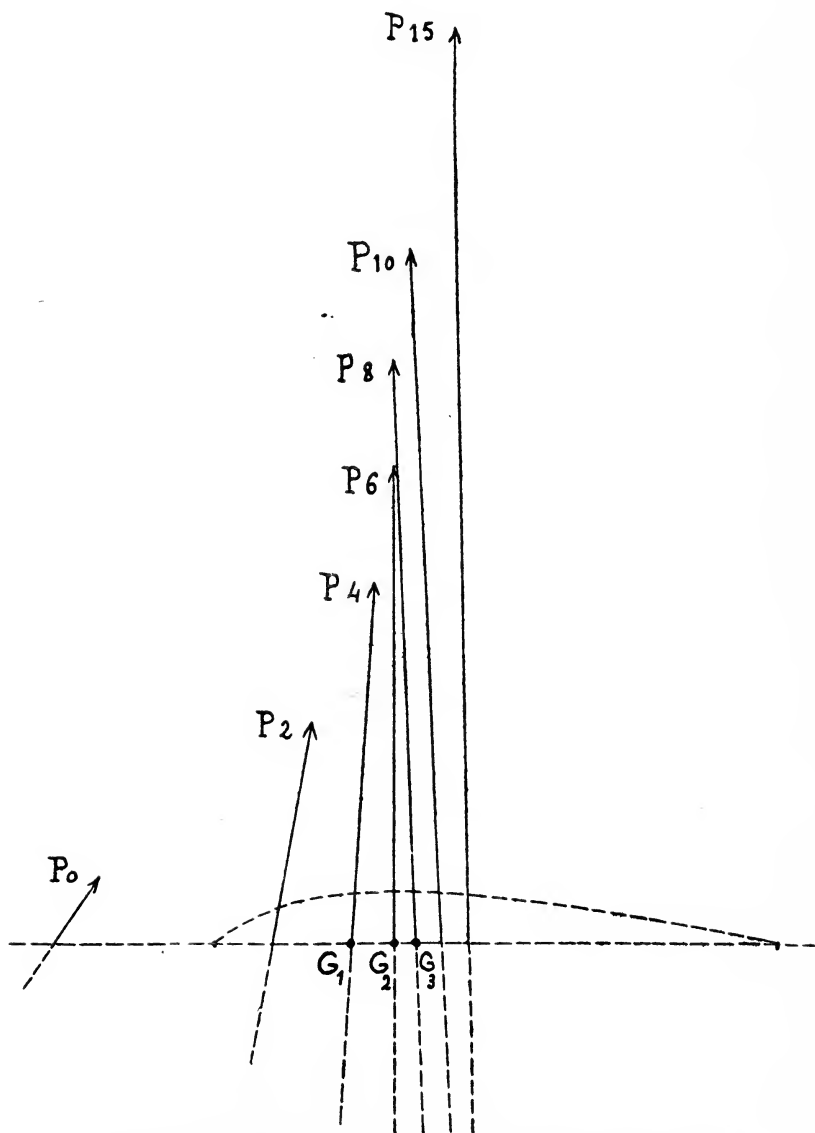

FIG. 43.—Sheaf of total pressures on a Bleriot XI. monoplane with a longitudinal V of 8° .

therefore integrally the same as that of the angle of the tail plane.

If the centre of gravity is at G_2 , the normal angle of incidence would pass from 6° to $3\frac{1}{2}^\circ$, and would therefore vary by $2\frac{1}{2}^\circ$ for a variation in the angle of the tail of only 2° .

Lastly, if the centre of gravity is at G_3 , the normal angle of incidence would pass from 8° to 5° , a variation equal to one and a half times that of the angle of the tail.

A comparison of figs. 43 and 44 further shows that the lines of total pressure are spaced further apart the greater the longitudinal dihedral. Now, other things being equal, the farther apart the lines of pressure the greater the longitudinal stability of an aeroplane. Hence the value of the longitudinal dihedral is most important from the point of view of stability.

If the tail plane (non-lifting) is normally parallel to the relative wind, the longitudinal dihedral is equal to the normal angle of incidence. But if a lifting tail is employed, the longitudinal dihedral must necessarily be smaller than the angle of incidence (this is clearly shown in fig. 36). If the normal angle of incidence is small, as in the case of large biplanes and high-speed machines, the longitudinal dihedral is very small indeed and stability may reach a vanishing point.

But if, in normal flight, the tail plane meets the wind with its upper surface (*i.e.* flies at a negative angle), the longitudinal dihedral, however small the normal angle of incidence, will always be sufficient to maintain an excellent degree of stability. This conclusion may be compared with that put forward in the previous chapter in regard to the advantage of causing the tail to fly at a negative angle.

The foregoing shows that the reduction of the angle of incidence by means of a movable tail plane—*i.e.* by altering the longitudinal dihedral—has the disadvantage that every alteration in the position of the tail plane brings

about a variation in the condition of stability of the aeroplane.

By plotting the sheaf of total pressures corresponding to very small values of the longitudinal dihedral, it would soon be seen that if the latter is too small, equilibrium may become unstable.

A machine with a movable tail and normally possessing but little stability—such, for instance, as a machine whose tail lifts too much—may lose all stability if the angle of incidence is reduced for the purpose of returning to earth. This effect is particularly liable to ensue when, at the moment of starting a glide, the pilot reduces his incidence, as is the general custom.

Losing longitudinal stability, the machine tends to pursue a flight-path which, instead of remaining straight, curls downwards towards the ground, and at the same time the speed no longer remains uniform and is accelerated.

The glide becomes ever steeper. The machine dives, and frequently the efforts made by the pilot to right it by bringing the movable tail back into a stabilising position are ineffectual by reason of the fact that the tail becomes subject, at the constantly accelerating speed, to pressures which render the operation of the control more and more difficult.

In the author's opinion, the use of a movable tail is dangerous, since the whole longitudinal equilibrium depends on the working of a movable control surface which may be brought into a fatal position by an error of judgment, or even by too ample a movement on the part of the pilot.

For, apart from the case just dealt with, should the movable tail happen to take up that position in which the one angle of incidence making for stability is that corresponding to zero lift, *i.e.* when the main plane meets the wind along its "imaginary chord" (see Chapter I.) longitudinal equilibrium would disappear and the machine would dive headlong.

In this respect, therefore, the movements of a movable

tail should be limited so that it could never be made to assume the dangerous attitude corresponding to the rupture or instability of the equilibrium.

A better method is to have the tail plane fixed and rigid, and, in order to obtain the variations in the angle of incidence required in practical flight, to make use of an auxiliary surface known as the *elevator*.

Take a simple example, that of the aeroplane diagrammatically shown in fig. 45, possessing a non-lifting tail

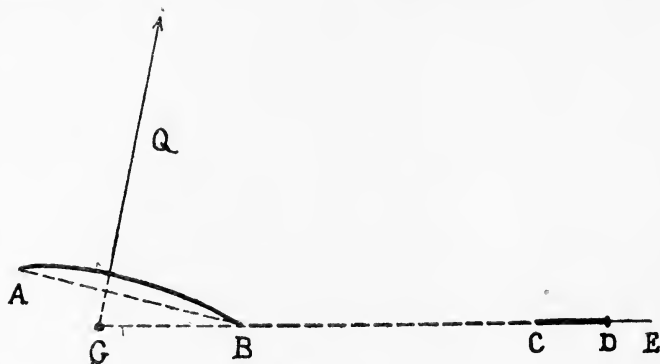

FIG. 45.

plane CD, normally meeting the wind edge-on, to which is added a small auxiliary plane DE, constituting the elevator, capable of turning about the axis D.

So long as this elevator remains, like the fixed tail, parallel to the flight-path, the equilibrium of the aeroplane will remain undisturbed. But if the elevator is made to assume the position DE (fig. 46), the relative wind strikes its upper surface and tends to depress it. Hence the incidence of the main plane will be increased until the couple of the pressure Q exerted about the centre of gravity, and the couple of the pressure q' exerted on the elevator, together become equal to the opposite moment of the pressure q on the fixed tail.

Again, if the elevator is made to assume the position

DE_2 (fig. 47), the incidence decreases until a fresh condition of equilibrium is re-established.

Each position of the elevator therefore corresponds to

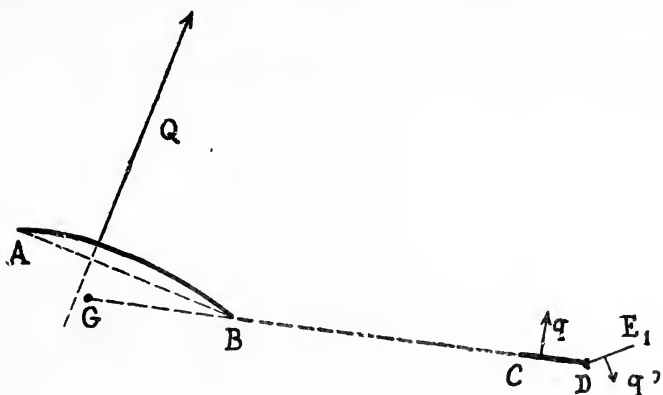

FIG. 46.

one single angle of incidence; hence the elevator can be used to alter the incidence according to the requirements of the moment.

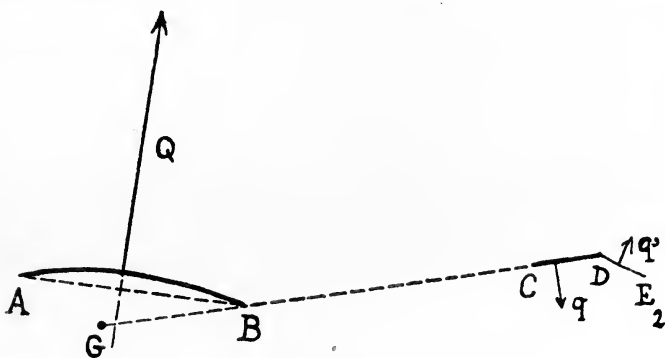

FIG. 47.

It will be obvious that the effectiveness of an elevator depends on its dimensions relatively to those of the fixed tail, and, further, that if small enough it would be incapable, even in its most active position, to reduce the angle of

incidence to such an extent as to break the longitudinal equilibrium of the aeroplane.

This, in the author's opinion, is the only manner in which the elevator should be employed, for the danger of increasing the elevator relatively to the fixed tail to the point even of suppressing the latter altogether has already been referred to above.

In the position of longitudinal equilibrium corresponding to normal flight, the elevator, in a well-designed and well-tuned machine, should be neutral (see fig. 45). It follows that all the remarks already made with reference to the important effect on stability of the value of the longitudinal dihedral apply with equal force when the movable tail has been replaced by a fixed tail plane and an elevator.

The extent of the longitudinal dihedral depends on the design of the machine, and more especially on the position of the centre of gravity relatively to the planes, and on its normal angle of incidence, which, again, is governed by various factors, and in chief by the motive-power.

The process of tuning-up, just referred to, consists principally in adjusting by means of experiment the position of the fixed tail so that normally the elevator remains neutral. Tuning-up is effected by the pilot; in the end it amounts to a permanent alteration of the longitudinal dihedral; wherefore attention must be drawn to the need for caution in effecting it.

There are certain pilots who prefer to maintain the longitudinal dihedral rather greater than actually necessary (*i.e.* with the arms of the ∇ close together), with the consequence that their machines normally fly with the elevator slightly placed in the position for coming down, or meeting the wind with its upper surface. In the case of machines with tails lifting rather too much, the practice is one to be recommended, for machines of this description are dangerous even when possessing a fixed tail, since if the elevator is moved into the position for descent the longitudinal dihedral is still diminished, though in a lesser

degree, and if it were already very small, stability would disappear and a dive ensue.

Therefore the tuning-up process referred to has this advantage in the case of an aeroplane with a fixed tail exerting too much lift, that it reduces the amplitude of dangerous positions of the elevator and increases the amplitude of its righting positions.

If the size of the elevator is reduced, with the object of preventing loss of longitudinal equilibrium or stability, to such a pitch as to cause fear that it would no longer suffice to increase the angle of incidence to the degree required for climbing, an elevator can be designed which would act much more strongly for increasing the angle than for reducing it, by making it concave upwards if situated in the tail, or concave downwards if placed in front of the machine.

For it may be placed either behind or in front, and analogous diagrams to those given in figs. 46 and 47 would show that its effect is precisely the same in either case.

But it should also be noted that if an elevator normally possessing no angle of incidence is moved so as to produce a certain variation in the angle of incidence of the main plane, of 2° , for instance, the angle through which it must be moved will be smaller in the case of a front elevator than in that of a rear elevator, the difference between the two values of the elevator angle being double (*i.e.* 4° in the above case) that of the variation in the angle of incidence (assuming, of course, that front and rear elevators are of equal area and have the same lever arm).

This is easily accounted for by the fact that a variation in the angle of incidence, which inclines the whole machine, is added to the angular displacement of a front elevator, whereas it must be deducted from that of the rear elevator.

Thus, if we assume that the elevator must be placed at an angle of 10° to cause a variation in the incidence of 2° , the elevator need only be moved through 8° if placed in

front, whereas it would have to be moved through 12° if placed in rear.

A front elevator therefore is stronger in its action than a rear elevator. But it is also more violent, as it meets the wind first, which may tend to exaggerated manœuvres. Finally, referring to the remarks in the previous chapters regarding the "tail-first" arrangement, the longitudinal stability of an aeroplane is diminished to a certain degree when the elevator is situated in front. These are no doubt the reasons that have led constructors to an ever-increasing extent to give up the front elevator.*

All these facts plainly go to show, as already stated, that stability does not necessarily increase with speed. Aeroplanes subject to a sudden precipitate diving tendency only succumb to it when their incidence decreases to a large extent and their speed exceeds a certain limit, sometimes known as the *critical speed*, at which longitudinal stability, far from increasing, actually disappears altogether. The term *critical speed* is not, however, likely to survive long, if only because it refers to a fault of existing machines which, let us hope, will disappear in the future. And it would disappear all the more rapidly if the variations in the angle of incidence required in practical flight could be brought about, not by a movable plane turning about a horizontal axis, but by shifting the position of the centre of gravity relatively to the planes, which could be done by displacing heavy masses (such as the engine and passengers' seats, for example) on board or, also, by shifting the planes themselves.

In this case, as we have seen, the variations of the incidence would have no effect on the longitudinal dihedral, so that the sheaf of total pressures would not change, and then it would be true that stability increased with the speed. Then, also, there would be no *critical speed*.

* The placing of the propeller in front and the production of tractor machines—though, in the author's opinion, an unfortunate arrangement—has also formed a contributory cause.

As stated previously, the horizontal flight of an aeroplane is a perpetual state of equilibrium maintained by constantly actuating the elevator. The idea of controlling this automatically is nearly as old as the aeroplane itself. But, as this question of automatic stability chiefly arises through the presence of aerial disturbances and gusts, its discussion will be reserved for the final chapter, which deals with the effects of wind on an aeroplane.

Hitherto it has been assumed that the propeller-thrust passes through the centre of gravity, and therefore has no effect on longitudinal equilibrium. The angle of incidence corresponding to a given position of the elevator therefore remains the same in horizontal, climbing, or gliding flight.

But if the propeller-thrust does not pass through the centre of gravity, it will exert at this point a couple which, according to its direction, would tend either to increase or diminish the incidence which the aeroplane would take up as a glider (assuming that the elevator had not been moved). In that case any variation in the propeller-thrust more particularly if it ceased altogether either by engine failure or through the pilot switching off, would alter the angle of incidence.

Thus if the thrust passed below the centre of gravity the stopping of the engine would cause the angle of incidence to diminish, and thus produce a tendency to dive. On the other hand, if the thrust is above the centre of gravity, the stopping of the engine would increase the angle of incidence, and therefore tend to make the machine stall.

Practical experience with present-day aeroplanes teaches that in case of engine stoppage it is better to decrease the angle of incidence than to leave it unchanged, and, above all, than to increase it.

The reason for this is that the transition from horizontal flight to gliding flight is not instantaneous as is often thought from purely theoretical considerations. An aero-

plane moving horizontally tends, through its inertia, to maintain this direction. Since there is now no longer any propeller-thrust to balance the head resistance of the machine, it loses speed, which is to be avoided at all costs by reason of the ensuing dive. Therefore a pilot reduces his angle of incidence in order to diminish the drag of the aeroplane, and hence to maintain speed as far as possible.

This action usually produces the desired effect, as the normal angle of incidence of most aeroplanes is greater than their optimum angle; but this would not be the case if the optimum angle, or a still smaller angle, constituted the normal flying angle.

The reduction of the angle of incidence at the moment the engine stops has the additional effect of producing the flattest gliding angle, which, as has already been shown, corresponds to the use of the optimum angle. On the other hand, stability increases through the reduction of the incidence (which is here equivalent to an increase in speed) so long as this does not reduce the longitudinal dihedral.

Bearing these various considerations in mind, it would seem preferable, in contradiction to a very general view which at one time the author shared, to make the propeller-thrust pass below rather than above the centre of gravity, at any rate in the case of machines normally flying at a fairly large angle of incidence.

As a general rule the propeller-thrust passes approximately through the centre of gravity, and this, perhaps, is the best solution of all.

Since the direction of the propeller-thrust is under consideration, it may be as well to note that this direction need not necessarily be that of the flight-path of the aeroplane. Take the case where the thrust passes through the centre of gravity; it will be readily understood that if the direction of the thrust is altered this cannot have any effect on longitudinal equilibrium. Hence there is no theoretical

reason why an aeroplane with an inclined propeller shaft should not fly horizontally.

The only effect on the flight of an aeroplane by tilting the propeller shaft up at an angle would be to reduce the speed, because the thrust doing its share in lifting, the planes need only exert a correspondingly smaller amount of lift. Therefore the lifting of the propeller shaft virtually amounts to diminishing the weight of the aeroplane, thereby, other things being equal, reducing the speed.

If the thrust became vertical, the planes could be dispensed with, horizontal speed would disappear, and the aeroplane would become a helicopter.

It can easily be shown that the most advantageous direction to give to the propeller-thrust is that wherein the shaft is slightly inclined upwards, as is done in the case of certain machines, though in others the thrust is normally horizontal.

To wind up these remarks on longitudinal stability, we will describe various types of little paper gliders which will afford in practical fashion some interesting information concerning certain aspects of longitudinal equilibrium and of gliding flight. The results, of course, are only approximate in the widest sense, since such paper gliders are very erratic as they do not preserve their shape for any length of time.

Experiments with these little paper models are most instructive and are to be highly recommended to every reader; however childish they may at first appear, they will not be waste of time. By experimenting oneself with such miniature flying-machines one can learn many valuable lessons in regard to points of detail, only a few of which can here be set out. To make these little models it is best to use the hardest obtainable paper, though it must not be heavy; Bristol-board will serve the purpose. Even better is thin sheet aluminium about one-tenth of a millimetre in thickness, but in this case the dimensions given hereafter should be slightly increased.

TYPE I.

An ordinary rectangular piece of paper, in length about twice the breadth (12 cm. by 6 cm., for instance), folded longitudinally down the centre (see fig. 48) so as to form a very open angle (the function of this, which affects lateral stability, will be explained in the next chapter).

Reference to fig. 32, Chapter VI., will show that for a single flat plane to assume one of the ordinary angles of incidence (roughly, from 2° to 10°), its centre of gravity must be situated at a distance of from one-third to one-quarter of the fore-and-aft dimension of the plane from the forward edge. This is easily obtained by attaching to

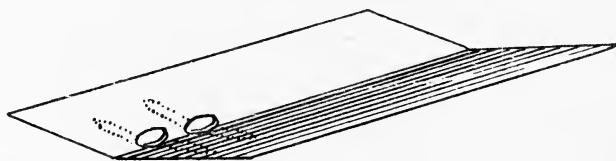

FIG. 48.—Perspective.

the paper a few paper clips or fasteners, fixed near one of the ends of the central fold at a slight distance from the edge (about $\frac{1}{2}$ cm.).

If the ballasted paper is held horizontally by its rear end and is thrown gently forward, it will behave in one of the three following ways:—

(a) The paper inclines itself gently and glides down regularly without longitudinal oscillations.

This is the most favourable case, for at the first attempt the ballast has been placed in the position where the corresponding single angle of incidence was one of the usual angles. Practice therefore confirms theory, which taught that a single flat plane is longitudinally stable.

(b) The paper dips forward and dives.

The centre of gravity is too far forward and in front of the forward limit of the centre of pressure. To obtain

a regular glide the ballast must be moved slightly toward the rear. In effecting this, it will probably be moved too far back and the paper will in that case behave in the opposite manner, which is about to be described.

(c) The paper at first inclines itself, but, after a dive whose proportions vary with several factors, and chiefly with the force with which the model has been thrown, it rears up, slows down, and starts another dive bigger than the first, and thus continues its descent to the ground, stalling and diving in succession (see fig. 49).



FIG. 49.

As a matter of fact, the dive following the first stalling may be final and become vertical if during the accompanying oscillation the paper should meet the air edge-on, so that actually it has no angle of incidence, for such a glider if dropped vertically, leading edge down, has no occasion to right itself and continues to fall like any solid body.

The above experiment is quite instructive. It corresponds to the case where the single angle of incidence at which flight is possible, owing to the centre of gravity being too far back, is greater than the usual angles of incidence.

As it begins its descent the sheet of paper, having been thrown forward horizontally, has a small angle of incidence, and hence tends to acquire the fairly high speed corresponding to this small angle. But the pressure of the air, passing

in front of the centre of gravity, produces a stalling couple which increases the incidence. Owing to its inertia, the paper will tend to maintain its speed, which has now become higher than that corresponding to its large angle of incidence, and so the pressure of the air becomes greater than the weight, on account of which the flight-path becomes horizontal again and even rises.

The same thing, in fact, always happens if for some reason or other a glider or an aeroplane should attain to a higher speed than that corresponding to the incidence given it by the elevator, and also if the angle of the planes is suddenly increased. This rising flight-path by an increase in the angle of incidence is constantly followed by birds, and especially by birds of prey such as the falcon, which uses it to seize its prey from underneath.

Pilots also use it in flattening out after a steep dive or *vol piqué*, though the manœuvre is distinctly dangerous, since it may produce in the machine reactions of inertia which may cause the failure of certain parts of the structure.

Returning to the ballasted sheet of paper: as the flight-path rises, the glider loses speed; in fact, it may stop altogether. It is then in the same condition as if it were released without being thrown forward, and falls in a steep dive which, as already stated, may prove final.

There are many variants of the three phenomena described.

Thus, the stalling movement may become accentuated to such an extent as to cause the sheet of paper to turn right over and "loop the loop." * Again, the paper may start to glide down backwards and do a "tail-slide."

These variants depend mainly on how far back the centre of gravity is situated, that is, on the value of the single angle of incidence at which the sheet can fly. If

* It is interesting to note that this and many of the following manœuvres are precisely those practised by Pégoud and his imitators, although the above was written long before they were attempted in practice.—TRANSLATOR.

this angle is only slightly greater than the usual angles of incidence, the stability of the glider—which is less, of course, at large angles than at small ones—will still be sufficient to prevent the effect of inertia of oscillation from bringing it into a position where it is liable to dive, to turn over on its back, or slide backwards. It will therefore follow a sinuous flight-path consisting of successive stalling and diving, but will not actually upset.

But if the centre of gravity is brought further back and the angle of incidence corresponding to this position is much greater than the usual angles of incidence, the stabilising couples no longer suffice to overcome the effects of inertia to turning forces, the condition of stability in oscillation is no longer fulfilled, and the glider behaves in one of the ways already described.

It should, however, be pointed out that a rectangular sheet of paper has a far larger moment of inertia in respect to pitching than a glider generally conforming, as our next models will do, to the shape of an aeroplane.

To prevent these occurrences from taking place, all that is required is to bring the ballast further forward and to adjust the incidence by cutting off thin strips from the forward edge. By these means it is possible eventually to obtain a regular gliding path without longitudinal oscillations.

If thin strips of paper are thus cut off with sufficient care,* the various properties of gliding flight set forth in Chapter II. can be very easily followed.

It will be seen that by gradually reducing the angle of incidence by cutting back the forward edge, the glide becomes both longer and faster. Next, when the angle has become smaller than the optimum angle of this embryo glider, the length of the glide diminishes, the path becomes steeper, and the glider tends to dive.

Towards the end the process of adjustment becomes

* In case the ballast should be in the way, the paper can be cut away diagonally and equally on either side, as shown in fig. 50.

exceptionally delicate, for since the optimum angle of a model of this nature is very small indeed, by reason of the fact that its detrimental surface is almost zero relatively to its lifting area, the slightest shifting of the centre of gravity is enough to cause a large variation in the gliding angle and to upset longitudinal stability.

Now let us suppose that, the ballast being so placed that the glider tends to dive, we proceed to rectify by cutting away pieces of the trailing edge as in fig. 50. If the outer rear tips thus symmetrically formed are bent upwards,

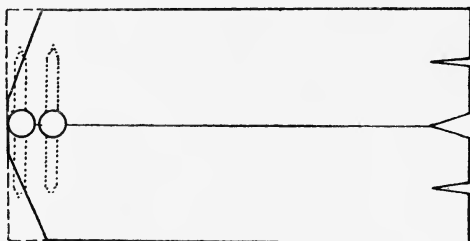

FIG. 50.

the glider will no longer tend to dive and will assume a position of equilibrium.

By bending these outer tips through various degrees, and also, if necessary, bending up the inner portion of the trailing edge, all the various forms of gliding flight can be reproduced which were previously obtained by shifting the ballast and cutting back the forward edge.*

But to whatever degree the tips may be bent up, henceforward the stalling movement will not be followed by a dive, nor will the glider loop the loop or do a tail-slide.

This is due to the fact that instead of being constituted by a single flat plane, the glider now possesses a tail, which gives it much better longitudinal stability. The effects of

* The rear tips may not be bent exactly equally on either side, with the result that the glider may tend to swerve to left or right. To counteract this, the tip on the side towards which the paper swerves should be bent up a little more.

inertia are now overcome by the stabilising moments arising from the tail. Moreover, a glider of this description when dropped vertically rights itself. It can no longer dive headlong.

If the tips are bent back to their original horizontal position, it is evident that the sheet of paper will dive once more, and to an even greater extent if the tips were bent down instead of up. This plainly shows the danger of allowing the elevator to constitute the solitary tail plane, for, unless its movement is limited, it could cause equilibrium to be lost.

TYPE II.

1. Fold a sheet of paper in two, and from the folded paper cut out the shape shown in fig. 51.

2. Fold back the wings and the tail plane along the dotted lines. The wings should make a slight lateral V or dihedral.

3. Ballast the model somewhere about the point L—the exact spot must be found by experiment—with one or more paper fasteners.

This model approaches more nearly to the usual shape of an aeroplane. By finding the correct position for the ballast, so that the centre of gravity is situated on the total pressure line corresponding approximately to the optimum angle, this little glider can be made to perform some very pretty glides.*

The ballast may be brought further forward or additional paper fasteners may be affixed without making the model dive headlong.

It will dive, and on this account may be brought to fall headlong if the height above the ground is only slight; but if there is room enough it will recover and, though coming down steeply, will not fall headlong. It is still gliding,

* Should it tend to swerve to either side, bend up slightly the rear tip of the wing on the opposite side of that towards which the aeroplane tends to turn.

since during its descent the air still exerts a certain amount of lift. Longitudinal equilibrium is not upset, and if the glider does not lose its proper shape on account of its high speed, *it cannot fall headlong*, whatever the excess of load carried, by reason of the fact that the main and tail planes are placed at an angle to one another.

The reduction in the angle of incidence by bringing the centre of gravity further forward therefore maintains stability, and even increases it as the speed grows. And this because the longitudinal dihedral has not been touched.

By shifting the ballast toward the rear, the model will

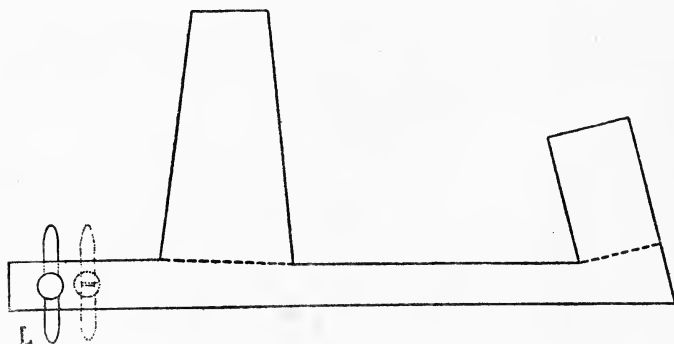

FIG. 51.

also follow a steep downward path, but this time the angle of incidence is large, the speed slow, and therefore the glider remains almost horizontal and "pancakes." This shows conclusively that the same gliding path can be followed at two different normal angles of incidence and at two different speeds.

By still shifting the ballast farther back, the model may be made to glide as if it belonged to the tail-foremost or "Canard" type (*cf.* the third model described hereafter). Flight at large angles of incidence is now possible and will not cause the model to overturn as in the case of the single sheet of paper, as the moment of pitching inertia is much feebler than in the former case. The stability of

oscillation is therefore still adequate at large angles of incidence.

Now let us shift the ballast back again so that the glide becomes normal once more; at the rear of the tail plane, bend down either the whole or half the trailing edge to the extent of 2 mm. This will give us an elevator, while the fixed tail is retained.

By moving this elevator the conditions of gliding flight can obviously be modified; for instance, if the outer halves of the rear edge are evenly bent down to an angle of some 45° —that is, to have their greatest effect in reducing the angle of incidence—the glider will extend the length of its flight and travel faster (see fig. 52).

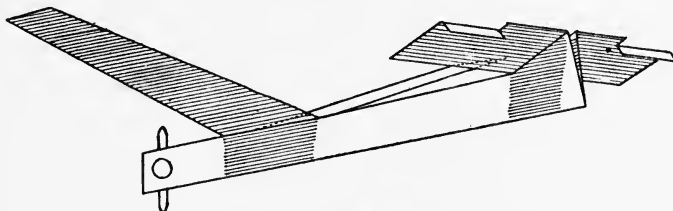

FIG. 52.—Perspective.

But it will still be impossible by the operation of the elevator to make the model fall headlong. The fixed tail will prevent this, and will overcome the action of the elevator because the latter is small in extent. Hence, *an elevator small enough relatively to the tail plane cannot make an aeroplane dive headlong.*

If the whole of the trailing edge is bent down it might possibly cause longitudinal equilibrium to be upset and make the glider dive. And should this not prove to be the case, it could be done without fail by increasing the depth of the elevator.

The experiment shows that the size of the elevator should not be too large; it should merely be sufficient to cause the alterations of the angle of incidence required for ordinary flight and should never be able to upset stability.

TYPE III.

1. Cut out from a sheet of paper folded in two a piece shaped as in fig. 53.

2. Fold back the wings along the dotted lines.

3. Fold the wing-tips upwards along the outer dotted line.

This tail-first glider will be stable without ballast and



FIG. 53.

glides very prettily on account of its lightness. It will be referred to again in connection with directional stability.*

TYPE IV.

1. Cut out from a sheet of paper folded in two the shape shown in fig. 54.

2. Cut away from the outer edge of the fold two portions about 1 mm. deep, and of the length shown at AB and CD.

3. Inside the fold fix with glue—

(a) At AB a strip of cardboard or cut from a visiting card; 5 cm. long, 1 cm. broad. The inner end of the strip is shown by the dotted line at AB.

(b) At CD glue a similar strip as shown.

* If it tends to swerve, slightly bend the whole of the front tail in the opposite sense.

4. Fold back the wings and the tail plane along the dotted lines.

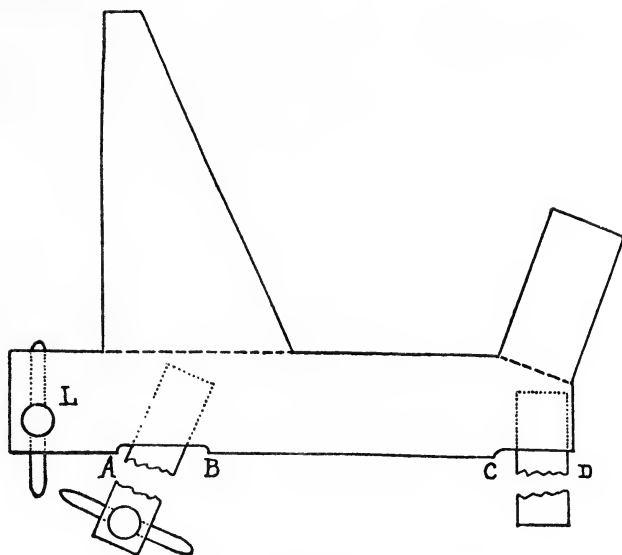

FIG. 54.

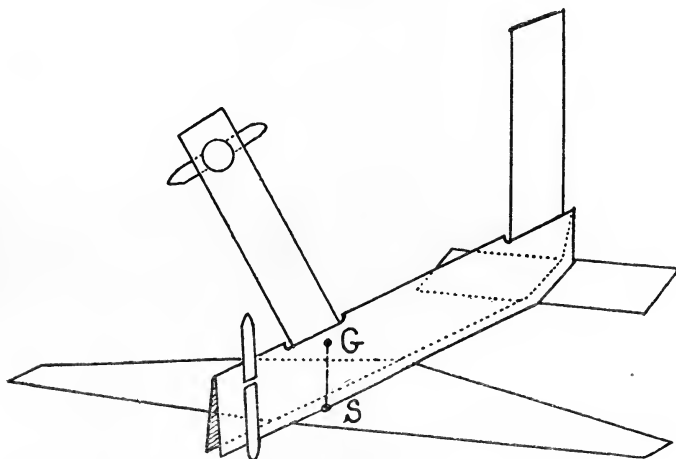

FIG. 55.—Perspective.

5. Ballast the model with a paper clip placed at the end of the strip AB, and with another in the neighbourhood of

L. The exact positions are to be found by experiment, and it may therefore be as well to turn the cardboard about its glued end before the glue has set.

If this glider is thrown upwards towards the sky, it will right itself and glide away in the attitude shown in fig. 55. Now the centre of gravity of a glider of this kind lies somewhere about G.

On the other hand, the point sometimes termed the "centre of lift" is situated on the plane at the spot which, in equilibrium, is on the perpendicular from the centre of gravity and shown at S. This point S lies below the centre of gravity.

Now, if an aeroplane ought to be considered as suspended in space from a so-called "centre of lift," its centre of gravity could not, perforce, be anywhere but below this "centre of lift."

In the case just mentioned the opposite took place, which shows very clearly that this idea of a "centre of lift" is erroneous.

An aeroplane has one centre only, its centre of gravity.

CHAPTER VIII

STABILITY IN STILL AIR

LATERAL STABILITY

FOR the complete solution of the problem of aviation the aeroplane must possess, in addition to stable longitudinal equilibrium, stable lateral equilibrium or, more briefly, *lateral stability*.

The fundamental principle laid down in Chapter VI. is equally applicable to lateral equilibrium.*

But in the case of longitudinal equilibrium the movements that had to be considered in respect of stability could be simply reduced to turning movements about a single axis, the pitching axis. The matter becomes exceedingly complicated in the case of lateral equilibrium, for the turning movements can take place about an infinite number of axes passing through the centre of gravity and situated in the symmetrical plane of the machine.

For instance, assume that the aeroplane diagrammatically shown in fig. 56 were moving horizontally and that the path of the centre of gravity G were along GX. If the machine were to turn through a certain angle about the path GX, clearly no change would take place in the manner in which the air struck any part of the machine,† and no turning *moment* would arise tending to bring the

* From the point of view of equilibrium and stability, the aeroplane may be regarded as if it were suspended from its centre of gravity, and were thus struck by the relative wind created by its own speed.

† Assuming, of course, that the turning movement does not alter the path of the centre of gravity.

machine back to its former position or to cause it to depart therefrom still further.

It can therefore be stated that *the lateral equilibrium of an aeroplane is neutral about an axis coincident with the path of the centre of gravity.*

But when we come to consider turning movements about other axes such as GX_1 or GX_2 which do not coincide with the path of the centre of gravity, it is evident that such movements will have the effect of causing the aeroplane to meet the air dissymmetrically, and consequently to set up lateral moments tending to increase or diminish the tilt of the machine—that is, *upsetting or righting couples.*

Before going further it is readily evident that, the axis

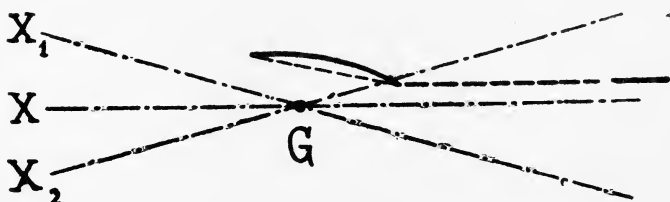

FIG. 56.

GX being neutral, axes such as GX_1 and GX_2 , lying on opposite sides of GX , will have a different effect, and that a turning movement begun about one series of axes will encounter a resistance due to the dissymmetrical reaction of the air which it creates, while any turning movement begun about the other series of axes, again owing to the dissymmetrical reaction of the air, will go on increasing until the machine overturns.

The former series will be known as the *stable axes*, the latter as the *unstable axes*. The *neutral axis* is that coinciding with the path of the centre of gravity. Further, the term *raised axis* will be used to denote an axis with its forward extremity raised like GX_1 and *lowered axis* for that which, like GX_2 , has its forward extremity lowered.

The shape of the aeroplane determines which axis is unstable.

In many aeroplanes, and in monoplanes in particular,* the forward edges of the wings do not form an exact straight line, but a dihedral angle or ∇ opening upwards.

We shall also have to examine—though the arrangement in question has never to the author's knowledge been adopted in practice—the case of the machine with wings forming an inverted dihedral or \wedge .† Lastly, the forward edges of the two wings may form a straight line, and such wings will hereafter be described as *straight wings*.

In an aeroplane with straight wings, a turning movement imparted about an axis situated in the symmetrical plane of the machine increases the angle of incidence if the axis

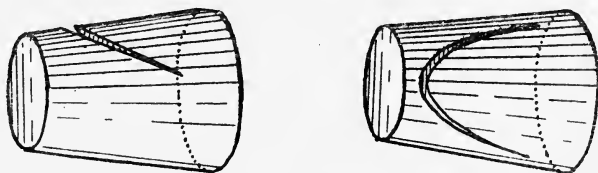

FIG. 57.

is a *lowered* axis, and diminishes the angle if the axis is a *raised* axis. This can easily be proved geometrically, and can be shown very simply by the following experiment.

Make a diagonal cut in a cork, as shown in fig. 57 (front and side views). In this cut insert the middle of one of the longer sides of a visiting-card, and thrust a knitting-needle or the blade of a knife into the centre of the cork on the side where the card projects. Now place this con-

* In the case of large-span biplanes the flexing on the planes in flight forces them into a curve which in its effects is equivalent, for purposes of lateral stability, to a lateral dihedral.

† The "Tubavion" shown at the 1912 Salon is stated to have flown with wings thus disposed.

TRANSLATOR'S NOTE.—The same device was adopted by Cody in his earlier machines, and in the "June Bug," the first machine designed by Glenn Curtiss.

trivance in the position shown in fig. 58, with the needle horizontal and at eye-level. If the needle is rotated slowly, the card will always appear to have the same breadth whatever its position.

If this visiting-card is taken to represent the straight

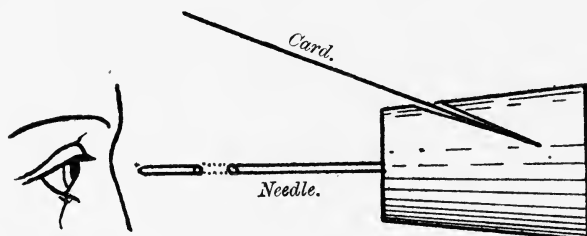

FIG. 58.

wings of an aeroplane struck by the wind represented by the line of sight, this shows that a turning movement about the *neutral axis* of an aeroplane with straight wings produces no change in the angle of incidence, as already known.

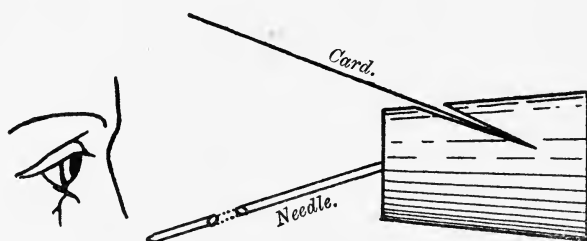

FIG. 59.

But if the needle is inserted in the position shown in fig. 59, it will be found that by rotating the needle without altering its position, the breadth of the card will appear to increase, thus showing, retaining the same illustration, that when the axis of rotation of a machine with straight wings is a lowered axis, the incidence increases as the result of the turning movement.

This effect is the more pronounced the smaller the angle of incidence.

But if the needle is inserted as shown in fig. 60, the breadth of the card when the needle is rotated will appear to diminish.

If the needle is parallel to the card, a turn of the needle through 90° brings the card edge-on to the line of sight.

Lastly, if the needle and the card are in converging positions, a slight turn of the needle brings the card edge-on, and beyond that its upper surface alone is in view.

From this we may conclude that if the axis of rotation of an aeroplane with straight wings is a raised axis, the angle of incidence diminishes as the result of a turning

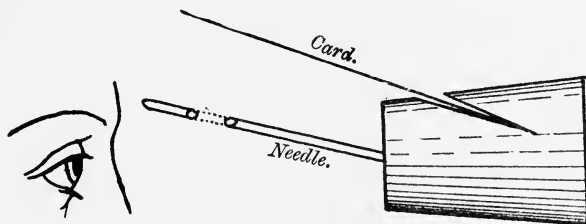

FIG. 60.

movement, and if the axis is raised to a sufficient degree, the angle of incidence may become zero and even negative.

This effect is the more pronounced the larger the angle of incidence.

It should be noted that in neither case is the action dissymmetrical and that both wings are always equally affected. In other words, should a machine with straight wings turn about an axis lying within its plane of symmetry, no righting or upsetting couple is produced by the turning movement.

On the other hand, if the eye looks down vertically upon the cork from above, it will be seen that a turning movement about a lowered axis has the effect of causing the rising wing to advance, while in the case of a raised axis a turning movement causes it to recede (fig. 61). Now, by

advancing a wing, the centre of pressure is slightly shifted; this may produce a couple tending to raise the advancing wing.

Should the advancing wing be the lower one, which corresponds to the case of a raised axis, this couple is a righting couple. In the reverse case it is an upsetting couple.

In this respect, for aeroplanes with straight wings a raised axis is stable, a lowered axis unstable.

This effect in itself is very slight, but it represents the nature of the lateral equilibrium of an aeroplane with

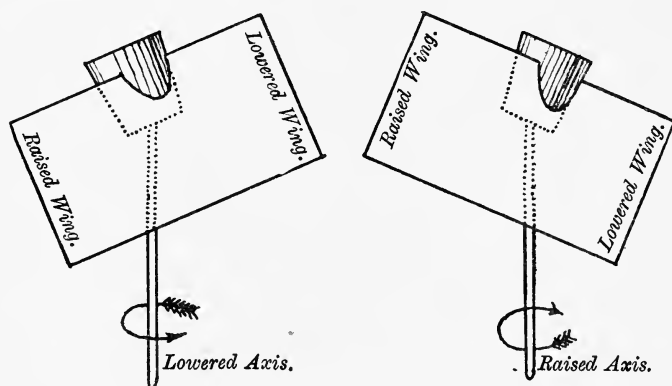

FIG. 61.

straight wings; for if it were not present, a machine with straight wings would be in neutral equilibrium and possess no stability.

But as soon as the wings form a lateral dihedral, whether upwards or downwards, this effect practically disappears and becomes negligible. This is the case next to be examined.

Let us suppose, to begin with, that the wings form an upward lateral dihedral, or open V. Each of the wings may be considered in the light of one-half of a set of straight wings which has begun to turn about the axis represented by the apex of the V, the movement of each

wing being in the opposite direction, *i.e.* while one is falling the other is rising.

The considerations set forth above show that a turning movement about a raised axis causes the incidence of the

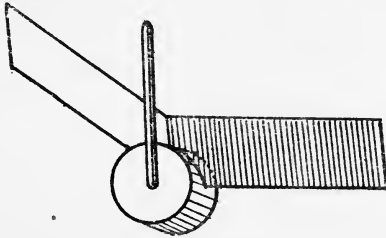

FIG. 62.—Stable. Lateral V and raised axis.

rising wing to diminish while that of the falling wing increases; the contrary takes place in the case of a lowered axis.

This is easily demonstrated by tilting upward the two halves of the visiting-card used in the previous experiment. If the contrivance is looked at as before, so that the axis of the cork is horizontal and on a level with the eye, it will be found that any rotation about the needle, when this is directed upwards, causes the rising wing to appear to diminish in surface while the falling wing increases (see fig. 62). But if the needle points downwards, the opposite takes place (fig. 63).

In the first case, therefore, the turning movement produces a righting couple, in the second case an upsetting couple.

This effect is the more pronounced the larger the angle of incidence.

Therefore in the case of wings forming a lateral dihedral, a raised axis is stable, a lowered axis unstable, and the more so the greater the angle of incidence.

This effect is added to the secondary effect already referred

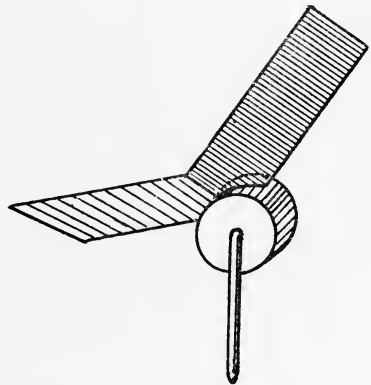

FIG. 63.—Unstable. Lateral V with lowered axis.

to in the case of straight wings; but as soon as the dihedral is appreciable, the former effect becomes by far the stronger.

Now consider the case of wings forming an inverted dihedral or Λ . The same line of reasoning shows (see figs. 64 and 65) that:

In the case of wings forming an inverted lateral dihedral a raised axis is unstable, a lowered axis stable, and this the more so the smaller the angle of incidence.

In this case the secondary effect acts in opposition, but it becomes negligible as soon as the inverted dihedral is appreciable.

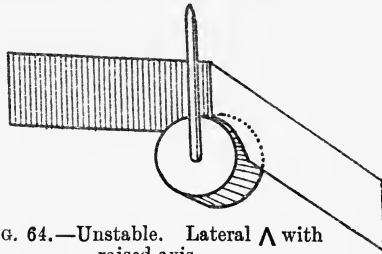

FIG. 64.—Unstable. Lateral Λ with raised axis.

These various effects are increasingly great, it will be readily understood, as the span is increased in size, for the upsetting or righting couples have lever arms directly proportional to the span. Besides, but quite apart from the value of the incidence in a given case,

it is clear that the righting couples are greater the higher the speed of flight, since they are proportional to the square of the speed. Broadly speaking, therefore, though with certain reserva-

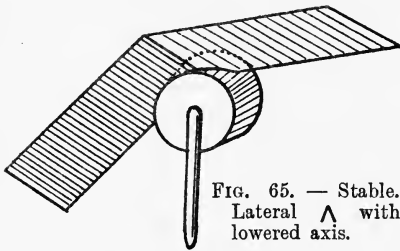

FIG. 65.—Stable. Lateral Λ with lowered axis.

tions into which we need not here enter in detail, it may be stated that the higher the flying speed the greater is lateral stability.

Although the stability or instability of any axis depends chiefly on the main planes, other parts of the aeroplane can affect it to a certain extent, hence their effect should be taken into account as well.

The tail plane, which is usually straight, only affects lateral stability to an inappreciable extent.

But it should be noted, as already stated, that any turning movement about an axis other than the neutral axis will affect the incidence at which the tail plane meets the air; and, since such a turning movement also affects, as already known, the incidence of the main plane, this dual effect must needs disturb the longitudinal equilibrium of the machine. Hence, we arrive at the general proposition that *rolling begets pitching*.

As regards the remaining parts of the aeroplane—fuselage, chassis, vertical surfaces, etc.—they experience from the relative wind, when the aeroplane turns about an axis in the median plane, certain reactions which may be dissymmetric and would thus affect the equilibrium of the machine on its flight-path. More particularly when the parts in question are excentric relatively to the turning axis can they influence—though usually only to a small extent—lateral equilibrium.

For the sake of convenience and in a manner similar to that previously adopted in the case of the detrimental surface, the effects of all these parts may be concentrated and assumed to be replaced by the effect of a single fictitious vertical surface, which may be termed the *keel surface*, which would, as it were, be incorporated in the symmetrical plane of the machine.

Certain parts of the aeroplane, such as the vertical rudder, the sides of a covered-in fuselage, vertical fins, form actual parts of the keel surface.

Evidently, according to whether the pressure exerted on the keel surface, by reason of a turning movement about a given axis, passes to one side or the other of this axis, the couple set up will be either a righting or upsetting couple.

It is easily shown that a keel surface which is raised relatively to the axis of rotation can be compared, proportions remaining the same, to a plane with an upward dihedral, or ∇ , and that a keel surface which is low relatively

to the axis of rotation to a plane with a downward dihedral or Λ .

For this purpose, the cork, visiting-card, and needle previously employed may be discarded in favour of a visiting-card fixed flag-wise to a knitting-needle. It is clear, as shown in fig. 66, that when the axis of rotation is raised, a high keel surface renders this axis stable and a low keel surface renders it unstable, while the reverse is the case if the axis of rotation is lowered (see fig. 67).

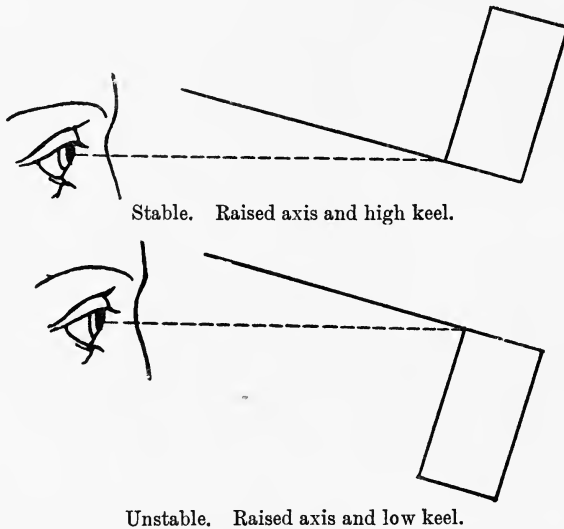

FIG. 66.

But this effect, as previously explained, is of small importance as compared with that due to the shape of the main plane; for, while the pressures on the keel surface are never far removed from the axis of rotation, the differential variations in the pressure exerted on the two wings of a plane folded into a dihedral have, relatively to the axis, a lever arm equal to half the span of the wing, and accordingly these variations are considerable.

The effect of the dihedral of the main plane is therefore not equivalent in magnitude to that of the keel surface formed by the projected dihedral (fig. 68). The dihedral

has a much greater effect on lateral stability than a similar keel surface.

We now know the position of the stable and the unstable axes of rotation according to the particular struc-

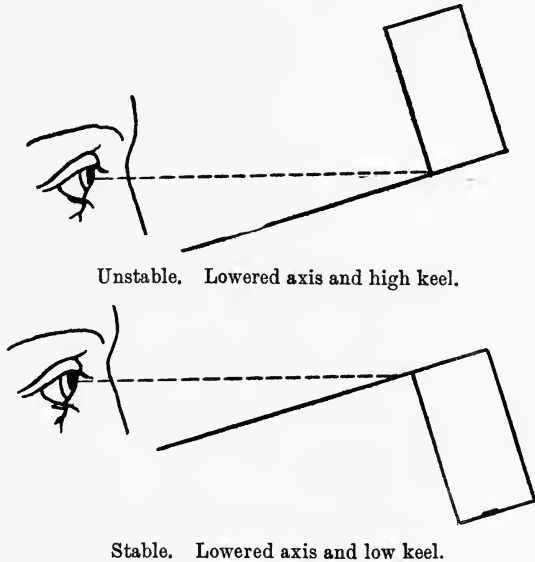

FIG. 67.

ture of the aeroplane, and we have found that the same machine can be stable laterally for one axis of rotation, and unstable for another.

This is scarcely reassuring and inevitably leads to the

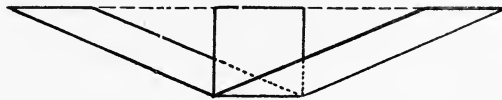

FIG. 68.

question: *About which axis can an aeroplane, flying freely in space, be brought to turn?*

In the first place, the position of the axes obviously depends on the causes which can bring about the turning movement. But these causes are known; so far as lateral

equilibrium is concerned, they can only consist in excess of pressure on one wing or on the keel surface.

Here, then, we have one important element of the question already settled. Nevertheless, the problem cannot be solved in its entirety without having recourse to ordinary mechanics and calculations, though the results thus obtained may well be called into question, since the calculations have to be based on hypotheses which are not always certain in the present state of aerodynamical knowledge.

Without attempting to examine this difficult problem in all its details, we may nevertheless remark that in its solution the most important part is played by the distribution of the masses constituting the aeroplane or, in other words, by its structure considered from the point of view of inertia.

Let us take a long iron rod AB (fig. 69), ballasted with a mass M, and suspend it from its centre of gravity G; add a small pair of very light wings in the neighbourhood of the centre of gravity.

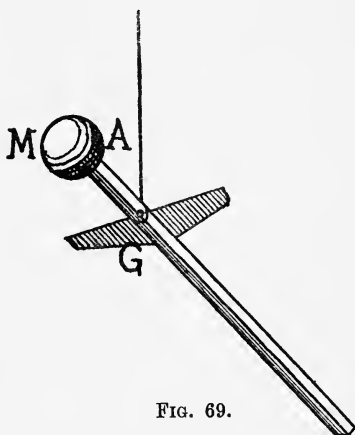

FIG. 69.

If, with a pair of bellows, pressure is created beneath one of the wings, the device will start to oscillate laterally, and these oscillations will obviously take place about the axis of the iron bar. If this is placed in the position shown in fig. 69, the axis of rotation will be a raised axis; if in the position illustrated in fig. 70, it will be a lowered axis.

Now every aeroplane, and every long body in fact, has a certain axis passing through the centre of gravity, about which axis we can assume the masses to be distributed, as in the case of the present device they are about the axis of the iron bar.

Lateral oscillations tend to take place about this axis, which may be termed the *rolling axis*. The term, it is true, is not absolutely accurate, and lateral oscillations do

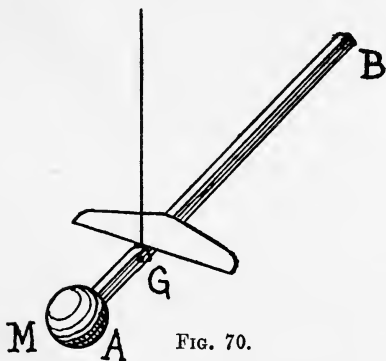

FIG. 70.

not take place mathematically about this axis; but at the same time, as further investigations would show, the true rolling axes only differ from it to a very slight extent, and are always slightly more *raised* than the rolling axis. This brings us to the moment of rolling inertia.

In Chapter VII. was defined the moment of inertia of a body about any axis; in the examination of longitudinal stability the moment of inertia of an aeroplane about its pitching axis was considered as the moment of pitching inertia. But in the present case we have only to deal with the moment of inertia of an aeroplane about its rolling axis—that is, its moment of rolling inertia.

As a matter of fact, the true axis of lateral oscillations coincides more closely with the rolling axis as, on the one hand, the incidence of the main plane is nearer to the *best incidence* (see Chapter III.) and the corresponding drag-to-lift-ratio is smaller, and, on the other hand, as the ratio between the moment of rolling inertia and the moment of pitching inertia is smaller.

Owing to the fact that this latter ratio is very small in the diagrammatic case just considered, the lateral oscillations of this device take place almost exactly about the rolling axis, *i.e.* about the axis of the iron bar.*

* The moment of rolling inertia is very slight, since those parts which are at any distance from the rolling axis, *i.e.* the wings, are very light, while the moment of pitching inertia is great, owing to the length and the weight of the iron bar.

From all this it is clear that, according to the position of the aeroplane in flight, its natural axis of lateral oscillation, or approximately its rolling axis, will be either a raised or a lowered axis. For an aeroplane to possess lateral stability, its natural axes of oscillation must obviously be *stable axes*.

Thus, if the wings of an aeroplane form an upward dihedral or ∇ , or if the machine has a high keel surface, its natural axes of oscillation must be raised axes, if lateral stability is to be ensured. This condition is complied with if the rolling axis of the aeroplane is itself a raised axis, and even when the rolling axis is slightly lowered, since the natural axes of oscillation are relatively slightly raised.

It is also clear that the stability will be better the greater the angle of incidence.

On the other hand, if the main planes form a downward dihedral or \wedge , the machine will be unstable laterally if the rolling axis is a raised one or even if it is only slightly lowered. But the aeroplane can be made stable if its rolling axis is lowered to a sufficient extent, and the more so the smaller the angle of incidence.

This conclusion is distinctly interesting since it is directly at variance with the views held by the late Captain Ferber, whose great scientific attainments lent him all the force of authority, to the effect that an upward dihedral was essential to lateral stability.

But it is even more important by reason of the fact—which will be duly discussed in the final chapter,—already noted by Ferber himself, that whereas the upward dihedral or ∇ is disadvantageous in disturbed air, the downward dihedral has distinct advantages in this respect.

On the whole, however, Ferber's view is correct at present, since in the majority of aeroplanes of to-day the rolling axis is practically identical with the trajectory of the centre of gravity or only very slightly lowered. But in an aeroplane with a rolling axis lowered to an appreciable extent, the upward dihedral might be highly injurious from the point of view of lateral stability, whereas the inverted

dihedral or Λ would, contrary to general opinion, be eminently stable.

How is this arrangement to be carried out in practice?

The rolling axis is a line which passes through the centre of gravity and lies close to the masses situated at the end of the fuselage, such as the tail plane and controlling surfaces. When the centre of gravity is normal, this line consequently lies along the axis of the fuselage. But if the centre of gravity is situated low relatively to the wings, the rolling axis is also lowered. The same would occur if the machine was so arranged as to fly with its tail high, so that the axis of its fuselage would form an angle, distinctly greater than the normal incidence, with the chord of the main plane.

On the other hand, a low centre of gravity, if unduly exaggerated, presents certain disadvantages.

The best method of obtaining a rolling axis such that the inverted dihedral of the main plane produces lateral stability would seem to be by combining both devices, *i.e.* by slightly lowering the centre of gravity and raising the tail in flight.

This conclusion was formed by the author several years ago; and in 1909, somewhat fearful of running counter to the authoritative views of Captain Ferber, the opinion was sought of the eminent engineer, M. Rodolphe Soreau, another recognised authority, in regard to the position of the axis about which an aeroplane's natural lateral oscillations take place. In 1910 in a previous work,* the author first enunciated in definite form the proposition that an aeroplane with its main planes arranged to form an inverted dihedral could, under given conditions, remain stable laterally. Since then the point has been dealt with in an article in *La Technique Aéronautique* and in a paper read before the Académie des Sciences.†

* *The Mechanics of the Aeroplane* (Longmans, Green & Co.).

† *La Technique Aéronautique*, December 15, 1910; *Comptes Rendus*, May 15, 1911.

Summing up :

- (1) In aeroplanes of the shape hitherto generally employed, a straight plane produces no lateral stability, apart from the very slight stabilising effect produced by the secondary cause, already referred to.
- (2) In such aeroplanes a dihedral angle of the wings or the use of a high keel surface produces lateral stability, and this in an increasing degree as the angle of incidence is greater.
- (3) If the centre of gravity of the aeroplane is low, or if its tail in normal flight is high (or if both these features are incorporated in the machine), an inverted dihedral or \wedge of the wings with a low keel surface may produce lateral stability, and this to an increasing extent the smaller the angle of incidence.

Lateral stability, therefore, depends on several different parts of the structure, but it can never attain the same magnitude as longitudinal stability, which is easily explained. For, whereas in the case of longitudinal stability any angular displacement in the sense of diving or stalling affects to its full extent the angle of the main and the tail planes, as regards lateral stability a great angular displacement in the sense of rolling is required to produce even a slight difference in the incidence of the two wings.

The righting couples are therefore much smaller in the lateral than the longitudinal sense for any given oscillations. If, as in Chapter VI., the degree of lateral stability of an aeroplane is represented by the length of a pendulum arm, it will be found that even with the most stable machines this length is hardly in excess of 0.5 m., while attaining 2.5 and even 3 m. in the case of longitudinal stability.

As with longitudinal stability, so here again there exists a condition of stability of oscillation—that is, a definite

proportion must exist between the stabilising effect of the shape of the machine and the value of its moment of rolling inertia, so that the lateral oscillations can never increase to the point of making the aeroplane turn turtle. For this reason, since lateral stability is relatively small, the moment of rolling inertia should not be too great. On the other hand, an increase in span, which increases this moment of inertia, also gives the stabilising effect a long lever arm. Hence, a middle course had best be adopted.

Aeroplanes with a large rolling inertia oscillate slowly, so that there is time to correct the oscillations, but these tend to persist.

So far as the wind is concerned, it would appear an advantage to concentrate the masses, thus keeping the moment of inertia small (see Chapter X.).

A low centre of gravity, as already shown, increases to a considerable extent the moment of inertia both to pitching and to rolling. Hence, if unduly low, it may set up lateral oscillations, which constitutes the disadvantage previously referred to. If, therefore, a low centre of gravity is resorted to with the object of inclining the rolling axis to permit the use of wings with an inverted dihedral or Λ , care should be taken that it be not too low, and it would seem in every respect preferable to obtain the same result by raising the tail.*

Aeroplanes with little rolling inertia oscillate more quickly than the others. If this is slightly disadvantageous since these oscillations cannot be so easily corrected, quick oscillations, on the other hand, possess the advantage of being accompanied by a damping effect similar to that existing in the case of longitudinal oscillations and referred to above. For, if a plane oscillates laterally, the wind strikes it at either a greater or smaller angle than when it is motionless, and this becomes the more marked the quicker the oscillation.

* Such a tail should obviously offer as little resistance as possible.

The small degree of lateral stability possessed by aeroplanes, especially of those with straight planes would, generally speaking, usually not suffice to prevent the upsetting of the machine owing to atmospheric disturbances, the more so since, as Chapter X. will show, the very shapes and arrangements which produce lateral stability may at times interfere with the flying qualities of the machine in disturbed air.

Hence it is necessary to give the pilot a means of powerful control over lateral balance in order to counteract the effects of air disturbances.

This means consists in *warping*, which was probably first conceived by Mouillard, and first carried out in practice by the brothers Wright. Other devices, such as ailerons, have since been brought out, the object in each case being to produce, differentially or not, an excess of pressure on one wing.

The pilot therefore controls the lateral balance of his machine, and this has to be constantly corrected and maintained by him.

Naturally, the idea of providing some automatic device to replace this controlling action by the pilot has arisen, but this question will be left for discussion in the last chapter, which deals with the effects of wind on the aeroplane.

The rotation of a single propeller causes a reaction in an aeroplane tending to tilt it laterally to some extent. This could easily be corrected by slightly overloading the wing that shows the tendency to rise; but in this event the reverse effect would take place when the engine stopped, either unintentionally or through the pilot's action when about to begin a glide—that is, at the very moment when longitudinal balance is already disturbed.

Lateral balance is bound to be disturbed in some degree owing to the propeller ceasing to revolve, but it would seem preferable that at the moment when this occurs both wings should be evenly loaded.

For this reason constructors generally leave it to the pilot to correct the effect referred to by means of the warp (which term includes all the different devices producing lateral stability). Probably the effect is responsible for the tendency which most aeroplanes possess of turning more easily in one direction than the other.*

* Another effect due to the rotation of the propeller, the gyroscopic effect, will be briefly considered in the following chapter.

CHAPTER IX

STABILITY IN STILL AIR

LATERAL STABILITY (*concluded*)—DIRECTIONAL STABILITY—TURNING

OUR examination of lateral stability may well be brought to a conclusion by considering the interesting lessons that may be learned from experiments with little paper gliders. First, we will take some of those gliders which have been described in previous chapters and examine them in regard to lateral stability.

Type 1 (see Chapter VII.)—This, it will be remembered, is a simple rectangular piece of paper. It has already been explained that it was necessary to bend it so as to form a lateral V.

This arrangement is essential for obtaining lateral stability with this particular glider, since its rolling axis, which corresponds approximately with the fold along the centre, is a *raised axis*, for the reason that the path followed by the centre of gravity must be at a lesser angle than this central fold, in order to give the gliders an angle of incidence. Practice here will be seen to confirm theory.

Cut out a rectangular sheet of very stiff paper and, *without folding it*, load it with ballast as shown in Chapter VII.

During the process of finding, by experiment, the correct position for the ballast, it will be found that the flight of such a glider is accompanied by considerable lateral oscillations. More, these oscillations are both lateral and directional; in other words, the path followed by the

centre of gravity is a sinuous one, and the glider not only tilts up on to one wing and the other in succession, but each time it tends to change its course and swerve round towards the lower wing, and thus it is virtually always skidding or yawing sideways.

In this way it appears to oscillate not about an axis passing through the centre of gravity, but about a higher axis.

The reason for this, which will be entered into more fully in connection with directional stability, is the extremely small keel surface of such a glider. This might at first appear to conflict with the fundamental principle,* but the anomaly is simply due to the fact that the lateral oscillations which, as always, do indeed occur about an axis passing through the centre of gravity, are combined with the zig-zag movement due to the small keel surface, which is moreover the outcome of the oscillations.

The tendency to roll is the result of the very slight lateral stability of a straight plane, which possesses practically no keel surface, and this tendency is counteracted by nothing but the small secondary damping effect referred to in Chapter VIII.

Oscillatory stability is therefore almost absent, and the first rolling movement would increase until the glider was overturned, but for the fact that, the air pressure being no longer directed vertically upwards, the path followed by the centre of gravity is deflected sideways and the glider tends to turn bodily towards its down-tilted side.

The glider promptly obeys this tendency, for its mass is feeble while it possesses practically no keel surface offering lateral resistance; hence the centre of pressure moves towards the side in which movement is taking place and thus creates a righting couple. Consequently, in a measure, the yawing saves the glider from overturning.

This tendency to yaw which is displayed by machines with

* That an aeroplane should be considered as being suspended from its centre of gravity (see p. 93).

straight wings and a small keel surface is to be observed, for it would seem to furnish the reason for the side-slips to which aeroplanes devoid of a lateral dihedral are prone.

Now, if the sheet of paper is slightly folded upwards from the centre, these various movements decrease, and, finally, if folded up still further, disappear altogether. The dihedral angle increases lateral stability and oscillatory stability, while the considerable keel surface which the glider now possesses stops all tendency to yaw.

Since the stabilising effect of the dihedral in the example chosen is due to the rolling axis being a *raised axis*, it is to be expected that, when launched upside down, the glider will prove to be laterally unstable. This, in fact, is what occurs if the dihedral is pronounced enough. The glider immediately turns right side up.

If the glider has no dihedral, or only a slight one, and if the span is reduced (in this case either the ballast must be moved back or—and this is preferable—the wing-tips must be turned up aft, for the weight of the ballast is now disproportionate to the weight of the paper so that the centre of gravity has moved forward), it may be observed that the lateral oscillations become quicker, which is due to the moment of rolling inertia having diminished.

Type 2 (see Chapter VII).—This model represents the normal shape of an aeroplane (fig. 51). It has already been explained that it should be given a slight dihedral, which, in any case, it will tend to assume of its own accord owing to the combined forces of gravity and air pressure.

This glider will be found to possess good lateral stability, its rolling axis coinciding approximately with the central fold, so that it is a *raised axis*.

Oscillatory stability is good and rolling almost absent.

If the glider is bent into a downward dihedral or Λ (this fold should be somewhat emphasised in view of the tendency of the glider to assume an ordinary ∇ of its own accord), it will overturn, which is quite in accord with theory, as the natural rolling axis is a *raised axis*.

Type 3 (see Chapter VII).—This is the “Canard” or tail-first type (fig. 53). The wing-tips being bent vertically upward, form a high keel surface, while, as in the previous case, the glider naturally tends to assume a ∇ .

Hence it is laterally stable, and the rolling axis, coinciding with the central fold, is a *raised axis*.

There are no appreciable oscillations. If it is bent downward into a Λ , and this to a pronounced extent owing to the stabilising effect of the fins, or if these latter are folded down, the glider overturns.

These three types, therefore, are in accordance with the principle laid down by Captain Ferber, to the effect that a lateral ∇ is necessary for lateral stability.

Examination of the following two models, on the other hand, shows them to be in contradiction with this principle, and bears out the author's contention that lateral stability may be obtained in an aeroplane possessing a downward dihedral or Λ .

*Type 5.**—1. Cut out from a sheet of paper folded in two the outline shown in fig. 71.

2. Cut away, in the dimensions shown, the folded edge at AB and CD.

3. Glue to the inside of the fold: (a) at AB, a small strip of cardboard cut from a visiting-card (5 to 6 cm. long and 1 cm. broad), (b) at CD a rectangular piece of paper (4 cm. by 15 mm.).

4. Fold back the wings and the tail plane along the thick dotted lines. The wings should be folded so as to form a lateral Λ . (If any difficulty is experienced in maintaining this shape, a thin strip of cardboard, 4 to 5 mm. wide, may be glued along the forward edge.)

5. Affix the ballast, consisting of one or more paper fasteners, to the end of the paper strip in front. (The correct position must be found by experiment, and it may be useful, for this purpose, to adjust the forward

* This number was given so as not to break the numerical sequence. Type 4 was dealt with in Chapter VII.

strip of cardboard to the correct position before the glue is quite dry.)

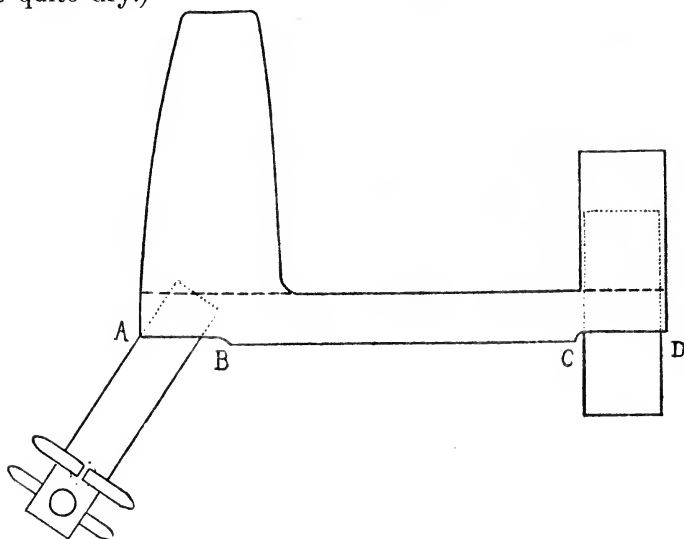

FIG. 71.

Type 6.—1. Cut out from a sheet of paper folded in two the outline shown in fig. 72.

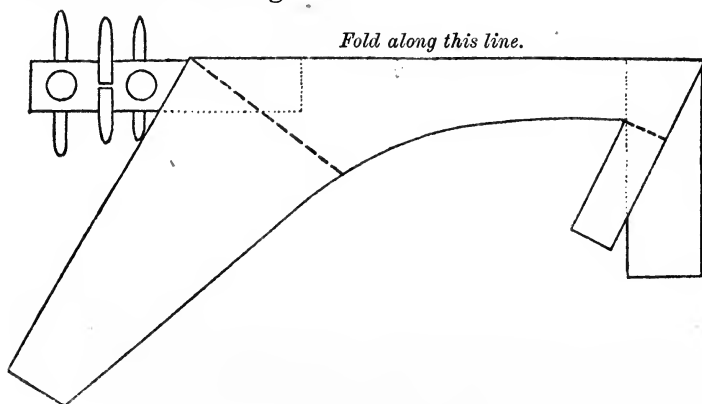

FIG. 72.

2. Fold back the wings and the tail plane along the thick dotted lines. The wings are folded so as to form an

inverted dihedral or Λ , the edge of the fold being uppermost in this model.

3. Glue to the inside of the fold: (a) in front and so as to form a continuation of the fold, a strip of cardboard cut from a visiting-card, and measuring 5 or 6 cm. by 1 cm.; (b) in the rear and at right angles to the fold, another strip of cardboard measuring 4 cm. by 15 mm.

4. Affix ballast in the shape of two or three paper clips at the extremity of the foremost cardboard strip.

These models belonging to types 5 and 6 have to be adjusted with great care and will probably turn over at the first attempt, until balance is perfect, but this need not discourage further attempts.

If they display a marked tendency to side-slip or yaw or to turn to one side, the trailing edge of the opposite wing-tip should be slightly turned up, until balance is obtained.

But if the model rolls in too pronounced a fashion, such oscillations may be caused to disappear either by shifting the ballast or even by turning up or down the rear edge of the tail plane. In some cases the same result may be obtained simply by emphasising the Λ of the wings.

Once they are properly adjusted, these gliders assume on their flight-path the attitudes shown respectively in figs. 73 and 74. These are the attitudes imposed by the laws of equilibrium; and if the gliders are thrown skyward anyhow, they will always resume these positions, provided they are at a sufficient height above the ground.

Model 5 displays a slight tendency to roll, but model 6 follows its proper flight-path, which can be made perfectly straight, in quite a remarkable manner.

This is all in accordance with the theory put forward in Chapter VIII. Because the rolling axis is a lowered axis—since in model 5 the centre of gravity is situated very low and in model 6 the tail is very high—the inverted dihedral or Λ of the wings produces stable lateral equilibrium.

On the other hand, in model 5 the centre of gravity is exceptionally low; hence the moment of rolling inertia is

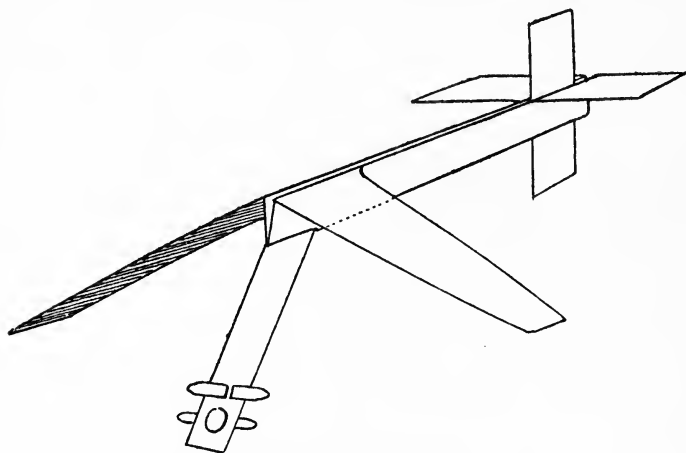

FIG. 73.—Perspective.

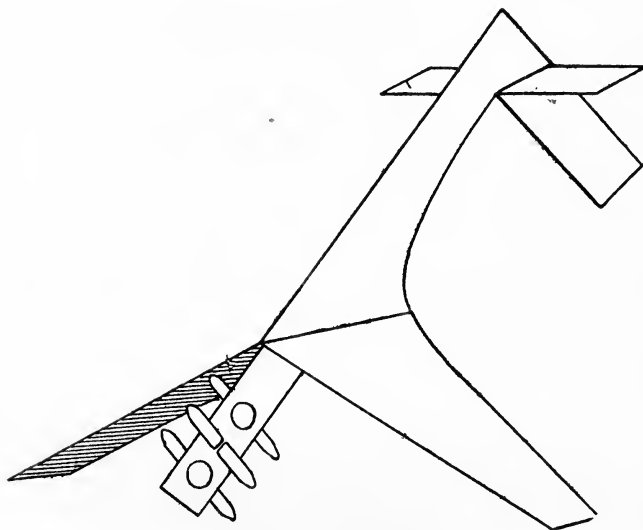

FIG. 74.—Perspective.

great, so that oscillatory stability is not quite perfect and there remains a tendency to swing laterally, whereas in

model 6 this defect is absent, since the centre of gravity is only slightly lowered.

The latter arrangement is therefore the one to be adopted in designing a full-size aeroplane of this type.

In both cases, by increasing the Λ the tendency to oscillate is reduced, owing to the fact that, up to a certain limit, the value of the righting couples is hereby increased likewise. The same is true of a decrease in the angle of incidence, effected either by displacing the ballast farther forward or by adjusting the tail, because, as has been shown previously, any decrease in the incidence augments lateral stability if the wings are placed at a Λ .

Our theory would be even more conclusively proved correct, if, when the wings were turned up into a ∇ , the glider overturned.

As a matter of fact this does occur sometimes, especially with model 6, but not always, and with its wings so arranged the model may still retain a certain amount of lateral stability.

This apparent conflict of practice and theory may be explained by the fact that, by turning up the wings of such a model the centre of gravity is raised, since the wings constitute an important part of the weight of these little gliders; consequently the rolling axis is also raised, and since, as previously stated, lateral oscillation occurs not precisely about the rolling axis but about a higher axis still, the true rolling axis may prove to be a stable axis for ∇ -shaped wings. This is borne out further by the fact that in many cases, and especially with model 6, this does not occur and that the glider overturns.

With the kind assistance of M. Eiffel, the author carried out in the Eiffel laboratory a series of tests with a scale model of greater size and so designed that its wings could be altered to form either an upward or a downward dihedral, and these tests appear to be conclusive.

The model, perfectly stable when its wings formed a Λ , showed a strong tendency to overturn when the wings

formed a ∇ . (The raising of the centre of gravity caused by upturning the wings was neutralised by lowering the ballast to a corresponding extent.)

But even if this further proof were absent, it would nevertheless remain true—and the fact is most important, as will be shown in Chapter X.—that *it seems possible to build aeroplanes, with wings forming an inverted dihedral angle, which in spite of this are laterally stable.*

DIRECTIONAL STABILITY

An aeroplane must possess more than longitudinal and lateral stability; it must maintain its direction of flight, must always fly head to the relative wind, and must not swing round owing to a slight disturbance from without. This is expressed by the term *directional stability*.

In other words, an aeroplane should behave, in the wind set up by its own speed through the air, like a *good weathercock*.

In fig. 75, let AB represent, looking downwards, a weathercock, turning about the vertical axis shown at O, the direction of the wind being shown by the arrow.

From our knowledge of the distribution of pressure on a flat plane (fig. 32, Chapter VI.), it is clear that if the axis O is situated behind the limit point of the centre of pressure, the weathercock, in order to be in equilibrium, would have to be at an angle with the wind such that the corresponding pressure passed through the point O. Hence, the weathercock would assume the position A'B' or A''B''.

It would be a *bad weathercock* because it formed an angle with the wind. A good weathercock always lies absolutely parallel with the wind, which thus always meets it head-on.

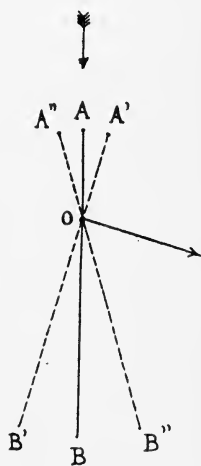

FIG. 75.—Plan.

Therefore, in a good flat weathercock the axis of rotation must be situated in front of the limit point of the centre of pressure, *i.e.* in the first fourth from front to rear.

In so far as its direction in the air is concerned, an aeroplane behaves in exactly the same way as the weathercock which we have termed its *keel surface*, the axis of rotation being approximately a vertical axis passing through the centre of gravity.

It can therefore be stated that for an aeroplane to possess directional or *weathercock stability*, the limit point of the centre of pressure on its keel surface, when it meets the air at even smaller angles, must lie behind the centre of gravity.

Directional equilibrium is thus obviously stable, since any change of direction sets up a righting couple, because the pressure on the keel surface always passes behind the centre of gravity.*

Directional stability is usually maintained by the means already provided to secure lateral stability, the rear portion of the fuselage, which is often covered in with fabric, constituting the rear part of the keel surface. Moreover, this is further increased by the presence of a vertical rudder still further aft.

But there are certain machines in which special means have to be taken to secure directional stability—the tail-first or “Canard” machine is of this type.

In Chapters VI. and VII. it was stated that the fact that this type of machine has its tail plane in front tends to longitudinal instability, which is only overcome by the unusually high stabilising efficiency of the main planes,

* Reference to Chapters VI. and VII. will show that longitudinal equilibrium is also, in effect, weathercock equilibrium. But in this respect, the planes must always form an angle with the relative wind, which constitutes the angle of incidence and produces the lift. In regard to longitudinal stability, the aeroplane should therefore be a bad weathercock. Further, it will be shown in Chapter X. that, in considering the effect of the wind on an aeroplane, two classes of bad weathercocks have to be distinguished, and that an aeroplane should be, if the term be allowed to pass, a “good variety of bad weathercocks.”

which are of relatively great size and situated at a considerable distance behind the centre of gravity.

The same is true in regard to directional stability, and the existence in the forward part of the machine of a long fuselage, comparable to a weathercock turned the wrong way round, would speedily cause the aeroplane to turn completely round if it were not provided with considerable keel surface behind the centre of gravity. The necessity for this arrangement will readily appear if, in the little paper glider No. 3, already described, the vertical fins at the wing-tips are removed. The glider will then turn about itself without having any fixed flight-path.*

In Chapter VIII. it was shown that lateral stability is affected by raising or lowering the vertical keel surface. But even if it is neither high nor low, and though it may appear to affect only directional stability, every bit of keel surface plays an important part in lateral stability. For these two varieties of stability are not absolutely distinct. Both, in fact, relate to the rotation of the aeroplane about axes situated in the plane of symmetry.

When these axes are close to the flight-path of the centre of gravity, only lateral stability comes in question; but when they are more nearly vertical, the rotary movement about them belongs to directional stability.

Nevertheless, any turning movement about any axis other than that formed by the path of the centre of gravity plays its part in both lateral and directional stability, and it is only in so far as it affects the one more than the other that it is classified as belonging to lateral or directional stability. The line of cleavage between these two varieties of stability is by no means clear.

From this it follows, in the author's opinion, that the means for obtaining lateral stability gain considerably in effectiveness if they also produce directional stability. If

* To obtain good directional stability, those paper models with a ballasted strip of cardboard in front were all provided with a vertical fin in the rear.

aeroplanes with wings forming a Λ are ever built, they should be provided with a considerable amount of keel surface aft (placed low rather than high).

In conclusion, it may be said that, of the three varieties of stability, directional stability is at the present time the most perfect, which is to be accounted for on the ground that the pressure on the keel surface must always pass behind the centre of gravity, whence arise strong righting couples.

In the order of their effectiveness at the present day, the three classes of stability can therefore be arranged as follows:—

Directional stability.

Longitudinal stability.

Lateral stability.

By careful observation of the oscillations of an aeroplane the truth of this statement will be borne out. Every aeroplane betrays some tendency to roll; at times it also tends to pitch, but it hardly ever swerves from side to side on its flight-path, zigzag fashion.

TURNING

The vertical flight-path of an aeroplane is controlled by the elevator; but the pilot must also be able to change his direction and to execute turning movements to right and left.

A few points of elementary mechanics may here be usefully recalled.

If a body is freely abandoned to its own devices after having been launched at a certain speed (omitting from consideration the action of gravity), it continues by reason of its inertia to advance in a straight line at its original speed, and an outside *force* is required in order to modify this speed or to alter the direction followed by the body.

A body following a curved path therefore only does so through the action of an outside force.

If the body follows a circular path, the force which pre-

vents it from getting further away from the centre of the circle, although its inertia seeks to propel it in a straight line, to move away at a tangent, is termed *centripetal force*.

For instance, if a stone attached to the end of a string is whirled round, it describes a circle instead of following a straight line only because the string resists and exerts on it a centripetal force. If this force is stopped and the string is let go, the stone will fly off at a tangent.

On the other hand, a body, in this case the stone, always tends to fly off; it thus reacts, exerting in its turn on the cause which maintains it in a circular path—in this case, on the string—a force termed *centrifugal force*, which, in accordance with the well-known principle of mechanics concerning the *equality of action and reaction*, is exactly equal and opposite to the centripetal force which causes it.

In the example chosen, the value of the centripetal and centrifugal forces (the same in both cases) could be measured by attaching a spring balance to the string. It would be found that, as is easily shown in theory, this value is proportional to the square of the speed of rotation and inversely proportional to the radius of the circle described.

From this it is clear that in order to curve the flight-path of an aeroplane, that is, to make it turn, it is necessary to exert upon it by some means or other a centripetal force directed from the side in which the turn is to be made. This can be done by creating, through movable controlling surfaces, a certain lack of symmetry in the shape of the aeroplane which will result in a corresponding lack of symmetry in the reactions of the air upon it.

The most obvious proceeding is to provide the aeroplane with the same device by which ships are steered and to equip it with a *rudder*. But, just as a ship without a keel responds only in a slight measure to the action of a rudder, so an aeroplane offering little lateral resistance—that is, having but little *keel surface*—only responds to the rudder in a minor degree.

In order to make this clear, we will take the case of an aeroplane entirely devoid of keel surface, though this is an impossibility on a par with the case of an aeroplane wholly devoid of detrimental surface, since the structure of an aeroplane must perforce always offer some lateral resistance, even though the constructor has tried to reduce this to vanishing-point.

However, let us assume that such an aeroplane, having

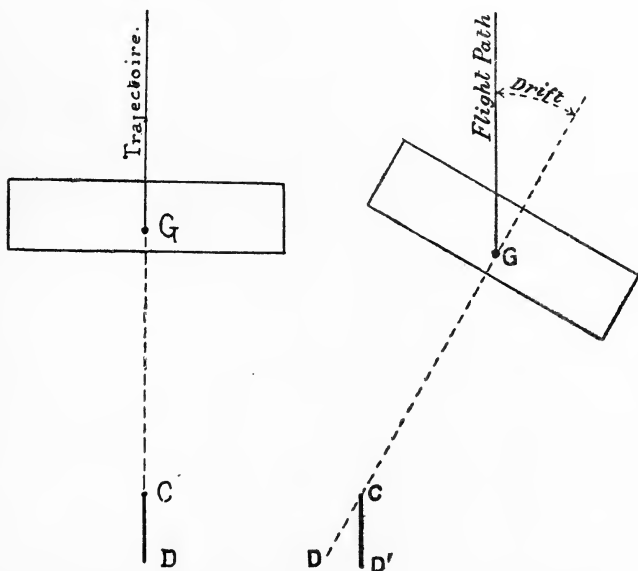

FIG. 76.

its centre of gravity at G (fig. 76), is provided with a rudder CD .

If the rudder is moved to the position CD' , the aeroplane will turn about its centre of gravity until the rudder lies parallel with the wind. But there will not be exerted on the centre of gravity any unsymmetrical reaction, any *centripetal force* capable of curving the flight-path.

The aeroplane will therefore still proceed in a straight line, and the only effect of the displacement of the rudder

will be to make the aeroplane advance crabwise, without any tendency to turn on its flight-path.

But if the machine is equipped with a keel surface AB (fig. 77), directional equilibrium necessitates that this keel surface should present an angle to the wind, and become thereby subjected to a pressure Q , whose couple relatively

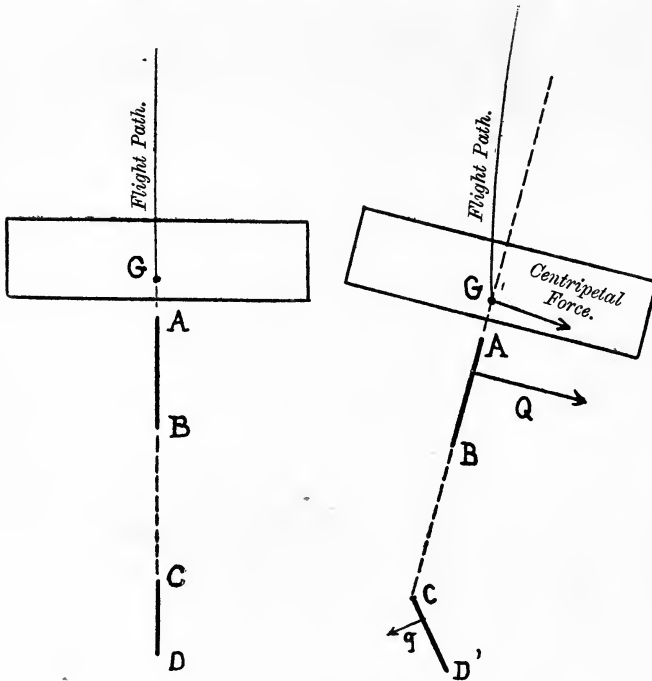

FIG. 77.—Plan.

to the centre of gravity is equal and opposite to the pressure q exerted on the displaced rudder CD' . Since Q is considerably greater than q , there is exerted on the centre of gravity, as the result of their simultaneous effect, a resultant pressure approximately equal to their difference (which could be found by compounding the forces), and this forms a centripetal reaction capable of curving the flight-path—that is, of making the machine turn.

It should be observed that the nearer the keel surface is to the centre of gravity the greater is the centripetal force set up by the action of the rudder. Similarly, the intensity of this force also depends on the extent of the keel surface. And lastly, since the centripetal force has a value equal to the difference between the pressures Q and q , it becomes greater the smaller the latter pressure. Hence there is an advantage in using a small rudder, which

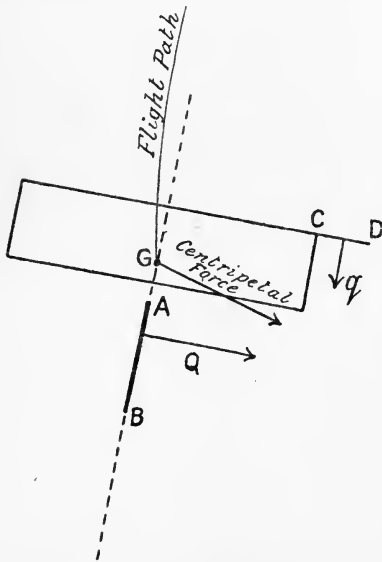

FIG. 78.—Plan.

must, in consequence, have a long lever arm in order to balance the effect of the keel surface.

A turn might also be effected by lowering a flap CD, as shown in fig. 78 at the extremity of one wing, this flap constituting a brake. In this case, too, a keel surface is essential and equilibrium would exist if the couples set up by the pressures Q and q , exerted on the keel surface and on the brake respectively, were equal.

A centripetal reaction, the resultant of these pressures, would act on the centre of gravity and bring about a turn.

There remains a third and last means of making an aeroplane perform a turn, and this requires no keel surface. This consists in causing the aeroplane to assume a permanent lateral tilt.

The pressure exerted on the plane (which is roughly equal to the weight of the machine) is tilted with the aeroplane and has a component p (fig. 79) which assumes the part of centripetal force, and makes the machine turn.

The machine can be tilted in various ways—for instance, by overloading one of the wings. But the more usual method is that of the *warp*, which has already been referred to as the pilot's means of maintaining lateral balance.

By increasing the incidence, or its equivalent the lift, of one wing-tip and decreasing that of the other, the former wing is raised and the latter lowered, so that the machine is tilted in the manner required to make a turn.

But in warping, the wing with increased lift also has an increased drag or head resistance, while the reverse takes place with the other wing.

This secondary effect is analogous with that of the air brake just considered and is exerted in the opposite way to that required to perform the turn. It is usually smaller than the main effect of the warp, but still interferes with its efficacy. On the other hand, in some aeroplanes it may gain the upper hand, as in the noteworthy case of the Wright machines.

In order to overcome this defect, the brothers Wright produced, through the means of the rudder (which played no other part), a couple opposed to the braking effect, which left its entire efficiency to the differential pressure variation exerted on the wings by the action of the warp. Further, the warp and rudder could be so interconnected as to act simultaneously by the movement of a single lever (this constituted the main principle of the Wright patents).

This detrimental secondary effect could, it would appear, be easily overcome by using a plane with wing-tips uptilted in the rear as at BC in fig. 80.

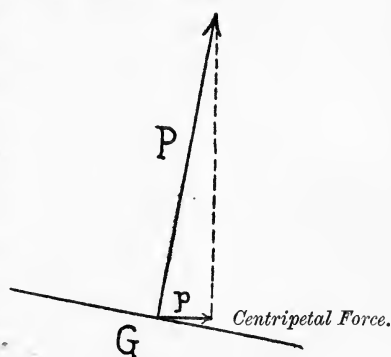

FIG. 79.—Front elevation.

By depressing the trailing edge BC of the wings, which are purposely made flexible, the lift is increased and the drag diminished at the wing-tip. By turning up the trailing edge the lift is decreased and the drag increased. Both effects therefore combine to assist in making the turn instead of impeding it. Instead, finally, of adopting this particular warping method, the same result could be obtained by using negative-angle ailerons.

It should be noted—and the fact is of importance both so far as turning and lateral balance are concerned—that the effect of the warp is definitely limited. It is known that beyond a certain incidence (usually in the neighbourhood of 15° to 20°) the lift of a plane diminishes while the drag increases rapidly.

If the warp is therefore used to an exaggerated extent, the detrimental secondary effect referred to above comes



FIG. 80.—Profile.

into play, with the result that its effect is the reverse of the usual one. This may prove a source of danger, and it might be well in

certain machines, if not to limit the warp absolutely, at any rate to provide some means of warning the pilot that he is approaching the danger-point.

Since the rudder sets up a couple tending to counteract this secondary effect, it should be resorted to in case an undue degree of warp causes a reverse action to the one intended.

The banking of the planes which, as already seen, may provoke a turn, always results from it; for, as the aeroplane swings round, the outer wing travels faster than the inner wing, so that the pressure on the one differs from that on the other, with the result that the outer one is raised.

Therefore, if the centripetal force which causes the turn does not originate from the intentional banking of the planes, this banking which results from the turning

movement produces the necessary force to balance the centrifugal force set up by the circular motion of the machine.

It follows that the amount of the bank during a turn depends on those factors which determine the amount of centrifugal force. Hence, the bank is steeper the faster the flying speed (being proportional to the square of the speed), and the sharper the turn. It may therefore be dangerous to turn too sharply at high speeds.

Equilibrium between centripetal and centrifugal force is important simply in so far as it concerns the movement of the aeroplane along its curved path, or, in other words, the movement of its centre of gravity. But, in addition, the machine itself should be in equilibrium about its centre of gravity—that is, the couples exerted upon it by the air in its dissymmetrical position during the turn must exactly balance one another.

This position of equilibrium during a turn evidently depends on various factors, among which are the means whereby the turn has been produced and the distribution of the masses of the machine.

For instance, if the turn is caused by banking, it might be thought that so long as the cause remained, the bank would continue to grow more and more steep. But usually this is not the case, for if the aeroplane possesses any natural stability, the bank will itself set up a righting couple balancing the couple which produced the bank.

The value of this righting couple depends, of course, on the shape of the aeroplane and especially on the position of its rolling axis. If the machine has little natural stability, the pilot may have to use his controls in order to limit the bank, as otherwise the machine would bank ever more steeply and the turn become ever sharper until the aeroplane fell.*

* Pilots have often mentioned an impression of being drawn towards the centre when turning sharply.

As a rule, the warp is not used for producing a turn, for the majority of machines possess sufficient keel surface to answer the rudder perfectly.

Often the rudder aids the warp in maintaining lateral balance: for instance, by turning to the left a downward tilt of the right wing may be overcome.

Possibly in future the warp will become even less important, so that this device, which is generally thought to have been imitated from birds (which have no vertical rudder), may eventually vanish altogether.* The Paulhan-Tatin "Torpille," referred to in previous chapters, had no warp, neither had the old Voisin biplane, one of the first aeroplanes that ever flew. This was due to the fact that in both cases the keel surface (a pronounced curved dihedral in the "Torpille," and curtains in the Voisin) was sufficient to render the rudder highly effective.

It is to be noted that, whatever the cause of the turn, the dissymmetrical attitude adopted as a result by the aeroplane simultaneously causes the drag to increase while the lift decreases owing to the bank. At the same time, the angle of incidence alters, since any alteration in lateral balance brings about an alteration in longitudinal balance, for rolling produces pitching.

For these reasons *an aeroplane descends during a turn.*

The pilot feels that he is losing air-speed and puts the elevator down. Theory, on the other hand, would appear to teach that he ought to climb. But, as already stated, this apparent divergence is due to the fact that theory applies chiefly to a machine in *normal* flight. When an aeroplane changes its flight and passes from one position to another, effects of inertia may arise during the transition stage which may vitiate purely theoretical conclusions, and in

* Although the author has carefully studied the flight of large soaring and gliding birds in a wind, he has never found them to warp their wing-tips to a perceptible extent to obtain lateral balance, while, on the other hand, probably for this very purpose, they continually twist their tails to right and left.

such a case theory must give way to practice. In any event, practice need not necessarily remain the same should the shape of the aeroplane undergo considerable alterations and, more especially, if in future the lift coefficient becomes very small.*

In conclusion, something remains to be said of the *gyroscopic effect* of the propeller. Any body turning about a symmetrical axis tends, for reasons of inertia, to preserve its original movement of rotation.

The direction of the axis about which turning takes place remains fixed in space, and, in order to alter it, a force must be applied to it, which must be the greater the higher the speed of rotation, the greater the movement of inertia, and the sharper the effort to alter it.

But now arises the curious fact that if it is sought to move the axis in a given direction, it will actually move in a direction at right angles to this. This characteristic of rotating bodies may be observed in the case of gyroscopic tops, which only remain in equilibrium and only adopt a slow conical motion when their axis becomes inclined towards the end of their spinning, for this very reason.

Now a propeller which has a high moment of inertia, especially if of large diameter, and turning at a great speed, constitutes a powerful gyroscope (which is further increased if the motor is of the rotary type).

It follows that any sudden action tending to modify the direction of flight results in a movement at right angles to that desired. Thus, a sudden swerve to one side may pro-

* It may be added that at very high speeds an aeroplane during a sharp turn actually rises instead of coming down, but this is due to quite a different cause. At the moment of turning, when already banked and the rudder is brought into play, the machine for a fraction of time, owing to its inertia, slides outward and upward on its planes. This effect was particularly noticeable during the Gordon-Bennett race in 1913, when, long before the turning-point was reached, the aeroplanes were gradually banked over, until at the last moment a sudden movement of the rudder bar sent them skimming round, the while shooting sharply upward and outward.—TRANSLATOR.

duce a tendency either to dive or to stall, according to which side the swerve is made and to the direction of rotation of the propeller.

Accidents have sometimes been ascribed to this gyroscopic effect, but its importance would appear to have been greatly exaggerated, and so long as the controls are not moved very sharply, it remains almost inappreciable.

CHAPTER X

THE EFFECT OF WIND ON AEROPLANES

EVERY previous chapter related to the flight of an aeroplane in perfectly still air. To round off our treatise, the behaviour of the aeroplane must be examined in disturbed air—in other words, we now have to deal with the effect of wind on an aeroplane.

The atmosphere is never absolutely at rest; there is always a certain amount of wind. The two ever-present characteristic features of a wind are its direction and its speed. No wind is ever regular. Both its velocity and its direction constantly vary and, save in a hurricane, these variations do not depart from the mean beyond certain limits. Hence, the wind as it exists in Nature may be regarded as a normal wind, as if it had a mean speed and direction, with variations therefrom.

These variations may be in themselves irregular or regular up to a point. Near the ground the wind follows the contour of the earth, encounters obstacles, and flows past them in eddies; hence it is perforce irregular, like the flow of a stream along the banks.

Eddies are formed in the air, as in water: valleys, forests, damp meadows where humidity is present—all these produce in the air that lies above them descending currents, sometimes called "holes in the air"; while hills and bare ground radiating the sun's heat produce rising currents of air.

These effects are only felt up to a certain height in the atmosphere, and the higher one flies the more regular

becomes the wind. In the upper reaches the wind seems to pulsate and to undulate in waves comparable to the waves of the sea.

The regular mean wind which reigns there may therefore be considered as possessing atmospheric pulsations, propagated at a speed differing from the speed of the wind itself, comparable to the ripples produced by throwing a stone in flowing water—ripples which move at a speed differing from that of the current itself.

This comparison of a regular wind with a flowing stream enables the effect of such a wind on an aeroplane to be studied in a very simple manner.

For the last time we will refer to that elementary principle of mechanics applicable to any body moving through a medium which itself is in motion—the principle of the *composition of speeds*.

A speed, just as a force, may be represented by an arrow of a length proportional to the speed and pointing in the direction of movement.

For example, let us suppose that a boat is moving through calm water at a speed represented by the arrow OA (fig. 81).

Now, if instead of being still, the water were flowing at a speed represented by the arrow OB, the ship, although still heading in the same direction, would have a *real speed* and direction represented by the arrow OC. This speed is the resultant of the speeds OA and OB, and this composition of speeds, it will be seen, is simply effected by drawing the parallelogram.

The ship will appear still to be following the course OA, which will be its *apparent* course, while in fact following the *real* course OC.

Instead of a ship through flowing water, let us now take the case of an airship or aeroplane moving through a current of air or regular wind. Such a craft, while driven forward through the air by its own motive power at the speed it would attain if the air were perfectly calm, is at

the same time drawn along by the wind together with the surrounding air, of which it forms, as it were, a part, and this without the pilot being able to perceive this motion, unless he looks at some fixed landmark on the ground.

An aeroplane may be likened to a fly in a railway carriage, which is unable to perceive, and remains unaffected by, the speed at which the train is moving.

In a free spherical balloon drifting before a regular wind not a breath of air is perceptible. On board an aeroplane

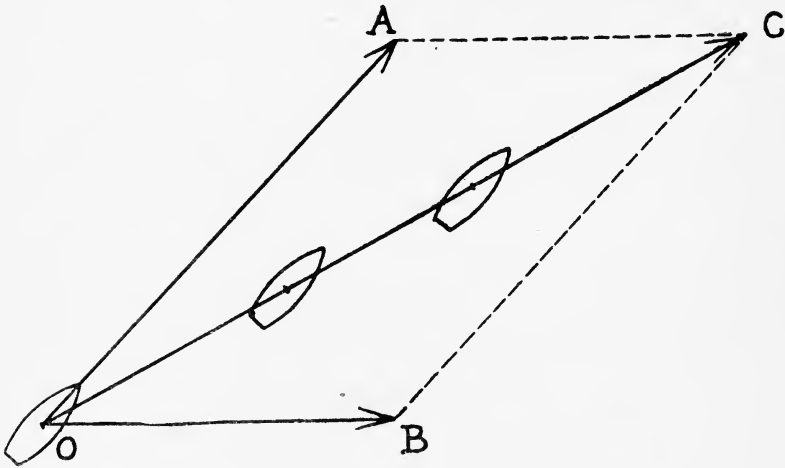

FIG. 81.

or airship only the *relative wind* is felt which is created by the speed of flight, no matter whether in still air or in wind.

In a side-wind, in order to attain to a given spot, a pilot does not steer straight for his objective, but allows for the *drift*, like a boatman crossing a swift-flowing river.

When the direction of the wind coincides with the path of flight the speeds are either added to or subtracted from one another; for instance, an aeroplane with a flying speed of 80 km. per hour in a calm will only have a real speed of 50 km. per hour against a 30-km. per hour wind, but will attain 110 km. per hour when flying before it.

In order to be dirigible, an aircraft must have a speed

greater than that of the wind. In practice an aeroplane virtually never flies in a wind of greater velocity than its own flying speed, and hence is always dirigible.

The wind further affects the gliding path of an aeroplane. For example, if an aeroplane with a normal gliding path OA in a calm (fig. 82) comes down against the wind, its *real* gliding path will be OC_1 , which is steeper than OA , while with the wind behind it will be flatter, as shown by OC_2 . The arrows OC_1 and OC_2 represent the resultant speeds of the gliding speed OA in calm air and of the speeds of the wind OB_1 and OB_2 .

But in all these different gliding paths, the gliding angle

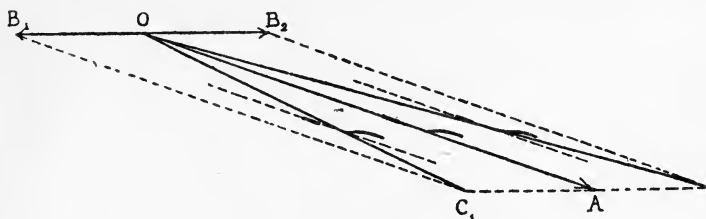

FIG. 82.

of the aeroplane remains the same, since the apparent gliding path relatively to the wind always remains the same.

If the speed of the wind is equal to that of the aeroplane, the machine, still preserving its normal gliding angle, would come down vertically and would alight gently on the earth without rolling forward.

Birds often soar in this manner without any perceptible forward movement, but, apart perhaps from the brothers Wright during the course of their gliding experiments in 1911, no aeroplane pilot would appear to have attempted the feat hitherto.*

* This statement is no longer correct. Many pilots have undoubtedly flown in winds equal and even superior to their own flying speed. Moreover, this vertical descent is sometimes made intentionally with such machines as the Maurice Farman, the engine being stopped and the aeroplane being purposely stalled until forward motion appears to cease and the machine seems to float motionless in the air.—
TRANSLATOR.

A regular wind may be a rising current. In this case, if sufficiently strong, it may render the gliding path horizontal. Thus, if an aeroplane in calm air glides at a speed OA (fig. 83), which has a horizontal component equal to 15 m. per second, and follows a descending path of 1 in 6, a regular ascending current with a speed OB_1 or OB_2 , with a vertical component equal to 2.5 m. per sec., would enable an aeroplane to glide horizontally.

The existence of such ascending currents is sometimes taken in order to explain the soaring flight practised by certain species of large birds over the great spaces of the ocean or the desert. But it is difficult to accept this as the only explanation of this wonderful mode of flight,

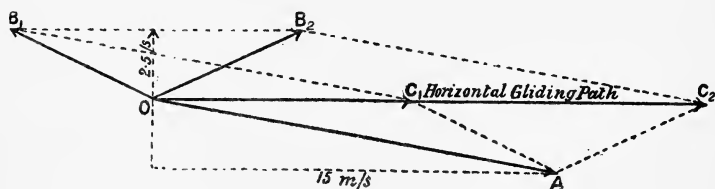

FIG. 83.

which often extends for hours at a time, and would presuppose the permanency of such rising currents. Another explanation will be given hereafter.

We may now examine the effects on an aeroplane of irregularities in the wind.

Any disturbance in the air may at any time be characterised by the modification in speed and direction of the wind; such modifications could be measured by means of a very sensitive anemometer mounted on a universal joint.

The first effect of a disturbance is to tend to impart its own momentary speed and direction to anything borne by the air which it affects. Very light objects, feathers, tissue-paper, etc., immediately yield to a gust.

If an aeroplane were devoid of mass, and therefore of inertia, it would behave in the same way; it would instantly assume the new speed and direction of the wind and would

promptly obey its every whim. In this case the pilot would be unable to perceive, except by looking at the ground, any gusts or their effect; for him it would be the same as though he were flying in a regular wind.

But all aircraft possess considerable mass, and therefore do not immediately obey the modifications resulting from a wind gust in which they are flying. The disturbance therefore exerts upon it, during a variable period, a certain action, also variable, which can be likened to that which would be experienced if the movements of the aeroplane were restrained. This action, which may be termed the *relative action* of a disturbance, modifies both in speed and in direction the *relative wind* which the aeroplane normally encounters, and these modifications can be felt by the pilot and measured by an anemometer.

For the sake of simplicity, let us suppose that a wind of a certain definite value is quite instantaneously succeeded by a wind of another value, the wind being regular in each case. A craft without mass would forthwith conform to the new wind. The primary gust effect would be complete, its relative action would be zero.

For any craft possessing mass the primary gust effect would at first be zero and the relative action at a maximum; but, as the machine gradually yields to the gust, the relative action grows smaller and finally vanishes altogether when the aeroplane has completely conformed to the new wind. The greater the inertia of the machine, the longer will be the transition period.

Still keeping to our hypothesis of an instantaneous change of condition, an anemometer fixed in space and another carried on the aeroplane might for one brief instant record the same indications; but while those of the fixed anemometer would be constant, the other instrument would sooner or later, according to the aeroplane's inertia, return to its original indications.

If it is remembered that gusts, even the most violent, are never perfectly instantaneous, it seems probable that

the relative action of a gust on an aeroplane is never so intense as it would be were the machine fixed in space, and that it dies away the more quickly the lighter the aeroplane.

But the pilot of a machine in flight does not perceive this relative action in the same way that he would if the machine were immovable—for instance, if the aeroplane were struck by a gust coming from the right at right angles, the pilot of a stationary aeroplane would only feel the gust on his right cheek, while in flight he would only perceive the existence of a gust by the fact that the relative wind was just a little stronger on his right cheek than on the left. It is simply a question of the *composition of speeds*.

We have distinguished a primary gust effect and a relative effect. The results of each may now be examined.

The primary effect modifies in magnitude and in direction the *real* speed of the aeroplane, which yields the more slowly the greater its mass and inertia.

Now, instead of consisting, as our hypothesis required, of an instantaneous succession of two winds of different value, a gust is a more or less gradual and wavelike modification of the mean speed of the wind, lasting usually not more than a few seconds.

Hence, if the aeroplane's inertia be sufficient, the cause may cease before the gust has exerted its primary effect on the aeroplane, the whole energies of the gust being absorbed in producing the relative effect.

The direction of flight and the real speed of the aeroplane, provided it has enough inertia, may consequently be only slightly altered by the gust which would pass like a wave past a floating body. This is why, whereas a toy balloon is tossed by every little gust, a great passenger balloon sails majestically on its way without being affected in the slightest degree.

Why, therefore, should this not be the case with an aeroplane which has a mass not differing widely from that

of a balloon? The cause must be sought for in the relative effect of the gust. This relative effect is only slight in the case of a balloon which is based on *static* support according to the Archimedean law; but it affects the very essence of the equilibrium of an aeroplane based on the *dynamic* principle of sustentation by its speed and incidence.

Any variation in the speed or direction of the relative wind, therefore, usually affects the values of the pressures on the various planes, and consequently further affects its attitude in the air which is determined by a perpetual equilibrium.

The effects produced by the relative action of a gust may be divided into two classes: the *displacement effect* and the *rotary effect*.

The *displacement effect* is that produced by the relative action of the gust on the machine as a whole, and seen in the modification of the path followed before by the centre of gravity and the speed at which it moved until then.

The displacement effect must not be confused with the primary gust effect previously referred to.

For instance, if an aeroplane in horizontal flight is struck head-on by a horizontal gust, the primary gust effect takes the shape of a reduction in the real flying speed, which reduction is the greater the smaller the inertia of the machine. But this will not alter the horizontal nature of the flight-path.

On the other hand, the displacement effect produced by the gust will result in raising the whole machine which, owing to its inertia and in increasing measure as its inertia is greater, experiences an increase in the speed of the relative wind, with the result that the lift on the planes also increases.

The *rotary effect* is that produced by the relative action of the gust on the equilibrium of the aeroplane about its centre of gravity. This is due to the fact that the modifications in the relative wind destroy the harmony between

the pressures on the various parts of the aeroplane, which balanced one another and thus maintained the machine in stable equilibrium.

Certain rotary effects are due to the fact that no gust is instantaneous, but always moves at a speed which, however great, is still limited. A gust may therefore first strike one part of the aeroplane and produce a first rupture of equilibrium; then, continuing, it may strike the opposite side which may already have been shifted out of position, and affect this in turn either in the sense of restoring equilibrium or the reverse.

The displacement and rotary effects due to a gust will now be successively examined, beginning with those which affect equilibrium of sustentation and longitudinal equilibrium, these being closely interconnected. For the time being, therefore, we will only deal with gusts moving in the plane of symmetry of the aeroplane—that is, with *straight* gusts, which affect the speed and the angle at which the relative wind meets the planes.

First, let us examine the displacement effect. It will result in a modification in the *lift* of the planes. The lift, normally equal to the weight of the machine, has for its value the lift coefficient of the planes multiplied by their area and the square of the speed. If the lift coefficient remains constant, and the relative wind increases as a result of the gust, the lift of the planes increases; if the speed of the wind diminishes, so does the lift.

It is readily seen that in the case of small variations in the speed, the variations in the lift are increasingly large, the greater the weight of the machine and the lower its normal flying speed. These variations depend neither on the wing area nor on the value of the lift coefficient.

For instance, if an aeroplane weighing 400 kg. and flying at 20 m. per second or 72 km. per hour, experienced, as the result of a gust from the rear, a decrease in the relative speed of 2 m. per second, the lift will decrease by 76 kg. If it weighed 600 kg. instead of 400, its normal flying speed

being still 20 m. per second, the same decrease in the speed would bring about a reduction in the lift of $76 \times \frac{600}{400} = 114$ kg. proportional to the weight.

If, weighing 400 kg., its normal speed were 30 m. per second instead of 20, the same decrease of 2 m. per second in the speed would produce a reduction in the lift of only 52 kg. instead of 76 as before.

These results remain true irrespectively of the plane area and the lift coefficient.*

Now, suppose that, the speed of the relative wind remaining constant, the angle at which it meets the aeroplane changes; the value of the angle of incidence of the planes is thereby modified and with it the lift coefficient. The lift therefore also varies in this case, and a simple calculation shows that these variations are the greater the greater the weight and the smaller the lift coefficient.

For example, a machine weighing 400 kg. and possessing a lift coefficient of 0.05, will, if this lift coefficient is reduced by 0.005—which is equivalent to lessening the angle of incidence by one degree—experience a loss of lift of about 40 kg. If the weight were 600 kg., the loss of lift would be 60 kg.

If it weighed 400 kg. and the normal lift coefficient were 0.025 instead of 0.05, the loss of lift resulting from a re-

* The method of calculation is quite simple.

Example.—If the weight is 400 kg. and the speed 20 m. per second—the square of the latter being 400,—the product of the plane area and the lift coefficient remains 1 whether the area be 20 sq. m. and the lift coefficient 0.05, or the area 25 sq. m. and the lift coefficient 0.04, or whatever be the combination. This being so, if the speed decreases to 18 m. per second, the square of which is 324, it is clear that the lift is reduced from 400 to 324 kg., and consequently there is a reduction in the lift of 76 kg. as stated.

If the normal speed were 30 m. per second, the product of the area and the lift coefficient would be $\frac{400}{900} = 0.444$; the decrease in the speed to 28 m. per second (the square of which is 784) would give the lift a value of $0.444 \times 784 = 348$ kg. The loss of lift therefore would be only 52 kg.

duction of the lift coefficient by 0.005 would be 80 kg. instead of 40 kg.

These results hold good irrespectively of the area and the speed.

Finally, if both the speed and the angle of wind vary at one and the same time, both results are added to one another.

From this it may be deduced that for an aeroplane to experience the least possible loss of lift owing to an atmospheric disturbance, it should be light, fly at a high speed, and possess a big lift coefficient.

These two latter conditions are not so contradictory as might be supposed; and if considered together, further confirm the view expressed in Chapter III., as the result of totally different considerations, that an increase in the speed of aeroplanes should be sought for rather in the reduction of their area than of their lift coefficient. Apart from the question of weight, which will be dealt with further on, this may be one of the reasons why, as a general rule, monoplanes behave better in a wind than biplanes.*

The relative action of a gust moving in the plane of symmetry of an aeroplane, results, as we have just seen, in a modification of the lift of the planes. This modification produces the displacement effect.

Suppose, for instance, that an aeroplane flying horizontally at a definite speed suddenly were to lose the whole of its lift; it would become comparable to a projectile launched horizontally, and, while retaining a certain forward speed, would fall. If the air in no way resisted its fall, this would take place at the rate of any body falling freely in a vacuum; that is, after one second it would have fallen about 5 m., at the end of 2 seconds 20 m., etc.

Its trajectory would be a curve bending ever more steeply

* Responsibility for this statement, in which I do not concur, rests entirely in the author.—TRANSLATOR.

towards the earth. Naturally this curve would be flatter the higher the flying speed of the aeroplane.

Actually the air opposes, in the vertical sense, considerable resistance to the fall of a machine provided with planes, so that an aeroplane would not fall so fast as mentioned above.

Moreover, as a gust is not instantaneous and only lasts a short while, the flight-path straightens out again fairly quickly as soon as the lift returns, and this the more quickly the smaller the mass of the aeroplane.

This modification of the flight-path constitutes the displacement effect due to the gust.

The pilot only feels, in the case under consideration, the sensation of a vertical fall though actually this movement is progressive. According to pilots' accounts these vertical falls are considerable, from which one judges that either the duration of the gusts is fairly long or that the planes may, under given conditions, lose more than their total lift.*

This displacement effect is devoid of danger, when it is not excessive, if it is in the sense of raising the machine. When it is considerable, the pilot corrects it by reducing his incidence by means of the elevator.

On the other hand, if it tends to make the aeroplane fall, it may be dangerous if occurring near the ground; it is here, moreover, that there always exists a source of danger, for eddies are more frequent than higher up in the atmosphere.

Besides, pilots always fear a loss of lift or, what is often the equivalent, a loss of air speed, for, apart altogether

* The discovery made during the inquiry into certain accidents that the upper stay-wires of monoplanes have broken in the air, would at first sight appear to confirm the view that their wings may at times be struck by the wind on their upper surface.

Nevertheless this view should be treated with caution, for the breakage of the overhead stay-wires could be attributed equally well to the effects of inertia produced when, at the end of a dive, the pilot flattens out too abruptly.

from the ensuing fall, the aeroplane then flies in a condition where the ordinary laws normally determining the equilibrium and stability of an aeroplane no longer apply. This stability may become most precarious, and this is apparent to the pilot by the fact that the controls no longer respond. The only remedy is to regain air speed, which is effected by diving.*

Usually, therefore, the correction of displacement effects due to gusts consists in diving. Nevertheless, if a head gust slanting downward forced the aeroplane down, the pilot would naturally have to elevate. In this case there would be no loss of air speed, and the loss of lift would be due to the reduction of the relative incidence.

Let us now turn to the rotary effects of atmospheric disturbances acting in the plane of symmetry of the aeroplane. A machine with a fixed elevator can only fly at a single angle of incidence. Therefore, if the relative wind which normally strikes an aeroplane changes its inclination by reason of a gust, the machine will of its own accord seek to resume, relatively to the new direction of the relative wind, the only angle of incidence at which it flies in longitudinal equilibrium.

The same thing will happen if the displacement effect already referred to should modify the trajectory of the centre of gravity; the latter will always tend to adhere to its flight-path.

The rotary effect resulting will take place all the quicker, and will die away all the more rapidly, as the longitudinal moment of inertia of the machine is smaller. Thus, in the case, already considered, of an aeroplane losing air speed and falling, it may do this bodily, without any appreciable dive, if its moment of inertia is big; whereas, if bow and tail are lightly loaded, it yields to the gust and dives in a more or less pronounced fashion.

* Air-speed indicators, consisting of some form of delicate anemometer, constantly record the relative speed and enable the pilot to operate his controls in good time.

This latter quality would appear to be the better one of the two, since, in the case under consideration, the pilot always has to dive to re-establish equilibrium. Hence, in this respect, an aeroplane should have as small a longitudinal moment of inertia as possible.

Another rotary effect may arise through a cause already referred to—if the disturbance does not reach the main plane and the tail simultaneously. In this case there is exerted on the first surface struck, if considered independently from the rest, a modification in the magnitude and the position of the pressure, which in turn brings about a modification in the couple which it normally exerted about the centre of gravity.

If the couple due to the main plane takes the upper hand, the machine tends to stall; if the reverse takes place, it tends to dive. A stalling aeroplane always loses some of its air speed; moreover, if the gust strikes it head-on the machine is still further exposed, being stalled, to its disturbing effect. As has already been shown, the correcting movement for the majority of cases of displacement effect consists not in stalling but in diving.

For these various reasons, and excepting always the case of a downward current forcing the machine down, the rotary effect of a gust should cause the aeroplane to dive of its own accord.

In this respect, the manner in which fore-and-aft balance is maintained is most important. If the tail is a lifting tail (see fig. 36, Chapter VI.), the pressure normally exerted on the main plane passes in front of the centre of gravity. This being so, the action of a gust striking the main plane first, would produce as its rotary effect a stalling movement, except only if the gust had a pronounced downward tendency, in which case the stalling movement is the right one.

A gust from the rear, striking the tail first, decreases its lift and also provokes stalling. In every case, therefore, the rotary effect of the gust is detrimental to stability.

A lifting tail which, as seen in Chapter VI., is the most defective in regard to lateral stability in still air, is consequently equally unfavourable in disturbed air.

On the other hand, if the tail is normally placed at a negative angle (see fig. 42, Chapter VI.), the normal pressure on the main plane passes behind the centre of gravity. The action of a head gust, unless pointing downward to a considerable extent, in this case produces as its rotary effect a diving movement, and the same is true of a gust from behind which diminishes the downward pressure normally exerted on the tail plane. If the gust is a downward one to a marked extent, it will tend to stall the machine, which, again, is as it should be. In every case the rotary effect of the gust is favourable.

The use of a negative tail plane, which has already been seen to be excellent in regard to stability in still air, is therefore equally beneficial in disturbed air. Nor should this cause surprise.

Previously it was shown that the presence of a plane normally acting in front of the centre of gravity was productive of longitudinal instability, since it really acted as a reversed and overhung weathercock. It is quite clear that if a gust strikes such a plane first, it will tend, being a bad weathercock, to be displaced still further and thereby become still more exposed to the disturbing action of the gust.

On the other hand, if both the main plane and the tail act behind the centre of gravity, where they combine to procure for the machine an excellent degree of longitudinal stability in still air, they will constitute a good weathercock which will always float in a head gust so that the upsetting action vanishes,* and the aeroplane itself absorbs the gust. In so far as gusts from behind are concerned,

* Earlier, it was stated (see p. 170) that longitudinally an aeroplane must necessarily always be a bad weathercock, but some distinction of quality still remains and, so far as the effects of wind are concerned, an aeroplane should belong to a "good variety of bad weathercocks."

this arrangement is again productive of good stability since the rotary effect due to the gust brings about the very manœuvre which the pilot would have otherwise to perform in order to correct the displacement effect.

These rotary effects have an intensity and duration depending on the moment of longitudinal inertia of the machine. The science of mechanics proves that a definite amount of disturbing energy applied to aeroplanes possessing the same degree of longitudinal stability* gives them an identical angular displacement irrespective of their moment of inertia. The latter only affects the duration of the displacement. The greater the moment of inertia, the slower does the oscillation come about.

Nevertheless, it should be remembered that a force, however great, can only put forth an amount of energy proportional to the displacement produced.†

Hence, if the gust is only a brief one, the disturbing energy applied to the aeroplane and the ensuing angular displacement will be all the smaller the more reluctantly the aeroplane yields to the gust. Wherefore, there is a distinct advantage to be derived from increasing the longitudinal moment of inertia.

But, if the gust lasts some considerable time, this advantage disappears and the great moment of inertia has the effect of prolonging the disturbing impulse. Besides, it may happen that two gusts follow one another at a brief interval and that the second, which would encounter an aeroplane with little inertia already re-established in a position of equilibrium, would strike a machine heavily loaded fore and aft before it had recovered, or even when it was still under the influence of the first gust.

* In Chapter VI. it was shown that the longitudinal stability of an aeroplane can be represented by the length of a pendulum arm weighted at the end with the weight of the aeroplane.

† If a pony is harnessed to a heavy wagon, it will be unable to move it; its force will be wasted, since it will produce no energy. But if it is harnessed to a light cart, its force, though smaller than that put forth in the former case, will produce useful energy.

Moreover, for the same reason, the first machine would more readily answer its controls and would respond more perfectly to the wishes of most pilots, who desire, above all, a controllable aeroplane.

It should be noted that, in so far as rotary effects are concerned, it is desirable that gusts should clear an aeroplane as quickly as possible, and, for this reason, it should be fairly short fore and aft, after the example of birds who fly particularly well.

The negative-angle tail complies well with this requirement and also compensates the lessening of the lever arm of the tail plane which ensues through its important increase in stability due to the increase in the longitudinal V .

Moreover, by bringing the main and tail planes closer together, the longitudinal moment of inertia is reduced, whereby the machine is rendered more responsive to its controls.

For these reasons, the author is of opinion that the present type of aeroplane with its tail far outstretched will give way to a machine at once much shorter, more compact, and easier to control.*

Summarising our conclusions, we find that :

(1) In regard to the relative action of gusts, which are the main cause of loss of equilibrium, an aeroplane should be as light as possible, so as to be able to yield in the greatest possible measure to the displacement effect of gusts, which reduces their relative effect. This conclusion is clearly open to question, and may be opposed by the illustration that large ships have less to fear from a storm than small boats. But the comparison is not exact, for the simple reason that boats are supported by *static* means, whereas aeroplanes are upheld in the air *dynamically*.

* Not that it will be possible to suppress the tail entirely, as some have attempted to do. Oscillatory stability (see Chapter VII.) would suffer if this were done, and the braking effect would disappear. Besides, Nature would have made tailless birds, could these have dispensed with their tails.

(2) Regarding its behaviour in a wind, an aeroplane should :

- (a) possess high speed, with the proviso that its speed should not be obtained by reducing its lift coefficient, so that any increase in speed should be achieved rather by reducing the area than the lift coefficient ;
- (b) be naturally stable longitudinally ;
- (c) have a small longitudinal moment of inertia ;
- (d) be short in the fore-and-aft dimension ;
- (e) be so designed that any initial displacement due to a gust causes it to turn head to the gust instead of exposing it still further to its disturbing effect.

The negative tail arrangement seems to answer the most perfectly to (b), (c), (d), and (e).

It has often been stated that those provisions ensuring stability in still air were harmful to stability in disturbed air. If this were true, the future of aviation would indeed be black. Fortunately it is erroneous, even though practice has borne it out hitherto with few exceptions.

It has been attempted, as in the case of the brothers Wright, to overcome this difficulty by only providing the minimum degree of stability essential to the correct behaviour of a machine in still air, leaving the pilot to make the necessary corrections to counteract the disturbing effects of the wind by giving him exceptionally powerful means of control.

The slight degree of natural stability possessed by such an aeroplane renders it most responsive to its controls—a feature agreeable to the majority of pilots. On the other hand, by actuating the control a pilot may unduly modify, even to a dangerous extent, the normal state of equilibrium. More especially is this true of longitudinal equilibrium, for here, as has been shown, a slight degree of stability may change into actual instability—for instance, by putting the elevator down too far. This is due (as explained in

Chapters VI. and VII.) to the fact that the sheaf of total pressures of the aeroplane is thereby altered, with the result that the longitudinal V is diminished, and consequently the diminution of the angle of incidence, instead of increasing stability, as in the case of advancing the centre of gravity, would bring it down to vanishing-point.

Aeroplanes which display a tendency towards uncontrollable dives, are simply momentarily unstable longitudinally and refuse to answer the pilot's controls because, owing to their acceleration, their dive soon becomes a headlong fall, so that the precarious degree of stability which they possessed in normal flight has disappeared. In such a case it would be incorrect to say that an increase of speed augments stability, for, on the contrary, when the speed passes a certain limit termed the "critical speed" (in the author's opinion, this term is not correct, since a well-designed aeroplane should have no critical speed), all stability vanishes.

An aeroplane should always be so designed as to be naturally stable in still air, and at the same time every effort should be made to arrange its structure so as to render it stable also in disturbed air.

It has already been shown that it seems possible, in regard to longitudinal stability, to achieve this result without sacrificing controllability, which would appear to be dependent, above all, on a small moment of inertia.

Whether the negative tail arrangement, previously referred to, or some other similar device should prove the better in the long run, this for the time being is the right road along which to make endeavours and to try to reduce to the lowest possible degree the intervention of the pilot in controlling the stability of an aeroplane. The whole future of aviation is bound up in the solution of this problem. An aeroplane should be able to fly in the worst weather without demanding from its pilot an incessant, tiring, and often dangerous, struggle against the elements. Not until this is achieved will aviation cease to be the sport of the

few and become a speedy and practical, and above all, safe, means of locomotion.

It has ere now been sought to reduce the necessity for constant control on the part of the pilot by rendering aeroplanes *automatically stable*. The problem is an unusually complex one, for automatic stability devices are required to correct not only the effects of gusts that come from without, but faults that arise from within the aeroplane itself, such as a loss of power, motor failure, mistakes in piloting, etc.

This being so, if a device of this nature fulfils one part of its required functions, almost inevitably it will fail in others, and this is the rock against which all attempts so far made have been shattered. Not that the difficulty cannot be overcome, but it is undoubtedly a grave one.

Hitherto such attempts at solution as have been made have usually related to longitudinal stability. Among such devices may be mentioned the ingenious invention of M. Doutré, who utilised the effects of inertia exerted on weights to actuate, at any change of air speed, the elevator through the intermediary of a servo-motor.

Even now some lessons may be drawn from previous attempts. More especially would it seem desirable to prevent the effects of gusts rather than to correct them once they have been produced. The use of "antennæ" or "feelers"—that is, of some kind of organ instantaneously yielding to aerial disturbances and thus preparing, through the intermediary of the requisite controls, an aeroplane to meet the gust—would seem preferable to organs which only right it once it has assumed an inclined position after having been struck by the gust.

Important results, in this respect, also appear to have been obtained by M. Moreau, who seems to have succeeded in applying the principle of the pendulum to produce a self-righting device.

In addition it has been sought to ensure automatic stability by constantly maintaining the air speed of an

aeroplane. But it has already been shown that this is inadequate in certain circumstances, more especially if the aeroplane has a small lift coefficient, which is the case with machines of large wing area, and the lift often decreases to a far greater extent as the result of a decrease in the relative incidence than in the speed. Hence, not only the relative speed, but the relative incidence should be preserved.

In regard to the effects of wind alone, therefore, the problem is already complicated enough; but it becomes even more complex if disturbances due to the machine itself are taken into consideration.

Without the slightest wish to deny the great importance of the problem, the author, nevertheless, reiterates his opinion that the *first* necessity is to so design the structure of an aeroplane as to render it immune from dangers through wind. Later, an automatic stability device could be added in order to correct in just proportion the effects of gusts and further to correct disturbances due to the machine itself. If this were done, the functions of automatic stability devices would be greatly simplified.

In addition, it should not be forgotten that by adding to an aeroplane further moving organs which are consequently subject to lagging and even to breakdowns, an element of danger is created. In any event, any such device must perforce constitute a complication.*

Until now only those gusts have been considered which blow in the plane of symmetry of the aeroplane—straight gusts which only affect the flying and longitudinal

* Virtually, this stricture, while perfectly correct in itself, only applies to such extraneous stability devices as those of Doutre and Moreau, and not to the automatic stability inherent in the forms of the aeroplane itself which has been produced by J. W. Dunne. This latter possesses automatic stability in both senses, and in principle is based on the automatic maintenance of air speed without the pilot's intervention. In this respect it undoubtedly constitutes one of the greatest advances yet made in aviation, though opinions may well differ on the point whether it is desirable to rob the pilot of control in order to confide it to automatic mechanism.—TRANSLATOR.

equilibrium of the machine. Let us now examine the effect of side-gusts. By doing so, we shall have considered the effect of almost every variety of aerial disturbance, which can in most cases be resolved into an action directed in the plane of symmetry of the aeroplane and into one acting laterally.

In this case again we distinguish a primary effect and a relative effect.

If the aeroplane had no inertia, it would immediately be

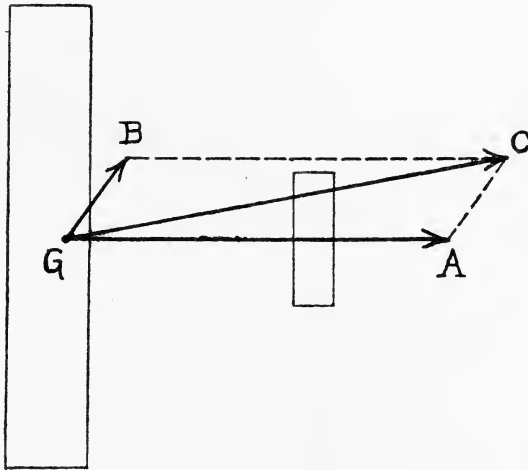

FIG. 84.

carried away by the gust together with the mass of supporting air, and this movement would not be perceptible to the pilot except by observing the ground beneath. But this is a purely hypothetical case, and the gust exerts a relative action on the machine, which is the more pronounced the greater the mass of the latter.

This action is perceptible by a modification in the direction and speed of the relative wind. For, if the aeroplane were flying in still air, thereby encountering a relative wind GA (fig. 84), and were struck by a lateral gust whose action is represented by the speed GB, the relative speed of the machine becomes GC. Both the

magnitude and direction of the speed have, consequently, altered.

The fact of the relative speed varying in magnitude shows that, apart from effects due to its dissymmetrical position, the relative action of a side-gust must exert on the flying and longitudinal equilibrium an influence similar to that produced by the straight gusts already considered.

A lateral gust, therefore, can cause an aeroplane to rise or fall at the same time that it disturbs its longitudinal equilibrium. But for the sake of simplicity this part of the effects of side-gusts may be ignored, and only those effects need be taken into account which modify the direction of flight, and lateral and directional stability.

First, the *displacement effect* due to the relative action of a side-gust consists in creating a centripetal force tending to curve the flight-path and to produce a turn in the direction opposite to that from which the gust comes.

Among the *rotary effects*, as in the case of straight gusts, that particular one should first be distinguished which causes an aeroplane, in regard to directional equilibrium, to adhere to its flight-path—or, in other words, to behave like a good weathercock.

If the flight-path curves, as the result of the displacement effect of a gust, in the opposite direction to that from which the gust comes, the rotary effect which will tend to make the aeroplane adhere to its new flight-path will cause it to be exposed still further to the disturbing effect of the gust. It will turn away from the wind. So far as this point is concerned, it would seem desirable that an aeroplane should take up its new flight-path—as slowly as possible.

But a second rotary effect causes the aeroplane to assume the new direction of the relative wind, like a good weathercock, and this is an advantage, since, by heading into the wind, the lateral disturbing effect of the gust is damped out.

Of these two rotary effects the second is probably the first to occur and to remain the more intense.

In order to reduce the first rotary effect, the lateral

resistance of the aeroplane—that is, its keel surface—should not exceed certain proportions. Moreover, the directional stability should also be reduced to a minimum from this point of view; the second and more important rotary effect, on the other hand, points to an increase in directional stability as desirable.

Both theories have their friends and foes, and here again the view has been advanced that the aeroplane should be given only that measure of stability which is strictly necessary in order to prevent it from yielding too easily to the rotary effects of gusts and to render it easily controllable. Such a reduction in directional stability is not so detrimental as a diminution of longitudinal stability, since it in no way affects the cardinal principles of sustentation.

Nevertheless, in the author's opinion a definite degree of directional stability is desirable, since this would also produce some amount of lateral stability which is always somewhat defective. In any case, usually the structure of the aeroplane and the rudder in the rear suffice for the purpose.

There remain the most important rotary effects due to side-gusts—those which affect lateral stability.

Any modification in the direction of the relative wind results in a lateral displacement of the normal pressure on the main planes, which causes a couple tending to tilt the aeroplane sideways. If that wing which is struck by the gust rises, the aeroplane will turn into the opposite direction, thus turning *away from the wind*, and thereby, as already seen, exposes itself still further to the disturbing effect of the gust.

But if the wing struck by the gust falls, the aeroplane swings round, *heading into the wind*, which damps out the disturbing effect. These movements are intensified by reason of the gust not striking both wings at once.

According to the principle already cited, the initial displacement due to a gust should cause an aeroplane to

turn into the wind instead of causing it to become exposed to the disturbing influence still further, which renders the second rotary effect the more favourable.

If the wings are straight and, still more, if they have a lateral dihedral or ∇ , the first effect is produced. Hence a lateral dihedral seems unfavourable in disturbed air. Besides, it is fast disappearing, and pilots of such machines are obliged to counteract the effects of gusts by lowering the wing struck first—that is, of momentarily suppressing, as far as is in their power, the lateral dihedral, while swinging round into the wind.

On the other hand, if the wings have an inverted dihedral or Λ , the rotary effect of a side-gust will be the second and desirable effect; the aeroplane will turn into the wind of its own accord, which will cause the disturbing effect to disappear.

Captain Ferber from the very first pointed out this fact and remarked that sea-birds only succeeded in gliding in a gale because they placed their wings so as to form an inverted dihedral angle. But he also thought that these birds could only assume this attitude, believed by him to be unstable, by constant balancing. In Chapters VIII. and IX. it was shown that it is possible, by lowering the rolling axis of an aeroplane in front (by lowering the centre of gravity or, better, by raising the tail), to build machines with wings forming a downward dihedral and nevertheless stable in still air.*

In regard to lateral stability, as with longitudinal, the natural stability of an aeroplane and good behaviour in a wind are, contrary to general opinion, in no wise incompatible, and both these important qualities can be obtained in one and the same machine by a suitable arrangement of its parts.

* As previously mentioned, the "Tubavion" monoplane has flown with its wings so arranged, and the pilot is stated to have noted a great improvement in its behaviour in winds. This machine had a low centre of gravity and a high tail.

Attempts to produce automatic lateral stabilisers have hitherto not given very good results.*

So far as the moment of rolling inertia is concerned, previous considerations point to the desirability of reducing this as much as possible by the concentration of masses. The machine is thus rendered easily controllable, and the rapidity of its oscillations guards against the danger arising from too quick a succession of two gusts. This is of exceptional importance from the point of view of lateral stability, which we know to be the least effective of all or, at any rate, the most difficult to obtain in any marked degree.

Summarising these conclusions, it may be stated, that for good behaviour in winds, an aeroplane should :

- (1) be light, thus yielding more readily to the primary effect of gusts, whereby it is not so much affected by their relative action; only if this relative action could be wholly eliminated would an increase in the weight become an advantage;
- (2) fly normally at high speed, provided that an increase in speed be not obtained by unduly reducing the lift coefficient;
- (3) be naturally stable both longitudinally and laterally;
- (4) have a small moment of inertia and its masses concentrated;
- (5) head into the wind instead of turning away from it.

The fulfilment of the last condition is the most likely to produce the best results in regard to the behaviour of an aeroplane in a wind, and this has been shown to be in no way incompatible with excellent stability in still air and adequate controllability. The arrangement proposed by the author—a negative-angle tail and a downward

* This is hardly correct so far as the Dunne aeroplane is concerned, which is automatically stable in a wind. This machine, it should be noted, has in effect a downward dihedral and a comparatively low centre of gravity, coupled with a relatively high tail which is constituted by the wing-tips.—TRANSLATOR.

dihedral*—is not perhaps that which careful experiment methodically pursued would finally cause to be adopted; but at any rate it provides a good starting-point.

What is required *first of all* is to so design the structure itself of the aeroplane as to render it immune to danger from gusts. The future of aviation depends upon this to a large extent, and it is for this reason that attention has been drawn to it with such insistence in these pages, for in this respect much, if not almost all, remains to be done.

Afterwards, may come the study of movable organs producing automatic stability, and in all probability this study will have been greatly simplified if the first essential condition has been complied with.

Who knows whether one day we shall not learn how to impress into our service, like the birds, that very internal work of the wind which now constitutes a source of danger and difficulty? Some species of birds appear to know the secret of how to utilise the external energy of the movements of the atmosphere and to remain aloft in the air for hours at a time without expending the slightest muscular effort.

It is certain that for this purpose they make use of ascending currents, but it is difficult to believe that these currents are sufficiently permanent to explain the mode of soaring flight alluded to.

More probable is it that birds which practise soaring flight—be it noted that they are all large birds, and consequently possessing considerable inertia—meeting a head gust, give their wings a large angle of incidence and thus rise upon the gust, and then glide down at a very flat angle in the ensuing lull.

Even in our latitudes certain big birds of prey, such as the buzzard, rise up into the air continuously, without any motion of their wings, *but always circling*, when the wind

* This arrangement was first proposed by the author in a paper contributed to the Académie des Sciences on March 25, 1911 (*Comptes Rendus*, vol. clii. p. 1295).

is strong enough. This circling appears essential, and may possibly be explained on the supposition that the circling speed is in some way connected with the rhythmic wave-like pulsations of the atmosphere in such a fashion that these pulsations, whether increasing or diminishing, are always met by the bird as increasing pulsations, and on this account it circles.

It appears in no way impossible that we should one day be able to imitate the birds and to remain, without expending power, in the air on such days when the intensity of atmospheric movements, an inexhaustible supply of power, is sufficient for the purpose.

One thing is to be remembered: wind, and probably irregular wind, is *absolutely essential* to enable such flight to be possible; it would be an idle dream to hope to overcome the never-failing force of gravity without calling into play some external forces of energy, and on those days when this energy could not be derived from the wind, it would have to be supplied by the motor.

But in any event this stage has not yet been reached, and before we attempt to harness the movements of the atmosphere they must no longer give cause for fear. To this end the aerial engineer must direct all his efforts for the present.

The really high-speed aeroplane forms one solution, even though probably not the best, since such machines must always remain dangerous in proximity to the surface of the earth.*

Without a doubt, a more perfect solution awaits us somewhere, and the future will surely bring it forth into the light. On that day the aeroplane will become a *practical* means of locomotion.

Let the wish that this day may come soon conclude this

* Slowing up preparatory to alighting forms no solution to the difficulty, since the machine would lose those very advantages, conferred by its high speed, precisely at the moment when these were most needed, in the disturbed lower air.

work. Every effort has been made to render the chapters that have gone before as simple and as attractive as the subject, often it is to be feared somewhat dry, permitted.

Not a single formula has been resorted to, and if the author has succeeded in his task of rendering the understanding of his work possible with the simple aid of such knowledge as is acquired at school, this is mainly due to the distinguished research work which has lately furnished aeronautical science with a mass of valuable facts: to the work of M. Eiffel, to which reference has so often been made in the foregoing pages.

No more fitting conclusion to these chapters could therefore be devised than this slight tribute to the indefatigable zeal and the distinguished labours of this great scientific worker who has rendered this book possible.

UNIVERSITY OF CALIFORNIA LIBRARY
BERKELEY

THIS BOOK IS DUE ON THE LAST DATE
STAMPED BELOW

Books not returned on time are subject to a fine of 50c per volume after the third day overdue, increasing to \$1.00 per volume after the sixth day. - Books not in demand may be renewed if application is made before expiration of loan period.

APR 4 1917

APR 30 1917

JUN 25 1917

JUL 27 1917

AUG 28 1917

SEP 11 1917

APR 16 1921

JAN 4 1932

26 Oct '55 VH

OCT 12 1955

21 May '60 FW

REC'D LD

MAY 14 1960

19 Jun '63 SD

REC'D LD

JUN 18 1963

~~15 NOV 63~~

J LD

NOV 8 '64 - 1 PM

Y-Ré
2 25 net

343112

Duchêne

TL670

D77

UNIVERSITY OF CALIFORNIA LIBRARY

