

UNIVERSITY OF ST. MICHAEL'S COLLEGE



3 1761 01921551 6

Digitized by the Internet Archive  
in 2008 with funding from  
Microsoft Corporation





THE FOUR GOSPELS  
WITH A  
PRACTICAL CRITICAL COMMENTARY

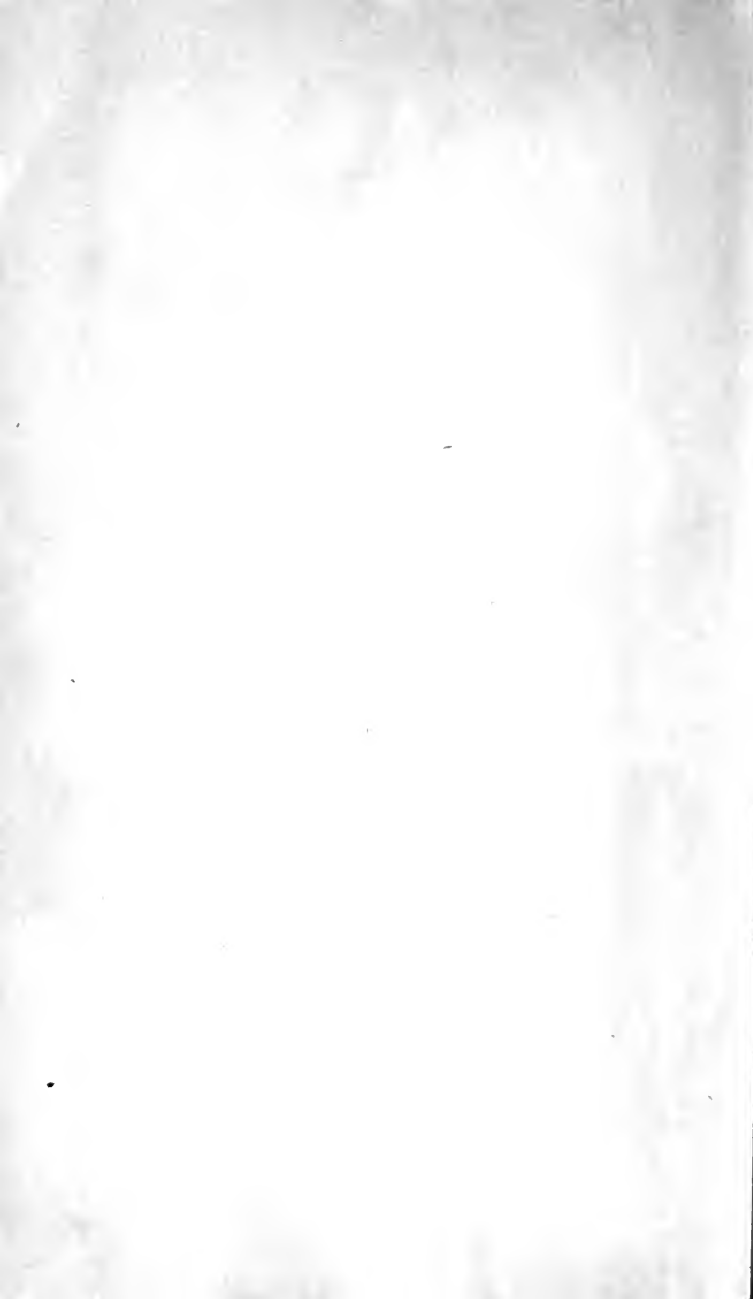



# PALESTINE, IN THE TIME OF CHRIST.

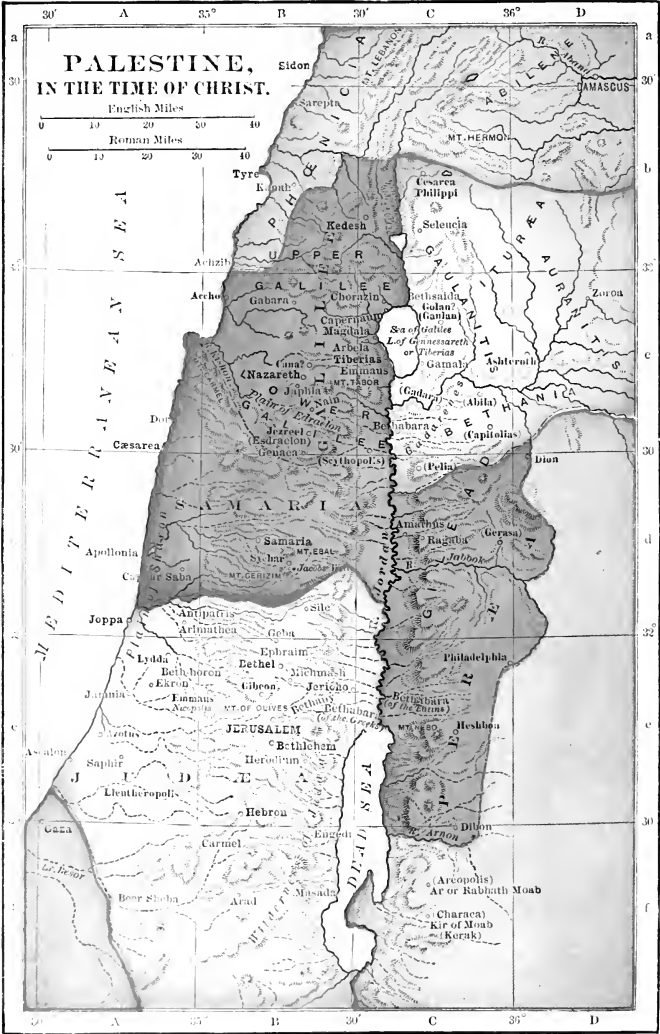
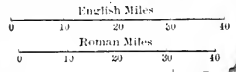



# THE FOUR GOSPELS

*With a  
Practical Critical Commentary  
for Priests and Students*

By

REV. CHARLES J. CALLAN, O. P.

LECTOR OF SACRED THEOLOGY AND PROFESSOR OF SACRED SCRIPTURE IN THE  
CATHOLIC FOREIGN MISSION SEMINARY, OSSINING, N. Y.



SECOND AND REVISED EDITION



NEW YORK  
JOSEPH F. WAGNER (INC).  
LONDON: B. HERDER

**Nihil Obstat**

E. G. FITZGERALD, O. P., S. T. B.

J. A. McHUGH, O. P., S. T. LR.

**Imprimi Potest**

J. R. MEAGHER, O. P., S. T. LR.

**Nihil Obstat**

ARTHUR J. SCANLAN, S. T. D.

*Censor Librorum*

**Imprimatur**

✠ JOHN CARDINAL FARLEY

*Archbishop of New York*

NEW YORK, December 10, 1917

Copyright, 1918, by JOSEPH F. WAGNER (Inc.), New York



## PREFACE

**T**HE study of Holy Scripture, and, in particular, the study of the Gospels, which give us the living and life-giving words and deeds of our Blessed Redeemer Himself, is at once a duty and a pleasure, a labor and a delight, than which there can be none more vital and all-important to the deeper religious life and fruitfulness of all Christians, and especially of those whose high office it is to guide and instruct others by holy words, precepts, and examples to virtuous living and to the ultimate perfection and rewards of the Christian life. This is what St. Paul was teaching when, moved by the Holy Ghost, he penned to Timothy those inspired words: "All Scripture, inspired of God, is profitable to teach, to reprove, to correct, to instruct in justice, that the man of God may be perfect, furnished to every good work."<sup>1</sup>

It is mainly through the Scriptures that we know God, and that we hear His words and learn the message He has delivered to mankind. Hence St. Jerome says that "to be ignorant of the Scripture is not to know Christ,"<sup>2</sup> while, as the same holy doctor elsewhere affirms, "a man who is well-grounded in the testimonies of the Scripture is the bulwark of the Church."<sup>3</sup> In the pages of the sacred books, and above all in the Gospels, we behold "the Image of Christ standing out before us, living and breathing, diffusing everywhere around consolation in trouble, encouragement to virtue, and attraction to the love of God; there we find so many references to the holy Church, so many ready and convincing arguments regarding her institutions, her nature, her office, and her gifts; there also the apostolic man finds abundant and excellent assistance, most holy precepts, gentle and strong exhortation, splendid examples of every virtue, the promise of eternal reward and the threat of eternal punishment, uttered in terms of solemn import, in God's name, and in God's own words."<sup>4</sup>

The Gospels are books of history, the facts of which are as well authenticated and as well attested to as are the best established facts

<sup>1</sup> 2 Tim. iii. 16, 17.

<sup>2</sup> In Isaiam, liv. 12.

<sup>3</sup> In Isaiam Prol.

<sup>4</sup> Leo XIII, Prov. Deus.

of any human history. They are books of theology, containing dogmatic and moral principles, doctrines, laws; and hence from them a great portion of our technical and scientific theology has been drawn. Finally, the Gospels are books of piety and devotion, for in them we see the God-man manifesting to us by word and example the life of the spirit in action, wrought to its highest perfection. These are the reasons why the faithful servants of Christ and His Church have ever read, studied, and loved the sacred pages of the Gospels.

It follows from what has been said that, while the study of the words of Christ, as handed down to us by the inspired Evangelists, is both the duty and the privilege of every intelligent Christian who desires to know God more directly and more intimately, through His own divine words, this sacred study is an absolute necessity for all those who profess to follow more strictly in the footsteps of the Saviour as His ministers and vicars in caring for souls, or who are aspiring to and preparing for that great calling. This deduction is obvious. How can he be a faithful disciple who has little or no acquaintance with the words and wishes of his Master? How can he be a genuine theologian who is ignorant of the principal source of the revelations from which theology is built? How can he be an effective and fruit-bearing preacher who knows not the word of God which he is supposed to preach, who is unfamiliar with the message which it is his duty to deliver? Rightly, indeed, did Pope Leo XIII say: "Those preachers are foolish and improvident who, in speaking of religion and proclaiming the things of God, use no other words but those of human science and human prudence, trusting to their own reasonings rather than to those of God. Their discourses may be brilliant and fine, but they must be feeble and they must be cold, for they are without the fire of the utterance of God, and they must fall far short of that mighty power which the speech of God possesses." \* But those, on the contrary, who are permeated with the words and thoughts of the sacred pages, "who infuse into their efforts the spirit and strength of the word of God, 'speak not in word only, but in power also, and in the Holy Ghost, and in much fulness.'" \*

All this is evident from the very nature of things, but it is also confirmed by the life and experience of all the great theologians and preachers of every age. St. Augustine, St. Jerome, St. Chrysostom, St. Thomas Aquinas, Suarez, Bossuet, Fénelon, Lacordaire, Monsabre, and the like, could never have been what they were as theo-

\* Prov. Deus.

\* Leo XIII, Prov. Deus.

logians and sacred orators had it not been for their assiduous reading of the Scripture and devout meditation on its pages. It was this realization of the importance of the matter that moved St. Jerome to write to Nepotian: "Often read the divine Scriptures; yea, let holy reading be always in thy hand; study that which thou thyself must preach. . . . Let the speech of the priest be ever seasoned with Scriptural reading."<sup>7</sup> And this again was what St. Paul had in mind when to Timothy, and through him, to the clergy as a whole, he addressed those imperative words: "Take heed to thyself and to doctrine: be earnest in them. For in doing this thou shalt both save thyself and them that hear thee."<sup>8</sup>

But the student of any considerable part of Holy Scripture must not and cannot entirely rely on himself for a correct understanding of many things that are found therein. By its nature the word of God is not easy to comprehend. Aside from the fact that it has been dictated by the Holy Ghost; aside from the supernatural revelation — the deep mysteries of faith of which it is the embodiment, and which unaided human reason is impotent to grasp and fathom; aside also from the different senses, literal and mystical, with which it has been enriched by God its author, there are many other difficulties which stand in the way of a ready and accurate comprehension of the meaning of the inspired Scriptures on the part of an ordinary reader or student. There is the language in which they were first set down; there are the human customs and manners to which they so often refer; there are the peculiar ways of thinking and speaking of their original human agents; there are the peoples, times, and circumstances amid which they were dictated and composed, — all of which are decidedly unfamiliar and foreign to the great majority of us in the western world, and in particular to students who are beginning their studies.

As a result of these difficulties, inherent to the nature, origin, and dress of all parts of the sacred writings, it is clear that the Scriptural student must have a guide, must have direction and help, if he is going to understand aright what he reads and studies. If, as St. Jerome tells us, "the office of a commentator is to set forth, not what he himself would prefer, but what his author says,"<sup>9</sup> it at once becomes doubly evident that all others need special assistance and guidance, and this is what a commentary is supposed to provide.

Years of experience in the class room have convinced the present writer — as indeed even a little experience must convince anyone —

<sup>7</sup> De Vita cleric. ad Nepot.

<sup>8</sup> 1 Tim. iv. 16.

<sup>9</sup> Ad Pammachium.

BS  
2555  
.C

that the mere taking of notes during the Scripture classes, or the mere listening to a professor, is a failure for the vast majority of students. The lecture may be ever so entertaining and instructive, it may develop and expose the subject ever so thoroughly, it may be ever so lucid and practical, but if the ordinary student is left to his memory day after day, or to a few hurried and disconnected notes which he may be able to get down during the class hour, his Scriptural equipment, at the end of his course, must of necessity be very meagre and far short of what it ought to be. A text book in exegesis, something around which the pupil can group what he hears, something which, when he retires to his study, will recall to his mind in an orderly and connected manner what he may have learned in the class room, is just as essential for profit and progress in Scripture as it is in theology, or philosophy, or any other branch of ecclesiastical study. Moreover, if, in after years, the priest is to be able to understand and make use of the Scriptures as he ought, he should have some book which he used during his course in the Seminary, with which, consequently, he is familiar, and to which he can readily have recourse at any time.

But a suitable commentary on the Gospels, or on any part of the New Testament, must provide many things. It must not only explain and interpret the sacred text in conformity with the teachings of the Church and the doctrines of the Fathers and theologians, but it must also, to be profitable, take into account the conditions and needs of the times and of those who are to study and use it. Hence it must avoid excess in length and excess in brevity. It must take care to treat everything essential, and in a manner suited to its end and purpose; but it must at the same time strive to avoid things useless and irrelevant. Much precious time to no profit can easily be squandered by dwelling too long on disputed questions, and by vain and prolonged attempts to reconcile the various opinions and sometimes curious speculations of doctors and commentators. Against all these tendencies the practical commentary must be at pains to guard. Our burdened students and busy priests need what is useful and practical; they have no time for the curious, unless things essential are to be sacrificed. All that is necessary they want. They want, in the first place, a clear explanation of the meaning of the sacred text; they want explained chronological and topographical difficulties of moment; they want reconciled historical and other apparent discrepancies; they want treated, or at least indicated, those dogmatic and moral passages on which much of our theology de-

pend; but all this our busy priests and students require to be done in the briefest and simplest manner that is adequate to the necessities of the case.

Such a commentary on the Gospels the author of the present work has endeavored to provide for the Catholic clergy, and for all intelligent readers and students of the records of the words and deeds of Christ. The author is well aware of the excellent qualities of Dr. MacEvilly's work in English, and of other English works on single Gospels. He is also well aware of the enduring merits of those many other splendid commentaries on the four Gospels in Latin, French, German, and Italian. But Dr. MacEvilly's work, as well as those other commentaries, for the most part, is altogether too long for a text book and for convenient use in the class room, particularly when there is question of a correlated study of all the Gospels. As reference books those lengthy commentaries are invaluable, and in this respect they can never be entirely supplanted by briefer works. They are especially useful for the professor and for the advanced student who may desire on a particular question a more exhaustive treatise than is furnished by the present work. But there has long been need of a briefer and more practical work on the Gospels in English — and this in a single volume of convenient size. The author, therefore, humbly submits this new commentary to its readers hoping that it will, at least to some extent, supply this need, and thereby serve the end and purpose for which it has been written.

Doubtless there will be some diversity of opinion as to what such a work should embrace, as to the manner in which certain questions should be treated, and the like; but in all these matters, and as regards any defects that may be discovered in this work, the author is trusting to the kind and indulgent consideration of his readers. He has been constantly aware, during the years of labor spent in the preparation of this volume, of the vast importance of the whole matter, and of the weight of the task in hand. He lays no claims to inerrancy, but he feels he can say with all assurance that there is nothing in the present work which is not based on the best Catholic authorities, a list of whom will be found at the end of the volume. If perchance anything has crept into this work which is not in harmony with these standard Catholic authorities, it is assuredly unknown to the author and has been entirely beside his intention. Where opinions on disputed passages have been so many as to be tedious or confusing, only those have been chosen which seemed most probable and convincing. If Protestant authors have

been consulted and quoted at times, this has been in matters, either where there was no question of doctrine, or where their opinions were in perfect conformity with Catholic teaching and principles.

The English text of the Gospels used in this volume is that published by John Murphy Company with the approbation of Cardinal Gibbons. The text of the Vulgate has not been included in order not to have the book too bulky and cumbersome.

CHARLES J. CALLAN, O.P.



# CONTENTS

	PAGE
PREFACE . . . . .	v
 <b>THE GOSPEL ACCORDING TO ST. MATTHEW</b>	
Introduction . . . . .	1
The Hidden Life of Jesus (I-II) . . . . .	5
The Public Life of Jesus (III-XXV) . . . . .	17
The Sorrowful Life of Jesus (XXVI-XXVII) . . . . .	165
The Glorious Life of Jesus (XXVIII) . . . . .	188
 <b>THE GOSPEL ACCORDING TO ST. MARK</b>	
Introduction . . . . .	194
The Preparation (I. 1-20) . . . . .	198
The Public Ministry in Galilee (I. 21-IX) . . . . .	200
The Public Ministry in Judea (X-XIII) . . . . .	235
The Passion and Death of Jesus (XIV-XV) . . . . .	249
The Glory of Jesus (XVI) . . . . .	256
 <b>THE GOSPEL ACCORDING TO ST. LUKE</b>	
Introduction . . . . .	261
Prologue (I. 1-4) . . . . .	265
Preparation for the Public Life (I. 5-IV. 13) . . . . .	266
The Ministry in Galilee (IV. 14-IX. 50) . . . . .	294
The Last Months of the Public Life (IX. 51-XIX. 27) . . . . .	319
Holy Week (XIX. 28-XXIII. 56) . . . . .	372
Resurrection, Manifestations, and Ascension (XXIV) . . . . .	392
 <b>THE GOSPEL ACCORDING TO ST. JOHN</b>	
Introduction . . . . .	400
Prologue (I. 1-18) . . . . .	406
The Manifestation of the Divinity of Jesus During the Public Life (I. 19-XII. 50) . . . . .	412
The Passion of Jesus (XIII-XIX) . . . . .	492
The Resurrection and Apparitions of Jesus (XX. 1-XXI. 23) . . . . .	526
Epilogue (XXI. 24, 25) . . . . .	534

HARMONY OF THE FOUR GOSPELS . . . . .	536
GENEALOGY OF THE HERODS . . . . .	545
BIBLIOGRAPHY . . . . .	546
INDEX OF SUBJECTS . . . . .	551

## MAPS

MAP OF PALESTINE . . . . .	<i>Frontispiece</i>
PLAN OF THE TEMPLE OF JERUSALEM . . . . .	Opp. 134

THE FOUR GOSPELS  
WITH A  
PRACTICAL CRITICAL COMMENTARY

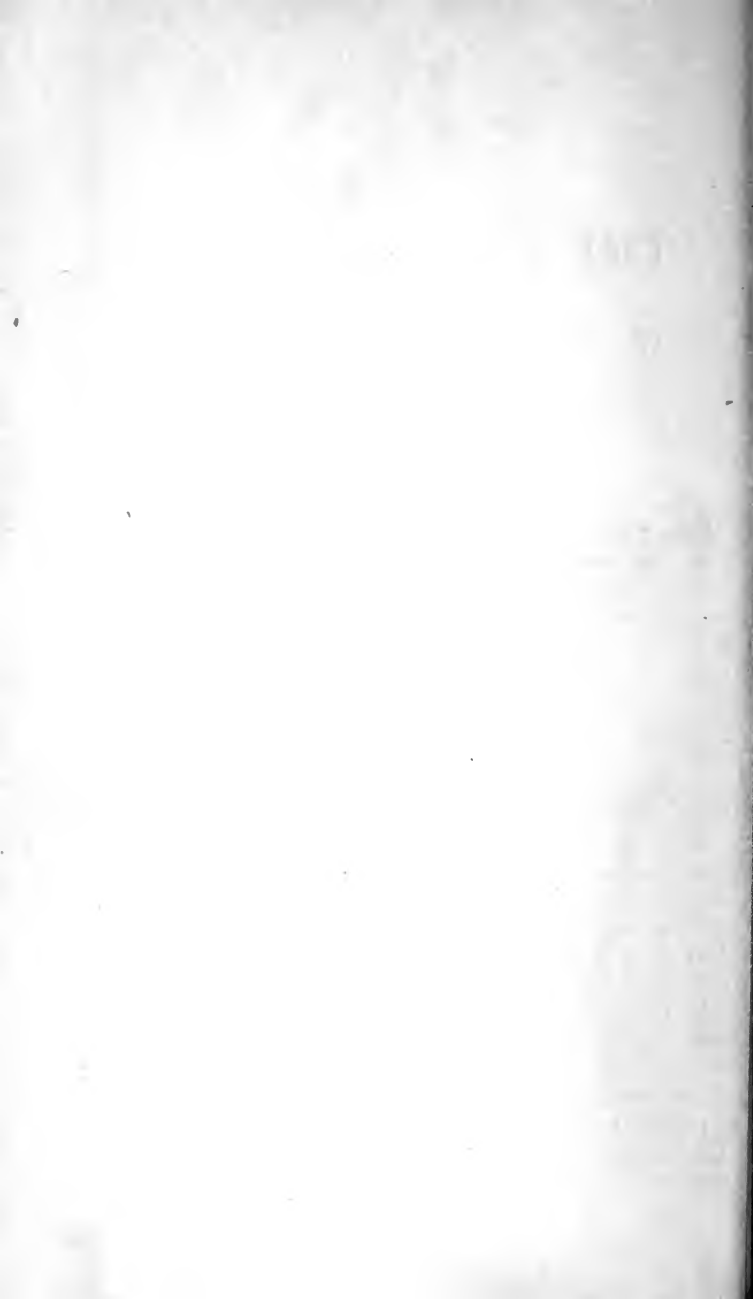

# THE FOUR GOSPELS

## THE GOSPEL ACCORDING TO ST. MATTHEW

### INTRODUCTION

I. **St. Matthew.** St. Matthew, also called Levi by Mark and Luke, was probably a native of Galilee. He was the son of Alpheus (Mark ii. 14); and, when called by our Lord to the apostolate, was a tax collector at Capharnaum (Matthew ix. 9; Mark ii. 14; Luke v. 27). Aside from his call, his occupation, and a farewell feast he gave at the time of his conversion (Matthew ix. 10; Luke v. 29), the Gospels tell us nothing more about him. According to tradition he preached for a number of years throughout Palestine, especially in Judea (Clem. Alex., *Paedag.* ii. 1); and afterwards, about A.D. 41 or 42, went to the Gentiles, most likely to Ethiopia. Some say he died a natural death, others that he was martyred in Ethiopia.

There can be no doubt that the Matthew of the First Gospel is the same person as Levi in Mark and Luke, because the circumstances of the three accounts are identical. It was quite common for Jews to change their names, and it is most probable that St. Matthew, out of gratitude to God for his conversion, changed his name from Levi to Matthew, which means *gift of God*.

II. **Time and Place of Writing.** According to the testimony of ancient writers St. Matthew was the first of the Evangelists to compose a Gospel. Eusebius (*Hist. Eccl.* iii. 24), St. Chrysostom (*In Matt. Hom.* i. 3), St. Jerome (*In Matt. Prolog.*) and others are of the opinion that Matthew wrote his Gospel about the year 41 or 42. This is likewise the opinion of Cornely, Patrizi, Vigouroux, and many more. Others believe that the Gospel was written later, be-

tween A.D. 50 and 60, and St. Irenaeus (*Adv. Haer.* iii. 1) seems to say that Matthew wrote his Gospel while Peter and Paul were preaching in Rome (about A.D. 60-61). That it was written a number of years after our Lord's Ascension is evident from chapters xxvii. 8; xxviii. 15.

The place of writing the First Gospel is also uncertain, but it seems very probable that it was in Palestine, perhaps at Capharnaum.

**III. Purpose and Motive.** St. Matthew wrote his Gospel for the Jewish Christians of Palestine. This is clear from the contents of the Gospel. Unlike the other Evangelists the author of the First Gospel never seems to think it necessary to explain Jewish customs and manners, or the topography and provincial peculiarities of Palestine. His aim was to prove to his countrymen that our Lord was in truth the Christ, the expected Messiah; and to this end he is ever citing the Messianic prophecies of the Old Testament and showing that they were fulfilled in Jesus. He assumes at all times that his readers are perfectly familiar with all his references to the Old Testament. The First Gospel contains more than sixty-five quotations from the Old Testament — more than in the three other Gospels put together.

**IV. Language.** Papias, Bishop of Hierapolis, in the first half of the second century, as well as other Fathers, tells us that Matthew wrote his Gospel in Chaldean or Aramaic, called Syro-Chaldaic, the Hebrew of the New Testament. "Matthew," he says, "composed the oracles (*τὰ λόγια*) in the Hebrew tongue, and every one interpreted them as he was able" (*Euseb. Hist. Eccl.* iii. 39). St. Irenaeus (*Haer.* iii. 1) categorically relates: "Matthew wrote a Gospel among the Hebrews in their dialect while Peter and Paul were founding the Church at Rome." At a very early date the First Gospel was translated into Greek, very probably for the use of Hellenistic converts. The Apostolic Fathers quote the Greek text. Who made the translation is not known with certainty. Some say the translator was St. Matthew himself; others say it was St. Luke; others, St. Paul or St. James, the first Bishop of Jerusalem. All agree that it is a substantial reproduction of the original.

**V. Characteristics.** The prevailing characteristic of the First Gospel, as said above, is its constant appeal to the Messianic prophecies of the Old Testament, which the Evangelist shows were ful-

filled in the person of our Lord. The authority of the Old Law is never questioned, and the Law of Moses is represented as attaining its completion and fulfillment in the New Covenant. St. Matthew's is the least chronological of all the Gospels. The author gathers together a number of our Lord's discourses, paying more attention to similarity of subject than to order of time.

**VI. Authenticity.** Tradition has unanimously attributed the First Gospel to St. Matthew. As the Protestant authority, A. Jülicher (*Einleitung in das Neue Testament*, Tübingen, 1906, p. 259) observes, "never in any ecclesiastical writing that has come down to us has it been doubted that the First Gospel was composed by the Apostle Matthew." The internal evidence is not so strong, but the testimony of the Fathers and early writers makes it certain that Matthew wrote the Gospel attributed to him.

Papias (Euseb. *Hist. Eccl.* iii. 39), who was a disciple of John the Evangelist and Bishop of Hierapolis, tells us that Matthew wrote the oracles or sayings (*τὰ λόγια*) of our Lord in Hebrew. It has been objected that the *λόγια* were only a collection of the sayings or speeches of Christ; but this exclusive meaning Papias could not have intended to give to the term, because, after having said that St. Mark wrote down the *words and deeds* of Christ, he observes that the latter's record was called *κυριακοὶ λόγοι* (Euseb. *Hist. Eccl.* iii. 39). Moreover, it was not infrequent with the Fathers to allude to the Gospels as the *λόγια τοῦ κυρίου*.

St. Irenaeus is perhaps even more explicit than Papias, for he says in his work, *Adv. Haer.*, iii. 1, that Matthew published a Gospel among the Hebrews in their own language while Peter and Paul were preaching in Rome. As Irenaeus was at all times most tenacious of ecclesiastical tradition, and intimately connected with the churches of Rome and of Asia Minor, and as he was a disciple of St. Polycarp, who, in turn, had sat at the knees of St. John the Evangelist, his testimony regarding the authorship of the First Gospel is especially strong. A similar testimony has been handed down by Origen (Euseb. *Hist. Eccl.* v. 14; vi. 25), by Tertullian (*Adv. Marc.* iv. 2, 5; *De Carne Christi*, 22), by Eusebius, and many of the Fathers. In his *Ecclesiastical History*, iii. 24, Eusebius writes: "Matthew, after having preached the faith to the Jews, being about to depart to announce the good news to the Gentiles, wrote the

Gospel in his own tongue, leaving it to those from whom he was about to depart to supply the loss of his own presence.”

The early heretics, such as the Gnostics Basilides and Valentine and the pagan Celsus, quote passages of the First Gospel. The attacks of the heretics show that the Gospel was considered canonical by the early Christians.

**VII. Division of the Gospel.** The First Gospel may be divided into four general parts, the first of which (i-ii) treats of the genealogy of Jesus, His virgin birth, the adoration of the Magi, the flight into Egypt, and the return to Nazareth.

The second part (iii-xxv), which treats of the public life of the Saviour, has three sections: (a) the preparation for the public life (iii-iv. 11), which records the preaching of John the Baptist, the baptism of our Lord, and His fast and temptation in the desert; (b) the ministry in Galilee (iv. 12-xviii. 35), during which the Saviour appears as teacher and legislator, as wonder-worker, as the founder of a new kingdom, and as the instructor of the Apostles; (c) the ministry in Judea (xix-xxv), where we find the journey of our Lord to Jerusalem, the last features of His activities in the Holy City, the maledictions pronounced against the faithless city, and the announcement of the end of the world.

The third part (xxvi-xxvii) contains the history of our Lord's Passion and death.

The fourth part (xxviii) narrates the Saviour's Resurrection and some of His appearances to the disciples.



# The Gospel according to St. Matthew

## CHAPTER I

THE GENEALOGY OF JESUS, 1-17.

THE BIRTH OF JESUS, 18-25.

1. The book of the generation of Jesus Christ, the son of David, the son of Abraham:

2. Abraham begot Isaac. And Isaac begot Jacob. And Jacob begot Judas and his brethren.

1. The first line of this chapter may be considered as a title, or short preface to the chapter.

The book; i.e., the narrative, or record, or catalogue "of the generation," i.e., of the ancestors of Christ. The Jews attached great importance to their genealogies, and in particular to that of David, from whose seed the Messiah and Saviour was to spring.

The son; i.e., the descendant. The Hebrews used the word *son* to designate every one descended from another in a direct line, however remotely. Our Lord was commonly called the "son of David" by the prophets, and Abraham is here mentioned, because it was to these two that a promise had been especially made that the Christ should be born of them, — of Abraham as head of the race, of David as head of the family. Cf. Luke iii. 31.

From the birth of Abraham to that of Christ there intervened a period of about 2000 years; from the death of David to the birth of Christ about 1013 years. St. Matthew traces the ancestors of Christ to Abraham through a succession of forty-two generations, in order to prove to the Jews that He was the true Messiah. St. Luke, writing for the Gentiles, traces our Lord's pedigree back to Adam, the father of the human race.

2. **Abraham begot Isaac.** Isaac alone, of all the sons of Abraham, is mentioned because it was of his seed that Christ was to be born: "But in Isaac shall thy seed be called" (Genesis xxi. 12; Romans ix. 7).

3. And Judas begot Phares and Zara of Thamar. And Phares begot Esron. And Esron begot Aram.

4. And Aram begot Aminadab. And Aminadab begot Naasson. And Naasson begot Salmon.

5. And Salmon begot Booz of Rahab. And Booz begot Obed of Ruth. And Obed begot Jesse.

6. And Jesse begot David the king. And David the king begot Solomon, of her that had been the wife of Urias.

7. And Solomon begot Roboam. And Roboam begot Abia. And Abia begot Asa.

8. And Asa begot Josaphat. And Josaphat begot Joram. And Joram begot Ozias.

9. And Ozias begot Joatham. And Joatham begot Achaz. And Achaz begot Ezechias.

10. And Ezechias begot Manasses. And Manasses begot Amon. And Amon begot Josias.

3. **Of Thamar.** Phares and Zara were twin sons of Thamar. It is remarkable that all the women mentioned in the genealogy of our Lord, with the exception of His Blessed Mother, were publicly subject to reproach as sinners or Gentiles. The most probable reason for this is that our Lord, who came to save sinners, Gentiles as well as Jews, wished to enumerate among His ancestors those who would be expressive types of sinners and Gentiles, who, nevertheless, were to be aggregated to His Church.

4. **Aminadab and Naasson** are mentioned, because, according to Num. i. 7, the latter was the leader of the tribe of Juda on the egress of the Hebrews from Egypt.

5. **Ruth**, a native of Moab,—another instance showing that our Lord wished to have among His ancestors Gentiles as well as Jews, so that all, Jews and Gentiles, might have hope in His mercy.

**Jesse.** Reference is here made to the prophecy of Isaias concerning our Redeemer, "Egredietur virga de radice Jesse" (Isaias xi. 1).

6. **David the king**, the first king among the ancestors of Christ. To him was made the promise of a perpetual kingdom.

8. **And Joram begot Ozias.** Between Joram and Ozias three kings, who reigned in immediate succession, are here passed over, Ochozias, Joas, and Amasias (4 Kings xi-xiv). The reason for this omission is variously explained, but it does not much affect the design of the Evangelist, which was to show that Christ was a descendant of David.

11. And Josias begot Jechonias and his brethren in the transmigration of Babylon.

12. And after the transmigration of Babylon, Jechonias begot Salathiel. And Salathiel begot Zorobabel.

13. And Zorobabel begot Abiud. And Abiud begot Eliacim. And Eliacim begot Azor.

14. And Azor begot Sadoc. And Sadoc begot Achim. And Achim begot Eliud.

15. And Eliud begot Eleazar. And Eleazar begot Mathan. And Mathan begot Jacob.

16. And Jacob begot Joseph the husband of Mary, of whom was born Jesus, who is called Christ.

17. So all the generations, from Abraham to David, are fourteen generations. And from David to the transmigration of Babylon, are fourteen generations: and from the transmigration of Babylon to Christ are fourteen generations.

**11. Josias begot Jechonias.** Josias was the grandfather of Jechonias (4 Kings xxiii. 34; xxiv. 6).

**And his brethren;** i. e., the uncles of Jechonias, Joakim, his predecessor, and Sedecias, his successor.

**In the transmigration of Babylon;** i. e., shortly before they were taken captive to Babylon.

**12. After the transmigration of Babylon;** i. e., during the seventy years' captivity at Babylon.

**Jechonias begot Salathiel.** St. Luke (iii. 27) says, "Salathiel, who was of Neri." *Answer:* Salathiel was the natural son of Neri, and the adopted son of Jechonias. Salathiel was of the royal line of David, through Nathan (Luke iii. 31), and Jechonias, who was to die childless (Jer. xxii. 30), adopted him so as to perpetuate his royal line.

**Salathiel begot Zorobabel.** According to 1 Paralipomenon iii. 19, Zorobabel was of Phadaia. *Answer:* This divergence is due either to an error of a copyist of Paralipomenon, or it is to be explained by the Levirate law, according to which a man should marry his brother's widow and raise up children to his brother. See below, verse 17.

**13. Zorobabel begot Abiud.** St. Luke (iii. 27) says, "Reza, who was of Zorobabel." *Answer:* Most likely Abiud was the brother of Reza.

**16. Who is called Christ;** i. e., according to the Hebrew idiom, who is in reality Christ, the Anointed, the Messiah.

**17. Fourteen generations.** Only fourteen are given in each of

the three epochs; several others are omitted. The third series has only thirteen, but the name which we do not count is probably Mary, which the Evangelist did count, since the royal descent passes from Joseph to Jesus through Mary.

Here it is important to note that there is a great discrepancy between the genealogies given by St. Matthew and St. Luke; they assign almost entirely different persons as the ancestors of our Lord. To explain this difficulty it may be observed, in a general way, that a strong extrinsic argument for the genuineness of both genealogies is found in the fact that neither of these was objected to by the Jews of their day, whether believers or unbelievers, who had every opportunity of knowing the state of the case, and many of whom would have gladly charged the Evangelists with mistakes, if such had really been the case. This argument is the more convincing since the Jews were always remarkable for paying the greatest attention to genealogies, especially where there was question of direct descent of illustrious persons.

In particular, two quite satisfactory explanations are given of the discrepancy between the two Evangelists. According to the more modern theory, St. Matthew gives the natural genealogy of St. Joseph, St. Luke that of the Blessed Virgin. Thus, in this interpretation, when St. Luke speaks of Joseph as the son of Heli, he means the son-in-law, married to the Blessed Virgin; and hence Heli must be identified with Joachim, whom tradition represents as the father of the Blessed Virgin. It is really possible that Heli is only an abbreviation of Eliachim, and that Eliachim is a synonym for Joachim. This theory was unknown before the fifteenth century, but it has the advantage of establishing between Jesus and the royal line of David a real, natural, and not merely a legal, relation.

According to the most ancient theory, both Matthew and Luke give us the genealogy of St. Joseph; the former, his legal, the latter his natural genealogy. This legal relationship was the result of a peculiar enactment of the Law of Moses (Deut. xxv. 5): "When brethren dwell together, and one of them dieth without children, . . . his brother shall take her, and raise up seed for his brother; and the first son he shall have of her, he shall call by his name," etc. In the third century Julius Africanus applied this law to

18. Now the generation of Christ was in this wise. When as his mother Mary was espoused to Joseph, before they came together, she was found with child, of the Holy Ghost.

Joseph, and said that he had the reason for so doing from the relations of our Lord Himself. His statement is this: Estha, the mother of Heli and Jacob, was married successively to Mathan and Melchi; of the former she begot Jacob, of the latter Heli. Jacob and Heli were therefore uterine brothers, of the same mother, but of different fathers. Now Jacob having died childless, Heli married his widow and had for issue, Joseph, who was the natural son of Heli and the legal son of Jacob. As Mathan and Melchi, to whom Estha was successively married, need not have been at all related, it is not wonderful that the two genealogies branch off very divergently without meeting again, save in Zorobabel and Salathiel, till they reach David, through Solomon, on the one side, and Nathan on the other. This interpretation is commonly adopted by the Fathers. As both genealogies, the *natural* and the *legal*, were regarded as of the greatest importance among the Jews, it is not strange that the Evangelists give both.

18. **The generation**; i. e., the birth, was in this new manner.

**Was espoused**; i. e., according to the Fathers commonly, was really married; but, according to Sts. Jerome, Chrysostom, and others, was only promised in marriage. During the time of espousals the future man and wife among the Jews did not live together, and saw each other but rarely; they could, however, have intercourse, and a child conceived during this period was not illegitimate, either in public opinion or before the Law. If any one violated another's spouse he was regarded as an adulterer.

Although Christian art has pictured St. Joseph as an old man, there is no good proof that he was not young when espoused to Mary. Joseph had been chosen by divine Providence to be the chaste support and protector of the Holy Family, and there is no reason to suppose that he was other than a young man when Mary, by her parents, was promised to him in marriage (Le Camus).

18 and 25. **Before**, as in the phrase, "before they came together" (verse 18); and till or until (verse 25) refer, according to the Hebrew idiom, to that which precedes the event spoken of, and in no wise relate to what may follow; that is, these expressions

19. Whereupon Joseph her husband, being a just man, and not willing publicly to expose her, was minded to put her away privately.

20. But while he thought on these things, behold the angel of the Lord appeared to him in his sleep, saying: Joseph, son of David, fear not to take unto thee Mary thy wife, for that which is conceived in her, is of the Holy Ghost.

21. And she shall bring forth a son: and thou shalt call his name JESUS. For he shall save his people from their sins.

22. Now all this was done that it might be fulfilled which the Lord spoke by the prophet, saying:

23. Behold a virgin shall be with child, and bring forth a son, and they shall call his name Emmanuel, which being interpreted is, God with us.

24. And Joseph rising up from sleep, did as the angel of the Lord had commanded him, and took unto him his wife.

25. And he knew her not till she brought forth her firstborn son: and he called his name JESUS.

simply mean that the Blessed Mother was a virgin in conceiving her divine Son, and that she was a virgin when she gave Him birth; they do not at all imply that she ceased to be a virgin after the birth of our Lord. St. Matthew is telling us what the Blessed Virgin was up to the birth of Christ; about what took place afterwards he says nothing.

Together, therefore, does not mean conjugal relation, but only dwelling together in the same house. The belief that Mary always lived with Joseph, as with a brother, is based on the most ancient and most unanimous Catholic tradition.

18. **Of the Holy Ghost.** The conception of Jesus in the womb of the Blessed Virgin is attributed to the Holy Ghost, because it was a work of love. All works external to the Holy Trinity are common to all three Persons, but certain works are attributed to one Person when these works have a peculiar fitness with the relation which that Person bears to the other two. The Holy Ghost *is the love* of the Father and the Son, and hence works of love are attributed to Him. The doctrine of the Virgin Birth is evident from verses 18, 20, 23, and 25 of this chapter.

20. **Fear not to take unto thee Mary thy wife;** i. e., to be thy wife in reality, and no longer merely thy betrothed.

21. **Jesus** means "Salvation of God"; it is the same name as Josue or Josuah.

23. This verse is taken from Isaias vii. 14.

## CHAPTER II

THE VISIT OF THE MAGI, 1-12.

THE FLIGHT INTO EGYPT, 13-15.

THE SLAUGHTER OF THE HOLY INNOCENTS, 16-19.

THE RETURN FROM EGYPT, 20-23.

1. When Jesus therefore was born in Bethlehem of Juda, in the days of king Herod, behold, there came wise men from the east to Jerusalem,

1. **In the days of king Herod.** It is difficult to determine just when this was, but it was probably about 6 or 4 B.C. This we conjecture from the death of Herod, which was around 4 or 2 B.C. Josephus (*Antiq.* xvii. 6) tells us that Herod the Great died shortly before the Passover, just after an eclipse of the moon, which eclipse seems to have been the one we know of on March 12-13, 4 B.C. Hence it is evident that our Lord must have been born at the latest in 5 B.C. (749 A.U.C.). Dionysius Exiguus erred, therefore, when he dated the Christian era from 754 A.U.C. It is generally admitted, likewise, that the Nativity cannot be placed earlier than 746, the date of the universal pacification of the world under Augustus.

There are four Herods mentioned in the New Testament: (a) Herod the Great, spoken of here, who was king of Judea, Samaria, Galilee, and part of Perea, and who died around 4 or 2 B.C. after a reign of 37 years; (b) Herod Antipas, son of Herod the Great, who, when his father's kingdom was divided into the four provinces of Judea, Galilee, Trachonitis, and Abilene, became tetrarch of Galilee; (c) Herod Agrippa (the elder), grandson of Herod the Great, and nephew of Herod Antipas; (d) Herod Agrippa (the younger).

**Wise men from the east.** These wise men, or Magi, were most probably from Persia or Chaldea. They were men of learning, devoted to the study of astrology and to the investigation of the truths of natural philosophy. It is probable also that they belonged to the sacerdotal class, as would appear from their devout sentiments. St. Augustine and St. Chrysostom, following the Syrian tradition, thought the Magi were twelve in number. The most

probable opinion is that of Origen (*in Gen. Hom.* xiv. 3) and St. Leo the Great (Serm. xxxi), who say they were only three. That they were kings was not believed before the sixth century.

There is a great dispute regarding the time of the Magi's visit. It is the common opinion of the Church that they arrived before the day of the Presentation and the Purification. Here, however, St. Matthew and St. Luke seem to disagree. According to the former it would appear that the visit of the Magi occurred shortly after the Nativity, and that the Holy Family set out for Egypt before the Presentation and Purification in the Temple; according to the latter, the child was taken to the Temple for the Presentation on the fortieth day after His birth, as the Law prescribed, and thence the Holy Family retired to Nazareth. According to St. Luke, therefore, it would seem that the visit of the Magi took place much later than is indicated by St. Matthew. The apparent discrepancy in the narratives of both Evangelists may be reconciled by supposing that shortly after the visit of the Magi our Lord was presented in the Temple; and thence the Holy Family proceeded to Nazareth, and that it was at Nazareth that Joseph was admonished in sleep to flee into Egypt. But if, as seems more natural from the context of St. Matthew, Joseph was admonished by the Angel at Bethlehem, we may explain the Magi's visit as follows: After the Presentation of the Child in the Temple the Holy Family made a short visit to Nazareth and then returned to Bethlehem, where a little later took place the visit of the Magi, which in turn was followed by the admonition of the angel and the consequent flight into Egypt. See below, on verse 16.

St. Luke makes no mention of the visit of the wise men, or of the flight into Egypt. There are two very probable reasons for this omission: (a) the stories were not found in the documents used by St. Luke, and were, consequently, most likely unknown to him; or (b) the narration of these facts did not pertain to the end St. Luke had in giving an account of the infancy of Jesus, which end was to show our Lord's submission and obedience to the Law according to the doctrine of St. Paul (Gal. iv. 5; Philipp. ii. 7 ff.). St. Matthew, on the contrary, narrates these events, because his purpose is to show the fulfillment of the ancient prophecies regarding the infancy of Christ.



2. Saying, Where is he that is born king of the Jews? For we have seen his star in the east, and are come to adore him.

3. And king Herod hearing this, was troubled, and all Jerusalem with him.

4. And assembling together all the chief priests and the scribes of the people, he inquired of them where Christ should be born.

5. But they said to him: In Bethlehem of Juda. For so it is written by the prophet:

6. And thou Bethlehem the land of Juda art not the least among the princes of Juda: for out of thee shall come forth the captain that shall rule my people Israel.

2. **Star.** This might have been a natural phenomenon by way of a comet, or, as Kepler and other modern scientists say, by the coinciding of two planets, Jupiter and Saturn, which occurs in May, in September, and in December every eight hundred years. More probably this star was miraculous. It attracted the Magi as something strange and new; it guided them toward Jerusalem; it was not visible while they were being interviewed by Herod, and when they left him it again appeared and guided them to Bethlehem; it traveled from north to south and not from east to west according to the natural course of the sidereal world; and finally when the Magi had arrived at Bethlehem, it again halted and "stood over where the child was" (verse 9). From all this it seems beyond doubt that this star, or luminous body, was not natural, but miraculous in its formation, course and purpose.

**We are come to adore him,** etc. From this it would seem that the Magi were enlightened from on high as to the divine character of our Lord.

4. **The chief priests, etc.;** i. e., the Sanhedrim, which was composed of the heads of the twenty-four sacerdotal families, the Scribes, or doctors of the Law, and the elders of the people, or influential laymen. In all there were seventy members in the Sanhedrim, presided over by the High-Priest.

**The scribes of the people** were a class of men whose office it was to preserve the sacred records, to announce and expound the sacred Scriptures to the people, and to solve doubts.

5. **In Bethlehem of Juda.** A better reading has, "In Bethlehem of Judea." Bethlehem formerly belonged to the kingdom of Juda.

6. **Art not least among the princes of Juda;** i. e., thou art by

7. Then Herod, privately calling the wise men, learned diligently of them the time of the star which appeared to them;

8. And sending them into Bethlehem, said: Go and diligently inquire after the child, and when you have found him, bring me word again, that I also may come and adore him.

9. Who having heard the king, went their way; and behold the star which they had seen in the east, went before them, until it came and stood over where the child was.

10. And seeing the star they rejoiced with exceeding great joy.

11. And entering into the house, they found the child with Mary his mother, and falling down they adored him; and opening their treasures, they offered him gifts; gold, frankincense, and myrrh.

12. And having received an answer in sleep that they should not return to Herod, they went back another way into their country.

13. And after they were departed, behold an angel of the Lord appeared in sleep to Joseph, saying: Arise, and take the child and his mother, and fly into Egypt: and be there until I shall tell thee. For it will come to pass that Herod will seek the child to destroy him.

no means insignificant among the leading cities of Juda. The citation is substantially from Micheas v. 2.

9. **Until it came and stood, etc.**, — literally, "till coming it stood" (*ἕως ἐλθῶν ἔστη*). It is evident from this and the following verse that the star reappeared at Jerusalem, when the Magi left Herod, and guided them to the cave at Bethlehem.

11. **House**; i. e., the stable or cave where our Lord was born; according to Jewish usage every dwelling place was called a *house*.

**Gifts.** It was a custom among the Easterns that no one should visit a king or prince for the first time without presenting to him gifts. In the case of the Magi these gifts — gold, frankincense and myrrh — were the usual presents in Chaldea. They signified the offerings we should present to God: *charity*, symbolized by gold; *prayer* and *devotion*, symbolized by frankincense; *mortification*, symbolized by myrrh.

13. **Fly into Egypt.** The Egyptian frontier was hardly two days' journey from Bethlehem. Egypt had always been the place of refuge for those who were persecuted in Palestine, and the very heart of the country could be reached in a week.

St. Matthew does not say that Joseph was admonished to flee immediately after the visit of the Magi; he merely states the fact, without giving the time, and hence we need not depart from the first explanation given above, verse 1.

14. Who arose, and took the child and his mother by night, and retired into Egypt: and he was there until the death of Herod:

15. That it might be fulfilled which the Lord spoke by the prophet, saying: Out of Egypt have I called my son.

16. Then Herod perceiving that he was deluded by the wise men, was exceeding angry; and sending killed all the men children that were in Bethlehem, and in all the borders thereof, from two years old and under, according to the time which he had diligently inquired of the wise men.

17. Then was fulfilled that which was spoken by Jeremias the prophet, saying:

18. A voice in Rama was heard, lamentation and great mourning; Rachel bewailing her children, and would not be comforted, because they are not.

14. **By night**; i. e., immediately, without delay, after having received the angel's warning.

**Into Egypt**, which was outside the jurisdiction of Herod.

**Until the death of Herod.** See above, ii. 1.

15. **Out of Egypt have I called my son.** These words refer directly to the Hebrew people who were delivered from Egypt. It was not uncommon for the Almighty to call His people by the title of "Son." Cf. Osee xi. 1. These words, however, refer secondarily to Christ, who was by excellence the Son of God.

16. **Killed all the men children in Bethlehem.** The population of this little town with its confines was perhaps about 3000; the male children of two years and under likely did not number more than twenty or thirty.

**Two years old and under.** From these words some commentators have concluded that the Magi saw the star two years before the birth of Christ; others with greater probability say that the star appeared simultaneously with the birth of Jesus. It is improbable, however, that the Holy Family remained for long at Bethlehem. Still it must be admitted that there is nothing in the Gospel narrative *to force* us to believe that the adoration took place at Bethlehem. Herod directed the Magi to go thither, but the star conducted them where the child was, which might have been at Nazareth. At any rate the two years and under most likely refer to the time between the appearance of the star and the visit of the Magi.

18. **A voice in Rama**,—literally, a *high place*. Rama is a town twelve miles north of Bethlehem on the confines of Juda and Benjamin. The words signify that there was loud crying heard at a great distance.

19. But when Herod was dead, behold an angel of the Lord appeared in sleep to Joseph in Egypt,

20. Saying: Arise, and take the child and his mother, and go into the land of Israel. For they are dead that sought the life of the child.

21. Who arose, and took the child and his mother, and came into the land of Israel.

22. But hearing that Archelaus reigned in Judea in the room of Herod his father, he was afraid to go thither: and being warned in sleep retired into the quarters of Galilee.

23. And coming he dwelt in a city called Nazareth: that it might be fulfilled which was said by the prophets: That he shall be called a Nazarene.

**Rachel bewailing her children;** i. e., as Rachel the grandmother of Ephraim, although in her grave, was said to mourn the loss of the ten tribes of Israel, whose first king, Jeroboam, had sprung from the tribe of Ephraim, and who were taken into captivity by the Babylonians, so now she is said to mourn again the slaughter of the Innocents by Herod. The quotation is from Jer. xxxi. 15.

19. **When Herod was dead.** Herod died an ignominious death at the age of seventy years (Josephus, *Antiq.* xvii. 6, 5; 8, 1).

20. **They.** Herod alone is referred to here (verse 19), but the plural form perhaps refers to the fact that he had sent soldiers to kill the Child.

22. **Who arose, etc.** The Holy Family left Egypt immediately on receiving the angel's message. Their stay in Egypt seems to have been brief.

22. **Archelaus reigned in Judea;** i. e., Archelaus exercised the office of his predecessor, although he was never appointed king. He was tetrarch of Judea, Samaria, and Idumea; but was shortly after deposed.

**He was afraid.** The cruelty of Archelaus was well known; and hence St. Joseph, who might have wished to return by way of Bethlehem and Jerusalem to render thanks to God in the Temple, chose to avoid him and go to Galilee.

23. **Nazareth;** i. e., the home of the Blessed Virgin and the scene of the Annunciation, a small town at the foot of Mt. Tabor.

**Nazarene, or Nazarite.** It is remarkable that in none of the prophets was it foretold that our Lord should be called a *Nazarene*. The majority of commentators understand the present verse to refer to the words of Isaias (xi. 1): "there shall come forth, etc. — and a flower shall rise up out of his root." The word here rendered *flower* is *Neser* in Hebrew — hence *Nazarite*. The passage

from Isaias should then be rendered: "And a *Nazarite* shall rise up out of his root."

## CHAPTER III

THE PREACHING OF JOHN THE BAPTIST, 1-12.

THE BAPTISM OF JESUS, 13-17.

1. And in those days cometh John the Baptist preaching in the desert of Judea.

2. And saying: Do penance: for the kingdom of heaven is at hand.

1. **In those days**; i. e., while our Lord was dwelling at Nazareth. These words do not imply that the event about to be spoken of occurred immediately after the event previously narrated. The date here referred to was around A.D. 25. Cf. Luke iii. 1.

**John the Baptist**, so styled from his office of preaching the baptism of penance, which was a preparation for the ministry of Christ.

**In the desert of Judea.** Origen, St. Jerome, and others tell us that the Baptist while yet an infant was taken by his mother Elizabeth into the desert to escape the cruelty of Herod. According to Cedrenus, Elizabeth died forty days after their flight, and the Baptist was reared by the help of angels, or by the help of an attendant of Elizabeth, his mother. From the interior of this wilderness or desert, John came forth to the country about the Jordan, which on account of its few inhabitants is also called the desert of Judea. It is a barren region stretching along the western side of the Dead Sea. Matthew and Mark say he preached "in the desert of Judea," by which they mean the confines of the desert, on the banks of the Jordan.

2. **Saying: Do penance**; i. e., perform the works of penance, such as fasting, alms-deeds, etc.

**The kingdom of heaven, or of God.** These words are not found in the Old Testament; here in St. Matthew they appear for the first time; Mark and Luke speak of the "kingdom of God." The "kingdom of heaven," or "of God," may mean: (a) the abode of the Blessed; (b) the Church on earth; (c) as here, the reign of the Messiah; (d) sometimes it merely means God's dealings with men, as in some of the parables. The first three meanings may be uni-

3. For this is he that was spoken of by Isaias the prophet, saying: A voice of one crying in the desert, Prepare ye the way of the Lord, make straight his paths.

4. And the same John had his garment of camels' hair, and a leathern girdle about his loins: and his meat was locusts and wild honey.

5. Then went out to him Jerusalem and all Judea, and all the country about Jordan:

6. And were baptized by him in the Jordan, confessing their sins.

fied, since the temporal reign of the Messiah was the prelude to, or beginning of, the establishment of the Church, or Christ's Kingdom on earth, and ended by opening the gates of Heaven.

3. **For this is he**, etc. These are the words of St. Matthew relative to John the Baptist.

**A voice of one crying**; i. e., the preaching of John, the forerunner of Christ, proclaiming the advent of the Messiah.

**Prepare ye the way**, etc. Here there is an allusion to the Eastern custom of sending men before the approach of kings or princes to remove all obstacles from their way and make easy their path. In this verse the phrase means to remove all obstacles which could be offensive to the Messiah, such as sin, the gratification of the passions, etc.

4. **Locusts**. These are well-known small insects considered as clean animals among the Jews. St. Jerome tells us that the poor people were accustomed to dry and salt them for food. Even now there are poor in the East who live on a certain kind of locust.

5. **Jerusalem and Judea**; i. e., great crowds went out from Jerusalem and all Judea to hear the Baptist's preaching.

6. **Baptized**; i. e., washing by immersion, as was the custom among the Jews, from the earliest times, and the form of conferring Baptism in the early Church. It is *de fide* from the Council of Trent that the baptism of John and that of Christ had not the same force or efficacy. The baptism of John was merely an external washing which disposed the penitent for forgiveness and newness of life, whereas the Baptism which Christ instituted penetrates to the soul and actually remits sin. It was only when accompanied by perfect contrition that John's baptism and penance blotted out sin; and even then, by virtue of perfect contrition only. John's baptism presupposed three conditions: (a) sorrow for sin; (b) faith in the Messiah to come; and (c) confession of some sins.

7. And seeing many of the Pharisees and Sadducees coming to his baptism, he said to them: Ye brood of vipers, who hath shewed you to flee from the wrath to come?

**Confessing their sins;** i. e., in detail, and not merely in a general way. The rite of confessing certain sins in particular was practiced among the Jews and enjoined by the law of Moses (Levit. iv and v; Num. v. 7); but the Jewish priests had no power of real and interior absolution.

**7. And seeing many of the Pharisees,** etc. There were among the Jews three leading religious and philosophical sects: the Pharisees, the Sadducees, and the Essenes. These sects first appeared in the time of the Machabees. The Pharisees were a separatist sect, as their name indicates (*Parusch, separated, sectary*). They considered themselves superior to others because of their knowledge and observance of the Law. Their prevailing characteristics came to be pride and hypocrisy; they taught traditions contrary to the law of God; but they believed in the resurrection of the body and in the immortality of the soul. Josephus (*Bell. Jud. lib. ii. c. 8*) seems to tell us that they also believed to some extent in the transmigration of souls; but it is more probable that the text cited from Josephus treats of the resurrection of the body. In some things the Pharisees were fatalists.

The Sadducees, so called from their founder, Sadoc, were noted for their rigorous justice in punishing offenders whenever they had any authority to exercise. They were free-thinkers and Epicureans in religion; they denied the resurrection of the body, and the existence of angels and spirits.

The Essenes are not mentioned in Scripture; but they are described by Josephus. Their one distinctive principle was to strive after purity, not the purity of the Pharisees, which meant freedom from ceremonial defilement, but a more absolute purity, which means freedom from contact with things material. Hence they lived separated from the world, chiefly in country districts, led lives of extreme simplicity and in community, took their meals together, and worked and prayed. All members of the order passed through a novitiate of three successive grades, each lasting a year. Admission to membership involved the taking of a severe oath binding them to a rigorous asceticism and strict secrecy.

8. Bring forth therefore fruit worthy of penance.

9. And think not to say within yourselves, We have Abraham for our father. For I tell you that God is able of these stones to raise up children to Abraham.

10. For now the axe is laid to the root of the trees. Every tree therefore that doth not yield good fruit, shall be cut down, and cast into the fire.

11. I indeed baptize you in water unto penance, but he that shall come after me, is mightier than I, whose shoes I am not worthy to bear; he shall baptize you in the Holy Ghost and fire.

12. Whose fan is in his hand, and he will thoroughly cleanse his floor and gather his wheat into the barn; but the chaff he will burn with unquenchable fire.

13. Then cometh Jesus from Galilee to the Jordan, unto John, to be baptized by him.

Who hath showed you, etc.; i. e., who has been able to persuade you of your own need of penance, and of the everlasting fire awaiting your sins.

8. Bring forth, etc.; i. e., be not penitent in word only, but do the works of penance, — exercise charity, humility, mercy.

9. The meaning of this verse is: Do not think that because you boast of Abraham as your father, you are thereby justified; but see to it that you practice the virtues of Abraham, for no matter how hard the hearts, even if they be like stones, God is able to raise up children from them who will imitate the virtues of Abraham.

10. The meaning of this verse is that God is about to administer speedy punishment to the unrepentant sinner, and every man that does not penance will be cut off and cast into the fire of hell.

11. I indeed baptize; i. e., my baptism disposes you for penance, and for the Baptism of Christ, the Divine Person who is to come after me, and whose Baptism will both cleanse from sin every soul worthily disposed, and will warm and purify it with His Holy Spirit, after the manner of fire.

12. In this verse there is reference to the ancient method of thrashing grain and winnowing the wheat from the chaff; just as the thrasher separates the wheat from the chaff, so will Christ separate the good from the bad, — the former destined for His Heavenly Kingdom, the latter for hell fire.

13. Then cometh Jesus from Galilee; i. e., from His home in Nazareth. It was the beginning of our Lord's public life.



14. But John stayed him, saying: I ought to be baptized by thee, and comest thou to me?

15. And Jesus answering, said to him: Suffer it to be so now. For so it becometh us to fulfil all justice. Then he suffered him.

16. And Jesus being baptized, forthwith came out of the water: and lo, the heavens were opened to him: and he saw the Spirit of God descending as a dove, and coming upon him.

**To be baptized.** Just as our Saviour submitted to circumcision, so now He suffers Himself to be baptized by John, in order to fulfill all justice, i. e., to practice the observance of the law which He preached to others, although He Himself stood in no need of these observances. It was an example of observance that He wished to give.

14. **But John stayed him;** i. e., John felt unworthy that he, a creature, should minister to the wishes of his Lord and Master. Most likely John had never seen Jesus before, although he was expecting Him (John i. 31); but now by an interior impulse, he recognized the Saviour.

**I ought to be baptized by thee;** i. e., I have some sins to be washed away, even though they be but venial; you have no sins.

15. **It becometh us to fulfil all justice.** For John the fulfilling of justice meant that he was to be the last representative of the Mosaic Law; that he was to announce the new kingdom of Christ, but die without becoming a member of it, or sharing in its blessings. He was to be saved by faith in the Messiah, and not by the Sacraments which that Messiah would institute. For Jesus, *justice* meant that, being born under the Law, He should obey it and thus fulfil it, until He had changed it for the New Law (Gal. iv. 4).

16. **The heavens were opened;** i. e., a rift was made in the cloud, or in the blue vault above, from which the voice of the Eternal Father was distinctly heard, and the descent of the Holy Ghost perceived. It is disputed whether this vision of the Holy Spirit was accorded to all, or to John only. The latter opinion seems to be the more probable, since it is hardly likely that our Lord would have wished to give open manifestation of His Divinity to all so early in His career. Further, such a public manifestation would have excited a popular demonstration which the Evangelists could not have failed to record.

**As a dove.** The Holy Spirit assumed the form of a dove, be-

17. And behold a voice from heaven, saying: This is my beloved Son, in whom I am well pleased.

cause the dove symbolizes His virtues, which are love, peace, purity, and the like.

17. **A voice from heaven**, which was the voice of the Eternal Father, bearing testimony to His Only-begotten Son, and introducing Him into the world. Our Lord was about thirty years of age (Luke iii. 23), the age at which a Levite was admitted to the exercise of his ministry (Num. iv. 3, 47), and a young man to the discharge of public affairs.

## CHAPTER IV

THE FAST AND TEMPTATION OF JESUS, I-II.

THE RETURN TO GALILEE, 12-17.

THE CALL OF THE FIRST FOUR APOSTLES, 18-22.

THE PREACHING OF JESUS, 23-25.

1. Then Jesus was led by the spirit into the desert, to be tempted by the devil.

2. And when he had fasted forty days and forty nights, afterwards he was hungry.

1. **Then Jesus was led by the spirit, etc.**; i. e., immediately after His baptism and the descent upon Him of the Holy Ghost in the form of a dove, Jesus was conducted by this same Holy Spirit into the desert. This desert was a rocky and mountainous wilderness stretching from north to south along the west coast of the Dead Sea.

**To be tempted**; i. e., to be subjected to trials, moral and physical, by the arch enemy of mankind. Our Lord could not be tempted from within, since He was sinless, and had no corrupt inclinations such as we have.

2. **And when he had fasted, etc.** It is sometimes questioned whether or not the fast of our Lord during forty days and forty nights was absolute. St. Luke seems to affirm that it was; and in view of recent examples of people abstaining from all food and drink for a time even longer than this, it seems altogether likely that the fast of Christ was absolute. Our Lord, before giving the New Law, thus fasted for forty days and forty nights in imitation

3. And the tempter coming said to him: If thou be the Son of God, command that these stones be made bread.

4. Who answered and said: It is written, Not in bread alone doth man live, but in every word that proceedeth from the mouth of God.

of Moses and Elias who fasted forty days, — the former, before giving the Old Law, and the latter, before reforming it. Unlike Jewish fasts, which were only during the daytime, our Lord's fast continued through the night as well.

He was hungry; i. e., He voluntarily submitted to suffer the pangs of hunger in His human nature, in order to prove His humanity, and to allow the devil to tempt Him.

3. **And the tempter coming**, etc. According to St. Luke (iv. 2) and St. Mark (i. 13) it seems that Christ was more or less continually subjected to temptations during His entire stay in the desert. The three temptations related at the end of His fast were but the culmination of those which had preceded.

On account of the hypostatic union of the divine and human natures in Christ the question arises how temptation could assail the soul of Jesus, and in what manner was the enemy able to attack Him. The theologians of all times have held that at the times of the trials and sufferings of our Lord, the Divinity withdrew, as it were, into the superior regions of His soul, thus leaving His human nature open to attack and suffering. Not that the Divinity of our Lord was at these times at all separated from His humanity, but only that the force of the former was, so to say, suspended. The presence of the Word ever assured the final triumph of the Saviour, while the momentary isolation of the soul established His merit (*Summa Theol.* iii. qu. 46, a. 8).

If thou be the son of God, etc.; i. e., if You be truly what the voice at Your baptism said You were, You are God; therefore do not ask and pray as You are doing, but *command* that these very stones round about You be made bread to satisfy Your hunger. This first temptation was to the concupiscence of the flesh, but our Lord was free from all concupiscence. The devil at this time was not certain of the Divinity of Christ.

4. **It is written**; i. e., in the Holy Scriptures (Deut. viii. 3).

**Not in bread alone**, etc. Bread is here used to signify all the elements by which we are naturally nourished.

5. Then the devil took him up into the holy city, and set him upon the pinnacle of the temple,

6. And said to him: If thou be the Son of God, cast thyself down, for it is written: That he hath given his angels charge over thee, and in their hands shall they bear thee up, lest perhaps thou dash thy foot against a stone.

7. Jesus said to him: It is written again: Thou shalt not tempt the Lord thy God.

8. Again the devil took him up into a very high mountain, and shewed him all the kingdoms of the world, and the glory of them,

But in every word, etc.; i. e., God chooses to nourish us now by certain elements; but His Providence is able to establish any other means of sustenance for us which He may think fit.

5. Then the devil took him up, etc. It may be remarked that commentators have long been divided as to whether the devil appeared visibly and conveyed our Lord visibly and physically to the Holy City, to the pinnacle of the Temple, and to the high mountain; or whether the tempter was invisible and the temptation merely spiritual. The majority hold the first opinion; the second seems more likely. At all events the temptation is the same; it was a real fact. This second temptation was to the pride of life.

Holy city; i. e., Jerusalem, which was called *holy* because of the Temple, which was the center of true worship.

Pinnacle of the temple; i. e., the most elevated part of the Temple.

6. If thou be the son of God, cast thyself down. It seems from these words that Satan was really doubting the Divinity of Christ and wanted proof of it.

He hath given his angels, etc., referring to Psalm xc. 11, 12, and perhaps to the guardian angel who has charge over each human soul. It is the common teaching of theologians that Christ had no guardian angel; the angel's office was discharged by the presence of the Word.

And in their hands, etc.; i. e., they shall guard and protect You from all harm.

7. Thou shalt not tempt, etc.; i. e., thou shalt not provoke God to anger, or make useless trials of His attributes. The quotation is from Deut. vi. 16.

8. Again the devil took him up, etc. This third temptation was to the concupiscence of the eyes, to the passion for power. What mountain is here referred to is unknown.

9. And said to him: All these will I give thee, if falling down thou wilt adore me.

10. Then Jesus saith to him: Begone, Satan: for it is written, The Lord thy God shalt thou adore, and him only shalt thou serve.

11. Then the devil left him; and behold angels came and ministered to him.

12. And when Jesus had heard that John was delivered up, he retired into Galilee:

13. And leaving the city Nazareth, he came and dwelt in Capharnaum on the sea coast, in the borders of Zabulon and of Nephtholim;

All the kingdoms of the world; i. e., Satan represented to our Lord the chief nations of the world. There is no mountain on earth from whose summit could really be seen all the kingdoms of the world.

9. All these will I give, etc. Here the devil was guilty of a lie, for he had not power over all the kingdoms of the world, not even power over his own evil kingdom, except in so far as God permitted it to him.

If falling down, etc. Satan now wishes to assume again, as in his first prevarication, the place of God.

10. The Lord thy God shalt thou adore. Theologians distinguish the worship due to God, to the saints, and to the Blessed Virgin: the first is called *latria*, or worship; the second *dulia*, or veneration; the third *hyperdulia*, or special veneration. The quotation is from Deut. vi. 13.

11. And behold angels came and ministered, etc.; i. e., angels came in visible form with food and nourishment to relieve the suffering Saviour.

12. And when Jesus had heard that John was delivered up; i. e., delivered over to Herod Antipas by the Pharisees; "He retired," i. e., returned into Galilee from Judea, where He had been preaching. John the Baptist was hated by the Pharisees on account of his influence with the people, and by Herod because he had reproved the latter for having his brother Philip's wife. It must be observed that the events here narrated did not occur immediately after the temptation in the desert. The Synoptists at this point omit a number of events narrated by St. John. This was our Lord's second journey to Galilee. For the events which preceded it, see John i, ii, iii.

13. And leaving the city Nazareth, where He had paid a short

14. That it might be fulfilled which was said by Isaias the prophet :

15. Land of Zabulon and land of Nephthalim, the way of the sea beyond the Jordan, Galilee of the Gentiles :

16. The people that sat in darkness, hath seen great light : and to them that sat in the region of the shadow of death, light is sprung up.

17. From that time Jesus began to preach, and to say : Do penance, for the kingdom of heaven is at hand.

18. And Jesus walking by the sea of Galilee, saw two brethren, Simon who is called Peter, and Andrew his brother, casting a net into the sea (for they were fishers).

19. And he saith to them : Come ye after me, and I will make you to be fishers of men.

20. And they immediately leaving their nets, followed him.

21. And going on from thence, he saw other two brethren, James the son of Zebedee, and John his brother, in a ship with Zebedee their father, mending their nets : and he called them.

22. And they forthwith left their nets and father, and followed him.

visit, "he came and dwelt in Capharnaum," which is on the north-west coast of the Sea of Galilee.

**Zabulon and Nephthalim; i. e.,** the portion of land originally distributed to these tribes.

15. **The way of the sea; i. e.,** along the coast, or toward the Sea of Tiberias. There should be a pause after "sea," because **beyond the Jordan** refers to another part of the country; namely, to Peraea, east of the Jordan.

**Galilee of the Gentiles; i. e.,** the extreme northern part of Galilee, called of "the Gentiles" because of the great numbers of Gentiles dwelling there.

16. In this verse there is reference to the devastation wrought in the above-named places by the Assyrians. They were left in ignorance and ruin. These people now welcomed the Messiah bringing to them the light of the Gospel. Verses 15 and 16 are from Isa. ix. 1.

17. **From that time, etc.; i. e.,** from the imprisonment of John the Baptist our Lord began to preach publicly and constantly.

18-22. In these verses there is given a brief account of the call of the first Apostles. A more detailed narrative of the same event is found in St. Luke (v. 1-11). We know from St. John (i. 35-43) that John, Andrew and Peter were already somewhat acquainted with our Lord. They had been invited on the banks of the Jordan to follow the Saviour occasionally and for a time only

23. And Jesus went about all Galilee, teaching in their synagogues, and preaching the gospel of the kingdom: and healing all manner of sickness and every infirmity, among the people.

24. And his fame went throughout all Syria, and they presented to him all sick people that were taken with divers diseases and torments, and such as were possessed by devils, and lunatics, and those that had the palsy, and he cured them:

out of friendship, but now they were called to be His constant Apostles.

23. **And Jesus went about, . . . healing all manner of sickness;** i.e., our Lord who had come to save all, did not confine His preaching to any one place, but went about everywhere preaching and relieving the miseries of the people, and performing miracles to prove the divinity of His mission and of His doctrine.

**Synagogues.** Synagogue means a meeting-house, a place of assembly. It first became a place of ordinary use for prayer during the Babylonian captivity, when the Jews were unable to visit the Temple. Every village had at least one synagogue, which was built on an eminence and pointed toward Jerusalem. At the front, or eastern end, was the Ark, containing the Books of the Law and the Prophets. Near this place, which was screened off by a curtain, were the "chief seats." Toward the middle was a pulpit, from which lessons were read and exhortations given to the people. The principal days of service were Mondays, Thursdays and Sabbaths. The service consisted of lessons read from Moses and the Prophets, prayer and exhortation. Anyone might be invited to read the lessons, and any Israelite instructed in the Law might be asked to exhort. Each synagogue had its chief rabbi, and, as a rule, a deacon and council of elders also.

24. **Throughout all Syria.** Syria was a very extensive region stretching from the Mediterranean on the west to the Euphrates on the east, and from Egypt on the south to Cilicia on the north.

**And such as were possessed by devils.** There is no account of possession by devils given in the Old Testament, but as far as we know from the Gospels this was very common at the time of our Lord. The reason for this may be that the evil spirits were making special effort just before their overthrow; or that Almighty God so permitted this evil in order the better to show His power in His Son.

25. And much people followed him from Galilee, and from Decapolis, and from Jerusalem, and from Judea, and from beyond the Jordan.

Possession by the devil means that an evil spirit has entered into the body of a person and makes use of it as his instrument. Possession was often accompanied by extreme physical and mental suffering, such as blindness (xii. 22), dumbness (ix. 32), insanity (xvii. 14), epilepsy (Mark ix. 16-26), etc. Here and elsewhere the Evangelists clearly distinguish between ordinary diseases and possession. Cf. Mark i. 32; vii. 32; Luke vi. 17, 18.

Those modern writers are, therefore, in error who maintain that there is no difference between ordinary maladies and the possession spoken of in the Gospels.

25. **From Decapolis.** Decapolis was a group of ten confederated cities extending from Philadelphia on the south to Damascus on the north. Scythopolis alone was west of the Jordan; the others were east of the river.

## CHAPTER V

THE SERMON ON THE MOUNT—THE BEATITUDES,  
1-12.

THE IMPORTANCE OF THE APOSTOLATE, 13-16.  
THE NEW LAW COMPLETES THE OLD, 17-48.

1. And seeing the multitudes, he went up into a mountain, and when he was set down, his disciples came unto him.

It is a question whether St. Matthew here and St. Luke (vi. 20-49) are giving the same identical discourse. It is possible that our Lord may have repeated the same discourse more than once, but it is probable that St. Matthew is only giving with more detail and greater development that of which St. Luke has preserved for us only an abridgment. The differences may all be explained by saying that one omits what he knows the other has.

Our Lord spent the night in prayer and on the morrow chose His twelve Apostles. To them and to the multitude that had gathered a little further down the hill, He immediately delivered the Sermon on the Mount. Cf. vi. 12-17.



2. And opening his mouth, he taught them, saying :
3. Blessed are the poor in spirit : for theirs is the kingdom of heaven.
4. Blessed are the meek : for they shall possess the land.
5. Blessed are they that mourn : for they shall be comforted.
6. Blessed are they that hunger and thirst after justice : for they shall have their fill.

A mountain, which was probably that called the *Horns of Hattin*, about two hours' distance from Tiberias.

2. **And opening his mouth.** Hitherto our Lord had spoken by the mouth of His prophets and by the silent voice of His own miracles; but now He has determined to give personal utterance to His teachings. The Sermon on the Mount is an exposition of our Lord's ideas of happiness, wisdom and justice. Its aim throughout is to show the contrast between the principles of His kingdom and the principles which prevail in the world and in an imperfect and degenerate Judaism. It may be divided in three parts: (a) Jesus promises happiness to those whom He calls; (b) He prescribes justice to those who come; (c) and He recommends wisdom to those who remain with Him (*Le Camus*).

3. **Blessed**; i.e., happy.

**Poor in spirit**; i.e., those who are not *attached* to riches or to the goods of this world, either by desire or by actual possession. It is, in particular, *detachment* from earthly goods that makes one *blessed*.

4. **Meek**; i.e., those who for Christ's sake willingly and patiently endure the evils and hardships of life. By "the meek" we are not to understand lifeless and colorless characters; but those who, possessed of real character and vigor, meekly control themselves for the sake of Christ, and out of imitation of Him.

**Shall possess the land.** This is commonly understood, after St. Jerome, to refer to the new heaven and the new earth, which the meek shall possess.

5. **Mourn**; i.e., those who grieve for their own and for others' offences, out of love of God, are blessed, happy.

6. **Hunger and thirst**, etc.; i.e., happy are those who are subjected to real hunger and thirst, because justice is not done them, but who nevertheless patiently bear the wrong done them for God's sake.

7. Blessed are the merciful: for they shall obtain mercy.
8. Blessed are the clean of heart: for they shall see God.
9. Blessed are the peacemakers: for they shall be called the children of God.
10. Blessed are they that suffer persecution for justice' sake: for theirs is the kingdom of heaven.
11. Blessed are ye when they shall revile you, and persecute you, and speak all that is evil against you, untruly, for my sake:
12. Be glad and rejoice, for your reward is very great in heaven. For so they persecuted the prophets that were before you.
13. You are the salt of the earth. But if the salt lose its savour, wherewith shall it be salted? It is good for nothing any more but to be cast out, and to be trodden on by men.

7. **Merciful**; i.e., happy are those who try to alleviate the miseries of others, who charitably overlook and forgive the sins and mistakes of others; as they really forgive others, so shall they be forgiven.

8. **Clean of heart**; i.e., happy are those who observe not only purity and chastity of body, but general purity and simplicity of conscience. It is certain that chastity of life will not only have an unspeakable reward hereafter, but that it leads to clearness of vision here below, in things purely natural, and especially in things supernatural.

9. **Peacemakers**; i.e., those who strive to reconcile the differences between others.

10. **For justice' sake**; i.e., happy are those who are persecuted on account of their faithfulness to the law of God and to their own duty. It is to be noted that throughout the beatitudes our Lord is continually raising our minds to the things of Heaven; we are not to expect temporal rewards for doing what He has enjoined; we are to look for our recompense hereafter.

11. **Untruly**. Our Lord promises no blessedness, no beatitude to those who deserve persecution and reviling; it is only to those who are unjustly so treated.

12. **Be glad**. Those who suffer for the sake of Christ have every reason to rejoice because of the reward awaiting them hereafter.

13. **You are the salt of the earth**. Salt is the symbol of wisdom; its property is twofold: to impart a flavor, and to preserve from corruption. The Apostles whom our Lord was addressing

14. You are the light of the world. A city seated on a mountain cannot be hid.

15. Neither do men light a candle and put it under a bushel, but upon a candlestick, that it may shine to all that are in the house.

16. So let your light shine before men, that they may see your good works, and glorify your Father who is in heaven.

17. Do not think that I am come to destroy the law, or the prophets. I am not come to destroy, but to fulfil.

18. For amen I say unto you, till heaven and earth pass, one jot, or one tittle shall not pass of the law, till all be fulfilled.

19. He therefore that shall break one of these least commandments, and shall so teach men, shall be called the least in the kingdom of heaven. But he that shall do and teach, he shall be called great in the kingdom of heaven.

were to carry His teachings into the world, to give life and strength, and to preserve the people from their sins and from spiritual death. But if, by disorderly lives and bad example, they should become false teachers and false guides, what would remain to enlighten them and save the people of God from corruption and death?

14. **You are the light of the world;** i.e., to you is committed the office of carrying the light of the Gospel to all the world.

15. Here our Lord repeats the mission of His Apostles, which is to teach, instruct and guide the faithful, by their doctrine and example, to life eternal.

16. **So let your light shine,** etc. Our Lord would have His Apostles and ministers use the talents given them, and make their own life and example correspond with their preaching, for the salvation of men's souls and for the honor and glory of God. He would not have them perform good works to be seen of men, as did the Pharisees, but only for the greater honor and glory of His Father.

17. **Law and prophets.** By the "law" is here meant the five books of Moses, and by the "prophets" the other books of the Old Testament. Our Lord would have His hearers understand that the doctrine which He is teaching, and about to teach, does not in any way change or destroy the Law of Moses and the Prophets; it is only a fulfilling and a perfecting of these.

18. **Till heaven and earth pass;** i.e., never shall the smallest part of the Law go without its due fulfilment.

19. **Least commandments;** i.e., he who shall violate one of the smallest commandments which I am about to give will be con-

20. For I tell you, that unless your justice abound more than that of the scribes and Pharisees, you shall not enter into the kingdom of heaven.

21. You have heard that it was said to them of old: Thou shalt not kill. And whosoever shall kill shall be in danger of the judgment.

22. But I say to you, that whosoever is angry with his brother, shall be in danger of the judgment. And whosoever shall say to his brother, Raca, shall be in danger of the council. And whosoever shall say, Thou fool, shall be in danger of hell fire.

sidered the "least," i.e., will be actually excluded from the kingdom of heaven; or, if saved, "yet so as by fire" (1 Cor. iii. 15).

Shall be called great; i.e., he who shall observe not only the "least," but all of My commandments, shall save his soul, and shall have a great reward.

20. Justice refers to the keeping of the law in general.

**Scribes and Pharisees.** These were very zealous about the external fulfillment of the law, and about external behavior; but in our Lord's time they had become so degenerate that they cared nothing for the interior man, for the acts of the will, feelings, desires, etc., and thus also did they teach others. Not only the letter, but the interior meaning and spirit of the New Law must be observed, says our Lord.

21. Our Lord now begins to show that the Old Law still remains, but that it is to be perfected by the added counsels of the New Law, and by a clearer understanding of the precepts of the natural law already existing.

You have heard, etc.; i.e. it was enjoined upon your forefathers, by the Law of Moses, etc.

**In danger of the judgment;** i.e., shall be liable to capital punishment. There were three tribunals of justice among the Jews: the first, whose duty was to treat trivial cases, such as rapine, theft, and the like, consisted of three judges; the second, composed of twenty-three judges and called the "Judgment," had to deal with more serious, and even criminal cases; the third, called the Sanhedrim, was composed of seventy-two judges, and its office embraced the larger public interests of religion and of the state. The members of the first two tribunals were appointed by the Sanhedrim (Edersheim, vol. ii. b. v. c. xiii.).

22. But I say to you. The Scribes and Pharisees regarded the precept "not to kill" as affecting only external acts, and so they

23. If therefore thou offer thy gift at the altar, and there thou remember that thy brother hath any thing against thee;

24. Leave there thy offering before the altar, and go first to be reconciled to thy brother: and then coming thou shalt offer thy gift.

25. Be at agreement with thy adversary betimes, whilst thou art in the way with him: lest perhaps the adversary deliver thee to the judge, and the judge deliver thee to the officer, and thou be cast into prison.

26. Amen I say to thee, thou shalt not go out from thence till thou repay the last farthing.

27. You have heard that it was said to them of old: Thou shalt not commit adultery.

28. But I say to you, that whosoever shall look on a woman to lust after her, hath already committed adultery with her in his heart.

taught others. Our Lord here corrects this teaching, and warns His hearers that serious anger, without cause, is a grievous sin. Anger becomes a mortal sin only when willfully and excessively indulged, and exercised in the way of unlawful vengeance.

*Raca* means a contemptible, foolish, or "empty-headed" fellow.

*Fool* implies a charge of irreligion, and hence was wont to signify among the Jews an atheist, an apostate, etc.

23, 24. To offer sacrifice is an act most agreeable to God; but our Lord here reminds us that if we have unjustly offended our neighbor by anger, by calling him *Raca*, *fool*, and the like, it is our duty to try to become reconciled with him before performing that act which is most pleasing to God. When we are the offending party we are obliged to seek to rectify matters in so far as prudence and circumstances allow. But if we are the offended party, all that is required of us is to forgive the offender from our heart, and be willing to accept the explanation which he offers.

25. **In the way**; i.e., while still in this life. Our Lord here admonishes us that if we be at variance with our neighbor we must endeavor to become reconciled with him before death, lest we appear before the judgment seat of God with our sin unforgiven.

26. **Last farthing** means, in the case of grievous sin, eternal punishment, — a debt that shall never be paid; in the case of venial sin, the fires of purgatory, which will last until all guilt is purged from the soul.

27. **Adultery**. Under this term are embraced all external carnal acts of unlawful intercourse.

28. Here our Lord, again correcting the teaching of the Phari-

29. And if thy right eye scandalize thee, pluck it out and cast it from thee. For it is expedient for thee that one of thy members should perish, rather than that thy whole body be cast into hell.

30. And if thy right hand scandalize thee, cut it off, and cast it from thee; for it is expedient for thee that one of thy members should perish, rather than that thy whole body go into hell.

31. And it hath been said, Whosoever shall put away his wife, let him give her a bill of divorce.

sees, condemns internal sins. The complete internal sin, according to St. Thomas, is not specifically distinct or different from the external sin. The external act adds increased malice to the internal sin, by intensifying it, by prolonging it, often by giving scandal, and by increasing the number of internal acts; but it does not change the *species* or nature of the internal sin.

29, 30. **Right eye — right hand** convey the idea of something very dear and highly useful; but if these should "scandalize," i.e., become the source of serious sin which cannot otherwise be removed, they are to be destroyed, just as a corrupting physical member is to be amputated rather than that the whole body should perish. Ordinarily, however, this passage is not to be understood literally.

Hell; i.e., *gehenna* (*γέεννα*), which is nothing else than the Hebrew *Ghe-Hinnom*, "the valley of Hinnom," where the faithless Jews used to sacrifice their children by burning them in honor of the idol, Moloch (4 Kings xxiii. 10). After the captivity the place was used as a dumping ground for refuse, and for the bodies of dead animals and criminals, to consume which a fire was kept burning there. This place was a figure of hell, the abode of damned souls, and hence hell was also called *gehenna*.

31. The right to divorce, or to put away one's wife was only permitted in the Old Law; but should a man put away his wife he was obliged to give her a *bill of divorce*, which made their separation lawful. Divorce was absolutely forbidden at the creation, but later on, owing to a degenerate state of society and the hardness of men's hearts, the Law of Moses permitted the marriage tie to be dissolved. The sole cause, however, justifying this step was *uncleanness* of some kind (Deut. xxiv. 1). In the time of our Lord the Jewish doctors, following the schools of Hillel and Shammai, were greatly divided as to what was required as a suffi-

32. But I say to you, that whosoever shall put away his wife, excepting for the cause of fornication, maketh her to commit adultery: and he that shall marry her that is put away, committeth adultery.

33. Again you have heard that it was said to them: of old, Thou shalt not forswear thyself: but thou shalt perform thy oaths to the Lord.

cient cause for divorce. The school of Hillel held that any cause, however trifling, was sufficient; while that of Shammai taught that adultery alone justified.

The privilege of divorce was originally conceded to the husband alone, but later Jewish women of the higher class also claimed a right to it, which, however, they were obliged to seek from the judge. The effect of this divorce of the Old Law was to dissolve the marriage tie, so as to permit the parties to re-marry. The husband could take back, if he chose, his divorced wife, provided she was not already married to another.

32. Our Lord here abolishes the law of divorce permitted by the Mosaic Law, and asserts that whoever puts away his wife without sufficient cause becomes guilty of the adultery which the one put away may commit. It is *de fide* from the Council of Trent that no consummated marriage between Christians can be dissolved *quoad vinculum* (Sess. xxiv. can. xii). Only fornication or adultery is here given by our Lord as a sufficient reason for separation, perhaps because it is the chief reason intrinsic to the marriage state for which one would be justified in putting away his spouse. There are other causes, however, permitting married Christians to separate; e.g., serious danger to spiritual or temporal welfare, constant disagreement, etc.; but these, as already said, cannot dissolve the consummated marriage of Christians *quoad vinculum*.

He that shall marry, etc., committeth adultery. This shows that whether the cause for separation be just or unjust, anyone who marries the separated party commits adultery.

33. Our Lord is here referring to the Second Commandment, and He condemns false oaths (cf. Lev. xix. 12), and reminds us that we should fulfill the *promissory* oaths we have made to God. Cf. Num. xxx. 3. The citation here is not literal, but is an abbreviation of various texts. (Exod. xx. 7; Lev. xix. 12; Deut. v. 11; xxiii. 21).

34. But I say to you not to swear at all, neither by heaven, for it is the throne of God:

35. Nor by the earth, for it is his footstool: nor by Jerusalem, for it is the city of the great king:

36. Neither shalt thou swear by thy head, because thou canst not make one hair white or black.

37. But let your speech be yea, yea: no, no: and that which is over and above these, is of evil.

38. You have heard that it hath been said, An eye for an eye, and a tooth for a tooth.

39. But I say to you not to resist evil: but if one strike thee on thy right cheek, turn to him also the other:

40. And if a man will contend with thee in judgment, and take away thy coat, let go thy cloak also unto him.

41. And whosoever will force thee one mile, go with him other two.

42. Give to him that asketh of thee, and from him that would borrow of thee turn not away.

34-36. In these verses we are forbidden to invoke God's Holy Name rashly and without grave necessity. Neither are we to swear by any of God's creatures, as the Pharisees had falsely taught; nor are we to call down destruction upon our own heads for any cause whatsoever, because our heads, like all our members, were given us for use, and they are not ours to destroy.

37. Yea, yea, etc.; i.e., we must be content with simple assertions, or simple denials, as the case may be, without resorting to unnecessary oaths.

Is of evil; i.e., from the devil, or perhaps from our own evil inclinations.

38. In this verse our Lord refers to the law of retaliation which was laid down in the Old Testament (Exod. xxi. 24; Lev. xxiv. 20). This was a just law, and had the effect of lessening crime; but it was to be exercised only by public authority, and not between private individuals, as the Pharisees taught.

39-41. Here our Lord commands us not to resist evil-doers more than our office, or the honor of God and the good of our neighbor demand. Rather than seriously offend charity and lose our peace of mind, we must be willing to forfeit some of our possessions and to incur not a little inconvenience.

42. In this verse our Lord commands that we should be willing to assist our neighbor, whether he has offended us or not, in so far as we are able.



43. You have heard that it hath been said, Thou shalt love thy neighbour, and hate thy enemy.

44. But I say to you, Love your enemies: do good to them that hate you: and pray for them that persecute and calumniate you:

45. That you may be the children of your Father who is in heaven, who maketh his sun to rise upon the good, and bad, and raineth upon the just and the unjust.

46. For if you love them that love you, what reward shall you have? do not even the publicans this?

47. And if you salute your brethren only, what do you more? do not also the heathens this?

48. Be you therefore perfect, as also your heavenly Father is perfect.

43, 44. **Thou shalt love thy neighbor**, etc. The Hebrew word for neighbor, *Reagh*, also signifies friend. From this the Pharisees falsely concluded and taught that as we should love our friends, so we should hate our enemies. The words, "And hate thy enemy," are nowhere to be found in the Scriptures; hence our Lord is here referring to the false additions to the Law made by the Pharisees.

But I say to you, etc.; i.e., I command you to love your enemies, and to be ready to perform towards them the offices of charity.

45, 46. Our Lord here gives us two motives for showing charity to our enemies; the first is, that by so doing we become His own beloved children and shall have a reward from Him; the second is, that by charity we are lifted above the condition of the Publicans.

The **Publicans** were tax gatherers for the Romans and merciless oppressors of the poor; they were consequently regarded by the Jews as a type of all that was bad. The *Publicans*, in reality, were wealthy Romans who dealt directly with the Roman government, but employed Jews of the lower class as agents to gather the taxes from the people. It is these Jewish agents who are referred to in the Gospel, and who, on account of their office and personal, merciless dishonesty, were held in supreme contempt by all patriotic Jews.

47. **Salute**. If we show signs of affection and friendship only to our friends and to those joined to us by the ties of blood, we are not above the condition of the heathens, for they also do these things.

48. **Perfect**. The perfection to which we are here invited refers chiefly to the virtues of mercy and charity, and, therefore, to the

whole law. We are God's chosen children and are blessed with His special gifts of faith and grace, hence we must show in our lives more than the heathens who have not received these gifts.

## CHAPTER VI

### THE RIGHT INTENTION IN GIVING ALMS, IN PRAY- ING, AND IN FASTING, 1-18. AVOIDANCE OF WORLDLY SOLICITUDE, 19-34.

1. Take heed that you do not your justice before men, to be seen by them: otherwise you shall not have a reward of your Father who is in heaven.

2. Therefore when thou dost an alms-deed, sound not a trumpet before thee, as the hypocrites do in the synagogues and in the streets, that they may be honoured by men. Amen I say to you, they have received their reward.

After condemning the teaching of the Pharisees our Saviour now proceeds to show us how far our own motives should excel the motives by which they were actuated. This chapter is most probably a continuation of the Sermon on the Mount, although none of it is found in St. Luke's Sermon on the Plain; some think it is a collection of parts of other discourses which our Lord delivered at different times.

1. **Justice.** As said above, this is a general term, used to signify the observance of the whole law. Our Saviour wishes to teach us to avoid all vain glory and pride in the performance of our various good works, otherwise we lose the reward in Heaven merited by these good works.

2. **Alms-deed.** All our good works may be classified under three heads: (a) those referring chiefly to the special worship of God, signified by "prayer"; (b) those which relate to our neighbor, signified by "alms-deeds"; (c) those which pertain to our own sanctification, signified by "fasting."

**Hypocrites.** A hypocrite in Greek means an *actor*, i.e., one whose external actions are out of harmony with his own character. Our Saviour admonishes us concerning the necessity of sincerity and of avoiding unnecessary publicity in the performance of good deeds.

3. But when thou dost alms, let not thy left hand know what thy right hand doth.

4. That thy alms may be in secret, and thy Father who seeth in secret will repay thee.

5. And when ye pray, you shall not be as the hypocrites, that love to stand and pray in the synagogues and corners of the streets, that they may be seen by men: Amen I say to you, they have received their reward.

6. But thou when thou shalt pray, enter into thy chamber, and having shut the door, pray to thy Father in secret: and thy Father who seeth in secret will repay thee.

7. And when you are praying, speak not much, as the heathens. For they think that in their much speaking they may be heard.

8. Be not you therefore like to them, for your Father knoweth what is needful for you, before you ask him.

9. Thus therefore shall you pray: Our Father who art in heaven, hallowed be thy name.

3, 4. Our Lord here inculcates the necessity of performing our works of charity for His sake only; He scrutinizes the heart, and on the last day He will make public all our good works and render to us an eternal reward.

5, 6. There is reference here to private prayers, and not to devotions performed in public, as in church; but even when our prayers are said in church we are to close the door of our hearts to all external things; in other words, in performing our devotions we are to guard against all undue publicity and ostentation.

7. **Speak not much.** These words convey no condemnation of frequent or repeated prayers, such as performed in our rosaries, litanies, and the like, for our Lord Himself gave us the example of repeating the same prayer in His agony, and of passing whole nights in prayer (Luke xviii. i; 1 Thess. v. 17; Coloss. iv. 2). What our Lord here condemns is the senseless repetition of the same word, and the vain, foolish and rhetorical language of the heathens, who thought in this wise to instruct the deity and provoke an answer to their desires.

8. **For your Father knoweth what is needful, etc.** Although Almighty God knows all our wants, still it is a part of His Providence that we honor Him and His goodness by supplicating Him for those things which we need.

9. After condemning the vain ostentation of the Pharisees and the false methods of prayer practised by the heathens, the Saviour now shows us in a positive way how we are to pray.

10. Thy kingdom come. Thy will be done on earth as it is in heaven.  
 11. Give us this day our supersubstantial bread.  
 12. And forgive us our debts, as we also forgive our debtors.

If the "Our Father" here given by St. Matthew was a part of the Sermon on the Mount, and that recorded by St. Luke (xi. 1-4) was delivered at another time and in another place, it is easy to understand the variations between the two. In the form of this prayer given us by St. Matthew there are six petitions, unless we subdivide the last one; St. Luke has only five.

**Our Father.** These words show the union which the Incarnation had established between God and His creature man. Thenceforth we are to regard God not merely as our Creator, but as our loving Father.

**Hallowed be thy Name;** i.e., let Thy Holy Name be glorified. This is the first petition of the Our Father, that the name of God, which is holy and adorable, be ever honored and glorified.

10. **Thy kingdom come.** In this second petition of the Lord's prayer we pray not only that God may exercise His supreme dominion over all creatures, but especially that the reign of His grace may be set up in the hearts and lives of all His creatures.

**Thy will be done,** etc. This, the third petition, desires that the will of God, as expressed in His law and precepts, and explained by His Church and lawful ministers, may be as faithfully obeyed by His children on earth as by the angels and Blessed in Heaven.

11. **Give us this day,** etc. The fourth petition requests, through the term "bread," the daily provision of all things necessary to sustain and prolong our present life. All, whether rich or poor, have need of this daily assistance, for there is no security in earthly possessions. The Greek word for daily, *ἐπιούσιον*, is translated by St. Jerome, *supersubstantialis*; which means *excellent above all substances*. But whether the translation of the Greek word be *daily* or *supersubstantial*, the meaning is quite the same. That this petition is limited to each twenty-four hours seems evident from the command of our Lord, not to be solicitous for the morrow. See on Luke xi. 3.

12. **And forgive us our debts,** etc. The fifth petition begs for the forgiveness of sins, since it is chiefly by sin that we are indebted to the justice of God.

13. And lead us not into temptation. But deliver us from evil. Amen.

14. For if you will forgive men their offences, your heavenly Father will forgive you also your offences.

15. But if you will not forgive men, neither will your Father forgive you your offences.

16. And when you fast, be not as the hypocrites, sad. For they disfigure their faces, that they may appear unto men to fast. Amen I say to you, they have received their reward.

As we forgive, etc.; i.e., as we *ought* to forgive our debts; namely, entirely and from our hearts.

13. **And lead us not into temptation.** Temptation sometimes means a trial or test of fidelity, sometimes an allurements to sin. God is often the author of the first (Gen. xxii.; Deut. xiii.; Ps. xxv.), but never of the second. This sixth petition of the Our Father has reference only to allurements to sin, and we ask God to deliver us from these, or at least to prevent us by His grace from consenting or yielding to sin.

**But deliver us from evil.** The evil here meant is commonly understood by the Greek Fathers to be the devil, or evil one (ἐκ τοῦ πονηροῦ); but most likely evil is here a neuter noun, and hence refers to evils in general, physical or spiritual, temporal or eternal.

**Amen** is a Hebrew word signifying, at the end of a sentence, consent or approval of what has preceded. Literally, when used at the beginning of a prayer, it means *surely*, in *truth*. In some few MSS. the Our Father terminates with these words: "For thine is the kingdom, the power, and the glory." But only one of these MSS., namely, the Peschito, dates beyond the fourth century; and none of the ancient Fathers who have expounded the Lord's Prayer have attached such a conclusion to it.

14, 15. Our Lord here explains, that as we measure to others, so will He measure to us.

16. As our Lord condemned ostentation and vain glory in giving alms and saying prayers, so now He warns against a vain show of our penances and acts of mortification. But one fast day in the year was obligatory for the Jews (Lev. xvi. 29). Out of devotion the disciples of John fasted often (Luke v. 33), and the Pharisees twice a week (Luke xviii. 12).

17. But thou, when thou fastest anoint thy head, and wash thy face;

18. That thou appear not to men to fast, but to thy Father who is in secret: and thy Father who seeth in secret, will repay thee.

19. Lay not up to yourselves treasures on earth: where the rust, and moth consume, and where thieves break through and steal.

20. But lay up to yourselves treasures in heaven: where neither the rust nor moth doth consume, and where thieves do not break through, nor steal.

21. For where thy treasure is, there is thy heart also.

22. The light of thy body is thy eye. If thy eye be single, thy whole body shall be lightsome.

23. But if thy eye be evil thy whole body shall be darksome. If then the light that is in thee, be darkness: the darkness itself how great shall it be!

24. No man can serve two masters. For either he will hate the one, and love the other: or he will sustain the one, and despise the other. You cannot serve God and mammon.

17, 18. **Anoint thy head, etc.** When about to partake of a feast the Jews were accustomed to wash their faces and anoint their heads with oil; to this practice our Lord is now referring. His words, however, are to be taken metaphorically, and signify only that we are to avoid ostentation in our fastings, etc.

19, 20. We should be zealous for the treasures of grace and future glory in Heaven, but not for the fleeting and insecure treasures of earth, as the Pharisees were.

21. Although free and rational creatures, we are chiefly led by our attachments and affections, and hence we should see to it that the objects of these be good.

22, 23. **If thy eye be single; i.e.,** if there be no obstruction, as a mote or beam, in your eye, your vision will be perfect. What the eye is to the body, the intention or motive is to the mind and soul. If the intention be good and pure and supernatural, one's actions and conduct will be likewise good and deserving of supernatural reward.

**Light and darkness** refer to moral good and evil. Therefore if our intentions and motives be upright and pure, our actions and deeds cannot be formally bad, provided we be in good faith.

24. **No man can serve two masters; i.e.,** no man can with generosity and entire fidelity serve two masters whose wishes and commands are opposed.

**Mammon** is an Aramaic word for riches. We cannot give our thoughts and affections to God and to the things of earth at one and the same time.

25. Therefore I say to you, be not solicitous for your life, what you shall eat, nor for your body, what you shall put on. Is not the life more than the meat: and the body more than the raiment?

26. Behold the birds of the air, for they neither sow, nor do they reap, nor gather into barns: and your heavenly Father feedeth them. Are not you of much more value than they?

27. And which of you by taking thought, can add to his stature one cubit?

28. And for raiment why are you solicitous? Consider the lilies of the field, how they grow: they labour not, neither do they spin.

29. But I say to you, that not even Solomon in all his glory was arrayed as one of these.

30. And if the grass of the field, which is to-day, and to-morrow is cast into the oven, God doth so clothe: how much more you, O ye of little faith?

31. Be not solicitous therefore, saying, What shall we eat: or what shall we drink, or wherewith shall we be clothed?

32. For after all these things do the heathens seek. For your Father knoweth that you have need of all these things.

25, 26. In these verses our Lord is condemning undue solicitude for the needs of the body in the present life. His words do not imply that we are to indulge idleness and indolence, but only that we are not to be over-anxious about material, transitory things.

**The life;** i.e., the soul is more important than the care of the body, as the body is more than its covering.

27. **Can add,** etc. A cubit was about eighteen inches. How vain is it to be anxious and disturbed about the welfare of the body, since after all we cannot do, if ever so anxious, such a small thing as to increase our stature!

28, 29. "What silken works," says St. Jerome, "what royal purple, what woven picture, can be compared to flowers? What so blushing as the rose? What so white as the lily?" All the glory of Solomon therefore is not to be compared with the lilies and flowers of the field; and if Almighty God so provides for these, how much more will He provide for us!

30. **The grass of the field;** i.e., the lilies He has just been speaking about, — if He so clothe them, whose life is so short, how much more will He provide for us who are to live forever!

31, 32. We are to labor for our daily sustenance, but in so doing we must not be over-anxious for the needs and goods of this present life. To be unduly solicitous for temporal things is characteristic of the heathen. Our confidence in our heavenly Father, like our

33. Seek ye therefore first the kingdom of God, and his justice, and all these things shall be added unto you.

34. Be not therefore solicitous for to-morrow for the morrow will be solicitous for itself. Sufficient for the day is the evil thereof.

charity toward our neighbor, must far exceed the virtues of the heathen.

33. Seek ye therefore first the kingdom of God, and his justice; i.e., our first care should be to please God, and by faithful observance of His law and commands to work for His honor and glory, and for the salvation of our own souls; all temporal things are to be subordinated to these higher duties; and if we seek God and the observance of His precepts (justice), all temporal things will be added according to our needs.

34. **Solicitous for to-morrow.** The meaning here is that we should not worry about the future, but try contentedly and patiently to bear the burdens of each day as it comes.

**To-morrow** is understood by St. Augustine to mean temporal things; by St. Chrysostom, the superfluities of life; but it is more likely that the term means the future time.

## CHAPTER VII

NOT JUDGING OUR NEIGHBOR, 1-6.

PRAYER, 7-11.

CHARITY AND SELF-DENIAL, 12-14.

FALSE PROPHETS, 15-23.

THE TRULY WISE, 24-27.

CONCLUSION, 28, 29.

1. Judge not, that you may not be judged.

There are many verses in this chapter which correspond to St. Luke's Sermon on the Plain.

1. **Judge not**; i.e., rashly and falsely. The judgment here condemned is in regard to sins and faults unseen and uncertain. When sins are manifest, our judgment of them cannot be called rash.



2. For with what judgment you judge, you shall be judged: and with what measure you mete, it shall be measured to you again.

3. And why seest thou the mote that is in thy brother's eye; and seest not the beam that is in thy own eye?

4. Or how sayest thou to thy brother: Let me cast the mote out of thy eye; and behold a beam is in thy own eye?

5. Thou hypocrite, cast out first the beam out of thy own eye, and then shalt thou see to cast out the mote out of thy brother's eye.

6. Give not that which is holy to dogs; neither cast ye your pearls before swine, lest perhaps they trample them under their feet, and turning upon you, they tear you.

7. Ask, and it shall be given you: seek, and you shall find: knock, and it shall be opened to you.

**That you be not judged.** Men usually judge us as we are accustomed to judge others; and while God will pass just judgment on us, He will be the more severe in proportion as we are merciless in our judgments of others.

2. **For with what judgment, etc.** As we treat others, so in the main do they treat us; and as we judge others, so, *servata justitia*, God will judge us, i.e., measure to us.

3-5. **Mote and beam** are terms literally meaning small and large pieces of wood. They are used here, as elsewhere in the Scriptures, to denote slight and grave faults. Before condemning and correcting others (unless it be our office to do so), we are first to endeavor to correct our own lives, otherwise our action is hypocritical. Cf. Rom. ii. 1-3, 20-22.

6. **Give not that which is holy to dogs, etc.** There is reference here to Exod. (xii. 8-10). The Jews were obliged to consume or burn all meat offered in sacrifice; it would have been an impious act to give such meat to dogs. Everything set apart from all profane use was considered by the Jews to be "holy." "Dogs," like "swine," in the Scriptures, are types of things unclean. The meaning of this verse is, that we are not to expose the precious teachings of the Gospel and the august mysteries of our holy faith to the danger of being profaned and blasphemed by unholy and impious men.

7. **Ask, etc.** St. Luke (xi. 9-12) connects these words with the petitions of the Lord's prayer. The meaning is, that to fulfill God's precepts and counsels we need His constant help, and this we are to seek by confident, diligent, and persevering prayer.

8. For every one that asketh, receiveth: and he that seeketh, findeth: and to him that knocketh, it shall be opened.

9. Or what man is there among you, of whom if his son shall ask bread, will he reach him a stone?

10. Or if he shall ask him a fish, will he reach him a serpent?

11. If you then being evil, know how to give good gifts to your children: how much more will your Father who is in heaven, give good things to them that ask him?

12. All things therefore whatsoever you would that men should do to you, do you also to them. For this is the law and the prophets.

13. Enter ye in at the narrow gate: for wide is the gate, and broad is the way that leadeth to destruction, and many there are who go in thereat.

14. How narrow is the gate, and strait is the way that leadeth to life: and few there are that find it!

8-11. For everyone that asketh, receiveth; i.e., every one who with proper dispositions asks those things which are not opposed to God's glory and his own spiritual well-being, shall receive the answer of his prayers. The failure to have our prayers answered and petitions granted comes from the fact that we either do not ask properly, or because we ask that which would be hurtful to our greater good. God loves us, as a father his children; but just as the father does not grant every wish of his child, because he sees that to do so would be hurtful to the child, so Almighty God does not always answer our prayers.

12. In this verse Our Lord inculcates the necessity of fulfilling the second precept, which is included in the first. We are to love our neighbor as ourselves out of love for God.

Law here means the five books of Moses (Pentateuch), the Prophets, and other books of the Old Testament. Strictly speaking the Law meant only the five books of Moses.

13, 14. Our Saviour shows us here that the fulfillment of His law, and our consequent salvation, are matters of great difficulty. Hence the way to Heaven is called narrow, whereas the way to sin and eternal perdition is broad. Our Lord is here answering the question put to Him in St. Luke (xiii. 23, 24), "are they few that are saved?" and He seems plainly to answer that the majority of men are lost.

Commentators and theologians are greatly divided as to the number of the saved. St. Thomas (1<sup>a</sup>, qu. 23, a. 7 ad. 3) and many others hold that the majority of mankind will not be saved; but

15. Beware of false prophets, who come to you in the clothing of sheep, but inwardly they are ravening wolves.

16. By their fruits you shall know them. Do men gather grapes of thorns, or figs of thistles?

17. Even so every good tree bringeth forth good fruit, and the evil tree bringeth forth evil fruit.

18. A good tree cannot bring forth evil fruit, neither can an evil tree bring forth good fruit.

19. Every tree that bringeth not forth good fruit, shall be cut down, and shall be cast into the fire.

20. Wherefore by their fruits you shall know them.

21. Not everyone that saith to me, Lord, Lord, shall enter into the kingdom of heaven: but he that doth the will of my Father who is in heaven, he shall enter into the kingdom of heaven.

the weight of opinion seems in favor of the doctrine that the majority of Christians will be saved.

15. **Prophets.** The word prophet in its strict sense means one who has been divinely instructed to foretell future events. Here, however, it means a teacher who has been sent by God to instruct His people. **False prophets** means false teachers, heretics, etc., within the fold of Christ.

**Who come;** i.e., who are self-sent, without divine commission; who have the external appearances of **sheep**, i.e., of orthodoxy, but who are in reality **wolves**, i.e., false teachers.

16. **By their fruits**, etc.; i.e., by their false doctrine, which is out of harmony with the doctrine of Christ, and especially by the evil moral effects of their teaching on themselves and others.

17, 18. Every teacher whose doctrine is true, and who is sincerely living, or trying to live, according to his preaching will produce good fruit; whereas every teacher of false doctrine must yield bad fruit.

19. There is referencè here to all evil-doers in general, and to false teachers in particular, to whom due punishment shall be administered.

21. **Not every one**, etc. Here our Saviour observes that not every one who teaches in His name, or invokes Him, or belongs to His visible Church will be saved; but only those who do the "will" of His Father, i.e., who faithfully keep His commandments. See Luke vi. 46.

**Will of my Father**, which was His own will also, because He and the Father are one (John x. 30).

22. Many will say to me in that day: Lord, Lord, have not we prophesied in thy name, and cast out devils in thy name, and done many miracles in thy name?

23. And then will I profess unto them, I never knew you: depart from me, you that work iniquity.

24. Every one therefore that heareth these my words, and doth them, shall be likened to a wise man that built his house upon a rock,

25. And the rain fell, and the floods came, and the winds blew, and they beat upon that house, and it fell not, for it was founded on a rock.

26. And every one that heareth these my words, and doth them not, shall be like a foolish man that built his house upon the sand,

27. And the rain fell, and the floods came, and the winds blew, and they beat upon that house, and it fell, and great was the fall thereof.

22. **In that day**; i.e., on the day of the General Judgment many false teachers will appeal to Christ for eternal life in view of their having preached in His name, and many likewise who have had His divine assistance, and have exercised the functions of true teachers shall, because of sinful lives, be excluded from the kingdom of God. See Luke xiii. 26, 27.

23. When the time of patient endurance shall have come to an end, then will be the time for the denunciation of false teachers, and of all those who, while apparently doing His work, shall have been untrue to the doctrine they preached.

**I never knew you**; i.e., you were never my chosen friends, predestined to glory.

**Depart from me**; i.e., go into everlasting punishment, "you that work iniquity," i.e., that were unfaithful in life and died in your sins.

24, 25. Some commentators see in verse 21 a transition from false teachers to the common faithful. The present verse would seem to justify such an interpretation, because there is here clear reference to all the faithful. As in verse 15 the Saviour inculcates the necessity of true faith, so now He is insisting on the performance of good works. Therefore He concludes, that whosoever has received His doctrine and lived in accordance with it, has built his moral structure on a foundation which shall not be moved, i.e., which shall endure forever.

26, 27. Those who do not hear the words and doctrine of Christ, or who accept His doctrine, but do not prove their faith by works, i.e., by keeping His commandments, shall be easily swept away by

28. And it came to pass when Jesus had fully ended these words, the people were in admiration at his doctrine.

29. For he was teaching them as one having power, and not as the scribes and Pharisees.

the storms of temptation and trial, like a house without foundation, which is swept away by the winds and floods.

28. **In admiration**; i.e., they were astonished.

29. **As one having power**; i.e., as one who spoke His own doctrine and not that of another, as did the prophets, who were only the mouthpiece of God; nor again as the Scribes and Pharisees, who, perverting the true teaching of Scripture, taught the traditions of men.

## CHAPTER VIII

THE LEPER IS HEALED, 1-4.

THE SERVANT OF THE CENTURION, 5-13.

THE MOTHER-IN-LAW OF PETER, 14, 15.

THE DEMONIAK IS CURED, 16, 17.

THE DISPOSITIONS NECESSARY FOR A DISCIPLE, 18-22.

JESUS STILLS THE STORM AT SEA, 23-27.

THE POSSESSED MEN OF GERGESA, 28-34.

1. And when he was come down from the mountain, great multitudes followed him:

2. And behold a leper came and adored him, saying: Lord, if thou wilt, thou canst make me clean.

1. St. Matthew's account here completes what St. Luke (vi. 17) has given. St. Luke records our Lord's descent from the top of the mountain to the level plain on the mountain side, where this discourse was delivered, but makes no mention of the further descent to the foot of the mountain.

**And when he was come**, etc.; i.e., when He had come to the foot of the mountain from the level plain on the mountain side where He had been discoursing to the multitudes (Luke vi. 17).

2. **A leper**. According to Jewish law (Lev. xiii. 44-46) lepers were not allowed to associate with other people, nor to dwell in the cities, because of the contagious character of their malady. Hence where they are spoken of as being in cities, we are to understand at the entrance of the cities; or if in the city, only as passing

3. And Jesus stretching forth his hand, touched him, saying: I will, be thou made clean. And forthwith his leprosy was cleansed.

4. And Jesus saith to him: See thou tell no man: but go, shew thyself to the priest, and offer the gift which Moses commanded for a testimony unto them.

through. The leper here spoken of was most likely met by our Lord just outside of Capharnaum. See on Luke v. 12-14. St. Matthew is probably not following the chronological order here, as this leper seems to have been cured before the Sermon on the Mount. See Mark i. 40; Luke v. 12.

Adored him; i.e., fell on his knees, or on his face (Luke v. 12).

3. **Touched him.** Although to touch a leper meant defilement (Lev. v. 3), our Lord, who was not subject to Jewish law, as being Himself the author of all law, disregarded this observance, and showed by touching the leper that He was above all defilement. Our Lord healed the leper out of compassion for his awful disease; He did not mean to suppress the law, and hence He sent the leper to the priests.

4. **Tell no man.** In saying these words our Lord most likely had in mind only to conceal the benefit He had conferred on the leper, out of love of humanity, and perhaps also He wished not to arouse the jealousy and anger of His enemies. At any rate the leper did not seem to feel himself bound to secrecy regarding his cure.

Show thyself to the priest, or as St. Mark (i. 44) has it, "to the high priest." This chief of the priests was perhaps the one that exercised authority over the others. The leper was to show himself to the priest in order to obtain a certificate of his cure, which would permit him to live again among men.

Offer thy gift, etc., which was a lamb with flour and oil; or, in case of poverty, two turtles or two young pigeons (Lev. xiv. 21, 22).

Testimony. This may mean that such gifts were commanded by Moses as a law, and as such could be enforced by the priests; or that if the priests accepted them, it would be a public recognition that the leper was healed, and that the miracle performed was a true one.

The lessons taught in this verse are humility, obedience, and gratitude; humility is shown in the desire on the part of our Lord

5. And when he had entered into Capharnaum, there came to him a centurion, beseeching him,

6. And saying, Lord, my servant lieth at home sick of the palsy, and is grievously tormented.

7. And Jesus saith to him: I will come and heal him.

8. And the centurion making answer, said: Lord, I am not worthy that thou shouldst enter under my roof: but only say the word, and my servant shall be healed.

9. For I also am a man subject to authority, having under me soldiers; and I say to this, Go, and he goeth, and to another, Come, and he cometh, and to my servant, Do this, and he doeth it.

10. And Jesus hearing this, marvelled; and said to them that followed him: Amen I say to you, I have not found so great faith in Israel.

11. And I say to you that many shall come from the east and the west, and shall sit down with Abraham, and Isaac, and Jacob in the kingdom of heaven:

12. But the children of the kingdom shall be cast out into the exterior darkness: there shall be weeping and gnashing of teeth.

to keep the benefit concealed, obedience by the leper's going to the priest, and gratitude by the gift offered.

5, 6. **Had entered into Capharnaum**, etc. From these words we may conclude that the leper was cured at the entrance to the city.

**There came to him.** From St. Luke (vii. 1-10) it seems that messengers were first sent by the centurion to beseech our Lord in his behalf, and from St. Matthew that the centurion himself later met our Lord. This seems the best way to explain the differences between the accounts of the event given by Matthew and Luke.

8. **Lord, I am not worthy.** These words were addressed to our Lord either by the centurion himself, or by those whom the centurion had instructed to say them.

**Only say the word;** i.e., only give the command, or elicit the wish,—which words show that the centurion recognized the omnipotent power of the Saviour.

9. **Subject to authority;** i.e., one who has subjects and subordinates under him, to whom he issues commands.

10. **Wondered;** i.e., was astonished at the faith of this Gentile and pagan Roman soldier, as contrasted with the faith of the Jews.

11, 12. **Many shall come**, etc.; i.e., a great multitude, through the power of the Gospel and God's grace, shall be brought from all quarters of the earth to membership in Christ's kingdom here and hereafter, while the Jews, the natural heirs, shall be cast out.

13. And Jesus said to the centurion: Go, and as thou hast believed, so be it done to thee. And the servant was healed at the same hour.

14. And when Jesus was come into Peter's house, he saw his wife's mother lying, and sick of a fever:

15. And he touched her hand, and the fever left her, and she arose and ministered to them.

16. And when evening was come, they brought to him many that were possessed with devils: and he cast out the spirits with his word: and all that were sick he healed:

**Exterior darkness;** i.e., out of the light of God's presence into the darkness of hell.

**Weeping and gnashing,** etc. These words are understood by St. Jerome and others to signify that in hell there will be continuous alternations between extreme heat and extreme cold. There is foundation for this interpretation in the words of Job (xxiv. 19), although they do not prove. "Weeping and gnashing of teeth" express, without doubt, the pain of loss, the eternal regret and remorse of the damned.

13. **At the same hour;** i.e., at the very moment that our Lord uttered the words of his cure.

14. According to the order of time the miracles narrated here (verses 14-17) follow after the call of the Apostles (iv. 22).

**Peter's house.** It seems that after the call of Peter and Andrew our Lord entered Capharnaum, and having preached there for a time retired to Peter's house. Cf. Mark i. 22; Luke iv. 32. The house in question some say belonged to Peter's father; others believe it was the property of Peter's mother-in-law. Peter and Andrew were likely accustomed to stop there while in Capharnaum, hence it is called by St. Mark (i. 29) "the house of Simon and Andrew."

**Mother-in-law.** Peter is the only one of the Apostles whom we know from the Scriptures to have been married.

15. **She arose,** etc. We know from St. Luke (iv. 38) that her illness was very great, hence this sudden and complete cure was a miracle *quoad modum*.

16. **When evening was come.** Although the cure of Peter's mother-in-law and of the demoniac had taken place on the Sabbath (Mark i. 21; Luke iv. 31), it was considered unlawful to do any work on that day, and therefore, since the Sabbath ended at sunset, they waited till evening to bring the sick to our Lord.



17. That it might be fulfilled, which was spoken by the prophet Isaias, saying: He took our infirmities, and bore our diseases.

18. And Jesus seeing great multitudes about him, gave orders to pass over the water.

19. And a certain scribe came and said to him: Master, I will follow thee whithersoever thou shalt go.

20. And Jesus saith to him: The foxes have holes, and the birds of the air nests: but the son of man hath not where to lay his head.

21. And another of his disciples said to him: Lord, suffer me first to go and bury my father.

22. But Jesus said to him: Follow me, and let the dead bury their dead.

**And all that were sick, etc.** Those who were possessed were commonly spoken of as "the sick"; and rightly so, because the devil, by entering into a man, can to such an extent upset his reason and imagination as to make him the subject of all kinds of ills. Thus the possessed were often epileptics, maniacs, deaf, dumb, etc. The devil, although he ever remains an exterior agent, can in these ways afflict human beings, because he is a spirit, and as such enjoys great power over matter and, through matter, over mind and will. See on iv. 24.

17. **He took our infirmities, etc.** The prophecy of Isaias (liii. 4, 5) refers directly to sin and its punishment. Our Lord by His Passion and death on the cross, took away sin and the eternal punishment due to sin; but sickness and disease are consequences of sin; and hence St. Matthew says that our Lord, by taking away sin, took away also sickness and disease. All sickness and suffering, however, will not disappear until the next life, in Heaven.

18. **Gave orders, etc.** The fame of His miracles had attracted great crowds, and in order to avoid too much human applause He wished to cross to the other side of the lake.

19. Most commentators who identify this verse with Luke ix. 57 believe that the Third Gospel gives the right chronology, and consequently that verses 19 to 22 should be considered as parenthetical here, as giving two sayings of our Lord during the last autumn of His life.

20. **Son of man; i.e.,** according to the prophecy of Daniel (vii. 13), the perfect type of man, the Messiah. Our Lord was a true man, having the same human nature that we have, without our tendencies to corruption and sin.

21, 22. **Follow me.** Our Lord wishes here to call attention that

23. And when he entered into the boat, his disciples followed him :
24. And behold a great tempest arose in the sea, so that the boat was covered with waves, but he was asleep.
25. And they came to him, and awaked him, saying: Lord, save us, we perish.
26. And Jesus saith to them: Why are you fearful, O ye of little faith? Then rising up he commanded the winds, and the sea, and there came a great calm.
27. But the men wondered, saying: What manner of man is this, for the winds and the sea obey him?
28. And when he was come on the other side of the water, into the country of the Gerasens, there met him two that were possessed with devils, coming out of the sepulchres, exceeding fierce, so that none could pass that way.

our duties to Him transcend all natural duties. **Let the dead bury their dead**, i.e., let those who are spiritually dead bury them that are corporally, physically dead. It is well enough for those who are dead to all spiritual interests to busy themselves with material, earthly things, but not so one who wishes to follow Christ and be a true disciple.

23. **His disciples followed him**; i.e., into the boat. The stilling of the storm follows chronologically after the parables in chapter xiii.

25. **We perish**; i.e., we are about to perish.

26. **O ye of little faith**. Mark (iv. 40) and Luke (viii. 25) say that our Lord added these words after the miracle of the calming of the sea.

**He commanded the winds**, etc. As the sleep of our Lord had shown His human nature, so now the commanding of the winds and the waves showed His divine nature and sovereign power.

27. **The men wondered**; i.e., the disciples, or perhaps the men rowing the boat; more likely all who witnessed the miracle were astonished at the power of our Saviour.

28. **The country of the Gerasens**. The place here mentioned was most probably Gergesa, now Kersa on the east side of the sea of Galilee. In different MSS. the three Synoptics have Gerasa, Gadara, and Gergesa. But it is hardly possible that the scene in the Gospel, which is represented as having taken place on the shores of the lake, could have been at either of the first two places, since they are both a long distance away from the lake. It is probable that Gergesa belonged to the district of Gadara, which Jo-

29. And behold they cried out, saying: What have we to do with thee, Jesus Son of God? art thou come hither to torment us before the time?

30. And there was, not far from them, an herd of many swine feeding.

31. And the devils besought him, saying: If thou cast us out hence, send us into the herd of swine.

32. And he said to them: Go. But they going out went into the swine, and behold the whole herd ran violently down a steep place into the sea: and they perished in the waters.

sephus (*Bell. Jud.* iv. 7, 3) tells us was the capital of Peraea. If this be true, the two readings, Gergeseans and Gadaranians are correct. The reading *Gerasens* is not exact and was introduced perhaps because Gerasa was better known than Gergesa.

**There met him two.** Mark and Luke mention only one, perhaps because the condition of one was much more terrible than that of the other. It is thought more probable, however, that the translator here read the singular for the plural, in the original Aramean, and that Mark and Luke are right in speaking of only one demoniac on this occasion.

**Sepulchres.** These were vault-like structures built outside the cities and towns, in accordance with the Mosaic Law, and large enough to admit several men.

29. **They cried out**, when our Lord ordered them to leave the bodies of the possessed (Mark v. 7).

**What have we to do with thee;** i.e., leave us in peace. By an ordinance of God the devils were permitted to roam the earth for a certain time, after which they should be obliged to return to the confinement of hell. They feared, therefore, that our Lord, whom they at least suspected to be the Christ, the Son of God, would drive them back into hell before the end of the time allowed them to roam the earth.

30, 31. **Not far.** One reading says a great way off, but most readings favor that of the Vulgate. The swine were about two thousand in number and the devils were very many, — legion (Mark v. 9, 13).

**Send us into the herd**, etc. The devils did not want to be cast into hell; they wished to remain on earth to destroy the property of men whom they hated, and to instigate men against Christ whom they also hated.

32. **Go.** Our Lord here shows that even the demons are subject

33. And they that kept them fled: and coming into the city, told every thing, and concerning them that had been possessed by the devils.

34. And behold the whole city went out to meet Jesus, and when they saw him, they besought him that he would depart from their coasts.

to Him. Commentators say that He sent the devils into the swine: (a) in order to spread abroad a knowledge of the miracle performed; (b) to show the existence of spirits and devils, which many then as now denied; (c) to show that He had power over the demons.

Into the sea; i.e., the Sea of Galilee.

34. The whole city went out, etc.; i.e., a great number from the city.

Depart. The faithless people preferred to lose the presence of our Saviour, rather than suffer any further temporal loss.

## CHAPTER IX

THE CURE OF THE PARALYTIC AND THE POWER ON EARTH TO FORGIVE SINS, 1-8.

THE CALL OF ST. MATTHEW AND THE FEAST IN HIS HOUSE, 9-17.

THE DAUGHTER OF JAIRUS, 18-26.

THE TWO BLIND MEN, 27-31.

THE DUMB MAN, 32-34.

JESUS TEACHES AND PREACHES IN GALILEE, 35-38.

1. And entering into a boat, he passed over the water and came into his own city.

2. And behold they brought to him one sick of the palsy lying in a bed. And Jesus, seeing their faith, said to the man sick of the palsy: Be of good heart, son, thy sins are forgiven thee.

1. His own city, which was Capharnaum, as is clear from iv. 13. Nazareth was called "his own country" (xiii. 54).

2. One sick of the palsy. Palsy is the same as paralysis. The order of Matthew here does not quite agree with that of Mark (ii. 1-12) and Luke (v. 18-26), but Matthew is following a topical rather than a chronological order.

3. And behold some of the scribes said within themselves: He blasphemeth.
4. And Jesus seeing their thoughts, said: Why do you think evil in your hearts?
5. Whether is easier, to say, Thy sins are forgiven thee: or to say, Arise, and walk?
6. But that you may know that the Son of man hath power on earth to forgive sins, (then said he to the man sick of the palsy,) Arise, take up thy bed, and go into thy house.
7. And he arose, and went into his house.

Seeing their faith; i.e., the faith of those who carried the sick man (Mark ii. 3 ff.; Luke v. 18 ff.), which shows that favors are conferred by reason of the prayers and faith of others.

**Thy sins are forgiven thee.** All bodily sufferings are the effect of sin, original or actual, or both, and our Lord before removing the illness of the sick man first removed the cause; namely, his sins.

3. **Said within themselves;** i.e., in their hearts. **He blasphemeth.** They wished to say that our Lord was not God, and so blasphemed in ascribing to Himself the power of God.

4. **Seeing their thoughts,** which should have proved to them that He was really God, because only God can read the heart. He accused them of evil because He had already given them sufficient signs that He was God.

5. **Whether is easier, to say,** etc. It is easier merely to say, i.e., to pretend, to forgive sin than to cure a paralytic, because the latter is an object of ocular vision, whereas the former is unseen in its effects. St. Augustine and many of the Fathers say it is much more difficult actually to forgive sin than to cure any corporal malady, or even to create heaven and earth; but in order that these Scribes might have ocular demonstration of the miracle, our Lord chose to heal the sick man in their presence.

6. **Power to forgive sins.** By performing a miracle which all could see our Lord wished in this instance to prove that He had also power to forgive sin, because any miracle performed in approbation, in substantiation, of His doctrine was sufficient to prove the truth of that doctrine. Jesus claims to have the power to forgive sin, and He performs a miracle which all can see to prove His claim. But only God can remit sin. Therefore Jesus, who has proved that He can remit sin, *is God*.

7. **He arose,** showing that his cure was complete.

8. And the multitude seeing it, feared, and glorified God that gave such power to men.

9. And when Jesus passed on from thence, he saw a man sitting in the custom house, named Matthew; and he saith to him: Follow me. And he arose up and followed him.

10. And it came to pass as he was sitting at meat in the house, behold many publicans and sinners came, and sat down with Jesus and his disciples.

11. And the Pharisees seeing it, said to his disciples: Why doth your master eat with publicans and sinners?

12. But Jesus hearing it, said: They that are in health need not a physician, but they that are ill.

13. Go then and learn what this meaneth, I will have mercy and not sacrifice. For I am not come to call the just, but sinners.

8. **Feared**, — literally, *marveled* (*ἐθαύμασον*) at the sight of the miracle.

9. **Custom-house** was a place where taxes on exports and imports were collected by the Roman authorities. See on v. 46.

**Named Matthew.** Mark and Luke called this man Levi; but he calls himself Matthew, perhaps out of gratitude to God for his call, because the Hebrew word *Mattathah* means "gift of God."

10. **In the house**; i.e., in Matthew's house. St. Matthew passes over very briefly the feast which he gave our Saviour, doubtless out of a sense of humility.

**Sinners.** The Jews were accustomed to call the Gentiles sinners, but those here mentioned were likely Jews who led sinful lives and associated with the Gentiles. These publicans and sinners were probably friends of Matthew, who also perhaps wanted to meet Jesus and become His disciples. It was customary in the East, where the houses were kept open, for friends freely to enter the house of a friend, and take their places at his table.

11. **Pharisees seeing it**; i.e., when they had learned of it from others, for they were not present at the time.

**Why doth your master eat, . . . ?** i.e., why do you and your Master eat, . . . ? Cf. Luke v. 3. The Pharisees pretended to a superior degree of sanctity and so contemned others. See on iii. 7.

12. **Jesus hearing it**; i.e., later from His disciples.

13. **Mercy and not sacrifice.** The meaning is that mercy is preferred to sacrifice (Osce vi. 6). Mercy represents the actual

14. Then came to him the disciples of John, saying: Why do we and the Pharisees fast often, but thy disciples do not fast?

15. And Jesus said to them: Can the children of the bridegroom mourn, as long as the bridegroom is with them? But the days will come, when the bridegroom shall be taken away from them, and then they shall fast.

works of charity toward our neighbor, whereas sacrifice, to the mind of the Pharisee, had reference chiefly to the external acts of worship. By these words our Lord wished to call attention to the fact that real interior religion is far more excellent than the mere external show which the Pharisees practiced.

**But sinners.** The purpose of Christ's coming was to redeem the world from sin, and to enable man to attain his supernatural destiny.

14. **The disciples of John.** Most likely some Scribes and Pharisees were with John's disciples when they came to our Lord (Mark ii. 18; Luke v. 33). Those who asked the question were apparently moved by jealousy towards the Saviour, and wished to insinuate that His association with sinners, as at the recent feast, was not to save them, but rather for self-indulgence. It would be a mistake to conclude from this message of John to Jesus that the Baptist himself entertained any doubts as to the character and mission of our Lord. It was only to satisfy some of his disciples whose faith perhaps, by contact with the Pharisees, had begun to waver a bit.

15. **Children of the bridegroom;** i.e., the close friends and companions of the bridegroom.

**Bridegroom,** in its figurative sense, means our Lord, who is the spouse of His Church (John iii. 29).

**Mourn;** i.e., fast. Our Lord did not wish to condemn future fasting in His Church, which He really predicted in this verse; He wished only to say that it was unbecoming that His disciples should fast while enjoying His blessed presence.

John the Baptist (John iii. 29) had called our Lord the "Bridegroom" of His people, and our Lord now reminded the disciples of John of their master's testimony. During wedding festivities, according to Jewish custom, there was no fasting for the members of the wedding party. Therefore, while the Saviour was with His disciples they were exempted from fasting.

16. And nobody putteth a piece of raw cloth unto an old garment. For it taketh away the fulness thereof from the garment, and there is made a greater rent.

17. Neither do they put new wine into old bottles. Otherwise the bottles break, and the wine runneth out, and the bottles perish. But new wine they put into new bottles: and both are preserved.

18. As he was speaking these things unto them, behold a certain ruler came up, and adored him, saying: Lord, my daughter is even now dead; but come, lay thy hand upon her, and she shall live.

19. And Jesus rising up followed him, with his disciples.

20. And behold a woman who was troubled with an issue of blood twelve years, came behind him, and touched the hem of his garment.

16, 17. **Raw cloth** means new and undressed cloth, fresh from the weaver. This new unyielding piece takes wholeness and completeness from the old, and if sewed to the old would soon contract and tear it.

**Old bottles.** These were not glass bottles, but wine-skins made from the hides of sheep and goats; and because they were old and no longer elastic they could not expand with the fermentation of new wine, and so would burst. The meaning of these similitudes is that our Lord did not consider His disciples yet sufficiently instructed and advanced in His teaching to be able to withstand the austerities of a life of penance and mortification. As yet they were men of the ancient Judaism, and Judaism was not strong enough to support the religious perfection of Christianity.

18. **As He was speaking, etc.** The raising of the daughter of Jairus followed the encounter with the demoniacs of Gergesa (Mark v. 1; Luke viii. 26), which happened after the dispute about fasting. Hence **these things** refers not only to the things said in verses 14-17, but to all the previous teaching of our Lord given in this Gospel.

**A certain ruler,** who was president of the synagogue, and whose name was Jairus (Mark v. 22; Luke viii. 41).

**Is even now dead.** Mark and Luke say she was dying. The girl was likely at the point of death when the ruler left her, and judging from the extremity of her illness he considered her to be dead when he was speaking to our Lord.

20. **An issue of blood.** Such a person was considered unclean according to the Law of Moses (Lev. xv. 25), hence she came timidly behind the Saviour and touched His garment.



21. For she said within herself: If I shall touch only his garment, I shall be healed.

22. But Jesus turning and seeing her, said: Be of good heart, daughter, thy faith hath made thee whole. And the woman was made whole from that hour.

23. And when Jesus was come into the house of the ruler, and saw the minstrels and the multitude making a rout,

24. He said: Give place, for the girl is not dead, but sleepeth. And they laughed him to scorn.

25. And when the multitude was put forth, he went in, and took her by the hand. And the maid arose.

26. And the fame hereof went abroad into all that country.

27. And as Jesus passed from thence, there followed him two blind men crying out and saying, Have mercy on us, O Son of David.

28. And when he was come to the house, the blind men came to him. And Jesus saith to them, Do you believe, that I can do this unto you? They say to him, Yea, Lord.

22. **Thy faith.** The woman had implicit faith in the power of our Lord, and this was a disposition which induced Him to cure her.

23. **Minstrels.** These were hired mourners consisting of at least two flute-players and one wailing woman. They were engaged for every Jewish funeral to excite the grief and lamentation of the relatives. In the case of rich people, such as this ruler, many mourners were employed.

**Making a rout** by their loud manifestations of grief.

24. **The girl is not dead;** i.e., she is not beyond the power of God to resuscitate her. Death is often spoken of as *sleep* in the Scriptures; thus Lazarus when dead was said to sleep (John xi. 11); but that this girl was really dead is evident from the fact that those around laughed our Lord to scorn when He said "she sleepeth." The Saviour spoke of her death as a sleep, because to His almighty power death is never more than sleep.

25. **When the multitude was put forth.** In order to conceal the performance of this miracle from unworthy witnesses, who would be only irritated by it, our Lord excluded from the room all except near relatives and His favorite Apostles, Peter, James and John. Cf. Mark v. 37; Luke viii. 51.

27. **Son of David.** This was a title which the Jews had ascribed to the Messiah, hence the blind men recognized our Lord as the Messiah.

**Have mercy on us;** i.e., restore our sight.

28. **To the house,** likely Peter's house at Capernaum.

29. Then he touched their eyes, saying, According to your faith, be it done unto you.

30. And their eyes were opened, and Jesus strictly charged them, saying, See that no man know this.

31. But they going out, spread his fame abroad in all that country.

32. And when they were gone out, behold they brought him a dumb man, possessed with a devil.

33. And after the devil was cast out, the dumb man spoke, and the multitudes wondered, saying, Never was the like seen in Israel.

34. But the Pharisees said, By the prince of devils he casteth out devils.

35. And Jesus went about all the cities, and towns, teaching in their synagogues, and preaching the gospel of the kingdom, and healing every disease, and every infirmity.

36. And seeing the multitudes, he had compassion on them: because they were distressed, and lying like sheep that have no shepherd.

37. Then he saith to his disciples, The harvest indeed is great, but the labourers are few.

**Yea, Lord.** The blind men had heard of our Lord's power and miracles and they appealed in confidence to His goodness.

30. **Strictly charged them.** Our Saviour's time for suffering had not yet come, and He did not want to excite His enemies too much lest they put Him to death before He had finished His work. He also most probably was moved out of humility to wish to conceal the miracles He had performed; and hence the Fathers commonly teach that the blind men did not sin in disobeying His request.

32. **When they were gone out;** i.e., when these two men just cured of blindness had gone out they brought a man who was dumb, owing to diabolical possession. See on iv. 24; viii. 16.

33. **Never was the like seen in Israel.** This was one of many miracles, the like of which had never been seen in Israel.

34. **Prince of devils;** i.e., Beelzebub. Out of envy and malice the Scribes and Pharisees did not want to admit the divine power of our Lord, and so ascribed His works to the prince of devils.

35. **Preaching the gospel of the kingdom;** i.e., the good tidings of redemption so near at hand.

36. Our Saviour, beholding the people distressed, i.e., worried and afflicted with all kinds of evils, spiritual and corporal, was moved by deepest pity for them.

37. **The harvest;** i.e., the people and their needs.

**Laborers are few.** So far there were only our Lord and John

38. Pray ye therefore the Lord of the harvest, that he send forth labourers into his harvest.

the Baptist. The Scribes and Pharisees had neglected their duty altogether.

38. **Lord of the harvest**; i.e., the householder, or lord of the vineyard, here to be understood of our Saviour, who was to send His Apostles into the world.

## CHAPTER X

THE CHOOSING OF THE TWELVE APOSTLES, 1-4.

THE MISSION OF THE APOSTLES TO GALILEE, 5-15.

GENERAL INSTRUCTIONS TO THE APOSTLES, 16-42.

1. And having called his twelve disciples together, he gave them power over unclean spirits, to cast them out, and to heal all manner of diseases, and all manner of infirmities.

2. And the names of the twelve apostles are these: The first, Simon who is called Peter, and Andrew his brother,

1. St. Matthew here, in connection with the first public mission of the Apostles, briefly alludes to the calling of the Apostles, which, according to St. Mark (iii. 13) and St. Luke (vi. 13), preceded the Sermon on the Mount. We have here the first mission of the Apostles, on which they were to preach to others the doctrine the Master had been teaching them for two years: this doctrine they were to confirm by the manifestation of extraordinary powers, such as the healing of the sick, the casting out of devils, etc. Their second and fuller mission came only after the Ascension and Pentecost.

**Unclean spirits.** The devil and evil spirits are called "unclean" because of the sinful acts in which they delight, and which they lead men to commit.

2. **Names of the apostles.** The word "apostle" signifies one sent to execute a mission, from the Greek, *ἀποστέλλειν*, to send.

**Twelve Apostles** were chosen by our Lord most likely in order that the first heads of the Christian Church might correspond in number with the twelve Fathers or Patriarchs of the Jews.

**First Simon**, etc. The Primacy of St. Peter seems clearly in-

3. James the son of Zebedee, and John his brother, Philip and Bartholomew, Thomas and Matthew the publican, and James the son of Alpheus, and Thaddeus,

4. Simon the Cananean, and Judas Iscariot, who also betrayed him.

5. These twelve Jesus sent: commanding them, saying: Go ye not into the way of the Gentiles, and into the city of the Samaritans enter ye not.

dedicated from the fact that, in all the lists of the Apostles, his name stands first. Cf. Mark iii. 16; Luke vi. 14; Acts i. 13. This is the more significant since Andrew was older than Peter and was known to our Lord before him.

3. **And Matthew.** It is believed that St. Matthew added, "the publican," out of humility.

**James, son of Zebedee;** i.e., James the Greater, who became the Apostle of Spain.

**James, son of Alpheus;** i.e., James the Less, author of the Epistle of St. James and first Bishop of Jerusalem.

**Thaddeus;** i.e., Jude, author of the Epistle of St. Jude.

4. **Simon, the Cananean,** so called because he belonged to the party of "Zealots," distinguished for their zeal in the observance of the law, — from the Hebrew word *Kana*, meaning *zeal*.

**Judas Iscariot;** i.e., "Judas of Kerioth" in Judea, from whence he came. Of all the Apostles only Judas was a Judean.

5. **These twelve Jesus sent.** This mission of the Apostles, which took place in March, should be distinguished from that of the seventy-two disciples in the following October or November.

**Go ye not into the way of the Gentiles;** i.e., do not go to preach to the Gentiles, or to those in the cities of the Samaritans. Our Lord wished the Apostles not to preach among the Gentiles until after His Resurrection. And He likewise excluded the Samaritans because they had strayed away from the true and pure worship of Jehovah. Ever since the Assyrian Captivity, the people of Samaria had been under the control of the Assyrian Kings, and because they had united the worship of the true God with that of idols, they were commonly despised by the Jews. When the Jews were about to rebuild the Temple of Jerusalem, the Samaritans offered their assistance; but, this having been rejected, the Samaritans erected a rival temple on Mount Garizim, near the city of Samaria, where victims were offered as at Jerusalem. From this, the Samaritans considered themselves to be true Israelites, who

6. But go ye rather to the lost sheep of the house of Israel.

7. And going, preach, saying: The kingdom of heaven is at hand.

8. Heal the sick, raise the dead, cleanse the lepers, cast out devils: freely have you received, freely give.

9. Do not possess gold, nor silver, nor money in your purses:

10. Nor scrip for your journey, nor two coats, nor shoes, nor a staff; for the workman is worthy of his meat.

preserved intact the observance of the Law of Moses. Nevertheless, because of their pagan practices and the pagan rulers who controlled them, our Lord here mentions them in connection with the Gentiles.

6. **Lost sheep of Israel**; i.e., the Jews, who had become spiritually lost. Let it be observed here that the preceding precepts to avoid the Gentiles and the Samaritans were to be in force only during our Lord's lifetime, for, after His Resurrection, He gave the unlimited command to preach the Gospel to all nations, "Going therefore teach ye all nations" (Matt. xxviii. 19).

7. **Kingdom of heaven is at hand**; i.e., the reign of the Messiah, which was the prelude to the establishment of the Church of Christ. Sometimes the "Kingdom of God" means the reign of grace in the heart. "Kingdom of heaven" is also used when speaking of the life hereafter. See on iii. 2.

8. **Freely you have received, etc.**; i.e., as you have been gratuitously given these spiritual powers, exercise them in behalf of others without material compensation.

**Heal the sick, etc.** These miraculous works were to be the signs and proofs of the divine mission of the Apostles.

9, 10. **Do not possess gold, etc.** This precept most probably refers principally to the mission of the Apostles among the Jews, as would appear from Luke xxii. 35. However, it doubtless has reference also to the spirit of detachment from earthly goods, and the entire reliance on God's Providence which ought to characterize every minister of the Gospel. The general meaning of this passage is that everything not essential should be discarded.

**Scrip** was a satchel or small bag for food, bread, drink, etc.

**Nor staff.** See Mark vi. 8, which reads, "but a staff only." It is most probable that two different kinds of staff are here referred to by Sts. Matthew and Mark; the former speaking of the weapon

11. And into whatsoever city or town you shall enter, inquire who in it is worthy, and there abide till you go thence.

12. And when you come into the house, salute it, saying: Peace be to this house.

13. And if that house be worthy, your peace shall come upon it; but if it be not worthy, your peace shall return to you.

14. And whosoever shall not receive you, nor hear your words: going forth out of that house or city shake off the dust from your feet.

15. Amen I say to you, it shall be more tolerable for the land of Sodom and Gomorrhah in the day of judgment, than for that city.

for offence and defence, the latter referring only to the stick used as a support in walking in Oriental countries.

For the workman is worthy, etc. The Apostles, as they proceeded, were to receive what was necessary in food and clothing from those whose sick they cured and whose dead they raised to life. They were not to get a complete recompense for their labors, because spiritual works are beyond all price.

11. **Who in it is worthy;** i.e., who is distinguished for a good and religious life. Prudence and care in the choice of their lodgings were here enjoined upon the Apostles.

12. **Peace be to this house;** i.e., to the inhabitants of this house.

13. **Your peace shall return,** etc.; i.e., although rebuffed, you shall not lose the peace of God which is with you, and your future reward shall not be lost.

14. **Shake off the dust,** etc. This action would be a testimony on the day of judgment against the incredulity of those who rejected the Apostles. Sts. Paul and Barnabas literally observed this precept. Cf. Acts xiii. 51; xviii. 6. To shake the dust from their feet was a sign that those who rejected them had sinned by so doing.

15. **Sodom and Gomorrhah,** etc. Those who rejected the Apostles' ministry and preaching shall be treated more severely hereafter than were the Sodomites, whom fire from heaven destroyed. It seems that the instructions thus far given were intended only for the Jewish mission of the Apostles. Our Lord now proceeds to give important general instructions for the guidance of His ministers for all time and in all places. It is most likely also that St. Matthew has here gathered together all that our Lord said on several different occasions, as was probably the case also with the Sermon on the Mount.

16. Behold I send you as sheep in the midst of wolves. Be ye therefore wise as serpents and simple as doves.

17. But beware of men. For they will deliver you up in councils, and they will scourge you in their synagogues.

18. And you shall be brought before governors, and before kings for my sake, for a testimony to them and to the Gentiles:

19. But when they shall deliver you up, take no thought how or what to speak: for it shall be given you in that hour what to speak.

20. For it is not you that speak, but the Spirit of your Father that speaketh in you.

21. The brother also shall deliver up the brother to death, and the father the son; and the children shall rise up against their parents, and shall put them to death.

22. And you shall be hated by all men for my name's sake: but he that shall persevere unto the end, he shall be saved.

16. **Sheep in the midst of wolves.** "So long as we are sheep," says St. Chrysostom, "we are victorious, though a thousand wolves surround us; but if we turn into wolves, we are beaten, for the aid of our Shepherd is withdrawn from us: He is the Shepherd, not of wolves, but of sheep."

**Wise as serpents;** i.e., the minister of the Gospel must endeavor to avoid all dangers to his work on the part of men; on the other hand, he must bear with the mildness of a dove all injuries received.

17. **Beware of men;** i.e., of the enemies of the Gospel.

**Councils.** The Council was a local tribunal, where offenders were tried and punished. See on v. 21. The Jews were also accustomed to scourge in their synagogues transgressors of their laws.

18. **Brought before governors and kings;** i.e., to be tried for life. These governors and kings were Gentile authorities; thus St. Paul was brought before the governor Festus and the king Herod Agrippa II. Cf. Acts xxv. 13.

**For a testimony;** i.e., of the truth of the Gospel to the Jews and Gentiles.

19. **Take no thought,** etc. Our Lord here warns the Apostles against anxiety as to what they will say or do in the day of trial. Having done in advance what their duty required, they were to put away anxiety for the future, and rely entirely on God.

22. **Hated by all men;** i.e., by the enemies of God and the Gospel. All who wish to serve God must suffer and be persecuted

23. And when they shall persecute you in this city, flee into another. Amen I say to you, you shall not finish all the cities of Israel, till the Son of man come.

24. The disciple is not above the master, nor the servant above his lord.

25. It is enough for the disciple that he be as his master, and the servant as his lord. If they have called the goodman of the house Beelzebub, how much more them of his household?

26. Therefore fear them not. For nothing is covered that shall not be revealed: nor hid, that shall not be known.

27. That which I tell you in the dark, speak ye in the light: and that which you hear in the ear, preach ye upon the housetops.

28. And fear ye not them that kill the body, and are not able to kill the soul: but rather fear him that can destroy both soul and body in hell.

29. Are not two sparrows sold for a farthing? and not one of them shall fall on the ground without your Father.

30. But the very hairs of your head are all numbered.

31. Fear not therefore: better are you than many sparrows.

for their very goodness; but, if they persevere in spite of suffering, they shall be saved.

23. **You shall not finish all the cities of Israel.** These words had reference not only to the short mission of the Apostles, they are a rule for the ministers of the Gospel for all time. The meaning most probably is: There will always be places to which you can flee for protection and for the spreading of the Gospel; and you shall not have converted all the Jews before the final coming of Christ.

25. **The good man of the house; i.e., Christ Himself.**

Beelzebub was an idol of the Philistines, and was an object of horror and hatred to the Jews; hence they applied this name to the devil. Literally, the word means, "The lord of flies."

27. **Preach upon the house-tops; i.e., publicly.** The houses in Palestine are usually only one story high and have flat roofs; hence a speaker could easily address a crowd speaking from the housetops.

28. **Fear ye not, etc.** In endeavoring to live Christian and religious lives, the Apostles were not to fear men, but only God; and this fear of God was to be born of love.

29-31. **Two sparrows are sold for a farthing, etc.** The meaning of these verses is that if God so carefully provides for things of such little worth as sparrows, how much more will He care for us. It is certain that God exercises a direct and personal Providence over each one of His rational creatures.



32. Every one therefore that shall confess me before men, I will also confess him before my Father who is in heaven.

33. But he that shall deny me before men, I will also deny him before my Father who is in heaven.

34. Do not think that I came to send peace upon earth: I came not to send peace, but the sword.

35. For I came to set a man at variance against his father, and the daughter against her mother, and the daughter in law against her mother in law.

36. And a man's enemies shall be they of his own household.

37. He that loveth father or mother more than me, is not worthy of me; and he that loveth son or daughter more than me, is not worthy of me.

38. And he that taketh not up his cross, and followeth me, is not worthy of me.

39. He that findeth his life, shall lose it: and he that shall lose his life for me, shall find it.

**Fear not, therefore, them, etc.;** i.e., let the servant of God continue to serve and labor for God, and not hesitate to trust the goodness of Providence.

**32, 33. Everyone that shall confess me, etc.** The meaning is that if we acknowledge our faith in Christ here on earth, He will reward us hereafter; but if we deny Him here, He will punish us hereafter.

**34, 35. I come not to send peace, etc.** Our Lord announces in these verses that what He seeks among men is, above all, faith in Himself, and that this faith may often separate and set at variance the most intimate relationships. He is the "Prince of Peace" (Isa. ix. 6), but of a peace that is holy and spiritual and lasting.

**36. And a man's enemies shall be those of his own household.** This verse is quoted from Mich. vii. 6. The words refer directly to the siege of Jerusalem by the Chaldeans, and the prophet is foretelling how, in the day of sorrow, many will turn against their own to save themselves. As here accommodated by our Lord, the words mean that oftentimes our nearest relatives will stand between us and God.

**37. He that loveth father, or mother, etc.** In this verse, our Saviour declares that whenever our duties to God collide with those to any creature, however close, the latter must yield to the former.

**38. His cross.** He who does not willingly and patiently bear the trials and sufferings which Providence sends him, is not worthy to belong to Christ, or to have part in the glory of Christ.

**39. He that findeth his life, etc.** These words mean that whoso-

40. He that receiveth you, receiveth me: and he that receiveth me, receiveth him that sent me.

41. He that receiveth a prophet in the name of a prophet, shall receive the reward of a prophet: and he that receiveth a just man in the name of a just man, shall receive the reward of a just man.

42. And whosoever shall give to drink to one of these little ones a cup of cold water only in the name of a disciple, amen I say to you, he shall not lose his reward.

ever will deny Christ to save his temporal life, shall lose the life eternal; but he that is willing to sacrifice his temporal existence, if need be, for the sake of Christ and His Gospel, shall gain life everlasting. Thus, apostates, to save their present life, may deny Christ, but only to lose the life to come.

40, 41. **Prophet** here means a preacher of the Gospel.

**In the name;** i.e., on the faith of Christ.

**Reward of a prophet;** i.e., shall have part in the merits of a prophet, and a consequent part in his glory.

42. **One of these little ones,** etc.; i.e., the least of my disciples, or of those who believe in me.

## CHAPTER XI

JESUS AND THE DISCIPLES OF JOHN THE BAPTIST, 1-6.

JESUS EULOGIZES JOHN, BUT DECLARES THAT HE IS  
LESS THAN THE LEAST IN THE NEW KINGDOM,  
7-15.

THE INCREDULITY OF THE JEWS, 16-19.

JESUS UPBRAIDS THE IMPENITENT CITIES, 20-24.

FAITH IS REVEALED TO LITTLE ONES, 25-30.

1. And it came to pass, when Jesus had made an end of commanding his twelve disciples, he passed from thence, to teach and preach in their cities.

2. Now when John had heard in prison the works of Christ: sending two of his disciples he said to him:

1. **When he had made an end of commanding;** i.e., when He had finished instructing (*διὰ τὸ σῶσαι*) His disciples.

**In their cities** may mean, either in the cities of Galilee, or in the Jewish cities to which the Apostles were sent on their first mission.

2. **John sending two of his disciples.** This message preceded

3. Art thou he that art to come, or look we for another?
4. And Jesus making answer said to them: Go and relate to John what you have heard and seen.
5. The blind see, the lame walk, the lepers are cleansed, the deaf hear, the dead rise again, the poor have the gospel preached to them.
6. And blessed is he that shall not be scandalized in me.

the mission of the Apostles (x. 5; Luke ix. 1-6). John's purpose in sending these disciples to Jesus was to convince them that He was the Messiah. It is certain that John himself had no doubts about the Messiahship of our Lord, for he had proclaimed Him from His mother's womb (Luke i. 41); he had seen the descent of the Holy Ghost and had heard the testimony of the Eternal Father announcing Jesus as His Beloved Son on the banks of the Jordan (Matthew iii. 17); and he himself had borne public testimony to our Lord's dignity as Messiah, when he declared himself unworthy to loose the latchet of His shoes (Mark i. 7), and when he pointed Jesus out as "The Lamb of God that taketh away the sins of the world" (John i. 29, 36). The reason, therefore, for this message on the part of John was to convince his own disciples of the Messiahship of Christ, for we know from St. Luke (vii. 18) that the disciples of John had become more or less jealous at the marvelous works of our Lord and His disciples. Doubtless, also, John wished our Lord to manifest Himself more openly to the people around.

**In prison.** The prison, Josephus tells us, was at Machaerus, east of the Dead Sea. John was cast into prison by Herod for having condemned his adulterous life with Herodias, the wife of his brother Philip. Cf. Mark vi. 16-18.

3. **Art thou he?**; i.e., the Messiah, the Redeemer.

4-6. **What you have heard and seen.** It is better to read, "what you hear and see," namely, the miracles which were being performed in the midst of those disciples.

**The blind see, etc.** These different miracles to which our Lord referred were the fulfillment of distinct prophecies uttered by Isaias, when describing the future character of the Messiah (Isa. xxxv. 5; lxi. 1).

**The poor;** i.e., the poor in spirit.

**Not scandalized in me;** i.e., not offended or shocked at the contrast between My heavenly doctrine, and My humble life and future

7. And when they went their way, Jesus began to say to the multitudes concerning John: What went you out into the desert to see? a reed shaken with the wind?

8. But what went you out to see? a man clothed in soft garments? Behold they that are clothed in soft garments, are in the houses of kings.

9. But what went you out to see? a prophet? yea I tell you, and more than a prophet.

10. For this is he of whom it is written: Behold I send my angel before thy face, who shall prepare thy way before thee.

11. Amen I say to you, there hath not risen among them that are born of women a greater than John the Baptist: yet he that is the lesser in the kingdom of heaven is greater than he.

death on the cross. St. Paul speaks of our Lord's death as "the scandal of the cross" (Gal. v. 11).

7. **A reed shaken, etc.;** i.e., a weak, inconstant man, bending with every blast.

9. **More than a prophet.** All held John as a prophet (Matthew xxi. 26), and this our Lord now confirms. Although John, out of humility, said he was not a prophet, our Lord here proclaims him more than a prophet, because of his superior vision of things spiritual, and because of the wonderful innocence and holiness of his life.

10. **My angel;** i.e., John the Baptist, whose life was angelic, and who performed the office of an angel (Gr. *ἄγγελος*) by announcing the coming of Christ. The quotation is from Malachy iii. 1.

**Before thy face.** In Malachy (iii. 1) we read, "my face, my way"; but there the prophet was speaking in the name of God the Son, and hence the words refer to Christ speaking of Himself (St. Jerome); here, however, they are the words of the Eternal Father addressing His Son.

**Who shall prepare thy way;** i.e., by moving the people to repentance, and preparing them for the doctrine of Christ.

11. **Greater than John the Baptist.** John is here compared with the saints of the Old Testament, none of whom had a greater office, and none of whom was more exalted in sanctity and spiritual gifts than he. The comparison is by no means understood to embrace the Blessed Virgin and the Apostles, who belonged to the New Dispensation.

**Yet he that is lesser, etc.** Some, following St. Jerome, say that "kingdom of heaven," here means the abode of the Blessed, every member of which is greater than John, because already crowned

12. And from the days of John the Baptist until now, the kingdom of heaven suffereth violence, and the violent bear it away.

13. For all the prophets and the law prophesied until John:

14. And if you will receive it, he is Elias that is to come.

15. He that hath ears to hear, let him hear.

16. But whereunto shall I esteem this generation to be like? It is like to children sitting in the market place.

17. Who crying to their companions say: We have piped to you, and you have not danced: we have lamented, and you have not mourned.

18. For John came neither eating nor drinking; and they say: He hath a devil.

19. The Son of man came eating and drinking, and they say: Behold a man that is a glutton and a wine drinker, a friend of publicans and sinners. And wisdom is justified by her children.

with glory. Others, that the "kingdom of heaven" in the present instance means the Church, the least of whose members is greater than John in dignity of state. That is to say, an ordinary Christian, under the New Law, has greater dignity than a priest or prophet under the Old Law. The whole question is one of dignity of state, not of sanctity of life.

12. **From the days of John**, etc.; i.e., from the beginning of his preaching. It would seem from Luke xvi. 16 that the time here spoken of was fully two years after the beginning of the Baptist's ministry. These words, however, might have been spoken on two different occasions.

**The kingdom of heaven suffereth violence**; i.e., all who enter the Church and live according to its teaching must suffer much and do violence to their own passions. Only those who thus exercise great efforts can live the life of a Christian and finally bear away the prize of eternal life.

13. **Until John**. John the Baptist was the last and the greatest of the prophets of the Old Law.

14. **He is Elias**; i.e., in spirit and in power, not in person. Cf. Luke i. 17; John i. 21. Just as Elias is to be the forerunner of the final coming of Christ, so John was the precursor of His first coming. Between the austere life, dress, and works of Elias and those of John, the resemblance was striking.

16-19. The **generation** here spoken of means the Scribes and Pharisees. Our Lord is telling them in these verses that nothing is able to move them, neither the austerity of the Baptist, nor the meekness and forbearance of the Saviour.

20. Then began he to upbraid the cities wherein were done the most of his miracles, for that they had not done penance.

21. Woe to thee, Corozain, woe to thee, Bethsaida: for if in Tyre and Sidon had been wrought the miracles that have been wrought in you, they had long ago done penance in sackcloth and ashes.

22. But I say unto you, it shall be more tolerable for Tyre and Sidon in the day of judgment, than for you.

23. And thou Capharnaum, shalt thou be exalted up to heaven? thou shalt go down even unto hell. For if in Sodom had been wrought the miracles that have been wrought in thee, perhaps it had remained unto this day.

24. But I say unto you, that it shall be more tolerable for the land of Sodom in the day of judgment, than for thee.

25. At that time Jesus answered and said: I confess to thee, O Father, Lord of heaven and earth, because thou hast hid these things from the wise and prudent, and hast revealed them to little ones.

26. Yea, Father; for so hath it seemed good in thy sight.

Wisdom is justified, etc.; i.e., the counsels and plans of God are wise and just, even though the Scribes and Pharisees, through their own fault, be lost.

By her children; i.e., by those who have actually embraced the faith of Christ. Cf. Luke vii. 35.

20-24. From St. Luke (x. 12-15), it would seem that these words were addressed to the seventy-two disciples after the return from their mission, and before sending them to more distant places. The Saviour upbraids the cities which had been so favored by His own and His disciples' preaching; and He says that, if the neighboring Gentile cities had been equally favored, they would have been far more responsive to the voice of Christ.

Sackcloth and ashes. This is an allusion to a manner of performing extraordinary penances under the Old Law, when the penitents wore sackcloth and sat in ashes.

Capharnaum was the city in Galilee on the north-western shore of the Lake of Genesareth especially loved by our Lord, and yet He laments that she too had been deaf to His preaching.

Shalt thou be exalted?; i.e., "thou art exalted" (Luke x. 15) by reason of great wealth and commerce, as well as by My preaching and many miracles; but thou shalt come down to hell, i.e., thou shalt be destroyed. Hell here means *Hades*, the underworld, or the grave; not *Gehenna*, the hell of fire.

25. At that time; i.e., on the return of the seventy-two disciples.

I confess to thee; i.e., I praise Thee.

27. All things are delivered to me by my Father. And no one knoweth the Son, but the Father: neither doth any one know the Father, but the Son, and he to whom it shall please the Son to reveal him.

28. Come to me, all you that labour, and are burdened, and I will refresh you.

29. Take up my yoke upon you, and learn of me, because I am meek, and humble of heart: and you shall find rest to your souls.

30. For my yoke is sweet and my burden light.

Because thou hast hid these things, etc. Our Lord rejoices, not at the blindness of the Pharisees, but at the justice of His Father which has denied to their unworthiness the light which He, in His mercy, has given to little ones, i.e., to the humble and docile. In a similar manner St. Paul spoke to the Romans (vi. 17).

27. All things are delivered to me, etc. These and the following words show that the Father and the Son are one.

No one knoweth the Son, etc.; i.e., comprehensively and perfectly no one knows the Son.

Neither doth anyone know the Father, etc.; i.e., the revelation of the Father was made to the world through the Son, according to St. John (xvii. 6), "I have manifested thy name to men," etc. These words show the equality of the Father and the Son. The Holy Ghost is not mentioned, because the knowledge which the Father and Son are said mutually to have of each other is spoken of as denied to creatures only. Without doubt the Holy Ghost, who is consubstantial with the Father and the Son, possesses equal knowledge with Them. (*Summa Theol.*, 1<sup>a</sup>, qu. 31, a. 4).

28. Come to me. Since the Father and the Son are equal, our Lord now invites all those who labor, i.e., who are burdened with spiritual or temporal evils, to come to Him for rest.

29. My yoke; i.e., the law of the Gospel. The law of the Gospel may be called a yoke, since it imposes certain obligations and rules; but with the help of divine grace, which the New Law imparts, the Gospel is a light yoke.

Learn of me, etc. The meaning is that, no matter how great our sinfulness and lowliness, we must not hesitate to come to our Lord, who will always receive us with kindness and gentleness, unlike the Scribes and Pharisees.

30. My yoke is sweet, etc.; i.e., is light in comparison with the yoke of the Mosaic Law, and the tyranny of the Scribes and Pharisees.

## CHAPTER XII

PLUCKING THE EARS OF CORN ON THE SABBATH, 1-9.

THE MAN WITH THE WITHERED HAND, 10-14.

THE MILDNESS AND HUMILITY OF JESUS, 15-21.

JESUS AND BEELZEBUB, 22-30.

THE SIN AGAINST THE HOLY GHOST, 31-37.

JESUS UPBRAIDS THE PHARISEES; THE SIGN OF JONAS;

THE UNCLEAN SPIRIT, 38-45.

THE RELATIVES OF JESUS, 46-50.

1. At that time Jesus went through the corn on the sabbath: and his disciples being hungry, began to pluck the ears, and to eat.

2. And the Pharisees seeing them, said to him: Behold thy disciples do that which is not lawful to do on the sabbath days.

3. But he said to them: Have you not read what David did when he was hungry, and they that were with him:

4. How he entered into the house of God, and did eat the loaves of proposition, which it was not lawful for him to eat, nor for them that were with him, but for the priests only?

1. **At that time.** Frequently these words are used in the Gospels without reference to any particular period of time, but the events now spoken of took place in the month of April or May, before the Sermon on the Mount and the mission of the Apostles. Cf. Mark ii. 23-28; Luke vi. 1-5.

**Sabbath;** i.e., the day of rest appointed by the Jewish Law to be kept wholly free from servile work.

**To pluck the ears.** According to Luke (vi. 1), "they rubbed the ears in their hands," which was allowed by Deut. (xxiii. 25); but the Pharisees tried to make out of the action of the disciples a servile work, such as reaping, or thrashing would be; and-hence they complained.

3, 4. **What David did, etc.** From 1 Kings xxi. 1-6, where the action of David is recorded, it would seem that he was alone at the time, his companions having remained a little behind until he brought them the bread.

**The house of God.** This does not mean the Temple, which was



5. Or have ye not read in the law, that on the sabbath days the priests in the temple break the sabbath, and are without blame?

6. But I tell you that there is here a greater than the temple.

7. And if you knew what this meaneth: I will have mercy, and not sacrifice: you would never have condemned the innocent.

8. For the Son of man is Lord even of the sabbath.

9. And when he had passed from thence, he came into their synagogues.

not then built, but the Tabernacle, or hall, near it, before which twelve loaves of proposition or "shew-bread" were placed each week. This bread was changed every Sabbath, and the loaves removed were to be eaten by the priests only. Cf. Lev. xxiv. 5-9. Neither David nor his companions had any right ordinarily to eat this bread, yet because of great necessity they did lawfully partake of it; and this, it seems, was done on the Sabbath. If, therefore, on account of hunger it was lawful for David and his companions to take and eat on the Sabbath the bread which was consecrated to God, and intended for the priests only, how much more lawful was it for our Lord's own disciples to satisfy their hunger on the Sabbath day by eating ears of corn which were not consecrated to God!

5. **The law;** i.e., of Moses. Cf. Num. xxviii. 9.

**Break the sabbath;** i.e., by performing the servile works of sacrificing two lambs in the morning and two in the evening, which was prescribed by the Law. Cf. Num. xxviii. 3-10.

6. **Here a greater than the temple.** If it was lawful to perform servile works for the service of the Temple, how much more so for the sake of Him who is Lord of the Temple and all; namely, Christ Himself!

7. **Mercy and not sacrifice.** The meaning is that mercy is to be preferred to sacrifice; to feed the hungry and starving is better than to sacrifice lambs in the Temple. The quotation is from 1 Kings xv. 22.

**The innocent;** i.e., the disciples who plucked the ears of corn.

8. **Son of man;** i.e., Christ, the Messiah, who is greater than the Sabbath, and Master of it.

9. **Came into their synagogues.** This event took place on another Sabbath day, as we learn from Luke (vi. 6-11).

10. And behold there was a man who had a withered hand, and they asked him, saying: Is it lawful to heal on sabbath days? that they might accuse him.

11. But he said to them: What man shall there be among you, that hath one sheep: and if the same fall into a pit on the sabbath day, will he not take hold on it and lift it up?

12. How much better is a man than a sheep? Therefore it is lawful to do a good deed on the sabbath days.

13. Then he saith to the man: Stretch forth thy hand; and he stretched it forth, and it was restored to health even as the other.

14. And the Pharisees going out made a consultation against him, how they might destroy him.

15. But Jesus knowing it, retired from thence: and many followed him, and he healed them all.

16. And he charged them that they should not make him known.

17. That it might be fulfilled which was spoken by Isaias the prophet saying:

18. Behold my servant whom I have chosen, my beloved in whom my soul hath been well pleased. I will put my spirit upon him, and he shall shew judgment to the Gentiles.

19. He shall not contend, nor cry out, neither shall any man hear his voice in the streets.

20. The bruised reed he shall not break: and smoking flax he shall not extinguish: till he send forth judgment unto victory.

21. And in his name the Gentiles shall hope.

22. Then was offered to him one possessed with a devil, blind and dumb: and he healed him, so that he spoke and saw.

10-13. **They asked him.** According to Mark (iii. 4) and Luke (vi. 9), He asked them; but since the questions asked could easily have been entirely different, there is no reason for supposing a contradiction. The argument our Lord used is an *a fortiori* one: If it is lawful, as the Pharisees admit, to save the life of a sheep on the Sabbath day, how much more lawful is it to save the life of a man.

14. **Made a consultation.** This consultation of the Pharisees took place in the early part of the second year of the public ministry. The Pharisees were simply enraged against our Lord for the miracle He had performed; and thus, for the second time, there was talk of putting Him to death. His own fellow-townsmen of Nazareth had attempted to kill Him the year before (Luke iv. 29).

15, 16. Our Lord now retired to the shore of the lake (Mark iii. 7), where He healed the sick of those who followed Him. He did not wish to excite His enemies too much, lest they should hasten His death, and thus cut short the work He had to perform. This is why our Lord did not wish His miracles to become too publicly known.

17-21. These verses refer to the Messianic prophecy of Isa.

23. And all the multitudes were amazed, and said: Is not this the son of David?

24. But the Pharisees hearing it, said: This man casteth not out devils but by Beelzebub the prince of the devils.

25. And Jesus knowing their thoughts, said to them: Every kingdom divided against itself shall be made desolate: and every city or house divided against itself shall not stand.

26. And if Satan cast out Satan, he is divided against himself: how then shall his kingdom stand?

27. And if I by Beelzebub cast out devils, by whom do your children cast them out? Therefore they shall be your judges.

xlii. 1-4, which describes the character of our Lord, and foretells His office of Redeemer in dealing with the souls of men.

**My servant**; i.e., Christ Jesus, as man. Through the prophet Almighty God is speaking of the human character and actions of His beloved Son, as Redeemer. Cf. Philip ii. 7.

**My spirit upon him**, refers to the special gifts of the Holy Spirit which were promised to Christ. Cf. Isa. xi. 2.

**He shall show judgment**; i.e., He shall manifest the righteous decrees of the Father.

**He shall not contend**, etc.; i.e., He shall be meek and gentle and merciful, avoiding all the ostentation and boisterousness of men.

**The bruised reed**, etc. Reference is here made to the gentleness of our Lord's dealings with the weak and sinful; all His actions were to be characterized by meekness and mercy, even in dealing with His adversaries.

**Till he send forth judgment**; i.e., in the end it shall be shown that the condemnation and rejection of His enemies have been merited by their own sinfulness.

**The gentiles shall hope**, a direct quotation from the Septuagint; translated from the Hebrew, the passage would be: "For his law the islands shall wait." The meaning is the same in both versions, since the term "islands" refers to the Gentiles living beyond the sea. Our Lord was to be the hope and salvation of all the world, of the Gentiles as well as the Jews.

23. **Son of David**; i.e., the Messiah, who was to come from the "seed," or line of David. See on i. 1.

24. **Beelzebub**. See on x. 25.

26. **His kingdom**; i.e., Satan's reign of sin among men.

27. **Your children**; i.e., the Jewish exorcists, who cast out devils

28. But if I by the Spirit of God cast out devils, then is the kingdom of God come upon you.

29. Or how can any one enter into the house of the strong, and rifle his goods, unless he first bind the strong? and then he will rifle his house.

30. He that is not with me, is against me: and he that gathereth not with me, scattereth.

31. Therefore I say to you: Every sin and blasphemy shall be forgiven men, but the blasphemy of the Spirit shall not be forgiven.

by the invocation of God; examples of these are found in Mark ix. 37; Luke ix. 49; Acts xix. 13.

**They shall be your judges; i.e.,** they shall be witnesses of the insincerity and malice of your accusation against Me. Since the Jews admitted that their children could, by the invocation of divine power, cast out evil spirits, nothing but malice could prompt them to attribute the miracles of our Lord to other than divine power.

28. **By the spirit of God, etc.** The power of casting out evil spirits is due, in an especial manner, to the Holy Ghost, the Spirit of Truth. Since then the miracles of our Lord, wrought in proof of His claims, were performed by the help of this Holy Spirit, they were a sign that Christ was a Divine Person, and that the reign of the Messiah was at hand. See on i. 18.

29. **Rifle his goods.** The meaning is that, in order to cast out the evil spirit from the body, one must be stronger than that evil spirit; that is, he must be more powerful than Satan.

30. **He that is not with me, etc.; i.e.,** he who is not inwardly and positively with Me is opposed to Me, even though he perform no external acts; thus Satan, and likewise the Pharisees, were always internally opposed to Christ. In Mark (ix. 39) and Luke (ix. 50) we read: "he that is not against you is for you." The two passages, however, are not opposed. Here, in Matthew, there is question of real, positive, internal opposition, such as was evident on the part of the Pharisees; but in the passages cited, our Lord is simply instructing His Apostles to make use of every opportunity to spread the Gospel; and He wishes to say that they must not be discouraged or hindered in their labors if all do not agree with them and join them; all may be considered with them, as long as no positive opposition is manifested.

31. **The blasphemy of the Spirit shall not, etc.** The miracles

32. And whosoever shall speak a word against the Son of man, it shall be forgiven him: but he that shall speak against the Holy Ghost, it shall not be forgiven him, neither in this world, nor in the world to come.

33. Either make the tree good and its fruit good: or make the tree evil, and its fruit evil. For by the fruit the tree is known.

34. O generation of vipers, how can you speak good things, whereas you are evil? for out of the abundance of the heart the mouth speaketh.

which our Lord had been performing, and which the Pharisees had attributed to the power of the devil, were in a special manner the works of the Holy Ghost; and hence the Pharisees by attributing them to the devil were guilty of blasphemy. It is blasphemy to ascribe to the devil the works of God. Our Lord does not wish to say in this passage that there is any sin beyond His power, or the power of His Church, to forgive; but only that sins directly opposed to light and grace, such as were the sins of the Pharisees, are seldom, and with great difficulty, forgiven, simply because of the obduracy and malice of those who commit them. These sins against light, therefore, are said not to be forgiven, i.e., they are forgiven with great difficulty, if at all, only on account of the bad dispositions of those who commit them.

32. **The son of man;** i.e., our Lord in His human nature. The passage means that, if any one should be guilty of some lesser sin against Christ as man,—as when they accused Him of being a wine-bibber and a friend of sinners, etc.,—it would be forgiven without much difficulty. The reason is, because ignorance rather than malice lies at the bottom of these sins.

**Nor in the world to come.** These words clearly imply that there is a future state in which some sins shall be forgiven or purged away. Thus in purgatory venial sins are forgiven, as well as the temporal punishment due to sin. (*S. Th.*, qu. 7 de Malo, a. ix. ad 9 et 1.) Moreover, these words demonstrate the eternity of the punishment of hell.

33. In this verse our Lord wishes to show that His condemnation by the Pharisees was unwarranted, because the good works which He had performed should have been to them a proof of His goodness.

34. **O generation of vipers.** The Pharisees were wont to speak

35. A good man out of a good treasure bringeth forth good things : and an evil man out of an evil treasure bringeth forth evil things.

36. But I say unto you, that every idle word that men shall speak, they shall render an account for it in the day of judgment.

37. For by thy words thou shalt be justified, and by thy words thou shalt be condemned.

38. Then some of the scribes and Pharisees answered him, saying : Master we would see a sign from thee.

39. Who answering said to them : An evil and adulterous generation seeketh a sign : and a sign shall not be given it, but the sign of Jonas the prophet.

40. For as Jonas was in the whale's belly three days and three nights : so shall the Son of man be in the heart of the earth three days and three nights.

41. The men of Ninive shall rise in judgment with this generation, and shall condemn it : because they did penance at the preaching of Jonas. And behold a greater than Jonas here.

of Abraham as their father ; but here our Lord calls them the offspring of the " Old Serpent."

35. The virtues or vices that are stored in the heart and soul are the source of the actions which proceed from a man.

36. Idle word is usually interpreted to be something of no profit to the one who utters it, or to those who hear it.

By thy words thou shalt be condemned. This does not mean that one is to be accountable for his words only, but under words are implied thoughts and deeds also.

38. A sign. To cover up their insincerity, the Pharisees now asked our Lord to perform some extraordinary miracle, like calling down fire from heaven ; but he refused to give them any further signs of His Divinity, knowing that they would not profit by them. Instead of giving them a sign from heaven He pointed to a sign which should come from the bowels of the earth ; namely, His Resurrection.

39. Adulterous generation ; i.e., a faithless, degenerate race, who had fallen from the virtuous practices of their fore-fathers.

But the sign of Jonas the prophet. Our Lord refused to grant the Pharisees a sign from heaven, and instead pointed to His coming death and Resurrection, of which latter, the sign of Jonas was a type. Cf. Jonas ii. 1.

40. Three days and three nights ; i.e., parts of three natural days and nights ; namely, part of Friday, all of Saturday, and part of Sunday.

42. The queen of the south shall rise in judgment with this generation, and shall condemn it: because she came from the ends of the earth to hear the wisdom of Solomon, and behold a greater than Solomon here.

43. And when an unclean spirit is gone out of a man he walketh through dry places seeking rest, and findeth none.

44. Then he saith: I will return into my house from whence I came out. And coming he findeth it empty, swept, and garnished.

45. Then he goeth, and taketh with him seven other spirits more wicked than himself, and they enter in and dwell there: and the last state of that man is made worse than the first. So shall it be also to this wicked generation.

46. As he was yet speaking to the multitudes, behold his mother and his brethren stood without, seeking to speak to him.

47. And one said unto him: Behold thy mother and thy brethren stand without, seeking thee.

42. **Queen of the south**; i.e., the Queen of Saba, or Sheba, in Arabia. Cf. 3 Kings x. 1-10.

43. **Unclean spirit**, etc.; i.e., when a devil, by the grace of God, has been expelled from the human body, it walketh through dry, i.e., desert, waterless places, etc. "Desert places" were considered by the Jews to be the haunts of demons and evil spirits. Probably, however, our Lord in this parable is merely comparing the action of the devil to that of a man who has been driven from his house.

44. **Empty, swept and garnished**; i.e., devoid of virtues and the grace of God, possessing nothing to forbid the re-entrance of the unclean spirit.

45. **Seven other spirits**. "Seven" was an Oriental term used to designate an indefinite number. Our Lord here applies the foregoing similitude to the Jews, from whose midst the sway of Satan had been expelled by the Law and by God's special Providence; but who, by their unfaithfulness to the graces received, merited a complete domination and enslavement by the devil.

46. **His brethren**; i.e., His cousins, most probably the children of Mary, the cousin of the Blessed Virgin and wife of Alpheus or Cleophas. It was customary among the Jews to speak of cousins as brethren. In fact the term *brother* in Hebrew may mean *cousin*, *kinsman*, *friend*, or *fellow-countryman*. For such usages of the word, cf. Gen. xii. 5; xiii. 8; also Matthew xiii. 55 and Mark vi. 3, where James, Joseph, Simon, and Jude are called brethren of our Lord. James, Jude, and probably Simon we know were also Apostles. Cf. Rom. i. 13; ix. 3, 4.

48. But he answering him that told him, said: Who is my mother, and who are my brethren?

49. And stretching forth his hand towards his disciples, he said: Behold my mother and my brethren.

50. For whosoever shall do the will of my Father, that is in heaven, he is my brother, and sister, and mother.

48-50. From these verses it would be very wrong to conclude that our Lord wished to deny, or in any way slight His Blessed Mother and His relatives. He wished simply to call attention to the fact that there is a more intimate relationship between the soul and God than any which springs from merely natural ties; and in this higher relationship, He knew that His Blessed Mother participated more perfectly than any other creature.

## CHAPTER XIII

THE PARABLE OF THE SOWER, 1-23.

THE GOOD SEED AND THE COCKLE, 24-30.

THE GRAIN OF MUSTARD SEED, 31, 32.

THE LEAVEN, 33-35.

JESUS EXPLAINS THE PARABLE OF THE COCKLE, 36-43.

THE TREASURE, THE PEARL, THE DRAWNET, 44-52.

JESUS GOES TO NAZARETH, 53-58.

1. The same day Jesus going out of the house, sat by the sea side.
2. And great multitudes were gathered together unto him, so that he went up into a boat and sat: and all the multitude stood on the shore.

1. The events here narrated followed immediately after those mentioned in the last chapter, perhaps the same day, toward evening.

Jesus going out of the house; i.e., at Capharnaum, of which there is mention in xii. 47.

Sat by the sea side; i.e., by the Lake of Genesareth, or Sea of Galilee. St. Mark (iv. 1) says our Lord instructed the multitude from a boat near the shore of the lake.



3. And he spoke to them many things in parables, saying: Behold the sower went forth to sow.
4. And whilst he soweth some fell by the way side, and the birds of the air came and ate them up.
5. And other some fell upon stony ground, where they had not much earth: and they sprung up immediately, because they had no deepness of earth.
6. And when the sun was up they were scorched: and because they had not root, they withered away.
7. And others fell among thorns: and the thorns grew up and choked them.
8. And others fell upon good ground: and they brought forth fruit, some an hundredfold, some sixtyfold, and some thirtyfold.
9. He that hath ears to hear, let him hear.

3-8. **In parables.** This is the first mention of parables. And nowhere else in the Gospels have we so many parables so richly grouped together.

The parable is a prolonged simile, much the same as an allegory is a prolonged metaphor. The parable may be defined as a continued narrative of some possible, but fictitious event, designed to illustrate a sacred truth. It differs from a proverb in length, the latter being a condensation of the former; it differs also from the fable, especially in two points: (a) the parable always relates to possible events, the fable not so; (b) the parable is always intended to illustrate some high spiritual truth, the fable some maxim of human prudence. Parables have always been a very common mode of expressing truths among Oriental peoples; hence, our Saviour in using them, accommodated Himself to the customs and manners of His hearers. Rightly to understand Scriptural parables, we must bear in mind two things in particular: (a) that the whole parable is to be compared with the whole thing to be illustrated, and not part by part; (b) that incidents, descriptions, etc., are sometimes introduced for mere sake of ornament, and are not, therefore, to be applied to the thing illustrated. This first Parable of the Sower is found also in Mark (iv. 4-8, 14-21) and in Luke (vii. 5-8, 11-15).

Our Lord Himself explains the Parable of the Sower in verses 18-23 of the present chapter. The purpose of the parable is to show the effect of the word of God on different souls. The seed is the word of God; the soil, the hearts and souls of men; the sower, Christ and His ministers.

10. And his disciples came and said to him: Why speakest thou to them in parables?

11. Who answered and said to them: Because to you it is given to know the mysteries of the kingdom of heaven: but to them it is not given.

12. For he that hath, to him shall be given, and he shall abound: but he that hath not, from him shall be taken away that also which he hath.

13. Therefore do I speak to them in parables: because seeing they see not, and hearing they hear not, neither do they understand.

10. This question of the disciples was put after our Lord had retired from the lake, and the crowd had departed. Cf. Mark iv. 10.

11. Replying to the question of His disciples, our Lord says that it would not do to speak to the Pharisees in plain, unfigurative language, since, because of their evil hearts and bad dispositions, they would only spurn His sacred truths. Hence to speak to them plainly would be like casting pearls before swine. He therefore chose to veil His teaching in parables, when speaking to the multitude; but to His disciples, who were eager to learn the truth, He spoke in simple words. To these latter He communicates not only the ordinary truths of the Gospel, but even the deep mysteries of Heaven.

12. Here our Saviour gives a reason for the special gifts bestowed on His Apostles; namely, their faithfulness to graces already received.

He that hath; i.e., he that makes use of his graces; while, "he that hath not," means one who does not make use of the graces given him.

That also which he hath; i.e., which he seemeth to have (xxv. 29), or thinketh he hath (Luke viii. 18). "That which he hath" may also refer to one's natural gifts and virtues, which become blunted and impaired by misuse of grace.

13. Seeing they see not, etc.; i.e., they do not want to see, or hear; and because of this wilful perversity of their nature and hearts, our Saviour spoke in a language which they should not understand,— "that seeing, they might see, and not perceive" (Mark iv. 12; Luke viii. 10). It was their wilful failure to profit by the grace of God which blinded and hardened the hearts of the Pharisees.

14. And the prophecy of Isaias is fulfilled in them, who saith: By hearing you shall hear, and shall not understand: and seeing you shall see, and shall not perceive.

15. For the heart of this people is grown gross, and with their ears they have been dull of hearing, and their eyes they have shut: lest at any time they should see with their eyes, and hear with their ears, and understand with their heart, and be converted, and I should heal them.

16. But blessed are your eyes, because they see, and your ears, because they hear.

17. For, amen, I say to you, many prophets and just men have desired to see the things that you see, and have not seen them, and to hear the things that you hear and have not heard them.

18. Hear you therefore the parable of the sower.

19. When any one heareth the word of the kingdom, and understandeth it not, there cometh the wicked one, and catcheth away that which was sown in his heart: this is he that received the seed by the way side.

14, 15. According to the original Hebrew, this prophecy of Isaias (vi. 9, 10) should be rendered; "Go and thou shalt say to this people: hearing, hear and understand not; and see the vision, and perceive it not. Blind the heart of this people and make its ears dull and close its eyes." Thus the prophet is commanded by Almighty God to deliver this melancholy message to the Jewish people; and whenever God commands a prophet to say something, the thing said is usually to be understood as a prediction of what is to happen. In the present instance, therefore, the prophet is foretelling the sad fate of the Jews, how they would close their eyes to the law, become blind, obdurate, etc.

**Lest at any time they should see, etc.** The Pharisees wilfully closed their eyes and hearts to the light and warmth of divine grace, so that they might not see and be converted. They preferred their own will and pride to the will of God.

16, 17. **Blessed are your eyes, etc.** Our Lord now speaks of the great privilege and happiness of His Apostles, who see Him not only corporally, but spiritually; who behold the Messiah, not only by faith, but in person; who hear the good tidings of the Gospel, not only in promise from the prophets, but in reality from the Christ Himself.

19. The Saviour now begins to explain the Parable of the Sower and in this verse He is speaking of those that are hardened in sin.

20. And he that received the seed upon stony ground, is he that heareth the word, and immediately receiveth it with joy.

21. Yet hath he not root in himself, but is only for a time: and when there ariseth tribulation and persecution because of the word, he is presently scandalized.

22. And he that received the seed among thorns, is he that heareth the word, and the care of this world and the deceitfulness of riches choketh up the word, and he becometh fruitless.

23. But he that received the seed upon good ground, is he that heareth the word, and understandeth, and beareth fruit, and yieldeth the one an hundred-fold, and another sixty, and another thirty.

24. Another parable he proposed to them, saying: The kingdom of heaven is likened to a man that sowed good seed in his field.

**Understand it not; i.e., do not ponder it, and try to understand.**

20, 21. The class here described are the inconstant and fickle-minded.

22. This third class of hearers gladly receive and understand the word of the Gospel, but are engrossed with the "cares and riches and pleasures of life." Cf. Mark iv. 19; Luke viii. 14.

23. The fourth class of hearers are those in whom the words of the Gospel yield fruit. They differ from the first class, by keeping the words of the Gospel; from the second, by receiving them into good soil, i.e., into hearts well-disposed; from the third class, by bringing forth fruit,—the fruit of *good works*, in the present life, and of *reward* in the life to come.

24-30. We have here the second parable, called the Parable of the Cockle or Tares, which our Lord Himself again explains in verses 36-43. Having shown that the word of the Gospel is fruitful in only a portion of its hearers, the Saviour now goes on to explain how, even among the children of the Church, we must not expect that only good will be found. Even in the Church the good and the bad are mingled together. Cf. Mark iv. 26.

24. **The kingdom of heaven; i.e., the Church of Christ.** As a man may have in his field good and bad seed growing side by side, so the good and the bad are found in the Church.

In the preceding parable the *seed* is the word of God (cf. Luke viii. 11), or the word of the kingdom; here the *good seed* are the children of the kingdom, i.e., the faithful keepers of the word of God.

25. But while men were asleep, his enemy came and oversowed cockle among the wheat and went his way.

26. And when the blade was sprung up, and had brought forth fruit, then appeared also the cockle.

27. And the servants of the goodman of the house coming said to him: Sir, didst thou not sow good seed in thy field? whence then hath it cockle?

28. And he said to them: An enemy hath done this. And the servants said to him: Wilt thou that we go and gather it up?

29. And he said: No, lest perhaps gathering up the cockle, you root up the wheat also together with it.

30. Suffer both to grow until the harvest, and in the time of the harvest I will say to the reapers: Gather up first the cockle, and bind it into bundles to burn, but the wheat gather ye into my barn.

31. Another parable he proposed unto them, saying: The kingdom of heaven is like to a grain of mustard seed, which a man took and sowed in his field.

32. Which is the least indeed of all seeds; but when it is grown up, it is greater than all herbs, and becometh a tree, so that the birds of the air come, and dwell in the branches thereof.

25. **While men were asleep** means literally, during the night time; in its application the phrase means, during the inadvertence of the ministers of the Church. **Servants**; i.e., the angels, as explained below in verse 39. **Cockle or tares** represent evil-doers, sinful men, whether within or without the Church; they are the children of the enemy, the devil. **Field** may be considered as the Church, spread throughout the world, or as the world, in its literal sense.

31, 32. In these verses we have the third parable, which is also found in Mark iv. 30-32; Luke xiii. 18, 19. This Parable of the Mustard Seed is intended to illustrate the external growth of the Church, which, despite its humble beginning, is now spread over the entire world. The mustard seed was chosen, not so much on account of the smallness of the seed, nor of the greatness which it finally attains as a tree; but rather on account of the contrast between the smallness of the seed and the bigness of the tree into which it finally unfolds. The mustard plant or tree, of which there is mention here, is a small one in our country; but in hot climates, such as that of Judea, it becomes so large as to permit a man to climb into its branches, or to pass on horseback beneath them. Maldonatus tells us that in Spain he saw ovens heated with its branches; and that often, too, he saw great flocks of birds resting on its boughs.

To understand the meaning of the phrase, "the least of all seeds,"

33. Another parable he spoke to them. The kingdom of heaven is like to leaven, which a woman took and hid in three measures of meal, until the whole was leavened.

34. All these things Jesus spoke in parables to the multitudes: and without parables he did not speak to them.

35. That it might be fulfilled which was spoken by the prophet, saying: I will open my mouth in parables, I will utter things hidden from the foundation of the world.

we need only observe that the expression "small as a grain of mustard seed" was proverbial among the Jews, to express or signify something very minute.

**The kingdom of heaven** means here the doctrines and the preaching of the Gospel.

33. As the Parable of the Mustard Seed depicts the visible expansion and external growth of the Church, so this of the Leaven is calculated to illustrate its internal secret working and mysterious influence on the world. For the same parable, see Luke xiii. 20, 21.

**The kingdom of heaven**; i.e., the Gospel teaching.

**Three measures of meal.** This quantity of meal is mentioned because it was most probably the amount used at a single baking among the Jews.

**Until the whole was leavened,** refers to the final triumph of the Gospel when it shall have spread over the whole earth and ennobled all life. "Leaven" is often spoken of in Scripture to signify something evil, as when our Lord speaks of the leaven of the Pharisees (Luke xii. 1); but in such cases, it is to the puffing up, souring properties of leaven that allusion is made; while in the present parable, our Lord is referring to its warming, permeating, expanding qualities.

34. **Without parables, etc.;** i.e., on this particular occasion He spoke only in parables, for we know that many other times our Lord spoke to the multitude in plainest language. Doubtless the reason why He spoke in parables at this time was in order to conceal His meaning, to some extent, from the Pharisees, who, had they clearly understood Him, would have been the more enraged against Him.

35. **Spoken by the prophets.** The reference is to the Psalmist in Ps. lxxvii. 2. **I will open my mouth, etc.,** means, I will utter, or speak.

**Things hidden;** i.e., the mysteries of grace and glory revealed

36. Then having sent away the multitudes, he came into the house, and his disciples came to him, saying: Expound to us the parable of the cockle of the field.

37. Who made answer and said to them: He that soweth the good seed, is the Son of man.

38. And the field, is the world. And the good seed are the children of the kingdom. And the cockle, are the children of the wicked one.

39. And the enemy that sowed them, is the devil. But the harvest is the end of the world. And the reapers are the angels.

40. Even as cockle therefore is gathered up, and burnt with fire: so shall it be at the end of the world.

41. The Son of man shall send his angels, and they shall gather out of his kingdom all scandals, and them that work iniquity.

42. And shall cast them into the furnace of fire: there shall be weeping and gnashing of teeth.

43. Then shall the just shine as the sun, in the kingdom of their Father. He that hath ears to hear, let him hear.

44. The kingdom of heaven is like unto a treasure hidden in a field. Which a man having found, hid it, and for joy thereof goeth, and selleth all that he hath, and buyeth that field.

by Christ in His Church. In a literal sense, the Psalmist was speaking of the benefits conferred upon the Hebrew people from the beginning, down to his own time; but in a spiritual sense, he was foretelling the future blessings of Christ and His Church.

36. He came into the house at Capharnaum, which He had left the day before.

41. All scandals; i.e., all grievous sins and sinners of every kind.

42. The furnace of fire; i.e., hell, gehenna. See on v. 30. However some modern preachers may strive to explain this place of "everlasting fire" (xviii. 8), of "everlasting punishment" (xxv. 46), this "pool of fire" (Apoc. xx. 15), this "fire that is not extinguished" (Mark ix. 44), one thing seems so certain that none can deny it, namely, that the words used to describe that place of torment certainly point to some doom so intolerable that the Son of God came down from Heaven and tasted all the bitterness of death, that He might deliver us from ever knowing the secrets of anguish which, unless God be mocking men with empty threats, are shut up in these terrible words, — "there shall be weeping and gnashing of teeth" (Trench, *Notes on the Parables*, p. 86).

43. Shine as the sun is a reference to the happiness of the Blessed in Heaven.

44. The Parables of the Mustard Seed and of the Leaven illus-

45. Again the kingdom of heaven is like to a merchant seeking good pearls.

46. Who when he had found one pearl of great price, went his way, and sold all that he had, and bought it.

47. Again the kingdom of heaven is like to a net cast into the sea, and gathering together of all kind of fishes.

48. Which, when it was filled, they drew out, and sitting by the shore, they chose out the good into vessels, but the bad they cast forth.

49. So shall it be at the end of the world. The angels shall go out, and shall separate the wicked from among the just.

trate the vital force and expansiveness of the Gospel teaching; this present one of the Hidden Treasure is introduced to show the priceless value of the same teaching. Better to understand the force of the parable we must note, that in Oriental countries, because of the frequent changes of dynasties, it was customary for rich men, before leaving their country, to bury a portion of their money in the ground, in places unknown to any but themselves. It frequently happened that owners of this hidden wealth never returned, and that peasants who had purchased the land would, at times, while digging or plowing, accidentally stumble upon it. According to the Jewish law, the treasure found belonged to the one on whose property it was discovered. Our Lord, in this parable, likens the finding of the teaching of the Gospel to that of one of these treasures hidden in the earth.

Field may refer to the world in general, or more probably, to the Church, in its visible, outward aspect; while the treasure is the teaching of the Church, of the Gospel, or the inward spiritual meaning of that teaching.

Hid it does not mean that we should try to keep the Gospel doctrine from others; it rather points to the great diligence we should exercise lest, when we have found it, we lose it.

45, 46. This parable is nearly the same as the preceding one, except that the Pearl which is found was not discovered by accident, as in the case of the Hidden Treasure, but has been the result of steady, persistent quest. The preceding parable, therefore, illustrates the Gospel doctrine as coming to its possessor without any special effort, while the present one shows the great sacrifice one must be ready to make to secure its precious teaching.

47. The kingdom of heaven here means the Church, which is composed of all classes, rich and poor, good and bad.



50. And shall cast them into the furnace of fire: there shall be weeping and gnashing of teeth.

51. Have ye understood all these things? They say to him: Yes.

52. He said unto them: Therefore every scribe instructed in the kingdom of heaven, is like to a man that is a householder, who bringeth forth out of his treasure new things and old.

53. And it came to pass: when Jesus had finished these parables, he passed from thence.

54. And coming into his own country, he taught them in their synagogues, so that they wondered and said: How came this man by this wisdom and miracles?

55. Is not this the carpenter's son? Is not his mother called Mary, and his brethren James, and Joseph, and Simon, and Jude:

56. And his sisters, are they not all with us? Whence therefore hath he all these things?

50. **The furnace of fire.** See above, verse 42.

52. **Every scribe;** i.e., every teacher instructed in the law of the Gospel must be able to bring forth from the abundance of his knowledge the teaching necessary for his hearers; he must be able to adapt and apply the old truths to new conditions and new needs.

53. **He passed from thence;** i.e., from His house at Capharnaum, where He had been explaining the parable to His disciples.

54-56. **Coming into his own country;** i.e., to Nazareth, where He had grown up as a boy and was well known. Cf. Luke iv. 16.

**Synagogues** should be in the singular, according to the Greek. See on iv. 23.

**Brethren;** i.e., cousins and near relatives. They were perhaps the children of Mary, wife of Alpheus, or Cleophas. According to some commentators, this Mary was the cousin of the Blessed Virgin, and was married twice, first to Alpheus, of whom she had James and Joseph, and afterwards to Cleophas, of whom she had Simon and Jude (St. Thomas). Certain commentators say that Alpheus was a brother of St. Joseph. There are some who say that this Mary was the daughter of Cleophas, still others, that she was the sister of the Blessed Virgin (John xix. 25). At any rate, these "brethren" mentioned in the present verse would be cousins of our Lord, either on the side of His Blessed Mother, or on the side of St. Joseph. See above, xii. 46.

57. And they were scandalized in his regard. But Jesus said to them: A prophet is not without honour, save in his own country, and in his own house.

58. And he wrought not many miracles there, because of their unbelief.

57. They were scandalized in him; i.e., they were *offended* at His lowly birth and the poverty of His parents and relatives.

## CHAPTER XIV

THE MARTYRDOM OF JOHN THE BAPTIST, 1-12.

THE FIRST MULTIPLICATION OF THE LOAVES, 13-21.

JESUS STILLS THE WATERS, 22, 23.

THE RETURN TO GALILEE, 24-36.

1. At that time Herod the Tetrarch heard the fame of Jesus.

1. **At that time;** i.e., some time after the death of John the Baptist. John was beheaded after the mission of the Apostles, as recorded in chapter x; and it was after the return of the Apostles from their mission that John's death was made known to our Lord. Cf. Mark vi. 14; Luke ix. 7 ff.

**Herod the Tetrarch.** A tetrarch was a ruler of a fourth part of a province or kingdom. The Herod here spoken of was Herod Antipas, son of Herod the Great who had put to death the Holy Innocents. This tetrarch was surnamed "Antipas," and was the one before whom our Lord was mocked (Luke xxiii. 11). Upon the death of Herod the Great, his kingdom was divided by the Emperor Augustus as follows: half of the territory—embracing Idumea, Samaria, and Judea—was given to Archelaus with the title of Ethnarch; the other half was divided into two equal parts, called tetrarchies. One of these tetrarchies, composed of Galilee and Peraea, fell to the lot of Herod Antipas; while the other, comprising Ituraea, Trachonitis, Gaulanitis, Auranitis and Batanea, was handed over to Herod Philip II, the son whom Herod the Great had by Cleopatra of Jerusalem. St. Luke (iii. 1) speaks of Lysanias as tetrarch of Abilene which lay to the north of Ituraea, but it is uncertain whether this small state was ever a part of Herod the Great's domains.

2. And he said to his servants: This is John the Baptist: he is risen from the dead, and therefore mighty works shew forth themselves in him.

3. For Herod had apprehended John and bound him, and put him into prison, because of Herodias, his brother's wife.

4. For John said to him: It is not lawful for thee to have her.

5. And having a mind to put him to death, he feared the people: because they esteemed him as a prophet.

6. But on Herod's birthday, the daughter of Herodias danced before them: and pleased Herod.

7. Whereupon he promised with an oath, to give her whatsoever she would ask of him.

8. But she being instructed before by her mother, said: Give me here in a dish the head of John the Baptist.

9. And the king was struck sad: yet because of his oath, and for them that sat with him at table, he commanded it to be given.

**Heard of the fame of Jesus.** It seems strange that Herod had not before learned of the wondrous works of the Saviour, but this can be accounted for by his frequent absences, his preoccupations in temporal affairs, and his little interest in things religious.

2. **This is John the Baptist, etc.** From this it would seem that Herod believed in the resurrection of the dead, either because he was imbued with the errors of Pythagoras, according to which, the souls of the departed just were thought to exist in the bodies of other men; or because he had heard before of others coming back from the dead, such as the son of the widow of Sarephta (3 Kings xvii), the son of the woman of Sunam (4 Kings iv), etc.

3. **Had apprehended John; i.e.,** at the beginning of the public ministry of our Lord (iv. 12). John, at the time, was preaching in Peraea within the territory of the incestuous tetrarch; and yet he did not recoil from denouncing in boldest terms this sinful ruler.

**His brother's wife.** This brother was Philip, brother of Herod, but not the tetrarch of Ituraea. This Philip was son of Herod the Great by Mariamne and was the half-brother, consequently, of the tetrarch of Ituraea and Trachonitis, also named Philip.

4. **John said to him; i.e.,** to Herod Antipas. **It is not lawful, etc.,** because her husband, Herod Philip, was still living, and because his own wife was also still alive.

6. **The daughter of Herodias,** whose name was Salome, "the damsel," who was the daughter of Herodias and Herod Philip; she afterwards married Philip the tetrarch, her uncle.

10. And he sent, and beheaded John in the prison.

11. And his head was brought in a dish: and it was given to the damsel, and she brought it to her mother.

12. And his disciples came and took the body, and buried it, and came and told Jesus.

13. Which when Jesus had heard, he retired from thence by a boat, into a desert place apart, and the multitudes having heard of it, followed him on foot out of the cities.

14. And he coming forth saw a great multitude, and had compassion on them, and healed their sick.

15. And when it was evening, his disciples came to him, saying: This is a desert place, and the hour is now past: send away the multitudes, that going into the towns, they may buy themselves victuals.

16. But Jesus said to them, They have no need to go: give you them to eat.

17. They answered him: We have not here, but five loaves, and two fishes.

18. He said to them: Bring them hither to me.

19. And when he had commanded the multitudes to sit down upon the grass, he took the five loaves and the two fishes, and looking up to heaven, he blessed, and brake, and gave the loaves to his disciples, and the disciples to the multitudes.

20. And they did all eat, and were filled. And they took up what remained, twelve full baskets of fragments.

10. **John in prison**, in the castle of Machaerus, beyond the Jordan, near the Dead Sea.

13. **He retired from thence**. Upon hearing these things, our Saviour sailed across the Sea of Galilee, from Capharnaum to Bethsaida Julias, on the northeastern shore of the lake (Luke ix. 10). Whether this was the "desert place" where the multiplication of the loaves took place or not, is uncertain. Many commentators think it was; but there are others who think that *Tell-Hum*, the ancient and real Bethsaida, was the vicinity of the miracle (Le Camus).

15. **When it was evening**. St. Luke (ix. 12) says when "the day began to decline." The Hebrews distinguished two evenings, the first was about three o'clock in the afternoon, when the sun began to decline, the second was after sunset. Reference is here made to the first.

16. **Give you them to eat**, which the disciples did as soon as the Saviour had by the miracle provided the food (verse 19). Already the Apostles were exercising the duties of their office as "ministers of Christ and dispensers of the mysteries of God" (1 Cor. iv. 1).

19. **He blessed and brake**. These same words are used in the account of the institution of the Holy Eucharist (xxvi. 26; John

21. And the number of them that did eat, was five thousand men, besides women and children.

22. And forthwith Jesus obliged his disciples to go up into the boat, and to go before him over the water, till he dismissed the people.

23. And having dismissed the multitude, he went into a mountain alone to pray. And when it was evening, he was there alone.

24. But the boat in the midst of the sea was tossed with the waves: for the wind was contrary.

25. And in the fourth watch of the night, he came to them walking upon the sea.

26. And they seeing him walking upon the sea, were troubled, saying: It is an apparition. And they cried out for fear.

27. And immediately Jesus spoke to them, saying: Be of good heart: it is I, fear ye not.

28. And Peter making answer, said: Lord, if it be thou, bid me come to thee upon the waters.

29. And he said: Come. And Peter going down out of the boat, walked upon the water to come to Jesus.

vi. 11), from which it is clear that the multiplication of the loaves was a type of the institution of the Eucharist.

21. **Five thousand men.** The word *ἄνδρες* is used in the Greek to distinguish the men from the women and the children. The same term occurs in the other Synoptics, but in St. John (vi. 10) *ἀνθρώπων* is used,— a general term embracing men, women, and children.

22. **Obliged his disciples, etc.** The disciples got into the boat to return from Bethsaida Julias, or wherever the miracle took place, to Bethsaida of Galilee, near Capharnaum. Our Saviour, fearing that the people, on account of the miracle, “ would come and make him king ” (John vi. 15), thus sent away His disciples and dismissed the multitudes.

25. **Fourth watch of the night; i.e., between 3 and 6 A.M.** In the time of our Lord, the Jews had adopted the Roman division of the night into four watches of equal length. The first was from 6 to 9 P.M.; the second from 9 to 12, and so on.

26. **Were troubled.** The Apostles feared, not because of the roughness of the waves, since they were fishermen and accustomed to storms, but only because of the apparition, which they did not understand.

27. **Be of good heart; i.e., do not fear.**

28. **Lord, if it be thou, etc.** It was not that Peter's faith was

30. But seeing the wind strong, he was afraid: and when he began to sink, he cried out, saying: Lord, save me.

31. And immediately Jesus stretching forth his hand took hold of him, and said to him: O thou of little faith, why didst thou doubt?

32. And when they were come up into the boat, the wind ceased.

33. And they that were in the boat came and adored him, saying: Indeed thou art the Son of God.

34. And having passed the water, they came into the country of Genesar.

35. And when the men of that place had knowledge of him, they sent into all that country, and brought to him all that were diseased.

36. And they besought him that they might touch but the hem of his garment. And as many as touched, were made whole.

at fault that he asked this question, but because of his uncertainty as to the identity or reality of the person.

30, 31. So long as Peter had his mind and eyes fixed upon the Saviour, the waters did not yield under him; it was only when he began to consider the winds and waves and his own weakness that he began to sink. So long as his faith did not waver, he was safe.

33. **Son of God**; i.e., the Messiah. It was not generally understood by the Jews that the Messiah was to be the natural son of God; but, in the present instance, this appellation given to our Saviour by the disciples, because of the miracles they had witnessed, was a recognition of His natural sonship, and, consequently, of His Divinity.

34. **Genesar**; i.e., Genesareth, near Capharnaum. They landed from the boat on Friday. The multiplication of the loaves had taken place on Thursday afternoon toward evening, after which the disciples started across the lake in the boat. The day after our Lord landed at Capharnaum He entered the synagogue, it being the Sabbath, and there uttered the discourse recorded by St. John vi. 26-60.

36. **The hem of his garment.** In this, we find justification for, and approbation of, the Catholic practice of reverencing relics.

## CHAPTER XV

THE PHARISEES AND THEIR TRADITIONS, 1-20.

THE CANAANITE MOTHER, 21-28.

THE RETURN TO GALILEE AND THE CURE OF MANY  
INFIRM, 29-31.

THE SECOND MULTIPLICATION OF THE LOAVES, 32-39.

1. Then came to him from Jerusalem scribes and Pharisees, saying:
2. Why do thy disciples transgress the tradition of the ancients? For they wash not their hands when they eat bread.
3. But he answering, said to them: Why do you also transgress the commandment of God for your tradition? For God said:
4. Honour thy father and mother: And: He that shall curse father or mother, let him die the death.
5. But you say: Whosoever shall say to father or mother, The gift whatsoever proceedeth from me, shall profit thee.
6. And he shall not honour his father or his mother: and you have made void the commandment of God for your tradition.

1. **Then;** i.e., at the time of the Passover, about the beginning of the last year of our Lord's life. He was still in the vicinity of Genesar and Capharnaum. It seems He did not go up to Jerusalem to celebrate this Pasch; He remained in Galilee, out of fear of the Jews, lest they should put Him to death (John vii. 1).

**Scribes and Pharisees.** Scribes and Pharisees were scattered all over Palestine, but those at Jerusalem were considered the most learned and best versed in the Law; hence these were sent by the Sanhedrim into Galilee to interrogate our Lord, and examine into His teaching.

2. **The tradition of the ancients.** This tradition meant certain "washings" before and after and during meals, and at other times, which were of Pharisaical origin, and formed no part of the Mosaic Law. The "tradition" does not refer to the generations long past, but to the teachings of the rival schools of Hillel and Shammai who lived about the time of Christ. Both Hillel and Shammai were called "Ancients," i.e., "Presbyters," and by their teachings, which had a general influence on the people, they had caused to be multiplied many ceremonial observances that formed no part of the Law of Moses.

3-6. Without direct response to their question, our Lord tells

7. Hypocrites, well hath Isaias prophesied of you, saying :

8. This people honoureth me with their lips : but their heart is far from me.

the Pharisees that they are scrupulous about the traditions of men, but they do not hesitate to violate the law of God and of nature.

Honor thy father and mother, etc. See Exod. xx. 12; xxi. 17.

The English translation of verses 5 and 6 is not exact. The correct meaning, as gathered from the Greek, is that parents should not ask their children for any gifts or temporal support, inasmuch as all things were God's gifts, consecrated to His service, and as such, were to be given to Him alone. Thus, parents in their need, according to the Pharisees, were to be satisfied, not by receiving the help they needed, but in the thought that they had a part in the honor paid to God through the gift that was offered Him. Therefore, the Pharisees taught that honor paid to God was sufficient to dispense from the honor and support which were due to one's neighbor. The brevity of our Lord's words here shows that He was citing a saying familiar to every Jew. From St. Mark (vii. 11) we know that the Hebrew and Aramaic word for "gift," here mentioned, was *corban* or *quorban*; it was the name given to anything consecrated to God. And since the Pharisees taught that anything consecrated to God could not be used for other purposes, one could evade his duty (the Pharisees also taught) of paying his debts, or of helping his parents and neighbors by saying *corban* to all he possessed. Thus Jewish children used to make use of this teaching to dispense themselves from all obligations to father or mother. The present passage, then, together with its parallel in Mark (vii. 11) may be translated as follows: "Whosoever has said to his parents: 'corban to me are all the services that I might render to you,' can no longer do anything for them," or, as others translate it, "All my goods are consecrated to God, but I grant you a share of merit in my offering." See Le Camus, *Life of Christ*, vol. ii. pp. 120, 121.

And at the beginning of verse 6 is not to be found in many MSS., and its insertion makes no sense at all.

7. Isaias prophesied. The words of the prophet had direct reference to the Jews of his own time, and indirectly and prophetically to those of our Lord's time.

8. This people honoreth me, etc. In the LXX version, from



9. And in vain do they worship me, teaching doctrines and commandments of men.

10. And having called together the multitudes unto him, he said to them: Hear ye and understand.

11. Not that which goeth into the mouth defileth a man: but what cometh out of the mouth, this defileth a man.

12. Then came his disciples, and said to him: Dost thou know that the Pharisees, when they heard this word, were scandalized?

13. But he answering, said: Every plant which my heavenly Father hath not planted, shall be rooted up.

14. Let them alone: they are blind, and leaders of the blind. And if the blind lead the blind, both fall into the pit.

15. And Peter answering, said to him: Expound to us this parable.

16. But he said: Are you also yet without understanding?

17. Do you not understand, that whatsoever entereth into the mouth, goeth into the belly, and is cast out into the privy?

18. But the things which proceed out of the mouth, come forth from the heart, and those things defile a man.

19. For from the heart come forth evil thoughts, murders, adulteries, fornications, thefts, false testimonies, blasphemies.

20. These are the things that defile a man. But to eat with unwashed hands doth not defile a man.

which this verse is taken, the reading is: "This people approaches me with their mouth, and honors me with their lips," etc. The quotation is from *Isaias* xxix. 13.

9. **And in vain**, etc. The word "and" is again wanting in many MSS. "In vain" means without present or future merit.

11. **Not that which goeth into the mouth**, etc. These words are a refutation of the teaching of the Pharisees with regard to eating with unwashed hands. "Every creature of God is good in itself, if it be taken with thanksgiving" (1 Tim. iv. 4). It is <sup>the</sup> ~~the~~ moral uncleanness that defiles a man in the sight of God.

**But what cometh out of the mouth**, as explained below, in verses 18-20.

12. **Scandalized**; i.e., offended, because He rejected their traditions.

13. **Every plant**; i.e., every doctrine, every institution, or sect, such as that of the Pharisees.

14. **Blind**. From the malice and perversity of their own nature, the Pharisees chose not to know the truth and not to understand; hence they, and those who followed them, were blind.

15. **This parable**; i.e., this obscure saying, or use of language.

21. And Jesus went from thence, and retired into the coasts of Tyre and Sidon.

22. And behold a woman of Canaan who came out of those coasts, crying out, said to him: Have mercy on me, O Lord, thou son of David: my daughter is grievously troubled by a devil.

23. Who answered her not a word. And his disciples came and besought him, saying: Send her away, for she crieth after us:

24. And he answering, said: I was not sent but to the sheep that are lost of the house of Israel.

25. But she came and adored him, saying: Lord, help me.

26. Who answering, said: It is not good to take the bread of the children, and to cast it to the dogs.

27. But she said: Yea, Lord; for the whelps also eat of the crumbs that fall from the table of their masters.

The disciples, accustomed to the traditions of the Pharisees, according to which to eat with unwashed hands defiled the food taken, and the food the heart, were anxious to know from our Lord just what He meant by His words in verse 11; hence his explanation in verses 17-20.

21. **From thence;** i.e., from Genesar and the neighboring places.

Tyre and Sidon were Gentile cities of Phoenicia, north of Galilee. It is not known whether our Lord actually entered these Gentile cities, or only approached their frontiers.

22. **A woman of Canaan.** She was a Phoenician Gentile, called by St. Mark (vii. 26) a Syro-Phoenician, because Phoenicia was part of Syria, and to distinguish the place from Liby-Phoenicia in Africa. The Phoenicians and Canaanites were the same people, the descendants of Canaan, son of Cham. They were called **Canaanites** by the Jews, but Phoenicians by the Greeks.

24. **I was not sent,** etc.; the personal mission of Jesus, during His earthly life, was to the Jews; had He mingled among the Gentiles, the Jews would have had an excuse for not receiving Him as the Messiah. Cf. x. 5.

26. **Bread of the children;** i.e., the graces and blessings of His doctrine and miracles, primarily intended for the chosen people. The term **dogs** here means the Gentiles.

27. The woman's reply means that she is only demanding a little, a crumb, by asking her daughter's cure; and that the Jews who are blessed with so many miracles, will not suffer through the grant of her one request.

28. Then Jesus answering, said to her : O woman, great is thy faith : be it done to thee as thou wilt : and her daughter was cured from that hour.

29. And when Jesus had passed away from thence, he came nigh the sea of Galilee. And going up into a mountain, he sat there.

30. And there came to him great multitudes, having with them the dumb, the blind, the lame, the maimed, and many others : and they cast them down at his feet, and he healed them :

31. So that the multitudes marvelled seeing the dumb speak, the lame walk, the blind see : and they glorified the God of Israel.

32. And Jesus called together his disciples, and said : I have compassion on the multitudes, because they continue with me now three days, and have not what to eat, and I will not send them away fasting, lest they faint in the way.

33. And the disciples say unto him : Whence then should we have so many loaves in the desert, as to fill so great a multitude ?

34. And Jesus said to them : How many loaves have you ? But they said : Seven, and a few little fishes.

35. And he commanded the multitude to sit down upon the ground.

36. And taking the seven loaves and the fishes, and giving thanks, he brake, and gave to his disciples, and the disciples gave to the people.

37. And they did all eat, and had their fill. And they took up seven baskets full, of what remained of the fragments.

38. And they that did eat, were four thousand men, beside children and women.

28. **Be it done unto thee.** This affords an excellent example of the efficacy of humble, persevering prayer.

29. **From thence ;** i.e., from the borders of Tyre and Sidon. Our Lord went from Tyre around to the north and east, via Sidon, to the eastern shore of the Sea of Galilee.

30. **Lame, χωλοί,** — literally, the *crooked* in hand or arm, as distinguished from χυλλοί, the *maimed*.

33. From this verse it is evident that the disciples had not understood the previous miracle of the multiplication of the loaves (xiv. 19-21). Their hearts were blinded and they did not understand. (Mark vi. 52).

36. **Upon the ground,** for it was now summer and the grass was burned up by the sun.

37, 38. The differences in the number fed, the number of the loaves, and the number of baskets of fragments afterwards taken up, are more than sufficient to distinguish this miracle from the previous multiplication of the loaves (xiv. 19-21).

**Seven baskets,** or fish-hampers (σπυρίδας). These were large round baskets, with a flat bottom, used for carrying fish. It was

39. And having dismissed the multitude, he went up into a boat, and came into the coasts of Magedan.

in a basket of this kind that St. Paul was let down from the wall of Damascus (Acts ix. 25).

39. Magedan, or "Magadan," called by St. Mark (viii. 10) "Dalmanutha." This village was on the east coast of the Sea of Galilee, and must not be confounded with Magdala, the home of Mary Magdalen, on the west coast.

## CHAPTER XVI

THE SIGN OF JONAS, 1-4.

THE LEAVEN OF THE PHARISEES, 5-12.

THE CONFESSION OF PETER, 13-20.

JESUS FORETELLS HIS PASSION, 21-23.

CHRISTIAN ABNEGATION, 24-28.

1. And there came to him the Pharisees and Sadducees tempting: and they asked him to shew them a sign from heaven.

2. But he answered and said to them: When it is evening, you say, It will be fair weather, for the sky is red.

3. And in the morning: To day there will be a storm, for the sky is red and lowering. You know then how to discern the face of the sky: and can you not know the signs of the times?

4. A wicked and adulterous generation seeketh after a sign: and a sign shall not be given it, but the sign of Jonas the prophet. And he left them, and went away.

5. And when his disciples were come over the water, they had forgotten to take bread.

1. This visit of the Pharisees and Sadducees took place after our Lord had arrived at Magedan.

Sadducees were one of the three philosophico-religious sects among the Jews; the other two being the Pharisees and the Essenes. The Sadducees denied the resurrection of the body, the immortality of the soul, and the existence of spirits. See on iii. 7.

Sign from heaven, such as the calling down of fire by Elias, or the stopping of the sun by Josue, and the like.

2-4. Verse 2, after the words, "But he said to them," and all of verse 3 are wanting in the two oldest MSS. The argument of

6. Who said to them: Take heed and beware of the leaven of the Pharisees and Sadducees.

7. But they thought within themselves, saying: Because we have taken no bread.

8. And Jesus knowing it, said: Why do you think within yourselves, O ye of little faith, for that you have no bread?

9. Do you not yet understand, neither do you remember the five loaves among five thousand men, and how many baskets you took up?

10. Nor the seven loaves among four thousand men, and how many baskets you took up?

11. Why do you not understand that it was not concerning bread I said to you: Beware of the leaven of the Pharisees and Sadducees?

12. Then they understood that he said not that they should beware of the leaven of bread, but of the doctrine of the Pharisees and Sadducees.

13. And Jesus came into the quarters of Cesarea Philippi: and he asked his disciples, saying: Whom do men say that the Son of man is?

our Saviour, however, is that these hypocrites could forecast the weather by observing certain natural phenomena, but that they could not understand the signs, so many and so evident, which proved that He was the Messiah. Sufficient signs had been given in their midst, and consequently a special sign, such as they desired, was denied them.

6. **Leaven of the Pharisees, etc.** The term "leaven" is here used in a bad sense, and not as in xiii. 33. Here it means the false and erroneous doctrines and customs of the Pharisees. But this false doctrine, here condemned, is to be sharply distinguished from the teaching of the Law of Moses, of which the Pharisees were the lawful expounders. The Law of Moses, in fact, was not *their* doctrine, and it is only *their* doctrine, their useless additions to, and false interpretations of, the Law, against which our Lord is warning His disciples.

7-10. These verses again show that the disciples were slow to comprehend the meaning of the multiplication of the loaves.

13. **Borders of Caesarea Philippi.** Going from Bethsaida, near Capharnaum, our Lord came to the confines, or villages, of Caesarea Philippi. "Caesarea Philippi," i.e., Philip's Caesarea, ancient Paneas, was about thirty miles north and a little east of Capharnaum. It was called Philip's Caesarea, because built by Herod Philip II, tetrarch of Iturea, and named after Caesar and himself; it is not to be confounded with the other Caesarea, built by Herod the Great, on the sea-coast, north of Jaffa (Joppa).

14. But they said : Some John the Baptist, and other some Elias, and others Jeremias, or one of the prophets.

15. Jesus saith to them : But whom do you say that I am ?

16. Simon Peter answered and said : Thou art Christ, the Son of the living God.

17. And Jesus answering, said to him : Blessed art thou, Simon Bar-Jona : because flesh and blood hath not revealed it to thee, but my Father who is in heaven.

18. And I say to thee : That thou art Peter ; and upon this rock I will build my church, and the gates of hell shall not prevail against it.

**Son of man ;** i.e., the Messiah, whom our Lord identifies with Himself (verse 15).

14. **Some John the Baptist ;** i.e., such as Herod and others, imbued with the doctrine of transmigration of souls. **Some Elias.** Through a misunderstanding of the prophecy of Malachy (iv. 5), it was commonly believed among the Jews that Elias was to precede the first coming of the Messiah. **Others Jeremias.** Our Lord's fearless denunciation of wrong, and of the doers of wrong, made Him resemble in many ways the character of Jeremias.

16. **Thou art Christ,** etc. ; i.e., *The Christ, The Anointed, The Messiah* (ὁ Χριστός, ὁ υἱὸς τοῦ Θεοῦ τοῦ ζῶντος). By this confession, Peter acknowledged his belief that our Lord was the true Messiah, the natural, and not the adopted Son of the *Living* God. He spoke of Him as the "living" God, to distinguish Him from the idols and false gods of the Gentiles.

17. **Blessed ;** i.e., privileged, or highly favored.

**Simon Bar-Jona.** "Bar" means "son," in Chaldaic ; "Jona" is the contraction for "Johanna," the Hebrew for John ; hence, "Simon bar Jona" means "Simon, son of John."

**Because flesh and blood hath not,** etc. ; i.e., no man, no human or natural helps, had enabled Simon to make this supernatural confession. Although he had witnessed for a year and a half our Lord's miracles and holy life, still this was not sufficient for the confession he had just made, which grace alone could inspire. This verse offers a proof of the divine sonship, and of the consequent plurality of persons in the Godhead.

18. **Thou art Peter, and upon this rock I will build my church.** According to the Aramaic, or Syro-Chaldaic language, which our Lord used, this passage would run : "Thou art *Cephas*

19. And I will give to thee the keys of the kingdom of heaven. And whatsoever thou shalt bind upon earth, it shall be bound also in heaven: and whatsoever thou shalt loose on earth, it shall be loosed also in heaven.

20. Then he commanded his disciples, that they should tell no one that he was Jesus the Christ.

21. From that time Jesus began to shew to his disciples, that he must go to Jerusalem, and suffer many things from the ancients and scribes and chief priests, and be put to death, and the third day rise again.

(*Kepha*), and upon this *cephas* (*kepha*), I will build My Church." But whoever rendered this passage into Greek used the masculine form (*πέτρος*), in the first instance, as applied to the person of Peter, and (*πέτρα*), or the feminine form, in the second instance, as descriptive of the quality of stone. Some of the Fathers understand the "rock" as referring to Peter's faith, or confession, but this would not interfere with the usual interpretation which refers it to the person of Peter, since it is Peter's faith, or confession in the *concrete* that is in question.

**Gates of hell, etc.;** i.e., the power and strength of Satan, and of Satan's kingdom, shall never be able successfully to oppose or vanquish the Church. Gates among the Orientals signify power; and it was at the gates of a town that rulers were accustomed to sit in order to dispense justice.

19. **The keys of the kingdom of heaven.** Keys have always been a symbol of power and supreme authority; hence, in giving to Peter the "keys" of His Kingdom, i.e., of His Church, our Lord bestowed on Peter the right and power of supreme authority in His Church.

**Bind and loose.** According to the Hebrew usage, "to bind and loose" meant to declare lawful or unlawful, with respect to the Law; our Lord therefore in the foregoing words gave Peter authority, as head of the Church, to make known, explain, and determine the Law of the Gospel.

20. **Should tell no one.** The reason for this command is not altogether certain; according to some, He wished to avoid unduly exciting His enemies, who would only be the more irritated against Him, and might attempt to cut short the work and time allotted to Him by His heavenly Father; according to others, He wished to admonish His disciples that the time for an open manifestation of His Divinity was not until after His Resurrection and Ascension.

21. **From that time;** i.e., from the confession of St. Peter.

22. And Peter taking him, began to rebuke him, saying: Lord, be it far from thee, this shall not be unto thee.

23. Who turning, said to Peter: Go behind me, Satan, thou art a scandal unto me: because thou savourest not the things that are of God, but the things that are of men.

24. Then Jesus said to his disciples: If any man will come after me, let him deny himself, and take up his cross, and follow me.

25. For he that will save his life, shall lose it: and he that shall lose his life for my sake, shall find it.

26. For what doth it profit a man, if he gain the whole world, and suffer the loss of his own soul? Or what exchange shall a man give for his soul?

27. For the Son of man shall come in the glory of his Father with his angels: and then will he render to every man according to his works.

28. Amen I say to you, there are some of them that stand here, that shall not taste death, till they see the Son of man coming in his kingdom.

**The ancients;** i.e., the rulers of the nation, members of the Sanhedrim. See on xv. 2.

22, 23. **Lord, be it far from thee.** According to the Greek idiom (*Ἰλέως σοι*) it would be, "spare Thyself."

**Go behind me, Satan.** Our Lord addressed Peter as Satan, because in the present instance he was unintentionally doing the work of Satan, by trying to resist the will of God, which was that our Lord should suffer and die for the redemption of mankind.

**Thou art a scandal;** etc.; i.e., an occasion of sin unto Me. Peter, in his solicitude for our Lord's welfare, was consulting human ease and feelings, rather than the will and glory of the heavenly Father.

24. **Will come after me;** i.e., will follow Me, as My disciple.

**Let him deny himself;** i.e., let him practice self-denial, mortification, sacrifice, and even death itself, if such be necessary, to prove faithful to Christ and the Gospel.

25. The meaning of this verse is that he who would save his temporal life, at the cost of duty and things spiritual, will lose his soul eternally; but he who is willing to suffer the loss of all temporal things, if need be, for the sake of things eternal, will save his soul eternally.

27. **The son of man;** i.e., Christ Himself.

28. **Till they see the Son of man coming in his kingdom.** According to some, this refers to our Lord's Transfiguration; according to others, to the spread of His Church, after the Resurrection and Ascension.

The Transfiguration was indeed a real manifestation of Christ



in His glory, and a passing glimpse of the glory of the heavenly Kingdom; but the reference seems more likely to be to the glorious establishment and spread of the Church after the Resurrection and Ascension. In this sense the prediction, "Some that shall not taste death," etc., was more truly and literally verified.

## CHAPTER XVII

THE TRANSFIGURATION, 1-13.

THE LUNATIC BOY, 14-20.

THE SECOND PREDICTION OF THE PASSION, 21, 22.

THE STATER IN THE FISH'S MOUTH, 23-26.

1. And after six days Jesus taketh unto him Peter and James, and John his brother, and bringeth them up into a high mountain apart:

2. And he was transfigured before them. And his face did shine as the sun: and his garments became white as snow.

1. **After six days.** St. Luke (ix. 28), speaking in round numbers, or counting the incomplete parts of the first and eighth days, says, "about eight days after these words." The "six" or "eight" days were from the time of the discourse given in the preceding chapter.

**Peter, James and John**, who were our Lord's favorite disciples, and who were later present during His agony in the Garden of Gethsemani (xxvi. 37). The reason for taking *three* was very probably that He might fulfill the requirements for legal proof, according to the Law, "in ore duorum vel trium testium stet omne verbum" (Deut. xix. 15).

**A high mountain**, commonly believed to be Mt. Thabor, near Nazareth in Galilee; modern interpreters think it was one of the peaks of Mt. Hermon, a little to the north of Caesarea Philippi. To some, Hermon seems the scene much more likely of the Transfiguration. Jesus had gone to Caesarea Philippi for the express purpose of fleeing from His enemies in Galilee; hence it seems improbable that in six days we should find Him again in the very midst of Galilee (Le Camus).

2. **He was transfigured before them.** The glory and splendor which shone forth in our Lord's Transfiguration was not so much

3. And behold there appeared to them Moses and Elias talking with him.

4. And Peter answering, said to Jesus: Lord, it is good for us to be here: if thou wilt, let us make here three tabernacles, one for thee, and one for Moses, and one for Elias.

5. And as he was yet speaking, behold a bright cloud overshadowed them. And lo, a voice out of the cloud, saying: This is my beloved Son, in whom I am well pleased: hear ye him.

a miracle, as was the veiling of that glory and splendor throughout the rest of His life on earth. The brightness of the Transfiguration was natural to our Lord's body, and is now perpetual in His glorified state; it was rather a miracle, therefore, that this heavenly brightness should not have appeared at all times. The purpose of the Transfiguration was to give the disciples one more passing proof of His Divinity and to strengthen them for the trials of the Passion before He submitted Himself to the "scandal of the cross." Our Lord foresaw how the faith of the disciples in His Divinity would be tried during the suffering and humiliations of His coming Passion and death, and to them, and through them to us all, He consequently vouchsafed this splendid manifestation of His glory as God.

3. **Moses and Elias**, the former representing the Law, the latter the Prophets. **Talking with Him.** As St. Luke (ix. 31; xxiv. 44-46) informs us, Moses and Elias were conversing with our Lord at this time about His coming Passion and death.

4. **Let us make here three tabernacles**, which would most likely have been tents made from the branches of trees, similar to those accustomed to be used on the Feast of Tabernacles. We have another example of Peter's failure to understand the plan of divine Providence, which was that our Lord should suffer and die for the redemption of mankind.

5. **A bright cloud overshadowed them.** According to the more common opinion this bright cloud enveloped all present; according to others, however, it overshadowed only our Lord, Moses and Elias. The bright cloud was an indication of the presence of the divine Majesty; Almighty God was accustomed to appear to Israel in a cloud. Cf. Exod. xix. 9, 16, 18; xxiv. 16-18; Deut. xxxi. 15; 3 Kings viii. 10-12.

**This is my beloved son**,—literally, "this is my son, the beloved" (*ὁ υἱός, ὁ ἀγαπητός*). The word *ἀγαπητός*, when used in con-

6. And the disciples hearing, fell upon their face, and were very much afraid.

7. And Jesus came and touched them: and said to them, Arise, and fear not.

8. And they lifting up their eyes saw no one but only Jesus.

9. And as they came down from the mountain, Jesus charged them, saying: Tell the vision to no man, till the Son of man be risen from the dead.

10. And his disciples asked him, saying: Why then do the scribes say that Elias must come first?

nection with *ἅλος*, means, everywhere in the New Testament, the *eternal*, the *natural* son of God, as distinguished from those who were sons by adoption. The Eternal Father now utters the same testimony regarding our Lord which shortly before Peter had given; the purpose was to strengthen the faith of the Apostles in the Divinity of the Saviour.

Hear ye him; i.e., obey all that He says, He is the Teacher whom you are to follow and not the Pharisees.

6-8. According to some, it was night when the Transfiguration took place; and the disciples, waking from sleep, and beholding the brightness of our Lord's transfigured body, were terrified and could not bear the blaze of His unveiled beauty; hence they fell upon their faces in adoration and fear.

Saw no one, but only Jesus. This was when our Lord had again robed Himself in His humble, human form as man.

9. Tell the vision to no man. The chief reasons for our Lord's thus charging the disciples have already been given in the commentary on xvi. 20. In addition, it might be said that our Lord spoke thus to the three disciples, on the way down from the mountain, lest the other disciples, on hearing of the Transfiguration, should be moved to feelings of sadness and jealousy.

10. That Elias must come first. This question was put to our Lord by the three disciples, as they descended from the Mount of Transfiguration. Having witnessed the glory of the Transfiguration, they doubtless thought that the reign of the Messiah had already begun; and, according to the prophecy of Malachy (iv. 5, 6) and the teachings of the Scribes, they thought that Elias should precede the Messiah, hence they could not understand how the Messiah had come before Elias. They did not understand that Elias in person was to precede the second coming of Christ in

11. But he answering, said to them : Elias indeed shall come, and restore all things.

12. But I say to you, that Elias is already come, and they knew him not, but have done unto him whatsoever they had a mind. So also the Son of man shall suffer from them.

13. Then the disciples understood, that he had spoken to them of John the Baptist.

14. And when he was come to the multitude, there came to him a man falling down on his knees before him, saying : Lord, have pity on my son, for he is a lunatic, and suffereth much : for he falleth often into the fire, and often into the water.

15. And I brought him to thy disciples, and they could not cure him.

16. Then Jesus answered and said : O unbelieving and perverse generation, how long shall I be with you? How long shall I suffer you? bring him hither to me.

17. And Jesus rebuked him, and the devil went out of him, and the child was cured from that hour.

18. Then came the disciples to Jesus secretly, and said : Why could not we cast him out?

glory, and not His first coming in weakness and humility. It was only the spirit of Elias, in the person of John the Baptist, that was to precede the first coming of the Saviour (verse 12).

11. **Elias indeed shall come.** In these words, our Lord refers to the coming of Elias, in person, before His own second coming previous to the end of the world. At his coming, in person, Elias will fulfill the prophecy of Malachy by gathering together the remnant of the Jews, and the Gentiles scattered throughout the earth, into the Church of Christ.

12. **Elias is already come;** i.e., the spirit and power of Elias, in the person of John the Baptist. See above, verse 10.

14. **And when he was come to the multitude.** This was the next day after the Transfiguration, as we know from St. Luke (ix. 37).

**Lunatic.** It would appear from verse 17, below, that he was also possessed by the devil, which possession, according to St. Mark (ix. 17), showed itself in a kind of "falling" sickness, or "epilepsy." This also is evident from the fact that he often "fell into the fire" and "into the water." See on iv. 24; viii. 16.

16, 17. **Unbelieving and perverse generation.** These words were addressed directly to the multitude in general; indirectly, also to some extent, to the disciples, as is evident from verse 19. Our Lord expressed in the words of this verse His disgust for the un-

19. Jesus said to them: Because of your unbelief. For, amen I say to you, if you have faith as a grain of mustard seed, you shall say to this mountain, Remove from hence hither, and it shall remove; and nothing shall be impossible to you.

20. But this kind is not cast out but by prayer and fasting.

21. And when they abode together in Galilee, Jesus said to them: The Son of man shall be betrayed into the hands of men:

22. And they shall kill him, and the third day he shall rise again. And they were troubled exceedingly.

faithfulness of the Jewish people, and especially of His Apostles, whose long experience and training should have given them a stronger and a better faith. For this reason He seems to long for the day when He shall be gone from them all.

Jesus rebuked him; i.e., the evil spirit.

19. Our Lord now assigns two reasons for the inability of the disciples to cast out the devil: (a) their lack of lively faith; (b) their want of prayer and fasting. The disciples had the habit of faith, or ordinary faith, which believes in a general way that God can work miracles; but not the lively faith of miracles, which believes that He will work a miracle in a particular instance.

A grain of mustard seed, a proverbial expression for something very minute.

This mountain, also a proverbial expression, for something very great; perhaps also there was actual reference to the Mount of the Transfiguration from which He and the disciples had just before descended.

And it shall remove. We have no record of the Apostles having removed mountains; but we do know that they performed even greater miracles, such as the raising of the dead to life.

20. But by prayer and fasting. To perform miracles, our Lord admonishes, there is need of special lively faith; and, in some instances, of prayer and fasting;—of prayer, by which we become united to God, and of fasting, by which we become detached from the world and carnal things.

21, 22. Here our Lord refers a second time to His sorrowful Passion and death, which He predicts.

They abode together in Galilee; i.e., while they were passing through Galilee (*ἀναστρεφόμενων*, i.e., *passing through*). Cf. Mark ix. 29.

23. And when they were come to Capharnaum, they that received the didrachmas, came to Peter and said to him: Doth not your master pay the didrachmas?

24. He said: Yes. And when he was come into the house, Jesus prevented him, saying: What is thy opinion, Simon? The kings of the earth, of whom do they receive tribute or custom? of their own children, or of strangers?

25. And he said: Of strangers. Jesus said to him: Then the children are free.

26. But that we may not scandalize them, go to the sea, and cast in a hook: and that fish which shall first come up, take: and when thou hast opened its mouth, thou shalt find a stater: take that, and give it to them for me and thee.

23. **To Capharnaum**, from the Mount of the Transfiguration.

**The didrachmas.** The "didrachma," or two drachma piece, was a silver coin of Antioch, worth about 31 cents; it was a tax which each Israelite, from twenty to fifty years of age, was obliged to pay annually toward the support of the Temple and public worship (Exod. xxx. 13; 2 Paralip. xxiv. 6).

**Came to Peter**, perhaps because he was head and representative of all the Apostles.

24, 25. **Jesus prevented him**; i.e., began first to speak to him. **The kings of the earth**, etc. Our Lord asks Simon what the custom is of earthly kings in respect to paying their taxes, whether, namely, they required their own children, or only strangers, to pay them taxes. Peter replies that earthly kings receive taxes only from strangers, because the purpose of receiving them is for their own and their children's support. Hence, it would be absurd for them to require taxes from their children. Our Lord replies that the children, then, are free; and the inference is that, since He Himself is the Son of the King of Kings, He likewise should be free.

26. **That we may not scandalize them.** Although really exempt, by His nature, from paying tribute to anybody, our Lord does not wish to appear to disregard law or authority, or to be unconcerned about the service and support of the Temple.

**Go to the sea**; i.e., to the Lake of Genesareth.

**A stater.** The "stater" was equivalent in value to four drachmas, or about 62 cents; it was also equal in value to the Jewish shekel, which was officially tariffed at only 51 cents.

**For me and thee.** There is no reference to the other disciples, because Peter was the representative of all, and perhaps also because he and our Lord were alone at the time.

## CHAPTER XVIII

THE GREATEST IN THE KINGDOM OF HEAVEN, 1-5.

AGAINST SCANDAL, 6-10.

THE LOST SHEEP, 11-14.

FRATERNAL CORRECTION, 15-17.

PROMISES TO THE DISCIPLES, 18-20.

CHRISTIAN FORGIVENESS, 21, 22.

THE PARABLE OF THE INDEBTED SERVANTS, 23-35.

1. At that hour the disciples came to Jesus, saying: "Who thinkest thou is the greater in the kingdom of heaven?"
2. And Jesus calling unto him a little child, set him in the midst of them,
3. And said: Amen I say to you, unless you be converted, and become as little children, you shall not enter into the kingdom of heaven.
4. Whosoever therefore shall humble himself as this little child, he is the greater in the kingdom of heaven.

1. **At that hour**; i.e., while they were at Capharnaum. On the way from the Mount of Transfiguration to Capharnaum, the disciples had got into a dispute as to who should be the greatest in the future kingdom of the Messiah, which was most likely here understood by the Apostles to be the kingdom which our Lord was to establish after His Resurrection. There was still a glowing memory of the Transfiguration, and as their minds and hearts were yet earthly, they expected that our Lord would soon establish some glorious temporal kingdom; and this is why they were disputing among themselves as to who would be first in that kingdom. Some think that the disciples understood by the "kingdom of heaven" the abode of the Blessed; Maldonatus says they understood the Church Militant.

2-4. Our Lord replies to the question of the disciples by a concrete illustration. Referring to the little child before Him, and endeavoring to lift their minds from the thoughts of an earthly kingdom to the Kingdom of the Blessed above, He tells them that, unless they give up their worldly thoughts and contentious pride, and imitate the humility and virtues of children, they shall never enter the abode of the Elect. As humility is necessary for an en-

5. And he that shall receive one such little child in my name, receiveth me.

6. But he that shall scandalize one of these little ones that believe in me, it were better for him that a millstone should be hanged about his neck, and that he should be drowned in the depth of the sea.

7. Woe to the world because of scandals. For it must needs be that scandals come: but nevertheless woe to that man by whom the scandal cometh.

8. And if thy hand, or thy foot scandalize thee, cut it off, and cast it from thee. It is better for thee to go into life maimed or lame, than having two hands or two feet, to be cast into everlasting fire.

9. And if thy eye scandalize thee, pluck it out, and cast it from thee. It is better for thee having one eye to enter into life, than having two eyes to be cast into hell fire.

trance into Heaven, so a greater degree of that virtue is necessary in those who would be "greater" there.

5. Here our Lord says that whoever performs acts of kindness and charity towards one of His humble followers, for His sake, shall receive the same reward as if that charity and kindness were shown to Himself; and in St. Mark (ix. 36) He says that whosoever receives Him, receives His Father also.

6. **Scandalize one of these little ones**, etc.; i.e., whoever shall be the cause of the spiritual ruin of one of Christ's humble followers. Scandal is "any word or deed which may be the cause or occasion of another's spiritual ruin" (St. Thomas).

A mill-stone, — literally, an "ass millstone" (*μύλος ὄνικός*), or a stone so large as to require an ass (*ὄνος*) to turn it. St. Jerome tells us that the form of punishment spoken of in this verse was inflicted for grievous crimes among the Jews and Assyrians.

7. **It must needs be that scandals come.** That there should be scandals in the world is a necessity arising from the perversity and sinfulness of human nature. This necessity, however, is not one that destroys human liberty, for scandal is not necessary in any particular instance. Terrible is the malediction pronounced by our Lord upon the scandal-giver.

8, 9. The words **hand, foot, eye**, etc., are not to be taken too literally. They merely represent something which we consider very useful and very precious, and the lesson here taught is that, no matter how useful or precious things may be, we must give them up and avoid them, if they endanger our spiritual welfare and eternal salvation. Cf. on v. 29, 30.



10. See that you despise not one of these little ones: for I say to you, that their angels in heaven always see the face of my Father who is in heaven.

11. For the Son of man is come to save that which was lost.

12. What think you? If a man have an hundred sheep, and one of them should go astray: doth he not leave the ninety-nine in the mountains, and go to seek that which is gone astray?

13. And if it so be that he finds it: Amen I say to you, he rejoiceth more for that, than for the ninety-nine that went not astray.

14. Even so it is not the will of your Father, who is in heaven, that one of these little ones should perish.

15. But if thy brother shall offend against thee, go, and rebuke him between thee and him alone. If he shall hear thee, thou shalt gain thy brother.

10-14. **Despise not one of these little ones**; i.e., we must not disregard any of Christ's humble followers. It is a mortal sin, not only to give grievous scandal, but also carelessly to disregard the spiritual welfare of our neighbor (*Summa Theol.*, ii<sup>a</sup> ii<sup>ae</sup>, qu. xliiii. a. iv).

**Their angels in heaven**, etc. In these verses our Lord gives three reasons why we should not despise, or carelessly neglect, the spiritual welfare of any of His children: (a) because, so precious are they in His sight, that each one has an angel to guard him; (b) because He Himself has come down from Heaven to save each one; (c) because it is the will of His heavenly Father that none should be lost.

**The ninety-nine sheep** represent the just; "the one," the sinner. This one sinner is not more precious in God's sight than the ninety-nine just, but there is more actual expression of joy over his return to penance, than is felt for the ninety-nine, who need not penance. Our Lord is expressing Himself here in a human way, and only wishes to convey that great joy is felt over every repentant sinner.

15. **Rebuked him**. After telling the disciples to avoid scandal, our Lord next tells them what they should do to correct their erring brother, if need be. There is here a question of fraternal correction, for the administration of which, the following rules must be observed: (a) the fault to be corrected must be a grievous one, and it must be private, i.e., not known to public authority; (b) there must be a well-founded hope that the correction will be fruitful.

16. And if he will not hear thee, take with thee one or two more: that in the mouth of two or three witnesses every word may stand.

17. And if he will not hear them: tell the church. And if he will not hear the church, let him be to thee as the heathen and publican.

18. Amen I say to you, whatsoever you shall bind upon earth, shall be bound also in heaven; and whatsoever you shall loose upon earth, shall be loosed also in heaven.

19. Again I say to you, that if two of you shall consent upon earth, concerning any thing whatsoever they shall ask, it shall be done to them by my Father who is in heaven.

20. For where there are two or three gathered together in my name, there am I in the midst of them.

21. Then came Peter unto him and said: Lord, how often shall my brother offend against me, and I forgive him? till seven times?

22. Jesus saith to him: I say not to thee, till seven times; but till seventy times seven times.

16, 17. In administering fraternal correction, our Lord told His disciples that, first it should be in private, between the offender and the one offended, and if this were not sufficient, they should tell the "church," i.e., the authorities who represent the Church; and finally, if they could not by these processes correct the offending party, they should withdraw from and avoid him, as the Jews were accustomed to avoid the heathen and publicans. These verses, together with verse 18 following, are a proof of the definite organization and authority which Christ gave His Church.

18. *Whatsoever you shall bind, etc.* These words had already been addressed to St. Peter (xvi. 19), by which he was given power over all the Apostles. They are now addressed to all of the Apostolic college; but to Peter alone is given the supremacy.

19. *If two of you shall agree, etc.* These words were spoken to the Apostles, but they apply to all good Christians, as we know from vii. 7-11.

20. *In my name; i.e., in devout prayer.*

21. This question of Peter likely followed upon the discourse regarding fraternal correction. Peter doubtless thought that his charity was going a great way in being willing to forgive his brother seven times, since that was four times more than was required by the Jewish masters, who based the duty of forgiving three times only, upon Amos i. 3; ii. 6; and on Job xxxiii. 29, 30.

22. *Seventy times seven, like "seven times in a day" (Luke xvii. 4), means as often as he may offend.*

23. Therefore is the kingdom of heaven likened to a king, who would take an account of his servants.

24. And when he had begun to take the account, one was brought to him, that owed him ten thousand talents.

25. And as he had not wherewith to pay it, his lord commanded that he should be sold, and his wife and children and all that he had, and payment to be made.

26. But that servant falling down, besought him, saying: Have patience with me, and I will pay thee all.

27. And the lord of that servant being moved with pity, let him go and forgave him the debt.

28. But when that servant was gone out, he found one of his fellow servants that owed him an hundred pence: and laying hold of him, he throttled him, saying: Pay what thou owest.

29. And his fellow servant falling down, besought him, saying: Have patience with me, and I will pay thee all.

30. And he would not: but went and cast him into prison, till he paid the debt.

31. Now his fellow servants seeing what was done, were very much grieved, and they came and told their lord all that was done.

32. Then his lord called him; and said to him: Thou wicked servant, I forgave thee all the debt, because thou besoughtest me:

33. Shouldst not thou then have had compassion also on thy fellow servant, even as I had compassion on thee?

34. And his lord being angry, delivered him to the torturers until he paid all the debt.

35. So also shall my heavenly Father do to you, if you forgive not every one his brother from your hearts.

23-35. The Parable of the Unmerciful Servant, or of the Ten Thousand Talents, contained in these verses is found only in St. Matthew. It is the first of the parables in which God appears as King. Its object is to teach us the enormous difference in gravity between offences committed against God, and those committed against ourselves, and the consequent necessity of forgiving our offending brethren, if we ourselves would be forgiven by God.

Kingdom of heaven, here means the supernatural dealings of God with His rational creatures.

Ten thousand talents, nearly \$20,000,000.00; it is intended to signify a sum impossible to be paid. This shows the impossibility, on the part of any man, to make due reparation to God for one mortal sin.

His wife and children, etc. According to Roman law a man's wife and children were a part of his property; and according to both Roman and Jewish custom, it was allowed to sell an insolvent

debtor's wife and children in discharge of his debts. Cf. Levit. xxv. 39 and 41; 4 Kings iv. 1. This custom is referred to in the parable to illustrate the strictness of God's dealings with those who are unforgiving. The inability of the servant to pay his debt illustrates the utter bankruptcy of every child of Adam as he stands in the presence of his God, and is tried by the strictness of the divine law. The dreadful command that he shall be sold and all that he has, is the expression of God's right and power altogether to alienate from Himself, reject, and deliver over into bondage all those who have thus come short of His glory; and that these, unless they repent and be forgiven, shall be punished by everlasting destruction from the presence of the Lord and the glory of His power (Trench).

Forgave him the debt, which shows that God is willing and ready at all times to forgive the repentant sinner, however great may have been his offences.

Fellow-servants. This term does not imply equality of rank, but only that they both stood in the relation of servants to a common master.

An hundred pence, about \$16 or \$17 in our money.

Torturers. These tormentors in that other world of woe, whereof this prison is a figure, are fellow-sinners and evil angels — instruments of the just yet terrible judgments of God.

Until he paid all the debt (verse 34), does not mean that the servant's former sin (debt) returned; sins, once forgiven, never return; the unmerciful servant is therefore punished, not for his old debt, but for his new sin of heartlessness toward his fellow-servant. St. Aug., Cajetan, and others have explained the difficulty concerning the reviviscence of remitted sin as follows: "Repetuntur debita semel donata, non ut fuerant prius debita, sed ut modo effecta sunt materia ingratiitudinis" (St. Aug.). The punishment of the unmerciful servant is to continue without end. So it shall be with us, if we do not *from our hearts* forgive those who offend us and do us harm.

## CHAPTER XIX

JESUS ON HIS WAY UP TO JERUSALEM, 1, 2.

DIVORCE, 3-12.

JESUS AND THE LITTLE CHILDREN, 13-15.

THE RICH YOUNG MAN, 16-26.

THE REWARD OF FOLLOWING JESUS, 27-30.

1. And it came to pass when Jesus had ended these words, he departed from Galilee, and came into the coasts of Judea, beyond Jordan.

2. And great multitudes followed him: and he healed them there.

3. And there came to him the Pharisees tempting him, and saying: Is it lawful for a man to put away his wife for every cause?

1. **He departed from Galilee.** This departure of our Lord from Galilee is recorded by Mark (x. 1) and Luke (xvii. 11). Our Saviour was leaving Galilee for the last time and was going up to Jerusalem to suffer and die, in accordance with the promise He had made (xvi. 21). Between this final departure and the events recorded in the preceding chapter five or six months had elapsed. Our authorities for the occurrences during those months are Luke (ix. 51-xvii. 10) and John (vii. 2-xi. 56). The sequence of events between the Transfiguration and the last journey of Jesus to Jerusalem is one of the most difficult questions in the Gospels. See Fouard, *The Christ the Son of God*, vol. ii, Appendix ix.

**Came into the coasts of Judea beyond the Jordan**, i.e., into the confines of Judea and Peraea. "And" should be understood here before "beyond the Jordan." See on Mark x. 1. Jesus came from Capharnaum to Judea by way of Peraea, the country east of the Jordan. His purpose in taking this route was probably to escape the notice of His enemies.

2. **Followed him**; i.e., into Peraea.

3. **To put away his wife for every cause.** The two rival schools of Hillel and Shammai differently interpreted the words of Deut. (xxiv. 1), on the subject of putting away one's wife. The former school held that any cause whatsoever was sufficient for separation, while the latter maintained that only some "uncleanness," such as

4. Who answering, said to them: Have ye not read, that he who made man from the beginning, Made them male and female? And he said:

5. For this cause shall a man leave father and mother, and shall cleave to his wife, and they two shall be in one flesh.

6. Therefore now they are not two, but one flesh. What therefore God hath joined together, let no man put asunder.

7. They say to him: Why then did Moses command to give a bill of divorce, and to put away?

8. He saith to them: Because Moses by reason of the hardness of your heart permitted you to put away your wives: but from the beginning it was not so.

adultery, would be a sufficient reason. See on v. 31, 32. The Pharisees now asked our Lord which of these schools He favored. They thought by getting Him to take one side, to excite the other against Him.

4, 5. *Have you not read*, etc. Replying to the Pharisees, our Lord calls attention to the original institution of marriage, according to which man and wife are to be considered as one flesh, and therefore, by nature, inseparable. Thus He decides against both Hillel and Shammai, and shows that Moses' permission was a political condescension rather than the true expression of the moral law. Moreover, not only is it against nature to separate man and wife, but it is against the positive law of God, as is clear from this verse.

7. If marriage is by nature and the law of God indissoluble, how is it, asked the Pharisees, that "Moses commanded a bill of divorce to be given?"

8. Our Lord replies that Moses did not *command*, but only *permitted* them to put away their wives; and, if they did put them away, he commanded them to give a bill of divorce, so that the man putting the wife away could never reclaim her, and she might marry another man. "Giving a bill of divorce" was, therefore, *commanded*; but "putting away" was only *permitted*. And the reason for this permission of Moses was because he feared that the perversity of the Jews would lead them to put away their wives, in any event, or would cause them to maltreat and even kill them. Hence, this permission was granted because of the hardness of their hearts; but our Saviour now recalls marriage to its original sanctity and perfection.

In this passage, as in others, our Lord both recognizes and pro-

9. And I say to you, that whosoever shall put away his wife, except it be for fornication, and shall marry another, committeth adultery: and he that shall marry her that is put away, committeth adultery.

10. His disciples say unto him: If the case of a man with his wife be so, it is not expedient to marry.

claims the doctrinal authority of the books of Moses. He invokes, as undeniable authority, Genesis, in particular, and the very passages which are the most suspected by modern critics. Taking a portion of His testimony from the first chapter of this book, and a portion from the second, He implies that both are not only authentic, but mutually complementary. (Le Camus, *Life of Christ*, vol. ii. p. 490.)

9. According to the Council of Trent (Sess. xxiv. can. 7), and the constant teaching of the Church, the matrimony of Christians, once consummated, cannot be dissolved *quoad vinculum*, except by the death of one of the parties. This same teaching is explicitly found in St. Mark (x. 11, 12), in St. Luke (xvi. 18), and in St. Paul (1 Cor. vii. 11 and 39; Rom. vii. 3). After reminding the Pharisees of the original perfection of the marriage tie, our Lord now tells them that, on account of adultery, it is permitted to put away one's wife; but that re-marriage is never to be allowed. Hence, he who puts away his wife cannot marry again without committing adultery, nor can anyone marry her that is put away without committing adultery. With a slightly different reading, this same teaching is found also in v. 32. The *Codex Vaticanus* favors the reading of v. 32.

The wording of this present verse, as well as of verse 32 in chapter v of St. Matthew, is somewhat embarrassing, but in view of the parallel passages in St. Mark and in St. Luke, and the teaching of St. Paul on this point, there can be no doubt that St. Matthew should be understood as if worded as follows: "Whosoever, even though it be for fornication, shall put away his wife and shall marry another, committeth adultery." "The best MSS. have *μη̄ ἐπι πορνεία*; and why, instead of understanding *εἰ μη̄*, should we not say: *μη̄ καὶ ἐπι πορνεία*?" (Le Camus, *op. cit.* p. 494.)

10. If marriage entails such inevitable burdens, without any way of escape, the disciples concluded that it was better not to marry.

11. Who said to them: All men take not this word, but they to whom it is given.

12. For there are eunuchs, who were born so from their mother's womb: and there are eunuchs, who were made so by men: and there are eunuchs, who have made themselves eunuchs for the kingdom of heaven. He that can take, let him take it.

13. Then were little children presented to him, that he should impose hands upon them and pray. And the disciples rebuked them.

14. But Jesus said to them: Suffer the little children, and forbid them not to come to me: for the kingdom of heaven is for such.

15. And when he had imposed hands upon them, he departed from thence.

16. And behold one came and said to him: Good master, what good shall I do that I may have life everlasting?

17. Who said to him: Why askedst thou me concerning good? One is good, God. But if thou wilt enter into life, keep the commandments.

18. He said to him: Which? And Jesus said: Thou shalt do no murder, Thou shalt not commit adultery, Thou shalt not steal, Thou shalt not bear false witness.

19. Honour thy father and thy mother: and, Thou shalt love thy neighbour as thyself.

20. The young man saith to him: All these have I kept from my youth, what is yet wanting to me?

11. All men take not this word; i.e., all do not find it attractive or inviting to embrace a life of continency. Cf. 1 Cor. vii. 7.

He that can take, etc.; i.e., if one is willing to forego marriage and practice voluntary continence, which is the gift of a special grace, let him do it. But only he can do this who has been especially called by God to such perfection and who is the constant object of God's special grace.

13. Little children presented, etc. The Jews were accustomed to present their children to men of great holiness for their blessing.

14. The kingdom of heaven is of such; i.e., they who would belong to God in this life and enter the kingdom of the Blessed hereafter, must cultivate the humility, candor, innocence, etc., of children, and must accept, like little children, all the teachings of Christ's Church (xviii. 3).

16. One came and said to him, etc. This man was very rich (verse 22), and is called by St. Luke (xviii. 18), *ἀρχων*, a ruler.

17. One is good, God. Only God is absolutely and essentially good; all others are good in a limited way and by participation. Our Lord is here gently and indirectly calling attention to His own Divinity, that He is good, that He is God and superior to any creature.

18, 19. Our Lord mentioned only those commandments which



21. Jesus saith to him: If thou wilt be perfect, go sell what thou hast, and give to the poor, and thou shalt have treasure in heaven: and come follow me.

22. And when the young man had heard this word, he went away sad: for he had great possessions.

23. Then Jesus said to his disciples: Amen, I say to you, that a rich man shall hardly enter into the kingdom of heaven.

24. And again I say to you: It is easier for a camel to pass through the eye of a needle, than for a rich man to enter into the kingdom of heaven.

25. And when they had heard this, the disciples wondered very much, saying: Who then can be saved?

26. And Jesus beholding, said to them: With men this is impossible: but with God all things are possible.

relate to our neighbor,—the precepts of the Second Table, the proper observance of which, however, involves and presupposes those relating to God. The ninth and tenth, as being included in the sixth and seventh, are not mentioned explicitly. The Saviour was content with calling attention to the laws of the Second Table only, because these were more directly opposed to the selfish nature of the Jews, and were, consequently, most neglected by them.

21. **If thou wilt be perfect, etc.** The essence of the Law, which is necessary for salvation, consists in the observance of the commandments; but, for the highest perfection of the Christian life, the observance of the Evangelical counsels must be added. These latter are not necessary for salvation, and hence are only counselled, not commanded, by our Saviour.

22. **He went away sad.** No one knows whether he ever returned to the Master.

23. **A rich man shall hardly, etc.;** i.e., riches are usually a grave obstacle to salvation, as it seems they proved in the case of the rich young man.

24. **It is easier for a camel, etc.** This was a proverbial expression among the Jews to express something very difficult, or even *impossible naturally*. The wording generally used was, "an elephant before a needle's eye." Our Lord substitutes "camel" for "elephant" most likely because the camel was more common among the Jews.

25, 26. **Riches** are commonly a real hindrance to the service of God and the salvation of one's soul, but God can do all things possible. He can even put a camel through the eye of a needle, by removing from the "quantity" of the camel's body, the property

27. Then Peter answering, said to him: Behold we have left all things, and have followed thee: what therefore shall we have?

28. And Jesus said to them: Amen, I say to you, that you, who have followed me, in the regeneration, when the Son of man shall sit on the seat of his majesty, you also shall sit on twelve seats judging the twelve tribes of Israel.

29. And every one that hath left house, or brethren, or sisters, or father, or mother, or wife, or children, or lands for my name's sake, shall receive an hundredfold, and shall possess life everlasting.

or accident of extension. And hence His grace can likewise lift man above perishable riches to seek those that are imperishable.

27. **We have left all things.** Having heard the counsel given to the young man concerning voluntary poverty, Peter now asks what he himself and his companions, who have obeyed this counsel, are to expect. It is true they had not much to leave, but God looks rather to the generosity of the heart which surrenders, than to that which is surrendered.

28. **In the regeneration, etc.** This regeneration began with the inauguration of the Messianic reign — with the preaching of the Gospel, but is to be consummated in eternity at the General Judgment. Already the Apostles' reward had begun, for from the beginning of the Church they were constituted its judges and teachers, empowered with the authority to promulgate the doctrines of Christ, to regulate discipline, condemn error, etc. Thus even in this world they sat "on thrones," namely, on seats of authority, governing and regulating the entire Church, signified by the "twelve tribes of Israel." But this is not all; hereafter, at the General Judgment, when every one shall be judged according to the principles of faith which the Apostles preached, they will also be present to exercise in the judgment some special distinction of authority which Christ Himself will give them.

29. **And everyone that hath left house, etc.** This promise is extended to all who voluntarily renounce what this world holds in store for them, in order to serve Christ more perfectly and obey His Gospel more exactly. From Mark (x. 30) it would seem that this promise is to be fulfilled literally in this world; it is a *rule*, however, and thus admits of exceptions.

Shall possess life everlasting; i.e., those who have superadded the counsels to the observance of the commandments, shall receive,

30. And many that are first, shall be last: and the last shall be first.

*ceteris paribus*, greater rewards hereafter than those who have kept the commandments only.

30. **Many that are first shall be last**, etc. Many who are now considered great in the eyes of the world, with many possessions, much influence, honor, and the like, shall be the least in the Kingdom of God, if not entirely excluded; and, contrariwise, many who are now insignificant and lowly, shall be saved, and shall perhaps be highest in Heaven. This verse is also a warning to the Apostles, and to all who possess spiritual gifts, that, in order to be "first" hereafter, they must persevere in their good purposes and coöperate with the high graces they have received.

## CHAPTER XX

THE PARABLE OF THE LABORERS IN THE VINEYARD,  
1-16.

THE THIRD PREDICTION OF THE PASSION, 17-19.

THE PETITION OF THE SONS OF ZEBEDEE, 20-28.

THE BLIND MEN OF JERICHO, 29-34.

1. The kingdom of heaven is like to an householder, who went out early in the morning to hire labourers into his vineyard.

1. The Parable of the Laborers in the Vineyard, which extends from the first to the sixteenth verse of the present chapter, is found only in St. Matthew. This parable cannot be rightly understood out of connection with the last four verses of the preceding chapter, as it was called forth by the question of Peter, "what therefore shall we have?" (xix. 27). The scope and aim of the parable is primarily and directly to warn the Apostles, and, through them, the rest of the Jews that, although they were the first called and favored by Almighty God, they are nevertheless to enjoy no preference over the Gentiles in Christ's Kingdom, either here or hereafter. Secondly and indirectly, the parable is directed against every state of mind, which would make those in possession of spiritual privileges feel any right or title to special place or consideration in the Kingdom of God. The message, therefore, of the parable is a warning to Peter and the other Apostles, and through

2. And having agreed with the labourers for a penny a day, he sent them into his vineyard.

3. And going out about the third hour, he saw others standing in the market place idle.

4. And he said to them: Go you also into my vineyard, and I will give you what shall be just.

5. And they went their way. And again he went out about the sixth and the ninth hour, and did in like manner.

6. But about the eleventh hour he went out and found others standing, and he saith to them: Why stand you here all the day idle?

7. They say to him: Because no man hath hired us. He saith to them: Go you also into my vineyard.

8. And when evening was come, the lord of the vineyard saith to his steward: Call the labourers and pay them their hire, beginning from the last even to the first.

them, to the Jews and all true believers against a wrong spirit, which would lead them to look upon their spiritual blessings and favors as a result of their own merits, and not of the gratuitous grace of God; and which, consequently, would make them feel themselves worthy of some special reward or privilege in God's Church, either militant or triumphant. Our Lord would thus teach His Apostles, and all of us who are called to the service of God, that, however long and abundant our labors, they are nothing before God without humility and charity; and that, if we lose sight of these virtues, we shall in the end come short of the reward to which our labors were intended to lead.

Kingdom of heaven means here simply the manner of God's dealing with those whom He calls to labor in His service. The householder is Almighty God; the laborers, those called to the service of God; the vineyard, the Church.

2. A penny; i.e., a *denarius*, worth about 17 cents. It was the pay for a day's labor, a day's wages. In the parable, according to some, it represents salvation or life eternal; but this seems very improbable for the following reasons: (a) it was the same for all, and those who received it were jealous and bitter toward their companions whose labor was shorter; whereas in eternal life there can be no rancor or jealousy, and the degrees of glory are many; (b) in the parable the gratuitousness of the penny for the last laborers is emphasized; whereas eternal life is the reward of merit; (c) if the penny signified eternal life there would be as many chosen as called, contrary to the Master's words.

9. When therefore they were come, that came about the eleventh hour, they received every man a penny.

10. But when the first also came, they thought that they should receive more: and they also received every man a penny.

11. And receiving it they murmured against the master of the house,

12. Saying: These last have worked but one hour, and thou hast made them equal to us, that have borne the burden of the day and the heats.

13. But he answering said to one of them: Friend, I do thee no wrong: didst thou not agree with me for a penny?

14. Take what is thine, and go thy way: I will also give to this last even as to thee.

15. Or, is it not lawful for me to do what I will? is thy eye evil, because I am good?

More probably, then, the penny represents the gift of faith, the call to labor for God, the gratuitousness of which is emphasized in the parable in respect to the latest called.

A day means, according to some expositors, the period extending from the primeval revelation given to Adam down to the Apostles. Thus the different hours of the day would signify the various epochs at which God sent a special call to men to come and labor in His service. The *first* hour, e.g., refers to the primitive revelation given to Adam; the *third* hour, to the interval between Noah and Abraham; the *sixth* hour, to the time between Abraham and Moses; the *ninth* hour, to the period between Moses and Christ; and the *eleventh* hour, to the Christian dispensation.

Other commentators by "day" understand the years of a man's life on earth; and these see in the different hours of the day the various stages of life at which men are called to labor in God's service. Hence "evening" (verse 8), in this opinion, means at the close of one's life; while in the former opinion it refers to the end of the world.

9. **They received every man a penny.** This shows that the penny was given not so much on account of the labor done, as on account of the goodness of the lord of the vineyard (verse 15); it shows the gratuitousness of the pay, which we take to represent the gift of faith. God is free to distribute His graces as He will, and labors in His service are profitable for eternal life only in so far as animated by grace. Hence it can happen that some may labor much longer and much harder than others, and yet be rejected, while those others are received, that the first may be last, and the last first.

11. **They murmured.** The discontent of the murmurers (unless

16. So shall the last be first, and the first last. For many are called, but few chosen.

17. And Jesus going up to Jerusalem, took the twelve disciples apart, and said to them :

we disregard this notable feature of the parable) seems clearly to show that the "penny" does not represent salvation. These malcontents mistook the gift of their master's goodness as something due to their labors. The gift of faith is not the reward of merit; but faith, which is accompanied by good works, can merit eternal life. Not all who are called, who receive the gift of faith, make use of their gift unto life everlasting.

16. **So shall the last be first and the first last.** To some scholars these words signify the utter rejection of the Jews and the calling of the Gentiles. Thus the "first" who become "last" are they who are entirely excluded from the Kingdom of Heaven. The same words in Luke xiii. 30 are in favor of this interpretation. Moreover, this interpretation is more in harmony with the context (xix. 30) and with the words which follow in this verse, "for many are called, but few are chosen." Others, however, believe that "first" and "last" refer to the saved, some of whom, by greater zeal and fervor in laboring for God, attain precedence in Heaven over those who have labored longer, but with less fervor. To us who have the gift of faith the words of this verse contain a warning of what may occur in our regard, if we are neglectful of grace, rather than a prophecy of what is to be.

**For many are called, but few are chosen.** These words, which are also found in xxii. 14, are omitted here, according to the best MSS. A very probable meaning is that many are called to the service of God, which, if rightly discharged, merits eternal life, but few are the objects of God's special love and graces, by which special sanctity here, and special reward hereafter, are obtained. There are some, however, who see in the "called" those who are lost, and in the "chosen" those only who are saved.

17. Having spoken the last parable in Peraea, our Lord crosses the Jordan for the last time, on His way to Jerusalem, where He is to suffer and die.

Took the twelve disciples apart, that they who were to be

18. Behold we go up to Jerusalem, and the Son of man shall be betrayed to the chief priests and the scribes, and they shall condemn him to death.

19. And shall deliver him to the Gentiles to be mocked, and scourged, and crucified, and the third day he shall rise again.

20. Then came to him the mother of the sons of Zebedee with her sons, adoring and asking something of him.

21. Who said to her: What wilt thou? She saith to him: Say that these my two sons may sit, the one on thy right hand, and the other on thy left, in thy kingdom.

22. And Jesus answering, said: You know not what you ask. Can you drink the chalice that I shall drink? They say to him: We can.

23. He saith to them: My chalice indeed you shall drink; but to sit on my right or left hand, is not mine to give to you, but to them for whom it is prepared by my Father.

24. And the ten hearing it, were moved with indignation against the two brethren.

witnesses of His Resurrection should, beforehand, bear witness to His free submission to His Passion and death.

18. Our Lord here predicts His Passion for the third time, the details of which are now more minutely described.

19. **To the Gentiles;** i.e., to Pilate and the other Roman officers and soldiers. St. Luke (xviii. 34) says that the disciples "understood none of these things." They understood Him to speak of His death, but they could not understand the purpose, reason, and details of the sufferings which He predicted.

20. **The mother of the sons of Zebedee;** i.e., Salome, mother of John and James the Greater. **Asking something.** Her petition was likely prompted by the mention of the twelve thrones (xix. 28).

21. **In thy kingdom.** Salome, like the rest of the Jews, was looking forward to a great temporal kingdom which she thought our Lord was about to establish; and it was most probably some worldly dignities which she wished her sons to enjoy in this kingdom.

**The chalice,** in Scripture, often means one's lot in life (Ps. x. 7; xv. 5; xxii. 5, etc.). Here it means our Lord's sufferings and death.

**We can.** So great was the ambition of James and John for prominence in our Lord's kingdom, that they really felt they could follow Him in His Passion, not realizing, indeed, the full import of their words.

23. **My chalice you shall drink.** James was martyred by Herod; John was cast into boiling oil under Domitian, from which, having

25. But Jesus called them to him, and said: You know that the princes of the Gentiles lord it over them; and they that are the greater, exercise power upon them.

26. It shall not be so among you: but whosoever will be the greater among you, let him be your minister:

27. And he that will be first among you, shall be your servant.

28. Even as the Son of man is not come to be ministered unto, but to minister, and to give his life a redemption for many.

29. And when they went out from Jericho, a great multitude followed him.

30. And behold two blind men sitting by the way side, heard that Jesus passed by, and they cried out, saying: O Lord, thou son of David, have mercy on us.

31. And the multitude rebuked them that they should hold their peace. But they cried out the more, saying: O Lord, thou son of David, have mercy on us.

32. And Jesus stood, and called them, and said: What will ye that I do to you?

33. They say to him: Lord, that our eyes be opened.

34. And Jesus having compassion on them, touched their eyes. And immediately they saw, and followed him.

been miraculously delivered, he was banished to the Island of Patmos.

**Is not mine to give to you.** The "you" is not in the Greek. Our Lord means that it is not His, as man, to grant such favors, since all has been prepared, i.e., predestined, by His Father.

25-28. In these verses, our Lord calls attention to the way pagan rulers and potentates tyrannize over their subjects, and He implies that the unregulated ambition and indignation, just displayed by the Apostles, makes them similar in their actions to those pagans, whereas their conduct should be the very opposite. He is again inculcating lessons of charity and humility, and He points to Himself as the model which they are to imitate.

29. **Jericho** is about 15 miles northeast of Jerusalem, and is on the road from Perea to Jerusalem. It lies deep down in the Jordan valley, nearly 1200 feet below sea-level. From Jericho to Jerusalem it was a journey of about six hours up a steep ascent, the latter city being about 2500 feet above sea-level.

30. **Two blind men.** This same miracle is recorded by Mark (x. 46), where, however, only one blind man, Bartimeus, is spoken of. This difficulty is generally explained by saying that Mark mentions only one of the two, because himself or his blindness was the more widely known. In Luke (xviii. 35) we have mention



of a similar miracle, the only difference being that Luke speaks of it as having taken place when they approached Jericho rather than when they were leaving the city. One explanation of this difficulty is that the word "approach" means when they were "near" or in the "vicinity of" the city. Others think that St. Luke is speaking of a different miracle performed at another time; still others, that the blind man cried out for his cure as Jesus entered the city, but was not cured until the Saviour was leaving it (Luke xviii. 40-43).

## CHAPTER XXI

PALM SUNDAY — JESUS ENTERS JERUSALEM, 1-11.

THE TRAFFICKERS IN THE TEMPLE, 12-17.

THE CURSED FIG-TREE, 18-22.

BY WHAT AUTHORITY, 23-27.

THE PARABLE OF THE TWO SONS, 28-32.

THE PARABLE OF THE WICKED HUSBANDMEN, 33-46.

1. And when they drew nigh to Jerusalem, and were come to Bethphage, unto mount Olivet, then Jesus sent two disciples,
2. Saying to them: Go ye into the village that is over against you, and immediately you shall find an ass tied, and a colt with her: loose them and bring them to me.
3. And if any man shall say anything to you, say ye, that the Lord hath need of them: and forthwith he will let them go.
4. Now all this was done that it might be fulfilled which was spoken by the prophet, saying:
5. Tell ye the daughter of Sion: Behold thy king cometh to thee, meek, and sitting upon an ass, and a colt the foal of her that is used to the yoke.
6. And the disciples going, did as Jesus commanded them.

1. **Were come to Bethphage.** Bethany and Bethphage are close to each other on the east side of the Mount of Olives, and about two miles east of Jerusalem. The Saturday before Palm Sunday, our Lord stayed at Bethany, where He was entertained by Martha and Mary; the next morning He passed on to Jerusalem. **Mount Olivet**, which is the same as Mount of Olives. See on Luke xix. 29.

2. **The village** was probably Bethphage, through which they passed after leaving Bethany.

4, 5. In the Orient, the ass was the animal used to carry kings,

7. And they brought the ass and the colt, and laid their garments upon them, and made him sit thereon.

8. And a very great multitude spread their garments in the way: and others cut boughs from the trees, and strewed them in the way:

9. And the multitudes that went before and that followed, cried, saying: Hosanna to the son of David: Blessed is he that cometh in the name of the Lord: Hosanna in the highest.

10. And when he was come into Jerusalem, the whole city was moved, saying: Who is this?

11. And the people said: This is Jesus the prophet, from Nazareth of Galilee.

12. And Jesus went into the temple of God, and cast out all them that sold and bought in the temple, and overthrew the tables of the money changers, and the chairs of them that sold doves:

prophets, etc., and our Lord was now to fulfill the prophecy uttered concerning the Messiah by Isaias (lxii. 11) and Zacharias (ix. 9), so that the Jews might recognize Him as the Messiah. The other three Evangelists tell us that the colt, "on which no man had sat," was ridden, while the mother of the colt walked or trotted alongside.

7. To spread garments, palms, and the like, before one, was to pay him special honor, as a king or leader. Cf. 4 Kings ix. 13; 2 Mach. x. 7; 1 Mach. xiii. 51. The text of St. Matthew here offers a difficulty; from the words, *ἐπεκάθισεν ἐπάνω αὐτῶν*, it would appear that our Lord rode on both animals, which is improbable. To explain this some have said that *αὐτῶν* refers to *ἵματιων*; others see here an error on the part of a copyist or translator.

9. **Hosanna**, or **Hosianna**, means, "save, we beseech." It is an expression of joy and gratitude; hence, **Hosanna to the Son of David** were grateful and joyous words, addressed to Almighty God, beseeching Him to save and spare His royal Son, the Messiah, whose coming had been so long expected. **Hosanna in the highest** means "from the highest heavens, save and protect this royal heir."

11. **The people said**; i.e., those who had gone out to meet Him.

12. **Jesus went into the temple**; i.e., into that part of it called the Court of the Gentiles, to which Gentiles and legally defiled Jews were admitted. The Temple, as rebuilt by Herod the Great, was surrounded by three Courts: (a) the outer, or that of the Gentiles; (b) the inner, or that of the Israelites; (c) the Court

Fossa

Castle of Baris

BLOCK PLAN

OF

HEROD'S TEMPLE

Based on Actual Survey of the Site

Scale of Feet



Scale of Cubits

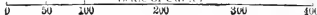

ANTONIA

Agrinna's Wall

Gate Tadi

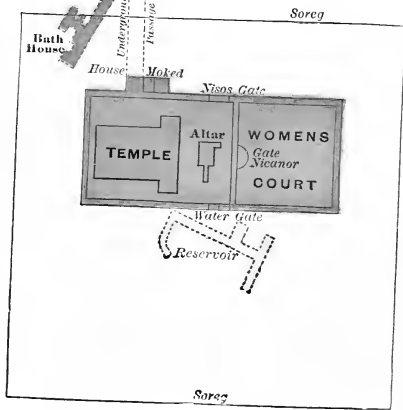

Parbar Gate

Bridge

Parbar Gate

Bridge

ROYAL CLOISTER

Huldah Gate

Huldah Gate

20. And the disciples seeing it wondered, saying: How is it presently withered away?

21. And Jesus answering, said to them: Amen, I say to you, if you shall have faith, and stagger not, not only this of the fig tree shall you do, but also if you shall say to this mountain, Take up and cast thyself into the sea, it shall be done.

22. And all things whatsoever you shall ask in prayer, believing, you shall receive.

23. And when he was come into the temple, there came to him, as he was teaching, the chief priests and ancients of the people, saying: By what authority dost thou these things? and who hath given thee this authority?

24. Jesus answering, said to them: I also will ask you one word, which if you shall tell me, I will also tell you by what authority I do these things.

25. The baptism of John, whence was it? from heaven or from men? But they thought within themselves, saying:

26. If we shall say, from heaven, he will say to us: Why then did you not believe him? But if we shall say, from men, we are afraid of the multitude: for all held John as a prophet.

pronounced on the Jewish Synagogue for its sterility. See on Mark xi. 13.

And immediately the tree withered away; i.e., death within the tree took place at once, although it was not evident externally until the next morning, as St. Mark (xi. 20) observes.

20. The disciples seeing it, wondered. This was the next morning, Tuesday (Mark xi. 20).

21. See above, xvii. 19.

22. See above, vii. 7-11.

23. The chief priests and ancients, — an official body sent by the Sanhedrim. This was on Tuesday of Holy Week.

By what authority. The priests had a right to ask this question from anyone who presumed to teach in the Temple without their permission or that of higher authority; but, in the present instance, they were at fault, because our Lord, by His numerous miracles, had amply proved His supreme authority over all things. They wanted, however, to discredit Him before the people and so, if He answered, "of God," they would accuse Him of blasphemy; if He said, "of men," they would reply that only they themselves could give him such authority, which they had not done.

25. The baptism of John, — embracing also his teaching, by what authority was it?

26. Why then did you not believe him? i.e., announcing Me to be the Messiah?

27. And answering Jesus, they said: We know not. He also said to them: Neither do I tell you by what authority I do these things.

28. But what think you? A certain man had two sons; and coming to the first, he said: Son, go work to-day in my vineyard.

29. And he answering, said: I will not. But afterwards, being moved with repentance, he went.

30. And coming to the other, he said in like manner. And he answering, said: I go, Sir; and he went not.

31. Which of the two did the father's will? They say to him: The first. Jesus saith to them: Amen I say to you, that the publicans and the harlots shall go into the kingdom of God before you.

32. For John came to you in the way of justice, and you did not believe him. But the publicans and the harlots believed him: but you, seeing it, did not even afterwards repent, that you might believe him.

33. Hear ye another parable. There was a man an householder, who planted a vineyard, and made a hedge round about it, and dug in it a press, and built a tower, and let it out to husbandmen; and went into a strange country.

27. **Neither do I tell you**, etc. Our Lord did not deign to answer them, since they had lied, and so might take His reply as an approval of their lie.

28. **A certain man** means, in the parable, Almighty God.

**Two sons**, the first of whom was a type of the publicans and harlots and all public sinners among the Jews, who at first were unfaithful to God, but later repented and obeyed His Law. The second son represents the Scribes and Pharisees, the priests and ancients of the people, who proposed to serve God, but did not—who drew near to Him with their lips, but whose heart was far from Him (xv. 8).

31. **They say to him, the first**. Therefore out of their own mouths they were condemned.

**Shall go before you**; etc., which meant that the publicans and harlots would repent and be saved, while the Scribes and Pharisees should be irrevocably lost (verse 32).

32. **You did not believe him**; i.e., they did not do penance, neither did they recognize our Lord as the Messiah.

33. **Another parable**. This Parable of the Wicked Husbandmen (verses 33-45) is found also in Mark (xii. 1-12), and in Luke (xx. 9-19). The **householder** means Almighty God; the **vineyard** "is the house of Israel" (Isa. v. 7); the **hedge about it**, which was to protect it against its enemies, the Gentiles, refers

34. And when the time of the fruits drew nigh, he sent his servants to the husbandmen that they might receive the fruits thereof.

35. And the husbandmen laying hands on his servants, beat one, and killed another, and stoned another.

36. Again he sent other servants more than the former; and they did to them in like manner.

37. And last of all he sent to them his son, saying: They will reverence my son.

38. But the husbandmen seeing the son, said among themselves: This is the heir: come, let us kill him, and we shall have his inheritance.

39. And taking him, they cast him forth out of the vineyard, and killed him.

to the Law of Moses and the special protection given to Israel by Almighty God; a **press**, in which the grapes were squeezed for wine, represents the altar of holocausts from which flowed the blood of the victims; by the **tower**, which served as a place from which to watch their enemies, is meant the Temple of Jerusalem; the **husbandmen** are the faithless rulers and teachers of God's people in every age.

**Went into a strange country**, means that the householder did not visibly interfere, but left His servants, the prophets, in charge of His interests.

34. **His servants**; i.e., the prophets, such as Isaias, Jeremias, Ezechiel, etc.

35, 36. The Jews beat Jeremias, killed Isaias, stoned and put to death Zacharias.

37. **His son**; i.e., our Lord, whom they should have recognized, from His doctrine and numerous miracles, as the dear Son of God the Father.

38. **His inheritance**. Rather than recognize our Saviour as God, and lose thereby their positions and unlawful hold on the people, the doctors of the Law, the Scribes and Pharisees, preferred to reject and put Him to death (verse 39).

It is to be observed that the different Synoptists do not agree in this parable as to the number of sendings and messengers. According to St. Matthew (verse 33 ff.) the King sent several servants on two occasions; according to St. Mark (xii. 2 ff.) he sent one on two occasions, and several at another time; and according to St. Luke (xx. 10 ff.) he sent only one on three occasions. While all three accounts are equally inspired, it must be that two of the Evangelists, at least, do not reproduce the exact words of the

40. When therefore the lord of the vineyard shall come, what will he do to those husbandmen?

41. They say to him: He will bring those evil men to an evil end; and will let out his vineyard to other husbandmen, that shall render him the fruit in due season.

42. Jesus saith to them: Have you never read in the Scriptures: The stone which the builders rejected, the same is become the head of the corner? By the Lord this has been done; and it is wonderful in our eyes.

43. Therefore I say to you, that the kingdom of God shall be taken from you, and shall be given to a nation yielding the fruits thereof.

44. And whosoever shall fall on this stone, shall be broken: but on whomsoever it shall fall, it shall grind him to powder.

45. And when the chief priests and Pharisees had heard his parables, they knew that he spoke of them.

46. And seeking to lay hands on him, they feared the multitudes: because they held him as a prophet.

Saviour. This same discrepancy in minor details occurs in many other passages of the Gospels, and with these minor differences the theories of inspiration must not forget to reckon.

40, 41. These verses predict the destruction which was to come upon Jerusalem, and the eternal damnation of the Scribes and Pharisees.

And will let out his vineyard to other husbandmen, which meant that the Apostles should take the place of the Law, and the Gentiles that of the Jews, in rendering to God the honor and service due to Him.

42. In the Scriptures; i.e., in Ps. cxvii. 22.

The stone; i.e., our Lord, as we know from St. Peter (1 Ep. ii. 4-7). It is wonderful in our eyes; i.e., the power and wisdom of God's Providence are wonderful in the eyes of men.

43. This is a clear application of the parable, and our Lord says plainly that the Kingdom of God, which means His Church and all the blessings that go with it, shall be taken away from the Jews, and shall be given to others; namely, the Gentiles, who shall yield fruits worthy of God.

44. Whoever shall fall on this stone; i.e., whoever shall be scandalized at our Lord, at His doctrine, and lowly life and poverty, as were the Scribes and Pharisees, shall be destroyed by God. By on whomsoever it shall fall are most probably meant those who, after our Lord's death and Resurrection, should refuse to believe in Him and in His doctrine,

## CHAPTER XXII

THE MARRIAGE OF THE KING'S SON, 1-14.

THE TRIBUTE MONEY TO CAESAR, 15-22.

THE SADDUCEES AND THE RESURRECTION, 23-33.

THE GREATEST COMMANDMENT IN THE LAW, 34-40.

THE MESSIAH, THE SON OF DAVID, 41-46.

1. And Jesus answering, spoke again in parables to them, saying:
2. The kingdom of heaven is likened to a king, who made a marriage for his son.
3. And he sent his servants, to call them that were invited to the marriage; and they would not come.
4. Again he sent other servants, saying: Tell them that were invited, Behold, I have prepared my dinner; my beeves and fatlings are killed, and all things are ready: come ye to the marriage.
5. But they neglected, and went their ways, one to his farm, and another to his merchandise.

1. This Parable of the Marriage-feast (verses 1-14) is in St. Matthew only. There is a similar one in St. Luke (xiv. 16-24).

2. **Kingdom of heaven** here means the Church of Christ. The abundant graces and blessings found in the Church, as a result of the Incarnation of the Son of God, the institution of the Sacrifice of the Mass, and the sacraments, are likened, in this parable, to a sumptuous marriage-feast prepared by a king for his son; hence the king, here spoken of, refers to Almighty God.

3. **Servants**, who were the Law of Moses and the Prophets under the Old Law, and John the Baptist and the Apostles in the time of Christ. All these were sent out as servants at different times by Almighty God to invite the Jewish people to prepare for and accept our Redeemer and His teaching.

4. **Other servants**; i.e., Paul and the other Apostles, who again went forth, after the Resurrection and Ascension of our Lord, to call the Jews to the faith of Christ.

5. Then as now the Jews as a class were engrossed with worldly interests and temporal affairs, and prized earthly above heavenly possessions.



6. And the rest laid hands on his servants, and having treated them contumeliously, put them to death.

7. But when the king had heard of it, he was angry, and sending his armies, he destroyed those murderers, and burnt their city.

8. Then he saith to his servants: The marriage indeed is ready; but they that were invited were not worthy.

9. Go ye therefore into the highways; and as many as you shall find, call to the marriage.

10. And his servants going forth into the ways, gathered together all that they found, both bad and good: and the marriage was filled with guests.

11. And the king went in to see the guests: and he saw there a man who had not on a wedding garment.

12. And he saith to him: Friend, how camest thou in hither not having on a wedding garment? But he was silent.

13. Then the king said to the waiters: Bind his hands and feet, and cast him into the exterior darkness: there shall be weeping and gnashing of teeth.

14. For many are called, but few are chosen.

6. **Treated them contumeliously, etc.**, which refers to the persecutions received by the Apostles from the Jews (Acts v. 40-41; vii. 59).

7-10. These verses refer to the destruction of Jerusalem under Titus and Vespasian in A.D. 70, and to the rejection of the Jews and the call of the Gentiles (Acts xiii. 46).

**His armies**; i.e., the Romans, whom Almighty God used to punish the unworthy Jews.

**Highways** signifies that the call was extended to all, even the most distant of the Gentiles.

**Bad and good.** Among the called were some naturally good, others bad, as even after their call there were both good and bad in the Church.

11. **The king** refers to Almighty God coming to judge the dead, in the Particular Judgment, at death; and in the General Judgment, at the end of the world.

**Wedding garment** represents charity, or sanctifying grace.

12. **He was silent**, with terror at the King's discovery of his condition.

13. **The king said to the waiters**; i.e., to the angels. Cf. viii. 12; xiii. 42. The reference to exterior darkness, to binding of hands and feet, etc., signifies eternal punishment. See on xiii. 50.

14. **Many are called, but few are chosen.** These words refer primarily to the Jewish people, many of whom were called to

15. Then the Pharisees going, consulted among themselves how to insnare him in his speech.

16. And they sent to him their disciples with the Herodians, saying: Master, we know that thou art a true speaker, and teachest the way of God in truth, neither carest thou for any man: for thou dost not regard the person of men.

17. Tell us therefore what dost thou think, is it lawful to give tribute to Cæsar, or not?

18. But Jesus knowing their wickedness, said: Why do you tempt me, ye hypocrites?

19. Shew me the coin of the tribute. And they offered him a penny.

20. And Jesus saith to them: Whose image and inscription is this?

21. They say to him: Cæsar's. Then he saith to them: Render therefore to Cæsar the things that are Cæsar's; and to God, the things that are God's.

embrace the faith of Christ, but did not. Secondly the words may also mean that many are the souls of men that are called to Christianity, but comparatively few embrace it and remain faithful to it.

15. **Then the Pharisees, going, etc.,** together with the Chief Priests and ancients, to whom our Lord had been speaking (xxi. 23).

16. **The Herodians.** These were friends and followers of Herod the Great, and of Herod Antipas, his son, who was tetrarch of Galilee, and who had come to Jerusalem at this time for the celebration of the Pasch.

**Master, we know that, etc.** These words were full of hypocrisy and dissimulation, and our Lord knew it (verse 18).

17. **Is it lawful to give tribute to Caesar?** By this question, the Pharisees sought to entrap our Lord. If He answered in the negative, He would displease the Herodians by appearing to oppose the existing authorities; if in the affirmative, He would lose favor with the people, who hated the Romans and the Roman rule.

19. **The coin of the tribute,** a Roman denarius, or penny, varying in value at different times, but worth about 17 cents at the time of Christ. Since this coin was made in Rome, there was stamped on it the image of the Emperor.

21. **Render therefore to Caesar, etc.** By this answer our Saviour avoids the question as to the lawfulness of the Roman tribute; He simply tells his questioners that they should render to Caesar whatever is lawfully his,—be it money, honor, respect, or what not; and that they are likewise to give to God whatever belongs to Him.

22. And hearing this they wondered, and leaving him, went their ways.

23. That day there came to him the Sadducees, who say there is no resurrection; and asked him,

24. Saying: Master, Moses said: If a man die having no son, his brother shall marry his wife, and raise up issue to his brother.

25. Now there were with us seven brethren: and the first having married a wife, died; and not having issue, left his wife to his brother.

26. In like manner the second, and the third, and so on to the seventh.

27. And last of all the woman died also.

28. At the resurrection therefore whose wife of the seven shall she be? for they all had her.

29. And Jesus answering, said to them: You err, not knowing the Scriptures, nor the power of God.

30. For in the resurrection they shall neither marry nor be married; but shall be as the angels of God in heaven.

31. And concerning the resurrection of the dead, have you not read that which was spoken by God, saying to you:

32. I am the God of Abraham, and the God of Isaac, and the God of Jacob? He is not the God of the dead, but of the living.

33. And the multitudes hearing it, were in admiration at his doctrine.

34. But the Pharisees hearing that he had silenced the Sadducees, came together:

22. And hearing this, they wondered; i.e., they marveled at the shrewdness of His reply.

23. **The Sadducees.** See on iii. 7.

24. **Moses said, in Deut. xxv. 5.** According to the Law, if a man died without issue, his brother should marry the widow, and their first-born son should be called the son of the deceased husband.

25-27. This may be only a fictitious case; but it illustrates.

28. **At the resurrection.** The materialistic Sadducees thought that marriage would, or ought to exist in a future life just as in this life; and hence they tried by an *argumentum ad absurdum* to disprove the doctrine of the resurrection and future life.

30. **As the angels of God.** The resurrected body will be angelic as regards its immortality and freedom from carnal tendencies.

32. **I am the God of Abraham, etc.** Our Lord now shows that the Sadducees, in spite of the fact that they quoted Moses, were nevertheless ignorant of the teaching of Moses, as found in Exod. (iii. 6). His argument is as follows: God, not only was, but is still, the God of Abraham, Isaac, and Jacob; but He is not the God of the dead, but of the living; therefore, Abraham, Isaac, and Jacob are still living. By this argument, He proves against the Saddu-

35. And one of them, a doctor of the law, asked him, tempting him :  
 36. Master, which is the great commandment in the law ?  
 37. Jesus said to him : Thou shalt love the Lord thy God with thy whole heart, and with thy whole soul, and with thy whole mind.  
 38. This is the greatest and the first commandment.  
 39. And the second is like to this : Thou shalt love thy neighbour as thyself.  
 40. On these two commandments dependeth the whole law and the prophets.  
 41. And the Pharisees being gathered together, Jesus asked them,  
 42. Saying : What think you of Christ ? whose son is he ? They say to him : David's.

cees two things: (a) the existence of souls or spirits; (b) the resurrection of the body, for the body is the natural complement of the soul, and the whole man is made up of the two, body and soul. Hence, He did not say, I am the God of Abraham's soul, but of *Abraham*, the man, etc. Moreover, our Lord's argument is the more conclusive when we remember that in antiquity the immortality of the soul and the resurrection of the body were not considered as apart, one from the other. The soul was not understood as living separate from the body, but both were regarded as dead or living together.

35. **Doctor of the law**; a Scribe, according to St. Mark (xii. 28). Scribes and "lawyers" were the same, and many of the Scribes were Pharisees.

36. **The great commandment**; i.e., the greatest or most important commandment in the Law of Moses. The Scribes did not all agree as to the relative importance of some of the commandments.

37. **Thou shalt love the Lord, thy God**, etc.; quoted from Deut. vi. 5. The meaning is that we are to love God as much as we can.

39. **The second is like to this**; i.e., the second in importance and dignity. We are bound to have for our neighbor the same quality of love, although not the same intensity, which we have for ourselves.

40. **Law and the prophets**. By "law" is meant the Pentateuch, or five books of Moses; by the "prophets" the rest of the Old Testament.

42. **What think you of Christ?** etc. Our Lord put this question to the Pharisees in order that they might be moved to recognize His Divinity.

43. He saith to them: How then doth David in spirit call him Lord, saying:  
 44. The Lord said to my Lord, Sit on my right hand, until I make thy enemies thy footstool?  
 45. If David then call him Lord, how is he his son?  
 46. And no man was able to answer him a word; neither durst any man from that day forth ask him any more questions.

43. **David in spirit**; i.e., under the inspiration of the Holy Ghost.  
 44. **The Lord said to my Lord**; i.e., God the Father said to God the Son. The quotation is from Psalm cix. 1. It is noticeable that our Lord attributes this psalm to David. But if David is the author of this Psalm, he is not the subject of it, as Ewald contends. The subject of the Psalm is a person who was to be both priest and king, and since only the Messiah was to enjoy these two dignities, it was our Lord of whom David in the Psalm was singing.

45. **How is he his son.** Our Lord, as man, was the descendant of David; as God, He was the Lord of David.

46. **From that day forth**, which was Tuesday of Holy Week.

## CHAPTER XXIII

THE PRIDE AND HYPOCRISY OF THE PHARISEES, 1-12.

THE EIGHT WOES AGAINST THE PHARISEES, 13-33.

THE LAST WORDS IN THE TEMPLE, THE CHASTISE-  
 MENT OF JERUSALEM, 34-39.

1. Then Jesus spoke to the multitudes and to his disciples,
2. Saying: The scribes and the Pharisees have sitten on the chair of Moses.

1. Having used every means in His power to convert the Pharisees from their blindness, our Lord now turns upon them in public denunciation and indulges in a severity of language such as is not found, at least to the same extent, in any other part of the Gospels. In Mark (xii. 38-40) and in Luke (xi. 39-52; xx. 45-47) we have only a few verses expressive of the same sternness of language, and aside from these verses we have no parallel to the present chapter in the Gospels.

2. **The chair of Moses**, which represented the authority divinely

3. All things therefore whatsoever they shall say to you, observe and do: but according to their works do ye not; for they say, and do not.

4. For they bind heavy and insupportable burdens, and lay them on men's shoulders; but with a finger of their own they will not move them.

5. And all their works they do for to be seen of men. For they make their phylacteries broad, and enlarge their fringes.

6. And they love the first places at feasts, and the first chairs in the synagogues,

7. And salutations in the market place, and to be called by men, Rabbi.

committed to Moses to instruct the Jewish people in the Law of God.

3. **All things**; i.e., all things which are in accordance with the teachings of Moses. Our Lord carefully distinguished between the public authority of the Pharisees, as exponents of the Law, and their private sins and errors. In their ministerial capacity, as expounders of the Law of Moses, they were to be obeyed; but as private individuals, posing as models of virtue, they were not to be followed. The people had the written Law to guide them.

Whether the Jewish Church possessed the gift of infallibility is not certain. The private teachings of its doctors were often erroneous; but the teaching body, as such, seems never to have erred in faith until the time when it rejected and condemned our Lord. Then, however, its mission and office were over.

4. **Insupportable burdens**; i.e., their own traditions and those of the ancients, together with the rigor with which they enforced their many ceremonial precepts.

5. **To be seen of men**. See on vi. 1-5.

**Phylacteries** (*φυλακτήρια*, *safeguards*) were strips or rolls of parchment, bound around the head or on the left wrist or arm during prayer, and containing a summary of the Law inscribed upon them.

**Their fringes** (Num. xv. 38, 39), which were tassels hanging from the four corners of the cloaks of the Jews, and intended as reminders of the obligation to keep the commandments.

6. **First places . . . first chairs**. Our Lord is here condemning all inordinate desire for honor and preëminence.

7. **Rabbi**; i.e., Master (John i. 38). Again it is the vain glory in bearing these titles that our Lord condemns, not the titles themselves.

8. But be not you called Rabbi. For one is your master; and all you are brethren.

9. And call none your father upon earth; for one is your father, who is in heaven.

10. Neither be ye called masters; for one is your master, Christ.

11. He that is the greatest among you shall be your servant.

12. And whosoever shall exalt himself shall be humbled: and he that shall humble himself shall be exalted.

13. But woe to you scribes and Pharisees, hypocrites; because you shut the kingdom of heaven against men, for you yourselves do not enter in; and those that are going in, you suffer not to enter.

14. Woe to you scribes and Pharisees, hypocrites: because you devour the houses of widows, praying long prayers. For this you shall receive the greater judgment.

15. Woe to you scribes and Pharisees, hypocrites; because you go round about the sea and the land to make one proselyte; and when he is made, you make him the child of hell twofold more than yourselves.

8-12. In these verses, our Lord is again teaching lessons of humility and charity, and condemning every spirit that would lead one to feel, because of any authority he may possess, that he is more pleasing in the sight of God than anyone else, however subject to him.

13. As in the Sermon on the Mount, our Lord had pronounced eight beatitudes for those who should be faithful to His teaching, so now He utters eight "woes" or curses against the Pharisees who have transgressed His Law.

Woe I, because you not only refuse to enter the Kingdom of God, but prevent others from entering. The Pharisees were not content to reject Christ and His teaching, but they tried in every way to get others to do the same. They even agreed to cast out of the Synagogue anyone who should confess His name. They concealed from the people, or misinterpreted, the Messianic prophecies, and they blasphemed Christ's teaching and miracles, which were a fulfillment of those prophecies.

14. Woe II, for exacting excessive fees from poor widows for spiritual offices performed for them. The best MSS. have not this verse. It is thought to be an interpolation here from Mark (xii. 40) and Luke (xx. 47).

**Long prayers.** Our Lord does not condemn long prayers, which He Himself practiced; but He does condemn the hypocrisy which they were intended to conceal in the case of the Pharisees.

15. Woe III, for evil proselytism.

16. Woe to you blind guides, that say, Whosoever shall swear by the temple, it is nothing; but he that shall swear by the gold of the temple, is a debtor.

17. Ye foolish and blind; for whether is greater, the gold, or the temple that sanctifieth the gold?

18. And whosoever shall swear by the altar, it is nothing; but whosoever shall swear by the gift that is upon it, is a debtor.

19. Ye blind: for whether is greater, the gift, or the altar that sanctifieth the gift?

20. He therefore that sweareth by the altar, sweareth by it, and by all things that are upon it:

21. And whosoever shall swear by the temple, sweareth by it, and by him that dwelleth in it:

22. And he that sweareth by heaven, sweareth by the throne of God, and by him that sitteth thereon.

23. Woe to you scribes and Pharisees, hypocrites; because you tithe mint, and anise, and cummin, and have left the weightier things of the law; judgment, and mercy, and faith. These things you ought to have done, and not to leave those undone.

24. Blind guides, who strain out a gnat, and swallow a camel.

**Proselyte** (*προσήλυτος*, a *new-comer*; *advena* in Latin), a Gentile convert. The zeal of the Pharisees in getting converts was not from a motive of religion, but in order to participate in the profits coming from the gifts which these converts would present in the Temple.

**Child of hell twofold**, etc., because the convert united to his own pagan vices the sins of his new masters.

16-20. Woe IV, for their false doctrine about oaths. The Pharisees taught that an oath taken in the name of any creature was not binding, unless that creature was to be offered as a gift. They exaggerated the sanctity of gifts above that of the altar and the Temple, simply because they shared in the profits of the gifts. Our Lord here reprobates their avarice, which led them so to destroy the proper order of things; and He shows them that all the holiness of a gift comes from the altar and the Temple consecrated to the service of God.

23. Woe V, for insisting on trivial things and neglecting great ones.

**You tithe**; i.e., you pay or receive taxes. Here the meaning is most likely to pay tithes or taxes.

**Mint, anise, cummin.** These were small Oriental herbs, on which no tithes, or very small ones, were levied. The Pharisees



25. Woe to you scribes and Pharisees, hypocrites; because you make clean the outside of the cup and of the dish, but within you are full of rapine and uncleanness.

26. Thou blind Pharisee, first make clean the inside of the cup and of the dish, that the outside may become clean.

27. Woe to you scribes and Pharisees, hypocrites; because you are like to whited sepulchres, which outwardly appear to men beautiful, but within are full of dead men's bones, and of all filthiness.

28. So you also outwardly indeed appear to men just; but inwardly you are full of hypocrisy and iniquity.

29. Woe to you scribes and Pharisees, hypocrites; that build the sepulchres of the prophets, and adorn the monuments of the just,

30. And say: If we had been in the days of our Fathers, we would not have been partakers with them in the blood of the prophets.

31. Wherefore you are witnesses against yourselves, that you are the sons of them that killed the prophets.

32. Fill ye up then the measure of your fathers.

33. You serpents, generation of vipers, how will you flee from the judgment of hell?

34. Therefore behold I send to you prophets, and wise men, and scribes: and some of them you will put to death and crucify, and some you will scourge in your synagogues, and persecute from city to city:

were very scrupulous in their observance of these trivial matters, while neglecting at the same time to keep the commandments.

Judgment; i.e., justice.

25. Woe VI, for fraud and theft.

You are full; according to the Greek (*γέμουσιν*), "they are full"; i.e., the cup and the dish are full. Uncleanness (*ἀκραισίας*) literally means here *intemperate* desire for riches.

27. Woe VII, for appearing to be what you are not.

Whitened sepulchres. To touch a sepulchre was to become unclean for seven days (Num. xix. 16); hence, to warn the people, the sepulchres were white-washed each year, a month before the Passover.

29-31. Woe VIII, for appearing to condemn the sins of your fathers, who persecuted and put to death the prophets, while you yourselves are repeating their crimes.

32. Fill ye up the measure, etc., which they later did by putting our Lord Himself to death.

33. Generation of vipers, — words before used by our Lord against the Pharisees in iii. 7; xii. 34.

34. Prophets, and wise men, and scribes. These words refer to

35. That upon you may come all the just blood that hath been shed upon the earth, from the blood of Abel the just, even unto the blood of Zacharias the son of Barachias. whom you killed between the temple and the altar.

36. Amen I say to you, all these things shall come upon this generation.

37. Jerusalem, Jerusalem, thou that killest the prophets, and stonest them that are sent unto thee, how often would I have gathered together thy children, as the hen doth gather her chickens under her wings, and thou wouldest not?

what our Lord, as God, did after His Ascension, in sending out the Apostles and first teachers of Christianity. St. Luke (xi. 49) speaks only of Apostles; but the Apostles were "prophets," in predicting future events; they were "wise men," owing to their supernatural knowledge; and they were also "scribes," as being expounders of the law of the Gospel.

35. The Jews were to be punished in a temporal way for the murders committed by their fathers, because temporal punishment descends to the third and fourth generation upon those who imitate the sins of their fathers (Exod. xx. 5).

**Zacharias, son of Barachias.** This Zacharias was the son of Joiada, the High Priest. He was put to death at the instigation of King Joas, for recalling the people from the worship of idols (2 Paralip. xxiv. 20, 21). Zacharias is here called "the son of Barachias," most likely by a mistake of some copyist, who added this name, having in mind Zacharias the prophet, who was in truth the son of Barachias. It is possible that Joiada was also called Barachias, which means "blessed of the Lord." Jews frequently had two names.

**Between the temple and the altar; i.e., in the Hall of the Priests,** which was between the vestibule of the Holy Place and the Altar of Holocausts. Our Lord's intention here is to cite the first and the last murder mentioned in the history of the Old Testament, that of Abel (Gen. iv. 8), and that of Zacharias (2 Paralip. xxiv. 20-21); the books of Paralipomenon occupy the last place in the Hebrew Canon.

36. **These things shall come upon this generation,** — which was verified in the siege of Jerusalem in the year 70.

37. **How often.** How many warnings and exhortations, through His prophets, His Apostles, and Himself, our Lord had sent in vain to the Jewish people!

38. Behold, your house shall be left to you, desolate.

39. For I say to you, you shall not see me henceforth till you say: Blessed is he that cometh in the name of the Lord.

38. **Your house**; i.e., the city of Jerusalem and all the land of Judea.

39. **You shall not see me**, etc. This was the close of our Lord's public teaching. The Jews, as a nation, were not to see Him again, until He comes in judgment at the end of the world. These words were spoken on Tuesday evening of Holy Week, as He was about to leave the Temple for the last time.

## CHAPTER XXIV

JESUS PREDICTS THE DESTRUCTION OF JERUSALEM AND  
WARNS AGAINST IMPOSTORS, 1-14.

THE SIGNS THAT SHALL PRECEDE THE DESTRUCTION  
OF JERUSALEM, 15-20.

THE COMING OF CHRIST AT THE END OF THE WORLD,  
21-35.

THE UNCERTAINTY OF THE HOUR OF THE JUDGMENT  
— VIGILANCE, 36-44.

THE PARABLE OF THE TWO SERVANTS, 45-51.

1. And Jesus being come out of the temple, went away. And his disciples came to shew him the buildings of the temple.

2. And he answering, said to them: Do you see all these things? Amen I say to you there shall not be left here a stone upon a stone that shall not be destroyed.

1, 2. The Temple of Jerusalem was one of the most magnificent structures ever built. It was begun by Herod the Great 20 B.C., and finished forty-six years later (John ii. 20). Much of the walls was covered with plates of gold, and the rest with the purest of white marble. The Temple was indeed the glory of the Jews, and its destruction they considered as an evil to be equaled only by the destruction of the world itself. They thought, in fact, that the destruction of the Temple and the end of the world would occur together. Haunted, therefore, by a sense of dread from what our Lord had been saying, some, or at least one, of the disciples (Mark

3. And when he was sitting on mount Olivet, the disciples came to him privately, saying: Tell us when shall these things be? and what shall be the sign of thy coming, and of the consummation of the world?

4. And Jesus answering, said to them: Take heed that no man seduce you:

5. For many will come in my name saying, I am Christ: and they will seduce many.

xiii. 1) called the Master's attention to the magnificence of the structure before them, as if to move Him to spare it; but He insists only the more on His predictions, which were later verified by the Romans.

3. The discourses of this and the following chapter, we believe, were delivered to the disciples privately on the Mount of Olives on Tuesday of the first Holy Week. There are some commentators, however, who hold that these discourses were given on Wednesday.

The present chapter refers both to the destruction of Jerusalem and the end of the world. As said before, the Jews regarded the destruction of the Temple and the end of the world as simultaneous events, which would be followed immediately by the second coming of Christ. These events were mixed together in their minds, and hence the answer to their questions and the prophecies now uttered by our Lord refer for the most part to both. According to St. Chrysostom, up to the twenty-third verse, the chapter deals exclusively with the destruction of Jerusalem; but St. Jerome, St. Augustine, and others hold that these verses treat indiscriminately of the destruction of Jerusalem and the end of the world. From a careful reading of the chapter, it would seem that, up to the twentieth verse, the destruction of Jerusalem is *chiefly* referred to, while from the twenty-first verse on, the primary reference is to the end of the world. Throughout this entire chapter, however, we must bear in mind that the destruction of Jerusalem was a type of the final destruction of the world, and that, consequently, the things which were foretold of the former shall be verified, only to a greater extent, in the latter.

5. Many . . . saying, I am Christ. Many of these impostors came before the destruction of Jerusalem, such as Theudas and Judas of Galilee (Acts v. 36, 37); Simon Magus (Acts viii. 9-11); the Egyptian impostor (Acts xxi. 38). The same, to a greater extent, will doubtless be true at the end of the world.

6. And you shall hear of wars and rumours of wars. See that ye be not troubled. For these things must come to pass, but the end is not yet.

7. For nation shall rise against nation, and kingdom against kingdom; and there shall be pestilences, and famines, and earthquakes in places:

8. Now all these are the beginnings of sorrows.

9. Then shall they deliver you up to be afflicted, and shall put you to death: and you shall be hated by all nations for my name's sake.

10. And then shall many be scandalized: and shall betray one another: and shall hate one another.

11. And many false prophets shall rise, and shall seduce many.

12. And because iniquity hath abounded, the charity of many shall grow cold.

13. But he that shall persevere to the end, he shall be saved.

14. And this gospel of the kingdom, shall be preached in the whole world, for a testimony to all nations, and then shall the consummation come.

15. When therefore you shall see the abomination of desolation, which was spoken of by Daniel the prophet, standing in the holy place: he that readeth let him understand.

6. **You shall hear of wars, etc.** Josephus tells us that this was literally verified before the destruction of Jerusalem.

7. **Nation shall rise against nation, etc.** This is more or less continuously true, but will doubtless be more so, as the end of the world draws near.

8. **The beginnings of sorrows, although the end may be much delayed.**

9. **Deliver you up . . . put you to death.** These things were verified with regard to the Apostles and early Christians: Peter and John, for example, appeared before the Great Council, James and Peter before Herod, Paul before Nero, etc.; and they will continue to be verified with respect to their successors to the end.

10. **Many be scandalized; i.e., turned away from the faith.**

11. **False prophets shall arise, such as the present-day heretics, who teach doctrines different from the doctrine of Christ.**

13. **Shall persevere to the end; i.e., to the end of life.**

14. This verse refers both to the destruction of Jerusalem and the end of the world, for we know, from the Epistles of St. Paul, that the Gospel had already been preached to the greater part of the then known world before Jerusalem fell; but it will reach to the uttermost parts of the earth before the final consummation comes.

15. **The abomination of desolation** means nothing else than the besieging Roman army under Titus, who ensnared the Holy City

16. Then they that are in Judea, let them flee to the mountains:  
 17. And he that is on the housetop, let him not come down to take any thing out of his house:  
 18. And he that is in the field, let him not go back to take his coat.  
 19. And woe to them that are with child, and that give suck in those days.  
 20. But pray that your flight be not in the winter, or on the sabbath.  
 21. For there shall be then great tribulation, such as hath not been from the beginning of the world until now, neither shall be.  
 22. And unless those days had been shortened, no flesh should be saved: but for the sake of the elect those days shall be shortened.  
 23. Then if any man shall say to you: Lo here is Christ, or there, do not believe him.  
 24. For there shall arise false Christs and false prophets, and shall show great signs and wonders, insomuch as to deceive (if possible) even the elect.  
 25. Behold I have told it to you, beforehand.  
 26. If therefore they shall say to you: Behold he is in the desert, go ye not out: Behold he is in the closets, believe it not.

in an iron network and seemed to bring the altars of paganism to the very doors of the Temple. The prophecy of Daniel (ix. 27) here referred to, relates to the end of the world.

16-18. These verses signify the haste which should be necessary in order to escape the common ruin wrought in Jerusalem by the Romans in the year 70.

19, 20. Such things as to be with child, winter, etc., would be impediments to flight. **The Sabbath** is mentioned, because the interpreters of the Mosaic Law (Exod. xvi. 29) restricted journeys made on that day to something under two miles. Cf. Acts i. 12.

21. From this verse on, the reference seems to be more to the end of the world; and although the tribulations which preceded the destruction of Jerusalem were extreme, it would appear that the reference here is more especially to the evils which shall precede the end of all things. The definite ruin and captivity of Jerusalem by the Romans was doubtless accompanied by the greatest tribulations that the Jews till then had ever experienced; but even these were only a type and figure of the still more dreadful distresses that shall usher in the end of all.

22. **No flesh should be saved**; i.e., no man should be saved, because of the awful persecutions and multiple false signs that shall precede the world's end.

23-26. These verses are a description of some of the trials which the faithful shall suffer towards the end of the world.

27. For as lightning cometh out of the east, and appeareth even into the west: so shall also the coming of the Son of man be.

28. Wheresoever the body shall be, there shall the eagles also be gathered together.

29. And immediately after the tribulation of those days, the sun shall be darkened and the moon shall not give her light, and the stars shall fall from heaven, and the powers of heaven shall be moved:

27. **As lightning cometh out of the east, etc.** The meaning is that the faithful are not to be deceived by false signs and false Christs, for the final coming of the Saviour will be as unmistakable as the lightning shining from the east even to the west.

28. This verse is a proverb quoted from Job (xxxix. 30), which means, in the present instance, that no one will need to inquire where the final judgment is to be held, for all men shall be gathered there as naturally as the eagles are drawn to the spot where lies a dead body.

29. **Immediately after the tribulation of those days, etc.** The words of this verse are usually understood to be prophetic in a special sense of the disturbances that shall precede the Last Judgment. Such they doubtless are, if the verses immediately before are also speaking of the end of the world. But those who take the verses that lead up to this one as referring to the destruction of Jerusalem cannot well explain this passage as referring to the end of the world. The word, *εὐθέως*, *immediately*, which opens the verse unites the meaning of the words that follow very closely with that of the words in the preceding verses.

It seems more probable that the predictions about the *darkened sun and moon*, the *stars falling*, etc., should not be taken in a literal sense, but should be regarded only as symbols, no more literally to be realized at the end of the world than now. Such descriptions are characteristic of prophecies. Thus Isaias (xiii. 9 ff.) foretelling the woes that should come upon Babylon, and portraying the awful judgments of Jehovah upon the Edomites (xxxiv. 4), speaks of the darkening of the sun and moon, the trembling of the heavens and the earth, of the fading away and the falling of the hosts of heaven and the celestial bodies. Similar language is used by Ezechiel (xxxii. 7, 8) when announcing the judgment of God upon Egypt, by Jeremias (iv. 23) in speaking of the impending woes of Israel, and by Joel (ii. 3, 4) when threatening the enemies of Israel.

30. And then shall appear the sign of the Son of man in heaven: and then shall all tribes of the earth mourn: and they shall see the Son of man coming in the clouds of heaven with much power and majesty.

31. And he shall send his angels with a trumpet, and a great voice: and they shall gather together his elect from the four winds, from the farthest parts of the heavens to the utmost bounds of them.

32. And from the fig tree learn a parable: When the branch thereof is now tender, and the leaves come forth, you know that summer is nigh.

33. So you also, when you shall see all these things, know ye that it is nigh, even at the doors.

34. Amen I say to you, that this generation shall not pass, till all these things be done.

30. **The sign of the Son of man**; i.e., the cross of Christ, which will precede the second coming of Christ. This cross will most likely be but a representation or image of the real cross on which our Saviour died. Those who understand verse 29 to be descriptive of events that went before the destruction of Jerusalem say that the "sign of the Son of man" here means nothing else than the power of Christ which, through the Apostles and their immediate successors, made the solemn inauguration of Christianity on a firm foundation coincide with the fall of the Jewish state.

**All tribes shall mourn**; i.e., all pagans, infidels, heretics, and the like.

**Coming in the clouds of heaven.** As, at the Ascension, Christ was taken up into the clouds, so shall He be seen coming forth from the clouds at the end (Acts i. 9-11).

31. **With a trumpet**,—literally, "with a trumpet of great voice," which shall call the dead to life and bid them come to judgment.

**From the four winds**; i.e., from all points of the compass.

32. **Learn a parable, etc.**; i.e., an illustration.

33. **It is nigh, even at the doors**; i.e., the redemption of the just (Luke xxi. 28).

34. **This generation shall not pass away, till, etc.** Some commentators understand "this generation" to refer to the human race, and especially to the Jewish people; others think it means the Christian Church; still others, that it designates the time between the first and second comings of Christ. But it is more in harmony with the context to take the expression in its literal sense, as referring to the people then living. Hence "all these things" can be



35. Heaven and earth shall pass, but my words shall not pass.

36. But of that day and hour no one knoweth, no not the angels of heaven, but the Father alone.

37. And as in the days of Noe, so shall also the coming of the Son of man be.

38. For as in the days before the flood, they were eating and drinking, marrying and giving in marriage, even till that day in which Noe entered into the ark,

39. And they knew not till the flood came, and took them all away; so also shall the coming of the Son of man be.

40. Then two shall be in the field: one shall be taken, and one shall be left.

41. Two women shall be grinding at the mill: one shall be taken, and one shall be left.

explained as referring literally to the events that preceded the destruction of Jerusalem, and the solid establishment of the Messianic reign, and, typically, to those that shall go before the end of the world. Most of the difficulties of this present chapter will disappear if we remember: (a) that, to the Jewish mind, the destruction of Jerusalem and the end of the world were to be coeval; and that, consequently, our Lord's words and answers to the Apostles were uttered conformably to the ideas and questions of the latter; (b) that this whole discourse has been incompletely given by the Evangelists, and without much attention to order.

35. **Heaven and earth shall pass away**; i.e., it is easier for this to happen than for the words of Christ to go unfulfilled. Cf. Luke xvi. 17.

36. From this verse it would seem that no creature, not even the Son of God (Mark xiii. 32), knows the exact moment or hour of Christ's second coming and the destruction of the world. Because of the intimate union of the divine and human natures in Christ, however, our Saviour, as God, and even as man, did indeed know the hour and the day when all things would end (xi. 27; Col. ii. 3); but the meaning here is that He did not know these things in such a way that He could communicate them to men.

37-39. Just as before the Deluge, the sinful and faithless were unmoved by the warnings of Noe, so in the last days they shall fail to profit by the tribulations of those times, and shall thus be taken unawares.

40, 41. **One taken . . . one left**; i.e., one shall be saved, the other left to condemnation.

42. Watch ye therefore, because you know not what hour your Lord will come.

43. But this know ye, that if the goodman of the house knew at what hour the thief would come, he would certainly watch, and would not suffer his house to be broken open.

44. Wherefore be you also ready, because at what hour you know not the Son of man will come.

45. Who, thinkest thou, is a faithful and wise servant, whom his lord hath appointed over his family, to give them meat in season.

46. Blessed is that servant, whom when his lord shall come he shall find so doing.

47. Amen I say to you, he shall place him over all his goods.

48. But if that evil servant shall say in his heart: My lord is long a coming:

49. And shall begin to strike his fellow servants, and shall eat and drink with drunkards:

50. The lord of that servant shall come in a day that he hopeth not, and at an hour that he knoweth not:

51. And shall separate him, and appoint his portion with the hypocrites. There shall be weeping and gnashing of teeth.

**Two women grinding, etc.**, as they are accustomed to do in the East; one shall be taken up with Christ into the clouds (1 Thes. iv. 16); the other left to her reprobation (2 Thes. i. 7-9). Some commentators think that these separations shall immediately precede the "tribulations of those days," rather than the coming of the Judge, since it is probable that none shall be alive at the day of judgment; or if some should still be living, they shall be so withered with fear as to make it impossible that they should be then going about their ordinary duties.

42. **Watch ye therefore, etc.** We are bidden to watch always, for we know neither the hour of Christ's general coming to judge the world, nor of His particular coming at the hour of our own death.

45-51. This Parable of the Two Servants is found in Luke (xii. 42-46); it perhaps belongs to an earlier date in our Lord's ministry, and is added here by St. Matthew, to illustrate the question in hand.

**Whom his lord hath appointed.** These words refer chiefly to the Apostles and their successors, and to all who have charge over others.

**Shall separate him.** In the Greek (*διχοτομήσει*), "shall cut him in two," as a punishment for his negligence.

## CHAPTER XXV

THE PARABLE OF THE TEN VIRGINS, 1-13.

THE PARABLE OF THE TALENTS, 14-30.

THE LAST JUDGMENT, 31-46.

1. Then shall the kingdom of heaven be like to ten virgins, who taking their lamps went out to meet the bridegroom and the bride.

2. And five of them were foolish, and five wise.

1. This Parable of the Ten Virgins (verses 1-13) is peculiar to St. Matthew.

**Then;** i.e., in the Day of Judgment, at the second coming of Christ.

The kingdom of heaven means the Church militant; the ten virgins represent all the faithful. The number "ten" is not accidental, because it took just so many to make a company among the Jews. The virginity here attributed to them means purity of faith, absence of spiritual fornication through corruption of doctrine.

**Taking their lamps.** Marriages, in the East, were, and are still, always celebrated at night.

**Went out to meet the bridegroom.** The bridal procession among the Jews was as follows: the bridegroom, accompanied by his friends, went to the home of the bride to lead her, with joy and gladness (1 Mach. ix. 37-39), to his own house; or, if that was too small, to some apartment large enough to accommodate the wedding party. The bride was accompanied from her father's house by her youthful friends and companions (Ps. xlv. 15), and others, here called "virgins," joined the procession along the way, to enter with the rest of the company the hall of feasting (Cant. iii. 4).

**Bridegroom** means Christ, who will come at the end of the world to take the Church, His Bride, to Himself (Trench).

**And the bride.** These words are not found in the best MSS. and should be omitted here.

2. **Five foolish . . . five wise.** All were virgins, because all had the true faith, but the difference between them was that the faith of the foolish virgins, being without good works, was dead.

3. But the five foolish, having taken their lamps, did not take oil with them:

4. But the wise took oil in their vessels with the lamps.

5. And the bridegroom tarrying, they all slumbered and slept.

6. And at midnight there was a cry made: Behold the bridegroom cometh, go ye forth to meet him.

7. Then all those virgins arose and trimmed their lamps.

8. And the foolish said to the wise: Give us of your oil, for our lamps are gone out.

9. The wise answered, saying: Lest perhaps there be not enough for us and for you, go ye rather to them that sell, and buy for yourselves.

10. Now whilst they went to buy, the bridegroom came: and they that were ready, went in with him to the marriage, and the door was shut.

11. But at last came also the other virgins, saying: Lord, Lord, open to us.

12. But he answering said: Amen I say to you, I know you not.

13. Watch ye therefore, because you know not the day nor the hour.

3. **Lamps . . . oil.** The lamps represent faith; oil, good works.

5. **The bridegroom tarrying** represents the delay in Christ's second coming. Our Lord never gave any hint as to the exact time when He should come. We know neither the day of our own death, nor that of the end of the world. Hence it behooves us ever to watch.

**Slumbered;** i.e., ceased to look for His coming; not that all had sinned, or were unprepared.

6. **At midnight** means at the most unexpected time (Luke xii. 40; 1 Thes. v. 2).

**A cry** refers to the voice of the last trumpet (1 Thes. iv. 15).

8. **Give us of your oil,** — words which signify the miserable plight of those who, at the last, shall find themselves in the presence of the Judge without good works, with no fruits of faith.

9. This answer of the wise virgins does not imply a lack of charity; they only wished to express their inability to supply what God alone can give.

10. **Went in with him to the marriage,** which represents the reception of the Elect into the abode of the Blessed.

11. **Lord, Lord, open to us.** Not that they had obtained oil, or enriched meanwhile their faith by works; they wished only to entreat for mercy. The Judge answers them (verse 12) that it is too late, the time for work and merit is over forever.

13. **Watch ye therefore.** The whole purpose of the parable is

14. For even as a man going into a far country, called his servants, and delivered to them his goods;

15. And to one he gave five talents, and to another two, and to another one, to every one according to his proper ability: and immediately he took his journey.

to teach us vigilance and preparation against the coming of Christ, whether at the end of the world, or at our own death.

14. The Parable of the Talents (verses 14-30) is also peculiar to St. Matthew. This parable, like the preceding one, was intended to teach us vigilance and faithfulness in the performance of our duties. A brief account of the parable of the talents with important variations and recollections of the Ten Virgins is found in Mark (xiii. 34-36). A similar parable, that of the "Pounds," is in Luke (xix. 11-27). Although they have the same object and purpose, the Parables of the Talents and of the Pounds are not the same;—that of the Talents was spoken on the Mount of Olives, Tuesday of Holy Week, while that of the Pounds was uttered when our Saviour was drawing near to, but had not yet entered, Jerusalem; the former was addressed only to the disciples, the latter to the multitude; in the former a different amount of money is given to different persons, in the latter the same amount is given to all.

**A man going into a far country** refers to our Lord Himself, who is about to return to His heavenly Father.

**His servants.** Servants in antiquity were often artisans to whom was committed by their masters a certain amount of money to be used in trading, the profits of which money were to be shared with the master. Here, the servants are primarily the Apostles, and secondarily all Christians.

**His goods** refers to the natural endowments, and especially to the spiritual gifts which Almighty God bestows upon His servants, all of which gifts and endowments are to be employed in His service.

15. **Five talents.** The value of the Jewish talent was about \$1920.00.

**According to his proper ability.** The difference in the number of talents given may only indicate the freedom with which God bestows His gifts; but it likely shows also that the gifts of grace

16. And he that had received the five talents, went his way, and traded with the same, and gained other five.

17. And in like manner he that had received the two, gained other two.

18. But he that had received the one, going his way digged into the earth, and hid his lord's money.

19. But after a long time the lord of those servants came, and reckoned with them.

20. And he that had received the five talents coming, brought other five talents, saying: Lord, thou didst deliver to me five talents, behold I have gained other five over and above.

21. His lord said to him: Well done, good and faithful servant, because thou hast been faithful over a few things, I will place thee over many things: enter thou into the joy of thy lord.

22. And he also that had received the two talents came and said: Lord, thou deliveredst two talents to me: behold I have gained other two.

23. His lord said to him: Well done, good and faithful servant: because thou hast been faithful over a few things, I will place thee over many things: enter thou into the joy of thy lord.

24. But he that had received the one talent, came and said: Lord, I know that thou art a hard man; thou reapest where thou hast not sown, and gatherest where thou hast not strewed.

25. And being afraid I went and hid thy talent in the earth: behold here thou hast that which is thine.

are not infrequently bestowed in accordance with one's natural capacity. Natural gifts are often a disposition for supernatural ones (Suarez).

16. **And gained other five.** This indicates the increase in grace, and consequently in glory, which follows the faithful and diligent use of what has been given.

18. **Hid his Lord's money;** i.e., failed to make use of his talents, became a truly "unprofitable servant."

19. **After a long time,** refers to the period between the Ascension and the second coming of Christ, and also to the period of each man's life, because the General Judgment at the end of the world will be but a public ratification of the sentence passed on each one at the hour of his death.

20-23. **Well done,** etc. Both servants received the same pay and the same reward, which is a proof that Almighty God does not so much regard the number of our gifts and the amount of our work, as the dispositions and fidelity with which we work.

24. **A hard man;** i.e., a man of severe and unmerciful disposition.

**Thou reapest where thou hast not sown,** — an adage expressing cruelty and severity.

26. And his lord answering, said to him: Wicked and slothful servant, thou knewest that I reap where I sow not, and gather where I have not strewed:

27. Thou oughtest therefore to have committed my money to the bankers, and at my coming I should have received my own with usury.

28. Take ye away therefore the talent from him, and give it him that hath ten talents.

29. For to every one that hath shall be given, and he shall abound: but from him that hath not, that also which he seemeth to have shall be taken away.

30. And the unprofitable servant cast ye out into the exterior darkness. There shall be weeping and gnashing of teeth.

31. And when the Son of man shall come in his majesty, and all the angels with him, then shall he sit upon the seat of his majesty:

32. And all nations shall be gathered together before him, and he shall separate them one from another, as the shepherd separateth the sheep from the goats:

33. And he shall set the sheep on his right hand, but the goats on his left.

34. Then shall the king say to them that shall be on his right hand: Come, ye blessed of my Father, possess you the kingdom prepared for you from the foundation of the world.

26. **Wicked servant;** in excusing his sloth by calumniating his master. Then our Lord turns his reasons back upon him.

28, 29. The first punishment the wicked servant received is the forfeiture of his talent.

**To everyone that hath, etc.;** i.e., everyone who makes a good use of the graces given him shall receive more, while he who has failed to make use of his gifts and graces shall be forced to forfeit all that has been given him.

**That which he seemeth to have.** The word "seemeth" is not in the Greek, which gives *ὃ ἔχει*, *what he hath*.

30. **Exterior darkness** represents the eternal punishment in store for the unprofitable servant.

31. This verse shows the difference between Christ's first coming, in humility and weakness, and His second, in majesty and power.

32. **All nations . . . before him.** It is generally believed that even infants who die without Baptism shall appear at the General Judgment; what their judgment will be, however, is not known. Their lot, according to the common opinion, will be the greatest natural happiness (St. Th., ii. Sent., dist. 33, qu. 2, a. 2 ad 5).

**Sheep . . . goats,** — types of the Elect and the reprobates.

34. **Kingdom prepared.** This shows that the predestination of the Elect is from all eternity (Eph. i. 4; 1 Pet. i. 20).

35. For I was hungry, and you gave me to eat; I was thirsty, and you gave me to drink; I was a stranger, and you took me in:

36. Naked, and you covered me: sick, and you visited me: I was in prison, and you came to me.

37. Then shall the just answer him, saying: Lord, when did we see thee hungry, and fed thee; thirsty, and gave thee drink?

38. And when did we see thee a stranger, and took thee in? or naked, and covered thee?

39. Or when did we see thee sick or in prison, and came to thee?

40. And the king answering, shall say to them: Amen I say to you, as long as you did it to one of these my least brethren, you did it to me.

41. Then he shall say to them also that shall be on his left hand: Depart from me, you cursed, into everlasting fire which was prepared for the devil and his angels.

42. For I was hungry, and you gave me not to eat: I was thirsty, and you gave me not to drink.

43. I was a stranger, and you took me not in: naked, and you covered me not: sick and in prison, and you did not visit me.

44. Then they also shall answer him, saying: Lord, when did we see thee hungry, or thirsty, or a stranger, or naked, or sick, or in prison, and did not minister to thee?

45. Then he shall answer them, saying: Amen I say to you, as long as you did it not to one of these least, neither did you do it to me.

46. And these shall go into everlasting punishment: but the just, into life everlasting.

35, 36. In these verses are enumerated six of the corporal works of mercy; the seventh, the burying of the dead, is in Tobias (xii. 12). Mercy is here commended because it is one of the highest virtues and presupposes faith and charity; and, only *corporal* works of mercy are spoken of, because they appeal more to the ordinary individual, than do the spiritual works of mercy. The latter, however, are by no means excluded from this general commendation.

40. *My least brethren*; i.e., any faithful Christian, however insignificant otherwise.

41. *Depart from me*, words which signify the *pain of loss*; into everlasting fire signifies the *pain of sense* of the damned.

42-45. The reprobate are here condemned for sins of omission, not because such sins are greater than those of commission, but to show the importance of the virtue of mercy.

46. *Everlasting punishment . . . everlasting life*. The Greek word, *αἰώνιον*, *everlasting*, modifying alike the punishment of the wicked and the life of the just, shows that the states of both are equal in duration.



## CHAPTER XXVI

THE CONSPIRACY OF THE SANHEDRIM, 1-5.

THE SUPPER AT BETHANY, 6-13.

THE TREASON OF JUDAS, 14-16.

THE PREPARATION FOR THE LAST SUPPER, 17-19.

THE DESIGNATION OF THE TRAITOR, 20-25.

THE INSTITUTION OF THE HOLY EUCHARIST, 26-29.

JESUS FORETELLS THE DESERTION OF HIS DISCIPLES,  
30-35.

JESUS IN THE GARDEN OF GETHSEMANI, 36-46.

THE BETRAYAL AND ARREST OF JESUS, 47-56.

JESUS BEFORE THE SANHEDRIM, 57-68.

THE TRIPLE DENIAL OF PETER, 69-75.

1. And it came to pass, when Jesus had ended all these words, he said to his disciples:

2. You know that after two days shall be the pasch, and the Son of man shall be delivered up to be crucified:

1. All these words; i.e., the discourse about the destruction of Jerusalem and the end of the world, the Parables of the Virgins and the Talents, which He had been delivering to His disciples on the western slope of the Mount of Olives. Jesus now full of sorrow and sadness, wends His way eastward over the Mount to Bethany.

2. After two days. According to what we said above (xxiv. 3) we should now say that these words were uttered on Tuesday evening, and consequently that the "two days" here spoken of were Wednesday and Thursday, or from Tuesday evening to Thursday evening.

**The Pasch.** Pasch is a Hebrew word (*pesach*) meaning *Pass-over*. It was the feast which commemorated the passing over Egypt of the angel that destroyed the first born of the Egyptians and spared the Hebrew children. The Pasch was the most important of the Jewish festivals and lasted for eight days, beginning about sunset on the 14th of Nisan (Deut. xvi. 6) and ending at sunset on the 21st of Nisan, the first month of the Jewish sacred year.

3. Then were gathered together the chief priests and ancients of the people into the court of the high priest, who was called Caiphas:

4. And they consulted together, that by subtilty they might apprehend Jesus, and put him to death.

5. But they said: Not on the festival day, lest perhaps there should be a tumult among the people.

6. And when Jesus was in Bethania, in the house of Simon the leper,

7. There came to him a woman having an alabaster box of precious ointment, and poured it on his head as he was at table.

The other great feasts among the Jews were those of Pentecost and Tabernacles. The former was celebrated just fifty days after the Pasch and lasted for only one day, marking the completion of the harvest (Exod. xxiii. 16; Deut. xvi. 9), and commemorated the giving of the Law by Moses; the latter was observed from the evening of the 14th till that of the 22nd of Tisri, the seventh month of the sacred year and celebrated the ingathering of all fruits (Exod. xxxiv. 22; Levit. xxiii. 34-43).

3. Then, which, according to ancient tradition, was Wednesday around nightfall, although it might have been in the morning.

Chief priests and ancients; i.e., members of the Great Council, the Sanhedrim, who assembled in the interior court-yard (*εις την αυλην*), or palace itself of the High Priest.

5. The festival day may refer to any day within the octave of the Paschal feast, but here it most probably means the Pasch itself. Many thousands of Jews came to Jerusalem for the Paschal celebration, and many among these, especially from Galilee, were favorably disposed toward Jesus; hence the authorities feared a "tumult among the people."

6. When Jesus was in Bethania. St. John (xii. 1, 2) tells us that this was six days before the Pasch, and therefore it must have been on Saturday, the 8th of Nisan. Matthew and Mark make mention of this event to explain the action of Judas in going to the High-Priests (verse 14).

Simon the leper. Many identify this Simon with the Simon mentioned by St. Luke (vii. 40). He was called "the leper" very probably because he had been cured of the disease of leprosy. Lazarus was a guest at this supper given by Simon, and Martha served at it (John xii. 2).

7. A woman, who was Mary, the sister of Lazarus and Martha

8. And the disciples seeing it, had indignation, saying: To what purpose is this waste?

9. For this might have been sold for much, and given to the poor.

10. And Jesus knowing it, said to them: Why do you trouble this woman? for she hath wrought a good work upon me.

11. For the poor you have always with you: but me you have not always.

12. For she in pouring this ointment upon my body, hath done it for my burial.

13. Amen I say to you, wheresoever this gospel shall be preached in the whole world, that also which she hath done, shall be told for a memory of her.

14. Then went one of the twelve, who was called Judas Iscariot, to the chief priests,

15. And said to them: What will you give me, and I will deliver him unto you? But they appointed him thirty pieces of silver.

16. And from thenceforth he sought opportunity to betray him.

17. And on the first day of the Azymes, the disciples came to Jesus, saying: Where wilt thou that we prepare for thee to eat the pasch?

(John xii. 3). It was customary among the ancients for a host to honor his guests by pouring a sweet scented oil on their heads during the repast. This office Mary discharged for our Lord at the supper in Bethany. "The precious ointment" was a perfume of very pleasant odor obtained from an Indian plant (*Nardostachys Jatamansi*).

8. **The disciples . . . had indignation**; i.e., one of the disciples, Judas Iscariot (John xii. 4).

11. **But me you have not always**; i.e., the poor shall never cease to be visibly present in the land (Deut. xv. 11), but the visible presence of our Lord on the earth was only for a time.

12. **For my burial**; i.e., in anticipation of His burial. The Jews were accustomed to anoint the bodies of their dead out of affection for them, as well as to preserve the bodies from corruption.

14. **To the chief priests**; i.e., to the members of the Sanhedrim, mentioned above (verse 3).

15. **Thirty pieces of silver**, equal to about \$15.30; it was the price of a slave among the Jews (Exod. xxi. 32).

16. **From thenceforth**; i.e., from the time of his compact with the members of the Sanhedrim.

17. **On the first day of Azymes**; i.e., of unleavened bread (*ἄζυμα, unleavened*), from the sunset of the 14th of Nisan to sunset of the 15th of Nisan. Legally all leaven had to be out of Jewish

houses by noon of the 14th of Nisan. To make sure of this the clearing of the houses of leaven commenced the evening before, i.e., on the 13th of Nisan. Hence the words, "first day of Azymes," *could* be taken to mean the 13th of Nisan.

All four Gospels agree that our Lord ate the Last Supper on Thursday evening, and that He was put to death on Friday. Cf. Matthew xxvii. 62; Mark xv. 42; Luke xxiii. 54; John xix. 31. But did the Jews and our Lord celebrate the Pasch on the same evening? This is a much disputed question. According to the Synoptics, we should be inclined to say that they did, on the evening of the 14th of Nisan; but according to St. John, it would seem that our Lord, the last year of His life, ate the Pasch the night before the Jews ate theirs. Those who accept this latter opinion try to explain the Synoptics in accordance with St. John. On what date, then, in this opinion, did our Lord celebrate the Pasch? *Answer:* On the evening of the 14th of Nisan, if we suppose that the Jews, on account of the 14th that year being the day before the Sabbath, transferred their Pasch to the 15th; but, on the 13th, provided the Jews, as usual, celebrated theirs on the 14th. As it is not well proved that the Jews ever transferred the Pasch to the 15th of Nisan, the advocates of this opinion say that the Lord celebrated the last Passover with His disciples on the evening of the 13th of Nisan (the beginning of the 14th). Thus He was crucified on the 14th of Nisan, and the Jews ate their Pasch that evening, after the crucifixion.

Arguments for this opinion:—(a) St. John (xiii. 1) says the Last Supper was "before the festival day of the Pasch"; (b) The Law (Exod. xii. 22) forbade the Israelite, after the Paschal meal, to go out of his house until the next morning; but that night Judas went out immediately after the meal and that, as the Apostles thought (John xiii. 29), to buy things for the festival day, and soon after our Lord and all the disciples went out; (c) The next morning, St. John (xviii. 28) says, the Jews would not enter the Praetorium of Pilate, "that they might not be defiled, but that they might eat the Pasch"; hence they had not yet eaten the Pasch; (d) St. John (xix. 31) calls the day following the crucifixion a "great Sabbath day," doubtless because it was at once the Sabbath and the first or solemn day of the Pasch; (e) the trial, condemnation, and cruci-

fixion of Jesus would have been morally impossible on the solemn day of the Pasch.

Objections to this opinion:— (a) St. Matthew (xxvi. 17) and the other Synoptists say our Lord ate the Pasch “on the first day of the unleavened bread.” *Answer*: The first day of the unleavened bread began at sunset, the 13th of Nisan, and it was only after this sunset that it is maintained that our Lord did eat the Pasch. Moreover, some hold that *ἡμέρα πρώτη* should be translated as if written *ἡμέρα προτέρα*, i.e., the day *before*, and not the *first* day of unleavened bread.

(b) All four Evangelists speak of the liberation of Barabbas the day of our Lord’s death, and Sts. Matthew (xxvii. 15), Mark (xv. 6), and John (xviii. 39), say it was customary thus to free a prisoner on the festival day, i.e., on the Pasch. *Answer*: As they were to eat the Pasch that same evening, the liberation of Barabbas could have been by anticipation.

(c) If Christ ate the Pasch on the evening of the 13th of Nisan, how could He have had the lamb killed in the Temple in the presence of the priests, since this was to be done only on the afternoon of the 14th of Nisan? *Answer*: According to a more ancient practice the lamb was slain privately by the head of the family; hence St. Peter could have been delegated for this purpose.

(d) Fermented bread was used on the 13th of Nisan; hence if our Lord celebrated the Last Supper on that date, He must have used leavened bread. *Answer*: It is the common opinion of the Church that the Last Supper was the Pasch (*Con. Trid.*, Sess. xxii. can. i), but for the Pasch only unleavened bread was allowed.

Following the obvious data of the Synoptics the old and more common opinion is that the Pasch, the last year of our Lord’s life, was celebrated by Him and the Jews alike on the same day, the evening of the 14th of Nisan.

Arguments for this opinion:— (a) St. Mark (xiv. 12) expressly says that our Lord sent His disciples to prepare the Pasch “on the first day of unleavened bread, when they sacrificed the Pasch,” and with this St. Matthew (xxvi. 17–20) agrees perfectly; but the first day of unleavened bread was the 14th of Nisan, i.e., Thursday, at sunset of which the 15th of Nisan began; (b) Some writers claim that there was a traditional custom among the Jews, whenever the

Pasch would fall on the day before the Sabbath, to postpone the Paschal Supper from Thursday evening (the 14th-15th of Nisan) to Friday evening (the 15th-16th of Nisan), so as to avoid the occurrence of two solemn feasts on successive days; and this, these writers say, was done the last year of our Lord's life on earth. But the existence of such a tradition at that time has never been well established, and it is most probable that the custom referred to is of a date later than the time of our Lord; (c) All four Evangelists speak of the liberation of Barabbas on the day on which our Lord was put to death, and St. Matthew (xxvii. 15) says that this liberation of a prisoner was always on a festival day, and St. John (xviii. 39) says that this *festival* day was "the pasch." Hence it follows that our Lord's crucifixion took place on the feast of the Pasch, i.e., the day after He and the Jews had eaten the Paschal Supper.

Objections to this opinion:— (a) St. John (xiii. 1) says our Lord ate the Last Supper "before the festival day of the Pasch." *Answer:* St. John was speaking of the civil day, from midnight to midnight, in accordance with the usage to which he had become accustomed living among the Greeks.

(b) St. John (xviii. 28) says that when the Jews were accusing our Lord, "they went not into the hall that they might not be defiled, but that they might eat the Pasch"; hence, they had not yet eaten the Pasch. *Answer:* The word Pasch sometimes means "Paschal Lamb," sometimes it refers to other victims which were offered and eaten during the Paschal celebration. It is perhaps in this latter sense that St. John used the word in the above quotation.

(c) During our Lord's trial and condemnation, there were many things which would have been forbidden on a festal day. *Answer:* There is no proof that any of these were strictly against the letter of the Law.

(d) St. John (xix. 31) calls the day following our Lord's crucifixion "a great Sabbath day," which would indicate that the Pasch and Sabbath were combined. *Answer:* Any Sabbath following within the octave of the Pasch could, with equal reason, have been called a great Sabbath day.

(e) St. John (xix. 14) says our Lord was crucified on "the parasceve of the Pasch," which means the "preparation of the

18. But Jesus said: Go ye into the city to a certain man, and say to him: The master saith, My time is near at hand, with thee I make the pasch with my disciples.

19. And the disciples did as Jesus appointed to them, and they prepared the pasch.

20. But when it was evening, he sat down with his twelve disciples.

Pasch." *Answer*: "Parasceve," in the sense of preparation, could have been given to the day, because it was the preparation of the Sabbath; but Parasceve also commonly meant the *sixth* day of the week.

(f) St. John (xiii. 29) says that when Judas left the Supper room the other Apostles thought Jesus had sent him out to buy things "for the festival day," or to "give something to the poor." But on the night of the 14th of Nisan it was not lawful to buy or sell, and if the feast had already begun the conjecture of the Apostles would have been out of place. *Answer*: Buying and selling of articles of food was not forbidden during the Pasch (Exod. xii. 16), and since the celebration continued during seven days, it was not out of place in the Apostles to think that Judas had gone to make provision for the days that were to come.

The disciples came to Jesus; i.e., two of the disciples (Mark xiv. 13), who were Peter and John (Luke xxii. 8).

18. Go ye into the city; i.e., into Jerusalem, which alone was appointed by law for the Paschal celebration (Deut. xvi. 5-7).

To a certain man, who was doubtless one of the Master's disciples. Some say he was Mark, the author of the Second Gospel.

My time is near at hand; i.e., to depart out of the world.

19. And they prepared the pasch; i.e., they made ready the preliminaries of the Paschal meal, which comprised the presentation of the Paschal Lamb in the court of the Temple, where the head of the family assisted the Levites in immolating it, the preparation of the unleavened bread, and the purchase of the bitter herbs.

20. He sat down, — rather, *He reclined* (*ἀνέκειτο*). At this time the Jews reclined at their meals on low couches or mats. They lay while at table on their left side, so as to assist themselves with their right hand. The command to stand while eating (Exod. xii. 11) did not oblige after the Jews had reached the promised land.

21. And whilst they were eating, he said: Amen I say to you, that one of you is about to betray me.

22. And they being very much troubled, began every one to say: Is it I, Lord?

23. But he answering, said: He that dippeth his hand with me in the dish, he shall betray me.

24. The Son of man indeed goeth, as it is written of him: but woe to that man by whom the Son of man shall be betrayed: it were better for him, if that man had not been born.

25. And Judas that betrayed him, answering, said: Is it I, Rabbi? He saith to him: Thou hast said it.

26. And whilst they were at supper, Jesus took bread, and blessed, and broke: and gave to his disciples, and said: Take ye, and eat. This is my body.

21. **One of you is about to betray me.** According to St. Luke (xxii. 21) the traitor was denounced after the institution of the Blessed Eucharist, but it is more likely that St. Matthew and St. Mark are correct in placing the denunciation before. Probably, then, Judas did not receive Communion with the rest of the Apostles. See on Luke xxii. 19-23.

23. **He that dippeth his hand with me, etc.** As there were several of such dishes on the table, these words would seem to show that Judas occupied a place near our Lord. It is wrong, however, to suppose that Judas was putting his hand into the dish just when our Lord spoke thus. Had this been true all would have known at once who the traitor was, and the subsequent question would have been superfluous.

24. **It were better for him, etc.** These words seem clearly to show the condemnation of Judas, because these words would not be true of any of those who are finally saved.

25. **Thou hast said it,** — a mild form of expressing "yes;" these words must have been expressed quietly, as the other Apostles seemed not to understand.

26. **Whilst they were at supper,** — literally, *as they were eating* (ἐσθίουστων δὲ αὐτῶν). This was towards the end of the meal, after eating the Paschal Lamb and partaking of the common Jewish supper, which succeeded the eating of the Paschal Lamb.

**Jesus took bread;** i.e., unleavened bread, the only kind then to be had; or at least, the only kind that was allowed for the Paschal Supper.

**And broke.** Our Lord broke the bread before distributing it.



27. And taking the chalice, he gave thanks, and gave to them, saying: Drink ye all of this.

28. For this is my blood of the new testament, which shall be shed for many unto remission of sins.

29. And I say to you, I will not drink from henceforth of this fruit of the vine, until that day when I shall drink it with you new in the kingdom of my Father.

**And gave to his disciples.** Since the institution of the Blessed Sacrament most likely took place toward the end of the Supper, and since Judas seems to have left the table at the beginning of the meal, it would appear that the traitor did not receive the Sacred Species.

**This is my body;** i.e., this thing which I give you is my body, — words which express *transubstantiation*. Bread is not the body of Christ; neither is the body of Christ bread; therefore, the words “this is my body” can be true only on condition that the bread was changed into the body of Christ.

**27. The chalice.** This was probably the third, or fourth, of the four cups of wine mingled with water that were used at the Paschal Supper.

**He gave thanks,** to Almighty God, for the great benefit about to be bestowed on man.

**Drink ye all of this,** — “all” refers to the Apostles, and not to the contents of the cup.

**28. For this is my blood,** words signifying the *transubstantiation* of the wine into the blood of Christ.

**Of the new testament;** i.e., of the New Covenant between God and man. Blood was the ratification of the Covenant. The Old Covenant, which was but a figure of the New, was ratified by the blood of the sacrifice (Exod. xxiv. 7, 8), and now the New Covenant of the Gospel was ratified by the blood of Christ.

**Which shall be shed for many.** The Greek reads, “is shed” (*ἐκχυννόμενον*). The use of the present participle shows that our Lord was already pouring out His blood in the Eucharistic sacrifice. The blood of Christ is poured out for all, but all do not partake of its fruits.

**29. Fruit of the vine** does not refer to the wine which Christ had consecrated into His blood, but to the other cups which were served during the Paschal celebration. Usually, four cups of wine

30. And a hymn being said, they went out unto mount Olivet.

31. Then Jesus saith to them: All you shall be scandalized in me this night. For it is written: I will strike the shepherd, and the sheep of the flock shall be dispersed.

32. But after I shall be risen again, I will go before you into Galilee.

33. And Peter answering, said to him: Although all shall be scandalized in thee, I will never be scandalized.

34. Jesus said to him: Amen I say to thee, that in this night before the cock crow, thou wilt deny me thrice.

35. Peter saith to him: Yea, though I should die with thee, I will not deny thee. And in like manner said all the disciples.

36. Then Jesus came with them into a country place which is called Gethsemani; and he said to his disciples: Sit you here, till I go yonder and pray.

mingled with water were served at the Paschal Supper, as said above (verse 27); the meaning of the passage is that this is our Lord's last feast on earth as mortal man.

With you new; i.e., in a glorified state, in Heaven.

30. **A hymn being said.** It was customary to close the Paschal Supper with a song of thanksgiving, the concluding part of the *Hallel* (Psalms cxiv-cxvii).

31. **Then;** i.e., as they went to Gethsemani from the supper room, perhaps about 10 o'clock in the evening.

**Scandalized;** i.e., shocked, disappointed,—and even led into sin, in so far as they should waver in their faith.

**For it is written,** in Zach. (xiii. 7), where we read the imperative form, "strike the shepherd," as if commanded by Almighty God. Our Lord now applied the prophecy to Himself and His Apostles, under the symbols of a shepherd and sheep.

32. **I will go . . . into Galilee,** as was afterwards verified (xxviii. 7, 10, 16). Our Lord had already four times predicted that His Resurrection would follow upon His death, and now He adds that after it He will appear in Galilee.

33, 34. **Before the cock crow.** St. Mark (xiv. 30) has, "before the cock crow twice." The cock was wont to crow at midnight and at daybreak. The other Evangelists, besides St. Mark, refer only to the last crowing.

Peter loved Christ, but he relied too much on himself. He did not know, as our Lord did, his own weakness.

36. **A country place** (*χωριον*, a farm), which was an enclosed garden, containing many olive-trees.

37. And taking with him Peter and the two sons of Zebedee, he began to grow sorrowful and to be sad.

38. Then he saith to them: My soul is sorrowful even unto death: stay you here, and watch with me.

39. And going a little further, he fell upon his face, praying, and saying: My Father, if it be possible, let this chalice pass from me. Nevertheless not as I will, but as thou wilt.

40. And he cometh to his disciples, and findeth them asleep, and he saith to Peter: What? Could you not watch one hour with me?

41. Watch ye, and pray that ye enter not into temptation. The spirit indeed is willing, but the flesh weak.

42. Again the second time, he went and prayed, saying: My Father, if this chalice may not pass away, but I must drink it, thy will be done.

43. And he cometh again, and findeth them sleeping: for their eyes were heavy.

**Gethsemani** means "oil press," so called because many olives were there produced. Gethsemani was east of the city, just across the brook Cedron at the foot of the Mount of Olives, about one mile from Jerusalem.

He said to his disciples; i.e., to those whom He left without the garden gate; Peter, James and John entered with Him into the garden (Mark xiv. 32, 33).

37. **Sorrowful . . . sad**, words which express the agony of His Passion. St. Luke (xxii. 43, 44) observes that so great was His agony that "his sweat became as drops of blood trickling down upon the ground." If we do not understand how this was possible in our Lord, who was also God, it is because we do not know all the relations and conditions between the human and divine natures in Christ. But the possibility of a natural perspiration of blood is no longer questioned by science. See Le Camus, *Life of Christ*, vol. iii, p. 286, note.

38. **Then he saith to them**; i.e., to Peter, James and John.

39. **A little further**; i.e., about a "stone's throw" (Luke xxii. 41), in order to be more alone with His heavenly Father.

**If it be possible**; i.e., if it be consistent with the eternal decrees; our Lord was speaking as man. **Chalice** means His Passion.

**Not as I will, but as thou wilt**, — giving us an example how we should pray.

40. **He saith to Peter**, who had been so boastful in his promises. It was not indifference, but their very sorrow which caused the disciples to fall asleep (Luke xxii. 45).

41. **That ye enter not into temptation**; i.e., that ye be not over-

44. And leaving them, he went again: and he prayed the third time, saying the selfsame word.

45. Then he cometh to his disciples, and saith to them: Sleep ye now and take your rest; behold the hour is at hand, and the Son of man shall be betrayed into the hands of sinners.

46. Rise, let us go: behold he is at hand that will betray me.

47. As he yet spoke, behold Judas, one of the twelve, came, and with him a great multitude with swords and clubs, sent from the chief priests and the ancients of the people.

48. And he that betrayed him, gave them a sign, saying: Whomsoever I shall kiss, that is he, hold him fast.

49. And forthwith coming to Jesus, he said: Hail, Rabbi. And he kissed him.

50. And Jesus said to him: Friend, whereto art thou come? Then they came up, and laid hands on Jesus, and held him.

51. And behold one of them that were with Jesus, stretching forth his hand, drew out his sword: and striking the servant of the high priest, cut off his ear.

52. Then Jesus saith to him: Put up again thy sword into its place: for all that take the sword shall perish with the sword.

53. Thinkest thou that I cannot ask my Father, and he will give me presently more than twelve legions of angels?

54. How then shall the scriptures be fulfilled, that so it must be done?

come by, or yield to, temptation. Soon temptation would sorely try them.

44. **He prayed the third time,** — to teach us perseverance in prayer. It was likely this time that the angel came to strengthen Him (Luke xxii. 43).

45. **Sleep ye now and take your rest.** These words were most probably spoken ironically, as if to say, "when there was need of vigilance, you were sleeping; now it is too late." The words convey a gentle reproach.

46. **Let us go;** i.e., to meet the traitor Judas.

47. **Judas led this infamous band to the garden where Jesus was praying.**

50. **Friend, whereto, etc.,** — literally, "sir, what is your business?" (*Ἐταίρε ἐφ' ὃ πάρει*).

51. **One of them, who was Simon Peter (John xviii. 10), struck with his sword the "servant of the high-priest," whose name was Malchus (John xviii. 10), and "cut off his ear."**

52. **All that take the sword shall perish, etc.** The meaning is that all who enter battle to kill others, must themselves expect to be killed.

53, 54. These verses show that our Lord's Passion was volun-

55. In that same hour Jesus said to the multitudes: You are come out as it were to a robber with swords and clubs to apprehend me. I sat daily with you, teaching in the temple, and you laid not hands on me.

56. Now all this was done, that the scriptures of the prophets might be fulfilled. Then the disciples all leaving him, fled.

57. But they holding Jesus led him to Caiphaz the high priest, where the scribes and the ancients were assembled.

58. And Peter followed him afar off, even to the court of the high priest. And going in, he sat with the servants, that he might see the end.

59. And the chief priests and the whole council sought false witness against Jesus, that they might put him to death:

60. And they found not, whereas many false witnesses had come in. And last of all there came two false witnesses:

tary, and that, had He wished, He could have prostrated all His enemies.

55, 56. All this was done that the scriptures . . . be fulfilled. If our Lord's enemies did not lay hands upon Him when He was teaching in the Temple, it was because He did not permit them; but now, that the prophecies (Isa. liii; Ps. xxi; Lam. iv) might be fulfilled, He permits the atrocities of His Passion.

57-59. If the members of the Sanhedrim were gathered that night at the High-Priest's house it was not for the judicial trial of our Lord, which took place "as soon as it was day" (Luke xxii. 66). The Great Council was not allowed to meet for official business during the night, but we know from St. John that there were also two night trials of our Lord — one before Annas (John xviii. 13), which the Synoptists do not mention; the other before Caiphaz (John xviii. 24), of which St. John says nothing, because the Synoptists had given an account of it. In the session before Annas no capital sentence was pronounced, but in the house of Caiphaz our Lord was declared guilty of death for blasphemy and Caiphaz ordered Him to be kept under guard until His formal trial before the Sanhedrim the next morning. There were, then, according to St. John, two night trials of our Lord in two different places, before two different judges and with two different results prior to the judicial trial before the Council the following morning. This is the obvious meaning of the texts of St. John, and it is St. John, and not the Synoptists, who should be our guide here.

60. **Two false witnesses.** At least two witnesses were necessary,

61. And they said: This man said, I am able to destroy the temple of God, and after three days to rebuild it.

62. And the high priest rising up, said to him: Answerest thou nothing to the things which these witness against thee?

63. But Jesus held his peace. And the high priest said to him: I adjure thee by the living God, that thou tell us if thou be the Christ the Son of God.

64. Jesus saith to him: Thou hast said it. Nevertheless I say to you, hereafter you shall see the Son of man sitting on the right hand of the power of God, and coming in the clouds of heaven.

65. Then the high priest rent his garments, saying: He hath blasphemed; what further need have we of witnesses? Behold, now you have heard the blasphemy:

66. What think you? But they answering, said: He is guilty of death.

67. Then did they spit in his face, and buffeted him: and others struck his face with the palms of their hands,

68. Saying: Prophesy unto us, O Christ, who is he that struck thee?

according to the Law, to establish any trustworthy testimony (Deut. xix. 15); but these were false witnesses.

61. **I am able to destroy this temple, etc.** Our Lord had never said what these witnesses alleged. What He did say was: "Destroy this temple, and I will raise it up" (John ii. 19). Moreover, He was speaking of His body, and not of the Temple in Jerusalem.

63. **Jesus held his peace, as nothing of importance had yet been brought against Him.**

**I adjure thee; i.e., I publicly and solemnly oblige you.**

**If thou be the Christ the Son of God; i.e., the Messiah and the natural Son of God, as our Lord had proclaimed Himself to be.**

64. **Thou hast said it, — a mild way of saying, "I am."**

**Hereafter, you shall see, etc.; i.e., after His Resurrection and Ascension, His enemies should know from the Church which He had established that He was, in truth, the Son of God. It would not be necessary to wait till His second coming in glory and majesty.**

65. **Rent his garments, in indignation, but contrary to the Law (Levit. x. 6; xxi. 4, 10).**

**He hath blasphemed, by proclaiming Himself to be the Son of God.**

66, 67. **He is guilty of death; i.e., he deserves death for saying He is the Son of God.**

**Spit in his face and buffeted him, after they had blindfolded Him (Mark xiv. 65; Luke xxii. 64).** These atrocities took place after His condemnation by Caiphas during the night session. See

69. But Peter sat without in the court: and there came to him a servant maid, saying: Thou also wast with Jesus the Galilean.

70. But he denied before them all, saying: I know not what thou sayest.

71. And as he went out of the gate, another maid saw him, and she saith to them that were there: This man also was with Jesus of Nazareth.

72. And again he denied with an oath: I know not the man.

above, verses 57-59. The next morning, after the judicial trial and condemnation by the Sanhedrim (Luke xxii. 66), He was delivered up to Pilate.

69. Peter sat in the court; i.e., in the court-yard. Houses of importance in the East have a spacious interior court-yard surrounded by a cloister. Entrance to this court-yard from the street is made through a narrow door cut in a large monumental gate. The gate and door are guarded by a porter.

Jesus, the Galilean. These words were spoken in contempt, since no prophet was thought to come from Galilee (John vii. 52).

70. The apparent differences in the story of Peter's denials, as given by the four Evangelists, cause some difficulty. They are reconciled as follows: (a) When Peter, at John's request, was admitted to the court-yard of the High-Priest our Lord was before Annas. John went at once to the apartment where Jesus was being examined, but Peter remaining in the court-yard took a seat among the servants who were gathered around a fire. One of the servants, the portress, suspecting him said: "Thou also wast with Jesus the Galilean" (verse 69); but he replied: "I know not what thou sayest" (verse 70). And to her repeated questions, he answered: "I am not" one of his disciples (John xviii. 25), "woman, I know him not" (Luke xxii. 57). Just after this Jesus was led from the apartments of Annas across the court-yard to those of Caiphas, and Peter in shame at the sight of Jesus fled towards the gate of the court as if to escape (Mark xiv. 68; Matthew xxvi. 71), when the cock crew (Mark xiv. 68). (b) It was now a little after midnight, and Peter returning to the fire was again accused by the portress and another maid-servant (Matthew xxvi. 71) and by one of the bystanders (Luke xxii. 58) of being a disciple of Jesus; but he swore, "I know not the man" (Matthew xxvi. 72), "O man, I am not" (Luke xxii. 58). Meanwhile the second night trial of Jesus before Caiphas in the presence of the members of the Sanhedrim, unlawfully assembled, was going on. (c) When

73. And after a little while they came that stood by, and said to Peter: Surely thou also art one of them; for even thy speech doth discover thee.

74. Then he began to curse and to swear that he knew not the man. And immediately the cock crew.

75. And Peter remembered the word of Jesus which he had said: Before the cock crow, thou wilt deny me thrice. And going forth, he wept bitterly.

finally, about three o'clock in the morning, the Saviour was led out to be subjected to the insults of the servants of the High-Priest of the Temple, Peter was still in the court-yard under the fire of the questions of the bystanders; one of these called attention to his Galilean accent (Matthew xxvi. 73), another protested that he had seen him in the garden with Jesus (John xviii. 26); but Peter swore "he knew not the man" (Matthew xxvi. 74). Just then the cock crowed the second time, and Jesus, turning for a second from the blows and spittle with which He was being outraged, cast a glance at the miserable Apostle. Peter, overwhelmed by that look of sorrow, fled from the palace and wept bitterly.

73. Thy speech doth discover thee; i.e., thy Galilean accent.

## CHAPTER XXVII

THE COUNCIL OF THE SANHEDRIM, 1, 2.

THE EVIL END OF JUDAS, 3-10.

JESUS BEFORE PILATE, 11-14.

JESUS AND BARABBAS, 15-18.

PILATE'S WIFE, 19.

JESUS IS CONDEMNED, 20-26.

JESUS IS MOCKED, 27-31.

THE WAY OF THE CROSS, 32-34.

THE CRUCIFIXION OF JESUS, 35-44.

THE AGONY AND DEATH OF JESUS, 45-54.

THE PIOUS WOMEN FROM GALILEE, 55, 56.

THE BURIAL OF JESUS, 57-66.

1. And when morning was come, all the chief priests and ancients of the people took counsel against Jesus, that they might put him to death.

1. **The chief priests and ancients.** This was the formal meeting of the Sanhedrim, which properly could not meet at night. See above, xxvi. 57-59.



2. And they brought him bound, and delivered him to Pontius Pilate the governor.

3. Then Judas, who betrayed him, seeing that he was condemned, repenting himself, brought back the thirty pieces of silver to the chief priests and ancients.

4. Saying: I have sinned in betraying innocent blood. But they said: What is that to us? look thou to it.

5. And casting down the pieces of silver in the temple, he departed: and went and hanged himself with an halter.

6. But the chief priests having taken the pieces of silver, said: It is not lawful to put them into the corbona, because it is the price of blood.

7. And after they had consulted together, they bought with them the potter's field, to be a burying place for strangers.

8. For this cause that field was called Haceldama, that is, The field of blood, even to this day.

9. Then was fulfilled that which was spoken by Jeremias the prophet, saying: And they took the thirty pieces of silver, the price of him that was prized, whom they prized of the children of Israel.

10. And they gave them unto the potter's field, as the Lord appointed to me.

2. **Delivered him to Pontius Pilate**, because only the Governor could lawfully sentence an accused to death, at least by crucifixion. Pontius Pilate was the sixth of the Roman Procurators to administer the affairs of Judea. He resided ordinarily at Caesarea, on the sea-coast, but whenever great crowds of people were assembled at Jerusalem, Pilate was accustomed to be present there with his soldiers.

3. **Judas seeing that he was condemned**, which was more than Judas had expected.

4. **What is that to us.** These words show that the members of the Sanhedrim wished the death of our Lord, whether He was guilty or not.

5. **And hanged himself**, the effects of which are given more in detail by St. Peter (Acts i. 18).

6. **Corbona**; i.e., the treasury of the Temple; *corbona*, from *corban*, "a gift."

8. **Even to this day**, — words which show that St. Matthew's account was written perhaps some years after the death of Christ.

9. **Jeremias the prophet.** In Jeremias (xxxii. 6 ff.) there is an account of the purchase of a field, but the quotation here made is partly from Zacharias (xi. 12, 13). The quotation is attributed to Jeremias, because the latter was better known.

11. And Jesus stood before the governor, and the governor asked him, saying: Art thou the king of the Jews? Jesus saith to him: Thou sayest it.

12. And when he was accused by the chief priests and ancients, he answered nothing.

13. Then Pilate saith to him: Dost not thou hear how great testimonies they allege against thee?

14. And he answered him to never a word; so that the governor wondered exceedingly.

15. Now upon the solemn day the governor was accustomed to release to the people one prisoner, whom they would.

16. And he had then a notorious prisoner, that was called Barabbas.

17. They therefore being gathered together, Pilate said: Whom will you that I release to you, Barabbas, or Jesus that is called Christ?

18. For he knew that for envy they had delivered him.

19. And as he was sitting in the place of judgment, his wife sent to him, saying: Have thou nothing to do with that just man; for I have suffered many things this day in a dream because of him.

20. But the chief priests and ancients persuaded the people, that they should ask Barabbas, and make Jesus away.

21. And the governor answering, said to them: Whether will you of the two to be released unto you? But they said, Barabbas.

22. Pilate saith to them: What shall I do then with Jesus that is called Christ? They say all: Let him be crucified.

23. The governor said to them: Why, what evil hath he done? But they cried out the more, saying: Let him be crucified.

24. And Pilate seeing that he prevailed nothing, but that rather a tumult was made; taking water washed his hands before the people, saying: I am innocent of the blood of this just man; look you to it.

25. And the whole people answering, said: His blood be upon us and upon our children.

26. Then he released to them Barabbas, and having scourged Jesus, delivered him unto them to be crucified.

11. **Before the governor.** Our Lord seems to have appeared before Pilate three times during His trial. This is His first appearance, also mentioned by St. John (xviii. 29-31); the second is related by St. John (xviii. 33-38), and the third, also (xix. 8-16).

15. **The solemn day**, which would seem to have been the Pasch, as we infer from St. John (xviii. 39), i.e., the day following the evening on which the Paschal Lamb was eaten, or should have been eaten, according to Law. However, the phrase, *κατὰ τὴν ἑορτήν*, merely means, *during the festival time*.

16. **Barabbas**, who was a robber and a murderer (Mark xv. 7; John xviii. 40).

19. **In a dream**, of which we know nothing further.

24. **Washed his hands**, showing that he believed our Lord to

27. Then the soldiers of the governor taking Jesus into the hall, gathered together unto him the whole band;

28. And stripping him, they put a scarlet cloak about him.

29. And plating a crown of thorns, they put it upon his head, and a reed in his right hand. And bowing the knee before him, they mocked him, saying: Hail, king of the Jews.

30. And spitting upon him, they took the reed, and struck his head.

31. And after they had mocked him, they took off the cloak from him, and put on him his own garments, and led him away to crucify him.

32. And going out, they found a man of Cyrene, named Simon: him they forced to take up his cross.

33. And they came to the place that is called Golgotha, which is the place of Calvary.

be innocent. This was the third appearance of our Lord before Pilate; the sending to Herod and the scourging took place between the first and second arraignments before Pilate. It is not probable that our Lord was scourged more than once. Therefore, St. Matthew relates the scourging (verse 26) out of its order. Scourging with the *flagellum* was the ordinary punishment of a slave, and was usually inflicted on a prisoner before crucifixion. Pilate, however, in our Lord's case, seems to have intended to scourge Him and then release Him (Luke xxiii. 16, 22).

27. Into the hall of the Governor's residence.

The whole band; i.e., Pilate's body-guard, composed of some hundreds of men.

28, 29. Scarlet cloak . . . crown of thorns, in derision of His claim to kingship. "Scarlet," or dark red, given here, is the same as the "purple" of St. Mark (xv. 20).

32, 33. Going out, of the city to the place of crucifixion. Among the Jews, as among the Romans, the guilty were executed outside the city.

Of Cyrene, which was a city of Lybia, in northern Africa, west of Egypt.

They forced; i.e., they forced him against his will (*ἀγγαρεύουσι*). It is more probable that our Lord carried the cross Himself, as long as He could, and that it was then taken by Simon alone.

Golgotha, an Aramaic word meaning a "skull." Calvary is the Latin word for "skull." The hill of Calvary was so called, perhaps, because of the skulls of many criminals executed there; or, it may be, because the formation of the hill resembled that of a skull.

34. And they gave him wine to drink mingled with gall. And when he had tasted, he would not drink.

35. And after they had crucified him, they divided his garments, casting lots; that it might be fulfilled which was spoken by the prophet, saying: They divided my garments among them; and upon my vesture they cast lots.

36. And they sat and watched him.

37. And they put over his head his cause written: **THIS IS JESUS THE KING OF THE JEWS.**

38. Then were crucified with him two thieves: one on the right hand, and one on the left.

39. And they that passed by, blasphemed him, wagging their heads,

40. And saying, Vah, thou that destroyest the temple of God, and in three days dost rebuild it: save thy own self: if thou be the Son of God, come down from the cross.

41. In like manner also the chief priests, with the scribes and ancients, mocking, said:

42. He saved others; himself he cannot save. If he be the king of Israel, let him now come down from the cross, and we will believe him.

43. He trusted in God; let him now deliver him if he will have him; for he said: I am the Son of God.

34. Wine, mingled with gall. St. Mark (xv. 23) says, "with myrrh." This was a narcotic beverage, prepared by some pious women to deaden the pain of those to be executed.

He would not drink, which shows that our Lord wanted consciously to suffer for us.

35. After they had crucified him. It seems more probable that our Lord was nailed to the cross with four nails, a separate nail through each foot, as well as through each hand. The feet were nailed with the soles flat to the wood; and, hence, when He hung on the cross, He was in a crouching posture, with knees bending outward.

They divided my garments, Psalm xxi. 19.

37. His cause; i.e., the reason for which He was condemned. St. John (xix. 19), who was an eye-witness, has perhaps given us the most authentic version of the superscription on the cross, "Jesus of Nazareth, the King of the Jews."

38. Two thieves, thus verifying the prophecy of Isaias, "and with the wicked, he was reputed" (liii. 12).

42, 43. These verses show how little the Jews understood the purpose of Christ's death; just because He was the Messiah and the King of the Jews, it was necessary that He should suffer and die, that His children might live.

44. And the selfsame thing the thieves also, that were crucified with him, reproached him with.

45. Now from the sixth hour there was darkness over the whole earth, until the ninth hour.

46. And about the ninth hour Jesus cried with a loud voice, saying: Eli, Eli, lamma sabacthani? that is, My God, my God, why hast thou forsaken me?

47. And some that stood there and heard, said: This man calleth Elias.

48. And immediately one of them running took a sponge, and filled it with vinegar; and put it on a reed, and gave him to drink.

49. And the others said: Let be, let us see whether Elias will come to deliver him.

44. **The thieves also**, which St. Mark (xv. 32) likewise seems to say; but St. Luke (xxiii. 39-41) says, "one of the thieves" reproached Him. If the good thief had upbraided our Lord at first, he afterwards repented of it.

45. **From the sixth hour until the ninth**; i.e., from about noon to about 3 P.M. This darkness was due to a special miracle; it was not due to an eclipse of the sun, because there was full moon at the time.

There is not a little difficulty in explaining the statements of St. John and the Synoptists regarding the hour of the crucifixion. St. Matthew here, St. Mark (xv. 33) and St. Luke (xxiii. 44) suppose it was about midday or before; but St. John (xix. 14) says "it was about the sixth hour." To explain this divergence some have said that, as the third hour ended and the sixth hour began at midday, the Synoptists were speaking of the ending of the third hour, and St. John was referring to the beginning of the sixth, therefore, "about the sixth hour." Others prefer to say that the divergence between the Evangelists is due to a divergence in the oral tradition which they followed, or that an error was made by some copyist in transcribing St. John.

46. **Eli, Eli, lama sabacthani?** "Eli," in Hebrew, means "My God." St. Mark (xv. 34) has the Aramaic form, "Eloi, Eloi." "Lamma" means "why?" "Sabacthani" means "hast thou forsaken me?" These words are from the popular Hebrew and Aramaic of the time.

47. **Calleth Elias.** This was said perhaps in mockery, because Elias was expected to come with the Messiah; or, perhaps, they understood "Eli" for "Elias."

48. **With vinegar,**—a sour wine called *posca* which was the

50. And Jesus again crying with a loud voice, yielded up the ghost.

51. And behold the veil of the temple was rent in two from the top even to the bottom, and the earth quaked, and the rocks were rent.

52. And the graves were opened: and many bodies of the saints that had slept arose,

53. And coming out of the tombs after his resurrection, came into the holy city, and appeared to many.

54. Now the centurion and they that were with him watching Jesus, having seen the earthquake, and the things that were done, were sore afraid, saying: Indeed this was the Son of God.

55. And there were there many women afar off, who had followed Jesus from Galilee, ministering unto him:

56. Among whom was Mary Magdalen, and Mary the mother of James and Joseph, and the mother of the sons of Zebedee.

ordinary drink of the Roman soldiers. Our Lord had just before uttered the words, "I thirst" (John xix. 28).

50. **Crying.** What He said was, "Father, into thy hands I commend my spirit" (Luke xxiii. 46).

It is consummated; i.e., all the prophecies concerning Me have been fulfilled, and the work committed to Me by My Father has been accomplished.

51. **The veil of the temple;** i.e., of the Sanctuary (*τοῦ ναοῦ, of the sanctuary*), which was hung over the entrance to the Holy of Holies.

**Bodies, . . . arose,** after His Resurrection (verse 53). It is the opinion of most commentators that these risen bodies, being re-animated by their souls, never again returned to their graves, but were taken by our Lord to Heaven, the first trophies of His own glorious Resurrection.

54. **The centurion,** — literally, "the commander of a hundred"; he was stationed "over against" our Lord, to prevent Him from being rescued.

55. **Many women afar off.** It was not safe to be too near. Among these women was the Blessed Virgin (John xix. 25).

56. **Mary Magdalen,** who, it is commonly supposed, was the sister of Lazarus and Martha. She was called Magdalen from Magdala, probably her native town on the west shore of the Sea of Galilee. **Mary, mother of James and Joseph.** This was Mary of Cleophas; some say she was a sister of the Blessed Virgin; others, of St. Joseph.

57. And when it was evening, there came a certain rich man of Arimathea, named Joseph, who also himself was a disciple of Jesus.

58. He went to Pilate, and asked the body of Jesus. Then Pilate commanded that the body should be delivered.

59. And Joseph taking the body, wrapped it up in a clean linen cloth.

60. And laid it in his own new monument, which he had hewed out in a rock. And he rolled a great stone to the door of the monument, and went his way.

61. And there was there Mary Magdalen, and the other Mary sitting over against the sepulchre.

62. And the next day, which followed the day of preparation, the chief priests and the Pharisees came together to Pilate,

63. Saying: Sir, we have remembered that that seducer said, while he was yet alive: After three days I will rise again.

64. Command therefore the sepulchre to be guarded until the third day: lest perhaps his disciples come and steal him away, and say to the people: He is risen from the dead; and the last error shall be worse than the first.

65. Pilate saith to them: You have a guard; go, guard it as you know.

66. And they departing, made the sepulchre sure, sealing the stone, and setting guards.

**Mother of the sons of Zebedee; i.e., Salome.**

57. **Arimathea; i.e., Ha-Ramathaïm**, a town of Judea, north of Jerusalem, the home of Samuel (1 Kings vii. 17). Some say it was between Hebron and Bethlehem, therefore south of Jerusalem.

59. **Joseph taking the body, wrapped it, etc.** St. Mark (xv. 46) says that Joseph had bought the "fine linen" at that same hour. This seems to prove that our Lord did not die on the 15th of Nisan, the solemnity of the Passover, because some say it was never permitted to buy on the Passover; nor even on a Sabbath day, unless preparations for a Passover which followed the Sabbath made it necessary to buy. See above, xxvi. 17 ff.

60. **A new monument.** There seems to be no good reason for doubting that the site of the Holy Sepulchre was on the very spot which the faithful now venerate. See Le Camus, *Life of Christ*, vol. iii, pp. 397 ff., note. The sepulchre was hewed out of a rock according to the Jewish custom of the time. It was entered through a narrow door, but was spacious enough within to accommodate several persons.

61. **Mary Magdalen and the other Mary**, who waited there until the sun had set and the Sabbath commenced.

62-66. **The next day; i.e., on the Sabbath.**

**The last error shall be worse than the first; i.e., if our Lord**

should raise Himself from the dead, His hold on the people would be greater than that produced by His doctrine and miracles. These transactions, conducted on the Sabbath, show how little the members of the Sanhedrim cared about observing the Sabbath; and they are against the opinion which says that our Lord could not have been put to death on the Feast of the Pasch, because of the servile works thereby made necessary.

## CHAPTER XXVIII

THE RESURRECTION OF CHRIST, 1-10.

THE SLEEPING WITNESSES, 11-15.

THE FINAL COMMISSION OF THE APOSTLES, 16-20.

1. And in the end of the sabbath, when it began to dawn towards the first day of the week, came Mary Magdalen and the other Mary, to see the sepulchre.

1. **In the end of the sabbath;** i.e., when the Sabbath was well over (*ὀψέ δὲ σαββάτων*). The Sabbath closed at sunset, and this was the next morning. *Σαββάτων*, the plural, means the same as the singular, i.e., the Sabbath day, or the week of seven days, of which the Sabbath was one day.

Mary Magdalen and the other Mary, mentioned above (xxvii. 61).

**To see the sepulchre.** St. Mark (xvi. 1) tells us that their purpose was to embalm the body of Jesus. There occurs a difficulty here. St. Mark (xvi. 2) says the holy women came to the sepulchre *after sun-rise*, whereas the other Evangelists speak of the holy women's going to the sepulchre *before sun-rise*, and St. John especially (xx. 1) says, "while it was yet dark." *Answer:* St. Mark is speaking of the time of the arrival of the holy women; the other Evangelists, of the time when they set out for the sepulchre. In Palestine, there is scarcely any twilight at all, and hence the transition from day to night and night to day is very sudden. Moreover Magdalen and Mary of Cleophas most probably set out from Bethany, Magdalen's home, which was three miles from Calvary; hence it could have been dark when they left Bethany, but daylight when they arrived at Calvary.



2. And behold there was a great earthquake. For an angel of the Lord descended from heaven, and coming, rolled back the stone, and sat upon it.
3. And his countenance was as lightning, and his raiment as snow.
4. And for fear of him, the guards were struck with terror, and became as dead men.

There is some difficulty, as in the present and other instances, in reconciling the manner and details of the Resurrection, as described by the four Evangelists; but many apparent contradictions and discrepancies will be explained if we remember that each Evangelist is giving us an *incomplete* and *independent* account of a very unusual and exciting event. The discrepancies are really a proof of the independence, and therefore of the reliability of the different authors. The one great fact that they are all intent upon, and upon which they all agree, is that our Lord *was truly risen*.

2-4. **A great earthquake**, mentioned only by St. Matthew. This was a manifestation of the divine power, through which our Lord Himself had shortly before gone forth from the sealed tomb. The earthquake did not occur, neither did the angel descend from Heaven for the purpose of opening the tomb for our Lord to rise; our Saviour came forth from the tomb without breaking its seal in any way, just as later He entered the chamber where the Apostles were, the door being closed.

**Angel.** One of the greatest difficulties, as to the details of the Resurrection, is that which has to do with the number, places and postures of the different angels as they appeared. Thus, Matthew and Mark speak of one angel, Luke and John of two; Matthew says the angel was outside the tomb and sitting on the stone; Mark and John say he was inside. *Answer:* All these difficulties can best be explained by saying that there were doubtless many angels around the tomb that Easter morning, only a few of which allowed themselves to be seen, and this in different ways and different places, by different individuals.

Many apparent discrepancies relative to the appearances of the angels and the visit of the pious women on that Easter morning may also be harmonized as follows: Our Lord quitted the sealed tomb perhaps about daybreak. Shortly afterwards an angel descended from Heaven and rolled back the stone that was against the entrance to the sepulchre and sat upon it. Just then, the sun

5. And the angel answering, said to the women: Fear not you; for I know that you seek Jesus who was crucified.

6. He is not here, for he is risen, as he said. Come, and see the place where the Lord was laid.

7. And going quickly, tell ye his disciples that he is risen: and behold he will go before you into Galilee; there you shall see him. Lo, I have foretold it to you.

8. And they went out quickly from the sepulchre with fear and great joy, running to tell his disciples.

being up, the pious women arrived and beheld the stone rolled away and the angel seated on it. Magdalen, perhaps immediately perceiving that the tomb was empty, hastened away to tell the Apostles (John xx. 2), leaving her companions still at the grave. The companions then entered the sepulchre, and an angel appeared and addressed them there (verse 5; Mark xvi. 5). Affrighted at the sight of an angel (Mark xvi. 5) Magdalen's companions then hurried away with delight and excitement to tell the disciples what they had seen (Mark xvi. 8). During the absence of her companions Magdalen returned to the tomb, preceded somewhat by Peter and John to whom she had announced that the sepulchre was empty (John xx. 2). Remaining at the tomb after Peter and John had departed Magdalen first beheld two angels *sitting* (John xx. 12), and then Jesus appeared to her (John xx. 14-17). Very soon after this appearance to Magdalen Jesus appeared also to her companions who were on their way to tell the Apostles (verse 9).

5. **The angel answering**, a Hebrew way of saying, "began to speak."

7. **He will go**, — rather "He goeth" (*πρόσγει*).

8. Some difficulties occur here. From this verse, as from verse 1, and from Mark (xvi. 1), it is evident that, not only Mary Magdalen, but the other holy women also, came to the sepulchre; and it would seem that they all saw the angel and heard his announcement (verses 5-7), and then hurried away to tell the Apostles. But St. John (xx. 1, 2) mentions only Mary Magdalen as having come to the tomb and as running to tell the Apostles that the Lord was not there. *Answer*: Some say that St. John does not give us all the details in this matter, and that he mentions Mary Magdalen only as the principal one, or leader among those who came; but

9. And behold Jesus met them, saying: All hail. But they came up and took hold of his feet, and adored him.

10. Then Jesus said to them: Fear not. Go, tell my brethren that they go into Galilee, there they shall see me.

this difficulty is also explained from what was just said above, on verses 2-4.

But again, St. John (xx. 2) says Magdalen went and told, not all the Apostles, but Peter and John. *Answer:* She told Peter and John first, or as the two chief Apostles, but this does not prove that she did not also tell the others. Furthermore from the commentary on verses 2-4, above, we see that Magdalen's companions announced the news to the other Apostles.

But St. Luke (xxiv. 9, 10) says that Mary Magdalen and the other holy women came and told the eleven the things they had seen and heard regarding the Resurrection; whereas St. John (xx. 2) says that Mary Magdalen announced that the Saviour had been taken away and that she knew not where they had laid Him. *Answer:* St. John does not contradict St. Luke; he wishes only to show that the vision and words of the angels had not removed all the doubts and fears of Magdalen. Hence also St. John (xx. 11) represents her as weeping without the sepulchre on her second visit to the tomb after Peter and John had been there and left. Patrizi thinks that St. Luke xxiv. 9, 10 is a summary account of all the announcements made that Easter morning to the different disciples of Christ by the various pious women.

9. **Jesus met them.** From the explanation given above (verses 2-4) we should say that the "them" and the "they" of this verse refer to the companions of Magdalen to whom Jesus appeared as they were hastening away to announce to the disciples what they had seen at the tomb during Mary's absence. Others, however, hold that this is the same apparition as is recorded in Mark (xvi. 9) and John (xx. 14-16) which was made to Mary Magdalen alone. St. Matthew, these authorities say, uses the plural "them," "they," because he identifies Mary with the group of holy women, of which she was the leader, and he speaks of what happened to her as happening to all.

10. **Tell my brethren.** The brethren here spoken of were not

11. Who when they were departed, behold some of the guards came into the city, and told the chief priests all things that had been done.

12. And they being assembled together with the ancients, taking counsel, gave a great sum of money to the soldiers,

13. Saying: Say you, His disciples came by night, and stole him away when we were asleep.

14. And if the governor shall hear of this, we will persuade him, and secure you.

15. So they taking the money, did as they were taught: and this word was spread abroad among the Jews even unto this day.

16. And the eleven disciples went into Galilee, unto the mountain where Jesus had appointed them.

17. And seeing him they adored: but some doubted.

only the Apostles, but all the faithful followers of our Lord, who had come down from Galilee to Judea for the Passover.

11. This coming of some of the guards to the Sanhedrim to announce what had happened took place after the visit and departure of Peter, John and the holy women.

12-15. The account given in these verses must have come, either from the Sanhedrim, or from friends of the guards to whom they had communicated what had taken place and what had been done.

Even to this day, — another passage which shows that St. Matthew's Gospel was written some years after the Resurrection of our Lord.

16. This apparition in Galilee was the solemn and formal reunion between the risen Saviour and all His Apostles and disciples. Some say that this is the apparition mentioned by St. Paul (1 Cor. xv. 6), as having been made to more than five hundred brethren at once. St. Matthew, in his fragmentary account, says nothing of the previous appearances to many at Jerusalem (John xx. 19-29; Luke xxiv. 36-49) most likely because these were more private in character and calculated only as a preparation for the solemn meeting of all in Galilee.

The mountain, — perhaps Mount Tabor, or the Mount of the Beatitudes.

17. Some doubted, — at first, because the body of our Lord, although the same, appeared altogether different after the Resurrection; it was endowed with the supernatural qualities of risen bodies.

18. And Jesus coming, spoke to them, saying: All power is given to me in heaven and in earth.

19. Going therefore teach ye all nations; baptizing them in the name of the Father, and of the Son, and of the Holy Ghost.

20. Teaching them to observe all things whatsoever I have commanded you: and behold I am with you all days, even to the consummation of the world.

18. **All power is given to me.** The exercise of absolute power was now given to our Lord by His heavenly Father; and, in virtue of this authority, He sends the Apostles into the entire world to preach the Gospel to every creature (Mark xvi. 15).

19, 20. **Going therefore teach.** The message which the Apostles were to teach "all nations" was nothing less than the revelation which our Lord had committed to them.

**All things;** i.e., all the doctrines regarding faith and morals which He had made known to them for the salvation of mankind.

**I am with you all days;** i.e., He is with the Apostles and their successors to the end of the world. If this promise had extended to the Apostles only, and not to their successors for all time, the words which follow, "to the consummation of the world," would have no meaning. These words express in the plainest manner possible the Perpetuity and Indefectibility of Christ's Church, which by His solemn promise shall continue *all days even to the end of time* to teach *all nations* the things which He Himself taught while on earth.

# THE GOSPEL ACCORDING TO ST. MARK

## INTRODUCTION

I. **St. Mark.** Mark is the Latin surname of the author of the Second Gospel. His name in Hebrew was John. He was a native of Jerusalem and was the son of Mary (Acts xii. 12). Joseph, the Levite, afterwards known as Barnabas, was his uncle or cousin (Col. iv. 10). Mark was very probably instructed and baptized by St. Peter (1 Peter v. 13). About A.D. 44 we find him associated with St. Paul and Barnabas and accompanying them on their first missionary journey to the west (Acts xiii. 5). Having reached Perge, however, Mark left his two companions, much to the displeasure of St. Paul, and returned to Jerusalem. For this reason he was not allowed by St. Paul to join them on a second mission some five or six years later, whereupon Barnabas and Mark separated from St. Paul and went themselves to Cyprus. It seems, however, that Paul and Mark were afterwards reconciled, because about A.D. 62, when St. Paul was in prison in Rome we find Mark was also in Rome and regarded by St. Paul as a "fellow-laborer" (Col. iv. 10; Philemon, verse 24). St. Peter, in his First Epistle to the converts of Asia Minor, which was dated from "Babylon," a mystical name for Rome, speaks of "my son Mark" (1 Peter v. 13). This shows that Mark was intimately associated with St. Peter and well known to the Christians of Asia Minor. Later, about A.D. 67 St. Paul, during his second captivity in Rome, wrote to Timothy: "Take Mark and bring him with thee, for he is useful to me for the ministry" (2 Tim. iv. 11).

But, however much associated with St. Paul, Mark is generally described by the Fathers as the companion and "interpreter" of St. Peter. As St. Peter did not need an interpreter in Palestine it

seems beyond doubt that it was in Rome that Mark was associated with him. According to the Fathers also Mark was the founder of the church and bishopric of Alexandria.

II. **Time and Place of Composition.** Papias and Clement of Alexandria speak of the Second Gospel as having been written during the lifetime of St. Peter and with his approval. Hence the date of its composition was earlier than A.D. 67, when St. Peter was martyred. St. Irenaeus (*Adv. Haer.* iii. 1) says that Mark wrote his Gospel after the departure (*ἐξοδον*) of St. Peter and St. Paul. Some understand this to mean, "after their death," which would place the date of writing the Gospel after A.D. 67; but it is more probable that *ἐξοδος* means, after their departure from Palestine on their missionary journeys. That the Gospel was written some time after our Lord's Ascension seems clear from its closing words: "They going forth preached everywhere" (xvi. 20). The most probable date of composition seems to be between A.D. 42 and 50.

Tradition has always pointed to Rome as the place where St. Mark wrote his Gospel. The same is evident from the book itself, some passages of which refer indirectly to Rome, as xv. 21; cf. Rom. xvi. 13. Then also the occurrence of many Latin words in Greek form; such as *πραιτώριον*, *κῆνος*, *κεντυρίων*, *κοδράντης*, etc.; and the explanations of Jewish customs, as in v. 41, vii. 3, xiv. 12, xv. 22, 34, 42, — show that Latin was the language of his readers and that they were unfamiliar with Palestine.

III. **Scope and Purpose.** Since St. Mark was the interpreter and companion of St. Peter his purpose in writing was the same as that of the latter in preaching; namely, to prove that Christ was truly the Son of God. Hence Mark passes over the infancy and childhood of our Lord, and begins his Gospel with the preaching of John the Baptist. Straightway he proceeds to the baptism and public life of the Saviour, and is insistent throughout his narrative on the miracles of our Lord, which he intended should convince his Gentile readers that Christ was truly God. So constant is Mark in relating the number, kind, and variety of the miracles performed by our Saviour that his has been called the "Gospel of Miracles."

IV. **Language and Characteristics.** Writing for the same Gentile converts to whom St. Peter had preached St. Mark, it is ad-

mitted by all critics, made use of the Greek language. His Gospel has little proper to itself; nearly all the facts it relates are found in the other Synoptics, especially in St. Matthew. The Second Gospel's striking similarity to the first has led some to believe that St. Mark translated the original Hebrew of St. Matthew into Greek for the Roman or Alexandrian church. But as Mark was the "interpreter" of St. Peter, and wrote for those to whom Peter had preached, it is only natural that he should omit much given by Matthew, and confine himself to the needs of his Gentile readers; and further it is but natural that the contents of his Gospel should have much in common with St. Peter's first sermon to the Gentiles at Caesarea (Acts x. 34-43).

But notwithstanding the similarity between St. Matthew's and St. Mark's Gospels, there are also many differences. St. Matthew, for example, is constantly noting that our Lord fulfilled the ancient prophecies, while St. Mark speaks of the fulfillment of only two (i. 1, 2; xv. 28); St. Matthew is careful to show that the New Law is but a fulfillment of the Old, whereas St. Mark makes no mention of this; St. Mark gives only eight of our Lord's parables, while St. Matthew relates about twenty; finally St. Mark, unlike St. Matthew, gives no genealogy of our Lord, he adds many explanations which Jewish readers would not need (i. 5; ii. 18; xiii. 3), he interprets Hebrew words, such as *Boanerges* (iii. 17), *Talitha cumi* (v. 41), *Corban* (vii. 11), and uses several Latin words peculiar to his Gospel.

The style of St. Mark is swift and vivid. He is fond of descriptions and minute details, and passes rapidly from one event to another. His favorite word is *immediately* (*εὐθέως*), which occurs in his Gospel not less than forty times. The very looks, accents, and gestures of our Lord are noticed and recorded by him (iii. 5, 34; v. 32; x. 23; xi. 11).

**V. Authenticity of the Second Gospel.** The unanimous tradition of the Christian Church makes St. Mark the author of the Second Gospel. Certain of the early ecclesiastical writers—especially Papias of Hierapolis, Irenaeus, and Clement of Alexandria—made distinct mention of this.

Papias (Euseb. *Hist. Eccl.* iii. 39) who lived in the first part of the second century, and who was acquainted with many who had



known St. Mark personally, says: "That presbyter (most probably St. John the Apostle) said, 'Mark who was the interpreter of Peter wrote down very accurately the words and deeds of Christ, so far as he remembered them.'" Later, in the second century, Irenaeus (*Adv. Haer.* iii. 1), who was a disciple of Polycarp, who in turn was a disciple of St. John the Apostle, says: "After their (i.e. Sts. Peter's and Paul's) departure Mark, the disciple and interpreter of Peter, likewise handed down to us in writing what Peter had preached." Towards the close of the same century Clement of Alexandria (Euseb., *Hist. Eccl.* vi. 14) says: "When Peter was at Rome preaching the word of God his hearers went to Mark with the request that he should write down what was said, for he had long followed Peter, and remembered his words. After writing his Gospel he handed it to those who had made the request, and Peter, knowing of it, neither hindered nor encouraged him."

From what has been observed under different headings above, it is also clear that the Second Gospel gives evidence of having been written at Rome, and by one who was most familiar with the preaching of St. Peter. That St. Mark was the companion and interpreter of St. Peter is likewise plain from what has been already said.

**VI. Division of the Gospel.** The Second Gospel may be divided into five parts as follows:

In the first part (i. 1-20), which forms an introduction, the Evangelist relates the preaching of John the Baptist, the baptism and temptation of our Lord, and the call of the first disciples.

In the second part (i. 21-ix. 49) the public ministry of our Lord in Galilee is given.

In the third part (x-xiii. 37) the public ministry in Judea is related.

In the fourth part (xiv-xv) we find the history of the Passion and death of Jesus.

In the fifth part (xvi) we have an account of the Resurrection, manifestation, and Ascension of our Lord, together with the sending of the Apostles into the whole world.

# The Gospel according to St. Mark

## CHAPTER I

THE PREACHING OF JOHN THE BAPTIST, 1-8.

THE BAPTISM AND TEMPTATION OF JESUS, 9-13.

THE BEGINNING OF THE PREACHING OF JESUS AND  
THE CALLING OF THE FIRST APOSTLES, 14-20.

JESUS AT CAPHARNAUM CURES A DEMONIAIC, 21-28.

THE HEALING OF PETER'S MOTHER-IN-LAW, 29-37.

PREACHING THROUGH GALILEE, AND THE HEALING  
OF A LEPER, 38-45.

1. The beginning of the gospel of Jesus Christ, the Son of God.
2. As it is written in Isaias the prophet: Behold I send my angel before thy face, who shall prepare the way before thee.
3. A voice of one crying in the desert: Prepare ye the way of the Lord, make straight his paths.

1. Some regard this verse as the title of, others as the preface to, the present Gospel. The first three verses, in fact, make up the superscription of the Gospel, after which the narrative begins.

The meaning of this first verse is that the Gospel, i.e., "the joyous message of redemption" which Christ brought and preached to the world, began, according to the predictions of the prophets, with the ministry and preaching of John the Baptist in the desert.

2, 3. **Behold I send . . . before thy face**, etc. These words are from the prophet Malachy (iii. 1), whereas the words "make straight his paths" (verse 3) are from Isaias xl. 3. *Answer:* It was customary among the Jews to call a book by the name of the author who was first in its contents; hence, as Isaias was first in the Book of the Prophets in old Hebrew Bibles, the whole book was called by his name. Or it may be that Malachy was explaining Isaias, and Mark quotes the latter as explained.

**A voice of one crying**, etc. See on Matthew iii. 3.

4. John was in the desert baptizing, and preaching the baptism of penance, unto remission of sins.

5. And there went out to him all the country of Judea, and all they of Jerusalem, and were baptized by him in the river of Jordan, confessing their sins.

6. And John was clothed with camel's hair, and a leathern girdle about his loins; and he ate locusts and wild honey.

7. And he preached, saying: There cometh after me one mightier than I, the latchet of whose shoes I am not worthy to stoop down and loose.

8. I have baptized you with water; but he shall baptize you with the Holy Ghost.

9. And it came to pass, in those days, Jesus came from Nazareth of Galilee, and was baptized by John in the Jordan.

10. And forthwith coming up out of the water, he saw the heavens opened, and the Spirit as a dove descending, and remaining on him.

11. And there came a voice from heaven: Thou art my beloved Son; in thee I am well pleased.

12. And immediately the Spirit drove him out into the desert.

13. And he was in the desert forty days and forty nights, and was tempted by Satan; and he was with beasts, and the angels ministered to him.

14. And after that John was delivered up, Jesus came into Galilee, preaching the gospel of the kingdom of God,

4. **The desert** was a desolate region covering the southern portion of the Jordan valley and the mountain slopes on the west side of the river, up to the confines of Bethany. See on Matthew iii. 1.

**Baptizing and preaching.** The preaching preceded, and was a preparation for, the baptizing.

**The baptism of penance.** John's baptism was an external washing, by which the subject acknowledged his sinfulness and his disposition for an amendment of life. It did not, of itself, remit sin, but was a preparation for the Gospel and Baptism of Christ, through which sins were to be remitted. See on Matthew iii. 6.

5. See on Matthew iii. 5, 6.

6. **Locusts.** See on Matthew iii. 4.

7, 8. See on Matthew iii. 11.

9. See on Matthew iii. 13.

10, 11. See on Matthew iii. 16, 17.

12, 13. See on Matthew iv. 1-11.

14. **After John was delivered up**, by Herod Antipas, the tetrarch of Galilee and Peraea. Herod had married his brother Philip's wife, while the brother was still living, which, being denounced by John, was the cause of the latter's imprisonment.

15. And saying: The time is accomplished, and the kingdom of God is at hand: repent, and believe the gospel.

16. And passing by the sea of Galilee, he saw Simon and Andrew his brother, casting nets into the sea (for they were fishermen).

17. And Jesus said to them: Come after me, and I will make you to become fishers of men.

18. And immediately leaving their nets, they followed him.

19. And going on from thence a little farther, he saw James the son of Zebedee, and John his brother, who also were mending their nets in the ship:

20. And forthwith he called them. And leaving their father Zebedee in the ship with his hired men, they followed him.

21. And they entered into Capharnaum, and forthwith upon the sabbath days going into the synagogue, he taught them.

22. And they were astonished at his doctrine. For he was teaching them as one having power, and not as the scribes.

23. And there was in their synagogue a man with an unclean spirit; and he cried out,

24. Saying: What have we to do with thee, Jesus of Nazareth? art thou come to destroy us? I know who thou art, the Holy One of God.

**Jesus came into Galilee.** This is perhaps the same visit to Galilee mentioned by Luke (iv. 14) and John (iv. 43). It was when Galilee became the chief theatre of our Lord's public ministry. St. John (i. 43; ii. 13; iii. 22-24) speaks of an earlier visit to Galilee, which was succeeded by a ministry in Jerusalem and Judea, before the imprisonment of the Baptist. Our Lord chose Galilee for the greater part of His public ministry: (a) because it was a great industrial region and thickly populated; (b) because there He would encounter less of opposition from the Doctors of the Law and the leaders of the people in Jerusalem. See on Matthew iv. 12.

15. **The time is accomplished;** i.e., the reign of the Messiah, or the preaching of the Gospel, is at hand.

16-20. See on Matthew iv. 18-22.

21. **The synagogue.** Synagogues were places of assembly for public prayer, for the reading and expounding of the Scriptures, and even for schools. Their existence dated from the time of the Babylonian captivity. See on Matthew iv. 23.

22. See on Matthew vii. 28, 29.

**Scribes.** See on Matthew ii. 4.

23. **An unclean spirit.** See on Matthew x. 1.

24. **What have we to do with thee,**—more literally, "what hast thou against us that thou shouldst thus torment us."

25. And Jesus threatened him, saying: Speak no more, and go out of the man.

26. And the unclean spirit tearing him, and crying out with a loud voice, went out of him.

27. And they were all amazed, insomuch that they questioned among themselves, saying: What thing is this? what is this new doctrine? for with power he commandeth even the unclean spirits, and they obey him.

28. And the fame of him was spread forthwith into all the country of Galilee.

29. And immediately going out of the synagogue they came into the house of Simon and Andrew, with James and John.

30. And Simon's wife's mother lay in a fit of a fever: and forthwith they tell him of her.

31. And coming to her, he lifted her up, taking her by the hand; and immediately the fever left her, and she ministered unto them.

32. And when it was evening, after sunset, they brought to him all that were ill and that were possessed with devils.

33. And all the city was gathered together at the door.

34. And he healed many that were troubled with divers diseases; and he cast out many devils, and he suffered them not to speak, because they knew him.

Art thou come to destroy us? The clause in Greek is rather affirmative than interrogative, "thou art come," etc. The evil spirit doubtless knew that Jesus was the Messiah; hence he addresses Him as the "Holy One." See on Matthew iv. 24; viii. 16.

25. Jesus threatened him; i.e., He rebuked the evil spirit.

26. The spirit, tearing him; i.e., trying to tear him; that he did not succeed we know from St. Luke (iv. 35).

27. This new doctrine; i.e., this new mode of teaching concerning the Kingdom of God.

29. They came, etc. This occurred on the Sabbath day (Luke iv. 38).

31. This miracle, not given by St. Matthew, is mentioned by St. Luke (iv. 38, 39). The passage shows that Peter was married before his call to the apostolate. See Matthew viii. 14, 15.

32. After sunset; i.e., when the Sabbath was ended, which was at sunset.

34. He suffered them not to speak. Our Lord did not wish, at this time, to spread too much abroad the wonders He was working, lest He should unduly arouse the opposition of His enemies. Furthermore, He wished that those about Him should rather grasp

35. And rising very early, going out, he went into a desert place: and there he prayed.

36. And Simon, and they that were with him, followed after him.

37. And when they had found him, they said to him: All seek for thee.

38. And he saith to them: Let us go into the neighbouring towns and cities, that I may preach there also; for to this purpose am I come.

39. And he was preaching in their synagogues, and in all Galilee, and casting out devils.

40. And there came a leper to him, beseeching him, and kneeling down said to him: If thou wilt, thou canst make me clean.

41. And Jesus having compassion on him, stretched forth his hand; and touching him, saith to him: I will. Be thou made clean.

42. And when he had spoken, immediately the leprosy departed from him, and he was made clean.

43. And he strictly charged him, and forthwith sent him away.

44. And he saith to him: See thou tell no one; but go, shew thyself to the high priest, and offer for thy cleansing the things that Moses commanded, for a testimony to them.

45. But he being gone out, began to publish and to blaze abroad the word: so that he could not openly go into the city, but was without in desert places: and they flocked to him from all sides.

the spirituality of His teaching than be moved by the cures performed on their bodies.

35. And rising very early; i.e., very early the next morning (Luke iv. 42).

There he prayed. Our Lord was accustomed frequently to withdraw from the crowds and retire to the mountains or desert places, in order the better to be able to speak to His Father in prayer, thus giving us an example of how we should act.

38. For to this purpose am I come, — literally, "did I come" (ἐξῆλθεν). Our Lord came to preach the Gospel, not to one or another city, but to all who needed it among the Jews (Luke iv. 43).

40-44. See on Matthew viii. 2-4.

He strictly charged him; i.e., He earnestly charged him, for the reason given above in verse 34.

Show thyself to the priest. See Lev. xiv. 2.

45. So great was the leper's joy over being cured that he could not keep from publishing his cure. Evidently he did not take seriously our Lord's command.

## CHAPTER II

THE HEALING OF THE PARALYTIC AT CAPHARNAUM,  
1-12.

THE CALLING OF LEVI, THE PUBLICAN, 13-17.

THE DISCOURSE ON FASTING, 18-22.

THE PLUCKING OF THE EARS OF CORN ON THE SAB-  
BATH, 23-28.

1. And again he entered into Capharnaum after some days.
2. And it was heard that he was in the house, and many came together, so that there was no room; no, not even at the door; and he spoke to them the word.
3. And they came to him, bringing one sick of the palsy, who was carried by four.
4. And when they could not offer him unto him for the multitude, they uncovered the roof where he was; and opening it, they let down the bed wherein the man sick of the palsy lay.
5. And when Jesus had seen their faith, he saith to the sick of the palsy: Son, thy sins are forgiven thee.
6. And there were some of the scribes sitting there, and thinking in their hearts:
7. Why doth this man speak thus? he blasphemeth. Who can forgive sins, but God only?
8. Which Jesus presently knowing in his spirit, that they so thought within themselves, saith to them: Why think you these things in your hearts?
9. Which is easier, to say to the sick of the palsy: Thy sins are forgiven thee; or to say: Arise, take up thy bed, and walk?
10. But that you may know that the Son of man hath power on earth to forgive sins, (he saith to the sick of the palsy,)
11. I say to thee: Arise, take up thy bed, and go into thy house.
12. And immediately he arose; and taking up his bed, went his way in the sight of all; so that all wondered and glorified God, saying: We never saw the like.

1. **After some days.** It must have been several weeks, because meanwhile He had been preaching in all Galilee, as expressly stated in i. 39.

2. **In the house,** of St. Peter, where He was before (i. 29).

**He spoke to them the word;** i.e., the word of God. Cf. Acts x. 36, 37.

4. **They uncovered the roof,** etc. The roofs of houses in Palestine were flat, and were often ascended from the outside by stairs. They were covered with tiles (Luke v, 19).

5-12. See on Matthew ix, 2-8,

13. And he went forth again to the sea side; and all the multitude came to him, and he taught them.

14. And when he was passing by, he saw Levi the son of Alpheus sitting at the receipt of custom; and he saith to him: Follow me. And rising up, he followed him.

15. And it came to pass, that as he sat at meat in his house, many publicans and sinners sat down together with Jesus and his disciples. For they were many, who also followed him.

16. And the scribes and the Pharisees, seeing that he ate with publicans and sinners, said to his disciples: Why doth your master eat and drink with publicans and sinners?

17. Jesus hearing this, saith to them: They that are well have no need of a physician, but they that are sick. For I came not to call the just, but sinners.

13. **To the sea side;** i.e., to the shore of the Sea of Galilee, or Lake of Genesareth, as it was also called. From this verse, it seems evident that Capharnaum was some little way back from the lake.

14. **He saw Levi.** Levi was St. Matthew. All the Synoptics note the call of Matthew after the healing of the paralytic (Matthew ix. 9; Luke v. 27).

**At the receipt of custom.** See on Matthew v. 46; ix. 9.

**And rising up he followed him.** This could not have been immediately, since we know from the verse following, and from Luke (v. 29), that first "he made a great feast in his own house" for our Lord. Hence some little time must have been allowed him to arrange his affairs and provide this feast.

15. **Many publicans and sinners sat down,** etc. These were friends of Matthew. As the houses were kept open in the East, it was not unusual for friends of a host freely to enter during a feast and take their place at table.

**They were many who also followed him;** i.e., many publicans and sinners like Matthew also became Christ's disciples.

16, 17. See on Matthew ix. 11, 12.

**Why doth your master eat and drink.** The Scribes and Pharisees were trying to influence the disciples against our Saviour by intimating that, since He ate and drank with sinners, He Himself must be a sinner.

**They that are well,** etc. Our Lord in these words shows the Pharisee that His purpose in the world is to save sinners, and not to conform to the prescriptions of Pharisaical formalism.



18. And the disciples of John and the Pharisees used to fast; and they come and say to him: Why do the disciples of John and of the Pharisees fast; but thy disciples do not fast?

19. And Jesus saith to them: Can the children of the marriage fast, as long as the bridegroom is with them? As long as they have the bridegroom with them, they cannot fast.

20. But the days will come when the bridegroom shall be taken away from them; and then they shall fast in those days.

21. No man seweth a piece of raw cloth to an old garment: otherwise the new piecing taketh away from the old, and there is made a greater rent.

22. And no man putteth new wine into old bottles: otherwise the wine will burst the bottles, and both the wine will be spilled, and the bottles will be lost. But new wine must be put into new bottles.

23. And it came to pass again, as the Lord walked through the corn fields on the sabbath, that his disciples began to go forward, and to pluck the ears of corn.

24. And the Pharisees said to him: Behold, why do they on the sabbath day that which is not lawful?

25. And he said to them: Have you never read what David did when he had need, and was hungry himself, and they that were with him?

26. How he went into the house of God, under Abiathar the high-priest, and did eat the loaves of proposition, which was not lawful to eat but for the priests, and gave to them who were with him?

27. And he said to them: The sabbath was made for man, and not man for the sabbath.

28. Therefore the Son of man is Lord of the sabbath also.

For I am come not to call the just, etc. The conjunction "for" is not in the Greek. See on Matthew ix. 13.

18-20. See on Matthew ix. 14, 15.

21, 22. In these verses, our Lord tells the Scribes and Pharisees that it will not do to impose too quickly on His disciples the perfection of the New Law, that the worn-out observances of the Old Dispensation are not able to support the sublime requirements of the New. See on Matthew ix. 16, 17.

23-26. See on Matthew xii. 1-5.

And it came to pass again; i.e., on another occasion. The word "again" is not in the Greek.

Under Abiathar the high-priest, — rather, "in the days of Abiathar the high-priest" (*ἐπὶ Ἀβιάθαρ ἀρχιερέως*). But *de facto* Abimelech, the father of Abiathar, was then High-Priest (1 Kings xxi. 1). *Answer:* Our Lord speaks of Abiathar as High-Priest, because he became so after his father, and even during his father's life was the more famous of the two.

28. See on Matthew xii. 8.

## CHAPTER III

THE MAN WITH THE WITHERED HAND, 1-6.

VARIOUS MIRACLES ON THE BORDERS OF THE LAKE,  
7-12.

THE CHOOSING OF THE APOSTLES, 13-19.

JESUS AND BEELZEBUB, 20-30.

JESUS SOUGHT BY HIS MOTHER AND BRETHREN, 31-35.

1. And he entered again into the synagogue, and there was a man there who had a withered hand.

2. And they watched him whether he would heal on the sabbath days; that they might accuse him.

3. And he said to the man who had the withered hand: Stand up in the midst.

4. And he saith to them: Is it lawful to do good on the sabbath days, or to do evil? to save life, or to destroy? But they held their peace.

5. And looking round about on them with anger, being grieved for the blindness of their hearts, he saith to the man: Stretch forth thy hand. And he stretched it forth: and his hand was restored unto him.

6. And the Pharisees going out, immediately made a consultation with the Herodians against him, how they might destroy him.

1-5. This was on "another sabbath" (Luke vi. 6). See on Matthew xii. 9-13.

**They watched him;** i.e., the Pharisees watched Him, because they held that it was unlawful to heal on the Sabbath. **Is it lawful to do good . . . or to do evil;** i.e., is it lawful to show charity and mercy, and thereby do good on the Sabbath, or to withhold these virtues, and thereby do evil? **But they held their peace,** because they did not want the crowd around to see their hypocrisy. **And looking round about . . . with anger,** etc. This is one of St. Mark's graphic touches to show the indignation of Jesus towards the Pharisees.

**Made a consultation.** See on Matthew xii. 14.

**With the Herodians.** The Herodians were the party in Galilee favorable to Herod the tetrarch. For any other purpose, except to destroy our Lord, the Pharisees would have nothing to do with the Herodians; they hated them.

7. But Jesus retired with his disciples to the sea; and a great multitude followed him from Galilee and Judea,

8. And from Jerusalem, and from Idumea, and from beyond the Jordan. And they about Tyre and Sidon, a great multitude, hearing the things which he did, came to him.

9. And he spoke to his disciples that a small ship should wait on him because of the multitude, lest they should throng him.

10. For he healed many, so that they pressed upon him for to touch him, as many as had evils.

11. And the unclean spirits, when they saw him, fell down before him: and they cried, saying:

12. Thou art the Son of God. And he strictly charged them that they should not make him known.

13. And going up into a mountain, he called unto him whom he would himself: and they came to him.

14. And he made that twelve should be with him, and that he might send them to preach.

15. And he gave them power to heal sicknesses, and to cast out devils.

16. And to Simon he gave the name Peter:

17. And James the son of Zebedee, and John the brother of James; and he named them Boanerges, which is, The sons of thunder:

18. And Andrew and Philip, and Bartholomew and Matthew, and Thomas and James of Alphaeus, and Thaddeus, and Simon the Cananean:

19. And Judas Iscariot, who also betrayed him.

20. And they come to a house, and the multitude cometh together again, so that they could not so much as eat bread.

7, 8. But Jesus retired . . . to the sea; i.e., to the Sea of Galilee; in the Greek verse 7 is introduced by "and" instead of "but," which seems much more proper. And from Idumea, which is southeast of Judea. And from beyond the Jordan, which was the region called Peraea.

**Tyre and Sidon.** Tyre was the capital of Phoenicia; Sidon was an important commercial city of the same country on the seashore.

9. A small ship, etc., in order that He might be able to retire from the crowd.

11, 12. See on Matthew xii. 15, 16. Unclean spirits . . . fell down before him; i.e., the people possessed by these evil spirits fell down before Him. The devils that tormented these unfortunates recognized and declared our Saviour to be their spiritual Master, the true Son of God.

13-19. St. Luke (vi. 12), tells us that our Lord, the night before He called His Apostles, spent the whole night on the mountain

21. And when his friends had heard of it, they went out to lay hold on him. For they said: He is become mad.

22. And the scribes who were come down from Jerusalem, said: He hath Beelzebub, and by the prince of devils he casteth out devils.

23. And after he had called them together, he said to them in parables: How can Satan cast out Satan?

24. And if a kingdom be divided against itself, that kingdom cannot stand.

25. And if a house be divided against itself, that house cannot stand.

26. And if Satan be risen up against himself, he is divided, and cannot stand, but hath an end.

in prayer. The mountain here mentioned was some one near the Sea of Galilee, most likely the Horns of Hattin behind Capharnaum. In these verses St. Mark points out the purpose for which our Lord chose His Apostles; namely, (a) to be His constant companions; (b) to preach and carry on His teaching; (c) to heal the sick and cast out devils. This was the formal calling of the Apostles, to which that mentioned in i. 16; ii. 14, was only a preliminary.

**Boanerges**, which means "Sons of Thunder." They were so named because of the energy and fire of their character.

**James of Alphaeus**, who was James the Less, first Bishop of Jerusalem.

**Simon, the Cananean.** "Cananean" here means "Zealot," from the Hebrew *Kana*—*to be zealous*. He was called a *Zealot*, perhaps because of his zeal in the observance of the Law, perhaps also because he had formerly belonged to the party of "Zealots."

**Judas Iscariot**; i.e., Judas of Kerieth, or Karioth, a town of Judea. Judas was the only Judean among the Apostles. See also on Matthew x. 1-4.

21. **His friends**; i.e., those who belonged to Him (*οἱ παρ' αὐτοῦ*), His relatives, who are mentioned as brethren in verse 31.

**He is become mad** (*ἐξέστη*). The meaning is that His relatives thought He was carried away by enthusiasm; not that they thought our Lord was insane. For this common use of the verb, *ἐξίσταται*, cf. v. 42; Luke viii. 56; Acts x. 45; 2 Cor. v. 13. Our Blessed Lady never thought her Divine Son was mad, or that He acted strangely.

22. **Beelzebub.** See on Matthew x. 25; ix. 34.

23. **Parables.** The term here means *illustrations, comparisons*.

24-26. The argument of these verses is that it is impossible to

27. No man can enter into the house of a strong man and rob him of his goods, unless he first bind the strong man, and then shall he plunder his house.

28. Amen I say to you, that all sins shall be forgiven unto the sons of men, and the blasphemies wherewith they shall blaspheme:

29. But he that shall blaspheme against the Holy Ghost, shall never have forgiveness, but shall be guilty of an everlasting sin.

30. Because they said: He hath an unclean spirit.

31. And his mother and his brethren came; and standing without, sent unto him, calling him.

32. And the multitude sat about him; and they say to him: Behold thy mother and thy brethren without seek for thee.

33. And answering them, he said: Who is my mother and my brethren?

34. And looking round about on them who sat about him, he saith: Behold my mother and my brethren.

35. For whosoever shall do the will of God, he is my brother, and my sister, and mother.

be at the same time working against the devil and in league with him; no one can successfully work against himself without eventually suffering defeat.

27. See on Matthew xii. 29.

28, 29. See on Matthew xii. 31, 32.

30. Here the Evangelist gives the reason why our Lord had condemned the Pharisees.

31-35. See on Matthew xii. 46-50.

## CHAPTER IV

THE PARABLE OF THE SOWER, 1-20.

THE MESSIANIC LIGHT, 21-25.

THE PARABLE OF THE SEED, 26-29.

THE PARABLE OF THE MUSTARD SEED, 30-34.

THE STILLING OF THE TEMPEST, 35-40.

1. And again he began to teach by the sea side; and a great multitude was gathered together unto him, so that he went up into a ship, and sat in the sea; and all the multitude was upon the land by the sea side.

2. And he taught them many things in parables, and said unto them in his doctrine:

1. And again he began to teach. "Again" here refers back to ii. 13 and iii. 7. Cf. on Matthew xiii. 1.

2. In his doctrine; i.e., in His teaching (*διδάχην*).

3. Hear ye: Behold, the sower went out to sow.

4. And whilst he sowed, some fell by the way side, and the birds of the air came and ate it up.

5. And other some fell upon stony ground, where it had not much earth; and it shot up immediately, because it had no depth of earth.

6. And when the sun was risen, it was scorched; and because it had no root, it withered away.

7. And some fell among thorns; and the thorns grew up, and choked it, and it yielded no fruit.

8. And some fell upon good ground; and brought forth fruit that grew up, and increased and yielded, one thirty, another sixty, and another a hundred.

9. And he said: He that hath ears to hear, let him hear.

10. And when he was alone, the twelve that were with him asked him the parable.

11. And he said to them: To you it is given to know the mystery of the kingdom of God: but to them that are without, all things are done in parables:

12. That seeing they may see, and not perceive; and hearing they may hear, and not understand: lest at any time they should be converted, and their sins should be forgiven them.

13. And he saith to them: Are you ignorant of this parable? and how shall you know all parables?

14. He that soweth, soweth the word.

15. And these are they by the way side, where the word is sown, and as soon as they have heard, immediately Satan cometh, and taketh away the word that was sown in their hearts.

16. And these likewise are they that are sown on the stony ground: who when they have heard the word, immediately receive it with joy.

3-8. See on Matthew xiii. 3-8.

10-12. See on Matthew xiii. 10-13. **But to them that are without;** i.e., to all who are not well disposed to receive His teaching.

**All things . . . in parables;** i.e., all the truths relating to God and His kingdom are imparted in a veiled manner as a punishment to those who are ill disposed to receive them.

**That seeing they may see, etc.** This describes the state of obduracy and blindness which, because of their sins, the Scribes and Pharisees were allowed to fall into. What was for the good of others was for them an evil and a punishment. See on Matthew xiii. 14, 15.

13. **How shall you know all parables;** i.e., all the other parables which He was to give.

14-20. See on Matthew xiii. 18-23.

17. And they have no root in themselves, but are only for a time: and then when tribulation and persecution ariseth for the word, they are presently scandalized.

18. And others there are who are sown among thorns: these are they that hear the word,

19. And the cares of the world, and the deceitfulness of riches, and the lusts after other things entering in choke the word, and it is made fruitless.

20. And these are they who are sown upon the good ground, who hear the word, and receive it, and yield fruit, the one thirty, another sixty, and another a hundred.

21. And he said to them: Doth a candle come in to be put under a bushel, or under a bed? and not to be set on a candlestick?

22. For there is nothing hid, which shall not be made manifest: neither was it made secret, but that it may come abroad.

23. If any man have ears to hear, let him hear.

24. And he said to them: Take heed what you hear. In what measure you shall mete, it shall be measured to you again, and more shall be given to you.

25. For he that hath, to him shall be given: and he that hath not, that also which he hath shall be taken away from him.

26. And he said: So is the kingdom of God, as if a man should cast seed into the earth,

27. And should sleep, and rise, night and day, and the seed should spring, and grow up whilst he knoweth not.

28. For the earth of itself bringeth forth fruit, first the blade, then the ear, afterwards the full corn in the ear.

29. And when the fruit is brought forth, immediately he putteth in the sickle, because the harvest is come.

21, 22. In these verses our Lord tells the Apostles that the truths He is explaining to them in private are nevertheless to be preached to the whole world, in order that all who are well disposed may profit by them.

24, 25. Here our Lord admonishes the Apostles, and all who have received special graces and favors from Him, that they must be faithful to the gifts received; and that, in proportion to their faithfulness and zeal, shall be their reward and the bestowal of further graces. Cf. on Matthew xxv. 20-24; 26-30.

26-29. This Parable of the Seed Growing Secretly is peculiar to St. Mark. It is perhaps a variant of that of the Cockle and the Wheat in Matt. xiii. 24-30. Its purpose is to illustrate the progress and fruitfulness in the Church of the Gospel preaching. The seed is the teaching of the Gospel; the sower is primarily Christ, who first promulgated this teaching, and then left it to the Church

30. And he said: To what shall we liken the kingdom of God? or to what parable shall we compare it?

31. It is as a grain of mustard seed: which when it is sown in the earth, is less than all the seeds that are in the earth:

32. And when it is sown, it groweth up, and becometh greater than all herbs, and shooteth out great branches, so that the birds of the air may dwell under the shadow thereof.

33. And with many such parables, he spoke to them the word, according as they were able to hear.

34. And without parable he did not speak unto them; but apart, he explained all things to his disciples.

35. And he saith to them that day, when evening was come: Let us pass over to the other side.

36. And sending away the multitude, they take him even as he was in the ship: and there were other ships with him.

37. And there arose a great storm of wind, and the waves beat into the ship, so that the ship was filled.

He founded and endowed; and secondarily, the Apostles and their successors and the ministers in the Church. By **earth** is meant the hearts and souls of men in which the word of God is implanted. The words **sleep, rise, and he knoweth not**, can refer only to the human ministers of the Gospel, to whose efforts, however zealous and prolonged, the truth and growth of the Gospel teaching is not to be ascribed; it is only God who gives the increase. He who **putteth in the sickle** is none other than our Lord coming at the end of the world. At His first coming in the flesh, Christ sowed in the world the Gospel teachings and planted His Church; this done, He withdrew, and He shall not return till the harvest time, till the consummation of all things.

30-32. See on Matthew xiii. 31, 32.

34. **Without parables he did not speak unto them**; i.e., on this and similar occasions, when speaking of the foundation of His Church, He spoke only in parables.

35. **Let us pass . . . to the other side**; i.e., to the east side of the Lake of Genesareth, or Sea of Galilee.

36. **They take him even as he was in the ship**, from which He had been speaking to the multitude.

37-40. See on Matthew viii. 24-27. **A great storm of wind**. The Sea of Galilee is subject to frequent and violent storms, being surrounded as it is with high hills, rent here and there by deep ravines, through which the wind rushes with great violence.



38. And he was in the hinder part of the ship, sleeping upon a pillow; and they awake him, and say to him: Master, doth it not concern thee that we perish?

39. And rising up, he rebuked the wind, and said to the sea: Peace, be still. And the wind ceased: and there was made a great calm.

40. And he said to them: Why are you fearful? have you not faith yet? And they feared exceedingly: and they said one to another: Who is this (thinkest thou) that both wind and sea obey him?

So that the ship was filled; i.e., it was becoming full, or they feared it would be filled.

And they feared exceedingly, not because of the storm, which was passed, but because of the presence of Him in whom such wonderful power had been manifested.

## CHAPTER V

THE GERASENE DEMONIAK, 1-20.

THE DAUGHTER OF JAIRUS, AND THE WOMAN WITH  
AN ISSUE OF BLOOD, 21-43.

1. And they came over the strait of the sea into the country of the Gerasens.
2. And as he went out of the ship, immediately there met him out of the monuments a man with an unclean spirit,
3. Who had his dwelling in the tombs, and no man now could bind him, not even with chains.
4. For having been often bound with fetters and chains, he had burst the chains, and broke the fetters in pieces, and no one could tame him.
5. And he was always day and night in the monuments and in the mountains, crying and cutting himself with stones.
6. And seeing Jesus afar off, he ran and adored him.
7. And crying with a loud voice, he said: What have I to do with thee, Jesus the Son of the most high God? I adjure thee by God that thou torment me not.
8. For he said unto him: Go out of the man, thou unclean spirit.

1-7. See on Matthew viii. 28, 29. Over the strait of the sea; i.e., to the opposite coast (*εἰς τὸ πέρας*), across the narrow part of the sea.

The country of the Gerasens, — a district called Gergesa, on the eastern coast of the Sea of Galilee, opposite Capharnaum; it was a hilly district noted for its tombs.

And adored him; i.e., the unclean spirit caused the man to fall down before our Lord, but not in a spirit of adoration.

9. And he asked him: What is thy name? and he saith to him: My name is Legion, for we are many.

10. And he besought him much, that he would not drive him away out of the country.

11. And there was there near the mountain a great herd of swine, feeding.

12. And the spirits besought him, saying: Send us into the swine, that we may enter into them.

13. And Jesus immediately gave them leave. And the unclean spirits going out, entered into the swine: and the herd with great violence was carried headlong into the sea, being about two thousand, and were stifled in the sea.

14. And they that fed them fled, and told it in the city and in the fields. And they went out to see what was done:

15. And they came to Jesus, and they see him that was troubled with the devil, sitting, clothed, and well in his wits, and they were afraid.

16. And they that had seen it, told them, in what manner he had been dealt with who had the devil; and concerning the swine.

17. And they began to pray him that he would depart from their coasts.

18. And when he went up into the ship, he that had been troubled with the devil, began to beseech him that he might be with him.

19. And he admitted him not, but saith to him: Go into thy house to thy friends, and tell them how great things the Lord hath done for thee, and hath had mercy on thee.

20. And he went his way, and began to publish in Decapolis how great things Jesus had done for him: and all men wondered.

21. And when Jesus had passed again in the ship over the strait, a great multitude assembled together unto him, and he was nigh unto the sea.

**Son of . . . God**, which was a confession of our Lord's Divinity on the part of the unclean spirit.

9. **Legion**. A Roman legion numbered about 6000 soldiers; the term, as used here, means an indefinite number. We need not suppose that this number was all within the man possessed, but rather in the region of Gergesa, which was largely inhabited by pagans. The evil spirit spoke through the organs of the possessed man.

10. **Out of the country**. The evil spirit feared that he should be driven back to the torments and confinement of hell.

11-17. See on Matthew viii. 30-34.

19. **And he admitted him not**, because our Lord did not want to attract too much attention among the Jews to His miracles, for reasons explained above, i. 34, 43.

**To thy friends**; i.e., to thy relatives (*πρὸς τοὺς σοῦς*).

20. **Decapolis**; a district comprising ten cities east of the Jordan. See on Matthew iv. 25.

21. **Over the strait**, on His way back to Capharnaum. **He**

22. And there cometh one of the rulers of the synagogue named Jairus: and seeing him, falleth down at his feet.

23. And he besought him much, saying: My daughter is at the point of death, come, lay thy hand upon her, that she may be safe, and may live.

24. And he went with him, and a great multitude followed him, and they thronged him.

25. And a woman who was under an issue of blood twelve years,

26. And had suffered many things from many physicians; and had spent all that she had, and was nothing the better, but rather worse,

27. When she had heard of Jesus, came in the crowd behind him, and touched his garment.

28. For she said: If I shall touch but his garment, I shall be whole.

29. And forthwith the fountain of her blood was dried up, and she felt in her body that she was healed of the evil.

30. And immediately Jesus knowing in himself the virtue that had proceeded from him, turning to the multitude, said: Who hath touched my garments?

31. And his disciples said to him: Thou seest the multitude thronging thee, and sayest thou who hath touched me?

32. And he looked about to see her who had done this.

33. But the woman fearing and trembling, knowing what was done in her, came and fell down before him, and told him all the truth.

was nigh unto the sea; i.e., in the place whither He had retired after His trouble with the Pharisees at Capharnaum over the healing of the man with the withered hand (iii. 6, 7).

22. See on Matthew ix. 18.

**Jairus**, — the presiding elder of the council of the synagogue.

23. **My daughter is at the point of death.** Matthew (ix. 18) says, "she is even now dead." The ruler doubtless made both of these statements, that given by Matthew after the statement given by Mark. He was urging our Lord to come, and perhaps thinking his daughter was already dead, he finally so expressed himself in order the more to prevail upon the Saviour's assistance.

25. **An issue of blood.** See on Matthew ix. 20.

26. This verse shows us how deeply seated and irremediable by human means was the woman's malady; it had lasted so long, defied the skill of so many doctors; had cost her so much, and after all was only worse. Faith did for her what human means could not do.

27-33. These verses illustrate St. Mark's care for details.

34. And he said to her: Daughter, thy faith hath made thee whole: go in peace, and be thou whole of thy disease.

35. While he was yet speaking, some come from the ruler of the synagogue's house, saying: Thy daughter is dead: why dost thou trouble the master any further?

36. But Jesus having heard the word that was spoken, saith to the ruler of the synagogue: Fear not, only believe.

37. And he admitted not any man to follow him, but Peter, and James, and John the brother of James.

38. And they come to the house of the ruler of the synagogue; and he seeth a tumult, and people weeping and wailing much.

39. And going in, he saith to them: Why make you this ado, and weep? the damsel is not dead, but sleepeth.

40. And they laughed him to scorn. But he having put them all out, taketh the father and the mother of the damsel, and them that were with him, and entereth in where the damsel was lying.

41. And taking the damsel by the hand, he saith to her: Talitha cumi, which is, being interpreted: Damsel (I say to thee) arise.

42. And immediately the damsel rose up, and walked: and she was twelve years old: and they were astonished with a great astonishment.

43. And he charged them strictly that no man should know it: and commanded that something should be given her to eat.

34. Thy faith. See on Matthew ix. 22.

35. Thy daughter is dead, — just what Jairus had concluded when speaking to our Lord, as recorded by St. Matthew.

43. And he charged them strictly, etc., for the reasons given above, i. 34 and 43.

## CHAPTER VI

JESUS AT NAZARETH, 1-6.

THE MISSION OF THE APOSTLES, 7-13.

THE DEATH OF ST. JOHN THE BAPTIST, 14-29.

THE RETURN OF THE APOSTLES, 30-33.

THE FIRST MULTIPLICATION OF THE LOAVES, 34-44.

JESUS WALKING ON THE WATERS, 45-52.

OTHER PRODIGES, 53-56.

1. And going out from thence, he went into his own country; and his disciples followed him.

1. Going out from thence; i.e., from the ruler's house, which was most likely at Capharnaum. Into his own country; i.e., to Nazareth.

2. And when the sabbath was come, he began to teach in the synagogue: and many hearing him were in admiration at his doctrine, saying: How came this man by all these things? and what wisdom is this that is given to him, and such mighty works as are wrought by his hands?

3. Is not this the carpenter, the son of Mary, the brother of James, and Joseph, and Jude, and Simon? are not also his sisters here with us? And they were scandalized in regard of him.

4. And Jesus said to them: A prophet is not without honour, but in his own country, and in his own house, and among his own kindred.

5. And he could not do any miracles there, only that he cured a few that were sick, laying his hands upon them.

6. And he wondered because of their unbelief, and he went through the villages round about teaching.

7. And he called the twelve; and began to send them two and two, and gave them power over unclean spirits.

8. And he commanded them that they should take nothing for the way, but a staff only: no scrip, no bread, nor money in their purse,

9. But to be shod with sandals, and that they should not put on two coats.

10. And he said to them: Whosoever you shall enter into an house, there abide till you depart from that place.

11. And whosoever shall not receive you, nor hear you; going forth from thence, shake off the dust from your feet for a testimony to them.

2. **Were in admiration**; i.e., they were astonished (*ἐξεπλήσσαντο*).

**At his doctrine** is not in the Greek MSS.

3. See on Matthew xiii. 55; also xii. 46.

4. This verse expresses a truth which, in its measure, is commonly realized; one is usually appreciated more by those who are not too well acquainted with him; but in our Lord's case the truth of the proverb was emphasized by the fact that those who had known Him in His youth saw no signs of the extraordinary things for which He was now famed.

5. **He could not do any miracles there**; i.e., He could do no mighty work (*δύναμιν*), not because of want of power on His part, but because of the indispositions of the unbelieving Nazarenes.

6. **And he wondered**,—not that their unbelief was not fore-known by Him, but because their lack of faith was a thing marvellous in itself.

7. Our Lord now sends His Apostles on their first mission. He sends them "two and two" in order that they may have companionship, and He renews the grant of power which He had either given or promised to give them in iii. 15. See on Matthew x. 1, 8.

8-11. See on Matthew x. 9-14.

12. And going forth they preached that men should do penance :

13. And they cast out many devils, and anointed with oil many that were sick, and healed them.

14. And king Herod heard, (for his name was made manifest,) and he said : John the Baptist is risen again from the dead, and therefore mighty works shew forth themselves in him.

15. And others said : It is Elias. But others said : It is a prophet, as one of the prophets.

16. Which Herod hearing, said : John whom I beheaded, he is risen again from the dead.

17. For Herod himself had sent and apprehended John, and bound him in prison for the sake of Herodias the wife of Philip his brother, because he had married her.

18. For John said to Herod : It is not lawful for thee to have thy brother's wife.

19. Now Herodias laid snares for him : and was desirous to put him to death, and could not.

20. For Herod feared John, knowing him to be a just and holy man : and kept him, and when he heard him, did many things : and he heard him willingly.

21. And when a convenient day was come, Herod made a supper for his birthday, for the princes, and tribunes, and chief men of Galilee.

12. **That men should do penance**, as a preparation for the Kingdom of God which was at hand (Luke ix. 2). The mission of the Apostles was the same in purpose as that of John the Baptist (Matthew iii. 2).

13. **Anointed with oil many that were sick.** This anointing with oil cured all manner of diseases, not by virtue of the oil itself, but through the power given the Apostles by our Lord. The Apostles were not at this time administering the sacrament of Extreme Unction, which was instituted later, but their present action of anointing the sick with oil was a foreshadowing of the sacrament to which St. James (v. 14, 15) refers.

14-16. **King Herod.** See on Matthew xiv. 1.

**John the Baptist, etc.** See on Matthew xiv. 2. When Herod had heard of the mighty works (*δυνάμεις*) of the Saviour he concluded that John the Baptist was alive again; others thought He was Elias, because Elias was expected to precede the Messiah; still others considered Him to be one of the usual prophets by whom Israel of old had been favored.

17, 18. See on Matthew xiv. 3, 4.

20. **Kept him, and when he heard him, etc.;** i.e., while Herod

22. And when the daughter of the same Herodias had come in, and had danced, and pleased Herod, and them that were at table with him, the king said to the damsel: Ask of me what thou wilt, and I will give it thee.

23. And he swore to her: Whatsoever thou shalt ask I will give thee, though it be the half of my kingdom.

24. Who when she was gone out, said to her mother, What shall I ask? But she said: The head of John the Baptist.

25. And when she was come in immediately with haste to the king, she asked, saying: I will that forthwith thou give me in a dish, the head of John the Baptist.

26. And the king was struck sad. Yet because of his oath, and because of them that were with him at table, he would not displease her:

27. But sending an executioner, he commanded that his head should be brought in a dish.

28. And he beheaded him in the prison, and brought his head in a dish: and gave it to the damsel, and the damsel gave it to her mother.

29. Which his disciples hearing came, and took his body, and laid it in a tomb.

30. And the apostles coming together unto Jesus, related to him all things that they had done and taught.

31. And he said to them: Come apart into a desert place, and rest a little. For there were many coming and going: and they had not so much as time to eat.

32. And going up into a ship, they went into a desert place apart.

33. And they saw them going away, and many knew: and they ran flocking thither on foot from all the cities, and were there before them.

kept John in prison, he consulted him on many things, and was much impressed by his advice.

22. **Daughter of Herodias.** See on Matthew xiv. 6.

28. **And brought his head, etc.** This could not have been during the feast, if the feast was celebrated at Tiberias (verse 21), because John's prison was at Machaerus, several days' journey from Tiberias.

29. **His disciples; i.e., John's disciples; they buried him at Samaria (St. Jerome).**

30. **And the apostles coming together unto Jesus; i.e., on their return from their first missionary journey.**

31, 32. **They went into a desert place, which was an uninhabited place probably on the east shore of the lake, belonging to Bethsaida Julias (John vi. 1). See on Matthew xiv. 13.**

33. **They ran flocking thither; i.e., the people, seeing our Lord and the disciples crossing over the lake from west to east, hurried**

34. And Jesus going out saw a great multitude : and he had compassion on them, because they were as sheep not having a shepherd, and he began to teach them many things.

35. And when the day was now far spent, his disciples came to him, saying : This is a desert place, and the hour is now past :

36. Send them away, that going into the next villages and towns, they may buy themselves meat to eat.

37. And he answering said to them : Give you them to eat. And they said to him : Let us go and buy bread for two hundred pence, and we will give them to eat.

38. And he saith to them : How many loaves have you? go and see. And when they knew, they say : Five, and two fishes.

39. And he commanded them that they should make them all sit down by companies upon the green grass.

40. And they sat down in ranks, by hundreds and by fifties.

41. And when he had taken the five loaves, and the two fishes : looking up to heaven, he blessed, and broke the loaves, and gave to his disciples to set before them : and the two fishes he divided among them all.

42. And they all did eat, and had their fill.

43. And they took up the leavings, twelve full baskets of fragments, and of the fishes.

44. And they that did eat, were five thousand men.

45. And immediately he obliged his disciples to go up into the ship, that they might go before him over the water to Bethsaida, whilst he dismissed the people.

around the northern part of the lake on foot and were there before them.

34. **Jesus going out** ; i.e., going out of the boat, He saw the great multitude who had arrived at the spot before Him.

35-37. See on Matthew xiv. 15, 16. **Two hundred pence** ; i.e., two hundred *denarii*, a sum equal to about \$34.00 in our money. So much at least would be necessary, the disciples thought, in order that each person might have a little to eat.

41. **He blessed and broke**, etc. See on Matthew xiv. 19. The bread and fishes must have been multiplied in our Lord's hands, as He handed them out to the disciples.

45. **Over the water to Bethsaida** ; i.e., across to Bethsaida of Galilee on the north-western shore of the lake. Bethsaida means "Fishtown" ; hence, it is not remarkable that there should have been several of them around the Lake of Genesareth. Josephus, however, speaks only of Bethsaida Julias, in the vicinity of which the multiplication of the loaves had taken place. See on Matthew xiv. 22.



46. And when he had dismissed them, he went up to the mountain to pray.

47. And when it was late, the ship was in the midst of the sea, and himself alone on the land.

48. And seeing them labouring in rowing, (for the wind was against them,) and about the fourth watch of the night, he cometh to them walking upon the sea, and he would have passed by them.

49. But they seeing him walking upon the sea, thought it was an apparition, and they cried out.

50. For they all saw him, and were troubled. And immediately he spoke with them, and said to them: Have a good heart, it is I, fear ye not.

51. And he went up to them into the ship, and the wind ceased: and they were far more astonished within themselves:

52. For they understood not concerning the loaves; for their heart was blinded.

53. And when they had passed over, they came into the land of Genesareth, and set to the shore.

54. And when they were gone out of the ship, immediately they knew him:

55. And running through that whole country, they began to carry about in beds those that were sick, where they heard he was.

56. And whithersoever he entered, into towns or into villages or cities, they laid the sick in the streets, and besought him that they might touch but the hem of his garment: and as many as touched him were made whole.

46. **He went up into a mountain to pray**, as He was accustomed to do after the labors of the day were over. Cf. Matthew xxvi. 36; Mark i. 35; Luke vi. 12; ix. 18, 29.

48. See on Matthew xiv. 25. **He would have passed by them**; i.e., He made it appear that He wished to pass them by; He wanted them to call Him.

50. **Were troubled**. See on Matthew xiv. 26.

52. **For their heart was blinded**. The disciples were so carnal and human in their conception of things that they could not easily understand or long remember spiritual benefits, and hence they had so soon forgotten the miraculous multiplication of the loaves.

53. See on Matthew xiv. 34.

54. **Immediately they knew him**; i.e., the people of Genesareth recognized Him at once.

56. **The hem of his garment**. See on Matthew xiv. 36.

## CHAPTER VII

THE PHARISEES AND THE TRADITION, 1-23.

THE SYROPHENICIAN WOMAN, 24-30.

THE HEALING OF THE DEAF AND DUMB MAN, 31-37.

1. And there assembled together unto him the Pharisees and some of the scribes, coming from Jerusalem.

2. And when they had seen some of his disciples eat bread with common, that is, with unwashed hands, they found fault.

3. For the Pharisees, and all the Jews eat not without often washing their hands, holding the tradition of the ancients:

4. And when they come from the market, unless they be washed, they eat not; and many other things there are that have been delivered to them to observe, the washing of cups and of pots, and of brazen vessels, and of beds.

5. And the Pharisees and scribes asked him: Why do not thy disciples walk according to the tradition of the ancients, but they eat bread with common hands?

1. **Pharisees and scribes, coming from Jerusalem.** These enemies of our Lord were becoming more and more inflamed against Him, and hence the ablest doctors of the Law came from Jerusalem to Galilee to investigate what they had been hearing about Him.

2. **Common** (*κοίνα*); i.e., with hands legally unclean.

**They found fault** (*εμέμψαντο*),—wanting in the best Greek MSS.

3, 4. In these verses St. Mark explains for His Roman and Gentile Christians many of the manners and rites practiced by the Jews.

**The tradition of the ancients** does not refer to the practices of generations long past, but to the ceremonial observances, introduced shortly before our Lord's time by Hillel and Shammai, who were known as "the ancients," and who were the heads of the two great rival schools which flourished just around our Lord's birth. See on Matthew xv. 2.

6. But he answering, said to them: Well did Isaias prophesy of you hypocrites, as it is written: This people honoureth me with their lips, but their heart is far from me.

7. And in vain do they worship me, teaching doctrines and precepts of men.

8. For leaving the commandment of God, you hold the tradition of men, the washings of pots and of cups; and many other things you do like to these.

9. And he said to them: Well do you make void the commandment of God, that you may keep your own tradition.

10. For Moses said: Honour thy father and thy mother; and He that shall curse father or mother, dying let him die.

11. But you say: If a man shall say to his father or mother, Corban, (which is a gift,) whatsoever is from me, shall profit thee.

12. And further you suffer him not to do any thing for his father or mother,

13. Making void the word of God by your own tradition, which you have given forth. And many other such like things you do.

14. And calling again the multitude unto him, he said to them: Hear ye me all, and understand.

15. There is nothing from without a man that entering into him, can defile him. But the things which come from a man, those are they that defile a man.

16. If any man have ears to hear, let him hear.

6, 7. Isaias (xxix. 13) was speaking of the Jews of his own time, but what he said was even more true of the Jews of our Lord's time. Our Lord here quoted from the Septuagint version of Isaias, which is slightly different from the Hebrew, thereby giving His sanction to the former.

9. Well do you make void, etc. Well (*καλῶς*); i.e., "admirably," our Lord was speaking ironically.

10-12. See on Matthew xv. 3-6.

**Corban**; i.e., a gift, as St. Mark explains for his non-Jewish readers. The Pharisees had taught the people that any gift which had been offered to God could not be given to others without profanation; and because they themselves had a part in the profits of all gifts offered to God, they incited the people thus to consecrate all their possessions to God. Hence, it would happen that, if the parents were in need and requested anything from their children for their support, the latter could say that all their possessions had been offered to God, and so could not be used for the support of their parents.

15. See on Matthew xv. 11.

17. And when he was come into the house from the multitude, his disciples asked him the parable.

18. And he saith to them: So are you also without knowledge? understand you not that every thing from without, entering into a man cannot defile him:

19. Because it entereth not into his heart, but goeth into the belly, and goeth out into the privy, purging all meats?

20. But he said that the things which come out from a man, they defile a man.

21. For from within out of the heart of men proceed evil thoughts, adulteries, fornications, murders,

22. Thefts, covetousness, wickedness, deceit, lasciviousness, an evil eye, blasphemy, pride, foolishness.

23. All these evil things come from within, and defile a man.

24. And rising from thence he went into the coasts of Tyre and Sidon: and entering into a house, he would that no man should know it, and he could not be hid.

25. For a woman as soon as she heard of him, whose daughter had an unclean spirit, came in and fell down at his feet.

26. For the woman was a Gentile, a Syrophenician born. And she besought him that he would cast forth the devil out of her daughter.

27. Who said to her: Suffer first the children to be filled: for it is not good to take the bread of the children, and cast it to the dogs.

28. But she answered and said to him: Yea, Lord; for the whelps also eat under the table of the crumbs of the children.

29. And he said to her: For this saying go thy way, the devil is gone out of thy daughter.

30. And when she was come into her house, she found the girl lying upon the bed, and that the devil was gone out.

17. **Asked him the parable.** The word "parable" here means an obscure saying. See on Matthew xv. 15.

19-23. In these verses our Lord shows the disciples in detail just what things defile a man. The Pharisees were very solicitous about external things, such as eating with unwashed hands, but they give little attention to the internal evils which really corrupt the heart.

24. **And rising from thence, etc.;** i.e., setting out from the vicinity of Capharnaum, our Lord went to Tyre and Sidon, which were seaport cities lying to the north of Galilee. See on Matthew xv. 21.

25, 26. See on Matthew xv. 22.

27. **Suffer first the children to be filled.** By these words our Lord wishes to tell the Gentile woman that the Gospel is first to be preached to the Jewish people, who were by adoption the children of God. See on Matthew xv. 24.

28, 29. See on Matthew xv. 27, 28.

31. And again going out of the coasts of Tyre, he came by Sidon to the sea of Galilee, through the midst of the coasts of Decapolis.

32. And they bring to him one deaf and dumb; and they besought him that he would lay his hand upon him.

33. And taking him from the multitude apart, he put his fingers into his ears, and spitting, he touched his tongue:

34. And looking up to heaven, he groaned, and said to him: Ephpheta, which is, Be thou opened.

35. And immediately his ears were opened, and the string of his tongue was loosed, and he spoke right.

36. And he charged them that they should tell no man. But the more he charged them, so much the more a great deal did they publish it.

37. And so much the more did they wonder, saying: He hath done all things well; he hath made both the deaf to hear, and the dumb to speak.

31. See on Matthew xv. 29.

33. **And taking him from the multitude apart.** This our Lord did most likely in order to avoid ostentation and also to dispose the heart of the patient for faith.

**And spitting, he touched his tongue.** The use of saliva among the Jews was an ordinary remedy for afflictions of the eyes and ears. Of itself it had no curative power, but in the present instance it was the outward sign used by our Lord to signify the divine power which wrought the cure.

34. **He groaned,** perhaps in order to implore the help of the heavenly Father, and also to express His sympathy for His afflicted patient.

**Ephpheta.** In Hebrew, the form is *Ethpathach*, which is the imperative of the verb *pathach*, meaning, *be opened*.

## CHAPTER VIII

THE SECOND MULTIPLICATION OF THE LOAVES, 1-10.

A SIGN FROM HEAVEN, 11-13.

THE LEAVEN OF THE PHARISEES, 14-21.

THE BLIND MAN OF BETHSAIDA, 22-26.

THE CONFESSION OF ST. PETER, 27-30.

JESUS FORETELLS HIS PASSION, 31-33.

FOLLOWING JESUS, 34-39.

1. In those days again, when there was a great multitude, and had nothing to eat; calling his disciples together, he saith to them:

2. I have compassion on the multitude, for behold they have now been with me three days, and have nothing to eat.

3. And if I shall send them away fasting to their home, they will faint in the way; for some of them came from afar off.

4. And his disciples answered him: From whence can any one fill them here with bread in the wilderness?

5. And he asked them: How many loaves have ye? Who said: Seven.

6. And taking the seven loaves, giving thanks, he broke, and gave to his disciples for to set before them; and they set them before the people.

7. And they had a few little fishes; and he blessed them, and commanded them to be set before them.

8. And they did eat and were filled; and they took up that which was left of the fragments, seven baskets.

9. And they that had eaten were about four thousand; and he sent them away.

1. In those days; i.e., after He had returned from Tyre and Sidon to the territories of Decapolis. **Again** has reference to the previous multiplication of the loaves, when more than 5000 were fed.

4. **From whence can any one fill them**, etc. It may at first be surprising that, after the previous miracle of the multiplication of the loaves, the disciples should put this question; but we must remember that their heart was blinded and they did not understand (vi. 52). Moreover, it is probable that, by asking this question, the disciples might have wished to induce our Lord to repeat the previous miracle.

8, 9. See on Matthew xv. 37, 38. **Four thousand**; i.e., there were about four thousand men, besides women and children (Matthew xv. 38).

10. And immediately going up into a ship with his disciples, he came into the parts of Dalmanutha.

11. And the Pharisees came forth, and began to question with him, asking him a sign from heaven, tempting him.

12. And sighing deeply in spirit, he saith: Why doth this generation seek a sign? Amen, I say to you, a sign shall not be given to this generation.

13. And leaving them, he went up again into the ship, and passed to the other side of the water.

14. And they forgot to take bread; and they had but one loaf with them in the ship.

15. And he charged them, saying: Take heed and beware of the leaven of the Pharisees, and of the leaven of Herod.

16. And they reasoned among themselves, saying: Because we have no bread.

17. Which Jesus knowing, saith to them: Why do you reason, because you have no bread? do you not yet know nor understand? have you still your heart blinded?

18. Having eyes, see you not? and having ears, hear you not? neither do you remember.

19. When I broke the five loaves among five thousand, how many baskets full of fragments took you up? They say to him, Twelve.

20. When also the seven loaves among four thousand, how many baskets of fragments took you up? And they say to him, Seven.

21. And he said to them: How do you not yet understand?

10. And immediately . . . he came into the parts of Dalmanutha. In Matthew (xv. 39), it is said, "into the coasts of Magedan." The site of these places is not known for certain but it would seem that they were on the east coast of the Sea of Galilee; tradition, however, places them on the west coast, a few miles north of Tiberias.

11. See on Matthew xvi. 1. The Pharisees had no intention of believing in any miracle our Lord might perform; they only wanted to cast discredit on the multiplication of the loaves by asking now for something even more extraordinary, but which they knew He would not grant.

12. And sighing deeply in spirit, because of the incredulity of the Pharisees.

**This generation;** i.e., this race or class of people.

13. **To the other side of the water;** i.e., He went from the eastern to the western shore of the lake, provided Dalmanutha was on the eastern shore; otherwise He was passing from west to east.

15. See on Matthew xvi. 6.

16-21. See on Matthew xvi. 7-10.

22. And they came to Bethsaida; and they bring to him a blind man, and they besought him that he would touch him.

23. And taking the blind man by the hand, he led him out of the town; and spitting upon his eyes, laying his hands on him, he asked him if he saw any thing.

24. And looking up, he said: I see men as it were trees, walking.

25. After that again he laid his hands upon his eyes, and he began to see, and was restored, so that he saw all things clearly.

26. And he sent him into his house, saying: Go into thy house, and if thou enter into the town, tell nobody.

27. And Jesus went out, and his disciples, into the towns of Cæsarea Philippi. And in the way, he asked his disciples, saying to them: Whom do men say that I am?

28. Who answered him, saying: John the Baptist; but some Elias, and others as one of the prophets.

29. Then he saith to them: But whom do you say that I am? Peter answering said to him: Thou art the Christ.

22. **And they came to Bethsaida.** This was Bethsaida of Galilee, if our Lord had passed from east to west; but Bethsaida Julia, if He had crossed from west to east. "A blind man," — mentioned by St. Mark only.

23. **And spitting upon his eyes.** See above vii. 33.

24. **I see men as it were trees, walking.** His sight was coming back gradually. The man could not have been blind from birth, since he had an appreciation of the relative heights of men and trees.

25. **So that he saw all things clearly.** Why our Lord should choose to work this cure by gradual stages, we do not know. Perhaps at first the man's faith was at fault. At all events, we know that the Saviour at different times worked various miracles in various ways.

26. **Go into thy house . . . tell nobody.** Evidently the man did not live at Bethsaida, and our Lord imposed silence on him in order not to attract undue attention to His miracles.

27-29. See on Matthew xvi. 13-16. It must be observed that St. Mark wrote his Gospel under the guidance of St. Peter, or at least in accordance with the latter's preaching, and therefore he omits in this account, as in other similar instances, all that would redound to Peter's praise. Hence there is no mention here, as in Matthew, of the exalted dignity conferred on Peter by reason of his beautiful confession, "Thou art the Christ," etc. (Matthew xvi. 17, 18).



30. And he strictly charged them that they should not tell any man of him.

31. And he began to teach them, that the Son of man must suffer many things, and be rejected by the ancients and by the high priests, and the scribes, and be killed: and after three days rise again.

32. And he spoke the word openly. And Peter taking him, began to rebuke him.

33. Who turning about and seeing his disciples, threatened Peter, saying: Go behind me, Satan, because thou savourest not the things that are of God, but that are of men.

34. And calling the multitude together with his disciples, he said to them: If any man will follow me, let him deny himself, and take up his cross, and follow me.

35. For whosoever will save his life, shall lose it: and whosoever shall lose his life for my sake and the gospel, shall save it.

36. For what shall it profit a man, if he gain the whole world, and suffer the loss of his soul?

37. Or what shall a man give in exchange for his soul?

38. For he that shall be ashamed of me, and of my words, in this adulterous and sinful generation: the Son of man also will be ashamed of him, when he shall come in the glory of his Father with the holy angels.

39. And he said to them: Amen I say to you, that there are some of them that stand here, who shall not taste death, till they see the kingdom of God coming in power.

30. On the one hand, our Lord wished the people to learn for themselves His Divinity and the spiritual meaning of His mission; and on the other hand, He did not want His enemies to be too much incited against Him. Cf. on Matthew xvi. 20.

31-33. See on Matthew xvi. 21-23. **Threatened Peter**; i.e., He *rebuked* him (*ἐπετίμησεν*).

34. **And calling the multitude together**, etc. Our Lord now announces, not only to the disciples, but also to the multitude, — and through them to us all, the conditions under which He is to be served; if any man would be His disciple and faithful follower, he must be ready to renounce himself and to suffer anything, even death itself, if need be.

35. **And the gospel**; i.e., the doctrine which He was preaching and giving to the world. See on Matthew xvi. 25.

38. **This adulterous and sinful generation**. These words refer to the Jewish people, who having been espoused to God under the Old Covenant, had become unfaithful to Him, as an adulterous wife to her husband. Cf. Jer. ii. 2 ff.

39. See on Matthew xvi. 28.

## CHAPTER IX

THE TRANSFIGURATION, 1-12.

THE CURE OF THE EPILEPTIC, 13-29.

ANOTHER PREDICTION OF THE PASSION, 30, 31.

EXHORTATION TO HUMILITY, 32-39.

CHARITY, 40.

AGAINST SCANDAL, 41-49.

1. And after six days Jesus taketh with him Peter and James and John, and leadeth them up into an high mountain apart by themselves, and was transfigured before them.

2. And his garments became shining and exceeding white as snow, so as no fuller upon earth can make white.

3. And there appeared to them Elias with Moses; and they were talking with Jesus.

4. And Peter answering, said to Jesus: Rabbi, it is good for us to be here: and let us make three tabernacles, one for thee, and one for Moses, and one for Elias.

5. For he knew not what he said: for they were struck with fear.

6. And there was a cloud overshadowing them: and a voice came out of the cloud, saying: This is my most beloved son; hear ye him.

7. And immediately looking about, they saw no man any more, but Jesus only with them.

8. And as they came down from the mountain, he charged them not to tell any man what things they had seen, til the Son of man shall be risen again from the dead.

9. And they kept the word to themselves; questioning together what that should mean, when he shall be risen from the dead.

1. See on Matthew xvii. 1, 2.

3, 4. See on Matthew xvii. 3, 4.

5. For he knew not what he said. These are the words of the Evangelist. Peter misunderstood the purpose of the Transfiguration, and therefore foolishly thought that the glorious temporal reign of the Messiah was then and there to begin.

6-8. See on Matthew xvii. 5-9.

9. And they kept the word to themselves; i.e., they maintained the silence and secrecy imposed upon them by our Lord.

Questioning together what that should mean. Filled with the idea that the Messiah was about to inaugurate His glorious temporal reign, the disciples could not understand this announcement of proximate suffering, death and resurrection. They believed, indeed, in the general resurrection of the body, and they thought

10. And they asked him, saying: Why then do the Pharisees and scribes say that Elias must come first?

11. Who answering, said to them: Elias, when he shall come first, shall restore all things; and as it is written of the Son of man, that he must suffer many things and be despised.

12. But I say to you, that Elias also is come, (and they have done to him whatsoever they would,) as it is written of him.

13. And coming to his disciples, he saw a great multitude about them, and the scribes disputing with them.

14. And presently all the people seeing Jesus, were astonished and struck with fear; and running to him, they saluted him.

15. And he asked them: What do you question about among you?

16. And one of the multitude, answering, said: Master, I have brought my son to thee, having a dumb spirit,

17. Who, wheresoever he taketh him, dasheth him, and he foameth, and gnasheth with the teeth, and pineth away; and I spoke to thy disciples to cast him out, and they could not.

18. Who answering them, said: O incredulous generation, how long shall I be with you? how long shall I suffer you? bring him unto me.

our Lord would have a part in it, but they could not understand the resurrection of which He was now speaking.

10. See on Matthew xvii. 10.

11. Elias when he shall come first; i.e., Elias does indeed come first (*ἐλθὼν μὲν πρῶτον*) and restores all things. The reference is to the coming of Elias in person before the final coming of Christ at the end of the world. See on Matthew xvii. 11.

And as it is written of the Son of man, — more literally, “but is it not written of the Son of Man,” etc.? While the disciples were recalling prophecies about Elias and his coming, our Lord wished to direct their attention to those other prophecies concerning Himself and His sufferings. Cf. Isa. liii. 3, 4.

12. This verse refers to John the Baptist as the disciples understood (Matthew xvii. 13). But it is nowhere directly prophesied that John the Baptist should be made to suffer especially. *Answer:* Our Lord means to say here that John had been made to suffer things similar to those foretold of Elias.

13. And coming to his disciples; i.e., to those disciples who had not been with him at the Transfiguration.

And the scribes disputing with them. The Scribes were questioning and ridiculing the disciples about their inability to cast the deaf and dumb spirit out of the man's son (verse 17).

16-18. See on Matthew xvii. 14-18.

19. And they brought him. And when he had seen him, immediately the spirit troubled him; and being thrown down upon the ground, he rolled about foaming.

20. And he asked his father: How long time is it since this hath happened unto him? But he said: From his infancy:

21. And oftentimes hath he cast him into the fire and into waters to destroy him. But if thou canst do any thing, help us, having compassion on us.

22. And Jesus saith to him: If thou canst believe, all things are possible to him that believeth.

23. And immediately the father of the boy crying out, with tears said: I do believe, Lord: help my unbelief.

24. And when Jesus saw the multitude running together, he threatened the unclean spirit, saying to him: Deaf and dumb spirit, I command thee, go out of him; and enter not any more into him.

25. And crying out, and greatly tearing him, he went out of him, and he became as dead, so that many said: He is dead.

26. But Jesus taking him by the hand, lifted him up; and he arose.

27. And when he was come into the house, his disciples secretly asked him: Why could not we cast him out?

28. And he said to them: This kind can go out by nothing, but by prayer and fasting.

29. And departing from thence, they passed through Galilee, and he would not that any man should know it.

30. And he taught his disciples, and said to them: The Son of man shall be betrayed into the hands of men, and they shall kill him; and after that he is killed, he shall rise again the third day.

31. But they understood not the word, and they were afraid to ask him.

32. And they came to Capharnaum. And when they were in the house, he asked them: What did you treat of in the way?

22. The man's faith did not affect our Lord's power to perform the miracle, except as a disposition. Faith was a necessary disposition on the part of the man to merit a miraculous exercise of divine power.

23. **Help my unbelief**; i.e., perfect my faith; the father realized that his faith was imperfect, and therefore he appealed to the Saviour to perfect it.

24. **I command thee, go out of him.** Our Lord here speaks in His own name, showing that He was God Himself.

28. See on Matthew xvii. 20.

29. **Departing from thence**; i.e., going from the Mount of Transfiguration they passed through Galilee on their way to Capharnaum.

30. See on Matthew xvii. 21, 22.

31. **But they understood not the word.** Again the disciples

33. But they held their peace, for in the way they had disputed among themselves, which of them should be the greatest.

34. And sitting down, he called the twelve, and saith to them: If any man desire to be first, he shall be the last of all, and the minister of all.

35. And taking a child, he set him in the midst of them. Whom when he had embraced, he saith to them:

36. Whosoever shall receive one such child as this in my name, receiveth me. And whosoever shall receive me, receiveth not me, but him that sent me.

37. John answered him, saying: Master, we saw one casting out devils in thy name, who followeth not us, and we forbade him.

38. But Jesus said: Do not forbid him. For there is no man that doth a miracle in my name, and can soon speak ill of me.

39. For he that is not against you, is for you.

40. For whosoever shall give you to drink a cup of water in my name, because you belong to Christ: amen I say to you, he shall not lose his reward.

were unable to reconcile the predictions just uttered by our Lord with the thoughts uppermost in their minds of the glorious temporal kingdom which they thought was about to be established. Their perplexity is the same as that mentioned in viii. 32; ix. 9.

33. **But they held their peace.** On their way back to Capharnaum our Lord had heard the disciples wrangling among themselves as to who would be first in the new temporal kingdom, but when He asked them of what they had "treated in the way," they were ashamed to admit what was the object of their vain ambition. See on Matthew xviii. 1 ff.

34. **And sitting down;** i.e., at Capharnaum, in the house of Peter (i. 29).

35, 36. See on Matthew xviii. 3-5.

37. **John answered him;** etc. What our Lord had been saying (verse 36) had suggested the remark now made by John. Hence the Evangelist says, "John answered him." John thought that the one in question had been working miracles without due authorization, and ought, therefore, to be stopped.

38. **For there is no man that doth a miracle,** etc. By these words our Lord wished to say that no man whose faith has merited the gift of miracles can soon turn against Him.

39. See on Matthew xii. 30.

40. In this verse our Lord is directly commending the action of the exorcist about whom St. John had raised a question, and His argument is this: If even a drink of water given in My name shall

41. And whosoever shall scandalize one of these little ones that believe in me; it were better for him that a millstone were hanged about his neck, and he were cast into the sea.

42. And if thy hand scandalize thee, cut it off: it is better for thee to enter into life, maimed, than having two hands to go into hell, into unquenchable fire:

43. Where their worm dieth not, and the fire is not extinguished.

44. And if thy foot scandalize thee, cut it off. It is better for thee to enter lame into life everlasting, than having two feet, to be cast into the hell of unquenchable fire:

45. Where their worm dieth not, and the fire is not extinguished.

46. And if thy eye scandalize thee, pluck it out. It is better for thee with one eye to enter into the kingdom of God, than having two eyes to be cast into the hell of fire:

47. Where their worm dieth not, and the fire is not extinguished.

48. For every one shall be salted with fire: and every victim shall be salted with salt.

have its reward, how much more, then, the casting out of a devil from one who is dear to Me? (Matthew x. 42).

41. Our Lord now resumes the thread of His instruction, which was interrupted by John's remark (verse 37). See on Matthew xviii. 6.

42. See on Matthew xviii. 8, 9. Hell; i.e., *Gehenna* (γέεννα), the Valley of Hinnom (*Gey-Hinnom*), southwest of Jerusalem. It was here that idolaters, during the reign of wicked kings, used to worship Moloch, by casting their children into the fire in his honor. The name of the place was later used to designate the abode of the wicked after death. See on Matthew v. 30.

Into unquenchable fire; i.e., into the fire that cannot be quenched (εἰς τὸ πῦρ τὸ ἄσβεστον). These words are considered genuine here, as being found in the best MSS.; and they unmistakably express the reality and durability of the fire of hell. The same words are repeated in verses 44 and 46, but are not to be found there in the best MSS.

43. Where their worm dieth not. Some understand the worm here spoken of in a literal sense, of insects which will be supernaturally preserved by God in the fire of hell to torment the souls of the damned. It is more probable, however, that the term means simply the remorse of conscience.

44-46. See on Matthew xviii. 8, 9.

48. For every one shall be salted with fire. The most prob-

49. Salt is good. But if the salt become unsavoury; wherewith will you season it? Have salt in you, and have peace among you.

able meaning of these words is that the fire of hell will possess the properties of salt, which are to burn, and preserve from corruption. Thus, by the power of God, the fire of hell will torture and preserve forever unconsumed the souls of the damned.

**And every victim shall be salted with salt.** This clause is wanting in the best MSS. It is doubtless genuine, however. The allusion is to the Old Law (Lev. ii. 13), which required every victim offered to God to be seasoned with salt. Here, according to some, the words refer to the servants of God, who, in order to please Him, must be seasoned with the salt of trial and tribulation. According to others, the reference is to the damned who will be seasoned with the salt of hell fire, as victims of God's eternal justice.

49. Having spoken of salt in the preceding verse, our Lord now takes occasion to admonish the Apostles that they are the salt of the earth, and as such, should give up vain ambitions and contentious wrangling, of which they were guilty on their way to Capharnaum, and which called forth the present discourse on scandal.

## CHAPTER X

JESUS IN PERAEA, I.

THE PHARISEES AND DIVORCE, 2-12.

JESUS BLESSING CHILDREN, 13-16.

THE RICH YOUNG MAN AND PERFECTION, 17-27.

THE REWARD OF THOSE WHO FOLLOW EVANGELICAL  
PERFECTION, 28-31.

ANOTHER PROPHECY OF THE PASSION, 32-34.

THE SONS OF ZEBEDEE, 35-40.

HUMILITY, 41-45.

THE BLIND MAN OF JERICO, 46-52.

1. And rising up from thence, he cometh into the coasts of Judea beyond the Jordan: and the multitudes flock to him again. And as he was accustomed, he taught them again.

1. **And rising from thence; i.e., from where He was in Galilee. The coasts of Judea beyond the Jordan.** An "and" should be

2. And the Pharisees coming to him asked him: Is it lawful for a man to put away his wife? tempting him.

3. But he answering, saith to them: What did Moses command you?

4. Who said: Moses permitted to write a bill of divorce, and to put her away.

5. To whom Jesus answering, said: Because of the hardness of your heart he wrote you that precept.

6. But from the beginning of the creation, God made them male and female.

7. For this cause a man shall leave his father and mother; and shall cleave to his wife.

8. And they two shall be in one flesh. Therefore now they are not two, but one flesh.

9. What therefore God hath joined together, let not man put asunder.

10. And in the house again his disciples asked him concerning the same thing.

11. And he saith to them: Whosoever shall put away his wife and marry another, committeth adultery against her.

12. And if the wife shall put away her husband, and be married to another, she committeth adultery.

13. And they brought to him young children, that he might touch them. And the disciples rebuked them that brought them.

14. Whom when Jesus saw, he was much displeased, and saith to them: Suffer the little children to come unto me, and forbid them not; for of such is the kingdom of God.

15. Amen I say to you, whosoever shall not receive the kingdom of God as a little child, shall not enter into it.

16. And embracing them, and laying his hands upon them, he blessed them.

17. And when he was gone forth into the way, a certain man running up and kneeling before him, asked him, Good Master, what shall I do that I may receive life everlasting?

18. And Jesus said to him, Why callest thou me good? None is good but one, that is God.

19. Thou knowest the commandments: Do not commit adultery, do not kill, do not steal, bear not false witness, do no fraud, honour thy father and mother.

20. But he answering, said to him: Master, all these things I have observed from my youth.

inserted before the phrase "beyond the Jordan," according to the best MSS.; there was probably no part of Judea which lay beyond the Jordan. See on Matthew xix. 1.

2-9. See on Matthew xix. 3-9.

In verses 11 and 12, our Lord clearly states that marriage in His Church is altogether indissoluble. See on Matthew xix. 9.

13-15. See on Matthew xix. 13, 14.

17-19. See on Matthew xix. 16-19.



21. And Jesus looking on him, loved him, and said to him: One thing is wanting unto thee: go, sell whatsoever thou hast, and give to the poor, and thou shalt have treasure in heaven; and come, follow me.

22. Who being struck sad at that saying, went away sorrowful: for he had great possessions.

23. And Jesus looking round about, saith to his disciples: How hardly shall they that have riches, enter into the kingdom of God!

24. And the disciples were astonished at his words. But Jesus again answering, saith to them: Children, how hard is it for them that trust in riches, to enter into the kingdom of God?

25. It is easier for a camel to pass through the eye of a needle, than for a rich man to enter into the kingdom of God.

26. Who wondered the more, saying among themselves: Who then can be saved?

27. And Jesus looking on them, saith: With men it is impossible; but not with God: for all things are possible with God.

28. And Peter began to say unto him: Behold, we have left all things, and have followed thee.

29. Jesus answering, said: Amen I say to you, there is no man who hath left house or brethren, or sisters, or father, or mother, or children, or lands, for my sake and for the gospel,

30. Who shall not receive an hundred times as much, now in this time; houses, and brethren, and sisters, and mothers, and children, and lands, with persecutions: and in the world to come life everlasting.

31. But many that are first, shall be last: and the last, first.

32. And they were in the way going up to Jerusalem: and Jesus went before them, and they were astonished; and following were afraid. And taking again the twelve, he began to tell them the things that should befall him.

21-24. See on Matthew xix. 21-23.

And the disciples were astonished at his words. The Jews always had regarded temporal prosperity and temporal possessions as a reward of virtuous living, hence the Apostles were exceedingly astonished (*ἐθαμβοῦντο*) at our Lord's words.

For them that trust in riches, — not found in the best MSS.

25-30. See on Matthew xix. 24-29. With persecutions. The present verse shows that the faithful disciple of Christ will receive special temporal, as well as spiritual and eternal rewards; but our Lord reminds the disciples that, along with temporal recompenses, they must be prepared to find the cross.

31. See on Matthew xix. 30.

32. And following were afraid; i.e., those who were following were afraid for His safety. The disciples were astonished at His bravery. The Saviour was on His way from Perea to Jerusalem

33. Saying: Behold we go up to Jerusalem, and the Son of man shall be betrayed to the chief priests, and to the scribes and ancients, and they shall condemn him to death, and shall deliver him to the Gentiles.

34. And they shall mock him, and spit on him, and scourge him, and kill him: and the third day he shall rise again.

35. And James and John the sons of Zebedee, come to him, saying: Master, we desire that whatsoever we shall ask, thou wouldst do it for us:

36. But he said to them: What would you that I should do for you?

37. And they said: Grant to us, that we may sit, one on thy right hand, and the other on thy left hand, in thy glory.

38. And Jesus said to them: You know not what you ask. Can you drink of the chalice that I drink of: or be baptized with the baptism wherewith I am baptized?

39. But they said to him: We can. And Jesus saith to them: You shall indeed drink of the chalice that I drink of: and with the baptism wherewith I am baptized, you shall be baptized.

40. But to sit on my right hand, or on my left, is not mine to give to you, but to them for whom it is prepared.

41. And the ten hearing it, began to be much displeased at James and John.

42. But Jesus calling them, saith to them: You know that they who seem to rule over the Gentiles, lord it over them: and their princes have power over them.

43. But it is not so among you: but whosoever will be greater, shall be your minister.

44. And whosoever will be first among you, shall be the servant of all.

45. For the Son of man also is not come to be ministered unto, but to minister, and to give his life a redemption for many.

for the last time, and the disciples, and those who followed had grave apprehensions of what might befall Him at Jerusalem.

33, 34. Our Lord again predicts His Passion, for the third time (see viii. 31; ix. 30), and describes more than before the details of His suffering and death. The disciples cannot understand it (Luke xviii. 34), and to comfort their troubled minds, the Saviour this time, as on each of the other occasions, announces His glorious Resurrection.

35. And James and John . . . come to him, etc.; i.e., they asked the favor through their mother; she made the request in their name (Matthew xx. 20).

36-38. See on Matthew xx. 21-23. Or be baptized with the baptism, etc. The comparison is the same as that of the chalice our Lord is directing attention to His sufferings, in which He will be immersed, as one baptized is immersed in the water.

39, 40. See on Matthew xx. 23.

42-45. See on Matthew xx. 25-28.

46. And they came to Jericho: and as he went out of Jericho, with his disciples, and a very great multitude, Bartimeus the blind man, the son of Timeus, sat by the way side begging.

47. Who when he had heard, that it was Jesus of Nazareth, began to cry out, and to say: Jesus son of David, have mercy on me.

48. And many rebuked him, that he might hold his peace; but he cried a great deal the more: Son of David, have mercy on me.

49. And Jesus, standing still, commanded him to be called. And they call the blind man, saying to him: Be of better comfort: arise, he calleth thee.

50. Who casting off his garment leaped up, and came to him.

51. And Jesus answering, said to him: What wilt thou that I should do to thee? And the blind man said to him: Rabboni, that I may see.

52. And Jesus saith to him: Go thy way, thy faith hath made thee whole. And immediately he saw, and followed him in the way.

46, 47. See on Matthew xx. 29, 30.

51. **Rabboni**, which is a more reverential form of "Rabbi."

## CHAPTER XI

### THE TRIUMPHAL ENTRY OF JESUS INTO JERUSALEM,

#### I-II.

#### THE BARREN FIG-TREE, 12-14.

#### THE TRAFFICKERS IN THE TEMPLE, 15-19.

#### CONFIDENCE IN GOD, 20-26.

#### THE QUESTION ABOUT JOHN THE BAPTIST, 27-33.

1. And when they were drawing near to Jerusalem and to Bethania at the mount of Olives, he sendeth two of his disciples.

2. And saith to them: Go into the village that is over against you, and immediately at your coming in thither, you shall find a colt tied, upon which no man yet hath sat: loose him, and bring him.

3. And if any man shall say to you, What are you doing? say ye that the Lord hath need of him: and immediately he will let him come hither.

4. And going their way, they found the colt tied before the gate without, in the meeting of two ways: and they loose him.

5. And some of them that stood there, said to them: What do you loosing the colt?

6. Who said to them as Jesus had commanded them; and they let him go with them.

1, 2. See on Matthew xxi. 1, 2; Luke xix. 29. **Upon which no man yet hath sat**, because this colt was to be used for a religious purpose, and it was considered irreverent to use for such a purpose

7. And they brought the colt to Jesus; and they lay their garments on him, and he sat upon him.

8. And many spread their garments in the way: and others cut down boughs from the trees, and strewed them in the way.

9. And they that went before and they that followed, cried, saying: Hosanna, blessed is he that cometh in the name of the Lord.

10. Blessed be the kingdom of our father David that cometh: Hosanna in the highest.

11. And he entered into Jerusalem, into the temple: and having viewed all things round about, when now the eventide was come, he went out to Bethania with the twelve.

12. And the next day when they came out from Bethania, he was hungry.

13. And when he had seen afar off a fig tree having leaves, he came if perhaps he might find any thing on it. And when he was come to it, he found nothing but leaves. For it was not the time for figs.

14. And answering he said to it: May no man hereafter eat fruit of thee any more for ever. And his disciples heard it.

15. And they came to Jerusalem. And when he was entered into the temple, he began to cast out them that sold and bought in the temple, and overthrew the tables of the moneychangers, and the chairs of them that sold doves.

16. And he suffered not that any man should carry a vessel through the temple;

17. And he taught, saying to them: Is it not written, My house shall be called the house of prayer to all nations? But you have made it a den of thieves.

an animal which had been put to profane uses. See also on Matthew xxi. 4, 5.

7. See on Matthew xxi. 7.

9, 10. See on Matthew xxi. 9.

13. And when he had seen afar off a fig-tree having leaves. In the Holy Land, the fruit of the fig-tree appears before the leaves, and therefore, although it was not time for figs, this fig-tree "having leaves" gave the appearance of having fruit also, which it did not have. In this way, the fig-tree was a fitting type of the Synagogue, which it illustrated, for the latter was profuse in external observances and ceremonies (leaves) but singularly wanting in the true religious spirit (fruit) which Almighty God required of it.

15. See on Matthew xxi. 12.

16. This verse shows how strictly the Temple was to be guarded against secular traffic. According to Josephus (*Contra Appionem* ii. 7), it was forbidden to carry a vessel into the Temple enclosure.

17. See on Matthew xxi. 13.

18. Which when the chief priests and the scribes had heard, they sought how they might destroy him. For they feared him, because the whole multitude was in admiration at his doctrine.

19. And when evening was come, he went forth out of the city.

20. And when they passed by in the morning they saw the fig tree dried up from the roots.

21. And Peter remembering, said to him: Rabbi, behold the fig tree, which thou didst curse, is withered away.

22. And Jesus answering, saith to them: Have the faith of God.

23. Amen I say to you, that whosoever shall say to this mountain, Be thou removed and be cast into the sea, and shall not stagger in his heart, but believe, that whatsoever he saith shall be done; it shall be done unto him.

24. Therefore I say unto you, all things, whatsoever you ask when ye pray, believe that you shall receive; and they shall come unto you.

25. And when you shall stand to pray, forgive, if you have aught against any man; that your Father also, who is in heaven, may forgive you your sins.

26. But if you will not forgive, neither will your Father that is in heaven, forgive you your sins.

27. And they come again to Jerusalem. And when he was walking in the temple, there come to him the chief priests and the scribes and the ancients,

28. And they say to him: By what authority dost thou these things? and who hath given thee this authority that thou shouldst do these things?

29. And Jesus answering, said to them: I will also ask you one word, and answer you me, and I will tell you by what authority I do these things.

30. The baptism of John, was it from heaven, or from men? Answer me.

31. But they thought with themselves, saying: If we say, From heaven; he will say, Why then did you not believe him?

32. If we say, From men, we fear the people. For all men counted John that he was a prophet indeed.

33. And they answering, say to Jesus: We know not. And Jesus answering, saith to them: Neither do I tell you by what authority I do these things.

18. The chief priests and the scribes sought to destroy him, because those booths which our Lord had overturned were a source of revenue to them.

23. Whosoever shall say to this mountain. See on Matthew xvii. 19.

24-26. See on Matthew vii. 7-11. And when you shall stand to pray. It was customary among the Jews often to pray in a standing posture.

27. There came to him chief priests . . . scribes . . . ancients, — a deputation from the Sanhedrim.

## CHAPTER XII

THE PARABLE OF THE WICKED HUSBANDMEN, 1-12.

TRIBUTE TO CAESAR, 13-17.

THE SADDUCEES AND THE RESURRECTION, 18-27.

THE FIRST COMMANDMENT, 28-34.

THE MESSIAH THE SON OF DAVID, 35-37.

THE HYPOCRISY OF THE SCRIBES, 38-40.

THE WIDOW'S MITE, 41-44.

1. And he began to speak to them in parables: A certain man planted a vineyard and made a hedge about it, and dug a place for the winefat, and built a tower, and let it to husbandmen; and went into a far country.

2. And at the season he sent to the husbandmen a servant to receive of the husbandmen of the fruit of the vineyard.

3. Who having laid hands on him, beat him, and sent him away empty.

4. And again he sent to them another servant; and him they wounded in the head, and used him reproachfully.

5. And again he sent another, and him they killed: and many others, of whom some they beat, and others they killed.

6. Therefore having yet one son, most dear to him; he also sent him unto them last of all, saying: They will reverence my son.

7. But the husbandmen said one to another: This is the heir; come let us kill him; and the inheritance shall be ours.

8. And laying hold on him, they killed him, and cast him out of the vineyard.

9. What therefore will the lord of the vineyard do? He will come and destroy those husbandmen; and will give the vineyard to others.

10. And have you not read this scripture, The stone which the builders rejected, the same is made the head of the corner:

11. By the Lord has this been done, and it is wonderful in our eyes.

12. And they sought to lay hands on him, but they feared the people. For they knew that he spoke this parable to them. And leaving him, they went their way.

1-8. See on Matthew xxi. 33-38. He began to speak to them in parables; i.e., He began to speak to them after the manner of parables; there is only one parable mentioned here. The servants mentioned in verses 2, 4, and 5, represent the various prophets who, one after another, had been sent to the people of Israel, as Samuel, Nathan, Elias, Isaias, Jeremias, etc.

9-11. See on Matthew xxi. 40-42.

12. And they sought to lay hands on him; i.e., the priests and

13. And they sent to him some of the Pharisees and of the Herodians; that they should catch him in his words.

14. Who coming, say to him: Master, we know that thou art a true speaker, and carest not for any man; for thou regardest not the person of men, but teachest the way of God in truth. Is it lawful to give tribute to Cæsar; or shall we not give it?

15. Who knowing their wiliness, saith to them: Why tempt you me? bring me a penny that I may see it.

16. And they brought it him. And he saith to them: Whose is this image and inscription? They say to him, Cæsar's.

17. And Jesus answering, said to them: Render therefore to Cæsar the things that are Cæsar's, and to God the things that are God's. And they marvelled at him.

18. And there came to him the Sadducees, who say there is no resurrection; and they asked him, saying:

19. Master, Moses wrote unto us, that if any man's brother die, and leave his wife behind him, and leave no children, his brother should take his wife, and raise up seed to his brother.

20. Now there were seven brethren; and the first took a wife, and died leaving no issue.

21. And the second took her, and died: and neither did he leave any issue. And the third in like manner.

22. And the seven all took her in like manner; and did not leave issue. Last of all the woman also died.

23. In the resurrection therefore, when they shall rise again, whose wife shall she be of them? for the seven had her to wife.

24. And Jesus answering, saith to them: Do ye not therefore err, because you know not the scriptures, nor the power of God?

25. For when they shall rise again from the dead, they shall neither marry, nor be married, but are as the angels in heaven.

26. And as concerning the dead that they rise again, have you not read in the book of Moses, how in the bush God spoke to him, saying: I am the God of Abraham, and the God of Isaac, and the God of Jacob?

27. He is not the God of the dead, but of the living. You therefore do greatly err.

28. And there came one of the scribes that had heard them reasoning together, and seeing that he had answered them well, asked him which was the first commandment of all.

elders, who knew that the parable just spoken was directed against them, sought to lay hands on Him; but they did not, lest they should attract the attention and incur the indignation of the crowd.

13-17. See on Matthew xxii. 16-22.

18-25. See on Matthew xxii. 23-30.

26, 27. See on Matthew xxii. 32.

28. And there came one of the scribes, etc. St. Matthew (xxii. 35) says he was a doctor of the Law, and that he asked our

29. And Jesus answered him: The first commandment of all is, Hear, O Israel: the Lord thy God is one God.

30. And thou shalt love the Lord thy God, with thy whole heart, and with thy whole soul, and with thy whole mind, and with thy whole strength. This is the first commandment.

31. And the second is like to it: Thou shalt love thy neighbour as thyself. There is no other commandment greater than these.

32. And the scribe said to him: Well, Master, thou hast said in truth, that there is one God, and there is no other besides him.

33. And that he should be loved with the whole heart, and with the whole understanding, and with the whole soul, and with the whole strength; and to love one's neighbour as one's self, is a greater thing than all holocausts and sacrifices.

34. And Jesus seeing that he had answered wisely, said to him: Thou art not far from the kingdom of God. And no man after that durst ask him any question.

35. And Jesus answering, said, teaching in the temple: How do the scribes say, that Christ is the son of David?

36. For David himself saith by the Holy Ghost: The Lord said to my Lord, Sit on my right hand, until I make thy enemies thy footstool.

37. David therefore himself calleth him Lord, and whence is he then his son? And a great multitude heard him gladly.

38. And he said to them in his doctrine: Beware of the scribes, who love to walk in long robes, and to be saluted in the marketplace,

Lord, "tempting him"; but "tempting" does not always imply an evil motive; often, as in the present case, it simply means to "put one to a test." This Scribe was well-intentioned, as appears from what follows.

The first commandment; i.e., the most important, or "greatest" commandment.

29, 30. **With thy whole mind.** This phrase is wanting in Deut. (vi. 5), but is found in all the best MSS. of St. Mark. See also on Matthew xxii. 37.

31. See on Matthew xxii. 39.

32, 33. Holocausts and sacrifices are good, but they are not so necessary and pleasing to God as is charity; charity is the animating principle of the spiritual life, without which all else is "as sounding brass or a tinkling cymbal" (I Cor. xiii. 1).

34. **Thou art not far from the kingdom of God.** By these words the Saviour meant that the Scribe in question was not far from understanding and embracing the entire teaching of the Gospel.

35-37. See on Matthew xxii. 42-45.

38. **In his doctrine; i.e., in His teaching.** Our Lord was about



39. And to sit in the first chairs, in the synagogues, and to have the highest places at suppers:

40. Who devour the houses of widows under the pretence of long prayer: these shall receive greater judgment.

41. And Jesus sitting over against the treasury, beheld how the people cast money into the treasury, and many that were rich cast in much.

42. And there came a certain poor widow, and she cast in two mites, which make a farthing.

43. And calling his disciples together, he saith to them: Amen I say to you, this poor widow hath cast in more than all they who have cast into the treasury.

44. For all they did cast in of their abundance; but she of her want cast in all she had, even her whole living.

to leave the Temple forever, and He made His last words a scathing denunciation of the false and unfaithful leaders of His people.

39, 40. See on Matthew xxiii. 4-6.

41. **And Jesus sitting over against the treasury;** i.e., opposite the Treasury (*γαζοφυλάκιον*). This Treasury was in the Court of the Women within the Temple proper (*ναός*). It was made up of thirteen trumpet-shaped vessels, placed under the colonnade around the Court of the Women, and into these vessels the people dropped their offerings. See on Matthew xxi. 12.

42. **Two mites.** A mite was the smallest bronze coin in use, equal in value to half a *quadrans*. The mite, therefore, was equal to about one-fourth of a cent.

43, 44. These verses show that the merit of our actions depends, not so much on what we do, as on the interior dispositions by which our actions are prompted.

## CHAPTER XIII

THE QUESTIONS OF THE DISCIPLES ABOUT THE END OF THE WORLD, 1-4.

THE CALAMITIES AND PERSECUTIONS THAT THE FOLLOWERS OF CHRIST SHALL HAVE TO ENDURE AT ALL TIMES UNTIL THE END OF THE WORLD, 5-13.

THE DESTRUCTION OF JERUSALEM, WITH CAUTIONS AND COUNSELS NECESSARY FOR THAT DREADFUL TIME, 14-19.

THE SIGNS THAT SHALL PRECEDE THE END OF THE WORLD AND THE GENERAL JUDGMENT, 20-31.

EXHORTATION TO VIGILANCE, 32-37.

1. And as he was going out of the temple, one of his disciples said to him: Master, behold what manner of stones, and what buildings are here.

2. And Jesus answering, said to him: Seest thou all these great buildings? There shall not be left a stone upon a stone, that shall not be thrown down.

3. And as he sat on the mount of Olivet over against the temple, Peter and James and John and Andrew asked him apart:

4. Tell us, when shall these things be? and what shall be the sign when all these things shall begin to be fulfilled?

5. And Jesus answering, began to say to them, Take heed lest any man deceive you.

6. For many shall come in my name, saying, I am he; and they shall deceive many.

1, 2. Commentators are not agreed as to how the present chapter should be divided. Perhaps the best division is that given by Knabenbauer, which we have adopted in the above analysis. See also on Matthew xxiv. 3.

And as he was going out of the temple. This was the final departure of our Lord from the Temple.

The temple. See on Matthew xxiv. 1, 2.

3, 4. Over against the temple; i.e., opposite the Temple. The Mount of Olives was about a mile east of Jerusalem.

5-13. See on Matthew xxiv. 4-14.

7. And when you shall hear of wars and rumours of wars, fear ye not. For such things must needs be, but the end is not yet.

8. For nation shall rise against nation, and kingdom against kingdom, and there shall be earthquakes in divers places, and famines. These things are the beginning of sorrows.

9. But look to yourselves. For they shall deliver you up to councils, and in the synagogues you shall be beaten, and you shall stand before governors and kings for my sake, for a testimony unto them.

10. And unto all nations the gospel must first be preached.

11. And when they shall lead you and deliver you up, be not thoughtful beforehand what you shall speak; but whatsoever shall be given you in that hour, that speak ye. For it is not you that speak, but the Holy Ghost.

12. And the brother shall betray his brother unto death, and the father his son; and children shall rise up against the parents, and shall work their death.

13. And you shall be hated by all men for my name's sake. But he that shall endure unto the end, he shall be saved.

14. And when you shall see the abomination of desolation, standing where it ought not: he that readeth let him understand: then let them that are in Judea, flee unto the mountains:

15. And let him that is on the housetop, not go down into the house, nor enter therein to take any thing out of the house:

16. And let him that shall be in the field, not turn back to take up his garment.

17. And woe to them that are with child, and that give suck in those days.

18. But pray ye, that these things happen not in winter.

19. For in those days shall be such tribulations, as were not from the beginning of the creation which God created until now, neither shall be.

20. And unless the Lord had shortened the days, no flesh should be saved: but for the sake of the elect which he hath chosen, he hath shortened the days.

21. And then if any man shall say to you, Lo, here is Christ; lo, he is here: do not believe.

22. For there will rise up false Christs and false prophets, and they shall shew signs and wonders, to seduce (if it were possible) even the elect.

23. Take ye heed therefore; behold I have foretold you all things.

24. But in those days, after that tribulation, the sun shall be darkened, and the moon shall not give her light.

25. And the stars of heaven shall be falling down, and the powers that are in heaven, shall be moved.

26. And then shall they see the Son of man coming in the clouds, with great power and glory.

27. And then shall he send his angels, and shall gather together his elect from the four winds, from the uttermost part of the earth to the uttermost part of heaven.

14-23. See on Matthew xxiv. 15-25.

24-27. See on Matthew xxiv. 29-31.

28. Now of the fig tree learn ye a parable. When the branch thereof is now tender, and the leaves are come forth, you know that summer is very near.

29. So you also when you shall see these things come to pass, know ye that it is very nigh, even at the doors.

30. Amen, I say to you, that this generation shall not pass, until all these things be done.

31. Heaven and earth shall pass away, but my word shall not pass away.

32. But of that day or hour no man knoweth, neither the angels in heaven, nor the Son, but the Father.

33. Take ye heed, watch and pray. For ye know not when the time is.

34. Even as a man who going into a far country, left his house; and gave authority to his servants over every work, and commanded the porter to watch.

35. Watch ye therefore, (for you know not when the lord of the house cometh: at even, or at midnight, or at the cock-crowing, or in the morning,)

36. Lest coming on a sudden, he find you sleeping.

37. And what I say to you, I say to all: Watch.

28-32. See on Matthew xxiv. 32-36.

33. **Take ye heed, watch and pray.** The Saviour, now coming to the close of His admonitions, again warns His disciples and through them, all of us, that, since we know not the hour of His coming, or the end of the world, our only safety rests in vigilance and prayer.

34. In this verse, the **man going into a far country** represents our Lord, who will ere long ascend to His Father in Heaven; by the **house** is meant the Church; his **servants** represent all the faithful, and by the **porter** is designated the Apostles, their successors, and all lawful superiors in the Church.

35. In this verse, we are told that we know not when the Saviour may come to us individually at death, or to judge the world in general. **At even**, literally means between 6 and 9 o'clock P.M.; **at midnight**, 9 to 12 P.M.; **at the cock-crowing**, 12 to 3 A.M.; **in the morning**, 3 to 6 A.M. These different hours express simply the uncertainty at what time or at what age of our life the coming of Christ may occur.

## CHAPTER XIV

THE CONSPIRACY OF THE SANHEDRIM, 1, 2.

THE FEAST AND THE ANOINTING AT BETHANY, 3-11.

THE PASCHAL SUPPER AND THE HOLY EUCHARIST,  
12-26.

THE SCANDAL OF THE DISCIPLES, 27-31.

JESUS IN GETHSEMANI, 32-42.

JESUS TAKEN CAPTIVE, 43-52.

JESUS BEFORE THE SANHEDRIM, 53-65.

THE DENIALS OF PETER, 66-72.

1. Now the feast of the pasch, and of the Azymes was after two days; and the chief priests and the scribes sought how they might by some wile lay hold on him, and kill him.

2. But they said: Not on the festival day, lest there should be a tumult among the people.

3. And when he was in Bethania, in the house of Simon the leper, and was at meat, there came a woman having an alabaster box of ointment of precious spikenard: and breaking the alabaster box, she poured it out upon his head.

4. Now there were some that had indignation within themselves, and said: Why was this waste of the ointment made?

5. For this ointment might have been sold for more than three hundred pence, and given to the poor. And they murmured against her.

6. But Jesus said: Let her alone, why do you molest her? She hath wrought a good work upon me.

7. For the poor you have always with you: and whensoever you will, you may do them good: but me you have not always.

8. She hath done what she could: she is come beforehand to anoint my body for the burial.

9. Amen, I say to you, wheresoever this gospel shall be preached in the whole world, that also which she hath done, shall be told for a memorial of her.

1. See on Matthew xxvi. 2, 3.

2. **The festival day.** See on Matthew xxvi. 5.

3, 4. See on Matthew xxvi. 6-8.

5. **Three hundred pence;** i.e., three hundred *denarii*, equal to about \$50.00 in our money; it was a large sum for those days. A denarius was a day's pay for a laborer.

8. See on Matthew xxvi. 12.

10. And Judas Iscariot, one of the twelve, went to the chief priests, to betray him to them.

11. Who hearing it were glad; and they promised him they would give him money. And he sought how he might conveniently betray him.

12. Now on the first day of the unleavened bread, when they sacrificed the pasch, the disciples say to him: Whither wilt thou that we go, and prepare for thee to eat the pasch?

13. And he sendeth two of his disciples, and saith to them: Go ye into the city; and there shall meet you a man carrying a pitcher of water, follow him;

14. And whithersoever he shall go in, say to the master of the house, The master saith, Where is my refectory, where I may eat the pasch with my disciples?

15. And he will shew you a large dining room furnished; and there prepare ye for us.

16. And his disciples went their way, and came into the city; and they found as he had told them, and they prepared the pasch.

17. And when evening was come, he cometh with the twelve.

18. And when they were at table and eating, Jesus saith: Amen I say to you, one of you that eateth with me shall betray me.

19. But they began to be sorrowful, and to say to him one by one: Is it I?

20. Who saith to them: One of the twelve, who dippeth with me his hand in the dish.

21. And the Son of man indeed goeth, as it is written of him: but woe to that man by whom the Son of man shall be betrayed. It were better for him, if that man had not been born.

22. And whilst they were eating, Jesus took bread; and blessing, broke, and gave to them, and said: Take ye. This is my body.

23. And having taken the chalice, giving thanks, he gave it to them. And they all drank of it.

24. And he said to them: This is my blood of the new testament, which shall be shed for many.

25. Amen I say to you, that I will drink no more of the fruit of the vine, until that day when I shall drink it new in the kingdom of God.

26. And when they had said an hymn, they went forth to the mount of Olives.

27. And Jesus saith to them: You will all be scandalized in my regard this night; for it is written, I will strike the shepherd, and the sheep shall be dispersed.

28. But after I shall be risen again, I will go before you into Galilee.

10. See on Matthew xxvi. 14.

11. See on Matthew xxvi. 15.

12-14. See on Matthew xxvi. 17, 18.

15. A large dining room, — rather an "upper room," or "a room on the upper floor" (*ἀνάγαιον*).

16-18. See on Matthew xxvi. 19-21.

20, 21. See on Matthew xxvi. 23, 24.

22-28. See on Matthew xxvi. 26-32.

29. But Peter saith to him: Although all shall be scandalized in thee, yet not I.

30. And Jesus saith to him: Amen I say to thee, to-day, even in this night, before the cock crow twice, thou shalt deny me thrice.

31. But he spoke the more vehemently: Although I should die together with thee, I will not deny thee. And in like manner also said they all.

32. And they came to a farm called Gethsemani. And he saith to his disciples: Sit you here, while I pray.

33. And he taketh Peter and James and John with him; and he began to fear and to be heavy.

34. And he saith to them: My soul is sorrowful even unto death; stay you here, and watch.

35. And when he was gone forward a little, he fell flat on the ground; and he prayed, that if it might be, the hour might pass from him.

36. And he saith: Abba, Father, all things are possible to thee: remove this chalice from me; but not what I will, but what thou wilt.

37. And he cometh, and findeth them sleeping. And he saith to Peter: Simon, sleepest thou? couldst thou not watch one hour?

38. Watch ye, and pray that you enter not into temptation. The spirit indeed is willing, but the flesh is weak.

39. And going away again, he prayed, saying the same words.

40. And when he returned, he found them again asleep, (for their eyes were heavy,) and they knew not what to answer him.

41. And he cometh the third time, and saith to them: Sleep ye now, and take your rest. It is enough: the hour is come: behold the Son of man shall be betrayed into the hands of sinners.

42. Rise up, let us go. Behold, he that will betray me is at hand.

43. And while he was yet speaking, cometh Judas Iscariot, one of the twelve: and with him a great multitude with swords and staves, from the chief priests and the scribes and the ancients.

44. And he that betrayed him, had given them a sign, saying: Whomsoever I shall kiss, that is he; lay hold on him, and lead him away carefully.

45. And when he was come, immediately going up to him, he saith: Hail, Rabbi; and he kissed him.

46. But they laid hands on him, and held him.

47. And one of them that stood by, drawing a sword, struck a servant of the chief priest, and cut off his ear.

30. See on Matthew xxvi. 34.

32-35. See on Matthew xxvi. 36-39.

36. **Abba, Father.** "Abba" is the Aramaic word for "father"; it is the word which our Lord Himself used, and St. Mark, in repeating it, adds the Greek equivalent for his Gentile readers.

37, 38. See on Matthew xxvi. 40, 41.

40-43. See on Matthew xxvi. 44-47.

47. See on Matthew xxvi. 51.

48. And Jesus answering, said to them: Are you come out as to a robber, with swords and staves to apprehend me?

49. I was daily with you in the temple teaching, and you did not lay hands on me. But that the scriptures may be fulfilled.

50. Then his disciples leaving him, all fled away.

51. And a certain young man followed him, having a linen cloth cast about his naked body; and they laid hold on him.

52. But he, casting off the linen cloth, fled from them naked.

53. And they brought Jesus to the high priest; and all the priests and the scribes and the ancients assembled together.

54. And Peter followed him afar off, even into the court of the high priest; and he sat with the servants at the fire, and warmed himself.

55. And the chief priests and all the council sought for evidence against Jesus, that they might put him to death, and found none.

56. For many bore false witness against him, and their evidences were not agreeing.

57. And some rising up, bore false witness against him, saying:

58. We heard him say, I will destroy this temple made with hands, and within three days I will build another not made with hands.

59. And their witness did not agree.

60. And the high priest rising up in the midst, asked Jesus, saying: Answerest thou nothing to the things that are laid to thy charge by these men?

61. But he held his peace, and answered nothing. Again the high priest asked him, and said to him: Art thou the Christ the Son of the blessed God?

62. And Jesus said to him: I am. And you shall see the Son of man sitting on the right hand of the power of God, and coming with the clouds of heaven.

63. Then the high priest rending his garments, saith: What need we any further witnesses?

64. You have heard the blasphemy. What think you? Who all condemned him to be guilty of death.

65. And some began to spit on him, and to cover his face, and to buffet him, and to say unto him: Prophecy: and the servants struck him with the palms of their hands.

66. Now when Peter was in the court below, there cometh one of the maid-servants of the high priest.

67. And when she had seen Peter warming himself, looking on him she saith: Thou also wast with Jesus of Nazareth.

48-50. See on Matthew xxvi. 55, 56.

51. And a certain young man, who, according to many, was St. Mark himself; according to others, he was the owner or keeper of the Garden of Gethsemani.

Having a linen cloth cast about his naked body, which shows that, whoever he was, he must have hurriedly risen from bed in order to follow the Saviour.

53-58. See on Matthew xxvi. 57-61.

60-72. See on Matthew xxvi. 62-75.



68. But he denied, saying: I neither know nor understand what thou sayest. And he went forth before the court; and the cock crew.

69. And again a maidservant seeing him, began to say to the standers by: This is one of them.

70. But he denied again. And after a while they that stood by said again to Peter: Surely thou art one of them; for thou art also a Galilean.

71. But he began to curse and to swear, saying; I know not this man of whom you speak.

72. And immediately the cock crew again. And Peter remembered the word that Jesus had said unto him: Before the cock crow twice, thou shalt thrice deny me. And he began to weep.

## CHAPTER XV

JESUS BEFORE PILATE, 1-15.

JESUS MOCKED BY THE SOLDIERS, 16-19.

THE WAY OF THE CROSS, THE CRUCIFIXION, AND THE  
DEATH OF JESUS, 20-41.

JESUS IS BURIED, 42-47.

1. And straightway in the morning, the chief priests holding a consultation with the ancients and the scribes and the whole council, binding Jesus, led him away, and delivered him to Pilate.

2. And Pilate asked him: Art thou the king of the Jews? But he answering, saith to him: Thou sayest it.

3. And the chief priests accused him in many things.

4. And Pilate again asked him, saying: Answerest thou nothing? behold in how many things they accuse thee.

5. But Jesus still answered nothing; so that Pilate wondered.

6. Now on the festival day he was wont to release unto them one of the prisoners, whomsoever they demanded.

7. And there was one called Barabbas, who was put in prison with some seditious men, who in the sedition had committed murder.

8. And when the multitude was come up, they began to desire that he would do, as he had ever done unto them.

9. And Pilate answered them, and said: Will you that I release to you the king of the Jews?

10. For he knew that the chief priests had delivered him up out of envy.

1. See on Matthew xxvii. 1, 2.

4. See on Matthew xxvii. 11.

6, 7. See on Matthew xxvii. 15, 16.

11. But the chief priests moved the people, that he should rather release Barabbas to them.

12. And Pilate again answering, saith to them: What will you then that I do to the king of the Jews?

13. But they again cried out: Crucify him.

14. And Pilate saith to them: Why, what evil hath he done? But they cried out the more: Crucify him.

15. And so Pilate being willing to satisfy the people, released to them Barabbas, and delivered up Jesus, when he had scourged him, to be crucified.

16. And the soldiers led him away into the court of the palace, and they called together the whole band:

17. And they clothe him with purple, and plating a crown of thorns, they put it upon him.

18. And they began to salute him: Hail, king of the Jews.

19. And they struck his head with a reed: and they did spit on him. And bowing their knees, they adored him.

20. And after they had mocked him, they took off the purple from him, and put his own garments on him, and they led him out to crucify him.

21. And they forced one Simon a Cyrenian who passed by, coming out of the country, the father of Alexander and of Rufus, to take up his cross.

22. And they bring him into the place called Golgotha, which being interpreted is, The place of Calvary.

23. And they gave him to drink wine mingled with myrrh; but he took it not.

24. And crucifying him, divided his garments, casting lots upon them, what every man should take.

11-14. Crucifixion was not properly a Jewish punishment, and among Romans it was inflicted only on slaves and malefactors of the worst kind. Pilate, therefore, since he could find no fault in our Lord, wondered exceedingly that the Jews should be demanding that He be crucified.

15. Pilate against his own conscience (Matthew xxvii. 24), out of fear lest the Jews should accuse him of neglect of duty to Rome, delivered our Lord to be scourged. The *flagellum* was a whip with three thongs of leather, knotted with sharp-edged pieces of bone or leather so as to cut the flesh. Roman scourging was, therefore, a most cruel kind of punishment — so cruel as often to cause death while being inflicted.

16-18. See on Matthew xxvii. 27-29.

21. **Coming out of the country.** These words are used as an argument to prove that the day of our Lord's crucifixion was the day before the Pasch, as otherwise Simon would not have been coming from the field. See on Matthew xxvii. 32.

22-24. See on Matthew xxvii. 33-35.

25. And it was the third hour, and they crucified him.

26. And the inscription of his cause was written over: **THE KING OF THE JEWS.**

27. And with him they crucify two thieves; the one on his right hand, and the other on his left.

28. And the scripture was fulfilled, which saith: And with the wicked he was reputed.

29. And they that passed by blasphemed him, wagging their heads, and saying: Vah, thou that destroyest the temple of God, and in three days buildest it up again;

30. Save thyself, coming down from the cross.

31. In like manner also the chief priests mocking, said with the scribes one to another: He saved others; himself he cannot save.

32. Let Christ the king of Israel come down now from the cross, that we may see and believe. And they that were crucified with him reviled him.

33. And when the sixth hour was come, there was darkness over the whole earth until the ninth hour.

34. And at the ninth hour, Jesus cried out with a loud voice, saying: Eloi, Eloi, lamma sabacthani? Which is, being interpreted, My God, my God, why hast thou forsaken me?

35. And some of the standers by hearing, said: Behold he calleth Elias.

36. And one running and filling a sponge with vinegar, and putting it upon a reed, gave him to drink, saying: Stay, let us see if Elias come to take him down.

37. And Jesus having cried out with a loud voice, gave up the ghost.

38. And the veil of the temple was rent in two, from the top to the bottom.

39. And the centurion who stood over against him, seeing that crying out in this manner he had given up the ghost, said: Indeed this man was the son of God.

40. And there were also women looking on afar off: among whom was Mary Magdalen, and Mary the mother of James the less and of Joseph, and Salome:

41. Who also when he was in Galilee followed him, and ministered to him, and many other women that came up with him to Jerusalem.

25. **And it was about the third hour.** St. John says it was about the "sixth hour"; but the two Evangelists wished to say, roughly, that it was along in the forenoon that our Lord was delivered by Pilate to be crucified. In those days people were accustomed to speak somewhat inaccurately regarding time. For further explanation, see on Matthew xxvii. 45.

26-28. See on Matthew xxvii. 37, 38. Verse 28 here is not found in the best MSS.

31-38. See on Matthew xxvii. 41-51.

39-41. See on Matthew xxvii. 54-56.

42. And when evening was now come, (because it was the Parasceve, that is, the day before the sabbath,)

43. Joseph of Arimathea, a noble counsellor, who was also himself looking for the kingdom of God, came and went in boldly to Pilate, and begged the body of Jesus.

44. But Pilate wondered that he should be already dead. And sending for the centurion, he asked him if he were already dead.

45. And when he had understood it by the centurion, he gave the body to Joseph.

46. And Joseph buying fine linen, and taking him down, wrapped him up in the fine linen, and laid him in a sepulchre which was hewed out of a rock. And he rolled a stone to the door of the sepulchre.

47. And Mary Magdalen, and Mary the mother of Joseph, beheld where he was laid.

42. **And when evening was now come**; i.e., when it was getting near sunset, the beginning of the Sabbath. It was not permitted that a dead body should be left on a cross during the Sabbath.

43. **Counsellor**; i.e., a Sanhedrist, a lawyer (*βουλευτής*).

“Arimathea.” See on Matthew xxvii. 57.

44. **But Pilate wondered**, etc., because victims, who were crucified, usually lived for several days upon the cross.

46, 47. See on Matthew xxvii. 59-61.

## CHAPTER XVI

THE RESURRECTION OF JESUS, 1-8.

JESUS APPEARS TO THE HOLY WOMEN AND THE DISCIPLES, 9-18.

THE ASCENSION OF JESUS, 19, 20.

1. And when the sabbath was past, Mary Magdalen, and Mary the mother of James, and Salome, bought sweet spices, that coming, they might anoint Jesus.

1. **And when the sabbath was past**, etc.; i.e., Saturday evening, after sunset, the holy women immediately purchased sweet ointments, that, coming early the next morn, they might embalm the body of Jesus. According to custom, the embalming process consisted first, in washing the dead body, then in anointing it with

2. And very early in the morning, the first day of the week, they come to the sepulchre, the sun being now risen.

3. And they said one to another: Who shall roll us back the stone from the door of the sepulchre?

4. And looking, they saw the stone rolled back. For it was very great.

5. And entering into the sepulchre, they saw a young man sitting on the right side, clothed with a white robe: and they were astonished.

6. Who saith to them: Be not affrighted; you seek Jesus of Nazareth, who was crucified: he is risen, he is not here, behold the place where they laid him.

7. But go, tell his disciples and Peter that he goeth before you into Galilee; there you shall see him, as he told you.

8. But they going out, fled from the sepulchre. For a trembling and fear had seized them: and they said nothing to any man; for they were afraid.

9. But he rising early the first day of the week, appeared first to Mary Magdalen, out of whom he had cast seven devils.

sweet ointments, and lastly in wrapping it up in linen cloths, interspersed with spices.

2. See on Matthew xxviii. 1.

4. **And looking**, — rather, “looking up” (*ἀναβλέψασαι*), as they came near the tomb.

5. **And entering into the sepulchre**; i.e., into the outer chamber of the tomb. See on Matthew xxvii. 60. **They saw a young man**; i.e., an angel, who appeared as a young man. **And they were astonished**, — rather, “affrighted” (*ἐξεθαμβήθησαν*) at the sight of an angel. See on Matthew xxviii. 2-4.

7. **Tell his disciples and Peter**. St. Mark is the only Evangelist who, in this connection, mentions Peter in particular.

8. **And they said nothing to any man**; i.e., on their way back to tell the Apostles the holy women had nothing to say to anyone until they saw the Apostles. See on Matthew xxviii. 2-4.

9. **Appeared first to Mary Magdalen**. This was during the second visit of Magdalen to the tomb, after the Apostles Peter and John had been there, and had returned to Jerusalem. See on Matthew xxviii. 9; John xx. 14-16. The authenticity of verses 9-20 of this chapter of St. Mark has been called into question since the early centuries; and although Catholics, since the Council of Trent, are not permitted to doubt their divine inspiration, still it is not altogether forbidden to hold that they were written by some other inspired author than St. Mark. The reasons, however, against St. Mark's authorship, while forcible, are not beyond a satisfactory solution. These reasons are:—

10. She went and told them that had been with him, who were mourning and weeping.

11. And they hearing that he was alive, and had been seen by her, did not believe.

(a) The verses in question are not found in the two oldest Greek MSS. which we have, i.e., the Vatican and the Sinaitic. *Answer:* The omission of these verses in the Vatican and Sinaitic MSS. only proves that the transcriber of those MSS. (he was the same scribe for both), had doubts about their genuinity and so omitted them; that he knew of their existence is evident from the fact that he leaves a blank space in the Vatican MS., probably intending to insert them later.

(b) Saint Jerome and Eusebius tell us that these verses were wanting in the majority of Greek MSS. of their day. *Answer:* While the majority of Greek MSS. do not contain the verses quoted, they are in the oldest Greek MSS. that we possess, except the Vatican and Sinaitic, and in most of the oldest translations, such as the Itala, the Syriac and the Coptic, which go back to the second century, at least.

(c) These verses seem not to have the usual graphic style of St. Mark. *Answer:* But consider, "who were mourning and weeping" (verse 10), and the details of verses 17 and 18.

(d) Certain words are found in these verses (e.g., *θεάσθαι*, *ἀπιστεῖν*, *φαιέσθαι*), which occur nowhere else in St. Mark. *Answer:* This simply proves that the author had no need before of such words in his Gospel.

(e) Why were these verses omitted from so many Greek MSS., and why do they not make better connection with what precedes in the chapter? *Answer:* Most likely because St. Mark added them only after many copies of his unfinished work had been made and put into circulation; or perhaps because, for some special reason, these verses were omitted in the copies of the Gospel used for public reading in the early churches.

10. She went and told them that had been with him; i.e., she went and told His disciples and companions.

11. And they . . . did not believe; i.e., some of the Apostles did not believe; this could hardly be said of Peter and John, who had already visited the empty tomb (John xx. 3-10).

12. And after that he appeared in another shape to two of them walking, as they were going into the country.

13. And they going told it to the rest: neither did they believe them.

14. At length he appeared to the eleven as they were at table: and he upbraided them with their incredulity and hardness of heart, because they did not believe them who had seen him after he was risen again.

15. And he said to them: Go ye into the whole world, and preach the gospel to every creature.

16. He that believeth and is baptized, shall be saved: but he that believeth not shall be condemned.

12. **To two of them walking**; i.e., to the two disciples who were going to Emmaus (Luke xxiv. 13).

13. **Neither did they believe them**; i.e., some of the other disciples did not believe; just as some had doubted the testimony of Magdalen, so now did they doubt that of the two who had met our Lord on the way to Emmaus.

14. **At length he appeared**, etc.; i.e., towards the end of that first Easter day He appeared to the eleven. There were at least four apparitions of our Lord upon the day of His Resurrection:—first to Mary Magdalen (John xx. 14); second, to Peter (Luke xxiv. 34); third, to the two disciples going to Emmaus (Luke xxiv. 15); fourth, to the eleven, as they were at table, here mentioned by St. Mark, and also by St. Luke (xxiv. 36) and St. John (xx. 19). There was also a fifth apparition, if we accept the very probable opinion which says that our Lord appeared separately to the holy women in the absence of Magdalen. See on Matthew xxviii. 2-4.

**To the eleven, as they were at table.** This apparition was perhaps "in the upper room," where our Lord had instituted the Holy Eucharist. The term "eleven" is used speaking roundly, because we know that St. Thomas was not present on this occasion (John xx. 24).

15. Some think that the words of this verse were not spoken at the same time as those of the preceding verse, but later, when our Lord appeared in Galilee. Cf. Matthew xxviii. 18, 19.

16. **He that believeth and is baptized**, etc. From these words, it is evident that faith and Baptism are essential to salvation; and the faith here referred to is the acceptance, not of any and every doctrine in matters religious, but only of the doctrine revealed by Christ and committed to His Apostles and His Church. Men are

17. And these signs shall follow them that believe: In my name they shall cast out devils: they shall speak with new tongues.

18. They shall take up serpents; and if they shall drink any deadly thing, it shall not hurt them: they shall lay their hands upon the sick, and they shall recover.

19. And the Lord Jesus, after he had spoken to them, was taken up into heaven, and sitteth on the right hand of God.

20. But they going forth preached everywhere: the Lord working withal, and confirming the word with signs that followed.

not at liberty to believe what they please. Further, mere intellectual acceptance of the teachings of Christ and His Church are not enough for salvation; but the faith which is necessary must embrace good works and a thorough obedience to all the injunctions contained in Christ's revelation to His Apostles and to His Church.

**But he that believeth not shall be condemned,** — words which show that it is impossible to be saved without faith, i.e., without faith in what Christ taught, and commanded His Apostles and Church to teach till the end of the world (Matthew xxviii. 18-20).

17, 18. **And these signs shall follow them that believe.** This does not mean that each of the faithful shall possess the power of working miracles; the words mean that the power of working miracles is communicated to, and shall ever abide with, the Church of Christ. Miracles were more necessary in the beginning in order that the faith might more easily spread and take root in the hearts of men. That the powers foretold in these verses were actually possessed by the Apostles is evident from Acts ii. 4; x. 46; xvi. 18; xxviii. 5, 8.

19. **After he had spoken to them;** i.e., during the period of forty days.

20. **But they going forth, preached everywhere;** i.e., in the principal parts of the then known world.



# THE GOSPEL ACCORDING TO ST. LUKE

## INTRODUCTION

I. **St. Luke.** Tradition has always ascribed the Third Gospel, as well as the Acts of the Apostles, to Lucas, the disciple and companion of St. Paul. Eusebius (*Hist. Eccl.* iii. 4) tells us that Luke was born at Antioch, in Syria. He was doubtless of Gentile origin, because St. Paul (Col. iv. 11) carefully distinguishes him from those who were circumcised. That he was a physician by profession is clear from the testimony of St. Paul (Col. iv. 14), from the testimonies of St. Jerome and St. Gregory Nazianzen, and also from the fact that, while Sts. Matthew and Mark used popular language when speaking of diseases, St. Luke uses technical terms. St. Luke accompanied St. Paul on the latter's second missionary journey from Asia Minor to Macedonia (Acts xvi. 10), staying at Philippi while St. Paul went south to Achaia. Later, when St. Paul was on his third missionary journey to the east, St. Luke joined him at Philippi, accompanied him to Jerusalem, and shared his imprisonment at Caesarea (Acts xxi. 15 and 18). Thereafter we find the two unseparated. They went to Rome together, and during St. Paul's two imprisonments there St. Luke was his faithful companion (2 Tim. iv. 11). St. Jerome (*de Scrip. Eccl.*) tells us that St. Luke died at Patarae in Achaia at an advanced age.

II. **Time and Place of Writing.** The Gospel of St. Luke was most likely written between A.D. 59 and 63. It certainly could not have been written before A.D. 50, because it was only around that date that St. Luke became the companion of St. Paul. Neither was it written after A.D. 63, since the Acts of the Apostles, which came after the Third Gospel, speak, toward the close of the book (xxviii. 16), of St. Paul's imprisonment at Rome, but say nothing

of his release. But we know from tradition that St. Paul was freed from prison at Rome in A.D. 63, — an event which St. Luke would not have omitted had he written later than 63. As the labors and distractions, therefore, of the missionary journeys gave little or no time for composition it seems very probable that St. Luke arranged his Gospel during the imprisonment of St. Paul at Caesarea, and committed it finally to writing at Rome, during the Apostle's imprisonment there.

**III. Scope, Purpose and Characteristics.** In the first four verses of the first chapter of his Gospel, St. Luke tells us that his purpose in writing is to supplement and put in order the previously existing records of the life, teaching, and labors of the Saviour. In this there is doubtless reference to the first two Gospels which St. Luke had before him, as well as to other more fragmentary accounts of our Lord's life and works, which, not having Apostolic authority and sanction, have perished. St. Matthew, for example, tells us very little about our Lord's childhood; St. Mark, nothing at all; and both Matthew and Mark abruptly introduce the Baptist without having told us anything of His early life and origin. Regarding these and many other things St. Luke had acquired a fuller knowledge, which he felt it his duty to give to his readers.

But, moreover, it is clear from both internal evidence and tradition that St. Luke wrote for the Gentiles to whom St. Paul had preached. The prevailing features of the Apostle's preaching are everywhere plainly discernible in the Third Gospel. The great purpose of the Evangelist is, therefore, to show the universality of Christ's redemption. Salvation is for all: for the Jews (i. 32, 54, 68, 79; ii. 10); for the Samaritans (ix. 51-56; x. 30-37; xvii. 11-19); for the publicans and sinners (iii. 12, 13; v. 27-32; vii. 37-50; xv. 1, 2, 11-32), and in particular for the Gentiles (ii. 32; iii. 6, 38; iv. 25-27; vii. 9; x. 1; xiii. 29; xxi. 24; xxiv. 47). With the same end in view St. Luke traces our Lord's genealogy back to Adam, the father of all men; he says that the peace announced at our Lord's birth was for all men of good will (ii. 14); and that the preaching of the Baptist attracted not only Jews, but Gentiles (iv. 25 ff.). So much has St. Luke emphasized our Lord's mercy for sinners that his has been called the "Gospel of Mercy" (cf. vii. 44-48; x. 30-37; xv. 8-10; xviii. 1-7; xix. 1-10; xxiii. 34, 39-43).

IV. **Sources of the Gospel.** St. Luke had never known or seen our Lord. He derived his information, as he tells us, from those who had been companions and eye-witnesses of the word, from the beginning of our Lord's public life. These were especially the Apostles and first disciples of the Master, the Blessed Virgin, and St. Paul. The influence of St. Paul's preaching on the Gospel of St. Luke is clear, as said above, from the striking similarity between the two; the dominant ideas of both are the same, — that all men have sinned and need redemption, that Christ came to save all sinners, that there is no distinction between Jew and Gentile. Another important source of St. Luke's information was doubtless the *Apostolic Catechism* which was the oral summary of Christian doctrine preached by the Apostles from the beginning and taught to all of the new converts, and on which each of the Synoptists based his Gospel, at least in part.

V. **Authenticity.** That the Third Gospel was well known in the first century is proved from the fact that a number of the early Fathers quote from it. Thus St. Clement, who succeeded St. Peter as Pope in A.D. 90, in his letters to the Corinthians (i. 46; ii. 8) twice quotes the words: "He that is faithful in that which is least, is faithful also in that which is greater" (Luke xvi. 10). Likewise Polycarp, St. John's disciple, quotes (Phil. ii) the passage: "Be ye therefore merciful as your heavenly Father is also merciful" (Luke vi. 36). Justin Martyr also, who was almost St. Luke's contemporary, (c. *Tryph.* 103, 105) speaks of our Lord's last words: "Jesus cried with a loud voice, Father into thy hands I commend my spirit" (Luke xxiii. 46).

That Luke was the name of the author of the Third Gospel we do not know from himself, but from other witnesses. *The Muratorian Fragment*, for example, which was written in the second century, contains these words: "Tertium evangelii librum secundum Lucam. Lucas iste medicus," etc. Again, St. Irenaeus (Euseb. *Hist. Eccl.* v. 10) says: "Luke, the companion of Paul, recorded in writing the Gospel preached by him." Furthermore we have the testimonies of Clement of Alexandria (*Strom.* i. 21), of Origen (*in Matt.* i.) and of Tertullian that Luke was the author of the Third Gospel.

Finally, the Third Gospel gives evidence throughout of having

been written by one who was not a Jew, who was an excellent Greek scholar, and had been a physician by profession, and who had been long and intimately associated with St. Paul, — all of which we know from tradition was true of Luke of Antioch. In the Acts of the Apostles the author often speaks of himself and St. Paul, showing that he was the companion of the latter. Since, therefore, we know, on the one hand, that St. Luke was St. Paul's companion and the writer of the Acts, and, on the other, that the Third Gospel and the Acts bear unmistakable evidence of having had the same author and are dedicated to the same person, Theophilus, it follows quite conclusively that St. Luke was the writer of the Gospel attributed to him.

**VI. Division of the Gospel.** There are five general parts to the Third Gospel besides a prologue.

The prologue (i. 1-4) contains the dedication of the Gospel to Theophilus and explains the author's purpose in writing.

In the first part (i. 5-iv. 13) we have an account of the birth of Jesus and of the Baptist, our Lord's manifestation in childhood and growth to manhood, and His baptism and temptation.

The second part (iv. 14-ix. 50) embraces the Saviour's ministry in Galilee.

The third part (ix. 51-xix. 27) describes the last journey of Jesus from Galilee to Jerusalem.

The fourth part (xix. 28-xxiii. 56) treats of the Passion and death of our Lord.

The fifth part (xxiv. 1-53) gives us an account of the Resurrection of our Lord, of certain manifestations, and of the Ascension.

# The Gospel according to St. Luke

## CHAPTER I

PROLOGUE, 1-4.

THE BIRTH OF JOHN THE BAPTIST IS ANNOUNCED,  
5-25.

THE ANNUNCIATION, 26-38.

THE VISITATION, 39-56.

THE BIRTH OF JOHN THE BAPTIST, 57-80.

1. Forasmuch as many have taken in hand to set forth in order a narration of the things that have been accomplished among us :

2. According as they have delivered them unto us, who from the beginning were eyewitnesses and ministers of the word :

3. It seemed good to me also, having diligently attained to all things from the beginning, to write to thee in order, most excellent Theophilus,

1. The first four verses of the present chapter form a brief introduction to the whole Gospel. They tell us the purpose of the Gospel, as well as the source of St. Luke's information.

**Many.** This term could hardly refer to Sts. Matthew and Mark alone, at least, who were only *two*; neither could it mean the writers of the apocryphal gospels, whose works are not inspired. The reference is doubtless to a number of well-intentioned writers, who failed to bring their accounts to completion, and whose records were consequently most likely not inspired.

**To set forth in order,** etc.; i.e., to give an orderly account of the life, teachings, and works of Christ. **Among us;** i.e., during our own time.

2. **According as they had delivered them unto us,** etc. These words are probably to be connected with verse 3, and hence there should be a full-stop after verse 1. **Of the word;** i.e., of the Gospel teaching.

3. **Having diligently attained,** etc. St. Luke is here telling us that he wishes to give us a carefully investigated account of the

4. That thou mayest know the verity of those words in which thou hast been instructed.

5. There was in the days of Herod, the king of Judea, a certain priest named Zachary, of the course of Abia; and his wife was of the daughters of Aaron, and her name Elizabeth.

6. And they were both just before God, walking in all the commandments and justifications of the Lord without blame.

7. And they had no son, for that Elizabeth was barren, and they both were well advanced in years.

life, teachings, and doings of the Saviour, in accordance with the testimony of those who had been eye-witnesses of the events about to be narrated.

**In order** may refer to the arrangement of the events narrated; but more probably the phrase expresses St. Luke's intention to make his narrative chronological.

**Theophilus** was most likely some influential Gentile Christian whom St. Luke himself had instructed and converted to the faith.

4. **Instructed**; i.e., *catechized* (κατηχήθης). This is the first usage of the term "catechize" in the sense of embracing a course of Christian instruction.

5. **Herod**. This is Herod the First, the Great, who put to death the Holy Innocents. See on Matthew ii. 1.

**Zachary** means "memorial of the Lord." **Of the course of Abia**; i.e., of the rank or order of Abia. King David had divided the descendants of Aaron into twenty-four courses, or classes, each of which were to discharge the priestly functions in the Temple for a week at a time, from one Sabbath to another. The class of Abia was the eighth (1 Paralip. xxiv. 3-10). **Elizabeth** means "oath of God."

6. **Just before God**. This means that they were free from all grievous sin, pleasing in the sight of God. The words do not mean that they were exempted or free from all venial offences, which the Council of Trent (Sess. vi. can. 23) teaches is impossible without a special privilege from God.

7. **And they had no son**. This was a great source of sorrow and humiliation to Jewish parents, because it frustrated all hope of having the Messiah born to them.

**Well advanced in years**. This only means that they had been a long time married; and now, that they were getting along in

8. And it came to pass, when he executed the priestly function in the order of his course before God,

9. According to the custom of the priestly office, it was his lot to offer incense, going into the temple of the Lord.

10. And all the multitude of the people was praying without, at the hour of incense.

11. And there appeared to him an angel of the Lord, standing on the right side of the altar of incense.

12. And Zachary seeing him, was troubled, and fear fell upon him.

years, there was little hope that they should have a son. As Zachary was still officiating in the Temple he could not have been fifty years old, because at the completion of their fiftieth year the Levites ceased to exercise their solemn functions (Num. viii. 23).

8, 9. These verses show that Zachary was not the High-Priest, because the High-Priest did not belong to any course, and hence could minister in the Temple at any function, as often as he pleased.

**According to the custom of the priestly office.** It was customary for the priests of the same course to distribute the duties of the week by casting lots. This particular week, it fell to the lot of Zachary to offer incense, which was the most coveted and honorable of the priestly functions.

**Going into the temple of the Lord;** i.e., into the Holy Place, to which the priests alone were admitted. The Holy Place was in the Court of the Priests, and separated from the Holy of Holies by only a veil. Only the High-Priest was allowed to enter the Holy of Holies. See on Matthew xxi. 12.

**10. And all the multitude of the people was praying without.** From this it would seem that Zachary was performing his functions on a Sabbath, or festival day, since a large crowd of people had assembled in the Temple. The people were in the Court of Israel, which was outside of the Court of the Priests, but inside the Court of the Gentiles. See on Matthew xxi. 12.

**At the hour of incense.** Incense was offered on the Golden Altar of Incense, in the Court of the Priests, morning and evening of each day.

**11. An angel.** This was the Archangel Gabriel (verse 19).

**12. And Zachary . . . was troubled,** — most likely because of the sudden and unexpected appearance of the angel in human form.

13. But the angel said to him: Fear not, Zachary, for thy prayer is heard; and thy wife Elizabeth shall bear thee a son, and thou shalt call his name John:

14. And thou shalt have joy and gladness, and many shall rejoice in his nativity.

15. For he shall be great before the Lord; and shall drink no wine nor strong drink: and he shall be filled with the Holy Ghost, even from his mother's womb.

16. And he shall convert many of the children of Israel to the Lord their God.

17. And he shall go before him in the spirit and power of Elias; that he may turn the hearts of the fathers unto the children, and the incredulous to the wisdom of the just, to prepare unto the Lord a perfect people.

**13. For thy prayer is heard.** There is a question as to what prayer of Zachary the angel here referred. The common opinion of the Fathers is that he had been praying for the speedy coming of the Messiah and Redeemer; others, however, think that his prayer had been for a son. It may well be that the angel referred to something which Zachary had been praying for, not at this particular time, but in the past.

**John.** The name "John," in Hebrew, means "grace or mercy of Jehovah." This name was especially appropriate in the case of John the Baptist, who was in a particular manner the gift of God's grace and mercy.

**15. For he shall be great before the Lord.** John was to be great: (a) because sanctified from his mother's womb; (b) because of his office as Precursor to our Lord; (c) because of the austerity of his life; (d) because he should convert many Israelites to the faith and justice of their fore-fathers.

**He shall be filled . . . from his mother's womb.** It is the common teaching of the Fathers that the soul of John was cleansed from original sin, and filled with the gifts and graces of the Holy Ghost, before his birth and while yet in his mother's womb. He was not, however, like the Blessed Virgin, free from all stain of original sin from the first moment of his conception; neither in his after life was he, like her, exempt from all venial offences.

**17. And he shall go before, etc.;** i.e., John, as Precursor, was to go before our Lord, the Messiah, and prepare the people for the reception of Christ and His teaching.

**In the spirit and power of Elias.** John was to exhibit in his person many of the characteristics and virtues of Elias, especially the courage, fortitude and fearless denunciation of sin which had



18. And Zachary said to the angel: Whereby shall I know this? for I am an old man, and my wife is advanced in years.

19. And the angel answering, said to him: I am Gabriel, who stand before God; and am sent to speak to thee, and to bring thee these good tidings.

20. And behold, thou shalt be dumb, and shalt not be able to speak until the day wherein these things shall come to pass, because thou hast not believed my words, which shall be fulfilled in their time.

21. And the people were waiting for Zachary; and they wondered that he tarried so long in the temple.

22. And when he came out, he could not speak to them: and they understood that he had seen a vision in the temple. And he made signs to them, and remained dumb.

23. And it came to pass, after the days of his office were accomplished, he departed to his own house.

24. And after those days, Elizabeth his wife conceived, and hid herself five months, saying:

25. Thus hath the Lord dealt with me in the days wherein he hath had regard to take away my reproach among men.

shown forth in the great prophet; hence, John was to appear in the "spirit and power of Elias" (Mal. iv. 5).

That he may turn the hearts of the fathers, etc. This may mean that, by his preaching, he was to recall the faithless and degenerate Israelites of his day to the faith and virtues of their forefathers, the Patriarchs; or that he was to arouse the people, the children of the patriarchs, to a new life of faith and virtue, which would thus, as it were, cause the Patriarchs to look from the spirit world with pleasure and satisfaction on their repentant descendants.

18. **Whereby shall I know this.** By these words nearly all the Fathers believe that Zachary expressed a doubt as to the truth of the angel's words, and that he was consequently guilty of at least venial sin.

19. **Gabriel**, — which means the "power of God."

20. **Thou shalt be dumb.** This affliction was to be a sign of the truth of the angel's message, and also a punishment for Zachary's doubt. **Until the day;** i.e., until the birth of John.

21. **And they wondered**, etc.; because the priest was not supposed to remain longer than was necessary in the Holy Place.

22. **And he made signs to them;** most likely indicative of what had just taken place between himself and the angel.

24, 25. These verses show that after conceiving, Elizabeth kept

26. And in the sixth month, the angel Gabriel was sent from God into a city of Galilee, called Nazareth,

27. To a virgin espoused to a man whose name was Joseph, of the house of David; and the virgin's name was Mary.

28. And the angel being come in, said unto her: Hail, full of grace, the Lord is with thee: blessed art thou among women.

aloof from the eyes of the world, most likely out of a sense of modesty; but especially in order to be more united with God in prayer and thanksgiving for the great benefit which had been bestowed upon her.

26. **And in the sixth month;** i.e., after the conception of Elizabeth. Hence John the Baptist was just six months older than our Lord.

**Nazareth.** See on Matthew ii. 23.

27. **To a virgin espoused.** From these words, some conclude that the Blessed Virgin was already really married to Joseph; others that she was only promised in marriage by her family. The latter opinion would seem more probable because otherwise she would have been actually living with St. Joseph, as was customary with those really married. See on Matthew i. 18.

**Of the house of David.** St. Joseph and the Blessed Virgin were both of the family of David. Our Lord was therefore truly "the Son of David" on his mother's side.

**Mary.** This name is derived from the Hebrew "Miriam," which signifies "Star of the Sea," or, in Chaldaic, "Lady."

28. **And the angel being come in.** It is the common opinion that our Blessed Lady was rapt in devout prayer when the angel entered her room.

**Full of grace.** This is the Catholic translation of the Greek, *κεχαριτωμένη*, and is in conformity with the authority of the Latin Fathers, and of the ancient Syriac and Arabic versions of this passage. Protestants widely differ as to the meaning of the word. The Authorized Version translates it, "highly favored." Literally, the term would seem to mean "highly pleasing," or "highly favored," or "singularly endowed." Since, therefore, it is grace alone which renders one highly pleasing in the sight of God, the translation "full of grace" would seem to be most correct. Just as Solomon was called "The Wise One," and our Lord, "The Just

29. Who having heard, was troubled at his saying, and thought with herself what manner of salutation this should be.

30. And the angel said to her : Fear not, Mary, for thou hast found grace with God.

31. Behold thou shalt conceive in thy womb, and shalt bring forth a son; and thou shalt call his name Jesus.

32. He shall be great, and shall be called the Son of the most High; and the Lord God shall give unto him the throne of David his father; and he shall reign in the house of Jacob for ever.

33. And of his kingdom there shall be no end.

One," so here our Blessed Lady is addressed as "The Highly-favored One," i.e., favored above all others.

**The Lord is with thee.** By "Lord," we are here to understand Jehovah (God); not our Lord, whom as yet our Blessed Lady had not conceived.

**Blessed art thou among women.** These words, although found in most MSS., are wanting in the Vatican and a few other ancient MSS. Our Blessed Lady is here compared, not with the whole of mankind, but with all other women.

29. **Who having heard,** who rather "having seen" (*ἰδοῦσα*). It was a shock to our Lady's modesty to see the angel in her room in the form of a young man. It was likewise a shock to her humility to hear the words of praise which he addressed to her. **Was troubled,** because she was most probably only promised in marriage by her family. Her heart and her own final promise of marriage had never been given, nor perhaps had she intended to give them to any man.

30. **Fear not, Mary.** The angel now speaks to her more familiarly, calling her by her name, which shows that she was no stranger to him, and he assures her that no evil can befall her since she is under divine protection.

31. **Behold, thou shalt conceive in thy womb.** The Blessed Virgin knew that the Prophet Isaias had foretold, seven hundred years before, that the Messiah should be conceived by a virgin (Isa. vii. 14), but how this should be, she did not know.

**Jesus** is the Greek form of the Hebrew *Josue*; it means Saviour. Jesus was to save his people from their sins (Matthew i. 21).

32. **He shall be great,**— (a) because He shall be called, and shall be in reality, the Son of God; (b) because He shall be the everlasting ruler of the people of God.

34. And Mary said to the angel: How shall this be done, because I know not man?

35. And the angel answering, said to her: The Holy Ghost shall come upon thee, and the power of the most High shall overshadow thee. And therefore also the Holy which shall be born of thee shall be called the Son of God.

36. And behold thy cousin Elizabeth, she also hath conceived a son in her old age; and this is the sixth month with her that is called barren:

**Throne of David his father.** Our Lord was to be the descendant of David, and He was to be David's successor and the spiritual ruler of the chosen people of God.

**In the house of Jacob forever.** Our Lord was to exercise dominion, not over a few tribes of Israel, as did some of the descendants of Jacob, but over all of the twelve tribes, and over all those who in future should be aggregated to His Church.

34. **How shall this be done**, etc. By these words the Blessed Virgin did not express any doubt, as we know from verse 45; she wished to know only the manner in which the angel's announcement was to be fulfilled.

**Because I know not man.** From these words, expressed in the present tense, the Fathers and commentators infer that the Blessed Virgin had made a vow of perpetual virginity. The use of the present tense seems to embrace all time, past, present, and future. See above, verse 29.

35. **The Holy Ghost shall come upon thee**, etc. The angel now assures our Lady that the Holy Ghost, without any detriment to her virginity, shall miraculously cause her to conceive a son. This work is appropriated to the Holy Ghost, because it is a work of love. The external works (*opera ad extra*) of the Holy Trinity are differently appropriated to the different persons; thus, power is appropriated to the Father, wisdom to the Son, love to the Holy Ghost. The appropriations are founded on the different relations to one another of the three Divine Persons of the Holy Trinity.

It is to be noted that this and the preceding verse afford a proof of the Virgin Birth of our Lord. Cf. on Matthew i. 18-25.

**The holy**; i.e., the holy offspring, "which shall be born,"—literally, "which is born" (*γεννώμενον*); i.e., which is just about to be conceived. The phrase "of thee" is wanting in most Greek MSS.

36. **Thy cousin Elizabeth.** Elizabeth was of the daughters of

37. Because no word shall be impossible with God.

38. And Mary said: Behold the handmaid of the Lord; be it done to me according to thy word. And the angel departed from her.

39. And Mary rising up in those days, went into the hill country with haste into a city of Juda.

40. And she entered into the house of Zachary, and saluted Elizabeth.

41. And it came to pass, that when Elizabeth heard the salutation of Mary, the infant leaped in her womb. And Elizabeth was filled with the Holy Ghost:

Aaron and Mary was of the tribe of Juda; but since they are cousins, it must be that one of Elizabeth's ancestors, on the maternal side, was married to a man of the tribe of Juda.

**She also hath conceived**, etc. The angel spoke these words to Mary, not because the latter had doubted, but only to strengthen her faith. Just as Elizabeth, who by age was sterile, had become fecund by the gift of God, so should Mary be able to conceive a son without any intervention on the part of man.

**That is called barren**; i.e., who is commonly known to be barren.

37. **No word**; i.e., *no promise* of God is impossible of fulfillment; *no thing* is beyond God's power.

38. **Behold the handmaid of the Lord**. As soon as Mary understood that she was to conceive without detriment to her virginity, she at once humbly bowed to the will of God; and at that moment she conceived her Divine Son.

39. **In those days**; i.e., soon after she had conceived our Lord.

**Into a city of Juda**. This was doubtless some sacerdotal city, as Elizabeth was of the daughters of Aaron. Some think it was Hebron, about eighty miles south of Nazareth; others believe it was Jutta, or Juttah. The exact indications of tradition are that Zachary dwelt in Ain-Karim, about three and a half miles southwest of Jerusalem, and nearly four miles northwest of Bethlehem. The journey from Nazareth to the hill-country south of Jerusalem took about four days. The purpose of our Lady's visit to her cousin was not to satisfy any personal doubts or curiosity, but only to congratulate Elizabeth on the great gifts which God had conferred upon her.

41. **The infant leaped**. The infant "leaped for joy" (verse 44). It is a common belief of the Fathers that John was at this moment given the use of reason in a passing way, and that his expression of joy was because he understood that, in Mary's womb, was con-

42. And she cried out with a loud voice, and said: Blessed art thou among women, and blessed is the fruit of thy womb.

43. And whence is this to me, that the mother of my Lord should come to me?

44. For behold as soon as the voice of thy salutation sounded in my ears, the infant in my womb leaped for joy.

45. And blessed art thou that hast believed, because those things shall be accomplished that were spoken to thee by the Lord.

46. And Mary said: My soul doth magnify the Lord.

47. And my spirit hath rejoiced in God my Saviour.

ceived the Eternal Son of God. It is the common belief, also, that it was at this time that John was cleansed from original sin and filled with the Holy Ghost.

And Elizabeth was filled with the Holy Ghost; i.e., she then became endowed with special gifts which, according to St. Bede, enabled her to know the past, present, and future. She seemed to know the past, because she at once said (verse 45) "blessed art thou that hast believed"; and the present, because she said (verse 43) "that the mother of my Lord should come to me"; and the future, because she predicts (verse 45) "that those things shall be accomplished," etc.

42. Blessed art thou among women; i.e., highly favored and gifted, above all other women.

43. That the mother of my Lord, etc. These words show that Elizabeth recognized the infant in Mary's womb as the Eternal Son of God.

44, 45. See above, verse 41.

46. My soul doth magnify the Lord. The Magnificat is the most sublime canticle in the Bible. It is similar to that spoken by Anna, the mother of Samuel (1 Kings ii. 1 ff.), which the Blessed Virgin must have known. The Magnificat is divided into three parts: the first part (verses 46-50) expresses Mary's gratitude for the singular gifts and graces which Almighty God had bestowed upon her; the second part (verses 50-54) treats of the many benefits which Almighty God had bestowed at all times on the people of Israel; the third part (verses 54, 55) refers again to the mystery of the Incarnation, the promise made of old to the Fathers.

My soul. The word "soul" is here meant to embrace Mary's whole being.

47. In God my Saviour. This is not a reference to the Second

48. Because he hath regarded the humility of his handmaid; for behold from henceforth all generations shall call me blessed.

49. Because he that is mighty, hath done great things to me; and holy is his name.

50. And his mercy is from generation unto generations, to them that fear him.

51. He hath shewed might in his arm: he hath scattered the proud in the conceit of their heart.

52. He hath put down the mighty from their seat, and hath exalted the humble.

53. He hath filled the hungry with good things; and the rich he hath sent empty away.

54. He hath received Israel his servant, being mindful of his mercy:

55. As he spoke to our fathers, to Abraham and to his seed for ever.

56. And Mary abode with her about three months; and she returned to her own house.

57. Now Elizabeth's full time of being delivered was come, and she brought forth a son.

58. And her neighbours and kinsfolks heard that the Lord had shewed his great mercy towards her, and they congratulated with her.

Person of the Blessed Trinity, but to the Godhead in general, the Creator and Preserver of all men.

48. **The humility of his handmaid;** i.e., the unworthiness and lowliness of our Blessed Lady. Mary was not referring to her humility as a virtue, but to her unworthiness of so great a gift of God.

49. **He that is mighty,** — rather, the Mighty One (*ὁ δυνατός*).

50. **To them that fear him;** i.e., to them that have the salutary fear of the Lord, which teaches the observance of His commandments.

51, 52. In these verses the Blessed Virgin is extolling the goodness of God to the whole world, which rewards the humble and punishes the proud.

53. **He hath filled the hungry,** etc. These words refer to the spiritual benefits, as well as temporal, which Almighty God at all times bestowed upon the Jewish people, and which in general He bestows upon the world.

54. **He hath received Israel;** i.e., He has come to the assistance of His chosen people, in accordance with His promise to Abraham, their father (verse 55).

56. **About three months.** Most probably the Blessed Virgin remained with Elizabeth until after the birth of John. It would

59. And it came to pass, that on the eighth day they came to circumcise the child, and they called him by his father's name Zachary.

60. And his mother answering, said: Not so; but he shall be called John.

61. And they said to her: There is none of thy kindred that is called by this name.

62. And they made signs to his father, how he would have him called.

63. And demanding a writing table, he wrote, saying: John is his name. And they all wondered.

64. And immediately his mouth was opened, and his tongue loosed, and he spoke, blessing God.

65. And fear came upon all their neighbours; and all these things were noised abroad over all the hill country of Judea.

66. And all they that had heard them laid them up in their heart, saying: What an one, think ye, shall this child be? For the hand of the Lord was with him.

be unseemly that she should remain until the very time of so great an event and depart before its occurrence.

59. **On the eighth day**, etc. The circumcision of John was most likely performed in Zachary's home, at which were present priests, as well as friends and neighbors of the family. Circumcision remitted original sin, and also actual sin, if the person circumcised was guilty of any. In addition, it conferred sanctifying grace, not indeed of itself, as does Baptism, but inasmuch as it was a sign of faith in the redemption to come. Circumcision did not, however, remit all the temporal punishment due to sin, as Baptism does. Those who died before the eighth day, or before the institution of circumcision, which was in the time of Abraham, were saved by the faith of their parents in the Redeemer to come.

**He shall be called John.** Perhaps from Zachary Elizabeth had learned that the child's name was to be John, in accordance with the announcement of the angel; perhaps, also, this had been made known to her by revelation.

62. **They made signs to his father**, because Zachary was still deaf and dumb.

63. **And they all wondered**; i.e., that Zachary and Elizabeth should have insisted on the name John.

65. **Fear came upon all**, etc.; i.e., a fear of reverence, on account of the wonderful things which had taken place in regard to the new-born child.



67. And Zachary his father was filled with the Holy Ghost; and he prophesied, saying:

68. Blessed be the Lord God of Israel; because he hath visited and wrought the redemption of his people:

69. And hath raised up an horn of salvation to us, in the house of David his servant:

70. As he spoke by the mouth of his holy prophets, who are from the beginning:

71. Salvation from our enemies, and from the hand of all that hate us:

67. Zachary . . . was filled with the Holy Ghost; i.e., over and above the sanctifying grace which he possessed, he received the gift of prophecy.

68. Here begins the Benedictus, which is the second canticle of the New Testament. It is chiefly prophetic in character, and is divided into two parts: the first part (verses 68-75) sings the praises of God for the great mystery of the Incarnation, and for the blessings which are to follow therefrom. The second part (verses 76-79) refers to John, whom Zachary addresses as the Precursor of the Messiah.

**Blessed be the Lord, God of Israel; i.e., praised be the One, True God, as distinguished from all false gods.**

**Because he hath visited, etc.** The reference here is to the Incarnation of the Son of God in Mary's womb, which had been made known to Zachary by the Holy Ghost.

**And wrought the redemption, etc.** Zachary spoke in the past tense, feeling that the Redemption already begun in the Incarnation of the Son of God was certain of accomplishment. Some think that he spoke of the future event, as already past, in accordance with prophetic usage.

69. **An horn of salvation.** The term "horn" is frequently used in the Scriptures to denote power, strength; the figure is taken from the strength which resides in the horns of animals. "Horn of salvation" here refers to the Powerful King, the Messiah, who was to be born.

**House of his servant David,** because from the house, or line of David, the Messiah was to come.

70. **As he spoke, etc.; i.e., as He had promised through the true prophets, who were from the beginning of the world.**

71. **Salvation from our enemies, etc.** The ancient prophets had

72. To perform mercy to our fathers, and to remember his holy testament,  
 73. The oath, which he swore to Abraham our father, that he would grant to us,  
 74. That being delivered from the hand of our enemies, we may serve him without fear,  
 75. In holiness and justice before him, all our days.  
 76. And thou, child, shalt be called the prophet of the Highest: for thou shalt go before the face of the Lord to prepare his ways:  
 77. To give knowledge of salvation to his people, unto the remission of their sins:  
 78. Through the bowels of the mercy of our God, in which the Orient from on high hath visited us:

foretold the deliverance of God's people from their enemies, and now Zachary interprets their meaning as referring to spiritual enemies.

72. **To perform mercy**, etc.; i.e., Almighty God had raised up the Messiah, the Powerful King, in accordance with His merciful promise, made to the Patriarchs, that a Redeemer should deliver them from their sins.

**His holy testament.** This was the covenant which God had made with Abraham (Gen. xvii. 7-9; xxii. 16-18), which embraced three things:— (a) that he should have a numerous progeny; (b) that he should inherit the Land of Canaan; (c) that, in his seed, all nations should be blessed.

73. **The oath**; i.e., His promise to keep His covenant.

74. **Without fear**; i.e., without inordinate and immoderate fear.

76. **For thou shalt go before**, etc. These words refer to the prophecy of Malachy (iii. 1), and are regarded as a proof of the Divinity of Christ, because He, of whom John was the Precursor, is called "The Highest" and "The Lord."

77. **To give knowledge**, etc. John's office was to preach the baptism of penance, and thereby dispose the hearts and minds of men for the reception of Christ and His teaching, through which the remission of their sins was to be obtained.

78. **Through the bowels of the mercy**, etc. The phrase "through the bowels" is not infrequent in Scripture, and signifies intense feeling, sympathy, etc.

**The Orient**; i.e., "the dawn." There is reference here to the Sun. Just as the Sun is said to rise over the world of darkness, so our Lord the "Sun of Justice" rose over the world enveloped in the darkness of sin and ignorance. Cf. Isa. ix. 2; Mal. iv. 2.

79. To enlighten them that sit in darkness, and in the shadow of death: to direct our feet into the way of peace.

80. And the child grew, and was strengthened in spirit; and was in the deserts until the day of his manifestation to Israel.

79. **In darkness.** The darkness here referred to must be taken in its spiritual sense, the result of sinfulness and ignorance, which oppressed the entire human race before the coming of Christ.

## CHAPTER II

JESUS IS BORN IN BETHLEHEM, 1-20.

THE CIRCUMCISION AND PRESENTATION IN THE  
TEMPLE, 21-38.

THE INFANCY OF JESUS, 39, 40.

JESUS AMONG THE DOCTORS IN THE TEMPLE, 41-52.

1. And it came to pass, that in those days there went out a decree from Cæsar Augustus, that the whole world should be enrolled.

2. This enrolling was first made by Cyrinus, the governor of Syria.

1. **And it came to pass, etc. ; i.e.,** it happened in accordance with the decrees of Divine Providence, that, soon after the birth and circumcision of John the Baptist, a decree emanated from the Roman Emperor that the census of the whole Roman Empire should be taken. The object of this census was most probably for the sake of increasing the tax income.

**Caesar Augustus,** who was the first Roman Emperor, and grand nephew of Julius Caesar. Augustus reigned forty-three years. Christ was born around the 25th year of his reign.

2. **This enrolling was first made by Cyrinus, etc.** This verse causes a difficulty, because Tertullian (*Adv. Marc.* iv. 7, 19) tells us that the census was taken by Sentius Saturninus. The difficulty is first explained by saying that the census was taken by S. Saturninus (then Governor of Syria), but under the direction of Cyrinus, who was especially appointed for this purpose by the Emperor, and who, ten years later, became Governor of Syria. St. Luke therefore speaks of Cyrinus as the Governor of Syria, most probably, because he was later appointed to that office. Another good explanation is that this particular census was begun by Saturninus

3. And all went to be enrolled, every one into his own city.

4. And Joseph also went up from Galilee, out of the city of Nazareth into Judea, to the city of David, which is called Bethlehem: because he was of the house and family of David,

5. To be enrolled with Mary his espoused wife, who was with child.

6. And it came to pass, that when they were there, her days were accomplished, that she should be delivered.

and Quintilius Varus, but was brought to a close by their successor, Cyrinus, who, consequently, gave his name to it. According to Mommsen (*Res gestae divi Augusti*) and Zumt (*De Syria Romana Provincia*) Cyrinus was twice governor of Syria, — first from 750–753 of Rome, when this “first” census was completed; and a second time from 759–765, when another, or second census was taken, which caused a great revolt in Galilee. The second census is mentioned by St. Luke in Acts v. 37, and by Josephus in *Jewish Ant.* xviii. 1.

3. **Everyone into his own city**; i.e., into the city from which the head of his family had sprung. Bethlehem was the City of David, and this is why Joseph and Mary, who were of the family of David, went thither. The Jewish custom required that each one should be enrolled in the place where his ancestors were born, and this census seems to have been taken by the local authorities and according to the custom of the Jews.

4. **Bethlehem** means “house of bread.” It was situated on a ridge of hills about seven miles south of Jerusalem, and eighty miles from Nazareth.

5. **With Mary.** Both Joseph and Mary went to Jerusalem to be enrolled, because women, as well as men, had to be enrolled when there was a question — as most likely in the present instance — of capitation-tax. Women were inscribed upon the public registers only when, having no brothers, they inherited the paternal property. Hence Mary, who seems to have had no brothers, went to be enrolled most likely under the title of heiress. Some say that the obligation of enrollment was imposed upon all the women of Israel. At any rate the law made subject to personal tax all women between the ages of twelve and sixty years. Cf. Ulpianus, *D. L. XV. De Censibus*.

6. **When they were there**, etc. It is the opinion of some that our Lord was born immediately after Joseph and Mary reached

7. And she brought forth her firstborn son, and wrapped him up in swaddling clothes, and laid him in a manger; because there was no room for them in the inn.

8. And there were in the same country shepherds watching, and keeping the night watches over their flock.

9. And behold an angel of the Lord stood by them, and the brightness of God shone round about them; and they feared with a great fear.

10. And the angel said to them: Fear not; for, behold, I bring you good tidings of great joy, that shall be to all the people:

Bethlehem; others think the nativity occurred during a few days which they spent there, either before or after the enrollment.

7. **And she brought forth, etc.** The Blessed Virgin gave birth to our Lord, not only without detriment to her virginity, but also without the pain, labor, and fatigue which are experienced by ordinary mothers.

**Her first-born son.** He is called the "first-born," because special rights and duties fell to the lot of the first-born. According to the almost universal tradition of the Church our Lord was born on December 25.

**And laid him in a manger.** These words show that our Lord was born in a stable; both tradition and modern research are agreed that this stable was a cave hewn out of a rock, into which animals, especially sheep, were driven during storms, and for shelter at night. The inns at Bethlehem were all filled with the multitudes who had come there for enrollment.

8. **In the same country; i.e., in the neighborhood of Bethlehem.**

**Shepherds watching, etc.** The Greek word for watching is *ἀγραιοῦντες*, which literally means, "dwelling in the fields." It was not extraordinary that shepherds with their flocks should be in the fields at this season of the year. Experienced travelers tell us that the end of December in Palestine is often the most agreeable time of the year. Even to-day, after the December rains, the Arabs leave their dwellings about the middle of the month and go down into the plains with their flocks.

9. **Stood by them, — rather, "came upon them" (ἐπέστη).** **And they feared, etc.,** because the Jews believed that whoever saw an angel must die (Judges vi. 22, 23; xiii. 22).

10. **That shall be to all the people; i.e., to all the Jewish people.** Our Lord was to be in reality the Saviour of all men, both Jews

11. For, this day, is born to you a Saviour, who is Christ the Lord, in the city of David.

12. And this shall be a sign unto you. You shall find the infant wrapped in swaddling clothes, and laid in a manger.

13. And suddenly there was with the angel a multitude of the heavenly army, praising God, and saying :

14. Glory to God in the highest ; and on earth peace to men of good will.

15. And it came to pass, after the angels departed from them into heaven, the shepherds said one to another : Let us go over to Bethlehem, and let us see this word that is come to pass, which the Lord hath shewed to us.

16. And they came with haste ; and they found Mary and Joseph, and the infant lying in the manger.

17. And seeing, they understood of the word that had been spoken to them concerning this child.

and Gentiles, but the angels perhaps did not know that He was to be the Saviour of the Gentiles also.

11. **Christ the Lord** ; i.e., the Anointed, the Messiah.

12. **And laid in a manger.** The stable and manger here referred to were doubtless well known to all the shepherds of that neighborhood ; otherwise the angel would have designated more definitely the manger in which our Lord lay.

13. **A multitude of the heavenly army** ; i.e., a great number of angels who, because of their number, power, and obedience to the commands of God, are spoken of as belonging to an " army."

14. **Peace to men of good will** ; i.e., peace and tranquillity of mind and soul to all men, who, through the gracious mystery of the Incarnation, are shown to be objects of God's good-will and pleasure. The word, *εὐδοκία*, here translated " good-will " is used in the New Testament to signify God's good-pleasure in saving men through Christ.

15. **This word that is come to pass.** The term " word " here, as in other places, simply means *thing*, i.e., this event which the angels had announced. Cf. on i. 37.

**Which the Lord hath showed to us** ; i.e., hath " revealed " to us. These words indicate that the shepherds had received an interior revelation from God to know the importance of the angelic announcement.

16. **They came with haste.** The shepherds were perhaps some little distance from the stable, some say about a mile.

17. **They understood of the word** ; i.e., they understood the meaning of the announcement.

18. And all that heard, wondered; and at those things that were told them by the shepherds.

19. But Mary kept all these words, pondering them in her heart.

20. And the shepherds returned, glorifying and praising God, for all the things they had heard and seen, as it was told unto them.

21. And after eight days were accomplished, that the child should be circumcised, his name was called JESUS, which was called by the angel, before he was conceived in the womb.

22. And after the days of her purification, according to the law of Moses, were accomplished, they carried him to Jerusalem, to present him to the Lord:

23. As it is written in the law of the Lord: Every male opening the womb shall be called holy to the Lord:

24. And to offer a sacrifice, according as it is written in the law of the Lord, a pair of turtledoves, or two young pigeons:

18. **And at those things, etc.** The "and" at the beginning of this clause is not found in the Greek and Syriac texts of St. Luke; hence there should be no stop after "wondered."

19. **Pondered them in her heart.** While others wondered and talked about the marvellous things that had occurred in connection with the birth of our Lord, Mary remained silent, quietly revolving in her mind the great mystery of the Redemption, and the ancient prophecies, which had foretold it.

21. **After eight days; i.e.,** on the eighth day, when it was required, according to the Law, that the child should be circumcised.

**Circumcised.** Our Lord submitted to this painful operation, not because He stood in any need of it, since He was spotless; but in order: (a) to show respect and obedience to the existing Law; (b) in order that the Jews might have no pretext for accusing and rejecting Him; (c) to give sanction to the rite of circumcision. The ceremony of circumcision was performed, according to Jewish custom, not in the Temple, but at the home of the family, — in the case of our Lord — in the cave. It was ordinarily performed by the father, or head of the family, and in the presence of ten witnesses, who attested the child's enrollment among the theocratic people.

22-24. **After the days of her purification, etc.; i.e.,** on the fortieth day after the birth of her son. According to the Law of Moses (Lev. xii. 1-6), a mother remained "unclean" forty days after the birth of a male child, and eighty days after the birth of a female child; at the end of these periods, she was to present herself in the Temple, to be purified by certain ceremonies.

Another enactment of the Law (Lev. xii. 6-8) required a mother

25. And behold there was a man in Jerusalem named Simeon, and this man was just and devout, waiting for the consolation of Israel; and the Holy Ghost was in him.

26. And he had received an answer from the Holy Ghost, that he should not see death, before he had seen the Christ of the Lord.

27. And he came by the Spirit into the temple. And when his parents brought in the child Jesus, to do for him according to the custom of the law,

28. He also took him into his arms, and blessed God, and said:

29. Now thou dost dismiss thy servant, O Lord, according to thy word in peace;

at her purification, to offer in the Temple to the priests a lamb, one year old, for a holocaust, and a turtle-dove, or young pigeon, for a sin offering, provided the parents were rich; if the family was poor, two turtle doves, or two young pigeons, one for a holocaust and the other for a sin offering, were to be offered. As the Blessed Virgin was poor, she made the second offering.

According to a third enactment of the Law (Exod. xiii. 2; Num. xviii. 15), the child, if a first-born, belonged to God, and was to be a priest of the family, unless redeemed by an offering of five shekels.

Since the Blessed Virgin brought forth her son without any physical or moral defilement, she was not held by the Law of Purification (Lev. xii. 1-6), neither, perhaps, by the Law requiring the mother to redeem her first-born (Exod. xiii. 2). She submitted, however, to both, in order to give a good example, and to show obedience and respect for the Law.

25. **Waiting for the consolation of Israel;** i.e., waiting for the Christ, the Messiah, who was expected to be the Saviour and consoler of Israel.

**The Holy Ghost was in him,** — rendering him pleasing to God through sanctifying grace, and endowing him with the gift of prophecy.

26. **An answer** here means an interior assurance. **The Christ of the Lord;** i.e., the Messiah.

27. **And he came by the Spirit into the temple;** i.e., under the direction and inspiration of the Holy Ghost he came to the Temple.

28. **And blessed God;** i.e., he thanked the Eternal Father for having fulfilled His promise by giving to the world a Redeemer.

29. Here begins the Cantic of Simeon, the third cantic of the New Testament.



30. Because my eyes have seen thy salvation,  
 31. Which thou hast prepared before the face of all peoples:  
 32. A light to the revelation of the Gentiles, and the glory of thy people Israel.  
 33. And his father and mother were wondering at those things which were spoken concerning him.  
 34. And Simeon blessed them, and said to Mary his mother: Behold this child is set for the fall, and for the resurrection of many in Israel, and for a sign which shall be contradicted;

**Thou dost dismiss thy servant**, — literally, "Thou dost loosen or dissolve (*ἀπολύεις*) thy servant." The meaning is, that, since Simeon had lived to see the Christ, he was willing that God should take him from this world.

**According to thy word in peace**; i.e., according to Thy promise. Simeon thought the fulfillment of the promise that he should live to see the Christ, implied the further promise to call him to his reward.

30. **Thy salvation**; i.e., the Only-begotten Son of God, who in Scripture is often called "Salvation." Cf. Gen. xlix. 18; Isa. xxxiii. 2; Ps. l. 14.

31. **Before the face of all peoples**; i.e., for all Jews and Gentiles alike, to all of whom our Lord was to be a Saviour.

32. **A light to the revelation of the Gentiles . . . glory of thy people**, etc. Our Lord was a light to deliver the Gentiles from the darkness of sin and ignorance, and He was also the glory of the Jewish people, among whom He was born, among whom He preached, worked miracles and passed His earthly life.

33. **Were wondering**. Mary and Joseph wondered at the prophecy of Simeon and doubtless also at many of the details of our Lord's future mission which Simeon pointed out. They knew very well that their child was the Son of God, but all the details of His ministry, especially in regard to the Gentiles, even His mother most likely did not know.

34. **And Simeon blessed them**. From this some believe Simeon to have been a priest; but it is improbable that he was, otherwise St. Luke would have told us so. The blessing Simeon gave Mary and Joseph was, therefore, that which it was customary for venerable and holy men to confer.

**This child is set for the fall**, etc. The Saviour was directly intended by Almighty God to raise many in Israel from a state of

35. And thy own soul a sword shall pierce, that, out of many hearts, thoughts may be revealed.

36. And there was one Anna, a prophetess, the daughter of Phanuel, of the tribe of Aser; she was far advanced in years, and had lived with her husband seven years from her virginity.

37. And she was a widow until fourscore and four years; who departed not from the temple, by fastings and prayers serving night and day.

38. Now she, at the same hour, coming in, confessed to the Lord; and spoke of him to all that looked for the redemption of Israel.

sin and ignorance; He became at the same time the occasion of the fall and ruin of many, who through their own perversity rejected Him and His doctrine.

And for a sign, etc. Our Lord was not only a sign, but He was in reality a Redeemer and a Saviour; but there were to be many who by their own obstinacy would make Him the opposite in their regard.

35. **A sword shall pierce.** Simeon is here prophesying the dolors which Mary in future was to suffer as a consequence of the future sufferings, Passion, and death of her divine Son.

**That out of many hearts, etc.** Some connect this clause with the end of the preceding verse, in which case the meaning would be, that our Lord was to be the cause or the occasion of making manifest what were the thoughts and dispositions of many in Israel; some, like Mary, Joseph, Simeon, Zachary, Elizabeth, the Apostles, etc., would show the sincerity of their thoughts and sentiments, by welcoming the advent and the teachings of the Messiah; others, like the Pharisees, would deceitfully plot against and reject Him. Other commentators, however, connect the above words with the preceding clause; and for them the meaning would be that the sorrows of the Blessed Virgin would be the cause of producing in the hearts of many a belief in her Son.

36. **Anna means "grace."** She was far advanced in years, about eighty-four years old (verse 37).

**Seven years from her virginity; i.e.,** she had been a virgin up to the time of her marriage, and had thereafter lived seven years in the married state. She was fifteen years old when married.

37. **Who departed not from the temple, etc.** These words simply mean that a great part of her time was spent in the Temple.

38. **Coming in,** — rather "coming up" (ἐπιστᾶσα) towards the

39. And after they had performed all things according to the law of the Lord, they returned into Galilee, to their city Nazareth.

40. And the child grew, and waxed strong, full of wisdom; and the grace of God was in him.

41. And his parents went every year to Jerusalem, at the solemn day of the pasch,

42. And when he was twelve years old, they going up into Jerusalem, according to the custom of the feast,

43. And having fulfilled the days, when they returned, the child Jesus remained in Jerusalem; and his parents knew it not.

Holy Family from the place she had been occupying in the Temple. Anna's confession was the second testimony to our Lord's Divinity given at His presentation in the Temple.

39. **They returned into Galilee.** St. Luke makes no mention of the visit of the Magi and of the flight into Egypt, perhaps because these events had already been treated by St. Matthew. St. Luke does not say just when the Holy Family went to Nazareth, he merely wishes to state that whereas our Lord had been born at Bethlehem, He afterwards had His home at Nazareth. It is also probable that St. Luke knew nothing about the visit of the Magi and the flight into Egypt. See on Matthew ii. 1.

40. **Child grew . . . full of wisdom.** Our Lord progressed physically as did other children, thereby proving the reality of His human body. He also appeared externally and in the sight of man to advance in wisdom and knowledge, but internally He could have no increase in knowledge, because from the first moment of His Incarnation "in him were hidden all the treasures of wisdom," etc. (Coloss. ii. 3). Experimentally, however, there was progress in our Lord's knowledge.

41. **His parents went every year, etc.** The Law of Moses required all men to go to Jerusalem and offer sacrifice three times each year, — at the festivals of Pasch, Pentecost, and Tabernacles. Boys at the age of twelve, which is the age of virility among Orientals, fell under this law, and hence our Lord was obliged to be present the year mentioned here (verse 42). It was not obligatory upon women to attend these festivals, but it was a pious practice, to which our Lady was doubtless always faithful.

43. **Having fulfilled the days; i.e., when the octave of the festival was over. The child Jesus remained, etc.** It was a part of the plan of Divine Providence that our Lord should remain in

44. And thinking that he was in the company, they came a day's journey, and sought him among their kinsfolks and acquaintance.

45. And not finding him, they returned into Jerusalem, seeking him.

46. And it came to pass, that, after three days, they found him in the temple, sitting in the midst of the doctors, hearing them, and asking them questions.

47. And all that heard him were astonished at his wisdom and his answers.

48. And seeing him, they wondered. And his mother said to him: Son, why hast thou done so to us? behold thy father and I have sought thee sorrowing.

49. And he said to them: How is it that you sought me? did you not know, that I must be about my father's business?

Jerusalem this particular year, after the departure of the rest. It was not due to negligence on the part of Mary and Joseph that the child Jesus was left behind, because it was customary for people of the same neighborhood to travel in different companies during the day without distinction of families until they halted at evening; hence, Mary and Joseph thought our Lord to be in some one of the several companies of their neighborhood. Some say it was also customary for the men to travel in one company and the women in another, and thus Joseph supposed the Child to be with Mary, and Mary supposed Him to be with Joseph.

44. **A day's journey.** The Holy Family, Joseph and Mary, had proceeded about a third of the distance from Jerusalem back to Nazareth, when at night-fall, they discovered that Jesus was not with them.

46. **After three days.** They had proceeded a day's journey from the Holy City, a second day was consumed in returning; and the third day they found our Lord "in the temple," that is, in the Court, or in that part of the Temple in which the Doctors were accustomed to assemble for public instruction and disputation. Our Lord was most probably speaking to the Doctors about the Messiah and the prophecies which concerned His mission and life.

48. **They wondered,** — not that Mary and Joseph were unaware that their son was the true Son of God, but they were surprised at this sudden and unexpected appearance of their child in public.

**Son, why hast thou done so,** etc. These words do not imply any reproof on the part of Mary. They simply express the sorrow and anxiety which filled the mother's and Joseph's hearts.

49. **Did you not know,** etc. Neither do these words of our Lord contain a rebuke to His mother. Our Lord was simply calling her

50. And they understood not the word that he spoke unto them.

51. And he went down with them, and came to Nazareth, and was subject to them. And his mother kept all these words in her heart.

52. And Jesus advanced in wisdom, and age, and grace with God and men.

attention to the fact that the Father's business, which He had come on earth to perform, was His most important duty.

50. **And they understood not the word**, etc.; i.e., neither Mary nor Joseph fully understood the connection between the great work of Redemption, which our Lord came to perform, and this early public appearance of His in the Temple. It is not derogatory to the Blessed Virgin to say that, while full of grace, she did not, from the beginning, have the fullness of knowledge of all things relating to the mystery of the Redemption.

51. **And was subject to them**. These words show the great reverence and respect of our Lord towards His Blessed Mother and foster father, for whom He labored, and to whom He was obediently subject until He was about thirty years of age.

**His mother kept all these words in her heart**. The Blessed Virgin constantly meditated on the words and actions of her Divine Son, and their relations to the great mysteries of the Incarnation and Redemption.

52. **Jesus advanced in wisdom**, etc. See above, verse 40.

## CHAPTER III

THE MISSION AND PREACHING OF JOHN THE BAPTIST, 1-14.

THE BAPTIST RENDERS TESTIMONY TO JESUS, 15-18.

JOHN THE BAPTIST IS IMPRISONED, 19, 20.

THE BAPTISM OF JESUS, 21, 22.

THE GENEALOGY OF JESUS, 23-38.

I. Now in the fifteenth year of the reign of Tiberius Cæsar, Pontius Pilate being governor of Judea, and Herod being tetrarch of Galilee, and Philip his brother tetrarch of Iturea, and the country of Trachonitis, and Lysanias tetrarch of Abilina;

I. **In the fifteenth year**. This was about 779 of Rome, or A.D. 26. Tiberius Caesar succeeded Augustus, his predecessor, A. U. C. 767; but he became associated with Augustus, as joint-Emperor, after his

2. Under the high priests Annas and Caiphas; the word of the Lord was made unto John, the son of Zachary, in the desert.

triumph over the Pannonians and Dalmatians, in A. U. C. 765, and it is from this latter date that St. Luke is here reckoning.

**Pontius Pilate being governor of Judea.** After the deposition and banishment of Archelaus, A.D. 6, Judea was governed by a Procurator, or Deputy Governor, subject to the Roman Proconsul of Syria. Pilate was the fifth or sixth successor to this office of Deputy Governorship, and ruled for ten years, A.D. 27 to 37. He was deposed for his cruelties and unpopularity with the Jews and Samaritans, and was exiled by Caius, the successor of Tiberius. Pilate finally committed suicide.

**Herod being tetrarch of Galilee.** This was Herod Antipas, who put to death John the Baptist, and mocked our Lord in His Passion.

**Philip . . . tetrarch of Iturea.** This Philip was son of Herod the Great and Cleopatra of Jerusalem. Iturea was a barren region, east of Galilee, inhabited mostly by outlaws and robbers.

**Trachonitis** was south of Iturea, and also a desolate region, full of bandits and robbers. Iturea and Trachonitis are mentioned nowhere else in the Bible.

**Lysanias, tetrarch of Abilina.** Lysanias was probably not a Jew. His territory, called from its principal city, Abila, was north of Iturea, and was never a part of the original kingdom of Herod the Great.

2. **Annas and Caiphas.** The office of High-Priest, according to Jewish law, could be occupied by one only at a time, and that for life. But, owing to the corruptions introduced by the Romans, it became the prize of the highest bidder. Thus, Annas, who was appointed High-Priest by Cyrinus, the Governor, in A.D. 7, was deposed in A.D. 14. Caiphas was made High-Priest in A.D. 24, but as Annas was his father-in-law, and very influential with the people, it is probable that they both took part to some extent in administering the functions of High-Priest. They may have occupied the office alternately, as would seem to be implied by St. John (xi. 49), who says that Caiphas was the High-Priest of *that* year, i.e., of our Lord's Passion.

**The word of the Lord;** i.e., God spoke or made known to John His will.

**John . . . in the desert.** See on Matthew iii. 1.

3. And he came into all the country about the Jordan, preaching the baptism of penance for the remission of sins;

4. As it was written in the book of the sayings of Isaias the prophet: A voice of one crying in the wilderness: Prepare ye the way of the Lord, make straight his paths.

5. Every valley shall be filled; and every mountain and hill shall be brought low; and the crooked shall be made straight; and the rough ways plain;

6. And all flesh shall see the salvation of God.

7. He said therefore to the multitudes that went forth to be baptized by him: Ye offspring of vipers, who hath shewed you to flee from the wrath to come?

8. Bring forth therefore fruits worthy of penance; and do not begin to say, We have Abraham for our father. For I say unto you, that God is able of these stones to raise up children to Abraham.

9. For now the axe is laid to the root of the trees. Every tree therefore that bringeth not forth good fruit, shall be cut down and cast into the fire.

10. And the people asked him, saying: What then shall we do?

11. And he answering, said to them: He that hath two coats, let him give to him that hath none; and he that hath meat, let him do in like manner.

12. And the publicans also came to be baptized, and said to him: Master, what shall we do?

13. But he said to them: Do nothing more than that which is appointed you.

3. See on Matthew iii. 6, 11.

4, 5. See on Matthew iii. 3. The leveling of mountains and hills, etc., here spoken of, is evidently to be taken in a metaphorical sense; the reference is to the Oriental custom of removing all obstacles, and preparing the way for the advent of kings and rulers.

6. This verse expresses the universality of salvation through Christ. The Messiah was to be the Saviour, not only of the Jews, but of the Gentiles also.

7-9. See on Matthew iii. 7-10.

10. The people asked him, etc.; i.e., those who, unlike the Scribes and Pharisees, were well-disposed, and were anxious to know what they should do in the way of penance.

11. He that hath two coats, etc. St. John here mentions only two corporal works of mercy, — clothing the naked and feeding the hungry, — but these are mentioned because they would appeal more to the people, and in them are included all the other works of mercy, both corporal and spiritual.

12, 13. The publicans also came, etc. The reply John made to the publicans was that they should exact nothing more than was lawful. The publicans were hated by the Jews: (a) because of

14. And the soldiers also asked him, saying: And what shall we do? And he said to them: Do violence to no man; neither calumniate any man; and be content with your pay.

15. And as the people were of opinion, and all were thinking in their hearts of John, that perhaps he might be the Christ;

16. John answered, saying unto all: I indeed baptize you with water; but there shall come one mightier than I, the latchet of whose shoes I am not worthy to loose: he shall baptize you with the Holy Ghost, and with fire:

17. Whose fan is in his hand, and he will purge his floor, and will gather the wheat into his barn; but the chaff he will burn with unquenchable fire.

18. And many other things exhorting, did he preach to the people.

19. But Herod the tetrarch, when he was reproved by him for Herodias, his brother's wife, and for all the evils which Herod had done;

20. He added this also above all, and shut up John in prison.

21. Now it came to pass, when all the people were baptized, that Jesus also being baptized and praying, heaven was opened;

22. And the Holy Ghost descended in a bodily shape, as a dove upon him; and a voice came from heaven: Thou art my beloved Son; in thee I am well pleased.

23. And Jesus himself was beginning about the age of thirty years; being (as it was supposed) the son of Joseph, who was of Heli, who was of Mathat,

their office as tax-gatherers for the Romans, whom the Jews regarded as unjust oppressors; (b) because of the extortion and dishonesty which they practiced in the discharge of their hated office. See on Matthew v. 46.

14. **Do violence to no man, etc.** John cautioned the soldiers against those crimes to which they were most inclined; namely, the unjust oppression of the poor, unjust denunciation of their enemies, and mutiny and rebellion against lawful authority.

15. **The people were of opinion; i.e., they were expecting, wishing** (*προσδοκῶντος*) that Christ would come, and they thought perhaps that John was He.

16, 17. See on Matthew iii. 11, 12.

19, 20. See on Matthew xiv. 3, 4. St. Luke, in order to complete the history of the Baptist, here recounts his imprisonment, which in reality did not occur until much later.

21, 22. See on Matthew iii. 16, 17.

23. **And Jesus himself was beginning.** The meaning here is that our Lord, being about thirty years of age, began His public ministry. It was not lawful among the Jews for anyone to exercise the office of doctor or teacher before he was thirty years old. See also on Matthew iii. 17.



24. Who was of Levi, who was of Melchi, who was of Janne, who was of Joseph,
25. Who was of Mathathias, who was of Amos, who was of Nahum, who was of Hesli, who was of Nagge,
26. Who was of Mahath, who was of Mathathias, who was of Semei, who was of Joseph, who was of Juda,
27. Who was of Joanna, who was of Reza, who was of Zorobabel, who was of Salathiel, who was of Neri,
28. Who was of Melchi, who was of Addi, who was of Cosan, who was of Helmadan, who was of Her,
29. Who was of Jesus, who was of Eliezer, who was of Jorim, who was of Mathat, who was of Levi,
30. Who was of Simeon, who was of Judas, who was of Joseph, who was of Jona, who was of Eliakim,
31. Who was of Melea, who was of Menna, who was of Mathatha, who was of Nathan, who was of David,
32. Who was of Jesse, who was of Obed, who was of Booz, who was of Salmon, who was of Naasson,
33. Who was of Aminadab, who was of Aram, who was of Esron, who was of Phares, who was of Judas,
34. Who was of Jacob, who was of Isaac, who was of Abraham, who was of Thare, who was of Nachor,
35. Who was of Sarug, who was of Ragau, who was of Phaleg, who was of Heber, who was of Sale,
36. Who was of Cainan, who was of Arphaxad, who was of Sem, who was of Noe, who was of Lamech,
37. Who was of Mathusale, who was of Henoch, who was of Jared, who was of Malaleel, who was of Cainan,
38. Who was of Henos, who was of Seth, who was of Adam, who was of God.

24-38. St. Luke, writing for the Gentiles, wished to show that Christ came to save all men, and hence he traces the Saviour's human ancestry back to the father of the human race, to Adam; whereas St. Matthew, who wrote for the Jews, traces our Lord back to Abraham, the father of the Jewish race, from whose seed the Messiah was to spring. In giving their genealogies both St. Matthew and St. Luke followed records already existing; but the latter, unlike the former, scrupulously adhered to the record before him, without any omissions and without adding any of his own reflections. St. Luke has added from the Septuagint Cainan, not found in the Hebrew text. His genealogy comprises seventy-seven members, and the number of generations he establishes quite exactly corresponds with the number of years elapsed. In Salathiel and Zorobabel, as well as in Mathan or Mathat, he seems to co-

incide with St. Matthew, but aside from these two instances, St. Luke appears to be following independent documents. As to the discrepancies between the genealogies given by the two evangelists, see on Matthew i. 17.

## CHAPTER IV

THE FAST AND TEMPTATION OF JESUS, 1-13.

JESUS BEGINS TO TEACH AT NAZARETH, 14-30.

JESUS WORKS MIRACLES AT CAPHARNAUM, 31-44.

1. And Jesus being full of the Holy Ghost, returned from the Jordan, and was led by the Spirit into the desert,

2. For the space of forty days; and was tempted by the devil. And he ate nothing in those days; and when they were ended, he was hungry.

3. And the devil said to him: If thou be the Son of God, say to this stone that it be made bread.

4. And Jesus answered him: It is written, that Man liveth not by bread alone, but by every word of God.

5. And the devil led him into a high mountain, and shewed him all the kingdoms of the world in a moment of time;

6. And he said to him: To thee will I give all this power, and the glory of them; for to me they are delivered, and to whom I will, I give them.

7. If thou therefore wilt adore before me, all shall be thine.

8. And Jesus answering said to him: It is written: Thou shalt adore the Lord thy God, and him only shalt thou serve.

9. And he brought him to Jerusalem, and set him on a pinnacle of the temple, and he said to him: If thou be the Son of God, cast thyself from hence.

10. For it is written, that He hath given his angels charge over thee, that they keep thee.

11. And that in their hands they shall bear thee up, lest perhaps thou dash thy foot against a stone.

12. And Jesus answering, said to him: It is said: Thou shalt not tempt the Lord thy God.

13. And all the temptation being ended, the devil departed from him for a time.

14. And Jesus returned in the power of the spirit, into Galilee, and the fame of him went out through the whole country.

1-13. See on Matthew iv. 1-II.

14. **Jesus returned . . . into Galilee**; i.e., Jesus returned from the scenes of His baptism and temptations to the place in Galilee where He had been before going to the Jordan for John's baptism. This is the second return of our Lord to Galilee, after His fast and baptism; the first return is recorded by St. John (i. 43). St. Luke passes over many events in our Lord's life between His fast of forty

15. And he taught in their synagogues, and was magnified by all.

16. And he came to Nazareth, where he was brought up: and he went into the synagogue, according to his custom, on the sabbath day; and he rose up to read.

17. And the book of Isaias the prophet was delivered unto him. And as he unfolded the book, he found the place where it was written:

18. The Spirit of the Lord is upon me. Wherefore he hath anointed me to preach the gospel to the poor, he hath sent me to heal the contrite of heart,

19. To preach deliverance to the captives, and sight to the blind, to set at liberty them that are bruised, to preach the acceptable year of the Lord, and the day of reward.

days and this second visit to Galilee. These events recorded by St. John are: (a) the testimony borne to the Saviour by the Baptist when the latter addressed Him as the Lamb of God; (b) the marriage feast of Cana; (c) the call of Andrew, Phillip, and Peter; (d) the wonders performed at Capharnaum; (e) the going up to Jerusalem at the Pasch, etc. Cf. John i, ii, iii.

15. **Synagogues.** See on Matthew iv. 23.

16. **According to his custom,** etc. This may mean that it was customary for our Lord to enter the synagogue on the Sabbath to pray; or that, since the beginning of His public ministry, He was accustomed to preach to the people in the synagogues on the Sabbath day. It was customary for all the Jews to enter the synagogues on the Sabbath and festival days, for the purpose of praying, reading, and hearing the word of God, etc. Anyone supposed to be learned in the Law might be invited to speak, or expound some passage of the Scriptures.

17. **The book of Isaias . . . was delivered unto him,** by the minister of the synagogue (verse 20).

**And as he unfolded the book.** Books, in those days, consisted of sheets of parchment, folded about a roller, as maps are in our days.

18, 19. This passage of Isaias (xli. 1, 2) St. Luke quotes according to the Septuagint, which differs in some details from that of the Vulgate. The words of the prophet refer literally to the deliverance of the Jewish people from the Babylonian Captivity, but spiritually they signify Christ's mission as Deliverer of the Jews from the spiritual captivity of sin and ignorance. But in the quotation here we find a clause (*ἀποστείλαι τεθραυσμένους ἐν ἀφέσει*) which is neither in the Septuagint nor Hebrew text of Isaias lxi. This clause is found in Isaias lviii. 6. How, then, did our Lord read them out

20. And when he had folded the book, he restored it to the minister, and sat down. And the eyes of all in the synagogue were fixed on him.

21. And he began to say to them: This day is fulfilled this scripture in your ears.

22. And all gave testimony to him: and they wondered at the words of grace that proceeded from his mouth, and they said: Is not this the son of Joseph?

23. And he said to them: Doubtless you will say to me this similitude: Physician, heal thyself: as great things as we have heard done in Capharnaum, do also here in thy own country.

24. And he said: Amen I say to you, that no prophet is accepted in his own country.

25. In truth I say to you, there were many widows in the days of Elias in Israel, when heaven was shut up three years and six months, when there was a great famine throughout all the earth.

26. And to none of them was Elias sent, but to Sarepta of Sidon, to a widow woman.

27. And there were many lepers in Israel in the time of Eliseus the prophet: and none of them was cleansed but Naaman the Syrian.

of place? *Answer:* St. Luke, quoting from the Septuagint, most likely found the above clause as a marginal note in his copy and transferred it from ch. lviii to ch. lxi; or he might have combined the two passages because of their similarity.

The last words of verse 19 here, "and the day of reward," are wanting in the Greek text of St. Luke, but are found in *Isaias*.

20. **He sat down.** The Jews were accustomed to preach in a sitting posture.

21. **This day is fulfilled, etc.** By these words our Lord announced Himself to be the Messiah, the promised Liberator of God's people.

22. **All gave testimony to him,** — not precisely that He was the Messiah, but that He spoke with "power and authority" (*Matthew vii. 29*).

23. Our Lord in this verse forestalls the objections of the Nazarites. Two things they had against Him: (a) His humble origin and boyhood; (b) the fact that He had wrought so few wonders among them.

24-27. In these verses, Jesus gives the reason for His few miracles among His own townsmen; namely, their own unworthiness; and He cites the example of two illustrious ancient prophets, who like Himself, passed over their own people, because of their unworthiness, and worked miracles for Gentiles who were better disposed.

28. And all they in the synagogue, hearing these things, were filled with anger.

29. And they rose up and thrust him out of the city; and they brought him to the brow of the hill, whereon their city was built, that they might cast him down headlong.

30. But he passing through the midst of them, went his way.

31. And he went down into Capharnaum, a city of Galilee, and there he taught them on the sabbath days.

32. And they were astonished at his doctrine: for his speech was with power.

33. And in the synagogue there was a man who had an unclean devil, and he cried out with a loud voice,

34. Saying: Let us alone, what have we to do with thee, Jesus of Nazareth? art thou come to destroy us? I know thee who thou art, the holy one of God.

35. And Jesus rebuked him, saying: Hold thy peace, and go out of him. And when the devil had thrown him into the midst, he went out of him, and hurt him not at all.

36. And there came fear upon all, and they talked among themselves, saying: What word is this, for with authority and power he commandeth the unclean spirits, and they go out?

37. And the fame of him was published into every place of the country.

38. And Jesus rising up out of the synagogue, went into Simon's house. And Simon's wife's mother was taken with a great fever, and they besought him for her.

39. And standing over her, he commanded the fever, and it left her. And immediately rising, she ministered to them.

40. And when the sun was down, all they that had any sick with divers diseases, brought them to him. But he laying his hands on every one of them, healed them.

41. And devils went out from many, crying out and saying: Thou art the Son of God. And rebuking them he suffered them not to speak, for they knew that he was Christ.

42. And when it was day, going out he went into a desert place, and the multitudes sought him, and came unto him: and they stayed him that he should not depart from them.

28, 29. The Nazarites were incensed against our Lord for assigning their unworthiness as the reason for His few miracles among them.

30. But he passing through the midst, etc. Our Lord's hour had not yet come, and so His enemies were powerless to destroy Him.

31, 32. See on Matthew vii. 28, 29.

33-37. See on Mark i, 23-27.

38-40. See on Matthew viii. 14, 15.

41. See on Mark i. 34.

42. See on Mark i. 35.

43. To whom he said: To other cities also I must preach the kingdom of God: for therefore am I sent.

44. And he was preaching in the synagogues of Galilee.

43. See on Mark i. 38.

44. **Of Galilee.** The best MSS. have "of Judea." The preaching here spoken of perhaps embraced both Galilee and Judea.

## CHAPTER V

THE MIRACULOUS DRAUGHT OF FISHES, 1-11.

JESUS HEALS A LEPER, 12-16.

JESUS HEALS THE PARALYTIC, 17-26.

THE CALL OF LEVI, 27-32.

FASTING, 33-39.

1. And it came to pass, that when the multitudes pressed upon him to hear the word of God, he stood by the lake of Genesareth,

2. And saw two ships standing by the lake: but the fishermen were gone out of them, and were washing their nets.

3. And going into one of the ships that was Simon's, he desired him to draw back a little from the land. And sitting he taught the multitudes out of the ship.

4. Now when he had ceased to speak, he said to Simon: Launch out into the deep, and let down your nets for a draught.

5. And Simon answering said to him: Master, we have laboured all the night, and have taken nothing: but at thy word I will let down the net.

6. And when they had done this, they enclosed a very great multitude of fishes, and their net broke.

7. And they beckoned to their partners that were in the other ship, that they should come and help them. And they came, and filled both the ships, so that they were almost sinking.

1. **Genesareth.** The Lake of Genesareth, called by Matthew and Mark the Sea of Galilee, and by John, the Sea of Tiberias, is situated in the central part of Galilee, which, in the time of our Lord, was the most flourishing region of Palestine. Along its shores, in the time of Christ, there were at least nine populous and flourishing cities. The lake is about thirteen miles long, seven miles wide at its widest point, and about one hundred and sixty feet deep at its greatest depth.

5. **Master;** i.e., *teacher* (*ἐπιστάτα*). St. Luke alone uses this term; the other Evangelists speak of our Lord by the Hebrew title "Rabbi."

8. Which when Simon Peter saw, he fell down at Jesus' knees, saying: Depart from me, for I am a sinful man, O Lord.

9. For he was wholly astonished, and all that were with him, at the draught of the fishes which they had taken.

10. And so were also James and John the sons of Zebedee, who were Simon's partners. And Jesus saith to Simon: Fear not: from henceforth thou shalt catch men.

11. And having brought their ships to land, leaving all things, they followed him.

12. And it came to pass, when he was in a certain city, behold a man full of leprosy, who seeing Jesus, and falling on his face, besought him, saying: Lord, if thou wilt, thou canst make me clean.

13. And stretching forth his hand, he touched him, saying: I will. Be thou cleansed. And immediately the leprosy departed from him.

14. And he charged him that he should tell no man, but, Go, shew thyself to the priest, and offer for thy cleansing according as Moses commanded, for a testimony to them.

15. But the fame of him went abroad the more, and great multitudes came together to hear, and to be healed by him of their infirmities.

16. And he retired into the desert, and prayed.

8. Depart from me . . . O Lord. Peter recognized that our Lord was indeed a divine Person; and hence, out of reverence for Him, and from a sense of his own unworthiness, he uttered the foregoing words.

The account here given by St. Luke in verses 1-11, although differing in minor details, is the same as that of Matthew (iv. 18-22), in which a more summary account of the call of the first Apostles is given. St. Luke here recounts the full and final call to the Apostleship of Peter, Andrew, James and John.

It is to be noted that St. Thomas, Maldonatus, and others distinguish this call of the Apostles from that given in Matthew iv. 18; Mark i. 16.

12-14. See on Matthew viii. 2-4. Leprosy was a disease contracted by the Jews in Egypt in the land of Gessen. The Law of Moses required the leper to live apart from other people, until his disease reached a stage when it was no longer contagious. Hence the lepers lived outside the cities in desert places. At the worst period of leprosy the body swells up, the nails and flesh fall off the feet and hands, the vital juices of the body change in essence, and escape from the eyes, nose and mouth, and the voice becomes shrill and harsh. Should the unfortunate victim survive this crisis his disease is no longer contagious and he may again communicate with others (Le Camus, *Life of Christ*, vol. i. p. 378).

17. And it came to pass on a certain day, as he sat teaching, that there were also Pharisees and doctors of the law sitting by, that were come out of every town of Galilee, and Judea and Jerusalem: and the power of the Lord was to heal them.

18. And behold, men brought in a bed a man, who had the palsy: and they sought means to bring him in, and to lay him before him.

19. And when they could not find by what way they might bring him in, because of the multitude, they went up upon the roof, and let him down through the tiles with his bed into the midst before Jesus.

20. Whose faith when he saw, he said: Man, thy sins are forgiven thee.

21. And the scribes and Pharisees began to think, saying: Who is this who speaketh blasphemies? Who can forgive sins, but God alone?

22. And when Jesus knew their thoughts, answering, he said to them: What is it you think in your hearts?

23. Which is easier to say, Thy sins are forgiven thee; or to say, Arise and walk?

24. But that you may know that the Son of man hath power on earth to forgive sins, (he saith to the sick of the palsy,) I say to thee, Arise, take up thy bed, and go into thy house.

25. And immediately rising up before them, he took up the bed on which he lay; and he went away to his own house, glorifying God.

26. And all were astonished; and they glorified God. And they were filled with fear, saying: We have seen wonderful things to-day.

27. And after these things he went forth, and saw a publican named Levi, sitting at the receipt of custom, and he said to him: Follow me.

28. And leaving all things, he rose up and followed him.

29. And Levi made him a great feast in his own house; and there was a great company of publicans, and of others, that were at table with them.

30. But the Pharisees and scribes murmured, saying to his disciples: Why do you eat and drink with publicans and sinners?

31. And Jesus answering, said to them: They that are whole, need not the physician: but they that are sick.

32. I came not to call the just, but sinners to penance.

33. And they said to him: Why do the disciples of John fast often, and make prayers, and the disciples of the Pharisees in like manner; but thine eat and drink?

34. To whom he said: Can you make the children of the bridegroom fast, whilst the bridegroom is with them?

35. But the days will come, when the bridegroom shall be taken away from them, then shall they fast in those days.

36. And he spoke also a similitude to them: That no man putteth a piece from a new garment upon an old garment; otherwise he both rendeth the new, and the piece taken from the new agreeth not with the old.

37. And no man putteth new wine into old bottles: otherwise the new wine will break the bottles, and it will be spilled, and the bottles will be lost.

38. But new wine must be put into new bottles; and both are preserved.

39. And no man drinking old, hath presently a mind to new: for he saith, The old is better.

17. To heal them; i.e., to heal those who sought His help.

18-39. See on Matthew ix. 2-17. Here in Luke, verse 33, the



Scribes and Pharisees are said to speak, in Mark ii. 18, both the Pharisees and John's disciples ask the question, and in Matthew ix. 14 only the disciples of John speak. This is another instance of difference in details among the sacred writers which theories of inspiration should not overlook.

## CHAPTER VI

THE EARS OF CORN, AND THE SABBATH, 1-5.

THE MAN WITH THE WITHERED HAND, 6-11.

THE CHOOSING OF THE TWELVE APOSTLES, 12-16.

THE SERMON ON THE MOUNT, 17-49.

1. And it came to pass on the second first sabbath, that as he went through the corn fields, his disciples plucked the ears, and did eat, rubbing them in their hands.

2. And some of the Pharisees said to them: Why do you that which is not lawful on the sabbath days?

3. And Jesus answering them, said: Have you not read so much as this, what David did, when himself was hungry, and they that were with him:

4. How he went into the house of God, and took and ate the bread of proposition, and gave to them that were with him, which is not lawful to eat but only for the priests?

5. And he said to them: The Son of man is Lord also of the sabbath.

1, 2. **The second first sabbath.** It is difficult to explain the meaning of the term "second-first," which is found only in this place, and which is wanting in some of the best MSS. According to the Paschal Chronicle, the day referred to was the first of the seven Sabbaths, reckoned from the second day of the Paschal week (16th of Nisan) to Pentecost. Some think that the Jews had a civil and ecclesiastical year, and that the first Sabbath of the civil year was called "first-first," while the first of the ecclesiastical year was called "second-first." At any rate, the day here spoken of must have been some Sabbath in the spring or early summer, shortly after the Passover, because the new fruits would not have been due before the early part of April. See on Matthew xii. 1.

3, 4. See on Matthew xii. 3, 4.

5. See on Matthew xii. 8.

6. And it came to pass also on another sabbath, that he entered into the synagogue, and taught. And there was a man, whose right hand was withered.

7. And the scribes and Pharisees watched if he would heal on the sabbath; that they might find an accusation against him.

8. But he knew their thoughts; and said to the man who had the withered hand: Arise, and stand forth in the midst. And rising he stood forth.

9. Then Jesus said to them: I ask you, if it be lawful on the sabbath days to do good, or to do evil; to save life, or to destroy?

10. And looking round about on them all, he said to the man: Stretch forth thy hand. And he stretched it forth: and his hand was restored.

11. And they were filled with madness; and they talked one with another, what they might do to Jesus.

12. And it came to pass in those days, that he went out into a mountain to pray, and he passed the whole night in the prayer of God.

13. And when day was come, he called unto him his disciples; and he chose twelve of them (whom also he named apostles):

14. Simon, whom he surnamed Peter, and Andrew his brother, James and John, Philip and Bartholomew,

15. Matthew and Thomas, James the son of Alpheus, and Simon who is called Zelotes,

16. And Jude, the brother of James, and Judas Iscariot, who was the traitor.

17. And coming down with them, he stood in a plain place, and the company of his disciples, and a very great multitude of people from all Judea and Jerusalem, and the sea coast both of Tyre and Sidon,

18. Who were come to hear him, and to be healed of their diseases. And they that were troubled with unclean spirits, were cured.

19. And all the multitude sought to touch him, for virtue went out from him, and healed all.

6-II. See on Matthew xii. 9-14.

12. See on Matthew v. 1.

13-16. See on Matthew x. 1-3. In St. John (xxi. 1, 2) we find Nathanael mentioned among the Apostles and distinguished from the disciples; but in the lists of the Apostles given by the Synoptists and in the Acts his name does not occur. How is this? *Answer:* St. John in his Gospel makes no mention of Bartholomew, while the Synoptists, on the contrary, do not speak of Nathanael; hence it is concluded that Nathanael and Bartholomew are the same person, the first being his proper, the latter his patronymic name.

17-19. And coming down . . . he stood in a plain place. The place here mentioned was likely some slope or partly level place on the mountain side, because what follows here (verses 20-49) is most probably substantially the same as St. Matthew's Sermon on the Mount (Matthew v, vi, vii). The two accounts differ in many details,

20. And he, lifting up his eyes on his disciples, said: Blessed are ye poor, for yours is the kingdom of God.

21. Blessed are ye that hunger now: for you shall be filled. Blessed are ye that weep now: for you shall laugh.

22. Blessed shall you be when men shall hate you, and when they shall separate you, and shall reproach you, and cast out your name as evil, for the Son of man's sake.

23. Be glad in that day and rejoice; for behold, your reward is great in heaven. For according to these things did their fathers to the prophets.

24. But woe to you that are rich: for you have your consolation.

25. Woe to you that are filled: for you shall hunger. Woe to you that now laugh: for you shall mourn and weep.

26. Woe to you when men shall bless you: for according to these things did their fathers to the false prophets.

27. But I say to you that hear: Love your enemies, do good to them that hate you.

28. Bless them that curse you, and pray for them that calumniate you.

29. And to him that striketh thee on the one cheek, offer also the other. And him that taketh away from thee thy cloak, forbid not to take thy coat also.

30. Give to every one that asketh thee, and of him that taketh away thy goods, ask them not again.

31. And as you would that men should do to you, do you also to them in like manner.

32. And if you love them that love you, what thanks are to you? for sinners also love those that love them.

33. And if you do good to them who do good to you, what thanks are to you? for sinners also do this.

34. And if you lend to them of whom you hope to receive, what thanks are to you? for sinners also lend to sinners, for to receive as much.

35. But love ye your enemies: do good, and lend, hoping for nothing thereby: and your reward shall be great, and you shall be the sons of the Highest; for he is kind to the unthankful, and to the evil.

but substantially they are one. The fact that St. Matthew makes his Sermon on the Mount precede the calling of the Apostles, is explained by the fact that he was not following the chronological order.

20. See on Matthew v. 3.

21. See on Matthew v. 5, 6.

22, 23. See on Matthew v. 11, 12.

24-26. St. Luke gives only four of the eight Beatitudes, but he recounts four maledictions uttered by the Saviour, parallel with the four benedictions.

27, 28. See on Matthew v. 44.

29, 30. See on Matthew v. 39, 40.

32-34. See on Matthew v. 46, 47.

35. See on Matthew v. 43, 44.

36. Be ye therefore merciful, as your Father also is merciful.

37. Judge not, and you shall not be judged. Condemn not, and you shall not be condemned. Forgive, and you shall be forgiven.

38. Give, and it shall be given to you: good measure and pressed down and shaken together and running over shall they give into your bosom. For with the same measure that you shall mete withal, it shall be measured to you again.

39. And he spoke also to them a similitude: Can the blind lead the blind? do they not both fall into the ditch?

40. The disciple is not above his master: but every one shall be perfect, if he be as his master.

41. And why seest thou the mote in thy brother's eye: but the beam that is in thy own eye thou considerest not?

42. Or how canst thou say to thy brother: Brother, let me pull the mote out of thy eye, when thou thyself seest not the beam in thy own eye? Hypocrite, cast first the beam out of thy own eye; and then shalt thou see clearly to take out the mote from thy brother's eye.

43. For there is no good tree that bringeth forth evil fruit; nor an evil tree that bringeth forth good fruit.

44. For every tree is known by its fruit. For men do not gather figs from thorns; nor from a bramble bush do they gather the grape.

45. A good man out of the good treasure of his heart bringeth forth that which is good: and an evil man out of the evil treasure bringeth forth that which is evil. For out of the abundance of the heart the mouth speaketh.

46. And why call you me, Lord, Lord; and do not the things which I say?

47. Every one that cometh to me, and heareth my words, and doth them, I will shew you to whom he is like.

48. He is like to a man building a house, who digged deep, and laid the foundation upon a rock. And when a flood came, the stream beat vehemently upon that house, and it could not shake it; for it was founded on a rock.

49. But he that heareth, and doth not, is like to a man building his house upon the earth without a foundation: against which the stream beat vehemently, and immediately it fell, and the ruin of that house was great.

36. See on Matthew v. 48.

37, 38. See on Matthew vii. 1, 2.

39. See on Matthew xv. 14.

40. See on Matthew x. 24, 25.

41, 42. See on Matthew vii. 3-5.

43-45. See on Matthew vii. 17-20.

46-49. See on Matthew vii. 21-27.

## CHAPTER VII

JESUS HEALS THE CENTURION'S SERVANT, 1-10.

JESUS RESTORES TO LIFE THE SON OF THE WIDOW OF  
NAIM, 11-17.

JOHN SENDS HIS DISCIPLES TO JESUS, 18-35.

THE SINFUL WOMAN AT THE FEET OF JESUS, 36-50.

1. And when he had finished all his words in the hearing of the people, he entered into Capharnaum.

2. And the servant of a certain centurion, who was dear to him, being sick, was ready to die.

3. And when he had heard of Jesus, he sent unto him the ancients of the Jews, desiring him to come and heal his servant.

4. And when they came to Jesus, they besought him earnestly, saying to him: He is worthy that thou shouldest do this for him.

5. For he loveth our nation; and he hath built us a synagogue.

6. And Jesus went with them. And when he was now not far from the house, the centurion sent his friends to him, saying: Lord, trouble not thyself; for I am not worthy that thou shouldest enter under my roof.

7. For which cause neither did I think myself worthy to come to thee; but say the word, and my servant shall be healed.

8. For I also am a man subject to authority, having under me soldiers: and I say to one, Go, and he goeth; and to another, Come, and he cometh; and to my servant, Do this, and he doth it.

9. Which Jesus hearing, marvelled: and turning about to the multitude that followed him, he said: Amen I say to you, I have not found so great faith, not even in Israel.

10. And they who were sent, being returned to the house, found the servant whole who had been sick.

11. And it came to pass afterwards, that he went into a city that is called Naim; and there went with him his disciples, and a great multitude.

1-5. See on Matthew viii. 5, 6.

6-9. See on Matthew viii. 8-10.

10. See on Matthew viii. 13.

11. **And it came to pass afterwards.** It is commonly held that the word "afterwards" here refers to the day following the cure of the Centurion's servant, although it may refer to a much longer period.

**Naim** signifies "pasture." It was a small city lying at the foot of the Lesser Hermon, about twenty-five miles southwest of Capharnaum, and two miles north of Mt. Tabor.

12. And when he came nigh to the gate of the city, behold a dead man was carried out, the only son of his mother; and she was a widow: and a great multitude of the city was with her.

13. Whom when the Lord had seen, being moved with mercy towards her, he said to her: Weep not.

14. And he came near and touched the bier. And they that carried it, stood still. And he said: Young man, I say to thee, arise.

15. And he that was dead, sat up, and began to speak. And he gave him to his mother.

16. And there came a fear on them all: and they glorified God, saying: A great prophet is risen up among us: and, God hath visited his people.

17. And this rumour of him went forth throughout all Judea, and throughout all the country round about.

18. And John's disciples told him of all these things.

19. And John called to him two of his disciples, and sent them to Jesus, saying: Art thou he that art to come; or look we for another?

20. And when the men were come unto him, they said: John the Baptist hath sent us to thee, saying: Art thou he that art to come; or look we for another?

21. (And in that same hour, he cured many of their diseases, and hurts, and evil spirits: and to many that were blind he gave sight.)

12. **To the gate of the city.** The funeral procession was passing out of the city because the Jews always buried their dead outside the cities, as a rule in tombs hewn in the rocky hillsides.

**A great multitude of the city.** This miracle was performed by our Lord in the presence of a multitude, who had accompanied Him and His disciples, and in the presence of a multitude that followed the dead man.

14. **Came near and touched the bier.** The bodies of the dead were not enclosed in coffins, as with us, but were wrapped in linen cloths and carried on open biers.

16. **A great prophet is risen among us.** The sight of this miracle recalled to the minds of the multitude the works of the ancient prophets, Elias and Eliseus, who also had raised the dead to life; it is not probable, however, that they recognized in our Lord anything more than a great prophet, like those just mentioned. There are three cases recorded in the Gospels in which Christ raised the dead to life: (a) the widow's son, here mentioned; (b) the daughter of Jairus (viii. 49-56); (c) Lazarus (John xi. 1-45).

18-20. See on Matthew xi. 2.

22. And answering, he said to them: Go and relate to John what you have heard and seen: the blind see, the lame walk, the lepers are made clean, the deaf hear, the dead rise again, to the poor the gospel is preached:

23. And blessed is he whosoever shall not be scandalized in me.

24. And when the messengers of John were departed, he began to speak to the multitudes concerning John. What went ye out into the desert to see? a reed shaken with the wind?

25. But what went you out to see? a man clothed in soft garments? Behold they that are in costly apparel and live delicately, are in the houses of kings.

26. But what went you out to see? a prophet? Yea, I say to you, and more than a prophet.

27. This is he of whom it is written: Behold I send my angel before thy face, who shall prepare thy way before thee.

28. For I say to you: Amongst those that are born of women, there is not a greater prophet than John the Baptist. But he that is the lesser in the kingdom of God, is greater than he.

29. And all the people hearing, and the publicans, justified God, being baptized with John's baptism.

30. But the Pharisees and the lawyers despised the counsel of God against themselves, being not baptized by him.

31. And the Lord said: Whereunto then shall I liken the men of this generation? and to what are they like?

32. They are like to children sitting in the marketplace, and speaking one to another, and saying: We have piped to you, and you have not danced: we have mourned, and you have not wept.

33. For John the Baptist came neither eating bread nor drinking wine; and you say: He hath a devil.

34. The Son of man is come eating and drinking: and you say: Behold a man that is a glutton and a drinker of wine, a friend of publicans and sinners.

35. And wisdom is justified by all her children.

36. And one of the Pharisees desired him to eat with him. And he went into the house of the Pharisee, and sat down to meat.

22-28. See on Matthew xi. 4-11.

29, 30. These verses show the difference between the sincerity of the people and the simple publicans, who, yielding to God's Providence in their regard, acknowledged their sins by receiving John's baptism; and the hypocrisy of the Pharisees and lawyers, on the other hand, who spurned the counsel of God in their behalf, and refused to acknowledge their sinfulness and receive John's baptism. Commentators generally understand these two verses to be a part of our Lord's discourse.

31-35. See on Matthew xi. 16-19. The words, "And the Lord said" (verse 31) are not in the best MSS.

36. And one of the Pharisees, whose name was "Simon" (verse 40). It is very probable that this Simon is the same as

37. And behold a woman that was in the city, a sinner, when she knew that he sat at meat in the Pharisee's house, brought an alabaster box of ointment;

"Simon the Leper" mentioned by Matthew (xxvi. 6), although the present occurrence seems to have taken place at Naim, in Galilee, two years before that mentioned by Matthew, which occurred at Bethany, on the eve of the Passion. If this be true, Simon must meanwhile have moved from Galilee to Judea. Some authorities (Le Camus, *Life of Christ*, vol. ii. p. 32) think that the reasons given to prove that the present incident took place at Naim or Capharnaum are not good. This verse of St. Luke, it is maintained, is only a fragment, having no connection with what precedes or follows.

37. **A woman that was in the city, a sinner; i.e., a woman who was a sinner in the city.**

**An alabaster box of ointment**, which was a small phial containing precious ointment, used to anoint the head and feet of guests. Whether the anointing here recounted is the same as that mentioned by the other three Evangelists (Matthew xxvi. 7; Mark xiv. 3; John xii. 3), and whether, consequently, the woman "who was a sinner," and Mary, the sister of Lazarus, were one and the same person, has been disputed from the earliest times. Some hold that the anointing mentioned by St. Luke, since it occurred in Galilee, two years before our Lord's Passion, is not the same as that recorded by the other Evangelists, which was in Bethany, on the eve of the Passion. Others say that the anointing took place but once, hence St. Luke's account must be the same as that of the other Evangelists. This, however, seems very improbable. To identify the account of St. Luke with that of the other Evangelists is to overlook those differences of time, place, and persons which make it next to impossible to consider the two anointings as one. There are chiefly the following differences: (a) St. Luke's account is in Galilee in the second year of the Messianic ministry, whereas the account of the other Evangelists is at Bethany in Judea, only six days before the last Pasch; (b) in St. Luke's account the woman is supposed to be a stranger; but in the other instance she appears as well known as if in her own home; (c) in the former account our Lord grants a solemn pardon to a repentant sinner, in the latter He praises a friend and announces His own death. At any rate,



38. And standing behind at his feet, she began to wash his feet, with tears, and wiped them with the hairs of her head, and kissed his feet, and anointed them with the ointment.

whether there was one or two anointings, the general teaching of the Latin Church has always been that these services for our Lord were performed by one and the same person, and that consequently, Mary Magdalen, Mary, the sister of Lazarus, and the sinner here mentioned were one and the same person.

This is further proved as follows: (a) St. Luke in the present chapter (verses 36-50) narrates the conversion of a sinner who devotes herself entirely to the Saviour; and in the following chapter (viii) he speaks of certain women who were devoutly ministering to our Lord, and he names in the first place Mary Magdalen "out of whom seven devils were gone forth" (verse 2). Now this seems plainly to identify Mary Magdalen and the sinner. (b) St. John (xi. 2) speaks of Mary, the sister of Lazarus, as the one who had anointed our Lord and wiped His feet with her hair, and since this anointing cannot be understood as referring to any other than that mentioned by St. Luke (vii. 36-50), it follows that Mary the sister of Lazarus and the sinner were the same person. (c) In Mary, the sister of Lazarus, in Mary Magdalen, and in the sinner, we find the same identical characteristics—the same intense love for and fervent desire to be with the Saviour; and hence we must naturally conclude that the three names belong to the self-same person. Cf. Matt. xxvi. 7; Mark xiv. 3; Luke vii. 47; x. 38-42; John xi. 32, 33; xii. 2, 3.

It is idle to object here that our Lord could not have admitted one who had been a great sinner to His close friendship; Christ came to save sinners. Neither is there any difficulty in the fact that Mary of Bethany should have been called the Magdalen, since she might have lived for a time, or had possessions at Magdala.

38. **And standing behind at his feet.** The guests at the table were reclining, in accordance with the custom first introduced from the Persians. They rested on their left arm, their unsandalled feet being concealed behind the triclinium.

**She began to wash his feet, etc.** These services were not unusual, although the anointing of the head was more common than the anointing of the feet. The anointing was the expression of

39. And the Pharisee, who had invited him, seeing it, spoke within himself, saying: This man, if he were a prophet, would know surely who and what manner of woman this is that toucheth him, that she is a sinner.

40. And Jesus answering, said to him: Simon, I have somewhat to say to thee. But he said: Master, say it.

41. A certain creditor had two debtors, the one owed five hundred pence, and the other fifty.

42. And whereas they had not wherewith to pay, he forgave them both. Which therefore of the two loveth him most?

43. Simon answering, said: I suppose that he to whom he forgave most. And he said to him: Thou hast judged rightly.

44. And turning to the woman, he said unto Simon: Dost thou see this woman? I entered into thy house, thou gavest me no water for my feet; but she with tears hath washed my feet, and with her hairs hath wiped them.

45. Thou gavest me no kiss; but she, since she came in, hath not ceased to kiss my feet.

46. My head with oil thou didst not anoint; but she with ointment hath anointed my feet.

welcome and homage, proceeding from the deepest and truest feelings of the human heart.

39. **If he were a prophet, etc.** Simon thought that if our Lord were truly a prophet, He would possess the gifts of a prophet, one of which was to know hidden things. But in thus reasoning, Simon seriously erred: (a) because it was by no means essential to a prophet's gifts that he should know hidden things, except in so far as it might please God to enlighten him; (b) because he erroneously thought that to come in external contact with a sinner could defile a soul; (c) because he mistook the purpose of Christ's mission, which was not to keep aloof from sinners, but to draw near them, in order to save them.

40. **And Jesus answering, said, etc.** Our Lord now showed the Pharisee that He did possess the gift of knowing hidden things, since He made known the Pharisee's secret thoughts.

41. **The one owed five hundred pence, the other fifty.** The penny, or denarius, was equal to about 17 cents in our money. The different quantities of money are here mentioned to show the difference in indebtedness in which two debtors stood to a common creditor.

43. **Thou hast judged rightly,** and by so doing the Pharisee condemned his own previous rash and false judgment.

44-46. In these verses our Lord showed the Pharisee that he had denied Him courtesies and acts of respect which were altogether

47. Wherefore I say to thee: Many sins are forgiven her, because she hath loved much. But to whom less is forgiven, he loveth less.

48. And he said to her: Thy sins are forgiven thee.

49. And they that sat at meat with him began to say within themselves: Who is this that forgiveth sins also?

50. And he said to the woman: Thy faith hath made thee safe, go in peace.

according to custom; he had not given Him water for His feet (Gen. xviii. 4; Judg. xix. 21); he had not offered Him the kiss of peace (Gen. xli. 29; Exod. xviii. 7); neither had he anointed the head of his guest, as was the custom at festivals (Ps. xxii. 5; cxi. 5); whereas this woman had lavishly rendered these courtesies, and even more.

47. **Many sins are forgiven her**, etc.; i.e., *have been forgiven* her (*ἀφέωνται*), because she hath loved much. The perfect charity of Mary, founded on faith in the power and goodness of our Lord, which prompted her to come to Him and perform towards Him those several acts of courtesy and love, had already obtained for her the remission of her sins. It was her longing for God, her earnest desire for forgiveness, and her hatred of her sins, which constituted that love which the Saviour here assigns as the *cause*, or at least *the necessary condition*, of the pardon which Mary had obtained, before she had begun to anoint our Lord.

It is doing violence to the text and to the ordinary meaning of the Greek connective (*ὅτι*), to maintain, as some do, that the love of Mary here spoken of was the consequence, and not the cause or condition, of the forgiveness granted to her by our Lord. Without doubt, Mary's love, in gratitude for her forgiveness, was far greater than that of the proud Pharisee, who had little sense of his own condition; but in her case, the Saviour speaks only of the love which preceded her pardon; whereas in the case of the Pharisee He alludes exclusively, in the present verse, to the love which follows forgiveness, "but to whom less is forgiven, he loveth less."

48. **Thy sins are forgiven thee**; i.e., *have been forgiven thee*, as just explained (verse 47).

50. **Thy faith hath made thee safe**, etc. Faith is a necessary condition for charity or love of God, hence it was Mary's lively faith which was the foundation, or fundamental cause or condition, of the charity she had and of the forgiveness she obtained.

## CHAPTER VIII

JESUS IN GALILEE IS MINISTERED TO BY HOLY  
WOMEN, 1-3.

THE PARABLE OF THE SOWER, 4-18.

THE MOTHER AND RELATIVES OF JESUS, 19-21.

JESUS STILLS THE STORM AT SEA, 22-25.

THE GERASENE DEMONIAK, 26-39.

JESUS RAISES TO LIFE THE DAUGHTER OF JAIRUS,  
40-56.

1. And it came to pass afterwards, that he travelled through the cities and towns, preaching and evangelizing the kingdom of God; and the twelve with him:

2. And certain women who had been healed of evil spirits and infirmities; Mary who is called Magdalen, out of whom seven devils were gone forth,

3. And Joanna the wife of Chusa, Herod's steward, and Susanna, and many others who ministered unto him of their substance.

1. **Afterwards.** The time was perhaps towards the end of the second year of our Lord's public ministry. He is still in Galilee.

**And the twelve;** i.e., the Apostles whom He had chosen (vi. 13), and whom He was now instructing in the important work of the ministry.

2. **Mary, who is called Magdalen.** She was called Magdalen from the city in which she lived, which was Magdala, a town on the western coast of the Sea of Galilee. It is most probable that this Mary was the same as the sinful woman spoken of in the last chapter, who was also the sister of Lazarus. She was perhaps living at Magdala in Galilee, when our Lord began His public ministry, and having been converted by Him, she followed Him from Galilee to Judea, to Bethany, which some say was her native place, and which was the home of Martha and Lazarus.

3. **Joanna . . . Susanna . . . and many others, etc.** It was customary among the Jews for ministering women thus to follow and assist great teachers. Cf. 1 Cor. ix. 5.

4. And when a very great multitude was gathered together, and hastened out of the cities unto him, he spoke by a similitude.

5. The sower went out to sow his seed. And as he sowed, some fell by the way side, and it was trodden down, and the fowls of the air devoured it.

6. And other some fell upon a rock: and as soon as it was sprung up, it withered away, because it had no moisture.

7. And other some fell among thorns, and the thorns growing up with it, choked it.

8. And other some fell upon good ground; and being sprung up, yielded fruit a hundredfold. Saying these things, he cried out: He that hath ears to hear, let him hear.

9. And his disciples asked him what this parable might be.

10. To whom he said: To you it is given to know the mystery of the kingdom of God; but to the rest in parables, that seeing they may not see, and hearing may not understand.

11. Now the parable is this: The seed is the word of God.

12. And they by the way side are they that hear; then the devil cometh, and taketh the word out of their heart, lest believing they should be saved.

13. Now they upon the rock, are they who when they hear, receive the word with joy: and these have no roots; for they believe for a while, and in time of temptation, they fall away.

14. And that which fell among thorns, are they who have heard, and going their way, are choked with the cares and riches and pleasures of this life, and yield no fruit.

15. But that on the good ground, are they who in a good and perfect heart, hearing the word, keep it, and bring forth fruit in patience.

16. Now no man lighting a candle covereth it with a vessel, or putteth it under a bed; but setteth it upon a candlestick, that they who come in may see the light.

17. For there is not any thing secret that shall not be made manifest, nor hidden, that shall not be known and come abroad.

18. Take heed therefore how you hear. For whosoever hath, to him shall be given: and whosoever hath not, that also which he thinketh he hath, shall be taken away from him.

19. And his mother and brethren came unto him; and they could not come at him for the crowd.

20. And it was told him: Thy mother and thy brethren stand without, desiring to see thee.

21. Who answering, said to them: My mother and my brethren are they who hear the word of God, and do it.

4-10. See on Matthew xiii. 3-13.

11-15. See on Matthew xiii. 19-23.

16. See on Matthew v. 15; Mark iv. 21.

17. See on Mark iv. 21, 22.

18. See on Matthew xiii. 12; xxv. 29.

19-21. See on Matthew xii. 46-50.

22. And it came to pass on a certain day that he went into a little ship with his disciples, and he said to them: Let us go over to the other side of the lake. And they launched forth.

23. And when they were sailing, he slept; and there came down a storm of wind upon the lake, and they were filled, and were in danger.

24. And they came and awaked him, saying: Master, we perish. But he arising, rebuked the wind and the rage of the water; and it ceased, and there was a calm.

25. And he said to them: Where is your faith? Who being afraid, wondered, saying one to another: Who is this, (think you), that he commandeth both the winds and the sea, and they obey him?

26. And they sailed to the country of the Gerasens, which is over against Galilee.

27. And when he was come forth to the land, there met him a certain man who had a devil now a very long time, and he wore no clothes, neither did he abide in a house, but in the sepulchres.

28. And when he saw Jesus, he fell down before him; and crying out with a loud voice, he said: What have I to do with thee, Jesus, Son of the most high God? I beseech thee, do not torment me.

29. For he commanded the unclean spirit to go out of the man. For many times it seized him, and he was bound with chains, and kept in fetters; and breaking the bonds, he was driven by the devil into the deserts.

30. And Jesus asked him, saying: What is thy name? But he said: Legion; because many devils were entered into him.

31. And they besought him that he would not command them to go into the abyss.

32. And there was there a herd of many swine feeding on the mountain; and they besought him that he would suffer them to enter into them. And he suffered them.

33. The devils therefore went out of the man, and entered into the swine; and the herd ran violently down a steep place into the lake, and were stifled.

34. Which when they that fed them saw done, they fled away, and told it in the city and in the villages.

35. And they went out to see what was done; and they came to Jesus, and found the man, out of whom the devils were departed, sitting at his feet, clothed, and in his right mind; and they were afraid.

36. And they also that had seen, told them how he had been healed from the legion.

37. And all the multitude of the country of the Gerasens besought him to depart from them; for they were taken with great fear. And he, going up into the ship, returned back again.

22. See on Matthew viii. 18.

23-25. See on Matthew viii. 23-26.

27-37. See on Matthew viii. 28-34. From the stories of St. Luke and St. Mark regarding this demoniac it seems that the demoniac did not first recognize Jesus; it was Jesus who first saw and recognized the demoniac. Jesus had commanded the demon to leave the

38. Now the man, out of whom the devils were departed, besought him that he might be with him. But Jesus sent him away, saying :

39. Return to thy house, and tell how great things God hath done to thee. And he went through the whole city, publishing how great things Jesus had done to him.

40. And it came to pass, that when Jesus was returned, the multitude received him : for they were all waiting for him.

41. And behold there came a man whose name was Jairus, and he was a ruler of the synagogue : and he fell down at the feet of Jesus, beseeching him that he would come into his house :

42. For he had an only daughter, almost twelve years old, and she was dying. And it happened as he went, that he was thronged by the multitudes.

43. And there was a certain woman having an issue of blood twelve years, who had bestowed all her substance on physicians, and could not be healed by any.

44. She came behind him, and touched the hem of his garment ; and immediately the issue of her blood stopped.

45. And Jesus said : Who is it that touched me ? And all denying, Peter and they that were with him said : Master, the multitudes throng and press thee, and dost thou say, Who touched me ?

46. And Jesus said : Somebody hath touched me ; for I know that virtue is gone out from me.

47. And the woman seeing that she was not hid, came trembling, and fell down before his feet, and declared before all the people for what cause she had touched him, and how she was immediately healed.

48. But he said to her : Daughter, thy faith hath made thee whole ; go thy way in peace.

49. As he was yet speaking, there cometh one to the ruler of the synagogue, saying to him : Thy daughter is dead, trouble him not.

50. And Jesus hearing this word, answered the father of the maid : Fear not ; believe only, and she shall be safe.

51. And when he was come to the house, he suffered not any man to go in with him, but Peter and James and John, and the father and mother of the maiden.

52. And all wept and mourned for her. But he said : Weep not ; the maid is not dead, but sleepeth.

53. And they laughed him to scorn, knowing that she was dead.

54. But he taking her by the hand, cried out, saying : Maid, arise.

55. And her spirit returned, and she arose immediately. And he bid them give her to eat.

56. And her parents were astonished, whom he charged to tell no man what was done.

man, and this is why the demoniac came and spoke to Him as recorded by St. Luke here in verse 29.

38, 39. See on Mark v. 18, 19.

41-55. See on Matthew ix. 18-25.

## CHAPTER IX

THE MISSION OF THE APOSTLES, 1-9.

THE RETURN OF THE APOSTLES, 10, 11.

THE FIRST MULTIPLICATION OF THE LOAVES, 12-17.

THE CONFESSION OF PETER AND THE FIRST PREDICTION OF THE PASSION, 18-22.

CHRISTIAN ABNEGATION, 23-27.

THE TRANSFIGURATION, 28-36.

JESUS HEALS THE MAN POSSESSED BY A DEVIL, 37-43.

THE SECOND PREDICTION OF THE PASSION AND LESSONS IN HUMILITY, 44-50.

JESUS DEPARTS FROM GALILEE, 51-56.

LESSONS IN CHARITY AND SELF-DENIAL, 57-62.

1. Then calling together the twelve apostles, he gave them power and authority over all devils, and to cure diseases.

2. And he sent them to preach the kingdom of God, and to heal the sick.

3. And he said to them: Take nothing for your journey; neither staff, nor scrip, nor bread, nor money; neither have two coats.

4. And whatsoever house you shall enter into, abide there, and depart not from thence.

5. And whosoever will not receive you, when ye go out of that city, shake off even the dust of your feet, for a testimony against them.

6. And going out, they went about through the towns, preaching the gospel, and healing everywhere.

7. Now Herod, the tetrarch, heard of all things that were done by him; and he was in a doubt, because it was said

8. By some, that John was risen from the dead: but by other some, that Elias had appeared; and by others, that one of the old prophets was risen again.

9. And Herod said: John I have beheaded; but who is this of whom I hear such things? And he sought to see him.

10. And the apostles, when they were returned, told him all they had done. And taking them, he went aside into a desert place, apart, which belongeth to Bethsaida.

11. Which when the people knew, they followed him; and he received them, and spoke to them of the kingdom of God, and healed them who had need of healing.

1. See on Matthew x. 1.

2. See on Matthew x. 7, 8.

3-5. See on Matthew x. 9-14.

7-9. See on Matthew xiv. 1-10.

10. See on Matthew xiv. 13.



12. Now the day began to decline. And the twelve came and said to him: Send away the multitude, that going into the towns and villages round about, they may lodge and get victuals; for we are here in a desert place.

13. But he said to them: Give you them to eat. And they said: We have no more than five loaves and two fishes; unless perhaps we should go and buy food for all this multitude.

14. Now there were about five thousand men. And he said to his disciples: Make them sit down by fifties in a company.

15. And they did so; and made them all sit down.

16. And taking the five loaves and the two fishes, he looked up to heaven, and blessed them; and he broke, and distributed to his disciples, to set before the multitude.

17. And they did all eat, and were filled. And there were taken up of fragments that remained to them, twelve baskets.

18. And it came to pass, as he was alone praying, his disciples also were with him: and he asked them, saying: Whom do the people say that I am?

19. But they answered, and said: John the Baptist; but some say Elias; and others say that one of the former prophets is risen again.

20. And he said to them: But whom do you say that I am? Simon Peter answering, said: The Christ of God.

21. But he strictly charging them, commanded they should tell this to no man.

22. Saying: The Son of man must suffer many things, and be rejected by the ancients and chief priests and scribes, and be killed, and the third day rise again.

23. And he said to all: If any man will come after me, let him deny himself, and take up his cross daily, and follow me.

24. For whosoever will save his life, shall lose it; for he that shall lose his life for my sake, shall save it.

25. For what is a man advantaged, if he gain the whole world, and lose himself, and cast away himself?

12. See on Matthew xiv. 15.

13. See on Matthew xiv. 16.

14. **About five thousand men.** St. Matthew (xiv. 21) says about five thousand men, "besides women and children."

16. See on Matthew xiv. 19.

18-20. See on Matthew xvi. 13-16. St. Luke passes over several important events recorded by Matthew and Mark. St. Luke, however, here observes that our Lord prayed before announcing His Passion, as He was accustomed to do before any important event.

From the fact that Luke omits all mention of Jesus' journey to Caesarea and supposes the scene of ix. 18 to have been in some unknown place, exegetes argue that the accounts of Matthew and Mark were unknown to him.

21, 22. See on Matthew xvi. 20, 21.

23, 24. See on Matthew xvi. 24, 25.

26. For he that shall be ashamed of me and of my words, of him the Son of man shall be ashamed, when he shall come in his majesty, and that of his Father, and of the holy angels.

27. But I tell you of a truth: There are some standing here that shall not taste death, till they see the kingdom of God.

28. And it came to pass about eight days after these words, that he took Peter, and James, and John, and went up into a mountain to pray.

29. And whilst he prayed, the shape of his countenance was altered, and his raiment became white and glittering.

30. And behold two men were talking with him. And they were Moses and Elias,

31. Appearing in majesty. And they spoke of his decease that he should accomplish in Jerusalem.

32. But Peter and they that were with him were heavy with sleep. And waking, they saw his glory, and the two men that stood with him.

33. And it came to pass, that as they were departing from him, Peter saith to Jesus: Master, it is good for us to be here; and let us make three tabernacles, one for thee, and one for Moses, and one for Elias; not knowing what he said.

34. And as he spoke these things, there came a cloud, and overshadowed them; and they were afraid, when they entered into the cloud.

35. And a voice came out of the cloud, saying: This is my beloved Son; hear him.

36. And whilst the voice was uttered, Jesus was found alone. And they held their peace, and told no man in those days any of these things which they had seen.

37. And it came to pass the day following, when they came down from the mountain, there met him a great multitude.

38. And behold a man among the crowd cried out, saying: Master, I beseech thee, look upon my son, because he is my only one.

39. And lo, a spirit seizeth him, and he suddenly crieth out, and he throweth him down and teareth him, so that he foameth; and bruising him, he hardly departeth from him.

40. And I desired thy disciples to cast him out, and they could not.

41. And Jesus answering, said: O faithless and perverse generation, how long shall I be with you, and suffer you? Bring hither thy son.

42. And as he was coming to him, the devil threw him down, and tore him.

43. And Jesus rebuked the unclean spirit, and cured the boy, and restored him to his father.

26. See on Matthew x. 32, 33. Although the application of this verse is general, the primary reference here is doubtless to our Lord's Passion.

27. See on Matthew xvi. 28.

28-36. See on Matthew xvii. 1-9.

37-43. See on Matthew xvii. 14-17.

44. And all were astonished at the mighty power of God. But while all wondered at all the things he did, he said to his disciples: Lay you up in your hearts these words, for it shall come to pass, that the Son of man shall be delivered into the hands of men.

45. But they understood not this word; and it was hid from them, so that they perceived it not. And they were afraid to ask him concerning this word.

46. And there entered a thought into them, which of them should be greater.

47. But Jesus seeing the thoughts of their heart, took a child and set him by him,

48. And said to them: Whosoever shall receive this child in my name, receiveth me; and whosoever shall receive me, receiveth him that sent me. For he that is the lesser among you all, he is the greater.

49. And John, answering, said: Master, we saw a certain man casting out devils in thy name, and we forbade him, because he followeth not with us.

50. And Jesus said to him: Forbid him not; for he that is not against you, is for you.

51. And it came to pass, when the days of his assumption were accomplishing, that he steadfastly set his face to go to Jerusalem.

44. See on Matthew xvii. 21, 22.

45. See on Mark ix. 31.

46-48. See on Matthew xviii. 1-4.

49, 50. See on Mark ix. 37, 38.

Maldonatus and other commentators believe that the man who is here said to have been casting out devils had not the power, but only the wish to cast them out. The right of exorcism, it seems, was as yet enjoyed only by the twelve Apostles.

51. **When the days of his assumption were accomplished.** "Assumption" here means the Ascension of our Lord into Heaven. The Ascension was to be the crowning event of our Lord's earthly life; hence this verse means, "when the days of His Ascension were approaching their accomplishment." Our Lord was now to leave Galilee and was going in the direction of Jerusalem, where, some six months later, "after his passion and death," His Ascension was to take place. During the six months that intervened, we know, from St. John (vii.-x. 22), that He made two visits to Jerusalem before His crucifixion,—at the Feasts of Tabernacles and of the Dedication. Our Lord was occupied, during these six months, in preaching throughout Judea, Peraea, and Samaria. It is probable that our Lord, after the Feast of Tabernacles, returned to Galilee. His final departure thence is given in xvii. 11.

52. And he sent messengers before his face; and going, they entered into a city of the Samaritans, to prepare for him.

53. And they received him not, because his face was of one going to Jerusalem.

54. And when his disciples James and John had seen this, they said: Lord, wilt thou that we command fire to come down from heaven, and consume them?

55. And turning, he rebuked them, saying: You know not of what spirit you are.

56. The Son of man came not to destroy souls, but to save. And they went into another town.

52. **He sent messengers; i.e.,** He sent two of His disciples, perhaps James and John (verse 54), ahead into Samaria, to prepare accommodations for Himself and those who were with Him.

53. **And they received him not.** The Samaritans knew that the Jews were now on their way up to Jerusalem to worship in the Temple; and hence, from the time, as well as from the appearance of our Lord and His disciples, they knew that He was also on His way to worship in the Temple of Jerusalem. It was because they knew the end and purpose our Lord had in His journey through Samaria that they refused Him hospitality. There was a long-standing and bitter feud between the Jews and the Samaritans over the place of the true worship of God, — the former contending that the Temple, in Jerusalem, the latter that their temple on Mount Garizim was the proper place of worship. Had the Samaritans not known the purpose of our Lord's going to Jerusalem at this particular time, they would not have refused Him hospitality, any more than the Samaritan woman at the well had refused Him, or the good Samaritan had refused help to the wounded Jew.

55. **He rebuked them, saying, etc.** Our Lord here reminds His Apostles that they are no longer under the Old Law of revenge and retaliation, but under the New Law of patience, forgiveness and charity; and He seems somewhat displeased that the disciples had so soon forgotten His injunction to return good for evil, love for hate, kindness for persecution.

56. **The Son of man came not to destroy souls, etc.** Our Lord here reannounces His great purpose in the world, which was to save *all*, both good and bad, if only they would hear and obey His teaching and coöperate with His grace.

57. And it came to pass, as they walked in the way, that a certain man said to him: I will follow thee whithersoever thou goest.

58. Jesus said to him: The foxes have holes, and the birds of the air nests; but the Son of man hath not where to lay his head.

59. But he said to another: Follow me. And he said: Lord, suffer me first to go and to bury my father.

60. And Jesus said to him: Let the dead bury their dead: but go thou, and preach the kingdom of God.

61. And another said: I will follow thee, Lord; but let me first take my leave of them that are at my house.

62. Jesus said to him: No man putting his hand to the plough, and looking back, is fit for the kingdom of God.

57-60. See on Matthew viii. 19-22.

62. **No man putting his hand to the plow, etc.** In these words, our Lord announces that, if anyone is engaged in His ministry, or be His faithful follower, whether as cleric or layman, he must devote himself unreservedly to the vocation which he has embraced, and exclude everything that is opposed to such service.

## CHAPTER X

THE MISSION OF THE SEVENTY-TWO DISCIPLES, AND  
THEIR RETURN, 1-24.

THE GOOD SAMARITAN, 25-37.

MARTHA AND MARY, 38-42.

1. And after these things the Lord appointed also other seventy-two: and he sent them two and two before his face into every city and place whither he himself was to come.

1. **The Lord appointed also other seventy-two;** i.e., besides the twelve Apostles already chosen, He now selected seventy-two others for the work of the ministry. Many MSS. have "seventy," instead of "seventy-two," but the latter reading, found in almost all the Latin versions, seems to be the better. These seventy or seventy-two disciples were inferior to the Apostles in dignity and subordinated to them. Commentators see in their mission the establishment of a kind of hierarchy among the disciples. The

2. And he said to them: The harvest indeed is great, but the labourers are few. Pray ye therefore the Lord of the harvest, that he send labourers into his harvest.

3. Go: Behold I send you as lambs among wolves.

4. Carry neither purse, nor scrip, nor shoes; and salute no man by the way.

5. Into whatsoever house you enter, first say: Peace be to this house.

6. And if the son of peace be there, your peace shall rest upon him; but if not, it shall return to you.

7. And in the same house, remain, eating and drinking such things as they have: for the labourer is worthy of his hire. Remove not from house to house.

8. And into what city soever you enter, and they receive you, eat such things as are set before you.

9. And heal the sick that are therein, and say to them: The kingdom of God is come nigh unto you.

10. But into whatsoever city you enter, and they receive you not, going forth into the streets thereof, say:

11. Even the very dust of your city that cleaveth to us, we wipe off against you. Yet know this, that the kingdom of God is at hand.

12. I say to you, it shall be more tolerable at that day for Sodom, than for that city.

“seventy-two” were pastors of the second order, while the Apostles were those of the first order; the former are perpetuated in the priests, the latter in the Bishops.

**Two and two**, — for sake of companionship, mutual help, and testimony.

**Into every city**; i.e., into Judea, Samaria and Peraea, where He Himself had labored.

2. See on Matthew ix. 37, 38. These same words had been previously addressed to the twelve. The twelve had been sent to Israel, Matthew x. 5; but the seventy-two, according to Le Camus, might go even to the non-Jewish population of Palestine.

3. **Lambs among wolves.** See on Matthew x. 16.

4. See on Matthew x. 10; cf. also 4 Kings iv. 29.

**Salute no man**, etc., means that they were to waste no unnecessary time in executing their mission.

5, 6. See on Matthew x. 12, 13.

7. See on Matthew x. 10, 11.

9. See on Matthew x. 8.

10-12. See on Matthew x. 14, 15.

13. Woe to thee, Corozain, woe to thee, Bethsaida. For if in Tyre and Sidon had been wrought the mighty works that have been wrought in you, they would have done penance long ago, sitting in sackcloth and ashes.

14. But it shall be more tolerable for Tyre and Sidon at the judgment, than for you.

15. And thou, Capharnaum, which art exalted unto heaven, thou shalt be thrust down to hell.

16. He that heareth you, heareth me; and he that despiseth you, despiseth me; and he that despiseth me, despiseth him that sent me.

17. And the seventy-two returned with joy, saying: Lord, the devils also are subject to us in thy name.

18. And he said to them: I saw Satan like lightning falling from heaven.

19. Behold, I have given you power to tread upon serpents and scorpions, and upon all the power of the enemy: and nothing shall hurt you.

20. But yet rejoice not in this, that spirits are subject unto you; but rejoice in this, that your names are written in heaven.

13-15. See on Matthew xi. 21-24. St. Matthew relates these denunciations much earlier, but it would seem that he is not following the chronological order. St. Augustine, however, believes that these woes were repeated on two different occasions.

16. This verse shows the absolute divine authority with which the disciples and their successors in the Church were endowed by our Lord Himself.

18. **I saw satan like lightning falling**, etc. The seventy-two were rejoicing before our Lord over the great powers they had been exercising in His name during their mission. The Lord's answer to them may mean that in His divine knowledge, He knew and foresaw all that they were telling Him, and that, therefore, they were communicating nothing new to Him, — He saw Satan during their preaching losing his dominion over the possessed, and his kingdom destroyed with the rapidity of lightning at the advance of the Messianic kingdom; or it may, and more probably does, mean that they, the disciples, should be on their guard against spiritual pride. Pride was the cause of Satan's fall, and pride might cause them likewise to fall, if they guarded not against it. The gift of miracles is not necessarily a guarantee of personal sanctity, or of final salvation.

20. **But rejoice in this**, etc. Our Lord does not forbid the disciples reasonably to rejoice over the powers He had given them, but He wishes to warn them against pride, and exhorts them rather to rejoice above all passing things in the hope of eternal salvation.

21. In that same hour, he rejoiced in the Holy Ghost, and said: I confess to thee, O Father, Lord of heaven and earth, because thou hast hidden these things from the wise and prudent, and hast revealed them to little ones. Yea, Father, for so it hath seemed good in thy sight.

22. All things are delivered to me by my Father; and no one knoweth who the Son is, but the Father; and who the Father is, but the Son, and to whom the Son will reveal him.

23. And turning to his disciples, he said: Blessed are the eyes that see the things which you see.

24. For I say to you, that many prophets and kings have desired to see the things that you see, and have not seen them; and to hear the things that you hear, and have not heard them.

25. And behold a certain lawyer stood up, tempting him, and saying, Master, what must I do to possess eternal life?

26. But he said to him: What is written in the law? how readest thou?

27. He answering, said: Thou shalt love the Lord thy God with thy whole heart, and with thy whole soul, and with all thy strength, and with all thy mind: and thy neighbour as thyself.

28. And he said to him: Thou hast answered right: this do, and thou shalt live.

He speaks as if their names were actually written in the Book of Life, i.e., as if their predestination were certain; but His words are to be taken only conditionally, provided, namely, that they persevere in His service and friendship.

21, 22. See on Matthew xi. 25-27.

23, 24. See on Matthew xiii. 16, 17.

25. A certain lawyer . . . tempting him, etc. On account of the lawyer's respectful tone and language, we are not to understand the word "tempting" in a bad sense, as if he meant to entrap our Lord; but as merely seeking for information. Having heard the Saviour speak of eternal life the lawyer wanted to know what he himself must do to obtain it. The Law of Moses promised only temporal life to its observers, although the hope of eternal life had long been in the Jewish mind, and became more distinct and more ardent from generation to generation. See *Summa Theol.*, i<sup>a</sup> ii<sup>ae</sup>, qu. 99, a. 6; qu. 91, a. 5; qu. 107, a. 1 ad 2.

27, 28. Thou shalt love the Lord thy God, etc. The lawyer's answer is really a quotation from Deut. (vi. 5) and Levit. (xix. 18). Life was promised to those who observed the Law, but of eternal life as such the Law made no explicit mention. Cf. on Matthew xxii. 36-40.



29. But he willing to justify himself, said to Jesus: And who is my neighbour?

30. And Jesus answering, said: A certain man went down from Jerusalem to Jericho, and fell among robbers, who also stripped him, and having wounded him went away, leaving him half dead.

31. And it chanced, that a certain priest went down the same way: and seeing him, passed by.

32. In like manner also a Levite, when he was near the place and saw him, passed by.

33. But a certain Samaritan being on his journey, came near him; and seeing him, was moved with compassion.

34. And going up to him, bound up his wounds, pouring in oil and wine: and setting him upon his own beast, brought him to an inn, and took care of him.

29. **To justify himself**; i.e., wishing to show that his question was not yet solved; nor so easy of solution as might appear. His difficulty was in determining his neighbor. This we can understand when we remember that the Jews considered as their neighbor only the just and observant members of their own race; their conception of neighbor was a very narrow and restricted one.

30. By a beautiful illustration, which many authors believe to have been founded in fact, our Lord now proceeds to show the lawyer who his neighbor really was.

**A certain man went down**, etc. Jerusalem was situated on an eminence and Jericho was some fifteen miles distant, and situated in the low-lying Jordan valley. The road between the two was then, as now, infested with robbers and banditti.

31. **A certain priest**, who perhaps had just been offering sacrifice in the Temple, and who was supposed more than others to give an example of charity and mercy. Cf. Exod. xxiii. 5.

32. **A levite**, who also was of the priestly race, although inferior to the priests.

33. **A certain Samaritan**. The Samaritans were strangers and bitter enemies of the Jews, and yet it was one of them who was found to show the charity and mercy that was lacking in the priest and levite. From this the lawyer could see that not only the Jews were his neighbor, but all men, even strangers and enemies.

34. **Oil and wine** were commonly used among the Jews as remedies for hurts and wounds; wine was used for its cleansing properties, oil for its soothing and healing qualities.

35. And the next day he took out two pence, and gave to the host, and said: Take care of him; and whatsoever thou shalt spend over and above, I, at my return, will repay thee.

36. Which of these three, in thy opinion, was neighbour to him that fell among the robbers?

37. But he said: He that shewed mercy to him. And Jesus said to him: Go, and do thou in like manner.

38. Now it came to pass as they went, that he entered into a certain town: and a certain woman named Martha, received him into her house.

39. And she had a sister called Mary, who sitting also at the Lord's feet, heard his word.

40. But Martha was busy about much serving. Who stood and said: Lord, hast thou no care that my sister hath left me alone to serve? speak to her therefore, that she help me.

41. And the Lord answering, said to her: Martha, Martha, thou art careful, and art troubled about many things:

42. But one thing is necessary. Mary hath chosen the best part, which shall not be taken away from her.

**An inn.** A Samaritan could not accept hospitality from Jews, and had, consequently, to seek shelter in a public place.

35. **Two pence;** i.e., two *denarii*, equal to about 17 cents each in our money. This amount would be sufficient to take care of the sick man for several days.

38. **As they went;** i.e., from Jericho to Jerusalem. Our Lord with His disciples was most probably on the way to Jerusalem to assist at the Feast of Tabernacles.

**He entered into a certain town,** which was most likely Bethany, the home of Martha and Mary (John xi. 1).

**Named Martha.** There is mention here only of Martha, probably because she was the elder of the family, with whom Lazarus and Mary lived. Perhaps the house belonged to Simon the leper (Matthew xxvi. 6; Mark xiv. 3), who was absent at this particular time, and whose place was taken by Martha. Theophylact on this passage thinks Simon was Martha's father.

39. **A sister called Mary,** who was most probably Mary Magdalen, as we saw above (vii. 37-48).

**Who sitting at our Lord's feet.** The term "sitting" here refers rather to the attitude of mind and heart with which Mary was listening to the counsels and teaching of the Saviour, than to the posture she took.

42. **But one thing is necessary.** The one thing necessary for

each and all of us is the eternal salvation of our souls and the means required for this end. Other things, indeed, are necessary in a relative sense; namely, in so far as they are required for eternal salvation. Our Lord commends Mary for choosing the means more directly conducive to the great end of life, than those employed by Martha. He does not condemn Martha for her work, but merely wishes to show that to listen to His counsels and teachings is more important than any other work we can perform. Martha and Mary are types respectively of the active and contemplative lives; both are good, but the contemplative life is the more excellent, since in it there are fewer chances for deviation from the path of holiness.

## CHAPTER XI

JESUS TEACHES HIS DISCIPLES TO PRAY, 1-13.

JESUS CASTS OUT A DEVIL AND REFUTES THE PHARISEES, 14-28.

THE SIGN OF JONAS, 29-36.

JESUS REPROACHES THE PHARISEES, 37-54.

1. And it came to pass, that as he was in a certain place praying, when he ceased, one of his disciples said to him: Lord, teach us to pray, as John also taught his disciples.

2. And he said to them: When you pray, say: Father, hallowed be thy name. Thy kingdom come.

3. Give us this day our daily bread.

4. And forgive us our sins, for we also forgive every one that is indebted to us. And lead us not into temptation.

1-4. The exact time and place in which our Lord spoke these words cannot be determined. Most likely it was after He and His disciples had attended the feast of Tabernacles at Jerusalem and had returned to the country beyond the Jordan where John had preached. See on John x. 39, 40. Hence it was that the disciples were reminded of John, and of what he had taught his own disciples.

The Lord's Prayer here given by St. Luke contains only five petitions, whereas in St. Matthew (vi. 9-13) it has seven.

5. And he said to them: Which of you shall have a friend, and shall go to him at midnight, and shall say to him: Friend, lend me three loaves,

6. Because a friend of mine is come off his journey to me, and I have not what to set before him.

7. And he from within should answer and say: Trouble me not, the door is now shut, and my children are with me in bed; I cannot rise and give thee.

8. Yet if he shall continue knocking, I say to you, although he will not rise and give him, because he is his friend; yet, because of his importunity, he will rise, and give him as many as he needeth.

9. And I say to you, Ask, and it shall be given you: seek, and you shall find: knock, and it shall be opened to you.

10. For every one that asketh, receiveth; and he that seeketh, findeth; and to him that knocketh, it shall be opened.

11. And which of you, if he ask his father bread, will he give him a stone? or a fish, will he for a fish give him a serpent?

12. Or if he shall ask an egg, will he reach him a scorpion?

13. If you, then, being evil, know how to give the good gifts to your children, how much more will your Father from heaven give the good Spirit to them that ask him?

Moreover, according to St. Matthew this prayer was uttered during the Sermon on the Mount and before a multitude. To explain these differences many commentators believe we have two versions of the same prayer spoken on different occasions; and the five petitions of St. Luke, they maintain, substantially contain the seven petitions of St. Matthew, just as the four beatitudes given by St. Luke contain the eight given by St. Matthew.

The Greek word, *ἐπιούσιος*, which is here (verse 3) translated "daily," is the same in each Gospel, and yet it is not found in any of the Greek authors. "It is found," says Origen, "neither in the language of the learned nor in that of the unlearned." No other word could be found for the Aramean term used by our Lord, and hence those who wished to teach the Lord's Prayer in Greek coined this word for the purpose. See on Matthew vi. 11.

5-12. After giving His disciples the prayer which they ought to say, our Lord now teaches them by an illustration the fervor and perseverance with which they ought to pray. They are to ask, to seek, and to knock at the door of His bounty until the heavenly Father shall be moved to hear them. See on Matthew vii. 7-11.

14. And he was casting out a devil, and the same was dumb: and when he had cast out the devil, the dumb spoke: and the multitudes were in admiration at it:

15. But some of them said: He casteth out devils by Beelzebub, the prince of devils.

16. And others tempting, asked of him a sign from heaven.

17. But he seeing their thoughts, said to them: Every kingdom divided against itself, shall be brought to desolation, and house upon house shall fall.

18. And if Satan also be divided against himself, how shall his kingdom stand? because you say, that through Beelzebub I cast out devils.

19. Now if I cast out devils by Beelzebub; by whom do your children cast them out? Therefore they shall be your judges.

20. But if I by the finger of God cast out devils; doubtless the kingdom of God is come upon you.

21. When a strong man armed keepeth his court, those things are in peace which he possesseth.

22. But if a stronger than he come upon him, and overcome him; he will take away all his armour wherein he trusted, and will distribute his spoils.

23. He that is not with me, is against me; and he that gathereth not with me, scattereth.

24. When the unclean spirit is gone out of a man, he walketh through places without water, seeking rest; and not finding, he saith: I will return into my house whence I came out.

25. And when he is come, he findeth it swept and garnished.

26. Then he goeth and taketh with him seven other spirits more wicked than himself, and entering in they dwell there. And the last state of that man becomes worse than the first.

27. And it came to pass, as he spoke these things, a certain woman from the crowd, lifting up her voice, said to him: Blessed is the womb that bore thee, and the paps that gave thee suck.

28. But he said: Yea rather, blessed are they who hear the word of God, and keep it.

14-23. See on Matthew xii. 22-30.

24-26. See on Matthew xii. 43-45.

27. **Blessed is the womb that bore thee, etc.** It is not certain whether this woman thus addressed our Lord as the result of an interior illumination regarding His Divinity, or from a merely natural admiration of His person and teaching.

28. **Yea rather, blessed are they, etc.** Our Lord now commends above all others those who hear and keep His teaching. He puts spiritual relationship above carnal; but in so doing, He commends His blessed Mother above all, because she more than all heard and observed the word of God. See also on Matthew xii. 50.

29. And the multitudes running together, he began to say: This generation is a wicked generation: it asketh a sign, and a sign shall not be given it, but the sign of Jonas the prophet.

30. For as Jonas was a sign to the Ninivites; so shall the Son of man also be to this generation.

31. The queen of the south shall rise in the judgment with the men of this generation, and shall condemn them: because she came from the ends of the earth to hear the wisdom of Solomon; and behold more than Solomon here.

32. The men of Ninive shall rise in the judgment with this generation, and shall condemn it; because they did penance at the preaching of Jonas; and behold more than Jonas here.

33. No man lighteth a candle, and putteth it in a hidden place, nor under a bushel; but upon a candlestick, that they that come in, may see the light.

34. The light of thy body is thy eye. If thy eye be single, thy whole body will be lightsome: but if it be evil, thy body also will be darksome.

35. Take heed therefore, that the light which is in thee, be not darkness.

36. If then thy whole body be lightsome, having no part of darkness; the whole shall be lightsome; and as a bright lamp, shall enlighten thee.

37. And as he was speaking, a certain Pharisee prayed him, that he would dine with him. And he going in, sat down to eat.

38. And the Pharisee began to say, thinking within himself, why he was not washed before dinner.

39. And the Lord said to him: Now you Pharisees make clean the outside of the cup and of the platter; but your inside is full of rapine and iniquity.

40. Ye fools, did not he that made that which is without, make also that which is within?

41. But yet that which remaineth, give alms; and behold, all things are clean unto you.

29-32. See also on Matthew xii. 38-42.

33. See on Matthew v. 15, 16.

34, 35. See on Matthew vi. 22, 23.

36. **The whole shall be lightsome;** i.e., if the eye, or intention, be upright and pure, the body will be pure and the whole man will be pure. See on Matthew vi. 22, 23.

37-39. The Pharisee requested our Lord to come and dine with him, not out of a sense of hospitality, but because he wished an opportunity carefully to observe Him, and if possible, to catch Him in some fault. See on Matthew xxiii. 13-25.

40. In this verse our Lord condemns the Pharisees for their hypocrisy in being so zealous about washing the body while caring nothing for the defilement of their hearts and souls.

41. **But yet that which remaineth, give alms.** Although the iniquity of the Pharisees is extreme, still our Lord tells them there is some hope for them, provided they give alms. "That which

42. But woe to you, Pharisees, because you tithe mint and rue and every herb; and pass over judgment, and the charity of God. Now these things you ought to have done, and not to leave the other undone.

43. Woe to you, Pharisees, because you love the uppermost seats in the synagogues, and salutations in the marketplace.

44. Woe to you, because you are as sepulchres that appear not, and men that walk over are not aware.

45. And one of the lawyers answering, saith to him: Master, in saying these things, thou reproachest us also.

46. But he said: Woe to you lawyers also, because you load men with burdens which they cannot bear, and you yourselves touch not the packs with one of your fingers.

47. Woe to you who build the monuments of the prophets: and your fathers killed them.

48. Truly you bear witness that you consent to the doings of your fathers: for they indeed killed them, and you build their sepulchres.

49. For this cause also the wisdom of God said: I will send to them prophets and apostles; and some of them they will kill and persecute.

50. That the blood of all the prophets which was shed from the foundation of the world, may be required of this generation,

51. From the blood of Abel unto the blood of Zacharias, who was slain between the altar and the temple: Yea I say to you, It shall be required of this generation.

52. Woe to you lawyers, for you have taken away the key of knowledge: you yourselves have not entered in, and those that were entering in, you have hindered.

remaineth" (*τὰ ἐνόητα*) means, according to some, that which is left over on their table after their feasts, which they should give as alms to the poor. Others understand the words to refer to the superfluities of their lives, which should be given as alms to the poor.

42-44. See on Matthew xxiii. 23-29.

45. **One of the lawyers answering, etc.;** i.e., one of the Scribes, who were the teachers and interpreters of the Law. The Pharisees observed the Law strictly according to the teaching of the Scribes or lawyers, and hence the condemnation of the Pharisees was indirectly a condemnation of the lawyers or Scribes. Many Scribes were also Pharisees.

46. See on Matthew xxiii. 4.

47-51. See on Matthew xxiii. 29-36.

52. **You have taken away the key of knowledge, etc.** The lawyers or Scribes being the interpreters and expounders of the Law were guilty of the ignorance and errors of the people. By

53. And as he was saying these things to them, the Pharisees and the lawyers began violently to urge him, and to oppress his mouth about many things,

54. Lying in wait for him, and seeking to catch something from his mouth, that they might accuse him.

arrogating to themselves the exclusive right to interpret the Law they prevented the people from getting a correct understanding of it. Thus they themselves refused to recognize our Lord as the Messiah and taught the people erroneously, and in this way prevented them from hearing Christ and obeying Him.

53. Violently to urge him, etc.; i.e., fiercely to beset Him (*δεινῶς ἐνέχειν*) with captious questions, in order somehow to entrap and condemn Him.

And to oppress his mouth; i.e., to flood Him with questions and extort hasty replies (*ἀποστροματίζειν*) in which they hoped to find some fault.

## CHAPTER XII

THE LEAVEN OF THE PHARISEES — THE DISCIPLES  
ARE NOT TO FEAR MEN, 1-9.

THE SIN AGAINST THE HOLY GHOST, 10-12.

CAUTIONS AGAINST AVARICE AND THE EVILS OF  
RICHES, 13-21.

CONFIDENCE IN GOD, 22-34.

VIGILANCE, 35-48.

JESUS IS COME TO CAST FIRE AND DIVISION, 49-53.

THE SIGNS OF THE TIMES, 54-59.

1. And when great multitudes stood about him, so that they trod one upon another, he began to say to his disciples: Beware ye of the leaven of the Pharisees, which is hypocrisy.

2. For there is nothing covered, that shall not be revealed: nor hidden, that shall not be known.

1. He began to say to his disciples; i.e., He spoke first (*πρῶτον*) to His disciples, and afterwards to the multitude.

Beware ye of the leaven, etc. See on Matthew xvi. 6.

2. For there is nothing covered, etc. Our Lord here refers to the final revelation of the Last Judgment of the labors and sufferings of His faithful followers, together with the wickedness and hypocrisy of His enemies and the enemies of the Gospel.



3. For whatsoever things you have spoken in darkness, shall be published in the light : and that which you have spoken in the ear in the chambers, shall be preached on the housetops.

4. And I say to you, my friends : Be not afraid of them who kill the body, and after that have no more that they can do.

5. But I will shew you whom you shall fear : fear ye him, who after he hath killed, hath power to cast into hell. Yea, I say to you, fear him.

6. Are not five sparrows sold for two farthings, and not one of them is forgotten before God?

7. Yea, the very hairs of your head are all numbered. Fear not therefore : you are of more value than many sparrows.

8. And I say to you, Whosoever shall confess me before men, him shall the Son of man also confess before the angels of God.

9. But he that shall deny me before men, shall be denied before the angels of God.

10. And whosoever speaketh a word against the Son of man, it shall be forgiven him : but to him that shall blaspheme against the Holy Ghost, it shall not be forgiven.

11. And when they shall bring you into the synagogues, and to magistrates and powers, be not solicitous how or what you shall answer, or what you shall say ;

12. For the Holy Ghost shall teach you in the same hour what you must say.

13. And one of the multitude said to him : Master, speak to my brother that he divide the inheritance with me.

14. But he said to him : Man, who hath appointed me judge, or divider, over you?

3. **Shall be preached on the housetops.** See on Matthew x. 27.

4, 5. See on Matthew x. 28. **Into hell.** See on Matthew v. 30.

6, 7. See on Matthew x. 29-31. In the time of Cicero a farthing (the Roman *as*) was worth about a cent in our money.

8, 9. See on Matthew x. 32, 33.

10. See on Matthew xii. 31, 32.

11, 12. See on Matthew x. 18, 19.

13. **Master, speak to my brother, etc.** The Law of Moses (Deut. xxi. 17) directed that the first born should receive a double share of his father's property, or twice as much as any other one of the children. In the present case, the elder brother had perhaps seized everything, and hence the complaint of the younger brother.

14. **Man, who hath appointed me judge, etc.** Our Lord had, indeed, power to decide any question spiritual or temporal, but here He calls the attention of His hearers to the fact that His mission

15. And he said to them: Take heed, and beware of all covetousness; for a man's life doth not consist in the abundance of things which he possesseth.

16. And he spoke a similitude to them, saying: The land of a certain rich man brought forth plenty of fruits.

17. And he thought within himself, saying: What shall I do, because I have no room where to bestow my fruits?

18. And he said: This will I do: I will pull down my barns, and will build greater; and into them will I gather all things that are grown to me, and my goods.

19. And I will say to my soul: Soul, thou hast much goods laid up for many years, take thy rest; eat, drink, make good cheer.

20. But God said to him: Thou fool, this night do they require thy soul of thee: and whose shall those things be which thou hast provided?

21. So is he that layeth up treasure for himself, and is not rich towards God.

is above all a spiritual one, and that He does not wish to become involved in temporal affairs. From this it is rightly inferred that spiritual matters should likewise engage the chief attention of Christ's followers, even though it be necessary at times to take a reasonable part in temporal concerns.

15. **Take heed, and beware of all covetousness.** Our Lord takes this occasion to warn His disciples against all inordinate seeking after temporal things, which should at best be only means to spiritual ends.

**For a man's life doth not consist, etc.;** i.e., the true and higher life (*ζωή*), by which a man lives, is not able to be satisfied by perishable goods.

16-21. The Saviour now proceeds to illustrate by a parable the utter insufficiency and instability of worldly goods to satisfy the needs of the soul, and the folly of any man who puts his trust in riches. **My soul** (verse 19) means "myself."

20. **This night do they require, etc.** The term "they" may here refer to God and His angels, who are about to come to judge the "rich fool"; or it may simply express in a personal, and therefore more forceful, way that his soul *is required*.

21. **So is he that layeth, etc.** He that has no love to God, no large spiritual affections, no sympathies with his brethren, is wretched and miserable, and poor, and blind, and naked, and shall one day discover that he is so, however now he may be saying, "I am rich and increased with goods, and have need of nothing" (Apoc. iii. 17) (Trench).

22. And he said to his disciples: Therefore I say to you, be not solicitous for your life, what you shall eat; nor for your body, what you shall put on.

23. The life is more than the meat, and the body is more than the raiment.

24. Consider the ravens, for they sow not, neither do they reap, neither have they storehouse nor barn, and God feedeth them. How much are you more valuable than they?

25. And which of you, by taking thought, can add to his stature one cubit?

26. If then ye be not able to do so much as the least thing, why are you solicitous for the rest?

27. Consider the lilies, how they grow: they labour not, neither do they spin. But I say to you, not even Solomon in all his glory was clothed like one of these.

28. Now if God clothe in this manner the grass that is to-day in the field, and to-morrow is cast into the oven; how much more you, O ye of little faith?

29. And seek not you what you shall eat, or what you shall drink: and be not lifted up on high.

30. For all these things do the nations of the world seek. But your Father knoweth that you have need of these things.

31. But seek ye first the kingdom of God and his justice, and all these things shall be added unto you.

32. Fear not, little flock, for it hath pleased your Father to give you a kingdom.

33. Sell what you possess and give alms. Make to yourselves bags which grow not old, a treasure in heaven which faileth not: where no thief approacheth, nor moth corrupteth.

34. For where your treasure is, there will your heart be also.

35. Let your loins be girt, and lamps burning in your hands.

36. And you yourselves like to men who wait for their lord, when he shall return from the wedding; that when he cometh and knocketh, they may open to him immediately.

22-28. See on Matthew vi. 25-32.

29. **Be not lifted up on high**; i.e., be not over anxious, over solicitous (*μη μετρωπιζετε*) over temporal things and the needs of the body. Some say that the clause means, "be not puffed up with pride" (St. Augustine).

32. **Little flock**. Our Lord now addresses His disciples, who were the nucleus of His Church, and He tells them to be calm and peaceful, for the heavenly Father has provided for them a place of happiness and abundance in Heaven.

33. **Sell what you possess, etc.** In order to invite His disciples to still greater perfection, the Saviour here counsels them to sell what they possess and become poor for His sake.

35, 36. **Let your loins be girt**. This injunction refers to the custom among the Orientals of tucking up their long, flowing gar-

37. Blessed are those servants, whom the Lord when he cometh, shall find watching. Amen I say to you, that he will gird himself, and make them sit down to meat, and passing will minister unto them.

38. And if he shall come in the second watch, or come in the third watch, and find them so, blessed are those servants.

39. But this know ye, that if the householder did know at what hour the thief would come, he would surely watch, and would not suffer his house to be broken open.

40. Be you then also ready: for at what hour you think not, the Son of man will come.

41. And Peter said to him: Lord, dost thou speak this parable to us, or likewise to all?

42. And the Lord said: Who (thinkest thou) is the faithful and wise steward, whom his lord setteth over his family, to give them their measure of wheat in due season?

43. Blessed is that servant, whom when his lord shall come, he shall find so doing.

44. Verily I say to you, he will set him over all that he possesseth.

45. But if that servant shall say in his heart: My lord is long a coming; and shall begin to strike the menservants and maidservants, and to eat and to drink and be drunk:

46. The lord of that servant will come in the day that he hopeth not, and at the hour that he knoweth not, and shall separate him, and shall appoint him his portion with unbelievers.

ments under a leather girdle which they wore around the waist; this they were accustomed to do when about to begin a journey or undertake some special work (4 Kings iv. 29; ix. 1). The lamps refer to the torches which were carried at weddings, because marriage feasts in the Orient were always celebrated at night. See on Matthew xxv. 1-13.

37. In this verse our Lord tells His disciples that so pleased will He be with His faithful and persevering servants, that when He comes He will minister to them by receiving them into His Kingdom and crowning them with eternal delights. On certain feast days among the Jews servants were allowed to eat with their masters in order to share their joy (Deut. xii. 17, 18; xvi. 11, 12). It is to this custom that our Lord now refers.

38. The night was divided into four watches, according to the Roman custom; but there is mention here of the second and third watches only, because, the first watch would be too early, the fourth too late, to be returning from a banquet. To come **in the third watch** meant to come at the end of the night, towards morning.

42-46. See on Matthew xxiv. 45-51. By this parable Peter's

47. And that servant who knew the will of his lord, and prepared not himself, and did not according to his will, shall be beaten with many stripes.

48. But he that knew not, and did things worthy of stripes, shall be beaten with few stripes. And unto whomsoever much is given, of him much shall be required: and to whom they have committed much, of him they will demand the more.

49. I am come to cast fire on the earth: and what will I, but that it be kindled?

50. And I have a baptism wherewith I am to be baptized: and how am I straitened until it be accomplished?

51. Think ye, that I am come to give peace on earth? I tell you, no; but separation.

52. For there shall be from henceforth five in one house divided: three against two, and two against three.

53. The father shall be divided against the son, and the son against his father, the mother against the daughter, and the daughter against the mother, the mother in law against her daughter in law, and the daughter in law against her mother in law.

question (verse 41) was clearly answered; clearly the words of our Lord applied to the disciples, and to all who are entrusted with the work of God.

47, 48. These verses plainly show that the punishment meted out to sinners hereafter will not be equal; each one will be rewarded or punished according to his works.

49. **I am come to cast fire**, etc. The fire here spoken of is variously interpreted by different commentators. Most probably it refers to the preaching of the Gospel, which, like fire, should enlighten the minds and warm the hearts of all well disposed to hear it. Others think it refers to the Holy Ghost and His gifts, which were to inflame the hearts of the disciples. Still others believe that the passage refers to the persecutions which the followers of Christ were to suffer for accepting and obeying the Gospel teaching.

**And what will I but that it be kindled**; i.e., how great is my desire that this fire should begin to burn.

50. **I have a baptism**, etc. Baptism here refers to our Lord's Passion, which He was eagerly waiting to undergo for the redemption of mankind. See on Mark x. 38.

51-53. Here our Lord predicts the divisions and separations which the Gospel teaching is going to effect even among those who are most closely united by ties of kindred and friendship. See on Matthew x. 34, 35.

54. And he said also to the multitudes: When you see a cloud rising from the west, presently you say: A shower is coming: and so it happeneth:

55. And when ye see the south wind blow, you say: There will be heat: and it cometh to pass.

56. You hypocrites, you know how to discern the face of the heaven and of the earth: but how is it that you do not discern this time?

57. And why even of yourselves, do you not judge that which is just?

58. And when thou goest with thy adversary to the prince, whilst thou art in the way, endeavour to be delivered from him: lest perhaps he draw thee to the judge, and the judge deliver thee to the exacter, and the exacter cast thee into prison.

59. I say to thee, thou shalt not go out thence, until thou pay the very last mite.

54-56. **You hypocrites, you know how to discern, etc.** Our Lord addresses the Scribes and Pharisees as hypocrites, because they were able to understand the meaning of natural phenomena, but feigned to be unable to see the fulfillment in Himself of all the signs and prophecies which related to the Messiah.

58. In this verse the Saviour warns His hearers that they should endeavor by faith in Him and in His preaching to do penance for their sins, and to become reconciled with His heavenly Father while they were living. Otherwise the day of judgment might overtake them and find them still at enmity with God.

59. See on Matthew v. 26.

## CHAPTER XIII

THE NECESSITY OF PENANCE AND GOOD WORKS, 1-9.

THE CURE OF THE INFIRM WOMAN, 10-17.

THE GRAIN OF MUSTARD-SEED, AND THE LEAVEN,  
18-21.

THE NUMBER OF THE ELECT, 22-30.

THE HOSTILITY OF HEROD, 31-33.

JESUS LAMENTS OVER JERUSALEM, 34, 35.

1. And there were present, at that very time, some that told him of the Galileans, whose blood Pilate had mingled with their sacrifices.

1. **And there were present, etc.,**—rather, “there came up” (*παρηΐσαν*). This was at the very time that our Lord was delivering the discourse of the preceding chapter.

2. And he answering, said to them: Think you that these Galileans were sinners above all the men of Galilee, because they suffered such things?

3. No, I say to you: but unless you shall do penance, you shall all likewise perish.

4. Or those eighteen upon whom the tower fell in Siloe, and slew them: think you, that they also were debtors above all the men that dwelt in Jerusalem?

5. No, I say to you; but except you do penance, you shall all likewise perish.

6. He spoke also this parable: A certain man had a fig-tree planted in his vineyard, and he came seeking fruit on it, and found none.

7. And he said to the dresser of the vineyard: Behold, for these three years I come seeking fruit on this fig-tree, and I find none. Cut it down therefore: why cumbereth it the ground?

8. But he answering, said to him: Lord, let it alone this year also, until I dig about it, and dung it.

9. And if happily it bear fruit: but if not, then after that thou shalt cut it down.

2, 3. **These Galileans.** These were perhaps some seditious followers of Judas of Galilee who, having in some way rebelled against or criticized Pilate, were put to death by him at the very time their sacrifices were being offered in the Temple.

Our Lord in these verses asked His hearers whether they considered themselves less guilty of sin than were these Galileans whom Pilate put to death; and His answer to them is that they, indeed, are not less guilty or in less need of penance.

4, 5. **The tower of Siloe** was perhaps one of the towers on the walls surrounding the City of Jerusalem, not far from the fountain of Siloe which was in the south-eastern part of the city. It appears that shortly before the present discourse, this tower had fallen and killed eighteen men, because of their sins. Our Lord again asks His hearers if they consider themselves more innocent and less deserving of chastisement than these eighteen victims. That they were not should have been plain to them later on, during the last awful siege of Jerusalem by the Romans, when so many of them, in the very midst of their sacrifices, were crushed beneath the ruins of their falling Temple and city. The two calamities here adduced were, therefore, only faint pictures of the doom which awaited the Jewish people.

6-9. The barren fig-tree is usually regarded as a type of the Jewish Synagogue. Just as the fig-tree was plentiful in leaves but had no fruit, so the Synagogue was abundant in external obser-

10. And he was teaching in their synagogue on their sabbath.

11. And behold there was a woman, who had a spirit of infirmity eighteen years: and she was bowed together, neither could she look upwards at all.

12. Whom when Jesus saw, he called her unto him, and said to her: Woman, thou art delivered from thy infirmity.

13. And he laid his hands upon her, and immediately she was made straight, and glorified God.

14. And the ruler of the synagogue (being angry that Jesus had healed on the sabbath) answering, said to the multitude: Six days there are wherein you ought to work. In them therefore come, and be healed; and not on the sabbath day.

vances and ceremonies, but sadly wanting in genuine religious fruitfulness.

A fig-tree in a vineyard would be strange with us, but it was not so among the Jews. In Palestine it is natural to find fig-trees, thorn-trees, or apple trees in cornfields and vineyards, or any place where they can get soil to support them. See Stanley, *Sinai & Palestine*, p. 413.

These three years (verse 7) St. Augustine understands to represent the natural law, the written law, and, at last, the law of grace. At all these different periods the man of the vineyard, Almighty God, had been expecting His chosen people to yield Him fruit, but now the time of their probation was nearing its end.

10. **In their synagogue.** The Greek has it, "in one of their synagogues,"—where the Jews were accustomed to assemble on the Sabbath to read the Scriptures and listen to religious instruction. See on Matthew iv. 23.

11, 12. **A spirit of infirmity**, which is called in our day curvature of the spine. The disease still defies the best efforts of physicians. Commentators remark that this is one of the few instances in which our Lord performed a cure without first being asked to do so.

13. **And he laid his hands upon her**, etc. Our Lord could have cured the woman by a single word, but in this instance, as in many others, He wished to show, as St. Cyril says, that His Sacred Flesh was endowed with supernatural powers.

14. **The ruler of the synagogue**; i.e., the president of the synagogue. See on Matthew iv. 23.

**Six days there are**, etc. The ruler quoted correctly from Deut. (v. 13), showing that he knew the Law, at least in a mechanical way. But his application of the Law was erroneous: (a) because the woman had not come for the purpose of being healed; (b) even



15. And the Lord answering him, said: Ye hypocrites, doth not every one of you, on the sabbath day, loose his ox or his ass from the manger, and lead them to water?

16. And ought not this daughter of Abraham, whom Satan hath bound, lo, these eighteen years, be loosed from this bond on the sabbath day?

17. And when he said these things, all his adversaries were ashamed: and all the people rejoiced for all the things that were gloriously done by him.

18. He said therefore: To what is the kingdom of God like, and whereunto shall I resemble it?

19. It is like to a grain of mustard seed, which a man took and cast into his garden, and it grew and became a great tree, and the birds of the air lodged in the branches thereof.

20. And again he said: Whereunto shall I esteem the kingdom of God to be like?

21. It is like to leaven, which a woman took and hid in three measures of meal, till the whole was leavened.

22. And he went through the cities and towns teaching, and making his journey to Jerusalem.

23. And a certain man said to him: Lord, are they few that are saved? But he said to them:

24. Strive to enter by the narrow gate; for many, I say to you, shall seek to enter, and shall not be able.

25. But when the master of the house shall be gone in, and shall shut the door, you shall begin to stand without, and knock at the door, saying: Lord, open to us. And he answering, shall say to you: I know you not, whence you are.

if to be healed had been her aim, her action would not have been a *work* in the true sense of the Law.

15. **Ye hypocrites.** Our Lord addresses His criticizers as "hypocrites" because they were pretending to have zeal for the Sabbath, whereas in reality they wished only to condemn Him, whose teaching was against their sinful lives. He then proceeded in this and the following verse to draw a comparison between a dumb animal and a child of Abraham, and He contrasts the work of loosing and leading an animal to water, which was something really servile, with the laying on of a hand to cure the suffering woman. The hypocrisy of their position was plain to all (verse 17).

18-21. See on Matthew xiii. 31-33.

22. The Paschal feast was now about three months off and our Lord was making use of the time by preaching and teaching in various places throughout Peraea.

24. **Strive to enter by the narrow gate.** In the Greek the word for "strive" (*ἀγωνίζεσθε*) means to exercise the greatest effort, to strive with all one's might. From the words of our Lord, in this

26. Then you shall begin to say: We have eaten and drunk in thy presence, and thou hast taught in our streets.

27. And he shall say to you: I know you not, whence you are: depart from me, all ye workers of iniquity.

28. There shall be weeping and gnashing of teeth, when you shall see Abraham and Isaac and Jacob, and all the prophets, in the kingdom of God, and you yourselves thrust out.

29. And there shall come from the east and the west, and the north and the south; and shall sit down in the kingdom of God.

30. And behold, they are last that shall be first; and they are first that shall be last.

31. The same day, there came some of the Pharisees, saying to him: Depart, and get thee hence, for Herod hath a mind to kill thee.

32. And he said to them: Go and tell that fox, Behold, I cast out devils, and do cures to-day and to-morrow, and the third day I am consummated.

33. Nevertheless I must walk to-day and to-morrow, and the day following, because it cannot be that a prophet perish, out of Jerusalem.

and the following verse, it would seem that the majority of men are lost, although we may reasonably say that His words applied chiefly, if not only, to those to whom He was speaking, or to the Jews of His day. St. Thomas and theologians generally teach that the majority of mankind are lost; it is the common opinion, however, and especially in our day, that most Christians are saved.

26. **We have eaten and drunk in thy presence**, etc. This was directly true of those who lived in the time of our Lord, but it is also indirectly applicable to all Christians who have been nourished by the doctrine and sacraments of Christ and His Church.

27. See on Matthew vii. 22, 23; cf. Ps. vi. 9.

28, 29. See on Matthew viii. 11, 12.

30. See on Matthew xix. 30; xx. 16.

31. **Some of the Pharisees**, etc. The Pharisees were scattered all over Palestine. This present event most likely took place in Peraea. See on ix. 1-4.

32. **Go and tell that fox**. These words show that our Lord was well aware of the trickery and cunning of Herod.

**Behold I cast out devils**, etc.; i.e., I continue to exercise charity and perform works of mercy in accordance with My mission.

**And the third day I am consummated**. By these words commentators think that our Lord meant to show that His Passion was near at hand (John xix. 30).

33. **I must walk to-day**, etc.; i.e., I must continue My work

34. Jerusalem, Jerusalem, that killest the prophets, and stonest them that are sent to thee, how often would I have gathered thy children as the bird doth her brood under her wings, and thou wouldest not?

35. Behold your house shall be left to you desolate. And I say to you, that you shall not see me till the time come, when you shall say: Blessed is he that cometh in the name of the Lord.

according to the decrees of the heavenly Father. **It cannot be that a prophet perish, out of Jerusalem.** Although some of the prophets, e.g., Jeremias and Ezechiel, were killed outside of Jerusalem, still our Lord's words are a sad reminder that Jerusalem, the place above all others favored by the prophets, was the chief scene of their martyrdom.

34, 35. These lamentations were repeated during Holy Week. See on Matthew xxiii. 37-39.

## CHAPTER XIV

JESUS HEALS THE MAN WITH DROPSY ON THE SABBATH, 1-6.

THE PARABLE OF THE WEDDING SUPPER, 7-14.

THE PARABLE OF THE GREAT SUPPER, 15-24.

HOW TO FOLLOW JESUS, 25-35.

1. And it came to pass, when Jesus went into the house of one of the chief of the Pharisees, on the sabbath day, to eat bread, that they watched him.

2. And behold, there was a certain man before him that had the dropsy.

3. And Jesus answering, spoke to the lawyers and Pharisees, saying: Is it lawful to heal on the sabbath day?

4. But they held their peace. But he taking him, healed him, and sent him away.

5. And answering them, he said: Which of you shall have an ass or an ox fall into a pit, and will not immediately draw him out, on the sabbath day?

6. And they could not answer him to these things.

1. **And it came to pass, when Jesus went, etc.** We do not know just when this took place; the event is mentioned by St. Luke only. Between this, however, and the events of the preceding chapter occurred the feast of the Dedication (John x. 22). **To eat bread** means to take food. **They watched him** to see if they could not find some fault in Him.

2-6. Our Lord took the present occasion to teach a lesson of

7. And he spoke a parable also to them that were invited, marking how they chose the first seats at the table, saying to them :

8. When thou art invited to a wedding, sit not down in the first place, lest perhaps one more honourable than thou be invited by him :

9. And he that invited thee and him, come and say to thee, Give this man place : and then thou begin with shame to take the lowest place.

10. But when thou art invited, go, sit down in the lowest place ; that when he who invited thee, cometh, he may say to thee : Friend, go up higher. Then shalt thou have glory before them that sit at table with thee.

11. Because every one that exalteth himself, shall be humbled ; and he that humbleth himself, shall be exalted.

12. And he said to him also that had invited him : When thou makest a dinner or a supper, call not thy friends, nor thy brethren, nor thy kinsmen, nor thy neighbours who are rich ; lest perhaps they also invite thee again, and a recompense be made to thee.

13. But when thou makest a feast, call the poor, the maimed, the lame, and the blind ;

14. And thou shalt be blessed, because they have not wherewith to make thee recompense : for recompense shall be made thee at the resurrection of the just.

15. When one of them that sat at table with him, had heard these things, he said to him : Blessed is he that shall eat bread in the kingdom of God.

mercy. The argument which He gave to the Pharisees was so evident that they could not answer Him without condemning themselves, hence they were silent.

7-11. After curing the infirm man our Lord now gives the Pharisees an illustration calculated to help their spiritual infirmity. He strives to warn them against pride and ambition, and shows them the benefits of humility.

12-14. **Call not thy friends, nor thy brethren, etc.** In these words and in the verses that follow our Lord by no means wished to encourage disloyalty to friends or kindred, for He above all was most loyal to His friends and kindred ; but He desired to show that we should be kind not only to friends and to those who are rich, but also to the poor and to those who can make no return for our kindness. But to be of merit in His sight this kindness and hospitality to others must be done for God's sake. Cf. Tob. iv. 7 ; Prov. iii. 9.

15. **Blessed is he that shall eat bread, etc.** Most likely this man was inspired by the words of our Lord to rise above all carnal desires for eating and drinking, and to long for the true spiritual delights which are the portion of the Blessed in Heaven.

16. But he said to him: A certain man made a great supper, and invited many.

17. And he sent his servant at the hour of supper to say to them that were invited, that they should come, for now all things are ready.

18. And they began all at once to make excuse. The first said to him: I have bought a farm, and I must needs go out and see it: I pray thee, hold me excused.

19. And another said: I have bought five yoke of oxen, and I go to try them: I pray thee, hold me excused.

20. And another said: I have married a wife, and therefore I cannot come.

21. And the servant returning, told these things to his lord. Then the master of the house, being angry, said to his servant: Go out quickly into the streets and lanes of the city, and bring in hither the poor, and the feeble, and the blind, and the lame.

22. And the servant said: Lord, it is done as thou hast commanded, and yet there is room.

16. The present Parable of the Great Supper directly and immediately has reference to the reprobation and rejection of the Jews and the calling of the Gentile world to the teachings of the Gospel and the Church. The **certain man** is none other than Almighty God, and the **great supper** means the teachings of the Gospel revealed to the world through Christ. The many who were invited were the Jewish people.

17. **And he sent his servant**, etc. Under the term "servant" are doubtless to be understood the ancient prophets who from time to time were sent to the Jewish people; but in particular St. John the Baptist, the Precursor of the Messiah, who endeavored by his preaching to prepare the people for the immediate reception of Christ and the Gospel. Some commentators, however, think that by "servant," we are more probably to understand the Apostles and Evangelists whom our Lord Himself sent out to call the Jews to the Gospel teaching. The Apostles and disciples were doubtless the last of the servants sent to call the Jews to enter the New Kingdom.

18-20. The various excuses given by those invited represent some of the chief failings of the Jewish people, and indeed of Christians; namely, inordinate attachment to worldly things, pride and curiosity, unregulated indulgence and gratification of carnal desires.

21. **The poor and the feeble and the blind**, etc. These classes of people doubtless represented the poor and suffering among the

23. And the Lord said to the servant: Go out into the highways and hedges, and compel them to come in, that my house may be filled.

24. But I say unto you, that none of those men that were invited, shall taste of my supper.

25. And there went great multitudes with him. And turning, he said to them:

26. If any man come to me, and hate not his father, and mother, and wife, and children, and brethren, and sisters, yea and his own life also, he cannot be my disciple.

27. And whosoever doth not carry his cross and come after me, cannot be my disciple.

Jews in contradistinction to the Scribes and Pharisees, the leaders and teachers of the people.

23. **Go out into the highways and hedges**, doubtless refers to the calling of the Gentiles. **Compel them to come in**. This does not mean that violence is to be exercised in order to lead people to embrace the Gospel teaching; it means only that the Apostle of Christ is to preach and teach and instruct, and by his own faith and holiness of life to endeavor to persuade others to embrace the truths of which he is the expounder.

24. **None of those men that were invited**, etc. This is a clear declaration of the rejection of all those who refused, or shall in future refuse, to accept our Lord's preaching and the teaching of the Gospel.

25. **And there went great multitudes**, etc.; i.e., great crowds of people followed Him as He proceeded from the banquet hall on His way through Peraea.

26. **And hate not his father**, etc. Most certainly these words do not mean that any one is really to hate his father or mother or brethren, because our Lord had already commanded in the Sermon on the Mount that we should love even our enemies. The meaning, therefore, is that we must never allow any ties of human relationship to stand between us and God. See also ix. 23, 24; on Matthew x. 37.

27. **Cannot be my disciple**. By "disciple" we are most probably to understand one who, like the Apostles and the seventy-two disciples, has embraced the evangelical counsels, and wishes to follow and minister to Christ in a special manner. The two parables that follow of the builder of the tower and the king about to make war, seem clearly to show that the word "disciple" here means

28. For which of you having a mind to build a tower, doth not first sit down, and reckon the charges that are necessary, whether he have wherewithal to finish it:

29. Lest, after he hath laid the foundation, and is not able to finish it, all that see it begin to mock him,

30. Saying: This man began to build, and was not able to finish.

31. Or what king, about to go to make war against another king, doth not first sit down, and think whether he be able, with ten thousand, to meet him that, with twenty thousand, cometh against him?

32. Or else, whilst the other is yet afar off, sending an embassy, he desireth conditions of peace.

33. So likewise every one of you that doth not renounce all that he possesseth, cannot be my disciple.

34. Salt is good. But if the salt shall lose its savour, wherewith shall it be seasoned?

35. It is neither profitable for the land nor for the dunghill, but shall be cast out. He that hath ears to hear, let him hear.

rather one devoted to the special service of Christ, than Christians in general. Maldonatus, however, understands "disciple" to refer to Christians in general.

28-33. These verses show the importance of careful consideration before undertaking to serve Christ as His special disciple. The words are applicable in a special manner to all who enter the ministry or religious life.

34, 35. **Salt is good.** The meaning here is: Just as salt is very useful so long as it retains its savor, but is utterly useless when it has lost it, so the follower of Christ is useful so long as he continues united to God by faith and love, but is fit only to be cast out of the Kingdom of God when he has proved unfaithful and sinful. See on Matthew v. 13.

## CHAPTER XV

THE PARABLES OF THE LOST SHEEP AND OF THE  
LOST COIN, 1-10.

THE PARABLE OF THE PRODIGAL SON, 11-32.

1. Now the publicans and sinners drew near unto him to hear him.

1. **The publicans and sinners.** The Greek has "all" the publicans and sinners. The meaning is that great numbers of these classes came to hear the teachings of our Lord.

2. And the Pharisees and the scribes murmured, saying: This man receiveth sinners, and eateth with them.

3. And he spoke to them this parable, saying:

4. What man of you that hath an hundred sheep: and if he shall lose one of them, doth he not leave the ninety-nine in the desert, and go after that which was lost, until he find it?

5. And when he hath found it, lay it upon his shoulders, rejoicing:

6. And coming home, call together his friends and neighbours, saying to them: Rejoice with me, because I have found my sheep that was lost?

7. I say to you, that even so there shall be joy in heaven upon one sinner that doth penance, more than upon ninety-nine just who need not penance.

2. **Murmured**; i.e., they were murmuring (*διεγόγγυζον*), as they were accustomed to do. The Scribes and Pharisees falsely taught that, just as the body became legally defiled by contact with sinners, so likewise the soul was defiled by mingling with them.

3. **This parable.** The two parables that follow, of the Lost Coin and the Prodigal Son, are found only in St. Luke. That of the Lost Sheep is also in Matthew xviii. 12-14, but there the circumstances and immediate sense are somewhat different. The purpose of these parables is to refute the erroneous opinions of the Scribes and Pharisees relative to the defilement arising from mingling with sinners, and to show how pleasing in God's sight is the conversion of a single sinner. St. Luke, writing for the Gentiles, takes special delight in recounting these parables which manifest the mercy of God toward sinners.

4-7. According to some, this Parable of the Lost Sheep is intended to teach the Scribes and Pharisees that there is more joy in Heaven over the conversion of one real sinner, such as they despised, than over ninety-nine so-called just people like themselves. Perhaps the true interpretation of the parable is, that a single one who embraces the teachings of the Gospel and follows Christ is far more pleasing in the sight of God and of His Angels than ninety-nine whose justness and righteousness do not go beyond the legal prescriptions of the Old Law. It is not true to say that the repentance of a sinner really causes more joy in Heaven than the justice of ninety-nine who have not deviated from the Gospel teaching. Our Lord was expressing Himself in a human way. See on Matthew xviii. 10-14. *Summa Theol.*, i<sup>a</sup>, qu. 20, a. 4 ad 4.



8. Or what woman having ten groats; if she lose one groat, doth not light a candle, and sweep the house, and seek diligently until she find it?

9. And when she hath found it, call together her friends and neighbours, saying: Rejoice with me, because I have found the groat which I had lost.

10. So I say to you, there shall be joy before the angels of God upon one sinner doing penance.

11. And he said: A certain man had two sons:

8-10. This Parable of the Lost Coin inculcates the same teaching as the preceding one. A *groat* was a small silver coin, a *denarius*, about seventeen cents in our money. The *woman* in this parable represents the Church, and the *candle*, the word of God.

**There shall be joy before the angels of God.** These words show that the angels in Heaven, and consequently the saints also, know at least to some extent what transpires here on earth. We do not know how or in what measure the angels and saints are aware of earthly happenings and events, but that they do know at least many temporal things is evident from the present passage. It is commonly taught that they see in God, or that in some way God makes known to them, all those temporal affairs which can to some degree increase their happiness. Indeed they might without injury to their happiness know even those earthly things which in this life would cause them pain, because in the state of glory the happiness of the saints consists in seeing God and in entire conformity to His will, and hence nothing can make them unhappy which His will permits.

11. The aim and purpose of the parable that follows is the same as in the two preceding parables of this chapter; namely, to refute the Pharisees and to justify our Lord's action in receiving and consorting with publicans and sinners. Some commentators see in the two sons types of the Gentile and the Jew, the former represented by the younger son, the latter by the elder. Thus, in this opinion, the departure of the younger son signifies the apostasy of the Gentile world from God, and his return, the admission of the Gentiles into the privileges and blessings of the New Covenant; while the elder son is a type of the narrow hearted, self-righteous Jew who was unwilling that the Gentiles should be received on a common footing with himself. But this interpretation does not seem in harmony with the scope of the parable which was to reprimand the murmurings of the Pharisees against the sinners whom

12. And the younger of them said to his father : Father, give me the portion of substance that falleth to me. And he divided unto them his substance.

13. And not many days after, the younger son, gathering all together, went abroad into a far country : and there wasted his substance, living riotously.

14. And after he had spent all, there came a mighty famine in that country ; and he began to be in want.

15. And he went and cleaved to one of the citizens of that country. And he sent him into his farm to feed swine.

16. And he would fain have filled his belly with the husks the swine did eat ; and no man gave unto him.

17. And returning to himself, he said : How many hired servants in my father's house abound with bread, and I here perish with hunger ?

our Lord admitted to His company. Hence, other commentators more probably see in the elder son a type of the Pharisees, and in the younger a type of the publicans and sinners. It would be a mistake, and beside the nature of parables, to endeavor to trace every detail of the parable and make it apply either to Gentile and Jew, on the one hand, or to Pharisee and sinner, on the other. In this, as in every parable, there are many things purely ornamental, for which, consequently, we need not seek an application.

The **certain man** of the parable means Almighty God ; the **two sons**, as we have seen, represent the just or the reputed just, and the sinners among mankind.

12. **And he divided unto them his substance.** We cannot suppose that this younger son requested his portion as a right, but only as a favor, as is evident from his own words. See on xii. 13.

13. **Went abroad into a far country.** The literal meaning of these words doubtless expresses distance of place ; but the sinner may be far alienated from God in heart although present in body.

14. **A mighty famine, etc.,**— words which express the utter distress and hunger of the heart of the sinner that has strayed away from his God.

15. **To feed swine.** The feeding of swine is one of the most abject and degrading duties that anyone can perform. This was especially true with the Jews who abhorred swine, in particular, as unclean.

16. **And he would fain have filled his belly, etc.** This shows the utter want to which the prodigal was reduced ; in its application it represents the state of destitution which sinners suffer.

**Husks.** These were perhaps a kind of coarse sweet fruit of the

18. I will arise, and will go to my father, and say to him: Father, I have sinned against heaven, and before thee:

19. I am not worthy to be called thy son: make me as one of thy hired servants.

20. And rising up he came to his father. And when he was yet a great way off, his father saw him, and was moved with compassion, and running to him fell upon his neck, and kissed him.

21. And the son said to him: Father, I have sinned against heaven, and before thee, I am not now worthy to be called thy son.

22. And the father said to his servants: Bring forth quickly the first robe, and put it on him, and put a ring on his hand, and shoes on his feet:

carob-tree enclosed in pods like beans; they were eaten pod and all, and were used to fatten pigs. If we see in the younger son the Gentile world, we can understand the state of want and misery to which the latter was reduced before the coming of our Lord. The culture and science of Greece, the wealth and luxuries of Rome, all pagan religions had striven for centuries to satisfy the heart of man, but all in vain. The state of the Gentiles at the coming of Christ was one of abject poverty of spirit and heart, fitly represented indeed, by this poor prodigal feeding on the husks of swine. Rightly indeed could it be said that "no man gave unto him." The efforts of man had been exhausted, and still the human heart was empty and full of hunger.

18. I will arise, and will go to my father, etc. The calling of the Gentiles to the Gospel teaching, and the raising of every sinner from a state of sin to a state of grace, are not the work of man, nor of the will of man, but the effect of divine grace illuminating the understanding and moving the will. The first movements of the will towards God are the effects of God's prevenient grace. Thus God's grace was the cause of the salutary resolution of the prodigal to arise and go to his father and ask pardon for his sin.

19. This verse shows the state of sincere repentance in which the prodigal approached his father.

20. Here we see represented the loving kindness of Almighty God towards the sinner, and His readiness to receive him back into His friendship.

22. The first robe . . . and a ring. The robe and the ring were ever regarded in the Orient as among the highest tokens of favor and honor (Gen. xli. 42; I Mach. vi. 15). This verse, therefore,

23. And bring hither the fatted calf, and kill it, and let us eat and make merry :

24. Because this my son was dead, and is come to life again : was lost, and is found. And they began to be merry.

25. Now his elder son was in the field, and when he came and drew nigh to the house, he heard music and dancing :

26. And he called one of the servants, and asked what these things meant.

27. And he said to him : Thy brother is come, and thy father hath killed the fatted calf, because he hath received him safe.

28. And he was angry, and would not go in. His father therefore coming out began to entreat him.

29. And he answering, said to his father : Behold, for so many years do I serve thee, and I have never transgressed thy commandment, and yet thou hast never given me a kid to make merry with my friends :

30. But as soon as this thy son is come, who hath devoured his substance with harlots, thou hast killed for him the fatted calf.

31. But he said to him : Son, thou art always with me, and all I have is thine.

32. But it was fit that we should make merry and be glad, for this thy brother was dead and is come to life again ; he was lost, and is found.

shows that the prodigal was received back by his father and given the highest signs of honor and love.

23. **The fatted calf** ; i.e., the calf which had evidently been kept for a time of special celebration.

25. **He heard music and dancing.** This does not mean that the members of the family themselves were playing music and dancing, which would be alien to the manners and feelings of the East ; but that the members of the family were assisting at the music and dancing furnished by others hired for the occasion.

28-32. If in the elder brother we see the Pharisee, and in the younger the publican, it is difficult to reconcile the following points : (a) the scope of the parable, which was aimed at the Pharisees, as against those whose righteousness was not real but feigned and hypocritical ; with (b) the apparent genuine goodness of the elder brother who had never departed from his father.

To solve this difficulty some commentators have thought that the father passes over the question of the elder brother's righteousness, not saying whether it was real or hypocritical ; but, granting it to be as the brother protests it is, the father argues with him about his begrudging attitude towards his younger brother. Others think, and more probably, that the protested and uncontradicted goodness of the elder brother was not altogether false and unreal,

but of a low standard, — a legal, servile, narrow justice which came from the Law, but which was far removed from the broad charity and mercy that should be characteristic of the New Kingdom, the Church of Christ. Into the spirit of this New Kingdom of charity and mercy the elder brother is invited to enter; but he hesitates and murmurs, not being able with his legal narrowness to take in the breadth of the spirit of Christ.

It may rightly be said that the elder son, inasmuch as he stayed with his father and observed his commands, is a type of the really and truly just, but in so far as he murmured, criticized his father, and envied his brother, he represented the Scribes and Pharisees whose justice for the most part was only feigned and hypocritical.

## CHAPTER XVI

THE PARABLE OF THE UNJUST STEWARD, 1-13.

THE REBUKE OF THE PHARISEES, AND THE SANCTITY  
OF MARRIAGE, 14-18.

THE PARABLE OF THE RICH MAN AND LAZARUS, 19-31.

1. And he said also to his disciples: There was a certain rich man who had a steward: and the same was accused unto him, that he had wasted his goods.

In the preceding parable of the Prodigal Son, which was probably spoken before the one which here follows, in the same place and at the same time, our Lord shows how riches can be squandered by riotous living and for evil ends; but in the present parable He wishes to teach us how to use them for our spiritual welfare and eternal salvation. This Parable of the Unjust Steward was addressed not only to the disciples, but to all who were then following our Lord.

**A certain rich man.** By "rich man" some understand Almighty God, the Lord of heaven and earth, with respect to whom we are all stewards. Others think that by the "rich man" we must understand Mammon personified. Since this is only a parable or illustration, it would seem more probable to say that by "rich man" no particular person is to be understood.

**A steward;** i.e., a dispenser (*οἰκονόμος*), who had charge of his

2. And he called him, and said to him: How is it that I hear this of thee? give an account of thy stewardship: for now thou canst be steward no longer.

3. And the steward said within himself: What shall I do, because my lord taketh away from me the stewardship? To dig I am not able; to beg I am ashamed.

4. I know what I will do, that when I shall be removed from the stewardship, they may receive me into their houses.

5. Therefore calling together every one of his lord's debtors, he said to the first: How much dost thou owe my lord?

6. But he said: An hundred barrels of oil. And he said to him: Take thy bill and sit down quickly, and write fifty.

7. Then he said to another: And how much dost thou owe? Who said: An hundred quarters of wheat. He said to him: Take thy bill, and write eighty.

8. And the lord commended the unjust steward, forasmuch as he had done wisely: for the children of this world are wiser in their generation than the children of light.

master's goods. **Was accused unto him;** i.e., was "denounced" (*διεβλήθη*).

**That he had wasted his goods;** i.e., the goods of his master to whom he was responsible.

2. **For now thou canst be steward no longer.** The spiritual meaning of these words is found in the death of each of us, after which we shall immediately be obliged to give an account of our stewardship. At death the time for work and merit will be over.

4. **They may receive me into their houses;** i.e., that the lord's debtors might receive him in his need and provide for his wants.

6. **An hundred barrels of oil.** A barrel (Gr. *βάτος*; Heb. *Bath*) was equal to about seven gallons.

7. **An hundred quarters of wheat.** A quarter (Gr. *κόρος*; Heb. *Cor*) was about sixty-four gallons, the largest dry measure among the Jews. It is evident that these two debts were very large.

8. **Forasmuch as he has done wisely;** i.e., shrewdly (*φρονίμως*). It is certain that our Lord did not here mean to commend the unjust action of the steward, but only his cunning and shrewdness.

**For the children of this world are wiser;** i.e., those who are guided by the wisdom of this world and labor for the possession of worldly ends and perishable riches are far more shrewd, zealous, and cunning in their efforts and dealings than are the children of light, i.e., than are those who profess to live by the light of the Gospel and labor for spiritual ends.

9. And I say to you: Make unto you friends of the mammon of iniquity; that when you shall fail, they may receive you into everlasting dwellings.

10. He that is faithful in that which is least, is faithful also in that which is greater: and he that is unjust in that which is little, is unjust also in that which is greater.

11. If then you have not been faithful in the unjust mammon; who will trust you with that which is the true?

12. And if you have not been faithful in that which is another's; who will give you that which is your own?

9. I say to you. Our Lord now begins to apply the parable in a practical way. **Make unto you friends of the mammon of iniquity.** Mammon is an Aramaic or Syrian word, meaning "riches." Riches are called "mammon of iniquity" because of their tendency to lead men into sin. Our Lord here tells His followers so to use riches for the glory of God, for the relief of the poor, and for their spiritual welfare, that when death comes they may receive an eternal reward, as a recompense for the good uses to which they shall have put their earthly possessions.

**That when you shall fail;** i.e., when you shall die. The best MSS. have, "when it shall fail." The meaning is the same. The good uses to which riches may be put are here personified and spoken of as being with God and waiting to receive their faithful and religious stewards into eternal happiness.

**Everlasting dwellings,**—literally, "everlasting tents." The allusion is to the tents of the Israelites which they used after leaving Egypt, and which were a type of the everlasting dwellings in Heaven.

10, 11. Our Lord now calls attention to the well-known fact that he who is faithful in little things will be faithful also in great things; he that is just in the discharge of temporal things will usually be found just in spiritual things. This precept about fidelity to little things seems out of place here; its natural place is after the two parables of the servants who are rewarded according to their fidelity in making their talents bear fruit (Luke xix. 11-28; Matthew xxv. 14-23).

12. **Who will give you that which is your own?** If we accept the reading "your own" (*ὑμέτερον*), the meaning is: If you have misused the temporal gifts of God entrusted to you, how will He trust you with the spiritual gifts which you need as a means to

13. No servant can serve two masters: for either he will hate the one, and love the other; or he will hold to the one, and despise the other. You cannot serve God and mammon.

14. Now the Pharisees, who were covetous, heard all these things: and they derided him.

15. And he said to them: You are they who justify yourselves before men, but God knoweth your hearts; for that which is high to men, is an abomination before God.

16. The law and the prophets were until John; from that time the kingdom of God is preached, and every one useth violence towards it.

17. And it is easier for heaven and earth to pass, than one tittle of the law to fall.

your end. Some MSS. have "our own" (*ἡμέτερον*)—according to which the meaning would be: Which of us would trust you with that which is our own, if you have been unfaithful with that which is God's?

13. **No servant can serve two masters;** i.e., no one can be the slave, or devoted servant of two masters diametrically opposed, as are God and mammon.

14. **Covetous;** i.e., devoted to, or the slave of riches.

**Derided him.** The Pharisees were incensed at our Lord's condemnation of riches, because they thought that the amassing of wealth was entirely compatible with God's service, especially since the Law of Moses had promised temporal blessings to its faithful observers.

15. **God knoweth your hearts.** Before men the Pharisees affected to be, and were reputed to be, just; but God, who could read their hearts, saw that they were filled with avarice, hypocrisy, and injustice.

**That which is high to men, etc.;** i.e., things that appear very great and good in the eyes of the world may be an abomination before God.

16. **The law and the prophets were until John;** i.e., that Law which promised temporal rewards to its faithful observers, but which was only a shadow of the New Law, was in force till the time of John the Baptist; but since that time the New Law, the Law of the Gospel, is preached, and promises, not temporal but eternal rewards to those who obey it. See also on Matthew xi.

12-14.

17. See on Matthew v. 18, 19.



18. Every one that putteth away his wife, and marrieth another, committeth adultery: and he that marrieth her that is put away from her husband, committeth adultery.

19. There was a certain rich man, who was clothed in purple and fine linen; and feasted sumptuously every day.

18. See on Matthew v. 31, 32; xix. 9. This verse calls attention to a part of the Law which the Pharisees commonly violated, hence its connection with the foregoing verses.

19. It is the opinion of many commentators that verses 13-18, inclusive, of this chapter were spoken on a different occasion, and inserted here by St. Luke when he wrote his Gospel, without much connection with what precedes or follows in the chapter. There is, however, a real connection. In the first ten verses our Lord is showing how riches can be prudently and profitably used in doing good, for spiritual ends; and now He describes to the Pharisees who "derided him" the terrible punishment which will befall those who neglect to relieve the poor and put their riches to higher uses.

Our Lord also wishes to show in the parable, or example, which follows, the difference between the true Israelites who were really faithful to the Law and the Prophets, and the false ones, like the Pharisees, who cited the Law and Prophets only when it was to their advantage, and who pretended a justice and an observance which did not belong to them.

It is a question among commentators whether our Lord is here (19-31) relating a historical fact, or giving a mere parable or imaginary picture, typical albeit of realities. The majority hold that He is recounting a historical fact, colored here and there with parabolical imagery.

The parable is directed against the Pharisees, who are called *covetous* or lovers of wealth, and who derided our Lord (verse 14) for warning them against the dangers of riches. But both in the Pharisees and in the rich man in the parable, the sin primarily condemned, the evil root out of which their other sins grew, is their lack of faith, of real belief in God and in spiritual things, and their consequent attachment to worldly possessions. The Pharisees were covetous, but they are nowhere charged with excess and prodigality in living; many of them, on the contrary, were austere ascetics. Their covetousness consisted in undue gathering and hoarding of

20. And there was a certain beggar, named Lazarus, who lay at his gate, full of sores,

21. Desiring to be filled with the crumbs that fell from the rich man's table, and no one did give him; moreover the dogs came, and licked his sores.

22. And it came to pass, that the beggar died, and was carried by the angels into Abraham's bosom. And the rich man also died: and he was buried in hell.

23. And lifting up his eyes when he was in torments, he saw Abraham afar off, and Lazarus in his bosom:

wealth, rather than in undue pursuit of pleasure. The primary intention, therefore, of this parable is to teach the dreadful consequences of unbelief in God and spiritual things, and of attachment to the things of the world. Inordinate self-indulgence, the abuse of wealth and hard-heartedness towards the poor, which were sins of the rich man in the parable, are the logical results of unbelief in God.

**A certain rich man.** Our Lord does not give the name of the rich man because, as St. Augustine says (*Serm. xli*), He seems to have "been reading from the Book of Life where He found the name of the poor man written, but found not the name of the rich."

20. **Lazarus**, — which means, "helped by God," or "God is my help."

21. **And no one did give him.** These words are not expressed in the Greek, although the utter destitution which they show is evident from the context.

22. **Into Abraham's bosom.** This was a familiar phrase among the Jews to express intimate relationship, innermost communion. The Jews thought that all true believers were taken after death into Abraham's bosom, i.e., into intimate companionship with the father of their race.

**Buried in hell.** The word "hell" means "Hades" (Heb. *Sheol*), which was a general term to designate the abode of all those who died before the Resurrection of Christ. Hades, therefore, was divided into two parts — one called Abraham's bosom, or Paradise (the *Limbo* of the Fathers); and *Gehenna*, or the place of torment for the wicked. Cf. on Matthew v. 30; xi. 23; xvi. 18; Luke x. 15. See also article by M. Tonzard, *Revue Biblique*, April, 1898.

23. **When he was in torments.** These words show that Dives was in that part of Hades called *Gehenna*.

**He saw Abraham afar off**, etc. These are figurative words

24. And he cried, and said: Father Abraham, have mercy on me, and send Lazarus, that he may dip the tip of his finger in water, to cool my tongue: for I am tormented in this flame.

25. And Abraham said to him: Son, remember that thou didst receive good things in thy lifetime, and likewise Lazarus evil things, but now he is comforted; and thou art tormented.

26. And besides all this, between us and you, there is fixed a great chaos: so that they who would pass from hence to you, cannot, nor from thence come hither.

27. And he said: Then, father, I beseech thee, that thou wouldst send him to my father's house, for I have five brethren,

which express the eternal anguish of the damned, as they ever revolve and compare in mind their miserable state with the state of the Blessed in Heaven.

24. **To cool my tongue.** This is a tropological way of expressing Dives' torment; although neither his tongue nor his body was in that place of punishment, yet there is mention of the tongue, perhaps because it was through that member that he had most offended during life. Cf. Apoc. xviii. 7.

**I am tormented in this flame.** Theologians are not agreed as to the manner in which material fire can torment a spirit. Suarez says that it is by a supernatural virtue communicated to fire; St. Thomas holds that material fire torments the lost spirits by *ligation*, by restraining them, and thus inhibiting their activity, which is the greatest torment a spirit can suffer.

25. **Good things.** In the Greek it is, "thy good things," — which were his temporal felicities, his purple and fine linen.

**Lazarus evil things,** — which were his poverty, his hunger, and his ulcers. The rich man was condemned not because he possessed riches, but because he abused them. Many of the saints had great possessions, but used them for good ends. Lazarus was rewarded not because he was poor and in suffering, but because of his poverty of spirit, his patience and resignation — all of which were the result of his faith.

26. **There is fixed a great chaos;** i.e., a great gulf, a chasm, which no one can bridge, and this "fixed," unchangeable.

27. **That thou wouldst send him,** etc. These words seem to indicate that Dives and his brothers were Sadducees at heart, who did not believe in the spirit world, and who, perhaps, as St. Augustine says, had often during life mocked together at that unseen world.

28. That he may testify unto them, lest they also come into this place of torments.

29. And Abraham said to him: They have Moses and the prophets; let them hear them.

30. But he said: No, father Abraham: but if one went to them from the dead, they will do penance.

31. And he said to him: If they hear not Moses and the prophets, neither will they believe, if one rise again from the dead.

28. Testify; i.e., admonish.

29. They have Moses and the prophets; i.e., they have God's inspired word in the Old Testament, which teaches everything sufficient for salvation.

30. If they hear not Moses, etc.; i.e., if they would not believe the word of God as revealed through Moses and the prophets, neither would they believe anyone who would come back from the dead, or as Abraham put it, prophetically foreseeing the Resurrection of Christ, "if one rise again from the dead." A similar answer might be given to the unbelievers of to-day. They have the revelations of the New Testament and the infallible teaching of Christ's Church; if they do not believe these, neither would they believe anyone coming back from the spirit world.

## CHAPTER XVII

SCANDAL, FRATERNAL CORRECTION, FAITH, OUR  
DUTY, 1-10.

THE TEN LEPERS, 11-19.

THE KINGDOM OF GOD, AND THE RETURN OF THE SON  
OF MAN, 20-37.

1. And he said to his disciples: It is impossible that scandals should not come: but woe to him through whom they come.

2. It were better for him, that a millstone were hanged about his neck, and he cast into the sea, than that he should scandalize one of these little ones.

3. Take heed to yourselves. If thy brother sin against thee, reprove him: and if he do penance, forgive him.

4. And if he sin against thee seven times in a day, and seven times in a day be converted unto thee, saying, I repent; forgive him.

5. And the apostles said to the Lord: Increase our faith.

1, 2. See on Matthew xviii. 6-8.

3, 4. See on Matthew xviii. 21, 22.

6. And the Lord said: If you had faith like to a grain of mustard seed, you might say to this mulberry tree, Be thou rooted up, and be thou transplanted into the sea: and it would obey you.

7. But which of you having a servant ploughing, or feeding cattle, will say to him, when he is come from the field: Immediately go, sit down to meat:

8. And will not rather say to him: Make ready my supper, and gird thyself, and serve me, whilst I eat and drink, and afterwards thou shalt eat and drink?

9. Doth he thank that servant, for doing the things which he commanded him?

10. I think not. So you also, when you shall have done all these things that are commanded you, say: We are unprofitable servants; we have done that which we ought to do.

6. See on Matthew xvii. 19. Our Lord speaks here of the "mulberry tree" which was perhaps nearby, as was doubtless also the mountain of which He spoke in St. Matthew.

7-10. Commentators have always found it difficult to see a connection between these verses and their immediate context. Some have denied all connection; others have traced a connection, but in different ways. There seems however to be a real connection when we reflect that our Lord had just been exhorting His disciples to special virtues and declaring to them the mighty works which a lively faith would enable them to perform; and then, lest a knowledge of these gifts should tempt them to pride and vain self-complacency, He gives them a parable to teach them humility. He wishes them, and all of us, ever to bear in mind that we are but servants, and that when we labor for Him or keep His commandments we are doing only what we ought to do.

**We are unprofitable servants.** It by no means follows from these words of our Lord that our good works are not meritorious, or that we shall not be rewarded for virtuous living. Hence He did not say, you are "unprofitable servants"; but "say you: we are unprofitable servants." He is inculcating humility, and he wishes His disciples and all His followers to recognize at all times that He by His grace, and not we ourselves, is the cause and source of all the good we do. We are unprofitable servants in the sense that of ourselves we can do nothing worthy of eternal life, and that when assisted by His grace, we owe all to Him and are doing only what we ought to do. In strict justice Almighty God is not

11. And it came to pass, as he was going to Jerusalem, he passed through the midst of Samaria and Galilee.

12. And as he entered into a certain town, there met him ten men that were lepers, who stood afar off;

13. And lifted up their voice, saying: Jesus, master, have mercy on us.

14. Whom when he saw, he said: Go, shew yourselves to the priests. And it came to pass, as they went, they were made clean.

15. And one of them, when he saw that he was made clean, went back, with a loud voice glorifying God.

16. And he fell on his face before his feet, giving thanks: and this was a Samaritan.

17. And Jesus answering, said, Were not ten made clean? and where are the nine?

18. There is no one found to return and give glory to God, but this stranger.

bound to give us any reward; but according to the riches of His grace, He *will* reward us.

11. **As he was going to Jerusalem, etc.** This was our Lord's final departure from Galilee, and He was passing through the country lying between, or on the borders of, Samaria and Galilee (*διὰ μέσον*). See on Matthew xix. 1.

12. **A certain town**, which was on the confines of the two provinces of Samaria and Galilee.

**Who stood afar off.** The lepers did not draw near to our Lord, because their loathsome disease according to the Law of Moses excluded them from the society of others. See on v. 12-14.

13. **Jesus, master.** The term "master" (*ἐπιστάτα*) is peculiar to St. Luke and means not a mere teacher, but one who taught with special authority.

14. **Go shew yourself to the priests.** This our Lord bade the lepers do to test their faith and obedience, in virtue of which they were healed as they went. The priests had no power to heal the lepers; all they could do was to give them a certificate testifying to their cure and admitting them again to society. Cf. on Matthew viii. 4-6; Luke v. 12.

15. **And one of them when he saw, etc.** As the lepers were cured on their way to the priests, it may be concluded that this one turned immediately back to render thanks for his cure. It is likely that this leper was not only cleansed in body, but in soul also (verse 19).

16-18. **And this was a Samaritan.** St. Luke calls attention to

19. And he said to him: Arise, go thy way; for thy faith hath made thee whole.

20. And being asked by the Pharisees, when the kingdom of God should come? he answered them, and said: The kingdom of God cometh not with observation:

21. Neither shall they say: Behold here, or behold there. For lo, the kingdom of God is within you.

22. And he said to his disciples: The days will come, when you shall desire to see one day of the Son of man; and you shall not see it.

23. And they will say to you: See here, and see there. Go ye not after, nor follow them:

24. For as the lightning that lighteneth from under heaven, shineth unto the parts that are under heaven, so shall the Son of man be in his day.

this to show that "this stranger," who was alien to the Jews both by race and religion, had more gratitude than they who, as the chosen people, had been the objects of God's continual and special Providence.

19. **For thy faith hath made thee whole.** These words seem to indicate that the Samaritan had been liberated from the leprosy of sin, as well as from his physical malady.

20. **The kingdom of God cometh not with observation.** The Pharisees had just asked our Lord when the temporal reign of the Messiah, the Kingdom of God, was to begin; and He replied that the Kingdom of God would not come with wealth and pomp and splendor, like earthly kingdoms. The Kingdom of God was to be spiritual; their ideas of it were carnal.

21. **The kingdom of God is within you.** "Within you" means "in your midst" (*ἐν τῷ ὑμῶν*). We must bear in mind that our Lord was replying to the Pharisees, and He told them that the Kingdom of God was already in their midst. It was this Kingdom that He was preaching, that He was inaugurating, and they did not recognize it. It seems altogether wrong to say that "within you" means "in your hearts," for the Kingdom of God was certainly not in the hearts of the Pharisees, to whose question our Lord was replying.

22-24. See on Matthew xxiv. 23-27. Here our Lord is speaking of the time between His Ascension and His second coming, and foreseeing most likely that many of His followers would grow weary of waiting for Him, He warns them not to be deceived by false reports or false prophets.

25. But first he must suffer many things, and be rejected by this generation.

26. And as it came to pass in the days of Noe, so shall it be also in the days of the Son of man.

27. They did eat and drink, they married wives, and were given in marriage, until the day that Noe entered into the ark: and the flood came and destroyed them all.

28. Likewise as it came to pass, in the days of Lot: they did eat and drink, they bought and sold, they planted and built.

29. And in the day that Lot went out of Sodom, it rained fire and brimstone from heaven, and destroyed them all.

30. Even thus shall it be in the day when the Son of man shall be revealed.

31. In that hour, he that shall be on the housetop, and his goods in the house, let him not go down to take them away: and he that shall be in the field, in like manner, let him not return back.

32. Remember Lot's wife.

33. Whosoever shall seek to save his life, shall lose it: and whosoever shall lose it, shall preserve it.

34. I say to you: in that night there shall be two men in one bed; the one shall be taken, and the other shall be left.

35. Two women shall be grinding together: the one shall be taken, and the other shall be left: two men shall be in the field; the one shall be taken, and the other shall be left.

36. They answering, say to him: Where, Lord?

25. Here our Lord again predicts His Passion, as He had done several times before (ix. 22; xii. 49; xiii. 33).

26, 27. See on Matthew xxiv. 37-39.

28-30. In these verses our Lord is giving another illustration of the unexpected manner which will characterize His second coming. Cf. Gen. xix. 25.

31. See on Matthew xxiv. 16-18.

32. Lot's wife had been commanded by the angel not to look back at Sodom after leaving it; but her inordinate attachment to persons and things there led her to disobey, and she was turned into a pillar of salt. Cf. Gen. xix. 26. Our Lord is now warning the disciples to disengage themselves from all inordinate attachment to the world and worldly things.

33. See on Matthew x. 39; xvi. 25.

34, 35. See on Matthew xxiv. 40, 41.

36. **Where, Lord?** Having heard our Lord speak of the separation of the good and the bad, of one being taken and another left, the disciples asked where this should take place.



37. Who said to them: Wheresoever the body shall be, thither will the eagles also be gathered together.

37. **Thither will the eagles**, etc. Vultures are called *eagles* in Scripture. As vultures in great multitudes quickly gather to devour the body of an animal that has died in the desert, so at the end of the world will the angels swiftly come to gather God's Elect from the four winds. The angels come to save, the vultures to destroy, but this is not the likeness of the illustration; the likeness of the comparison is in the swiftness with which the coming is made.

## CHAPTER XVIII

THE PARABLE OF THE UNJUST JUDGE, 1-8.

THE PHARISEE AND THE PUBLICAN, 9-17.

LESSONS ON POVERTY, 18-30.

JESUS FORETELLS HIS PASSION, 31-34.

THE BLIND MAN OF JERICHO, 35-43.

1. And he spoke also a parable to them, that we ought always to pray, and not to faint,

2. Saying: There was a judge in a certain city, who feared not God, nor regarded man.

1. **That we ought always to pray**, etc. Our Lord had been telling the disciples of the temptations and trials which would usher in the last days before His second coming, and He wished to caution them that they should not grow weary, but be ever instant in prayer. But how are we always to pray? By a habitual love of God and hatred for sin, and by habitually living in His presence and performing our actions for His sake. St. Augustine explains it thus: "Can we indeed without ceasing bend the knee, bow the body or lift up the hands, that we should say 'Pray without ceasing'? There is another interior prayer without intermission, and that is the longing of thy heart. . . . If thou wishest not to intermit to pray, see that thou do not intermit to desire; thy continual desire is thy continual voice" (*In Ps. xxxvii. 10*).

3. And there was a certain widow in that city, and she came to him, saying: Avenge me of my adversary.

4. And he would not for a long time. But afterwards he said within himself: Although I fear not God, nor regard man,

5. Yet because this widow is troublesome to me, I will avenge her, lest continually coming she weary me.

6. And the Lord said: Hear what the unjust judge saith.

7. And will not God revenge his elect who cry to him day and night: and will he have patience in their regard?

8. I say to you, that he will quickly revenge them. But yet the Son of man, when he cometh, shall he find, think you, faith on earth?

9. And to some who trusted in themselves as just, and despised others, he spoke also this parable:

10. Two men went up into the temple to pray: the one a Pharisee, and the other a publican.

3. **A certain widow.** The destitution of the state of widowhood in the East was extreme. So helpless were widows that they had a kind of claim for protection from the Law (Deut. xiv. 29; xvi. 11; Acts vi. 1, etc.).

**Avenge me of my adversary,** — literally, “do me right on my adversary; give me justice on my oppressor” (*ἐκδίκησον*).

5. **Lest continually coming she weary me,** — literally, “lest in the end she bruise me in the face” (*ὄπωπιάζῃ*). Although the judge was hard and unjust, he was willing to grant the request of the widow because of her perseverance.

6-8. In these verses our Lord says that if the unjust judge finally heard the request of the helpless widow, how much more will God, who is justice and goodness itself, hear the prayers of His Elect!

**But yet the Son of man when he cometh, shall he find, think you, faith on earth?** i.e., will there be at the end of the world, just before the second coming of Christ, that lively faith which is trustful in the midst of difficulties, which inspires one to hope against hope?

9. **And to some who trusted in themselves,** etc. Having just exhorted His disciples to perseverance in prayer, our Lord now, by addressing some of the Pharisees who were present, teaches His disciples by a parable the kind of prayer they ought to practice; namely, humble, penitent prayer.

10. **Went up into the temple.** The two men are said to have gone “up,” because the Temple was on Mt. Moriah.

11. The Pharisee standing, prayed thus with himself: O God, I give thee thanks that I am not as the rest of men, extortioners, unjust, adulterers, as also is this publican.

12. I fast twice in a week: I give tithes of all that I possess.

13. And the publican, standing afar off, would not so much as lift up his eyes towards heaven; but struck his breast, saying: O God, be merciful to me a sinner.

14. I say to you, this man went down into his house justified rather than the other: because every one that exalteth himself, shall be humbled: and he that humbleth himself, shall be exalted.

15. And they brought unto him also infants, that he might touch them. Which when the disciples saw, they rebuked them.

16. But Jesus, calling them together, said: Suffer children to come to me, and forbid them not: for of such is the kingdom of God.

**A Pharisee.** See on Matthew iii. 7. **A publican.** See on Matthew v. 46.

11. **The Pharisee standing prayed thus, etc.** According to the sentiment that animated them the Jews prayed sometimes standing, sometimes on their knees (3 Kings viii. 22; 2 Paral. vi. 12; Dan. vi. 10; 2 Paral. vi. 13). Catholics for the most part pray kneeling in accordance with the perpetual tradition of the Church. The Pharisee is said to have prayed "with himself," because his prayer proceeded from himself and not from the grace of God, because it was an act of self-praise and had not God's approval.

**O God, I give thee thanks, etc.** The Pharisee thanked God in words, but in his heart he meant to praise himself; in fact he used this form of address only to ventilate his own superiority.

12. **I give tithes.** See on Matthew xxiii. 23.

13. **And the publican standing afar off, etc.** He was perhaps standing in the Court of the People. It was against the Law for publicans to enter the Temple, unless they were pagans, and then their place was in the Court of the Gentiles. This publican seems to have been a Jew.

**To me a sinner,**—literally, "to me the sinner," as if the publican regarded himself as the greatest of all sinners.

14. **This man went down into his house justified rather than the other.** This does not mean that the justification of the publican was relative, as compared with that of the Pharisee; his justification was absolute, as is clear from the context.

15, 16. See on Matthew xix. 13, 14.

17. Amen, I say to you: Whosoever shall not receive the kingdom of God as a child, shall not enter into it.

18. And a certain ruler asked him, saying: Good master, what shall I do to possess everlasting life?

19. And Jesus said to him: Why dost thou call me good? None is good but God alone.

20. Thou knowest the commandments: Thou shalt not kill: Thou shalt not commit adultery: Thou shalt not steal: Thou shalt not bear false witness: Honour thy father and mother.

21. Who said: All these things have I kept from my youth.

22. Which when Jesus had heard, he said to him: Yet one thing is wanting to thee: sell all whatever thou hast, and give to the poor, and thou shalt have treasure in heaven: and come, follow me.

23. He having heard these things, became sorrowful; for he was very rich.

24. And Jesus seeing him become sorrowful, said: How hardly shall they that have riches enter into the kingdom of God.

25. For it is easier for a camel to pass through the eye of a needle, than for a rich man to enter into the kingdom of God.

26. And they that heard it, said: Who then can be saved?

27. He said to them: The things that are impossible with men, are possible with God.

28. Then Peter said: Behold, we have left all things, and have followed thee.

29. Who said to them: Amen, I say to you, there is no man that hath left house, or parents, or brethren, or wife, or children, for the kingdom of God's sake,

30. Who shall not receive much more in this present time, and in the world to come life everlasting.

31. Then Jesus took unto him the twelve, and said to them: Behold, we go up to Jerusalem, and all things shall be accomplished which were written by the prophets concerning the Son of man.

32. For he shall be delivered to the Gentiles, and shall be mocked, and scourged, and spit upon:

33. And after they have scourged him, they will put him to death; and the third day he shall rise again.

34. And they understood none of these things, and this word was hid from them, and they understood not the things that were said.

35. Now it came to pass, when he drew nigh to Jericho, that a certain blind man sat by the way side, begging.

17. See on Matthew xviii. 3.

18-20. See on Matthew xix. 16-19.

22, 23. See on Matthew xix. 21, 22.

24-30. See on Matthew xix. 23-29.

31-34. See on Matthew xx. 17-19.

35. See on Matthew xx. 29, 30.

36. And when he heard the multitude passing by, he asked what this meant.
37. And they told him, that Jesus of Nazareth was passing by.
38. And he cried out, saying: Jesus, son of David, have mercy on me.
39. And they that went before, rebuked him, that he should hold his peace: but he cried out much more: Son of David, have mercy on me.
40. And Jesus standing, commanded him to be brought unto him. And when he was come near, he asked him,
41. Saying: What wilt thou that I do to thee? But he said: Lord, that I may see.
42. And Jesus said to him: Receive thy sight: thy faith hath made thee whole.
43. And immediately he saw, and followed him, glorifying God. And all the people, when they saw it, gave praise to God.

36-43. In these verses we have an illustration of what our Lord was trying to teach the disciples in the first verses of the present chapter. It was the constant faith of the blind man that moved our Lord to restore his sight.

## CHAPTER XIX

ZACHEUS THE PUBLICAN, 1-10.

THE PARABLE OF THE POUNDS, 11-27.

THE TRIUMPHAL ENTRY OF JESUS INTO JERUSALEM,  
28-44.

THE PROFANERS OF THE TEMPLE, 45-48.

1. And entering in, he walked through Jericho.
2. And behold, there was a man named Zacheus, who was the chief of the publicans, and he was rich.
3. And he sought to see Jesus who he was, and he could not for the crowd, because he was low of stature.
4. And running before, he climbed up into a sycamore tree, that he might see him; for he was to pass that way.

1. Jericho. See on Matthew xx. 29.
2. Zacheus . . . chief of the publicans. Zacheus was not one of the actual tax-collectors, but a superintendent (*ἀρχιτελώνης*) placed over the collectors.
4. A sycamore tree. The sycamore was a species of fig-tree, called the "Egyptian fig-tree"; its leaves were like those of a mulberry; its size and shape like a fig-tree.

5. And when Jesus was come to the place, looking up, he saw him, and said to him: Zacheus, make haste and come down; for this day I must abide in thy house.

6. And he made haste and came down; and received him with joy.

7. And when all saw it, they murmured, saying, that he was gone to be a guest with a man that was a sinner.

8. But Zacheus standing, said to the Lord: Behold, Lord, the half of my goods I give to the poor; and if I have wronged any man of any thing, I restore him fourfold.

9. Jesus said to him: This day is salvation come to this house, because he also is a son of Abraham.

10. For the Son of man is come to seek and to save that which was lost.

11. As they were hearing these things, he added and spoke a parable, because he was nigh to Jerusalem, and because they thought that the kingdom of God should immediately be manifested.

12. He said therefore: A certain nobleman went into a far country, to receive for himself a kingdom, and to return.

5. Jesus . . . said to him: Zacheus, make haste, etc. Although our Lord had never seen Zacheus before, He calls him by his name.

7. They murmured. The Pharisees complained at our Lord's friendship with Zacheus, because the latter, on account of his infamous profession, was regarded as a great sinner.

8. But Zacheus standing said to the Lord. Zacheus had overheard the murmuring of the Pharisees, and now to prove in public the genuineness of his repentance and conversion he says that he is willing, if he has wronged any man, to restore fourfold. This was much more than the Law required, for the Law (Num. v. 7) said that if anyone had defrauded another, he should restore the principal itself and a fifth part over and above; Zacheus is ready to do much more.

9. Because he also is a son of Abraham. There were two reasons why Zacheus merited forgiveness and approval by our Lord: (a) because he was a son of Abraham; (b) because he was one of the lost sheep of the House of Israel. As said on Matt. xv. 24, our Lord's mission during His time on earth was chiefly to the Jewish people, to reclaim the "lost sheep of the house of Israel"; but after His Ascension this mission of redemption was extended through the Apostles to all the world.

11, 12. See on Matthew xxv. 14. The certain nobleman refers to our Lord; the far country to the Kingdom of Heaven

13. And calling his ten servants, he gave them ten pounds, and said to them : Trade till I come.

14. But his citizens hated him : and they sent an embassy after him, saying : We will not have this man to reign over us.

15. And it came to pass, that he returned, having received the kingdom : and he commanded his servants to be called, to whom he had given the money, that he might know how much every man had gained by trading.

16. And the first came, saying : Lord, thy pound hath gained ten pounds.

17. And he said to him : Well done, thou good servant, because thou hast been faithful in a little, thou shalt have power over ten cities.

18. And the second came, saying : Lord, thy pound hath gained five pounds.

19. And he said to him : Be thou also over five cities.

20. And another came, saying : Lord, behold here is thy pound, which I have kept laid up in a napkin ;

to which our Lord was soon to ascend ; and the return represents the second coming of Christ.

13. He gave them ten pounds. A pound, or *mina*, was worth about 100 *denarii*, or about \$17.00 in our money. In their application the pounds represent the various talents and gifts with which Almighty God has endowed each one of us, and which we are supposed to use for His glory and our own salvation.

14. But his citizens hated him, etc. It was not infrequent for the Jews, who hated their Roman rulers, to appeal to Rome to have them removed. The words of the text here have reference to this custom ; but in their application they refer to the Jewish people who as a body hated and rejected our Lord.

15. It came to pass that he returned, etc. These words refer to the second coming of Christ and the General Judgment, when each one shall be rewarded or punished according to his works.

17. Well done thou good servant . . . thou shalt have power over ten cities. It was customary in the East for kings to reward the faithfulness of their servants by making them rulers over districts or provinces. Thus, also, hereafter Christ will reward the faithful servants by placing them, as it were, on thrones, i.e., by rewarding them according to their merits.

19. Be thou also over five cities. The reward in the second case is as absolute as in the first, although less in degree, in accordance with the few talents employed. This shows the differences in the reward of the Elect, which shall be proportioned to each one's merits.

21. For I feared thee, because thou art an austere man: thou takest up what thou didst not lay down, and thou reapest that which thou didst not sow.

22. He saith to him: Out of thy own mouth I judge thee, thou wicked servant. Thou knewest that I was an austere man, taking up what I laid not down, and reaping that which I did not sow:

23. And why then didst thou not give my money into the bank, that at my coming, I might have exacted it with usury?

24. And he said to them that stood by: Take the pound away from him, and give it to him that hath ten pounds.

25. And they said to him: Lord, he hath ten pounds.

26. But I say to you, that to every one that hath shall be given, and he shall abound: and from him that hath not, even that which he hath, shall be taken from him.

27. But as for those my enemies, who would not have me reign over them, bring them hither, and kill them before me.

28. And having said these things, he went before, going up to Jerusalem.

29. And it came to pass, when he was come nigh to Bethphage and Bethania, unto the mount called Olivet, he sent two of his disciples,

30. Saying: Go into the town which is over against you, at your entering into which you shall find the colt of an ass tied, on which no man ever hath sitten: loose him, and bring him hither.

31. And if any man shall ask you: Why do you loose him? you shall say thus unto him: Because the Lord hath need of his service.

32. And they that were sent, went their way, and found the colt standing, as he had said unto them.

33. And as they were loosing the colt, the owners thereof said to them: Why loose you the colt?

34. But they said: Because the Lord hath need of him.

35. And they brought him to Jesus. And casting their garments on the colt, they set Jesus thereon.

36. And as he went, they spread their clothes underneath in the way.

37. And when he was now coming near the descent of mount Olivet, the whole multitude of his disciples began with joy to praise God with a loud voice, for all the mighty works they had seen,

38. Saying: Blessed be the king who cometh in the name of the Lord, peace in heaven, and glory on high!

39. And some of the Pharisees, from amongst the multitude, said to him: Master, rebuke thy disciples.

21. See on Matthew xxv. 24.

22-26. See on Matthew xiii. 12; xxv. 28, 29.

27. **But as for those my enemies . . . kill them before me.** These words refer both to the destruction of Jerusalem and the rejection and reprobation of the Jewish nation. By extension, they also refer to the eternal reprobation of all those who during this life have been enemies of God and of His teaching through Christ.

29-32. See on Matthew xxi. 1-5. Luke here (verse 29) and



40. To whom he said: I say to you, that if these shall hold their peace, the stones will cry out.

41. And when he drew near, seeing the city, he wept over it, saying:

42. If thou also hadst known, and that in this thy day, the things that are to thy peace; but now they are hidden from thy eyes.

43. For the days shall come upon thee: and thy enemies shall cast a trench about thee, and compass thee round, and straiten thee on every side,

44. And beat thee flat to the ground, and thy children who are in thee: and they shall not leave in thee a stone upon a stone: because thou hast not known the time of thy visitation.

Mark (xi. 1) seem to create a topographical difficulty in placing Bethpage before Bethany on the way to Jerusalem. To solve this difficulty some have said, in view of St. John (xii. 14), that our Lord after leaving Bethany could not find an ass at Bethpage, and so retraced His steps to Bethany. But others, regarding the Greek text of St. Mark xi. 1, — "When they were near to Jerusalem, to Bethpage, to Bethany, at the Mount of Olives," say that since the end of the journey, Jerusalem, is given first, it must be that the Evangelist in his narrative is retracing the steps of the journey as far as Bethany, the starting point of the pilgrimage.

40. **The stones will cry out.** The celebration of the triumphal entry of our Lord into Jerusalem had been so infallibly decreed that, had the people remained silent, the very stones would have been given the power of speech. The expression of course is hyperbolic and figurative, but it is intended to show the infallibility of God's decrees. The allusion was probably to Habac. ii. 11.

41. **He wept over it.** Only twice do we read that our Lord wept, — on this occasion, and over the death of Lazarus (John xi. 35).

42. **If thou also hadst known . . . the things that are to thy peace.** Our Lord in these words is regretting the blindness and obduracy of the Jewish people. He is lamenting that they had not known the things that could procure peace and salvation for them, i.e., that they should not have received Him and accepted His doctrine and teaching; but now He says, because of the hardness of their hearts, all these precious blessings were hidden from them.

43, 44. In these verses our Lord is foretelling the destruction of Jerusalem; and every word of the prophecy, as here recorded, was literally fulfilled by the Romans under Titus, A.D. 70-71, when not a stone of the city was left upon a stone. Cf. on Matthew xxiv. 1, 2.

45. And entering into the temple, he began to cast out them that sold therein, and them that bought.

46. Saying to them: It is written: My house is the house of prayer. But you have made it a den of thieves.

47. And he was teaching daily in the temple. And the chief priests and the scribes and the rulers of the people sought to destroy him:

48. And they found not what to do to him: for all the people were very attentive to hear him.

45-48. See on Matthew xxi. 12. From verse 45 here it would seem that the purification of the Temple took place on the very day of our Lord's triumphal entry into the city. The same would appear from St. Matthew (xxi. 12); but we know from St. Mark (xi. 12) that the incidents here given by St. Luke occurred the day following the triumphal entry. The Synoptics do not pretend to a greater accuracy than that warranted by their traditional origin, that is, than that warranted by the oral Gospel (Le Camus).

## CHAPTER XX

MEMBERS OF THE SANHEDRIM INQUIRE ABOUT OUR  
LORD'S AUTHORITY, 1-8.

THE PARABLE OF THE VINEYARD AND THE HUSBAND-  
MEN, 9-18.

THE TRIBUTE TO CAESAR, 19-26.

THE SADDUCEES AND THE RESURRECTION, 27-40.

THE MESSIAH IS THE SON AND LORD OF DAVID, 41-44.

THE HYPOCRISY OF THE SCRIBES, 45-47.

1. And it came to pass, that on one of the days, as he was teaching the people in the temple, and preaching the gospel, the chief priests and the scribes, with the ancients, met together.

2. And spoke to him, saying: Tell us, by what authority dost thou these things? or, Who is he that hath given thee this authority?

3. And Jesus answering, said to them: I will also ask you one thing. Answer me:

4. The baptism of John, was it from heaven, or of men?

5. But they thought within themselves, saying: If we shall say, From heaven: he will say: Why then did you not believe him?

6. But if we say, Of men, the whole people will stone us: for they are persuaded that John was a prophet.

7. And they answered, that they knew not whence it was.

8. And Jesus said to them: Neither do I tell thee by what authority I do these things.

1-8. See on Matthew xxi. 23-27.

9. And he began to speak to the people this parable: A certain man planted a vineyard, and let it out to husbandmen: and he was abroad for a long time.

10. And at the season he sent a servant to the husbandmen, that they should give him of the fruit of the vineyard. Who, beating him, sent him away empty.

11. And again he sent another servant. But they beat him also, and treating him reproachfully, sent him away empty.

12. And again he sent the third: and they wounded him also, and cast him out.

13. Then the lord of the vineyard said: What shall I do? I will send my beloved son: it may be, when they see him, they will reverence him.

14. Whom when the husbandmen saw, they thought within themselves, saying: This is the heir, let us kill him, that the inheritance may be ours.

15. So casting him out of the vineyard, they killed him. What therefore will the lord of the vineyard do to them?

16. He will come, and will destroy these husbandmen, and will give the vineyard to others. Which they hearing, said to him: God forbid.

17. But he looking on them, said: What is this then that is written, The stone, which the builders rejected, the same is become the head of the corner?

18. Whosoever shall fall upon that stone, shall be bruised: and upon whomsoever it shall fall, it will grind him to powder.

19. And the chief priests and the scribes sought to lay hands on him the same hour: but they feared the people, for they knew that he spoke this parable to them.

20. And being upon the watch, they sent spies, who should feign themselves just, that they might take hold of him in his words, that they might deliver him up to the authority and power of the governor.

21. And they asked him, saying: Master, we know that thou speakest and teachest rightly: and thou dost not respect any person, but teachest the way of God in truth.

22. Is it lawful for us to give tribute to Cæsar, or no?

23. But he, considering their guile, said to them: Why tempt you me?

24. Shew me a penny. Whose image and inscription hath it? They answering, said to him, Cæsar's.

25. And he said to them: Render therefore to Cæsar the things that are Cæsar's: and to God the things that are God's.

26. And they could not reprehend his word before the people: and wondering at his answer, they held their peace.

27. And there came to him some of the Sadducees, who deny that there is any resurrection, and they asked him,

9-19. See on Matthew xxi. 33-46. In the application of verse 22 of Psalm cxvii, quoted here (verse 17), the **builders** (of the Temple) were the rulers of Israel, the **stone** was the Messiah. As the builders of the Temple rejected some stones as unfit for use, so the rulers of Israel, as the prophets had foretold, rejected our Lord, as injurious to their purposes and teachings.

20-40. See on Matthew xxii. 15-32.

28. Saying: Master, Moses wrote unto us, If any man's brother die, having a wife, and he leave no children, that his brother should take her to wife, and raise up seed unto his brother.

29. There were therefore seven brethren: and the first took a wife, and died without children.

30. And the next took her to wife, and he also died childless.

31. And the third took her. And in like manner all the seven, and they left no children, and died.

32. Last of all the woman died also.

33. In the resurrection therefore, whose wife of them shall she be? For all the seven had her to wife.

34. And Jesus said to them: The children of this world marry, and are given in marriage:

35. But they that shall be accounted worthy of that world, and of the resurrection from the dead, shall neither be married, nor take wives.

36. Neither can they die any more: for they are equal to the angels, and are the children of God, being the children of the resurrection.

37. Now that the dead rise again, Moses also shewed, at the bush, when he called the Lord, The God of Abraham, and the God of Isaac, and the God of Jacob;

38. For he is not the God of the dead, but of the living: for all live to him.

39. And some of the scribes answering, said to him: Master, thou hast said well.

40. And after that they durst not ask him any more questions.

41. But he said to them: How say they that Christ is the son of David?

42. And David himself saith in the book of Psalms: The Lord said to my Lord, sit thou on my right hand,

43. Till I make thy enemies thy footstool.

44. David then calleth him Lord: and how is he his son?

45. And in the hearing of all the people, he said to his disciples:

46. Beware of the scribes, who desire to walk in long robes, and love salutations in the marketplace, and the first chairs in the synagogues, and the chief rooms at feasts:

47. Who devour the houses of widows, feigning long prayer. These shall receive greater damnation.

41-44. See on Matthew xxii. 42-45.

46, 47. See on Matthew xxiii. 5-7.

## CHAPTER XXI

THE WIDOW'S MITE, 1-4.

JESUS FORETELLS THE RUIN OF THE TEMPLE AND THE TRIALS OF HIS FOLLOWERS, 5-19.

THE DESTRUCTION OF JERUSALEM, 20-24.

THE SIGNS THAT SHALL PRECEDE THE FINAL COMING OF THE SON OF MAN, 25-28.

EXHORTATION TO VIGILANCE, 29-38.

1. And looking on, he saw the rich men cast their gifts into the treasury.
2. And he saw also a certain poor widow casting in two brass mites.
3. And he said: Verily I say to you, that this poor widow hath cast in more than they all:
  4. For all these have of their abundance cast into the offerings of God: but she of her want, hath cast in all the living that she had.
  5. And some saying of the temple, that it was adorned with goodly stones and gifts, he said:
  6. These things which you see, the days will come in which there shall not be left a stone upon a stone that shall not be thrown down.

1-4. See on Mark xii. 41-44.

5. **And some saying of the temple, etc.** The contents of this and of the following verse were spoken, as we know from St. Mark (xiii. 1), "as our Lord was going out of the temple" for the last time. Perhaps it was when they were already ascending the slopes of Mt. Olivet, and the disciples, struck sad, by the prediction which our Lord had just made, looked back at the Temple with its marble and gold glittering in the setting sun, and they called our Lord's attention to the magnificent spectacle it presented, as if to try to move Him to avert, if possible, the calamity which He had predicted would befall it.

**That it was adorned with goodly stones and gifts.** These gifts were votive offerings (*ἀναθήματα*) which kings and others had presented to the Temple (2 Mach. iii. 2; v. 16).

6. **These things which you see,** — *ταῦτα ἃ θεωρεῖτε*. These words show that our Lord and the disciples were contemplating the beauties of the Temple in all their external grandeur, and that they

7. And they asked him, saying: Master, when shall these things be? and what shall be the sign when they shall begin to come to pass?

8. Who said: Take heed you be not seduced; for many will come in my name, saying, I am he; and the time is at hand: go ye not therefore after them.

9. And when you shall hear of wars and seditions, be not terrified: these things must first come to pass; but the end is not yet presently.

10. Then he said to them: Nation shall rise against nation, and kingdom against kingdom.

11. And there shall be great earthquakes in divers places, and pestilences, and famines, and terrors from heaven; and there shall be great signs.

12. But before all these things, they will lay their hands on you, and persecute you, delivering you up to the synagogues and into prisons, dragging you before kings and governors, for my name's sake.

13. And it shall happen unto you for a testimony.

14. Lay it up therefore in your hearts, not to meditate before how you shall answer:

15. For I will give you a mouth and wisdom, which all your adversaries shall not be able to resist and gainsay.

16. And you shall be betrayed by your parents and brethren, and kinsmen and friends; and some of you they will put to death.

17. And you shall be hated by all men for my name's sake.

18. But a hair of your head shall not perish.

19. In your patience you shall possess your souls.

were, consequently, outside and some little distance from the magnificent structure. Only Matthew and Mark, however, explicitly state that our Lord had left the Temple when He pronounced His discourse on the end of the world.

7-12. See on Matthew xxiv. 3-9.

12. **But before all these things, etc.**; i.e., during the long period which will intervene between the prediction of our Lord and the end of the world, His disciples and faithful followers shall have many and diverse sufferings to bear.

13-17. See on Matthew x. 18-22.

18. This verse shows the careful providence of God over His devoted followers; nothing shall really harm them, and from all evils He will finally deliver them. The verse is not to be understood in its literal sense.

19. **In your patience you shall possess your souls**,—literally, "by your endurance you shall save your souls." The meaning is, that by a patient endurance of the trials and sufferings which fall to the lot of Christ's followers, they will save their souls for the life to come.

20. And when you shall see Jerusalem compassed about with an army; then know that the desolation thereof is at hand.

21. Then let those who are in Judea, flee to the mountains; and those who are in the midst thereof, depart out: and those who are in the countries, not enter into it.

22. For these are the days of vengeance, that all things may be fulfilled, that are written.

23. But woe to them that are with child, and give suck in those days; for there shall be great distress in the land, and wrath upon this people.

24. And they shall fall by the edge of the sword; and shall be led away captives into all nations; and Jerusalem shall be trodden down by the Gentiles; till the times of the nations be fulfilled.

25. And there shall be signs in the sun, and in the moon, and in the stars; and upon the earth distress of nations, by reason of the confusion of the roaring of the sea and of the waves;

26. Men withering away for fear, and expectation of what shall come upon the whole world. For the powers of heaven shall be moved;

27. And then they shall see the Son of man coming in a cloud, with great power and majesty.

28. But when these things begin to come to pass, look up, and lift up your heads, because your redemption is at hand.

29. And he spoke to them a similitude. See the fig tree, and all the trees:

30. When they now shoot forth their fruit, you know that summer is nigh;

31. So you also, when you shall see these things come to pass, know that the kingdom of God is at hand.

32. Amen, I say to you, this generation shall not pass away, till all things be fulfilled.

33. Heaven and earth shall pass away, but my words shall not pass away.

20-23. See on Matthew xxiv. 15-20. Verse 22 refers to Isaias (xxxiv. 8) and Daniel (ix. 26).

24. This verse expresses some of the sufferings which preceded the fall of Jerusalem, and it is especially descriptive of the lot of the Jews even to the end of the world. There is an intimation also in this verse, that just before the end of the world the Jews shall be aggregated to the Church; but the main thing which our Lord is insisting on here is, that the Gentiles are to be preferred, and that desolation shall continue for the Jews 'even to the consummation and to the end of the world' (Daniel ix. 27).

**The times of the Gentiles**, means the period before the call of the Gentiles into the Church and the second coming of Christ.

25-33. See on Matthew xxiv. 29-35.

34. And take heed to yourselves, lest perhaps your hearts be overcharged with surfeiting and drunkenness, and the cares of this life, and that day come upon you suddenly.

35. For as a snare shall it come upon all that sit upon the face of the whole earth.

36. Watch ye, therefore, praying at all times, that you may be accounted worthy to escape all these things that are to come, and to stand before the Son of man.

37. And in the daytime, he was teaching in the temple; but at night, going out, he abode in the mount that is called Olivet.

38. And all the people came early in the morning to him in the temple, to hear him.

34-36. In these verses our Lord is exhorting His disciples, and through them all of us, to be ever watchful and prepared for His coming, which will be at death, for each one individually, and at the end of the world for the race in general.

37. **And in the daytime he was teaching**, etc. This means that it had been His custom to teach daily in the Temple, etc. It does not mean that after the exhortation just given in the preceding verses, He taught daily in the Temple, because we know that He had already finally left the Temple after denouncing the Scribes and the Pharisees (Matt. xxiii. 39; xxiv. 1).



## CHAPTER XXII

JUDAS MAKES READY TO BETRAY OUR LORD, 1-6.

THE PREPARATION FOR THE PASCHAL SUPPER, 7-13.

THE LAST SUPPER AND THE INSTITUTION OF THE  
HOLY EUCHARIST, 14-20.

THE BETRAYAL IS ANNOUNCED, 21-23.

JESUS REBUKES THE APOSTLES FOR THEIR STRIFE,  
PRAYS FOR ST. PETER, FORETELLS THE DENIAL  
OF PETER, ETC., 24-38.

JESUS IN GETHSEMANI, 39-46.

JESUS IS APPREHENDED, 47-53.

THE DENIALS OF PETER, 54-62.

JESUS IS MOCKED, 63-65.

JESUS BEFORE THE SANHEDRIM, 66-71.

1. Now the feast of unleavened bread, which is called the pasch, was at hand.
2. And the chief priests and the scribes sought how they might put Jesus to death: but they feared the people.
3. And Satan entered into Judas, who was surnamed Iscariot, one of the twelve.
4. And he went, and discoursed with the chief priests and the magistrates, how he might betray him to them.
5. And they were glad, and covenanted to give him money.
6. And he promised. And he sought opportunity to betray him in the absence of the multitude.
7. And the day of the unleavened bread came, on which it was necessary that the pasch should be killed.
8. And he sent Peter and John, saying: Go, and prepare for us the pasch, that we may eat.
9. But they said: Where wilt thou that we prepare?
10. And he said to them: Behold, as you go into the city, there shall meet you a man carrying a pitcher of water: follow him into the house where he entereth in.
11. And you shall say to the goodman of the house: The master saith to thee, Where is the guest chamber, where I may eat the pasch with my disciples?
12. And he will shew you a large dining room, furnished; and there prepare.
13. And they going, found as he had said to them, and made ready the pasch.
14. And when the hour was come, he sat down, and the twelve apostles with him.

1, 2. See on Matthew xxvi. 2-5.

3-6. See on Matthew xxvi. 14-16.

7-14. See on Matthew xxvi. 17-20.

15. And he said to them: With desire I have desired to eat this pasch with you, before I suffer.

16. For I say to you, that from this time I will not eat it, till it be fulfilled in the kingdom of God.

17. And having taken the chalice, he gave thanks, and said: Take, and divide it among you:

18. For I say to you, that I will not drink of the fruit of the vine, till the kingdom of God come.

19. And taking bread, he gave thanks, and brake; and gave to them, saying: This is my body, which is given for you. Do this for a commemoration of me.

20. In like manner the chalice also, after he had supped, saying: This is the chalice, the new testament in my blood, which shall be shed for you.

21. But yet behold, the hand of him that betrayeth me is with me on the table.

22. And the Son of man indeed goeth, according to that which is determined: but yet, woe to that man by whom he shall be betrayed.

23. And they began to inquire among themselves, which of them it was that should do this thing.

15. **With desire I have desired**, etc. This is a Hebrew form of expression, which signifies intense desire. Our Lord eagerly desired to eat this last Pasch with His disciples, because He knew it was then that He would institute the Holy Eucharist, the enduring pledge of His love, and the perpetual memorial of His coming Passion.

16. See on Matthew xxvi. 29.

17. **Having taken the chalice**, etc. This was not the chalice our Lord consecrated into His blood, but one of the ceremonial chalices which were passed around during the Paschal Supper.

18. The words of this verse are placed by St. Matthew (xxvi. 29) and by St. Mark (xiv. 25) after the communion of the Apostles. But St. Luke is here relating what the others omitted; namely, the first benediction and distribution of wine, which marked the beginning of the Paschal Supper. This verse is suggestive of the official prayer which the father of the family was accustomed to recite at the beginning of the Paschal meal.

19-23. See on Matthew xxvi. 21-28. From these verses of St. Luke many of the Fathers of the Church have concluded that Judas partook with the rest of Holy Communion. But we know from St. Matthew (xxvi. 21-26) and from St. Mark (xiv. 18-22) that St. Luke here has not preserved the exact order of events. Hence from the earliest times down to St. Hilary many Doctors

24. And there was also a strife amongst them, which of them should seem to be the greater.

25. And he said to them: The kings of the Gentiles lord it over them; and they that have power over them, are called beneficent.

26. But you not so: but he that is the greater among you, let him become as the younger; and he that is the leader, as he that serveth.

27. For which is greater, he that sitteth at table, or he that serveth? Is not he that sitteth at table? But I am in the midst of you, as he that serveth:

28. And you are they who have continued with me in my temptations:

29. And I dispose to you, as my Father hath disposed to me, a kingdom;

30. That you may eat and drink at my table, in my kingdom: and may sit upon thrones, judging the twelve tribes of Israel.

of great weight have thought that Holy Communion was not instituted until after the departure of Judas. Cf. Cornely, iii. p. 298, note.

We have a fourfold account of the institution of the Blessed Eucharist; namely, in the three Synoptics and in St. Paul (1 Cor. xi. 23). The accounts of Matthew and Mark are almost identical, as are likewise the accounts of St. Luke and St. Paul. These latter two add to the accounts of the former:—(a) "This is My body which is given (St. Luke), bruised (St. Paul), for you"; (b) they explicitly state that the Saviour's blood is the "New Testament"; (c) finally they add, after the consecration of the bread, "Do this for a commemoration of me." Moreover it would seem from St. Luke and St. Paul that the consecration of both the bread and the wine took place after the supper, *μετὰ τὸ δειπνῆσαι*.

24-27. See on Matthew xx. 25-27. It would seem that these verses were here inserted by St. Luke out of order; but as strife among the disciples probably occurred somewhat frequently, it is possible that even at the Last Supper some contentious wrangling among them gave occasion for the rebuke from our Lord here narrated by St. Luke. St. Luke here (verses 24-30) ought naturally to be joined to St. John (xiii. 1-20).

28. **And you are they**, etc. After having just rebuked the disciples our Lord now consoles them, by reminding them of their constancy and faithfulness to Him throughout His trials and sufferings; and He promises to them, in the following verse, that they shall be rewarded in the Kingdom of His Father.

30. See on Matthew xix. 28.

31. And the Lord said: Simon, Simon, behold Satan hath desired to have you, that he may sift you as wheat:

32. But I have prayed for thee, that thy faith fail not: and thou, being once converted, confirm thy brethren.

33. Who said to him: Lord, I am ready to go with thee, both into prison, and to death.

34. And he said: I say to thee, Peter, the cock shall not crow this day, till thou thrice deniest that thou knowest me. And he said to them:

31. **Simon, Simon, behold Satan hath desired, etc.** Our Lord here reminds the Apostles that severe trials are in store for them, and addressing Peter as the head of the Apostles He tells him that Satan has desired, i.e., "has demanded" (*ἐξήγησάρο*) of Him, as before in the case of Job, that he be allowed to take the disciples and sift them as wheat, i.e., subject them to the severest temptations.

32. **But I have prayed for thee, that thy faith fail not.** It is remarkable that in the preceding verse Satan desired to put to trial, not only Peter, but all the Apostles ("you," *ὕμᾱς*), whereas our Lord addresses only Peter ("for thee," *περὶ σοῦ*), showing that He regarded Peter as the head of the Apostles.

**And thou being once converted;** i.e., after having repented of thy future denial, etc. Some think that "being converted" means simply, "in turn"; i.e., as our Lord had prayed for and confirmed Peter in the faith, so he, Peter, in turn, should confirm his brethren in the faith.

**Thy brethren,** by which is understood not only the Apostles but their successors also. These verses (31, 32) are rightly adduced as a proof of Papal Supremacy and infallibility; if they do not mean this, it is very difficult to see what significance they have. Cf. on Matthew xvi. 19.

33. Peter shows his readiness to suffer anything for our Lord, but in so doing he also manifests his misconception of his own weakness (verse 32). He relies more on his own strength than on the help of God.

34. **Till thou thrice deniest, etc.** St. Mark who received his information directly from St. Peter says more exactly, "before the cock crow twice." The meaning is that before the dawn of another day Peter would deny his Master. The cock was accustomed to crow twice during the night, at midnight and at dawn. Cf. on Matthew xxvi. 34.

35. When I sent you without purse, and scrip, and shoes, did you want any thing?

36. But they said: Nothing. Then said he unto them: But now he that hath a purse, let him take it, and likewise a scrip; and he that hath not, let him sell his coat, and buy a sword.

37. For I say to you, that this that is written must yet be fulfilled in me: And with the wicked was he reckoned. For the things concerning me have an end.

38. But they said: Lord, behold here are two swords. And he said to them, It is enough.

39. And going out, he went, according to his custom, to the mount of Olives. And his disciples also followed him.

40. And when he was come to the place, he said to them: Pray, lest ye enter into temptation.

41. And he was withdrawn away from them a stone's cast; and kneeling down, he prayed,

42. Saying: Father, if thou wilt, remove this chalice from me: but yet not my will, but thine be done.

43. And there appeared to him an angel from heaven, strengthening him. And being in an agony, he prayed the longer.

44. And his sweat became as drops of blood, trickling down upon the ground.

45. And when he rose up from prayer, and was come to his disciples, he found them sleeping for sorrow.

46. And he said to them: Why sleep you? arise, pray, lest you enter into temptation.

35, 36. In these verses our Lord is hinting at His coming Passion and death, after which His disciples will not have the help and strength of His comforting presence in human form. He does not mean that they are literally to carry a sword, but that the enemies they shall encounter will be such as severely to try them.

37. **And with the wicked he was reckoned**, from the prophecy of Isaias (liii. 12). **For the things concerning me.** etc., i.e., all the prophecies relative to the Messiah are soon to have their fulfillment.

38. **Here are two swords.** The most probable way of accounting for the two swords which the disciples had is that it was customary for Galileans going to Jerusalem to arm themselves to some extent, because of the robbers along the way.

**It is enough;** i.e., enough said about this. The Apostles had failed to understand the figurative meaning of our Lord's words, and He wished to put an end to the conversation.

39. **According to his custom.** It was our Lord's custom whenever He was at Jerusalem to go out at night to the Mount of Olives and spend the night in prayer.

40-46. See on Matthew xxvi. 37-41. Verses 43 and 44 are

47. As he was yet speaking, behold a multitude; and he that was called Judas, one of the twelve, went before them, and drew near to Jesus, for to kiss him.

48. And Jesus said to him: Judas, dost thou betray the Son of man with a kiss?

49. And they that were about him, seeing what would follow, said to him: Lord, shall we strike with the sword?

50. And one of them struck the servant of the high priest, and cut off his right ear.

51. But Jesus answering, said: Suffer ye thus far. And when he had touched his ear, he healed him.

52. And Jesus said to the chief priests, and magistrates of the temple, and the ancients, that were come unto him: Are ye come out, as it were against a thief, with swords and clubs?

53. When I was daily with you in the temple, you did not stretch forth your hands against me: but this is your hour, and the power of darkness.

54. And apprehending him, they led him to the high priest's house. But Peter followed afar off.

55. And when they had kindled a fire in the midst of the hall, and were sitting about it, Peter was in the midst of them.

56. Whom when a certain servant maid had been sitting at the light, and had earnestly beheld him, she said: This man also was with him.

57. But he denied him, saying: Woman, I know him not.

58. And after a little while, another seeing him, said: Thou also art one of them. But Peter said: O man, I am not.

59. And after the space, as it were of one hour, another certain man affirmed, saying: Of a truth, this man was also with him; for he is also a Galilean.

60. And Peter said: Man, I know not what thou sayest. And immediately, as he was yet speaking, the cock crew.

wanting in the Vatican and Alexandrian MSS., but since all the most ancient versions have them, and since they are approved by a number of the Fathers in their time, they are believed to be authentic. The apparition of the angel (verse 43) is regarded by some as an interior, invisible assistance given to our Lord. The majority of authorities, however, have held that the angel was really one of the heavenly spirits sent to Jesus to sustain Him and to testify to His fortitude.

47. See on Matthew xxvi. 47.

48-51. See on Matthew xxvi. 51, 52.

52, 53. See on Matthew xxvi. 55, 56.

54. See on Matthew xxvi. 57-59.

55. See on Matthew xxvi. 69.

58, 59. See on Matthew xxvi. 70.

60. **The cock crew.** This was the last crow of the cock at dawn, just before which Peter had uttered his third denial of our Lord.

61. And the Lord turning looked on Peter. And Peter remembered the word of the Lord, as he had said: Before the cock crow, thou shalt deny me thrice.

62. And Peter going out, wept bitterly.

63. And the men that held him, mocked him, and struck him.

64. And they blindfolded him, and smote his face. And they asked him, saying: Prophesy, who is it that struck thee?

65. And blaspheming, many other things they said against him.

66. And as soon as it was day, the ancients of the people, and the chief priests and scribes, came together; and they brought him into their council, saying: If thou be the Christ, tell us.

67. And he saith to them: If I shall tell you, you will not believe me.

68. And if I shall also ask you, you will not answer me, nor let me go.

69. But hereafter the Son of man shall be sitting on the right hand of the power of God.

70. Then said they all: Art thou then the Son of God? Who said: You say that I am.

71. And they said: What need we any further testimony? for we ourselves have heard it from his own mouth.

66. See on Matthew xxvii. 1.

**If thou be the Christ;** i.e., the Messiah, the Anointed, whom the Jews were expecting. The Sanhedrim were seeking some cause for which to condemn our Lord. They wished to force Him to proclaim Himself King, since only His claim to kingship would have any influence with Pilate.

67-71. St. Luke in these verses gives a more detailed account of our Lord's trial before the Sanhedrim than does St. Matthew, but he omits the preliminary examination which Matthew gives (xxvi. 59-66).

## CHAPTER XXIII

JESUS BEFORE PILATE AND HEROD, 1-16.

BARABBAS IS PREFERRED, JESUS CONDEMNED, 17-25.

THE WAY OF THE CROSS, 26-33.

JESUS ON THE CROSS, 34-43.

THE AGONY AND DEATH OF JESUS, 44-49.

THE BURIAL OF JESUS, 50-56.

1. And the whole multitude of them rising up, led him to Pilate.
2. And they began to accuse him, saying: We have found this man perverting our nation, and forbidding to give tribute to Cæsar, and saying that he is Christ the king.
3. And Pilate asked him, saying: Art thou the king of the Jews? But he answering, said: Thou sayest it.
4. And Pilate said to the chief priests and to the multitudes: I find no cause in this man.
5. But they were more earnest, saying: He stirreth up the people, teaching throughout all Judea, beginning from Galilee to this place.
6. But Pilate hearing Galilee, asked if the man were of Galilee?
7. And when he understood that he was of Herod's jurisdiction, he sent him away to Herod, who was also himself at Jerusalem, in those days.
8. And Herod seeing Jesus, was very glad; for he was desirous of a long time to see him, because he had heard many things of him; and he hoped to see some sign wrought by him.
9. And he questioned him in many words. But he answered him nothing.
10. And the chief priests and the scribes stood by, earnestly accusing him.

1-3. See on Matthew xxvii. 11. Neither St. Luke nor the other Synoptists have the characteristic beginning of the trial, which St. John has preserved for us.

4. **I find no cause in this man.** Three different times—here and in verses 14 and 22, Pilate publicly acknowledges that he can find nothing in our Lord wherefore He should be condemned to death; but because of his weakness and indecision of character Pilate is unable to resist the Jews and act according to his own convictions.

7. **To Herod.** This was Herod Antipas, tetrarch of Galilee and son of Herod the Great. Pilate wished to avoid the responsibility of condemning our Lord, and this is why he sent Him to Herod.



11. And Herod with his army set him at nought, and mocked him, putting on him a white garment, and sent him back to Pilate.

12. And Herod and Pilate were made friends, that same day; for before they were enemies one to another.

13. And Pilate, calling together the chief priests, and the magistrates, and the people,

14. Said to them: You have presented unto me this man, as one that perverteth the people; and behold I, having examined him before you, find no cause in this man, in those things wherein you accuse him.

15. No, nor Herod neither. For I sent you to him, and behold, nothing worthy of death is done to him.

16. I will chastise him therefore, and release him.

17. Now of necessity he was to release unto them one upon the feast day.

18. But the whole multitude together cried out, saying: Away with this man, and release unto us Barabbas:

19. Who, for a certain sedition made in the city, and for a murder, was cast into prison.

20. And Pilate again spoke to them, desiring to release Jesus.

21. But they cried again, saying: Crucify him, crucify him.

22. And he said to them the third time: Why, what evil hath this man done? I find no cause of death in him. I will chastise him therefore, and let him go.

23. But they were instant with loud voices, requiring that he might be crucified; and their voices prevailed.

24. And Pilate gave sentence that it should be as they required.

25. And he released unto them him who for murder and sedition, had been cast into prison, whom they had desired; but Jesus he delivered up to their will.

26. And as they led him away, they laid hold of one Simon of Cyrene, coming from the country; and they laid the cross on him to carry after Jesus.

27. And there followed him a great multitude of people, and of women, who bewailed and lamented him.

11. **Set him at naught**; i.e., despised Him, and had Him clothed with a white garment in mockery of His claim to kingship.

13. **And the people.** This time Pilate called the people to witness that he could find nothing against our Lord.

16. **I will chastise him.** Being unable to resist the people, although he knew our Lord was innocent, Pilate decided to have Him scourged. He thought this would satisfy them and would release himself from the responsibility of condemning the Saviour to death.

17. See on Matthew xxvii. 15. In many of the best MSS. this verse of St. Luke is omitted, but as the same thought is expressed in Matthew it must be regarded as genuine here.

18. See on Matthew xxvii. 16.

22-25. See on Matthew xxvii. 24.

26. See on Matthew xxvii. 32, 33.

28. But Jesus turning to them, said: Daughters of Jerusalem, weep not over me; but weep for yourselves, and for your children.

29. For behold, the days shall come, wherein they will say: Blessed are the barren, and the wombs that have not borne, and the paps that have not given suck.

30. Then shall they begin to say to the mountains: Fall upon us; and to the hills: Cover us.

31. For if in the green wood they do these things, what shall be done in the dry?

32. And there were also two other malefactors led with him to be put to death.

33. And when they were come to the place which is called Calvary, they crucified him there; and the robbers, one on the right hand, and the other on the left.

34. And Jesus said: Father, forgive them, for they know not what they do. But they, dividing his garments, cast lots.

35. And the people stood beholding, and the rulers with them derided him, saying: He saved others; let him save himself, if he be Christ, the elect of God.

36. And the soldiers also mocked him, coming to him, and offering him vinegar,

37. And saying: If thou be the king of the Jews, save thyself.

38. And there was also a superscription written over him in letters of Greek, and Latin, and Hebrew: THIS IS THE KING OF THE JEWS.

28-30. In these verses our Lord admonishes the women who were sympathizing with Him of the terrible evils that shall befall the Jewish people because of their treatment and condemnation of Him.

31. The first, or direct meaning of this verse is, if fire burns the green wood, how much more will it burn the dry; in the application it means that if the innocent like our Lord have so much to suffer, what will be the sufferings and punishments of the guilty children of Israel? Cf. Ps. i. 3; Jer. xvii. 8, 32, 33. See on Matthew xxvii. 33, 38.

34. **Father, forgive them**, etc. While the cruel tormentors were nailing our Lord to the cross He prayed to His Father for their forgiveness.

**Divided his garments.** See on Matthew xxvii. 35.

35. See on Matthew xxvii. 42, 43.

36. St. Luke here seems less exact than St. Matthew (xxvii. 34) and St. Mark (xv. 23).

38. See on Matthew xxvii. 37.

39. And one of those robbers who were hanged, blasphemed him, saying: If thou be Christ, save thyself and us.

40. But the other answering, rebuked him, saying: Neither dost thou fear God, seeing thou art under the same condemnation?

41. And we indeed justly, for we receive the due reward of our deeds; but this man hath done no evil.

42. And he said to Jesus: Lord, remember me when thou shalt come into thy kingdom.

43. And Jesus said to him: Amen I say to thee, this day thou shalt be with me in paradise.

44. And it was almost the sixth hour; and there was darkness over all the earth until the ninth hour.

45. And the sun was darkened, and the veil of the temple was rent in the midst.

46. And Jesus crying with a loud voice, said: Father, into thy hands I commend my spirit. And saying this, he gave up the ghost.

47. Now the centurion, seeing what was done, glorified God, saying: Indeed this was a just man.

48. And all the multitude of them that were come together to that sight, and saw the things that were done, returned striking their breasts.

49. And all his acquaintance, and the women that had followed him from Galilee, stood afar off, beholding these things.

50. And behold there was a man named Joseph, who was a counsellor, a good and a just man,

51. (The same had not consented to their counsel and doings;) of Arimathea, a city of Judea; who also himself looked for the kingdom of God.

52. This man went to Pilate, and begged the body of Jesus.

53. And taking him down, he wrapped him in fine linen, and laid him in a sepulchre that was hewed in stone, wherein never yet any man had been laid.

54. And it was the day of the Parasceve, and the sabbath drew on.

39-41. See on Matthew xxvii. 44.

44. See on Matthew xxvii. 45.

45. See on Matthew xxvii. 51.

46. See on Matthew xxvii. 50.

47-49. See on Matthew xxvii. 54, 55.

50, 51. See on Matthew xxvii. 57. Although Joseph was more probably from Ha-Ramathaim, north of Jerusalem, it is certain that he was dwelling in Jerusalem at this time.

53. See on Matthew xxvii. 60. The text of the Synoptists would lead us to believe that the body of Jesus was not embalmed before burial, but from St. John we know otherwise.

54. The day of the parasceve; i.e., the day of preparation for the Sabbath; and the sabbath drew on, i.e., the Sabbath was

55. And the women that were come with him from Galilee, following after, saw the sepulchre, and how his body was laid.

56. And returning, they prepared spices and ointments; and on the sabbath day they rested, according to the commandment.

about to begin, — literally, “dawned” (*ἐπέφωσκεν*). It was just about sunset, and the Sabbath began at sunset.

55. And the women . . . from Galilee. Many of the holy women in Galilee had been accustomed to follow our Lord and minister to His wants.

## CHAPTER XXIV

THE RESURRECTION OF JESUS, 1-12.

THE DISCIPLES GOING TO EMMAUS, 13-35.

JESUS APPEARS TO THE APOSTLES AT JERUSALEM,  
36-43.

FINAL INSTRUCTIONS TO THE APOSTLES, 44-49.

THE ASCENSION OF JESUS INTO HEAVEN, 50-53.

1. And on the first day of the week, very early in the morning, they came to the sepulchre, bringing the spices which they had prepared.

2. And they found the stone rolled back from the sepulchre.

3. And going in, they found not the body of the Lord Jesus.

4. And it came to pass, as they were astonished in their mind at this, behold, two men stood by them, in shining apparel.

5. And as they were afraid, and bowed down their countenance towards the ground, they said unto them: Why seek you the living with the dead?

1. See on Matthew xxviii. 1; Mark xvi. 1. Some think St. Luke is here speaking of a different company of women from that spoken of by the other Evangelists. This company, they say, arrived earlier than the company of which the other Gospels speak, as appears from verse 22.

2. See on Matthew xxviii. 2-4.

3. See on Mark xvi. 5.

4. They were astonished; i.e., they hesitated, doubted.

Two men stood by them, etc.; i.e., two angels in human form appeared. See on Matthew xxviii. 2-4. If St. Luke's company of pious women was not that of the other Evangelists we can understand how they beheld angels *standing*.

5. As they were afraid. The holy women bowed their heads

6. He is not here, but is risen. Remember how he spoke unto you, when he was yet in Galilee,

7. Saying: The Son of man must be delivered into the hands of sinful men, and be crucified, and the third day rise again.

8. And they remembered his words.

9. And going back from the sepulchre, they told all these things to the eleven, and to all the rest.

10. And it was Mary Magdalen, and Joanna, and Mary of James, and the other women that were with them, who told these things to the apostles.

11. And these words seemed to them as idle tales; and they did not believe them.

12. But Peter rising up, ran to the sepulchre, and stooping down, he saw the linen cloths laid by themselves; and went away wondering in himself at that which was come to pass.

13. And behold, two of them went, the same day, to a town which was sixty furlongs from Jerusalem, named Emmaus.

before the angels partly out of fear, partly also, perhaps, out of reverence.

6-8. From these verses it is evident that our Lord while in Galilee had explained not only to His disciples, but to the holy women also how He was to be delivered up, made to suffer, and finally put to death, and the third day rise again. Cf. Matthew xvi. 21; xvii. 21; Mark viii. 31; ix. 30; Luke ix. 22.

9, 10. See on Matthew xxviii. 8; Mark xvi. 8.

11. See on Mark xvi. 11.

12. **But Peter rising up . . . and stooping, etc.** From St. John (xx. 3 and 6) we know that the beloved Apostle accompanied St. Peter to the sepulchre, and further, that St. Peter not only stooped to look into the tomb, but actually entered it. Commentators feel that this present verse of St. Luke was taken from a separate document and therefore has not any connection with verse 11. The verse, however, is authentic, and even its connection with verse 11 can be explained, if we bear in mind what has been said on Mark xvi. 11.

13. **Two of them.** That these disciples were not two of the "eleven" is evident from verse 33, below.

**Emmaus.** It is disputed whether this was the town now known by the same name about seven miles west of Jerusalem, or whether it is the town now called Nicopolis, about twenty-two miles west of Jerusalem. St. Jerome and other Fathers, following some MSS., believe it was the latter place. The true reading of this verse of

14. And they talked together of all these things which had happened.

15. And it came to pass, that while they talked and reasoned with themselves, Jesus himself also drawing near, went with them.

16. But their eyes were held, that they should not know him.

17. And he said to them: What are these discourses that you hold one with another as you walk, and are sad?

18. And the one of them, whose name was Cleophas, answering, said to him: Art thou only a stranger in Jerusalem, and hast not known the things that have been done there in these days?

19. To whom he said: What things? And they said: Concerning Jesus of Nazareth, who was a prophet, mighty in work and word before God and all the people;

20. And how our chief priests and princes delivered him to be condemned to death, and crucified him.

21. But we hoped, that it was he that should have redeemed Israel: and now besides all this, to day is the third day since these things were done.

22. Yea and certain women also of our company affrighted us, who before it was light, were at the sepulchre,

23. And not finding his body, came, saying, that they had also seen a vision of angels, who say that he is alive.

24. And some of our people went to the sepulchre, and found it so as the women had said, but him they found not.

St. Luke says that the place whither the disciples went was sixty furlongs — about seven miles from Jerusalem. Moreover, had they gone to Emmaus Nicopolis, a distance of twenty-two miles from Jerusalem, they could not have made the journey in one afternoon.

18. **Art thou only a stranger in Jerusalem;** i.e., of the many strangers who have just been at Jerusalem for the Paschal celebration, are you the only one that is unaware of the events that have taken place there?

19. **Concerning Jesus of Nazareth, etc.** It is uncertain whether these disciples really believed in the Divinity of our Lord, or whether they regarded Him only as a great prophet.

21. **But we hoped;** i.e., “we were hoping” (*ἠλπίζομεν*), — as if now they had given up hope.

**And now besides all this, etc.;** i.e., besides all the disgraceful events which had taken place during the Passion and at the death of Christ, there was this further embarrassment that the day had arrived on which He had said He would rise from the dead, and yet, so far as these two disciples knew, He had not risen.

22. See on Matthew xxviii. 1.

24. **And some of our people, etc.** In verse 12 above St. Luke

25. Then he said to them: O foolish, and slow of heart to believe in all things which the prophets have spoken.

26. Ought not Christ to have suffered these things, and so to enter into his glory?

27. And beginning at Moses and all the prophets, he expounded to them in all the scriptures, the things that were concerning him.

28. And they drew nigh to the town, whither they were going: and he made as though he would go farther.

29. But they constrained him; saying: Stay with us, because it is towards evening, and the day is now far spent. And he went in with them.

30. And it came to pass, whilst he was at table with them, he took bread, and blessed, and brake, and gave to them.

spoke as if only Peter had gone to the tomb, but here he supposes that Peter was not alone, or the only one to go there. The Evangelist's first statement in verse 12 is, therefore, incomplete. See John xx. 3-10.

25, 26. The Saviour now upbraids the two disciples for not having rightly understood the prophecies concerning the Christ, according to which it was necessary that He should suffer and be put to death, and thus enter into His glory.

27. **Beginning from Moses, etc.** The Saviour now expounded to the two disciples the meaning of all the prophecies which had been uttered regarding the Messiah.

29. **Stay with us, etc.** It is commonly believed that Cleophas, one of the two disciples, had his home at Emmaus, and that it was there they entertained our Lord.

30. **He took bread and blessed and brake, etc.** Commentators disagree as to whether our Lord celebrated the Holy Eucharist with the two disciples. St. Augustine, St. Jerome, and others hold that He did, which seems more probable for the following reasons: (a) the words used regarding that occasion were the same as those used relative to the institution of the Holy Eucharist. Cf. Matthew xxvi. 26. (b) The effect of this breaking of bread seemed miraculous, inasmuch as it enabled the disciples to recognize our Lord. (c) The blessing given on that occasion was not at the beginning, but at the end of the supper, which shows it was not the ordinary blessing given at meals.

Calmet, Jansenius, and others believed our Lord did not celebrate the Holy Eucharist with the disciples at this time.

31. And their eyes were opened, and they knew him: and he vanished out of their sight.

32. And they said one to the other: Was not our heart burning within us, whilst he spoke in the way, and opened to us the scriptures?

33. And rising up, the same hour, they went back to Jerusalem: and they found the eleven gathered together, and those that were with them,

34. Saying: The Lord is risen indeed, and hath appeared to Simon.

35. And they told what things were done in the way; and how they knew him in the breaking of bread.

36. Now whilst they were speaking these things, Jesus stood in the midst of them, and saith to them: Peace be to you; it is I, fear not.

37. But they being troubled and frightened, supposed that they saw a spirit.

38. And he said to them: Why are you troubled, and why do thoughts arise in your hearts?

31. **He vanished**, thereby showing the qualities of His glorified body which could become visible and invisible at will.

32. **Was not our heart burning within us.** By these words the disciples seemed to express the unusual, ardent effect on their hearts of the exposition of the Scriptures which the Saviour had given them.

33. **And they found the eleven.** St. John (xx. 24) tells us that Thomas was not present on this occasion, but this does not contradict St. Luke, because the latter spoke of the Apostles as a group, and the term "eleven" was commonly used in speaking of the group.

34. **Appeared to Simon.** St. Paul (1 Cor. xv. 5) cites this apparition to Simon as the first of all, but we know nothing further about it. It seems that the first two apparitions of our Lord after His Resurrection were to Mary, the sinner, and to Simon the renegade. The present verse of St. Luke seems to be contradicted by St. Mark (xvi. 13); but see on Mark xvi. 13. The Apostles (Mark xvi. 13) did not doubt that our Lord had risen, but only that He had appeared to the two disciples.

36. **Jesus stood in the midst of them.** Again our Lord manifests the subtlety of His glorified body by which He was able to enter the room, "the doors being closed" (John xx. 19).

**Peace be to you** was an ordinary mode of salutation among the Jews.

38. **Why do thoughts arise, etc.;** i.e., why do you doubt; our Lord read the secret doubts of the hearts of the Apostles.



39. See my hands and feet, that it is I myself; handle, and see: for a spirit hath not flesh and bones, as you see me to have.

40. And when he had said this, he shewed them his hands and feet.

41. But while they yet believed not, and wondered for joy, he said: Have you here any thing to eat?

42. And they offered him a piece of a broiled fish, and a honeycomb.

43. And when he had eaten before them, taking the remains, he gave to them.

44. And he said to them: These are the words which I spoke to you, while I was yet with you, that all things must needs be fulfilled, which are written in the law of Moses, and in the prophets, and in the psalms, concerning me.

45. Then he opened their understanding, that they might understand the scriptures.

46. And he said to them: Thus it is written, and thus it behoved Christ to suffer, and to rise again from the dead, the third day:

47. And that penance and remission of sins should be preached in his name, unto all nations, beginning at Jerusalem.

48. And you are witnesses of these things.

39-43. To prove the reality of His risen body our Lord next offered to the disciples His hands and feet to be touched; He also ate with them. Our Lord did not eat because of any need which He felt; neither was the food which He took digested and assimilated by His risen body. It was taken into His stomach, but in some way disposed of by the divine Power.

**Taking the remains, etc.** These words are wanting in some MSS.

44. **These are the words which I spoke to you, etc.;** i.e., "This is what I meant when I said that all the prophecies concerning me must have their fulfillment."

St. Luke makes no mention of the apparitions of our Lord in Galilee, but commentators see in this and in the following verse a trace of the instructions which Jesus gave to the Apostles in Galilee, or somewhere else. Thus we must admit that there is here an omission in St. Luke regarding the going of the Apostles to Galilee. From Luke alone, it would appear that the Apostles did not quit Jerusalem between the Resurrection and the Ascension, which we know from the other Evangelists was not so. St. Luke was evidently following the documents he had before him, which seemed to have dealt only with our Lord's appearances in Jerusalem. Verse 46 seems to be the beginning of our Lord's final discourse in Jerusalem before the Ascension.

45-48. Our Lord by His grace illuminated the minds of the

49. And I send the promise of my Father upon you: but stay you in the city, till you be endued with power from on high.

50. And he led them out as far as Bethania: and lifting up his hands, he blessed them.

51. And it came to pass, whilst he blessed them, he departed from them, and was carried up to heaven.

52. And they adoring went back into Jerusalem with great joy.

53. And they were always in the temple, praising and blessing God. Amen.

disciples that they might understand the meaning of all the prophecies which had been spoken and written concerning the Messiah — how it was necessary that He should suffer, and die, and the third day rise again, for the salvation of the human race. Had He not done so, the penance which men needed would not have been fruitful unto the remission of their sins. But now that the prophecies had been fulfilled, He tells the Apostles that they must begin to preach first at Jerusalem, in order that salvation might first be offered to the Jews, and then to the Gentiles and to the entire world.

49. **But stay you in the city;** i.e., the disciples were not to depart at once after the Ascension, but were to remain in Jerusalem until the day of Pentecost, when the Holy Ghost would come down upon them and clothe them with authority and strength as with a garment.

50, 51. **And he led them as far as Bethania.** Bethany was about two miles from Jerusalem at the eastern foot of Mt. Olivet. As the Mount of Olives had been the scene of our Lord's suffering, so now it was to witness His triumphal Ascension into Heaven.

It is surprising that only St. Mark and St. Luke speak of the Ascension of our Lord, and this very briefly. In the Book of the Acts St. Luke has a more detailed account of the great event. But if St. Matthew and St. John make no explicit mention of it, this is because it is presupposed in their writings, and because they regarded it as the natural outcome and climax of the Resurrection. Jesus could not die any more, He had passed from their midst only to enter into His glory.

53. **And they were always in the temple,** etc. These words may refer to the practice of the Apostles during the days between the Ascension and Pentecost, but they more probably relate to the preaching of the Apostles in the Temple after the coming of the Holy Ghost (Acts ii. 46; v. 21 and 42), because during the days between Ascension and Pentecost the Apostles and the Blessed

Virgin were persevering in prayer in the Upper Room (Acts i. 13, 14).

It is to be noted that St. Luke speaks very summarily in this chapter of the events that took place between the Resurrection and the Ascension of our Lord; he has left us a more elaborate and detailed account of these events in the Acts of the Apostles. From reading this chapter alone one might get the impression that all herein narrated took place on the very same day, the day of the Resurrection, but this the Evangelist never meant to convey, as is clear from his other work, and from the Gospels of Matthew and Mark, a knowledge of which he presupposes. We must conclude, therefore, as said before, that verses 46-49 here were spoken shortly before the Ascension, since the promised Spirit was to descend upon the disciples "not many days after."

# THE GOSPEL ACCORDING TO ST. JOHN

## INTRODUCTION

I. **St. John.** St. John, the fourth Evangelist, was born in Galilee near the Lake of Genesareth. He was the son of Zebedee and Salome, and the brother of James the Greater, the Apostle of Spain. St. John followed the calling of his father, which was that of a fisherman, until the appearance of John the Baptist, when he became a disciple of the latter. John was later sent by his master, the Baptist, to Jesus (John i. 35 ff.); and not long after this meeting with the Saviour at the Jordan, John and his brother James returned to Galilee to resume their work as fishermen. Soon, however, they were called to be the constant companions of our Lord (Mark i. 19, 20). St. John was known as the "disciple whom Jesus loved" (John xiii. 23), and together with his brother and St. Peter was especially favored by our Lord at the Transfiguration on Thabor, at the Last Supper, during the Agony in Gethsemani, and on Calvary (Mark ix. 1; xiv. 33; and John xiii. 23; xxi. 20; xix. 26). To St. John at our Lord's death was committed the charge of the Blessed Virgin (John xix. 27). After the Ascension, he remained at Jerusalem, strenuously assisting St. Peter in the establishment of the Church there (Gal. ii. 9). About A.D. 51 he left Jerusalem for Asia Minor, and we next hear of him as Bishop of Ephesus. Later, during the reign of Domitian, as Tertullian, St. Jerome, and others tell us, John was taken to Rome and put into a cauldron of burning oil, from which, however, he came forth uninjured. He was then banished to the island of Patmos, but after the death of Domitian was allowed to return to Ephesus, where he died at the age of about 100.

II. **Time and Place of Writing.** Tradition is quite unanimous

in asserting that St. John wrote his Gospel at Ephesus shortly before his death, perhaps around the year 98. St. Irenaeus (*Adv. Haer.* iii. 3) expressly says that the Fourth Gospel was published while St. John was at Ephesus. It is, indeed, clear from the contents of the Gospel that it was written to answer a later development of Christian life, than that for which the other Gospels were composed. The Gospel contains a reference to the crucifixion of St. Peter (xxi. 18), which shows it was written sometime after A.D. 67; and whenever the Evangelist speaks of places in or about Jerusalem he uses the past tense (xi. 18; xviii. 1; xix. 41), which indicates that Jerusalem was already destroyed when he wrote. Hence the year 70 was past. Furthermore, the manner in which the Evangelist speaks of the opponents of Christianity (*οἱ Ἰουδαῖοι*) shows that the Jews as a people were hardly known except as enemies, and that the Gentiles were in the majority in the Christian Church (xi. 19, 55; xiii. 33; xviii. 20, 36). Again, Cerinthus, the Nicolaites, and the Ebionites, against whom the Fourth Gospel was written, did not appear till towards the end of the first century.

**III. Purpose, Motive, and Characteristics.** St. John himself tells us the object which he had in view in writing his Gospel, — “Many other signs also did Jesus in the sight of his disciples which are not written in this book; but these are written, that you may believe that Jesus is the Christ, the Son of God, and that believing you may have life in his name” (xx. 30, 31). The primary object, therefore, of the Fourth Gospel is clearly to establish the Divinity of Christ and His divine mission as Messiah.

But another purpose which the Evangelist also had in view, and which is directly connected with the first, was to combat certain heresies which had arisen in the Church. We know from St. Irenaeus (*Adv. Haer.* iii. 11), and St. Jerome (*Prol. in Matthew*), and others that certain errors concerning our Lord's Divinity and humanity had arisen toward the end of the second century in Asia Minor, especially those of Cerinthus, the Ebionites, and the Nicolaites. Hence it cannot be doubted that St. John who had been in particular requested by the Bishops and leaders of the Asiatic Church to write his Gospel (*Murat. Frag.*), had also in mind to refute the doctrines which were making a rent in the seamless garment of the Church. It is likewise certain that St. John had

a still further purpose in writing, which was to supplement the Synoptics. He omits most of the things recorded by the other Evangelists, and adds many events connected with our Lord's life which they had not recounted. His Gospel presupposes the other three (i. 15, 32; iii. 24; xviii. 33, etc.).

St. John's Gospel has always been known as the divine or spiritual Gospel. The Synoptists are concerned for the most part with the human side of our Lord's life, whereas St. John is absorbed with the spiritual and divine features of the life of the Saviour. The Synoptists give us our Lord's labors in Galilee, St. John treats of those things which were done in Judea, especially around Jerusalem. The Synoptists have recorded many parables of our Lord, St. John has given us none; St. John records only two miracles which are common to the Synoptists (vi. 5 and 19), but he gives us four others which the Synoptists do not relate; namely, — (a) the changing of water into wine, (b) the healing of the impotent man, (c) the cure of the man born blind, (d) the raising of Lazarus.

IV. **Authenticity.** That the Fourth Gospel was written by St. John, the Apostle, has been the almost unanimous teaching of tradition. With the sole exception of a few obscure heretics of the second century, known as the Alogi, the authorship of this Gospel remained unquestioned down to the end of the eighteenth century. Since that time, however, it has been frequently attacked by Rationalists. Some of these, like Weisse, have held that portions of the Gospel are the work of St. John, or at least of the disciples of the Apostle, who put to writing what they had learned from him. Renan goes further and denies that the Gospel has any connection with St. John, except in so far as its historical portions represent traditions reaching back to the Apostle's time. A third class deny to the Gospel all historical value, and attribute its composition to the second half of the second century. But against these theories both external and internal evidence unite to show that the Fourth Gospel was written before the end of the first century, and that the author was St. John, the Apostle.

**External evidence.** In the first place there is the unwavering teaching of the Church and tradition to which none, except the Alogi, ever objected till the end of the eighteenth century. And

even the Alogi, who lived in the second century and who rejected the Gospel, not on historical, but on dogmatic grounds, did not regard it as of a later date than the first century, but on the contrary ascribed it to Cerinthus, a contemporary of St. John. The great majority of the most extreme of modern critics hold that the Gospel was written before A.D. 125, and Harnack says its date is between the appearance of the Synoptics and A.D. 110. Loisy puts it at about A.D. 100; E. A. Abbott, earlier than A.D. 108. Dr. Sanday, Zahn, Wernle, Loisy, and others tell us that the letters of St. Ignatius, which date from A.D. 110-115, bear unmistakable familiarity with the ideas and writings of the Fourth Gospel, showing that the Gospel had been in existence some time before the year 110. Quotations from this Gospel are found in the works of Polycarp, who was a disciple of St. John, and also in the works of Papias, a contemporary of Polycarp. St. Irenaeus (*Adv. Haer.* iii. 1), a disciple of Polycarp, expressly says that St. John published the Gospel ascribed to him during his residence at Ephesus. St. Clement of Alexandria (*Apud Euseb.* vi. 4) tells us that he gathered "from the elders of old" that John, unlike the other Evangelists, composed at the request of friends and with the assistance of the Spirit, a spiritual Gospel. In fact Clement, Tertullian, Irenaeus, and Eusebius speak of the Fourth Gospel as universally received and recognized as St. John's. Much more external evidence might be adduced in favor of the Johannine authorship of the Gospel, but the above seems to us sufficient to convince any reasonable person.

**Internal evidence.** Although the author of the Fourth Gospel nowhere gives his name, still he describes himself as an eye-witness (i. 14, 35; xix. 35; xxi. 24), and as our Lord's beloved and highly favored disciple (xiii. 23; xix. 26; xx. 2). Now we know that the disciples especially favored by our Lord were Peter, James, and John. But the reference in the passages above cited could not have been to Peter, as is evident from John xiii. 24; xxi. 21; nor to James, because James the Greater was the first of the Apostles to be put to death (Acts xii. 2), whereas the beloved disciple in question was very old (John xxi. 23). It is evident, moreover, from the Gospel itself that its author was: (a) a Jew thoroughly familiar with Palestine; (b) an eye-witness of the events he records; (c)

an Apostle, who was John, the son of Zebedee. That he was a Jew, familiar with the Old Testament and with Jewish customs, modes of thought, etc., is clear from i. 45; ii. 17; iii. 14; v. 39, 46; vi. 45; viii. 17; x. 34; xii. 14, 15, 38; ii. 6; iv. 9, 20, 27; etc. The author is no stranger unacquainted with the topography of Palestine, as we can see from i. 28; ii. 12; iii. 23; iv. 6, 11, 20, 35, 47, 49; vi. 19, 23; xi. 18, 54. He actually witnessed the events he has recorded, — vi. 9; xviii. 10, 15, 26; xix. 23; etc. And if he was not an Apostle, how explain i. 37 ff.; iv. 27; vi. 5-9, 69-72; xi. 4; xiii; xiv-xvi; etc.? Finally, that the author of the Fourth Gospel was John the son of Zebedee is also indirectly, at least, evident from the Gospel. While John and his brother James are not named in this Gospel, they are frequently spoken of in the Synoptics, and are there placed among the three most favored Apostles. They were present with Peter at the raising of Jairus' daughter, at the Transfiguration, and in Gethsemani. John was regarded by St. Paul as one of the "pillars" of the Church (Gal. ii. 9; Acts i. 13; iv. 19; viii. 14); and by the infant Church generally he was put next to Peter. From all this it seems beyond doubt that, had any other than John himself been author of the Fourth Gospel, he certainly would not have failed to mention by name such an illustrious Apostle; that is, such a conspicuous and highly favored disciple of our Lord could never have passed unnamed in the Fourth Gospel, except in the supposition that this Gospel was written by himself.

V. **Historical character.** From what has just been said it would seem beyond question, not only that the Fourth Gospel was written by St. John, the Apostle, but also that the Gospel is a true record of real events in the life of Christ. And yet there are many critics of recent times who contend that the facts narrated in the Fourth Gospel are wholly or partly symbolical or allegorical compositions not of Christ, but of the Evangelist himself. The author, therefore, they say, has given us an account, not of what our Lord actually said and did; but of what he, the Evangelist, thought of the words and deeds of the Saviour many years afterwards. The discourses and incidents, then, of the Fourth Gospel, in this opinion, are entirely, or at least partly, the work of the Evangelist.

Against such an erroneous opinion it must first be observed that the Gospel itself pretends to be a record of fact (xx. 30, 31), and



secondly that it actually gives us many events which, from the Synoptics, we know are historical; for example, in i. 19-34; ii. 13-16; vi. 1-13; 16-21; xii. 1-8; 12-16. Since the very same events narrated in the passages here cited are related by the Synoptics and are there regarded as historical, why should they not be so regarded in St. John? And with respect to those facts which are peculiar to the Fourth Gospel, it must be admitted that they are so graphically and accurately related by the author, with the utmost regard for minute details, that no one who has any knowledge of the laws of criticism ought to call them into question. See, e.g., iii. 2; iv. 5, 6; v. 2; ix. 7; etc.

Those who pretend to find difficulty in the differences between St. John and the Synoptists are not warranted in their conclusions against the historicity of the account of the former, because they do not allow for the difference in character and scope of the Synoptists and St. John. As a matter of fact there are too many likenesses between the Fourth and the Synoptic Gospels to permit the denial of the historic character of the one without at the same time rejecting that of the others. Besides the passages above indicated compare, for instance, John ii. 19 with Matthew xxvi. 61; John iv. 44 with Luke iv. 24; John vi. 20 with Mark vi. 50; John xii. 8 with Mark xiv. 7; John xii. 25 with Mark viii. 35.

**VI. Division of the Gospel.** The Fourth Gospel has three general parts, besides a prologue and an epilogue.

In the prologue (i. 1-18) the Evangelist briefly exposes the doctrine concerning the Incarnate Word.

In the first part (i. 19-xii. 50) we have narrated the manifestation of the Divinity and glory of Jesus during His public life.

In the second part (xiii. 1-xix. 42) the Evangelist gives an account of the Passion of our Lord.

In the third part (xx. 1-xxi. 23) are recorded the Resurrection and certain apparitions of the Saviour.

In the epilogue (xxi. 24, 25) it is said that Jesus did many other things which are not recorded in this book.

# The Gospel according to St. John

## CHAPTER I

THE DIVINITY OF THE WORD, 1-5.

THE MISSION OF JOHN THE BAPTIST, 6-13.

THE INCARNATION OF THE WORD, 14-18.

TWO TESTIMONIES OF THE BAPTIST TO CHRIST, 19-34.

THE FIRST FIVE DISCIPLES OF CHRIST, 35-51.

1. In the beginning was the Word, and the Word was with God, and the Word was God.

1. In the beginning; i.e., at the dawn of creation, when time began, when all created things began to be, the Word was already in existence, — from which it follows that the Word had no beginning, and consequently was eternal.

Was. The imperfect tense ( $\eta\nu$ ) is here used to signify continuous existence; had the perfect tense been used a cessation of existence, following upon the beginning of created things, would be implied.

The Word ( $\delta\ \lambda\acute{o}\gamma\omicron\varsigma$ ), means here the Second Person of the Blessed Trinity, as is evident from verse 14, where it is said, "the Word was made flesh." It is only St. John who makes use of the term  $\lambda\acute{o}\gamma\omicron\varsigma$ , *Word*, to signify a person; and this he does not only in his Gospel, but in his First Epistle (i. 1) and in the Apocalypse (xix. 13). In other parts of the Old and New Testaments the term,  $\lambda\acute{o}\gamma\omicron\varsigma$ , usually means *speech*, *word*.

It is a grave mistake, however, to hold as some do, that St. John got his idea of the *Word* or the term *Logos* other than from Biblical or divine sources. First of all the name *Logos* is not uncommon to the language of the Old Testament. The sacred writers often speak of a divine envoy, *Maleach*, who was to be the final Mediator (cf. Gen. xvi. 7, 13; Exod. xxiii. 20; Osee xii. 4, 5; Zach. xii. 10). They personify divine Wisdom, with which the *Memra*, or *Word*

2. The same was in the beginning with God.

3. All things were made by him: and without him was made nothing that was made.

of the Eternal, is eminently endowed, and make both divine Wisdom and the Word special agents of divine activity in the work of creation and in the world (Prov. viii; Ps. cvi. 20; cix. 1; Isa. lv. 11).

It was natural, therefore, that St. John, in characterizing the Messianic action of Jesus, should identify the Christ with the Angel of the Covenant, the Wisdom and the Word of Jehovah, since these are the personal and external manifestation of God. Perhaps also St. John was moved by divine inspiration to make use of the term *Logos* in speaking of the Second Divine Person, in order to refute many of the heretics of His time who had abused the term in expressing their own errors. Cf. Le Camus, *Life of Christ*, vol. i. p. 139.

**The Word was with God;** i.e., this Second Divine Person existed from eternity with God the Father, one with the Father in nature, but distinct from Him in person.

**The Word was God,** *καὶ Θεὸς ἦν ὁ λόγος*. This clause expresses the essence or the nature of the Word. The use of the article *ὁ* before *λόγος* shows that *λόγος*, and not *Θεός*, is the subject of the clause. The identity, therefore, of the nature of the Word with the nature or essence of the Godhead is here distinctly declared. It is absurd for the Arians to say that the use of *Θεός* here without the article means a being with a nature inferior to the Supreme Being.

2. This verse is but a recapitulation of the first verse.

3. **All things were made by him,** — literally, *through him*. The Evangelist now passes on to a consideration of the relations of the Word towards created things; and he shows that all things that have had a beginning have come into being by or through the *Logos*. The Arians maintained that since creation was *through* the Word, the Son was therefore inferior to the Father, forgetful of the fact that, as the essence and nature of the Father and the Son are one, the action of the one must be the action of the other. The Father and the Son are inseparable in the creative act, precisely because they are one in nature.

**Was made nothing that was made.** While this is the usual

4. In him was life, and the life was the light of men.
5. And the light shineth in darkness, and the darkness did not comprehend it.
6. There was a man sent from God, whose name was John.
7. This man came for a witness, to give testimony of the light, that all men might believe through him.
8. He was not the light, but was to give testimony of the light.

punctuation of these words, there is equal authority in both Latin and Greek for putting the period after *nothing*, and writing the remaining words with the following verse thus: "What was made in him was life," — meaning that living creatures were made *to live by His power*. **In him** means *by him*; and **life** is taken passively, meaning *made to live, vivified*. Cf. *Summa Theol.* i<sup>a</sup>, qu. 18, a. 4.

4. **In him was life**; i.e., in Him, as in its cause, was that supernatural life which, through His revelation and grace, He has communicated to men. The life, then, here spoken of was supernatural, of which men and angels only are capable.

**And the life was the light of men**; i.e., this Divine Word who was the source of all supernatural spiritual life was also the source and author of the faith which men have. "The light of men" means, therefore, their faith; and the Word, who is the source and author of faith, is the cause of the faith which men possess.

5. **And the light shineth**. The term "light" here means the Word, and this Divine Word or light has been shining on men from the beginning, enlightening them through their reason and through divine revelation. He has offered the light to men, but men have been free to accept or reject it.

The darkness signifies the moral obscurity to which unbelief had reduced man. Sins are "works of darkness" (Eph. v. 11; vi. 12).

**The darkness did not comprehend it**. The meaning is that the majority of men did not believe in God whose existence and attributes were manifested by the visible things of the world from the beginning; nor did they believe the revelation which God gave them through Christ. This rejection of belief in God and His revelation was possible only because men were free agents.

6-8. **There was a man sent from God**, etc. The Evangelist now introduces John the Baptist and his mission, for two reasons: (a) as a witness to prove that our Lord was the Messiah; (b) to show that the Baptist himself was not the Christ, as some erroneously

9. That was the true light, which enlighteneth every man that cometh into this world.

10. He was in the world, and the world was made by him, and the world knew him not.

11. He came unto his own, and his own received him not.

thought. John's mission was a divine one, it was from God, but it was only to prepare the way for the Messiah and to give testimony to him.

9. **That was the true light, etc.** The most probable Greek construction of this verse is that which connects *ἐρχόμενον* (*coming*) with *ἄνθρωπον* (*man*), which gives the meaning that the Word was the essential, everlasting light *which enlighteneth*, so far as He is concerned, every man born of women. If this true light does not enlighten everyone, it is because men are free to prevent it, just as they are free to conceal themselves from the light of the sun shining in the heavens. The Word, therefore, not only at His coming into the world, at His Incarnation, but from the very beginning, was the cause and source of the faith of men; but men, of course, as free agents, were and are able to reject belief in God and in God's revelation.

10. **He was in the world.** "He," i.e., the Word was in the world from the time of its creation, conserving it in existence, "sustaining all things by the word of His power" (Heb. i. 3). The Word was God, and God is everywhere by His essence, by His presence and by His power. Thus nearly all the Fathers understand the reference here to be to the presence of the Word in the world, as God and Creator, before the Incarnation, from the very creation of the world. Maldonatus, however, holds that there is reference here only to the presence of the Word in the world during His mortal life.

**And the world was made by him, etc.** Although the Word was the Creator and Conserver of the world from the beginning, still the majority of mankind had failed to recognize Him, transferring the worship due Him to senseless idols (Rom. i. 23).

11. **He came unto his own, etc.** All the Fathers understand this to refer to the Incarnation of the Word. By His Incarnation the Word came into His own world which He had created and conserved; and in particular He came to His own chosen people, the

12. But as many as received him, he gave them power to be made the sons of God, to them that believe in his name.

13. Who are born, not of blood, nor of the will of the flesh, nor of the will of man, but of God.

14. And the Word was made flesh, and dwelt among us, (and we saw his glory, the glory as it were of the only begotten of the Father,) full of grace and truth.

Jews, and they "received him not," they would not, as a race, believe in Him, but on the contrary rejected Him.

12. To all who did believe in Him, whether Jew or Gentile, the Eternal Word gave the power, i.e., the grace, to become God's adopted children. The faith of those who did believe in Him was the effect of grace and a necessary condition of the justification which followed and which made them sons of God. Faith, as the Council of Trent teaches (Sess. vi. can. vi, viii) is the root of justification, it is the condition *sine qua non*; but faith is neither the formal, nor even the meritorious cause of justification; men are justified by charity which follows upon faith.

13. **Who are born, not of blood . . . but of God.** This shows that while men, and the will of men, are the cause of carnal generation, it is only God who can be the cause of spiritual generation through faith and Baptism. This was an argument against the Jews who considered themselves just because they had Abraham as their father.

14. **And the Word was made flesh.** Some think this clause should be introduced by *for* instead of *and*, in which case the Evangelist would be assigning the cause, or the reason, why those who received the Word were made sons of God. "Flesh" may be only a Hebraism for *man*, or it may have been used intentionally against the Docetae—heretics who denied that Christ had taken flesh because they considered flesh to be essentially corrupt.

**Dwelt**; i.e., took up a transitory abode (*ἐσκήνωσεν*) on earth among men,—literally, "pitched His tent or tabernacle." The Incarnation of the Word was permanent, but His visible dwelling among men was not so.

**And we saw his glory.** St. John is here proclaiming himself to have been an eye-witness of the glory of the Word.

**Glory as it were, etc.;** i.e., such glory as was befitting and possible only to the Only-begotten Son of the Father.

15. John beareth witness of him, and crieth out, saying: This was he of whom I spoke: He that shall come after me, is preferred before me: because he was before me.

16. And of his fulness we all have received, and grace for grace.

17. For the law was given by Moses; grace and truth came by Jesus Christ.

**Full of grace and truth.** These words are to be joined with the first part of the verse, so as to read as follows: "And the Word was made flesh and dwelt among us, full of grace and truth." The clause, "and we saw his glory," etc., is parenthetic. Our Lord was "full of grace" in the strictest and widest sense of the term, both as God and as man, and hence He was an overflowing source of sanctification to all men. He was "full of truth" as containing all the treasures of wisdom and knowledge (Coloss. ii. 3), and as being the all-wise and infallible Teacher of faith and the way to Heaven.

15. **This was he,** etc. The Evangelist more probably is here giving by anticipation what he describes more fully in verses 29, 30. He is citing the testimony of John the Baptist relative to the Incarnation of the Word "full of grace and truth."

**He that shall come after me,** etc.; i.e., "He that shall succeed me in the exercise of His public ministry" is preferred before me" in dignity, "because He existed before me." Our Lord being eternal existed before John the Baptist, and was superior to the Baptist in dignity, and preferred before him in the designs and counsels of the Eternal Father.

16. **And of his fullness we have all received.** These are the words of the Evangelist continuing what he said in verse 14.

**Grace for grace.** This is explanatory of the preceding clause, and means, according to the more probable opinion of Patrizi and others, the more abundant and perfect grace of the New Law, as compared with that of the Old Law. The opinion also seems very probable which says that the above phrase means a succession of graces, one after another.

17. The Evangelist had already asserted the superiority of our Lord over John the Baptist, and now he proclaims Him superior to Moses. Through Moses the Jews had received the Law which pointed out man's duties, but did not of itself give grace to fulfil those duties; whereas Christ, the author and source of grace and truth, in the New Law has given to the world not only a thorough

18. No man hath seen God at any time: the only begotten Son who is in the bosom of the Father, he hath declared him.

19. And this is the testimony of John, when the Jews sent from Jerusalem priests and Levites to him, to ask him: Who art thou?

20. And he confessed, and did not deny: and he confessed: I am not the Christ.

21. And they asked him: What then? Art thou Elias? And he said: I am not. Art thou the prophet? And he answered: No.

knowledge of the things necessary for man's salvation, but abundant grace also to perform all these things.

18. **No man hath seen God at any time;** i.e., no man while here on earth, at least while living the life of the senses, has ever seen God as He is in Himself. When we read in Scripture that Jacob or Job or Moses or Isaias saw God, the meaning is that they saw Him represented under some visible human form, or as an angel who had assumed human appearances in order to represent in some degree the glory of God. St. Thomas, however, holds that Moses and St. Paul here below enjoyed while in rapture a real vision of the divine essence.

The angels and saints in Heaven see God as He is, they behold His essence, but even then only according to their own capacity and not *comprehensively*. As God is infinite in essence it is impossible that any creature should see and understand Him perfectly and completely. The present verse seems to assign the reason why the New Law and the gifts of Christ are so superior to the Law of Moses; namely, because Christ who is consubstantial with the Father and knows all the secrets of the Godhead, has declared the doctrines and mysteries contained in the New Law.

19. The Evangelist is here recording one of the most important testimonies of John the Baptist. There was a general feeling among many of the Jews that the Baptist was the Christ, and hence a very superior deputation was sent from Jerusalem to John, most probably by the Sanhedrim, the supreme council among the Jews, whose office it was to enquire into the authority and credentials of every preacher; they wanted to know authoritatively whether John was the Messiah.

20. In a most emphatic manner John declares that he is not the Christ.

21. **Art thou Elias?** According to the prophecy of Mal. (iv. 5),



22. They said therefore unto him: Who art thou, that we may give an answer to them that sent us? What sayest thou of thyself?

23. He said: I am the voice of one crying in the wilderness, make straight the way of the Lord, as said the prophet Isaias.

24. And they that were sent, were of the Pharisees.

25. And they asked him, and said to him: Why then dost thou baptize, if thou be not Christ, nor Elias, nor the prophet?

26. John answered them, saying: I baptize with water; but there hath stood one in the midst of you, whom you know not.

Elias should return to earth before the coming of Christ; but the prophecy refers only to the second coming of Christ, which alone Elias is to precede in person. As the Jews did not distinguish the first coming of Christ in humility and meekness from His second coming in power and glory, they thought that John the Baptist who came in the spirit and power of Elias (Luke i. 17) was himself Elias. See on Matthew xvii. 10-12.

**Art thou the prophet?** The Jews misunderstood Deut. (xviii. 15) which, when it speaks of the prophet (*ὁ προφήτης*) refers without doubt to our Lord; they understood the passage to refer to some other prophet.

22. If the Baptist were not the Christ, nor Elias, nor the prophet, the priests and levites could not understand who he was.

23. **The voice of one crying.** See on Matt. iii. 3. Far from being the Messiah, John professes himself to be nothing more than a voice, whose crying and preaching were only to prepare the way and dispose the hearts of the people for the coming Messiah.

24. **Pharisees.** See on Matthew iii. 7.

25. **Why then dost thou baptize?** The Pharisees who were versed in the Law knew from Ezech. (xxxvi. 25) and Zach. (xiii. 1) that, at the time of the Messiah, there would be a baptism for the remission of sins, and from these passages they wrongly concluded that only the Messiah, or some one with Him, could confer this baptism. Hence they could not understand why John was baptizing.

26. **I baptize with water.** The baptism which was foretold by the prophets was to be for the remission of sins; but the baptism which John was conferring was only a disposition, a preparation for that spoken of by the prophets.

**There hath stood, etc.,**—literally, “there standeth” (*ἔστηκεν* or *σῆκει*). The meaning of the passage is not that our Lord was

27. The same is he that shall come after me, who is preferred before me: the latchet of whose shoe I am not worthy to loose.

28. These things were done in Bethania, beyond the Jordan, where John was baptizing.

29. The next day, John saw Jesus coming to him, and he saith: Behold the Lamb of God, behold him who taketh away the sin of the world.

30. This is he, of whom I said: After me there cometh a man, who is preferred before me: because he was before me.

31. And I knew him not, but that he may be made manifest in Israel, therefore am I come baptizing with water.

then and there present, but that He was already living among the Jews.

27. In this verse the following words: "the same is," and "who is preferred before me" are not found in many MSS. In the latter part of the verse the Baptist declares he is not worthy to perform the most menial service for Christ.

28. **Bethania**, or "Bethabara," as some readings have it, means "the house of a boat." It was east of the Jordan in Peraea, and was a point from which people commonly crossed the river from Peraea to Judea. This was why John chose the spot for his preaching and baptism. We must carefully distinguish this Bethania from the town in Judea where Lazarus lived.

29. **The next day John saw Jesus**; i.e., the day following the one on which he had given the preceding testimony. We do not know for certain whence our Lord was coming, but it is most probable that He was coming from the desert after His forty days' fast.

**Behold the Lamb of God.** Our Lord was spoken of as the lamb of God most probably because He was to be offered for the sins of men. To point Him out as the Lamb of God was equivalent to designating Him as the Messiah, because Isaias (liii. 7-12) had compared the Messiah to a lamb that should bear the sins of men.

**Who taketh away the sin**, etc.; i.e., who will wipe away completely the sins, not only of the Jews or of one nation, but of all men.

30. In this verse there is reference most probably to the testimony recorded in verse 15.

31. **And I knew him not**; i.e., publicly or officially; or even personally, perhaps. St. John had been brought up in the hill country of Judea, whereas our Lord had grown to manhood in Nazareth

32. And John gave testimony, saying: I saw the Spirit coming down, as a dove from heaven, and he remained upon him.

33. And I knew him not; but he who sent me to baptize with water, said to me: He upon whom thou shalt see the Spirit descending, and remaining upon him, he it is that baptizeth with the Holy Ghost.

34. And I saw, and I gave testimony, that this is the Son of God.

35. The next day again John stood, and two of his disciples.

36. And beholding Jesus walking, he saith: Behold the Lamb of God.

37. And the two disciples heard him speak, and they followed Jesus.

38. And Jesus turning, and seeing them following him, saith to them: What seek you? Who said to him, Rabbi, (which is to say, being interpreted, Master,) where dwellest thou?

39. He saith to them: Come and see. They came, and saw where he abode, and they stayed with him that day: now it was about the tenth hour.

of Galilee, hence it is not probable that the two were personally acquainted before they had grown to manhood.

32. **And John gave testimony, saying.** These are the words of the Evangelist interrupting the narrative of the Baptist.

I saw the Spirit coming down, etc., which was at our Lord's baptism. See on Matthew iii. 16, 17.

33. **But he who sent me . . . said to me, etc.** Here the Baptist makes known that the sign he had perceived at our Lord's baptism had previously been revealed to him as one that would designate the Messiah, and so confirm his faith in the Messiah.

**That baptizeth with the Holy Ghost; i.e.,** that takes away the sins of men by the graces of the Holy Ghost.

34. **And I gave testimony that this, etc.** It does not appear from the Gospel just when the Baptist uttered this testimony that our Lord was "the Son of God," except, indeed, in so far as it was implied in speaking of our Lord's superior character, exalted dignity, of His taking away the sins of the world, etc.; but that he did recognize the Messiah as God is certain.

35. **Two of his disciples.** One of these disciples was Andrew, as is evident from verse 40; the other was most likely St. John the Evangelist himself.

38. **Rabbi.** The Evangelist here gives the Greek rendering of the Aramaic word *Rabbi*, thereby showing that he was writing for his Greek disciples of Asia Minor.

39. **Tenth hour; i.e.,** about two hours before sunset. The Jews

40. And Andrew, the brother of Simon Peter, was one of the two who had heard of John, and followed him.

41. He findeth first his brother Simon, and saith to him: We have found the Messias, which is, being interpreted, the Christ.

42. And he brought him to Jesus. And Jesus looking upon him, said: Thou art Simon the son of Jona: thou shalt be called Cephias, which is interpreted Peter.

43. On the following day, he would go forth into Galilee, and he findeth Philip. And Jesus saith to him: Follow me.

44. Now Philip was of Bethsaida, the city of Andrew and Peter.

divided their days and nights into twelve equal parts or hours, varying in length according to the seasons of the year. The tenth hour, therefore, of the day must have been two hours before sunset or the close of the day.

40. See on verse 35.

41. **The Messias.** Here again the Evangelist explains for his Greek readers the meaning of the Aramaic word *Messiah* from the Hebrew, *Mashach*.

42. **Thou shalt be called Cephias.** It is disputed whether our Lord at this time conferred on Simon the name "Cephas" or "Peter"; or whether He only foretells it here. It seems more probable that the name "Peter" was not conferred, but only foretold at this time; the actual conferring of the name seems to have been later, as recorded by Matt. xvi. 18.

*Cephas*, meaning rock, is the Greek for the Aramaic *Kepha*. See on Matt. xvi. 18.

43. **Into Galilee.** Our Lord had come from Nazareth in Galilee to be baptized by John (Matt. iii. 13). Immediately after His baptism, He retired to the desert for forty days (Matt. iv. 1); and when He came forth from the desert He was witnessed to by St. John the Baptist (John i. 15, 19-36); and now, after all this, He was about to return to Galilee.

**Follow me.** This call of Philip was an invitation to become a disciple only, not a formal call to the Apostleship. The same is true of the others, Peter, Andrew, James, John and Nathanael, spoken of in this chapter. The formal call of the Apostles is recorded in Matt. iv. 18-22; Luke v. 1-11.

44. **Bethsaida.** This was Bethsaida of Galilee on the western coast or shore of the Sea of Galilee, about four miles south of Capharnaum.

45. Philip findeth Nathanael, and saith to him: We have found him of whom Moses in the law, and the prophets did write, Jesus the son of Joseph of Nazareth.

46. And Nathanael said to him: Can any thing of good come from Nazareth? Philip saith to him: Come and see.

47. Jesus saw Nathanael coming to him: and he saith of him: Behold an Israelite indeed, in whom there is no guile.

48. Nathanael saith to him: Whence knowest thou me? Jesus answered, and said to him: Before that Philip called thee, when thou wast under the fig-tree, I saw thee.

49. Nathanael answered him, and said: Rabbi, thou art the Son of God, thou art the king of Israel.

50. Jesus answered, and said to him: Because I said unto thee, I saw thee under the fig-tree, thou believest: greater things than these shalt thou see.

45. **Nathanael** was a native of Cana in Galilee, and was afterwards known as the Apostle Bartholomew.

**Jesus, the son of Joseph.** It is clear that Philip regarded our Lord as the natural son of Joseph, but it would be stupid to conclude that St. John the Evangelist, who was merely recording the words of Philip, was also ignorant of the miraculous birth of the Christ.

46. **Can anything of good come from Nazareth.** Nazareth was an obscure village of lower Galilee, and was generally held in contempt; hence Nathanael expressed the doubt, or at least the surprise, that the Messiah should come from Nazareth. Nazareth was the home of the Blessed Virgin, the scene of the Incarnation, and of our Lord's childhood and private life.

47. **Behold an Israelite indeed, in whom, etc.** In these words our Lord pointed out Nathanael as a true son of Jacob or Israel, not only because he was a lineal descendant of Jacob, but also because he possessed the latter's simplicity and honesty of heart and mind.

49. **Thou art the Son of God.** It is disputed whether Nathanael recognized our Lord as the true consubstantial Son of God; or only the Son of God by excellence, above all others. The latter opinion would seem more probable, as the true confession of our Lord's Divinity seems to have been first made by St. Peter (Matt. xvi. 16-18). See, however, on Matthew xiv. 33. Cardinal Franzelin holds the former opinion, and à Lapide thinks Nathanael believed, in a confused way, in our Lord's Divinity.

50. **Greater things than these, etc.** Our Lord is here perhaps

51. And he saith to him: Amen, amen I say to you, you shall see the heaven opened, and the angels of God ascending and descending upon the Son of man.

referring to His future miracles, of which Nathanael should be a witness, and which should prove Him beyond doubt to be the Son of God in the strictest sense.

51. **Amen, amen**, I say. The repetition of the word "amen" is peculiar to St. John, the Evangelist, and is calculated to give force to what follows. It is never used in the Old Testament to affirm beforehand what follows, but only to assert more roundly what has been said. Cf. Num. v. 22; Deut. xxvii. 15; 2 Esd. v. 13, etc.

**You shall see the heaven opened**, etc. The meaning of these words is not certain. It is disputed whether they should be taken in a literal, or in a metaphorical sense. The most probable interpretation seems to be that given by Maldonatus, who explains the words literally, as referring to the Last Judgment when the appearance of our Lord in the clouds of the heaven, surrounded by His holy angels, will make it manifest to all that He is indeed the Son of God. Of the metaphorical interpretations the most probable is that which sees in these words a reference to Jacob's dream. The angels ascending and descending which Jacob saw in his dream signified special protection and favor on the part of God; and this special protection and favor signified in Jacob's dream was so to be verified in the case of our Lord, that it would be manifest beyond doubt that He was the Son of God.

**Son of man.** Here for the first time in this Gospel Jesus calls Himself the Son of man, and the meaning He attaches to it is that He is the offspring of our human race, but in the highest and most excellent manner, as well as the Son of God. The "Son of man," therefore, means the man foretold and awaited, the Messiah. In the Synoptics, chiefly in Matthew and Luke, this title is applied to our Lord thirty-nine times. It is employed ten times in St. John. See on Matthew viii. 20.

## CHAPTER II

THE MARRIAGE FEAST AT CANA, 1-11.

JESUS AT CAPHARNAUM, 12.

JESUS GOES TO JERUSALEM AND THERE DRIVES THE  
TRAFFICKERS OUT OF THE TEMPLE, 13-17.

ASKED BY THE JEWS FOR A SIGN OF HIS AUTHORITY  
JESUS PREDICTS HIS OWN RESURRECTION, 18-22.

AT THE FIRST PASCH OF HIS PUBLIC LIFE, MANY  
BELIEVE IN JESUS BECAUSE OF HIS MIRACLES,  
23-25.

1. And the third day, there was a marriage in Cana of Galilee: and the mother of Jesus was there.

2. And Jesus also was invited, and his disciples, to the marriage.

3. And the wine failing, the mother of Jesus saith to him: They have no wine.

4. And Jesus saith to her: Woman, what is that to me and to thee? my hour is not yet come.

1. The Evangelist has already told us how the Baptist witnessed to our Lord and how the first disciples joined the Saviour; and now he goes on to show how our Lord's Divinity was witnessed to by His own miracles.

The third day; i.e., the third day after His departure from Judea for Galilee (i. 43).

Cana of Galilee was near Capharnaum in the tribe of Zabulon. This is to be distinguished from the other Cana near Sidon in the tribe of Aser (Jos. xix. 28).

2. And Jesus also was invited. Maldonatus holds that the "and" in this clause is explanatory, hence the meaning is: Because the Blessed Virgin was there (verse 1), Jesus was invited. Our Lord assisted at this marriage out of charity for His friends and relatives, and to sanctify by His presence the marriage state.

3. They have no wine. The reason for thus addressing her divine Son was doubtless to induce Him to work a miracle for the sake of the guests at the wedding feast.

4. Woman, what is it to me and to thee? literally, "What to me and to thee, woman" (*τι ἐμοὶ καὶ σοὶ γύναι*). Some trans-

5. His mother saith to the waiters: Whatsoever he shall say to you, do ye. late the passage thus: "Woman, what need have we to trouble ourselves?" others, "Woman, what have I in common with thee?" But usually *τί ἐμοὶ καὶ σοί* in Scripture signifies: "leave it to me, leave me in peace." This is the meaning of the sentence in Judges xi. 12; 2 Kings xvi. 10; 3 Kings xvii. 18; 4 Kings iii. 13. The real meaning of these words, however, in the present instance, has puzzled the commentators of all times. Most Protestants have maintained that these words were a reproof of the Blessed Virgin. The older opinion among Catholic commentators was that they contain the *semblance* of reproof; the general opinion, however, among Catholic commentators now is that the words do not contain even a shadow of reproof. This last opinion seems quite certain for the following reasons: (a) there was nothing wrong in what was requested by our Blessed Lady; (b) there was no fault committed by her in making the request, because she was at all times without sin; (c) the thing requested was afterwards granted by our Lord; (d) in many places in the Old Testament, and in several of the New, the same expression, "what to me and to thee" is used, and in none of these instances do the words convey anything of censure or reproof. Cf. Judg. xi. 12; 3 Kings xvii. 18; 4 Kings iii. 13; 2 Paral. xxxv. 21; Mark v. 7; Luke viii. 28. Most Protestants now admit that the term *γύναι*, *Mistress, Lady*, implies respect, reverence and affection. Thus Trench (*Miracles*, p. 100) says: "So far from any harshness, the compellation has something solemn in it." Liddell & Scott's *Lexicon* says: "It is often used as a term of respect or affection, — mistress, lady."

**My hour is not yet come.** The expression "My hour" usually refers to our Lord's Passion; but here it means the time appointed by Divine Providence for working public miracles. Hence according to the general Providence of God, it was not *opportune* or *convenient* that our Lord should work a public miracle at this time; and hence the meaning of this whole verse is "what is it to me and to thee, lady, that they have no wine? I cannot well work a miracle now, because the time for my public miracles has not yet arrived."

5. **Whatsoever he shall say to you, do ye.** These words show that our Lady had not been reproved; but that, on the contrary, she knew that her request would be granted. Hence the words of



6. Now there were set there six water-pots of stone, according to the manner of the purifying of the Jews, containing two or three measures apiece.

7. Jesus saith to them: Fill the water-pots with water. And they filled them up to the brim.

8. And Jesus saith to them: Draw out now, and carry to the chief steward of the feast. And they carried it.

9. And when the chief steward had tasted the water made wine, and knew not whence it was, but the waiters knew who had drawn the water; the chief steward calleth the bridegroom,

10. And saith to him: Every man at first setteth forth good wine, and when men have well drunk, then that which is worse. But thou hast kept the good wine until now.

St. Justin Martyr: "He reproved not His Mother by what He said, who honored her by what He did."

6. **Six waterpots . . . containing two or three measures apiece.** The Greek liquid measure, *μετρητής*, here spoken of, contained about nine gallons. Each waterpot, therefore, if it contained two or three measures, would hold about eighteen or twenty-seven gallons; and since there were six of these waterpots the quantity of wine produced by the miracle would be about one hundred and eight or one hundred and sixty-two gallons. This was not an extraordinary quantity of wine, if we remember that the marriage feast lasted a week and was taken part in by a great crowd of people. The quantity of water made wine, however, showed the magnificence of the miracle.

According to the manner of the purifying, etc. See on Matt. xv. 2.

7. **Up to the brim**, which shows that there was no room left for fraud by mixing wine with the water.

8. **The chief steward**; i.e., the chief servant who had charge over the other servants, and of the entertainment as a whole.

9. **Who had drawn the water**; i.e., from the well for the purpose of filling the waterpots. The surprise of the chief steward and the reproof which, in the subsequent verse, he gave to the bridegroom show the reality of the miracle.

10. In this verse the chief steward refers to what was customary at banquets.

**When men have well drunk**, etc. This means when they have become quite satisfied; there is no question of intemperance here.

11. This beginning of miracles did Jesus in Cana of Galilee; and manifested his glory, and his disciples believed in him.

12. After this he went down to Capharnaum, he and his mother, and his brethren, and his disciples; and they remained there not many days.

13. And the pasch of the Jews was at hand, and Jesus went up to Jerusalem.

14. And he found in the temple them that sold oxen and sheep and doves, and the changers of money sitting.

15. And when he had made, as it were, a scourge of little cords, he drove them all out of the temple, the sheep also and the oxen, and the money of the changers he poured out, and the tables he overthrew.

11. **This beginning of miracles, etc.** This is the first of our Lord's public miracles, but it does not follow that He had not aforetime performed miracles in private, during the years He spent in Nazareth. The purpose of this miracle was like that of all the other of our Lord's miracles; namely, to manifest the glory of His Father and to provoke belief in His Divinity. The disciples believed in Him already, but this miracle strengthened their faith.

12. Since we are not told that our Lord's brethren were at Cana, it is possible that He went first to Nazareth where, being joined by His brethren who lived at Nazareth, He proceeded to Capharnaum on the north-west shore of the Sea of Galilee. See on Matthew xii. 46.

13. **And the pasch of the Jews was at hand.** St. John mentions this fact for his non-Jewish readers of Asia Minor. There were three principal feasts celebrated in the Temple at Jerusalem each year: the Pasch, Pentecost, and the Feast of Tabernacles; and at each of these all male adults were bound to be present. The Pasch was the greatest of the Jewish festivals and extended from the evening of the 14th to the evening of the 21st of Nisan. See also on Matthew xxvi. 2.

14. This ejection of the traffickers from the Temple took place at the beginning of our Lord's public ministry. A similar one occurred nearly three years later. Cf. Matthew xxi. 12; Mark xi. 15; Luke xix. 45. The traders ejected from the Temple were most probably in the Court of the Gentiles. See on Matthew xxi. 12.

15. **A scourge of cords**, which was used in driving out the cattle only. St. Jerome regards this whole occurrence as "the most marvellous of all the miraculous signs of our Lord's power. A man who was looked upon with scorn and was treated as the last of men, so as to be crucified, has the power to banish with a simple whip of

16. And to them that sold doves he said: Take these things hence, and make not the house of my Father a house of traffic.

17. And his disciples remembered, that it was written: The zeal of thy house hath eaten me up.

18. The Jews, therefore, answered, and said to him: What sign dost thou shew unto us, seeing thou dost these things?

19. Jesus answered, and said to them: Destroy this temple, and in three days I will raise it up.

20. The Jews then said: Six and forty years was this temple in building; and wilt thou raise it up in three days?

cords so great a multitude, upset their tables and do other things, which an armed force could hardly accomplish; and this, in the presence of the Pharisees and Doctors of the Law, transported with rage against Him, as well as of those whose traffic He ruined."

16. **A house of traffic.** The trading in the Temple was a sacrilegious act, because it was the profaning of a sacred place.

17. **Hath eaten me up.** A better reading has, "will eat me up" (*καταφάγεται*). The Psalmist, however, in the passage here quoted (Ps. lxxviii. 10) was speaking in the prophetic past, and yet he was describing the zeal of the future Messiah for the honor of the house of God. The disciples who were familiar with the Psalms, and other parts of Scripture recited in the synagogue, remembered that these words were predicted of the Christ, and they saw that in the present case the words were peculiarly applicable to our Lord.

18. **The Jews answered;** i.e., they began, or went on, to speak. They demanded another miracle as a proof of His authority to drive the dealers from the Temple, pretending not to realize the magnitude of the miracle He had just performed.

19. **Destroy this temple,** etc. Speaking of His body under the figure of a temple, our Lord now refers to the greatest of His miracles, which, consequently, was to be the greatest proof of His Divinity; namely, His Resurrection from the dead. The Jews, and even the disciples, apparently misunderstood Him to speak literally of Herod's temple. Our Lord spoke thus ambiguously because the Jews had shown themselves unworthy of plainer words; but even so, a deception did not necessarily follow, since the word, *ναός*, *temple*, could be properly used of a human body. Cf., e.g., 1 Cor. iii. 16, 17; vi. 19; 2 Cor. vi. 16.

20. **Six and forty years,** etc. The Temple here spoken of was

21. But he spoke of the temple of his body.

22. When therefore he was risen again from the dead, his disciples remembered, that he had said this, and they believed the scripture, and the word that Jesus had said.

23. Now when he was at Jerusalem, at the pasch, upon the festival day, many believed in his name, seeing his signs which he did.

24. But Jesus did not trust himself unto them, for that he knew all men,

25. And because he needed not that any should give testimony of man; for he knew what was in man.

known as Herod's Temple. The first temple, built by Solomon in eight years (3 Kings vi. 38) was destroyed by the Chaldeans; the second, called Zorobabel's Temple, was begun in the second year of Cyrus, and completed about forty-six years later, in the ninth year of Darius Hystaspes. In the time of Herod this second Temple was in a state bordering on ruin and was repaired, and to a certain extent rebuilt, by Herod the Great, beginning in the fifteenth or eighteenth year of his reign, or about 22 B.C. (Josephus, *Bell. Jud.* i. 21, 1; *Antiq.* xv. 11, 1), which would make about forty-six years to the time of the present occurrence. This Temple was not finally completed till about A.D. 64.

21. The Evangelist here cautions us against the error of the Jews, by giving us the meaning of our Lord's words.

22. After the Resurrection of our Lord the disciples clearly remembered and understood the words which He had spoken on this occasion relative to the rebuilding of the Temple, i.e., to the Resurrection of His body.

23. **Upon the festival day;** i.e., during the festival of the Pasch, which lasted a week. We have no record of the miracles wrought by our Lord on this occasion, but they must have been many and striking, since because of them "many believed in his name."

24. Although many believed in Him, our Lord, who read their hearts, saw that if put to trial they would forsake Him; and hence He did not trust Himself to them.

25. **He knew what was in man;** i.e., He read the secrets of men's hearts. This is another proof of His Divinity, for only God can know the secrets of the heart. (3 Kings viii. 39; Job xlii. 2; Ps. vii. 10).

## CHAPTER III

## THE DISCOURSE OF OUR LORD WITH NICODEMUS,

I-21.

## THE BAPTIST TESTIFIES ANEW TO JESUS, 22-36.

1. And there was a man of the Pharisees, named Nicodemus, a ruler of the Jews.

2. This man came to Jesus by night, and said to him: Rabbi, we know that thou art come a teacher from God; for no man can do these signs which thou dost, unless God be with him.

3. Jesus answered, and said to him: Amen, amen I say to thee, unless a man be born again, he cannot see the kingdom of God.

4. Nicodemus saith to him: How can a man be born when he is old? can he enter a second time into his mother's womb, and be born again?

5. Jesus answered: Amen, amen I say to thee, unless a man be born again of water and the Holy Ghost, he cannot enter into the kingdom of God.

1. **Nicodemus.** The Evangelist makes special mention of Nicodemus on account of his prominence, as a Pharisee. Nicodemus was one of those who believed in our Lord because of the miracles performed by Him during the festival of the Pasch.

2. **By night.** Nicodemus came to our Lord by night most probably because he was ashamed to let the other Pharisees know of his adherence to so humble a man as Jesus of Nazareth. At all events he showed that he really believed our Lord to be a messenger from God, and this because of His miracles.

3. **Unless a man be born again,** etc. Our Lord now points to the necessity of Baptism for spiritual birth, as an indispensable condition for entering the Kingdom of God. To enter Heaven a man must be a "new creature" (Gal. vi. 15), and the first step toward this newness of life is Baptism.

4. Nicodemus either misunderstood the meaning of our Lord's words, or pretended to misunderstand them, in order to get a fuller explanation of them.

5. In this verse the Saviour explains more definitely and concretely the nature of this second birth. The Council of Trent (Sess. VII. can. 2) defined: (a) that in this verse there is question of natural water; (b) and that this natural water is necessary for Baptism. Water, therefore, is here to be understood literally, not

6. That which is born of the flesh, is flesh; and that which is born of the Spirit, is spirit.

7. Wonder not, that I said to thee, you must be born again.

8. The Spirit breatheth where he will; and thou hearest his voice, but thou knowest not whence he cometh, and whither he goeth: so is every one that is born of the Spirit.

9. Nicodemus answered, and said to him: How can these things be done?

10. Jesus answered, and said to him: Art thou a master in Israel, and knowest not these things?

metaphorically; and it is not a mere sign or symbol, but an efficient cause, of grace. Those, consequently, who understand water as here used in a metaphorical sense, as a symbol or sign, stand condemned by the Council. Water is a real efficient cause, although secondary and instrumental, in conferring the grace of Baptism, the Holy Ghost being the primary or principal cause.

6. The meaning of this verse is: That which comes from man, as man, is merely natural; whereas that which proceeds from the Spirit of God is spiritual and supernatural. Since, then, this new life of regeneration of which our Lord is speaking is spiritual, it requires a spiritual and supernatural principle.

7. It is not wonderful, therefore, since the new life is a spiritual one, that man needs to be born again.

8. The sense of this verse depends upon the meaning we attach to the first "spirit." The more probable opinion is that "spirit" (*τὸ πνεῦμα*) means simply the wind. Hence our Lord's argument is, that just as we know not whence comes or whither goes the wind, although we must admit the fact of its existence, so are the operations of the spirit of God, — we perceive its influence and its effects, but more we do not understand. Others with less probability take "spirit" as meaning the Holy Ghost, whose operations in man are according to His own good pleasure.

It is not unusual for *πνεῦμα* to mean *wind* in the Bible; see, e.g., Gen. viii. 1; Ps. ciii. 4; Heb. i. 7.

9, 10. Nicodemus seems still bewildered over this new life of regeneration, but our Lord marvels at him, since he, a teacher in Israel and a member of the great Sanhedrim, does not seem to know that Ezechiel (xxxvi. 25) and Zacharias (xiii. 1) had foretold this very spiritual regeneration of which our Lord has been speaking.

11. Amen, amen I say to thee, that we speak what we know, and we testify what we have seen, and you receive not our testimony.

12. If I have spoken to you earthly things, and you believe not; how will you believe, if I shall speak to you heavenly things?

13. And no man hath ascended into heaven, but he that descended from heaven, the Son of man who is in heaven.

14. And as Moses lifted up the serpent in the desert, so must the Son of man be lifted up:

15. That whosoever believeth in him, may not perish; but may have life everlasting.

16. For God so loved the world, as to give his only begotten Son; that whosoever believeth in him, may not perish, but may have life everlasting.

11. **We speak what we know**, etc. Our Lord uses the plural. This is most probably the plural of majesty and solemnity; although some, with less probability, hold that our Lord used the plural to signify that, together with Himself, the Father and the Holy Ghost were witnesses of the truth of the doctrine He was teaching.

12. **Earthly things** most likely refer to the Baptism or regeneration concerning which He had just been speaking. If Nicodemus was unable to understand the process of this spiritual regeneration here on earth, which after all is a doctrine comparatively elementary, how could he hope to understand the higher spiritual truths of revelation?

13. The meaning of this verse is, that no man except the Son of God, Christ Himself, is able to speak with full knowledge and authority of the great mysteries of God. And the reason is, because Christ as God has been in Heaven from all eternity. The word, "ascended" is used only to accommodate the thought to human modes of speech and thought. "Hath ascended" is equivalent to "dwelling in Heaven." The words, "who is in heaven," are not in the best MSS.

14, 15. **As Moses lifted up the serpent in the desert**, in order that they who looked upon it might be healed (Num. xxi. 4-9), so must Christ be raised aloft on the cross for the salvation of all who believe in Him and keep His words. See on Mark xvi. 16.

16. The words of this verse are most likely Christ's, and not those of the Evangelist. And here we have assigned the reason why the Father sent His Only Son into the world; namely, because of His boundless love of souls who were in the world. But the

17. For God sent not his Son into the world, to judge the world, but that the world may be saved by him.

18. He that believeth in him is not judged. But he that doth not believe, is already judged: because he believeth not in the name of the only begotten Son of God.

19. And this is the judgment: because the light is come into the world, and men loved darkness rather than the light: for their works were evil.

20. For every one that doth evil hateth the light, and cometh not to the light, that his works may not be reprov'd.

21. But he that doth truth, cometh to the light, that his works may be made manifest, because they are done in God.

Incarnation and death of Christ are unavailable for salvation, unless we have faith in Christ and His teaching and order our lives according to His teaching.

17, 18. In these verses it is insisted that the primary purpose of the Incarnation was man's Redemption, but that the fruits of the Redemption cannot be shared by anyone without faith in Christ and His teaching. If men do not believe in Christ and obey His teaching they are like sick people, says St. Augustine, who prefer to die rather than make use of the services and remedies of a physician who is waiting to cure them.

19. **And this is the judgment**, etc.; i.e., this is the cause of the judgment or condemnation of the world; of those, namely, who do not believe, that they have not faith, but prefer darkness to light.

20. **Every one that doth evil**, etc.; i.e., every one who sins and prefers to live in his sin eschews the teaching of Christ, lest by that teaching he should find himself reprov'd and have to give up his sinful life. **Works** are here mentioned, which shows that faith alone without works is not all that is required (James ii. 14).

21. The meaning of this verse is uncertain. The sense most probably is, that he who does his best to live righteously comes to the light of faith and believes, so that the result of his former goodness is a proof that his previous works were "done in God," i.e., were the effect of grace. It is *de fide* from the Council of Trent that faith is not the first grace, and that good works performed before the dawn of faith are the result of grace. The proposition, "Faith is the first grace," was condemned by Pius VI in the Bull *Auctorem Fidei*.



22. After these things Jesus and his disciples came into the land of Judea: and there he abode with them, and baptized.

23. And John also was baptizing in Ennon near Salim; because there was much water there; and they came and were baptized.

24. For John was not yet cast into prison.

25. And there arose a question between some of John's disciples and the Jews concerning purification:

26. And they came to John, and said to him: Rabbi, he that was with thee beyond the Jordan, to whom thou gavest testimony, behold he baptizeth, and all men come to him.

27. John answered and said: A man cannot receive any thing, unless it be given him from heaven.

28. You yourselves do bear me witness, that I said, I am not Christ, but that I am sent before him.

22. After our Lord's discourse with Nicodemus at Jerusalem, He and His disciples retired from the city of Jerusalem into the country districts of Judea.

23. **Ennon near Salim.** Some think this place was situated in the north-eastern part of Samaria about eight miles south of Scythopolis, because at that spot there were many springs, and "Ennon" (*Αινών*) is from an Aramaic word meaning *springs*. Others prefer to believe that this Ennon was on the southern frontier of Judea, because Josue (xv. 32) speaks of the cities of Silhim-Ain in the tribe of Juda. More probably the place meant is indicated by the splendid springs, about five miles south of Bethlehem, which feed the basins of Solomon.

24. The Evangelist calls attention to this fact, lest we should conclude from Matt. (iv. 11, 12) that the imprisonment of the Baptist followed immediately after the forty days' fast of Christ in the desert. This shows that the Gospel of St. Matthew was known to the author of the Fourth Gospel.

25, 26. A discussion between John's disciples and some of the Jews took place regarding the relative merits of the Baptism of Christ and that of John. Most likely John's disciples were influenced by jealousy, because their master was being eclipsed by the Christ.

27, 28. John answers his disciples by telling them that his mission was only that of a Precursor, to prepare the way for Christ, and that his mission is now fulfilled. Which being so, there remains nothing more for him to do, because it is not lawful for

29. He that hath the bride, is the bridegroom: but the friend of the bridegroom, who standeth and heareth him, rejoiceth with joy because of the bridegroom's voice. This my joy therefore is fulfilled.

30. He must increase, but I must decrease.

31. He that cometh from above, is above all. He that is of the earth, of the earth he is, and of the earth he speaketh. He that cometh from heaven, is above all.

32. And what he hath seen and heard, that he testifieth: and no man receiveth his testimony.

33. He that hath received his testimony, hath set to his seal that God is true.

34. For he whom God hath sent, speaketh the words of God: for God doth not give the Spirit by measure.

men to assume spiritual duties, except in as far as they are authorized to do so by proper authority.

29, 30. It was customary at Jewish weddings to have a friend of the bridegroom, whose duties were to arrange the preliminary affairs of the wedding and to assist and minister to the bridegroom at the marriage feast. John, therefore, speaks of himself as the friend of the Bridegroom, and this Bridegroom is Christ, the Spouse of the Church. It has been his privilege, therefore, to prepare for the coming of Christ and to bear witness to Him; which done, his own mission is fulfilled. It is only natural, consequently, that Christ, the Bridegroom, should increase; and that John, the friend of the Bridegroom, should decrease.

31. The meaning of this verse is, that he that comes from God, that has a divine origin, such as Christ, is above all men in knowledge and dignity; whereas he that comes from the earth, i.e., has only a natural origin, is only earthly and human and natural.

32. **And what he hath seen . . . that he testifieth;** i.e., the teaching which Christ has given to the world was what He had received directly and immediately from the Godhead, since He Himself is God; and yet there were very few among the Jews who believed Him. This verse and the rest of the chapter are most probably a continuation of the Baptist's words giving reasons why Christ must increase.

33. The meaning is that he who accepts the teaching of Christ thereby acknowledges the truthfulness of God the Father, by whom Christ was sent into the world, and whose doctrine Christ taught to the world.

34. **For he whom God hath sent, etc.;** i.e., Christ, whom God

35. The Father loveth the Son: and he hath given all things into his hand.

36. He that believeth in the Son, hath life everlasting; but he that believeth not the Son, shall not see life; but the wrath of God abideth on him.

the Father has sent, delivered to the world the message of God the Father.

**For God doth not give**, etc. The meaning here is, that to Christ, as God, were communicated by the Father in an infinite degree all the perfections of the gifts of the Holy Spirit; and to Christ as man were communicated the same perfections in so far as human nature was capable of receiving them. Hence of Christ as man, St. Paul says that in Him were concealed all the treasures of wisdom and knowledge (Coloss. ii. 3).

35, 36. All things were committed by the Father to the Son; hence he who would have life everlasting must receive it from Christ the Son: but life everlasting is given only on condition that one have faith in Christ and in His teaching. They are still in their sins who believe not in Christ. Cf. 1 Cor. xv. 17.

## CHAPTER IV

JESUS SETS OUT FROM JUDEA TO GALILEE, 1-4.

JESUS DISCOURSES WITH THE WOMAN OF SAMARIA  
AT SICHAR, 5-26.

THE DISCOURSE WITH THE DISCIPLES, 27-38.

JESUS STAYS WITH THE PEOPLE OF SICHAR, 39-42.

JESUS CONTINUES HIS JOURNEY INTO GALILEE, AND  
HEALS THE RULER'S SON, 43-54.

1. When Jesus therefore understood that the Pharisees had heard that Jesus maketh more disciples, and baptizeth more than John,

2. (Though Jesus himself did not baptize, but his disciples,)

3. He left Judea, and went again into Galilee.

1. As man, our Lord appeared to learn of the jealousy and envy of the Pharisees; but as God, He knew it from the beginning.

2. From this verse we must not infer that Jesus Himself never administered Baptism, but only that it was His custom to leave this to His disciples, as also did St. Paul (1 Cor. i. 14-16).

3. **He left Judea.** This was the second time that our Lord journeyed from Judea into Galilee; the first return to Galilee is re-

4. And he was of necessity to pass through Samaria.
5. He cometh therefore to a city of Samaria, which is called Sichar, near the land which Jacob gave to his son Joseph.
6. Now Jacob's well was there. Jesus therefore being wearied with his journey, sat thus on the well. It was about the sixth hour.
7. There cometh a woman of Samaria, to draw water. Jesus saith to her: Give me to drink.
8. For his disciples were gone into the city to buy meats.

corded above (i. 43). The reason for retiring this time from Judea was in order not to arouse before the appointed time the final opposition of the Pharisees, which was to end in the Passion and death of the Saviour.

4. It was not altogether necessary that our Lord should pass through Samaria in going from Judea into Galilee, although that was the direct and natural route. He could have crossed the Jordan, and thus entered Galilee through Peræa as some did who wished to avoid all contact with the Samaritans.

5. **A city of Samaria which is called Sichar.** The territory of Samaria received its name from its principal city, also called Samaria. Sichar is considered by modern geographers to be the same as the present Askar, although the common opinion is that Sichar is identical with ancient Sichem, now called Nâbulus. Against the former view it is objected that a clear and abundant stream flows through Askar, which would make unintelligible the woman's coming to Jacob's well for water; and against the second view it is similarly objected that Sichem contained a number of flowing springs from which the woman could have drawn water, and that Sichem was two miles distant from Jacob's well. Some, therefore, prefer to believe that the place in question was smaller than Sichem and nearer to Jacob's well.

6. **Jacob's well;** i.e., the well which Jacob dug or bought while living there. Jacob bought land there and erected an altar (Gen. xxxiii. 18-20), but the story of the well was a tradition of the Samaritans.

**Thus,** may refer to the posture He took as He rested there; or it may simply mean, "therefore." **The sixth hour;** i.e., about mid-day, when the Jews were accustomed to take rest and refreshments.

7. **A woman of Samaria;** i.e., from the country called Samaria, from Sichar, or the place that was nearby.

9. Then that Samaritan woman saith to him: How dost thou, being a Jew, ask of me to drink, who am a Samaritan woman? For the Jews do not communicate with the Samaritans.

10. Jesus answered, and said to her: If thou didst know the gift of God, and who he is that saith to thee, Give me to drink; thou perhaps wouldst have asked of him, and he would have given thee living water.

11. The woman saith to him: Sir, thou hast nothing wherein to draw, and the well is deep; from whence then hadst thou living water?

12. Art thou greater than our father Jacob, who gave us the well, and drank thereof himself, and his children, and his cattle?

13. Jesus answered, and said to her: Whosoever drinketh of this water, shall thirst again; but he that shall drink of the water that I will give him, shall not thirst for ever:

14. But the water that I will give him, shall become in him a fountain of water, springing up into life everlasting.

15. The woman saith to him: Sir, give me this water, that I may not thirst, nor come hither to draw.

9. The Samaritans were a mixed race who had sprung from the intermarrying of Jews and Assyrians after the Assyrian captivity under Salmanassar (721 B.C.). They were heartily disliked by the Jews, not only as an alien race, but because they had corrupted the pure worship of Jehovah, and also because of their constant opposition to the Jews and the Jewish worship of God. Hence there was no intercourse between Jews and Samaritans.

For the Jews do not communicate, etc. These are the words of the Evangelist, added for the instruction of his non-Jewish readers.

10. The gift of God; i.e., the gift of sanctifying grace. The word "perhaps" is not expressed in the Greek. Living water; i.e., life-giving water, as opposed to stagnant and putrid water. This shows the difference between the grace which Christ would give and the assistance of the Old Dispensation.

11, 12. The woman gently upbraids our Lord for pretending, as she thinks, to be greater than Jacob, whom the Samaritans also regarded as their Father. She took our Lord's words literally, and so failed to get their real meaning.

13, 14. These words of our Lord show that sanctifying grace is of itself a permanent quality of the soul, which sin only can expel, and further that it is the beginning or germ of life everlasting.

15. The woman still misunderstands the meaning of the living water which Christ is able to give.

16. Jesus saith to her : Go, call thy husband, and come hither.

17. The woman answered, and said : I have no husband. Jesus said to her : Thou hast said well, I have no husband :

18. For thou hast had five husbands : and he whom thou now hast, is not thy husband. This thou hast said truly.

19. The woman saith to him : Sir, I perceive that thou art a prophet.

20. Our fathers adored on this mountain, and you say, that at Jerusalem is the place where men must adore.

21. Jesus saith to her : Woman, believe me, that the hour cometh, when you shall neither on this mountain, nor in Jerusalem, adore the Father.

16-18. We have here another proof of our Lord's supernatural knowledge by which He wished to manifest Himself to this woman as the Messiah. The woman most probably was separated from the husbands whom she had had, not by one dying after the other, but by having been divorced by them (Deut. xxiv. 1, 2; Matt. xix. 3). Maldonatus and others think that her so-called husbands were only paramours. This opinion, however, seems not in accord with the obvious meaning of the text.

19. **A prophet**; i.e., one who was able to know things naturally hidden and unknowable. The woman did not mean by this term to designate our Lord as the Messiah.

20. **Our fathers**, — most probably she had in mind her Assyrian ancestors; some think she meant to refer to the forefathers of the Jews.

**Adored**; i.e., worshipped in public, in particular, by offering sacrifice. It was only the offering of sacrifice, and not private devotions such as personal prayer, that the Jews contended should be restricted to Jerusalem.

**This mountain**; i.e., Mt. Garizim, overhanging the town of Sichar. The Temple on Mt. Garizim was built about 330 B.C. by the king of Sichem, for Manasses, a Jewish priest who had married the king's daughter, and had, in consequence, been deprived of the exercise of his office among the Jews. Sacrifice was offered in this temple until about 130 B.C. when the temple was destroyed, after which sacrifice continued to be offered on Mt. Garizim on an altar erected for the purpose by the Samaritans.

21. **That the hour cometh**, and was already come (verse 23) when the worship of God should not be restricted either to the Jews or to the Samaritans, but should be extended to the whole world.

22. You adore that which you know not: we adore that which we know; for salvation is of the Jews.

23. But the hour cometh, and now is, when the true adorers shall adore the Father in spirit and in truth. For the Father also seeketh such to adore him.

24. God is a spirit; and they that adore him, must adore him in spirit and in truth.

25. The woman saith to him: I know that the Messiah cometh (who is called Christ); therefore, when he is come, he will tell us all things.

22. You adore that which you know not; i.e., the Samaritans' conception of God was an ignorant and erroneous one, as being more or less mixed up with false ideas of the Deity entertained by their Assyrian ancestors. The pure and true concept of God was preserved by the Jews only.

23. **In spirit and in truth.** There are several interpretations of these words, the most probable of which are the following: (a) "in spirit," i.e., in reality, and not merely in an external, ceremonial manner, as the Jews worshipped; "in truth," i.e., not falsely, as worshipped the Samaritans; (b) Maldonatus and others hold that "in spirit and in truth" are synonymous, as expressing true supernatural worship which springs from hearts animated by faith and assisted by grace. The distinguishing marks of the New Dispensation are that it is to be *universal*, not restricted to the Jews or Samaritans only, but extended to the entire world; and that it is to be *spiritual*, from the heart animated by faith and love.

24. **Must adore him in spirit; i.e.,** their worship of God must come from the heart and be real, not merely external, as was, for the most part, the Jewish worship. From these words, however, it by no means follows that there are to be no rites and ceremonies in the Christian form of worship, as is evident from our Lord's own acts (Luke xxii. 41; xxiv. 50).

25. The knowledge of the Messiah and of His speedy coming which this woman had must have come from the Jews, because the Samaritans admitted only the Pentateuch, wherein the term "Messiah" does not occur and the time of His coming is not designated. It is not certain whether the words, "who is called Christ," were uttered by the woman or by the Evangelist. St. John is accustomed to explain such terms as *Messias* for his Gentile readers. Cf. i. 41; xi. 16; xx. 24; xxi. 2.

26. Jesus saith to her : I am he, who am speaking with thee.
27. And immediately his disciples came ; and they wondered that he talked with the woman. Yet no man said : What seekest thou ? or, why talkest thou with her ?
28. The woman therefore left her water-pot, and went her way into the city, and saith to the men there :
29. Come, and see a man who has told me all things whatsoever I have done. Is not he the Christ ?
30. They went therefore out of the city, and came unto him.
31. In the mean time the disciples prayed him, saying : Rabbi, eat.
32. But he said to them : I have meat to eat, which you know not.
33. The disciples therefore said one to another : Hath any man brought him to eat ?
34. Jesus saith to them : My meat is to do the will of him that sent me, that I may perfect his work.
35. Do not you say, There are yet four months, and then the harvest cometh ? Behold, I say to you, lift up your eyes, and see the countries ; for they are white already to harvest.

26, 27. Hardly had our Lord declared Himself to the woman as the Messiah when the disciples returned with food. They were astonished to find Him discoursing with a woman — a thing unusual with Jewish doctors. According to an ancient rabbinical prejudice woman was considered absolutely devoid of all deep religious refinement.

28-30. Forgetful of the water which she came to draw the woman dropped her waterpot by the well and hastened to Sichar, or to the village whence she had come, to announce to her fellow citizens the presence in their midst of one whom she considered to be a prophet, and possibly the Messiah.

34. **My meat is to do the will of him that sent me.** While the disciples were urging our Lord to partake of the material food they had procured, He admonished them that He had a much more serious duty to perform ; namely, to do the will of His heavenly Father, which at that particular time regarded the conversion of the Samaritans.

35. **There are yet four months.** These words were most likely spoken in the month of December towards the end of the first year of our Lord's public life, because the barley harvest in Palestine is around the last of April. The corn was ripe in May. But the harvest of souls, in the persons of the Samaritans, now hastening from the village to see and hear the Master, was already fit for the sickle.



36. And he that reapeth receiveth wages, and gathereth fruit unto life everlasting: that both he that soweth, and he that reapeth, may rejoice together.

37. For in this is the saying true: That it is one man that soweth, and it is another that reapeth.

38. I have sent you to reap that in which you did not labour: others have laboured, and you have entered into their labours.

39. Now of that city many of the Samaritans believed in him, for the word of the woman giving testimony: He told me all things whatsoever I have done.

40. So when the Samaritans were come to him, they desired that he would tarry there. And he abode there two days.

41. And many more believed in him because of his own word.

42. And they said to the woman: We now believe, not for thy saying: for we ourselves have heard him, and know that this is indeed the Saviour of the world.

43. Now after two days, he departed thence, and went into Galilee.

44. For Jesus himself gave testimony that a prophet hath no honour in his own country.

36-38. Our Lord now consoles His disciples by telling them that, unlike the lots of the earthly sower and reaper, who oftentimes do not share together the fruits of their labors, the spiritual sower and the spiritual reaper shall in Heaven rejoice in their mutual rewards.

**I have sent you to reap**, etc. These words most probably refer to the divine decree later to send the Apostles on their mission; it is not probable that the Apostles had already received their formal call (Matthew iv. 18-22; x. 1).

**Others have laboured**, etc. By these words are to be understood not only the prophets and doctors who had prepared Israel for the coming of the Messiah, but also Christ and His teaching, the fruits of which the Apostles were to reap.

39-41. Not only did many of the Samaritans believe in our Lord because of what the woman had told them, but many more believed in Him on account of the discourses He delivered to them during the two days He tarried there.

42. **The Saviour of the world**; i.e., the Redeemer whose salvation would embrace the entire human race.

44. **A prophet hath no honour**, etc. In these words our Lord most likely was assigning the reason why He was again going from Judea to Galilee. Others think that He was giving the reason why He had previously left Galilee, or why He was passing by Nazareth without stopping on His way to Capharnaum (Matthew iv. 13).

45. And when he was come into Galilee, the Galileans received him, having seen all the things he had done at Jerusalem on the festival day; for they also went to the festival day.

46. He came again therefore into Cana of Galilee, where he made the water wine. And there was a certain ruler, whose son was sick at Capharnaum.

47. He having heard that Jesus was come from Judea into Galilee, went to him, and prayed him to come down, and heal his son; for he was at the point of death.

48. Jesus therefore said to him: Unless you see signs and wonders, you believe not.

49. The ruler saith to him: Lord, come down before that my son die.

50. Jesus saith to him: Go thy way; thy son liveth. The man believed the word which Jesus said to him, and went his way.

51. And as he was going down, his servants met him; and they brought word, saying, that his son lived.

52. He asked therefore of them the hour wherein he grew better. And they said to him: Yesterday, at the seventh hour, the fever left him.

53. The father therefore knew, that it was at the same hour that Jesus said to him, Thy son liveth; and himself believed, and his whole house.

54. This is again the second miracle that Jesus did, when he was come out of Judea into Galilee.

45. The Galileans received Him with much enthusiasm remembering the miracles He had performed in their presence on the previous Pasch at Jerusalem. Cf. ii. 13, 23.

46. A certain ruler, who was most likely one of the officers of Herod Antipas, tetrarch of Galilee. The ruler very likely had witnessed the previous miracle at Cana (ii. 6-11).

48. Unless you see signs and wonders. Through the ruler our Lord now upbraids the Galileans for the slowness and weakness of their faith, in spite of the miracles they had already witnessed from Him.

50. Go thy way, thy son liveth. This miracle must not be identified with that recorded by Matt. (viii. 5 ff.) and Luke (vii. 2 ff.), for there the centurion's servant was ill, here the ruler's son; there the illness was paralysis, here fever; there Christ goes to the sick man, here He does not go.

52. The seventh hour; i.e., about 1 P.M.

54. The second miracle. The cure of the ruler's son was the second miracle He had performed in Galilee, the first being the conversion of water into wine at Cana (ii. 6-11).

## CHAPTER V

JESUS AT JERUSALEM CURES A MAN AT THE POOL ON  
THE SABBATH DAY, 1-9.

THE OPPOSITION AND ACCUSATIONS OF THE JEWS,  
10-16.

JESUS PROCLAIMS HIS EQUALITY WITH THE FATHER,  
17-30.

JESUS IS WITNESSED TO BY JOHN THE BAPTIST, BY  
HIS MIRACLES, AND BY THE PROPHECIES OF THE  
OLD TESTAMENT, 31-47.

1. After these things was a festival day of the Jews, and Jesus went up to Jerusalem.

2. Now there is at Jerusalem a pond, called Probatice, which in Hebrew is named Bethsaida, having five porches.

3. In these lay a great multitude of sick, of blind, of lame, of withered; waiting for the moving of the water.

4. And an angel of the Lord descended at certain times into the pond; and the water was moved. And he that went down first into the pond after the motion of the water, was made whole, of whatsoever infirmity he lay under.

1. A festival day, which was most probably the Pasch, as this would correspond with what our Lord had said shortly before (iv. 35) about the harvest being four months off. Some commentators, however, understand this "festival day" to have been Pentecost, or the Feast of Tabernacles, or the Purification of the Temple, or Purim.

2. Probatice, — in the Vulgate, "Probatice piscina," means a "sheep-gate" (*πίλη, gate*, being understood). The pond was called "Probatice," because it was near this sheep-gate through which the sheep destined for sacrifice were led. Sheep were washed in this pond or pool in preparation for sacrifice.

Bethsaida. The common reading is "Bethesda," which in Aramaic means "house of mercy," — so named from the many merciful cures performed there. The porches were open on the sides, but covered overhead to protect the sick from the sun and rain.

4. The genuineness of this verse, together with "waiting for the moving of the water" (verse 3), is disputed; but while the passage

5. And there was a certain man there, that had been eight and thirty years under his infirmity.

6. Him when Jesus had seen lying, and knew that he had been now a long time, he saith to him: Wilt thou be made whole?

7. The infirm man answered him: Sir, I have no man, when the water is troubled, to put me into the pond. For whilst I am coming, another goeth down before me.

8. Jesus saith to him: Arise, take up thy bed, and walk.

9. And immediately the man was made whole: and he took up his bed, and walked. And it was the sabbath that day.

10. The Jews therefore said to him that was healed: It is the sabbath; it is not lawful for thee to take up thy bed.

11. He answered them: He that made me whole, he said to me, Take up thy bed, and walk.

12. They asked him therefore: Who is that man who said to thee, Take up thy bed, and walk?

13. But he who was healed, knew not who it was; for Jesus went aside from the multitude standing in the place.

is wanting in the best MSS., such as the Vatican, the Sinaitic, and others, it is found in the Itala, the Syriac, the Persian, Coptic, Arabian, etc., and is, consequently, most probably genuine.

That the efficacy of the water of this pond was miraculous is evident from the following facts: (a) it had to be moved by an angel; (b) only the first person entering was cured; (c) the cure was immediate and complete; (d) it cured any disease.

5-9. The infirmity of the sick man was most probably paralysis, or something similar. The instantaneousness and completeness of his cure proved that it was miraculous.

When we read in the Gospels of the sick being told to take up their beds and walk we must remember that the beds of those days, especially of the poor, were of a very light framework, often consisting of nothing more than a carpet or mattress. So it was in the present case.

10. It is not lawful, basing their contentions on the authority of Exod. (xx. 8) and Jer. (xvii. 21, 22).

11. The cured man implied by his answer that He who was able to heal him must also have power to dispense from the rest of the Sabbath. The Sabbath was of the positive, and not of the natural law.

13. For Jesus went aside, — according to a more correct reading, “for Jesus had gone aside, there being a crowd in the place.”

14. Afterwards, Jesus findeth him in the temple, and saith to him: Behold thou art made whole: sin no more, lest some worse thing happen to thee.

15. The man went his way, and told the Jews, that it was Jesus who had made him whole.

16. Therefore did the Jews persecute Jesus, because he did these things on the sabbath.

17. But Jesus answered them: My Father worketh until now; and I work.

18. Hereupon therefore the Jews sought the more to kill him, because he did not only break the sabbath, but also said God was his Father, making himself equal to God.

19. Then Jesus answered, and said to them: Amen, amen, I say unto you, the Son cannot do any thing of himself, but what he seeth the Father doing: for what things soever he doth, these the Son also doth in like manner.

20. For the Father loveth the Son, and sheweth him all things which himself doth: and greater works than these will he shew him, that you may wonder.

14. **Sin no more.** By these words our Lord insinuated that the man's previous disease had been the result of sin; He therefore cautions him against sinning in the future, lest something more terrible happen to him.

17. **My Father.** Notice that Jesus said: "*My Father,*" showing that He was the natural and not, as other men, the merely adopted, son of God.

**Worketh until now,** etc.; i.e., continually, on the Sabbath, as well as on other days. As the Father from the beginning of creation had been working, i.e., conserving, governing, and moving all things without cessation, so the Son, who is identical with the Father in nature, power, and operation, works continually, on the Sabbath, as on other days.

18. **To kill him,** not only because they considered that He had violated the Sabbath, but also, and especially because He had made Himself equal to God. Cf. Deut. xiii. 5; Levit. xxiv. 16.

19. From this verse to verse 30 our Lord is proving His Divinity from His own testimony, which, according to their Law, the Jews ought to accept, because His testimony is not alone, but is corroborated by that of His Father also.

**The Son cannot do anything,** etc. These and the following words show the perfect equality of the Father and the Son as God; they both do the same thing in the same manner. The Son cannot work alone, and yet He is not dependent on the Father, for He and the Father are one (x. 30).

20. In this verse we have assigned the reason why the Father

21. For as the Father raiseth up the dead, and giveth life: so the Son also giveth life to whom he will.

22. For neither doth the Father judge any man, but hath given all judgment to the Son.

23. That all men may honour the Son, as they honour the Father. He who honoureth not the Son, honoureth not the Father, who hath sent him.

24. Amen, amen I say unto you, that he who heareth my word, and believeth him that sent me, hath life everlasting; and cometh not into judgment, but is passed from death to life.

25. Amen, amen I say unto you, that the hour cometh, and now is, when the dead shall hear the voice of the Son of God, and they that hear shall live.

from eternity has communicated to the Son the one divine power by which He Himself doth all things. **Greater works**; i.e., the Father is about to show through the Son greater works than the healing of the paralytic, "in order that you may believe."

21. One of the greater works which the Father will show through the Son will be the raising of the dead to life. The reference is probably to the corporal resurrection which our Lord afterwards effected in the person of Lazarus and the son of the widow of Naim, etc., and especially to the spiritual resurrection which His miracles and the preaching of the Gospel later produced. What the Father does, the Son does; there is perfect equality of power and oneness of nature and will in them both, as God.

22. **For neither doth the Father judge any man.** Another of the greater works which the Father will show through the Son is the judgment of mankind. From all eternity the Father had communicated to the Son the power of judging all men, which power the Son was to exercise *visibly* as man.

23. The purpose of giving to the Son the supreme power of judging mankind was that men might honor the Son equally with the Father; hence they who dishonor the Son, dishonor likewise the Father.

24. **Hath life everlasting**; i.e., they who believe in Christ and practice His teaching have passed from a state of sin to a state of grace, which is the beginning of life everlasting.

25. **When the dead shall hear the voice, etc.**; i.e., the time of the resurrection spoken of on verse 21 is at hand.

26. For as the Father hath life in himself, so he hath given to the Son also to have life in himself:

27. And he hath given him power to do judgment, because he is the Son of man.

28. Wonder not at this; for the hour cometh, wherein all that are in the graves shall hear the voice of the Son of God.

29. And they that have done good things, shall come forth unto the resurrection of life; but they that have done evil, unto the resurrection of judgment.

30. I cannot of myself do any thing. As I hear, so I judge: and my judgment is just; because I seek not my own will, but the will of him that sent me.

31. If I bear witness of myself, my witness is not true.

32. There is another that beareth witness of me; and I know that the witness which he witnesseth of me is true.

33. You sent to John, and he gave testimony to the truth.

34. But I receive not testimony from man: but I say these things, that you may be saved.

26. Life dwells essentially in the Father, and consequently also in the Son, who is equal to the Father.

27. Power to do judgment. From all eternity the Son had been given the power which He is to exercise visibly as God-man of judging all men both in the Particular Judgment and in the General Judgment.

28. All that are in the graves. These words refer to the general resurrection of the dead, and our Lord tells the Jews that in virtue of this general resurrection of the flesh they ought not to be surprised at the spiritual resurrection of which He had just been speaking (verses 19-21).

29. From this verse we see that faith without works does not justify.

30. Our Lord again asserts His inability to do anything of Himself alone, because of His identity in nature, power, operation, and will with the Father. The will of our Lord, as God, was identical with the will of the Father; and His human will, while not identical with the Father's, was ever in conformity with the will of the Father.

31. The meaning of this verse is that if our Lord's testimony were alone, not corroborated by His Father's also, those whom He addressed might have some reason for rejecting His word, in particular since they did not believe in His Divinity.

32. In verses 32-35 our Lord appeals to the testimony of John the Baptist as a proof of His Messiahship, not that He needs any

35. He was a burning and a shining light: and you were willing for a time to rejoice in his light.

36. But I have a greater testimony than that of John: for the works which the Father hath given me to perfect; the works themselves, which I do, give testimony of me, that the Father hath sent me.

37. And the Father himself who hath sent me, hath given testimony of me: neither have you heard his voice at any time, nor seen his shape.

38. And you have not his word abiding in you: for whom he hath sent, him you believe not.

39. Search the scriptures, for you think in them to have life everlasting; and the same are they that give testimony of me.

40. And you will not come to me that you may have life.

man's testimony (verse 34), but for the sake of the Jews who regarded John as a prophet.

35. **He was a burning and a shining light.** The Greek has, "He was the lamp that burns and shines." From the use of the past tense "*was*" it seems that the Baptist had already been imprisoned by Herod Antipas (Mark vi. 17-20.).

36. Here our Lord appeals to a greater testimony than that of John in proof of His Divinity; namely, the testimony of His own miracles.

37-39. In these verses Christ appeals to the testimony of His Father as a proof of His Divinity.

**The Father . . . hath given testimony of me.** When did the Father bear this testimony to Christ? St. Chrysostom and à Lapidè say it was at the time of our Lord's baptism. Maldonatus and others hold that it was given through the miracles of our Lord. Others believe that the reference is to the Father's testimony through the Scriptures, in the writings of Moses and the prophets. This last opinion seems most probable in view of verse 39.

37. **Neither have you heard his voice at any time, etc.** Some understand this to mean that those addressed had never listened to, or heeded the voice of the Father speaking to them through the Scriptures; others, that while the Father had borne undoubted testimony to His Son through the Scriptures, it was not in a visible manner so that He could be seen or heard by them.

39. **Search the scriptures, etc.** Both in Latin and Greek the construction here is doubtful, so that the verb might be understood either in the indicative or imperative mood. From the context, however, it seems quite certain that the form is indicative; i.e.,



41. I receive not glory from men.

42. But I know you, that you have not the love of God in you.

43. I am come in the name of my Father, and you receive me not: if another shall come in his own name, him you will receive.

44. How can you believe, who receive glory one from another: and the glory which is from God alone, you do not seek?

45. Think not that I will accuse you to the Father. There is one that accuseth you, Moses, in whom you trust.

46. For if you did believe Moses, you would perhaps believe me also; for he wrote of me.

47. But if you do not believe his writings, how will you believe my words?

“you search,” etc., and this is the opinion of the best modern commentators even among the Protestants. But even though the sentence were imperative we must remember that it was addressed only to the Jewish teachers, and that in respect to one point only; namely, the fulfillment of prophecy in regard to our Lord. Hence the inference of many Protestants, that from this verse we have a precept to read the Scriptures for the purpose of forming our own opinions and private judgments, is false.

41. The meaning here is that our Lord is not seeking His own glory, but the salvation of the Jews.

42. The reason why the Jews did not believe our Lord was because they had not the love of God in their hearts.

43. The truth of this verse was verified, as we know, because many false Christs who appeared before the destruction of Jerusalem actually obtained a following among the Jews (Matthew xxiv. 24).

44. The vanity and pride of the Jews was another reason for their unbelief in our Lord.

45-47. Here our Lord tells the Jews that it will not be necessary for Him to accuse them to the Father, since they are already accused by the Lawgiver, Moses, whom they profess to believe, but whose writings regarding our Lord they did not accept.

## CHAPTER VI

JESUS CROSSES TO THE EASTERN SHORE OF THE LAKE,  
AND THERE MIRACULOUSLY FEEDS FIVE THOUSAND,  
1-13.

JESUS WITHDRAWS FROM THE MULTITUDE, WHO  
WOULD MAKE HIM KING, 14, 15.

JESUS WALKS ON THE WATERS, 16-21.

THE NEXT DAY THE MULTITUDES CROSS TO THE  
WESTERN SHORE OF THE LAKE AND ENTER  
CAPHARNAUM WHERE JESUS IN THE SYNAGOGUE  
DISCOURSES TO THEM ON THE BLESSED EUCHA-  
RIST, 22-60.

THE DISCIPLES MURMUR AT OUR LORD'S DISCOURSE;  
HE REPLIES AND PERMITS THEM TO DEPART,  
61-67.

PETER'S NOBLE CONFESSION, 68-70.

JESUS REFERS TO A WICKED APOSTLE, 71, 72.

1. After these things Jesus went over the sea of Galilee, which is that of Tiberias.

1. **After these things.** If we accept the festival day, spoken of in v. 1 as the Pasch, or as the Feast of Pentecost, nearly a year intervened between the events narrated in this and the preceding chapter. St. John passes over the events of that year, or ten months, because they had already been recorded by the Synoptists. See Luke iv. 14-ix. 10.

**Sea of Galilee.** In the last chapter our Lord was at Jerusalem, now we find Him on the shores of the Lake of Genesareth, in the eastern part of Galilee. The Jews called every large body of water a sea; this lake, or sea, was also called the "Sea of Tiberias" from the town of Tiberias, built on its western shore by Herod Antipas, and called after Tiberius, the Roman Emperor.

It is worthy of remark that in the present chapter (verses 1-21) St. John for the second time gives the same account as the Synoptists (Matthew xiv. 13-36; Mark vi. 30-56; Luke ix. 10-17). There

2. And a great multitude followed him, because they saw the miracles which he did on them that were diseased.

3. Jesus therefore went up into a mountain, and there he sat with his disciples.

4. Now the pasch, the festival day of the Jews, was near at hand.

5. When Jesus therefore had lifted up his eyes, and seen that a very great multitude cometh to him, he said to Philip: Whence shall we buy bread, that these may eat?

6. And this he said to try him; for he himself knew what he would do.

7. Philip answered him: Two hundred pennyworth of bread is not sufficient for them, that every one may take a little.

8. One of his disciples, Andrew, the brother of Simon Peter, saith to him:

9. There is a boy here that hath five barley loaves, and two fishes; but what are these among so many?

10. Then Jesus said: Make the men sit down. Now there was much grass in the place. The men therefore sat down, in number about five thousand.

11. And Jesus took the loaves: and when he had given thanks, he distributed to them that were set down. In like manner also of the fishes, as much as they would.

12. And when they were filled, he said to his disciples: Gather up the fragments that remain, lest they be lost.

13. They gathered up therefore, and filled twelve baskets with the fragments of the five barley loaves, which remained over and above to them that had eaten.

are sufficient divergences in details to show the independence of each account, but the main points and final result are the same in all four Evangelists,—there are crowds following Jesus into the desert, the five thousand men, the five loaves and two fishes, the twelve baskets of fragments, etc.

For the first parallel account between St. John and the Synoptists see John iv. 1-3; Matt. iv. 12; Mark i. 14, 15; Luke iv. 14.

2. See on Matthew xiv. 13.

4. **The pasch**, which was the second or third Pasch of our Lord's public life, according to the view one takes of v. 1. If the feast there mentioned was the Pasch, this would be the third Pasch of our Lord's public life; if it was some other festival within the year following the first Pasch (ii. 13), this would be the second Passover of the public ministry. See Harmony of the Gospels, page 536.

5-16. See on Matthew xiv. 15-22.

7. **Two hundred pennyworth**; i.e., two hundred *denarii*. The denarius was a Roman silver coin worth in our Lord's time about 17 cents. Hence the sum mentioned by Philip would be about \$34.00. This was not much for so great a multitude.

14. Now those men, when they had seen what a miracle Jesus had done, said: This is of a truth the prophet, that is to come into the world.

15. Jesus therefore, when he knew that they would come to take him by force, and make him king, fled again into the mountain himself alone.

16. And when evening was come, his disciples went down to the sea.

17. And when they had gone up into a ship, they went over the sea to Capharnaum; and it was now dark, and Jesus was not come unto them.

18. And the sea arose, by reason of a great wind that blew.

19. When they had rowed therefore about five and twenty or thirty furlongs, they see Jesus walking upon the sea, and drawing nigh to the ship, and they were afraid.

20. But he saith to them: It is I; be not afraid.

21. They were willing therefore to take him into the ship; and presently the ship was at the land to which they were going.

22. The next day, the multitude that stood on the other side of the sea, saw that there was no other ship there but one, and that Jesus had not entered into the ship with his disciples, but that his disciples were gone away alone.

23. But other ships came in from Tiberias; nigh unto the place where they had eaten the bread, the Lord giving thanks.

24. When therefore the multitude saw that Jesus was not there, nor his disciples, they took shipping, and came to Capharnaum, seeking for Jesus.

25. And when they had found him on the other side of the sea, they said to him: Rabbi, when camest thou hither?

26. Jesus answered them, and said: Amen, amen I say to you, you seek me, not because you have seen miracles, but because you did eat of the loaves, and were filled.

14. **The prophet;** i.e., the Messiah so long expected.

17. St. Matthew (xiv. 22) tells us that immediately after the miracle Jesus told His disciples to go before Him across the lake, while He dismissed the crowd.

18-21. See on Matthew xiv. 24-33.

19. **Five and twenty or thirty furlongs.** The Vulgate has "*Stadia viginti quinque aut triginta.*" The furlong is about 660 feet; the stadium equals 625 feet. Hence the disciples had rowed about three miles, when they saw our Lord coming to them walking on the water. It was perhaps about 4 A.M., as the fourth watch of the night was from 3 to 6 A.M.

21. **They were willing therefore to take him into the ship.** St. Mark (vi. 51) tells us that they actually took Him into the boat.

22-24. The morning following the multiplication of the loaves the crowd sought our Lord on the east side of the lake, thinking Him still to be there, since He did not leave by the only boat which

27. Labour not for the meat which perisheth, but for that which endureth unto life everlasting, which the Son of man will give you. For him hath God, the Father, sealed.

left there the previous evening. But not finding Him on the east side they came across to the west, and looked for Him at Capharnaum, His usual stopping place.

27. Although it is not *de fide* that there is reference to the Blessed Eucharist in this chapter, it is nevertheless certain. Most Protestant commentators hold that there is reference here to the reception of our Lord only through faith in Him and His doctrine; and those of them who do admit that in the present chapter we have a reference to the Eucharist say that Christ is only *spiritually* present in this sacrament.

Against the first class the following may be said: (a) if there is no mention of the Eucharist in this chapter, it is entirely omitted by St. John — a thing very improbable; (b) Christ speaks here of a food that is to be given in the future, whereas His person and doctrine had already been given; (c) His hearers understood Him to speak of the real eating of His real flesh (verse 61), and being consequently offended they turned away from Him (verse 67).

Against the second class we may observe: (a) Christ compares (verses 49, 50, 59) the bread which He will give to the manna of the desert, which was real, and was really eaten; (b) at the murmurings of the Jews (verse 53) our Lord only insisted the more that His flesh was truly meat and His blood truly drink (verses 54-59); (c) both the Jews and the disciples understood our Lord's words in their proper literal meaning, as is evident from the whole context; and yet instead of softening or explaining His words the Saviour only insists more strongly that He will give His real flesh and blood to eat and drink, and that it is necessary to eat and drink His flesh and blood. So much does He emphasize this point that finally some of His disciples turned for good away from Him (verse 67). On similar occasions of grave moment, when the disciples failed to grasp the real meaning of His words, or when His hearers were displeased at the plain sense of His speech, He would either explain, as in John iii. 3-8; Matt. xvi. 6-12; or He would insist the more, as in John viii. 51-59; Matt. ix. 2-7. (d) It is the unanimous consent of the Holy Fathers, with very few exceptions,

that our Lord's words regarding the Eucharist in this chapter are to be taken literally.

While, therefore, there is reference in the present chapter to the Blessed Eucharist, and while the words of Christ relative to the giving of His body and blood under the form of bread and wine are to be taken in a literal, and not in a metaphorical sense, all do not agree just where in the chapter this reference to the Blessed Sacrament begins. The majority of Catholic commentators hold that it begins at verse 48; others, at verse 51; and still others, at verse 52. It seems more probable, however, that the reference to the Blessed Eucharist is made, at least in a general way, in verse 27, because: (a) our Lord in this verse speaks of a food which is to be given; (b) for this food promised in verse 27 faith is a necessary preparation (verse 29); (c) the properties attributed in verses 32, 33 to this bread are the same as those spoken of in verse 59; but all admit that there is a real reference to the Eucharist in verse 59.

This whole present chapter, therefore, falls naturally into three general parts:—in the first part (verses 1–25) are described the miracles of the multiplication of the loaves and the walking on the water, which being an exhibition of our Lord's power, were calculated to dispose the minds of the Jews for belief in His promise of the Blessed Eucharist; the second part (verses 26–60) contains the discourse of our Lord about the Eucharist, introduced by verse 26; and the third part (verses 61–72) describes the effects of this discourse.

The second part of the chapter (verses 26–60), which gives the discourse on the Blessed Eucharist, may also be divided into three parts:—the first part (verses 26–34) is introductory to the explicit promise of the Blessed Eucharist, giving this promise in a general way (verse 27) and exhorting the Jews to seek after a spiritual food; in the second part (verses 35–47) our Lord asserts that He is the bread of life in the sense that all who wish to be saved must believe in Him; and in the third part (48–59) the Saviour explicitly declares that He is the bread of life, inasmuch as He will give us His flesh to eat and His blood to drink.

There is, then, in the present chapter: (a) a distinct reference to the Blessed Eucharist; (b) this reference begins in a general way

28. They said therefore unto him: What shall we do, that we may work the works of God?

29. Jesus answered, and said to them: This is the work of God, that you believe in him whom he hath sent.

30. They said therefore to him: What sign therefore dost thou shew, that we may see, and may believe thee? What dost thou work?

31. Our fathers did eat manna in the desert, as it is written: He gave them bread from heaven to eat.

32. Then Jesus said to them: Amen, amen I say to you; Moses gave you not bread from heaven, but my Father giveth you the true bread from heaven.

33. For the bread of God is that which cometh down from heaven, and giveth life to the world.

34. They said therefore unto him: Lord, give us always this bread.

35. And Jesus said to them: I am the bread of life: he that cometh to me shall not hunger: and he that believeth in me shall never thirst.

36. But I said unto you, that you also have seen me, and you believe not.

37. All that the Father giveth to me shall come to me; and him that cometh to me, I will not cast out.

in verse 27, but is continued more explicitly and clearly in verse 48; (c) the words of our Lord in verses 48-59 at least, are to be understood in a real literal sense, as promising to give His real flesh and blood as food and drink for the life of the world.

For him hath God the Father sealed. The meaning is that only our Lord, the Son of Man, is able to give the food which nourisheth unto life everlasting, because on Him God the Father has impressed the seal of Divinity.

28, 29. In order to get this food our Lord tells the Jews that they must believe in Him.

30-33. The Jews now ask the Saviour to give them a sign by which they can believe in Him, and they indirectly refer to the recent multiplication of the loaves as if that were not to be compared with the manna which Moses gave them and their whole race for forty years in the desert. But our Lord corrects their assertion by telling them that it was not Moses, but His Father, who gave them the manna, and that the Father also has given them the true bread from Heaven by giving them His Son in the Incarnation, and that now the Son Himself is soon to give them a bread more real and perfect than the manna, which will sustain not only one people for a temporal existence, but the whole world unto life everlasting.

34-37. Still understanding our Lord's words in a material sense,

38. Because I came down from heaven, not to do my own will, but the will of him that sent me.

39. Now this is the will of the Father who sent me: that of all that he hath given me, I should lose nothing; but should raise it up again in the last day.

40. And this is the will of my Father that sent me: that every one who seeth the Son, and believeth in him, may have life everlasting, and I will raise him up in the last day.

41. The Jews therefore murmured at him, because he had said: I am the living bread which came down from heaven.

42. And they said: Is not this Jesus, the son of Joseph, whose father and mother we know? How then saith he, I came down from heaven?

43. Jesus therefore answered, and said to them: Murmur not among yourselves.

44. No man can come to me, except the Father, who hath sent me, draw him; and I will raise him up in the last day.

45. It is written in the prophets: And they shall all be taught of God. Every one that hath heard of the Father, and hath learned, cometh to me.

46. Not that any man hath seen the Father; but he who is of God, he hath seen the Father.

the Jews asked Him to give them this wonderful bread, but the Saviour immediately tells them that this bread is to be Himself, and that faith in Him is required for a fruitful reception of this bread.

38-40. In these verses our Lord declares that He has come into the world to do the will of His Father, and that will is that He should save all those who believe in Him, and who order their lives in accordance with their belief.

41-43. The Jews, or at least the Scribes and Pharisees among them, resented our Lord's claim that He was the living bread come down from Heaven.

44, 45. Our Lord declares that no one can come to Him, i.e., believe in Him, except he be given grace. The necessity, therefore, of prevenient and assisting grace for faith is here plainly declared. The word for "draw" (*ἐλκεῖν*) here used, does not mean that violence is used, but only that an effective influence is exerted on the will.

And they all shall be taught of God. This is substantially from Isaias (liv. 13), and the meaning is that people are drawn to faith only by God, i.e., by an illumination of the intellect and a motion of the will.

46. Lest the Jews should say that they had not learned from God, because they had not seen Him, our Lord here tells them that



47. Amen, amen I say unto you: He that believeth in me, hath everlasting life.

48. I am the bread of life.

49. Your fathers did eat manna in the desert, and are dead.

50. This is the bread which cometh down from heaven; that if any man eat of it, he may not die.

51. I am the living bread which came down from heaven.

52. If any man eat of this bread, he shall live for ever; and the bread that I will give, is my flesh, for the life of the world.

He Himself hath seen the Father, and that in seeing Him and hearing Him, they see and hear the Father also.

47. Here again our Lord insists on the necessity of faith in Him as a means of worthily receiving the bread which nourishes unto life everlasting.

48-51. Now our Lord resumes His discourse about the Blessed Eucharist which He had begun in a general way in verse 27, but which was interrupted by the question of the Jews in verse 28. Now He says in explicit terms that He is the living bread which has come down from Heaven, unlike the manna which was rained down from the clouds and which did not preserve unto life everlasting.

52. Up to this verse our Lord has been declaring that He is the bread of life, and that in order to receive Him worthily, faith is necessary; but here He states the *manner* in which He is to be the bread of life; namely, by giving His flesh and blood to be eaten and drunk. Our Lord here attains the climax of His discourse, which has been gradually rising to the present point. In verses 33, 35, 41, and 45, especially, He insists that *He is the living bread*, and that if men wish to live they *must come to Him*, i.e., they must *believe* in Him. In verses 48 and 50 He repeats that He is the living bread, and goes on to say that if men will live they *must eat* this bread; and eat here must be taken literally, for *eating* in Scripture never means *believing*. Finally in verses 52 and 53 He declares that the bread that He will give is His flesh, and that if men will live they *must eat His flesh*. And to *eat His flesh* can only be taken literally, because to eat one's flesh figuratively has only a bad meaning in Scripture; namely, *to do one an injury*, as in Ps. xxvi. 2; Job xix. 22; Mich. iii. 3; Gal. v. 15.

In the latter part of this verse many Greek MSS. read: "and the

53. The Jews therefore strove among themselves, saying: How can this man give us his flesh to eat?

54. Then Jesus said to them: Amen, amen I say unto you: Except you eat the flesh of the Son of man, and drink his blood, you shall not have life in you.

55. He that eateth my flesh, and drinketh my blood, hath everlasting life: and I will raise him up in the last day.

56. For my flesh is meat indeed: and my blood is drink indeed.

57. He that eateth my flesh, and drinketh my blood, abideth in me, and I in him.

58. As the living Father hath sent me, and I live by the Father; so he that eateth me, the same also shall live by me.

bread that I will give is my flesh, *which I will give* for the life of the world," but since the words "which I will give" are omitted in the Vulgate and by many of the best Greek editions it is thought more probable that they are not genuine.

53-55. The Jews were disputing among themselves about what our Lord had said, but Jesus far from trying to clear up their doubts only insists the more on the necessity of receiving His body and blood as a means to spiritual and everlasting life. It must not be argued from these verses that Communion under both species is necessary. It is true that by *virtue of the words of consecration* only the body of Christ is present under the species of bread, and likewise only the blood of Christ under the species of wine; but since Christ's body is a living body, and because of the necessary union in a living body between the flesh, blood and soul, it follows that where Christ's flesh is, there also are His blood and soul, and *vice versa*. Moreover, by reason of the hypostatic union between the human and divine natures in Christ, it follows also that His Divinity is likewise present under each species in the Blessed Eucharist. But it may be asked: Why, then, did Christ give both species: *Answer*: (a) because He wished this Sacrament to be partaken of after the manner of a real banquet, a real repast, which supposes both meat and drink; (b) because this Sacrament was to be a commemoration of His death, in which His body and blood were separated.

57. The meaning of this verse is that He who eats the flesh and drinks the blood of Christ, abides in Christ as the branch abides in the vine, and that Christ abides in Him as the life of the vine abides in the branch.

58. There are two principal explanations of the meaning of this

59. This is the bread that came down from heaven. Not as your fathers did eat manna, and are dead. He that eateth this bread, shall live for ever.

60. These things he said, teaching in the synagogue, in Capharnaum.

61. Many therefore of his disciples, hearing it, said: This saying is hard, and who can hear it?

62. But Jesus, knowing in himself, that his disciples murmured at this, said to them: Doth this scandalize you?

63. If then you shall see the Son of man ascend up where he was before?

64. It is the spirit that quickeneth: the flesh profiteth nothing. The words that I have spoken to you, are spirit and life.

verse: (a) as I live on account of, and for the sole purpose of the Father who sent Me, so he that eateth Me shall live on account of, and for the sole purpose of Me; (b) according to others, the meaning is that, as Christ lives by the eternal life communicated to Him by His Father in eternal generation, so the communicant shall live by the spiritual life communicated to him by our Lord in Holy Communion.

59. This verse concludes the discourse of our Lord (verses 26-60) about the giving of the Blessed Eucharist and points out the difference in effect between it and the manna in the desert.

61, 62. Having understood our Lord's words in their literal sense many of His disciples found it hard to accept them, but our Lord remained unmoved.

63. There are two ways of explaining the meaning of this verse: (a) if you are scandalized at My words about giving My flesh and blood as meat and drink, you will be able more easily to understand this when you see My Divinity manifested in My Ascension into Heaven; (b) if you are scandalized at My promising to give you My flesh and blood, how much harder will it be for you when you see My body ascending into Heaven, while you are still asked to believe that it is present on earth to be eaten.

**Ascend up where he was before.** Of these words Dr. Westcott says: "No phrase could show more clearly the unchanged personality of Christ." He that ascends is the identical, self-same person that descended. Cf. Eph. iv. 10.

64. There are two leading interpretations of this verse: (a) according to St. Chrysostom and others our Lord here meant to say that the words He had been speaking were to be understood only by minds illumined with faith and quickened by grace; human

65. But there are some of you that believe not. For Jesus knew from the beginning, who they were that did not believe, and who he was, that would betray him.

66. And he said: Therefore did I say to you, that no man can come to me, unless it be given him by my Father.

67. After this many of his disciples went back; and walked no more with him.

68. Then Jesus said to the twelve: Will you also go away?

69. And Simon Peter answered him: Lord, to whom shall we go? thou hast the words of eternal life.

70. And we have believed and have known, that thou art the Christ, the Son of God.

71. Jesus answered them: Have not I chosen you twelve; and one of you is a devil?

72. Now he meant Judas Iscariot, the son of Simon: for this same was about to betray him, whereas he was one of the twelve.

nature of itself being unable to grasp His meaning; (b) Maldonatus and many others say the meaning is, as if our Lord had said: "It is My Divinity that will quicken my flesh and make it a meat nourishing unto life everlasting; My flesh alone without My Divinity profiteth nothing."

65. **But there are some of you that believe not;** i.e., some among our Lord's hearers believed not in His Divinity, and consequently found His words hard to accept. Judas was evidently among the unbelievers.

66. Alluding to what He had said in verse 44, our Lord repeats that no one can believe in Him unless His Father draw him by grace. Those who did not believe resisted the promptings of grace. See on verses 44, 45.

67, 68. These verses show beyond doubt that the disciples understood our Lord's words in their literal sense, and that our Lord permitted many of them to turn away, — He even insinuated that the twelve might go, rather than that He should change their understanding of His words.

69, 70. Peter, speaking for all the Apostles, now professes his entire belief in the words of our Lord. For verse 70 the oldest Greek MSS. read: "And we have believed and know that thou art the Holy One of God."

It is uncertain whether Peter's words meant a recognition of our Lord's Divinity or only of His Messiahship.

71, 72. Peter in professing his belief in the words of our Lord

had spoken for the twelve, but our Lord here reminds the Apostles that one of them is His enemy.

**Judas Iscariot**; i.e., Judas of Kerioth, a town in the tribe of Juda.

## CHAPTER VII

JESUS AT THE FEAST OF TABERNACLES, 1-10.

THE CHIEF MEN AMONG THE JEWS LOOK FOR JESUS  
AT THE FEAST, 11-13.

JESUS PROCLAIMS HIS DIVINE MISSION, 14-36.

JESUS REVEALS THE HOLY SPIRIT, 37-39.

THE DIFFERENT OPINIONS OF THE JEWS REGARDING  
JESUS, 40-43.

THEY SEEK TO APPREHEND JESUS, 44-49.

NICODEMUS DEFENDS JESUS BEFORE THE SANHEDRIM,  
50-53.

1. After these things Jesus walked in Galilee; for he would not walk in Judea, because the Jews sought to kill him.

2. Now the Jews' feast of tabernacles was at hand.

3. And his brethren said to him: Pass from hence, and go into Judea; that thy disciples also may see thy works which thou dost.

4. For there is no man that doth any thing in secret, and he himself seeketh to be known openly. If thou do these things, manifest thyself to the world.

1. **After these things.** These words refer to a period of about six months, between March and September, the events of which are related by St. Mark vii-ix.

2. **Feast of tabernacles.** See on Matthew xxvi. 2. This feast was established at first to celebrate the memory of Israel wandering in the desert, but because of the circumstances of time and season it also became a feast of thanksgiving for the fruits of the year. It lasted for eight days, and was called *tabernacles* because of the wooden booths or huts, covered over with branches, in which the people lived during the feast in memory of their passage through the desert.

3. **His brethren**; i.e., his cousins. See on Matthew xii. 46; xiii. 55.

**Thy disciples**; i.e., those who were desirous of learning His doc-

5. For neither did his brethren believe in him.
6. Then Jesus said to them: My time is not yet come; but your time is always ready.
7. The world cannot hate you; but me it hateth; because I give testimony of it, that the works thereof are evil.
8. Go you up to this festival day, but I go not up to this festival day: because my time is not accomplished.
9. When he had said these things, he himself stayed in Galilee.
10. But after his brethren were gone up, then he also went up to the feast, not openly, but, as it were, in secret.
11. The Jews therefore sought him on the festival day, and said: Where is he?
12. And there was much murmuring among the multitude concerning him. For some said: He is a good man. And others said: No, but he seduceth the people.
13. Yet no man spoke openly of him, for fear of the Jews.
14. Now about the midst of the feast, Jesus went up into the temple, and taught.
15. And the Jews wondered, saying: How doth this man know letters, having never learned?
16. Jesus answered them, and said: My doctrine is not mine, but his that sent me.

trine; or the term "disciples" may refer to some of the Apostles whose faith was still imperfect.

5. See above, verse 3; and also vi. 65.
6. **My time**; i.e., the time for going up to Jerusalem to manifest Himself at the festival.
- 8-10. **I go not up**; i.e., publicly, in your company (verse 10). As many ancient MSS. have *οὐπω*, *not yet*, for *οὐκ*, *not*, some interpreters believe that the meaning of this passage is, "I go not up yet or now," implying that He would go up later. Because this journey of Jesus to the Feast of Tabernacles is very different in details from the journey mentioned by St. Luke (ix. 51), some think it should not be regarded as the same. The differences, however, can be reconciled. See Fouard, *op. cit.* Book V. c. 4.
13. **Openly**; i.e., with open approval (*ἐν παρρησία*), because they feared the enemies of Christ.
15. This verse shows that Jesus had never attended any school, and hence was not supposed to be able to read and expound the Scriptures.
16. **My doctrine is not mine**. The meaning is that His doctrine was not different from that of His Eternal Father. The doctrine

17. If any man will do the will of him; he shall know of the doctrine, whether it be of God, or whether I speak of myself.

18. He that speaketh of himself, seeketh his own glory: but he that seeketh the glory of him that sent him, he is true, and there is no injustice in him.

19. Did not Moses give you the law, and yet none of you keepeth the law?

20. Why seek you to kill me? The multitude answered, and said: Thou hast a devil; who seeketh to kill thee?

21. Jesus answered, and said to them: One work I have done; and you all wonder:

22. Therefore, Moses gave you circumcision, (not because it is of Moses, but of the fathers;) and on the sabbath day you circumcise a man.

23. If a man receive circumcision on the sabbath day, that the law of Moses may not be broken; are you angry at me because I have healed the whole man on the sabbath day?

of our Lord, as God, was identical with the doctrine of the Father, having been communicated to Him in His eternal generation; and as man, it was the same as the Father's, having been infused into His human soul at the Incarnation.

17, 18. In these verses our Lord gives two proofs of the truth of His doctrine: (a) if anyone will test it in practice, he will find by experience that it is not human, but divine; (b) those who preach their own doctrine seek their own glory, but He is seeking only the glory of His Father, therefore, He is preaching the Father's doctrine which, they must admit, is true. The Father's doctrine was of course our Lord's also; but, since the Jews did not understand the Divinity of Christ, it would be of little use for Him at this time to claim as His own the doctrine He was preaching.

19, 20. Remembering that the Jews on a former occasion had accused Him of violating the Sabbath (v. 16-18), our Lord now accuses them of violating a more serious law themselves by seeking to kill Him against the express prohibition of Exod. (xx. 13).

**Thou hast a devil.** It is more likely that these words were uttered by the very ones whose evil intentions our Lord had just unveiled. They were infuriated at His discovery of their malicious designs. Their accusation meant that He was either a "possessed person," or that He was raving.

21-23. In these verses our Lord adduces an argument against those who the previous year (v. 5-16) had murmured because He cured the paralytic on the Sabbath. These same Jewish rulers had still in mind the charge they brought against Him on that occasion, and our Lord now reminds them that they do not hesitate

24. Judge not according to the appearance, but judge just judgment.

25. Some therefore of Jerusalem said: Is not this he whom they seek to kill?

26. And behold, he speaketh openly, and they say nothing to him. Have the rulers known for a truth, that this is the Christ?

27. But we know this man, whence he is: but when the Christ cometh, no man knoweth whence he is.

28. Jesus therefore cried out in the temple, teaching, and saying: You both know me, and you know whence I am; and I am not come of myself; but he that sent me, is true, whom you know not.

29. I know him, because I am from him, and he hath sent me.

30. They sought therefore to apprehend him: and no man laid hands on him, because his hour was not yet come.

31. But of the people many believed in him, and said: When the Christ cometh, shall he do more miracles, than these which this man doth?

32. The Pharisees heard the people murmuring these things concerning him: and the rulers and Pharisees sent ministers to apprehend him

to set aside the observation of the Sabbath when this conflicts with the day on which a child should be circumcised; namely, the eighth day after birth (Luke ii. 21). Hence the argument is: If you do not violate the law of the Sabbath by circumcising a child on that day, why are you angry with Me for curing a man's body and soul on the Sabbath day?

The "therefore" (*διὰ τοῦτο*) of verse 22 causes some difficulty. Some connect it with verse 21; but it more probably belongs to what follows in verse 22, and the sense is: On this account Moses gave you circumcision; namely, because it had come down from the Fathers, Abraham, Isaac, Jacob, etc. (Gen. xvii. 10-14), — not that Moses himself was the author of it.

24-27. Some of the inhabitants of Jerusalem (*Ἱεροσολυμειτῶν*) began to wonder if the rulers really considered our Lord to be the Christ, so openly did they allow Him to talk; but they concluded that such could not be the case inasmuch as they knew whence this man was, whereas no man would know whence Christ was. Their erroneous ideas about the Christ were likely grounded on a misunderstanding of Isaias liii. 8; Mich. v. 2; and Mal. iii. 2.

28, 29. Our Lord here tells the Jews that they do know Him *as man*, and they know His parents; and yet He does not come of His own authority, but is sent by His Father.

32. Rulers; i.e., chief priests, who were probably members of the Sanhedrim, and sent by that body.



33. Jesus therefore said to them: Yet a little while I am with you: and then I go to him that sent me.

34. You shall seek me, and shall not find me: and where I am, thither you cannot come.

35. The Jews therefore said among themselves: Whither will he go, that we shall not find him? will he go unto the dispersed among the Gentiles, and teach the Gentiles?

36. What is this saying that he hath said: You shall seek me, and shall not find me; and where I am, you cannot come?

37. And on the last, and great day of the festivity, Jesus stood and cried, saying: If any man thirst, let him come to me, and drink.

38. He that believeth in me, as the scripture saith, Out of his belly shall flow rivers of living water.

39. Now this he said of the Spirit which they should receive, who believed in him: for as yet the Spirit was not given, because Jesus was not yet glorified.

40. Of that multitude therefore, when they had heard these words of his, some said: This is the prophet indeed.

41. Others said: This is the Christ. But some said: Doth the Christ come out of Galilee?

42. Doth not the scripture say: That Christ cometh of the seed of David, and from Bethlehem the town where David was?

43. So there arose a dissension among the people because of him.

44. And some of them would have apprehended him: but no man laid hands upon him.

45. The ministers therefore came to the chief priests and the Pharisees. And they said to them: Why have you not brought him?

46. The ministers answered: Never did man speak like this man.

47. The Pharisees therefore answered them: Are you also seduced?

48. Hath any one of the rulers believed in him, or of the Pharisees?

49. But this multitude, that knoweth not the law, are accursed.

33. **A little while**; i.e., about six months more.

34. **You shall seek me**; i.e., many of the Jews would seek Him in vain after His departure from earth. These same words were later addressed to the Apostles (xiii. 33).

35. **The dispersed among the Gentiles**; i.e., the Gentiles, or Greek speaking peoples, scattered over the civilized world ('Ελληνων). That the Jews dispersed over the world were not meant seems clear from the words, "and teach the Gentiles."

37. **If any man thirst**, etc.; i.e., if any one have spiritual desires, let him come to the fountain of grace and be filled.

38. **Out of his belly**, etc. This passage is not found anywhere in the Old Testament, but the allusion is most likely to such passages as Isa. lv. 1; xliv. 3; Ezech. iii. 3; xxxvi. 25.

39. The Evangelist here explains the futurity of our Lord's

50. Nicodemus said to them, (he that came to him by night, who was one of them:)

51. Doth our law judge any man, unless it first hear him, and know what he doth?

52. They answered, and said to him: Art thou also a Galilean? Search the scriptures, and see, that out of Galilee a prophet riseth not.

53. And every man returned to his own house.

words in the preceding verse; and he means to say that, while the just of the Old Law possessed the Holy Ghost, still the universal and abundant gifts of the Spirit were reserved for Pentecost, after Jesus had been glorified (xvi. 7).

50-52. The Sanhedrim resented the defense of our Lord by Nicodemus, and in their impatience they drew several wrong conclusions: (a) that our Lord was born in Galilee; (b) that being a Galilean He could not be a prophet; (c) that the Scriptures say that no prophet arises out of Galilee. The Scriptures (4 Kings xiv. 25) show that the prophet Jonas was from Galilee.

## CHAPTER VIII

THE WOMAN TAKEN IN ADULTERY, 1-11.

JESUS IS THE LIGHT OF THE WORLD, 12-20.

JESUS UPBRAIDS THE PHARISEES AND FORETELLS HIS  
OWN CRUCIFIXION, 21-30.

MANY BELIEVE IN HIM, WHILE OTHERS, WHOM HE  
CALLS THE CHILDREN OF THE DEVIL, REMAIN IN-  
CREDULOUS, 31-51.

JESUS IS BEFORE, AND IS GREATER THAN, ABRAHAM,  
52-59.

The genuineness of the passage vii. 53-viii. 11 has been very seriously questioned for the following reasons: (a) it is wanting in the best Greek MSS. and in many of the best MSS. of the different versions, such as the *Vetus Itala*, the Gothic, the Coptic, etc.; (b) it is ignored by all of the Greek Fathers who wrote on this Gospel; (c) it contains many words and phrases not elsewhere used by St. John. That these verses, however, are genuine seems very probable, if not altogether certain, from the following: (a) they are found in a great number of Greek MSS., and in such versions as the Vulgate, the Arabic, Ethiopic, Persian, etc.; (b) they are ap-

1. And Jesus went unto mount Olivet.
2. And early in the morning he came again into the temple, and all the people came to him, and sitting down he taught them.
3. And the scribes and Pharisees bring unto him a woman taken in adultery: and they set her in the midst,
4. And said to him: Master, this woman was even now taken in adultery.
5. Now Moses in the law commanded us to stone such a one. But what sayest thou?
6. And this they said tempting him, that they might accuse him. But Jesus bowing himself down, wrote with his finger on the ground.
7. When therefore they continued asking him, he lifted up himself, and said to them: He that is without sin among you, let him first cast a stone at her.
8. And again stooping down, he wrote on the ground.
9. But they hearing this, went out one by one, beginning at the eldest. And Jesus alone remained, and the woman standing in the midst.
10. Then Jesus lifting up himself, said to her: Woman, where are they that accused thee? Hath no man condemned thee?

proved by most of the Latin Fathers; (c) if strange words are used in these verses, this proves nothing, because other strange words are found in other passages of St. John about which there is no question; (d) the Council of Trent (Sess. iv) seems to imply that these verses are a true portion of the inspired Scriptures. We may, therefore, conclude that the above passage is: (a) a genuine narrative; (b) that it had Apostolic sanction, and was most probably written by St. John; (c) that its inspiration cannot be questioned by Catholics.

1-10. While the people retired to their homes, our Lord went to the Mount of Olives, about a mile east of Jerusalem, to spend the night in prayer. The next morning He came to the Temple, and was there teaching the people, who had come to the city from all parts of Palestine for the Feast of Tabernacles, and who were still in the city. The Pharisees brought to Him a woman whom they had apprehended in the very act of adultery (*μοιχευομένη*), and they hoped to entrap Him by getting Him to acquit her against the command of the Law (Lev. xx. 10), or by inducing Him to condemn her and thus defy the Roman Law which at that time denied to the Jews the right of capital punishment (John xviii. 31). How Jesus foiled their wicked attempt to catch Him! What He wrote on the ground we do not know. According to some MSS. (the *U* and others) He added to the name of each accuser a list of his own faults. At any rate, what He wrote was sufficient to send away in shame and confusion the accusers of the woman.

11. Who said: No man, Lord. And Jesus said: Neither will I condemn thee. Go, and now sin no more.

12. Again therefore, Jesus spoke to them, saying: I am the light of the world: he that followeth me, walketh not in darkness, but shall have the light of life.

13. The Pharisees therefore said to him: Thou givest testimony of thyself: thy testimony is not true.

14. Jesus answered, and said to them: Although I give testimony of myself, my testimony is true: for I know whence I came, and whither I go: but you know not whence I come, or whither I go.

15. You judge according to the flesh: I judge not any man.

16. And if I do judge, my judgment is true: because I am not alone, but I and the Father that sent me.

17. And in your law it is written, that the testimony of two men is true.

18. I am one that give testimony of myself: and the Father that sent me giveth testimony of me.

19. They said therefore to him: Where is thy Father? Jesus answered: Neither me do you know, nor my Father: if you did know me, perhaps you would know my Father also.

It is nowhere stated in the Pentateuch that an adulterer or adulteress should be *stoned*, but that her death, which was commanded by Lev. (xx. 10), should be by stoning was perhaps gathered from Ezech. (xvi. 38-40).

11. **Neither will I condemn thee. Go, etc.** Our Lord implies that the woman had been guilty, but having moved her by His grace to sorrow, He pardons her and bids her go and sin no more.

12. This verse is very probably a continuation of the discourse spoken of in verse 2 above. **I am the light, etc.** St. Aug. (*Tract. in Joan.* xxxv. 4-6) thus sets forth this argument: "*Lumen et alia demonstrat et seipsum; testimonium sibi perhibet lux, aperit sanos oculos, et sibi ipsa testis est ut cognoscatur lux. . . . Ergo verum est testimonium luminis, sive se ostendit, sive alia; quia sine lumine non potes videre quodlibet aliud quod non est lumen.*"

14. **For I know whence I came, etc.** By this our Lord meant to say that He was God, and therefore His testimony was true and should be accepted.

15. **You judge according to the flesh; i.e., according to carnal ideas and the natural man (Rom. viii. 4-6; I Cor. ii. 14). I judge not any man; i.e., now, at My first coming. At His second coming our Lord is to be the judge of all mankind.**

16-19. Our Lord now says that, should He judge anyone, His judgment will be true, because His judgment is identical with that

20. These words Jesus spoke in the treasury, teaching in the temple: and no man laid hands on him, because his hour was not yet come.

21. Again therefore Jesus said to them: I go, and you shall seek me, and you shall die in your sin. Whither I go, you cannot come.

22. The Jews therefore said: Will he kill himself, because he said: Whither I go, you cannot come?

23. And he said to them: You are from beneath, I am from above. You are of this world, I am not of this world.

24. Therefore I said to you, that you shall die in your sins. For if you believe not that I am he, you shall die in your sin.

25. They said therefore to him: Who art thou? Jesus said to them: The beginning, who also speak unto you.

of the Father; and further, that His testimony as man ought to be accepted, because it is backed by two witnesses, as the Law (Deut. xvii. 6; xix. 15) requires; namely, by His own testimony as God, and by that of His Father (v. 36). But the Jews did not know Him as God, and hence they knew not the Father either.

20. **In the treasury**; i.e., in the cloister in the Court of the Women where this treasury was located. See on Mark xii. 41.

21. The meaning here is that after our Lord had ascended on high the faithless Jews would seek Him, in order to kill Him again. But they should not find Him, because He would be in Heaven whither they should never come. They would die in their sin, i.e., in their infidelity, and would be buried in hell. See on vii. 34.

25. **The beginning**, etc. This is a very obscure passage, and the explanations of it are many. The whole trouble is caused by the Greek, which has, *τὴν ἀρχὴν ὃ τί (ἢ) οὐτι) καὶ λαλῶ ὑμῖν*. Since *τὴν ἀρχὴν* are in the accusative, and not in the nominative case, the translations in the English and Vulgate cannot be correct. St. Augustine says that the verb *believe, credite*, is presupposed to the accusative *principium*, or *ἀρχήν*; hence the construction would be: "believe me to be the beginning," etc. This explanation agrees with the context, and is, therefore, probable. But since *τὴν ἀρχὴν* is quite often taken as an adverb in the Old Testament (Dan. viii. 1; Gen. xli. 21; xliii. 20), as well as in profane authors, it is thought better by many commentators to take it adverbially here, as meaning, *from the beginning*; or, *absolutely, precisely*. Hence, regarding *τὴν ἀρχὴν* as an adverb we should say that the most probable renderings of the passage are: (a) "From the beginning I am what I declare to

26. Many things I have to speak and to judge of you. But he that sent me, is true: and the things I have heard of him, these same I speak in the world.

27. And they understood not, that he called God his Father.

28. Jesus therefore said to them: When you shall have lifted up the Son of man, then shall you know, that I am he, and that I do nothing of myself, but as the Father hath taught me, these things I speak:

29. And he that sent me, is with me, and he hath not left me alone: for I do always the things that please him.

30. When he spoke these things, many believed in him.

31. Then Jesus said to those Jews, who believed him: If you continue in my word, you shall be my disciples indeed.

32. And you shall know the truth, and the truth shall make you free.

33. They answered him: We are the seed of Abraham, and we have never been slaves to any man: how sayest thou: you shall be free?

34. Jesus answered them: Amen, amen I say unto you: that whosoever committeth sin, is the servant of sin.

35. Now the servant abideth not in the house for ever; but the son abideth for ever.

36. If therefore the son shall make you free, you shall be free indeed.

37. I know that you are the children of Abraham: but you seek to kill me, because my word hath no place in you.

you"; (b) "From the beginning I am (the Word) who speak to you"; (c) "I am absolutely, precisely what I say to you."

The Revised Version has in the margin: "How is it that I even speak to you?" which is similar to the explanation given by St. Chrysostom, and agrees very well with the following verse.

26. The meaning of this verse is: I have many things wherein to condemn you, especially your incredulity, since you do not believe Me, although He that sent Me is true, and I speak His words.

27. The Greek of this verse is: "They did not know that He spoke to them of the Father."

28. *Lifted up the Son of man*, etc. The meaning here is that after they had crucified our Lord they would recognize Him to be God, which was at once verified, as we know from Matthew (xxvii. 54) and Luke (xxiii. 48).

*As the Father hath taught*, etc. See on v. 19, 20.

31. Our Lord here gives the rule by which His true disciples are to be tested.

32. *You shall know the truth*, etc.; i.e., you shall know Me and accept My revelation, and you shall be made *free* from the slavery of sin (verse 34).

33-36. Some of the unbelievers among our Lord's hearers, ap-

38. I speak that which I have seen with my Father: and you do the things that you have seen with your father.

39. They answered, and said to him: Abraham is our father. Jesus saith to them: If you be the children of Abraham, do the works of Abraham.

40. But now you seek to kill me, a man who have spoken the truth to you, which I have heard of God. This Abraham did not.

41. You do the works of your father. They said therefore to him: We are not born of fornication: we have one Father, even God.

42. Jesus therefore said to them: If God were your Father, you would indeed love me. For from God I proceeded, and came; for I came not of myself, but he sent me:

43. Why do you not know my speech? Because you cannot hear my word.

44. You are of your father the devil, and the desires of your father you will do. He was a murderer from the beginning, and he stood not in the truth; because truth is not in him. When he speaketh a lie, he speaketh of his own: for he is a liar, and the father thereof.

parently not understanding that He spoke of the slavery of sin, replied that they had never been slaves to any man. It is true the Jews who were then living had never been *slaves* to any man, although they were subject to the Romans; but their forefathers had been slaves to the Egyptians, Babylonians, and others.

Since, then, these Jews were the slaves of sin, they were subject to the condition of slaves, and might, consequently, be cast out of the Master's house, temporal and eternal, at any time. But if the Son of the Father should make them free, their liberty would be of the most excellent kind — a liberty from the bondage of sin and their own passions.

38. **Your father; i.e., the devil (verse 44).**

39. **If you be the children, etc.,** — rather, "if you were the children, you would," etc., according to the Greek.

41. **Born of fornication.** The word *πορνεία*,<sup>1</sup> *fornication*, is often used in Scripture (e.g., Ezech. xvi. 15 ff.; Osee ii. 4, 5) of idolatry, and thus did the Jews here understand our Lord to deny that they were the spiritual descendants of Abraham.

43. The reason why the Jews did not understand our Lord's words was because they did not accept His doctrine; and the reason why they did not accept His doctrine was because they did not want to correct their own lives and their false notions regarding the Messiah.

44. **A murderer,** because by tempting our first parents he brought

45. But if I say the truth, you believe me not.
46. Which of you shall convince me of sin? If I say the truth to you, why do you not believe me?
47. He that is of God, heareth the words of God. Therefore you hear them not, because you are not of God.
48. The Jews therefore answered, and said to him: Do not we say well that thou art a Samaritan, and hast a devil?
49. Jesus answered: I have not a devil: but I honour my Father, and you have dishonoured me.
50. But I seek not my own glory: there is one that seeketh and judgeth.
51. Amen, amen I say to you: If any man keep my word, he shall not see death for ever.
52. The Jews therefore said: Now we know that thou hast a devil. Abraham is dead, and the prophets; and thou sayest: If any man keep my word, he shall not taste death for ever.
53. Art thou greater than our father Abraham, who is dead? and the prophets are dead. Whom dost thou make thyself?
54. Jesus answered: If I glorify myself, my glory is nothing. It is my Father that glorifieth me, of whom you say that he is your God.
55. And you have not known him, but I know him. And if I shall say that I know him not, I shall be like to you, a liar. But I do know him, and do keep his word.
56. Abraham your father rejoiced that he might see my day: he saw it, and was glad.

death upon the world (Rom. v. 12). He speaketh of his own, i.e., according to his own nature.

45. **If I say.** The Greek has, "because (*ὅτι*) I say."
- 46, 47. Since our Lord was God He could not sin, He could not lie. The real reason why the Jews did not receive and believe Him was because they were not of God.
48. **A Samaritan.** By this they meant to say that our Lord was not a true son of Abraham, and consequently not of God. See on iv. 5. **And hast a devil.** See on vii. 20.
50. **There is one that seeketh, etc.;** i.e., God the Father will avenge the dishonor given to His Son. Cf. Deut. xviii. 19.
52. The Jews wrongly understood our Lord to speak of the death of the body.
56. **Abraham . . . rejoiced;** i.e., after it had been revealed to Abraham that the Messiah was to be born of his seed, he yearned and longed to see Christ's day, i.e., the period of our Lord's earthly life.

**He saw it, and was glad.** Most commentators believe that Almighty God revealed to Abraham in Limbo the time when Christ



57. The Jews therefore said to him: Thou art not yet fifty years old, and hast thou seen Abraham?

58. Jesus said to them: Amen, amen I say to you, before Abraham was made, I am.

59. They took up stones therefore to cast at him. But Jesus hid himself, and went out of the temple.

was on earth. Others, however, regarding the past tense of the Greek (*εἶδεν καὶ ἐχάρη*) think that, by special revelation while on earth, Abraham was enabled to see the future life and labors of the Messiah here below. Cf. Gen. xv. 8-17; Heb. xi. 13.

57. **Fifty years old.** The Jews assigned an age for our Lord long enough to exclude all doubt. St. Irenaeus (*Adv. Haer.* ii. 39, 40) believed our Lord lived to be fifty; but the common opinion is that Christ was put to death in His thirty-fourth year. See on Luke iii. 23.

58. **I am.** Here our Lord declares His eternity.

59. **Stones to cast at him.** They rightly understood our Lord to proclaim His eternity and divine origin, and considering Him thereby to blaspheme they were going to stone Him, in accordance with the command of the Law (Lev. xxiv. 16). Cf. x. 31-33.

## CHAPTER IX

THE CURE OF THE MAN BORN BLIND, 1-7.

THE ASTONISHMENT AND COMMENTS OF THE PEOPLE,  
8-12.

THE CURED MAN IS BROUGHT TO THE PHARISEES,  
WHO QUESTION HIM AND THEN INTERVIEW HIS  
PARENTS, AND FINALLY CAST HIM OUT, 13-34.

JESUS FINDS HIM AND ENLIGHTENS HIM, AND CON-  
DEMNS THE PHARISEES, 35-41.

I. And Jesus passing by, saw a man, who was blind from his birth:

1. **Jesus passing by.** The term "Jesus" is not genuine in this verse, and should be understood from the last verse of the preceding chapter. From this and from the context it seems more probable that the events about to be narrated occurred immediately after our Lord had left the Temple (viii. 59).

2. And his disciples asked him: Rabbi, who hath sinned, this man, or his parents, that he should be born blind?

3. Jesus answered: Neither hath this man sinned, nor his parents; but that the works of God should be made manifest in him.

4. I must work the works of him that sent me, whilst it is day: the night cometh, when no man can work.

5. As long as I am in the world, I am the light of the world.

6. When he had said these things, he spat on the ground, and made clay of the spittle, and spread the clay upon his eyes,

7. And said to him: Go, wash in the pool of Siloe, which is interpreted, Sent. He went therefore, and washed, and he came seeing.

8. The neighbours therefore, and they who had seen him before that he was a beggar, said: Is not this he that sat and begged? Some said, This is he.

9. But others said: No, but he is like him. But he said: I am he.

10. They said therefore to him: How were thy eyes opened?

11. He answered: That man that is called Jesus made clay, and anointed my eyes, and said to me: Go to the pool of Siloe, and wash. And I went, I washed, and I see.

12. And they said to him: Where is he? He saith: I know not.

13. They bring him that had been blind to the Pharisees.

14. Now it was the sabbath, when Jesus made the clay, and opened his eyes.

2. **This man, or his parents.** It was quite possible that the man's blindness might be a punishment for the sins of his parents (Exod. xx. 5); but it is impossible to see how his own sins could be the cause of his blindness, except by their being foreseen and fore-punished, and this is absurd. The absurdity of the man's own sins being the cause of his blindness was likely not adverted to by the disciples, who asked the question.

3. Our Lord explains that the man's blindness was ordained in order to afford occasion for the miracle which was about to be performed.

4. **Day** means the period of our Lord's life, as mortal man; **night** refers to the time when He would no longer work visibly before men.

6. See on Mark vii. 33.

7. **Siloe.** The pool of Siloe or Siloah is situated a little to the south-east of Jerusalem at the foot of Mount Sion, and may be seen at the present time. The waters of the pool came from a spring, which has been later called the *Fountain of the Virgin*. Siloe, which comes from a Hebrew verb, *salah*, to send, was a type of Christ who was sent to this world by His Father (xvii. 3).

12-14. Since the cure of the blind man was wrought on the

15. Again therefore the Pharisees asked him, how he had received his sight. But he said to them: He put clay upon my eyes, and I washed, and I see.

16. Some therefore of the Pharisees said: This man is not of God, who keepeth not the sabbath. But others said: How can a man that is a sinner do such miracles? And there was a division among them.

17. They say therefore to the blind man again: What sayest thou of him that hath opened thy eyes? And he said: He is a prophet.

18. The Jews then did not believe concerning him, that he had been blind, and had received his sight, until they called the parents of him that had received his sight,

19. And asked them, saying: Is this your son, who you say was born blind? How then doth he now see?

20. His parents answered them, and said: We know that this is our son, and that he was born blind:

21. But how he now seeth, we know not; or who hath opened his eyes, we know not: ask himself: he is of age, let him speak for himself.

22. These things his parents said, because they feared the Jews: for the Jews had already agreed among themselves, that if any man should confess him to be Christ, he should be put out of the synagogue.

23. Therefore did his parents say: He is of age, ask himself.

24. They therefore called the man again that had been blind, and said to him: Give glory to God. We know that this man is a sinner.

25. He said therefore to them: If he be a sinner, I know not: one thing I know, that whereas I was blind, now I see.

26. They said then to him: What did he to thee? How did he open thy eyes?

Sabbath, the people appealed to the Pharisees as judges to ascertain if such an event could come from God. Our Lord often worked cures on the Sabbath in order to correct the false notions of the Pharisees regarding Sabbatical observance.

15-17. The Pharisees could not deny the reality of the miracle, and yet, because our Lord had violated their own false ideas about the observance of the Sabbath, some of them said that the miracle was due to other than divine agencies. They did not agree among themselves as to the character of our Lord, and so they again questioned the man who answered that Christ was a prophet.

18-23. Beginning to discredit the cure of the blind man, the Pharisees appeal to his parents, to whom they propose three questions. The parents respond that this is their son and that he was born blind, but they refuse, out of fear of excommunication from the Synagogue, to say anything about Him who cured their son.

24. While pretending to get the truth from the man the Pharisees tried first of all to influence him to reply against our Lord.

27. He answered them: I have told you already, and you have heard: why would you hear it again? will you also become his disciples?

28. They reviled him therefore, and said: Be thou his disciple; but we are the disciples of Moses.

29. We know that God spoke to Moses: but as to this man, we know not from whence he is.

30. The man answered, and said to them: Why, herein is a wonderful thing, that you know not from whence he is, and he hath opened my eyes.

31. Now we know that God doth not hear sinners: but if a man be a server of God, and doth his will, him he heareth.

32. From the beginning of the world it hath not been heard, that any man hath opened the eyes of one born blind.

33. Unless this man were of God, he could not do any thing.

34. They answered, and said to him: Thou wast wholly born in sins, and dost thou teach us? And they cast him out.

35. Jesus heard that they had cast him out: and when he had found him, he said to him: Dost thou believe in the Son of God?

36. He answered, and said: Who is he, Lord, that I may believe in him?

27. **And you have heard.** The Greek is: "and you did not heed" (*καὶ οὐκ ἠκούσατε*).

30. The blind man means to say that the fact that Jesus has performed so great a miracle as to cure his blindness ought to be proof to the Pharisees that such a one is from God and has divine authority.

31. **God doth not hear sinners**, etc. These are the words of the blind man, and are not always true. Certain prayers and acts, even though performed by sinners, e.g., the Mass, the sacraments, etc., are heard by God, because their value is *ex opere operato*. And even those acts and prayers which have their value only *ex opere operantis* are sometimes heard by God, provided the proper conditions for good prayer are present. The inspiration of this passage is protected by the fact that the inspired Evangelist tells that the man spoke these words.

33. **He could not do anything**; i.e., he could not do anything like the miracle just performed.

34. **They cast him out**, from their presence.

35. **Son of God.** The Vatican and Sinaitic MSS. have, "Son of man." The meaning is practically the same, as our Lord was known by both titles.

36. **Lord**, *κύριε*, *sir*, was used as a term of respect, but here it does not imply that the man recognized our Lord to be God.

37. And Jesus said to him: Thou hast both seen him; and it is he that talketh with thee.

38. And he said: I believe, Lord. And falling down, he adored him.

39. And Jesus said: For judgment I am come into this world; that they who see not, may see; and they who see, may become blind.

40. And some of the Pharisees, who were with him, heard: and they said unto him: Are we also blind?

41. Jesus said to them: If you were blind, you should not have sin: but now you say: We see. Your sin remaineth.

37. **Thou hast both seen him**, — rather, “thou seest him.” The Greek perfect has here a present meaning.

38. **He adored him**; i.e., he worshipped Him as God.

39. **For judgment I am come**, etc.; i.e., the result or effect of Christ's first coming was to separate the good from the bad, to prepare the materials for the judgment of *condemnation* which is spoken of in iii. 17; viii. 15, and which He will execute at His second coming. Cf. Rom. v. 20; Cor. i. 27. The blind here are those who would not see; namely, the Pharisees (Matthew xxiii. 26).

41. **If you were blind**, etc.; i.e., if you were ignorant, uninstructed, there would be some excuse for you; but you profess to see, to be instructed, hence your sin remaineth.

## CHAPTER X

THE GOOD SHEPHERD, 1-21.

JESUS AT THE FEAST OF THE DEDICATION, 22-24.

JESUS IS CONSUBSTANTIAL WITH THE FATHER, 25-30.

THE HOSTILITY OF THE JEWS, 31-39.

JESUS RETIRES TO PERAEA, 40-42.

1. Amen, amen I say to you. He that entereth not by the door into the sheepfold, but climbeth up another way, the same is a thief and a robber.

2. But he that entereth in by the door is the shepherd of the sheep.

1, 2. From the relation between the last chapter and the first part of the present one some commentators hold that the first eighteen verses of this chapter rightly belong to that. The connection,

3. To him the porter openeth; and the sheep hear his voice: and he calleth his own sheep by name, and leadeth them out.

according to St. Augustine, is in this, that Christ was condemning the Pharisees as *blind*, because they did not recognize Him as the *door* to salvation and as the true *shepherd* of souls.

This allegory, or parable, of the good Shepherd is best understood when we know something of the pastoral life of the Orient, and of the relations between the shepherd and his sheep. Throughout the daytime in clement weather the Jewish shepherd was accustomed to lead his sheep to pasture over the hills and through the valleys of Palestine. He did not drive his flock, as we do in our country, but led them, and protected them during the entire day from all evils and dangers which robbers and wild beasts often sought to inflict upon them. At night the shepherd would gather his sheep into the sheepfold, and it sometimes happened that the flocks of several shepherds would be enclosed in the same fold. The fold was nothing more than a high wall of stones, left open over head and having but one door, which was guarded during the night by a doorkeeper. If a thief wished to steal, he would be obliged to climb over the wall. In the morning the shepherd or shepherds would come to the fold, and, entering by the door, would call their flocks by name and lead them out to pasture and to refreshing waters. The sheep knew their own shepherd, whose voice they would always obey, and they had implicit confidence in him; but at the sight of strangers, and at the sound of strange voices they were filled with fear and would flee.

With this brief account in mind the allegory, or parable, and its application are clear. The Church is the *sheepfold*, Christ is the *door*, the Holy Ghost, who opens and enlightens the mind and heart, is the *porter* and the Scribes and Pharisees are the *thieves and robbers* who invade and injure the flock of God. He who would enter the sheepfold, i.e., the Church of Christ and be saved must enter by the door, i.e., through Christ, by way of the doctrines which Christ revealed and taught; otherwise the Holy Spirit will not open to him His graces, and if he enter the fold at all, it will be only by the way of thieves and robbers.

3. **And leadeth them out;** i.e., the good pastor of souls does for the faithful what the shepherd does for his sheep; namely, he guides

4. And when he hath let out his own sheep, he goeth before them: and the sheep follow him, because they know his voice.

5. But a stranger they follow not, but fly from him, because they know not the voice of strangers.

6. This proverb Jesus spoke to them. But they understood not what he spoke to them.

7. Jesus therefore said to them again: Amen, amen I say to you, I am the door of the sheep.

8. All others, as many as have come, are thieves and robbers: and the sheep heard them not.

9. I am the door. By me, if any man enter in, he shall be saved: and he shall go in, and go out, and shall find pastures.

10. The thief cometh not, but for to steal, and to kill, and to destroy. I am come that they may have life, and may have it more abundantly.

them, protects them, and provides them with the nourishment they need. There is this difference between the earthly and the spiritual shepherd, that the latter, unlike the former, has his pastures and sources of nourishment within the fold. It is not necessary to seek exact likeness in everything between the two. To do so would be against the nature of parables and illustrations.

4. **He goeth before them.** The good pastor not only guides and instructs and protects his flock, but he goes before them by setting an example which they can imitate.

5. The faithful who are rightly instructed, and to whom the porter, the Holy Spirit by His graces, has opened the door of the fold, do not follow after strangers or strange teachers and doctrines. They know not the voice of heretics and false guides.

7. See on verses 1, 2.

8. **All others, etc.;** i.e., all others that have come "before me" (as in most MSS.) *as door*, pretending to be the Messiah, such as Theudas, Judas of Galilee, Sadoc the Pharisee (Acts v. 36, 37) and others, "are thieves and robbers." Such also, in a particular way, were the Pharisees who had exercised so baneful an influence on the people of Israel as to close upon them the door of the Heavenly Kingdom.

9. Here Christ declares explicitly that He is the *door* through which His true sheep and shepherds must enter the sheepfold. Those who enter by the door **shall go in and go out**, i.e., shall enjoy freedom and security in the discharge of their duties and offices.

11. I am the good shepherd. The good shepherd giveth his life for his sheep.

12. But the hireling, and he that is not the shepherd, whose own the sheep are not, seeth the wolf coming, and leaveth the sheep, and flieth: and the wolf catcheth, and scattereth the sheep:

13. And the hireling flieth, because he is a hireling: and he hath no care for the sheep.

14. I am the good shepherd; and I know mine, and mine know me.

15. As the Father knoweth me, and I know the Father: and I lay down my life for my sheep.

16. And other sheep I have, that are not of this fold: them also I must bring, and they shall hear my voice, and there shall be one fold and one shepherd.

11. **I am the good shepherd.** Dr. MacRory holds that in this discourse on the good shepherd there are two parables, in the first of which Christ is represented by the *door* of the sheepfold, and in the second, by the good shepherd. In this verse, according to that opinion, begins the second parable, in which our Lord appears as the good shepherd, as foretold by the prophets (Ezech. xxxiv. 1, 2, 11, 15, 16, 22, 23; Zach. xi. 17; Isa. xl. 11).

**Give his life,** etc. This is an allusion to the Saviour's Passion in the prophecy of Isaias (liii. 10), "If he shall lay down his life for sin," etc.

14. **I know mine,** etc. The good Shepherd knows every member of His flock, and they know Him through faith. Further He loves not merely the Elect, but all His sheep, and if all do not love Him, that is not His fault; they are free creatures.

15. This verse continues from verse 14, **I know mine, and mine know me, as the Father knoweth me, and I know the Father;** i.e., there is a similarity, not an equality, of knowledge. Christ's flock know Him only imperfectly, at best, whereas His knowledge of them, like the mutual knowledge between Him and the Father, is perfect.

**I lay down my life,** etc., as later in His Passion He freely and willingly did, in accordance with His Father's wish and will (verse 18).

16. **And other sheep I have,** etc. This refers to the Gentiles who were to be gathered into His Church, and whom He therefore speaks of, by anticipation, as His own. These He brought to the new fold, the Church, after His Ascension, through the preaching of the Apostles. Cf. Acts x.



17. Therefore doth the Father love me: because I lay down my life, that I may take it again.

18. No man taketh it away from me: but I lay it down of myself, and I have power to lay it down: and I have power to take it up again. This commandment have I received of my Father.

19. A dissension rose again among the Jews for these words.

20. And many of them said: He hath a devil, and is mad: why hear you him?

21. Others said: These are not the words of one that hath a devil: Can a devil open the eyes of the blind?

One fold, one shepherd; i.e., one *flock* (*μία ποίμνη*) and one shepherd. This distinctly shows the unity of Christ's Church, and the oneness of its head, who is Christ Himself in the invisible world, and the Pope, His representative in this world. This verse, therefore, declares: (a) that the faith is also to be preached to the Gentiles; (b) that the flock of Christ, composed alike of Jews and Gentiles, is to be one; (c) that the visible head of this flock of Christ is to be one (MacRory).

17. That I may take it again. "That" (*ἵνα*), according to Maldonatus, here means, *so as*; according to Patrizi, *on the condition that*. Our Lord has supreme control over His own life and death, and this is a proof of His Divinity.

18. This verse creates a difficulty. In the first part our Lord seems clearly to say that His death is voluntary, because freely submitted to, but in the end He declares that it was commanded by the Father. Since theologians generally hold that the death of Christ was really commanded by the Father, and since from St. Paul (Phil. ii. 8) it is clear that our Lord was commanded to die, and that by the "death of the cross," the most probable explanations of the above difficulty are the following: (a) the will of the Father became a command only after it had been freely accepted by Christ, and thus His death, though commanded, was freely submitted to (Franzelin); (b) the human will of Christ *intrinsically* had the power to resist the command of the Father, and was consequently free in yielding to death, although *extrinsically*, by reason of the hypostatic union of the divine and human natures in Christ, it was impossible that the human will of our Lord should ever be out of harmony with the will of the Father; *intrinsically*, therefore, the human will of Christ freely accepted death, although *extrinsically* it could not do otherwise (Suarez, à Lapide); (c) Christ was able

22. And it was the feast of the dedication at Jerusalem: and it was winter.  
 23. And Jesus walked in the temple, in Solomon's porch.  
 24. The Jews therefore came round about him, and said to him: How long dost thou hold our souls in suspense? If thou be the Christ, tell us plainly.  
 25. Jesus answered them: I speak to you, and you believe not: the works that I do in the name of my Father, they give testimony of me.  
 26. But you do not believe, because you are not of my sheep.  
 27. My sheep hear my voice: and I know them, and they follow me.

not to die, if death be considered merely in itself, and not as something *commanded*; but although Christ was not able to refuse the death commanded Him, He was nevertheless free, because the power to disobey a command does not pertain to liberty; in other words Christ in this instance possessed the *liberty of exercise*, or of *contradiction*, which alone is required for free will; but He did not possess the *liberty of specification* or *contrariety* (Billuart, *De Incarnatione*, Diss. xviii. art. 4). This last explanation seems best to us.

22. **The feast of the dedication.** This feast was instituted by Judas Machabeus after his victory over the Syrians about 165 B.C. (1 Mach. iv. 52 ff.; 2 Mach. x. 5-8) to commemorate the purification of the Temple and the restoration of the altar which had been profaned for six years by Antiochus Epiphanes, king of Syria. It lasted for eight days, and was celebrated annually, beginning on the 25th of Casleu (December).

23. It was bitterly cold during this feast, and our Lord to keep warm walked to and fro in Solomon's porch, the eastern cloister of the Court of the Gentiles.

24, 25. **Tell us plainly.** Already in viii. 12-24, 58, 59, and on other occasions He had told them and showed them by word and deed that He was the Christ; but because they thought the Messiah should be a temporal ruler and restore their nation to independence and prominence, they wished now to get Him to proclaim Himself as such, so that they might have cause to denounce Him to Rome. Since, therefore, the term *Christ* was wrongly understood by the Jews, our Lord declines to answer their question by a simple "yes" or "no." He refers them to His miraculous works, performed in the name of His Father and in proof of His own claims.

27. **Sheep** here refers to all the faithful.

28. And I give them life everlasting; and they shall not perish for ever, and no man shall pluck them out of my hand.

29. That which my Father hath given me, is greater than all: and no one can snatch them out of the hand of my Father.

30. I and the Father are one.

31. The Jews then took up stones to stone him.

32. Jesus answered them: Many good works I have shewed you from my Father; for which of those works do you stone me?

33. The Jews answered him: For a good work we stone thee not, but for blasphemy; and because that thou, being a man, makest thyself God.

34. Jesus answered them: Is it not written in your law: I said you are gods?

35. If he called them gods, to whom the word of God was spoken, and the scripture cannot be broken;

36. Do you say of him whom the Father hath sanctified and sent into the world: Thou blasphemest, because I said, I am the Son of God?

28. As far as lies with Him our Saviour gives life everlasting to all His faithful; He gives them grace here below, which is the beginning of life everlasting, and if they coöperate with His grace, He will save them eternally.

29, 30. **That which the Father hath given me;** etc. Some MSS. have  $\delta$   $\delta\acute{\epsilon}\delta\omega\kappa\epsilon\nu$ ; others,  $\delta\varsigma$   $\delta\acute{\epsilon}\delta\omega\kappa\epsilon\nu$ . The former is perhaps the better reading, and hence the meaning of the above words is: "That divinity or divine nature which I have in common with the Father is greater than all," etc. This meaning is stated more clearly in verse 30. If we choose the second reading, the meaning is: "My Father who gave to Me (My sheep) is greater than all," etc. The sense is really the same in both readings, and the doctrine taught in these two verses is the *identity of nature and power* of the Father and the Son. It is on account of this unity and identity between the Father and the Son that no one can wrest from the hands of the latter the sheep which the Father has given Him; the hand of the one is the hand of the other.

31. See on viii. 59.

34-36. **Written in your law;** i.e., in Ps. lxxxix. 6, 7. Under the name "Law" our Lord here includes not only the five books of Moses, but all the inspired writings which served as the religious and moral rule for the people of God. The fathers, judges, and princes, as ministers of God and dispensers of His law, had a kind of divine dignity and were called gods. If, therefore, the Scriptures do not blaspheme in applying the term *gods* to mere human judges,

37. If I do not the works of my Father, believe me not.  
 38. But if I do, though you will not believe me, believe the works: that you may know and believe that the Father is in me, and I in the Father.  
 39. They sought therefore to take him; and he escaped out of their hands.  
 40. And he went again beyond the Jordan, into that place where John was baptizing first; and there he abode.  
 41. And many resorted to him, and they said: John indeed did no sign.  
 42. But all things whatsoever John said of this man, were true. And many believed in him.

how is Jesus a blasphemer in calling Himself God, since He is the very messenger, the sanctified, the anointed of the Father (Le Camus and others). Jesus, therefore, has a right to call Himself God, and what is more, He is God, as He goes on to show in the following verses.

37, 38. Our Lord now appeals to His miracles as proof of His Divinity in the strict sense of the term. The Father is in Him, and He is in the Father as an equal in an equal (St. Aug.).

The *consubstantiality* of our Lord with His Father is declared in verse 30; His divine *Filiation* in verse 36; and His *circumincision* in verse 38.

39, 40. Since our Lord not only did not retract, but emphasized His words, the Jews were about to capture Him, but He escaped from their hands and went again to Peraea, to Bethania, or Bethabara, where John had baptized (i. 28, 29). Verse 40 shows that our Lord had been in Peraea before the feast of the Dedication. This present retirement was most likely in January of the last year of our Lord's life. The parables spoken during this time are recorded by St. Luke (xiv-xvi).

41. This verse shows that in spite of the greatness and popularity of John the Baptist, the people did not attribute to him miraculous powers. Fame for miracles was not, then, a popular delusion in our Lord's time, as the Rationalists would have us believe.

## CHAPTER XI

LAZARUS' ILLNESS AND DEATH, 1-16.

CHRIST ON HIS WAY TO LAZARUS IS MET BY THE  
SISTERS OF THE DEAD MAN AND BY MANY JEWS,  
17-32.

LAZARUS IS RAISED TO LIFE, 33-44.

MANY BELIEVE IN JESUS ON ACCOUNT OF THE  
MIRACLE, BUT THE CHIEF PRIESTS AND PHARI-  
SEES ARE ANGERED AND RESOLVE TO PUT HIM TO  
DEATH, 45-56.

1. Now there was a certain man sick, named Lazarus, of Bethania, of the town of Mary and of Martha her sister.

2. (And Mary was she that anointed the Lord with ointment, and wiped his feet with her hair: whose brother Lazarus was sick.)

3. His sisters therefore sent to him, saying: Lord, behold, he whom thou lovest is sick.

4. And Jesus hearing it, said to them: This sickness is not unto death, but for the glory of God: that the Son of God may be glorified by it.

5. Now Jesus loved Martha, and her sister Mary, and Lazarus.

1. The raising of Lazarus to life is one of the most beautiful and important narratives of the Gospel history, and yet it gives rise to one of the greatest difficulties. It is beautiful in its naturalness and completeness, bearing at every step its own assurance of truthfulness; it is of highest importance, as being the one event finally to provoke the Sanhedrim to extreme measures against Jesus; it is unsurpassed in the difficulty it creates, since it is passed over in complete silence by the Synoptic Gospels. St. John's failure to recount the institution of the Eucharist is the only other event in all the Gospels whose omission causes such wonder and astonishment as does the silence of the Synoptics in regard to the resurrection of Lazarus. For both omissions there seems, indeed, only one explanation of value, and that is the fragmentary character of the Gospels.

**Bethania**, or Bethany, on the eastern slope of the Mount of Olives, about two miles from Jerusalem.

2. See on Luke vii. 37, 38.

4. This sickness is not unto death; i.e., the death which will

6. When he had heard therefore that he was sick, he still remained in the same place two days.

7. Then after that, he said to his disciples: Let us go into Judea again.

8. The disciples say to him: Rabbi, the Jews but now sought to stone thee: and goest thou thither again?

9. Jesus answered: Are there not twelve hours of the day? If a man walk in the day, he stumbleth not, because he seeth the light of this world:

10. But if he walk in the night, he stumbleth, because the light is not in him.

11. These things he said; and after that he said to them: Lazarus our friend sleepeth; but I go that I may awake him out of sleep.

12. His disciples therefore said: Lord, if he sleep, he shall do well.

13. But Jesus spoke of his death; and they thought that he spoke of the repose of sleep.

14. Then therefore Jesus said to them plainly: Lazarus is dead.

15. And I am glad, for your sakes, that I was not there, that you may believe: but let us go to him.

16. Thomas therefore, who is called Didymus, said to his fellow disciples: Let us also go, that we may die with him.

17. Jesus therefore came, and found that he had been four days already in the grave.

result is not definitive, not the end of his mortal life, but only to afford occasion for a miracle.

6. Our Lord remained where He was, probably at Bethabara, two days after receiving the message about Lazarus' death, not out of indifference, but in order to render the miracle which was to follow the more convincing by permitting the man to be some time dead.

9, 10. The meaning here is: As the daytime is a determined period of light in which one may walk without fear of stumbling, so the mortal life of our Lord was a fixed period in which there was nothing to fear before the time determined by the Eternal Father. But after this time determined by the Father is reached, then there will be reason for fear.

15. Our Lord rejoices that He was not present at the death of Lazarus, because now, that Lazarus has been dead for some days, the miracle that shall be performed will be the more convincing to the disciples, and will, therefore, strengthen their faith.

16. *Didymus* is the Greek for the Aramaic word *Thomas*, and means a *twin*. Thomas feared our Lord would be killed, and yet he is willing, and encourages the other Apostles, to go and share death with the Master.

17. **Four days in the grave.** The Jews were accustomed to bury their dead on the same day on which they died. The messengers

18. (Now Bethania was near Jerusalem, about fifteen furlongs off.)

19. And many of the Jews were come to Martha and Mary, to comfort them concerning their brother.

20. Martha therefore, as soon as she heard that Jesus was come, went to meet him: but Mary sat at home.

21. Martha therefore said to Jesus: Lord, if thou hadst been here, my brother had not died.

22. But now also I know that whatsoever thou wilt ask of God, God will give it thee.

23. Jesus saith to her: Thy brother shall rise again.

24. Martha saith to him: I know that he shall rise again, in the resurrection at the last day.

25. Jesus said to her: I am the resurrection and the life: he that believeth in me, although he be dead, shall live:

26. And every one that liveth, and believeth in me, shall not die for ever. Believeth thou this?

27. She saith to him: Yea, Lord, I have believed that thou art Christ the Son of the living God, who art come into this world.

28. And when she had said these things, she went, and called her sister Mary secretly, saying: The master is come, and calleth for thee.

29. She, as soon as she heard this, riseth quickly, and cometh to him.

30. For Jesus was not yet come into the town: but he was still in that place where Martha had met him.

31. The Jews therefore, who were with her in the house, and comforted her, when they saw Mary that she rose up speedily and went out, followed her, saying: She goeth to the grave to weep there.

32. When Mary therefore was come where Jesus was, seeing him, she fell down at his feet, and saith to him: Lord, if thou hadst been here, my brother had not died.

likely started for Jesus immediately after the death of Lazarus, and as the Saviour was some distance away from Bethany and remained two days after getting the message, the four days in the grave are easily understood.

18. Fifteen furlongs; i.e., about two miles. See on vi. 19.

21-23. Martha has faith in our Lord, and hopes that He may still do something for her dead brother, but her faith is not entirely perfect. To try her faith Jesus purposely uses ambiguous language.

25, 26. Here our Lord declares that He is the author and cause of the resurrection of the dead, and of the enduring life of the living; if any one, believing in Him and living according to His doctrine, die, his death shall be only the prelude to his resurrection and to life everlasting.

27. Martha professes her unqualified belief in the Divinity of Jesus, and thereby implies her belief in all that He says.

33. Jesus, therefore, when he saw her weeping, and the Jews that were come with her, weeping, groaned in the spirit, and troubled himself,

34. And said: Where have you laid him? They say to him: Lord, come and see.

35. And Jesus wept.

36. The Jews therefore said: Behold how he loved him.

37. But some of them said: Could not he that opened the eyes of the man born blind, have caused that this man should not die?

38. Jesus therefore again groaning in himself, cometh to the sepulchre. Now it was a cave; and a stone was laid over it.

39. Jesus saith: Take away the stone. Martha, the sister of him that was dead, saith to him: Lord, by this time he stinketh, for he is now of four days.

40. Jesus saith to her: Did not I say to thee, that if thou believe, thou shalt see the glory of God?

41. They took therefore the stone away. And Jesus lifting up his eyes said: Father, I give thee thanks that thou hast heard me.

33. **Groaned.** The real meaning of the Greek word, *ἐνεβριμήσατο*, here translated *groaned*, is, *He was angry*. What was the cause of His indignation? Some say it was sin and death, or Satan, the source of sin and death; others, that it was the internal struggle of the soul, which eagerly wished to work the miracle, but at the same time foresaw the fatal consequences that this work would entail for Him. To raise Lazarus was to sign His own death warrant (*Le Camus, Life of Christ*, vol. ii. p. 455). This latter opinion seems the more probable.

35. **Jesus wept.** This shows the tenderness of our Lord's humanity. As His Divinity was made manifest by the miracle He was about to perform, so His humanity was clearly demonstrated by thus sharing in the grief of those He loved. Truly refined and superior natures are always capable of a most delicate tenderness and susceptibility, however much these qualities may be held in restraint.

38. The Jews usually buried their dead in caves or vaults hollowed out of a rock. Cf. Gen. xxiii. 9; Isa. xxii. 16; John xix. 41.

39. Comparison of this verse with verse 17 shows that Lazarus must have been buried the very day he died.

40. **The glory of God;** i.e., the power of God. It is not certain just when our Lord said this. Some think it was in verse 4, others in verses 23-26.

41. **Father, I give thee thanks.** Our Lord, as man, gave thanks to His Father for the power He was about to exercise. That He



42. And I knew that thou hearest me always; but because of the people who stand about have I said it, that they may believe that thou hast sent me.

43. When he had said these things, he cried with a loud voice: Lazarus, come forth.

44. And presently he that had been dead came forth, bound feet and hands with winding bands; and his face was bound about with a napkin. Jesus said to them: Loose him, and let him go.

45. Many therefore of the Jews, who were come to Mary and Martha, and had seen the things that Jesus did, believed in him.

46. But some of them went to the Pharisees, and told them the things that Jesus had done.

47. The chief priests therefore, and the Pharisees, gathered a council, and said: What do we, for this man doth many miracles?

48. If we let him alone so, all will believe in him; and the Romans will come, and take away our place and nation.

49. But one of them, named Caiphas, being the high priest that year, said to them: You know nothing.

50. Neither do you consider that it is expedient for you that one man should die for the people, and that the whole nation perish not.

51. And this he spoke not of himself: but being the high priest of that year, he prophesied that Jesus should die for the nation.

52. And not only for the nation, but to gather together in one the children of God, that were dispersed.

53. From that day therefore they devised to put him to death.

did not enter the sepulchre, as some adversaries have said, is evident from the words, "Lazarus, come forth" (verse 43).

42. The raising of Lazarus from the dead was a public and very manifest proof of the Divinity of Christ. It was performed precisely as a proof of all He had been claiming to be; namely, that He was the Son of God (verse 4), that He was one with the Father (x. 28-30), that He had been sent by the Father, as here stated.

49-52. **You know nothing**, etc. Caiphas meant to say that, in order to prevent the Romans from destroying their Temple, city, and nation, Jesus, who might be regarded as a rival king, should be put to death. But the Holy Ghost, speaking through these same words of Caiphas, as St. John tells us, meant that the death of Jesus was necessary for the eternal salvation of the human race. From this it is evident that a prophet may not be a good man himself, and that he may not always know the inspiration of his words. Cf. Num. xxii-xxiv.

**High-priest of that year.** The High-priest was supposed to be irremovable (Num. xxxv. 28), but the Romans had done away with this life dignity. The immediate predecessors of Caiphas, — Simon,

54. Wherefore Jesus walked no more openly among the Jews; but he went into a country near the desert, unto a city that is called Ephrem, and there he abode with his disciples.

55. And the pasch of the Jews was at hand; and many from the country went up to Jerusalem, before the pasch to purify themselves.

56. They sought therefore for Jesus; and they discoursed one with another, standing in the temple: What think you that he is not come to the festival day? And the chief priests and Pharisees had given a commandment, that if any man knew where he was, he should tell, that they might apprehend him.

Eleazar, and Ismael, had held their office for only one year; and thereafter it was naturally expected that the High-priest would be changed each year. St. John, however, merely states that Caiphas was the High-priest that particular year, without saying anything about the length of his tenure of office.

54. **Ephrem**, which was situated in the hills of Judea, about fifteen or twenty miles north-east of Jerusalem.

55. **The pasch of the Jews**, which was the last of our Lord's public life.

To purify themselves, from legal uncleannesses (Lev. vii. 21; Num. ix. 10; Acts xxi. 24-26).

## CHAPTER XII

THE SUPPER AT BETHANY, 1-11.

THE NEXT DAY JESUS ENTERS TRIUMPHANTLY INTO  
JERUSALEM, 12-19.

THE HOMAGE OF SOME GENTILES, 20-36.

THE FAITHLESSNESS OF THE JEWS, 37-50.

1. Jesus therefore, six days before the pasch, came to Bethania, where Lazarus had been dead, whom Jesus raised to life.

2. And they made him a supper there: and Martha served: but Lazarus was one of them that were at table with him.

1. **Six days before the pasch**; i.e., on Saturday the eighth of Nisan, perhaps towards evening. The Pasch or Passover was celebrated on the 14th of Nisan (Lev. xxiii. 5). **The pasch**. See on Matthew xxvi. 2.

**Bethania**. See on Matthew xxvi. 6.

2. It is clear from this verse that the supper was not given by the family of Lazarus, since Lazarus is mentioned only as a casual

3. Mary therefore took a pound of ointment of right spikenard, of great price, and anointed the feet of Jesus, and wiped his feet with her hair; and the house was filled with the odour of the ointment.

4. Then one of his disciples, Judas Iscariot, he that was about to betray him, said:

5. Why was not this ointment sold for three hundred pence, and given to the poor?

6. Now he said this, not because he cared for the poor; but because he was a thief, and having the purse, carried the things that were put therein.

7. Jesus therefore said: Let her alone, that she may keep it against the day of my burial.

8. For the poor you have always with you; but me you have not always.

9. A great multitude therefore of the Jews knew that he was there; and they came, not for Jesus' sake only, but that they might see Lazarus, whom he had raised from the dead.

10. But the chief priests thought to kill Lazarus also:

11. Because many of the Jews, by reason of him, went away, and believed in Jesus.

12. And on the next day, a great multitude that was come to the festival day, when they had heard that Jesus was coming to Jerusalem,

13. Took branches of palm trees, and went forth to meet him, and cried: Hosanna, blessed is he that cometh in the name of the Lord, the king of Israel.

14. And Jesus found a young ass, and sat upon it, as it is written:

guest. The host was Simon the leper (Matthew xxvi. 6; Mark xiv. 3) who gave this banquet in honor of our Lord and His disciples out of gratitude, no doubt, for the cure which he had received from the Master.

3. See on Matthew xxvi. 7. **Right spikenard**; i.e., *genuine* nard or ointment; according to others, it means *liquid* nard or ointment. St. John tells us that Mary anointed our Lord's feet, thus supplementing Matthew and Mark, who mention the anointing of His head only.

4, 5. See on Matthew xxvi. 8; Mark xiv. 5. Sts. Matthew and Mark speak as if at least two of the disciples murmured, but they probably used the plural in an indefinite manner. If other disciples than Judas did complain, their motives certainly could not have been the same as his.

7. See on Matthew xxvi. 12.

8. **The poor you have**, etc., as said in Deut. xv. 11.

**Me you have not always**; i.e., in My mortal body and visible form.

12. **The next day**, which we take to have been Palm Sunday, the day following the banquet at Bethany.

13, 14. See on Matthew xxi. 7-9; and on Luke xix. 29.

15. Fear not, daughter of Sion: behold, thy king cometh, sitting on an ass's colt.

16. These things his disciples did not know at the first; but when Jesus was glorified, then they remembered that these things were written of him, and that they had done these things to him.

17. The multitude therefore gave testimony, which was with him, when he called Lazarus out of the grave, and raised him from the dead.

18. For which reason also the people came to meet him, because they heard that he had done this miracle.

19. The Pharisees therefore said among themselves: Do you see that we prevail nothing? behold, the whole world is gone after him.

20. Now there were certain Gentiles among them, who came up to adore on the festival day.

21. These therefore came to Philip, who was of Bethsaida of Galilee, and desired him, saying: Sir, we would see Jesus.

22. Philip cometh, and telleth Andrew. Again Andrew and Philip told Jesus.

23. But Jesus answered them, saying: The hour is come, that the Son of man should be glorified.

24. Amen, amen I say to you, unless the grain of wheat falling into the ground die,

25. Itself remaineth alone. But if it die, it bringeth forth much fruit. He that loveth his life shall lose it; and he that hatheth his life in this world, keepeth it unto life eternal.

26. If any man minister to me, let him follow me; and where I am, there also shall my minister be. If any man minister to me, him will my Father honour.

15. This quotation is from Zach. ix. 9.

16. St. Matthew (xxi. 4) tells us that these things were done in order that the prophecy might be fulfilled. From the present verse we see that the disciples did not know this until Jesus was glorified, i.e., until the day of Pentecost (Acts ii. 4), when their minds were enlightened by the Holy Ghost.

20. **Certain Gentiles;** i.e., certain Hellenists or Greeks. These were Gentiles who went up to Jerusalem every year to adore Jehovah. They were Greek in origin and speech, and must be distinguished from the Greek-speaking Jews who lived in pagan lands.

23. **The hour is come, etc.;** i.e., the time of His death, glorious Resurrection and Ascension.

24. Just as it is necessary for the seed to die, or change its form, before it can germinate into the living grain, so says our Lord, is it necessary for Him to die in order to be glorified. Cf. 1 Cor. xv. 36.

25. See on Matthew x. 39; xvi. 25.

27. Now is my soul troubled. And what shall I say? Father, save me from this hour. But for this cause I came unto this hour.

28. Father, glorify thy name. A voice therefore came from heaven: I have both glorified it, and will glorify it again.

29. The multitude therefore that stood and heard, said that it thundered. Others said: An angel spoke to him.

30. Jesus answered, and said: This voice came not because of me, but for your sakes.

31. Now is the judgment of the world: now shall the prince of this world be cast out.

27. To show the reality of His human nature our Lord now manifests fear and dread at the thought of His approaching Passion; and yet He represses this feeling by saying, "But for this cause I came unto this hour," just as later during His Passion He checked a similar impulse in the words, "not my will, but thine be done" (Luke xxii. 42-44).

28. **Father, glorify thy name.** As is evident from the Father's response, the *direct* object of glorification in both instances seems to be the Father's name (MacRory). The Fathers, however, generally make our Lord the object of glorification; but they do not agree in their explanation. That is to say, the Latin Fathers take the sense to be: I have glorified Thee (Son) from all eternity, and will glorify Thee again as God-man after Thy Ascension. But the Greek Fathers say the meaning is: I have already glorified Thee (Christ) by numerous miracles, and will again glorify Thee through the miracles of Thy death, Resurrection, Ascension, etc. Through the Son, of course, the Father is always *indirectly* glorified.

30. **For your sakes;** i.e., to convince you that I am what I tell you.

31. **The judgment of the world.** To be judged is to be condemned or to be liberated. Whether there is question here of the liberation or condemnation of the world is disputed. St. Augustine, Maldonatus, and others hold that the liberation and salvation of the world from the yoke of Satan is spoken of here. But St. Chrysostom and most of the Greek Fathers say that St. John, in the present instance, is speaking of the judgment of condemnation. Hence in this opinion the world is to be condemned in its evil works, in its wicked representatives, and above all in its malicious "prince," the devil, who is to be vanquished and cast out. Doubtless these two opinions can be made to harmonize, for the condemnation and cast-

32. And I, if I be lifted up from the earth, will draw all things to myself.

33. (Now this he said, signifying what death he should die.)

34. The multitude answered him: We have heard out of the law, that Christ abideth for ever; and how sayest thou: The Son of man must be lifted up? Who is this Son of man?

35. Jesus therefore said to them: Yet a little while, the light is among you. Walk whilst you have the light, that the darkness overtake you not. And he that walketh in darkness, knoweth not whither he goeth.

36. Whilst you have the light, believe in the light, that you may be the children of light. These things Jesus spoke; and he went away, and hid himself from them.

37. And whereas he had done so many miracles before them, they believed not in him:

38. That the saying of Isaias the prophet might be fulfilled, which he said: Lord, who hath believed our hearing? and to whom hath the arm of the Lord been revealed?

39. Therefore they could not believe, because Isaias said again:

40. He hath blinded their eyes, and hardened their heart, that they should not see with their eyes, nor understand with their heart, and be converted, and I should heal them.

ing out of the wicked one means the liberation and salvation of the world.

32. St. John in the following verse gives us an interpretation of this present one. Our Lord predicts that after His death on the cross He will draw all things (*πάντα*), all peoples (*πάντας*), both Jews and Gentiles, to Himself.

34. **Out of the law;** i.e., from the Scriptures. The objectors doubtless had in mind such passages as Dan. vii. 13, 14; Isa. ix. 6, 7; Ps. lxxxviii. 26-37; etc., which seemed to say that "Christ remaineth forever." They forgot those other passages of the inspired books, such as Dan. ix. 26, and Isa. liii, which announced that the Messiah must suffer and die.

35. **Yet a little while, etc.** Our Lord replies to the questions of the Jews that He will be with them on earth in a visible manner only a little while longer, and that they should make use of His bodily presence to the best advantage while they have it. **Darkness** here means, according to some, *sin* and *unbelief*; according to others, the death of Christ, as opposed to His visible presence.

38. **Our hearing;** i.e., our message to them from God (Isa. liii. 1; Rom. x. 16).

39, 40. See on Matthew xiii. 13-15. Almighty God withdraws

41. These things said Isaias, when he saw his glory, and spoke of him.
42. However, many of the chief men also believed in him; but because of the Pharisees they did not confess him, that they might not be cast out of the synagogue.
43. For they loved the glory of men more than the glory of God.
44. But Jesus cried, and said: He that believeth in me, doth not believe in me, but in him that sent me.
45. And he that seeth me, seeth him that sent me.
46. I am come a light into the world; that whosoever believeth in me, may not remain in darkness.
47. And if any man hear my words, and keep them not, I do not judge him: for I came not to judge the world, but to save the world.
48. He that despiseth me, and receiveth not my words, hath one that judgeth him; the word that I have spoken, the same shall judge him in the last day.
49. For I have not spoken of myself; but the Father who sent me, he gave me commandment what I should say, and what I should speak.
50. And I know that his commandment is life everlasting. The things therefore that I speak, even as the Father said unto me, so do I speak.

His graces from the persistent, wilful sinner and thus permits him to become hardened and blinded. In the Septuagint of Isa. vi. 9, 10 it is the people that hardens its own heart; and in Hebrew, it is the prophet Isaias himself who is to blind and harden this people. The prophet means that God will accomplish this through him; and thus it is, as St. John here observes, that God has blinded and hardened Israel.

41. **His glory.** This vision is related by Isaias (vi. 1-5). Most likely the Son of God appeared Himself to the prophet on this occasion.

42. **The chief men;** i.e., members of the Sanhedrim. Cf. ix. 22.

44, 45. It is uncertain just when the words of our Lord in the rest of this chapter were spoken; they are a summing up of former discourses. In these verses Christ positively asserts His substantial identity with the Father.

46. **In darkness;** i.e., in sin and unbelief.

47. **I do not judge him;** i.e., I do not condemn him. At His first coming our Lord was to save, not to condemn. Cf. iii. 17; viii. 15, 50.

48. **Hath one that judgeth him;** namely, the Father; and on the last day he shall be condemned by My words also.

49, 50. Those who rejected the words of Christ thereby rejected

the words of the Father also, and by rejecting the words of the Father they cast away their chance for eternal life. This is what will stand against them in the day of judgment.

## CHAPTER XIII

THE WASHING OF THE FEET AND THE LAST SUPPER,  
1-17.

THE PREDICTION OF THE BETRAYAL BY JUDAS, 18-30.  
JESUS PREDICTS HIS OWN DEATH AND GLORIFICATION,  
GIVES THE NEW COMMANDMENT OF CHRISTIAN  
CHARITY, AND FORETELLS THE TRIPLE  
DENIAL OF PETER, 31-38.

1. Before the festival day of the pasch, Jesus knowing that his hour was come, that he should pass out of this world to the Father: having loved his own who were in the world, he loved them unto the end.

2. And when supper was done, (the devil having now put into the heart of Judas Iscariot, the son of Simon, to betray him,)

1. St. John here (verses 1-20) and St. Luke (xxii. 24-30) coincide in a remarkable manner,—so much so, indeed, that it is thought the two narratives ought to be united in one, in order to have their natural meaning and succession (Le Camus).

Before the festal day of the pasch. There are chiefly two ways of understanding these words: (a) they mean the evening of the 13th of Nisan, if we hold that Christ anticipated by a day the Paschal Feast the last year of His life; (b) they mean the evening of the 14th of Nisan, if we say that our Lord that year celebrated the Paschal Supper on the day appointed by the Law, and that St. John, who wrote his Gospel sixty years later, was speaking of the civil computation of time, from midnight to midnight. See discussion of this question on Matthew xxvi. 17.

He loved them unto the end; i.e., to the end, or extreme limits, of love. The words do not mean, to the end of His life only.

2. And when supper was done. The Greek is *δέπνου γινομένου*, at least in many of the best MSS., and the meaning is: "When the meal was just beginning"; or, "during the supper." If we choose



3. Knowing that the Father had given him all things into his hands, and that he came from God, and goeth to God;

4. He riseth from supper, and layeth aside his garments, and having taken a towel, girded himself.

5. After that, he putteth water into a basin, and began to wash the feet of the disciples, and to wipe them with the towel wherewith he was girded.

6. He cometh therefore to Simon Peter. And Peter saith to him: Lord, dost thou wash my feet?

7. Jesus answered, and said to him: What I do thou knowest not now; but thou shalt know hereafter.

8. Peter saith to him: Thou shalt never wash my feet. Jesus answered him: If I wash thee not, thou shalt have no part with me.

9. Simon Peter saith to him: Lord, not only my feet, but also my hands and my head.

the reading, *δελπνου γενομένου*, the meaning can easily be: "The supper being ready," or "the meal being served."

3. In spite of our Lord's great dignity as God, and of His glorification so soon to be realized, He now proceeds to give His disciples a remarkable example of humility and fraternal charity.

4. **He riseth from supper.** Since both for hygienic and legal reasons the washing of the feet was supposed to precede the meal, it would seem that we should understand the above words as expressing what was done before they had begun to eat. The feet were supposed to be clean before the guests reclined on their couches. The traditional view, however, is that the washing of the feet took place during the supper (St. Augustine), which may be explained as follows: It is the common opinion that the Paschal Supper on this memorable night was followed by the ordinary supper or evening meal, and this, in turn, by the Eucharistic Supper. Now the traditional view is that the washing of the feet took place immediately after the Paschal Supper, or during the ordinary evening meal, and consequently, before the Eucharistic Supper.

**Layeth aside his garments;** i.e., the cloak or pallium which was worn loosely around the body, outside the tunic. Servants did not wear this cloak, and our Lord, about to perform the work of a servant, laid aside the garment which made His dress unlike that worn by servants.

6-9. It is commonly held that our Lord came to Peter first. Peter could not understand such condescension on the part of His Master and was about to refuse to have his feet washed, when our

10. Jesus saith to him: He that is washed, needeth not but to wash his feet, but is clean wholly. And you are clean, but not all.

11. For he knew who he was that would betray him; therefore he said: You are not all clean.

12. Then after he had washed their feet, and taken his garments, being set down again, he said to them: Know you what I have done to you?

13. You call me Master, and Lord; and you say well, for so I am.

14. If then I being your Lord and Master, have washed your feet; you also ought to wash one another's feet.

15. For I have given you an example, that as I have done to you, so you do also.

16. Amen, amen I say to you: The servant is not greater than his lord; neither is the apostle greater than he that sent him.

17. If you know these things, you shall be blessed if you do them.

18. I speak not of you all: I know whom I have chosen. But that the scripture may be fulfilled: He that eateth bread with me, shall lift up his heel against me.

Lord warned him that if he refused obedience in this matter he should be excluded from his Master's society for time and eternity. It was *obedience* that Christ was exacting from Peter on this occasion. It is the common teaching that the washing of the feet here was not a sacrament, that it did not confer grace, and that Peter was already in the state of grace before his feet were washed. If, however, Peter had obstinately refused to obey, he would have fallen from his state of grace.

10. The washing of the feet on the present occasion very probably symbolized cleansing from venial sin. Hence the meaning of this verse most likely is that he who is free from mortal sin needs only the lesser cleansing from venial sin for a more fitting preparation for the reception of the Holy Eucharist. All the Apostles on this occasion were in the state of grace, except Judas. Therefore He said: "And you are clean, but not all."

12-17. Our Lord had given the disciples an example of humility and charity which they were to imitate. If the humble offices He had just performed were not unworthy of Him, the Master, they were surely not beneath the disciples of the Master.

18. **Whom I have chosen.** St. Augustine and others understand these words to refer to the election to glory, for which Judas was not predestined; but Maldonatus, à Lapide, and others more probably see in these words a reference to the call to the Apostleship. Our Lord knew that Judas would freely choose to be a traitor when

19. At present I tell you, before it come to pass: that when it shall come to pass, you may believe that I am he.

20. Amen, amen I say to you, he that receiveth whomsoever I send, receiveth me; and he that receiveth me, receiveth him that sent me.

21. When Jesus had said these things, he was troubled in spirit; and he testified, and said: Amen, amen I say to you, one of you shall betray me.

22. The disciples therefore looked one upon another, doubting of whom he spoke.

23. Now there was leaning on Jesus' bosom one of his disciples, whom Jesus loved.

24. Simon Peter therefore beckoned to him, and said to him: Who is it of whom he speaketh?

25. He therefore, leaning on the breast of Jesus, saith to him: Lord, who is it?

He called him to be an Apostle, and yet He called the unfortunate betrayer who was to fulfill the mystical meaning of Psalm xl. 10.

19. The prediction of His future betrayal by Judas was a proof of our Lord's Divinity, since it corroborated His claims to be God.

20. It is difficult to see the connection between this verse and what precedes and follows in the context. Some, like Corluy, hold that the words of our Lord with which this verse is connected have been omitted by the Evangelist. Others say that, as the Saviour had just previously (verses 15-17) exhorted the Apostles to take part in His humiliations, so now, after digressing (verses 18, 19) to speak of the betrayal of Judas, He announces that they shall share in His glory and honor. If this present verse of St. John be inserted in the text of St. Luke xxii. 29, as some think it ought to be, it will find its proper place.

21, 22. **He was troubled.** See on xi. 33. Our Lord freely permitted His human soul to be troubled over the approaching treachery of Judas. From the accounts of the different Evangelists it seems quite certain that our Lord several times during the Last Supper disclosed the traitor more or less distinctly. As the meal proceeded the disciples came clearly to understand that one of their number was going to betray the Saviour, but who it was they did not know; although from verse 26 below, it would seem that the traitor must have been finally disclosed to St. John, at least. See on Matthew xxvi. 21; Luke xxii. 19-23.

23-25. In accordance with the Jewish custom then existing our Lord and the disciples reclined at the Last Supper. They rested on

26. Jesus answered: He it is to whom I shall reach bread dipped. And when he had dipped the bread, he gave it to Judas Iscariot, the son of Simon.

27. And after the morsel, Satan entered into him. And Jesus said to him: That which thou dost, do quickly.

28. Now no man at the table knew to what purpose he said this unto him.

29. For some thought, because Judas had the purse, that Jesus had said to him: Buy those things which we have need of for the festival day: or that he should give something to the poor.

30. He therefore having received the morsel, went out immediately. And it was night.

31. When he therefore was gone out, Jesus said: Now is the Son of man glorified, and God is glorified in him.

their left side, their feet being stretched obliquely behind them. Our Lord was immediately behind the beloved disciple and hence the latter was able to rest his head on the Saviour's bosom (verse 25). The "disciple whom Jesus loved" has always been identified with St. John the Evangelist.

26. From this verse it seems beyond doubt that the traitor was finally made known, at least, to St. John. The "bread dipped" here given to Judas was not consecrated species.

27. Satan entered into him; i.e., the devil got a more complete control over Judas; there is no question here of diabolical possession.

29. Buy those things, etc. From this verse some authors argue that our Lord could not have been celebrating the Paschal Supper on the regular day, the 14th of Nisan, since on the night of the 14th of Nisan it was not lawful to buy or sell, and hence the Apostles would not have conjectured that Judas was going out to buy things for the feast. But it is replied that buying and selling of food articles was not forbidden during the Pasch (Exod. xii. 16). See on Matthew xxvi. 17 ff.

30. It is the opinion of most of the Fathers that Judas did receive Holy Communion and that he was ordained a priest at the Last Supper. Dr. MacRory thinks this the more probable opinion, although there are many grave authorities against it. See on Matthew xxvi. 21; Luke xxii. 19-23.

31. Now is the Son of man glorified. The departure of Judas marked the beginning of the end of our Lord's life; hence soon after this He was to be glorified by His Passion, death, Resurrection, etc. The discourse of our Lord which is contained in the rest of this and in the following chapter was uttered in the Supper

32. If God be glorified in him, God also will glorify him in himself; and immediately will he glorify him.

33. Little children, yet a little while I am with you. You shall seek me; and as I said to the Jews: Whither I go you cannot come; so I say to you now.

34. A new commandment I give unto you: That you love one another, as I have loved you, that you also love one another.

35. By this shall all men know that you are my disciples, if you have love one for another.

36. Simon Peter saith to him: Lord, whither goest thou? Jesus answered: Whither I go, thou canst not follow me now; but thou shalt follow hereafter.

37. Peter saith to him: Why cannot I follow thee now? I will lay down my life for thee.

38. Jesus answered him: Wilt thou lay down thy life for me? Amen, amen I say to thee, the cock shall not crow, till thou deny me thrice.

Room. The Synoptic Gospels contain none of these sublime discourses which we find in St. John. The reason is plain: the Synoptics were the result and outcome of the oral preaching of the Gospel, which was accommodated to the capacity and needs of the first converts to Christianity, and which was, consequently, divested, as far as possible, of doctrines too transcendent to be appreciated by the common folk; St. John's Gospel, on the contrary, is largely the embodiment of those lofty discourses of our Saviour, which the beloved disciple's pure and fervent soul was best able to grasp, and which constant meditation had enabled him to treasure up unaltered in memory's folds.

32. **Immediately**; i.e., during His Passion.

33. **Yet a little while** refers to the short time yet remaining before His Passion.

**You shall seek me**, etc. Our Lord in His visible form was about to disappear from earth and go up on high to His Father. Thither the Apostles could not follow Him at once, although they would still be united with Him spiritually. See on vii. 34.

34. **A new commandment**; i.e., a commandment of the New Law, which enjoined a much more perfect love of our neighbor than was ever before commanded by the Law (Lev. xix. 18).

35. Tertullian (*Apol.* 39) tells us that the pagans used to say of the early Christians, "See how these Christians love one another."

36. To Peter's question our Lord answers that He is going to the Father, whither Peter will later follow Him.

37, 38. Peter misunderstands the words of Christ and protests

his willingness to go anywhere, even to death, with his Master. But our Lord now warns Peter of his weakness. If this prediction of Peter's denial took place, as seems certain, in the Supper Room, we must conclude that the prediction was twice uttered that night, for the prediction recorded by the other Evangelists was spoken on the way to Gethsemani.

The cock shall not crow. See on Matthew xxvi. 34, and on Luke xxii. 34. St. Mark (xiv. 30) says: "Before the cock crow twice." But "the cock crowing" always meant the second crowing, which was towards morning, and it is this second crowing that Matthew, Luke, and John speak of.

## CHAPTER XIV

JESUS GOES TO PREPARE A PLACE FOR HIS APOSTLES  
IN HIS FATHER'S HOUSE, 1-11.

THE POWER OF THE APOSTLES, THE EFFICACY OF  
THEIR PRAYERS, THE PROMISE OF THE HOLY  
GHOST, 12-17.

JESUS WILL NOT LEAVE HIS DISCIPLES ORPHANS,  
18-25.

THE HOLY GHOST WILL COMPLETE THE WORK OF  
JESUS, 26.

JESUS LEAVES HIS PEACE TO HIS DISCIPLES, 27-31.

1. Let not your heart be troubled. You believe in God, believe also in me.
2. In my Father's house there are many mansions. If not, I would have told you: because I go to prepare a place for you.

1. You believe in God, etc. The Greek for *believe* in both instances here is *πιστεύετε*, which may be imperative or indicative. Since the Apostles readily believed in God, but had not so firm a faith in the Divinity of our Lord, it seems best to follow the Vulgate reading, and make the first *believe* (*πιστεύετε*) indicative, and the second imperative. Our Lord is trying to console and fortify the disciples against the humiliations of the Passion which were coming.

2. Many mansions; i.e., many *stations*, or *places of rest* and refreshment. Our Lord here wishes to say that in Heaven there will be room enough for the Apostles and all of God's faithful children.

3. And if I shall go, and prepare a place for you, I will come again, and will take you to myself; that where I am, you also may be.

4. And whither I go you know, and the way you know.

5. Thomas saith to him: Lord, we know not whither thou goest; and how can we know the way?

6. Jesus saith to him: I am the way, and the truth, and the life. No man cometh to the Father, but by me.

7. If you had known me, you would without doubt have known my Father also: and from henceforth you shall know him, and you have seen him.

8. Philip saith to him: Lord, shew us the Father, and it is enough for us.

9. Jesus saith to him: Have I been so long a time with you; and have you not known me? Philip, he that seeth me seeth the Father also. How sayest thou, Shew us the Father?

**That I go to prepare, etc.,**— rather, “because (*ὅτι*) I go,” etc. This verse, then, should be understood as follows: (a) if there were not many mansions, etc., would I have told you that I go to prepare, etc.?— or, (b) if there were not many mansions, etc., I would have told you so, *because* I go to prepare a place for you.

3. **I will come again;** at death for each one individually, and for all at the General Judgment.

6. **I am the way, and the truth, etc.** St. Augustine and St. Thomas say that our Lord *as man* is *the way*; and *as God*, He is *the truth* and *the life*. Others say that our Lord's being *the truth and the life* explains how He is the way to the Father; namely, He is the way first, because He is the truth, i.e., the author of faith; secondly, because He is the life, i.e., the author of grace and supernatural life in the soul.

7. In the first part of this verse Christ tells the Apostles that if they had known Him as they should have done, they would know that He goes to the Father and that He is the way to the Father, because He and the Father are one (x. 30). In the second part of the verse He tells them that they already know Him to some extent (if we take the Greek to be present in meaning), or that they shall know Him as they ought when the Holy Ghost comes at Pentecost (St. Chrysostom).

9. In this verse Christ clearly affirms His substantial union with the Father: to see Him is substantially to see the Father, although He and the Father are distinct persons (verse 6). Cf. Heb. i. 3. The Vulgate *cognovistis* of this verse should be *cognovisti* (*ἐγγώκας*), as addressed to Philip.

10. Do you not believe, that I am in the Father, and the Father in me? The words that I speak to you, I speak not of myself. But the Father who abideth in me, he doth the works.

11. Believe you not that I am in the Father, and the Father in me?

12. Otherwise believe for the very works' sake. Amen, amen I say to you, he that believeth in me, the works that I do, he also shall do; and greater than these shall he do.

13. Because I go to the Father: and whatsoever you shall ask the Father in my name, that will I do: that the Father may be glorified in the Son.

14. If you shall ask me any thing in my name, that I will do.

15. If you love me, keep my commandments.

16. And I will ask the Father, and he shall give you another Paraclete, that he may abide with you for ever.

17. The spirit of truth, whom the world cannot receive, because it seeth him not, nor knoweth him: but you shall know him; because he shall abide with you, and shall be in you.

10, 11. Here again our Lord proclaims His unity of essence with the Father. The *creditis* in the Vulgate of verse 10 ought to be *credis*, according to the Greek *πιστεύεις*.

12. In this verse Christ insists that His miracles are a proof of His Divinity and of the truth of His doctrine.

**Greater than these.** St. Augustine says that the evangelizing of the Gentiles and the conversion of the world by the Apostles and their successors are greater wonders than the miracles of Christ.

13. **Because I go to the Father** belongs to the preceding verse, as in the Vulgate.

**In my name;** i.e., in virtue of My merits as Saviour. This does not mean that things asked in an improper manner, or things opposed to one's salvation, will ever be granted.

16. In this verse the Holy Ghost is promised to the Apostles and their successors to abide with the Church forever.

**Another Paraclete;** i.e., another Comforter. The term *another* shows that the Holy Ghost, like the Son, is also a Divine Person, who is sent in the place of Christ. And the fact that He is sent by the Father proves His procession from the Father. See on xv. 26.

17. **The spirit of truth;** i.e., the author and source of truth. **The world,** means sinful, carnal men. "The sensual man perceives not what is of the Spirit of God" (1 Cor. ii. 14).

**You shall know . . . he shall abide,** are in the present tense in Greek. The meaning is that the Apostles already know the Holy Ghost to some extent, because He is with them by sanctifying grace.



18. I will not leave you orphans, I will come to you.

19. Yet a little while: and the world seeth me no more. But you see me: because I live, and you shall live.

20. In that day you shall know, that I am in my Father, and you in me, and I in you.

21. He that hath my commandments, and keepeth them; he it is that loveth me. And he that loveth me, shall be loved of my Father: and I will love him, and will manifest myself to him.

22. Judas saith to him, not the Iscariot: Lord, how is it, that thou wilt manifest thyself to us, and not to the world?

23. Jesus answered, and said to him: If any one love me, he will keep my word, and my Father will love him, and we will come to him, and will make our abode with him.

24. He that loveth me not, keepeth not my words. And the word which you have heard, is not mine; but the Father's who sent me.

25. These things have I spoken to you, abiding with you.

18. **I will come to you.** St. Augustine, Maldonatus, and others think there is question here of our Lord's coming at the day of Judgment. St. Chrysostom, St. Thomas, and others hold that the reference is to our Lord's appearances after His Resurrection. Still others believe there is here question of Christ's coming with the Holy Ghost on the day of Pentecost, after which He will spiritually abide with the Church forever. This last view seems most probable.

19. **A little while** refers to the short time yet remaining before His death.

**But you see me;** i.e., you shall see Me. There is question here of spiritual vision resulting from living in the state of grace, which the Apostles would enjoy even after our Lord's bodily presence had disappeared.

20. **In that day;** i.e., after the day of Pentecost the disciples would know and understand the substantial unity between the Father and the Son; and this unity, although perfect, would be resembled by the intimate, but of course less perfect union, between Christ and His chosen souls here on earth: Christ is the vine and the souls of the just are the branches (xv. 1-8).

21-24. Jesus here says that keeping His commandments is the test of anyone's love for Him, and that if anyone keep His commandments he will be loved by the Father, and to him Christ will manifest Himself. Christ is hidden from the world, because the world does not love Him.

**The word . . . is not mine,** etc. Our Lord invokes the authority

26. But the Paraclete, the Holy Ghost, whom the Father will send in my name, he will teach you all things, and bring all things to your mind, whatsoever I shall have said to you.

27. Peace I leave with you, my peace I give unto you: not as the world giveth, do I give unto you. Let not your heart be troubled, nor let it be afraid.

28. You have heard that I said to you: I go away, and I come unto you. If you loved me, you would indeed be glad, because I go to the Father: for the Father is greater than I.

29. And now I have told you before it come to pass: that when it shall come to pass, you may believe.

30. I will not now speak many things with you. For the prince of this world cometh, and in me he hath not any thing.

31. But that the world may know, that I love the Father: and as the Father hath given me commandment, so do I: Arise, let us go hence.

of His Father, not because it is greater than His own, but because it appeals more to the disciples whose faith in His own Divinity is yet imperfect.

26. **In my name**; i.e., in My place, or at My request. The infallible teaching authority of the Apostles and their successors in the Church is clearly assured in this verse.

27. **Peace I leave with you**, etc. This was a form of parting salutation customary among the Jews. Our Lord was about to leave the Supper Room.

28. **The Father is greater than I**. The Arians made much of this text to prove that the Son was inferior to the Father. The meaning is that the Father is greater than the Son *as man*. Some of the greatest of the Fathers have admitted that the Son, even *as God*, can, not altogether improperly, be said to be less than the Father, not because there is any real inferiority, but because the title of Son implies a sort of subordination (cf. Le Camus, *Life of Christ*, vol. iii. p. 240). Certainly our Lord here did not wish to contradict what He had said in x. 30.

30. **In me he hath not any thing**; i.e., he (Satan) has no power over Me, since sin has no part in Me.

31. To prove to the world His love for His Father and for the Father's commands our Lord now rises from the Supper table ready to meet His enemies and to undergo His voluntary sacrifice. It is disputed whether the discourses of chapters xv and xvi, and the prayer of chapter xvii, were uttered while still in the Supper Room, or in some quiet place after the departure.

## CHAPTER XV

## THE ALLEGORY OF THE VINE AND THE BRANCHES,

I-II.

## FRATERNAL CHARITY, 12-17.

## THE WORLD'S HATRED OF THE DISCIPLES, 18-27.

1. I am the true vine; and my Father is the husbandman.
2. Every branch in me, that beareth not fruit, he will take away: and every one that beareth fruit, he will purge it, that it may bring forth more fruit.
3. Now you are clean by reason of the word, which I have spoken to you.
4. Abide in me, and I in you. As the branch cannot bear fruit of itself, unless it abide in the vine, so neither can you, unless you abide in me.
5. I am the vine; you the branches: he that abideth in me, and I in him, the same beareth much fruit: for without me you can do nothing.

1. **I am the true vine.** The relation of Christ to His disciples and true followers is similar to that of the vine to its branches (verse 5). As the branches draw their life and nourishment from the vine or trunk of the tree, so must the Apostles and all just souls, by faith in and love for Christ, draw their spiritual life and nourishment from Him.

**And my Father is the husbandman.** This means that Almighty God does for the faithful soul what the husbandman does for the branches of the vine by pruning. The words do not imply, as the Arians would have them do, that Christ was not of the same nature as the Father. Our Lord's words are plainly figurative; but the figure would be spoiled were He to call Himself both vine and husbandman, albeit *as God* He is as much the husbandman as the Father.

2. There are unfruitful branches of Christ the vine, dead members of His Church; but these Almighty God will cut away, perhaps now in this world, and surely in the world to come. The good branches He prunes by trials and sufferings, in order that they may bear more abundant fruit.

3. **Now you are clean, etc.** The meaning is that the Apostles had already been pruned and purified in faith and love by the doctrine which they had received from Christ, and especially by the discourse which He had just given them.

5. **Without me you can do nothing;** i.e., nothing supernatural,

6. If any one abide not in me, he shall be cast forth as a branch, and shall wither, and they shall gather him up, and cast him into the fire, and he burneth.

7. If you abide in me, and my words abide in you, you shall ask whatever you will, and it shall be done unto you.

8. In this is my Father glorified; that you bring forth very much fruit, and become my disciples.

9. As the Father hath loved me, I also have loved you. Abide in my love.

10. If you keep my commandments, you shall abide in my love; as I also have kept my Father's commandments, and do abide in his love.

11. These things I have spoken to you, that my joy may be in you, and your joy may be filled.

12. This is my commandment, that you love one another, as I have loved you.

13. Greater love than this no man hath, that a man lay down his life for his friends.

14. You are my friends, if you do the things that I command you.

15. I will not now call you servants: for the servant knoweth not what his lord doth. But I have called you friends: because all things whatsoever I have heard of my Father, I have made known to you.

16. You have not chosen me: but I have chosen you; and have appointed you, that you should go, and should bring forth fruit; and your fruit should remain: that whatsoever you shall ask of the Father in my name, he may give it you.

or worthy of life eternal. The words prove that no supernatural work is possible without the aid of grace.

6. The tenses of this verse, except the first, are present or aorist in the Greek; and the aorist has a present meaning. The eternal punishment of those who die separated from Christ is clearly indicated in this verse.

13. Our Lord was about to lay down His life for His Apostles and for all mankind, — than which a greater proof of love could not be given.

15. Jesus had previously (xii. 26; xiii. 16) referred to His disciples as servants; but now, after all the tender communications He had just made to them, He will no longer regard them as servants, but as friends.

All things whatsoever I have heard, etc.; i.e., all things necessary for the salvation of mankind.

16. You have not chosen me, etc. Here our Lord tells the Apostles that their call was gratuitous and unmerited on their part, and that, therefore, they should show their gratitude by laboring to bring forth abundant fruits in His service.

17. These things I command you, that you love one another.

18. If the world hate you, know ye, that it hath hated me before you.

19. If you had been of the world, the world would love its own: but because you are not of the world, but I have chosen you out of the world, therefore the world hateth you.

20. Remember my word that I said to you: The servant is not greater than his master. If they have persecuted me, they will also persecute you: if they have kept my word, they will keep yours also.

21. But all these things they will do to you for my name's sake: because they know not him that sent me.

22. If I had not come, and spoken to them, they would not have sin; but now they have no excuse for their sin.

23. He that hateth me, hateth my Father also.

24. If I had not done among them the works that no other man hath done, they would not have sin; but now they have both seen and hated both me and my Father.

25. But that the word may be fulfilled which is written in their law: They hated me without cause.

26. But when the Paraclete cometh, whom I will send you from the Father, the Spirit of truth, who proceedeth from the Father, he shall give testimony of me.

That whatsoever you shall ask, etc. Maldonatus and others hold that the meaning of *that* (*ὅτι*) here expresses consequence, and not purpose; hence the sense is: If your labors for Me are fruitful and attain the purpose for which I have chosen you, the result will be that whatsoever you ask of the Father in My name, He will give it you.

17. These things may mean that the observance of fraternal charity is the fulfilment of the whole law; or they may refer to the gratuitousness of the Apostles' call and His love for them, as a consequence of which they should love one another.

20. My word means the doctrine of Christ; and yours is this same doctrine as preached by the Apostles.

22-24. They would not have sin; i.e., not the sin of incredulity, although they might have other sins. Christ had given the Jews so many proofs of His Divinity and divine mission that their failure to believe in Him was inexcusable, and by rejecting Him they rejected His Father who sent Him.

25. The hatred of the world for Christ should have been an additional proof to the Jews that He was the Messiah, because the Scriptures (Ps. xxxiv. 19) foretold that the world would hate the Christ.

26. This verse is cited by the Greeks to show that the Holy Ghost

27. And you shall give testimony, because you are with me from the beginning.

proceeds from the Father only; but it is clear from this very verse that He proceeds also from the Son. For in xiv. 16 it was said that the Father would send the Holy Spirit, and here our Lord says that *He* will send the Paraclete, thereby showing that the sending of the Holy Ghost, and consequently His procession, is as much from the Son as from the Father. St. Thomas holds that the words, "who proceedeth from the Father," refer to the eternal procession of the Holy Ghost, while the previous words, "whom I will send," regard the temporal mission of the Paraclete; but this only emphasizes the doctrine of the procession from the Son, because the temporal mission of the Holy Spirit presupposes His eternal procession from the same Divine Person from whom He derives His temporal mission (*Summa Theol.*, 1<sup>a</sup>, qu. xliii, a. 1 and 8).

27. This verse means that the Apostles, when filled with the Holy Ghost, would also be witnesses of the Divinity of Christ.

## CHAPTER XVI

JESUS WARNS THE APOSTLES OF THE PERSECUTIONS  
THAT AWAIT THEM, 1-6.

HE COMFORTS THEM REGARDING HIS DEPARTURE,  
POINTS TO THE COMING OF THE HOLY GHOST, ETC.  
7-15.

HE PROMISES THEM THAT AFTER A BRIEF ABSENCE  
HE WILL RETURN, AND THEIR SORROW WILL BE  
TURNED TO JOY, 16-24.

HE HAS BEEN SPEAKING OBSCURELY TO THEM, BUT  
PRESENTLY HE WILL SPEAK TO THEM PLAINLY,  
25-33.

1. These things have I spoken to you, that you may not be scandalized.

1. These things most probably refer both to the coming of the Holy Ghost and the persecutions awaiting the Apostles.

May not be scandalized; i.e., may not be shaken or weakened in faith, on account of the coming persecutions.

2. They will put you out of the synagogues: yea, the hour cometh, that whosoever killeth you, will think that he doth a service to God.

3. And these things will they do to you; because they have not known the Father, nor me.

4. But these things I have told you, that when the hour shall come, you may remember that I told you of them.

5. But I told you not these things from the beginning, because I was with you. And now I go to him that sent me, and none of you asketh me: Whither goest thou?

6. But because I have spoken these things to you, sorrow hath filled your heart.

2. **Out of the synagogues;** i.e., excommunicate them. Cf. Acts xxiii. 12. **Synagogues.** See on Matthew iv. 23.

**A service to God.** In their ignorance the persecutors of the Apostles would think they were honoring God; but their ignorance was inexcusable, as Christ had given ample proof of His own Divinity and of His doctrine, for preaching which the Apostles were to be persecuted.

4. The knowledge which Christ had of the future persecutions of His disciples was a proof of His Divinity, since it is here implied that this foreknowledge is a confirmation of His claims.

It is clear from the Greek that there should be no comma in this verse after *eorum* of the Vulgate.

5. **I told you not these things,** etc. It is objected here that our Lord (Matthew x. 17, 18) had already foretold the persecutions of the Apostles. *Answer:* It is probable that St. Matthew x. 17, 18 is narrated out of order, and that, consequently, the Apostles' persecutions had never before now been predicted. At any rate they had never before been predicted with such precision and detail.

**And none of you asketh me,** etc. Our Lord slightly paused before speaking these words to see if, in view of His just having said that He was about to go to the Father, anyone would ask Him where He was going. On previous occasions when He had spoken thus Peter and Thomas (xiii. 36; xiv. 5), had asked Him where He was going; but now no one put any question to Him.

6. **These things.** See on verse 1. The Apostles were filled with sorrow over the departure of our Lord, even though the Holy Ghost was to come in His place, as well as over the prediction of the persecutions which awaited them.

7. But I tell you the truth: it is expedient to you that I go: for if I go not, the Paraclete will not come to you; but if I go, I will send him to you.

8. And when he is come, he will convince the world of sin, and of justice, and of judgment.

9. Of sin: because they believed not in me.

10. And of justice: because I go to the Father; and you shall see me no longer.

11. And of judgment: because the prince of this world is already judged.

12. I have yet many things to say to you: but you cannot bear them now.

13. But when he, the Spirit of truth, is come, he will teach you all truth. For he shall not speak of himself; but what things soever he shall hear, he shall speak; and the things that are to come, he shall shew you.

7. It is expedient to you, etc.; i.e., it was altogether fitting, and even necessary, that our Lord's visible mission on earth should draw to a close, so that the invisible mission of the Holy Ghost, according to the dispensation of divine Providence, might begin. It was the Holy Ghost who was to inspire and fortify the Apostles and the Church, and thus carry on and perfect the work which Christ had inaugurated.

8-11. The Holy Ghost, at His coming, was to prove the world to be guilty of *sin*, i.e., of the sin of unbelief in Christ; He was to convince the world of *justice*, i.e., of the righteousness of Christ, whom the wicked had accused of sin and blasphemy (ix. 24; x. 33); and finally He was to convince the world of *judgment*, i.e., of its own condemnation which was effected by the overthrow of the devil and his kingdom through the merits of the death of Christ. All these things the Holy Ghost, through the Church of Christ, has made sufficiently manifest to all who do not deliberately close their hearts to the promptings of grace, and their eyes to patent facts.

12. Many things most likely refer to the nature of His earthly kingdom, the Church, to many doctrines and mysteries later to be unfolded by His Church, to the treatment of the Gentiles and the abrogation of the Jewish Law.

13. He will teach you all truth, — more literally, “He will *guide* (*ὁδηγήσει*) you into all truth.” All the doctrines and mysteries which they could not now bear, but which were to constitute the deposit of faith in the Church, the Holy Ghost, at His coming, would make known to the Apostles. This was not all to take place on the day of Pentecost, but gradually during the lifetime of the



14. He shall glorify me; because he shall receive of mine, and shall shew it to you.

15. All things whatsoever the Father hath, are mine. Therefore I said, that he shall receive of mine, and shew it to you.

Apostles the sum total of God's revelation to the world was to be made known to them, and was afterwards, according to need, to be unfolded and developed in the Church.

**He shall not speak of himself.** The meaning is that the Holy Ghost would not make known anything of Himself, as distinct from what He had received from all eternity in His eternal procession from the Father and the Son. Being infinite a Divine Person cannot receive anything, or know anything otherwise than through His procession. The case was different with our Lord, because He had not only a divine, but also a human nature.

**The things that are to come, etc.** These words show that the Apostles were to be endowed with the gift of prophecy. Cf. Acts xx. 29; Apoc. i. 19; Jude 17, 18; 2 Peter ii.

14. **He shall receive of mine** means that the Holy Ghost shares the knowledge of the Son, and consequently proceeds from the Son, as is clear from verse 13. See on xv. 26. The Father first has the truth in Himself; but the Son, who is the thought of the Father, has it likewise and reflects it whole and entire; while the Spirit, who is the love of the Father and of the Son, shares also in this truth, which He has eternally from the Father and from the Son (Le Camus).

By inserting *πατρός* after *τοῦ ἐμοῦ* here, the schismatical Greeks endeavor to prove that the Holy Ghost proceeds only from the Father. Thus they would make the passage read, *τοῦ ἐμοῦ πατρός*, meaning that the Holy Ghost should receive from the Father. Against this the following are to be noted: (a) the context here shows that *τοῦ ἐμοῦ* refers not to the Father, but to the Son only (verse 15); (b) it is contrary to the rules of Greek syntax that the possessive pronoun *τοῦ ἐμοῦ* should refer to a word not expressed; (c) all the Greek and Latin Fathers understand *τοῦ ἐμοῦ* as referring to what is in the Son, and not to what is in the Father.

15. **Are mine.** The Greek plural of these words *ἐμὰ ἐστίν*, clearly proves that *mine* of this and the preceding verse refers to what is in the Son. The Son has all that the Father has, except the rela-

16. A little while, and now you shall not see me; and again a little while, and you shall see me: because I go to the Father.

17. Then some of his disciples said one to another: What is this that he saith to us: A little while, and you shall not see me; and again a little while, and you shall see me, and, because I go to the Father?

18. They said therefore: What is this that he saith, A little while? we know not what he speaketh.

19. And Jesus knew that they had a mind to ask him; and he said to them: Of this do you inquire among yourselves, because I said: A little while, and you shall not see me; and again a little while, and you shall see me?

20. Amen, amen I say to you, that you shall lament and weep, but the world shall rejoice; and you shall be made sorrowful, but your sorrow shall be turned into joy.

21. A woman, when she is in labour, hath sorrow, because her hour is come; but when she hath brought forth the child, she remembereth no more the anguish, for joy that a man is born into the world.

22. So also you now indeed have sorrow; but I will see you again, and your heart shall rejoice; and your joy no man shall take from you.

23. And in that day you shall not ask me any thing. Amen, amen I say to you: if you ask the Father any thing in my name, he will give it you.

24. Hitherto you have not asked any thing in my name. Ask, and you shall receive; that your joy may be full.

tion of paternity, of course; and hence both Father and Son have *spiratio activa*. Therefore the Holy Ghost proceeds from both the Father and the Son.

16. **A little while . . . and again a little while**, etc. More probably the first "little while" here refers to the time until the Ascension; and the second "little while," to the period between the Ascension and the coming of Christ at death, for each one in particular, and at the General Judgment for the race. After His Ascension our Lord would not again be visibly present on earth, at least to the world in general, until the General Judgment.

The best Greek texts omit here the words, "because I go to the Father."

20. **Your sorrow shall be turned**, etc. At death, as well as at the end of the world, the sorrows of the just are turned into eternal joy.

22. **I will see you again**, etc.; i.e., at death and at the General Judgment.

23. **In that day**; i.e., when they should be received into everlasting joy in Heaven.

A new verse should begin at the words "Amen, amen," of this

25. These things I have spoken to you in proverbs. The hour cometh, when I will no more speak to you in proverbs, but will shew you plainly of the Father.

26. In that day you shall ask in my name; and I say not to you, that I will ask the Father for you :

27. For the Father himself loveth you, because you have loved me, and have believed that I came out from God.

28. I came forth from the Father, and am come into the world: again I leave the world, and I go to the Father.

29. His disciples say to him: Behold, now thou speakest plainly, and speakest no proverb.

30. Now we know that thou knowest all things, and thou needest not that any man should ask thee. By this we believe that thou camest forth from God.

31. Jesus answered them: Do you now believe?

verse; our Lord begins to speak to the Apostles as still pilgrims in this world, and He tells them that anything they ask in His name will be granted to them; the usual conditions for good prayer are here presupposed, of course.

25. These things refer to what He had been telling the Apostles regarding the coming of the Holy Ghost, His death, the little while, etc. All these things our Lord had spoken in "proverbs," i.e., in an obscure manner, but now He was going to speak, more plainly to them.

The hour cometh, etc. This refers in particular to the time after the descent of the Holy Ghost at Pentecost, when all things would be made clear to the Apostles.

26, 27. I say not to you, etc. Our Lord wishes to say that, so great is the Father's solicitude for them, it will not be necessary for Him to intercede in their behalf. We know, of course, that Christ is always making intercession for us (Heb. vii. 25; ix. 24). Our Lord merely wanted to show how great was His Father's care for His faithful followers.

28. This verse sums up the whole Christian dispensation. Christ "came forth from the Father," and therefore He is God; He came into the world, was made man, in order to suffer, and to redeem mankind; He "leaves the world," taking with Him the human nature He had here put on for our sakes; and He "goes to the Father," bringing with Him His conquest of human souls, which later He will glorify with His Father in Heaven.

30. Now we know that thou knowest, etc. The disciples now

32. Behold, the hour cometh, and it is now come, that you shall be scattered every man to his own, and shall leave me alone; and yet I am not alone, because the Father is with me.

33. These things I have spoken to you, that in me you may have peace. In the world you shall have distress: but have confidence, I have overcome the world.

see that He has read their thoughts (verse 19), and they are satisfied that He is the Son of God.

32. **I am not alone**, etc. Our Lord's support during His bitter Passion was the consciousness of His own Divinity and oneness with the Father. Similarly our support in the trials of life is our consciousness of union with Christ through sanctifying grace.

33. **I have overcome the world**; i.e., prospectively, by anticipation, through His coming Passion, death, and Resurrection. As Christ overcame the world through His Divinity and union with the Father, so we in turn can overcome the world through union with Him and the grace He gives us.

## CHAPTER XVII

OUR LORD AS MAN PRAYS TO THE FATHER FOR HIMSELF, 1-5.

HE PRAYS FOR THE APOSTLES, 6-19.

HE PRAYS FOR THE WHOLE CHURCH, 20-26.

1. These things Jesus spoke, and lifting up his eyes to heaven, he said: Father, the hour is come, glorify thy Son, that thy Son may glorify thee.

1. **These things** refer to the discourses Christ had just finished delivering to His Apostles. The Saviour is about to leave the Supper Room, or, at any rate, to enter upon the way of His Passion, and He turns from instructing His Apostles to pray to His Eternal Father.

**The hour is come, glorify thy Son**, etc. The time of Christ's Passion was upon Him, and He asks the Eternal Father to sustain His humanity throughout the time of trial, so that He may emerge from it all glorious and triumphant, and thus give glory to the Father through the souls that will be saved as a result of His triumph (verse 2).

2. As thou hast given him power over all flesh, that he may give eternal life to all whom thou hast given him.

3. Now this is eternal life: That they may know thee, the only true God, and Jesus Christ, whom thou hast sent.

4. I have glorified thee on the earth; I have finished the work which thou gavest me to do.

5. And now glorify thou me, O Father, with thyself, with the glory which I had, before the world was, with thee.

2. **All whom thou hast given him**; i.e., all the Elect. Christ has power over all mankind, but He gives eternal life only to those who correspond with His graces. In the original and in the Vulgate the neuter is used for "all whom," but the meaning is clearly the same.

3. **Now this is eternal life**, etc.; i.e., this is the cause, the means, the pledge of eternal life. All theologians agree that no one can be saved without a knowledge of God, as a rewarder of the good and a punisher of the wicked. More probably also, according to St. Thomas, a knowledge of our Lord, as Redeemer, and of the Blessed Trinity is necessary for salvation, *necessitate medii*. St. Augustine, St. Ambrose, and many of the Fathers have held that the words of our Lord in this verse should be read thus: "Eternal life consists in acknowledging thee and Jesus Christ, whom thou hast sent, as the only true God." But even if we retain the usual wording of the Vulgate and our English version, it by no means follows, as the Arians would have us believe, that the Father is called the only true God to the exclusion of Jesus Christ. It is clear from the present verse that, for eternal life, the knowing of Jesus Christ is quite as essential as the knowing of the Father.

The Father, however, is rightly styled the only true God for the following reasons: (a) as distinguished from the false divinities of paganism; (b) as being the source and fountain of the Divinity, the origin and principle from which the other two Divine Persons proceed.

4. **I have finished**, etc. These words refer more probably to the work of preaching and teaching on earth which our Lord at this time had actually completed.

5. **Glorify thou me**, etc. Christ asks that His human nature, in so far as it is capable, may now be glorified with the glory which His Divinity has enjoyed from all eternity.

6. I have manifested thy name to the men whom thou hast given me out of the world. Thine they were, and to me thou gavest them; and they have kept thy word.

7. Now they have known, that all things which thou hast given me, are from thee:

8. Because the words which thou gavest me, I have given to them; and they have received them, and have known in very deed that I came out from thee, and they have believed that thou didst send me.

9. I pray for them: I pray not for the world, but for them whom thou hast given me: because they are thine:

10. And all my things are thine, and thine are mine; and I am glorified in them.

11. And now I am not in the world, and these are in the world, and I come to thee. Holy Father, keep them in thy name whom thou hast given me; that they may be one, as we also are.

12. While I was with them, I kept them in thy name. Those whom thou gavest me have I kept; and none of them is lost, but the son of perdition, that the scripture may be fulfilled.

13. And now I come to thee; and these things I speak in the world, that they may have my joy filled in themselves.

6. **To the men whom thou hast given me;** i.e., to the Apostles, who had been chosen from the beginning by the Eternal Father. To others who had not been thus elected our Lord had manifested the name and glory of His Father, but without avail.

9. **I pray not for the world.** Our Lord did not exclude the wicked of the world from *all* His prayers, but only from this particular one, which was for His Apostles.

10. Our Lord's words here plainly declare His substantial unity with the Father, besides giving another reason why His prayer for the Apostles should be heard.

11. **Whom thou hast given me.** These words are variously read in the Greek. Some MSS. have *οὓς δέδωκας*; others, *ὧ δέδωκας*; others, *ὁ δέδωκας*. This third is perhaps the best reading, and the meaning is: "Keep them in thy name, *that which* thou hast given me."

12. **Those whom thou gavest me,** — rather, "that which thou gavest me." The Greek readings are the same as in the preceding verse.

**The son of perdition** means Judas, whose loss, through his own fault, had already been decreed. **The Scripture** is Psalm cviii. 8. The Holy Ghost through the Scriptures had foretold the eternal loss of the traitor, because He foresaw that this would be the miserable Apostle's free choice.

13. **My joy** refers to our Lord's felicity in being under the

14. I have given them thy word, and the world hath hated them, because they are not of the world; as I also am not of the world.

15. I pray not that thou shouldst take them out of the world, but that thou shouldst keep them from evil.

16. They are not of the world, as I also am not of the world.

17. Sanctify them in truth. Thy word is truth.

18. As thou hast sent me into the world, I also have sent them into the world.

19. And for them do I sanctify myself, that they also may be sanctified in truth.

20. And not for them only do I pray, but for them also who through their word shall believe in me;

21. That they all may be one, as thou, Father, in me, and I in thee; that they also may be one in us; that the world may believe that thou hast sent me.

22. And the glory which thou hast given me, I have given to them; that they may be one, as we also are one:

23. I in them, and thou in me; that they may be made perfect in one: and the world may know that thou hast sent me, and hast loved them, as thou hast also loved me.

Father's protection, in fulfilling His will, and especially now in going to the Father.

14. **The world hath hated them.** The Apostles were hated by the wicked world, because they had received the words of Christ.

15. **From evil, ἐκ τοῦ πονηροῦ,** as in the Lord's Prayer. See on Matthew vi. 13.

17. **In truth,**—rather, "in the truth," which most probably means the word of God, the preaching of the Gospel (St. Chrysostom). The Apostles were *sanctified*, i.e., consecrated, set apart, for the preaching of the Gospel and the work of the ministry.

19. **I sanctify myself;** i.e., I set Myself apart, consecrate Myself as a victim. The reference is to our Lord's Passion which He was shortly to suffer.

**In truth,** here means *really, truly, in sincerity.* Cf. 2 John 1; 3 John 1.

21. **That the world may believe,** etc. These words show that our Lord, just before He suffered, prayed that His Church might enjoy the mark or note of unity to such a degree that it would resemble the unity of the Blessed Trinity and be to all the world a sign of the true Church. There was to be "one body and one Spirit, one Lord, one faith, one baptism" (Eph. iv. 4, 5).

22. **The glory,** most probably means the grace of divine filiation

24. Father, I will that where I am, they also whom thou hast given me may be with me; that they may see my glory which thou hast given me, because thou hast loved me before the creation of the world.

25. Just Father, the world hath not known thee; but I have known thee: and these have known that thou hast sent me.

26. And I have made known thy name to them, and will make it known; that the love wherewith thou hast loved me, may be in them, and I in them.

by which the Apostles were made the adopted sons of God; or, as others hold, the Divinity, which our Lord had from His Eternal Father, and which in the Blessed Eucharist He had that night communicated to the Apostles. Here in verses 20-23 our Lord is praying not only for the Apostles, but for all the faithful.

24. Here Christ prays that at length the Apostles may be made sharers with Him in eternal glory in Heaven.

25. **Just Father.** Christ now appeals to the justice of His Father to hear His prayer for His disciples.

26. **And will make it known;** i.e., through the Holy Ghost and the preaching of the Apostles.

## CHAPTER XVIII

JESUS IN THE GARDEN OF GETHSEMANI, I, 2.

THE BETRAYAL AND THE ARREST, 3-II.

JESUS BEFORE THE SANHEDRIM, 12-14.

THE FIRST DENIAL OF PETER, 15-18.

THE HIGH-PRIEST INTERROGATES JESUS, 19-24.

PETER'S SECOND AND THIRD DENIALS, 25-27.

JESUS BEFORE PILATE, 28-38.

BARABBAS IS RELEASED IN PREFERENCE TO JESUS,  
39-40.

1. When Jesus had said these things, he went forth with his disciples over the brook Cedron, where there was a garden, into which he entered with his disciples.

2. And Judas also, who betrayed him, knew the place; because Jesus had often resorted thither together with his disciples.

1. **He went forth;** i.e., from the Supper Room; or, as others say, from the place on the way to Gethsemani where the prayer of chapter xvii had been uttered.

**The brook Cedron,** a small stream flowing in winter, but dry



3. Judas therefore having received a band of soldiers and servants from the chief priests and the Pharisees, cometh thither with lanterns and torches and weapons.

4. Jesus therefore, knowing all things that should come upon him, went forth, and said to them: Whom seek ye?

5. They answered him: Jesus of Nazareth. Jesus saith to them: I am he. And Judas also, who betrayed him, stood with them.

6. As soon therefore as he had said to them: I am he; they went backward, and fell to the ground.

7. Again therefore he asked them: Whom seek ye? And they said, Jesus of Nazareth.

8. Jesus answered, I have told you that I am he. If therefore you seek me, let these go their way,

9. That the word might be fulfilled which he said: Of them whom thou hast given me, I have not lost any one.

10. Then Simon Peter, having a sword, drew it, and struck the servant of the high priest, and cut off his right ear. And the name of the servant was Malchus.

11. Jesus therefore said to Peter: Put up thy sword into the scabbard. The chalice which my Father hath given me, shall I not drink it?

12. Then the band and the tribune, and the servants of the Jews, took Jesus, and bound him:

13. And they led him away to Annas first, for he was father in law to Caiphas, who was the high priest of that year.

14. Now Caiphas was he who had given the counsel to the Jews: That it was expedient that one man should die for the people.

in summer, between Jerusalem and the Mount of Olives, on the east. See on Matthew xxvi. 36.

3. **A band of soldiers**; i.e., a Roman cohort (*τὴν σπέεραν*). At the Paschal festival the governor was accustomed to send a company of these warriors to guard at the gate of the Temple and to prevent any uprising. Cf. Acts xxi. 31.

4. **Jesus knowing**, etc. This foreknowledge is another proof of our Lord's Divinity, at least when taken in conjunction with His claims.

6. **Fell to the ground**. This was the effect of divine power which our Lord momentarily exercised against His enemies.

9. **That the word**, etc., which He had said, xvii. 12.

10. **Simon Peter**. Unlike the Synoptists, who wrote during Peter's lifetime, St. John, writing after Peter was dead, gives us his name in the present instance.

11. See on Matthew xxvi. 51-54.

12, 13. See on Matthew xxvi. 57-59. This was the first night trial of our Lord before Annas.

15. And Simon Peter followed Jesus, and so did another disciple. And that disciple was known to the high priest, and went in with Jesus into the court of the high priest.

16. But Peter stood at the door without. The other disciple therefore, who was known to the high priest, went out, and spoke to the portress, and brought in Peter.

17. The maid therefore that was portress, saith to Peter: Art not thou also one of this man's disciples? He saith: I am not.

18. Now the servants and ministers stood at a fire of coals, because it was cold, and warmed themselves. And with them was Peter also, standing, and warming himself.

19. The high priest therefore asked Jesus of his disciples, and of his doctrine.

20. Jesus answered him: I have spoken openly to the world: I have always taught in the synagogue, and in the temple, whither all the Jews resort; and in secret I have spoken nothing.

21. Why asketh thou me? ask them who have heard what I have spoken unto them: behold they know what things I have said.

22. And when he had said these things, one of the servants standing by, gave Jesus a blow, saying: Answerest thou the high priest so?

23. Jesus answered him: If I have spoken evil, give testimony of the evil; but if well, why striketh thou me?

24. And Annas sent him bound to Caiphias the high priest.

**High-Priest** of that year. See on xi. 49.

15-18. See on Matthew xxvi. 69, 70. It seems more probable that Annas and Caiphias occupied an official residence in common, or, at least, that Annas was the guest of Caiphias, his son-in-law, at the time of the Paschal feast. Thus Jesus, during His night trials, was led from the apartment of one to those of the other, across the common court attached to the house of Annas and Caiphias. In this court, too, it was that Peter denied His Master.

The **other disciple** was undoubtedly St. John the Evangelist.

21. **Ask them**, etc. This refers most likely, not only to the Scribes and Pharisees, who were present, but to all who had heard the teaching of Christ.

23. **Evil** may refer to the reply our Lord had just made to the High-Priest, or to His general teaching.

24. Our Lord was now led from Annas across the court to the apartments of Caiphias for His second night trial. See on Matthew xxvi. 57-59.

25. And Simon Peter was standing, and warming himself. They said therefore to him: Art not thou also one of his disciples? He denied it, and said: I am not.

26. One of the servants of the high priest (a kinsman to him whose ear Peter cut off) saith to him: Did not I see thee in the garden with him?

27. Again therefore Peter denied; and immediately the cock crew.

28. Then they led Jesus from Caiphas to the governor's hall. And it was morning; and they went not into the hall, that they might not be defiled, but that they might eat the pasch.

29. Pilate therefore went out to them, and said: What accusation bring you against this man?

30. They answered, and said to him: If he were not a malefactor, we would not have delivered him up to thee.

31. Pilate therefore said to them: Take him you, and judge him according to your law. The Jews therefore said to him: It is not lawful for us to put any man to death;

25-27. See on Matthew xxvi. 69, 70. If St. John represents Peter as standing during the denials, while St. Matthew speaks of him as seated, it is because they are referring to different moments.

St. John passes over the many indignities and outrages recorded by Matthew (xxvi. 66 ff.) and Mark (xiv. 64) which our Lord suffered between His night trials before the High-Priests and day-break. This is because the Synoptists had already recorded these events.

28. **The governor's hall**; i.e., the hall within the official residence at Jerusalem of Pontius Pilate who, as Roman Procurator, governed Judea at this time. Ordinarily the Roman Procurators resided at Caesarea on the sea-coast, but at great festivals they went up to Jerusalem with their soldiers to prevent any uprising or disturbance among the people (Josephus, *Bell. Jud.*, ii. 14, 3). At this time Pilate was staying in the castle of Antonia, north of the Temple. This was our Lord's first appearance before Pilate.

**That they might not be defiled**, etc. See Exod. xii. 15. Some understand this to mean that the Jews had not yet eaten the Paschal Supper. Others say that the legal defilement here referred to was guarded against in view of some other Paschal sacrifices which were partaken of during the seven days of the Paschal feast (Deut. xvi. 2, 3; 2 Paralip. xxx. 22). See on Matthew xxvi. 17 ff.

29-31. The Roman authorities had taken away from the Jews all power to inflict capital punishments for civil offences, and perhaps for religious ones also; but Pilate seems here to give them

32. That the word of Jesus might be fulfilled, which he said, signifying what death he should die.

33. Pilate therefore went into the hall again, and called Jesus, and said to him: Art thou the king of the Jews?

34. Jesus answered: Sayest thou this thing of thyself, or have others told it thee of me?

35. Pilate answered: Am I a Jew? Thy own nation, and the chief priests, have delivered thee up to me: what hast thou done?

36. Jesus answered: My kingdom is not of this world. If my kingdom were of this world, my servants would certainly strive that I should not be delivered to the Jews: but now my kingdom is not from hence.

37. Pilate therefore said to him: Art thou a king then? Jesus answered: Thou sayest that I am a king. For this was I born, and for this came I into the world; that I should give testimony to the truth. Every one that is of the truth, heareth my voice.

38. Pilate saith to him: What is truth? And when he said this, he went out again to the Jews, and saith to them: I find no cause in him.

39. But you have a custom that I should release one unto you at the pasch: will you, therefore, that I release unto you the king of the Jews?

40. Then cried they all again, saying: Not this man, but Barabbas. Now Barabbas was a robber.

power to condemn and execute Jesus, as they see fit, according to their own laws. The Jews, however, want Pilate to assume the responsibility for Jesus' death.

32. Jesus had foretold (Matthew xx. 19; John iii. 14; xii. 32-34) that He was to die by the death of the cross, and this was the "word" which was to be fulfilled. Had the Jews put Him to death it would have been by stoning, as a blasphemer (Lev. xxiv. 14).

33. In order the more to induce Pilate to condemn our Lord the Jews now accuse Him of civil crimes, such as, "perverting the nation, forbidding to give tribute to Caesar, and pretending to be king of the Jews" (Luke xxiii. 2). A claim to kingship naturally stirred Pilate, to some extent, because this was a threat against Rome.

34-37. Our Lord replies to Pilate that He is, indeed, a king; but not a temporal one, such as Caesar would fear. He is a spiritual king, who came into the world to found a spiritual kingdom, His Church, for the salvation of all mankind.

38. What is truth? This question Pilate asked, not for information, but out of contempt for what Christ had just said.

39, 40. The proposal to release Jesus or Barabbas was made after our Lord had been taken to Herod (Luke xxiii. 8-12). See on Matthew xxvii. 15, 16.

## CHAPTER XIX

JESUS IS CONDEMNED TO DEATH, 1-16.

THE WAY TO CALVARY, 17-24.

THE BLESSED VIRGIN AND ST. JOHN AT THE FOOT  
OF THE CROSS, 25-27.

JESUS DIES ON THE CROSS, 28-30.

JESUS IN THE SEPULCHRE, 31-42.

1. Then therefore, Pilate took Jesus, and scourged him.
2. And the soldiers plating a crown of thorns, put it upon his head; and they put on him a purple garment.
3. And they came to him, and said: Hail, king of the Jews; and they gave him blows.
4. Pilate therefore went forth again, and saith to them: Behold, I bring him forth unto you, that you may know that I find no cause in him.
5. (Jesus therefore came forth, bearing the crown of thorns and the purple garment.) And he saith to them: Behold the Man.
6. When the chief priests, therefore, and the servants, had seen him, they cried out, saying: Crucify him, crucify him. Pilate saith to them: Take him you, and crucify him: for I find no cause in him.

1. See on Matthew xxvii. 24. This scourging of Christ was according to the Roman method, which did not limit the number of stripes. Scourging according to Jewish Law was not to exceed forty stripes (Deut. xxv. 2, 3). The Roman *flagellum*, with which our Lord was scourged, was made of strong cords or strips of leather; it was knotted with pieces of bone or wood to tear the flesh.

2, 3. See on Matthew xxvii. 26-29. St. Matthew and St. Mark (xv. 15-18) seem to represent the crowning with thorns and the mocking of our Lord with the cloak as following the sentence of death, which, according to St. John, preceded those incidents. It is more probable that the first two Gospels have not preserved the strict order of events in this particular.

4-6. Pilate could find no guilt in Jesus, and he thought the sight of the Saviour's torn and bleeding body would satisfy the Jews;

7. The Jews answered him: We have a law; and according to the law he ought to die, because he made himself the Son of God.

8. When Pilate therefore had heard this saying, he feared the more.

9. And he entered into the hall again, and he said to Jesus: Whence art thou? But Jesus gave him no answer.

10. Pilate therefore saith to him: Speakest thou not to me? knowest thou not that I have power to crucify thee, and I have power to release thee?

11. Jesus answered: Thou shouldst not have any power against me, unless it were given thee from above. Therefore, he that hath delivered me to thee, hath the greater sin.

12. And from henceforth Pilate sought to release him. But the Jews cried out, saying: If thou release this man, thou art not Cæsar's friend. For whosoever maketh himself a king, speaketh against Cæsar.

13. Now when Pilate had heard these words, he brought Jesus forth, and sat down in the judgment seat, in the place that is called Lithostrotos, and in Hebrew Gabbatha.

14. And it was the parasceve of the pasch, about the sixth hour, and he saith to the Jews: Behold your king.

but seeing that they wanted Him crucified, he weakly yielded to their demands.

7. **We have a law**, referring to Levit. xxiv. 16, against blasphemers.

8-11. Hearing that Christ claimed to be the Son of God Pilate became still more anxious to release Him, and therefore he further questioned Jesus. The Saviour, however, considered no reply necessary. But when Pilate began to boast of his power, our Lord reminded him that all his power was from God.

Therefore he that hath delivered me to thee, etc. The most probable meaning here is: Because you have lawful authority derived from God and are, therefore, able to put Me to death, the Sanhedrim, which has delivered Me over to you, has a "greater sin" than it would have had you not such authority (Toletus).

12. In a final attempt to get Pilate to condemn Jesus the Jews intimated that, if he did not do so, they would denounce him to Caesar.

Lithostrotos; i.e., a *pavement*, — from *λίθος*, *stone*, and *στρωτός*, *paved*. Gabbatha means a "high place." The judgment seat was usually on an elevated platform in front of the Praetorium.

14. **The parasceve of the pasch**. "Parasceve" is a Greek word and means *preparation*, or *day of preparation*. Hence the above

15. But they cried out: Away with him; away with him; crucify him. Pilate saith to them: Shall I crucify your king? The chief priests answered: We have no king but Cæsar.

16. Then therefore he delivered him to them to be crucified. And they took Jesus, and led him forth.

17. And bearing his own cross, he went forth to that place which is called Calvary, but in Hebrew Golgotha.

18. Where they crucified him, and with him two others, one on each side, and Jesus in the midst.

19. And Pilate wrote a title also, and he put it upon the cross. And the writing was: JESUS OF NAZARETH, THE KING OF THE JEWS.

20. This title therefore many of the Jews did read: because the place where Jesus was crucified was nigh to the city: and it was written in Hebrew, in Greek, and in Latin.

21. Then the chief priests of the Jews said to Pilate: Write not, The King of the Jews; but that he said, I am the King of the Jews.

22. Pilate answered: What I have written, I have written.

23. The soldiers therefore, when they had crucified him, took his garments, (and they made four parts, to every soldier a part,) and also his coat. Now the coat was without seam, woven from the top throughout.

24. They said then one to another: Let us not cut it, but let us cast lots for it, whose it shall be; that the scripture might be fulfilled, saying: They have parted my garments among them, and upon my vesture they have cast lot. And the soldiers indeed did these things.

25. Now there stood by the cross of Jesus, his mother, and his mother's sister, Mary of Cleophas, and Mary Magdalen.

phrase may mean: (a) the preparation for the Paschal feast, or the day before the feast began; (b) the preparation for, or day before, the Sabbath. See on Matthew xxvi. 17 ff.

**About the sixth hour.** See on Mark xv. 25; Matthew xxvii. 45.

15. However much the Jews hated Caesar and the Romans they preferred them to Christ.

17. See on Matthew xxvii. 32, 33.

18. See on Matthew xxvii. 35.

19. See on Matthew xxvii. 37, 38.

20. **Was nigh to the city.** Calvary was about one mile from the center of the city of Jerusalem, and the city was filled with strangers who had come there for the Passover.

23, 24. See on Matthew xxvii. 35. The coat or tunic was worn under the garments. Tradition says that this seamless garment was woven for our Lord by the Blessed Virgin herself.

25. See on Matthew xxvii. 55, 56. This passage of St. John

26. When Jesus therefore had seen his mother and the disciple standing whom he loved, he saith to his mother: Woman, behold thy son.

27. After that, he saith to the disciple: Behold thy mother. And from that hour, the disciple took her to his own.

28. Afterwards, Jesus knowing that all things were now accomplished, that the scripture might be fulfilled, said: I thirst.

29. Now there was a vessel set there full of vinegar. And they, putting a sponge full of vinegar about hyssop, put it to his mouth.

30. Jesus therefore, when he had taken the vinegar, said: It is consummated. And bowing his head, he gave up the ghost.

31. Then the Jews, (because it was the parasceve,) that the bodies might not remain upon the cross on the sabbath day, (for that was a great sabbath day,) besought Pilate that their legs might be broken, and that they might be taken away.

32. The soldiers therefore came; and they broke the legs of the first, and of the other that was crucified with him.

33. But after they were come to Jesus, when they saw that he was already dead, they did not break his legs.

does not contradict St. Matthew. The holy women were doubtless obliged to remain at a distance for the most part, but they returned again and again to the foot of the cross. The two Evangelists, therefore, are speaking of different times. Cf. Mark xv. 40; Luke xxiii. 49.

26, 27. In these verses St. John is commended to Mary as a son, and she to him as a mother. St. Joseph being dead, the beloved Apostle was to have care of the Mother of Jesus and take her to his own dwelling. This is one of the strongest proofs that Mary had no other children.

It is to be noted that at this solemn moment our Lord addressed His Mother by the title, "Woman," *γύναι*, just as He had done before at the marriage feast of Cana (John ii. 4). As this title could not have been disrespectful on the present occasion, so it was not on the previous one.

28, 29. **Accomplished**; i.e., the prophecies concerning the Messiah were fulfilled and now He said, "I thirst," in accordance with the prophecy of Psalm lxviii. 22. See on Matthew xxvii. 48.

30. **It is consummated**; i.e., all the prophecies relative to the Messiah were fulfilled, and commending His soul to His Eternal Father (Luke xxiii. 46), He bowed His head and died.

31. **Because it was the parasceve**; i.e., Friday, the day before



34. But one of the soldiers with a spear opened his side, and immediately there came out blood and water.

35. And he that saw it, hath given testimony; and his testimony is true. And he knoweth that he saith true; that you also may believe.

36. For these things were done, that the scripture might be fulfilled: You shall not break a bone of him.

37. And again another scripture saith: They shall look on him whom they pierced.

38. And after these things, Joseph of Arimathea (because he was a disciple of Jesus, but secretly for fear of the Jews) besought Pilate that he might take away the body of Jesus. And Pilate gave leave. He came therefore, and took away the body of Jesus.

39. And Nicodemus also came, (he who at the first came to Jesus by night,) bringing a mixture of myrrh and aloes, about an hundred pound weight.

the Sabbath. That was called a "great sabbath day" because it fell within the octave of the Pasch.

34. **Opened**, — rather, *pierced*, which is according to the more probable Greek reading, *ἔνυξεν*.

**Blood and water.** The Fathers generally understand the blood and water from our Lord's side to have been miraculous. In the blood they see a type of the Blessed Eucharist, and in the flow of water a type of Baptism.

35. **He that saw it**, etc. "It" is not in the Greek, and the reference here is to all that is contained in the two preceding verses, and not merely to the flow of blood and water.

**That you may believe**; i.e., that Jesus was the true Messiah who fulfilled the prophecies foretold of Him.

36. **You shall not break a bone of him** refers literally to the Paschal lamb (Exod. xii. 46; Num. ix. 12), but typically to Christ, as St. John here tells us.

37. **They shall look upon him**, etc. This Messianic passage is from Zach. (xii. 10), and was verified in the case of our Lord, as we know from St. Luke (xxiii. 48).

38. **Joseph of Arimathea.** See on Matthew xxvii. 57; Mark xv. 42.

**Pilate gave leave**; i.e., after he had learned from the centurion that Jesus was really dead (Mark xv. 44, 45).

39. **He who at first came**, etc. The reference is to iii. 1 ff.

**Myrrh and aloes**, a compound made from the gum of the myrrh tree and a powder of the fragrant aloe wood.

40. They took therefore the body of Jesus, and bound it in linen cloths, with the spices, as the manner of the Jews is to bury.

41. Now there was in the place where he was crucified, a garden; and in the garden a new sepulchre, wherein no man yet had been laid.

42. There, therefore, because of the parasceve of the Jews, they laid Jesus, because the sepulchre was nigh at hand.

40. See on Mark xvi. 1.

41. **A new sepulchre.** See on Matthew xxvii. 60.

## CHAPTER XX

MARY MAGDALEN COMES TO THE TOMB, AND FINDING IT EMPTY, RUNS AND TELLS PETER AND JOHN, WHO ALSO COME TO THE TOMB, 1-10.

JESUS APPEARS TO MAGDALEN, 11-17.

MAGDALEN ANNOUNCES HER VISION OF JESUS TO THE DISCIPLES, 18.

JESUS APPEARS TO THE DISCIPLES ON EASTER SUNDAY MORNING, 19-23.

THE INCREDULITY OF THOMAS, 24, 25.

THOMAS BELIEVES WHEN JESUS APPEARS TO HIM AND THE OTHER DISCIPLES, 26-29.

EPILOGUE, 30, 31.

1. And on the first day of the week, Mary Magdalen cometh early, when it was yet dark, unto the sepulchre; and she saw the stone taken away from the sepulchre.

2. She ran, therefore, and cometh to Simon Peter, and to the other disciple whom Jesus loved, and saith to them: They have taken away the Lord out of the sepulchre, and we know not where they have laid him.

3. Peter therefore went out, and that other disciple, and they came to the sepulchre.

4. And they both ran together, and that other disciple did outrun Peter, and came first to the sepulchre.

1. See on Matthew xxviii. 1; Mark xvi. 1, 2. Most probably Magdalen had come from her home at Bethany, which was about three miles from Calvary. This explains how it could have been dark when she started, but sun up when she arrived, as St. Mark (xvi. 2) says.

2. See on Matthew xxviii. 2-4.

5. And when he stooped down, he saw the linen cloths lying; but yet he went not in.

6. Then cometh Simon Peter, following him, and went into the sepulchre, and saw the linen cloths lying,

7. And the napkin that had been about his head, not lying with the linen cloths, but apart, wrapped up into one place.

8. Then that other disciple also went in, who came first to the sepulchre: and he saw, and believed.

9. For as yet they knew not the scripture, that he must rise again from the dead.

10. The disciples therefore departed again to their home.

11. But Mary stood at the sepulchre without, weeping. Now as she was weeping, she stooped down, and looked into the sepulchre,

12. And she saw two angels in white, sitting, one at the head, and one at the feet, where the body of Jesus had been laid.

13. They say to her: Woman, why weepest thou? She saith to them: Because they have taken away my Lord; and I know not where they have laid him.

14. When she had thus said, she turned herself back, and saw Jesus standing; and she knew not that it was Jesus.

15. Jesus saith to her: Woman, why weepest thou? whom seekest thou? She, thinking that it was the gardener, saith to him: Sir, if thou hast taken him hence, tell me where thou hast laid him, and I will take him away.

**The other disciple whom Jesus loved, who was John the Evangelist.** Cf. xiii. 23; xix. 26; xxi. 20.

5, 6. **The linen cloths, which had been wrapped about the body of the Saviour.**

8. **And believed; i.e., that our Lord had truly risen from the dead, as He had foretold (Matthew xvii. 22; Mark x. 30; Luke ix. 22).**

9. **For as yet, etc.; i.e., until now they had not understood that our Lord should rise from the dead; and even now only St. John seemed to understand (Luke xxiv. 12).**

11. **But Mary stood at the sepulchre, etc.** This was Magdalen's second visit to the tomb, where she remained after Peter and John had departed. See on Mark xvi. 9.

12. See on Matthew xxviii. 2-4.

14. **She turned, etc.** Many believe, with St. Chrysostom, that the look which appeared on the face of the angels as they beheld our Lord behind Mary caused her to turn round.

15. After His Resurrection our Lord's body presented an appearance very different from that which it had before; in fact, it

16. Jesus saith to her: Mary. She turning, saith to him: *Rabboni* (which is to say, Master).

17. Jesus saith to her: Do not touch me, for I am not yet ascended to my Father. But go to my brethren, and say to them: I ascend to my Father and to your Father, to my God and your God.

18. Mary Magdalen cometh, and telleth the disciples: I have seen the Lord, and these things he said to me.

19. Now when it was late that same day, the first of the week, and the doors were shut, where the disciples were gathered together, for fear of the Jews, Jesus came and stood in the midst, and said to them: Peace be to you.

20. And when he had said this, he shewed them his hands and his side. The disciples therefore were glad, when they saw the Lord.

21. He said therefore to them again: Peace be to you. As the Father hath sent me, I also send you.

changed in appearance frequently. Cf. xxi. 4; Matthew xxviii. 17; Mark xvi. 12; Luke xxiv. 16, 32.

16. As soon as our Lord called Mary by her name she recognized Him, and addressed Him by the Syro-Chaldaic title, *Rabboni*, which means, "my Master."

17. **Do not touch me, μή μου ἅπτου.** These words constitute a great difficulty, and are variously explained. If we keep in mind that Mary was most probably prostrated at our Lord's feet to embrace them and perhaps was clinging to Him the following seem to be the best explanations of this passage: (a) "Do not detain Me, the time is not yet come to keep Me among you, I have not yet ascended to My Father." This would imply that our Lord's definite and permanent state in the Church would be only after the coming of the Holy Ghost at Pentecost. (b) "Do not waste time in embracing My feet and clinging to Me now, you shall have other opportunities to do so, for I have not yet ascended to My Father; go at once and announce the news of My resurrection to My brethren." This latter seems a very good and a very natural explanation of the difficulty. The former is not so satisfactory, as appears from Matthew xxviii. 9; Luke xxiv. 39. See on Luke xxiv. 39-43.

**To my Father** by nature, and to **your Father** by grace and adoption. As man, our Lord spoke of God, as **my God**.

18. See on Mark xvi. 11.

19. See on Mark xvi. 14; Luke xxiv. 33-36.

20. See on Luke xxiv. 39-43.

21. **As the Father hath sent me, etc.** As the Father had sent

22. When he had said this, he breathed on them; and he said to them: Receive ye the Holy Ghost.

23. Whose sins you shall forgive, they are forgiven them; and whose sins you shall retain, they are retained.

the Son with fulness of power to accomplish, by His labors, merits and death, the redemption of mankind, so now the Son sends the Apostles with the same fulness of power and authority to perfect the work of redemption by applying to the souls of men the merits of the life and death of Christ.

22. **Receive ye the Holy Ghost.** The breathing on the Apostles was an exterior sign used by our Lord, which signified the actual communication to them of the Holy Ghost. By this communication the Apostles received, not sanctifying grace which they already possessed, but the power of remitting and retaining the sins of men. This was a special gift, not to be confounded with the fulness of the gifts of the Holy Spirit which the Apostles later received in a public and visible manner on the day of Pentecost.

23. The Council of Trent (Sess. xiv. can. 3) has defined that the words of this verse express the power of remitting and retaining sins in the Sacrament of Penance, as the words naturally signify, and as the Church has always understood. The persons addressed, the Apostles and their successors, are herewith given the power and authority to pass judgment on sins and to decide what sins are to be remitted, and what retained; and this judicial authority on the part of the Apostles and their successors naturally supposes the correlative obligation on the part of the faithful of confessing their sins in order to obtain forgiveness. There is no limit to the power of forgiving which the Apostles receive, but they are hereby constituted the judges as to whose dispositions are suitable for pardon, and whose not.

From St. Luke (xxiv. 33) we learn that the Apostles were not alone when the words of this verse were spoken; but the Church, guided and taught by the Holy Ghost (John xvi. 13) has decided that the power then communicated was given only to the Apostles and their successors, the Bishops and priests of the Catholic Church.

Thomas was absent on this occasion and it is disputed whether he also received at this time the power of remitting and retaining sins. Maldonatus and others hold that he did, since he was a member of

24. Now Thomas, one of the twelve, who is called Didymus, was not with them when Jesus came.

25. The other disciples therefore said to him: We have seen the Lord. But he said to them: Except I shall see in his hands the print of the nails, and put my finger into the place of the nails, and put my hand into his side, I will not believe.

26. And after eight days again his disciples were within, and Thomas with them. Jesus cometh, the doors being shut, and stood in the midst, and said: Peace be to you.

27. Then he saith to Thomas: Put in thy finger hither, and see my hands; and bring hither thy hand, and put it into my side; and be not faithless, but believing.

28. Thomas answered, and said to him: My Lord, and my God.

29. Jesus saith to him: Because thou hast seen me, Thomas, thou hast believed: blessed are they that have not seen, and have believed.

30. Many other signs also did Jesus in the sight of his disciples, which are not written in this book.

the Apostolic group who received the power as a body. In favor of this view the case of Eldad and Medad, who though absent, received the spirit of prophecy given through Moses to the seventy of the Ancients of Israel, is cited. Toletus, à Lapide, and others believe that Thomas, owing to his incredulity, did not receive at this time the power granted to the others; it was given to him, they say, on the following Sunday when he believed (verse 28).

24. **Thomas, one of the twelve;** i.e., one of the original twelve. **Didymus.** See on xi. 16.

26-28. On Low Sunday our Lord appeared again, to all the Apostles this time, to convert Thomas from his incredulity and to confirm the faith of the others. Although Thomas was guilty of sin in disbelieving in the Resurrection of our Lord, still his incredulity has done more, as St. Gregory says, to strengthen the faith of all subsequent believers, than the faith of all the other disciples (St. Greg. *Hom. in Evang.* 26).

**My Lord, and my God,** *ὁ κύριός μου καὶ ὁ Θεός μου.* As these words were addressed to Christ, it is clear that they are a confession of faith in our Lord's Divinity. Thomas expresses the faith he has now in his heart.

29. This verse proves that the words of Thomas in the preceding verses were a confession of faith in our Lord's humanity and Divinity.

30. **Many other signs;** i.e., many other proofs of His Resurrec-

31. But these are written, that you may believe that Jesus is the Christ, the Son of God: and that believing, you may have life in his name.

tion were given to His disciples to strengthen and confirm their faith.

31. In this verse St. John gives the primary purpose and end for which He wrote his Gospel; namely, to prove the Divinity of Christ.

## CHAPTER XXI

JESUS APPEARS AT THE SEA OF GALILEE, 1-14.

AFTER A TRIPLE CONFESSION OF HIS LOVE FOR HIS  
MASTER PETER IS MADE VISIBLE HEAD OF THE  
WHOLE CHURCH, 15-17.

THE FUTURE OF PETER AND JOHN, 18-23.

THE CONCLUSION OF THE GOSPEL, 24-25.

1. After this, Jesus shewed himself again to the disciples at the sea of Tiberias. And he shewed himself after this manner.

2. There were together Simon Peter, and Thomas, who is called Didymus, and Nathanael, who was of Cana of Galilee, and the sons of Zebedee, and two others of his disciples.

Although this chapter gives evidence of having been added as an appendix to the Fourth Gospel, and its authenticity and inspiration have, therefore, been seriously questioned by scholars outside the Church, no Catholic is permitted to doubt its inspiration, and no one has reasonable grounds for doubting that St. John was its author. That the chapter is inspired is certain for Catholics from the Council of Trent, which defined that the *entire books* of the Vulgate with *all their parts* are inspired; and that it was written by St. John at the same time as, or very soon after, the rest of the Gospel is sufficiently proved from the fact that it is found in all the MSS. of the Gospel and is quoted by all the Fathers.

1. After this; i.e., some time after His appearance to Thomas and the other disciples on Low Sunday.

The Sea of Tiberias. See on vi. 1.

2. Nathanael. See on i. 45.

Two others. Who these two others were we do not know.

3. Simon Peter saith to them: I go a fishing. They say to him: We also come with thee. And they went forth, and entered into the ship: and that night they caught nothing.

4. But when the morning was come, Jesus stood on the shore: yet the disciples knew not that it was Jesus.

5. Jesus therefore said to them: Children, have you any meat? They answered him: No.

6. He saith to them: Cast the net on the right side of the ship, and you shall find. They cast therefore; and now they were not able to draw it, for the multitude of fishes.

7. That disciple therefore whom Jesus loved, said to Peter: It is the Lord. Simon Peter, when he heard that it was the Lord, girt his coat about him, (for he was naked,) and cast himself into the sea.

8. But the other disciples came in the ship, (for they were not far from the land, but as it were two hundred cubits,) dragging the net with fishes.

9. As soon then as they came to land, they saw hot coals lying, and a fish laid thereon, and bread.

10. Jesus saith to them: Bring hither of the fishes which you have now caught.

11. Simon Peter went up, and drew the net to land, full of great fishes, one hundred and fifty-three. And although there were so many, the net was not broken.

5. **Meat**, *προσφάγιον*, means "anything to eat."

6. **To draw it**; i.e., to draw it into the boat; they drew it after the boat (verse 8).

7. St. John, the beloved disciple, was first to recognize with his virgin eyes the Saviour.

**For he was naked**; i.e., he was without the outer coat usually worn by fishermen, having on him only his tunic, or under garments. Out of reverence and respect for our Lord he put round him his outer coat.

8. **Two hundred cubits**; i.e., about 300 feet. A cubit was about eighteen inches.

9. Most probably both the fire and the fish on this occasion were miraculously provided by our Lord to strengthen the faith of His disciples.

10. Our Lord wanted the disciples to see the number of fish caught, in order that they might recognize the magnitude of the miracle.

11. Peter was aided by the other disciples in drawing the net to land; but he was the leader in this whole affair of the fish, as later he was the head and leader among the Apostles in catching and saving men. Cf. Acts ii. 14-41; x. 1-48.



12. Jesus saith to them: Come, and dine. And none of them who were at meat, durst ask him: Who art thou? knowing that it was the Lord.

13. And Jesus cometh and taketh bread, and giveth them, and fish in like manner.

14. This is now the third time that Jesus was manifested to his disciples, after he was risen from the dead.

15. When therefore they had dined, Jesus saith to Simon Peter: Simon, son of John, lovest thou me more than these? He saith to him: Yea, Lord, thou knowest that I love thee. He saith to him: Feed my lambs.

16. He saith to him again: Simon, son of John, lovest thou me? He saith to him: Yea, Lord, thou knowest that I love thee. He saith to him: Feed my lambs.

17. He said to him the third time: Simon, son of John, lovest thou me? Peter was grieved, because he had said to him the third time: Lovest thou me? And he said to him: Lord, thou knowest all things: thou knowest that I love thee. He said to him: Feed my sheep.

12. **Come and dine**, ἀριστήσατε; i.e., come and *breakfast*, according to the Greek.

Our Lord's appearance on this occasion was not familiar to the disciples, and hence they feared to ask Him who He was, although they were satisfied from the miracle just performed that it was He.

13. It is probable that our Lord ate with the disciples on this, as He did on another occasion. See on Luke xxiv. 43.

14. **The third time**; i.e., this was the third public appearance to His disciples as a body. Patrizi and others think this was the seventh appearance of our Lord mentioned in the Gospels after the Resurrection. Thus the eighth appearance would be that on the mountain in Galilee (Matthew xxviii. 16).

15-17. The Vatican Council (Cap. i., *De Apost. Prim. Instit.*) has declared the meaning of these words; namely, that they express the bestowal on St. Peter of the primacy of honor and jurisdiction in the whole Church. No Catholic, therefore, may give any other sense to these verses. Several points in them are to be observed: (a) Christ, being about to bestow on Peter the commission promised in Matthew xvi. 17-19, now addresses him by his former name, Simon, as if to call his attention to the meaning of his new name, Peter, which means *rock*; (b) it is clear that our Lord is comparing Peter's love for Himself with the love of the other Apostles for Himself; (c) in the first two verses (15 and 16) Christ uses a less endearing term to express Peter's love for Him (ἀγαπᾷς, *diligis*), whereas Peter replies by a more tender term (φιλω, *amo*); but

18. Amen, amen I say to thee, when thou wast younger, thou didst gird thyself, and didst walk where thou wouldst. But when thou shalt be old, thou shalt stretch forth thy hands, and another shall gird thee, and lead thee whither thou wouldst not.

19. And this he said, signifying by what death he should glorify God. And when he had said this, he saith to him: Follow me.

20. Peter turning about, saw that disciple whom Jesus loved following, who also leaned on his breast at supper, and said: Lord, who is he that shall betray thee?

21. Him therefore when Peter had seen, he saith to Jesus: Lord, and what shall this man do?

22. Jesus saith to him: So I will have him to remain till I come, what is it to thee? follow thou me.

23. This saying therefore went abroad among the brethren, that that disciple should not die. And Jesus did not say to him: He should not die; but, So I will have him to remain till I come, what is it to thee?

24. This is that disciple who giveth testimony of these things, and hath written these things; and we know that his testimony is true.

25. But there are also many other things which Jesus did; which, if they were written every one, the world itself, I think, would not be able to contain the books that should be written.

finally, after being twice assured of Peter's tender affection, our Lord adopts the same word as Peter (*φιλεῖς*, *amas*); (d) in verse 15 the commission is: *Feed My lambs* (*βόσκει τὰ ὄρνια μου*), but in the two following verses it is: *Tend (rule) My sheep* (*ποιμαίνε τὰ πρόβατά μου*), or *little sheep* (*πρόβατα μου*), according to some MSS.

18, 19. The prediction of our Lord in regard to Peter was fulfilled in the latter's crucifixion at Rome A.D. 67. Hence St. John in writing this was speaking of an event long past.

Follow me, according to the Fathers generally, meant that Peter, through his death on the cross, should follow our Lord to the Father in Heaven. See on xiii. 36.

20. **Who also leaned.** See on xiii. 23-25.

21. Peter was anxious to know what end awaited the beloved disciple.

22. **So I will have, etc.** The *sic* of the Vulgate should be *si* (*ἐάν*), and hence the meaning is: "If I will have him remain till I come," etc. Till I come refers to the second coming of Christ at the end of the world. Our Lord here reproves Peter's curiosity.

23. St. John notes here the misunderstanding of our Lord's words in his regard which had gone abroad.

24, 25. These two verses form a second epilogue to this Gospel.

Their authenticity, however, has been very much doubted, even by some Catholic writers. The chief reasons for this are: (a) the writer speaks in the first person plural in verse 24, contrary to St. John's custom; (b) verse 25 is an exaggeration.

In reply we may say that the first reason proves nothing against the authorship of St. John, who, at the end of his Gospel, appeals to the authority of his contemporaries, as well as his own, in confirmation of the veracity of what he has written. Cf. i. 14; I Ep. i. 5; iii. 12. To the second objection we may say that there is no reason why St. John should not have used a striking figure to express the richness of the revelation made by Christ to the world.

Those Catholic authorities who question the authenticity of these two verses of St. John think they were written by the priests or Bishops of Asia Minor, at whose request John wrote his Gospel. The inspiration of the verses remains.

# HARMONY OF THE FOUR GOSPELS

## THE INFANCY OF CHRIST

	ST. MATTHEW	ST. MARK	ST. LUKE	ST. JOHN
The Divinity and Incarnation of Christ . . . . .				i 1-18
Zachary's vision . . . . .			i 5-25	
The Annunciation . . . . .			i 26-38	
The Visitation . . . . .			i 39-56	
The birth of John the Baptist . . . . .			i 57-80	
The genealogy of Jesus . . . . .	i 1-17		iii 23-38	
The anxiety of Joseph . . . . .	i 18-24			
The birth of Jesus . . . . .	i 25		ii 1-20	
The circumcision and presentation . . . . .			ii 21-38	
The adoration of the Magi . . . . .	ii 1-12			
The flight into Egypt . . . . .	ii 13-15			
The slaughter of the Innocents . . . . .	ii 16-18			
The return to Nazareth . . . . .	ii 19-23		ii 39-40	
The finding in the Temple . . . . .			ii 41-52	

## THE PREPARATION FOR THE PUBLIC LIFE

The preaching of John the Baptist . . . . .	iii 1-12	i 2-8	iii 1-18	
The baptism of Jesus . . . . .	iii 13-17	i 9-II	iii 21, 22	
The fast and temptation in the desert . . . . .	iv 1-II	i 12, 13	iv 1-13	

	ST. MATTHEW	ST. MARK	ST. LUKE	ST. JOHN
The first testimony of John . . . . .				i 19-34
The first disciples of Jesus . . . . .				i 35-51
The marriage feast at Cana . . . . .				ii 1-11
Jesus at Capharnaum . . . . .				ii 12

THE FIRST YEAR OF THE PUBLIC LIFE

The <i>first Pasch</i> at Jerusalem . . . . .				ii 13
Jesus drives the traders from the temple . . . . .				ii 14-25
Nicodemus . . . . .				iii 1-21
Jesus preaches in Judea . . . . .				iii 22
The second testimony of John . . . . .				iii 23-36
The imprisonment of John the Baptist . . . . .				
Jesus retires into Galilee . . . . .	xiv 3-5	vi 17-20	iii 19, 20	
The Samaritan woman . . . . .	iv 12	i 14	iv 14	iv 1-3
Jesus preaches in Galilee . . . . .				iv 4-42
Jesus at Cana heals the ruler's son . . . . .	iv 17	i 14, 15	iv 15-30	iv 43-45
Jesus at Capharnaum . . . . .				iv 46-54
The calling of the first Apostles and the miraculous draught of fishes . . . . .	iv 13-16		iv 31, 32	
The cure of the demoniac at Capharnaum . . . . .	iv 18-22	i 16-20	v 1-11	
Jesus heals Peter's mother-in-law and others . . . . .		i 21-28	iv 33-37	
The first mission through Galilee . . . . .	viii 14-17	i 29-34	iv 38-41	
The cure of a leper . . . . .	iv 23	i 39	iv 44	
The cure of a paralytic at Capharnaum . . . . .	viii 1-4	i 40-45	v 12-16	
The call of Matthew (Levi) and the question of fasting . . . . .	ix 1-8	ii 1-13	v 17-26	
	ix 9-17	ii 14-22	v 27-39	

## THE SECOND YEAR OF THE PUBLIC LIFE

	ST. MATTHEW	ST. MARK	ST. LUKE	ST. JOHN
The <i>second Pasch</i> at Jerusalem and the paralytic of Bethsaida . . . . .	xii 1-8	ii 23-28	vi 1-5	v 1-47
The plucking of the ears of corn on the Sabbath . . . . .	xii 9-14	iii 1-6	vi 6-11	
The man with the withered hand . . . . .	xii 15-21	iii 7-12		
Numerous cures in Galilee . . . . .	ix 35-x 4	iii 13-19	vi 12-16	
The call of the twelve Apostles . . . . .	v, vi, vii		vi 17-49	
The Sermon on the Mount . . . . .	viii 5-13		vii 1-10	
Jesus heals the centurion's servant . . . . .			vii 11-17	
The son of the widow of Naim . . . . .			vii 18-35	
The message of John the Baptist . . . . .	xi 2-19		vii 36-50	
The woman who was a sinner at the feet of Jesus . . . . .			viii 1-3	
The second mission through Galilee . . . . .			xi 14-26	
The blind and dumb demoniac . . . . .	xii 22-37	iii 20-30	viii 19-21	
The mother and the relatives of Jesus . . . . .	xii 46-50	iii 31-35	viii 4-18	
The parables illustrating the Kingdom of God . . . . .	xiii 1-53	iv 1-34	viii 22-25	
Jesus stills the tempest . . . . .	viii 23-27	iv 35-40	viii 26-39	
The possessed of Gergesa . . . . .	viii 28-34	v 1-20		
The daughter of Jairus and the woman with the issue of blood . . . . .	ix 18-26	v 21-43	viii 40-56	
Jesus cures two blind men and a demoniac . . . . .	ix 27-34			
Jesus visits Nazareth . . . . .	xiii 54-58	vi 1-6		
The third mission through Galilee and the instructions to the twelve Apostles . . . . .	x 5-xi 1	vi 6-13	ix 1-6	
The beheading of John the Baptist . . . . .	xiv 1-12	vi 14-29	ix 7-9	
The first multiplication of the loaves . . . . .	xiv 13-21	vi 30-44	ix 10-17	vi 1-15

Jesus walks on the water . . . . .  
 The cures in the country of Genesareth . . . . .  
 The bread of life . . . . .

THE THIRD YEAR OF THE PUBLIC LIFE

The <i>third Pasch</i> of the public life . . . . .	ST. MATTHEW	ST. MARK	ST. LUKE	ST. JOHN
The Pharisees and their traditions . . . . .	xiv 22-33	vi 45-52	.....	vi 16-21
Jesus on the confines of Tyre and Sidon. The Syro- phoenician woman . . . . .	xiv 34-36	vi 53-56	.....	.....
Jesus in the Decapolis cures a deaf mute and works other miracles . . . . .	.....	.....	.....	vii 1 (vi 4)
The second multiplication of the loaves . . . . .	xv 1-20	vii 1-23	.....	.....
A sign from heaven, and the leaven of the Pharisees and Sadducees . . . . .	xv 21-28	vii 24-30	.....	.....
The blind man of Bethsaida . . . . .	.....	vii 31-37	.....	.....
The confession of St. Peter . . . . .	xv 29-39	viii 1-10	.....	.....
The first prediction of the Passion . . . . .	xvi 1-12	viii 11-21	.....	.....
The Transfiguration . . . . .	.....	viii 22-26	.....	.....
Jesus cures the lunatic child . . . . .	xvi 13-20	viii 27-30	ix 18-21	.....
The second prediction of the Passion . . . . .	xvi 21-28	viii 31-39	ix 22-27	.....
The tribute money for the temple . . . . .	xvii 1-13	ix 1-12	ix 28-36	.....
Jesus instructs His disciples . . . . .	xvii 14-20	ix 13-28	ix 37-43	.....
Jesus leaves Galilee for the feast of Tabernacles . . . . .	xvii 21, 22	ix 29-31	ix 44, 45	.....
The inhospitality of the Samaritans . . . . .	xvii 23-26	.....	.....	.....
Following Jesus . . . . .	xviii 1-35	ix 32-49	ix 46-50	vii 2-10
	.....	.....	.....	.....
	.....	.....	ix 51-56	.....
	viii 18-22	.....	ix 57-62	.....

	ST. MATTHEW	ST. MARK	ST. LUKE	ST. JOHN
The seventy-two disciples . . . . .	xi 20-30		x 1-24	
The good Samaritan . . . . .			x 25-37	
Jesus visits Martha and Mary . . . . .			x 38-42	
Jesus teaches in the temple . . . . .				vii 11-53
The woman taken in adultery . . . . .				viii 1-11
Jesus is the Son of God . . . . .				viii 12-59
The cure of the man born blind . . . . .				ix 1-41
Jesus the good Shepherd . . . . .				x 1-21
Jesus teaches the disciples how to pray . . . . .			xi 1-13	
Jesus praises those that keep His word . . . . .			xi 27, 28	
The sign of Jonas . . . . .	xii 38-45		xi 29-36	
Jesus reproves the Pharisees . . . . .			xi 37-54	
Jesus warns against hypocrisy . . . . .			xii 1-12	
Jesus warns against covetousness . . . . .			xii 13-34	
Jesus admonishes all to watch . . . . .			xii 35-53	
The signs of the times . . . . .			xii 54-59	
The necessity of penance . . . . .			xiii 1-5	
The barren fig-tree . . . . .			xiii 6-9	
The cure of the woman infirm for eighteen years . . . . .			xiii 10-17	
Jesus journeys toward Jerusalem . . . . .			xiii 22	
The number of the Elect. The hostility of Herod . . . . .			xiii 23-33	
The blindness of Jerusalem . . . . .			xiii 34, 35	
Jesus at Jerusalem for the feast of the Dedication . . . . .				x 22-39
Jesus in Peratea . . . . .				x 40-42
Jesus heals the dropsical man . . . . .			xiv 1-15	
The parable of the Supper . . . . .			xiv 16-24	



	ST. MATTHEW	ST. MARK	ST. LUKE	ST. JOHN
Self-denial . . . . .			xiv 25-35	
The parable of the Lost Sheep . . . . .			xv 1-10	
The parable of the Prodigal Son . . . . .			xv 11-32	
The parable of the Unjust Steward . . . . .			xvi 1-13	
The hypocrisy of the Pharisees . . . . .			xvi 14-18	
The Rich Man and Lazarus . . . . .			xvi 19-31	
Lessons about scandal, forgiveness, faith and humility . . . . .			xvii 1-10	
The resurrection of Lazarus . . . . .				xi 1-53
Jesus goes to Ephrem . . . . .				xi 54-56

THE FOURTH YEAR OF THE PUBLIC LIFE

Jesus goes to Jerusalem for the <i>last Pasch</i> . . . . .	xix 1	x 1	xviii 11	
The ten lepers . . . . .			xviii 12-19	
The manner of the coming of Christ . . . . .			xviii 20-37	
We must pray always . . . . .			xviii 1-8	
The Pharisee and the Publican . . . . .			xviii 9-14	
The indissolubility of matrimony . . . . .	xix 3-12	x 2-12		
Jesus and little children . . . . .	xix 13-15	x 13-16	xviii 15-17	
The danger of riches. The rich young man . . . . .	xix 16-30	x 17-31	xviii 18-30	
The Laborers in the Vineyard . . . . .	xx 1-16			
The third prediction of the Passion . . . . .	xx 17-19	x 32-34	xviii 31-34	
The ambition of the two sons of Zebedee . . . . .	xx 20-28	x 35-45		
The blind men of Jericho . . . . .	xx 29-34	x 46-52	xviii 35-43	
Zacheus entertains Christ . . . . .			xix 1-10	
The parable of the Pounds . . . . .			xix 11-27	
The supper at Bethany . . . . .	xxvi 6-13	xiv 3-9		xii 1-11

## HOLY WEEK

	ST. MATTHEW	ST. MARK	ST. LUKE	ST. JOHN
The triumphal entry into Jerusalem (Palm Sunday) . . . . .	xxi 1-11	xi 1-11	xix 29-44	xii 12-19
Jesus curses the fig-tree (Monday) . . . . .	xxi 18, 19	xi 12-14	.....	.....
Jesus casts the traders out of the temple . . . . .	xxi 12-17	xi 15-19	xix 45-48	.....
The disciples see the withered fig-tree (Tuesday morning)	xxi 20-22	xi 20-26	.....	.....
The baptism of John . . . . .	xxi 23-27	xi 27-33	xx 1-8	.....
The parable of the Two Sons . . . . .	xxi 28-32	.....	.....	.....
The parable of the Wicked Husbandmen . . . . .	xxi 33-46	xii 1-12	xx 9-19	.....
The parable of the Marriage Feast . . . . .	xxii 1-14	.....	.....	.....
The tribute money to Caesar . . . . .	xxii 15-22	xii 13-17	xx 20-26	.....
The Sadducees and the resurrection . . . . .	xxii 23-33	xii 18-27	xx 27-40	.....
The great commandment . . . . .	xxii 34-40	xii 28-34	.....	.....
The Messiah is the son of David . . . . .	xxii 41-46	xii 35-37	xx 41-44	.....
Jesus warns the people against the Scribes and Pharisees	xxiii 1-36	xii 38-40	xx 45-47	.....
Jesus upbraids Jerusalem . . . . .	xxiii 37-39	.....	.....	.....
The widow's mite . . . . .	.....	xii 41-44	xx 1-4	.....
The Greeks in the temple. A voice from Heaven . . . . .	.....	.....	.....	xii 20-50
The destruction of Jerusalem and the end of the world . . . .	xxiv 1-51	xiii 1-37	xxi 5-38	.....
The parable of the Ten Virgins . . . . .	xxv 1-13	.....	.....	.....
The parable of the Talents . . . . .	xxv 14-30	.....	.....	.....
The Last Judgment . . . . .	xxv 31-46	.....	.....	.....
The conspiracy of the Sanhedrim against Jesus (Tuesday evening) . . . . .	xxvi 1-5	xiv 1, 2	xxii 1, 2	.....
The treason of Judas . . . . .	xxvi 14-16	xiv 10, 11	xxii 3-6	.....
The last supper (Thursday) . . . . .	{ xxvi 17-20; 29	xiv 12-17; 25	xxii 7-18	.....

	ST. MATTHEW	ST. MARK	ST. LUKE	ST. JOHN
Jesus washes His disciples' feet . . . . .				xiii 1-20
The greatest among the Apostles . . . . .			xxii 24-30	
Jesus announces His betrayal . . . . .	xxvi 21-25	xiv 18-21	xxii 21-23	xiii 21-30
The institution of the Holy Eucharist . . . . .	xxvi 26-28	xiv 22-24	xxii 19, 20	
The glorification of Jesus . . . . .				xiii 31-33
The commandment of love . . . . .				xiii 34, 35
Jesus foretells the denials of Peter . . . . .			xxii 31-34	xiii 36-38
The discourse of Jesus after the supper . . . . .				xiv 1-31
Jesus rising from table pronounces another discourse in the Cenacle . . . . .				xv-xvi
The sacerdotal prayer of Jesus . . . . .				xvii
Jesus makes ready to go to Gethsemani . . . . .			xxii 35-38	
Jesus predicts the denials and flight of the disciples . . . . .	xxvi 30-35	xiv 26-31		xviii 1

THE PASSION OF CHRIST

The agony in the garden . . . . .	xxvi 36-46	xiv 32-42	xxii 39-46	xviii 1
The arrest of Jesus . . . . .	xxvi 47-56	xiv 43-52	xxii 47-53	xviii 2-11
Jesus before Annas . . . . .				xviii 12-14; 19-23
Jesus before Caiphas . . . . .	xxvi 57-66	xiv 53-64	xxii 54	xviii 24
The triple denial of Peter . . . . .	xxvi 69-75	xiv 66-72	xxii 55-62	xviii 15-18; 25-27
The maltreatment of Jesus . . . . .	xxvi 67, 68	xiv 65	xxii 63-65	
Jesus before the Sanhedrim (Friday morning) . . . . .	xxvii 1	xv 1	xxii 66-71	
The despair of Judas . . . . .	xxvii 3-10			

	ST. MATTHEW	ST. MARK	ST. LUKE	ST. JOHN
First examination before Pilate . . . . .	{ xxvii 2; } 11-14	xv 2-5	xxiii 1-7	xviii 29-32
Jesus before Herod . . . . .	.....	.....	xxiii 8-11	.....
Jesus and Barabbas . . . . .	xxvii 15-23	xv 6-14	xxiii 12-23	xviii 39, 40
Jesus scourged and mocked . . . . .	xxvii 26-30	xv 16-20	.....	xix 1-7
Second examination before Pilate . . . . .	.....	.....	.....	xviii 33-38
Third examination before Pilate; condemnation of Jesus . . . . .	xxvii 24, 25	xv 15	xxiii 24, 25	xix 8-16
The way of the Cross . . . . .	xxvii 31-34	xv 21-23	xxiii 26-32	xix 17
The crucifixion . . . . .	xxvii 35-38	xv 24-28	xxiii 33-38	xix 18-24
Jesus on the cross is blasphemed . . . . .	xxvii 39-44	xv 29-32	xxiii 34-37	.....
Jesus promises paradise to the good thief . . . . .	.....	.....	xxiii 39-43	.....
John and Mary at the foot of the cross . . . . .	.....	.....	.....	xix 25-27
The agony and death of Jesus . . . . .	xxvii 45-53	xv 33-38	xxiii 44-46	xix 28-30
The centurion . . . . .	xxvii 54-56	xv 39-41	xxiii 47-49	xix 31-37
Jesus is buried . . . . .	xxvii 57-61	xv 42-47	xxiii 50-56	xix 38-42
Soldiers guard the sepulchre . . . . .	xxvii 62-66	.....	.....	.....

THE RESURRECTION OF CHRIST

The holy women go to the sepulchre (Sunday morning) . . . . .	xxviii 1-8	xvi 1-8	xxiv 1-11	xx 1
Peter and John go to the sepulchre . . . . .	.....	.....	xxiv 12	xx 2-10
Jesus appears to Magdalen and the holy women . . . . .	xxviii 9, 10	xvi 9-11	.....	xx 11-18
The guards of the sepulchre are bribed . . . . .	xxviii 11-15	.....	.....	.....
Jesus appears to the disciples going to Emmaus . . . . .	.....	xvi 12, 13	xxiv 13-35	.....
Jesus appears to the ten Apostles . . . . .	.....	xvi 14	xxiv 36-43	xx 19-23

Jesus appears to the Apostles and Thomas . . . . .	ST. MATTHEW . . . . .	ST. MARK . . . . .	ST. LUKE . . . . .	ST. JOHN . . . . .
Jesus appears on the sea of Tiberias . . . . .	. . . . .	. . . . .	. . . . .	XX 24-29
Jesus appears on a mountain in Galilee . . . . .	. . . . .	. . . . .	. . . . .	XXI 1-24
Final instructions of Our Lord to the Apostles . . . . .	xxviii 16-20	xvi 15	. . . . .	. . . . .
The Ascension . . . . .	. . . . .	xvi 16-18	xxiv 46-49	. . . . .
	. . . . .	xvi 19, 20	xxiv 50-53	. . . . .

**GENEALOGY OF THE HERODS**

HEROD THE GREAT (Matt. II. 1)

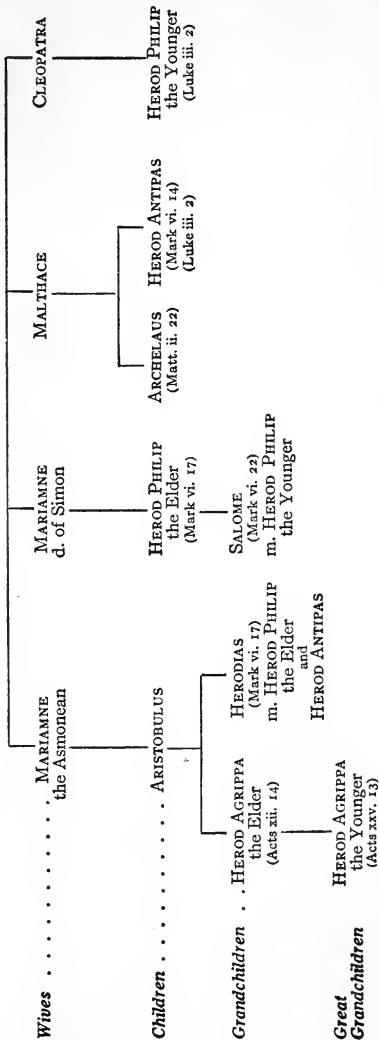

# PRINCIPAL COMMENTARIES ON THE GOSPELS

## I. GREEK

- Origen, *Comm. on St. Matt.* (c. 244); *Homilies on St. Luke* (c. 233); *Comm. on St. John* (c. 238).  
Eusebius of Caesarea († c. 340), *Comm. on St. Luke*.  
\*St. Chrysostom, *90 Homilies on St. Matt.* (c. 390); *88 Hom. on St. John* (c. 389).  
St. Cyril of Alex., *Comm. on St. John* (c. 430).  
Theophylact († c. 1090), *Comm. on 4 Gospels*. An edition in Greek and Latin published at Venice 1754-1763.  
Euthymius († c. 1118), *Comm. on the Gospels*. Latin translation, Louvain, 1544.

## II. LATIN

### (a) ON THE FOUR GOSPELS

- \*St. Augustine, *De Consensu Evang.* l. 4 (c. 400).  
St. Gregory the Great, *40 Hom. in Evangelia* (c. 591).  
Walafrid Strobo, *Glossa ordin.* (c. 840).  
Albert the Great († 1280).  
\*St. Thomas Aquinas († 1274), *Catena Aurca*.  
Nicholas de Gorham († 1295), *Postillae in Evangelia*.  
Cajetan, *In Evangelia Matt., Marci, Lucae, Joannis* (Venice, 1530).  
Jansenius of Ghent († 1576), *Comm. in Concordiam et totam Historiam Evang.*  
\*Maldonatus, *Comm. in 4 Evangelia* (Pont-à-Mousson, 1596-1597).  
Salmeron, *Comm. in Evangelicam Hist.* (Madrid, 1598).  
Jansenius of Ypres († 1638), *Comm. in 4 Evangelia*.  
\*Cornelius à Lapide, *Comm. in 4 Evangelia* (Antwerp, 1712).  
Liagre, *Comm. in libros hist. N. T.* (Tournai, 1883—).  
Knabenbauer, *Comm. in Ev. S. Matt., S. Marci, S. Lucae, S. Joan.* (Paris, 1892—).  
Ceulemans, *In Ev. secd. Matt.* (Malines, 1900); *secd. Marcum et Lucam* (1899); *secd. Joannem* (1901).

(b) ON ST. MATTHEW

- St. Hilary, *Comm. in Ev. Matt.* (c. 355).  
 \*St. Jerome, *Comm. in Ev. S. Matt.* (398).  
 \*St. Thomas Aquinas († 1274), *Comm. in Ev. Matt.*  
 Capponi (Venice, 1602).  
 Van Steenkiste, *Ev. secd. Matt.* (Paris, 1880-1882).  
 Van Oncebal, *In Matt.* (Ghent, 1900).  
 Niglutsch, *Brevis comm. in Ev. S. Matt.* (1909).

(c) ON ST. MARK

- St. Bede († 735).  
 \*Patrizi, *In Marcum Comm.* (Rome, 1862).

(d) ON ST. LUKE

- St. Ambrose, *Exp. Ev. secd. Lucam* (c. 388).  
 St. Bede († 735).  
 St. Bonaventure († 1274), *Comm. in Ev. S. Luc.*  
 \*Toletus, *Comm. in 1<sup>a</sup> XII capita J. C. D. N. Ev. secd. Lucam*  
 (Rome, 1600).

(e) ON ST. JOHN

- \*St. Augustine, *In Joannis Evang.* (c. 416).  
 Alcuin († 804).  
 \*St. Thomas Aquinas († 1274).  
 St. Bonaventure († 1274).  
 \*Toletus, *In Joannis Ev.* (Cologne, 1589).  
 Capponi (Venice, 1604).  
 \*Patrizi, *In Joan. Comm.* (Rome, 1857).  
 \*Corluy, *Comm. in Ev. S. Joan.* (Ghent, 1889).

III. FRENCH

- Calmet († 1757), *Comm. litt. sur tous les livres de l'Anc. et du  
 Nowv. Test.* (Paris, 1707-1716). Latin transl. by Mansi  
 (Lucca, 1730-1738).  
 Fillion, *La Sainte Bible* (Paris, 1878—).  
 Rose, *Évangile selon S. Math.* (Paris, 1906); *S. Marc* (Paris,  
 1904); *S. Luc* (Paris, 1904).  
 \*Thiriet, *L'Évangile Médité avec les Pères* (Paris, 1905).  
 Lagrange, *S. Marc* (Paris, 1912).

Girodon, *Comm. crit. et moral sur l'Évang. selon S. Luc* (Paris, 1904).

\*Calmes, *Évangile selon S. Jean* (Paris, 1906).

#### IV. GERMAN

Schanz, *Comm. über d. Ev. d. h. Matt., Mark, Luc., Joh.* (Tübingen, 1879-1885).

Gutjahr, *Das hl. Ev. nach Matt.* (Graz, 1904).

Bisping, *Erklär. d. Ev. nach Matt.* (Münster, 1864).

Schegg, *Ev. nach Matt. übersetzt u. erklärt* (Munich, 1856-1858); *Markus* (1870).

Maier, *Comm. über das Ev. des Joannes* (Frib. i. B., 1843).

Haneberg, *Das Ev. nach Johannes* (Munich, 1878).

Belser, *Das Ev. des h. Johannes* (Frib. i. B., 1905).

#### V. ITALIAN

Curci, *Il Nuovo Test. volgarizzato ed esposto in note esegetiche e morali* (Turin, 1879).

\*Sales, *Il Nuovo Test. Commentato* (Turin, 1911).

#### VI. ENGLISH

\*MacEvilly, *Exposition of the Gospels* (Dublin, 1876).

Breen, *A Harmonized Exposition of The Four Gospels* (Rochester, 1899-1903).

\*Maas, *The Gospel According to St. Matt.* (St. Louis, 1898).

\*Rickaby, *The Gospel According to St. Matt.* (London, 1913).

Allen (non-Cath.), *Comm. on The Gospel According to St. Matt.* (Edinburgh, 1907).

\*Smith, *The Gospel According to St. Mark* (London, 1915).

Swete (non-Cath.), *Comm. on St. Mark* (London, 1905).

Ward, *Comm. on St. Luke* (1897).

\*Darby and Smith, *The Gospel According to St. Luke* (London, 1914).

Plummer (non-Cath.), *Comm. on St. Luke, in Inter. Crit. Comm.* (Edinburgh, 1906).

\*MacRory, *The Gospel of St. John* (Dublin, 1897).

\*Rickaby, *The Gospel According to St. John* (London, 1912).

Westcott (non-Cath.), *Comm. on St. John* (new ed., London, 1908).

. . . . .



Besides the authorities marked above with \*, which have been extensively consulted in the preparation of this work, special use has been made of the following:

Le Camus, *The Life of Christ*; Fouard, *The Christ, The Son of God*; Edersheim, *The Life and Times of Jesus The Messiah*; Trench, *Notes on the Parables, Miracles; Helps to the Study of the Bible* (Oxford Univ. Press); Gigot, *Special Introd. to the Study of the Old Testament*; Seisenberger, *Practical Handbook for the Study of the Bible*; Messmer, *Outlines of Bible Knowledge*.



## INDEX OF SUBJECTS

- Abba, 251.  
 Abel, 151.  
 Abia, 266.  
 Abiathar, 205.  
 Abilene, 11, 94, 290.  
 Abimelech, 205.  
 Abiud, 7.  
 Abomination of desolation, 153.  
 Abraham, 5, 20, 468.  
 Abraham's bosom, 358.  
 Adoration, 25, 473.  
 Adultery, 33, 35, 123, 462, 463.  
 Age, 22, 292, 469.  
 Agony, 175.  
 Ain-Karim, 273.  
 à Lapide, 444, 477, 494, 530.  
 Alms, 38, 330.  
 Aloes, 525.  
 Alpheus, 83, 93.  
 Amen, 418.  
 Aminadab, 6.  
 Ancients, 99, 108, 136, 222.  
 Andrew, St., 26, 52, 299, 415, 416.  
 Angel, 24, 25, 72, 117, 143, 189, 190, 257, 267, 270, 281, 349, 386, 392, 527.  
 Anger, 33.  
 Anise, 148.  
 Anna, 286.  
 Annas, 177, 290, 517, 518.  
 Anointing, 218, 308.  
 Apocryphal, 265.  
 Apostle, 26, 27, 63, 208, 299, 322, 345, 383, 384, 416, 437, 509, 514, 515, 516, 529.  
 Appearances, 191, 192, 257, 258, 259, 397, 528, 530, 531, 533.  
 Archelaus, 16, 94, 290.  
 Arimathea, 187.  
 Ascension, 319, 398, 427, 455.  
 Assumption, 319.  
 Assyrians, 26, 64, 116, 217.  
 Augustine, St., 11, 44, 57, 120, 152, 323, 335, 340, 358, 359, 365, 395, 428, 464, 465, 474, 480, 489, 493, 494, 499, 501.  
 Augustus, 279.  
 Auranitis, 94.  
 Authenticity, 257, 258, 386, 389, 393, 439, 462, 531, 535.  
 Avarice, 148, 149.  
 Azymes, 167.  
 Babylon, 7.  
 Baptism, 18, 20, 21, 163, 199, 238, 259, 337, 413, 425, 426, 525.  
 Barabbas, 170, 182, 520.  
 Barachias, 150.  
 Barrels, 354.  
 Bartholomew, 302. See *Nathanael*.  
 Bartimeus, 132.  
 Basket, 103.  
 Batanea, 94.  
 Beatitudes, 29, 30, 303.  
 Bed, 440.  
 Bede, St., 274.  
 Beelzebub, 68.  
 Beginning, 465.  
 Bethabara, 414, 482.  
 Bethany, 133, 135, 165, 188, 312, 373, 398, 414, 481, 526.  
 Bethlehem, 12, 13, 14, 15, 16, 280.  
 Bethphage, 133, 373.  
 Bethsaida Julias, 96, 97, 219, 220.  
 Bethsaida of Galilee, 97, 105, 220, 416, 439.  
 Bier, 306.  
 Billuart, 478.  
 Binding and loosing, 107, 118.  
 Bishops, 322, 529.  
 Blasphemy, 57, 80, 81.  
 Blindness, spiritual, 86, 87, 373, 473.  
 Blood, 60, 215.  
 Boanerges, 208.  
 Bottles, 60.  
 Brethren, 89, 93, 191, 457.  
 Bridegroom, 430.  
 Burial, 167.  
 Caesarea, 105.  
 Caesarea Philippi, 105, 109, 317.  
 Cainan, 293.  
 Caiphas, 177, 290, 485, 518.  
 Cajetan, 120.  
 Calf, 352.  
 Called, 130, 141.  
 Calmet, 395.  
 Calvary, 183, 523, 526. See *Golgotha*.  
 Camel, 125.  
 Cana, 418.  
 Canaan, 102.  
 Canticle, 274, 277, 284.  
 Capharnaum, 26, 51, 56, 61, 74, 84, 91, 93, 96, 97, 98, 99, 114, 115, 204, 216.  
 Catechize, 266.  
 Cedrenus, 17.  
 Cedron, 175, 516.  
 Census, 279.  
 Centurion, 51, 186.  
 Cephas, 106, 416.  
 Chaldea, 11, 14.  
 Chalice, 131, 175, 382.  
 Cham, 102.  
 Charity, 36, 37, 118, 132, 147, 244, 320, 497, 505.  
 Chief priests, 13.

- Children, 124.  
 Christ, 7, 106, 178.  
 Christs, false, 152.  
 Chosen, 130, 141.  
 Chrysostom, St., 9, 11, 44, 444, 455, 466, 489, 499, 501, 515, 527.  
 Church, 118, 323, 477, 515.  
 Circumcision, 276, 283, 450.  
 Cleopatra, 94.  
 Cleophas, 83, 93, 395.  
 Cloth, 60.  
 Cloud, 110.  
 Coat, 523.  
 Cock crow, 174, 384, 386, 498.  
 Coming of Christ, 380.  
   *See End of world; Judgment.*  
 Commandment, 31, 125, 144, 324, 501.  
 Common, 222.  
 Conception, 10.  
 Confession, 19.  
 Continency, 124.  
 Corban, 100, 223.  
 Corbona, 181.  
 Corluy, 495.  
 Cornely, 383.  
 Correction, 117.  
 Conceit, 67.  
 Counsels, 125.  
 Courses, 266.  
 Covetousness, 334, 357.  
 Cross, 69.  
 Crucifixion, 184, 254.  
 Cubit, 43, 532.  
 Cumin, 148.  
 Custom house, 58.  
 Cyril, St., 340.  
 Cyrinus, 279.  
 Dalmanutha, 104, 227.  
 Dancing, 352.  
 Date, 11, 289, 436.  
 David, 5, 7, 9, 76.  
 Dead Sea, 17, 22, 96.  
 Debtor, 120.  
 Decapolis, 28, 214.  
 Dedication, 319, 343, 439, 478.  
 Defilement, 224, 348, 486.  
 Demoniac, 27, 52, 53, 55, 62, 79, 112, 200, 201, 207, 213, 214, 233, 314.  
 Denarius, 142, 249, 310, 326, 349, 371, 447.  
 Desert, 17, 22, 96, 199, 219.  
 Desire, 382.  
 Detachment, 65.  
 Devil, 23, 24, 25, 63, 80, 83, 107, 120, 323, 459.  
 Didrachma, 114.  
 Didymus, 482.  
 Disciple, 74, 321, 323, 346, 457.  
 Dispersion, 461.  
 Divinity of Christ, 21, 23, 24, 57, 75, 98, 106, 124, 145, 178, 214, 329, 394, 407, 417, 423, 424, 431, 441, 442, 444, 456, 469, 477, 479, 480, 484, 486, 491, 495, 498, 499, 500, 501, 502, 507, 512, 513, 516, 517, 530.  
 Division, 337.  
 Divorce, 34, 35, 121.  
 Doctors of the Law, 13, 144.  
 Door, 475.  
 Dust, 66.  
 Eagles, 365.  
 Earthquake, 189.  
 Edersheim, 32.  
 Egypt, 12, 14, 15, 16.  
 Elder, 13, 27.  
 Elect, 46, 342, 366.  
 Eleven, 306.  
 Eliachim, 8.  
 Elias, 23, 73, 104, 106, 110, 111, 112, 231, 268, 412.  
 Elizabeth, 17, 266.  
 Embalming, 391.  
 Emmaus, 259, 393, 394, 395.  
 End of world, 152, 153, 154, 155, 156, 157, 158, 378, 379. *See Coming of Christ; Judgment.*  
 Ennon, 429.  
 Ephraim, 16.  
 Ephrem, 486.  
 Essenes, 19.  
 Estha, 9.  
 Eternity, 469.  
 Eucharist, 172, 382, 383, 395, 449, 455, 481, 493, 496, 525.  
 Evening, 96.  
 Exorcism, 319.  
 External sins, 34.  
 Extreme Unction, 218.  
 Faith, 51, 57, 61, 69, 98, 113, 129, 215, 232, 259, 311, 363, 369, 428, 452, 453, 456, 498, 513.  
 Farthing, 33, 68, 333.  
 Fasting, 22, 41, 59, 113.  
 Father, Eternal, 21.  
 Fear, 68.  
 Fidelity, 355.  
 Fig-tree, 135, 240, 339.  
 Finding in Temple, 288.  
 Fire, 337.  
 First, 130.  
 Flight into Egypt, 12, 14.  
 Flock, 335.  
 Forgiveness, 33, 57, 81, 120, 311, 390.  
 Fornication, 467.  
 Fouard, 121, 458.  
 Franzelin, 477.  
 Fraud, 149.  
 Fringes, 146.  
 Funeral, 61.  
 Furlong, 448, 483.  
 Gabriel, 267.  
 Gadara, 54.  
 Galileans, 339.  
 Galilee, 11, 20, 25, 26, 70, 94, 99, 109, 113, 121, 174, 200, 287, 290, 294, 298, 312, 319, 392, 393, 416, 431, 432.  
 Galilee, Sea of. *See Genesareth, Lake of; Tiberias, Sea of.*  
 Gabbatha, 522.  
 Gall, 184.  
 Garizim, Mt., 64, 434.  
 Gate, 341.  
 Gaulanitis, 94.  
 Gehenna, 34. *See Hell.*  
 Genealogy, 58, 293.  
 Generation, 73, 156, 227, 229.  
 Genesar, 98, 99, 102.

- Genesareth, 98.  
 Genesareth, Lake of. See *Lake of Genesareth*.  
 Gentiles, 102, 131, 224, 285, 346, 349, 378, 379, 488.  
 Gerasa, 54.  
 Gerasens, 54, 213.  
 Gergesa, 54, 213.  
 Gethsemani, 174, 175.  
 Gifts, 14, 50, 148.  
 Glorified body, 396, 527.  
 Golgotha, 183. See *Calvary*.  
 Gomorrah, 66.  
 Good, 124.  
 Good Shepherd, 474, 475, 476, 477.  
 Gospel, 198, 229.  
 Grace, 270, 433, 452, 504.  
 Grave, 482, 484.  
 Gregory, St., 530.  
 Groan, 484.  
 Groat, 349.  
 Guards, 192.  
 Guest, 311.  
  
 Hallel, 174.  
 Ha-Ramathaim, 391.  
 Harvest, 62.  
 Heathens, 118.  
 Heaven, 91, 164, 498, 499.  
 Hebron, 273.  
 Heli, 8, 9.  
 Hell, 20, 34, 52, 74, 91, 164, 234, 358, 359.  
 Hermon, Mt., 109.  
 Herod Antipas, 11, 25, 94, 95, 106, 142, 199, 218, 219, 290, 342, 388, 389.  
 Herod Agrippa, the Elder, 11, 131, 153.  
 Herod Agrippa, the Younger, 11, 67, 105.  
 Herod Philip, the Elder, 25, 71, 95, 199.  
 Herod Philip, the Younger, 94, 95, 290.  
 Herod the Great, 11, 13, 14, 15, 16, 17, 71, 94, 105, 134, 142, 151.  
 Herodians, 142, 206.  
 Herodias, 71, 95.  
 High-priest, 13, 50, 290, 485.  
 Hilary, St., 382.  
 Hillel, 34, 99, 121, 222.  
 Hinnom, 34.  
 Holy Ghost, 10, 21, 22, 272, 462, 501, 505, 506, 508, 509, 529.  
 Horns of Hattin, 29, 208.  
 Hosanna, 134.  
 Hospitality, 344.  
 Hour, 185, 248, 255, 415, 420, 432.  
 House, 14.  
 House tops, 68.  
 Humanity of Christ, 489.  
 Humility, 75, 115, 124, 132, 147, 344, 361, 493.  
 Husks, 350.  
 Hypocrites, 38, 45, 105, 338, 341.  
  
 Idumea, 16, 94, 207.  
 Incarnation, 10, 409, 410.  
 Incense, 267.  
 Indefectibility, 193.  
 Infallibility, 146, 384.  
 Inheritance, 333.  
 Innocents, 11, 15, 16.  
 Inspiration, 138, 301, 531, 535.  
 Intention, 42, 330.  
 Internal sins, 34.  
 Irenaeus, St., 469.  
 Isaac, 5.  
 Ituraea, 94, 95, 105, 290.  
  
 Jacob, 9.  
 Jaffa (Joppa), 105.  
 Jairus, 60, 215.  
 James the Greater, St., 61, 64, 109, 131, 153, 175, 238, 299, 320, 416.  
 James the Less, St., 64, 83, 93, 208.  
 Jansenius, 395.  
 Jechonias, 7.  
 Jeremiah, 106.  
 Jericho, 132, 133, 325, 326.  
 Jeroboam, 16.  
 Jerome, St., 9, 17, 29, 43, 72, 116, 152, 219, 393, 395, 422.  
 Jerusalem, 18, 24, 27, 99, 121, 130, 132, 133, 141, 142, 150, 152, 153, 154, 166, 171, 288, 319, 325, 326, 327, 339, 343, 362, 372, 373, 379, 391, 394, 398, 445.  
 Jesse, 6.  
 Jesus, 10, 271.  
 Jews, 224, 349, 379.  
 Joachim, St., 8.  
 Joakim, 7.  
 Joanna, 312.  
 Joas, 150.  
 John the Baptist, St., 17, 18, 21, 25, 26, 59, 70, 71, 72, 73, 94, 95, 96, 106, 112, 136, 199, 218, 219, 231, 268, 273, 275, 276, 290, 292, 345, 346, 408, 411, 412, 413, 414, 415, 429, 430, 444, 480.  
 John the Evangelist, St., 26, 61, 109, 131, 1153, 175, 190, 191, 233, 238, 299, 320, 393, 410, 416, 496, 518, 524, 527, 532, 534, 535.  
 Joiada, 150.  
 Jonas, 82.  
 Joram, 6.  
 Jordan, 17, 26, 28, 121, 130, 236.  
 Josias, 7.  
 Joseph, St., 8, 9, 12, 14, 16, 93, 270, 280, 285, 288, 289, 417, 524.  
 Joseph of Alpheus, 83, 93.  
 Joseph of Arimathea, 187, 391.  
 Josephus, 11, 16, 19, 54, 71, 153, 220, 240, 280.  
 Josue, 10, 104.  
 Juda, 13, 14, 15.  
 Judas Iscariot, 64, 166, 167, 172, 173, 176, 181, 208, 382, 456, 457, 487, 494, 495, 496, 514.  
 Judas of Galilee, 152, 359, 475.  
 Jude, St., 64, 83, 93.  
 Judea, 11, 13, 16, 17, 18, 25, 94, 121, 236, 298, 391, 322, 431, 432.  
 Judge, 333.  
 Judgment, 32, 44, 48, 126, 149, 159, 163, 164, 332,

- 364, 379, 418, 442, 464,  
473, 489, 491, 492, 499.  
Julius Africanus, 8.  
Just, 266.  
Justice, 21, 32, 38.  
Jutta, 273.
- Kepler, 13.  
Kersa, 54.  
King, 520.  
Kingdom, 108, 131.  
Kingdom of God, 17, 44,  
139, 244, 363.  
Kingdom of Heaven, 17,  
65, 72, 73, 90, 92, 115,  
119, 124, 128, 140.  
Knowledge of Christ,  
287, 424, 458, 459, 517.
- Lamentation, 343.  
Lamb of God, 414.  
Lamps, 336.  
Lake of Genesareth, 74,  
84, 114, 204, 220, 298,  
446.  
Last, 130.  
Law, 21, 31, 32, 34, 46,  
144, 356.  
Lazarus, 61, 166, 480, 481,  
482, 483, 484, 485, 486.  
Leaven, 90, 105.  
Le Camus, 9, 29, 100, 109,  
123, 175, 187, 299, 308,  
484, 492, 502.  
Legion, 214.  
Leo the Great, St., 12.  
Lepers, 49, 202, 299, 362.  
Levi, 58, 204.  
Levirate law, 7, 8, 143.  
Levite, 325.  
Liberty of Christ, 477.  
Liby-Phoenicia, 102.  
Light, 31, 408, 409.  
Limbo, 358.  
Lithostrotos, 522.  
Little ones, 70, 75.  
Locusts, 18, 199.  
Loins, 335.  
Lord's prayer, 40, 327.  
Lysanias, 290.
- Machabees, 19.  
Machaerus, 71, 96, 219.  
MacRory, 476, 477, 489,  
496.
- Madness, 208.  
Magdala, 104, 186, 312.  
Magdalen, St. Mary, 104,  
133, 135, 166, 186, 187,  
188, 190, 191, 257, 309,  
311, 312, 326, 327, 396,  
487, 526, 527, 528.  
Magedan, 104, 227.  
Magi, 11, 12, 13, 14, 15,  
287.  
Malachy, 106, 111, 112.  
Malchus, 176.  
Maldonatus, 115, 299, 319,  
347, 418, 434, 435, 444,  
456, 477, 489, 494, 501,  
505, 529.  
Mammon, 42, 355.  
Manger, 281.  
Manna, 451.  
Mariamne, 95.  
Mark, 171, 252.  
Marriage, 122, 236.  
Martha, 133, 135, 166, 326,  
327, 483.  
Mary, Blessed Virgin, 9,  
83, 84, 93, 270, 280, 285,  
286, 287, 288, 289, 329,  
419, 420, 523, 524.  
Mary of Alpheus, 83, 93,  
186, 187, 188.  
Master, 298, 362.  
Mathan, 9, 293.  
Matthew, 58, 64, 204.  
Measure, 421.  
Mediterranean, 27.  
Melchi, 9.  
Mercy, 58, 77, 120, 164,  
291.  
Merit, 245.  
Messiah, 53, 61, 71, 77,  
98, 106, 111, 178, 416,  
434, 435, 478.  
Mill stone, 116.  
Minstrels, 61.  
Mint, 148.  
Miracles, 27, 50, 52, 54,  
55, 57, 60, 61, 62, 71, 78,  
82, 96, 97, 103, 110, 112,  
132, 201, 202, 213, 214,  
217, 220, 225, 226, 228,  
299, 306, 314, 317, 340,  
362, 369, 421, 422, 424,  
438, 440, 444, 448, 470,  
480, 485, 500, 517, 532,  
533.
- Miracles, gifts of, 65, 323.  
Mite, 245.  
Mna, 371.  
Moloch, 34.  
Mommson, 280.  
Moses, 19, 23, 110.  
Mountain, 24, 113.  
Mulberry tree, 361.  
Murder, 150.  
Murderer, 467.  
Mustard seed, 89, 113.  
Myrrh, 184, 525.
- Naasson, 6.  
Naim, 305, 308.  
Nathan, 7, 9.  
Nathanael, 302, 416, 417.  
Nativity, 281.  
Nazareth, 12, 16, 17, 20,  
25, 56, 78, 93, 109, 216,  
217, 288, 296, 297, 417.  
Nazarite, 16.  
Nephtalim, 26.  
Neri, 7.  
Nicodemus, 425, 462.  
Number of saved, 46.
- Oaths, 35, 36, 148.  
Obedience, 494.  
Olivet, Mt., 133, 152, 161,  
165, 175, 246, 385, 398,  
463.  
Origen, 12, 17, 328.  
Original sin, 268, 274.  
Ozias, 6.
- Palm Sunday, 133, 487.  
Parables, 83, 85, 86, 101,  
108, 210, 224, 242, 334,  
344, 361.  
Parable of the Barren  
Fig-tree, 339.  
— of the Candle, 31.  
— of the Cloth and  
Bottles, 60.  
— of the Cockle, 88.  
— of the Draw net, 92.  
— of the Fig-tree, 156.  
— of the Friend and  
the Loaves, 328.  
— of the Good Sa-  
maritan, 325.  
— of the Great Sup-  
per, 345.

- Parable of the Hidden Treasure, 91.  
 — of the Householder, 248.  
 — of the House on the Sand and on the Rock, 48.  
 — of the Laborers in the Vineyard, 127.  
 — of the Leaven, 90.  
 — of the Lost Coin, 349.  
 — of the Lost Sheep, 348.  
 — of the Marriage Feast, 140.  
 — of the Mustard Seed, 89.  
 — of the Pearl, 92.  
 — of the Pounds, 161, 370.  
 — of the Pharisee and the Publican, 366.  
 — of the Prodigal Son, 349.  
 — of the Rich Fool, 334.  
 — of the Rich man and Lazarus, 357.  
 — of the Seed Growing Secretly, 211.  
 — of the Servants Watching, 335.  
 — of the Sower, 85.  
 — of the Talents, 161.  
 — of the Ten Virgins, 159.  
 — of the Tower, 347.  
 — of the Two Debtors, 310.  
 — of the Two Servants, 158.  
 — of the Two Sons, 137.  
 — of the Unjust Judge, 366.  
 — of the Unjust Steward, 353.  
 — of the Unmerciful Servant, 119.  
 — of the Unprofitable Servants, 361.  
 — of the Vineyard and the Husbandmen, 375.
- Parable of the Wicked Husbandmen, 137.  
 — of the Wise Steward, 336.  
 Paraclete, 500.  
 Paradise, 358.  
 Parasceve, 391, 522.  
 Parents, 100.  
 Pasch, 99, 165, 171, 182, 187, 254, 287, 341, 382, 422, 424, 439, 446, 447, 486, 496.  
 Passion, 110, 113, 121, 131, 176, 230, 238, 318, 364, 385, 476, 490, 512, 515.  
 Patience, 378.  
 Patrizi, 191, 477, 533.  
 Peace, 502.  
 Penance, 218, 529.  
 Penny, 120, 128, 142, 220, 249, 310, 326, 447.  
 Pentecost, 166, 287, 422, 439, 446.  
 Peraea, 11, 26, 94, 95, 121, 130, 207, 319, 322, 341, 342, 346, 480.  
 Perpetuity, 193.  
 Persecution, 67, 153, 237, 507.  
 Persia, 11.  
 Peter, St., 26, 52, 61, 63, 98, 106, 109, 114, 118, 127, 153, 174, 176, 179, 190, 191, 201, 228, 257, 299, 384, 393, 395, 396, 416, 456, 493, 497, 517, 518, 519, 527, 532, 533, 534.  
 Phadaia, 7.  
 Phares, 6.  
 Pharisee, 19, 25, 32, 59, 73, 78, 99, 145, 307, 342, 350, 352.  
 Philadelphia, 28.  
 Philip, St., 416, 499.  
 Phoenicia, 102.  
 Phylacteries, 146.  
 Pilate, Pontius, 131, 181, 254, 290, 339, 388, 389, 519, 520, 521, 522, 525.  
 Pius VI., 428.  
 Pound, 371.  
 Poverty, 126, 335.  
 Power, 193.
- Prayer, 39, 45, 46, 103, 113, 118, 147, 176, 202, 221, 241, 248, 317, 327, 365, 366, 472, 505, 514.  
 Preaching, 26, 62, 260.  
 Predestination, 163, 324.  
 Presentation, 12, 284.  
 Pride, 323.  
 Priests, 19, 136, 322, 362, 539.  
 Primacy, 63, 106, 118, 533.  
 Prince of Peace, 69.  
 Probatica, 439.  
 Profanation, 45.  
 Prophecies, 71, 72, 78, 79, 87, 90, 100, 134, 174, 177, 181, 184, 198, 223, 231, 271, 278, 295, 296, 310, 373, 375, 385, 395, 397, 398, 412, 413, 444, 476, 488, 490, 491.  
 — of Christ, 384, 385, 427, 445, 466, 488, 490, 495, 498, 505, 507, 509, 514, 524, 525.  
 Prophets, 47, 70, 72, 144, 149, 242, 343, 434, 437, 460, 462, 485.  
 — false, 153.  
 Proselyte, 148.  
 Providence, 43, 68, 378.  
 Publicans, 37, 118, 291, 350.  
 Punishment, 48, 150, 163, 337, 504.  
 Purgatory, 33, 81.  
 Purification, 283.  
 Purim, 439.
- Quarters, 354.
- Rabbi, 27, 146, 298, 415, 528.  
 Raca, 33.  
 Rachael, 16.  
 Rama, 15.  
 Regeneration, 126, 425, 426.  
 Relics, 98.  
 Repentance, 20, 117, 120, 338, 348, 349, 351.  
 Resurrection, 61, 82, 131, 143, 144, 186, 189, 306, 360, 397, 423, 442, 443, 483, 484, 485, 527.

- Reviviscence, 120.  
 Reward, 237, 324, 356, 371.  
 Reza, 7.  
 Riches, 124, 125, 359.  
 Ring, 351.  
 Robe, 351.  
 Room, Upper, 250.  
 Ruler, 340, 438.  
 Ruth, 6.  
  
 Saba, 83.  
 Sabbath, 52, 76, 78, 153, 188, 206, 256, 295, 301, 341, 343, 392, 440, 460, 471.  
 Sackcloth, 74.  
 Sacrifice, 58, 77.  
 Sadducees, 19, 104, 143, 359.  
 Sadoc, 19.  
 Sadoc the Pharisee, 475.  
 Saints, Communion of, 349.  
 Salathiel, 7, 9, 293.  
 Salome, 95, 131, 187.  
 Salt, 30, 235, 347.  
 Salvation, 285.  
 Samaria, 11, 16, 94, 319, 320, 322, 432.  
 Samaritans, 64, 362, 432, 433, 434, 435, 468.  
 Sanhedrim, 13, 32, 99, 108, 136, 166, 177, 412.  
 Sarephta, 95.  
 Saturninus, 279.  
 Scandal, 34, 94, 114, 116, 153, 174.  
 Scourging, 183, 254, 389, 422, 521.  
 Scribes, 13, 32, 73, 99, 100, 144, 149, 331.  
 Scriptures, 444.  
 Scythopolis, 28.  
 Sea, Dead, 17.  
 — of Galilee, 26, 56, 96, 103, 204.  
 — of Tiberias. See *Sea of Galilee*.  
 Sects, 19.  
 Self-denial, 108.  
 Sepulchres, 55, 149, 187, 188, 257.  
 Sermon on the Mount, 28, 38, 49, 76.  
 Sermon on the Plain, 38, 44, 49, 302.  
 Shammai, 34, 99, 121, 222.  
 Sheep, 65, 67, 117, 474.  
 Shekel, 144.  
 Shepherd, 281.  
 Sichar, 432.  
 Sidon, 102, 103, 207, 224.  
 Sign, 82, 156, 260.  
 Siloe, 339, 470.  
 Silver, 167.  
 Simeon, 284.  
 Simon, 52, 63, 106.  
 — the Cananean, 64, 83, 93, 208.  
 — the Cyrenean, 183, 254.  
 — the Leper, 166, 326, 487.  
 — Magus, 152.  
 — the Pharisee, 307.  
 Sin, 57, 268, 274, 414.  
 Sinners, 58.  
 Slavery, 467.  
 Sodom, 66.  
 Soldier, 292, 517.  
 Son of Abraham, 5.  
 — of David, 5, 61, 79, 134.  
 — of God, 15, 23, 98, 110, 178, 214, 415, 472, 522.  
 — of Man, 53, 77, 81, 106, 108, 231, 418.  
 Spikenard, 487.  
 Stanley, 340.  
 Star, 13, 15.  
 Stater, 114.  
 Stone, 139, 375.  
 Storm, 212.  
 Strife, 383.  
 Suarez, 359, 477.  
 Sunam, 95.  
 Superscription, 184.  
 Supper, Last, 168, 492.  
 Susanna, 312.  
 Sword, 385.  
 Swine, 55.  
 Sycamore, 369.  
 Synagogue, 27, 135, 200, 340.  
 Syria, 27.  
 Syro-Phoenician, 102.  
 Tabernacles, 110, 166, 287, 319, 326, 327, 422, 439, 457, 458.  
 Talents, 119, 161.  
 Tax, 114.  
 Tell-Hum, 96.  
 Temple, 24, 64, 77, 114, 134, 150, 151, 152, 178, 240, 245, 267, 286, 287, 320, 366, 367, 377, 378, 380, 398, 423, 424.  
 Temptation, 22, 23, 175, 244, 324.  
 Tertullian, 279, 497, 498.  
 Testament, New, 173.  
 Thabor, Mt., 16, 109, 192.  
 Thaddeus, St., 64.  
 Tamar, 6.  
 Theft, 149.  
 Theophilus, 266.  
 Theophylact, 326.  
 Theudas, 152, 475.  
 Thieves, 184, 185.  
 Thomas Aquinas, St., 34, 46, 75, 81, 93, 116, 117, 163, 324, 342, 348, 359, 412, 499, 501, 506.  
 Thomas, St., 259, 482, 529, 530.  
 Thorns, Crown of, 183, 521.  
 Tiberias, 29, 219.  
 —, Sea of, 26, 446.  
 Tiberius, 289.  
 Tithes, 148.  
 Titus, 141, 153.  
 Toletus, 522, 530.  
 Tombs, 306.  
 Tonzard, 358.  
 Trachonitis, 11, 94, 95, 290.  
 Tradition, 99.  
 Traffickers, 135, 374, 422, 423.  
 Transfiguration, 109, 115, 121, 230.  
 Transubstantiation, 173.  
 Treasure, 42.  
 Treasury, 245, 465.  
 Trench, 120, 159, 334.  
 Trent, Council of, 428, 463, 529, 531.  
 Trials, 182, 387.  
 Tribute, 142.



- Truth, 520.  
Tyre, 102, 103, 207, 224.
- Ulpianus, 280.
- Varus, 280.  
Vatican, 'Council of, 533.  
Veil, 186.  
Vine, 503.  
Vinegar, 185.  
Vineyard, 340.  
Virginal Birth, 9, 10, 271.  
Virginity, 270.  
Vision of God, 412.  
Vocation, 321, 504.
- War, 153.  
Washing of feet, 493.  
Watches of the night, 97,  
336, 448.  
Watchfulness, 158, 160,  
248, 380.  
Waterpots, 421.  
Weddings, 59, 159, 336.  
Well, Jacob's, 432.  
Wept, 373, 484.  
Westcott, 455.  
Wheat and chaff, 20.  
Wine, 184.  
Wisdom, 74, 287.  
Wise man, 149.  
Woes, 147, 148, 149, 323.
- Woman, 419, 420, 524.  
Women, 392, 436.  
Wood, 390.  
Word, 273, 406.  
Works, good, 428.  
Worship, 435.  
Yoke, 75.  
Zabulon, 26.  
Zacheus, 369.  
Zacharias, 150.  
Zachary, 266, 269.  
Zara, 6.  
Zebedee, 131.  
Zorobabel, 7, 9, 293.  
Zumt, 280.

704218

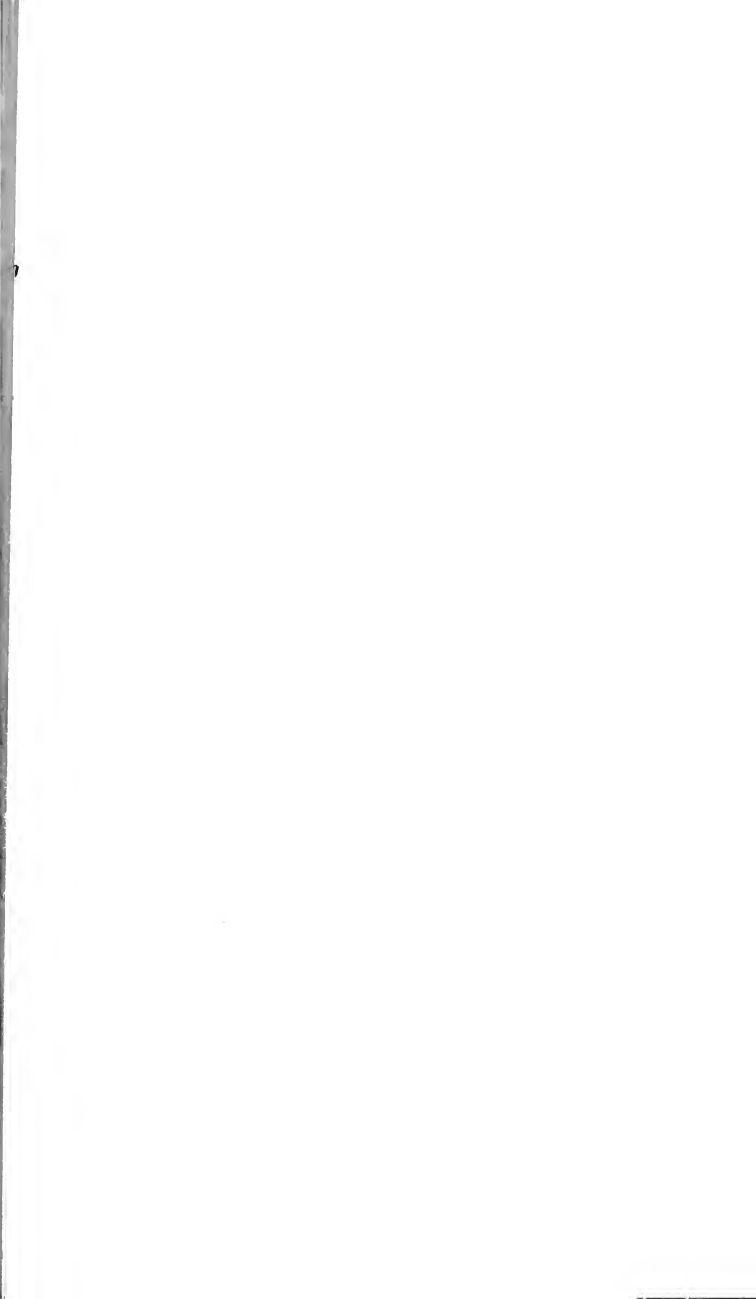



Oct. 25, 1918

Bible. N.T. Gospels. English.  
1918.

B3  
2555  
.025-

The four Gospels.

