

# FREE-HAND DRAWING.

A  
0  
0  
0  
6  
4  
7  
3  
4  
0  
9



UC SOUTHERN REGIONAL LIBRARY FACILITY

254/10<sup>00</sup>

OH Allis

Philadelphia

The author of this book  
Spent his life in teaching -  
and no doubt encountered  
many stupid students -

It never occurred to him  
that his way of teaching was  
calculated to make easy  
things difficult - and  
simple things unintelligible

Digitized by the Internet Archive  
in 2007 with funding from  
Microsoft Corporation



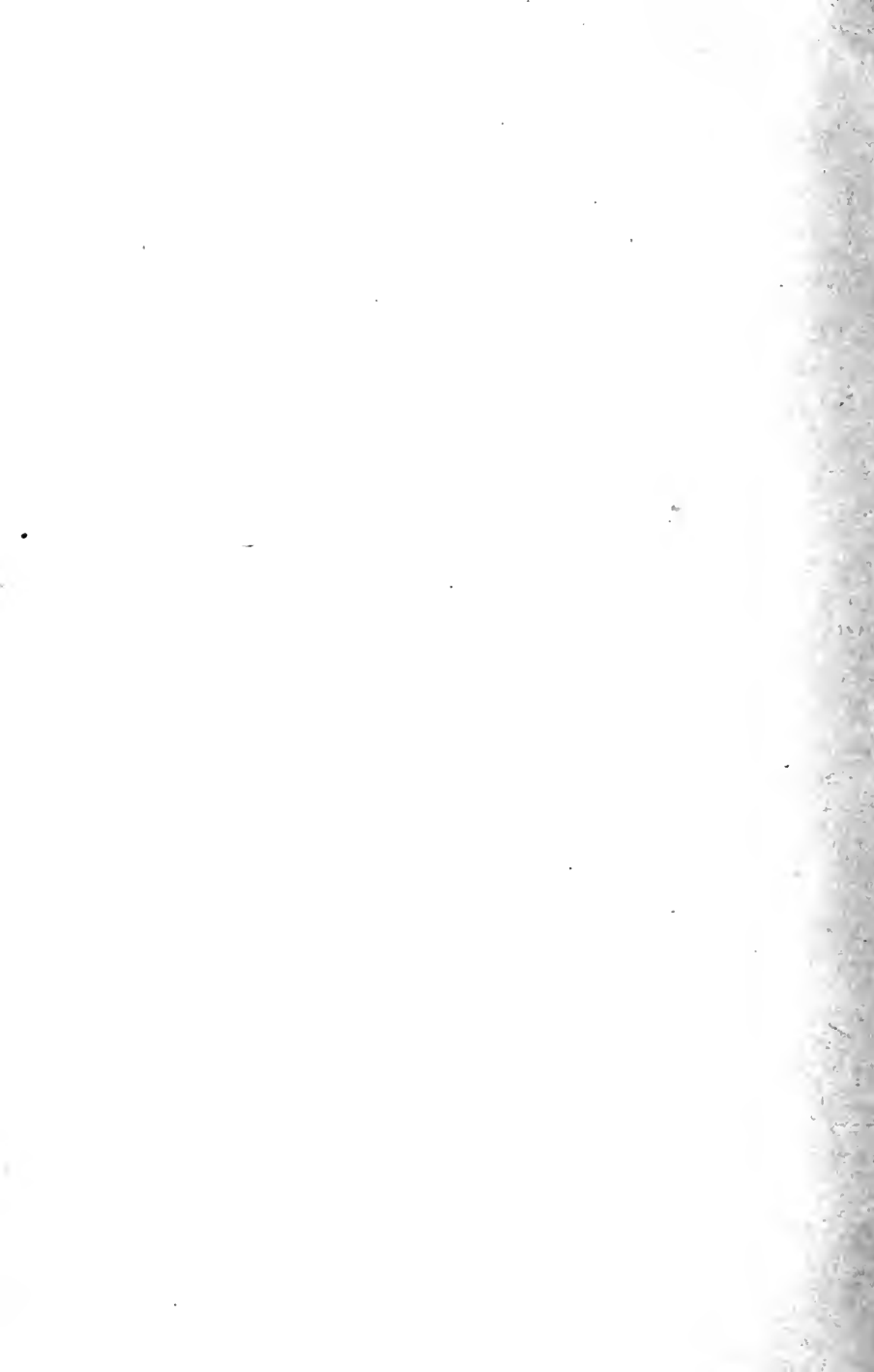

# FREE-HAND DRAWING

LIGHT AND SHADE

AND

FREE-HAND PERSPECTIVE

*FOR THE USE OF*

*Art Students and Teachers*

BY

ANSON K. CROSS

INSTRUCTOR IN THE MASSACHUSETTS NORMAL ART SCHOOL AND IN THE SCHOOL  
OF DRAWING AND PAINTING, MUSEUM OF FINE ARTS, BOSTON

*ILLUSTRATED BY 32 PLATES*

BOSTON

PUBLISHED BY THE AUTHOR

1892

COPYRIGHT, 1892,

By ANSON K. CROSS.

---

ALL RIGHTS RESERVED.

TYPOGRAPHY BY J. S. CUSHING & Co., BOSTON.



Plate I.

FIG. 1.  
THE  
DRAWING.

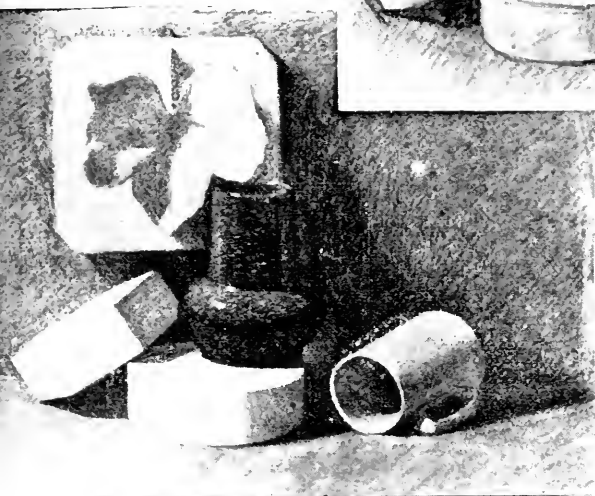
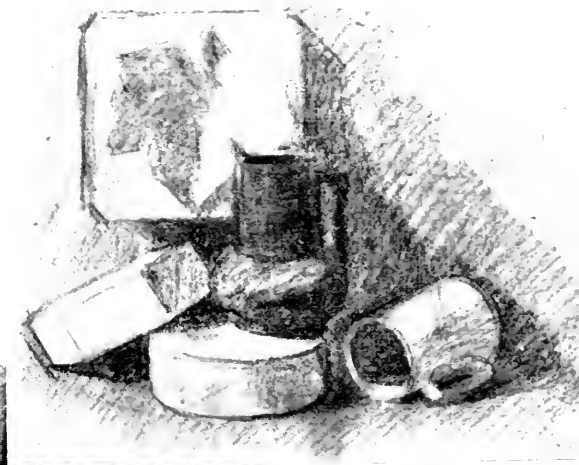

FIG. 2.  
THE  
MASSES.

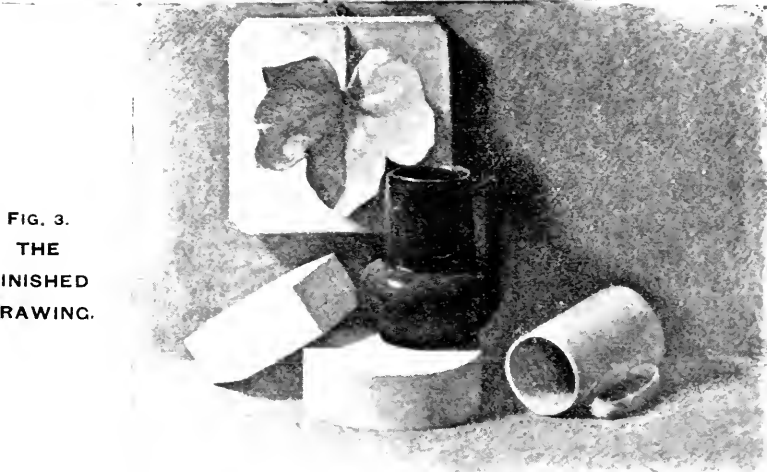

FIG. 3.  
THE  
FINISHED  
DRAWING.

4

TO  
MY FRIEND AND FIRST TEACHER

Robert W. Fernald

I INSCRIBE THIS BOOK  
IN RECOGNITION  
OF HIS EFFORTS TO ADVANCE  
SERIOUS AND CONSCIENTIOUS  
STUDY OF NATURE



## PREFACE.



THE notes on Model Drawing, forming the body of this book, were prepared for the use of the students of the Massachusetts Normal Art School. They were printed without illustrations, as explanations of the drawings given in the course of lectures on this subject, and will be of little assistance to those not taking the lectures. Having been requested for the book by persons not students of the school, and realizing that drawing is often poorly taught, especially in our public schools, and being unable to recommend a book which treats the subject simply and presents artistic methods of work, I concluded to rewrite the notes, adapting them to general use, and meeting, as far as possible, the demand for a text-book on the principles of free-hand drawing.

The book is intended especially for teachers, and at first glance the artist may think it considers more theory than is necessary. No one can be more strongly convinced than I, of the folly of teaching and depending upon theory alone. I believe that theory is of use only

to the artist who can draw without it. To such a person and to the teacher, theory may be of great assistance. The artist who should depend upon theory instead of upon his eyes, would certainly be very unwise, and would probably produce unsatisfactory work. If his work consisted simply in drawing from Nature, and from subjects before him exactly as they are to be represented, he would have little need of theory, and could safely depend upon his eyes; but the artist often has to design and draw without a subject before him, and for this work he must depend upon his knowledge. If this has been arranged under a few simple rules which he has discovered while drawing from Nature, he will draw with more freedom and far greater accuracy than when without these helps.

If his mind is so constructed that he cannot discover and apply the few rules necessary for this work, it is quite likely that his time will be more profitably spent in some other direction; for the rules of perspective which the artist requires are so simple as to be easily given in a few sentences. From the standpoint of the artist, then, there may be more theory than is needed, but the teacher of much experience will not find this true.

Every teacher has found the bright, thoughtful student who has asked questions of which the teacher has never thought. Nearly all the points considered in these notes

have been suggested by such questions, which have been referred to me. It is impossible to furnish answers to all the questions which the teacher is likely to be asked, but the main points can be covered, and these understood, other questions depending upon them can be readily met.

Though intended for the teacher and student, the subject-matter is to a greater or less extent interesting to the artist, the illustrator, and others who may not have the knowledge of Projection and Scientific Perspective necessary to follow some of the problems considered. The problems requiring this knowledge are more important to the teacher than to the artist, and it is hoped that the average art student may find the simpler problems suited to his capacity and his needs, and that those not interested in the scientific discussions will study the parts intended for them.

The teacher may feel inclined to criticise the way in which the free-hand part of the subject is presented. He may desire a rule as to which line to draw first, which second, etc. He may not wish to cultivate his feeling to such an extent as to cast aside conventional methods of working. He may upon consideration acknowledge the methods advised to be more artistic, but he may say that they are harder to teach. There is no question but that artistic feeling and correct taste are difficult to obtain, but surely this is no reason why we should not

cultivate the small amount of taste which the students may possess, no reason for choosing conventional and mechanical methods which must destroy artistic feeling.

An artistic method is difficult to teach to students who have been taught an inartistic one, and the change will involve a struggle on the part of both pupil and teacher; but I do not admit that it is more difficult to start right than to start wrong, and the objections of those who have to change old methods will last only as long as they refuse to change. I believe that the easiest and the best time to train the eye to see is in the beginning, when the mind has not been so developed as to perform nearly all the duties of the eye. If there were any way by which less knowledge of the things seen could be awakened, it would be unnecessary for the student to spend many years of severe labor to enable himself to see, and not to reason the appearance of Nature; but until the training of the mind to accept the story of the eye is made as complete as, and begins with, the training of the mind concerning facts, the art student will in truth find that "Art is long."

There is no good reason for postponing this training until the student decides to make Art his profession, and when it is realized that the teacher in charge of art education in the public schools has a most important position, the first step in advance will have been made. Ability to talk well and intelligently of general matters,



and even of art as presented by various writers, does not constitute this special fitness ; neither does the ability to draw pretty things upon the blackboard, nor to explain the course as arranged in a set of text-books ; and even the faculty of planning and carrying out a course so as to produce an interesting exhibition of drawings, fancy work, manual training, etc., is not enough. All these things are important, but of greater importance is personal artistic feeling and practical ability in art, involving more study than most who are teaching in the public schools have been able to give. Without this training, which alone can enable one to justly realize the end of his teaching and thus to work from the first for this end, the instruction given must be unnecessary, mechanical, illogical, and harmful.

I do not wish to disparage the valuable results which have been accomplished, nor to criticise the teachers who have worked so faithfully in this field. I wish simply to encourage those now in the work to look for its artistic qualities as much as possible, and to advise those intending to take up the study to obtain good art training, and not to accept as a good reason for proceeding in a certain way the fact that all authorities of the past have done thus. The influence of the honest impressionist is being felt. We are beginning to use our own eyes instead of those of other people, who in like manner have depended upon others, and the time is at hand when in

spite of the present ridicule of those who have never learned to see, the honest student of appearances will be appreciated, and those who ridicule will be forced to study or to step into the background.

## CHAPTER I.

### TRAINING OF THE ART STUDENT.

MUCH has been said and written concerning this subject, but there seems to be no more unanimity of opinion than in the past. I should hesitate to say anything upon this point, if the subject of art instruction could be considered in part ; but this is impossible. The influence of the higher art instruction is felt through all the earliest attempts in this direction, and the matter of art instruction in the public schools is in its present chaotic condition largely through the contradictory teachings of many advanced art schools.

I am aware that my opinions are very different from those of some who have established reputations as writers and teachers, but I also know that others will agree with me. The variety of opinions upon this subject is due to the different individualities and to the lines of training pursued. The average person changes faith in religion, Art, or any subject long considered very rarely. Prejudice and unquestioning faith in the doctrines in which

we have been educated prevent even consideration of the opinions of other people.

The ability to think and act independently is possessed by the few who lead. Thus it is that we recognize in the work of an artist the technique of the teacher with whom he has studied, and find him frequently unable to see merit except in his favorite school; and some are unable to separate the result from the way by which it was produced, the method being of greater importance than the result.

The tendency in this direction increases as the ability decreases, and is strongest among those who direct art instruction in the public schools. This is the result of teachers, who have given great attention to the best methods of teaching the ordinary branches, attempting to teach art when they know nothing of it, and naturally arises from the necessity which exists in most places for the regular teachers giving the lessons in drawing. I will consider this work by itself, but I wish now to express the impossibility of formulating systematized schemes arbitrarily fixing details of art work, and rules by which it is to be judged as good or bad.

I have known of teachers who have told their students that all methods but a certain way of working or using a medium were out of date, and that drawings made in these ways were necessarily bad. I have seen the attempt to produce work in accordance with some such

plan result in atrociously bad drawings, which nevertheless were to be admired because done according to the latest and only approved method. Some, for instance, now say that a charcoal drawing must be made entirely with the point of the charcoal, and that if the drawing shows any blending, it is not good. Such a statement results only from the ignorance which looks at the paper and charcoal instead of for the effect or the impression the drawing is intended to convey.

The problem for the art student to master is drawing, — it is drawing whether he uses the pencil in an outline sketch, the charcoal in a shaded sketch, or the brush and color. Though new colors may be discovered, the problem is practically what it has been for hundreds of years, during which time almost all ways and means of producing a drawing have been tried and used successfully by those who have practised art. The strong artists of the past did not confine themselves to one medium or to one way of using it. They worked with pencil, crayon, pen and ink, chalk, water color, oil, and other mediums, apparently often using that which was handiest. Their aim was not the way of using the medium, but the expression of an idea, and this must be the only end worthy of the best effort of the artist.

Too much importance is laid on technique and the way the story is told. It is even said that in looking at a picture, we should first see how it is painted, as if the

kind of canvas, the thickness or thinness of the paint, and how it is applied, concerns the public. As well might we say that we must analyze the peach to decide whether or no we like its flavor; or formulate a theory of color to decide if the color of its skin is agreeable; or analyze the sentences of an orator before we can permit ourselves to be moved by his eloquence. The question of technique should be accorded the importance which it deserves, and it deserves very little. If a picture tells its story well, and is pleasing in color and sentiment, it must be good whether painted with much labor or quickly, whether the paint is thick or thin, rough or smooth. When the public realizes that it is not methods but results which constitute art, a great advance will have been made.

The question of how the picture is painted should concern only the artist and the advanced student, for they are interested in its practical construction as a builder is interested in that of the houses which he sees.

To the student, a study of the ways in which other painters have secured results serves as a guide and corrective. But it is important to observe that strong painters work in many different ways, and pictures even by the same artist are entirely different in their handling. Study of the technique of others will soon convince the student that there is more than one way to paint.

The artist should understand all the details of his work

as fully as the workman in any of the industrial arts understands the use of his tools, but to produce the best work he must express his own personality.

Undoubtedly the first requisite for the student is to be able to represent Nature truly, and this is a point beyond which very few can expect to pass ; for the poetic temperament is rare, and without it the artist can simply study Nature. If possessed of this temperament, he must still be able to represent Nature as she appears, in order to exercise his higher faculties in the painting of compositions and imaginative subjects. The ability to represent Nature truthfully is the first step for the student, and he should be satisfied to study her seriously until he has attained a high degree of perfection. It is so often said that the aim of art should be not reproduction but idealization, that the student is likely to be deceived, and to attempt to produce the ideal before he can truthfully represent Nature. It cannot be contradicted that the higher is possible only through the lower, and the student must be satisfied to study until he can give easily and truthfully form, color, and values, — in short, effects. To produce a great work of art the mind must be given entirely to the result. This cannot be done if the attention is frequently diverted by drawing, light, and shade, and color. Through these the painter should express himself, as unconscious of means as the orator through words.

It is not meant that the final aim of the student should be the power of photographically delineating Nature, but that careful study of drawing, values and color should be considered necessary to the advanced and more valuable work where the artist is free to express his feeling.

“ Reproduction is impossible. We cannot “ paint ” even  
 “ the simplest object. We can only paint what may create  
 “ a more or less truthful impression of it. Many of Nature’s  
 “ effects are far beyond the possibilities of the palette, and  
 “ art must be acknowledged to be not reproduction. The  
 “ artist is thus justified in using whatever means may best  
 “ answer his purpose of creating an impression of the ideas  
 “ Nature creates in him, and in his highest work it is a  
 “ question not only of what he sees, but of what he feels.

*The common steps in the work of the art student are*

1st. Drawing in outline from Nature and sometimes from flat copy.

2d. Light and shade in charcoal from casts, the antique and still life.

3d. Study from life in charcoal.

4th. Color study from still life, life and Nature.

There is no question but that the color sense is the most difficult to cultivate, and is very rare at the present time. The deficiency in color perception is probably due to lack of training in this direction. If the education of the color sense were begun earlier, undoubtedly much good



would result, and it may be true, as some have suggested, that if the first instruction were in the use of color, far greater progress would be made.

The great difficulty is that before art instruction is given, the students have obtained a very practical knowledge of both the actual form and its absolute color. The knowledge of the form prevents the acceptance of its appearance, and the mind is trained to accept the image of the eye only after long-continued efforts. The form is absolute, and if the efforts are continued, almost any one can learn to draw fairly well. The color of the object is absolute, and the mind knows this color as well as the absolute form; but the color appears to change in a much greater degree than the form. The form appears to change according to certain fixed and simple laws, but the color changes according to no laws that can be given; for the same local color may appear an infinite number of different colors according to light and surroundings, and it is far more difficult to prove that a yellow appears blue or green or some color not yellow to a student who cannot see it, than it is to prove that a horizontal line below the eye appears to incline upward as it retreats.

The tendency of the student who knows theories of anatomy, or perspective, or color is too frequently to work by theory instead of by observation, and it is a question if in many cases he would not be better off without a care-

fully arranged theory for all conditions. Certainly this is so unless he can be made to realize that theory should come last and careful study of Nature first.

Though color is so difficult to realize, it is more important to the artist than any other quality. We see color first. We may not realize the appearance of the color, but we recognize the mass by the color, which is familiar to us through previous observation. Form may be almost obliterated by distance or other conditions, but the color is seen, and through it we know the object. The masses of light and shade are second in importance ; if these are correct, the effect of Nature is given even if the drawing of detail is faulty. This reverses the order in which these factors are often arranged, and according to which drawings are criticised.

Most instruction in drawing has for its end form. It may be that it is of no use to look for color, as some claim, that the student himself will acquire the color sense ; but this certainly is not true of values (the relations of the masses of light and dark) which are more necessary to the effect of a picture than absolute form. That students do not appreciate the masses, or the effect of Nature, is proven by the numbers of pictures which are so cut up by exaggerated detail that the effect cannot be realized at a proper distance. This criticism, more frequently than any other, may be made of the pictures in our exhibitions. The fault is due in part to the

search for form to the exclusion of other qualities, and it seems that the latter which are of so great importance should receive more attention, even if the elaboration of outline and detail at present attained, is not secured.

The training of the art student should be more liberal. Instead of continually working in one medium, as charcoal or crayon, and upon drawings of the same size, he should change the medium or its treatment, and the size of the drawing; and instead of always working for form, it is most important that he look for effect at least part of the time.

Drawing an object or a figure by itself without reference to its surroundings is very good practice in drawing, but this practice alone cannot prepare the student to paint a picture, in which there must be atmosphere, more or less of distance, and in which the proper relations of the parts to each other must be kept. Moreover, this work does not tend to give the student an idea of the simplicity of the masses. It is practice largely in drawing. If instead of representing the figure by dark upon a white surface, the effect of the figure against the background is studied and the background is represented of its proper value, the conventional character of the drawing at once disappears. The result is a picture instead of a drawing. The student is painting with charcoal instead of with color, and is becoming familiar with the problems he must meet in his later work.

When he is not likely to have a long course of study, I should advise that drawing and values be considered in this way in most if not all of his work. If the drawing is from life, very little time is required to indicate the background of its proper value; and in drawing from still life there is no excuse for not making a study of effects. This way is of much more value than that which permits the student in beginning to think of only one thing at a time. When he has formed this habit, it is almost impossible to break away so as to consider the parts with reference to the whole, and he can certainly never look at Nature as he should until he is able to see the masses and effects. The masses are of the greatest importance, and when our students start by observing them, one of the chief difficulties now in their way when they leave the schools will be removed.

The advanced student may sometimes study with advantage form or local values without a background. If his first study has enabled him to see relative values, he may not need farther study in this direction as much as special study, for instance of the figure. In the public schools, evening drawing schools, industrial schools, and all elementary and preparatory schools, values should be considered as important as form, and all work should represent the object and its background.

Another fact which does much to continue bad methods of work is that many art students, even in advanced

schools, are either advised or permitted to work from the part to the whole. Thus in a figure we find them painting the first day the head, the second, the shoulders, and so on, getting on the last day to the feet or possibly not as far as this, the canvas being covered part by part. By such work it is not possible to obtain a harmonious whole. In the first place, it is impossible to determine the effect until the entire canvas is covered ; second, the light and color are constantly changing, the effect being warm the first day, cool the second, and so on. Such a way of working does not consider the effect, and it is a wonder that students trained thus produce as good work as they do.

The endeavor of the artist should be to produce a pleasing effect of color, light and shade, and true values, in short, a satisfactory result. Why should not the training of the student look to these points? If it is to do this, the student must try to express the effect as quickly as possible, so that he may be able to change and bring all the detail into its proper relations. All parts of the drawing should be begun at once, and should be carried along together. It is of little importance how the student works, so long as he has as his aim the quickest possible suggestion of the whole effect. He may draw with charcoal or with the brush, or he may make no preliminary drawing, as some recommend, but he must get the canvas covered and the masses placed in a short space of

time, and in doing this he is working upon the most important part of the drawing all the time, until the effect is fairly obtained.

### *First Study.*

How shall the student who is commencing the study of art best spend his time? What shall he draw and what mediums shall he use? As has been stated, no one method should be permanently adopted to the exclusion of all others. There is value in all, and in his later work he may find it necessary to use many different means of expression. If we accept as well founded the practice of the schools, we shall postpone color, and begin with the pencil or charcoal, making outline or shaded drawings from casts or from geometric objects. In some cases, students begin by copying from the flat. Some benefit may be derived from this work, but it cannot be recommended.

The simplest drawing made from Nature is of more value than the most elaborate copy.

Copying of outlines cannot assist one to see the proportions for original drawings. Copying in other mediums can only assist in the matter of technique, and this should not concern the student at first. His problem is drawing, and the medium which allows him to think of the drawing, and does not require thought about its

handling, is the best for him to use until he can draw fairly well. The pencil or charcoal in outline work, and charcoal in light and shade, are means which enable him to give his entire thought to the drawing, and they should be used until form has been mastered.

He may work from the cast or from geometric objects. The geometric solids can be obtained in complete sets, exactly made and embodying all the type forms.<sup>1</sup> My experience has led me to believe that study from these objects for a few weeks will give greater ability in drawing than a similar amount of time spent in any other way. The lines of a cast or a figure are very fine, and it is more difficult to see them correctly than those of the geometric forms, in which foreshortening and convergence are illustrated in the simplest way. An untrained eye can see the errors of drawing much more easily in a cube or plinth than in the more difficult cast. Moreover, the means for testing the appearance of the geometric forms are so simple that a child can apply them, and discover the errors of his drawing; and when several objects are arranged together, every point is seen in relation to so many other points that this relation cannot be neglected. Thus the drawing involves so many problems that the training it gives is most valuable.

This work will also give a practical knowledge of per-

<sup>1</sup> They may be obtained of art dealers, also a set of vase forms, copied from the ancient Greek.

spective, which will be of great value to the student in all his later work. These subjects seem best for many reasons, but the strongest one is that the use of the thread to cover the various edges and continue them to intersect the opposite edges of the group (see page 74), provides a test so simple that all can apply it, and so sure that it discovers at once all serious errors in the drawing. It makes the student his own teacher, and if he carries on the drawing properly, uses first his eyes, then tests and changes without erasing but by drawing new lines, he will quickly attain ability which will enable him to draw with freedom from any subject.

Frequently the student is first required to draw in outline. Sometimes this may be necessary; but as correct values are second in importance to color, and outlines are of least importance, it seems that when possible he should combine the study of form and values in a light and shade drawing. If at first the attention is to be given to one medium for any length of time, charcoal in light and shade is preferable to outline work, but the best way is an alternation of light and shade with outline, as explained on page 22.

#### *Light and Shade.*

In order for the drawing to be a complete study of values, the subject must be represented with its background. It is not meant that when a group is seen

Value

Value



against other objects, all of these must be carefully drawn, but that the general value of the background as compared with the group should be given. It is well at first to place the objects so that they are seen against simple backgrounds, as a sheet of gray paper or any flat colored material. The group should have a strong light coming preferably from the left and from above. When drawing from the models, which are white, some dark object should always be placed in the group. If this is not done, the student will make the shades too strong, for by contrast with the lights the shades seem very dark when the objects are strongly lighted.

The drawing may be made as follows :—

The size and position of the drawing should first be determined by suggesting with light and rapid strokes the general effect of the mass of the group. This amounts to drawing the rough outline of the group seen as one object, as shown by Figs. 5 and 8. This drawing, as all, should be made by the eye unaided by tests or measurements (page 35). When made, it may be tested by measuring the apparent width and height of the group with the pencil, as explained on page 68. Within these lines the inner lines and the masses of light and dark should next be suggested, the drawing and the light and shade progressing at the same time. The tendency is to draw the outlines and then put in the shade, but it is better to allow the light and shade to help in the draw-

2 145

ing, for the masses of light and dark are more easily seen than the edges, which are often almost invisible in the light or lost in the shade. Then the cast shadows are very important, and of these the outline drawing takes no account. There is no preconceived idea concerning the shapes of the cast shadows, and thus the mind is in a condition to accept without prejudice the image of the eye, and the student will find that the shade and shadow together form masses of dark, which are more easily seen and placed than any other features. These masses being indicated of one value, it is easy to strengthen the darker part and thus bring out the separation or edge, whose direction is often placed much more truly by referring it to the shadow, than it would be by drawing first the outlines and then the shadows.

The masses of dark should be lightly indicated at first, in order that they may be moved about until they are rightly placed. Whatever lines may be drawn as representations of edges should be very lightly sketched, for the same reason. It is much better to change by drawing a new line slightly stronger than the first, and to thus continue until the correct position is secured, than to draw a line and erase as soon as it is found incorrect. Although the student may not see the importance of working in this way, too much stress cannot be placed on the value of the training obtained by bringing the drawing into place without erasing.

Figure 1 gives the appearance of the sketch when the drawing is found to be correct. The charcoal may now be removed from the lights by chamois skin, cloth, bread, or any kind of eraser, and the background may be carried as far as is necessary. This gives the second stage of the drawing, Fig. 2. For some time it will be well not to attempt more than the values of the background, the light (represented by a light tint of charcoal), the shade, and the cast shadow, as in Fig. 2.

The shades and cast shadows together, form dark masses which are opposed to the masses of light made by the surfaces which receive the direct rays of light; and the drawing, Fig. 2, must not be regarded as simply a stage, but as expressing a most important fact which is to be kept in mind in all the later work.

Many students have great difficulty in seeing the variety of light and shade in Nature, and nearly all make very serious errors. A common trouble is the failure to realize the difference between the shades and shadows on different colored objects. Thus the shade side of a white cube is made as dark as that of a red or blue box, and unimportant detail in the mass of either the light or the shade is made so strong as to entirely destroy all the effect, the grays in the light being as strong as the shade, and the reflected lights as strong as the high lights. Such errors will be made by all until the ability to look at the whole and not at a part is secured.

✓ I ←

Value

The effect can be realized only when the entire group is seen at a glance, and to do this the vision must be blurred until all parts are seen equally and necessarily indistinctly. This effect may be obtained with the eyes in focus for a shorter or longer distance than that of the group, and is the same as that given by looking through a lens of twelve or fifteen inches focus. Opening the eyes is better than nearly closing them, for this cuts off most of the light and loses the color. In light and shade this is a matter of not much consequence, but it is better to study in light and shade so as not to be obliged to change for advanced work.

The struggle comes in seeing for the first time. A lens of twelve inches focus has been of great assistance to many. By its aid they have been enabled to see the masses and to realize their errors when no amount of explanation or assertion on the part of the teacher has been of the least value. Some recommend the reducing glass or a Claude Lorraine mirror, but the blur glass is the only means that I have been able to use with any degree of success. After the student has once appreciated the masses, and has seen how unimportant is the detail in these masses, he will need no artificial help. A little practice will enable him to see the entire group without special effort ; in fact, to see naturally the group as a whole, and it must not be forgotten that this is the only way to see effects.

When a number of drawings which give simply the masses of light and dark, as Fig. 2, have been made, the student should try to get all the values, being careful that the grays and detail in the lights, and the reflected lights in the shade, are not made too prominent. He should understand that the first drawings made express the most important truth, that with strong light there is always the contrast of well defined masses of light and dark. The tendency is to look upon the drawing, Fig. 2, as simply a stage, and to study the detail, which can always be found upon close examination, so carefully as to lose all general effect. There is always a tendency to exaggerate the slight differences, which appear greater than they really are, and the student must struggle to keep the drawing simple. *Frequent comparison from a distance, of the drawing with the group is necessary*, the drawing being placed beside the group. If the two are thus compared, the effect being realized by use of the blur glass if the student has not yet learned to use his eyes, it is thought that if he works earnestly, he will in a short time be able to produce fairly truthful representations of the effect.

Figure 3 represents the group already studied with all the gradations. It will be noticed that there is always some point in the group that is lighter than any other, as the high light on a white vase or sphere. These points should be carefully considered, and it is evident that the rest of the masses of light must be slightly gray. There

Fig. 1

Value

Fig 3 - p 1

is also in every group some spot that appears darker than any other. All the other darks must be compared with this, and to be sure of truth with each other, as must also the grays in the light.

The tendency is to make the drawing too black. This may be avoided by comparing the darks in the group with a large piece of charcoal held in front of them, and shaded by the hand so as to appear black. This makes the darks of the group seem quite gray.

There is another point of great difficulty, and this is in regard to the colored objects ; for, as already explained, colors do not appear their real colors. The student who sees a colored object in front of a cast which is grayish white immediately thinks of the actual color of the object in comparison with the actual color of the cast. The color may be darker than the cast. This being so, it is frequently nearly impossible for him to realize that the color, even if quite dark, may be so lightened by direct light, as to appear even lighter than the gray of the cast without a shadow upon it.

The statement is often made that the surface receiving the most direct rays of light appears lightest. This is not true even for objects of the same color. The highest lights are the surfaces that reflect the light most directly to the eyes, not those that receive the most direct rays of light.

The difficulty increases if the colored objects have

smooth or polished surfaces, and frequently very dark colors may appear much lighter than the light objects of the group, through their reflecting more light to the eye than the lighter objects. The only safe rule for the student is not to work by theory, or to think how he ought to see the colors, but to look for the actual impression, remembering that this is very likely to contradict what he thinks. After having frequently made his drawing exactly opposite from what it should be, the student should have no difficulty in transferring his dependence upon his ideas to his eyes. When this step has been taken, Nature is before him as an open book, to be studied when he wishes, and it is no longer a question of seeing, but of the best way to do what he feels.

A point which must be carefully guarded against in all work is the hardness that comes from definite lines, and sharp separations between the different parts. The eye sees but a point at any one time. This point is seen clearly, all other points indistinctly, so that the effect of Nature cannot be given by a drawing in which all the edges and separations are brought out by hard lines. In Nature there are no lines. We see objects through contrasts of color and light and shade, and we do not see sharp definitions between the different colors. Even the straight edges of the models are not seen as sharp lines, the atmosphere and the action of the eye causing them to blur and soften.

The drawing must be definite without being hard. Frequently the outlines are entirely lost. This occurs in the shadows or in the mass of the light, and particularly is it true of detail in casts. Generally the outlines disappear for a short distance only. The student, knowing the form, is very apt to supply the missing part, and draw what he does not see, and thus his drawing becomes hard and cut up. If he will study the effect and draw only what he sees, avoiding sharp edges and hard separations, he cannot fail to make a good drawing.

I have described the way in which the student should work to produce the finished light and shade drawing, but do not advise him to spend all his time in this work, for I think great benefit will result from the study of outline simply. It is better from the start for him to give part of this time to pencil outline. I say pencil in preference to charcoal, because erasures should not be made until the correct outline is secured. If charcoal is used, it is impossible to make many changes without erasing. With a medium pencil the lines may be given many different positions, the last line being slightly strengthened each time, and the correct result obtained without erasing a line. The training thus given is very valuable. I would have drawings made in this way from the models, until groups of five or six of the most difficult ones can be correctly drawn in an hour or two. In finishing the drawings, the lines should be accented as explained on page 44.



In connection with this work the student will find that the making of quick sketches in a note-book, with a soft pencil, will greatly assist to freedom and accuracy. These sketches may be made complete studies of light and shade and values ; and if one is made each day, beginning with simple objects, he will soon be able to draw freely and well a group of several objects.

I have said little about tests. He who intends to study art as a profession, or even as an accomplishment, should be able to depend upon his eyes, and should use few tests. The following tests are sufficient : The pencil for measuring proportions, and held in front of lines to give their angles, or held horizontal or vertical for comparisons, and in beginning, the use of the thread, and later, the passing of the pencil point over the lines or the drawing in the air. If he cannot succeed with these, his time will be better spent in other work. Under the heading of tests, in the latter part of this book, are given several means for assisting the pupil to apply the tests correctly, but these are intended for public school teachers who have to teach those without special ability, and though such aids may be necessary in these cases, they should not be required by the art student.

P 147

*Use of Materials.*

At first, the matter of technique and handling is of no importance to the student, whose only aim should be to

*Value*

obtain good drawing and correct values. By this we do not mean that it is of no importance how the student works, for he may work in bad ways and with unworthy ends in view. We mean that, having as a result the production of drawings true in effect, in as direct a manner as possible, he is not likely to waste time over a way of handling which does not tend to this result, for the earnest and honest student is thinking of the effect rather than the execution of the drawing. It is interesting to see clever handling and brilliant execution, and they are to be desired, but the student should not try for them. Cleverness and style will come of themselves in time. If the student tries for these, he may secure them, but probably at the expense of the substantial qualities which make a strong picture. He should be satisfied to study Nature and work earnestly until a true representation of her is obtained. This drawing is much more valuable, even though the labor spent upon it is evident, than the most clever study which is untrue. Honest study gives the knowledge which in time enables one to express directly, and thus with an interesting handling.

Not only does this honest study of Nature and appearances produce the most valuable results, but from the start it is most interesting to the student who, each time that he discovers a new fact, experiences the pleasure of an investigator in a new field, and with each new idea, he presses on with renewed vigor.

That this study is interesting to all, even the youngest, is shown by Viollet Le Duc, in his most valuable work, "Learning to Draw." His illustration of little Jean's drawing of the cat strikes the keynote of the present tendency in art; and Jean's replies to his questions may be studied with great profit by many teachers. Especially when in answer to the question, "Do they teach you to draw at school?" he replies, "No, sir; they teach us to make only rounds and squares."

A stick of soft charcoal should be used for all except the careful drawing of the finishing touches. In the first stage the side of the charcoal may be placed upon the paper, and even tints be produced by a regular motion and uniform pressure, each movement making

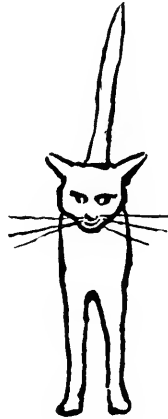

LITTLE JEAN'S DRAWING.

a wide tint, and only a few seconds being required to cover the background or any other large surface. In the later work for the careful drawing, it will be necessary to use a stick of hard charcoal sharpened to a chisel-shaped point.

Some teachers insist that the drawing shall be made entirely by the use of the point of the charcoal, and allow no softening or blending even by the finger, and

even beginners in the public schools are obliged to render light and shade by a hatching of lines as in a lithograph. Adherence to any such rules will cause much loss of time ; for sometimes one way is quickest, and sometimes another. But to make a light and shade drawing by means of lines is the most difficult and slowest way imaginable, and the student is advised to defer all ways of handling which are difficult and slow, to the time when he may pursue these methods for training simply in their handling, and not as mediums for the study of light and shade. He should work for effects until he can render them truly, and should not allow himself to be trammelled by arbitrary rules or difficult ways of working. He should aim to get good drawing and values in the shortest time, and all means which accomplish this should be legitimate.

Some teachers advise the use of the stump, the charcoal being rubbed by it to an even tint. The objection to "stumping" is that the pupils seem to think that smoothness is a virtue, and all that is necessary is to move the stump about vigorously, and in some way or other the stump will make the drawing. Such use of the stump not only quickly spoils the paper, but tends to create the idea that the drawing cannot be made directly. The stump may be used with advantage, to place the charcoal in parts too small for the finger, and for lifting the lights, but the tendency to use improperly is so strong that no rubbing with the stump should be allowed.

In order to get atmosphere, it will frequently be necessary to fill in the grain of the paper by moving the charcoal about until the depressions of the paper have received a tint. This may be done by very lightly passing the finger over the paper. When the grain of the paper has been filled in this way, the drawing should be finished, as directly as possible, with the point of the charcoal, a tint of the proper strength being placed by careful drawing just where it is wanted. If a small part has been made too dark, it may be lightened by touching with the finger or stump; a large part, by blowing off the charcoal. The lights may be drawn with an eraser. Faber's eraser made in pencil form is good for this work, and the fine lines of light may be taken out with the hard eraser called "Nigrivorine," which should be cut to a thin edge wide enough to be strong. Bread rolled into the form of a pencil is the best eraser. It will quickly remove almost all the charcoal from a large surface without injury to the texture of the paper.

When the drawing is finished, it must be sprayed with fixatif. This should be applied with great care. If drops are allowed to form on the paper, they will float the charcoal and spoil the drawing. If too much is applied, the drawing will shine and lose its life. It should be applied a little at a time and allowed to dry between the applications. It is well to avoid too much surface charcoal, on account of the difficulty of fixing the drawing

without floating it over the paper and thus spoiling the drawing.

The darkest parts will require more fixatif than the light parts. It can be placed upon these parts by covering the drawing with a paper in which a hole is made of the size of the place needing fixatif.<sup>1</sup>

Having described the ways in which the student may study to obtain facility in drawing, I wish to say that he who can draw and render values in charcoal is ready to work in any medium, and after the first experiments necessary to a new medium, he will do so with success if he understands that whatever the medium, the problem is the same, and is simply and always drawing and values and color.

There are too many who paint by receipt, but there should be no such thing as a rule or a way of doing, as many seem to think, when they ask how to represent trees, or grass, or drapery, etc. To all who would be serious, the problem is simply observation; and since Nature is always different, there can be no receipts for representing her infinite variety.

Some students seem to think that they are commencing a new subject when taking up a new medium. This

<sup>1</sup> Fixatif may be made by dissolving white shellac in pure alcohol. The alcohol should stand, after the gum has been dissolved, long enough for the impurities to settle at the bottom. The upper part will then be of a clear amber color. It may be turned into another bottle, and if too strong, diluted so that a drop will evaporate, leaving just a trace of gum.

is not so, for the subject is always the same, and the treatment should be the same in striving first for the masses and the effect.

The most frequent error of all is the attempt to finish a part before the effect is indicated. Much time is spent in carefully drawing and finishing a part, only to find when the rest is in place that it is out of drawing or incorrect in values. The drawing should begin and progress all at once and equally until the desired effect of the masses is attained, when the detail may be studied. The more quickly the white paper or the canvas is covered, the better, and until the values and masses are nearly correct nothing else should be considered.

There are so many drawings and paintings which are merely conventional pretty things, that the student may have difficulty in realizing that they are not true, and that his work should be serious and honest. It is hoped that soon a higher standard may be placed before the art student, that he may understand that not all his problem is in the drawing, but that values and color are equally and even more important than absolute form, and that he may acquire the power to represent Nature easily and truthfully.

## CHAPTER II.

### OUTLINE DRAWING.

It is often said that there are no outlines in Nature. In a way this is true, but it cannot be understood to mean that form is unnecessary or that it may be slighted. The student cannot learn to paint or to make pictures in any medium, without drawing the forms of the objects. The defining of the lights and shades and the various bits of color which are seen in Nature is necessary to give solidity and character to a picture, and it is useless to think that anything can be accomplished with color or light and shade if approximate representations of form cannot be made.

Every object has definite form and size, and though it may not be outlined, it has boundaries. Although the representation of objects in outline only, is at best a conventional and imperfect means of expression, so far often as even form is concerned, the student can be taught to observe effects, and may often succeed in conveying a fair impression of the character of the object, and of varieties of surface and texture. He will find that the study of appearances and their representation,



as fully as possible, even in so simple a way as outline drawing, will in great measure prepare the way for work in light and shade and color. The whole question is simply one of seeing, and the student should not trouble himself over technique, as his only aim should be a true representation of Nature.

The most important points in free-hand drawing are freedom, directness, and accuracy. It is difficult to give directions which will produce these results, as individuality will prevent all from working in a uniform way, and handling and technique are of little importance. Since the production of truthful drawings is the end desired, it is of no consequence that such drawings are produced by different persons in different ways, but it may be well to give a few general directions.

It is most important that the pencil should be held lightly, and the first lines of the drawing *suggested* freely and rapidly. The paper should be not less than eleven by fifteen inches, and the drawings should be large, as small drawings will produce a mechanical way of working. A long pencil will assist to freedom of motion. It may be held as a stick of charcoal between the thumb and first two fingers, and as far as possible from the point.

The paper should be fastened upon the board with its edges parallel to those of the board. If the edge of the paper is not straight, a horizontal line may be drawn

near its lower edge, so that directions may be referred to this line. Before attempting to draw any object, the student should acquire the freedom of motion which is necessary to good work, by drawing lines in all directions. Curved lines may be produced by swinging the pencil from the wrist, elbow, or shoulder; and straight lines by a motion of the entire arm. These movements should be practised until lines can be drawn instantly across the paper in any direction. This free motion is most important for all sketching, but in finishing or accenting a drawing, whose proportions have been thus sketched, more pressure will be required, and the pencil may be held more firmly and nearer the point.

The first subjects may be the geometric solids, or any common objects. I will explain the way in which these may be studied, by making a sketch of a box with its cover thrown back. (See Fig. 4.) *p 145*

First, nearly close the eyes and try to see the box, not as a solid, but as a silhouette, the outline of the mass of the box against the background being what should first be carefully studied. A little practice with the eyes nearly closed will enable one to see the mass in this way. (Fig. 5.)

In order to realize the directions which the edges appear to have, lines may be drawn in the air, by moving the pencil point so that it appears to cover the edges. When this is done, care should be taken not to move the pencil away from the eyes, that is, in the actual direc-

*3 methods  
1. method*

tion of the edges, but to keep the pencil point where it would be if it were held upon a pane of glass placed directly in front of the student. This test is the most valuable of all, because it is the simplest and easiest to apply. It is really the same as the use of the thread, explained on page 74, and nearly all other means of testing will at last be discarded in favor of this first and simplest.

After careful study of the mass, its outline may be lightly sketched, no measurements of proportion having been made.<sup>1</sup> The aim is to train the eye to see correctly. In order to do this, the student must depend upon his eye, and put down its first impression, rather than the results of mechanical tests of proportions. He must first draw, and then test by measuring.

When the outline of the mass has been sketched, the inner lines may be drawn, and the result carefully studied to see that it agrees with the appearance. When it is as near as can be seen, the drawing may be tested by measuring the proportions as explained on page 68. If the sketch does not agree with these tests, it must be changed. All changes should be made, not by erasing, but by drawing new lines, and the drawing should be carried on in this way, until the correct lines are found.

The first lines must be very light. As changes are made, the strength may be increased to distinguish them, until the correct line is secured. The drawing having

<sup>1</sup> These lines are approximate, and little time should be given them. See page 15.

been changed to agree with the measurements of the whole height and width, and tested by moving the pencil point to cover the edges, it will be well to test, by means of vertical and horizontal lines, taken through the different angles of the box. Thus, drop the pencil point vertically from point 1, and see where it cuts the lower edge, and carry the point horizontally from point 2, and note its intersection with the front edge. The pencil may now be made to continue the apparent directions of the edges A, B, C, etc., until the points where the continued lines appear to intersect the opposite outlines are noted. These tests may also be applied by the pencil used as a straight edge and held horizontal and vertical, and to appear to coincide with lines. These tests, if carefully made, will produce a drawing which is practically true, and should be depended upon. The first measurements of height and width should be very carefully taken. Distances which are nearly equal, as EF and FG, may also be compared, but as a rule, few measurements of proportion should be made, as short distances, or short with long distances, cannot be compared with sufficient accuracy to be of any value. (Fig. 6.)

The thread may be used instead of the pencil for tests, as explained on page 74. The thread appears a fine line, whose intersections with the edges may be easily placed, so that until the eye can be depended upon the thread is preferable to the pencil.

It is most important that all changes be made not by erasing, but by drawing new lines. Erasing and keeping but one line from first to last will surely produce a hard and inaccurate drawing; and although it may finally be made to agree with all the tests, it will still be lacking in spirit. It is difficult at first for most students to draw lightly enough to secure the correct lines without too great heaviness, but it is better, rather than to erase, to throw the drawing away and start anew until the result can be secured without having lines so black that they cannot be easily erased.

The reason for working in this way is that we wish the student to depend, as far as possible, on his eyes. If he erases and has one line from the start, unnecessary time is given to the drawing, and he will hesitate to erase his lines. If light lines are drawn and not erased, but others drawn as soon as there is doubt about the first being rightly placed, the student is much more free to change as each suggestion occurs, and toward the last he has his choice of the various lines already drawn and can experiment freely.

This is by far the quickest and most accurate way, and prepares for rapid and truthful sketching. It is difficult at first for the student who has been taught the mechanical way of drawing one line at a time, but he will not have to draw very long in this way before he will be able to produce truthful sketches without drawing many unnecessary lines.

There is not much choice of pencils for this part of the work, but it is well to use always as soft a one as the nature of the work will permit. As no pressure should be used, the lead making at first as light a line as can be seen, and as all lines except the correct ones must be erased, there is no reason why the student who has difficulty in using a soft pencil should not use a hard one until the drawing is ready to accent.

When the correct outline has been found, it is necessary to finish the drawing. The paper must first be cleaned, all the lines except the last being erased. The easiest way to reserve these lines is to make them stronger than the others so that they will show faintly, when the eraser has been passed over the paper, removing all but an indication of the result.

The drawing may now be accented with a soft pencil. The pencil may be held more firmly, and the lines drawn of their proper strength by one touch, the attempt being not to produce a fine even line in imitation of a ruled one, but rather a line of medium strength which will convey the idea of straight edges. For the present it is better for the lines to be made of uniform strength, with no attempt at gradation, or the frequent conventional accenting of the nearer edges by heavier lines. This point will be considered later, but we wish now to advise the student, if he is already familiar with it, to forget it as quickly as possible, and to finish in lines of one strength or as explained on page 44.

The student should draw from various objects in different positions, until he is able to see them very nearly correctly at first. The time required for this will depend wholly upon the pupil and the care with which directions are followed.

### *Groups.*

After the practice from single objects, several should be arranged in a group. The student will probably attempt to draw the objects one at a time, taking first the prism A, Fig. 7, next the vase B, then the cylinder C, and last the frame D. The objection to this way of proceeding is that as the objects are drawn one at a time, until the last is completed, the proportion of the whole group — that is, its greatest height in comparison with its greatest width — cannot be seen. Indeed, this is often not even considered, the student taking it for granted that since he measured and tested each object as it was drawn, the single objects are correct, and therefore the group. But from what has been said it will be seen that each object is likely to be a little out of proportion; indeed, we may say is sure to be so. This being the case, the errors are multiplied; and if the height and width are compared, the proportion is found to be far from correct. It is a principle generally acknowledged that in all teaching the whole should be presented before its parts, and it cannot be contradicted that adding one object to another

until finally the patchwork is complete is an uneducational way of proceeding. Practically it is also most unsatisfactory, as with each object the difficulties increase, and at last it becomes impossible to place the drawings where they belong. The only logical way is to draw the group all at once, first considering it as a mass and blocking in its proportions by lines passing from the principal points, Fig. 8. When these lines have been drawn and considered, they may be tested by measuring the whole height and width, and the directions tested by use of the thread or pencil as explained.

A good plan is, as soon as the proportions have been determined, to draw horizontal and vertical lines forming a rectangle enclosing the drawing, and to be careful that the drawing is kept within these lines. The proportions of the whole group being thus determined as nearly as measurements can determine, the objects may now be sketched by eye, the most important lines being drawn first. These are the lines whose positions and directions are most easily seen. They are the longest lines, lines of one object which are nearly continuations of those of some other object, and lines which are brought out distinctly by shade or shadow. It is evident that in this way the drawings of the different objects are proceeding at the same time, and the shorter and less prominent lines being drawn last, the group may be said to be drawn all at once, or as if a single object having many parts.



While drawing, the student must think of the tests, applied by the thread, of horizontal and vertical lines, and of continued lines ; and drawing in the air by passing the pencil point to hide the edges to be represented, will help greatly. The object should be studied in this way and changed as often as found incorrect, until the eye can do no more. It is now time to apply systematically the tests explained by the drawing of the box.

The first test is to compare the height and width of each object of the group, and also to compare these dimensions with those of the whole group. This test is the most important, and should be very carefully taken. Slight inaccuracy can hardly be avoided, but these dimensions are the longest measurements, and can be compared more accurately than any others, especially in the case of those which are nearly equal, and the best that can be done is to make the drawing agree with these measurements. By this time the student should be able to measure as accurately as these drawings require.

These tests will generally change the drawing throughout. The changes should be made, not by erasing, but by adding lines, and without other measurements until the eye can see no more to be done. The thread may then be used, first for the tests of horizontal and vertical lines, second for the continuing of all the edges, and third for covering points in the group opposite one another, that the intersections of these diagonal lines with the

edges may be noted. The thread used thus will discover every discrepancy except the slight deviations which only the accurate eye can detect. After the training which is given by these drawings made entirely by eye before any tests are applied, this accuracy will soon be secured.

When the correct lines have been found, the others are to be erased, as explained on page 36, and the drawing is to be accented. But now the student will do well to think of effect, and to see if more interest and expression cannot be given to the drawing than is given by uniform lines. The student has perhaps been taught that the nearest objects are seen most strongly, and that the strength diminishes with the distance. This of course is true in a general way. It is the effect of aerial perspective, or the changing of color by intervening atmosphere. Thus of a row of light objects the nearest will appear the lightest and brightest, and of a number of dark objects the nearest will appear the darkest. The light object in the distance appears darker,<sup>1</sup> and the dark one lighter, and in a sketch representing considerable distance this principle will be of assistance. But it must be stated so as not to convey the idea that there can be nothing in the distance as strong or stronger than the unimportant features of the foreground, for we do not see objects more or less distinctly according to their distance ; in fact,

<sup>1</sup> Very light objects may change but little.

distance has practically nothing to do with it. *We distinguish objects as masses of color, lighter or darker than the colors against which they are seen.* This being so, it is evident that a light object in the background, as a white house seen against dark foliage, must be much more prominent than a near object, seen against another of the same color.

In general, when there is little or no contrast of color, objects are difficult to see without regard to their distance. Place a square of white cardboard in front of a larger square of the same, the latter coming in front of the blackboard. The smaller can be seen very faintly. In comparison with the distinctness with which the larger is seen against the blackboard, the smaller is practically invisible. This experiment proves that we distinguish objects through contrasts of color, and we have to consider what can be done in outline simply, to render the effect of Nature. Can no more be done than to represent the form by lines of uniform strength?

The opinion seems to be general that more can be done. We find that instruction is often given to represent the nearer edges by strong lines, the farther ones by light lines; in fact, to proportion the strength of the line to the distance of the part it represents. Apply this rule to the representation of the two pieces of cardboard, and the nearer is accented by heavy lines, the farther by light lines. This is a direct contradiction of what we see,

for the outline of the nearer is barely visible, while the farther is distinct against the blackboard.

In color we certainly should not think of representing the nearer as darker than the farther, or in any other way than as it appears, and the same is true of light and shade. Why should we not do the same when possible, with outline? No reason to the contrary can be given, for the difference in clearness with which the various lines are seen is the result, not of distance, but of contrasts of color, and light and shade. Of course we shall expect to find the strongest lines among the nearest ones, but farther than this we cannot go, and if we adopt the conventional accenting recommended by text-books, we are working by rule and not by observation, and the result will be the production of hard, mechanical drawings.

Character appears in outlines. An object, as a cast, having a smooth, hard surface shows these qualities in its outlines, which will be represented by smooth lines. A cube with smooth faces has sharp, straight edges, which will be represented by straight lines. A box made of rough boards has broken edges, whose character may be given by drawing the irregular outline in which one surface breaks into the other. A drawing from the figure can express the variations in the appearance of the outlines, parts of which are sharp, other parts blurred by light or a growth of hair.

Light affects the appearance of the outlines strongly,

in some places making them distinct, in other places indistinct. An even line for everything disregards all these variations of effect ; so also does any conventional variation of strength. If the student is allowed to disregard effects in outline work, he will have great difficulty in seeing them in later work. There is no more labor involved in representing effects than in disregarding them, for one line is as easy to make as another, *observation only being required.* *The student who can see can perform,* and as long as any differences can be found between his drawing and Nature, he can learn to correct the errors.

The conventional accenting taught in the public schools produces the most mechanical, hard, and unnatural sketches when the student works from Nature, indoors or out. Undirected he would never produce such childish and ridiculous effects, but after his instruction in drawing from the object, where he has learned that lines must be represented with a degree of strength corresponding to their distance, he naturally does not think of observing and drawing what he sees, but simply mechanically grades the strength of line as he has been taught. He makes the heaviest lines of the drawing where there should be the faintest indications of lines, and often where no lines at all would be better than faint lines.

It is almost impossible to get a student from the public schools to make sketches in which the unimportant

detail, which is no part of the effect, is not brought out with heavy black lines. This is not surprising, for he sees this detail and it is near him, therefore according to his instruction it must be strongly accented.

In outline, as in other mediums, we should do the best we can to express what is before us. The effect of the subject should be considered as well as its form. There is no reason why the student should not be taught to observe the effect, and if once started rightly he will advance rapidly and will make drawings which, since they are representations of Nature, will have variety of effect, will be true, and artistic.

*No rule can be given* other than to study and represent simply what is seen, as far as possible, as it appears. In outline, without any light and shade, it is impossible to always accent the lines just as they appear. For instance, some edges of the object may be so lost in the shade as to be wholly invisible, but without them the drawing might be incomplete and unsatisfactory. *A correct impression of the facts must be conveyed.* No important line can be omitted even if not seen, but otherwise the lines should be represented as they appear.

In drawings of the geometric solids, where there are few lines in nature, it will sometimes be impossible to accent the lines as they appear, for some of the most important ones may be invisible, or seen so faintly that to represent them as they appear would make the draw-

ing give a false impression. Frequently when the objects are strongly lighted their outlines on the light side of the group intersect one another, so that the outline of the mass is composed of parts of those of several objects. This outline is very prominent, while the edges inside the outline are almost lost in the mass of light. It is evident that in this case we cannot accent as we see. We must accent as we feel the group, and when accenting as the lines are seen is unsatisfactory, we must use our judgment and make the accenting express the facts in a satisfactory manner.

When drawing from furniture or from any subject having many lines, the effect will generally be satisfactory when the lines are accented as they are seen. Here there are so many lines and so many changes in direction that the parts which are not seen will rarely be missed, and the student can represent more nearly what he sees. But it must be understood that it is wholly a matter of feeling for which no rule can be given.

At first most students will have difficulty in seeing any difference in the way in which the various edges appear. This is due to the fact that but a single point can be clearly seen at any one time. The eye glances rapidly over the whole of an object, carefully observing all its parts. We are unconscious of this motion. All parts of the object are seen distinctly, and the variety of effect is not realized. All the parts will continue to give the

impression of equal strength until the ability to see the whole of an object at once has been acquired, as explained on page 18. It is not possible otherwise to see simply, to realize effects and masses, and the student must practise until he can thus see before he thinks of success in any medium, for all demand equally a study of the comparative strength of detail.

Although no rule for accenting can be given, the effect is found to conform to the principle that *any detail which comes in either the mass of the light or that of the shade is unimportant*. Thus an edge defining a light surface against another surface also light is not prominent, and an edge separating a surface in the shade from another shade surface is seen faintly. The important features are those which come between the light and the shade.



1871  
1872  
1873  
1874  
1875  
1876  
1877  
1878  
1879  
1880  
1881  
1882  
1883  
1884  
1885  
1886  
1887  
1888  
1889  
1890  
1891  
1892  
1893  
1894  
1895  
1896  
1897  
1898  
1899  
1900

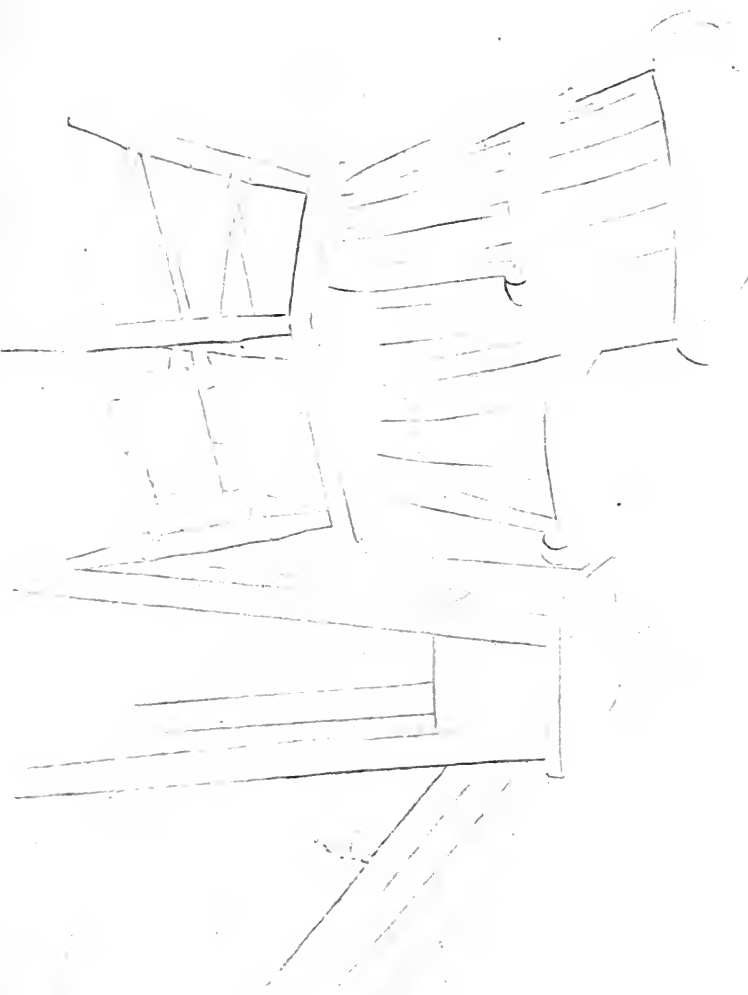



## CHAPTER III.

### INTERIORS AND GENERAL WORK.

ALL drawing, whatever the subject, should be carried on in the same way, first by blocking in the mass of the whole, then the masses of the various parts, the detail coming last but always being carefully studied.

In drawing from objects having curved lines, the student should be careful not to be content with the general effect of the line, but to give the variations from the regular curves found in many objects. Thus in a cast, lines which at first glance seem of uniform curvature will be found to be composed of many short, flat curves. Character will be given only by a study of these flat curves, but the search for straight lines must not lead to the drawing of straight lines where none can be seen, as in an ellipse.

After the models, common objects as boxes, furniture, etc., may be drawn. These may be arranged in groups and an idea of pleasing composition be given. This work leads directly to the drawing of interiors. No principles other than those explained are involved. In this work, as in all, the aim should be to represent as

nearly as possible the actual appearance of everything. We obtain the dimensions of this appearance on a plane which is perpendicular to the direction in which we see the object. Carrying out this principle and extending the subject, we find that the surface which gives the appearance is that of a sphere, which cannot be developed. This, then, is the reason why we cannot always draw just what we see, and it is impossible to make a sketch which shall include an extended range of vision, and give the exact appearance of each part, and a correct impression of the whole (pages 92, 93).

The space which can be included in a model drawing, and which may be represented on a plane without noticeable distortion, should not include an angle at the eye of over twenty-eight degrees. If this is much exceeded the questions of the curvature of parallel lines for both horizontal and vertical distances will arise, but as most drawings require a larger angle the question must be considered.

The mind, knowing lines to be straight, will hesitate to accept their representation by curved lines, or knowing them to be vertical, will not readily accept their representation by inclined lines. The drawing should give the impression of Nature, as far as possible, even when the eye is not at the proper distance. The impression of vertical lines is given by vertical lines, and of straight lines by straight lines. For this reason, it seems best

that the student should represent what he sees, as nearly as possible, but in accordance with the perspective principle that straight lines shall be represented by straight lines. This will cause him to represent horizontal lines which extend on both sides by parallel horizontal lines, and to substitute for the curved lines found in objects at angles with the picture, straight lines extending to two vanishing-points. This will change the drawing very little, as shown on plate 28.

When the subject is extended or comes very near the draughtsman, causing visual angles of from forty-five to one hundred degrees either horizontally or vertically, it is evident that the difference between the appearance and any drawing made on one plane will be very marked, and some parts of the drawing must be quite different from the actual visual angles formed in the eye. This may prevent the drawing from being truthfully blocked in as a whole at first. It can, however, and must in the beginning be placed as a whole approximately. The central part or the most important portion can then be drawn as it appears. The proportions of the outer parts can be referred to the central, and the distortion, which is inevitable somewhere in an extended subject, be reduced to the smallest degree by making the perspective of these outer and less important parts agree with that of the central and important mass.

The different parts of an extended subject cannot be

measured or compared by the ordinary use of the pencil, for its distance from the eye changes with every new position. If it is desired to compare the visual proportions, the pencil must be held at one distance from the eye by means of a thread attached to it and held at the brow by the left hand.

When it becomes necessary to make a perspective drawing throughout, as sometimes happens when three walls of a room are to be shown, the proportions of this drawing may be very exactly found by holding the pencil in a plane parallel to the end of the room.

This drawing should be avoided when possible on account of the serious distortion of its outer parts, and it will also be well to avoid representing one side of a room which extends far on both sides of the spectator. If one wall is to be represented, it is better to draw from one end of the room than from the centre, as the lines will vanish and the distortion be less marked. When two walls are represented, the lines of both must vanish. When three are shown, the middle one must have no vanishing. Figure 9 shows that if its lines vanish, the whole of the left wall will be outside of both vanishing points of the drawing, and thus very unpleasantly distorted. *A drawing should never extend beyond the vanishing points of its lines.*

A very slight distance may be represented to the left of the left point in Fig. 9, when the drawing represents a

court or any interior where the part at the left is a very unimportant portion of the drawing, but it is generally safer to end the drawing at the vanishing point.

Distortion such as that in Fig. 9, is seen in photographs taken with a lens of wide angle, and photographs, the most common perspective drawings, exert a strong influence to perpetuate the serious distortions in the drawings of our illustrators and artists.

In drawings of street scenes, etc., the lines are long and broken, and their apparent curvature may not be noticed if each part is drawn as it appears. In such subjects one does not know the conditions. The lines may be curved in Nature. Hence there is not the instant contradiction between the appearance of the drawing and the knowledge concerning the facts of the things represented. If the artist chooses sometimes to represent straight lines by curved lines, he has Nature as authority and the example of noted predecessors, and no one would wish to say that his drawing is not good or that it would be improved by plane perspective.

In interiors and in street scenes, there is not only the question of horizontal foreshortening to be considered, but also that of vertical foreshortening. Whether or no this foreshortening shall be given is a question which can be answered only as it arises, and decided according to the conditions of the subject and the aim of the drawing. It is a question of the less important giving way to the

more important, and is for the artist rather than the student, who should, until he has attained by long practice ability to judge proportions correctly, never be permitted to draw other than those he sees.

The unnumbered plates following are from students' drawings from Nature. Such work should be the aim of drawing in the public schools, whose pupils, taught to observe and to do what they see, may make a great advance in this direction.

The sketches are by students of the perspective classes at the School of Drawing and Painting of the Museum of Fine Arts, and at the Normal Art School. They illustrate the beginning and the end of a course in model drawing, which is the only perspective necessary to the artist.



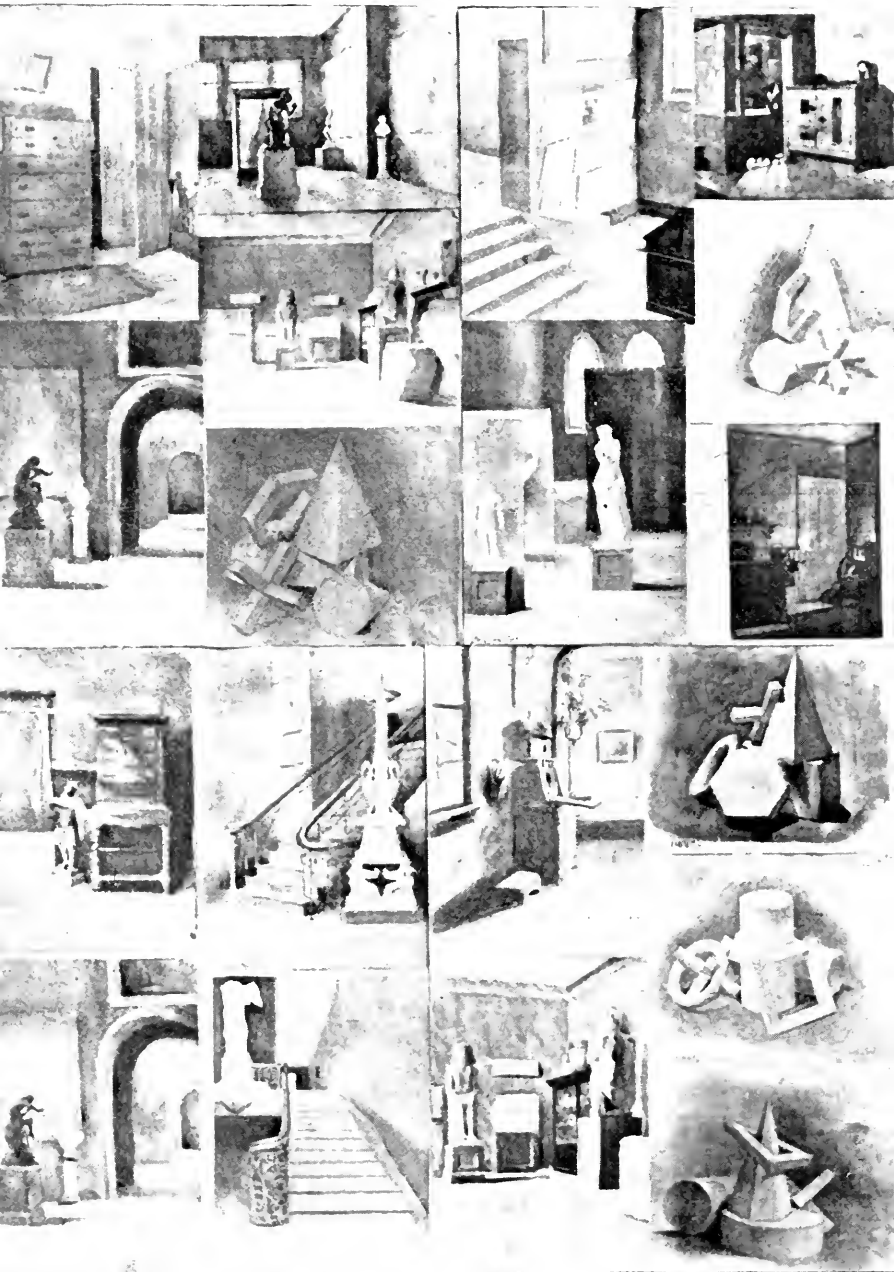



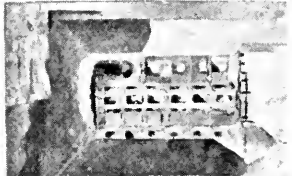
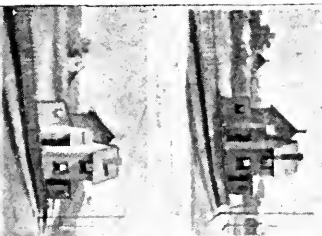
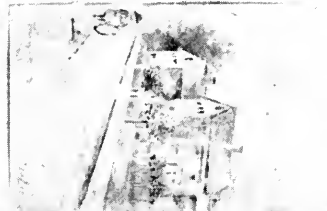
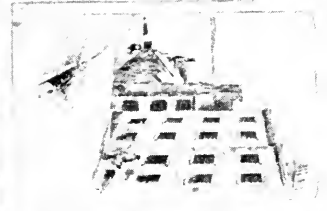
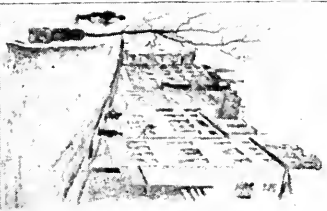

*Some of the  
many  
factories  
of  
the  
city*

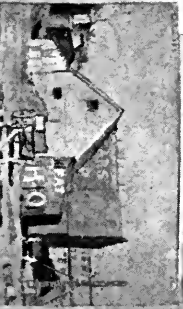
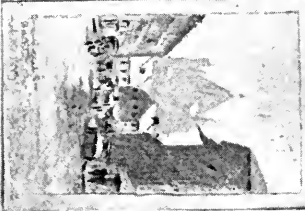



## CHAPTER IV.

### DRAWING IN THE PUBLIC SCHOOLS.

THE value of a course in drawing when the subject is properly presented can hardly be overestimated, but it must be confessed that much of the instruction given is such that its benefit is a matter of doubt.

At the beginning of his art education, the pupil should be taught to see correctly. When this has been accomplished, and he is able to represent truly what is before him as it appears, and not as he thinks he sees it, then he is in a position to advance, and his personality may be cultivated. But as the first point to be gained is ability to see truly, it follows that we should from the very start demand truth, truth of outline, truth of light and shade, and truth of color.

In beginning, I wish to say that drawing in the public schools can never accomplish results of any value until the pupils can observe for themselves; in other words, until they can draw from objects instead of from drawings. This is impossible in many places now because the teachers have not materials. The schools must have models and all necessary materials, or the work will be

simply the copying of drawings in the books, or if these are not used, the copying of theory drawings on the board. In the elementary grades the instruction can be given well enough in the classroom, but the advanced grades should have provided for them a room arranged for the purpose. Drawing cannot be taught without materials any more than manual training can be taught without tools, and a part of the necessary materials can be used in one no more than in the other.

No committee would expect a boy to use a gouge to do the work of a chisel, or to learn to use his tools without wood, or that a class should get along with tools for one student ; yet the committee or superintendent often expects drawing to be taught without materials, or with materials for part of the class.

In most public schools attention is now given to drawing. In cities this instruction is generally in charge of a special teacher, but this special teacher can do little more than to direct the regular teachers. The subject is comparatively new, these teachers have had perhaps no regular instruction in drawing, and few have had the liking for the subject necessary to interest them in the work, or to cause them to obtain the knowledge they are expected to impart, and with all the stress of work upon them, it is surprising that they have accomplished as much as has been done in some places. In many cases the special teachers have had but little training, and frequently this

has been simply in the direction of understanding the course of work laid out in drawing-books, or of studying the "best methods" instead of acquiring some practical ability in drawing. This has been the inevitable result of the rapid growth of the subject, and years must pass before it will be understood in all its bearings, and before there will be special instructors who have had the training requisite to success.

The aim of drawing in the public schools should be educational, and not specialistic. The pupils cannot all be artists or designers, or engineers, but all will be benefited by a logical course in drawing, and if they have it, discover special talent, which may be developed in the higher schools. The instruction in free-hand drawing can be practical and give to all right ideas, and to almost all ability to sketch from Nature with a degree of freedom and truth. The public school instruction can be such that the student who wishes to study art upon leaving school may do so with a good foundation and nothing to unlearn

The instruction in pictorial drawing is now the weakest part of the work in the public schools. It is so because it is neglected, or because bad methods are used. At the present time instruction in drawing in many places is largely instruction in manual training and kindergarten work. Without doubt this is valuable, but not as drawing, and it should not take the place of drawing. Draw-

ing should have an hour by itself. Cutting paper, whittling paper-knives, sewing pen-wipers, etc., can never give the least ability in drawing; neither can this work, as many carry it on, give any knowledge of working drawings. The making of objects can be of great assistance, and should naturally go with the study of working drawings, but the objects should be made from the drawings which must show all the construction.

I do not see how the making of objects can be done in school without special time being given to it, and the subject of drawing proper not suffer; and it seems that as the result in many places of the present agitation in favor of manual training, this subject takes the place of drawing. Many drawing teachers are unconsciously effecting this by placing in their course paper-cutting and the making of objects that have no connection with either the free-hand or the instrumental drawing.

In many cities drawing-books are used. These books contain examples of historic ornament and design which are to be copied, and also drawings of models and common objects, some of which are to be copied, and others are given as illustrations of possible appearances.

In many places most if not all of the work in object drawing is thus copying, and so little of actual drawing from the objects is done, that with the objects before them students are found copying the drawing of the student in front, and the drawings of a whole row are



alike ; or copying the drawing made upon the board to illustrate the principles. We have even known of cases where the pupil has turned to some text-book, as a geometry, in which he has tried to find the appearance of the object before him. Such are the results which come from copying drawings.

It is easier for the teacher to allow the pupil to copy, but such work is of no value, and the copies, even if neatly done, deserve only censure. The few teachers who have had the courage to dispense with copies deserve praise for showing that drawing can be taught from the objects, and their example should result in a general change from books to Nature. In many places it is possible that nothing could be done in drawing were it not for the books. Rightly used, they may be of assistance, but the pictorial drawing should be by itself in a blank book, and each drawing should be made from the object.

The change from copying to drawing from the object will require hard work from both pupil and teacher, and at first the drawings will be very unsatisfactory in themselves ; but after a short time, when the pupils have been started rightly in the lower grades, they will draw readily and with greater freedom; and will be able to draw from Nature, which they never are under the present systems that allow them to copy from a book or the board.

We have advised that art students draw with charcoal and in light and shade at once. Charcoal is not suited

to public school work, at least not in the lower grades, where it becomes a question of outline in pencil.

At present it is the aim of most courses in drawing to give a thorough knowledge of the actual form before attempting to represent its appearance. The knowledge of the facts is of course of some assistance to the person who is to represent them. A glance at the object and it is recognized, and the mind supplies the information which it might take the eye some time to discover. But this knowledge is more apt to do harm than good, for the pupil uses it instead of his eyes. For this reason, I should advise that the continued and thorough study of facts, now followed by most teachers, be postponed until the pupils have had some practice in representing the facts, or at least that the study of the appearance begin with the study of the facts.

The facts can be taught perfectly in a very short time, but to attain perfection in their representation is a problem requiring much more study and long continued effort, and for this reason it should be given earlier and more serious attention.

The study of appearances in the lower grades may begin with plane figures cut from cardboard or paper, as the square, circle, triangle, hexagon, etc. These may be placed horizontal upon the desk and their appearances studied. This involves the use of the pencil in measuring, and it must also be held horizontal to assist the pupil

to see the angles of the lines. In beginning, this work may be made easy by placing the card in the centre of the desk, when the lines of the desk serve for horizontal comparison.

The cards may be of such dimensions that the drawings can be made the size of the cards. The measurement of height will then be obtained by placing the lower end of the pencil at the nearest point or side of the card, and the thumb-nail to cover the farther angle or edge of the card. This gives the exact height of the drawing. It is thought that this use of the pencil in determining proportions will be readily understood. The pencil should of course be about vertical, but to be exact it should tip back slightly.

When the card has its nearest edge parallel to the desk line, the width of the drawing will be the length of this edge. If the edge is not parallel to the desk, its length will be measured on the pencil by placing the pencil parallel to the edge of the desk and touching the nearest end of the line, whose apparent length will be to the point just under the farther end, or to where a vertical pencil covering the farther point will meet the horizontal pencil. This way of measuring will give very good results, but before measuring any except the nearest edge, the drawing should be made by the eye alone.

It will be well to draw the cards at different levels. This may be done by placing them on boxes or books.

By holding them horizontal and on the level of the eye, the pupil will see that they all appear horizontal lines, and that their forms are seen only when they are above or below this level.

I should not attempt to teach much perspective theory. Until the pupils are older, practice alone is what they need. They can see that the apparent heights of the figures decrease as the planes are brought toward the level of the eye, at which all appear lines. They can also discover that parallel retreating edges appear to converge. This may be seen by placing two pencils together, and then separating them until each appears to coincide with an edge. The pencils must of course be held at right angles to the direction in which the object is seen.

The cards may be held in a vertical position by a small block of wood, to which they may be fastened by a tack. In this position the height will be the greatest dimension, but the proportions will be obtained as before. The positions of the cards being changed for each lesson, in a short time the pupils will learn to use their eyes and will draw the cards fairly well.

Both horizontal and vertical positions of the cards may be studied in the same lesson by folding a rectangular card so that a right angle is formed, one part being horizontal and the other vertical, and held at right angles by being tacked to a small piece of wood. Other forms may be studied in the same way.

When able to draw the cards from the position directly in front, the next step is to draw them when at the right or left. To do this, each pupil may draw from a card placed near the corner of his desk or on the desk at his side. This is much more difficult than to draw from the card placed on the centre of his own desk. The tendency will be to think of the line of the desk as appearing horizontal, when in this case it appears to vanish. For this work the pupil must learn to hold the pencil horizontal, and at right angles to the direction in which he sees the card. As this position of the card involves, beside this difficult test, the comparison of height and width on the pencil, it may be found necessary to postpone the work until the pupil has had practice in drawing from objects placed in front of him. It will be well to advance the work as rapidly as possible. The teacher should have little trouble in showing that the work is necessary and the beginning of pictorial drawing, and if properly presented, the pupils will be interested. The more the drawing seems in itself a picture and not a diagram, the more interested will they be.

A simple preparation for the subject of model drawing from the solid blocks may be given by drawing from two planes, so placed as to represent the bases or ends of the various prisms. Thus two squares may be fastened by a tack through their centres to a small cylinder of wood, which represents the axis of the prism. The prism thus

represented may be placed vertical or horizontal. As all the edges of each card are seen, this practice will help the pupil when he draws from a solid, in which all the edges are not seen.

A better arrangement is a skeleton frame in which the edges are represented by wires, or in which wires connect the bases of the object, which are sheets of tin. Drawing from these objects will be interesting and practical.

After this work the solids may be studied in whatever order seems best. If the pupil has learned to use his eyes, there is little choice as to the order, and by the time he is ready for the high school he should be able to draw the common forms quickly and truthfully, not only singly, but in groups.

The best and cheapest way to teach model drawing is by the use of a slate or glass on which the drawing is made with a pencil prepared for the purpose, and erased when finished. If drawings are made in this way, they can be instantly tested by holding the slate in front of the object so that the lines upon the slate appear to cover the edges of the object, the drawing being of such size that the slate may be held in the hand to apply the test. If the objects are large, they should be placed far enough away to have the drawing upon the slate come of the right size. The easiest way is to have the pupils draw from small objects on their own desks. When the

drawing is to be tested, the slate can rest upon the desk or be steadied by the hand.

As an objection to the use of this slate, it could be said that some might trace the appearance without previous drawing, but this would not in itself be harmful, for it would simply decrease the value derived from the lesson by drawing first by the eye alone.

When the drawing on this transparent slate has been carried as far as the pupil can see, he may instantly test it by holding it in front of the object. If correct, the lines of the drawing will appear to cover the edges of the object ; if not correct, the inaccuracies can be noted and a second attempt made.

The cost of the glass will be equalled in a short time by that of the paper saved by its use. I am confident that the slate used in this manner will in a short time give the average pupil of even the lower grades more ability in drawing than he now obtains by his entire public school training. This method will make drawing easier and more interesting, and will enable all the teachers, without special exertion, to make drawing of some value.

The drawing lesson will certainly be easier for the teacher than now, for the drawings will test themselves, and teachers who cannot draw may obtain good results. I do not mean that teachers can get along without being able to draw, for drawings on paper must be made and

corrected, but I think the glass will be of very great value, especially when teachers are not thoroughly prepared.

It is thought that this use of the slate will prove interesting to the pupils, but if it is found that they do not apply themselves to the work, thinking that a slate is too childish, it may be used at first as in the later work, in connection with the use of paper. The drawing may be made by eye alone, first on the slate or on the paper, as is preferred. In whatever way the work is carried on, the use of the slate gives an easy and sure test of the accuracy of the proportions, and for this purpose the slate may be used to great advantage through the work of all the grades and the high school.

An improvement on the simple frame is the attachment at each side of wires fitting in the frame so as to be drawn out to any length, the desk having two holes made to receive the wires. By means of these wires the slate with the drawing may be held perfectly steady, thus allowing the exact comparison of the drawing with the object. Of course the eye must be held in one place for this comparison.

By means of this slate, any teacher can quickly obtain all the practice necessary to make up for lack of training in drawing, and if the slate is properly used, the drawing always being made by eye before holding the glass slate in front of the object, it will be of great assistance to all who wish to learn to draw.



When the pupil can draw the simple objects, there is no reason why the light and shade may not be represented by pencil tints put on with the *side* of the pencil ; in the advanced grades charcoal can be used.

The high school work should include furniture drawing, and corners of the room, with more difficult groups of models. A graduate of this school should certainly have the ability to sketch indoors and out, with truth so far as proportion is concerned. It is hoped that the importance of this subject may be realized, and that, if necessary, some of the less important work may give way that this may improve.

Much help will be obtained from examples of good drawings by advanced students and illustrators. With very small outlay each teacher can procure from magazines and papers reproductions of pencil, pen and ink, and shaded drawings by the best artists. If these reproductions are placed where they can be seen all the time, they will interest the pupils, and give them an idea of expression such as they can never obtain from the mechanical cuts of most drawing-books. Care should be taken to secure some drawings simple in character, which may serve to interest the pupil in his own elementary work.

These drawings should not be copied, for if copying is begun, it is almost certain to be done to excess, and as has been said, the elementary work of the public schools cannot properly consider technique. It is hoped that

soon the teachers who are now talking about methods, etc., may give their attention to the simple study of Nature, and the making of truthful drawings.

Some have attempted to state theories of color and æsthetics, which the student may study to improve his taste. The value of this theory may be illustrated by referring to the numerous statements of perspective principles which have been drilled into the students of many schools, who are at the present time making the fearful and wonderful productions labelled "from the object."

The most practical solution of this problem has been given by an artist, who in one of the schools of Salem, Mass., has just arranged pictures by good artists, photographs, casts, and other reproductions of the best art work. The influence of good examples of this nature cannot fail to cultivate the taste and raise the artistic standard of the people. The time given to theories of the beautiful will be much better spent in the study of Nature involved in the simplest drawing.

## CHAPTER V.

### TESTS.

Paragraphs marked (T.) are for the use of teachers only.

IN beginning, the student should understand that his drawings are of no value in themselves, but are of use only as they train the eye to see correctly. The eye can be taught, or rather the mind can be made to accept the image of the eye, only by depending upon it, and *if the student begins by measuring and testing he will never be able to draw otherwise.* This is undesirable for many reasons, the most important being that no measurements can be applied which will take the place of correct perception, or begin to equal the trained eye. It is thus important that the student, from the beginning, depend entirely for his first drawing upon his eyes.

The best possible training for all young or old is the use of the glass, explained on page 62. Any one who wishes to train his eyes to correct seeing can do so most quickly by drawing with the special pencil upon this slate by eye alone, his impressions of the form, and then testing the drawing by holding it in front of the object.

The readiest way of determining the apparent proportions of an object is by the use of a pencil or any straight,

slender rod held at arm's length, and to appear to cover the lines to be compared. Thus the end of the pencil may be held so as to appear to cover the top of an object, whose apparent height may be measured on the pencil by means of the thumb-nail placed so as to appear to cover the bottom of the object. If the pencil is now turned into a horizontal position, the apparent height of the object may be compared with its apparent width. If the measurement covering the height is one-half the distance on the pencil which covers the width, the group appears twice as wide as high. In this way the apparent proportions of any object or group may be found.

It is important that this use of the pencil shall determine simply the proportion of the drawing and not its actual size. The measurements on the pencil must not be transferred to the paper, for the eye and hand are in different positions when the various measurements are taken, and if they are transferred to the paper the drawing resulting will be incorrect in proportion.

The slightest change in distance of the pencil from the eye when proportions are compared will occasion inaccuracy. The only way to be at all correct is to hold the pencil as far from the eye as possible, the arm being perfectly straight and the pencil being turned by twisting the entire arm.

The pencil must be at right angles to the direction in which the object is seen. Nearly all students think the

P 147

pencil should be parallel to the side of the room, or the bench upon which the object rests. This, however, is wholly false, for the position of the object with reference to its surroundings is of no consequence, and must not be considered when the actual appearance of the object is desired. If a cube is to be represented, the student must look at it, and the plane which gives its real appearance is perpendicular to the direction in which he looks, and when measuring, the pencil must always be held in this position. When thus held, its ends are the same distance from the eye.

A good plan is to find some position in the fingers in which the pencil is perpendicular to the arm, which when outstretched, brings the pencil into practically the correct position, Fig. 10.

P-147

(T.) *In the public schools* when the subject is begun, some may find that a pin pushed into the pencil at right angles to it will help to place the pencil. When the pencil is held so that only the head of the pin is seen, the pencil is perpendicular to the direction in which the pupil looks. A better device may be made by bending a piece of soft wire (a hair-pin) about a large knitting-needle as shown in Fig. 12. One end of the wire projects at right angles to the needle, and the other extends back and projects a short distance perpendicular to the first end. The longer end serves as a sight to place the needle correctly. The wire should press the needle enough to

keep in place upon it. It may be moved by the finger or thumb, and the measurement taken by sighting over the short end. This slide will assist greatly, and as it is important that measurements should be correct, it is advised that every student who cannot hold the pencil properly be provided with this measuring-needle and slide. It will also assist when one measurement is not an easily determined part of the other. See page 23.

(T.) The smaller measurement should always be compared with the larger. If the former is one-half or one-third of the latter, this is easily determined, but if the first is three-fifths or four-ninths of the second, the proportion is not so easy to determine, and if the two measurements can be taken in such a way that they may be compared at leisure, the proportion may be more surely determined. This may be done by taking the smaller by the sliding wire and the larger by the thumb.

If the back end of the pencil is used to measure by, the pencil will be held correctly when the end appears a straight line, thus producing the same result as the pin projecting from the pencil.

The distance of the needle or pencil from the eye when proportions are compared must be the same. The distance is so apt to vary that unless each comparison is made several times with the same result, there is little chance of the measurements being correct. It is useless to think that tests not carefully taken are worth the time

given them. It is much better to take the one proportion of height and width carefully, than to spend the time necessary to do this on half a dozen measurements which are sure to contradict, and do more harm than good.

It is impossible to compare accurately a short distance with a long. If the height is equal to or nearly one-half or one-third the width, care will so determine it, but with every new position of the hand in moving a short distance over a long, inaccuracy arises, and it is well to avoid such comparisons.

The inaccuracy is produced by inability to hold the pencil at exactly the right place, and also by the change in the distance of the pencil which every movement away from the first position occasions.

This movement may be realized by tying a thread to the pencil and measuring its distance from the eye by holding the thread with the left hand against the brow. If the arm is dropped for the measurement of a near object and the thread is tight, it will loosen when the arm is raised, and in the same way it will change for horizontal movement. The only way in which exact measurements of an extended subject can be taken is by the use of such a measuring-thread for the pencil; but we wish to simplify the subject as much as possible, and if reasonable care is exercised the variation in the distance of the pencil may be made so slight as to be unimportant in the drawing of small objects.

When possible, all comparisons should be made by swinging the pencil from a vertical into a horizontal position, by motion of the whole arm from the shoulder, and avoiding change in distance by revolving the pencil about one end of the first measurement. Thus if the height and width of a table are to be compared, instead of measuring the width along the top and dropping the hand to compare the width with the height, or measuring the height and then lifting the hand to compare with the width, make the comparison by taking the width along the top, and swinging the pencil down about the thumb; or by taking the width at the bottom and swinging the pencil up about the thumb, as in Fig. 13. Measuring in this way will assist greatly to correct results.

(T.) A short distance may of course be compared with a long, with a degree of accuracy varying with the student; but such measurements are not recommended and are unnecessary, as other tests will give better results. Another way by which distances may be compared is by marking upon the edge of a ruler or piece of cardboard with a pencil. The distances may be compared at leisure.

The above are the direct tests for proportion, and if carefully taken, should give the correct mass of the drawing, but for smaller proportions and directions of lines other tests are better.

The lines with which it is natural to compare directions



are vertical and horizontal lines. A horizontal line whose ends are equi-distant from the eye appears horizontal and is represented by a horizontal line. A vertical line appears vertical and is always represented by a vertical line. If a ruler is held horizontal, with its ends equally distant from the eye, it illustrates the appearance represented by a horizontal line in the drawing. By looking over the ruler thus held, the apparent directions of lines of the object may be compared with the horizontal.

A thread with a weight attached serves as a plumb-line. By holding it in front of the object its lines may be compared with the vertical. The thread is often better than the ruler or pencil for the horizontal line, as it hides none of the object. Care must always be taken to hold the thread perpendicular to the line of sight. This position is easiest obtained by directly facing the group, extending the arms equally, and holding about two feet of the thread, whose ends are then equally distant from the eye.

More care must be exercised to have the thread horizontal. This position can be obtained only by seeing nothing but the thread until it is levelled, when the student may look behind it. If the student sees the group before the thread is level, its lines will probably make the thread seem horizontal when it is not. If there are horizontal lines in the subject which are parallel to the pic-



ture ("not foreshortened"), they will appear horizontal and will place the thread correctly; but if the horizontal lines of the subject are not thus situated, they will not appear horizontal, and so will cause the thread to be out of level.

It may seem that unnecessary space has been given to these directions, but it has been found almost impossible to make many students understand the matter, and hold the thread correctly, even after repeated explanations and illustrations. Some, after months of study, are found holding the thread or pencil at an angle of from ten to thirty degrees away from the correct position, and it is thought that no explanation can be too careful. The problem is so simple that any student who wishes to succeed should have no difficulty. He may be sure that he will never learn to draw until he is able to discover his mistakes, and as the use of the thread is a most important test, it should be correctly applied.

Any object, as the cube, Fig. 14, having been drawn, it may be tested by the thread as follows: Hold the thread horizontal to cover point 5, and note its apparent intersections with the edges 1-6 and 6-7. Hold the thread vertical in front of point 3, and see where it intersects 5-6. Hold it in front of 6-7, and notice its intersection with 2-3. Hold the thread to cover 1 and 5, also 2 and 4, and compare the directions with a horizontal line. Continue the edge 2-7 to intersect 5-6, and

Fig. 147

4-7 to intersect 2-1. Cover any opposite points as 1 and 3, 3 and 6, 4 and 1, etc., and notice where the thread appears to intersect the edges between.

FIG - 14 -

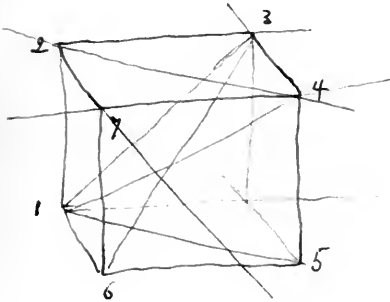

ply a more exact method using lines in the air, the eye is trained, the ruler, is all that is needed. The use of the thread preference which can be made to object, and its intersection much more readily than rule or rule, which hides consequences with the thread to discover every error of

(T.) A last test may be applied by holding two pencils together at right angles to the direction in which the object is seen, and separating them until one covers 2-3 and the other covers 5-6. If great care is taken, the directions of these lines with reference to each other may be seen, and the drawing tested by continuing these lines in the drawing.

(T.) One way of measuring the apparent angle between lines is by folding a piece of paper and holding it so that each part appears to coincide with one of the two lines. This way is easiest applied by the use of a hinged rule or straight edge of two parts. I cannot recommend

ture ("not foreshortened"), they will appear horizontal and will place the thread correctly; but if the horizontal lines of the subject are not thus situated, they will not appear horizontal, and so will cause the thread to be out of level.

It may seem that unnecessary directions, but it has been found to make many students understand the thread correctly, even after diagrams and illustrations. Some, after holding the thread or pencil ten to thirty degrees away from the vertical, it is thought that no explanation is needed. The problem is so simple that any student who succeeds should have no difficulty in repeating it; that he will never learn to draw without the thread is able to discover his mistakes, and as the use of the thread is a most important test, it should be correctly applied.

Any object, as the cube, Fig. 14, having been drawn, it may be tested by the thread as follows: Hold the thread horizontal to cover point 5, and note its apparent intersections with the edges 1-6 and 6-7. Hold the thread vertical in front of point 3, and see where it intersects 5-6. Hold it in front of 6-7, and notice its intersection with 2-3. Hold the thread to cover 1 and 5, also 2 and 4, and compare the directions with a horizontal line. Continue the edge 2-7 to intersect 5-6, and

4-7 to intersect 2-1. Cover any opposite points as 1 and 3, 3 and 6, 4 and 1, etc., and notice where the thread appears to intersect the edges between.

This use of the thread is simply a more exact method of discovering angles than drawing lines in the air, the first method explained. When the eye is trained, the first, which is of course the simpler, is all that is needed. But most students will find the use of the thread preferable, as it gives a fine line which can be made to exactly cover the edges of the object, and its intersection with the edges can be seen much more readily than that of a line formed by a pencil or rule, which hides considerable of the object. If these tests with the thread are applied, they cannot fail to discover every error of importance.

(T.) A last test may be applied by holding two pencils together at right angles to the direction in which the object is seen, and separating them until one covers 2-3 and the other covers 5-6. If great care is taken, the directions of these lines with reference to each other may be seen, and the drawing tested by continuing these lines in the drawing.

(T.) One way of measuring the apparent angle between lines is by folding a piece of paper and holding it so that each part appears to coincide with one of the two lines. This way is easiest applied by the use of a hinged rule or straight edge of two parts. I cannot recommend

this test, for there are two straight edges to be held at right angles to the direction in which the student looks, and it is so difficult to do this that I do not know of many students who have succeeded. Those who can hold the rules correctly, may depend upon their eyes and get the drawing better without many mechanical tests than with them.

(T.) Another way of testing the direction of a long line is to hold a straight edge upon the line of the drawing, and then lift the board and straight edge into the position of the picture plane, when the straight edge appears to coincide with the line if its direction in the drawing is correct.

I have dwelt thus carefully upon each test in the hope that the student may realize their importance, for he will learn to draw correctly only through his own efforts, gaining with each discovery of error. He can never become a draughtsman as long as he depends upon a teacher for corrections. Let him carry his drawing so far that a thorough application of the tests explained will show no error, then as it is simply a question of exactness to be determined by the eye, if the trained eye of the teacher discovers mistakes so slight that the student cannot rightly be expected to determine them, these may be pointed out. As the chief benefit results from what the student himself sees and does, he will be much better off without a teacher than with one who does his work for him.

As stated on page 23, the art student should use few texts and should not require the mechanical aids to testing which have been explained. They may sometimes be required by teachers in the public schools, when students have no capacity for the work, but even then they will not be necessary if the glass is used to train the eye to see proportions, or as a means for testing. In all work, the student should aim to use few aids and to throw these aside as soon as possible.

There are many who say that measurements and tests are mechanical, and that to learn to draw the student should draw by eye simply. It is true that measurements and tests, as unfortunately too many students are taught to use them, cannot fail to produce hard and mechanical drawings and retard progress. Still it seems better for the student, when he can see no farther, to be shown by tests where his eyes have failed, rather than to carry drawings only as far as he can by eye, and then put them away and begin others which can be carried but little if any farther. Therefore the student is advised to apply the tests explained after he has carried his drawings as far as he can see, and not to put any drawings away which the tests show to be untruthful. It is believed that this training will most quickly produce ability to draw truthfully at sight.

## CHAPTER VI.

### PERSPECTIVE PRINCIPLES.

(See Preface, page vii.)

“OUR whole past, and especially the ideas and emotions of the present moment, determine how we perceive any object.”

This being true, the student must work long and earnestly before he can separate facts from appearances, as the knowledge of the actual form prevents the mind from accepting its appearance. The impression conveyed to the mind of one not trained to accept the image of the eye, is the result of a combination of what the eye sees with what is by far the greatest factor, what the mind knows concerning the actual conditions of the object. The student must struggle continually not only against this influence of his mind, but also against the effect which one line exerts to change the apparent directions of others. This effect is sometimes so strong that even the practised eye of the artist is deceived, and we may safely say that the most perfect eye, with the longest training, is liable to be deceived. A knowledge of the perspective principles governing the appearance of form



is thus helpful to the draughtsman who would be truthful, and there is no reason why there should not be truth and artistic rendering at the same time.

*The Plane of the Drawing.*

*Begin*

The mind through the sense of sight perceives form, the rays of light from any object entering the eye, being focused on the retina, and forming an image of the object, as in the camera, except that in the latter the image is formed on a plane surface, while that in the eye is formed on a spherical surface. As but a single point can be seen clearly at any time, the image of the eye is practically the same as that of the camera.

The artist's problem is to make his drawing so that it shall create the same ideas of form, size, and position as the objects which it represents. It is evident that this must occur when the drawing produces the same image in the eye as the objects. To do this the drawing must be similar to the image.

The rays from any object to the eye form a conical body.\* If this cone of rays is intersected by any plane, the intersection is a picture of the object, which if the object is taken away, will still create its image in the eye. If this plane of the picture is at right angles to the cone, the section (the picture) will be a true picture of the object, that is, be similar to the image of the eye.

\* i.e. form a cone of visual rays  
see p 144

Figure 15 represents a circle A, placed vertical and in front of the eye. The cone formed by the visual rays is represented by lines  $b-b$ , and a vertical plane cutting through the cone of rays, by line P. If the student will hold any cone horizontal, it will perfectly illustrate the figure, the base of the cone representing the circle A, and the apex representing the eye. With the cone the student will at once see that a vertical plane between the eye and the base intersects the cone in a circle. This circle is the picture of the base A. 

Figure 16. If now the plane of the picture is inclined to the axis of the cone, its intersection with the cone is still a picture of the circle, but in shape it differs from that in Fig. 15, which is a circle. The oblique intersection is an ellipse, but it is important to notice that it does not appear such to the eye at the apex of the cone. It appears a circle exactly covering the base of the cone. It makes no difference how the plane of the picture is placed, or what the proportions of the resulting ellipse, it must always appear to the eye a circle, in fact, the circle of the base. When the eye is removed from the apex of the cone, the ellipse appears an ellipse, and is not a true picture of the circle. The circle of Fig. 15 and the ellipse of Fig. 16 are pictures of the circle A, and create in the eye, when it is at the apex, a circular image of the circle, but the former only is similar to the object A.

When looking at pictures we naturally hold them in

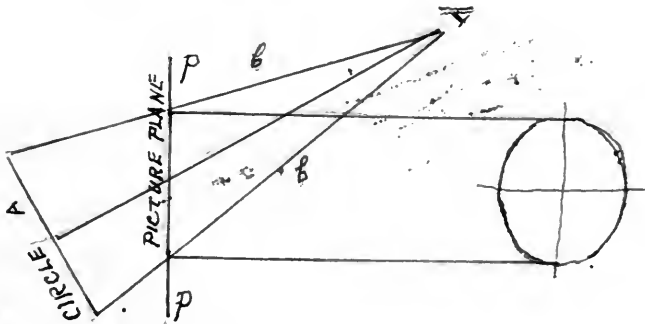
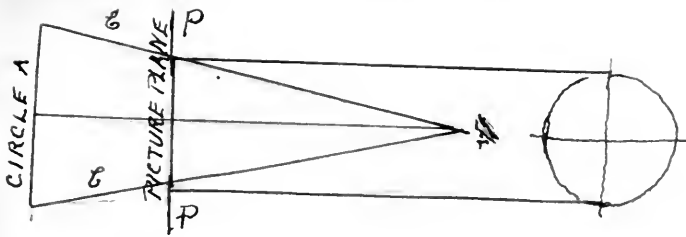

This must be at right angles to the direction in which the object is seen. The plane cannot be perpendicular to all the rays, but should be so to the central one. *Fig 16<sup>a</sup>* ←

A "true" picture of any object may be obtained by drawing upon a sheet of glass with a brush and color, or a special pencil, or on a wire screen with chalk. The glass or screen should be placed at right angles to a line from the centre of the object to the eye, the eye and screen held in one position, and lines drawn to cover all the edges which are seen. It is desired that every student make drawings in this way, a small pane of glass and a special pencil being the best materials. The drawings should be made with the glass at right angles to the rays, also when it is held obliquely. The drawings may be

line

4

2

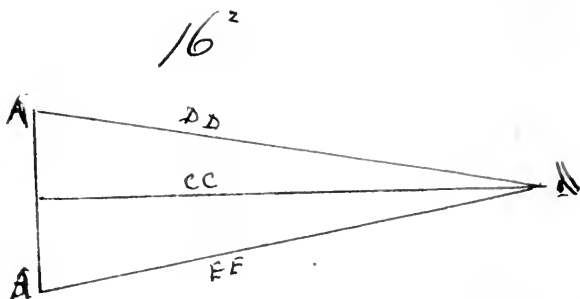

The author wishes to say that, if the plane  $AA$  is at right angles to the central axis of vision  $CC$  - that it cannot be at right angles to  $DD$  or  $EE$

tion is an ellipse, but it is important to notice that it does not appear such to the eye at the apex of the cone. It appears a circle exactly covering the base of the cone. It makes no difference how the plane of the picture is placed, or what the proportions of the resulting ellipse, it must always appear to the eye a circle, in fact, the circle of the base. When the eye is removed from the apex of the cone, the ellipse appears an ellipse, and is not a true picture of the circle. The circle of Fig. 15 and the ellipse of Fig. 16 are pictures of the circle  $A$ , and create in the eye, when it is at the apex, a circular image of the circle, but the former only is similar to the object  $A$ .

When looking at pictures we naturally hold them in

front of us, at right angles to our line of vision, as in the position of the plane P of Fig. 15. If plane P of Fig. 16 is thus held, the ellipse upon it appears an ellipse, and cannot create the idea of a circle. We see that the first picture is preferable to the second, for it is a circle, and wherever the eye is placed creates a circle in the eye. (It is of course understood that it is always looked at perpendicularly.)

We will distinguish the first picture from that given by any other position of the picture plane, by calling it a true picture, meaning that it is similar to the image created in the eye by the object. There can be but one position of the picture plane which gives a "true" picture. This must be at right angles to the direction in which the object is seen. The plane cannot be perpendicular to all the rays, but should be so to the central one. *Fig 16°*

A "true" picture of any object may be obtained by drawing upon a sheet of glass with a brush and color, or a special pencil, or on a wire screen with chalk. The glass or screen should be placed at right angles to a line from the centre of the object to the eye, the eye and screen held in one position, and lines drawn to cover all the edges which are seen. It is desired that every student make drawings in this way, a small pane of glass and a special pencil being the best materials. The drawings should be made with the glass at right angles to the rays, also when it is held obliquely. The drawings may be

*True  
picture*

*p 144*

*Fig 16°* ←

*?*

compared, and the student realize that the glass must be perpendicular to the direction in which he looks for the drawing to give the real appearance of the object.

x { It appears that a drawing on any plane or surface creates the correct impression, only when the eye is in the position which it had when the drawing was made. All drawings, then, are best seen from some one point or distance. The trained eye will select this distance. As, however, drawings and pictures will be viewed by untrained eyes, and as the proper point may not always be accessible, it is important that all should be avoided which causes marked distortion, when the picture is not seen from the proper point. If the picture is a "true" picture, the distortion produced when it is viewed from too long or short a distance, appears not in the shape of its parts, but only in the relative sizes of the objects represented. Thus the distortion of a "true" picture is always less than that of a drawing on a plane oblique to the visual rays, and the "true" picture is by far the best drawing that can be made for general use. It is called a Model Drawing.

2 ' Before beginning the problems, we will choose a term which shall mean the position in which any line appears its real length, and any plane its real shape. This occurs when the line or the plane is perpendicular to the direction in which it is seen, that is, is parallel to the picture plane. The words "parallel to the picture plane"

Also for anyone to enjoy or appreciate a picture he must view it from the same point that the artist had when he drew it.

might cause confusion, from the fact that in perspective the picture plane is generally vertical, and takes in a wide field of view, while in Model Drawing the plane is perpendicular to the direction in which one looks, and is thus continually changing. We wish a term which shall mean the position in which any line appears its real length and any plane its real shape, and will select the words not foreshortened. Any line is "not foreshortened" when its ends are equally distant from the eye, and any plane when its angles are equally distant.

*foreshortened*

We must also decide upon a term which shall mean the appearance of the facts instead of the facts. We select *perspectively*. "*Perspectively*" parallel thus means the appearance of parallel lines, which is that of convergence. "*Perspectively*" parallel lines are lines which converge towards a point, and "*perspectively*" equal distances on any line are unequal, the space representing the nearest of the equal distances being the longest, as in Fig. 24. x P. 90

?

The apparent angle at which parallel lines seem to converge, that is, the angle between the lines representing parallel lines, we may speak of as large or small, and say that lines converge or vanish quickly or slowly. They vanish quickly when the vanishing-point is near the drawing, and slowly when it is far from the drawing.

The angle which any line appears to make with a horizontal line that appears horizontal, we will call the



x The spaces 1. 2 3. 4. 5.

in fig 24 - are alluded to.

Page 90

P. 90

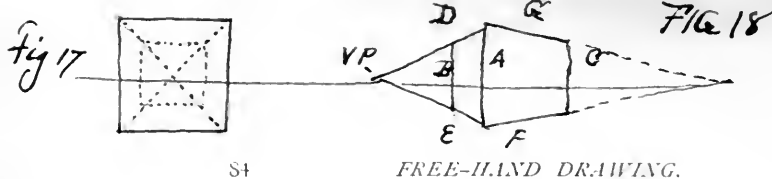

84

FREE-HAND DRAWING.

angle of inclination. Thus all horizontal lines whose ends are not equi-distant, appear to incline at smaller or greater "angles of inclination," according to the angles which the lines make with the picture plane. Lines not level appear inclined at "angles of inclination" which increase with the angles of the lines with the picture plane and the ground. *The "angles of inclination" of horizontal lines increase or decrease with the distance of the vanishing-point, that is, with the angle of convergence.*

In all the problems explained, the picture plane is supposed to touch the object at its nearest point, and the drawing is the largest possible to be made on a plane in front of the object.

#### *Study of Principles.*

Figure 17. Place a large cube a few feet distant from the eye, so that its centre is on the level of the eye, four of its edges vertical, and one face visible, with its angles equally distant from the eye. This face is "not foreshortened," and appears its real shape.

Figure 18. Turn the cube so that its left side appears very narrow. It will be noticed that the upper end of the farther vertical edge B appears below the upper end of the front edge A, and that the lower end of the farther edge appears above the lower end of the front edge. The farther edge thus appears shorter than the



front edge. It is also seen that the horizontal edges D and E, which connect the ends of these verticals, appear to converge. If these lines of the drawing are continued, they will meet. The continued lines must be the representations of continuations of the edges, and we see that parallel retreating lines in Nature appear to converge to a point called their vanishing-point. *V.P.*

We now find that the right edge C is farther from the eye, and thus appears shorter than the central edge A, and the horizontal edges F and G appear to converge, as the horizontal edges of the left face. The edge C is much nearer the eye than B, and appears longer. It is really but little farther from the eye than A, and the convergence of F and G is very slight. As the eye is opposite the centre of the cube, the apparent distances that the upper ends of B and C are below that of A must be the same as the apparent distances of the lower ends of B and C above that of A; and the "angles of inclination" of the upper edges D and G must be the same as those of the lower edges E and F. Since these edges appear equally inclined, they will appear to vanish on the level of the centre of the cube, that is, of the eye.

If now the eye is lifted, the "angles of inclination" at the top decrease, and those at the bottom increase. When the eye comes to the level of the top of the cube, the upper angles disappear, and the whole top is seen as a horizontal line.

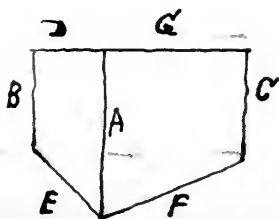

Fig 18  $\frac{1}{2}$

Fig 18  $\frac{1}{2}$

From this study of the cube, we see,—

1st. That of two parallel and equal lines which do not vanish, the nearer appears the longer. The relative lengths appear to decrease as the distances increase. See Fig. 19, in which B being twice the distance of A from the eye, appears one-half as long as A.

2d. That parallel, retreating lines appear to converge towards a point, called their vanishing-point. (All lines whose ends are unequally distant from the eye are retreating lines.)

3d. That horizontal, retreating lines appear to descend or vanish downward when the lines are above the level of the eye, and to ascend or vanish upward when they are below the level of the eye. This is evident from the fact that the eye must be dropped to look from the nearer to the farther end of the line above the eye, and be raised to look from the nearer end of the line below the eye to its farther end.

4th. That parallel, retreating horizontal lines appear to vanish at the level of the eye.

5th. That a horizontal line at the level of the eye appears horizontal, and a horizontal plane at this level is seen edgewise, and appears a horizontal line.

We will now draw upon the wall of any room lines which have the apparent directions of the horizontal lines A, B, C and D, at floor and ceiling, which are perpendicular to the wall. We find that the lines on the

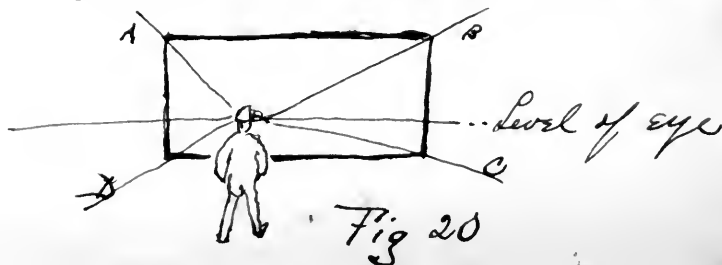
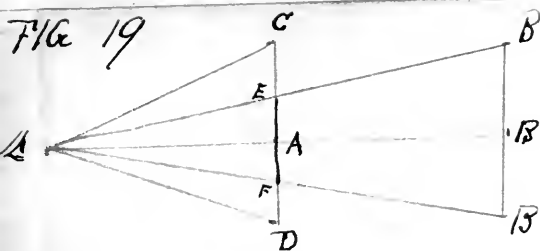

FIG 19



The line  $E'D$  = appears longer than  $B'B$  - simply because the angle  $C'D$  is greater than  $B'B$ . The latter seems no longer than  $E'F$ .

87  
 he eye. Par-  
point infinitely  
 e transparent,  
 continue on  
 to converge.  
 the continu-  
 se lines, (the  
point in the  
 . This point  
 room passing  
 ough the eye

Infinitely  
7 distant

Pictures

lines is in a

To draw the lines on the side of a room, two students must work together, one observing, the other drawing the lines with a straight edge. But the students may work individually by drawing a sketch of any room, the directions of the perpendiculars to the end being determined by holding the thread or a ruler to cover the lines. This experiment proves that *to see the vanishing-point of a system of parallel lines, we must look in their direction.*

All parallel lines which have one end nearer the eye than the other appear to converge, and the convergence is in the direction of their farther ends. According to this statement, the vertical edges of a cube above or below the eye appear to converge, but they are not so represented. In

From this study of the  
 1st. That of two parallel lines  
 vanish, the nearer appear  
 lengths appear to decrease.  
 See Fig. 19, in which B  
 from the eye, appears one  
 2d. That parallel, receding  
 towards a point, called the  
 whose ends are unequal  
 retreating lines.)

3d. That horizontal, receding  
 ascend or vanish downward  
 level of the eye, and to a  
 they are below the level of  
 the fact that the eye must  
 nearer to the farther end of the line above the eye, and  
 be raised to look from the nearer end of the line, below  
 the eye to its farther end.

4th. That parallel, retreating horizontal lines appear  
 to vanish at the level of the eye.

5th. That a horizontal line at the level of the eye  
 appears horizontal, and a horizontal plane at this level  
 is seen edgewise, and appears a horizontal line.

We will now draw upon the wall of any room lines  
 which have the apparent directions of the horizontal  
 lines A, B, C and D, at floor and ceiling, which are per-  
 pendicular to the wall. We find that the lines on the

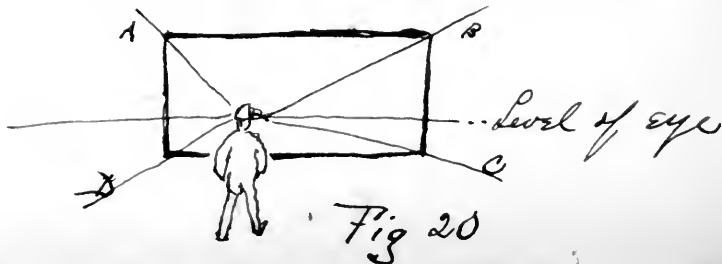

wall intersect at a point directly opposite the eye. Parallel lines in Nature appear to meet at a point infinitely distant. Suppose the end of the room to be transparent, and the lines perpendicular to the end to continue on the other side. Retreating, they appear to converge. The lines drawn on the end are pictures of the continuing lines. The point on the wall where these lines, (the pictures,) meet must be the picture of the point in the infinite distance where the actual lines meet. This point is in a perpendicular to the end of the room passing through the eye; that is, it is in a line through the eye parallel to the lines. Hence we see that,—

*The vanishing-point of any set of parallel lines is in a parallel to them, passing through the eye.*

To draw the lines on the side of a room, two students must work together, one observing, the other drawing the lines with a straight edge. But the students may work individually by drawing a sketch of any room, the directions of the perpendiculars to the end being determined by holding the thread or a ruler to cover the lines. This experiment proves that *to see the vanishing-point of a system of parallel lines, we must look in their direction.*

*All parallel lines which have one end nearer the eye than the other appear to converge, and the convergence is in the direction of their farther ends.* According to this statement, the vertical edges of a cube above or below the eye appear to converge, but they are not so represented. In

*Infinite  
distance*

*Pictures*

a model drawing vertical lines are represented by vertical lines (see page 96).

Figure 21. Place a cube so that its top and front faces are seen, and so its right side appears a vertical line. The edges A, A, A have their left ends a little farther from the eye than their right ends; but the distance is so short that the convergence is very slight, and the edges appear practically horizontal. Line B of the drawing is longer than C, and yet the edge C is nearer the eye than B. This proves inexact the statement frequently made that "of two parallel and equal lines, the nearer appears the longer." (X)

Figure 22 is a top view, representing the eye, a horizontal square, and a vertical picture plane. It shows that of two parallel and equal lines, AB and CD, unequally distant from the eye, the nearer, AB, appears the shorter when the lines are at a greater angle than  $45^\circ$  with the picture plane. When at a less angle than  $45^\circ$ , as BD and AC, the nearer, BD, appears the longer. This statement is only exact for lines whose angles are noticeably larger or smaller than  $45^\circ$ .

The figure also shows that of two equal lines, AB and BD, perpendicular to each other and having one end common, *the one which makes the greater angle with the picture appears the shorter*; or conversely, the one nearest parallel appears the longer. It shows, too, that *if one line of a right angle vanishes toward the left, the other must vanish toward the right.*

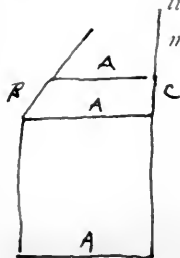

(X) Compare Figs 19 & 21 -

Fig. 21 -

opposite →

?

?



If one side of the right angle is "not foreshortened," the other side extends directly away from the spectator, and vanishes at a point above the side "not foreshortened," on the level of the eye.

Figure 23 shows that two equal, horizontal lines, perpendicular to each other, at equal angles with the picture, appear equal in length. When below or above the level of the eye they are at equal "angles of inclination."

In Figs. 22 and 23, the visual rays intersect the picture plane, and give the positions upon the picture plane of the vertical lines which contain the ends of the lines representing the sides of the square, which are thus

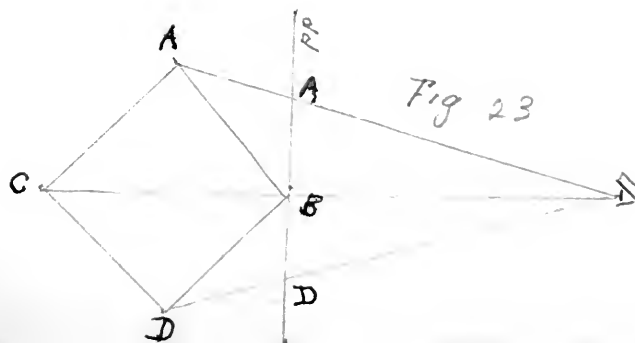
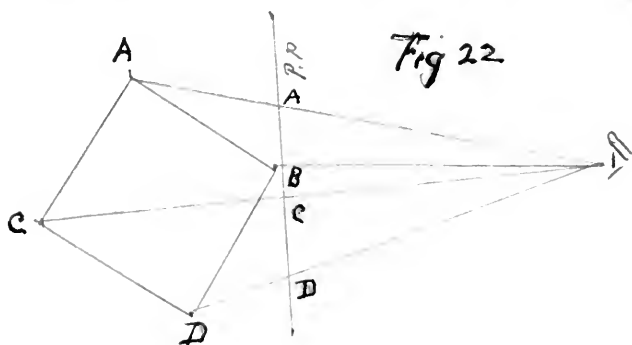

a model drawing vertical lines are represented by vertical lines (see page 96).

Figure 21. Place a cube so that its top and front faces are seen, and so its right side appears a vertical line. The edges A, A, A have their left ends a little farther from the eye than their right ends; but the distance is so short that the convergence is very slight, and the edges appear practically horizontal. Line B of the drawing is longer than C, and yet the edge C is nearer the eye than B. This proves inexact the statement frequently made that "of two parallel and equal lines, the nearer appears the longer." (X)



opposite →

?

]  
zor  
of  
dis  
wh  
pic  
an  
me  
lar

Bl  
co  
pic  
pa  
li.

Fig. 21-

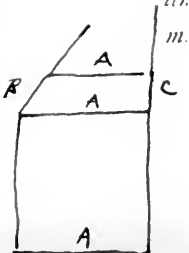



If one side of the right angle is "not foreshortened," the other side extends directly away from the spectator, and vanishes at a point above the side "not foreshortened," on the level of the eye.

Figure 23 shows that two equal, horizontal lines, perpendicular to each other, at equal angles with the picture, appear equal in length. When below or above the level of the eye they are at equal "angles of inclination."

In Figs. 22 and 23, the visual rays intersect the picture plane, and give the positions upon the picture plane of the vertical lines which contain the ends of the lines representing the sides of the square, which are thus longer than the distances seen in the plan.

The apparent length and angle of any retreating line depends upon its angle with the picture, the level of the line, (referred to the eye), and the distance of the eye from the line.

The greater the angle of any line with the picture, the more it is foreshortened, and the greater the "angle of inclination."

As the eye is lifted, the "angles of inclination" of the lines AB and CD, Figs. 22 and 23, increase. Placing the eye nearer the lines produces the same effect, but the "angles of inclination" must always be much less than the real angles which the lines make with the picture plane. The "angle of inclination" decreases as the eye approaches the level of the line, and also as the distance of the eye increases.

The statement often made that "of parallel and equal lines the more distant appears the shorter," has probably accomplished as much harm as good, for it is only true of lines "not foreshortened," and of vertical lines within the limits of ordinary drawings. It is not necessary to think of this point in the case of horizontal lines, for there are other tests upon which it is always better to depend.

Figure 24. AB represents a horizontal line lying upon the ground, and 1, 2, 3, etc., equi-distant points in the line. The lines from these points to the eye represent the visual rays by which the points are seen. These rays, intersecting the picture plane, show that *the equal distances appear unequal, the nearest appearing the longest, and the farthest the shortest, the apparent length decreasing as the distance increases.* This is always true of the appearance of equal lengths on retreating lines.

There are three sets of parallel lines in the cube.  
 They all appear to vanish unless they are "not foreshortened," and are so represented except when they are vertical, or are situated as in Figs. 21 and 25.

They vanish in the directions of their farther ends, and these are points of the invisible faces of the object.

If both ends of an edge are points of an invisible side of the object, the edge must be considered as "not foreshortened," even when the eye is not opposite its centre.

Figs 24<sup>a-b</sup>

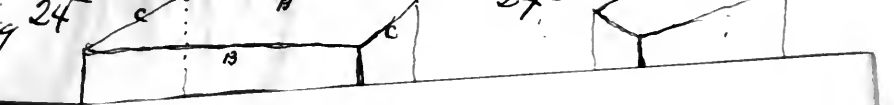

AAAA - point upward & downward  
BBBB " laterally  
CCCC " forward & backward

---

If the cube sits with one line touching through  
out on the picture line - then none of the  
lines parallel with it will vanish - neither will  
the vertical lines vanish - CCCC will vanish

---

If the cube touches P.P. only at one point  
all lines save the vertical will vanish

---

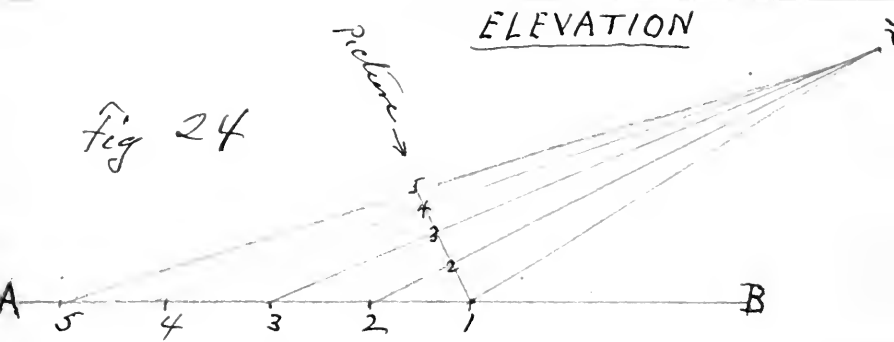

fig 24

Figure 24. AB represents a horizontal line lying upon the ground, and 1, 2, 3, etc., equi-distant points in the line. The lines from these points to the eye represent the visual rays by which the points are seen. These rays, intersecting the picture plane, show that *the equal distances appear unequal, the nearest appearing the longest, and the farthest the shortest, the apparent length decreasing as the distance increases.* This is always true of the appearance of equal lengths on retreating lines.

There are three sets of parallel lines in the cube. They all appear to vanish unless they are "not foreshortened," and are so represented except when they are vertical, or are situated as in Figs. 21 and 25.

They vanish in the directions of their farther ends, and these are points of the invisible faces of the object.

If both ends of an edge are points of an invisible side of the object, the edge must be considered as "not foreshortened," even when the eye is not opposite its centre.

Figs 24<sup>a-b</sup>

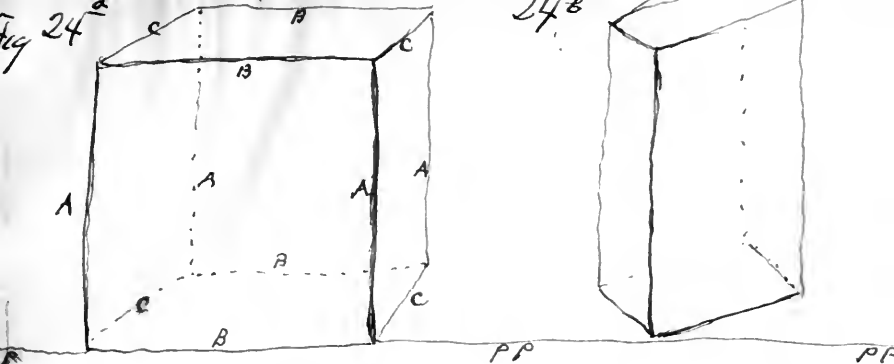

Three sets of parallel lines in a cube

- AAAA - points upward & downward
- BBBB " laterally
- CCCC " forward & backward

If the cube sits with one line touching through out on the picture line - then none of the lines parallel with it will vanish - neither will the vertical lines vanish - CCCC will vanish

If the cube touches P.P. only at one point all lines save the vertical will vanish

7

5

Figs

If the eye is opposite one end, as in Fig. 21, and the edges are short, they will be best represented by parallel, horizontal lines.

If the edges are long and the eye is opposite or near an end, as in Fig. 25, it may sometimes be better to distort the nearer and smaller part of the drawing in favor of the larger part, by representing the lines as they appear. This will happen in an interior when the prism is at the side of the picture so that the distortion of the nearer end is not very noticeable.

In any drawing representing simply the prism, it will generally be better to give the effect of a right prism, and avoid the distortion of the nearer part by making the lines horizontal. *In general, parallel horizontal lines which extend on both sides of the spectator should be represented by parallel horizontal lines.* The student should not be allowed any other way, but should treat all edges as "not foreshortened," when neither end face of the object is visible.

In Nature there is no effect like that given by parallel perspective. The difficulties which have just been considered are easiest settled by avoiding the question when possible, by moving so that an end appears and two vanishing-points can be used, the drawing being between them. If one vanishing-point is in the drawing, as in Fig. 9, the drawing must be distorted, for when one line of a right angle vanishes toward the left, we expect to see

the other vanish toward the right. When the question cannot be avoided in this way, and parallel straight lines extend on both sides of the spectator, they should be represented by parallel straight lines, and in the case of horizontal lines, by horizontal lines.

Parallel straight lines in Nature appear curved. This is shown by the shadows of clouds at sunset, which sometimes may be seen extending across the sky, converging in the west toward the sun, and in the east toward a point opposite the sun. Any straight lines which the mind does not know to be straight will, if long, produce the impression of curved lines. This is best shown by the rays of the electric search-light.

In many drawings from Nature by our leading illustrators, the curvature resulting from drawing the different parts of long lines as they appear, is very noticeable.

Although the student may have difficulty in seeing the effect of curvature, even in long lines, he may very easily prove that curvature will result if he draws the parts, even of short lines, as he sees them. This may be done by drawing from three boxes or prisms, placed a short distance apart and in a straight line, the central box being directly opposite him, so that only two faces are seen.

Figure 26 represents the appearance of the left-hand box, both sets of whose horizontal edges appear to vanish, for two sides of the box are seen.



Figure 27 represents the central of the three objects. Only one set of its horizontal edges vanishes, for since but one side is seen, the other set is "not foreshortened."

Figure 28 represents the right-hand box, whose appearance must be similar to that of the box at the left.

The vertical edges of the objects at the sides are farther from the eye than those of the central one, and thus appear a little shorter than the edges of the latter, and if the long lines of the drawings are continued, they will form curved lines.

Figures 26, 27, and 28 are each correct representations of the appearance of a single box; but if they are looked at all at once as a single picture, the impression of the objects being placed in a curve is produced. No one would think of making this drawing as a representation of three objects placed in a straight line. The drawing below, Fig. 29, would be made by all, but this drawing does not represent correctly the appearance of the boxes at either side, and it appears that to give the correct general impression, drawings sometimes cannot be exact in detail.

There are some who think that the study of this question is unnecessary, that without theory all would naturally make the drawing, Fig. 29, as a representation of the three boxes. This is probably true; but the knowledge that we see as we cannot always represent is very necessary, as is proved by the many illustrations from the pens

*12* 152

of those who fail to apply to a large subject the reasoning which gives Fig. 29, and thus produce drawings which are flagrant violations of the simplest rule of perspective, and this is frequently the result of the attempt to draw by eye the appearance of the parts of a large subject (see page 49).

Straight lines appear curved, but their representation by curved lines is generally unsatisfactory, and the student should never be allowed to represent straight by curved lines. As shown on plate 28, straight lines may be substituted for the curved lines, changing the drawing very little when there are two vanishing-points.

The influence of diagram perspective, and particularly the appearances of parallel perspective, are so powerful, that many illustrators do not realize that they do not see parallel perspectives in Nature, and that there must be two vanishing-points for the horizontal lines of any rectangular object, when two of its sides are seen. It is not necessary to advise the student not to make as one drawing the Figs. 26, 27, and 28, or not to represent the end of a room as curved; yet the draughtsman who would never think of making the latter mistake in the case of a single unbroken surface, will frequently do it when the surface is broken or when there are many short lines in different planes.

Diagram perspective has created many false ideas, and is responsible for much bad drawing, and yet the per-

ies

FIG 30

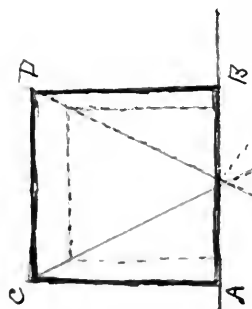

NB an ELEVATION is a SIDE VIEW  
a PLAN is a TOP VIEW

LEVEL OF EYE

C- POINT opposite EYE - i.e. Point of sight. The lines CC-DC  
GC and HD are Vanishing lines -

FIG 31

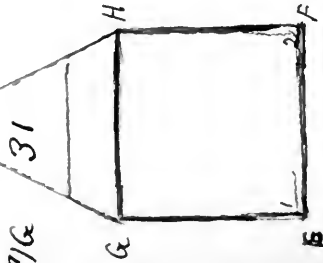

PICTURE PLANE

Fig 32 - (Elevation -)

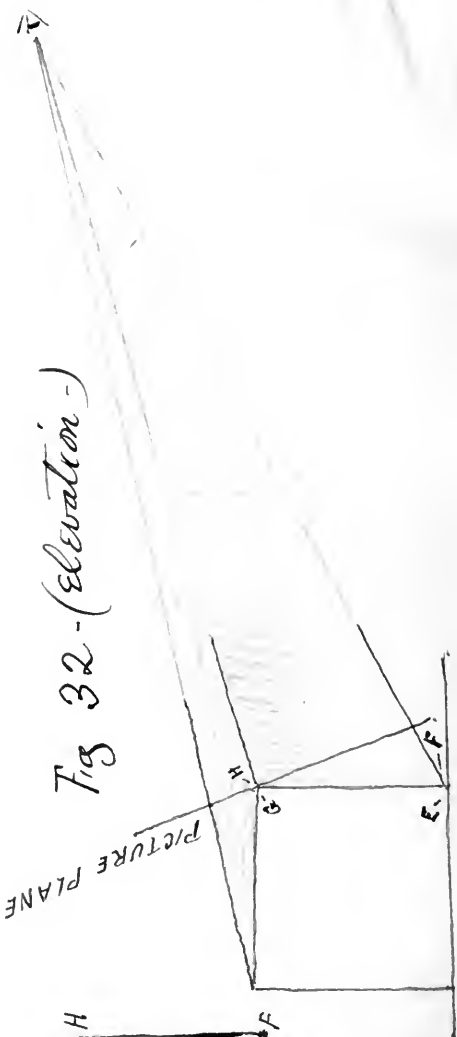

spective principle that straight, parallel lines have the same vanishing-point is absolutely necessary to the illustrator.<sup>1</sup>

*Application of Principles to Drawings of the Cube.*

A cube with edges of four feet. Scale  $\frac{1}{2}$  in. = 1 ft.

Figure 30. The cube with four edges vertical, its lower face on the level of the eye, and one surface visible with its lower edge AB "not foreshortened."

The lower face appears a horizontal line. The upper edge CD of the front face is farther from the eye than AB, but unless the eye is very near the object, the face will be foreshortened so little as to appear practically its real shape.

Figure 31. A cube with its top, four feet below the cube of Fig. 30.

The receding horizontal edges vanish at point C, the centre of edge AB, because this edge is on the level of the eye, and a line from its centre to the eye is parallel to the edges. The front face is below the eye, and will be foreshortened, as shown by Fig. 32, so that its apparent height is less than its width. The edge EF is farther

<sup>1</sup> Illustrators and artists, even the most noted, have made "parallel perspective" drawings from the earliest periods. The influence of the many strong painters who have used one vanishing-point when there was no reason for not drawing what was seen, and making use of two vanishing-points, probably accounts in large part for the frequent errors of the illustrators of the present time.

*dotted lines*

from the eye, and appears shorter than the edge GH. (X)  
 It appears the length of 1-2. (This distance may be found by means of a plan of the cube, the picture plane, and the eye.) Connecting 1-G and 2-H, the vertical edges are represented by inclined lines. This is not satisfactory. The model drawing must represent vertical edges by vertical lines. If verticals are drawn from G and H, the front face will seem too wide; if from 1 and 2, it will seem too narrow. The proper effect will be given by verticals between these lines, or by verticals from G and H, the line 1-2 being dropped a little.

The model drawing is not the exact drawing upon the inclined plane, but this drawing corrected by substituting vertical for inclined lines.

 Figure 33. The cube with its vertical faces at  $45^\circ$  to the picture plane, the top being on the level of the eye.

The top is seen as a horizontal line. The sides, since at equal angles with the picture, appear of equal width, and the edges A and B vanish upward at equal angles which depend upon the distance of the eye. When horizontal lines are at angles of  $45^\circ$  with a vertical picture plane, the distance of their vanishing-points from the centre of the picture, (that is, line E,) is the same as the distance of the eye from the picture plane.

The entire width of the appearance is the perspective of the diagonal 1-2 of the base of the cube, which is "not foreshortened." This line is behind the picture plane,

① The eye is on the level of A.B and is above GH and still more above E.F. ∴ GH is longer than EF

FIG XXXIII

FIG XXXIV

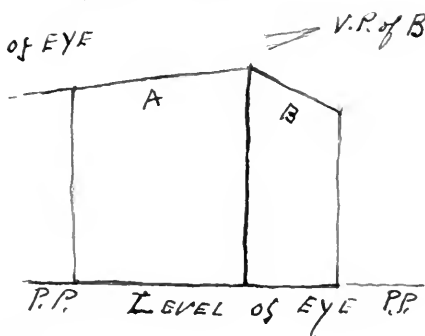
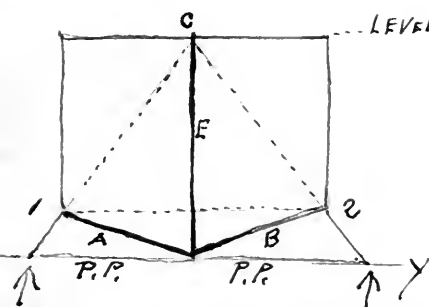

line 1.2 is parallel with X.Y

etc.

Figure 34. The cube, with its lower face on the level of the eye, and its vertical faces extending to the left at  $30^\circ$ , and to the right at  $60^\circ$ .

The left face is nearest parallel to the picture plane, and thus appears wider than the right face. The edges A and B vanish downward at angles which depend on the distance of the eye from the object, but the angle of A must always be less than that of B. For equal distances of the eye, the width of the appearance must be less, when the faces are seen unequally, than when they are seen equally. The apparent width decreases as the cube is turned toward the position in which only one side is seen.

Figure 35. The cube with its vertical faces vanishing equally, its top being four feet below the level of the eye.

XXXIII  $\frac{1}{2}$  Here the sides appear of equal width, and the "angles

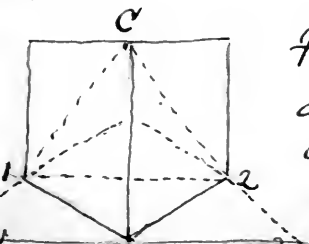

Fig 33  $\frac{1}{2}$  The line 1-2 is the diagonal of the base. and as the angles 232 and 131 are 45- 12 must be parallel with 133 12 = X.Y

↑ Fig 34

verticals between these lines, or by verticals from  $C$  to  $H$ , the line 1-2 being dropped a little.

The model drawing is not the exact drawing upon the inclined plane, but this drawing corrected by substituting vertical for inclined lines.

Figure 33. The cube with its vertical faces at  $45^\circ$  to the picture plane, the top being on the level of the eye.

The top is seen as a horizontal line. The sides, since at equal angles with the picture, appear of equal width, and the edges  $A$  and  $B$  vanish upward at equal angles which depend upon the distance of the eye. When horizontal lines are at angles of  $45^\circ$  with a vertical picture plane, the distance of their vanishing-points from the centre of the picture, (that is, line  $E$ ), is the same as the distance of the eye from the picture plane.

The entire width of the appearance is the perspective of the diagonal 1-2 of the base of the cube, which is "not foreshortened." This line is behind the picture plane,

① The eye is on the level of  $A, B$  and  $\therefore$   
above  $GH$  and still more above  $EF$ .  $\therefore$   
 $GH$  is longer than  $EF$



and so does not appear its real length. The exact length can be obtained by setting off the actual length of the diagonal on a horizontal line through the lower end of the front edge, and by drawing from its ends, lines to the point opposite the eye. The intersections of these lines with the lower lines of the drawing give the lower ends of the side verticals.

Any known length can thus be measured on the picture plane, and carried into the picture by means of parallel lines, which vanish at C, the point opposite the eye.

Figure 34. The cube, with its lower face on the level of the eye, and its vertical faces extending to the left at  $30^\circ$ , and to the right at  $60^\circ$ .

↑ Fig 34

The left face is nearest parallel to the picture plane, and thus appears wider than the right face. The edges A and B vanish downward at angles which depend on the distance of the eye from the object, but the angle of A must always be less than that of B. For equal distances of the eye, the width of the appearance must be less, when the faces are seen unequally, than when they are seen equally. The apparent width decreases as the cube is turned toward the position in which only one side is seen.

Figure 35. The cube with its vertical faces vanishing equally, its top being four feet below the level of the eye.

XXXIII 1/2 Here the sides appear of equal width, and the "angles

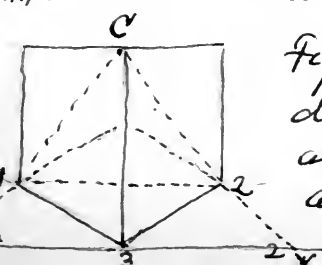

Fig 33 1/2 The line 1-2 is the diagonal of the base. and as the angles 2 3 2 and 1 3 1 are 45- 12 must be parallel with 1, 3, 2 12 = XY

of inclination" and convergence are alike on each side of the central edge. There are four parallel edges extending to the right, and four to the left. Parallel horizontal lines appear to converge toward a point on the level of the eye, and there will be two vanishing-points. Since the edges are at equal angles with the picture, they will incline at equal angles, and the vanishing-points will be equi-distant on each side of the central edge.

In this position of the square, which is the base of the cube, one diagonal, 1-2, is parallel to the picture ("not foreshortened") and appears a horizontal line. The other diagonal, 3-4, appears a vertical line, and the farther angle of the square seems directly over the nearer one. *When the top of the cube is seen in this way, the visible sides always appear of equal width.*

The diagonals are perpendicular to each other, and it is seen that if two lines are perpendicular to each other, and one is "not foreshortened," the right angles appear right angles.

Figure 36. The cube above the eye, its horizontal edges extending to the left at  $60^\circ$ , and to the right at  $30^\circ$ .

Both sets of edges vanish at points in a horizontal line at the level of the eye (called the horizon), the point at the left being nearest to the drawing, for *the line at the greatest angle with the picture appears the shortest*. The diagonals of the horizontal surfaces vanish. Point 2 is

left. The  
to be its

2, on the  
round, the  
tical face

when the  
45° to the  
vertical  
s directly  
1 1 and 2  
bisect the  
ht at the  
spectively  
earer end  
r vanishes  
ing-point,  
ines.

below the  
aring the

It is thus  
, and the  
nish more  
han those

LEVEL of EYE

Fig 35

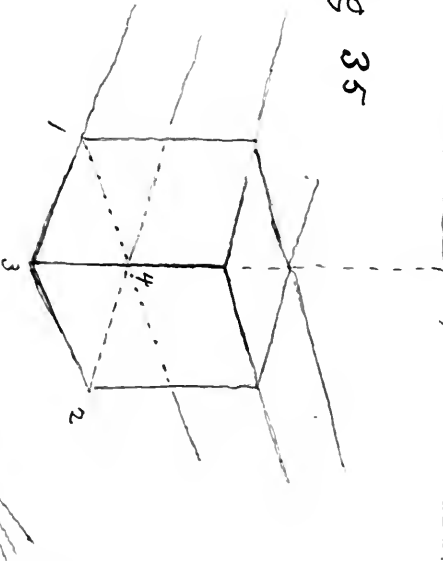
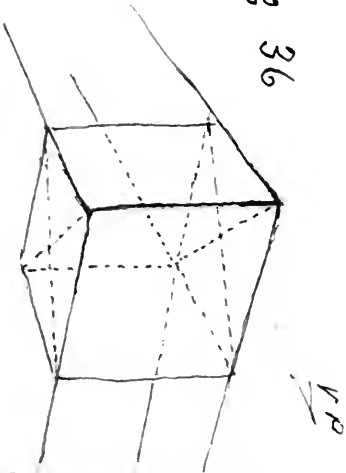

Fig 36



LEVEL of EYE



LEVEL of EYE

V P

FIG 38

Fig 37

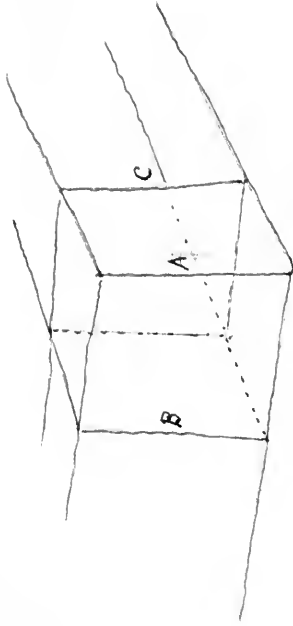
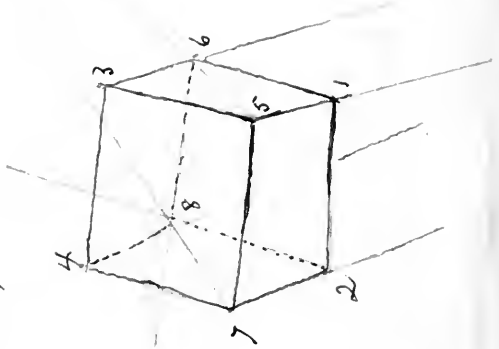

the nearer end of 1-2, which vanishes to the left. The other, 3-4, vanishes to the right, for 3 is seen to be its nearer end.

Figure 37. The cube resting on an edge, 1-2, on the ground, with four of its faces at  $45^\circ$  to the ground, the eye being above the object, and the right vertical face being visible.

The edge on the ground vanishes to the left, when the right vertical face is seen. If four faces are at  $45^\circ$  to the ground, the diagonals of the other faces must be vertical and horizontal lines. The upper edge, 3-4, is directly over the edge on the ground, and verticals from 1 and 2 contain 3 and 4. The horizontal diagonals bisect the vertical diagonals, and vanish toward the right at the level of the eye. Points 5, 6, and 7, 8, are perspectively equi-distant from the vertical diagonals. The nearer end of 5-3 is 5. This line vanishes upward, and 5-1 vanishes downward. Parallel lines have the same vanishing-point, and the other oblique edges vanish with these lines.

Figure 38. A cube resting on the ground, below the eye, with its vertical faces visible and appearing the widths AB and AC.

The face AC appears narrower than AB. It is thus at a greater angle with the picture than AB, and the horizontal edges extending to the right must vanish more quickly, and at greater "angles of inclination" than those extending to the left.

—  
*The Right Square Pyramid.*

The axis of this pyramid is perpendicular to the base at its centre. This point is found by drawing the diagonals.

Figure 39. When the base of the pyramid is horizontal, the drawing may be tested by a vertical line from the centre of the base. This should contain the vertex of the pyramid.

When two sides, AB and CD, of the base are "not foreshortened," they appear perpendicular to the axis, and one side only of the pyramid is seen if it is long or if it is above the eye. (Fig. 39.) If the axis is short or wholly below the eye, three of the triangular faces will be visible, the two outer ones appearing alike. (Fig. 40.)

One, two, three, or four sides, or the base with one, two, or three sides, may be visible at one time.

Figure 41. When two sides are seen, all the edges of the base appear to vanish. When two sides appear alike, the edges vanish at equal angles. The farther slant edge is just behind the nearer. One diagonal of the base, 3-4, appears to coincide with the axis of the pyramid, and the other, 1-2, appears at right angles to it.

Figure 42. When two sides are seen unequally, the axis of the pyramid appears perpendicular to a line which is parallel to the picture plane. A plan of the base and

FIG 39  
Y apex of Pyramid

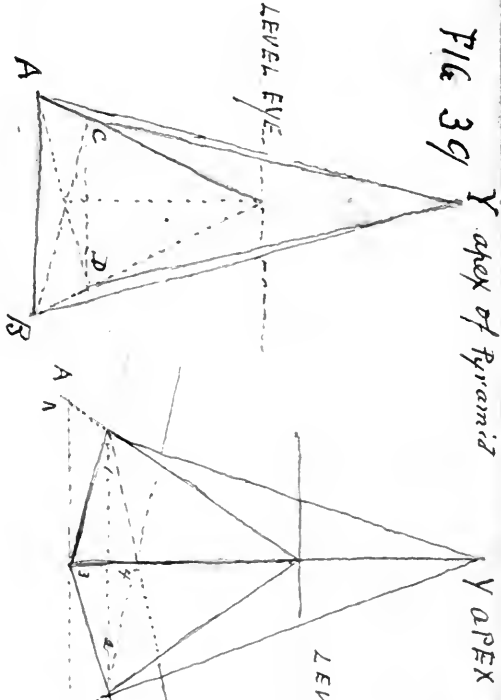

FIG 41

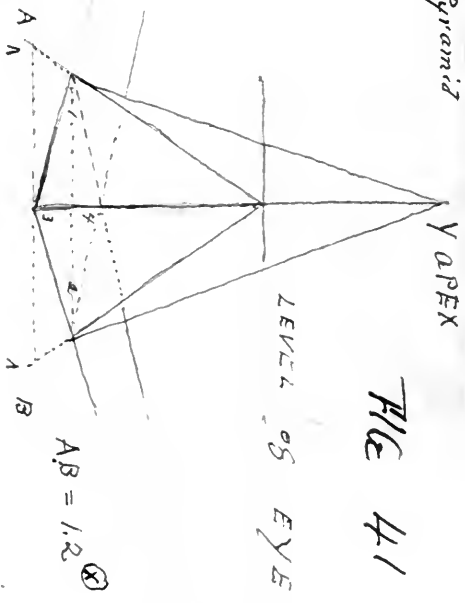

FIG 40

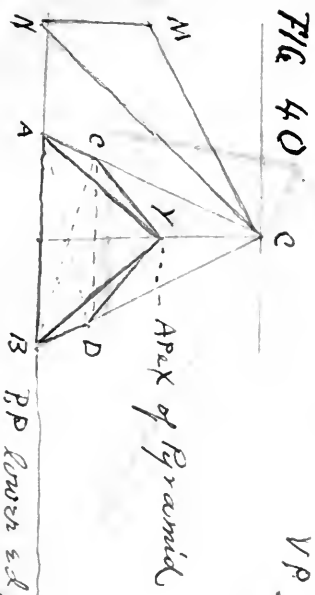
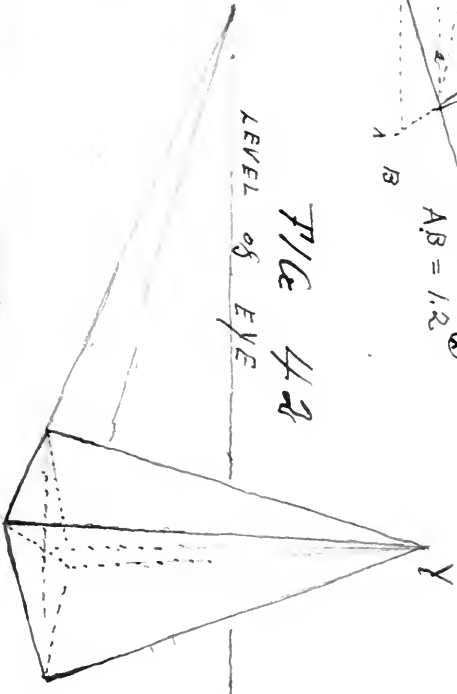

FIG 42



(4) The line AB is parallel

V.P

FIG 44

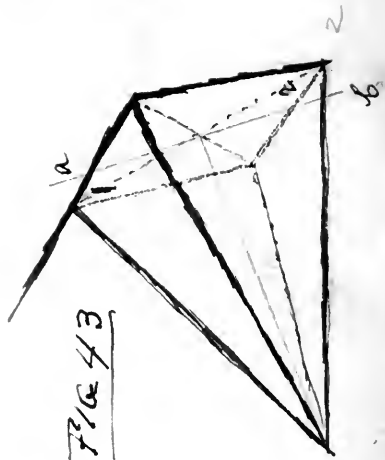
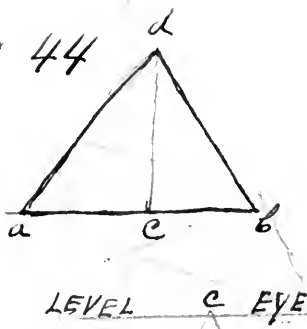
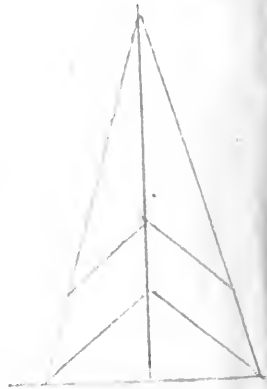

FIG 43

Fig 45





the picture plane will show the position of the line  $ab$  with reference to points 1 and 2. It passes behind 2, the nearer point, and in front of 1, the farther point. When the pyramid is vertical,  $ab$  appears horizontal. When oblique, as in Fig. 43, the line  $ab$  has the same relative position, passing in front of the farther angle of the base 1, and behind the nearer angle 2.

*The Triangle, and the Triangular Prism.*

Figure 44. When the triangle is equilateral or isosceles, and its base is a horizontal line, the altitude of the triangle is a vertical line, and intersects the centre of the base.

Figure 45. When neither end of the prism is seen, its long edges are "not foreshortened," and must be represented by parallel lines. Points 1 and 2 are in perpendiculars to the long edges, passing through the perspective centres 3 and 4, of the lower edges of the triangles.

Figure 46. When an end is seen with two sides which appear alike, one edge, A, of the base is "not foreshortened." The central, B, of the receding edges appears at right angles to this edge, and the end does not appear its real shape.

Figure 47. When an end and a side are seen, the drawing may be tested by a vertical line through point 1. This vertical should intersect 2-3, nearer 3 than 2, for

the nearer half of any retreating line appears longer than the farther half. The edges of the end vanish in the direction of their farther points, which are at once seen except in the case of the edge 1-2. If line 3-7 appears to intersect the centre of 1-2, edge 1-2 is "not foreshortened" and does not vanish. If 3-7 intersects 1-2 nearer 2 than 1, point 2 is the nearer end of the edge 1-2. If 3-7 intersects 1-2 nearer 1 than 2, point 1 is the nearer end.

The prism is so placed that the edges of the face on the ground are at equal angles with the picture. The length of the prism is twice that of the edge of its base. The edges 2-3 and 2-6 vanish at equal "angles of inclination." The nearer half of 2-6 appears as long as 2-3, the farther half, a little shorter than the nearer.

### *The Regular Hexagon.*

In the hexagon there are four sets of parallel lines, as A, B, C, and D, in Fig. 48. Its diagonal, o-4, is divided into four equal parts by the diameters D and the diagonals B and C. A drawing of this form will be tested by seeing that the parallel lines vanish in the directions of their farther ends, and that the diameters intersect the diagonal so that the points in it are perspectively equi-distant.

Figure 48 represents the hexagon when its centre is at the level of the eye, and it is "not foreshortened."

Figure 49 represents the plane after it has been revolved away from the spectator about angle  $o$ . A vertical line, the real length of a diameter, through  $o$ , will be a side of the rectangle shown in Fig. 48 enclosing the figure. The receding sides of this rectangle vanish at the level of the eye. The farther side is a vertical through  $4$ , whose position is determined by comparing the apparent width of the foreshortened figure with its height. The diagonals of the rectangle give the centre of the hexagon. A vertical,  $b$ , through the centre, bisects the rectangle, and diagonals from  $b$  to  $o$  and  $4$  give points  $5$  and  $6$  in the diameters of the hexagon. The diameters intersect the sides, giving the length of the sides  $A$ .

Figure 50 represents the hexagon in the same position as Fig. 48, except that a diagonal is vertical.

Figure 51 represents the foreshortened hexagon, when revolved back about side  $A$ . The enclosing rectangle is drawn as in Fig. 49. Its diagonals give the centre of the hexagon, through which passes the diagonal parallel to side  $A$ . Its ends,  $o$  and  $4$ , are angles of the hexagon. The vanishing lines  $D$ , from the nearer side  $A$ , give the farther side.

Figure 52. The hexagon having been sketched from the object, to test the drawing (assuming the diameter  $AB$  to be correctly placed),—

Draw  $CD$ , which will be horizontal, (parallel to  $AB$ .)

when point 4 appears over 0. Draw AD and BC. See that 0-1 is greater than 1-2 and 3-4 less than 2-3.

Figure 53. To test the sketch (assuming the nearest side to be correctly placed),—

Draw the diameters AC and BD, and the diagonals AD and BC, giving point 2. Through 2 draw 0-4. See that the points on this line are equi-distant, actually equi-distant when the line is "not foreshortened," and perspectively so when the line vanishes.

#### *The Hexagonal Prism and Pyramid.*

Figure 52 may represent the top of a vertical prism, two of whose sides will be seen equally when 4 appears just over 0. The side 0-A inclines at the same angle as 0-B, at both the top and the bottom of the prism, though the angles of the lower lines are greater than those of the upper. When two sides are seen equally and the prism is not vertical, the directions of the lines 0-A and 0-B may be determined by means of the diameters AB and CD of the hexagon, which appear perpendicular to the axis of the prism.

Figure 53 may represent the top of the prism when three of its vertical faces are seen, the two outer ones appearing of equal width. When thus seen, the edges AB and CD of the ends appear perpendicular to the axis of the prism.

Figure 54 represents the prism when three faces appear of unequal widths. The narrower A is the farthest from the eye. Points  $a$  and  $c$  are thus farther from the eye than  $b$  and  $d$ , and  $ab$  and  $cd$  vanish to the left. The parallel horizontal lines of the ends vanish in four points, which must be the same distance above the drawing (at the level of the eye). The equal spaces on  $o-4$  appear unequal. The vanishing of the parallel lines brings the lower base of the proper width, it being greater in this case than that of the top. The invisible end of a prism may appear wider or narrower than the visible end (see page 111).

Figure 55 represents a prism whose length is twice that of the diagonal of its base. The prism rests on one face on the ground, and is below the eye. The edges of this face are at equal angles with the picture.

The diameters of the ends are vertical lines and with the diagonals  $ab$  and  $cd$ , give points 1, 2, 3, etc., which are perspectively equi-distant. The narrower face A is the more distant, point  $a$  is the farther end of  $o-a$  and the edge vanishes upward. The "angle of inclination" of  $bd$  is the same as that of  $df$ . The side  $o-5$  is perspectively twice as long as the diagonal  $o-4$ . To fully test, draw the invisible edges, and the diameters and the diagonals of the bases. Continue all parallel lines to see that they vanish toward one point.

The question may arise "Shall the nearer half of the

diameter  $ad$ , be represented by a greater distance than the farther half?" ; omitting the convergence of the vertical lines makes the equal distances,  $ac$  and  $cd$ , equal in the drawing.

Figures 56 and 57. The tests for the pyramid are the same as for the prism and the square pyramid. When three faces are seen, the outer ones equally, the axis appears perpendicular to a diagonal of the base. When two faces appear equal, the axis appears perpendicular to a diameter. When two or three are seen unequally, the axis appears perpendicular to a line between the diameter and the diagonal, as in Fig. 42.

### *The Circle.*

The circle appears its real shape when it is "not foreshortened," and this means any position in which the circle is seen in a direction perpendicular to the circle at its centre. It appears a straight line when the eye is in the plane of the circle. In other positions, in which its entire circumference is seen, it appears an ellipse. If we suppose the picture plane to be a plane surface, the cone of visual rays will be intersected by it in a perfect ellipse, but if we suppose the picture plane to be a sphere or other curved surface, the section will not be an ellipse ; practically, the circle appears an ellipse.

Figure 58 is an elevation representing the eye, a

horizontal circle C on the level of the eye, and other circles, A, B, D, and E, above and below the level of the eye.

Figure 59 is a plan of the same. The circles are tangent to a vertical picture plane. In the elevation, lines to the ends of the horizontal lines representing the circles, represent the visual rays, by which their apparent heights are seen. These rays, intersecting the picture plane, give the short axes of the ellipses of Fig. 60. In the plan, the lines tangent to the circle represent visual rays, and intersecting the picture plane at 1 and 2, they give the length, 1-2, of the long axes seen in Fig. 60.

As the circle is dropped or lifted from the level of the eye, the length of the short axis increases, and within ordinary limits this is true of the appearance of all horizontal circles.

Figure 61 represents a square, two of whose sides are "not foreshortened." A circle inscribed in the square must be represented by an ellipse, tangent to the square at its diameters in points 1, 2, 3, and 4. The centre of the square is at the intersection of its diagonals, and appears nearer 2 than 1. The centre of the square, that is, the centre of the circle, is not the centre of the ellipse. In other words, the diameter of the circle does not appear as long as a chord in front of the diameter, and the long axis of the ellipse is not a diameter of the circle.

Figure 62 is an elevation representing the eye, the picture plane, and the ground, with the circle upon it.

Figure 63 is a plan of the same, both views corresponding with Fig. 61. The visual rays  $r, r$ , to points 1 and 2, determine at the picture plane the short axis of the ellipse. The line P, bisecting the angle between the rays, gives the centre of the ellipse, and continued to the ground, gives the position of the chord MN, which appears the longest line of the circle.

The eye is above the ground, and thus in the plan, the visual rays  $r, r$  do not come tangent to the circle at points M and N.

All lines whose ends are unequally distant must appear to vanish. In any circle there can be but one diameter which is "not foreshortened." This is the one which is perpendicular to the direction in which the circle is seen.

Such a horizontal line appears horizontal, and thus a horizontal circle always appears a horizontal ellipse, for though the diameter does not appear the long axis of the ellipse, it is parallel to the chord which appears the long axis, and this chord is thus "not foreshortened."

The short axis of an ellipse is perpendicular to, and bisects the long axis. The short diameter of the ellipse appears a vertical line in the case of a horizontal circle, and in any circle appears to coincide with a line perpendicular to the circle at its centre.

Conversely, the long axis of any ellipse appears perpendicular to a line which is at right angles to the plane of the circle at its centre.



Figure 64. The vertical circle A, when its centre is on the level of the eye, appears a circle, or an ellipse whose long axis 3-4 is vertical, for a horizontal line on the level of the eye appears horizontal, and this line determines the direction of the long axis of the ellipse.

B and C are vertical circles of the same size as A, directly over and under A, and in the same plane. Horizontal lines, perpendicular to these circles at their centres, vanish at the level of the eye. These lines determine the directions of the long axes 7-8 and 11-12 of the ellipses which represent B and C, and it is seen that *the axis of an ellipse which represents a vertical, foreshortened circle, on any level except that of the eye, must be an inclined line.*

The circles, being of the same size and in the same vertical plane, will be tangent to two vertical lines which are represented by vertical lines R and S. In order that the upper and lower ellipses shall be tangent to R and S, their short axes, 5-6 and 9-10, must be shorter than 1-2, that of the central ellipse. The width of the ellipse decreases as a vertical circle is raised or lowered.

The long axes 7-8 and 11-12 appear a little shorter than 3-4. Whether this difference shall be represented or not is a question similar to that considered on page 51.

*The Cylinder.*

When an end only is seen, it is "not foreshortened," and appears its real shape. If an end and the curved surface are seen, the end is foreshortened, and appears an ellipse. Less than half the curved surface of the cylinder can be seen at one time.

Figure 65. When one end of the cylinder appears a straight line, the other appears an ellipse, B.

When neither end surface is visible as a straight line, or as a surface, both ends appear narrow ellipses. The cylinder A is then "not foreshortened."

When one end of a vertical cylinder is visible, the other is invisible, and appears a wider ellipse than the visible end (see C and D).

The elements of a vertical cylinder appear to converge when the cylinder is not on the level of the eye, but are represented by vertical lines.

The long axis of the ellipse representing any circle is perpendicular to a line which is at right angles to the circle at its centre. In the cylinder this line is its axis, and in any drawing of the cylinder the long axes of the ellipses must always be at right angles to the axis of the cylinder. Generally, the fact that the centre of the ellipse is not the centre of the circle may be disregarded, and the line connecting the centres of the ellipses be considered the axis of the solid.

The visible end of any cylinder is nearer the eye than the invisible, which must thus appear smaller than the visible. The elements connecting the two ends appear to converge, as any parallel lines. The question of the comparative widths of the visible and the invisible ends has caused much trouble. Figures 22 and 23 show that the widths are dependent upon the position of the cylinder. When it is at an angle less than  $45^\circ$  with the picture, the invisible base appears the wider, as in the vertical cylinder as generally seen. When the cylinder is at a greater angle than  $45^\circ$  with the picture, the invisible base appears the narrower. This, however, is not exact for angles near  $45^\circ$ , and refers to common positions of the object. For unusual conditions, as a very long object near the spectator, or for a number placed in a line extending for some distance, it cannot apply; as the distortion caused by the use of any one picture plane would then be very great. It is best not to attempt to draw an object which is so near as to create a visual angle of over  $30^\circ$ .

Figure 66. The invisible base A is always at a less angle to the plane which gives the appearance than the visible B; that is, the visual rays to the invisible base make greater angles with it than those made by the visual rays to the visible base. The invisible base is nearer to the position in which it is "not foreshortened" than the visible, and though it appears narrower than the visible base, when the cylinder is at a greater angle than

$45^\circ$ , it also appears shorter, and *always appears proportionally wider than the visible*. This is the only rule that can be given. The difference between the apparent sizes depends upon the distance of the eye, and decreases as the distance increases. When the distance of the eye is short, the difference is marked.

Figure 67 represents a horizontal cylinder on the level of the eye. The cylinder extends to the left at  $45^\circ$  with the picture, and its base extends to the right at the same angle. Its length is twice its diameter.

The short axis 1-2 of the visible end A is a perspective half of the element 1-3. The contour elements converge toward the left.

Figure 68 represents the same cylinder, still at  $45^\circ$  to the picture, but inclining upward to the right instead of being horizontal.

The appearance is the same as that in Fig. 67. An object at an angle with the picture will present the same appearance as long as this angle is unchanged. It may revolve through a circle, and the only change is in the position of the appearance with reference to a horizontal line.

Figures 69 and 70 represent horizontal cylinders B and C, respectively over and under, and the same size as the horizontal cylinder A in Fig. 67, which is here represented by dotted lines. The ends are circles situated as those in Fig. 64, and the ellipses representing them must be tangent to two vertical lines.

Figure 71 represents a horizontal cylinder below the eye, and extending directly away from the spectator so that its axis appears a vertical line.

The end appears an ellipse, whose long axis being at right angles to the axis of the cylinder is a horizontal line. The tendency is to represent the end by a circle but it can appear so only when no part of the curved surface is seen.

Figure 72 represents a cylinder of the same size and parallel to that of Fig. 71, the ends of the cylinders being in the same planes.

In Fig. 71 the elements converge on the level of the eye. To this point the axis and elements of the parallel cylinder appear to extend. The centres of the ends are best represented by points in horizontal lines through the centres of the ends of the first object. The long axes of the ellipses pass through these points perpendicular to the axis of the cylinder. The short axes will be shorter than those of Fig. 71, for the ellipses must be tangent to horizontal lines, which are tangent to the ellipses of Fig. 71.

### *The Cone.*

The cone appears a circle when its axis would appear a point; a triangle, when its base is seen as a straight line. The entire curved surface is visible when the cone points toward the eye; none of the curved sur-

face is seen when the cone points directly away from the eye. Between these positions any part of the curved surface may be visible, the circle appearing an ellipse.

The base of the cone being at right angles to the axis as in the cylinder, it appears an ellipse whose long axis is perpendicular to the axis of the cone. The contour elements must appear tangent to the ellipse of the base.

Figure 73 represents three cones of the same size, A, B, and C, on a horizontal surface below the eye.

Cone A is vertical. The long axis of the ellipse of the base appears horizontal. The contour elements are tangent to the ellipse above its long axis, showing that more than half of the ellipse represents the visible edge of the base.

Cone B rests on an element on the ground. The base is visible, and appears wider than that of A. The axis thus appears shorter than that of A, and noting the tangent points of the elements, we see that less than half the curved surface is seen.

Cone C inclines toward the spectator. Its base appears wider and its axis shorter than that of B. Much more than half the curved surface is seen.

To draw the cone, cylinder, or any similar object, the methods explained on page 33 should be followed. The mass should be drawn first, and visible lines before imaginary ones. The axis, (which is an imaginary line,)

should not be drawn first, as is often recommended. After the position and proportions have been obtained, the axis may be indicated as a test before the drawing is accented, but on no account should this line be drawn first.

### *Concentric Circles.*

Concentric circles appear ellipses whose long axes are parallel, but since the centre of the circle is not the centre of the ellipse, the long axes of the two ellipses will not coincide.

Figure 74 represents in perspective and half plan concentric squares with tangent circles, the inner ones being half the diameter of the outer.

The angles of the inner square are in the diagonals of the outer, and are given in perspective by drawing the receding sides of the inner from the points 2 and 3 of the half plan. EF is the short axis of the ellipse tangent to the larger perspective square. GH, the short axis of the smaller ellipse. The long axes bisect the short, and it is seen that AB, that of the larger ellipse, comes in front of the centre of the square O, and also in front of IK, the long axis of the smaller ellipse.

Points E, G, O, H, and F are equi-distant in the diameter of the larger circle, and divide it into four equal spaces, which appear perspectively equal. The diameter CD of the circle is "not foreshortened," and

the equal divisions upon it appear equal. The diameter CD is not the long axis of either ellipse, but is parallel to them, and generally there is so little space between them that practically we may say that the equal divisions on the diameter of the circle appear in the long axis of the ellipse, and if the distance AI between the ellipses, measured horizontally, is one-fourth of the entire long axis AB, the distances EG and HF are perspective fourths of the entire short axis EF.

The apparent distances at front and back, between ellipses representing concentric circles, are always the same perspective parts of the entire short axis, that the distances between the ellipses on the long axis are of the entire long axis.

The distance between the long axes of the ellipses is equal to one-half the difference in length of HF and EG.

Figure 75 represents concentric circles more nearly as they generally appear, the distance FG being but little shorter than AB, and the long axes of the ellipses thus being very near together. The distance 5-6 is one-sixth of the axis 0-6, and shows that the spaces AB and FG must be perspective sixths of the short axis AG. The drawing shows that the retreating parallel circles do not appear to converge except beyond the centre of the circle. Thus, curved parallel retreating lines may appear to converge or diverge.



Figure 76 represents a circular ring, a cross-section of which is a square.

The circles are concentric on each side of the ring. The distance 4-8 is actually one-seventh of the long axis, and the distance 2-9 is a perspective seventh of the short axis. The square which is the section of the ring appears very nearly its real shape at the ends, the horizontal side 4-8 appearing a little longer than the vertical 3-4. The distance 1-2 at the front, is longer than 3-4, and at the back 5-6 is a little shorter. The invisible lines should always be sketched, so that the lines which are seen may have the right direction. Care must be taken not to exaggerate the distance between the long axes of the ellipses. In many cases it will not be necessary to draw more than one line as a test for both ellipses.

#### *The Frustum of the Pyramid and the Cone.*

When any pyramid is cut by a plane parallel to its base, the section is similar to the base and the lines of both figures are parallel.

Figure 77 represents the frustum of a square pyramid. This is a form frequently found in furniture, chairs, tables, etc. The drawings from these objects may be tested by seeing that the slant lines, when continued, meet at a point over the centre of the base, and that the lines of the upper base are parallel to those of the lower.

Figure 78 represents the frustum of a cone below the eye, with the larger base *A* visible.

The contour elements of the cone appear tangent to the ellipses of both bases and, when continued, meet at a point in the axis of the cone. The smaller base is invisible, and thus, being more distant, appears proportionally wider than the visible.

Figure 79 represents the same object, but seen from a nearer position, the ellipses appearing wider.

The contour elements are tangent to the ellipses farther from the ends of their long axes, and thus less of the convex surface is visible. A circle *A*, half-way between the two bases, is represented by an ellipse tangent to the contour elements, and perspectively half-way between the ellipses of the bases. The nearest element of the cone appears a vertical line and extends from its upper end *b* away from the eye. Its centre *1* thus appears nearer *a* than *b*. The farther element of the cone is nearer the position in which it is "not foreshortened," and point *2* is practically midway between *c* and *d*. The width of the ellipse is proportionally greater than that of the upper ellipse, but less than that of the lower.

Figure 80 represents the cone with its smaller base visible and a conical band about its surface. The elements are tangent to the ellipses behind the ends of their long axes, and more than half of the convex surface is seen. As already shown, the visible curved sur-

face of the cone may vary from none to all. Circles or bands about the convex surface will be visible in the same proportion as the surface of the cone ; less than half the ellipses being seen when the larger base of the cone is visible, and more than half when it is invisible. The apparent thickness of the ring or band, at the short and long axes of the ellipses, is given by the test for concentric circles.

Figure 81 represents a frustum of a cone and a circle between the two bases.

The apparent width of bands A and B varies with the angle of the cone and the position of the eye ; but this is a question of little importance, for the proportions of the ellipses can always be easily determined as explained, and the ellipses being correctly placed, the spaces between must be correctly represented.

Figure 82 represents a dish of conical form.

The nearer side of the dish is foreshortened more than the farther, and thus appears much narrower. The relative widths depend wholly upon the position of the eye. If lifted, the front appears narrower until it is seen edge-wise, and if farther raised, all the inner surface is visible.

An elevation of the object, representing the position of the eye, the picture plane, and the visual rays will assist in obtaining the proportions of the model drawing when it is made without the object. When drawing from the object, if the appearance of any part is not clearly under-

stood, this elevation will often help to make the principles clear.

Figure 83 represents a double cone, composed of intersecting cones A and B, whose bases are four inches in diameter, and whose axes are six inches. The whole length is eight inches.

The elements converge to points in the axis of the double cone, which are equidistant from the bases and from the intersection of the two objects. The smaller circle is common to both cones, and the ellipse which represents it must be tangent to the elements of both cones. Less than half the surface of A and more than half the surface of B is visible. It follows that the elements of the farther cone, B, must appear to intersect those of the nearer one, A. When the cones are much foreshortened this point is prominent, as in the sketch at the left.

#### *The Torus and Ring of Circular Section.*

The torus is a convex moulding frequently found in architecture, and in many common objects.

Figure 84. An easy way to draw this form is to sketch the ellipses representing the circles, which may be considered its bases. The section of the surface connecting these bases appears nearly its real shape at the ends of the long axes of the ellipses. (The semicircle in this

position below the eye appears half of a horizontal ellipse.) The curved contour of the moulding will be represented by a line tangent to the semicircle, and nearly so to the upper and lower ellipses, or, if the ellipses are wider, farther above and below the ellipses.

Figure 85 represents the ring. This object will be represented by concentric circles, when it is "not foreshortened," but when foreshortened, its outlines will not be ellipses. This is due to the fact that the outer visual rays are tangent in front below the centre of the ring, and behind above the centre. Thus the line on the ring which is on the contour is not a circle. When much foreshortened, the inner outline of the farther part will pass behind the outline of the nearer part, as in the drawing.

The centre line of the ring is a circle which, if seen, would appear an ellipse. Suppose a sphere of the diameter of the section of the ring to move, with its centre in the circle, around the circle. The sphere would describe the surface of the ring. The sphere will be represented in all its positions by a circle. When behind, by a circle slightly smaller than when in front. The outline of the ring must be represented by a line tangent to the circles representing the sphere. *Its outlines are thus very nearly parallel to the ellipse representing the centre of the ring.* It should be noted that if a line is parallel to an ellipse, it is not an ellipse. Parallel ellipses are impossible.

*Frames.*

In the frames of regular shapes are found concentric polygons. The angles of the inner figure being in the diagonals of the outer, this point enables us to test drawings of these objects.

Figure 86 represents a cubical frame.

The diagonals of any face, as ABCD, contain the angles of the inner square, any line of which being drawn, gives points in two other lines. Any angle of the object is an end of three lines. Thus, from E extend EF, EG, and EL. Continue any inner line to an outer edge of the object, and a point in the continuation of a second inner line is found. Thus, EG continued to AB gives point 1, which is in IK, and EF continued to the top, gives a point in an inner edge which extends to the left.

Figure 87 represents an equilateral triangular frame.

The angles of the inner triangle are in perpendiculars to the centres of the opposite sides. These lines intersect each other at the centre of the triangle. Any side of the inner triangle, as A, gives points 1 and 2 in the other sides, B and C. Any side, as A, may be continued to the outer triangle, giving 3. From 3 a parallel to the short edges gives 4, which is in the edge D, parallel to A.

Figure 88 represents a square frame with a circle A tangent to the inner square.

The student will probably draw the long axis of the ellipse representing this circle parallel to either the side or the diagonal of the square. The long axis is parallel to the side, when one outer side only, as B, of the square frame is seen. It is parallel to the diagonal only when two sides, as B and D, are seen equally. It is generally parallel to neither.

The long axis is perpendicular to the axis of the cylinder, of which the circle is the base. The direction of the axis of the cylinder is that of the short edges of the frame. A parallel to these lines, through the centre of the square, will be the short axis of the ellipse. The ellipse is tangent to the square at points *a*, *b*, *c*, and *d* in vertical and perspectively horizontal lines through the centre *e*. The long axis is perpendicular to, and bisects the short, and comes in front of the centre of the square.

Figure 89 represents a reading-glass, and illustrates the fact shown above, that the direction of the long axis of the ellipse must not be referred thoughtlessly to any other lines of the object.

The student who does not observe, will draw the long axis of the ellipse in the direction of the handle of the glass. It may, by chance, have this direction, but its direction may be very different. The handle radiates from the glass, as a spoke from its hub, and its direction may be that of any one of the many spokes in the wheel.

Figure 90 is an elevation, and Fig. 91 a model draw-

ing of a cylindrical object having a moulding and grooves about its surface.

Figure 90 represents the picture plane, and the visual rays converging toward the eye. These rays intersect the picture plane, and give upon it the positions of the various points to which they pass.

The upper form, A, is that of the torus, explained on page 120.

The central, B, is the reverse of this form. The circles appear lines, 5-6 and 7-8, in the elevation. The rays to these points intersect the picture plane, and give the short axes, 5-6 and 7-8, of the ellipses. The curved lines N and M, if visible, end above the long axis of the ellipse.

Form C is that of the double cone, explained on page 120.

### *Vase Forms.*

Figure 92 is an elevation representing the vase shown by the model drawing, Fig. 93, in which a common mistake is shown at the right side of the drawing, where the line representing the body of the vase extends to the long axis of the ellipse of the neck. The outline of the body must at least pass tangent to the ellipse, as at the left, and it may pass above the ellipse. The neck of the vase thus extends inside the outline of the body.



When the top of the vase is at right angles to the axis its circles are concentric, and appear as in Fig. 75.

Figure 94. When a handle projects from the side of the vase, its thickness breaks the outlines. When the handle extends toward the eye, the line of intersection appears fuller and more nearly its real shape, the more the handle is foreshortened.

Figure 95 represents the bottom of a vase, whose actual form is indicated by the light lines of the section. The lines of the stem appear to end above the centre of the ellipse, for any conical form which extends toward the eye must have more than half of its surface visible.

Figure 96 is an elevation of a vase, the picture plane, and the visual rays.

The rays, intersecting the picture plane, give the positions and the lengths of the short axes of the ellipses representing the three plinths, A, B, and C. These being drawn, the other lines of the model drawing, Fig. 97, are readily placed.

The curved lines of the neck appear above to intersect the lower ellipse of plinth A, and below, they end above the long axis of the upper ellipse plinth B. The body of the vase is represented by a line tangent to or above the lower ellipse of plinth B.

Figure 98 is an elevation of the lower part of a vase with a spherical shaped body and a cylindrical base having a curved moulding.

The curved edge may be drawn as the torus. The body of the vase is represented by a line tangent to the ellipse of the upper base of the plinth, at points depending upon the position of the eye. When the ellipses are narrow, the line will be tangent near the ends of the ellipse, as in Fig. 99.

When wider, the tangent points may be near the short axis (Fig. 100). If still wider, the curve of the body appears a continuous line covering part of the base (Fig. 101).

Figure 102 is an elevation of a vase whose appearance, (to the eye situated at the point of convergence of the visual rays,) is given by Fig. 103.

The elevation gives the positions and lengths of the short axes of the ellipses representing the different circles. The long axes are shorter than the actual diameters of the circles, because they are behind the picture plane. The upper edge of the vase is conical. The short, straight lines,  $a, a$ , tangent to the two ellipses, B and C, will be seen until the larger ellipse C is wholly visible.

The student who has a knowledge of Orthographic Projection may test his ability to draw from a description of the form and its position, by taking any sheets of projection showing objects one after another, supposing the objects to be seen from a certain point, and making model drawings which shall represent them. Thus, Fig.

104 represents several objects, and their relations to each other, and the planes of projection.

Figure 105 is a model drawing of the same, and supposes the objects to be seen from the left and from above, so that three faces of the cube are visible.

The cube is the first object, and any drawing which shows the top, front, and left sides, answers the requirements. When the cube is correct, the ground-line which is parallel to the edges extending to the right should be drawn.

The cone is the next object. Its base is a circle of the same diameter as the base of the cube. The best way to place the ellipse, which is the appearance of this circle, is to draw a square whose sides are parallel to the base of the cube. The ellipse must come tangent to the square at its diameters. The distance between the cone and the cube is equal to half the side of the cube. In perspective this distance 1-2 will be found by drawing the diagonals of the right front face of the cube. Setting off this distance on line AB, from 2 to 3, gives the nearest angle of the square. Its sides extending to the right are continuations of, and are perspective equal to those of the first square; and the sides extending to the left are parallel to those of the first. It should be remembered that these lines continue, and vanish at right and left in a horizontal line at the level of the eye, and all parallel lines should be continued as far as the drawing will

allow, so that they may be given the proper convergence. The student should not attempt to have the vanishing-points come on the paper. The diameters of the base give the tangent points of the circle and square, and through them the ellipse must pass. *The circle is horizontal, and the axis of the ellipse is a horizontal line.* The distance between the centre of the ellipse and the centre of the square is so slight as to be hardly noticeable. The long axis of the ellipse is, however, in front of the centre of the square; and in a larger drawing, where the ellipse is wide, if the axis should be drawn through the centre, the difference would be very noticeable. The axis passes through the centre of the square, and must be represented by a vertical line. Its length is readily determined by reference to the vertical edges of the cube, which are half as long as the axis.

The cylinder is next to be considered. The nearer circle is in the plane of the front face of the cube, and it will be best drawn by means of the square which circumscribes it. The sides of the square are parallel and equal to those of the right front face of the cube. Of course the distance 5-6 must be less than 3-4, as 3-4 is less than 0-2, and 4-5 is less than 2-3 (see Fig. 24). The diagonals of the square give its centre, and through this point the axis of the cylinder is drawn. The vertical and horizontal diameters give four points in the ellipse, whose long axis is a little in front of the centre of the square,

and at right angles to the axis of the cylinder. In the same way, the farther end may be drawn. The length of the cylinder being twice the side of the cube, the distance 7-8 is perspectively equal to 5-7.

The hexagonal prism is the last object. It is vertical, with one face in the plane of line AB. A diagonal of its base is parallel to AB. Its length may be placed on AB, from 9 to 10, perspectively equal to 5-6, the distance 6-9 being perspectively equal to 4-5. Points 11, 12, and 13, (dividing 9-10 into four perspectively equal parts,) being placed, the diameters of the hexagon extend from 11 and 13 toward the left-hand vanishing-point. The side 14-15 having been drawn, the diagonals 11-15 and 13-14 give the centre of the hexagon. Through this point the diagonal parallel to 11-13 passes, and the lines from 9 and 10 place in it the two remaining angles of the base, 16 and 17. The left vertical face A appears narrowest. This shows that 16 is nearer than 13, and the diameter 16-13 inclines upward slightly from 16.

These drawings call for lines at definite angles with the ground and the vertical plane. Such angles may be determined by means of the cube, and for this reason it will be well to draw this object first, even when it is not called for.

The edges of the cube, Fig. 106, being perpendicular to the two planes, the diagonals of its faces are at  $45^\circ$ . If smaller angles are desired, they can be obtained by

subdividing the angles of  $45^\circ$ . In making this division, it must be noticed that *equal angles never appear equal when occupying different positions with regard to the picture plane.*

Figure 107 shows that equal angles appear unequal, and *larger, the more the lines of the angles are foreshortened*, so that to divide any angle, the part which is most foreshortened must be represented by the greater angle, and as equal angles approach the position in which they are "not foreshortened," they will appear smaller.

By holding a triangular card, the student will see that an angle less than  $90^\circ$  may appear greater than  $90^\circ$ , when its sides are much foreshortened. In fact, the smallest angle may appear any angle up to  $180^\circ$ . An angle greater than  $90^\circ$  may in the same way appear any size up to  $180^\circ$ .

When the plane of the angle is foreshortened more than the sides of the angle, the angle appears less than its real size, and any angle may appear the smallest possible to be measured. *It is thus seen that an angle may appear any angle from the smallest up to  $180^\circ$ .*

Such practice will more quickly than any other work show the student whether he really understands the principles, or has been merely memorizing them. The latter, which unfortunately is the only way many study, will be found entirely useless, and those who have been working thus, must start again with the determination to see with

their own eyes, and to accept nothing which they have not verified by careful study.

The principles which have been explained enable one to see as it is impossible to see without them, to draw without the objects, to draw from memory, and to design geometric forms of any size and in any position. They are of so much value to the practical draughtsman that he cannot afford to be without them, even were it very difficult to obtain this knowledge. The principles are, however, so simple that there is no excuse for violations of the few essential ones ; yet such violations are found very frequently, not only in the work of the amateur, but also in that of the professional draughtsman.

Although the principles must be carried out in all good drawings, theory alone should be depended upon only when designing or drawing imaginary subjects. When Nature can be studied, the rules may be applied after careful consideration of the appearances, and it is not intended or supposed that the principles will render this study of Nature unnecessary. When understood, they are of most value in assisting the mind to accept the image of the eye, and *are unconsciously applied*.

#### *Review of Important Principles.*

Any line whose ends are equally distant from the eye appears its real length. Any plane whose angles are equally distant appears its real shape.

- 2 Parallel, retreating lines appear to converge, or vanish toward a point called their vanishing-point.
- 3 Of two parallel and equal lines which do not vanish, the nearer appears the longer.
- 4 Equal spaces on any retreating line appear unequal, the nearest appearing the longest.
- 5 All lines whose ends are unequally distant from the eye are lines which appear to vanish.
- 6 Horizontal, retreating lines, above the eye, appear to descend, or vanish downward.
- 7 Horizontal, retreating lines, below the eye, appear to ascend, or vanish upward.
- 8 Parallel, retreating horizontal lines appear to vanish at the level of the eye.
- 9 A horizontal line at the level of the eye appears horizontal, and a horizontal plane at this level appears a horizontal line.
- 10 The vanishing-point of any set of parallel lines is in a parallel to them passing through the eye. Hence, to see the vanishing-point of any lines, we must look in their direction.
- 11 Of two parallel and equal lines which are foreshortened, the nearer may appear the shorter.
- 12 Of two equal lines which are perpendicular to each other and have one end common, the one at the greater angle with the picture plane appears the shorter, and vanishes at the greater angle.



- 13 If one side of a square vanishes toward the left, the other side vanishes toward the right.
- 14 When the sides of a square make equal angles with the picture plane, they appear of equal lengths, and the "angles of inclination and convergence" are equal.
- 15 The "angle of inclination" of any retreating line depends upon the level of the eye and its distance from the line, but it is always much less than the real angle that the line makes with the picture.
- 16 The convergence of parallel lines is in the direction of their farther ends. These are points of the invisible faces of any right square prism.
- 17 If both ends of any edge are points of invisible faces, the edge must be considered as "not foreshortened," even if its ends are unequally distant from the eye.
- 18 Straight lines must generally be represented by straight lines; and vertical lines by verticals.
- 19 If two of the vertical sides of a cube or prism are seen, both sets of horizontal lines appear to converge.
- 20 When one diagonal of a horizontal square appears a vertical line, the other appears a horizontal line, and the sides vanish equally in each direction.
- 21 When the pyramid is vertical, its vertex is in a vertical line through the centre of the base.
- 22 The vertex of an isosceles or equilateral triangle is in a perpendicular to the base at its centre.
- 23 The diameters and diagonals of the regular hexagon

divide the diagonal which they intersect into four equal parts.

- 24 The circle generally appears a circle, a straight line, or an ellipse.
- 25 A horizontal circle, above or below the level of the eye, appears a horizontal ellipse.
- 26 The centre of the circle does not appear the centre of the ellipse, and the long axis of the ellipse is not a diameter of the circle.
- 27 The foreshortened vertical circle, when above or below the level of the eye, appears an ellipse whose long axis is not a vertical line.
- 28 The long axis of the ellipse appears perpendicular to a line which is at right angles to the circle at its centre.
- 29 Only one end of a cylinder can appear a straight line at one time. The other end appears an ellipse.
- 30 If any of the curved surface of the cylinder with an end is seen, the end does not appear a circle.
- 31 If the visible end appears an ellipse, the invisible end appears an ellipse proportionally wider than the visible end.
- 32 The long axes of the ellipses are perpendicular to the axis of the cylinder.
- 33 Any part of the convex surface of the cone may be seen at one time. When the cone is vertical and below the eye, more than half is visible; when above the eye, less than half.

- 34 When the base appears an ellipse, its long axis appears perpendicular to the axis of the cone.
- 35 The contour elements of the cylinder and cone appear tangent to the ellipses of the bases. In the cylinder, the tangent points are frequently not in the axis of the ellipse. In the cone, they are never in the axis.
- 36 The apparent distance, measured on the short axis, between the ellipses representing concentric circles is the same perspective part of the short axis that the distance between the ellipses, measured on the long axis, is of the entire long axis.
- 37 The lines which represent a foreshortened vertical ring are nearly parallel to an ellipse which represents its centre line. They are not ellipses.
- 38 The angles of two polygons, whose centres coincide, and whose sides are parallel, are in the same diagonal lines.
- 39 An angle may appear of any size, large or small, according to whether the sides or the plane of the sides is foreshortened.

The above are most of the points essential to the draughtsman; and those not teachers, and those unable to follow all the chapter, and those not interested in the subject for itself, may find that the review includes nearly all that they need.

## CHAPTER VII.

### QUESTIONS FOR EXAMINATIONS.

*To be answered by drawings, supplemented, if necessary, by writing. Unless otherwise stated, all drawings are to be Model Drawings.*

1. Illustrate by diagrams representing the eye, the picture plane, and a sphere, the different positions of the picture plane which produce "true" and distorted pictures.

2. How do parallel retreating lines appear? Illustrate by a cube all of whose lines appear to converge. Show by arrows the directions in which the lines vanish.

3. Illustrate by sketch of a cube the way parallel, retreating horizontal lines appear.

4. Represent a horizontal square plane, whose sides extend to the left at  $30^\circ$ , and to the right at  $60^\circ$ , when the plane is on the level of the eye.

5. In any background, how is the position found of the point where parallel lines appear to vanish? Illustrate by sketch of any room, with a box upon the floor, and write any points which the sketch may not make clear.

6. How do vertical lines above the eye appear, and how should they be represented? Illustrate by sketches of a cube.

7. Make a sketch of a cylinder or a square prism, which shall show that the more distant of two parallel and equal lines may appear the longer. Mark the nearer line AB, the farther CD.

8. The "angles of inclination" of the lower visible edges of a cube which is below the eye, and rests on a face on the floor are equal. Represent the cube.

9. How do parallel straight lines in Nature appear? Illustrate by representing the actual appearance of each of three cubes, placed first, in a straight line upon the floor; second, in a vertical line, one being on the floor, another on the level of the eye, and the last above this level.

10. By sketches of the three cubes in the above positions, show how straight lines should generally be represented.

11. Give the actual appearance of a horizontal cylinder whose length is 2, diameter 1,<sup>1</sup> when below the eye, and so placed that the left-hand base appears a vertical line.

12. Show by a sketch of an interior when this appearance would be the best drawing of the cylinder.

13. As a representation of simply the cylinder, what drawing is better than the actual appearance?

14. Represent a cube above the eye, with four edges vertical, when three of its sides are visible as surfaces.

<sup>1</sup> The cylinder may be drawn of any size but of these proportions, and the same for following problems.

15. The same cube when a diagonal of its visible horizontal face appears a vertical line; and a vertical square prism, whose length is 3, diameter 1, having upon it a square pyramid whose base is 2, axis 2. The axes of the solids coincide, and the edges of the bases are parallel. The lower base of prism on level of eye.

16. Above solids when the eye is on the level of the centre of the prism, and a face of this object is "not foreshortened."

17. The same solids and conditions, except that two faces of the prism are seen equally.

18. A prism whose ends are equilateral triangles whose sides are half as long as the prism, rests upon a face upon the floor below the eye. The sides of the face on the ground extend to right and left at equal angles with the picture. The left base is visible. Show all tests of the drawing, and the directions in which all the lines vanish.

19. The same when the object is above the eye.

20. The same object when above the eye, and the ends of its horizontal face are "not foreshortened."

21. A regular hexagonal card, horizontal and above the eye, with one diagonal "not foreshortened."

22. The same card vertical and on the level of the eye, and vanishing to the right. Its diameters are "not foreshortened."

23. The prism shown in Fig. 55, when it is horizontal and above the eye.

24. The same when it is below the eye, and horizontal, with its long edges "not foreshortened."

25. The pyramid of Fig. 56 when it is above the eye, with the diameters of its base "not foreshortened."

26. Place under the pyramid (Fig. 56) a cube, one diagonal of its top coinciding with the marked diagonal of the base of the pyramid. The square is to be larger than the hexagon.

27. Represent when below the eye a horizontal hexagonal plinth, a square pyramid placed upon its top, and a hexagonal pyramid resting obliquely upon the floor and the plinth.

28. A cube with inscribed circles tangent to each square, when below the eye with first, two surfaces visible; and second, three surfaces visible.

29. Show by a horizontal circle above the eye that the centre of the circle is not represented by the centre of the ellipse.

30. The long axis of the ellipse is what line of the circle?

31. How do equal spaces on any retreating line appear? Illustrate by an "elevation."

32. A horizontal circle is seen by several persons who are the same distance above, and away from the circle. Does the same line of the circle appear to the different observers the long axis of the ellipse? Illustrate by a "plan."

33. Sketch a spinning-wheel which is below the level of the eye.

34. A vertical cylinder whose visible end is above the level of the eye.

35. A horizontal cylinder on the level of the eye, the cylinder "not foreshortened."

36. Why do not the long axes of the ellipses in Fig. 68 vanish?

37. Represent a horizontal retreating cylinder above the level of the eye, and so situated that its axis appears a vertical line.

38. A parallel cylinder on the same level and to the right of the last object, the ends of the cylinders in the same planes.

39. The retreating vertical side of a building which has in it three semicircular arches in the same vertical line, the eye on the level of the centre of the central arch. (See Fig. 64.)

40. A vertical cylinder, diameter 1, length 2, with a cone upon it, the bases coinciding; eye on level of the centre of the cylinder.

41. A horizontal circle is represented by an ellipse, whose long axis is  $4\frac{3}{8}$ " long, whose short is  $1\frac{1}{2}$ " long. A concentric smaller circle appears an ellipse which intersects the long axis of the outer at points  $\frac{5}{8}$ " from its ends.

42. Represent a horizontal retreating pipe below the



level of the eye Its inner diameter half of its outside diameter.

43. A horizontal cylinder, diameter 1, length 2, its axis on the level of the eye, and extending to the right at an angle of  $45^\circ$  with the picture, and a second equal cylinder just below, its ends in the same planes as those of the upper.

44. A vertical cone, resting upon the centre of a horizontal square plinth whose vertical sides are seen unequally, and a circular ring square in section, resting obliquely against the plinth.

45. The pyramid of Fig. 77 when above the level of the eye.

46. The same for the cone of Fig. 80.

47. A conical pail, of which the curved outer surface with the inner surface of the bottom is visible.

48. A cuspidore of double cone form when below the eye.

49. The double cone of Fig. 83 when it is horizontal, below the eye, and at a large angle with the picture plane.

50. The ring of Fig. 85 when it is vertical, and on the level of the eye, and more foreshortened than in the figure.

51. The frame of Fig. 88 when the axis of the ellipse representing the tangent circle is parallel to a side, as B.

52. The same when the axis is parallel to a diagonal of the square.

53. A triangular frame when it is horizontal and below the eye, with the most distant sides of the triangles "not foreshortened."

54. A vertical, foreshortened hexagonal frame below the eye.

55. A table with a square top and inclined legs.

56. A vertical cylinder below the eye, with a moulding half round in section at the top, one square in section at the bottom, and a groove square in section cut in the centre of the cylinder. Diameter of cylinder 1, length 2. Width of bands  $\frac{1}{3}$ .

57. The vase of Fig. 92 when seen from below.

58. The same when seen from above, and very near so that the ellipses are wide.

59. The vase of Fig. 96 when the bottom is visible.

60. The same for Fig. 98.

61. The same for Fig. 102.

62. Sketch an interior representing the floor and two walls, with a table or other objects.

63. The same, showing in addition the ceiling, or horizontal objects above the eye.

64. Sketch an interior representing three walls and furniture.

65. An interior representing one wall, with objects parallel to the wall, and on each side of the spectator.

66. The same when spectator is near an end of the wall.

The following questions are for those who understand Orthographic Projection and Scientific Perspection.<sup>1</sup>

67. Illustrate the difference in appearance between a perspective drawing of a cube placed at the left, below the eye, and with one face parallel to the picture plane, and a model drawing of the same.

68. The same for a cone at the right and vertical.

69. The same for a horizontal cylinder parallel to the picture plane, and its right base visible.

70. Make a perspective drawing of a horizontal square, which shall show that the perspective of a retreating line may be longer than the line. Make a model drawing of the same square.

71. Illustrate by means of the perspectives of a sphere the distortion found in a Plane Perspective representing objects above, below, or to the left or the right of the point opposite the eye. State briefly the difference between a Perspective and a Model Drawing.

72. Represent the objects shown by Figs. 104 and 105 when they are seen from the right instead of from the left.

<sup>1</sup> An illustrated pamphlet comparing Plane Perspective and Model Drawing will be mailed on receipt of fifteen cents, to those teachers who wish more on this subject than this book contains.

As the eye can only take in  
 a single point - all the parts about  
 that spot must be less distinct  
 than the spot & the farther from  
 the spot the less distinct  
 angle of cone of vision  $60^\circ$

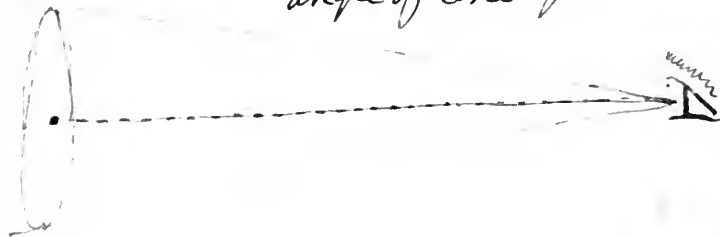

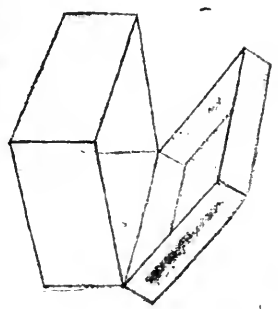

FIG. 4

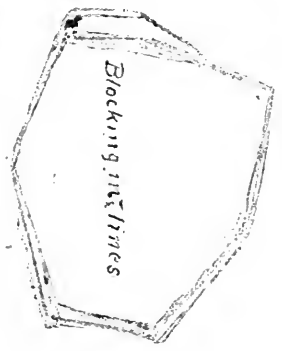

FIG. 5

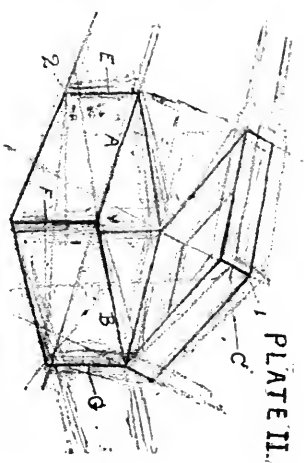

FIG. 6

PLATE II.

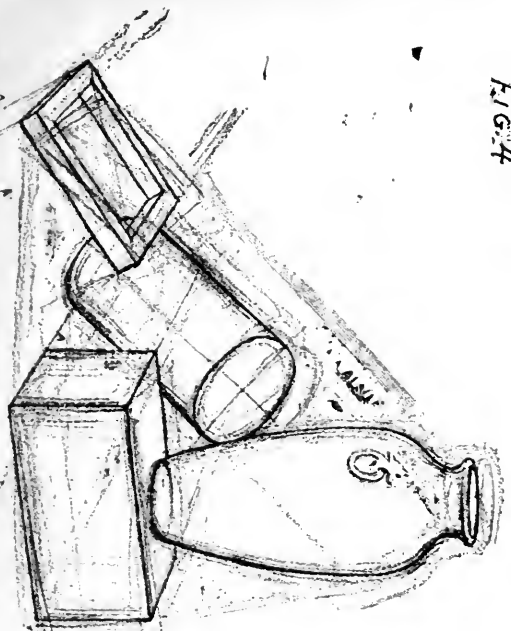

FIG. 7

Sketch when ready to erase and accent

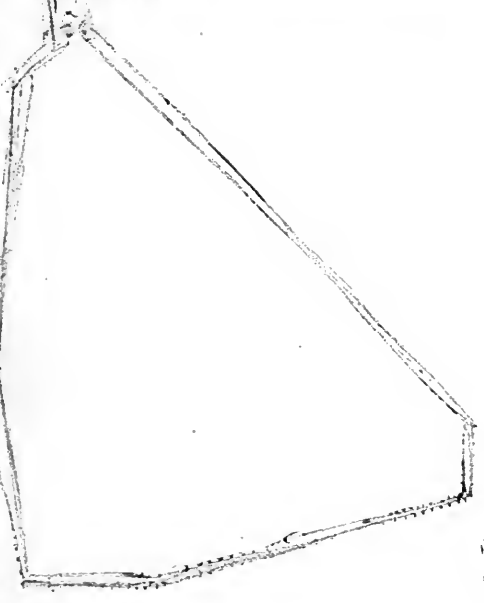

FIG. 8 Blocking in lines



Art's Level of eye

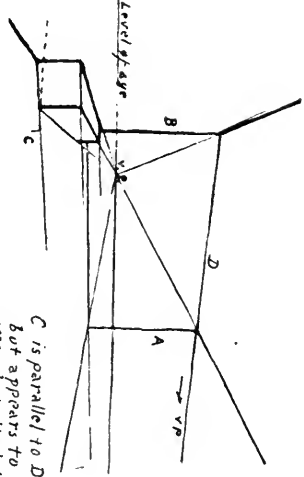

FIG 9

C is parallel to D but appears to vanish to the left.

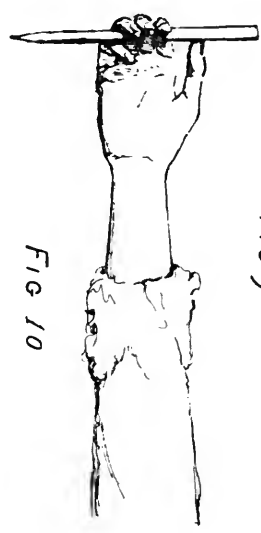

FIG 10

FIG 14

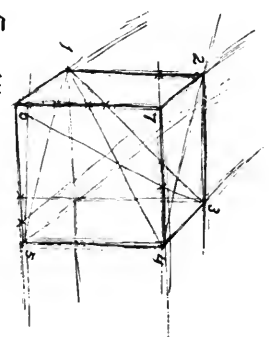

FIG 13

Compare proportions by turning the pencil about an end of the first measurement taken

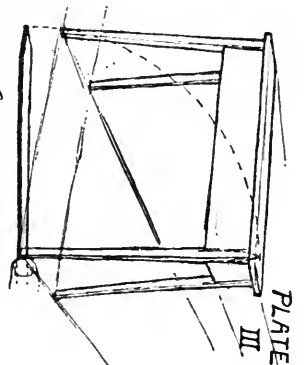

PLATE III

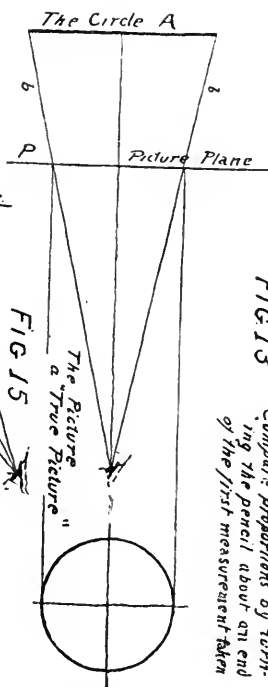

FIG 15

The Picture a "True Picture"

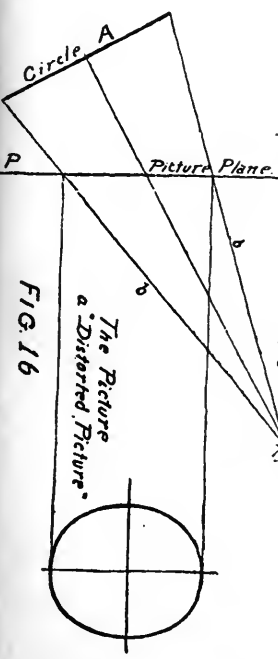

FIG 16

The Picture a "Distorted Picture"

FIG 11 See Page 74

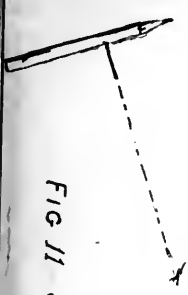
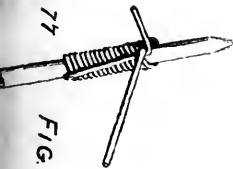

FIG 12







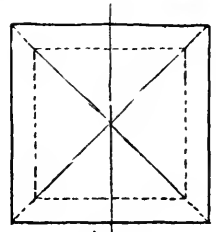

FIG. 17

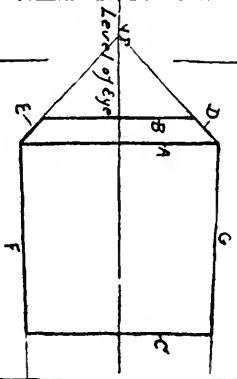

FIG. 18

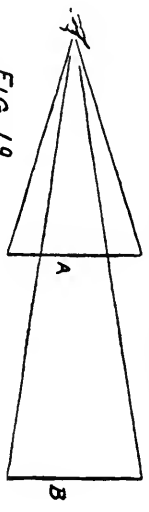

FIG. 19

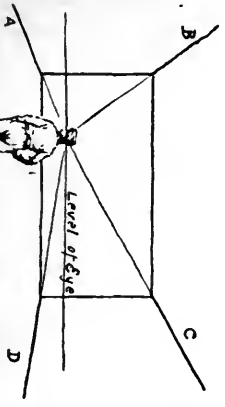

FIG. 20

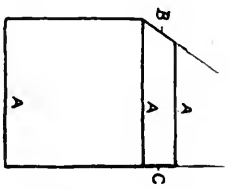

FIG. 21

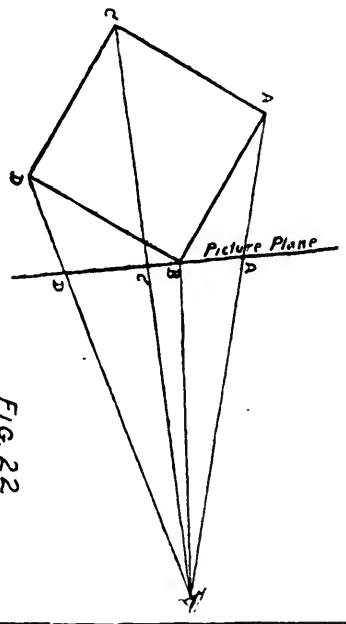

FIG. 22

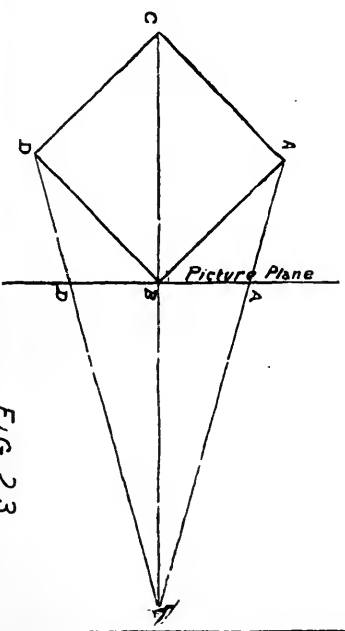

FIG. 23



SCALE OF FEET



PLATE 'V.

FIG. 30.

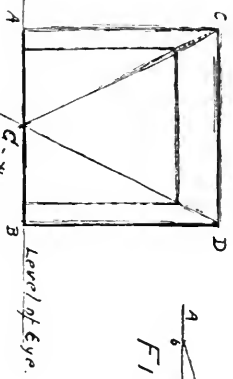
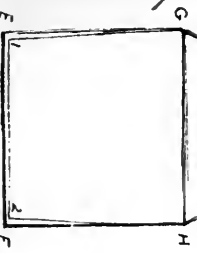

FIG. 31.



The light lines represent the appearance, the heavy, the most satisfactory drawing. Vertical lines should be constructed by

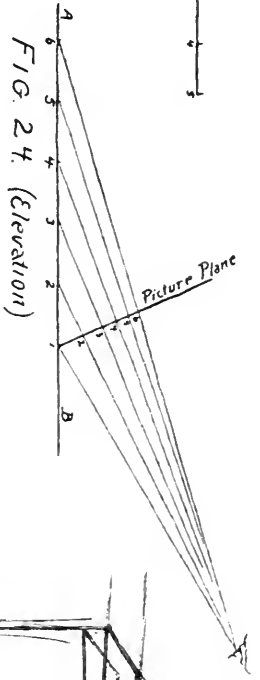

FIG. 24. (Elevation)

FIG. 32 (Elevation)

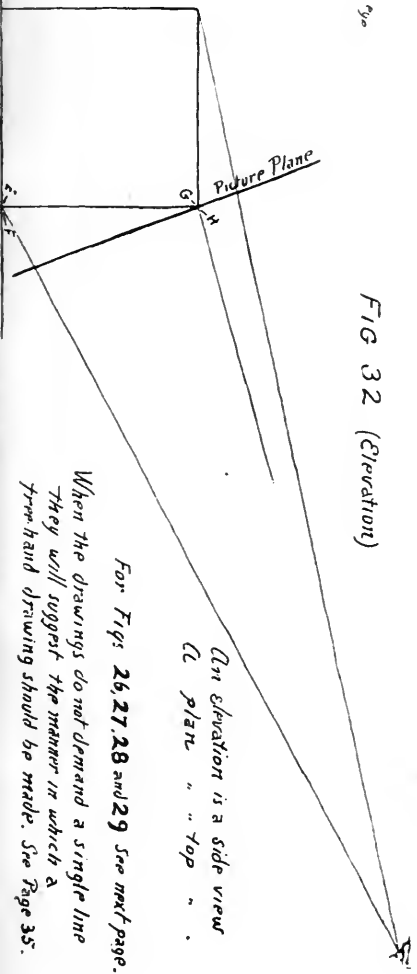
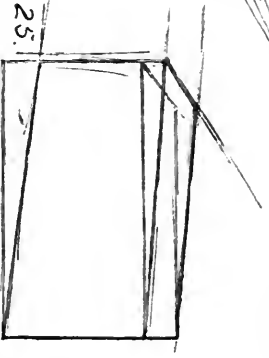

FIG. 25.



The heavy lines represent the appearance "light" "drawing generally most satisfactory.

An elevation is a side view  
A plan " " top " "

For Figs 26, 27, 28 and 29 See next page.

When the drawings do not demand a single line they will suggest the manner in which a front and drawing should be made. See Page 35.



FIG. 26

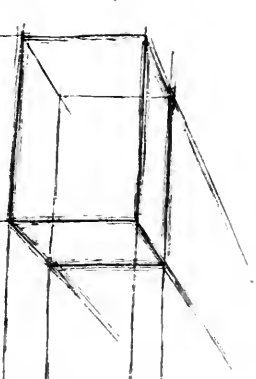

FIG. 27

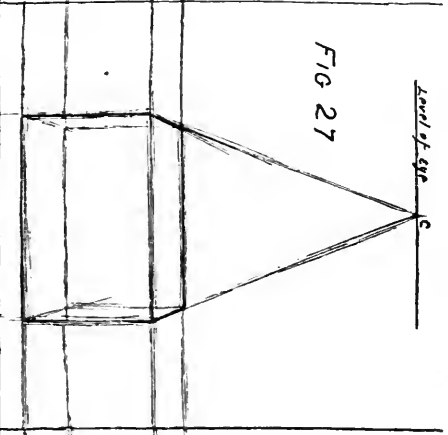
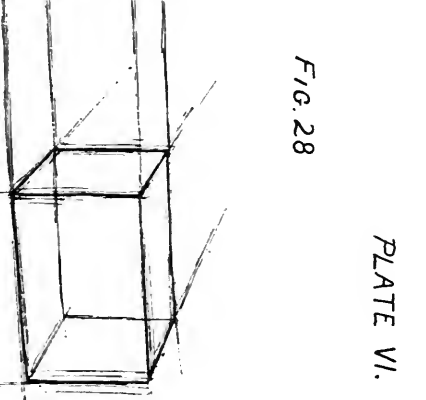

FIG. 28



*Changed by horizontal lines and by horizontal distances*

A

FIG. 29

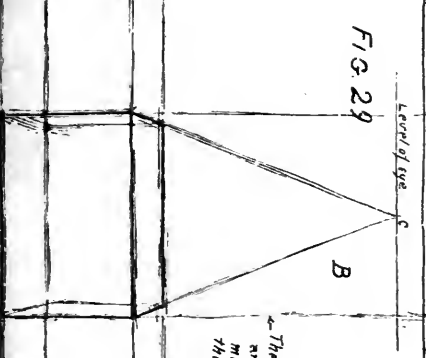

B

*The foreshortening of this space —→ end of the vertical sides of the box must sometimes be omitted and the drawing become in all respects a Parallel Perspective*

C

*Changed by horizontal lines*

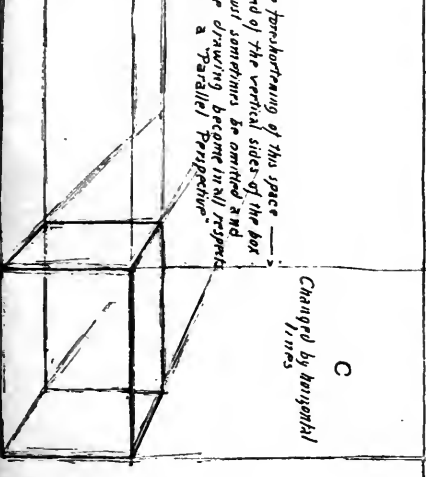

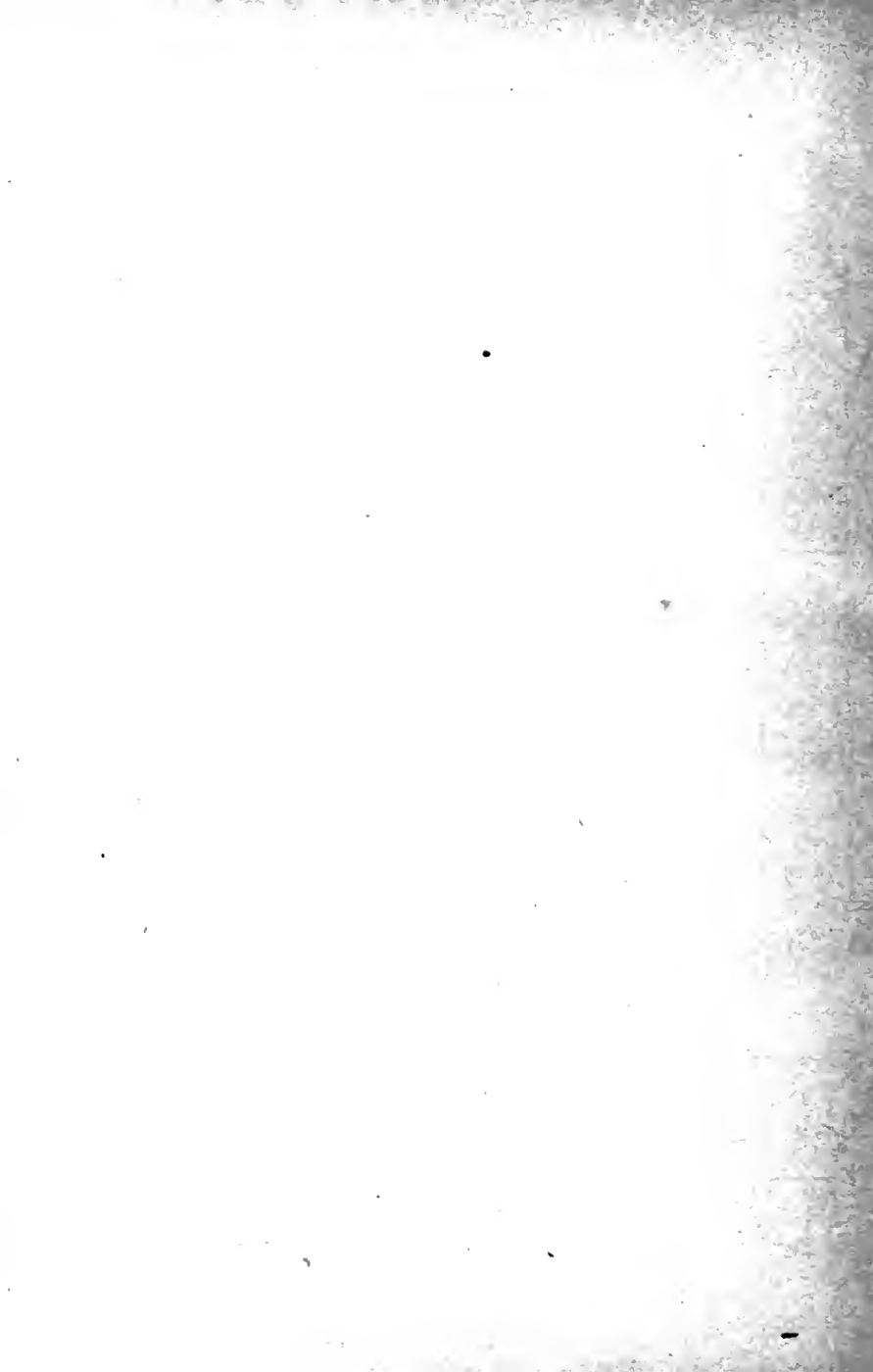

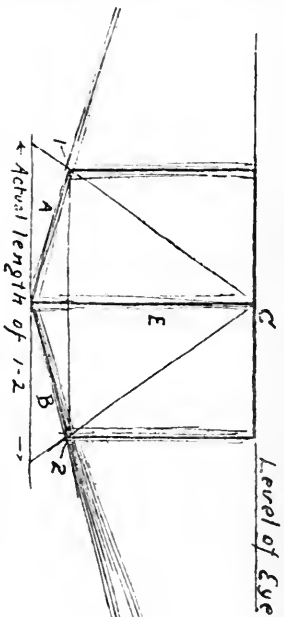

FIG. 33

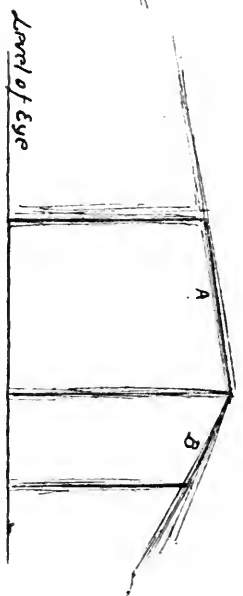

FIG. 34

Distance of the eye is greater than that of Fig. 33

Level of Eye

V.P.

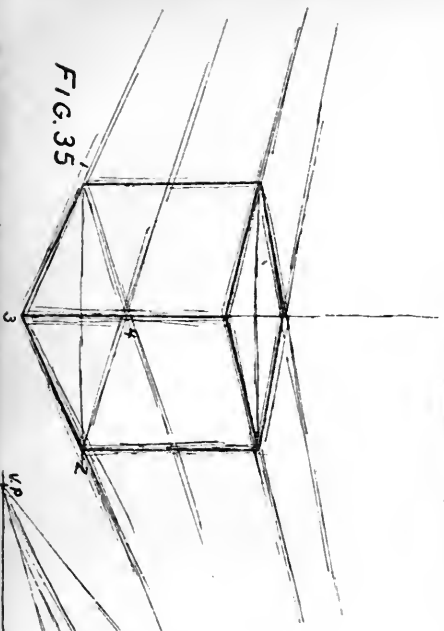

FIG. 35

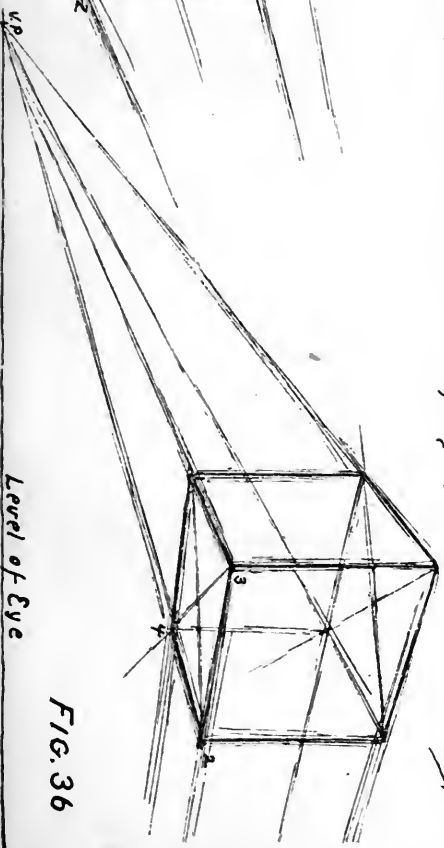

FIG. 36

Level of Eye





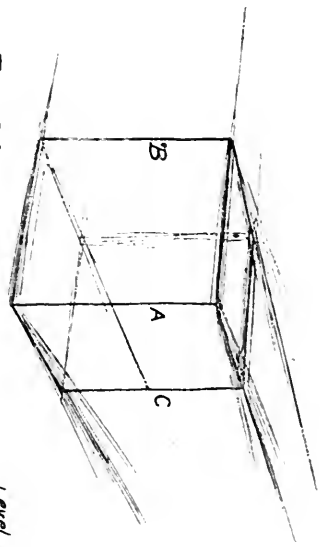

FIG. 38

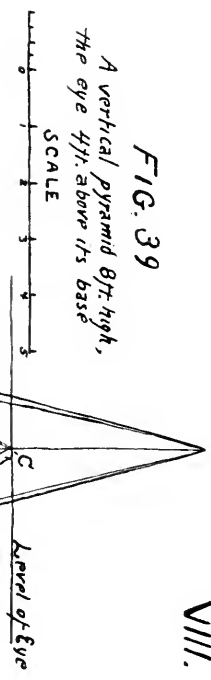

FIG. 39

A vertical pyramid 8 ft. high,  
the eye 4 ft. above its base

Level of Eye. U.P. of 5-6 and 7-8

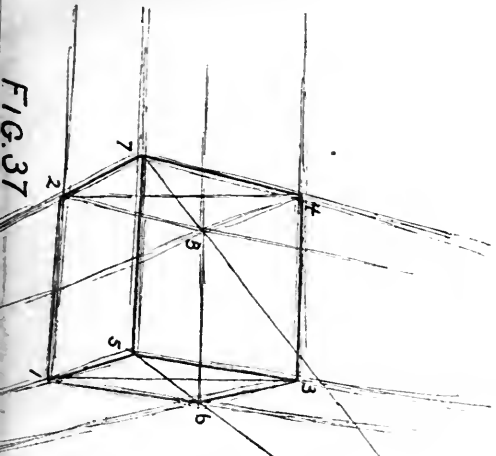
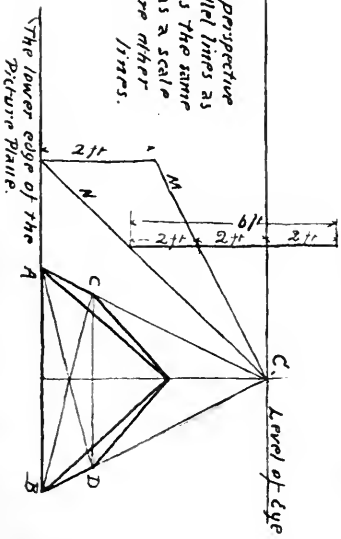
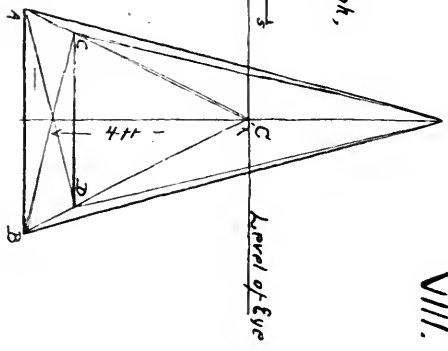

FIG. 37

The distance in perspective  
between two parallel lines as  
M and N is always the same  
and may be used as a scale  
by which to measure other  
lines.



The lower edge of the  
Picture Plane.

FIG. 40



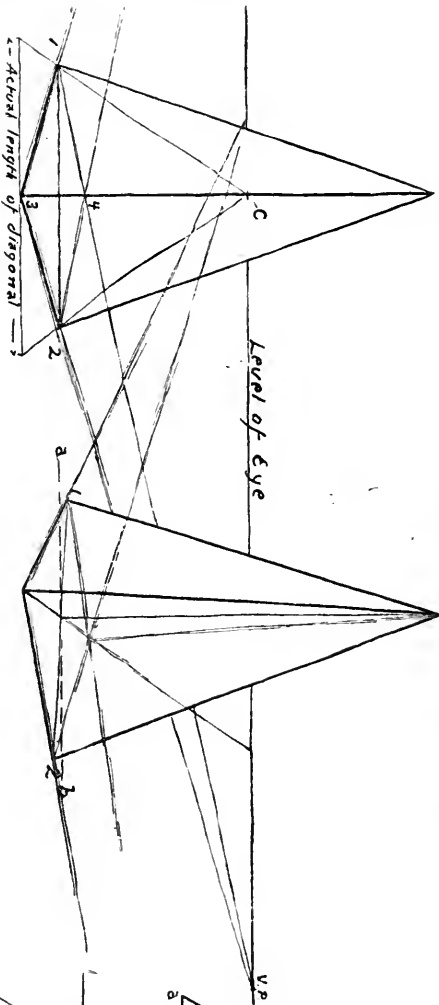

FIG. 41

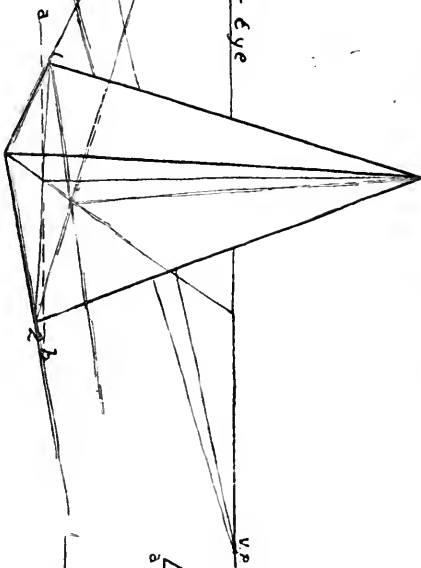

FIG. 42

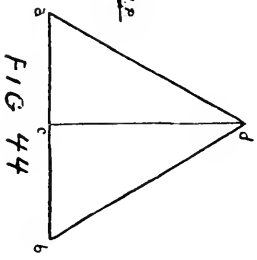

FIG. 44

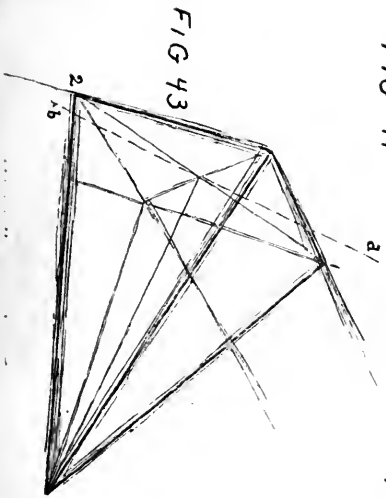

FIG. 43

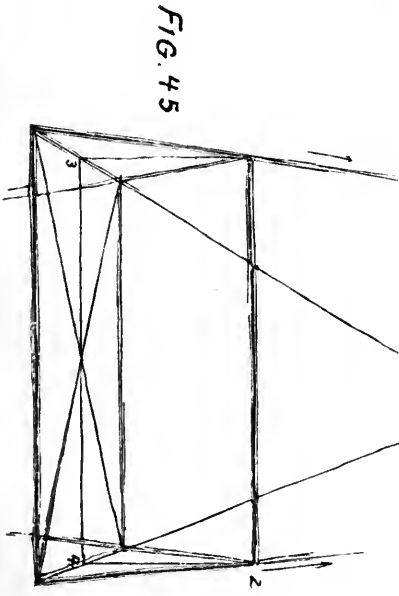

FIG. 45



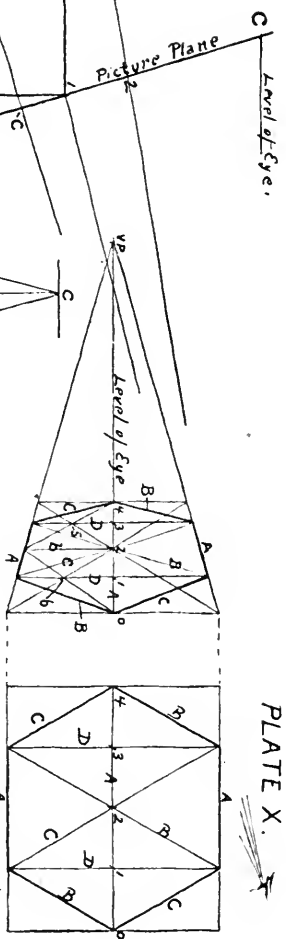

FIG. 49

FIG. 48

Elevation giving dimensions of Fig 46

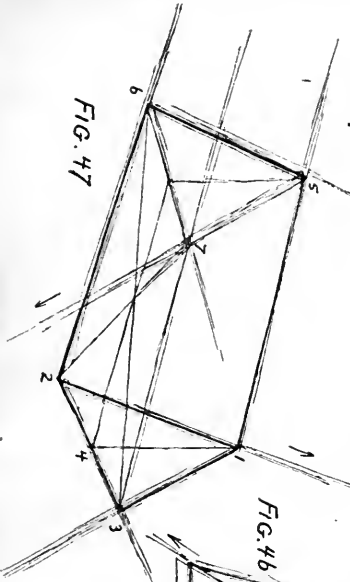

FIG. 46

FIG. 47

End does not appear its real shape.



Level of Eye

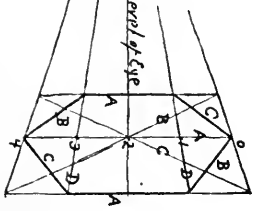

FIG. 51

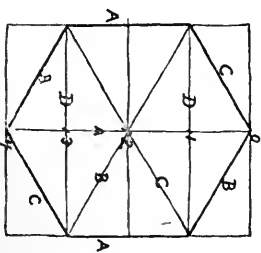

FIG. 50



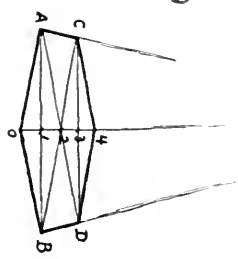

FIG. 52

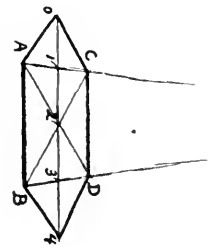

FIG. 53

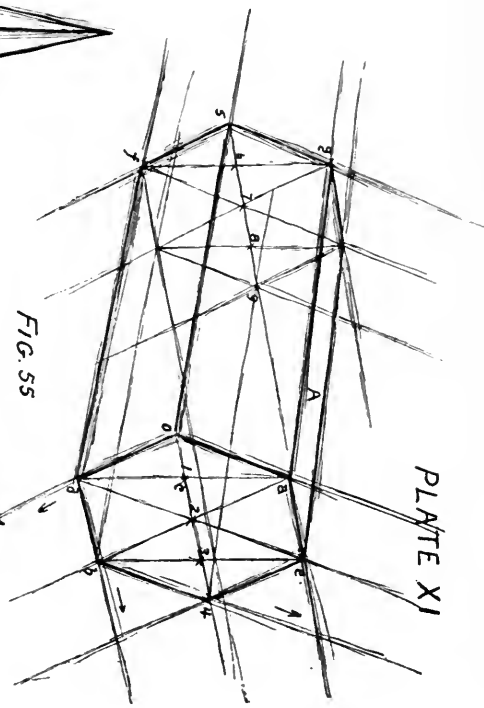

FIG. 55

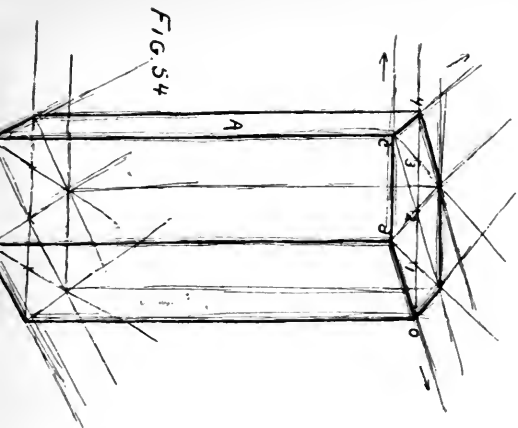

FIG. 54

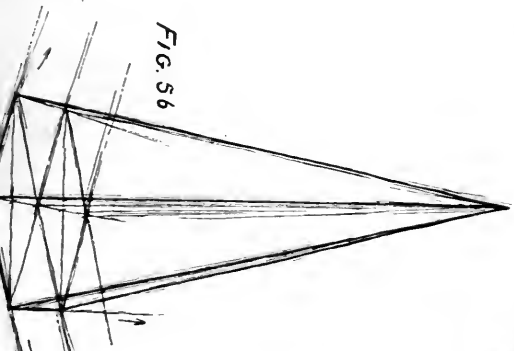

FIG. 56

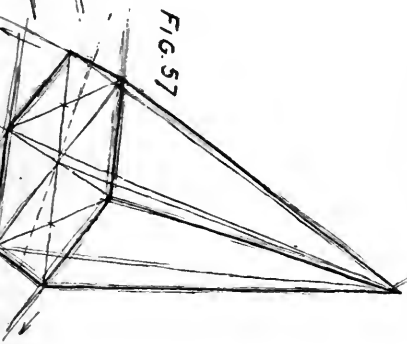

FIG. 57





FIG. 60  
Perspective of the  
circles.

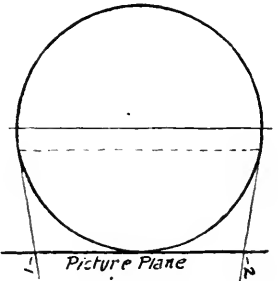
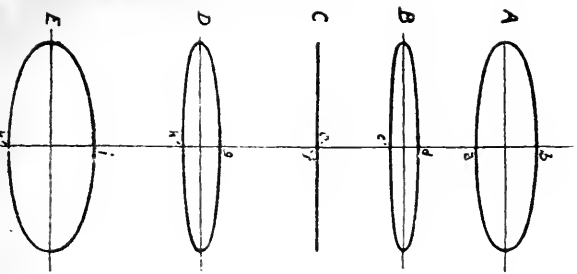

FIG. 59 A plan of the circles, the picture plane,  
and the eye

The eye

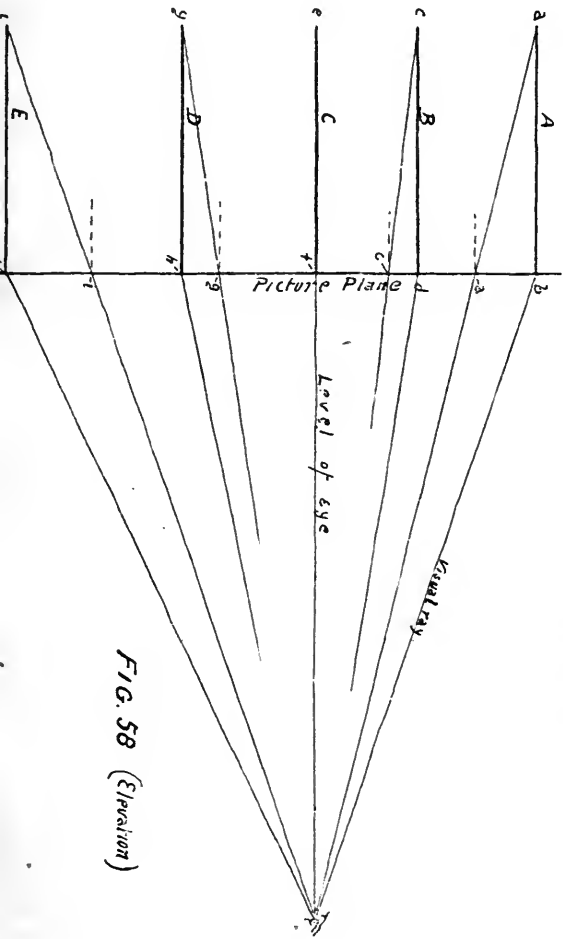

FIG. 58 (Elevation)



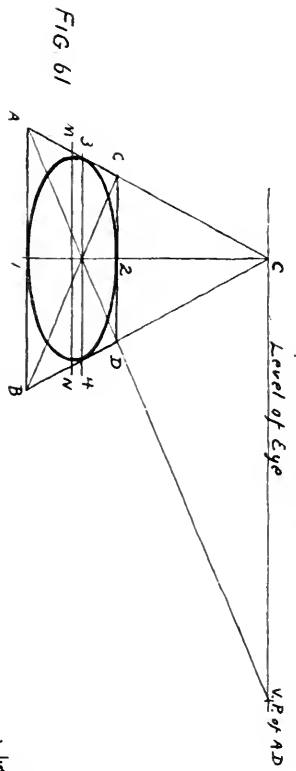

FIG 61

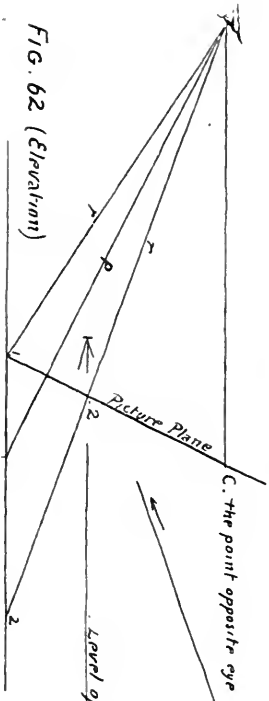

FIG. 62 (Elevation)

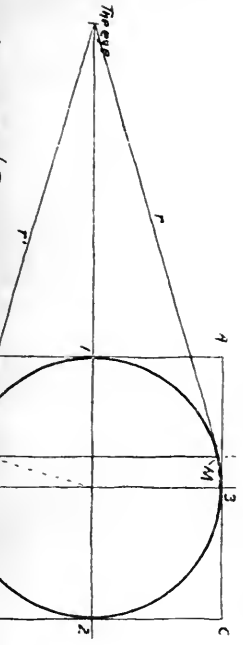
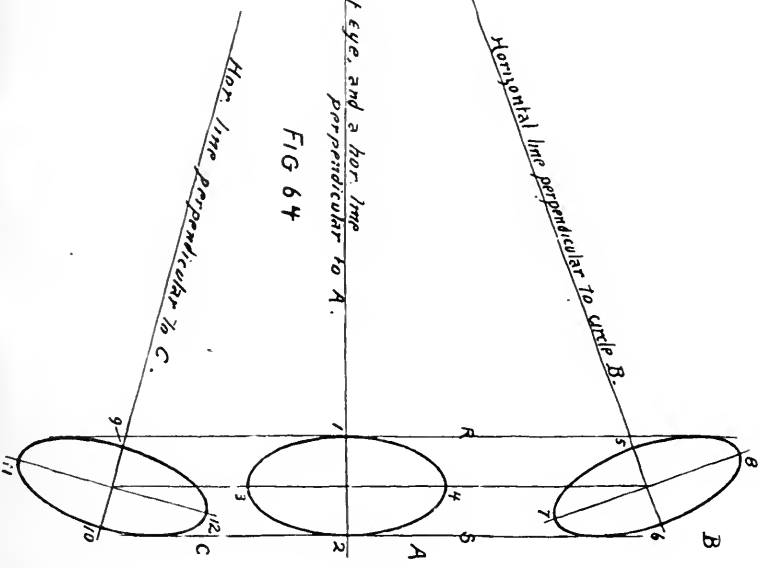

FIG 64



Hor. line perpendicular to C.

Level of eye, and a hor. line perpendicular to A.

Horizontal line perpendicular to circle B.

C. the point opposite the eye

Picture Plane

Level of Eye

V.P. of AD

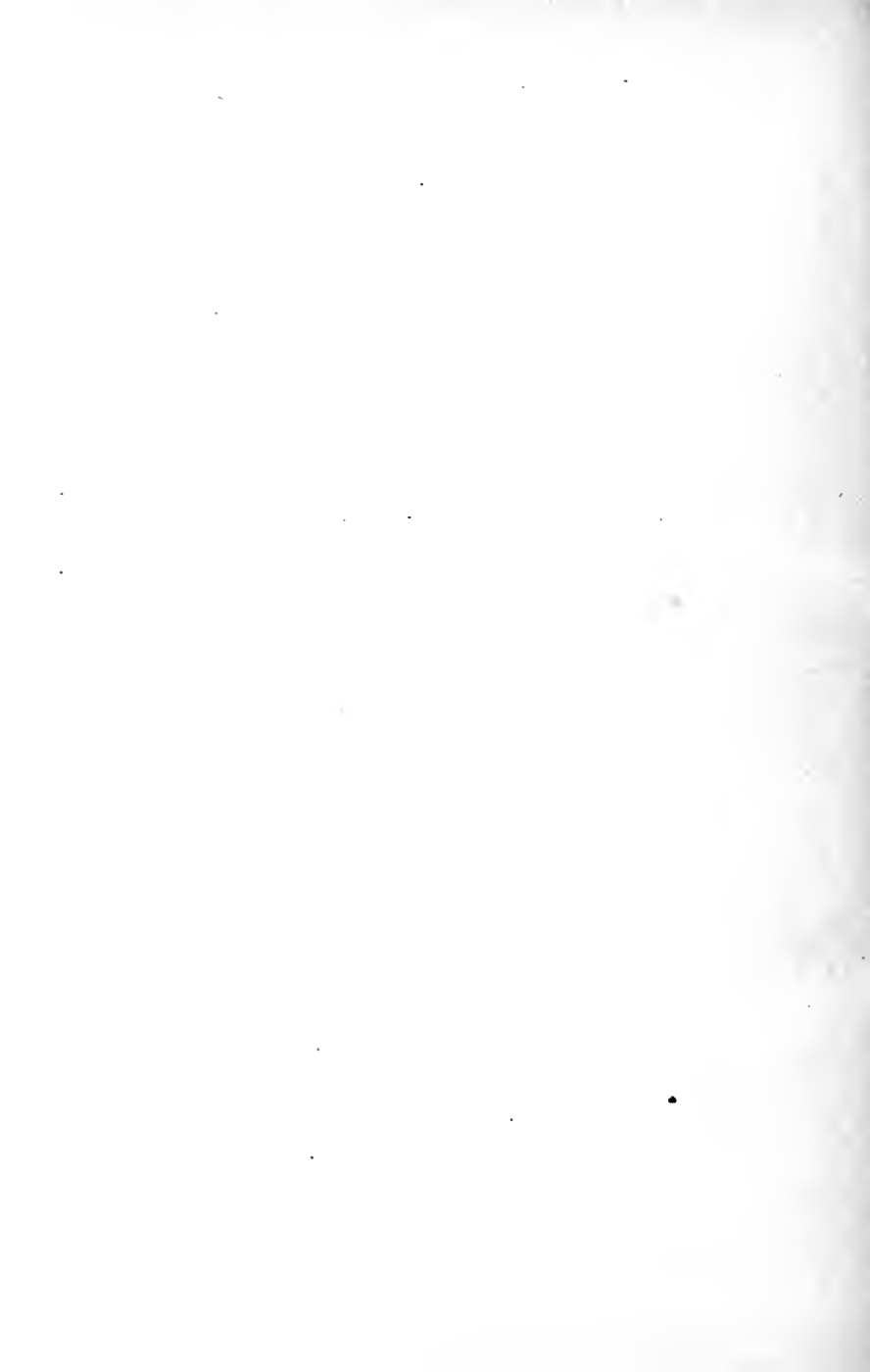
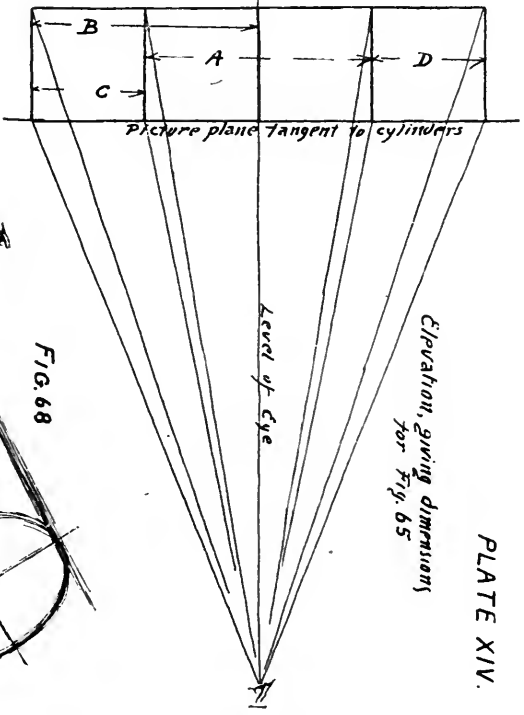
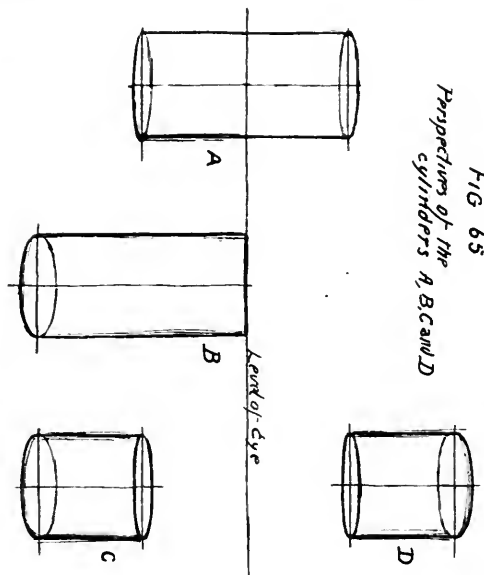

FIG 65  
 Perspectives of the  
 cylinders A, B, C and D



Elevation, giving dimensions  
 for Fig. 65

FIG 67

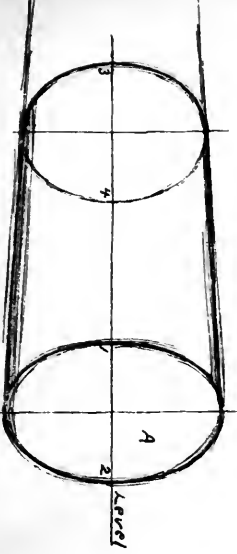

FIG. 66  
 (Elevation)

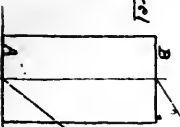
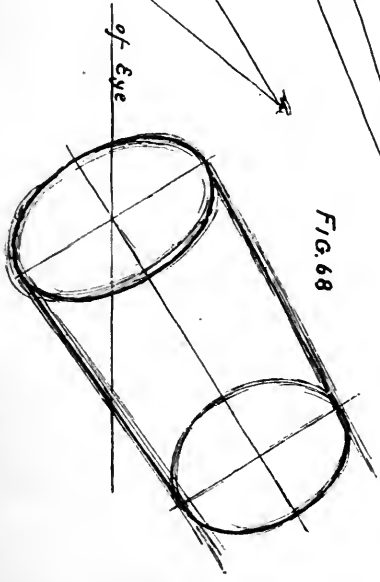

FIG. 68





Level of Eye  $\epsilon$

FIG. 72

FIG. 71

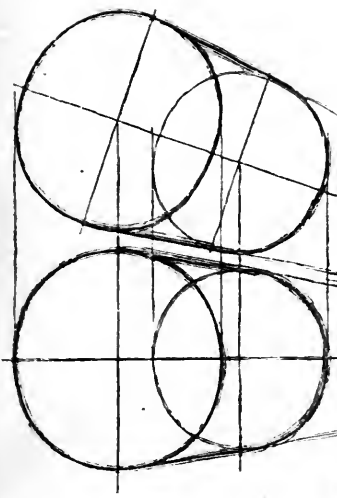

Level of Eye

FIG. 69

FIG. 70

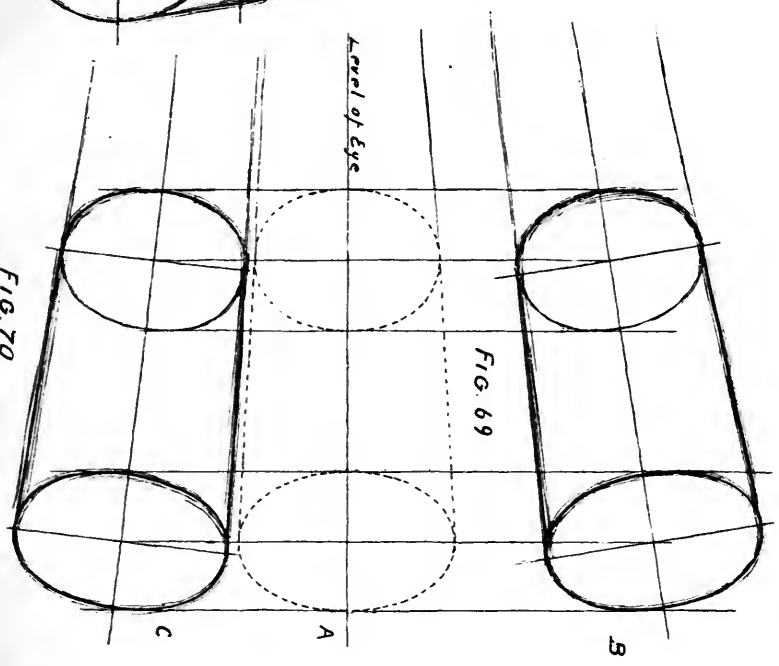





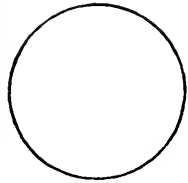

*This cone may appear a circle,*

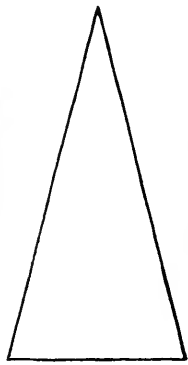
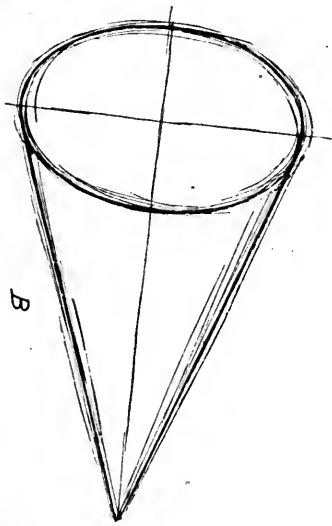
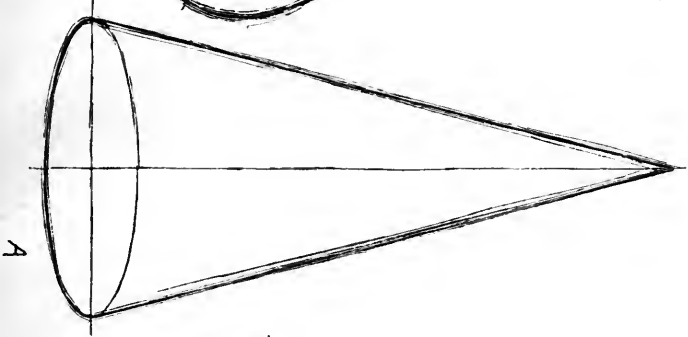
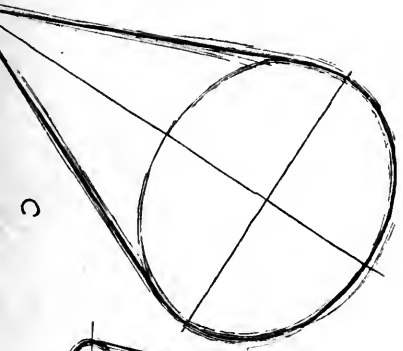

*or a triangle*

PLATE XVI.



9  
7  
FIG. 74

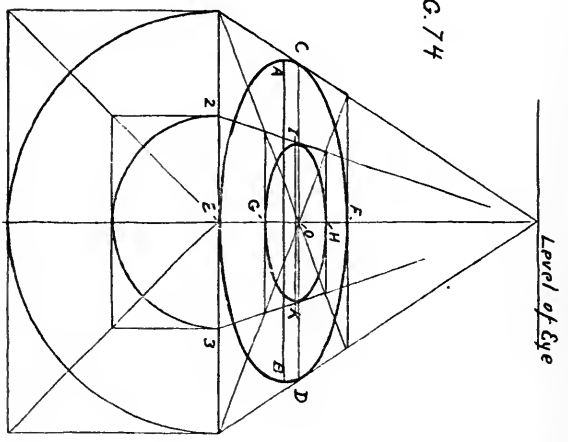

FIG. 75

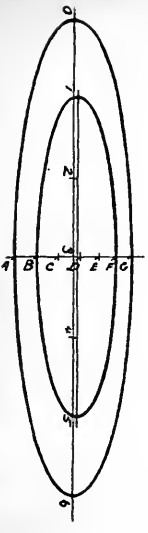

FIG. 76

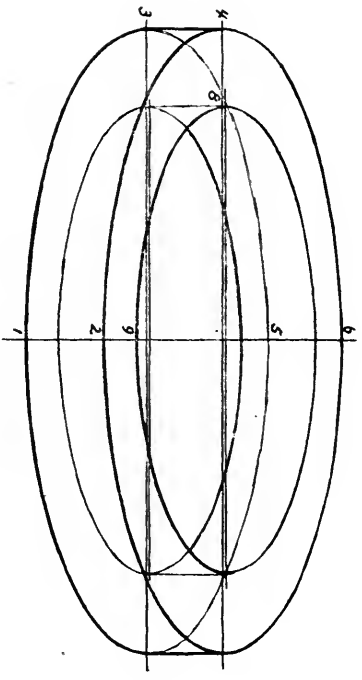



PLATE XVIII.

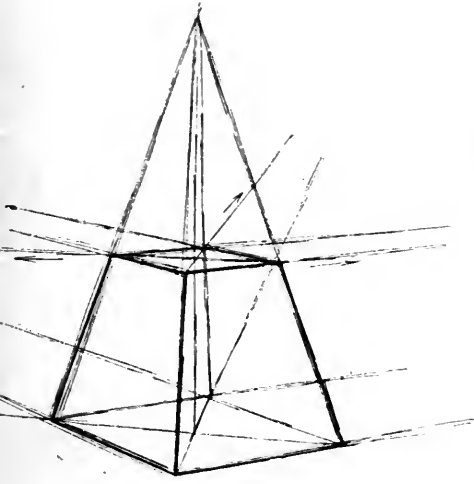

FIG. 77

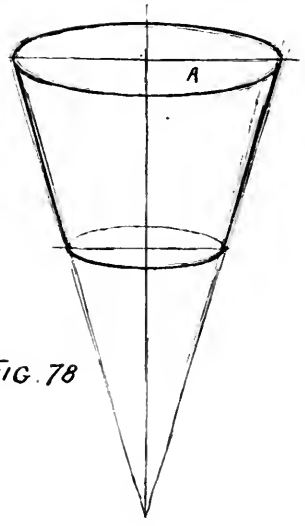

FIG. 78

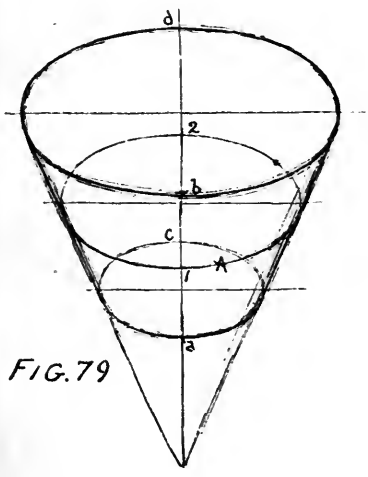

FIG. 79

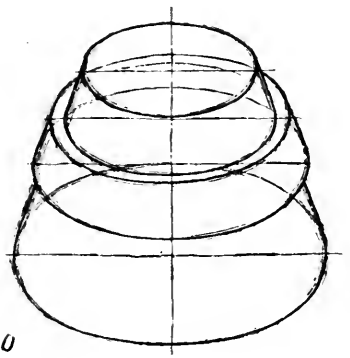

FIG. 80



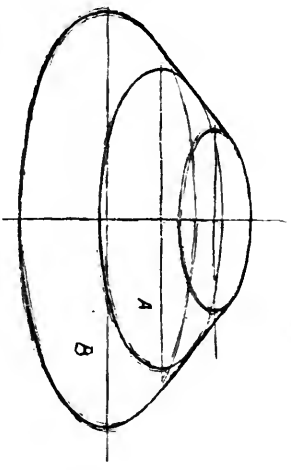

FIG. 81

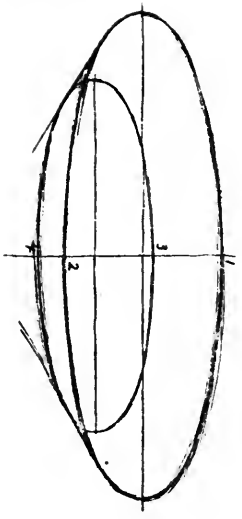
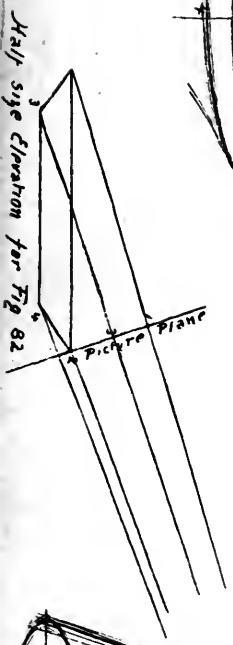
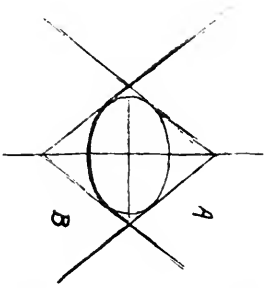

FIG. 82



Half size Elevation for Fig 82

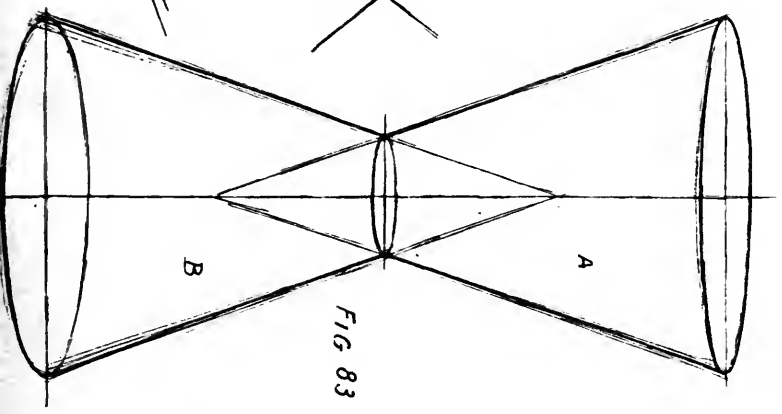

FIG. 83





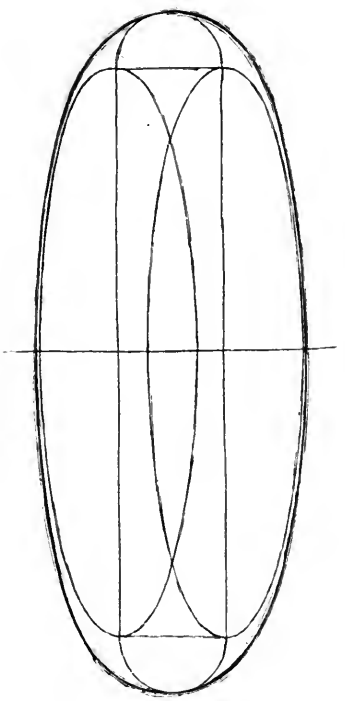

FIG. 84

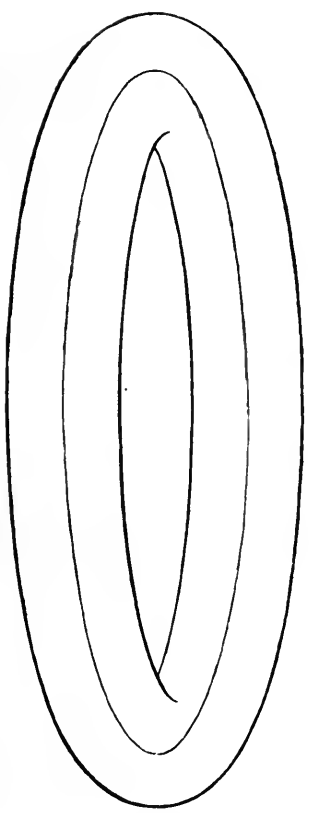
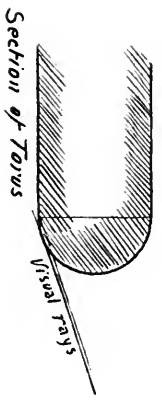

FIG. 85



32-98

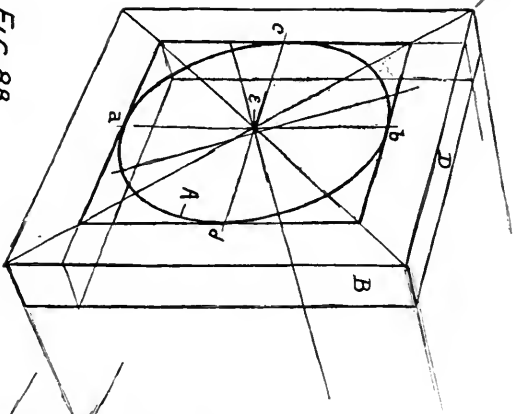

FIG. 88

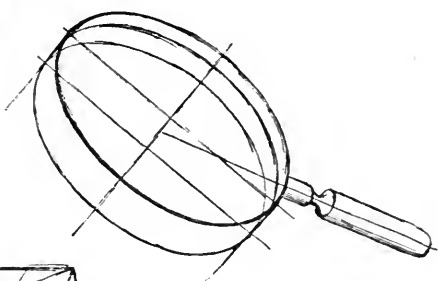

FIG. 89

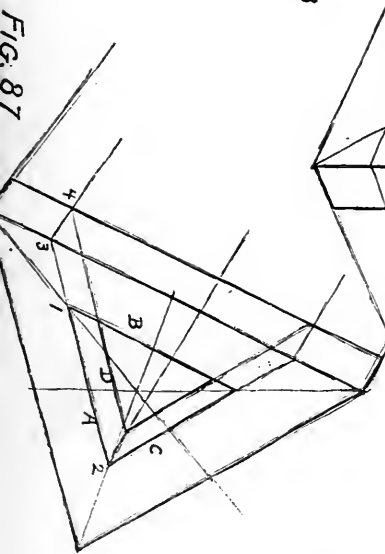

FIG. 87

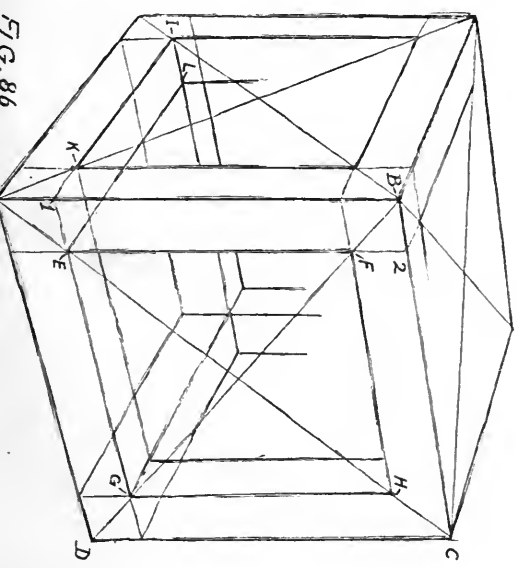

FIG. 86



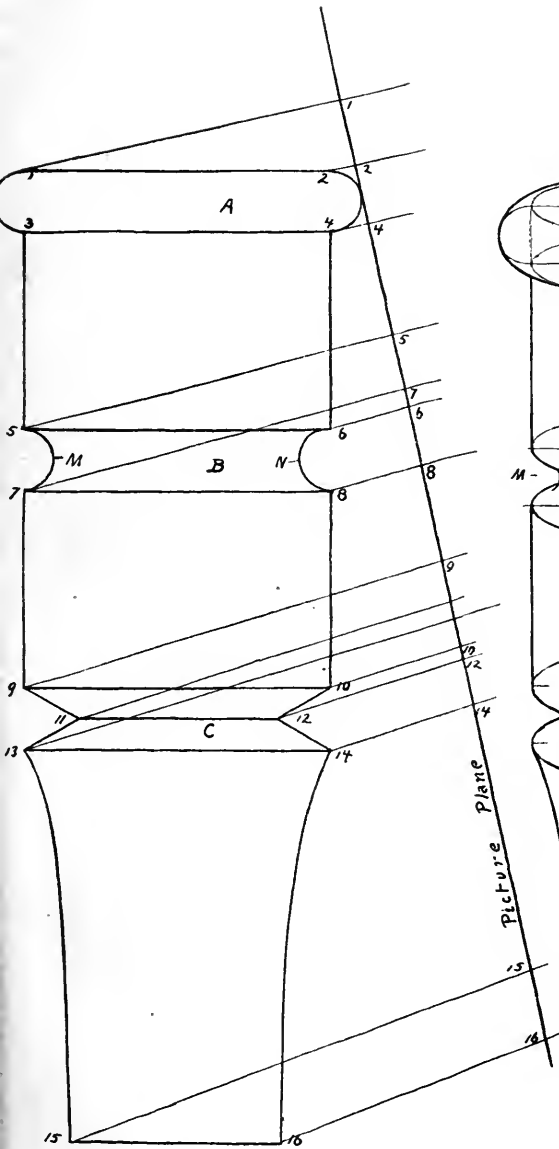

FIG. 90 (Elevation)

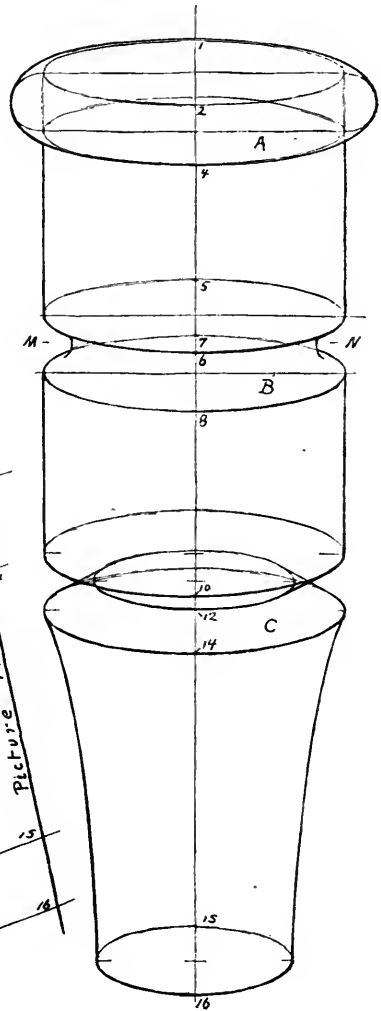

FIG. 91



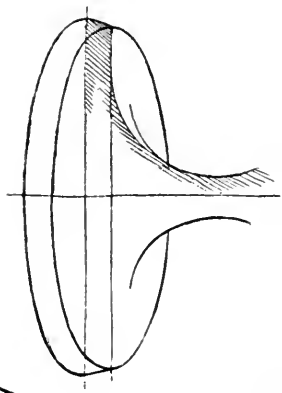

FIG. 95

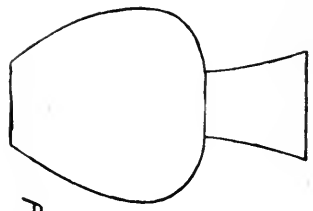
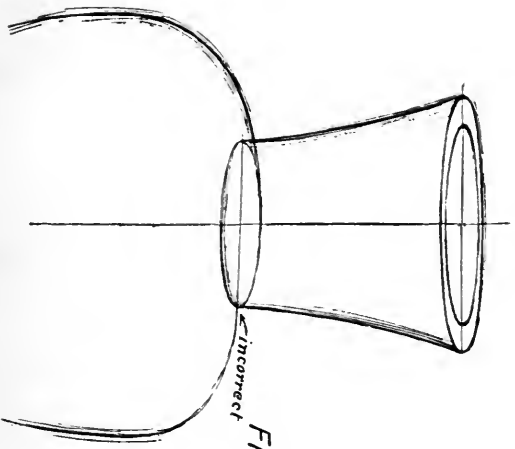

FIG. 92



INCORRECT  
FIG. 93

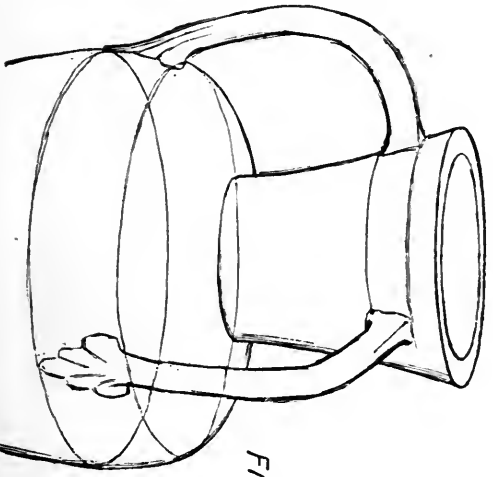

FIG. 94





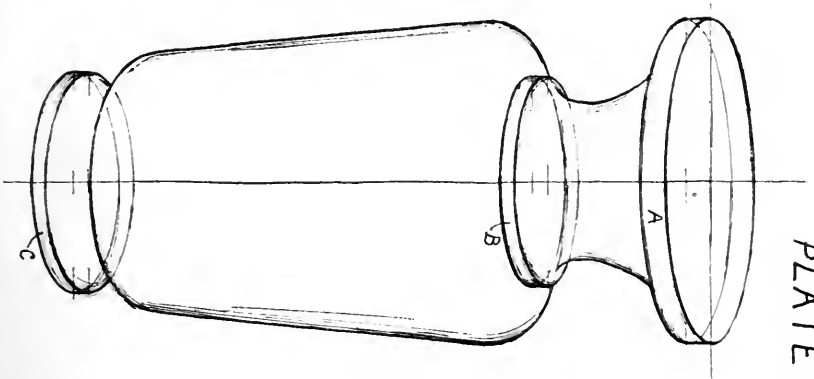

FIG. 97

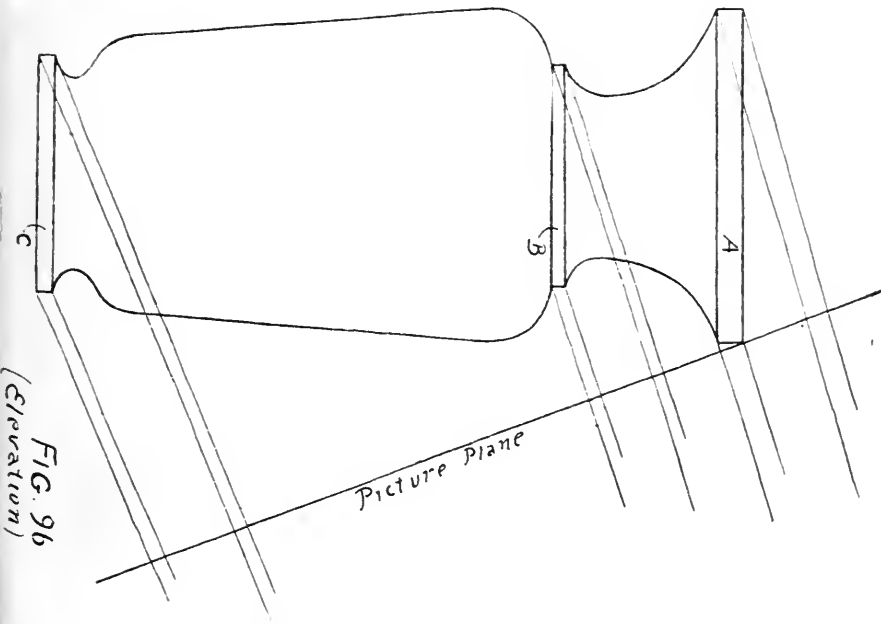

FIG. 96  
(Elevation)



FIG 98

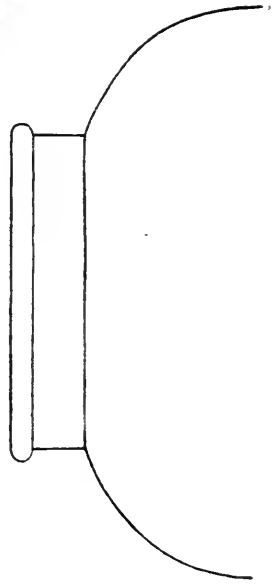

FIG 100

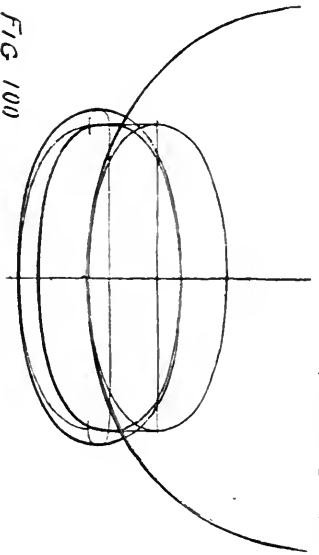

FIG. 99

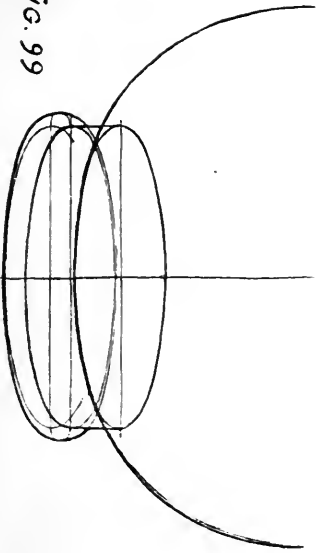
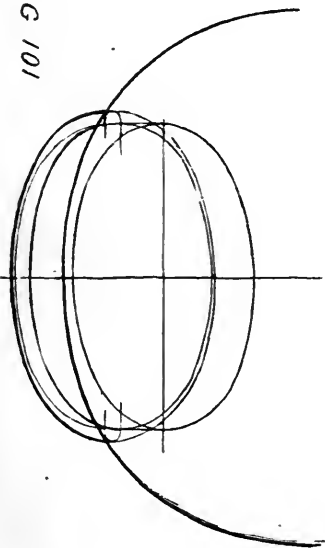
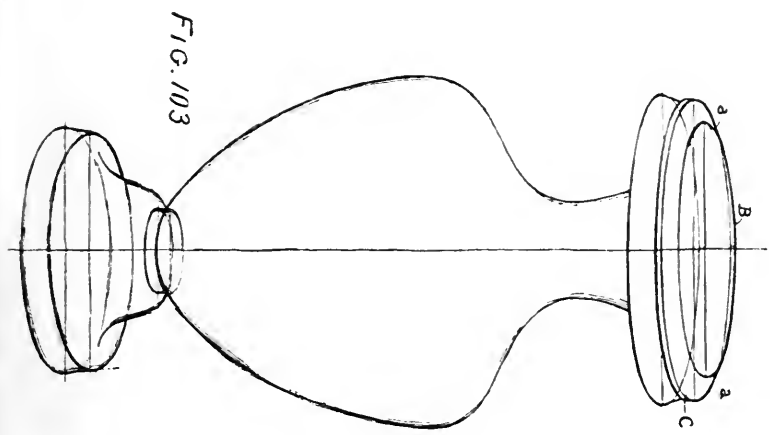
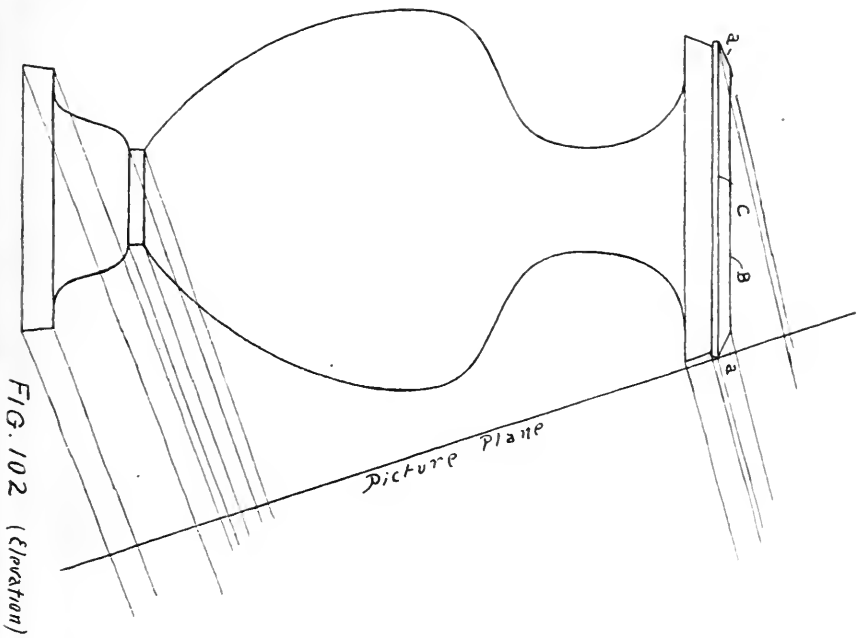

FIG 101









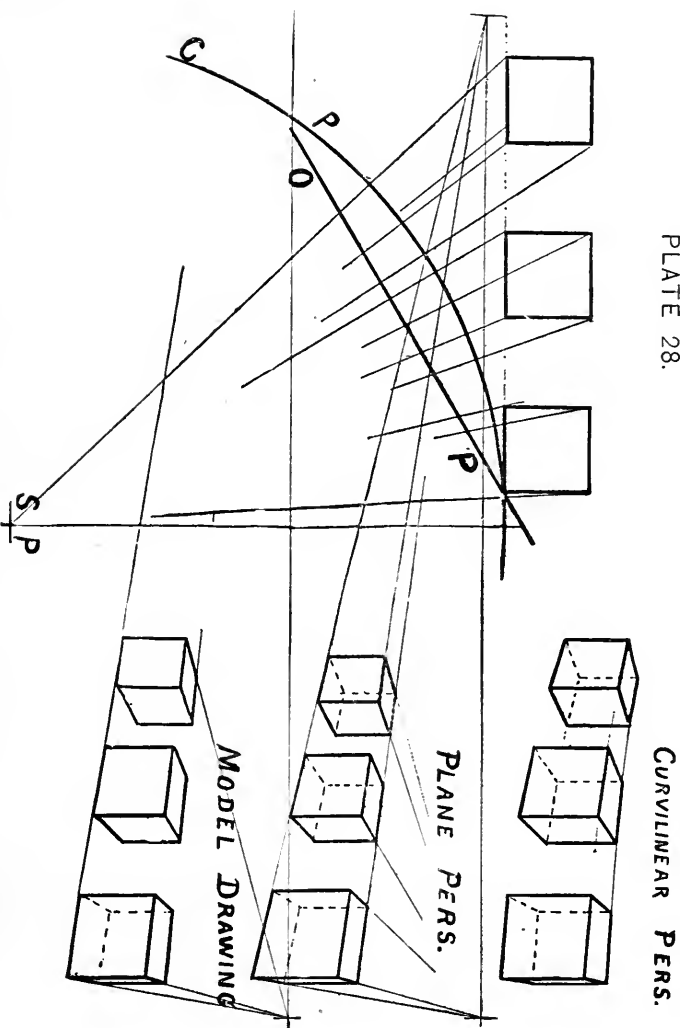

Plate comparing the representations of three cubes on a vertical cylindrical picture plane, CP (this drawing is called a Curvilinear Perspective), and on a vertical plane, OP (drawing is called a Plane Perspective), with a Model Drawing. The horizontal distances of the Model Drawing are the same as those of the Curvilinear Perspective, its vertical dimensions agree with the appearance (as far as possible), and it represents straight lines by straight lines.





# SUGGESTIONS FOR FIRST LESSONS IN THE PUBLIC SCHOOLS.

[These objects and similar ones should be studied in different positions until they can be well and easily drawn.]



Square Card.



Circular Card.

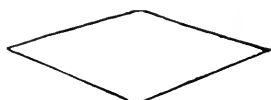

Square Card.



Triangular Card.



Square Card.

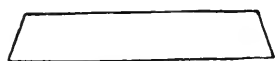

Rectangular Card.



Rectangular Card.

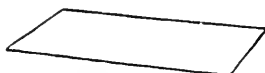

Rectangular Card.

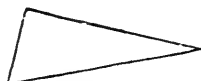

Triangular Card.



Hexagonal Card.

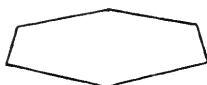

Hexagonal Card.



Triangular Card.

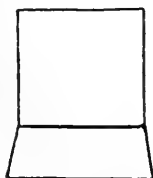

Horizontal and Vertical Squares.

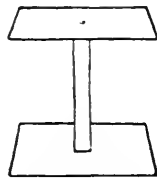
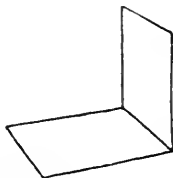

Horizontal Squares.

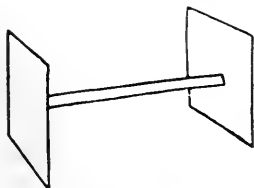

Vertical Squares.

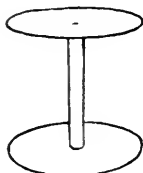

Horizontal Circles.

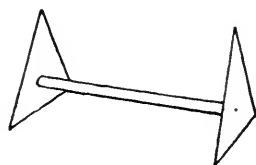

Vertical Triangles.







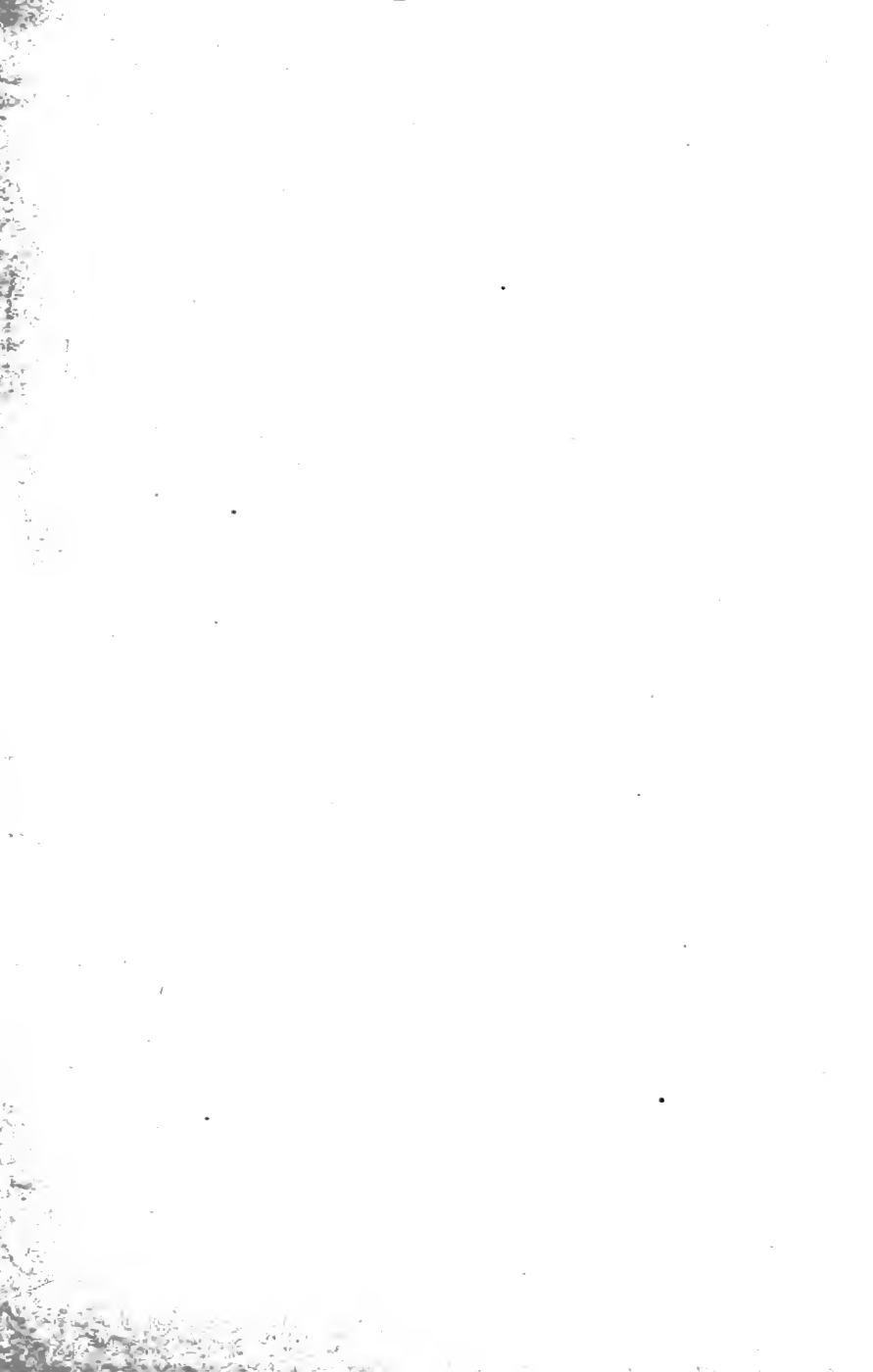

THE LIBRARY  
UNIVERSITY OF CALIFORNIA  
Santa Barbara

THIS BOOK IS DUE ON THE LAST DATE  
STAMPED BELOW.

MAY 3 1989

REC'D MAY 4 1989 H



3 1205 00823 2546

②

UC SOUTHERN REGIONAL LIBRARY FACILITY



**A** 000 647 340 9

