

HERP
QL
668
.E24
D83
1997

LIBRARY
EVS.COMB.ZOOLOGY
CAMBRIDGE, MASS.

Scientific Papers

Natural History Museum
The University of Kansas

24 September 1997

Number 3:1-41

Frogs of the *Hyla armata* and *Hyla pulchella* Groups in the Andes of South America, with Definitions and Analyses of Phylogenetic Relationships of Andean Groups of *Hyla*

By

WILLIAM E. DUELLMAN, IGNACIO DE LA RIVA¹, AND ERIK R. WILD²

*Division of Herpetology, Natural History Museum and
Department of Systematics and Ecology, The University of Kansas
Lawrence, Kansas 66045-2454, USA.*

CONTENTS

ABSTRACT	2
RESUMEN	2
INTRODUCTION	3
ACKNOWLEDGMENTS	3
MATERIALS AND METHODS	3
ANALYSIS OF CHARACTERS	4
MORPHOMETRICS	4
EXTERNAL MORPHOLOGY	7
COLORATION	9
OSTEOLOGY	9
ADVERTISEMENT CALLS	10
TADPOLES	10
ANDEAN GROUPS OF <i>HYLA</i>	12
<i>HYLA ARMATA</i> GROUP	12
<i>HYLA PULCHELLA</i> GROUP	15
<i>HYLA BOGOTENSIS</i> GROUP	30
<i>HYLA CHLOROSTEA</i> GROUP	31
<i>HYLA COLUMBIANA</i> GROUP	31
<i>HYLA GARAGOENSIS</i> GROUP	32

¹Present address: Museo Nacional de Ciencias Naturales, J. Gutiérrez Abascal 2, 28006 Madrid, Spain.

²Present address: Department of Biology, University of Dubuque, 2000 University Avenue, Dubuque, Iowa 52001, USA.

<i>Hyla labialis</i> GROUP	32
<i>Hyla larinopygion</i> GROUP	32
PHYLOGENETIC RELATIONSHIPS	33
RELATIONSHIPS AMONG ANDEAN GROUPS OF <i>Hyla</i>	33
RELATIONSHIPS OF THE <i>Hyla pulchella</i> GROUP	36
DISCUSSION	38
LITERATURE CITED	38
APPENDIX: SPECIMENS EXAMINED	40

ABSTRACT Andean hylid frogs of the genus *Hyla* are reviewed. Eight groups of *Hyla* recognized in the Andes are defined; the species in two of these groups are treated in detail. The large *H. armata*, characterized by hypertrophied forelimbs and clumps of nuptial spines on the prepollex and humerus in males, and a stream-adapted tadpole with a LTRF up to 15/17, is the sole recognized species in the *H. armata* group. Accounts of this species and six species (one new) in the *H. pulchella* group include diagnoses, descriptions of adults, larvae, advertisement calls, and information on ecology, and distribution. *Hyla ocapia* Andersson, 1938, is placed in the synonymy of *H. albonigra* Nieden, 1923; *H. callipleura* Boulenger 1902, is placed in the synonymy of *H. balzani* Boulenger 1898, and *H. pulchella andina* Müller, 1924, is recognized as a distinct species. The *H. pulchella* group is characterized by hypertrophied forelimbs and projecting prepollical spines in adult males, and generalized, stream-adapted tadpoles. These characters are shared by frogs in the *H. circumdata* group in southeastern Brazil, and the two groups are combined herein into the *H. pulchella* group. The presence of sharp, projecting prepollical spines is a character shared with several groups of *Hyla* in the neotropical lowlands. Phylogenetic analysis reveals that the *H. columbiana* and *H. labialis* groups are sister groups; this clade is the sister of a clade containing several groups of *Hyla* having a diploid number of 30 chromosomes and inhabiting Andes (*H. garagoensis* Group) and the neotropical lowlands. Frogs in the *H. bogotensis* group are characterized by the presence of a mental gland in males; this derived character is shared with *H. granosa* in the Amazon Basin and the Guiana Region. No unique synapomorphies exist for the frogs assigned to the *H. larinopygion* group. Too few data are available for *Hyla chlorostea* to associate it with any lineages of *Hyla*.

Key words: Hylidae; *Hyla armata*, *bogotensis*, *chloroseta*, *columbiana*, *garagoensis*, *labialis*, *larinopygion*, and *pulchella* groups; taxonomy; new species; phylogenetic relationships; South America; Andes.

RESUMEN Se revisan los hílidos andinos del género *Hyla* y se definen ocho grupos de especies. Las especies de dos de ellos son tratadas en detalle. *Hyla armata* es el único miembro de su grupo. Los adultos de esta especie son grandes, caracterizados por tener brazos hipertrofiados y grupos de espinas nupciales en el prepollex y húmero en los machos; las larvas están adaptadas a corrientes rápidas, y cuya fórmula de filas de dientes labiales es de hasta 15/17. La información aportada sobre esta especie y otras seis especies (una nueva) de grupo de *H. pulchella* incluye diagnóstico, descripciones de adultos, larvas, y llamadas de advertencia, y datos sobre ecología y distribución. *Hyla ocapia* Andersson, 1938, es puesta en la sinonimia de *H. albonigra* Nieden, 1923; *H. callipleura* Boulenger, 1902, es puesta en la sinonimia de *H. balzani* Boulenger, 1898; *H. pulchella andina* Müller, 1924, es elevada a rango específico. El grupo de *H. pulchella* se caracteriza por tener brazos hipertrofiados, machos con espinas sobresalientes en el prepollex, y larvas generalizadas, adaptadas a aguas corrientes. Estos caracteres son compartidos con las ranas del grupo *H. circumdata*, del sudeste de Brasil, por lo cual ambos grupos son combinados en el grupo de *H. pulchella*. La presencia de espinas sobresalientes y afiladas en el prepollex es un carácter compartido por varios grupos de *Hyla* en las tierras bajas neotropicales. Los análisis filogenéticos efectuados revelan que los grupos de *H. columbiana* e *H. labialis* son grupos hermanos. Este clado es el grupo hermano de un clado que contiene varios grupos de *Hyla* con número diploide de 30 cromosomas y que habitan los Andes (grupo de *H. garagoensis*) y en las tierras bajas neotropicales. Las ranas del grupo *H. bogotensis* se caracterizan por la presencia de una glándula mentoniana en los machos; este carácter derivado es compartido con *H. granosa*, una especie de la Cuenca Amazónica y la región de las Guayanas. No hay sinapomorfías únicas para las ranas asignadas al grupo de *H. larinopygion*. Se dispone de muy poca información sobre *H. chlorostea* como para asociarla con algún grupo de *Hyla*.

Palabras claves: Hylidae, Grupos de *Hyla armata*, *bogotensis*, *chloroseta*, *columbiana*, *garagoensis*, *labialis*, *larinopygion*, y *pulchella*; taxonomía; nueva especie; relaciones filogenéticas; Sudamérica; Andes.

INTRODUCTION

Many species of frogs of the immense, paraphyletic genus *Hyla* in South America have been placed in several phenetic groups (Frost, 1985). These include the *H. bogotensis* Group (Duellman, 1972), *H. columbiana* Group (Duellman and Trueb, 1983), *H. garagoensis* Group (Kaplan and Ruíz, 1997), *H. labialis* Group (Duellman, 1989), and the *H. larinopygion* Group (Duellman and Hillis, 1990). Nine nominal species from the Andes of Argentina, Bolivia, and Peru have not been associated with any group; these species are *H. albonigra* Nieden, *H. armata* Boulenger, *H. balzani* Boulenger, *H. charazani* Vellard, *H. chlorostea* Reynolds and Foster, *H. callipleura* Boulenger, *H. marianitae* Carrizo, *H. melanopleura* Boulenger, and *H. ocapia* Andersson, although Frost (1985) placed the latter without comment in the *Hyla ocapia* Group. With the exception of the description of the tadpole of *H. armata* (Cadle and Altig, 1991), morphology of the tadpole of *H. pulchella andina* (Lavilla and Fabrezi, 1987), additional distributional records from Bolivia (De la Riva, 1990; Reynolds and Foster, 1992), and descriptions of calls of some species (Barrio, 1965; Cadle and Altig, 1991; Márquez et al., 1993), no new information has been published on any of these species since their original descriptions. Casual examination of specimens of these species revealed that all, except *H. armata* and *H. chlorostea*, have projecting prepollices that are sexually dimorphic; this character is shared with *H. pulchella* Duméril and Bibron, and presumably related species in southeastern Brazil, northeastern Argentina, and Uruguay, with isolated populations in the Cordillera de Córdoba and in the Andes of northern and central Argentina and central Bolivia (Barrio, 1965; Lutz, 1973; Ceï, 1980).

Independent field work by De la Riva in Bolivia, and by Duellman and his associates in Argentina, Bolivia, and Peru has resulted in the acquisition of many specimens of these frogs and data on their ecology and life histories. The purposes of this paper are to: (1) present analyses of data on the external morphology and osteology of adults; (2) describe the tadpoles and advertisement calls; (3) synthesize all available information pertaining to the taxonomy, ecology, and distribution of the species; (4) define the *Hyla armata* and *Hyla pulchella* groups; and (5) attempt to determine the phylogenetic relationships of the groups of *Hyla* in the Andes.

MATERIALS AND METHODS

Specimens used in this study are referenced by their museum catalogue numbers prefaced by the institutional codes given by Leviton et al. (1985) with the addition of the following: CET = Centro de Estudios Tropicales, Sevilla, Spain; EBD = Estación Biológica Doñana, Sevilla, Spain; MHNSM = Museo de Historia Natural, Universidad Nacional Mayor de San Marcos, Lima Peru; MNHNB =

ACKNOWLEDGMENTS

For the loan of specimens, we thank Erick Ahlander (NHRM), José Cabot (EBD), Jonathan A. Campbell (UTA), Gustavo R. Carrizo (MACN), Javier Castroviejo (CET), Barry T. Clarke (BMNH), Guilano Doria (MSNG), Darrel R. Frost (AMNH), W. Ronald Heyer (USNM), and Anne M. Olher (MNHN). Duellman is grateful to Jesús Córdova (MHNSM), Alice G. C. Grandison (BMNH), Jean Guibé (MNHN) and the late Walter Hellmich (ZSM) and Greta Vestergren (NHRM) for the provision of working space in their respective collections. We thank Joseph R. Mendelson III for his assistance with the multivariate analysis and Hélio da Silva for his aid in the phylogenetic analyses. Amy Lathrop executed the drawings comprising Figures 4, 7, and 16. and John E. Simmons made the photographs comprising Figures 5 and 8. Michael B. Harvey provided data on frogs collected by him in Bolivia, as did Lily O. Rodríguez for frogs collected by her in Peru. We are grateful to John D. Lynch, Robert P. Reynolds, and Linda Trueb for critically reading the manuscript.

Duellman's visits to European museums was made possible by a grant (5063) from the Penrose Fund of the American Philosophical Society and his field work was supported by a grant from the National Science Foundation (DEB-7401998); he is grateful to his field companions—David C. Cannatella, the late Ismael Ceballos, Dana T. Duellman, Thomas H. Fritts, Oscar Ochoa M, John E. Simmons, and Linda Trueb. Furthermore, David C. Cannatella and Thomas J. Berger collected critical material in Bolivia. Appropriate permits were issued for Peru by Luis J. Cuento Aragón and Armando Pimentel Bustamente of the Dirección General Forestal y de Fauna. Logistic support in Peru was provided by Oscar Ochoa M. and in Argentina by Raymond F. Laurent.

The research was completed as part of a project on patterns of speciation and distribution of anurans in the Andes supported by the National Science Foundation (BSR-8805920; W. E. Duellman, principal investigator). De la Riva is indebted to the Asociación Amigos de Doñana for funding field work in Bolivia and to personnel at the Museo de Historia Natural Noel Kempff Mercado and the Colección Boliviana de Fauna for logistic support in Bolivia.

Museo Nacional de Historia Natural de Bolivia, La Paz, Bolivia³; MNK = Museo de Historia Natural Noel Kempff

³The collections in the MNHNB have been combined with the collection in the Instituto de Ecología; the new collection is known as the Colección Boliviana de Fauna (CBF). This occurred subsequent to our examination of specimens in the MNHNB, and the catalogue numbers that we give for specimens in that collection probably have been changed.

Table 1. Sexual dimorphism in snout-vent length (SVL) in *Hyla armata* and Andean species in the *Hyla pulchella* Group. n = males/females; in the columns of the sexes, the mean \pm one standard deviation is followed by the range in parentheses. Sexual dimorphism is the mean SVL of males divided by the mean SVL of females.

Species	N	Males	Females	Dimorphism
<i>Hyla albonigra</i>	9/11	50.5 \pm 3.15 (47.0–56.0)	54.9 \pm 4.06 (49.3–64.7)	92.0
<i>Hyla andina</i>	98/59	46.5 \pm 7.72 (34.6–57.6)	49.8 \pm 6.06 (37.0–62.7)	93.4
<i>Hyla armata</i>	28/22	59.6 \pm 4.82 (47.5–68.5)	64.3 \pm 5.93 (47.5–74.5)	92.7
<i>Hyla balzani</i>	61/8	40.4 \pm 3.66 (33.3–49.9)	48.5 \pm 2.73 (44.4–52.3)	83.3
<i>Hyla marianitae</i>	26/6	47.6 \pm 4.96 (36.5–56.8)	51.4 \pm 4.57 (45.0–56.5)	92.6
<i>Hyla melanopleura</i>	1/3	43.6	47.1 (46.4–47.7)	92.6
<i>Hyla palaestes</i>	25/1	39.5 \pm 3.53 (36.2–50.4)	49.0	80.6

Mercado, Santa Cruz de la Sierra, Bolivia. Specimens examined and their localities and catalogue numbers are listed in the Appendix.

Measurements of frogs and tadpoles were made to the nearest 0.1 mm with dial calipers in the manner described by Duellman (1970). Forearm length was measured from the base of the thenar tubercle to the proximal tip of the radioulna; forearm breadth was measured at the widest part of the forearm. Snout-vent length is abbreviated SVL throughout. Stepwise discriminate function analyses were accomplished using the BMDP Statistical Software (Dixon, 1981). Webbing formulae follow the methodology of Savage and Heyer (1967) as modified by Myers and Duellman (1982). Dried skeletons were prepared by hand;

cleared and stained specimens were prepared in the manner described by Dingerkus and Uhler (1977). Osteological terminology follows Trueb (1993). Tadpoles were staged according to Gosner (1960); descriptions generally follow those of Cadle and Altig (1991). The labial tooth row formula is abbreviated LTRF. Calls were recorded using portable tape recorders (Sony WM D6C and Sennheiser directional microphone model Me-80 or Uher with Uher microphone) and analyzed by means of the Canary 1.2 software (Charis et al., 1995) on a Macintosh computer. Phylogenetic analyses were accomplished using the DELTRAN option in PAUP software (Swofford, 1991). Credits for the color photographs in Figure 3 are: DCC = David C. Cannatella, IDIR = Ignacio de la Riva, WED = William E. Duellman.

ANALYSIS OF CHARACTERS

The following discussion includes only *Hyla armata* and those species in the *Hyla pulchella* Group that inhabit the Andes. For comments on the characteristics of extra-Andean species of the *Hyla pulchella* Group, see Phylogenetic Relationships.

MORPHOMETRICS

Mean SVLs of males vary from 39.5 mm in *Hyla palaestes* to 59.5 mm in *H. armata*, and the means of females vary from 47.1 in *H. melanopleura* to 74.5 mm in *H. armata*. Among those species for which series of adults of both sexes are available, sexual dimorphism in SVL is slight; SVL in males is more than 90% of that in females, except in *H. balzani* and *H. palaestes* (Table 1). Strong sexual dimorphism exists in the relative breadth of the forearm, which is massive in males and normal in females. Measurements of other external features are given in Table 2.

In order to determine morphometric distinctness, we performed a stepwise discriminate function analysis on measurements taken from 49 specimens of *Hyla armata* and 304 individuals of seven species of frogs in the *Hyla pulchella* group (sexes combined)—*Hyla albonigra* ($n = 15$), *H. andina* ($n = 156$), *H. balzani* ($n = 69$), *H. marianitae* ($n = 32$), *H. melanopleura* ($n = 3$), *H. palaestes* ($n = 26$), *H. pulchella* ($n =$

3). The two species with small sample sizes (*H. melanopleura* and *H. pulchella*) were treated as unknowns and, thus, were not used in determining the discriminate function. Twelve morphological variables were log transformed and included in the stepwise analysis, which identifies those variables that maximize separation of group means. The twelve variables are SVL, tibia length, foot length, head length, head width, interorbital distance, internarial distance, eyelid width, eye diameter, tympanum diameter, eye-nostril distance, and total number of vomerine teeth. Stepwise discriminate function analysis was terminated at a model that included all 12 variables as significant ($F > F_{0.05(5,330)} = 2.2388$). The approximate F-statistic rejected the null hypothesis of equality among means ($P < 0.001$). Multiple F-tests of pairwise comparisons among all groups using Bonferroni protection for multiple tests ($\alpha = 0.001$ for $\alpha = 0.05$; $F_{0.001(12,330)} = 2.8408$) indicated that the twelve variables were able to separate all group means effectively except for *Hyla melanopleura* and *H. albonigra* ($F = 1.47$), *H. melanopleura* and *H. andina* ($F = 1.70$), *H. melanopleura* and *H. marianitae* ($F = 2.22$), *H. melanopleura* and *H. pulchella* ($F = 2.57$), and *H. melanopleura* and *H. palaestes* ($F = 2.64$).

Overall jackknifed classification of individuals was 81% correct (not including individuals of species treated as

Table 2. Morphometric data for specimens of *Hyla armata* and Andean species of the *Hyla pulchella* Group. In each section, first line is the mean \pm one standard deviation; second line is range.

Character	Sex	<i>H. armata</i>	<i>H. albonigra</i>	<i>H. andina</i>	<i>H. balzani</i>	<i>H. marianitae</i>	<i>H. melanopleura</i>	<i>H. palaestes</i>
		28 ♂♂, 22 ♀♀	9 ♂♂, 11 ♀♀	98 ♂♂, 59 ♀♀	61 ♂♂, 8 ♀♀	26 ♂♂, 6 ♀♀	1 ♂, 3 ♀♀	25 ♂♂, 1 ♀
Tibia length	♂♂	31.6 \pm 2.44 26.1–34.7	26.9 \pm 2.52 23.4–31.0	24.5 \pm 2.95 17.3–32.2	21.6 \pm 2.11 17.8–27.9	26.1 \pm 2.83 19.2–31.8	21.6 21.6	21.9 \pm 1.77 19.1–26.9
	♀♀	34.2 \pm 2.16 27.2–39.0	25.7 \pm 1.94 23.6–29.9	25.8 \pm 3.08 18.2–32.1	26.0 \pm 1.00 24.5–27.4	26.6 \pm 2.57 22.5–29.4	24.7 24.2–25.2	23.7 23.7
Foot length	♂♂	28.3 \pm 2.63 21.8–32.0	23.1 \pm 2.21 19.6–26.5	21.7 \pm 2.90 13.3–29.5	18.0 \pm 2.37 14.6–29.4	21.3 \pm 2.39 15.4–24.9	17.7 17.7	17.3 \pm 1.55 14.8–22.1
	♀♀	31.1 \pm 3.42 23.6–37.1	25.7 \pm 1.94 23.6–29.9	22.8 \pm 3.24 16.2–29.0	22.0 \pm 1.55 19.2–23.7	22.3 \pm 2.19 19.2–24.7	20.6 20.5–20.7	17.4 17.4
Head length	♂♂	19.6 \pm 2.36 15.8–29.7	15.8 \pm 1.47 13.2–17.2	15.2 \pm 1.44 11.6–18.9	14.3 \pm 1.03 11.9–17.3	16.3 \pm 1.60 13.0–19.8	14.4 14.4	14.1 \pm 0.97 13.0–16.8
	♀♀	20.2 \pm 2.16 17.0–23.5	16.6 \pm 1.19 14.2–18.1	16.2 \pm 1.97 12.1–21.6	16.6 \pm 1.07 15.3–18.3	17.2 \pm 1.66 14.8–18.9	15.5 15.4–15.6	15.1 15.1
Head width	♂♂	20.3 \pm 1.46 16.5–23.0	17.4 \pm 1.93 15.5–20.8	15.0 \pm 1.82 11.1–19.5	13.9 \pm 1.27 11.8–17.7	16.3 \pm 1.65 13.0–20.3	14.4 14.4	14.1 \pm 1.38 12.5–18.5
	♀♀	21.8 \pm 1.70 17.8 \pm 24.2	18.5 \pm 2.61 12.8–22.2	15.9 \pm 2.25 11.7–20.7	16.6 \pm 0.87 15.1–18.0	17.1 \pm 1.18 15.5–18.5	15.5 15.4–15.6	14.8 14.8
Interorbital distance	♂♂	6.0 \pm 0.57 4.8–7.1	4.9 \pm 0.63 4.2–6.3	4.4 \pm 0.45 3.5–5.6	4.5 \pm 0.47 3.7–5.7	5.4 \pm 0.53 4.3–6.5	4.2 4.2	4.3 \pm 0.62 3.4–6.2
	♀♀	6.6 \pm 0.87 5.3–8.0	5.0 \pm 0.45 4.5–5.9	4.6 \pm 0.59 3.6–6.0	5.0 \pm 0.28 4.7–5.5	5.3 \pm 0.59 4.5–5.9	4.6 4.5–4.7	4.5 4.5
Eye diameter	♂♂	6.0 \pm 0.88 3.8–7.3	5.1 \pm 0.80 4.3–6.5	4.3 \pm 0.50 3.1–5.6	4.3 \pm 0.46 3.4–5.5	4.6 \pm 0.52 3.7–5.9	3.9 3.9	4.4 \pm 0.24 3.8–4.7
	♀♀	6.7 \pm 0.81 5.1–8.4	5.4 \pm 0.59 4.9–6.4	4.4 \pm 0.59 3.2–6.1	4.7 \pm 0.45 3.9–5.3	4.9 \pm 0.72 3.9–5.9	5.0 4.8–5.1	4.5 4.5
Tympanum diameter	♂♂	2.1 \pm 0.41 1.4–3.4	2.7 \pm 0.20 2.5–3.1	2.6 \pm 0.32 1.9–3.2	2.2 \pm 0.33 1.6–3.2	2.5 \pm 0.36 1.8–3.1	2.4 2.4	2.4 \pm 0.26 1.9–2.9
	♀♀	2.2 \pm 0.46 1.6–3.3	3.0 \pm 0.25 2.6–3.4	2.8 \pm 0.48 1.7–3.9	2.7 \pm 0.22 2.5–2.8	2.9 \pm 0.32 2.4–3.3	3.0 2.7–3.3	27 27

unknowns). *Hyla armata* was classified with 96% correct. *Hyla andina*, *H. marianitae*, and *H. palaestes* were all classified with over 80% correct, whereas *H. balzani* and *H. albonigra* were lower, with 62% and 40% correctly classified, respectively. Of the 67 cases misclassified, 50 can be considered borderline cases (posterior probability of group membership < 0.75). Of the nonborderline misclassifications, *H. andina* and *H. albonigra* had the greatest frequency with seven individuals of *H. andina* classified as *H. albonigra* and one *H. albonigra* classified as *H. andina*. Some individuals of *H. balzani* and *H. marianitae* also were confused, with three *H. balzani* classified as *H. marianitae*, and one *H. marianitae* classified as *H. balzani*. Other nonborderline misclassifications include two *H. palaestes* classified as *H.*

marianitae, two *H. balzani* classified as *H. palaestes*, and one *H. balzani* classified as *H. andina*. Classification of individuals for the two species treated as unknowns placed all three *H. pulchella* with *H. andina* (two with posterior probabilities of group membership > 0.75). *Hyla melanopleura* was classified as *H. andina* (one with high and one with low posterior probability of group membership) or *H. albonigra* (low posterior probability of group membership).

The first two canonical axes displayed 95% of the total dispersion (Fig. 1), both with eigenvalues greater than the mean; other axes had eigenvalues lower than the mean and contributed little to the cumulative proportion of the total dispersion. Values for canonical variables evaluated

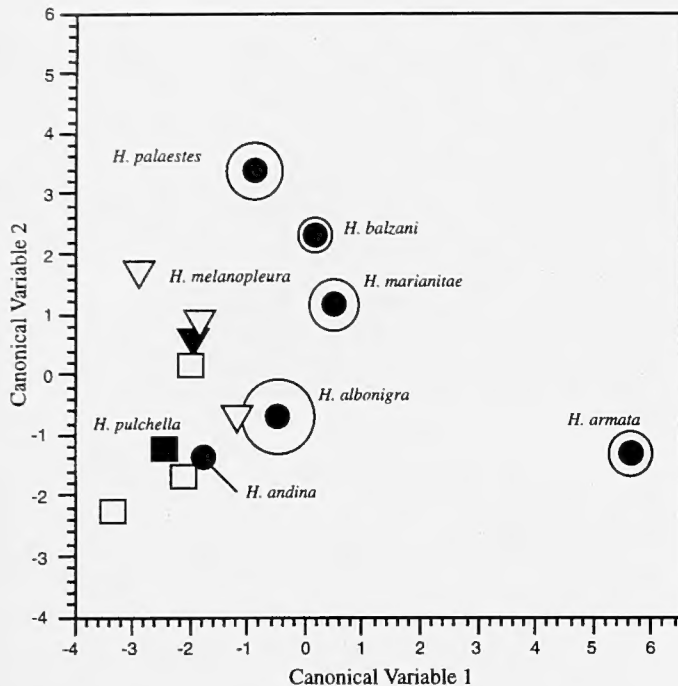

Fig. 1. Plot of canonical discriminant scores for *Hyla armata* and species of the *Hyla pulchella* Group. Closed symbols indicate group mean scores. All individual scores for *H. melanopleura* (inverted triangles) and *H. pulchella* (squares) are plotted as open symbols. 95% confidence intervals around mean scores are provided for the six other species (the 95% confidence interval for *H. andina* is smaller than the solid symbol; for the group mean).

at group means indicated that the first canonical axis was able to separate most groups. The least differentiated on the first axis were *H. andina* and *H. melanopleura*, although these are separated by the second axis. Examination of the standardized (by pooled within-group variances) coefficients for canonical variables shows that tympanum diameter was the most important variable on the first axis. The second axis had SVL as the most important variable, followed by foot length, head width, and eye-nostril distance. These standardized coefficients for canonical variables were: Canonical Axis I (Canonical Axis II) = SVL: -0.40 (-1.45), foot length: 0.07 (-0.88), head length: -0.01 (0.15), head width: 0.57 (0.75), interorbital distance: 0.48 (0.46), internarial distance: 0.34 (-0.33), eyelid width: 0.15 (0.05), eye diameter: 0.29 (0.08), tympanum diameter: -1.14 (0.21), eye-nostril distance -0.03 (0.69), VT: 0.40 (0.42).

In summary, the discriminate function model involving 12 variables could discriminate *Hyla armata*, and most of the species of the *Hyla pulchella* Group. The function was unable to differentiate group means of *H. melanopleura* from several other species (*H. albonigra*, *andina*, *marianitae*, *palaestes*, and *pulchella*). This is likely a result of the small sample size of *H. melanopleura*. The ability of the model to classify was not especially high (81%); however, most misclassified individuals were borderline cases and may

represent outliers, such as young individuals. Of those misclassifications that were not borderline cases, nearly half involved misclassified individuals of *H. andina* and *H. albonigra*. The first two axes displayed most of the variation among groups (95%). The first, in which tympanum diameter was by far the most important variable, showed *H. armata* to be distinct with the smallest tympanum. The first axis was not effective in discriminating *H. andina* from *H. melanopleura*. The second axis, in which SVL was the most important variable, improved the ability to distinguish these two species.

In order to determine morphometric differences among individuals of *Hyla andina* from different regions and to ascertain the possible existence of cryptic taxa, especially in Bolivia, stepwise discriminate function analysis was performed on measurements taken from 156 specimens from four regions (sexes combined): Bolivia ($n = 84$), and the provinces of Catamarca ($n = 35$), Jujuy ($n = 24$), and Tucumán ($n = 13$) in Argentina. The same 12 morphological variables used in the analysis of the *Hyla pulchella* Group were log transformed and included in the present stepwise analysis. Stepwise discriminate function analysis was terminated at a six variable model that included snout-vent length, foot length, interorbital diameter, internarial distance, eye-nostril distance, and number of vomerine teeth as significant ($F > F_{0.05[3,147]} = 2.6656$). The approximate F-statistic rejected the null hypothesis of equality among means ($P < 0.001$). Multiple F-tests of pairwise comparisons among all groups using Bonferroni protection for multiple tests ($\alpha = 0.001$ for $\alpha = 0.05$; $F_{0.001[6,147]} = 3.986$) indicated that the six variables were able to separate all group means effectively except those of Tucumán and Jujuy ($F = 1.33$), and those of Tucumán and Bolivia ($F = 3.07$).

Overall jackknifed classification of individuals was 56% correct. Specimens from Catamarca were correctly classified most frequently (69% correct), followed by those from Bolivia (60% correct). Specimens from Jujuy and Tucumán were classified with much lower success, 38% and 31%, respectively. The failure of the function to classify correctly individuals is even more evident when examining only those correct classifications that had high posterior probabilities of group membership (> 0.75): Catamarca 26%, Bolivia 17%, Tucumán 8%, and Jujuy 0%. Furthermore, there appears to be no evident pattern of misclassification among any of the localities and of the 69 cases misclassified; only five were not borderline cases (posterior probability of group membership > 0.75), which emphasizes the inability of the function to discriminate most individuals of the four groups.

The first two canonical axes displayed 96% of the total dispersion (Fig. 2). The first axis had an eigenvalue greater than the mean; the eigenvalue of the second axis was slightly less than the mean, and the third axis had a very low eigenvalue and contributed little to the cumulative proportion of the total dispersion. Values for canonical variables evaluated at group means indicated that the first canonical axis was able to separate populations from

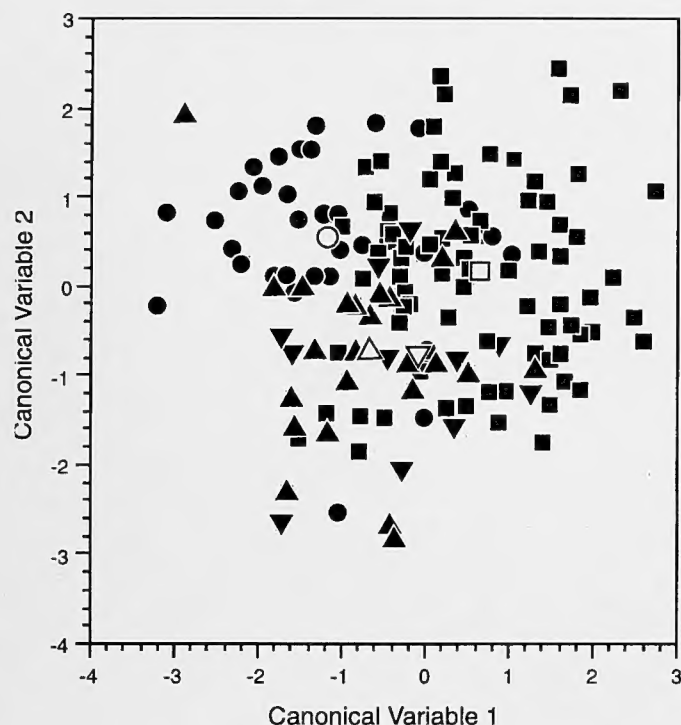

Fig. 2. Plot of canonical discriminant scores for individuals (closed symbols; $n = 156$) of *Hyla andina*. Open symbols indicate group mean scores. Squares = Bolivia, circles = Catamarca, triangles = Jujuy, and inverted triangles = Tucumán, Argentina.

Catamarca and Tucumán, whereas those from Bolivia and Jujuy were more similar, although these are separated by the second axis, as were Catamarca and Tucumán. Examination of the standardized (by pooled within-group variances) coefficients for canonical variables revealed that snout-vent length was the most important variable on the first axis, followed by eye-nostril distance. The second axis had foot-length as the most important variable, followed by snout-vent length. These standardized coefficients for canonical variables were: Canonical Axis I (Canonical Axis II) = SVL: -2.14 (1.17), foot length: 0.72 (-1.60), interorbital distance: 0.34 (-0.44), internarial distance: 0.82 (0.70), eye-nostril distance 1.04 (0.53), number of vomerine teeth: 0.40 (-0.61).

In summary, the discriminate function model involving six variables was able to discriminate means of some of the geographic groups of *Hyla andina*. The function was unable to differentiate group means of Tucumán and Bolivia, and Tucumán and Jujuy. The ability of the model to classify was poor (56%), with the majority of individuals classified, both correctly and incorrectly, with low confidence (low posterior probabilities of group membership). There was no pattern of misclassification evident among the localities. The first two axes displayed most of the variation among groups (96%). The first, in which snout-vent length was by far the most important variable, discriminated Catamarca and Tucumán, but was not effective at distinguishing Bolivia and Jujuy. The second axis in which

foot-length was the most important variable, improved the ability to distinguish all groups. The ability of the function to distinguish the mean of Catamarca from the other groups and the relatively high success of classification of individuals from Catamarca suggest that it is the most distinctive group, but the differences from the other groups is minimal. The failure to separate all group means coupled with the abysmal ability to classify individuals confidently, indicate that the morphological variables included in this analysis do not adequately distinguish the individuals from the four localities. In other words, the groups do not show sufficient morphometric differences to consider them distinct, although there are some differences in SVL.

EXTERNAL MORPHOLOGY

The body is moderately robust; head width and length are about equal, and the snout is short, usually rounded in dorsal view and bluntly rounded in profile (in dorsal view, nearly truncate in *Hyla armata* and subacuminate in *H. marianitae*). In transverse sectional profile, the canthus rostralis is acutely rounded to angular, and the lips are rounded. The internarial area usually is depressed slightly between protuberant nostrils that are directed dorsolaterally at a level just posterior to the anterior margin of the lower jaw. The top of the head is flat, and the interorbital distance usually is greater than the width of the upper eyelid. The tympanum is round with a distinct, smooth annulus; the supratympanic fold obscures the upper edge of the tympanum and abruptly curves downward to a point above the insertion of the arm.

In breeding males, the forearm is massive owing to greatly hypertrophied musculature. A small prepollical protrusion is evident in females, but in males of all species except *Hyla armata*, the prepollex is elongated and protrudes medially. Males of *Hyla armata* have a cluster of keratinous spines on the inside of the thumb and a similar cluster on the proximal ventral surfaces of the humerus. The relative lengths of the fingers are $I < II < IV < III$. Fingers II-IV bear distinct lateral fringes and have large, round discs. The fingers are about one-third to one-half webbed. The palmar tubercle is low, indistinct, and bifid; the thenar tubercle is low and elongately ovoid.

On both hands and feet, the subarticular tubercles are moderately large and round; the supernumerary tubercles are round to subconical, numerous proximally and readily evident in most specimens. The inner metatarsal tubercle is prominent and ovoid; an outer metatarsal tubercle is absent, except in *H. armata*, in which it is low and about one-fourth the size of the inner metatarsal tubercle. A tarsal fold extends the full length of the tarsus; the fold is conspicuously elevated in *H. albonigra*, weak in *H. marianitae*, and low in the other species. The relative lengths of the toes are $I < II < III < V < IV$; all toes bear distinct lateral fringes and moderately large, round discs. The toes are three-fourths to four-fifths webbed.

The skin on the dorsum and flanks is coarsely granular in *Hyla albonigra*, weakly granular to smooth in *H. andina*

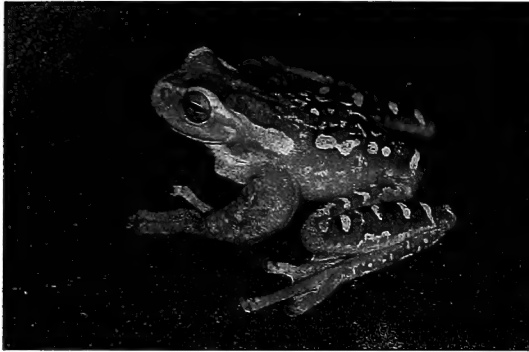

Hyla armata, KU 173219, male, 61.2 mm SVL. WED



Hyla armata, KU 163341, female, 68.6 mm SVL. WED

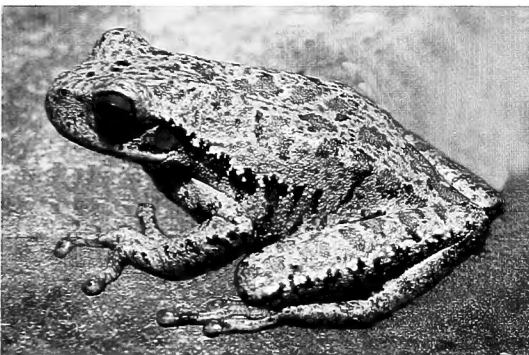

Hyla andina, KU 160344, female, 45.9 mm SVL. WED



Hyla andina, KU 160195, male, 45.1 mm SVL. WED



Hyla balzani, KU 139212, female, 46.8 mm SVL. WED



Hyla balzani, KU 183425, male, 42.0 mm SVL. DCC



Hyla marianitae, CET A109, male, 54.9 mm SVL. IDIR



Hyla palaestes, KU 163305, male, 46.3 mm SVL. WED

Fig. 3. Frogs of the *Hyla armata* and *Hyla pulchella* groups in the Andes.

and *H. armata*, and smooth in the other species. The skin on the throat, chest, belly, and proximal posteroventral surfaces of the thighs is coarsely granular, and the skin on other ventral surfaces is smooth. The cloacal opening is directed posteroventrally near the upper level of the thighs and covered by a short sheath; tubercles and folds in the cloacal region are absent. The vocal sac is single, median, and subgular; the vocal slits extend posterolaterally from the midlateral base of the tongue. The tongue is cordiform, shallowly notched posteriorly, and barely free behind. The dentigerous processes of the vomers are transverse to slightly oblique between the posterior margins of the rounded choanae and bear numerous teeth.

COLORATION

The dorsal coloration in these Andean species usually is brown to gray, but some individuals of *H. andina*, *callipleura*, and *marianitae* are green; normally, the markings on the dorsum are darker shades of the ground color. These markings vary from round spots in *H. armata* to narrow transverse bars in *H. balzani*, irregular dashes in *H. albonigra*, *andina*, *melanopleura*, and *palaestes*, and vermiculations in some *H. marianitae* (Figs. 3, 4). The venter is creamy white to creamy gray or pale yellow in all species, but the vocal sac is brown or dark gray. In most species, the most distinctive markings are on the flanks and hidden surfaces of the thighs. These markings consist of vertical black bars or irregular spots in *H. andina* and *H. albonigra*, large dark spots in *H. armata*, and pale spots on irregular marks on dark flanks in *H. balzani* and *H. marianitae*. The flanks and hidden surfaces of the thighs in *H. melanopleura* and *H. palaestes* are unpatterned, except for small pale dots on the ventrolateral edge of the flanks in *H. melanopleura*.

A transverse white, supraclacal stripe is characteristic of most species (absent in *H. albonigra*). Faint white dorso-lateral, ulnar, and tarsal stripes are present in *Hyla balzani* and *H. melanopleura*; these stripes are bold in some individuals of *H. andina*, some populations of which are characterized by blue in the axilla and groin in life.

OSTEOLOGY

The relatively few skeletal preparations of only a few taxa preclude a thorough analysis of skeletal features. Instead, a brief description is given of principal osteological features of *Hyla armata* and of three members of the *Hyla pulchella* Group (*H. andina*, *balzani*, and *palaestes*).

Hyla armata

Skull.—The skull is about as long as wide, and the snout region is short and blunt. The nasals are widest anteriorly and separated medially by a distance about equal to about one half of their greatest width. The nasal is not in contact with the frontoparietal and it bears a short maxillary process approximating, but not articulating with, the pre-orbital processes of the maxilla. The sphenethmoid is heavily ossified and broader than long in dorsal view; it underlies the nasals and anterior ends of the frontoparietals, and

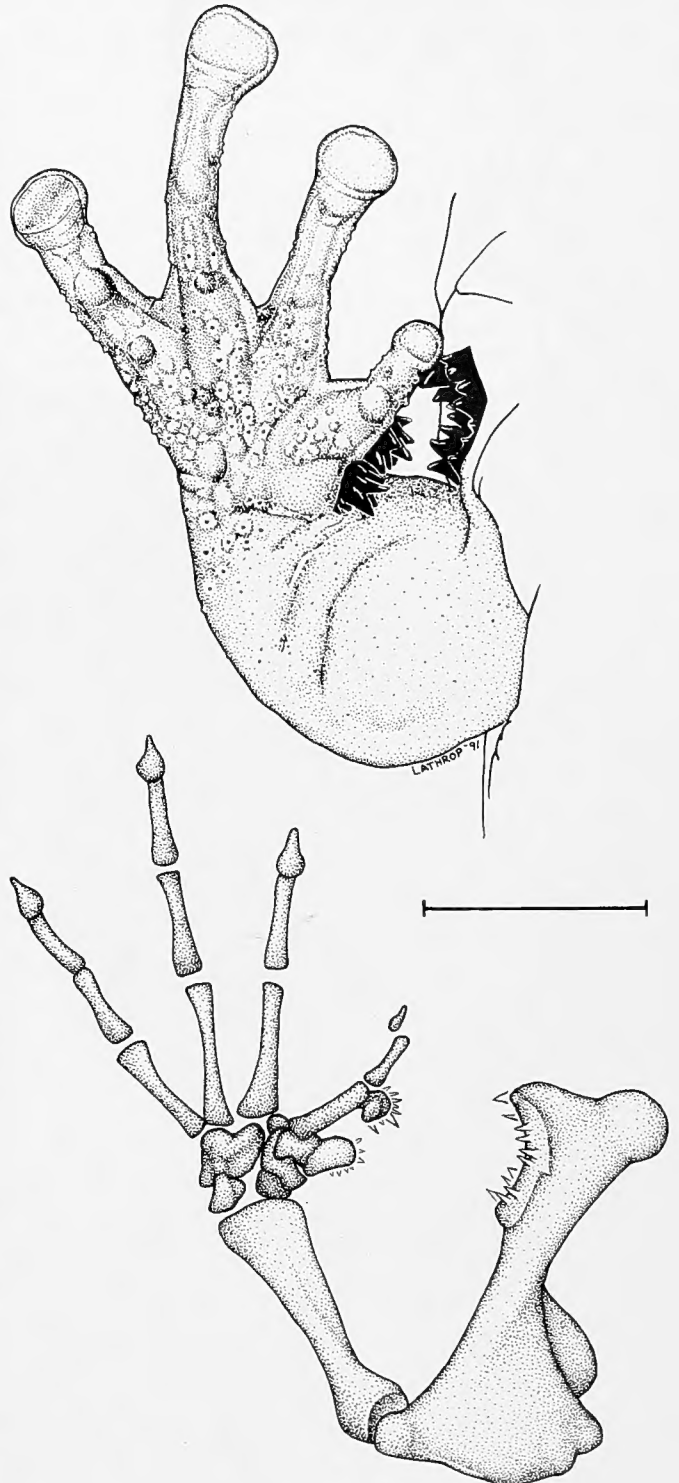

Fig. 4. Ventral views of right arm and hand of *Hyla armata*. Top, external view, KU 173219, male. Bottom, cleared-and-stained, KU 173220, male. Line = 10 mm.

forms the anterior margin of the frontoparietal fontanelle. The septum nasi is ossified and extends anteriorly beyond the anterior margins of the nasals. The frontoparietals are slender and approximate one another only posteriorly. The frontoparietal fontanelle is short and oval. The prooti and exoccipital are incompletely fused to one another, and the prootic is elaborated anteriorly. The crista parotica is moderately broad and narrowly separated by cartilage from the squamosal. The squamosal is robust; the zygomatic ramus is short, and has a lanceolate cartilaginous process distally. The premaxilla has a high, vertical alary processes. The maxilla has a high facial process and a long, slender preorbital process, but no postorbital process. The vomers are broad and juxtaposed medially; each bears a massive transverse dentigerous processes. Each slender neopalatine bears a ventral ridge; the bone articulates with the maxilla and sphenethmoid. The parasphenoid is slender anteriorly, where the tip is nearly at the level of the neopalatines; posteriorly, it is wider with irregular (feathered) lateral margins. The alary processes of the parasphenoid are narrow and directed posterolaterally; the posteromedial process is short and does not reach the margin of the foramen magnum. The medial ramus of the pterygoid is short and robust; it articulates with the anterolateral surface of the otic capsule. The anterior ramus of the pterygoid is long and slender; it is in broad contact with the maxilla anteriorly to the level of the neopalatine.

Postcranial skeleton.—With a few exceptions, the axial and appendicular skeletons are typical of hylid frogs. A notable exception is the complete ossification of the suprascapulae. Also, major differences exist in the forelimbs of adult males. In an adult male (KU 173200, SVL 60.5 mm), both the humerus and the radioulna are massive, and the former has greatly expanded flanges (Fig. 4). On the humerus, the crista lateralis is expanded laterally into a crescent-shaped process; the anterior part of the crescent bears numerous spines on the ventral surface. The cristae medialis and ventralis are greatly flared medially. In the hand, the prepollex is enlarged and supports an elliptical osseous plate medially. The first metacarpal is noticeably robust and distally supports a round osseous plate. Both plates support spines of soft tissue that are keratinized. In an adult female (KU 164085, SVL 71 mm) and a juvenile (KU 163334, SVL 32.4 mm), the humeri, radioulnae, and first metacarpals are not noticeably enlarged; the cristae on the humeri are not expanded. The prepollices in both specimens are elongate, triangular structures; they are cartilaginous in the juvenile and ossified in the adult female.

Hyla pulchella Group

Skull.—The skull is about as long as wide, and the snout region is short and bluntly rounded. The nasals are quadrangular and widely separated; the nasals are not in contact with the frontoparietals. Each nasal has a short maxillary processes approximating, but not articulating with,

the preorbital process of the maxille. The sphenethmoid is moderately ossified and broader than long in dorsal view. The septum nasi is not ossified anteriorly between the anteromedial margins of the nasals. The sphenethmoid does not underlie the nasals, but it does underlie the anterior ends of the frontoparietals. The frontoparietals are slender and approximate one another only posteriorly. The frontoparietal fontanelle is large and elongate. The prootic is completely fused with the exoccipital and is not elaborated anteriorly; the crista parotica is robust and narrowly separated by cartilage from the squamosal. The entire squamosal is rather slender; the zygomatic rami is short and lacks a cartilaginous process distally. The premaxilla has a high, vertical alary processes. The maxilla has a high facial process and long, slender preorbital process, but no postorbital process. The vomers are moderately ossified and narrowly separated posteromedially; each bears a small, arched dentigerous process. The neopalatine is slender and smooth; it articulates with the maxilla and sphenethmoid. The parasphenoid is slender anteriorly, where the tip does not extend to the level of the neopalatines; at about midlength of the orbit the parasphenoid becomes abruptly wider and has smooth lateral margins. The alary processes of the parasphenoid are narrow and directed posterolaterally; the posteromedial process is short in *H. balzani* and long and slender in *H. andina* and *H. palaestes*; it does not reach the margin of the foramen magnum. The medial ramus of the pterygoid is moderately long and slender; it articulates with the anteroventral surface of the otic capsule. The anterior ramus of the pterygoid is long and slender; it is in broad contact with the maxilla anteriorly nearly to the level of the neopalatine.

Postcranial skeleton.—The axial and appendicular skeletons are typical of hylid frogs. The suprascapulae are poorly ossified. The forelimbs of adult males have humeri with slightly expanded cristae medialis; the prepollex is enlarged and curved medially with a sharp distal point.

ADVERTISEMENT CALLS

The advertisement calls are known for five of the species, but few recordings are available. The call of *Hyla andina* was described by Barrio (1965) and Márquez et al. (1993), and that of *H. armata* was described by Cadle and Altig (1991) and Márquez et al. (1993), who also described the call of *H. marianitae* (as *H. callipleura*). Herein we present descriptions of the calls of *H. andina*, *armata*, *balzani*, *marianitae*, and *palaestes* in the individual species accounts. The calls of the Andean members of the *Hyla pulchella* Group are rather soft and low-pitched; they consist of a single note, as in *H. armata*, to a series of notes, as in *H. andina* (Table 3).

TADPOLES

Tadpoles of four species (*Hyla andina*, *armata*, *balzani*, and *palaestes*) are known. The tadpoles of *H. andina* and *H.*

Table 3. Characteristics of advertisement calls of *Hyla armata* and four Andean species in the *Hyla pulchella* Group. Ranges are in first row, and means are in parentheses in second row; *n* = number of calls.

Species	<i>n</i>	Notes/ call	Notes/ minute	Note duration (sec)	Pulses/ second	Frequency		
						Dominant (kHz)	Fundamental (kHz)	Modulation
<i>H. armata</i> ¹	3	1	2–6 (4)	0.16–0.24 (0.20)	59–64 (61.5)	2.5–4.7 (3.6)	2.4–2.5 (2.45)	Up
<i>H. andina</i> ²	2	2–3	21–24 (2.5)	0.01–0.06 (22.5)	110–120 (0.04)	1.7–2.3 (115)	1.1–1.2 (2.0)	Up (1.15)
<i>H. balzani</i>	2	1	2.5–4.0	0.17 (3.25)	80	1.15	1.15	No
<i>H. marianitae</i> ³	5	1	15–23	0.25–0.59 (18.7)	44–45 (0.36)	0.84–0.93 (44.6)	0.84–0.93 (0.88)	No (0.88)
<i>H. palaestes</i>	1	1	9	0.2–0.8	42–44 (0.36)	4.43–4.45 (43)	4.43–4.45 (4.44)	No (4.44)

¹ Based on data from Cadle and Altig (1991) and Márquez et al. (1993).

² Only recordings from Quebrada Grande, Prov. Jujuy, Argentina.

³ Based on data in Márquez et al. (1993).

armata were described by Lavilla (1984) and Cadle and Altig (1991), respectively, whereas those of *H. balzani*, and *H. palaestes* are described herein for the first time. Tadpoles of these four species are Type-IV tadpoles (Orton, 1953) characterized by: (1) large size (> 40 mm at stages 37–38); (2) labial tooth rows of at least 2/4; (3) modest jaw sheaths with upper widely arched and lower broadly V-shaped; (4) marginal papillae; (5) submarginal papillae or flaps laterally; (6) sinistral spiracle; (7) dextral vent opening from a large sacculus structure that underlies the limb buds; (8) uniformly pigmented, depressed bodies; (9) dorsal or dorsolateral eyes; (10) oval nares which are slightly medial to center of eyes, recessed, and weakly rimmed; (11) dorsal fin terminating at dorsal extent of tail-body junction; and (12) tail fins with blotches (Table 4).

Tadpoles of these four species exhibit considerable diversity, particularly in the elements of the oral disc; this variation seems to be associated with habitat preference. The tadpole of *H. armata* is easily distinguished from the other three species by its large size, TL = 78.2 at Stage 37 (Cadle and Altig, 1991), which is much greater than that of the tadpole of *H. andina*, the next largest with TL = 57.4 at Stage 38. The most striking feature of *H. armata* is the labial tooth row arrangement (LTRF) of 13(13)/16(1) (Cadle and Altig, 1991) which is radically different from the other three species, none of which possesses more than three upper and four lower rows of teeth. The oral disc of *H. armata* also possesses complete marginal papillae, is slightly emarginate, and has jaw sheaths with shelves. In the other three species, the oral disc has a median gap in the marginal papillae of the upper labium, is not emarginate, and lacks shelves on the jaw sheaths. The caudal musculature of *H. armata* is uniformly darkly pigmented,

whereas that of the other species at least has diffuse blotches.

The tadpole of *Hyla palaestes* is similar to that of *H. armata* in having dorsally positioned eyes and an acutely rounded snout in profile. Both *H. balzani* and *H. andina* have dorsolaterally positioned eyes, and broadly and bluntly rounded snouts, respectively. As in both *H. balzani* and *H. andina*, the tadpole of *H. palaestes* possesses small flaps, which resemble broad papillae, laterally on the oral disc, and as in *H. andina*, these possess minute teeth. Although all these tadpoles except those of *H. armata* have a median gap in the marginal papillae of the upper labium, that of *H. palaestes* is narrow, whereas that of *H. balzani* and *H. andina* is wider. The LTRF of *H. palaestes*, 2(1)/4(1) also differs from that of *H. balzani* and *H. andina*; the former variably possesses a third interrupted upper row, and in the latter, the fourth row is variably present. The tadpoles of *H. palaestes* differ from those of the other species in having an acutely rounded snout in dorsal view and pigment on the dorsum of the tail musculature extending for only half the length of the tail; the others have broadly or bluntly rounded snouts and tail musculature pigmentation on the dorsum for the entire length of the tail. The body of *H. palaestes* possesses olive-green mottling and the blotches of the tail are very distinct, differing from the non-blotched bodies and diffuse tail blotches of the other species.

The tadpoles of *Hyla balzani* and *H. andina* are the most similar of the four tadpoles. Both of these species have moderately wide gaps in the marginal papillae of the upper labium, dorsolateral eyes, dorsal body pigment extending posterior on the dorsum of the tail musculature for entire length of tail, white flecks on dorsum of body and tail fins, and diffuse blotches on the tail musculature and

Table 4. Comparisons of selected features of tadpoles of *Hyla armata* and the *Hyla pulchella* Group. Features for *Hyla pulchella* are from Lutz (1973) with some modification of terminology.

Character	<i>H. andina</i>	<i>H. armata</i>	<i>H. balzani</i>	<i>H. palaestes</i>	<i>H. pulchella</i>
Total length	57.4 mm (Stage 38)	78.2 mm (Stage 37)	41.7 mm (Stage 38)	55.2 mm (Stage 37)	71 mm (maximum)
Body shape	Elongately ovoid	Elongately ovoid	Oval	Oval	Oval
Eye position	Dorsolateral	Dorsolateral	Dorsolateral	Dorsal	Dorsolateral
Spiracle	Terminally free	Terminal third free	Terminally free	Completely attached	—
Fin terminus	Pointed	Rounded	Pointed	Pointed	Pointed
Ventral gut pigmentation	Little	Pigmented	Little	Little	—
LTRF	2(2)/4(1)	15(15)/17(1)	3(1,3)/4(1)	2(2)/4(1)	2(2)/3
Shelf on upper jaw sheath	None	Prominent	None	None	—
Gap in anterior marginal papillae	Middle third	None	Middle fifth	Middle seventh	Present

fins—all features in which *H. armata* and *H. palaestes* differ. Features unique to *H. balzani* include its small size (TL = 41.7 at Stage 38), short spiracle that is directed posteriorly, broadly rounded snout in profile, white flecks on venter, a dark brown interorbital bar in life, and the variable presence of a third row of labial teeth on the upper labium.

The tadpole of *H. andina* is unique in having a bluntly rounded snout in both dorsal view and profile, finely serrate jaw sheaths, a variably present fourth row of teeth on the lower labium with small teeth, lateral flaps with teeth forming a broken vertical row, dark brown spots scattered throughout dorsum of body, and a deep bronze belly with silvery lichenous marks in life.

ANDEAN GROUPS OF *HYLA*

The foregoing analysis of characters leads us recognize *Hyla armata* as being highly distinctive from the other species in the southern Andes; the latter we associate with the *Hyla pulchella* group. Six other phenetic groups of *Hyla* are recognized in the Andes—viz., *Hyla bogotensis* Group (Duellman, 1972), *Hyla chlorostea* (Reynolds and Foster, 1993), *Hyla columbiana* Group (Duellman and Trueb, 1983), *Hyla garagoensis* Group (Kaplan and Ruíz, 1997), *Hyla labialis* Group (Duellman, 1989), and *Hyla larinopygion* Group (Duellman and Hillis, 1990)⁴. In the following definitions of these groups, characters are arranged in the same nu-

merical order in each account; accounts of species are provided for taxa in the *Hyla armata* and *Hyla pulchella* groups. In the species accounts, we provide detailed information on each species in the *Hyla armata* and *Hyla pulchella* groups in the Andes. For ease of comparisons, the same seven characters are listed numerically in the diagnoses; these are followed by a paragraph discussing differences among similar species. Each description also is presented in a consistent format. Because of the great amount of variation in color pattern in some species, we provide many descriptions of living specimens. Criteria for synonymies and designation of lectotypes are given in the section on Remarks.

HYLA ARMATA GROUP

Definition.—(1) Large, stream-breeding frogs with males attaining SVLs of 68 mm and females 73 mm; (2) round mental gland absent; (3) preorbital ridge and lateral folds absent; (4) dorsum brown with darker brown spots or cream reticulations; (5) flanks pale with large dark spots; hidden surfaces of thighs uniform brown; (6) venter uniformly pale; (7) digits bearing large discs; (8) cluster of spines on prepollex and on proximal ventral surface of humerus (9) forearms of adult males greatly hypertrophied; (10) axillary membrane absent; (11) toes three-

⁴*Hyla charazani* was described from Charazani, 3200 m in the Andes of "Depto. Muñeca" (= Prov. Saavedra, Depto. La Paz) in northwestern Bolivia by Vellard (1970), who reported that the specimen was in a stream. Vellard's description of the unique holotype (an adult male 55 mm SVL) mentioned only a rudiment of a prepollex, broad dorsolateral stripes, granular skin, and bilateral vocal sac. The accompanying photographs of the holotype show the pale dorsolateral stripe, no enlargement of the forearm, and no indication of a protruding prepollical spine. We have not been able to examine the holotype, which was stated to have been deposited in the Museo Argentino de Ciencias Naturales (Vellard, 1970:16). However, the specimen was never deposited in that institution (Jorge Cranwell, in litt. to De la Riva). Subsequently, De la Riva was informed by Jehan Vellard (in litt.) that the specimen was in Vellard's home in Buenos Aires. If the description and illustrations portray the specimen accurately, it is not a member of the *Hyla pulchella* Group.

fourths webbed; (12) nasals moderately broad, separated medially; (13) frontoparietal fontanelle small; (14) sphenethmoid broad; septum nasi ossified anteriorly; (15) quadratojugal articulating with maxillary; (16) dentigerous processes of vomers long, transverse, posterior to choanae, barely separated medially; (17) tadpoles having long, muscular tails, low fins, and rounded terminus; (18) distal one third of spiracle free from body wall; (19) larval mouth large, ventral, with complete rows of marginal papillae, broad plate below serrations on upper jaw sheath, and a LTRF of 15/17; (20) advertisement call a single, high-pitched note.

Content.—One species: *Hyla armata* Boulenger, 1902.

Distribution.—Cloud forests at elevations of 1700–2400 m on the eastern slopes of the Andes from central Peru to central Bolivia.

Remarks.—Two series of tadpoles (KU 181882–83 from 25.5 and 28.3 km, respectively, SSW of Leimebamba, Depto. Amazonas, Peru) are like those of *Hyla armata* in having a large mouth directed ventrally, two complete rows of marginal papillae, a broad plate below the serrations on the upper jaw sheath (shelf of Cadle and Altig, 1991) and a round terminus to the tail. These tadpoles differ from those of *H. armata* in having the spiracular tube attached for its entire length to the body wall and fewer rows of labial teeth (LTRF 3/7(1)). These tadpoles were taken from pools in cascading streams at elevations of 3300 and 3450 m in the northern part of the Cordillera Central; no frogs have been associated with these tadpoles, which possibly represent the existence of a species related to *H. armata*. The presence of a cluster of spines on the prepollex and on the proximal ventral surface of the humerus in adult males is unique in the Hylidae. Similar, but less conspicuous, clusters of spines on the prepollex occur in breeding males of some species of *Ptychohyla*, plus *Hyla echinata*, *lancasteri*, and *pachyderma* in Middle America (Duellman, 1970).

Hyla armata Boulenger

Hyla armata Boulenger, 1902:394.—Syntypes: BM 1947.2.13.59–60 from “La Paz,” Bolivia.

Diagnosis.—A species in the *Hyla armata* Group characterized by: (1) snout bluntly rounded in dorsal view and in profile; (2) skin on dorsum smooth to weakly granular; (3) width of disc on Finger III about twice diameter of tympanum; (4) tarsal fold low; (5) dorsal color pattern consisting of moderately large round, dark spots, cream reticulations of cream spots; (6) flanks with large dark spots; (7) posterior surfaces of thighs dark brown.

Hyla armata differs from species in the *Hyla pulchella* group by its larger size, proportionately smaller tympanum, and in coloration—viz., the absence of dark bars or white or creamy-yellow spots on the flanks and posterior surfaces of the thighs. Moreover, the species is unique in the genus by having a large cluster of black spines on the inner surface of each thumb and on the proximal ventral surface of the humerus in adult males.



Fig. 5. Variation in dorsal color pattern in female *Hyla armata* from Peru. KU 166341, 68.8 mm SVL; KU 166342, 74.5 mm SVL; KU 166343, 57.3 mm SVL; KU 166344, 61.2 mm SVL (all from Río Cosñipata, Depto. Cuzco); KU 166345, 68.0 mm SVL, from Tutumbaro, Depto. Ayacucho.

Description.— $n = 36 \sigma\sigma$, 20 ff . Body robust; SVL in males to 68.5 mm, in females to 74.5 mm; head width about equal to head length, not as wide as body; head width 30.9–37.4% ($\bar{x} = 33.9$) of SVL; head length 28.4–36.5% ($\bar{x} = 32.3$) of SVL; snout short, bluntly rounded (nearly truncate) in dorsal view, bluntly rounded in profile; interorbital distance 96–146% ($\bar{x} = 118$) of width of eyelid; diameter of eye 104–177% ($\bar{x} = 144$) its distance from nostril; tympanum separated from eye by distance about twice diameter of tympanum; diameter of tympanum 23.2–50.0% ($\bar{x} = 34.8$) of diameter of eye in males, 23.9–40.3% ($\bar{x} = 33.2$) in. Breadth of forearm 66.2–74.2% ($\bar{x} = 69.2$, $n = 10$) of forearm length in males, 36.5–44.2% ($\bar{x} = 40.0$, $n = 10$) in females; row of low, indistinct ulnar tubercles; webbing formula for fingers: II (2–2⁺)—(3–3⁺) III (3–3)—(2–2½) IV; width of disc on Finger III at least twice diameter of tympanum; cluster of black nuptial spines on inner surface of thumb and on proximal ventral surface of forearm in breeding males (Fig. 4). Hind limb moderately robust; tibia length 47.2–58.6% ($\bar{x} = 53.0$) of SVL; foot length 43.0–60.8% ($\bar{x} = 47.9$) of SVL; inner tarsal fold low, barely curved; inner metatarsal tubercle ovoid, barely visible from above; outer metatarsal tubercle low, round, about one fourth size of inner metatarsal tubercle; webbing formula for toes: I (1–1½)—(1½–2) II (1–1⁺)—(1½–2) III (1⁺–1½)—(2–2⁺) IV(2–2⁺)—(1–1⁺) V. Skin on dorsum and flanks smooth to finely granular. Vomerine odontophores long, transverse, narrowly separated medially, posteromedial to rounded choanae, bearing total of 10–27 ($\bar{x} = 17.5$) teeth.

Coloration in preservative: Dorsum usually brown with darker brown or cream irregular markings (few large marks, many large rounded spots, or mottling) outlined, or not, by tan or black (Fig. 5); flanks uniform brown or tan or gray with dark brown spots or lateral extensions of

dorsal markings; variable number of broad to narrow transverse marks on limbs—1–3 on forearm, 3–6 on thigh, 2–5 on shank, 3–6 on tarsus; anterior and posterior surfaces of thighs uniform brown or more commonly marked with extensions of transverse marks on dorsal surfaces of thighs; ventral surfaces grayish brown to dark brown with or without cream streaks or reticulations on throat.

Coloration in life: In living individuals, the coloration is even more variable than in preservative, as evidenced from Figure 3 and the following excerpts of field notes:

KU 163341–44 from Río Cosñipata, 4 km SW Santa Isabel, Depto. Cuzco, Peru—Dorsum bronze tan mottled with dark brown and creamy yellow; flanks creamy yellow with dark brown and black spots and ocelli; axilla, groin, and posterior surfaces of thighs lavender; webbing pale lavender-gray; venter grayish brown; iris pale gray (W. E. Duellman field notes, 11 February 1975).

KU 163345 from Tutumbaro, Río Piene, Depto. Ayacucho, Peru.—Dorsum tan with dark brown spots; venter gray; iris olive-tan (W. E. Duellman field notes, 20 February 1975).

KU 173219–22 from Buenos Aires, Depto. Cuzco, Peru.—At night, uniform tan. By day: 173219, dorsum dark brown with olive-green spots; 173220–22 dull reddish brown with slightly darker bars on hind limbs; in all of above, venter dull grayish brown; spines on chest and thumbs black; webbing dull brown; iris dull olive-cream with fine black reticulations (W. E. Duellman field notes, 19 January 1977).

KU 183299–313 from 68.8 km SW Villa Tunari, 1860 m, Depto. Cochabamba, Bolivia.—Dorsum dark brown with olive markings; ventral surfaces dark brown with yellow-olive markings; vocal sac gray-brown; iris chocolate-brown (D. C. Cannatella field notes, 21 January 1979).

MNK AM963 from La Siberia, 2300 m, Depto. Cochabamba, Bolivia.—Dorsum beige with dark, irregular markings; venter purplish-brown with yellow dots. Iris pale green (I. De la Riva field notes, 16 February 1994).

One of the most striking variations is the color of the iris, which ranges from olive-tan in Ayacucho, Peru, to olive-cream or pale gray in Cuzco, Peru; more striking variants are known from Bolivia, where individuals having the iris chocolate-brown were found NW of Villa Tunari, reddish brown at Serranía Bellavista, and red or green at La Siberia (field notes and color transparencies of I. de la Riva).

Life history.—Calls of this species were recorded at Amaybamba, Depto. Cuzco, Peru (Cadle and Altig, 1991) and at Serranía de Bellavista, Depto. La Paz, Bolivia, (Márquez et al., 1993). The call was described as a high-pitched “whirr” by Cadle and Altig (1991). Analyses of these two recordings reveal the call to consist of a single monophasic, well-modulated note repeated at a rate of 2–6 notes per min and having a duration of 0.16–0.24 sec and a pulse rate of 59–64 pulses per sec. Three harmonics—2.4, 3.6, and 4.7 kHz (dominant)—are evident in the Peruvian call, whereas only two harmonics—2.5 (dominant)

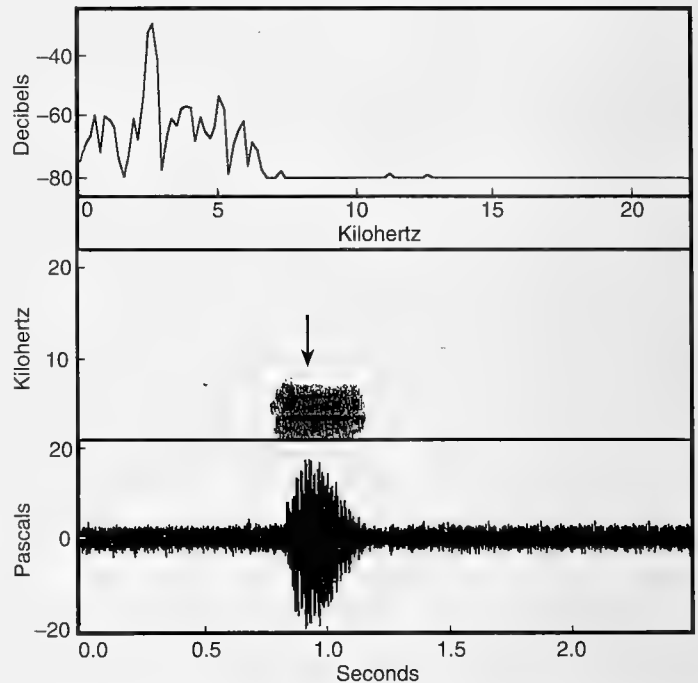

Fig. 6. Advertisement call of *Hyla armata* recorded at Serranía de Bellavista, Depto. La Paz, Bolivia. Spectrum, audiospectrogram, and waveform; arrow in audiospectrogram indicates point of spectrum.

and 5 kHz—are evident in the Bolivian recording (Fig. 6). Both calls show a slight upward frequency modulation.

Tadpoles of this species from Amaybamba, Depto. Cuzco, Peru, were described by Cadle and Altig (1991). They were characterized by being large (total length 78.2 in Stage 37) and having complete marginal papillae, slightly emarginate oral disc, jaws sheaths with shelves, and a labial tooth row formula (LTRF) of 13(13)/16(1). One tadpole (CET A483) from 40 km N Caranavi, Depto. La Paz, Bolivia, and two tadpoles (CET A484–85) from Carahuasi, Depto. Cochabamba, Bolivia, were taken in streams inhabited by adults of *Hyla armata* and are assigned to that species. In nearly all features they are like the tadpoles described by Cadle and Altig (1991), except that two of them have more rows of labial teeth (Fig. 7). The stages, sizes, and LTRFs of these tadpoles are: CET A483—Stage 25, body length 35.0 mm, total length 81.0 mm, LTRF 15(15)/17(1); CET A484—Stage 37, body length 29.0 mm, total length 73.5 mm, LTRF 14(14)/16(1); CET A485—Stage 25, body length 32.0 mm, total length 75.5 mm, LTRF 13(13)/16(1). The LTRF of 15/17 is close to the largest reported for any hylid frog; the highest LTRF is 14/21 in *H. imparquesi* (Ayarzagüena and Señaris, 1993).

Twenty-one juveniles (some with remnants of clusters of melanophores near the tip of the coccyx) were found on 10 February 1974 at the Río Cosñipata, 4 km W of Santa Isabel, Depto. Cuzco, Peru. Data were taken on 18 of these, which have SVLs of 28.0–33.3 mm (\bar{x} = 31.0). Coloration in preservative is highly variable (Fig. 8). Eleven individuals have distinct bars on the limbs; four have pale dorsolat-

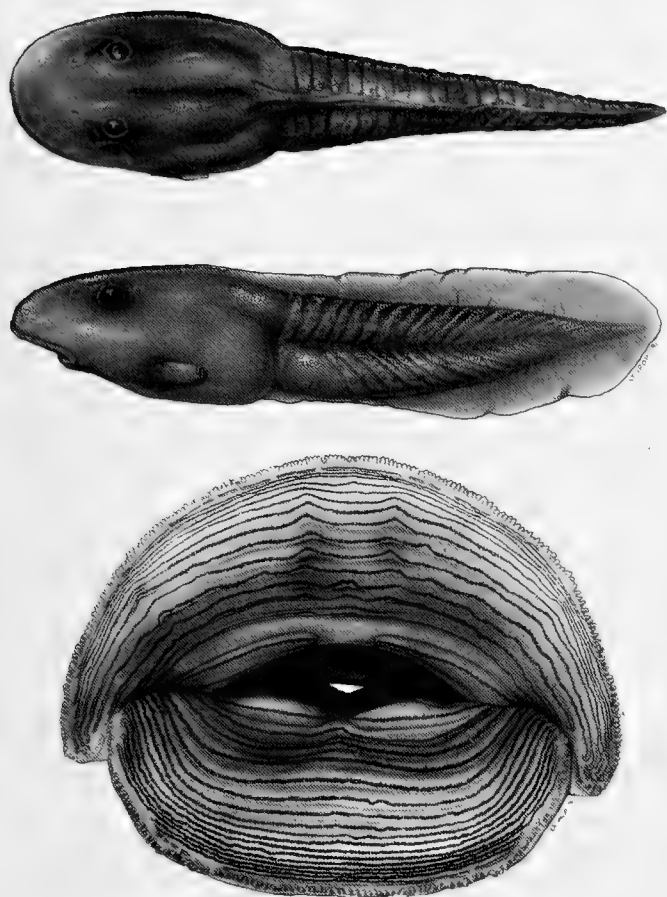

Fig. 7. Tadpole of *Hyla armata*, CET A483, Stage 25, total length 80.8 mm.

eral stripes. The dorsum of the body has distinct dark spots in five individuals, whereas in the other 13, the dorsum is brown with darker brown flecks. In all individuals, the venter is cream with a dusky suffusion on the throat. In life, the dorsum is tan with or without darker brown blotches and creamy-yellow dorsolateral stripes and bars on limbs; the venter is creamy white, and the iris is pale dull bronze with fine black reticulations (W. E. Duellman field notes, 10 February 1974).

Distribution and ecology.—*Hyla armata* is known from cloud forests at elevations of 1700–2400 m on the eastern slopes of the Andes from Depto. Ayacucho, Peru, south-eastward to Depto. Santa Cruz, Bolivia (Fig. 9). The species always is associated with cascading streams, where adults perch on boulders and cliffs in the spray zone of waterfalls, and adults and juveniles are on logs, branches, and leaves of plants usually within 1 m of the water, but some individuals have been found as high as 2 m above streams.

At Amaybamba, Peru, and at Carahuasi, Bolivia, tadpoles were in pools in streams, but at 40 km N Caranavi, Bolivia, a tadpole was in a small, high-gradient stream.



Fig. 8. Variation in dorsal color pattern in juvenile *Hyla armata* from the Río Cosñipata, Depto. Cuzco, Peru.

The tadpoles are capable of sustained swimming in strong currents (Cadle and Altig, 1991).

Remarks.—The type locality of “La Paz” (Boulenger, 1902:394) most certainly is incorrect and probably was the point of shipping from Bolivia. The city of La Paz lies at elevations of about 3500–4000 m, at least 1500 m higher than the known altitudinal distribution of *Hyla armata*.

Geographic variation seems to be apparent in the color of the iris in life. No red or green is evident in Peruvian specimens, but these colors and chocolate-brown are present in the iris in some populations in Bolivia. Also, the dorsal skin tends to be more granular in Bolivian specimens than in those from Peru. These slight differences suggest that possibly *Hyla armata*, as treated here, may represent more than one species. This idea is not novel, in that J. E. Cadle (pers. comm.) “thought” that specimens he collected at the Río Quiquira, Depto. Puno, Peru, had a different call from specimens that he recorded in Depto. Cuzco, Peru. Although both Duellman and De la Riva independently examined these specimens (USNM 299310–38) and confirmed their identity as *H. armata*, we were not given the opportunity to take data on them and to include them in our analyses.

Hyla pulchella Group

Definition.—(1) Moderately large, stream-breeding frogs with males attaining SVLs of 58 mm and females 63 mm; (2) round mental gland absent; (3) preorbital ridge and lateral folds absent; (4) dorsum brown, tan, green, or gray, usually with darker markings consisting of transverse bars, spots, or reticulations; (5) groin and hidden surfaces of thighs pale with black spots, bars, or reticulations, or dark with pale spots; (6) venter uniformly pale; (7) digits bearing large discs; (8) nuptial excrescences absent in males; enlarged, projecting prepollex present; (9) forearms of adult males hypertrophied; (10) axillary membrane absent; (11) toes three-fifths to three-fourths webbed; (12) nasals slender, widely separated medially; (13) frontoparietal fontanelle large; (14) sphenethmoid broad; septum nasi not ossified anteriorly; (15) quadratojugal articulating with maxillary; (16) dentigerous processes of vomers medium in length to moderately long, transverse, posterior to choanae, narrowly separated medially; (17) tadpoles having moderately long tails, moderately low fins, and pointed terminus; (18) spiracular tube attached to body wall for all, or nearly all, of its length; (19) larval mouth moderately small, directed anteroventrally with a median gap in the labial papillae on the anterior labium, no plate below serrations on upper jaw sheath, and a LTRF of 2–3/

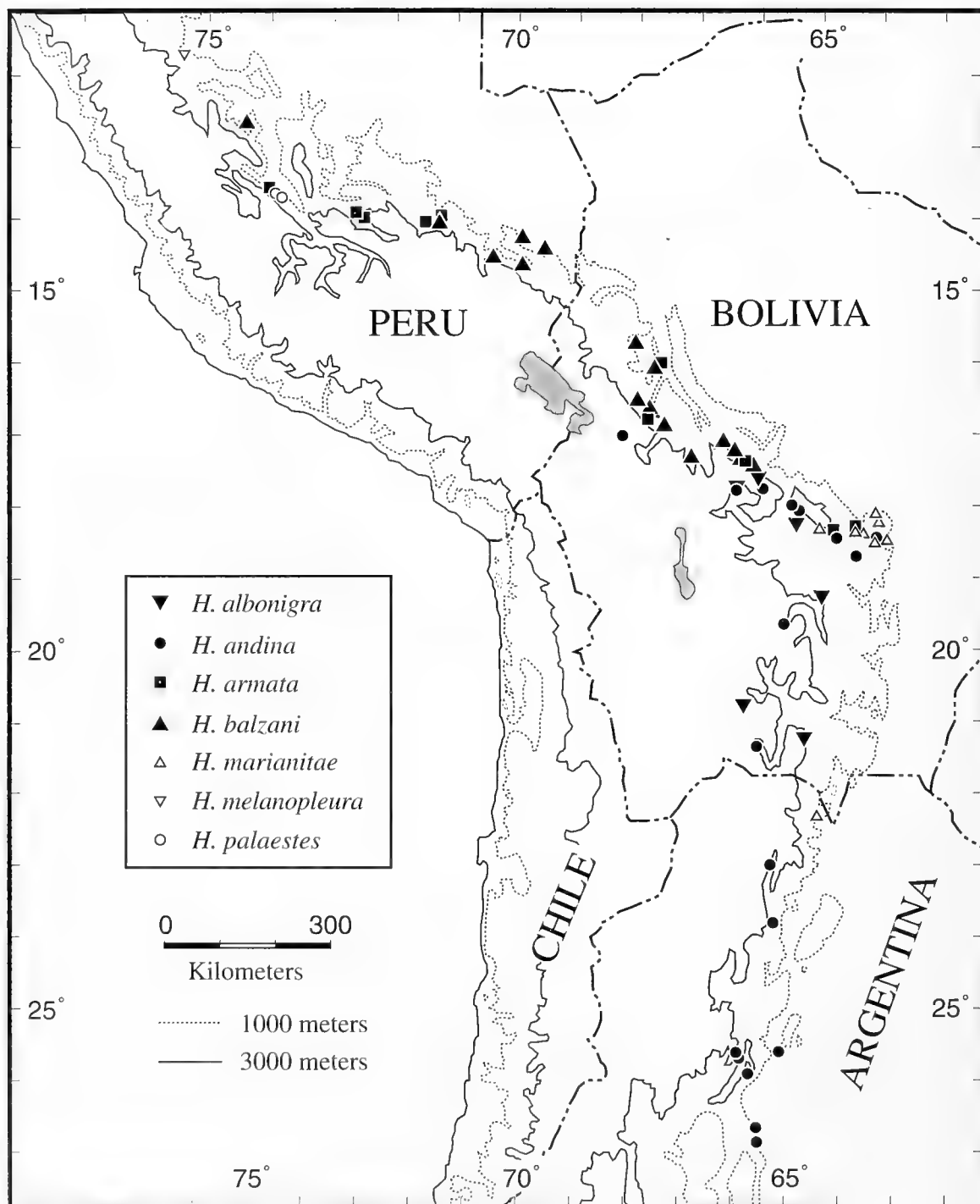

Fig. 9. Distribution of *Hyla armata* and species of the *Hyla pulchella* Group in the Andes.

3–5; (20) advertisement calls consisting of series of soft, bell-like notes.

Content.—Eleven species: *Hyla albonigra* Nieden, 1923 (*H. zebra* Duméril and Bibron, 1841, and *H. ocapia* Andersson, 1938, are synonyms); *H. andina* Müller, 1924; *H. balzani* Boulenger, 1898 (*H. callipleura* Boulenger, 1902 is a synonym); *H. cymbalum* Bokermann, 1963; *H. marginata* Boulenger, 1887; *H. marianitae* Carrizo, 1992; *H. melanopleura* Boulenger, 1912; *H. palaestes* new species; *H. prasina* Burmeister, 1856; *H. pulchella* Duméril and Bibron, 1841 (*H. leucomelas* Duméril and Bibron, 1841; *H. vauterii* Bibron, 1843⁵; *H. agrestis* Bibron, 1843; *H. leucotaenia* Burmeister 1861; *H. bracteator* Hensel, 1867; and *Hylodes orientalis*: Philippi, 1902, are synonyms); *H. semiguttata* Lutz, 1925.

Distribution.—In the Andes, elevations of 500–3416 m in cloud forest, dry forest, subparamo, and paramo from the Cordillera Oriental in central Peru to precordilleras in central Argentina; also in the Sierra de Córdoba in Argentina and in the Platine region of northeastern Argentina, Uruguay, and southeastern Brazil, where it ascends to elevations of 1100 in the Brazilian Highlands (Lutz, 1973).

Remarks.—The extra-Andean species include *Hyla cymbalum*, *marginata*, *prasina*, *pulchella*, and *semiguttata*, which is the only species having a LTRF of 3/5 (Faivovich, 1996). Although the *Hyla pulchella* Group was recognized and defined by Barrio (1965), Lutz (1973), and Cei (1980), the only Andean species recognized here that was referred to the group was *H. andina* (as *H. pulchella andina*). As noted by Lutz (1973), the taxonomic status of some members of this group in southeastern Brazil is questionable. (For further comments on the taxonomy, see Remarks in account of *H. andina*.)

The forelimbs in males are nearly as hypertrophied as those in *Hyla armata*, whereas the forelimbs in females are not enlarged (Fig. 10).

Hyla albonigra Nieden

Hyla zebra Duméril and Bibron, 1841: 575.—Syntypes: MNHN 4817 (2 specimens) from “Buenos Ayres” in error; Tacopaya, Departamento Chuquisaca, Bolivia (d’Orbigny, 1847). (Preoccupied by *Rana zebra* Shaw, 1802 = *Rana (Hyla) boans* Linnaeus, 1758).

Hyla albonigra Nieden, 1923:278.—New name for *Hyla zebra* Duméril and Bibron, 1841.

Hyla ocapia Andersson, 1938:19.—Syntypes: NHRM 1873 (7 specimens) from Puka Khara, Bolivia. New synonymy.

Diagnosis.—A large species in the *Hyla pulchella* Group characterized by: (1) snout rounded in dorsal view and bluntly rounded in profile; (2) skin on dorsum coarsely granular; (3) width of disc on Finger III equal to diameter of tympanum; (4) tarsal fold elevated; (5) dorsal color pattern consisting of small irregular spots; (6) flanks with dark vertical bars; (7) posterior surfaces of thighs with dark vertical bars.

⁵*Hyla vauterii* was recognized as a species distinct from *H. pulchella* by Klappenbach and Langone (1992).

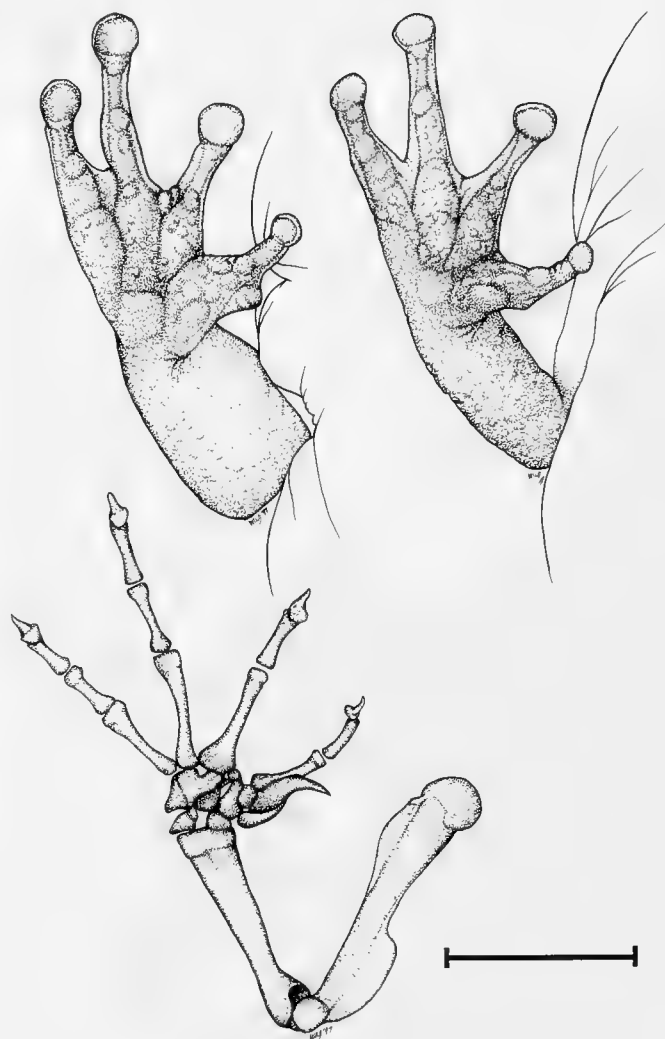

Fig. 10. Ventral views of the right arm and hand of *Hyla andina*. Top left, external view, KU 160418 ♂; top right, external view, KU 160412 ♀; bottom, cleared-and-stained, KU 182961, ♂. Line = 10 mm.

The only other species with dark vertical bars on the hidden surfaces of the thighs is *Hyla andina*, which differs from *H. albonigra* by having small dark spots on the flanks and ventral surfaces of the shanks (shanks unmarked in *H. albonigra*), a transverse white supraclacal stripe (absent in *H. albonigra*), width of disc on Finger III less than diameter of tympanum, and a low tarsal fold. Also the skin on the dorsum is not so coarsely granular in *H. andina* as in *H. albonigra*.

Description.— $n = 9$ ♂♂, 11 ♀♀. Body moderately robust; SVL in males to 56.0 mm, in females to 64.7 mm; head width slightly greater than head length, not as wide as body; head width 28.5–38.7% ($\bar{x} = 34.3$) of SVL; head length 24.6–34.8% ($\bar{x} = 30.3$) of SVL; snout rounded in dorsal view, bluntly rounded in profile; internarial region not depressed; interorbital distance 91–162% ($\bar{x} = 120$) of width of eyelid;



Fig. 11. *Hyla albonigra*, MNK A846, adult male, 48.7 mm SVL.

diameter of eye 105–142% (\bar{x} = 123) its distance from nostril; tympanum separated from eye by distance slightly less than diameter of tympanum; diameter of tympanum 43.1–63.3% (\bar{x} = 53.8) of diameter of eye. Breadth of forelimb 60.2–63.8% (\bar{x} = 62.1, n = 4) of forearm length in males, 32.7–38.5% (\bar{x} = 34.7, n = 3) in females; ulnar fold proximally, formed by coalesced tubercles; webbing formula for fingers: II (2–2)—3 III (2–3)—(2–2) IV; width of disc on Finger III about equal to diameter of tympanum; nuptial spines absent; nuptial excrescences absent in breeding males. Hind limb slender; tibia length 49.4–57.7% (\bar{x} = 53.9) of SVL; foot length 41.3–49.3% (\bar{x} = 46.1) of SVL; inner tarsal fold elevated, slightly curved; webbing formula for toes: I 1½—(2–2) II (1–1⁺)—(2–2⁺) III (1–1½)—(2⁺–2½) IV (2–2⁺)—1 V. Skin on dorsum, at least on head and anterior part of body, coarsely granular; flanks smooth. Dentigerous processes of vomers short, transverse, narrowly separated medially, posteromedial to rounded choanae, each bearing total 6–14 (\bar{x} = 9.1) teeth.

Coloration in preservative: Dorsum gray to brown with few to many dark gray to dark brown marks in the form of small spots or, more commonly, streaks or short transverse marks; limbs with narrow transverse bars, usually faint (Fig. 11); flanks cream with 2–5 black marks usually in the form of vertical bars; anterior and posterior surfaces of thighs cream to grayish tan with narrow, vertical black bars—2–5 on anterior surfaces, 3–8 (usually 6 or 7) on posterior surfaces; 2–5 bars on inner surfaces of shanks; venter creamy yellow, except throat dusky in females and dark grayish brown in males. One female (EBD 26926) with only two small black spots posteriorly on flanks, one spot proximally on anterior surface of thigh, and no marks on inner shank.

Coloration in life: José Cabot noted specimens from the Río Julpe, Depto. Cochabamba, Bolivia, as being green in life.

Life history.—Nothing is known.

Distribution and ecology.—The few localities from which this species is known are at elevations of 2000–3416 m on the eastern front of the Andes in southern Bolivia (Fig. 9). At the Río Julpe, Bolivia, individuals were perched in small trees and bushes at the edge of a stream at night.

Remarks.—Duméril and Bibron (1841:575) stated that the two syntypes of *Hyla zebra* were sent to Paris from “Buenos Ayres” by d’Orbigny. The same locality information was given by Boulenger (1882; 1887) in his redescription of the species. Berg (1896) pointed out that Duméril and Bibron gave an incorrect locality; d’Orbigny (1847) reported that he collected these specimens at Tacopaya, Bolivia. Tacopaya (19°10' S, 64°40' W) is in a region of high, arid mountains between Sucre and Río Grande in Departamento Chuquisaca, Bolivia.

When the syntypes of *Hyla zebra* were examined by Duellman on 3 July 1969, the specimens were soft and nearly completely bleached; however, the pattern of vertical dark bars on the posterior surfaces of the thighs was evident. Duméril and Bibron (1841:575) observed the granular nature of the skin (“Tête couverte de petites glandules.”) and noted the coloration on the flanks: “... grandes taches noires sur les flanc, ...” Examination of the seven syntypes of *Hyla ocapia* by Duellman on 17 July 1969 revealed that they were in good condition with distinct color patterns. The dorsum was pale gray with darker gray, irregular, small dark gray marks. The anterior and posterior surfaces of the thighs were creamy yellow with dark brown vertical marks; the throat and chest were creamy white; the belly and ventral surfaces of the limbs were creamy yellow. The skin on the dorsum was distinctly granular. The specimens closely match Andersson’s (1938) description and illustration. Examination of the type specimens of both species convinces us that *Hyla ocapia* Andersson, 1938, is a junior synonym of *Hyla zebra* Duméril and Bibron, 1841.

Andersson (1938) reported that one of the syntypes of *Hyla ocapia* (a male) had about 40 eggs covered with mucus and attached to the posterior part of the belly and commented about the differences with other hylid frogs, such as *Fritziana* (= *Flectonotus*) carrying eggs. We conclude that Andersson was mistaken in thinking that he witnessed an example of parental care, because he also mentioned that the frogs had been kept in a jar for several days and that the females spawned therein. Thus, it is most likely that part of a clutch adhered to the male, which was preserved “carrying” eggs in this fashion. Moreover, examination of the syntypes reveals that one of the females also has remnants of mucus adherent on the belly. Reproductive modes of frogs having parental investment in the form of egg-carrying or egg-brooding is correlated with a low number of eggs (Duellman and Trueb, 1986). One gravid female (EBD 28926) contained 750 pigmented eggs, 1.5–1.6 mm

in diameter; the number, sizes, and pigmentation of the eggs are consistent with aquatic deposition of eggs.

Hyla andina Müller (New combination)

Hyla raddiana andina Müller, 1924:77.—Syntypes: ZSM 18/1922 (3 specimens) from Nacimiento, Provincia Catamarca, Argentina.

Hyla pulchella andina—Barrio, 1965:124.

Diagnosis.—A moderate-sized species in the *Hyla pulchella* Group characterized by: (1) snout rounded in dorsal view and bluntly rounded in profile; (2) skin on dorsum smooth to granular; (3) width of disc on Finger III less than diameter of tympanum; (4) tarsal fold low; (5) dorsal color pattern consisting of small irregular spots; (6) flanks with small dark spots; (7) posterior surfaces of thighs with dark vertical bars.

The only other species with dark vertical bars on the hidden surfaces of the thighs is *Hyla albonigra*, which differs from *H. andina* by having vertical dark bars on the flanks and lacking dark spots on the ventral surfaces of the shanks (shanks with dark spots in *H. andina*), no transverse white supraocular stripe (present in *H. andina*), width of disc on Finger III equal to diameter of tympanum, and an elevated tarsal fold. Also the skin on the dorsum is more coarsely granular in *H. albonigra* than in *H. andina*.

Description.— $n = 98$ ♂♂, 59 ♀♀. Body moderately robust; SVL in males to 57.6 mm, in females to 62.7 mm; head width slightly greater than head length, about as wide as body; head width 28.0–36.0% ($\bar{x} = 32.0$) of SVL; head length 29.0–37.0% ($\bar{x} = 33.0$) of SVL; snout rounded in dorsal view, bluntly rounded in profile; internarial region not depressed; interorbital distance 84–192% ($\bar{x} = 121$) of width of eyelid; diameter of eye 86–167% ($\bar{x} = 122$) its distance from nostril; tympanum separated from eye by distance about equal to diameter of tympanum; diameter of tympanum 42.0–76.0% ($\bar{x} = 62.0$) of diameter of eye. Breadth of forearm 49.4–60.2% ($\bar{x} = 55.3$, $n = 10$) of forearm length in males, 34.4–39.0% ($\bar{x} = 36.7$, $n = 10$) in females; no row of tubercles on forearm; webbing formula for fingers: II 2—(3–3⁺) III 3—(2–2⁺) IV; width of disc on Finger III slightly smaller than diameter of tympanum; nuptial spines absent; nuptial excrescences absent in breeding males. Hind limb slender; tibia length 47.0–59.0% ($\bar{x} = 52.0$) of SVL; foot length 38.0–62.0% ($\bar{x} = 46.0$) of SVL; inner tarsal fold low, slightly curved; webbing formula for toes: I (1–1⁺)—(2–2⁺) II (1–1½)—(2–2⁺) III (1⁺–2)—(2⁺–3) IV (2⁺–2½)—(1–1½) V. Skin on dorsum weakly granular; flanks smooth. Denticulous processes of vomers short, transverse, narrowly separated medially, between posterior margins of rounded choanae, each bearing total 3–14 ($\bar{x} = 8.2$) teeth.

Coloration in preservative: Dorsum tan, grayish brown, or brown with darker brown markings—small, irregular spots on head and body with or without dashed white or cream dorsolateral line; some individuals also with white flecks or irregular streaks on dorsum or only with such markings; narrow transverse dark marks usually evident on dorsal surfaces of limbs—3 or 4 on forearm, 4–6 on thigh, 6 or 7 on shank, and row of dark spots on tarsus and Toes

IV and V; flanks tan or brown anteriorly and cream posteriorly, with many round to irregular dark brown to black spots, most numerous in groin; anterior and posterior surfaces of thighs cream to tan with vertical black bars or irregular black marks—3–5 on anterior surface and 4–10 on posterior surface; inner and ventral surfaces of shank cream with irregular black spots; venter dull cream; vocal sac grayish brown.

Coloration in life: The color pattern is highly variable and seems to show some geographic variation. (See Remarks.) This variation is evident from the photographs (Fig. 3) and the following descriptions of living individuals.

CET A122-126 from Río Corani, Depto. Cochabamba, Bolivia.—Dorsum brown with irregular dark blotches; a barred pattern consisting of narrow yellow and black transverse stripes on the groin, and on the anterior and posterior surfaces of thighs, shanks, and tarsi; dorsolateral stripes not distinct; no blue in groin and on hind limbs; by day, dorsum mostly greenish yellow with dark blotches (I. De la Riva field notes, 22 May 1988).

CET A134-135 from La Siberia, Depto Cochabamba, Bolivia.—Similar to specimens from Río Corani, but with blue in groin and on anterior and posterior surfaces of hind limbs (I. De la Riva field notes, 7 January 1989).

CET A144-145 from La Siberia, Depto. Cochabamba, Bolivia.—Dorsum uniformly green; flanks and groin blue with black spots; thighs and shanks with black and blue transverse bars (I. De la Riva field notes, 4 January 1990 and 9 March 1990).

CET A116 from 5 km E Samaipata, Depto. Santa Cruz, Bolivia.—Dorsum uniformly brown; no blue in groin or on hind limbs (I. De la Riva field notes, 18 May 1988). Variation in specimens from this locality was discussed by Köhler et al. (1995).

CET A117-121 from Comarapa, Depto. Santa Cruz, Bolivia.—Dorsum brown with irregular dark blotches and irregular dorsolateral creamy-white stripes; no blue in groin or on hind limbs (I. De la Riva field notes, 19 May 1988).

CET A146 from Vallegrande, Departamento Santa Cruz, Bolivia.—Dorsum green with white reticulations; no dorsolateral stripes; instead of typical barred pattern in groin and on anterior and posterior surfaces of hind limbs, these surfaces pale blue with small black and white spots (I. De la Riva field notes, 6 January 1990).

KU 160143 from 3 km S Epizana, Depto. Cochabamba, Bolivia.—Dorsum green with yellow flecks and black and gold bars on flanks; posterior surfaces of thighs grayish lavender with pale creamy-yellow and black vertical lines; belly pinkish cream; vocal sac bronze-tan; ventral surfaces of limbs pinkish gray; webbing and tympanum bronze-tan; iris bronze (W. E. Duellman field notes, 11 November 1974).

KU 183385-92 from 2.9 km S Epizana, 3070 m, Depto. Cochabamba, Bolivia.—Dorsum dark green to pale green;

pale yellow lines on flanks, forelimbs, thighs, and shanks; belly off-white; lateral portions of chin green, central region yellowish brown; dark blue markings on concealed surfaces of groin, thighs, shanks, and axilla, also in post-tympanic region; pale yellow bands fading to off white on concealed surfaces of thighs; upper lip from below eye to angle of jaw pale yellow; tympanum and iris gold; ventral surfaces of thighs, shanks, and forearms gray blue; webbing colorless; supraclavical tubercles pale yellow; all fingers and Toes IV and V green; Toes I–III grayish green; tongue very pale green (D. C. Cannatella field notes, 16 December 1977).

KU 160195 from 6 km W Betanzos, Depto. Potosí, Bolivia.—Dorsum green with golden-tan and reddish-brown transverse marks; groin and posterior surfaces of thighs pale blue with black and orange-cream bars; venter creamy white; iris and tympanum bronze (W. E. Duellman field notes, 13 November 1974).

KU 160236–39 from 12.5 km SSE Tupiza, Depto. Potosí, Bolivia.—Dorsum green with or without black dashes; labial, canthal, and supratympanic stripes bronze; ground and anterior and posterior surfaces of thighs pale blue with black bars; venter cream; webbing grayish brown; tympanum bronze-brown; iris dull reddish bronze (W. E. Duellman field notes, 15 November 1974).

KU 160337–41 from Río Grande, 10 km N Tilcara, Prov. Jujuy, Argentina.—Dorsum green with bronze dorsolateral stripe and labial stripe; flanks creamy blue with black spots; posterior surfaces of thighs pale blue with black dashes; vocal sac yellowish tan; rest of venter white; iris dark reddish bronze (W. E. Duellman field notes, 18 November 1974).

KU 160342–60 from Arroyo Los Naranjos, 8.3 km SSW Perico del Carmen, Prov. Jujuy, Argentina.—At night, dorsum tan with or without brown spots; flanks and hidden surfaces of hind limbs creamy white to pale bluish white with black spots and flecks; vocal sac dull yellow; rest of venter creamy white; webbing brown; some individuals have creamy-bronze canthal, dorsolateral, and tarsal stripes or rows of dashes; iris reddish brown. By day, some individuals changed to pale creamy tan and others to pale greenish bronze (W. E. Duellman field notes, 19 November 1974).

KU 182964–67 from Finca Jakúlika, Prov. Salta, Argentina.—Dorsum green or pale green; stripes dark blue on off-white background; vocal sac yellowish green. (D. C. Cannatella field notes, 15 December 1978).

KU 160365 from 21 km SSE Tafí del Valle, Prov. Tucumán, Argentina.—Dorsum pale green; stripes on lips and limbs cream; groin and posterior surfaces of thighs pale blue with black marks; iris reddish copper-bronze (W. E. Duellman field notes, 21 November 1974).

KU 160410–21 from Arroyo El Durazno, 19 km N La Merced, Prov. Catamarca, Argentina.—Dorsum green in most individuals; in others dorsum tan with or without brown spots; vocal sac yellowish tan; labial stripe pale

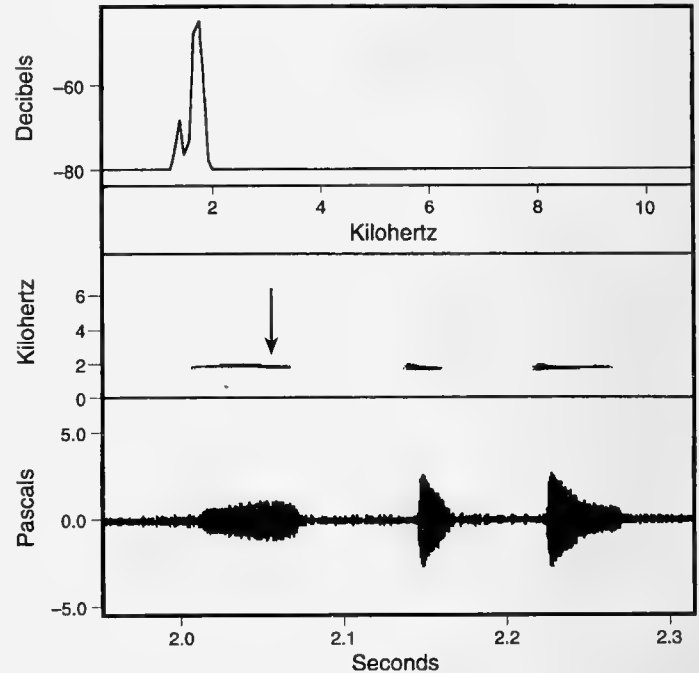

Fig. 12. Advertisement call of *Hyla andina*, KU Tape 1208, recorded at 19°C at Quebrada Grande, 10 km N Tilcara, Prov. Jujuy, Argentina. Spectrum, audiospectrogram, and waveform; arrow in audiospectrogram indicates point of spectrum.

greenish yellow; rows of flecks dorsolaterally on body and on shank and tarsus cream to bronze; iris copper-bronze (W. E. Duellman field notes, 3 December 1974).

Life history.—The advertisement call of individuals from Horco Molle, Prov. Tucumán, Argentina, was recorded at 13°C by Barrio (1965), who reported as many as seven notes per call and a dominant frequency at about 2400 Hz. At a site 2.9 km S of Epizana, Depto. Cochabamba, Bolivia, the call was described as a metallic “clink-clink” (D. C. Cannatella field notes, 16 January 1979). Reynolds and Foster (1992) described the call of individuals from Departamento Cochabamba, Bolivia, as containing one or two notes that are frequency modulated and have dominant frequencies of 1420–2000 Hz. Márquez et al. (1993) reported two tonal notes produced by individuals at Tablasmontes, Depto. Cochabamba, Bolivia. Two individuals were recorded at 18° and 19°C at Quebrada Grande, 10 km N of Tilcara, Prov. Jujuy, Argentina. The call is a series of tinkle-like notes. The call of one individual consisted of three notes per call, and the calls were repeated at a rate of 21 calls per min; the second individual produced only two notes per call at a rate of 24 calls per min. Analysis of two recordings (KU Tapes 1208 and 1210) reveals a pulse rate of 110–120 pulses per sec. The duration and modulation of notes is variable within a given call. For example in KU Tape 1208, the first note has a duration of 0.06 sec and one harmonic at 1940 Hz; the second note has a duration of 0.02 sec, and the third note has a duration of 0.05 sec, a harmonic at 1400 Hz, and a dominant harmonic at 1710 Hz (Fig. 12). In KU Tape 1210, duration of the first note in

each pair of notes is much shorter (0.01 sec) than the second note (0.06 sec); in these the dominant frequencies are at 2110 and 2270 Hz (Fig. 12).

The tadpole of *Hyla andina* was described and illustrated (as *H. pulchella andina*) by Cei (1980) and Lavilla (1984); the latter provided data on variation in tadpoles in some Argentine populations. Lavilla and Fabrezi (1987) described the chondrocranium and oral anatomy. The more complete description provided below (inconsistencies with Cei [1980] noted) is based on 35 specimens (Stages 27–41, KU 160144) from 3 km S Epizana, Cochabamba, Bolivia, 2825 m.

A specimen in Stage 38 (KU 160144) has the following measurements: total length 57.4, body length 19.5, tail muscle height at base 6.3, tail muscle width at base 5.0, maximum dorsal fin height 4.4 located 24.6 from body terminus, maximum ventral fin height 3.9 located 26.0 from body terminus, body width 11.9, body height 9.9, eye diameter 2.7, pupil diameter 1.1, interorbital distance 4.3, greatest and least nostril diameters 0.9×0.5 , internarial distance 3.0, snout-nostril 3.1, snout-eye 5.7, snout-spiracle 11.5, eye-nostril 1.7, and transverse oral disc diameter 4.9. Other major characteristics include a ventral oral disc, marginal papillae with median gap on upper labium, spiracle sinistral, eyes dorsolateral, vent dextral, dorsal fin terminating at the dorsal extent of the tail-body junction. The LTRF is 2(2)/4(1).

The outer wall of the spiracle is longer than the inner wall, and emerges from the ventrolateral surface of the body at midlength. The inner wall of the spiracular tube is attached to the body for most of its length; terminally it is free and hence the tube is free. The tube is directed posterodorsally and narrows at a round, posteriorly directed aperture. The vent tube is dextral, and is positioned at the posterolateral surface of a large saccular structure that underlies the limb buds and is contiguous with the ventral fin. The vent aperture is directed posteroventrally. The eyes are positioned dorsolaterally and directed laterally and slightly dorsally. Cei (1980) described the eyes as dorsal, but it is apparent from his figure that their position is dorsolateral in our terminology. The nares are oval, slightly medial to the center of the eyes, recessed, and weakly rimmed; the rim of the medial edge is raised slightly. The snout is bluntly rounded in dorsal view and profile. The body is elongately ovoid in dorsal view; in lateral view depressed dorsally and ventrally, becoming deeper posteriorly toward the bulging gut.

The oral disc is slightly emarginate posterolaterally and is completely circumscribed by marginal papillae except for a median gap in the middle third of the upper labium; several other specimens have fewer marginal papillae anteriorly on the upper labium and medially on the lower labium. Laterally, there are few submarginal papillae, but there are flaps that possess keratinized teeth forming broken vertical rows. The LTRF is 2(2)/4(1), with long, narrow, closely spaced teeth on all rows except P-4 which possesses much smaller teeth. The labial tooth rows of the

upper labium do not vary within the series, but only three rows on the lower labium are present in some specimens, in one of which the third row has a medial gap. This variation is consistent with the LTRF reported by Cei (1980) of 2(1-2)/3(1) with the exception of the gap in the upper anterior row of his specimen. The upper jaw sheath is moderate in width, widely arched, and finely serrate. The lower sheath is narrow, broadly V-shaped, and finely serrate.

The caudal musculature is highest at the tail-body junction and is the same height posteriorly to midlength, where it narrows gradually to a pointed tail terminus. Cei (1980) figured the tail musculature as terminating prior to the end of the tail; this is not the case in any of our specimens and is attributed to an error in his figure. In lateral view, the dorsal fin terminates at the dorsal tail-body junction, is highest on posterior third of the tail, and is shorter than musculature at midlength (i.e., taller posteriorly, shorter anteriorly). The ventral fin is shorter than the dorsal fin, except for the anterior and posterior extremes which are the same height as the dorsal fin. The ventral fin gradually increases in height from anterior to posterior until it abruptly narrows at the tail terminus. The ventral fin is shorter than the musculature at midlength (taller only on posterior third). The greatest height of tail is along the posterior third of the length. The tail terminates as a pointed tip.

In preservative, the dorsum of the body is uniformly pigmented with brown chromatophores with a few, tiny white flecks and larger, distinct, dark brown spots scattered throughout. The venter is transparent white with few melanophores, mostly laterally; the intestine is clearly visible. Dorsal pigmentation continues onto the dorsum of caudal musculature lateral to the base of the dorsal fin for the entire length of the tail. The remainder of the tail musculature is opaque yellowish brown, with many scattered melanophores, some of which form diffuse blotches. The fins are transparent with scattered white flecks and few melanophores, some of which form many small blotches. In life, the body is olive-tan above and deep bronze with silvery lichenous marks below; the tail is olive-tan with brown streaks, and the iris is bronze (W. E. Duellman field notes, 11 November 1974).

Distribution and ecology.—*Hyla andina* is widely distributed in the eastern Andes and the Andean precordilleras from northern Bolivia southward to Prov. Catamarca, Argentina (Fig. 9). In the northern part of its range it occurs at elevations of 1650–3400 m, but in the southern part (provincias Tucumán and Catamarca), it occurs at elevations of 500–1640 m. At high elevations, the frog inhabits montane grassland; in the northern part of its range it descends into cloud forest and temperate forest, whereas in the southern part of its range it occurs in premontane deciduous forest.

Throughout its range, *Hyla andina* is always near water, either lotic or lentic—viz., lagoons, ponds, large or small streams, or roadside seepages. By day, individuals perch on low (usually less than 1 m above the ground) branches

of trees or bushes, or they are on the ground at the edges of streams, especially above treeline. Occasionally they are on tall grasses or under stones. Individuals often are in direct sunlight. In contrast to most other tree frogs, they jump into the water when disturbed during the day. At night, males call from branches above or at the edge of water, stones in streams, the ground at the edge of water, or in shallow water in ponds, marshes, or pools in streams. At some places, especially above treeline and in temperate forests, the species is abundant, whereas it seems to be much less common along streams in cloud forest, which it seems to colonize via roadside seepages. In cloud forest, the frogs seem to prefer still or very slow-moving water, in contrast to the usual fast-moving water in most streams. Tadpoles have been found in shallow ponds, marshes, roadside ditches, and quiet pools in streams. These observations generally concur with the results of a detailed study of the ecology of tadpoles of this species in the Sierra de Metan, Prov. Salta, Argentina by Lavilla (1980).

Hyla andina apparently occurs in sympatry with *H. marianitae* at Carahuasi, Depto. Cochabamba, and in the vicinity of Samaipata, Depto. Santa Cruz, Bolivia; also, it has been reported from Cochabamba, Depto., Cochabamba, Bolivia, a locality from which *H. albonigra* has been reported.

Remarks.—According to the catalogue in the Zoologisches Staatsammlung München, there were originally five syntypes (ZSM 5/1922 from Argentina; ZSM 21/1922 and 23/1922 from Caspinchango, Prov. Catamarca, Argentina; ZSM 22/1922 from Famabalasto, Prov. Catamarca, Argentina; ZSM 38/1922 from northern Argentina) that are no longer extant. The three existing syntypes (ZSM 18/1922) were collected by F. Weiser in November 1921 at Nacimiento, Prov. Catamarca, Argentina. When examined on 30 July 1969, these specimens were in fairly good condition. The dorsum was gray with creamy-tan, irregular dashes and streaks; a white transverse supraocular stripe and dark bars in the groin and on the posterior surfaces of the thighs were evident.

The polytypic species *Hyla pulchella* was reviewed by Barrio (1965), who recognized five subspecies based on size, coloration, and advertisement call. Lutz (1968) recognized another subspecies, *H. pulchella joaquina* in Santa Catarina, southeastern Brazil. However, one of these subspecies, *H. pulchella prasina* Burmeister from moderate elevations in southeastern Brazil, was recognized as a distinct species by Lutz (1973). As presently recognized, the nominate subspecies is distributed in mesic lowlands in extreme southeastern Brazil, Uruguay, and northeastern Argentina; *H. pulchella cordobae* Barrio is restricted to the isolated Sierra de Córdoba in north-central Argentina, and the other two subspecies are in the Andes and Andean precordilleras (Barrio, 1965; Cei, 1980). Specimens lacking black bars on the flanks and thighs from the Andean slopes in Provincia La Rioja and extreme southern Provincia Cajamarca, Argentina, were referred to *H. pulchella riojana* Koslowsky by Barrio (1965), who recognized Andean

populations from elsewhere in Provincia Catamarca northward into Bolivia as *H. pulchella andina*. Structurally, all of these frogs are similar, but differences in color patterns and advertisement calls suggest that each might be distinct species. This suggestion is supported by discontinuities in distribution, although the ranges of *H. pulchella riojana* and *H. pulchella andina* may be parapatric or overlap. By recognizing *H. andina* as a species distinct from *H. pulchella*, we are inferring that *H. pulchella riojana* also is specifically distinct from *H. andina*. On the other hand, if future studies show that these two taxa are conspecific but distinct from *H. pulchella*, the oldest available name is *Hyla riojana* Koslowsky (1895).

As noted in the description of coloration, there is a vast array of color patterns in Bolivian populations. In some cases, consistent interpopulational differences seem to exist. However, we have limited confidence in the designation of coloration in preserved specimens, and we have not been able to quantify color patterns. Our assignment of all of these populations is supported by the discriminant functions analysis of morphometrics. Populations considered to have the typical pattern of *Hyla andina* (dorsum green with or without dark blotches and irregular white stripes on shanks and dorsolateral regions of body) in Central Bolivia occur only in localities above treeline (i.e., La Paz, Departamento La Paz; Colomi, López Mendoza, and Tiraque, Departamento Cochabamba). Below treeline (around 3000 m, depending on the areas considered), patterns and color vary dramatically. Populations living in the same general area below treeline may vary depending on the altitude, as is evident in those occurring in the area of La Siberia, Depto. Cochabamba. In Argentina, both green and brown individuals are known for the latitudinal length of the range of the species. Also, specimens from the southern part of the range (provincias Tucumán and Catamarca, Argentina) tend to have a white stripe on the outer edge of the shank and tarsus.

Hyla balzani Boulenger

Hyla balzani Boulenger, 1898:132.—Holotype: MCSN 28872 from "Prov. Yungas, 1600 metres altitude" (= Coroico and Chulumani, Depto. La Paz), Bolivia.

Hyla callipleura Boulenger, 1902.—Syntypes: BM 1947.2.13.64–73 from Charuplaya, 1350 m, Bolivia, and BM 1947.2.13.74 from San Ernesto, Bolivia. BM 1947.2.13.65 here designated as lectotype. New synonymy.

Diagnosis.—A moderate-sized species in the *Hyla pulchella* Group characterized by: (1) snout rounded in dorsal view and in profile; (2) skin on dorsum smooth; (3) width of disc on Finger III equal to or slightly less than diameter of tympanum; (4) tarsal fold low; (5) dorsum unicolor or having a pattern consisting of transverse dark marks or broad irregular dark mark enclosing pale spots; (6) flanks brown with small pale spots; (7) posterior surfaces of thighs usually brown with small cream spots.

One other species, *Hyla marianitae*, is like *H. balzani* in having dark flanks with pale spots. It differs from *H. balzani* by having a subacuminate snout in dorsal view, usually

irregular blotches or reticulations on the dorsum, cream and brown mottling on the posterior surfaces of the thighs, and a weak tarsal fold. *Hyla melanopleura* has dark brown flanks with small pale dots only along the ventral edge of the flanks.

Description.— $n = 61$ ♂♂, 8 ♀♀. Body moderately robust; SVL in males to 50.4 mm, in females to 50.9 mm; head width about equal to head length, usually not as wide as body; head width 32.0–37.0% ($\bar{x} = 34.0$) of SVL; head length 32.0–39.0% ($\bar{x} = 35.0$) of SVL; snout rounded in dorsal view and in profile; interorbital distance 98–177% ($\bar{x} = 128$) of width of eyelid; diameter of eye 93–159% ($\bar{x} = 124$) its distance from nostril; tympanum separated from eye by distance about equal to diameter of tympanum; diameter of tympanum 37.0–70.0% ($\bar{x} = 53.0$) of diameter of eye. Breadth of forearm 58.7–71.8 ($\bar{x} = 65.0$, $n = 10$) of forearm length in males, 38.8–41.2 ($\bar{x} = 39.8$, $n = 4$) in females; ulnar fold proximally and row of low, round tubercles distally on forearm; webbing formula for fingers: **II** 2⁻–(3–3⁺) **III** 2½–2⁺ **IV**; width of disc on Finger III equal to or slightly less than diameter of tympanum; prepollex blunt, projecting at right angle in males, short and blunt in females; nuptial spines absent. Hind limb slender; tibia length 49.0–58.0% ($\bar{x} = 54.0$) of SVL; foot length 41.0–66.0% ($\bar{x} = 45.0$) of SVL; inner tarsal fold low; inner metatarsal tubercle ovoid, widest proximally, not visible from above; webbing formula for toes: **I** (1–1½)–(2–2) **II** (1–1⁺)–(2–2⁺) **III** (1–1½)–(2–2½) **IV** (2–2⁺)–(1–1⁺) **V**. Skin on dorsum and flanks smooth. Denticerous processes of vomers short, transverse, narrowly separated medially, posteromedial to rounded choanae, bearing total of 7–24 ($\bar{x} = 14.2$) teeth.

Coloration in preservative: Side of head and dorsal surfaces of head, body, and limbs tan, beige, or grayish brown with or without irregular dark brown, usually transverse marks; as many as five such marks including interorbital bar (in some individuals, V-shaped with apex posteriorly, connected or not to transverse mark in scapular region); markings transverse across entire dorsum and more or less parallel to sinuous (in some individuals interconnected); some individuals with only irregular marks on dorsum; flanks usually dark brown (sharply demarcated from dorsal color) usually with creamy white, irregular spots; dorsal surfaces of limbs usually with dark brown transverse bars; posterior surfaces of thighs tan to dark brown with creamy-white blotches or spots; cream transverse stripe above cloacal opening; venter dull creamy white or grayish brown, with or without small brown flecks on throat, chest, and limbs; throat usually paler than belly; palmar and plantar surfaces tan or brown.

Coloration in life: The dorsum is brown or green, usually with darker markings; the flanks and posterior surfaces of the thighs are dark brown or green with creamy-white spots. The variation in coloration is evident from the following descriptions of living individuals (Fig. 3).

KU 139212 from 4 km SW Santa Isabel, Depto. Cuzco, Peru.—Dorsum tan with brown flecks and blotches narrowly outlined with creamy tan; chin creamy white with

black flecks; venter creamy white anteriorly becoming pale gray posteriorly on belly and legs; side of head below cream canthal and supratympanic stripe bronze-brown, bordered below by metallic green; labial stripe dusty cream; flanks and posterior surfaces of thighs dark brown with cream spots; supraclacal stripe and stripes on outer edges of feet creamy white; plantar surfaces and webbing gray; iris deep bronze, darkest anteriorly and posteriorly; palpebrum clear (W. E. Duellman field notes, 16 January 1971).

KU 163315 from 4 km SW Santa Isabel, Depto. Cuzco, Peru.—Dorsum tan with faintly darker brown markings; side of head and anterior flanks pale green; posterior surfaces of thighs and flanks dark brown with creamy-white spots; venter pale bluish gray; iris pinkish brown (W. E. Duellman field notes, 10 February 1975).

USNM 332412–14 from Cerros de Tavará, Depto. Puno, Peru.—Dorsum green or brown with white dorsolateral line bordered by reddish brown; irregular white flecks on flanks; white heel and supraclacal stripes; hidden surfaces of thighs mustard; webbing on feet yellow; toe pads green; iris yellow (Lily O. Rodriguez field notes, 1–2 June 1992)

KU 183326–28 from 58.1 km W Villa Tunari, Depto. Cochabamba, Bolivia.—Dorsum tan or brown with dark brown markings; ventral surfaces dark brown or brownish green, chin paler; flanks black with tan markings; posterior surfaces of thighs black with tan spots; ventral surfaces of hands and feet dark brown; ventral surfaces of toe pads pale green; bones green; iris pale gold (D. C. Cannatella field notes, 21 January 1979).

KU 183330–34 from 4.4 km E Chulumani, Depto. La Paz, Bolivia.—Dorsum brown or olive-brown with darker brown markings in some individuals; dark brown stripe (with touch of green) from nostril to tympanum and onto flanks; portion of upper lip below eye gold; flanks and anterior and posterior surfaces of thighs dark brown with pale tan markings; belly and chin off-white “gray”; ventral surfaces of limbs gray brown; pads greenish; iris gold with dark brown horizontal stripe; bones green; one individual (KU 183331) with white supraclacal and tarsal stripes gold (D. C. Cannatella field notes, 21 January 1979).

KU 183335–36 from 33.9 km E Unduavi, Depto. La Paz, Bolivia.—Dorsum brown with olive and rust markings; belly off-white; chin and ventral surfaces of limbs dark gray; flanks and posterior surfaces of thighs black with yellowish-white markings; webbing brown; supraclacal and tarsal stripes off-white; upper lip gold in KU 183335 gold (D. C. Cannatella field notes, 30 January 1979).

KU 183337–40 from Coroico, Depto. La Paz, Bolivia.—Dorsum green or brown with green blotches; flanks and posterior surfaces of thighs dark brown with off-white markings; brown to brown and green stripe from nostrils to flanks; belly off-white; chin yellowish white; ventral surfaces of limbs pale gray; supraclacal and heel stripes off-white; bones green; iris pale gold (D. C. Cannatella field notes, 31 January 1979).

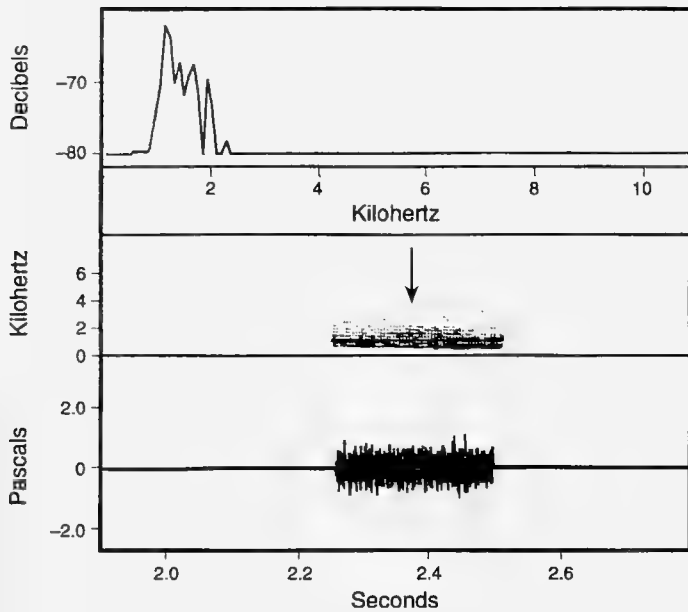

Fig. 13. Advertisement call of *Hyla balzani*, KU Tape 1229, recorded at 21°C at 4 km WSW Santa Isabel, Depto. Cuzco, Peru. Spectrum, audiospectrogram, and waveform; arrow in audiospectrogram indicates point of spectrum.

KU 183341–46 from Coroico, 1750 m, Depto La Paz, Bolivia.—Dorsum brown, olive, or yellowish green (D. C. Cannatella field notes, 4 February 1979).

Likewise, Reynolds and Foster (1992) commented on the variation in coloration of specimens from Departamento Cochabamba, Bolivia (USNM 257819–33). They stated that the dorsum was reddish brown to golden brown with pale to dark markings, and that the flanks and posterior surfaces of the thighs were mottled dark chocolate-brown and cream. Also, they described newly metamorphosed young as being opalescent greenish brown dorsally with small dark spots and stripes and the limbs as yellow green. The bones are green.

Life history.—The advertisement call consists of a short, low note repeated at a rate of 2.5–4 notes per minute. Analysis of two recordings (KU Tapes 1228–29) made at 17° and 21°C at the Río Cosñipata, Peru, revealed a note duration of 0.17 sec, a pulse rate of about 80 pulses per sec, and harmonics at 1150, 1400, 1650, and 1900 Hz, with the lowest harmonic being dominant (Fig. 13). Reynolds and Foster (1992) described the call as a sharp, moderately high-pitched “tink.” The recording tentatively identified as *Hyla callipleura* (= *H. balzani*) by Márquez et al. (1993) is actually *H. marianitae*.

Sixty-four specimens (Stages 25–45) of two series of tadpoles (KU 164052, 164053–54) are from 4 km SW Santa Isabel, Departamento Cuzco, Peru, 1700 m; one individual (KU 164054) of the latter series was allowed to develop to Stage 45 before being preserved four days after collection.

A specimen in Stage 38 (from KU 164053) has the following measurements: total length 41.7, body length 14.8,

tail muscle height at the base 5.3, tail muscle width at base 4.2, maximum dorsal fin height 3.5 located 20.9 from body terminus, maximum ventral fin height 3.0 located 20.0 from body terminus, body width 10.3, body height 7.6, eye diameter 1.9, pupil diameter 0.7, interorbital distance 3.4, greatest and least nostril diameters 0.5×0.2 , internarial distance 3.3, snout-nostril 3.0, snout-eye 4.8, snout-spiracle 8.5, eye-nostril 1.5, transverse oral disc diameter 4.3. Other major characteristics include a ventral oral disc, marginal papillae with median gap on upper labium, sinistral spiracle, dorsolateral eyes, dextral vent, and the dorsal fin terminating at the dorsal extent of the tail-body junction. The LTRF is 3(1,3)/4(1).

The outer wall of the spiracle is longer than the inner wall, and emerges from the ventrolateral surface of the body at midlength. The inner wall of the spiracular tube is attached to the body for most of its length; terminally it is free and hence the tube is free. The tube is directed posteriorly and narrows to form a round, posteriorly and slightly dorsally directed aperture. The vent tube is dextral, and is positioned at the posterolateral surface of a large saccular structure that underlies the limb buds and is contiguous with the ventral fin. The vent aperture is directed posteroventrally. The eyes are positioned dorsolaterally and directed laterally and slightly dorsally. The nares are oval, slightly medial to the center of the eyes, recessed, and weakly rimmed, with the rim of the medial edge slightly raised. The snout is broadly rounded in dorsal view and profile. The body is oval in dorsal view; in lateral view depressed dorsally and ventrally becoming deeper posteriorly toward the bulging gut.

The oral disc is slightly emarginate posterolaterally and is completely circumscribed by marginal papillae except for a median gap in the middle fifth of the upper labium; there are fewer marginal papillae medially on the lower labium. There are many submarginal papillae and flaps laterally. The LTRF is 3(1,3)/4(1) with long, narrow, closely spaced teeth. There is intraseries variation in the LTRF that seems to coincide with development. In KU 164053, tadpoles early in Stage 25 have a LTRF of 2(2)/3(1). A fourth lower row is gained later during Stage 25, this formula of 2(2)/4(1) is seen in specimens as advanced as Stage 30. A third upper row with a medial gap, thereby resulting in a LTRF 3(1,3)/4(1), is seen as early as, but usually later than, Stage 26. In KU 164052, tadpoles early in Stage 25 have a LTRF of 2(1)/4(1); later in this stage, tadpoles possess the gap in the other upper row, 2(2)/4(1). One specimen at Stage 31 of this series has the LTRF 3(1,3)/4(1) seen in advanced specimens of the first series. The upper jaw sheath is moderately wide, widely arched, and moderately serrate. The lower sheath is narrow, broadly V-shaped, and moderately serrate (Fig. 14).

The caudal musculature is highest at the tail-body junction and is the same height to midlength where it narrows gradually to a rounded (narrow and pointed in most other specimens) tail terminus. In lateral view, the dorsal fin terminates at the dorsal tail-body junction, is highest on the

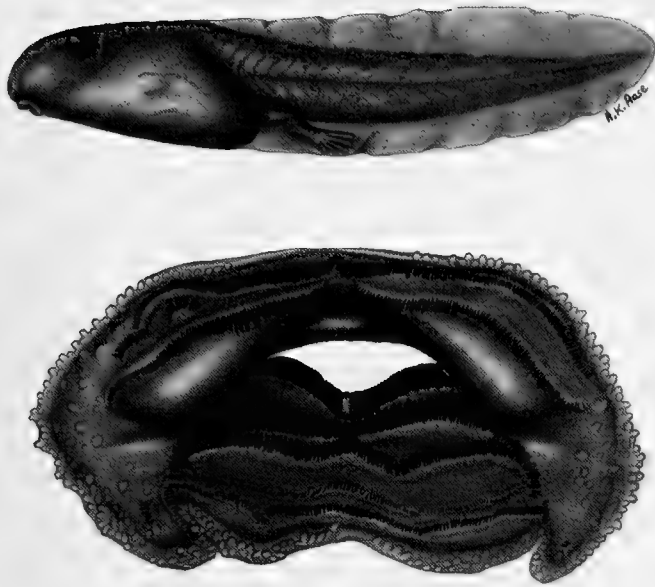

Fig. 14. Tadpole of *Hyla balzani*, KU 164053, Stage 38, total length 41.7 mm.

posterior fourth of tail, and is shorter than the musculature at midlength (taller posteriorly, shorter anteriorly). The ventral fin is shorter than the dorsal fin on the posterior half of the tail, taller for the anterior half; it does not vary in height until the posterior fourth of the tail where it is taller until narrowing abruptly at the tail terminus. The ventral fin is shorter than the musculature at midlength (taller only on posterior fourth). The greatest height of the tail is on the posterior fourth of the tail. The tail terminates as a rounded tip. (The tail tip is narrow and pointed in most other individuals of the series.)

In preservative, the dorsum of the body is uniformly pigmented with dark brown chromatophores and few white flecks anterior to the level of the spiracle. The venter has little or no pigment laterally, and possesses scattered white flecks; the intestine is clearly visible. The dorsal pigmentation continues posteriorly onto the dorsum of the caudal musculature lateral to the base of the dorsal fin posteriorly to tail tip. The remainder of the caudal musculature is opaque yellowish brown with scattered melanophores; some are located in patches forming diffuse, pale brown blotches. The fins are transparent gray with few scattered melanophores forming small diffuse blotches on the dorsal fin, but not on the ventral fin. Both fins have few scattered white flecks. In life (KU 164052), the body is grayish brown above with a dark brown interorbital bar, and the belly is silvery gray. The caudal musculature is tan with dark brown bars dorsally, and the fins are translucent with brown flecks; the iris is reddish bronze (W. E. Duellman field notes 10 February 1975).

Distribution and ecology.—*Hyla balzani* primarily is an inhabitant of cloud forests at elevations of 1200–2210 m on the eastern slopes of the Andes from central Peru to central Bolivia (Fig. 9), but the species is known from lower

elevations (500 m at San Ernesto, Depto. La Paz, Bolivia; 620 m at La Unión, Depto. Puno, Peru; 900 m at Cerros de Tavará, Depto. Puno, Peru; and 925 m at Huancabamba, Depto. Pasco, Peru). One specimen (USNM 98928) from “16 km E Loja City, 3000 m, Prov. Loja, Ecuador” is part of a collection received from Clodoveo Carrion; in the USNM catalogue, the date of collection as “Aug. 22, 1926.” We are skeptical of this record, because (1) the locality is about 500 km NNW of the northernmost locality of *H. balzani* (Huancabamba, Depto. Pasco, Peru); (2) the locality is north of the Huancabamba Depression, a major distributional barrier to anuran inhabitants of cloud forest (Duellman, 1979; Duellman and Wild, 1993); (3) the given elevation is 790 m higher than any other known for the species; and (4) extensive collections from the Abra de Zamora, 15–16 km E Loja contain no specimens of this species.

Although it seems to be primarily a forest-dweller, the species can tolerate a high degree of environmental disturbance. It has been found mainly along streams, ponds, and roadside seepages. At the Río Corani, Depto. Cochabamba, Bolivia, the species was common in a small pond (about 25 m diameter) close to the river. There, males called at night from stones in the middle of the pond, or perched on stones or vegetation (<1.5 m above ground) at the shore; also, they were observed on stones in the river. At Cerro Uchumachi, Depto. La Paz, Bolivia, individuals were found in a sloping, flooded meadow with scattered bushes; similarly, frogs were found in a flooded field at Coroico, Depto. La Paz, Bolivia. However, at most localities, males call from stones in, or vegetation above, small streams with moderate current. Tadpoles have been found in grassy pools, shallow roadside ditches, and pools in streams.

Hyla balzani has been found syntopically with *Hyla armata* in some streams in Bolivia and southern Peru—Paracti and Serranía Bellavista in Bolivia and the Río Cosñipata in Peru.

Remarks.—Although the holotype of *Hyla balzani* (MSNG 28872) is a small male with a SVL of 32.9 mm, it has vocal slits and well-developed prepollical spines. Comparison of this specimen with series of frogs that had been identified as *H. callipleura* revealed that they represent one taxon, the earliest name for which is *H. balzani* Boulenger, 1898. Thus, *H. callipleura* Boulenger, 1902, is a junior synonym of *H. balzani* Boulenger, 1898. In the type description of *Hyla callipleura*, Boulenger (1902) compared the species only with *H. crepitans* and made no mention of *H. balzani*. In the type description of *H. balzani*, Boulenger (1898:132) reported the specimen from “Prov. Yungas, 1600 metres altitude,” Bolivia. However, Boulenger (1898:128) listed the localities where L. Balzan had collected. The only locality in the Yungas is “Coroico and Chulumani, Prov. Yungas, 1600 metres alt.” This provides a reasonably precise locality, because Coroico and Chulumani are only a few kilometers apart on the slopes of the Andes in Depto. La Paz, Bolivia.

When the type series of *Hyla callipleura* was examined by Duellman on 16 June 1969, all specimens were in reasonably good condition. BMNH 1947.2.13.65 is an adult male with a SVL of 40.4 mm and the best-preserved color pattern; therefore, it is designated as the lectotype. Two other syntypes are adult males with SVLs of 37.2 and 43.3 mm; one is a gravid female with a SVL of 40.0 mm, and the other specimens are immature.

One specimen (CET A1453) from 10 km NW of Masicurí, Depto. Santa Cruz, Bolivia, may belong to this species. It is a male with a SVL of 34.8 mm, but it lacks a distinct tarsal fold. In preservative, the dorsum is pale brown with darker brown markings—a distinct triangular mark in the occipital region with the apex between the orbits and faint transverse marks on the body. The sides of the head and flanks are dark brown with three vertical pale marks on the posterior part of the flanks. A wide, pale cream labial stripe is present, and a pale cream stripe extends along the canthus rostralis, outer edge of upper eyelid, supratympanic fold, and along the dorsolateral surface of the body to the groin. White stripes are present on the heels and above the cloacal opening. The anterior and posterior surfaces of the thighs are creamy-tan, and the venter is creamy white. Color photographs of the living individual show the dorsum to be dull tan with faint brown markings, the flanks dark brown, and the iris dull tan; the labial, dorsolateral, supraclacal, and heel stripes are pale creamy gray.

Hyla marianitae Carrizo

Hyla marianitae Carrizo, 1992:18.—Holotype: MACN 32330 from the Río Pescado, Sierra de las Pavas, Parque Nacional Baritú, Departamento Orán, Provincia Salta, Argentina.

Diagnosis.—A moderate-sized species in the *Hyla pulchella* Group characterized by: (1) snout subacuminate in dorsal view and rounded in profile; (2) skin on dorsum smooth; (3) width of disc on Finger III less than diameter of tympanum; (4) tarsal fold low, weak; (5) dorsal color pattern consisting of irregular blotches or reticulations; (6) flanks brown with pale spots; (7) posterior surfaces of thighs with cream and dark brown mottling.

One other species in the *Hyla pulchella* group has dark flanks with pale spots. *Hyla balzani* differs by having a rounded snout in dorsal view, a more distinct tarsal fold, transverse dark marks on the dorsum, and the posterior surfaces of the thighs dark brown with discrete pale spots. *Hyla melanopleura* has dark brown flanks with small pale dots along the ventral edge of the flanks.

Description.— $n = 26 \sigma\sigma$, $6 \rho\rho$. Body robust; SVL in males to 56.8 mm, in females to 56.5 mm; head width about equal to head length, not as wide as body; head width 31.0–37.0% ($\bar{x} = 34.0$) of SVL; head length 32.0–36.0% ($\bar{x} = 34.0$) of SVL; snout slightly subacuminate in dorsal view, rounded in profile; interorbital distance 114–183% ($\bar{x} = 147$) of width of eyelid; diameter of eye 102–151% ($\bar{x} = 119$) its distance from nostril; tympanum separated from eye by distance about equal to diameter of tympanum; diameter

of tympanum 41.0–70.0% ($\bar{x} = 55.0$) of diameter of eye. Breadth of forearm 64.3–73.9 ($\bar{x} = 68.1$, $n = 10$) of forearm length in males, 40.5–44.3 ($\bar{x} = 43.2$, $n = 4$) in females; ulnar fold proximally and row of low, round tubercles distally on forearm; webbing formula for fingers: II (2–2⁺)—(3–3⁺) III 2½—(2–2⁺) IV; width of disc on Finger III slightly less than diameter of tympanum; prepollex blunt, projecting at right angle in male, short, blunt in female; nuptial spines absent and nuptial excrescences absent in breeding males. Hind limb moderately slender; tibia length 50.0–59.0% ($\bar{x} = 54.0$) of SVL; foot length 41.0–52.0% ($\bar{x} = 44.0$) of SVL; inner tarsal fold low, weak, curved; inner metatarsal tubercle ovoid, widest proximally, not visible from above; webbing formula for toes: I 1—(1½–2) II 1—(2–2⁺) III (1–1½)—(2–2⁺) IV (2–2⁺)—1 V. Skin on dorsum and flanks smooth. Dentigerous processes of vomers moderately long, transverse, narrowly separated medially, posteromedial to rounded choanae, each bearing total 6–22 ($\bar{x} = 12.3$) teeth.

Color in preservative: Side of head and dorsal surfaces of head, body, and limbs tan, gray, or brown, uniform to boldly patterned with irregular small dark markings (forming network pattern in some individuals), irregular large dark blotches, or transverse dark bars; flanks usually with dark markings (encircling creamy-white spots in some individuals); same kind of pattern usually present on anterior and posterior surfaces of thighs; dorsal surfaces of limbs usually unpatterned, but with indistinct transverse dark bars in some; creamy-white labial stripe usually present; transverse cream stripe above cloacal opening; venter cream, tan, or gray; throat and chest with or without brown flecks; palmar and plantar surfaces same color as limbs.

Color in life: The dorsal ground color usually is tan or brown, but a few individuals are vivid green (Fig. 3). This variation is apparent from the following descriptions of living individuals.

CET A89 from Arroyo Las Juntas, 8 km NW Samaipata, Depto. Santa Cruz, Bolivia.—Dorsal surfaces of body and limbs yellowish tan with some indistinct, irregular dark blotches; flanks and posterior surfaces of thighs gray, encircling dots of the same color as dorsum; belly pale yellow, throat yellow; ventral surfaces of limbs gray; iris golden-yellow (I. De la Riva field notes, 7 March 1990).

CET A88 from Carahuasi, Depto. Cochabamba, Bolivia.—Dorsal surfaces of body and limbs mostly uniformly tan; flanks cream with large dark brown, connected blotches (I. De la Riva field notes, 9 March 1990).

CET A109 from Río Cheyo, Amboró National Park, Depto. Santa Cruz, Bolivia.—Dorsal surfaces of body and limbs mostly uniformly pale green; flanks brown, encircling creamy white blotches; iris beige (I. De la Riva field notes, 16 March 1990).

Life history.—The advertisement call was described (as *Hyla callipleura*) by Márquez et al. (1993). The call consists of a single note repeated at a rate of 15–23 ($\bar{x} = 18.7$) notes per min; the notes have a duration of 0.025–0.059 ($\bar{x} = 0.036$)

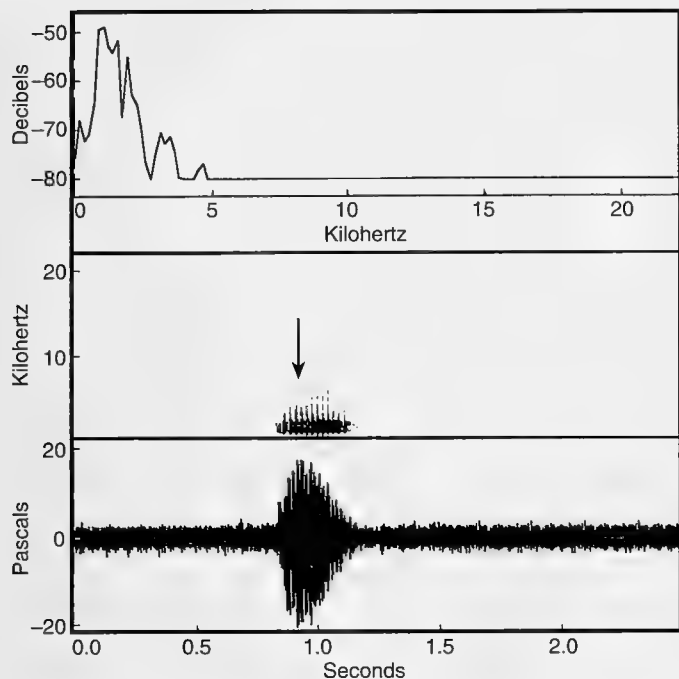

Fig. 15. Advertisement call of *Hyla marianitae*, recorded at Tablasmontes, Depto. Cochabamba, Bolivia. Spectrum, audiospectrogram, and waveform; arrow in audiospectrogram indicates point of spectrum.

sec. Analysis of recordings of five calls made at La Siberia, Depto. Santa Cruz, Bolivia, revealed a pulse rate of 44–45 (\bar{x} = 44.4) pulses per second and harmonics at about 880, 1250, and 1700 Hz, of which the lowest is the dominant frequency (Fig. 15).

The tadpoles are unknown; presumably they develop in the streams along which adults have been found.

Distribution and ecology.—*Hyla marianitae* is known from elevations of 700–2650 m on the eastern slopes of the Andes and Andean precordilleras from central Bolivia to northern Argentina (Fig. 9). It inhabits cloud forests, low montane rainforest, subhumid, and even dry temperate forests, where it is found in the immediate vicinity of streams. Some of these streams are permanent, but those in temperate valleys can become intermittent or dry by the end of the dry season. At night, individuals perch on, and call from, tree branches near the streams or, more often, on large stones in the middle or at the edge of streams. By day, individuals can be found under stones on the banks of streams. The species is common at some localities. At Carahuasi, Depto. Cochabamba, Bolivia, many individuals and amplexant pairs were observed on 9 March 1990. A female of a pair kept in a plastic bag laid pigmented eggs 2.6 mm in diameter. Males commonly have many scars on the dorsum; presumably these are injuries caused by prepollical spines during male-male encounters.

Hyla marianitae is allopatric to *H. balzani*. On the other hand, *H. marianitae* is sympatric with *H. andina* at Carahuasi, Depto. Cochabamba, Bolivia; it also occurs sym-

patrically with *H. armata* at El Chapé and Quebrada Huertillas, Depto. Santa Cruz, Bolivia.

Remarks.—In describing this species from two specimens from Parque Nacional Baritú in northwestern Argentina, Carrizo (1992) apparently was unaware that it was widely distributed to the north and west in Bolivia. Moreover, although Carrizo (1992) described and illustrated the prepollical spine, he did not associate the new species with the *Hyla pulchella* Group.

Although the holotype (MACN 32330) is slightly faded, a dorsal pattern of irregular dark markings is perfectly visible; on the flanks, irregular pale spots extend from the axilla to the groin. The snout is subacuminate in dorsal view and rounded in profile; the fingers are about one-third webbed, and the feet are nearly fully webbed. The tarsal fold is not discernible. Our comparison of the holotype of *Hyla marianitae* with specimens from Bolivia convinces us that they are conspecific.

Hyla melanopleura Boulenger

Hyla melanopleura Boulenger, 1912:185.—Syntypes: BM 1947.2.13.54–58 from Huancabamba, Departamento Pasco, Peru; BM 1947.2.13.56 designated as lectotype.

Diagnosis.—A small species in the *Hyla pulchella* Group characterized by: (1) snout rounded in dorsal view and bluntly rounded in profile; (2) skin on dorsum smooth; (3) width of disc on Finger III less than diameter of tympanum; (4) tarsal fold low; (5) dorsal color pattern consisting of triangular interorbital mark and irregular dashes on body; (6) flanks dark brown with small pale dots along the ventral edge; (7) posterior surfaces of thighs uniform dark brown.

The only other species in the *Hyla pulchella* Group lacking large marks on the flanks is *H. palaestes*, in which the flanks and posterior surfaces of the thighs are not darker than the dorsum and the dorsal color pattern consists of irregular, narrow transverse marks. Moreover, in *H. palaestes*, the width of the disc on Finger III equals the diameter of the tympanum.

Description.— n = 1 ♂, 4 ♀♀. Body moderately robust; SVL in males to 43.6 mm, in females to 47.7 mm; head width equal to head length, not as wide as body; head width and head length 32.7–33.2% (\bar{x} = 33.0) of SVL; snout rounded in dorsal view, bluntly rounded in profile; interorbital distance 124–136% (\bar{x} = 131) of width of eyelid; diameter of eye 108–155% (\bar{x} = 126) its distance from nostril; tympanum separated from eye by distance equal to diameter of tympanum; diameter of tympanum 56.3–64.7% (\bar{x} = 60.8) of diameter of eye. Breadth of forelimb 41% of forearm length in male, 33% in females; ulnar fold proximally and row of low, round tubercles distally on forearm; webbing formula for fingers: II (2–2)—(3–3) III 2½—(2–2+) IV; width of disc on Finger III slightly less than diameter of tympanum; prepollex pointed, projecting at right angle in male, short, blunt in females; nuptial spines absent; nuptial excrescence brown on inner side of base of thumb in

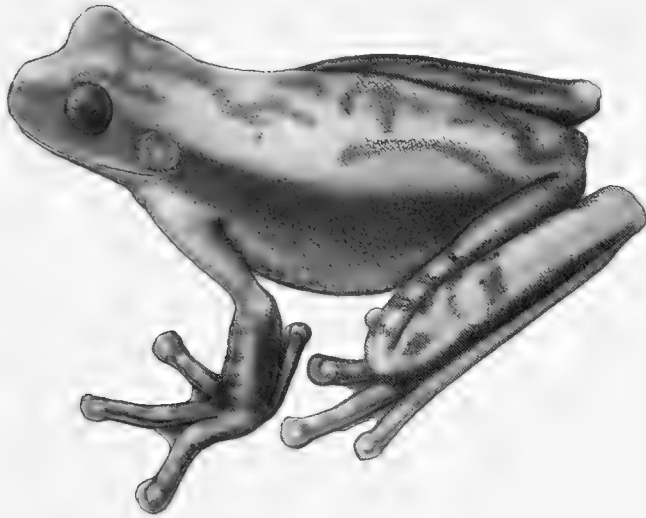

Fig. 16. *Hyla melanopleura*, BMNH 1947.1.13.54, adult female, 47.7 mm SVL.

breeding male. Hind limb slender; tibia length 51.8–63.3% (\bar{x} = 56.0) of SVL; foot length 40.6–44.4% (\bar{x} = 42.7) of SVL; inner tarsal fold low, curved; inner metatarsal tubercle ovoid, widest proximally, not visible from above; webbing formula for toes: I (1–1½)—(2–2⁺) II (1–1⁺)—(2⁺–2½) III (1–12)—(2–2½) IV (2–2⁺)—(1–1⁺) V. Skin on dorsum and flanks smooth. Vomerine odontophores short, transverse, narrowly separated medially, between ovoid choanae, each bearing total 3–6 (\bar{x} = 4.5) teeth.

Color in preservative: Dorsum tan with irregular brown markings—BMNH 1947.2.13.54: narrow triangle on head connected by narrow middorsal mark to long inverted V extending from scapular region to sacrum; irregular dashes postsacrally (Fig. 16). BMNH 1947.2.13.56: interorbital bar; irregular paravertebral marks extending from scapular region to sacrum; irregular dashes dorsolaterally and postsacrally. BMNH 1947.2.13.58: triangle with base between inner edges of eyelids and apex in scapular region; ovoid mark with tan center between scapular region and sacrum; diamond-shaped mark postsacrally. Irregular, transverse brown marks on forearms, shanks, and tarsi; flanks and anterior and posterior surfaces of thighs dark brown (with small white flecks on flanks in BMNH 1947.2.13.58). Side of head brown; creamy-white labial stripe (only posteriorly from point below orbit in BMNH 1947.1.13.54); white transverse stripe above vent (absent in BMNH 1947.2.13.54). Venter dull creamy white with small brown flecks on throat, chest, undersides of arms, and ventral surfaces of tarsi; webbing on hand tan, on feet, brown.

Color in life: Unknown. Boulenger (1912:186) described the color of the syntypes as follows: "Greyish or reddish brown above, sides blackish; the back may be spotted or dotted with brown, the sides dotted with white; limbs with irregular dark cross-bands; lower parts dirty white.

Life history.—Nothing is known.

Distribution and ecology.—This species is known only from the type locality, Huancabamba in the Departamento Pasco, Peru (Fig. 9). Huancabamba is at an elevation of 925 m on the Amazonian slopes of the Andes.

Remarks.—When the type series was examined on 17 June 1969, the specimens were soft, but the color pattern was discernible. Of the five syntypes, BM 1947.2.13.56 is a female having a SVL of 46.4 mm; it shows the color pattern better than the other specimens and thus is designated as the lectotype. See remarks in following account.

Hyla palaestes new species

Holotype.—KU 163305, an adult male, one of a series collected at south edge of Tutumbaro (12°42' S, 73°54' W, 1840 m), 5.4 km (by road) SW Ayna, Provincia La Mar, Departamento Ayacucho, Peru, on 20 February 1975 by William E. Duellman and Linda Trueb.

Paratypes.—KU 163306–14 collected with the holotype; KU 196844–53, and LSU 26002–15 from San José, Río Santa Rosa, 1005 m, Provincia La Mar, Departamento Ayacucho, Peru.

Referred specimens.—KU 164051 (tadpoles), KU 164092 (skeleton).

Diagnosis.—A moderate-sized species in the *Hyla pulchella* Group characterized by: (1) snout rounded in dorsal view and bluntly rounded in profile; (2) skin on dorsum smooth; (3) width of disc on Finger III equals diameter of tympanum; (4) tarsal fold low; (5) dorsal color pattern consisting of irregular dark, transverse marks; (6) flanks uniform tan; (7) posterior surfaces of thighs uniform tan.

The only other species in the *Hyla pulchella* Group lacking large marks on the flanks is *H. melanopleura*, in which the flanks and posterior surfaces of the thighs are darker than the dorsum and the dorsal color pattern consists of a triangular interorbital mark and irregular dashes on the body. Also, in *H. melanopleura*, small, pale spots are present ventrolaterally on the flanks, and the width of the disc on Finger III is less than the diameter of the tympanum.

Description.— $n = 29 \sigma\sigma, 1 \text{♀}$. Body moderately robust; SVL in males to 50.4 mm, in females to 50.9 mm; head width about equal to head length, not as wide as body; head width 32.0–38.4% (\bar{x} = 35.4) of SVL; head length 33.8–37.7% (\bar{x} = 35.5) of SVL; snout rounded in dorsal view, bluntly rounded in profile; interorbital distance 103–159% (\bar{x} = 128) of width of eyelid; diameter of eye 108–138% (\bar{x} = 123) its distance from nostril; tympanum separated from eye by distance about equal to diameter of tympanum; diameter of tympanum 48.9–67.5% (\bar{x} = 55.3) of diameter of eye. Breadth of forearm 41.9–51.3% (\bar{x} = 46.2, $n = 10$) of forearm length in males, 32% in female; ulnar fold proximally and row of low, round tubercles distally on forearm; webbing formula for fingers: II (2–2)—(3–3) III 2½—(2–2) IV; width of disc on Finger III about equal to diameter of tympanum; prepollex blunt, projecting at right angle in male, shorter in female; nuptial spines absent; nuptial excres-

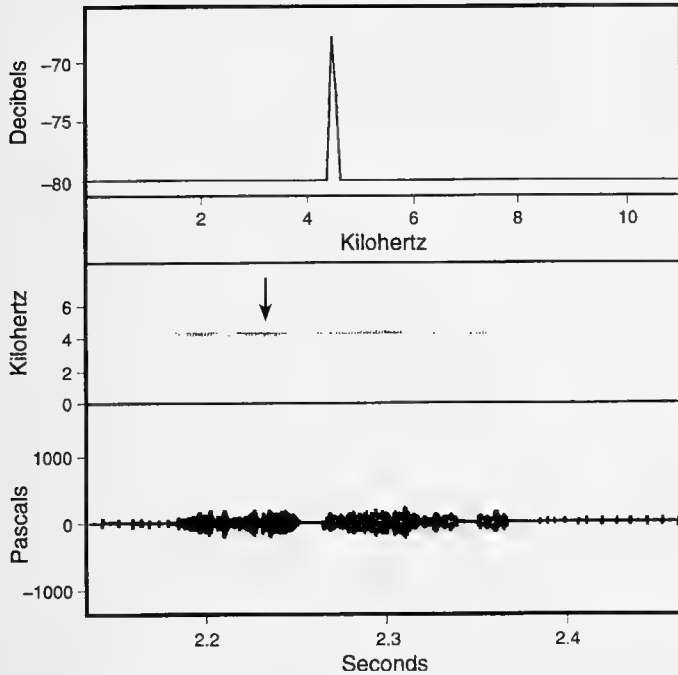

Fig. 17. Advertisement call of *Hyla palaestes*, KU Tape 1298, recorded at 14°C at Tutumbaro, Depto. Ayacucho, Peru. Spectrum, audiospectrogram, and waveform; arrow in audiospectrogram indicates point of spectrum.

cences absent in breeding males. Hind limb slender; tibia length 49.9–58.8% (\bar{x} = 53.2) of SVL; foot length 39.8–47.7% (\bar{x} = 43.6) of SVL; inner tarsal fold low, straight; inner metatarsal tubercle ovoid, widest proximally, visible from above; webbing formula for toes: I (1–1½)—(2–2½) II (1–1+)—(2–2+) III (1–1½)—(2–2½) IV (2–2+)—(1–1+) V. Skin on dorsum and flanks smooth. Vomerine odontophores short, transverse, narrowly separated medially, posteromedial to rounded choanae, each bearing total 4–9 (\bar{x} = 6.9) teeth.

Coloration in preservative: Dorsum and flanks tan to brown with or without indistinct darker markings (most distinct in tan individuals) consisting of interorbital bar and four or five transverse marks on body and usually with narrow, transverse lines in interspaces between primary marks; limbs with dark brown transverse bars—two or three on forearm, three or four (indistinct) on thigh, and four or five on shank; digits and webbing same color as dorsal ground color; anterior and posterior surfaces of thighs uniform pale brown; cloacal region dark brown with narrow, transverse creamy-white stripe above cloacal region (most distinct in smaller individuals); margin of upper lip creamy tan; venter uniform creamy tan. Juvenile (24.8 mm SVL) with narrow cream canthal and dorsolateral stripes bordered below by narrow, dark brown stripe; subadult male (32.5 mm SVL) with indistinct brown dorsolateral stripe.

Coloration in life: The dorsum is brown to tan with faint markings; the flanks lack contrasting markings, and the venter is white (Fig. 3).

KU 163305–13 from Tutumbaro, Depto. Ayacucho, Peru.—At night, dorsum of adults pale reddish brown to

olive-tan with faintly darker transverse markings on body and limbs; groin and hidden surfaces of hind limbs purplish gray; webbing brown; venter creamy white with tint of olive-green on vocal sac; supraclacal and heel stripes creamy white. By day, some individuals changed to pale greenish tan with olive-green markings. Juveniles colored like adults by day except for a greenish-white labial stripe, pale yellow canthal and dorsolateral stripes bordered below by narrow reddish-brown line; groin and hidden surfaces of hind limbs pale green. Iris pale creamy bronze (W. E. Duellman field notes, 20 February 1975).

Measurements of holotype: SVL 46.3, tibia length 24.3, foot length 20.1, head length 15.4, head width 16.7, interorbital distance 6.2, internarial distance 3.2, width of eyelid 3.9, eye-nostril distance 3.4, diameter of eye 4.7, diameter of tympanum 2.6.

Life history.—The advertisement call consists of a series of soft, low, trill-like notes of variable length. Analysis of one recording (KU Tape 1298) made at 14°C at the type locality reveals a call rate of nine calls per minute. Each call consists of four or five notes having durations of 0.02–0.08 sec (\bar{x} = 3.4) and 42–44 pulses per sec (\bar{x} = 43). Only a single harmonic at 4.43–4.45 kHz (\bar{x} = 4.44) is evident (Fig. 17). The first and last notes in a call are shorter than the intermediate ones; in one call, the lengths of sequential notes are 0.02, 0.03, 0.08, 0.03 sec, and in another they are 0.02, 0.04, 0.05, 0.02, 0.02 sec (Fig. 17).

Sixteen tadpoles (Stages 37–43; KU 164051) are from the Río Piene, Tutumbaro, Departamento Ayacucho, Peru. A specimen in Stage 37 (KU 164051) has the following measurements: total length 55.2, body length 18.5, tail muscle height at the base 6.2, tail muscle width at the base 5.6, maximum dorsal fin height 4.3 located 20.8 from body terminus, maximum ventral fin height 3.3 located 25.0 from body terminus, body width 13.0, body height 9.9, eye diameter 2.4, pupil diameter 0.7, interorbital distance 3.3, greatest and least nostril diameters 0.7 × 0.5, internarial distance 3.1, snout-nostril 3.3, snout-eye 6.0, snout-spiracle 9.8, eye-nostril 1.6, and transverse oral disc diameter 4.9. Other major characteristics include a ventral oral disc, marginal papillae with median gap on upper labium, sinistral spiracle, dorsal eyes, dextral vent, and dorsal fin terminating at the dorsal extent of the tail-body junction. The LTRF is 2(2)/4(1) (Fig. 18).

The outer wall of the spiracle is longer than the inner wall, and emerges from the ventrolateral surface of the body at midlength. The inner wall of the spiracular tube is attached to the body for its entire length; thus, none of the tube is free. The tube is directed posterodorsally and narrows to form a round, posteriorly directed aperture. The vent tube is dextral, and is positioned at the posterolateral surface of a large saccular structure that underlies the limb buds and is contiguous with the ventral fin. The vent aperture is directed posteroventrally. The eyes are positioned dorsally and directed dorsolaterally. The nares are oval, slightly medial to the center of the eyes, recessed, and weakly rimmed with the rim of the medial edge slightly

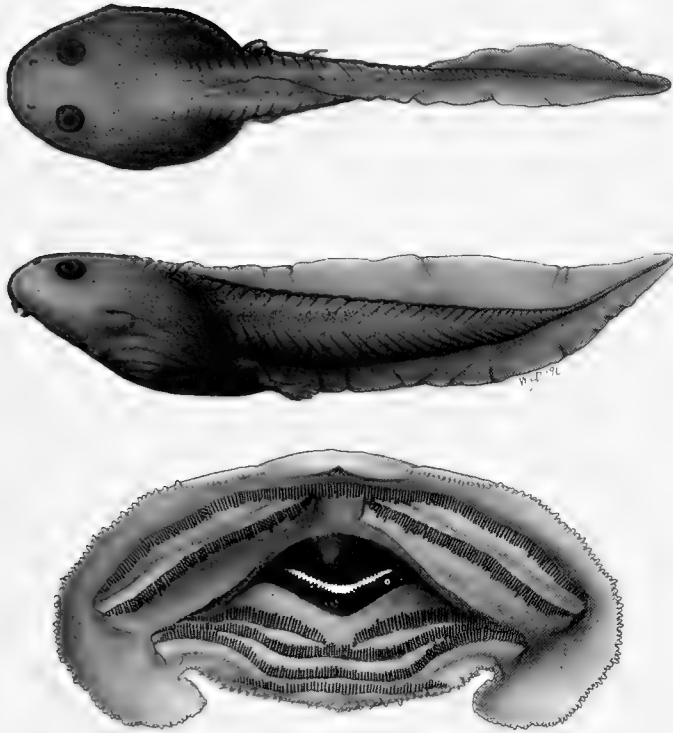

Fig. 18. Tadpole of *Hyla palaestes*, KU 164051, Stage 37, total length 55.2 mm

raised. The snout is acutely rounded in dorsal view, and acutely rounded in profile, gradually sloping posterodorsally. The body is oval in dorsal view; in lateral view depressed dorsally and ventrally becoming deeper posteriorly to bulging gut.

The oral disc is slightly emarginate posterolaterally and is completely circumscribed by marginal papillae except for a median gap in the middle seventh of the upper labium; there are fewer marginal papillae medially on the lower labium. Submarginal papillae are scarce and present laterally in addition to flaps, some of which possess minute teeth. The LTRF of most individuals is 2(2)/4(1) with long, closely spaced teeth, but a few have gaps in A-1, P-2, or P-3. The upper jaw sheath is moderately wide, widely arched, and moderately serrate. The lower jaw sheath is narrow, broadly V-shaped, and moderately serrate.

The caudal musculature is highest at the tail-body junction and is the same height to the midlength, where it narrows gradually to a long, narrow tail terminus. In lateral view, the dorsal fin terminates at the dorsal tail-body junction, is highest at about two-thirds length of tail, and is equal to musculature height at midlength of the tail (taller posteriorly, shorter anteriorly). The ventral fin is shorter than the dorsal fin at the midportion of tail (equal for posterior fourth, taller for anterior fourth). The ventral fin is shorter than the musculature at midlength (taller posteriorly, shorter anteriorly). The greatest height of the tail is at about midlength. The tail terminates as a long, narrow, pointed tip.

In preservative, the dorsum of the body is uniformly pigmented with brown chromatophores. The venter has little, if any pigment laterally, and the intestine is clearly visible. Dorsal pigmentation continues posteriorly onto dorsum of anterior half of caudal musculature. The fins are transparent, and the musculature is opaque yellowish brown; both have scattered discrete brown blotches; the blotches interconnect along the midheight of the musculature and are limited to the anterior part of the dorsal fin. In life, the dorsum is olive-tan with olive-green mottling, flanks greenish silver, and belly silver-white. The caudal musculature is grayish tan with brown spots which are also on the transparent fins; the iris is creamy bronze, and the bones are green (W. E. Duellman field notes 20, February 1975).

Distribution and ecology.—This species is known definitely only from two localities—San José on the Río Santa Rosa 1005 m and Tutumbaro on the Río Piene 1840 m—in the drainage of the Río Apurimac on the eastern face of the Andes in central Peru (Fig. 9). The localities are about 12 km (airline) apart.

Males were calling from dense vegetation within 0.5 m of a low-gradient stream after a rain of 12 mm on the night of 20 February 1975. The site is at an elevation of 1840 m at the south edge of the village of Tutumbaro in the valley of the Río Piene, a tributary of Río Apurimac. Tutumbaro is 5 km S of Ayna on the road to Ayacucho. The site is in disturbed cloud forest with bamboo, ferns, and elephant ear plants but no tree ferns and few bromeliads. Other anurans found at the same site include *Bufo veraguensis*, *Cochranella phenax*, *Hyalinobatrachium bergeri*, *Gastrotheca testudinea*, and *Hyla armata*.

Etymology.—The specific name, *palaestes*, is a Latin noun meaning wrestler; the name is used in reference to the robust arms of adult males.

Remarks.—This species is similar in size and coloration to *Hyla melanopleura*, which also lacks bold markings on the flanks, but has small pale spots ventrolaterally (absent in *H. palaestes*). However, in *H. melanopleura*, the flanks are much darker than the dorsum, whereas they are the same color as the dorsum in *H. palaestes*. The relative size of the disc on Finger III (smaller than tympanum in *H. melanopleura* and equal to diameter of tympanum in *H. palaestes*) may be an artifact of preservation.

Hyla bogotensis Group

Definition.—(1) Moderate-sized, stream-breeding frogs with males attaining SVLs of 45 mm and females 53 mm; (2) round mental gland in males; (3) preorbital ridge and lateral folds absent; (4) dorsum green or pale brown with or without dark flecks; (5) no conspicuous marks on flanks or hidden surfaces of thighs; (6) venter uniformly pale; (7) digits bearing small discs; (8) nuptial excrescences and projecting prepollical spines absent in males; (9) forearms of adult males not hypertrophied; (10) axillary membrane absent; (11) toes about three-fourths webbed; (12) nasals small, widely separated medially; (13) frontoparietal fon-

tanelle large; (14) sphenethmoid broad; septum nasi not ossified anteriorly; (15) quadratojugal usually articulating with maxillary; (16) dentigerous processes of vomers transverse, between posterior margins of choanae, narrowly separated medially; (17) tadpoles having long, muscular tails, low fins, and pointed terminus; (18) spiracle attached to body wall for its full length or free distally; (19) larval mouth large, anteroventral, complete rows of marginal papillae, no plate or narrow plate below serrations on upper jaw sheath, and a LTRF usually of 4-5/6-10 (maximum of 14/15 in *Hyla jahni*); (20) known advertisement calls consisting of series of short, loud peeps (trill in *H. jahni*).

Content.—Fourteen species: *Hyla alytolylax* Duellman, 1972; *H. bogotensis* (Peters, 1882); *H. callipeza* Duellman, 1989; *H. colymba* Dunn, 1931 (*H. alvaradoi* Taylor, 1952, is a synonym); *H. denticulenta* Duellman, 1972; *H. jahni* Rivero, 1961; *H. lascinia* Rivero, 1969; *H. lynchi* Ruíz-Carranza and Ardila-Robayo, 1991; *H. palmeri* Boulenger, 1908; *H. phyllognatha* Melin, 1941; *H. piceigularis* Ruíz-Carranza and Lynch, 1982; *H. platydactyla* Boulenger, 1905 (*H. paramica* Rivero, 1961, is a synonym); *H. simmonsii* Duellman, 1989; *H. torrenticola* Duellman and Altig, 1978.

Distribution.—Most species have allopatric distributions at elevations of 800–2600 m in cloud forests on the eastern and western flanks of the Andes in Colombia (also Cordillera Central) and Ecuador, and two species (*Hyla jahni* and *H. platydactyla*) occur sympatrically in the Mérida Andes in Venezuela (La Marca, 1985). *Hyla bogotensis* occurs in subparamo and paramo to elevations of 3600 m (Ruíz-Carranza and Lynch, 1982). On the Amazonian slopes of the Andes, *H. phyllognatha* ranges from southern Colombia to central Peru; it is the only species known to occur south of the Huancabamba Depression. *Hyla palmeri* is known from elevations of 100–1600 m in the Chocó lowlands and on the western slopes of the Cordillera Occidental in Colombia and Ecuador (Ruíz-Carranza et al., 1996) and from one locality in Central Panama, where it is sympatric with *H. colymba*, which has a discontinuous range from central Costa Rica to extreme eastern Panama (Myers and Duellman, 1982).

Remarks.—The *Hyla bogotensis* group was reviewed by Duellman (1972) and redefined by Duellman (1989); subsequently, *H. lynchi* was described by Ruíz-Carranza and Ardila-Robayo (1991).

Hyla chlorostea GROUP

Definition.—(1) Moderately small frog with only known male having a SVL of 39.7 mm; (2) round mental gland absent; (3) preorbital ridge and lateral folds present; (4) dorsum pale brown with darker brown markings; (5) no conspicuous marks on flanks or hidden surfaces of thighs; (6) venter uniformly pale; (7) digits bearing moderately large discs; (8, 9) unknown; (10) axillary membrane absent; (11) toes about three-fourths webbed; (12–15) unknown; (16) dentigerous processes of vomers short, slightly curved posteromedially, posterior to choanae; (17–20) unknown.

Content.—One species: *Hyla chlorostea* Reynolds and Foster, 1992.

Distribution.—Known only from Parjacti at an elevation of 2044 m in Departamento Cochabamba, Bolivia.

Remarks.—This highly distinctive species is known from only a subadult male. De la Riva and Duellman independently examined the holotype and concur with Reynolds and Foster (1992) that this frog cannot be assigned to any known group of *Hyla*.

Hyla columbiana GROUP

Definition.—(1) Small, pond-breeding frogs with males attaining SVLs of 26 mm and females 32 mm; (2) round mental gland absent; (3) preorbital ridge and lateral folds absent; (4) dorsum tan or brown with or without darker markings and pale dorsolateral stripes; (5) axilla and groin yellow, orange, or blue; no bold marks on hidden surfaces of thighs; (6) venter pale with darker spots; (7) digits bearing small discs; (8) nuptial excrescences and projecting prepollical spines absent in males; (9) forearms of adult males not hypertrophied; (10) axillary membrane present; (11) toes two-thirds to three-fourths webbed; (12) nasals small, widely separated medially; (13) frontoparietal fontanelle short, narrow; (14) sphenethmoid broad; septum nasi not ossified anteriorly; (15) quadratojugal absent; (16) dentigerous processes of vomers inclined posteromedially between choanae, moderately to widely separated medially; (17) tadpoles having moderately short tails, with high fins, and xiphicercal terminus; (18) spiracle attached to body wall for its entire length; (19) larval mouth small, terminal, directed anteroventrally, with broad median gap on upper labium, no plate below serrations on upper jaw sheath, and a LTRF usually of 1/2; (20) advertisement calls consisting of short, moderately pitched notes followed by shorter secondary notes

Content.—Three species: *Hyla carnifex* Duellman, 1969 (*H. bogerti* Cochran and Goin, 1970, and *H. charlesbogerti* Goin, 1970, are synonyms); *H. columbiana* Boettger, 1892 (*H. variabilis* Boulenger, 1896, is a synonym); *H. praestans* Duellman and Trueb, 1983.

Distribution.—Allopatric distributions at elevations of 975–2580 m on the Pacific slopes of the Cordillera Occidental in Ecuador and Colombia (*H. carnifex*), the upper Río Cauca (*H. columbiana*) and Magdalena (*H. praestans*) valleys, and northeastern slopes of the Cordillera Oriental (*H. garagoensis* and *H. stingi*) in Colombia.

Remarks.—The group was defined and reviewed by Duellman and Trueb (1983), who hypothesized that on the basis of larval characters and a diploid number of 30 chromosomes the *Hyla columbiana* group was the sister group of the *H. minuta*, *marmorata*, *parviceps*, *leucophyllata*, and *microcephala* groups inhabiting tropical lowlands in Middle and South America. Kaplan (1991) noted in his description of *H. garagoensis* that the larvae of *H. praestans* are unknown and the adults of that species closely resemble those of *H. garagoensis*; subsequently, Kaplan (1994) de-

scribed *H. stingi*, which he considered to be an independent lineage between the *H. columbiana* and *H. minuta* groups.

HYLA GARAGOENSIS GROUP

Definition.—(1) Small, pond-breeding frogs with males attaining SVLs of 30 mm and females 34 mm; (2) round mental gland absent; (3) preorbital ridge and lateral folds absent; (4) dorsum down with darker or paler marks and pale dorsolateral stripes; (5) groin and hidden surfaces of thighs yellow or orange; (6) venter pale with or without dark flecks on chest; (7) digits bearing small discs; (8) nuptial excrescences and projecting prepollical spines absent in males; (9) forearms of adult males not hypertrophied; (10) axillary membrane brief or absent; (11) toes one-half to two-thirds webbed; (12) nasals small, widely separated medially; (13) frontoparietal fontanelle short and posterior or long and slender; (14) sphenethmoid broad; septum nasi not ossified anteriorly; (15) quadratojugal absent; (16) dentigerous processes of vomers small, inclined posteromedially between choanae, moderately separated medially; (17) tadpoles having moderately short tails, with high fins and xiphicercal terminus; (18) unknown; (19) larval mouth small, terminal, directed anteroventrally, with broad median gap on upper labium, no plate below serrations on upper jaw sheath, and a LTRF of 0/0; (20) advertisement calls not reported.

Content.—Three species: *Hyla garagoensis* Kaplan, 1991; *H. padreluna* Kaplan and Ruíz, 1997; *H. virolinensis* Kaplan and Ruíz, 1997.

Distribution.—Allopatric distributions at elevations of 1750–2200 m on the eastern and western slopes of the Cordillera Oriental in central Colombia.

Remarks.—The group was defined by Kaplan and Ruíz (1997), who assumed that the species have $2N = 30$ chromosomes; in their phylogenetic analysis, the *Hyla garagoensis* Group formed a trichotomy with the *Hyla marmorata* Group and the clade containing the *H. parviceps*, *leucophyllata*, and *microcephala* groups. We have examined no specimens of this group and have relied on data published by Kaplan (1991) and Kaplan and Ruíz (1997), who noted that males of all three species were calling but neglected to describe the calls.

HYLA LABIALIS GROUP

Definition.—(1) Moderate-sized, pond- and slow-stream-breeding frogs with males attaining SVLs of 50 mm and females 55 mm; (2) round mental gland absent; (3) preorbital ridge and lateral folds absent; (4) dorsum green with or without diffuse black spots; (5) groin and hidden surfaces of thighs blue or yellow, mottled with black; (6) venter uniformly pale; (7) digits bearing small discs; (8) nuptial excrescences and projecting prepollical spines absent in males; (9) forearms of adult males not hypertrophied; (10) axillary membrane present or absent; (11) toes one-half to two-thirds webbed; (12) nasals small, slender, widely separated medially; (13) frontoparietal fontanelle

large; (14) sphenethmoid broad; septum nasi ossified anteriorly; (15) quadratojugal absent; (16) dentigerous processes of vomers inclined posteromedially between choanae, narrowly separated medially; (17) tadpoles having moderately short tails, high fins, and pointed terminus; (18) spiracular tube attached to body wall for its entire length; (19) larval mouth small, directed anteroventrally with broad median gap on upper lip, no plate below serrations on upper jaw sheath, and a LTRF of 1/2; (20) advertisement calls consisting of short series of guttural notes.

Content.—Three species: *Hyla labialis* Peters, 1863 (*H. wilsoniana* Cope, 1882, *H. creolica* Werner, 1899, *H. serovalina* Werner, 1899, *H. gularis* Werner, 1916, and *H. wilsoniana krausi* Hellmich, 1940, are synonyms); *H. meridensis* Rivero, 1961; *H. pelidna* Duellman, 1989.

Distribution.—Allopatric distributions in upper cloud forest, subparamo, and paramo at elevations of 2180–3400 m in the Cordillera Oriental in Colombia and the Mérida Andes in Venezuela.

Remarks.—The *Hyla labialis* group was defined by Duellman and Trueb (1983) and Duellman (1989). A diploid number of 30 chromosomes was reported for *H. labialis* by Bogart (1973).

HYLA LARINOPYGION GROUP

Definition.—(1) Large, stream-breeding frogs with males attaining SVLs of 68 mm and females 77 mm; (2) round mental gland absent; (3) preorbital ridge and lateral folds absent; (4) dorsum brown, gray, or black with or without pale markings; (5) groin and hidden surfaces of thighs black or marked with black bars or mottling; (6) venter black with or without pale spots or mottling; (7) digits bearing large discs; (8) nuptial excrescences absent in males; enlarged, nonprojecting prepollex present; (9) forearms of adult males not hypertrophied; (10) axillary membrane absent; (11) toes one-third to two-thirds webbed; (12) nasals long, slender, narrowly separated medially; (13) frontoparietal fontanelle small; (14) sphenethmoid broad; septum nasi ossified anteriorly; (15) quadratojugal articulating with maxillary; (16) dentigerous processes of vomers long, transverse, posterior to choanae, abutting medially; (17) tadpoles having long, muscular tails, low fins, and pointed terminus; (18) distal one-third of spiracular tube free from body wall; (19) larval mouth large, ventral, with complete rows of marginal papillae, no plate below serrations on upper jaw sheath, and a LTRF of 4–8/6–10; (20) advertisement calls consisting of series of whistles or ticklike notes.

Content.—Nine species: *Hyla caucana* Ardila-Robayo, Ruíz-Carranza, and Roa-Trujillo, 1993; *H. larinopygion* Duellman, 1973; *H. lindae* Duellman and Altig, 1978; *H. pacha* Duellman and Hillis, 1990; *H. pantosticta* Duellman and Berger, 1982; *H. psarolaima* Duellman and Hillis, 1990; *H. ptychodactyla* Duellman and Hillis, 1990; *H. sarampiona* Ruíz-Carranza and Lynch, 1982; *H. staufferorum* Duellman and Coloma, 1993.

Table 5. Character states of seven groups of Andean *Hyla*.

Group	Characters													
	A	B	C	D	E	F	G	H	I	J	K	L	M	N
Outgroup	0	0	0	0	0	0	0	0	0	0	0	0	0	0
<i>armata</i>	0	1	1	0	0	1	1	1	2	1	1	1	1	0
<i>bogotensis</i>	0	1	0	0	1	1	0	0	1	1	1	1	0	0
<i>columbiana</i>	1	0	0	1	0	1	0	0	3	0	0	2	0	1
<i>garagoensis</i>	1	0	0	0	0	1	0	0	3	0	0	2	0	1
<i>labialis</i>	1	0	0	0	0	1	0	0	0	0	0	2	0	1

Distribution.—Most species are inhabitants of the immediate vicinity of cascading streams in cloud forests at elevations of 1900–2700 m on the slopes of the Cordillera Occidental and Cordillera Oriental in Ecuador and southern Colombia, but two species occur in the Cordillera Central in Colombia—*H. caucana* at 2400 m and *H. larinopygion* at elevations of 2200–3100 m (Ardila-Robayo et al., 1993). Most of the species are known from only one or two localities, but *H. larinopygion* is widely distributed in the Cordillera Central in Colombia, and *H. psarolaima* has an

elevational range of 1950–2660 m on the Amazonian slopes of the Cordillera Oriental in southern Colombia and Ecuador where it occurs sympatrically with *H. lindae* and *H. pacha* (Duellman and Hillis, 1990).

Remarks.—The group was defined by Duellman and Hillis (1990), who provided a key to the species and a cladistic analysis of allozymes of five species. Subsequently, additional species were described by Ardila-Robayo et al. (1993) and Duellman and Coloma (1993).

PHYLOGENETIC RELATIONSHIPS

Hypothesizing phylogenetic relationships among species in the large and morphologically diverse genus *Hyla* is hampered by the large number of species (294; updated from Duellman, 1993), inadequate knowledge about many species, and absence of reliable hypotheses of higher-level relationships. For example, it is unlikely that all groups of Andean *Hyla* are closely related. Thus, the results of our analyses are used more to provide a framework for discussing the distribution of characters rather than hypothesizing phylogenetic relationships. Herein we employ the methodology of phylogenetic systematics (Wiley, 1981) and the principles of parsimony and outgroup comparison (Farris, 1982; Watrous and Wheeler, 1981).

Ascertaining polarity of characters is problematic. Nevertheless, certain characters seem to be plesiomorphic within the genus. These are: (1) quadratojugal present and articulating with maxilla; (2) dentigerous processes of vomers inclined posteromedially and separated from one another medially; (3) prepollex not modified into a projecting spine; (4) axillary membrane absent; (5) mental gland absent; (6) nuptial excrescences present; (7) forearms of adult males not hypertrophied; (8) clusters of spines on thumb and humerus absent; (9) tadpoles with high caudal fins and pointed tail and caudal musculature not robust; (10) larval oral disc directed anteroventrally; (11) larval oral disc having median gap anteriorly in marginal papillae; (12) LTRF 2/3; (13) larval mouth lacking plate below serrations on upper jaw sheath; (14) diploid chromosome number 24. These characters are present in many neotropical species of *Hyla*, including such diverse species as *H. loquax*, *punctata*, and *smithii*, as well as most species of such diverse genera as *Pseudacris*, *Scinax*, and *Smilisca* (Duellman, 1970; Duellman and Wiens, 1992; Gaudin, 1974). Thus, these taxa can be used collectively as

an outgroup for comparisons with the groups of Andean *Hyla*.

RELATIONSHIPS AMONG ANDEAN GROUPS OF *Hyla*

Herein we make no attempt to analyze the Andean *Hyla* at the species level. Instead, each of the groups previously defined is considered as an operational taxonomic unit (OTU). Insofar as is known, the characters listed above are consistent within six of the groups; thus, each can be treated as a terminal taxon. Apomorphies support the monophyly of five of the groups. The group represented solely by *Hyla chlorostea* is not included in the analysis because only three of the 14 characters could be coded for that species, which differs from all other *Hyla* in having two derived character states—a conspicuous preorbital ridge and heavy lateral folds.

The following characters were coded for the six groups of Andean *Hyla* (Table 5). These characters and the polarity (0 = primitive; 1, 2, and 3 derived) of their states are:

A. Quadratojugal.—The quadratojugal usually articulates anteriorly with the posterior tip of the maxilla and posteriorly with the pars articularis of the palatoquadrate; thus it forms the posterior part of the maxillary arcade. In some species (e.g., *Hyla leucophyllata* and *H. parviceps*), the quadratojugal is reduced in size and does not articulate with the maxilla; in other species (e.g., *H. carnifex* and *H. labialis*), the element is absent. Apparently, progressive reduction terminates in the absence of the element; thus, the states are coded: 0 = present, articulating with maxilla; 1 = not articulating with maxilla.

B. Dentigerous processes of vomers.—Dentigerous processes of the vomers (vomeric odontophores) usually are short, posteromedially inclined, and separated medi-

ally by a distance equal to about half the breadth of a process. A derived condition is the lengthening of the processes in a transverse plane and consequent reduction of the distance between the processes. The states are coded: 0 = detigerous processes short, posteromedially inclined, broadly separated medially; 1 = detigerous processes long, transverse, narrowly separated or abutting medially.

C. Prepollex.—In most hylids, the prepollex is somewhat enlarged and provides support for the nuptial excrescences on the thumb. In some species (e.g., *Hyla lindae*), the prepollex is greatly enlarged but does not have a projecting spine, whereas in other taxa (e.g., *H. pulchella* and *H. boans* groups) the prepollex in males has a projecting spine. The transformation series is ordered: 0 = prepollex not greatly enlarged; 1 = prepollex greatly enlarged but not having a projecting spine in males; 2 = prepollex greatly enlarged with a projecting spine in males.

D. Axillary membrane.—Usually, no web of skin (axillary membrane or patagium) is present between the posterior edge of the upper arm and the flank, but this membrane is present in many species (e.g., members of the *Hyla columbiana* and *H. leucophyllata* groups). The states are coded: 0 = axillary membrane absent; 1 = extensive axillary membrane present.

E. Mental gland.—Among Andean hylids, a round, glandular structure (mental gland) is present on the chin only in males of the *Hyla bogotensis* group. The states are coded: 0 = mental gland absent; 1 = mental gland present.

F. Nuptial excrescences.—Keratinized nuptial excrescences normally are present on the medial surface of the thumb in pond-breeding hylids and in some species that breed in streams (e.g., *Hyla bistincta* group). The absence of nuptial excrescences is considered to be a derived condition; thus the states are coded: 0 = nuptial excrescences present; 1 = nuptial excrescences absent.

G. Hypertrophy of forelimbs.—Usually, the arms of adult males are not noticeably more massive than those of females, but the arms are greatly hypertrophied in adult males of some species (e.g., members of the *Hyla armata* and *H. pulchella* groups). The states are coded: 0 = forearms not hypertrophied; 1 = forearms hypertrophied.

H. Spines on thumb and humerus.—Among hylids, keratin-covered bony spines are present on the thumb and proximal ventral surface of the humerus only in *Hyla armata*. The states are coded: 0 = spines absent; 1 = spines present.

I. Larval tail.—The generalized tadpole of *Hyla* and most other genera within the family has a tail no more than twice the length of the body; the caudal fins are much higher than the caudal musculature at midlength of the tail, and the tail terminates in a pointed tip. In many groups of stream-breeding hylids (e.g., *H. bogotensis* and *H. larinopygion* groups), the tail is more than twice the length of the body, the fins are only slightly higher or equal to the height of the caudal musculature at midlength of the tail, and the tip of the tail is pointed. *Hyla armata* has a tail like

that of members of the *H. bogotensis* and *H. larinopygion* groups, but the tip of the tail is bluntly rounded. Some pond-breeding *Hyla* (e.g., *H. columbiana* and *H. leucophyllata* groups) have tadpoles with high caudal fins and the tail terminating a long, slender tip (xiphicercal condition). The states are coded: 0 = short tail with high fins and pointed tip; 1 = long tail with low fins and pointed tip; 2 = long tail with low fins and bluntly rounded tip; 3 = short xiphicercal tail. The transformation is $3 \leftarrow 0 \rightarrow 1 \rightarrow 2$.

J. Orientation of larval oral disc.—In most pond-breeding hylids, the oral disc is directed anteroventrally, whereas in diverse groups of stream-breeding *Hyla* (e.g., *H. bogotensis*, *claresignata*, *larinopygion*, and *rivularis* groups), the oral disc is enlarged and directed ventrally. The states are: 0 = disc directed anteroventrally; 1 = disc enlarged, directed ventrally.

K. Marginal papillae on larval oral disc.—The plesiomorphic condition is the existence of at least one row of marginal papillae with a broad gap in the papillae on the anterior labium of the oral disc. In most species having an enlarged, ventral oral disc, the marginal papillae extend across the anterior labium. The states are coded: 0 = gap in marginal papillae on upper labium; 1 = marginal papillae extending completely across upper labium.

L. Labial tooth row formula (LTRF).—In most pond-breeding hylids, the standard tooth-row formula in tadpoles is 2/3, but it is not uncommon to have formulae of 3/4. In some stream-breeding *Hyla* with large, ventral oral discs (e.g., *H. bogotensis* and *H. larinopygion* groups) the LTRF is much larger, whereas in some pond-breeding *Hyla* (e.g., *H. columbiana* and *H. garagoensis* groups), the LTRF is reduced to 1/2 or even 0/0. The states are coded: 0 = LTRF 2/3 or 3/4; 1 = LTRF 4/6 or greater; 2 = LTRF 1/2; 3 = LTRF 0/0. The transformation is $3 \leftarrow 2 \leftarrow 0 \rightarrow 1$.

M. Larval upper jaw sheath.—Normally, the serrate edge forms the posterior margin of the upper jaw sheath, but in *Hyla armata*, the serrated edge is bordered posteriorly by a broad, smooth plate (shelf of Cadle and Altig, 1991). The states are coded: 0 = broad plate posterior to serrations absent; 1 = broad plate posterior to serrations present.

N. Chromosome number.—The normal diploid number of chromosomes is 24 in frogs of the subfamily Hyliinae. Based on the conclusions of Bogart (1973) and Morescalchi (1973) that 30 chromosomes in some groups of *Hyla* evolved by centric fission, we follow Duellman and Trueb (1983) in considering 30 chromosomes to be a uniquely derived condition in *Hyla*. This diploid number is known in only two groups (*H. columbiana* and *H. labialis*) in the Andes, as well as in several groups (e.g., *H. leucophyllata* and *H. parviceps* groups) in the neotropical lowlands. The states are coded: 0 = 24 chromosomes; 1 = 30 chromosomes.

An analysis of the seven groups using the 14 characters with states unordered resulted in a tree having a length of 20 steps and a consistency index of 0.90 (Fig. 19). An analysis with the states polarized as noted above resulted in

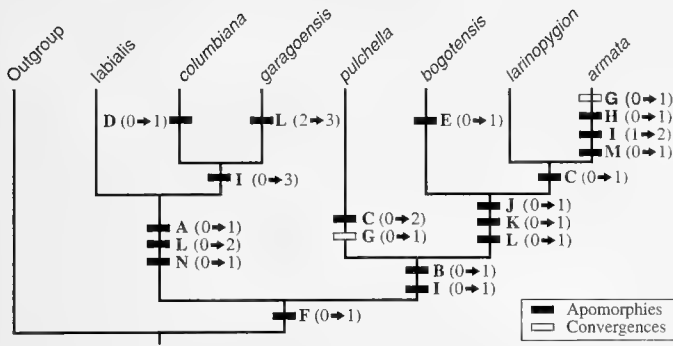

Fig. 19. Cladogram showing distribution of, and shifts in, character states within Andean groups of *Hyla*. The tree was generated by PAUP analysis using DELTRAN character optimization and has a length of 20 steps and a consistency index of 0.90. See text for states of characters A–N.

three equally parsimonious trees, each 21 steps long and having consistency indices of 0.857; the topology of one of these trees is like the one resulting from unordered character states. The differences among the three trees resulting from the analysis of polarized states are in the arrangement of the *H. bogotensis*, *larinopygion*, and *armata* groups; the only character that fluctuates in these topologies is Character C, enlargement of the prepollex and modification of the prepollex into a projecting spine in males. All four trees are consistent in sharing Character E, absence of nuptial excrescences, thereby distinguishing the Andean groups of *Hyla* from the outgroup and three characters (A, quadratojugal absent; L, labial tooth rows reduced; and N, 30 chromosomes) shared by the clade containing the *H. labialis*, *columbiana*, and *garagoensis* groups. The former is not supported by apomorphies, whereas the clade containing the *H. columbiana* and *H. garagoensis* groups is supported by one apomorphy and (I, xiphicercal tail in larvae). Within this clade, the *H. columbiana* Group has one apomorphy (D, axillary membrane present), and the *H. garagoensis* Groups has one apomorphy (L, LTRF reduced to 0/0). The other major clade containing four groups is consistently supported by two characters (B, dentigerous processes of vomers long, transverse, and narrowly separated medially; and I, larval tail with low fins and pointed tip). Within this clade, the *H. pulchella* Group is supported by one apomorphy (C, prepollex enlarged with a projecting spine in males) and one character transformation (G, hypertrophied forelimbs in males) also present in the *H. armata* Group. The clade containing the other three groups (*H. bogotensis*, *larinopygion*, and *armata*) is supported by three synapomorphies—all characters of the larval oral disc (J, disc enlarged and directed ventrally; K, marginal papillae complete across upper labium; and L, increased number of labial tooth rows). Of these three groups, the *H. bogotensis* Group has a single apomorphy (E, mental gland present). The *H. larinopygion* Group is not supported by apomorphies, whereas *H. armata* is distinguished by three apomorphies (H, spines on thumb and humerus; I, larval tail with a rounded tip; and M, broad plate posterior to

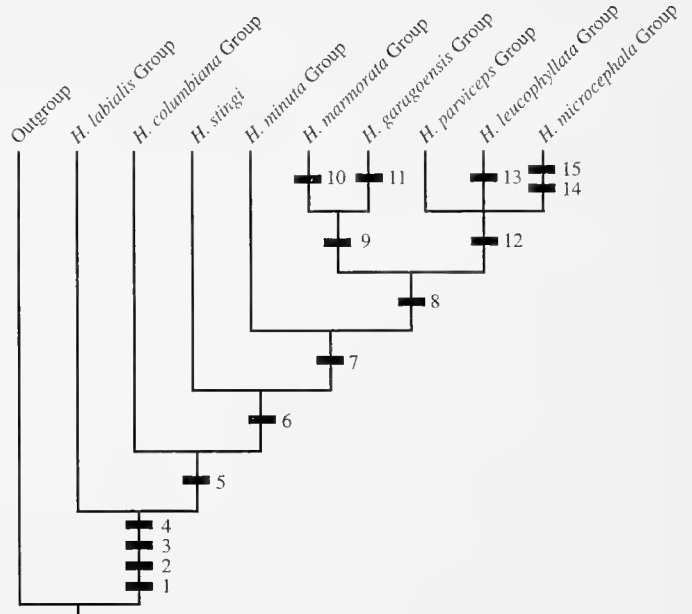

Fig. 20. Hypothesized phylogenetic relationships among *Hyla* having a diploid number of 30 chromosomes; based on Duellman and Trueb (1983), as modified by Kaplan (1994), Kaplan and Ruiz (1997), and data presented herein. Numbered synapomorphies are: 1 = 30 chromosomes, 2 = reduced quadratojugal, 3 = LTRF 1/2, 4 = nuptial excrescences absent, 5 = larval tail xiphicercal, 6 = larval mouth anterior, 7 = LTRF 0/1, 8 = LTRF 0/0, 9 = one ventral row of small labial papillae in larvae (two rows in some *H. padreluna*), 10 = extensive axillary membrane, 11 = longitudinal stripes on hind limbs of larvae, 12 = one ventral row of large papillae in larvae, 13 = larval body violin-shaped, 14 = larval body depressed, 15 = labial papillae absent in larvae.

serrations on upper jaw sheath of larvae); *H. armata* also has one character transformation (G, hypertrophied forelimbs in adult males) that also is present in the *H. pulchella* Group.

The *Hyla columbiana* and *H. labialis* groups (and presumably the *H. garagoensis* Group) differ from other Andean *Hyla* by having 30 chromosomes; this seems to relate them to several groups of species in the lowlands. This relationship is supported by the reduced features on the oral discs of the tadpoles of the *H. columbiana* and *H. labialis* groups and further reduction in the *H. garagoensis* Group and the lowland groups. On the assumption that a diploid number of 30 chromosomes is a synapomorphy for a major clade of neotropical *Hyla*, Duellman and Trueb (1983) provided a cladistic analysis which was based primarily on larval characters (Fig. 20). If, as they proposed, species of *Hyla* having 30 chromosomes represent a single phyletic lineage, the *H. columbiana*, *garagoensis*, and *labialis* groups are not related to other Andean *Hyla*. However, chromosome number must be used with caution, because the karyotypes are not known for all of the species. Among Andean *Hyla*, 30 chromosomes have been reported only for *H. labialis* (Bogart, 1973) and *H. carnifex* (Duellman and Trueb, 1983). Preparations of tissues of *H. armata* and *H. callipleura* from Peru by David C. Cannatella revealed a

diploid number of 24 chromosomes in these species. The chromosome number is not known for species in the *H. bogotensis* and *H. larinopygion* groups.

There is no compelling evidence that the other groups of Andean hylids are closely related. In the present analysis, they are united by two characters (**B**, dentigerous processes of vomers long, transverse, and narrowly separated medially; and **I**, larval tail with low fins and pointed tip). The latter character, together with Characters **J** (oral disc enlarged and directed ventrally), **K** (marginal papillae complete across upper labium), and **L** (increased LTRF), are common modifications in tadpoles among diverse groups of hylids inhabiting lotic environments. All species in several groups of stream-breeding hylids in Mexico and Central America have long, muscular tails with low fins with pointed tips and enlarged, ventral mouths with one or more rows of marginal papillae complete across the upper labium; the species of *Hyla* have LTRFs of 2/3 to 7/11 (Duellman, 1970), whereas those of *Plectrohyla* have a LTRF of 2/3 (Duellman and Campbell, 1992) and those of *Ptychohyla* have LTRFs of 2/5 to 6/9 (Campbell and Smith, 1992). Aside from Andean frogs in the *H. armata*, *bogotensis*, and *larinopygion* groups, few tadpoles adapted for life in torrential streams are known from South America. All of them have long muscular tails with low fins, large mouths directed ventrally, marginal papillae complete across the upper labium, and increased numbers of rows of labial teeth. These species are *H. claresignata* with a LTRF of 9/14 (Lutz and Orton, 1946), and *H. clepsydra* with a LTRF of 7/13 (Bokermann, 1972) in southeastern Brazil, and *Hyla aromatica* and *H. inparquesi* with LTRFs of 13/18 and 14/21, respectively, in the Guiana Highlands of southern Venezuela (Ayarzagüena and Señaris, 1993). It is unlikely that these larval characters are indicative of relationships; instead, they seem to represent convergent adaptations to lotic environments. Similar adaptive types of tadpoles are known in Australo-Papuan pelodryadine hylids of the genera *Litoria* and *Nyctimystes*, African *Heleophryne* and ranids of the genera *Conraua*, *Petropedetes*, and *Trichobatrachus*, and Asiatic pelobatids of the genus *Scutigera* and ranids of the genus *Rana* (Altig and Johnston, 1989; Duellman and Trueb, 1986).

Given the independent evolution of the same stream adaptations in tadpoles of unrelated species groups, genera, and even families of anurans, it is unlikely that the *Hyla armata*, *bogotensis*, *larinopygion*, and *pulchella* groups in the Andes had an immediate common ancestor. Of these groups, the *H. bogotensis* Group is unique in the presence of a mental gland in males, but a similar reniform or oval gland occurs in the lowland *H. granosa*, which breeds in ponds and has typical lentic tadpoles with a LTRF of 2/3 (Hoogmoed, 1979); thus, *H. granosa* may be a lowland relative of the Andean *H. bogotensis* Group, but detailed study of the glands must be undertaken to ascertain their homology. Aside from the general stream adaptations of the tadpoles and the long, transverse dentigerous processes of the vomers narrowly separated or abutting medially

(shared with the *H. larinopygion* Group), there are no characters to unite members of this group with other Andean *Hyla*. The latter also applies to the *H. larinopygion* Group, males of which have an enlarged, nonspinous prepollex and no nuptial excrescences. Similarly, Mexican frogs of the *H. distincta* Group also have enlarged, nonspinous prepollices, but these frogs have keratinized nuptial excrescences (Duellman, 1970; Duellman and Campbell, 1992). *Hyla armata* also has an enlarged nonspinous prepollex, but the prepollex (and humerus) bears keratinized spines in adult males, and the larvae are unique among Andean *Hyla* in having a bluntly rounded tail and a broad plate posterior to the serrations on the upper jaw sheath. Although no sister groups are apparent, it is possible that the *H. armata* and *H. larinopygion* groups evolved independently from separate lineages in the lowlands.

However, *Hyla armata* shares Character **G** (hypertrophied forelimbs) in males with the *H. pulchella* and *H. circumdata* groups. (See following section.) The extent of the hypertrophied forelimbs is much greater in *H. armata* than in the other taxa. Hypertrophied forelimbs also occur in adult males of the Middle American *H. distincta* Group and *Plectrohyla*; in most species of *Plectrohyla*, the cristae on the humerus are expanded, although not to the extent that they are in *H. armata* (Duellman, 1970; Duellman and Campbell, 1992).

Until more data, especially on tadpoles and skeletal features, are available, it is reasonable to assume that the *Hyla armata*, *bogotensis*, and *larinopygion* groups represent monophyletic lineages. *Hyla armata* may have been derived from a lowland lineage or be a highly derived species related to the *H. pulchella* Group. The *H. bogotensis* Group might be the sister group of *Hyla granosa*, with which it shares a mental gland in males. There is no obvious sister group to the *H. larinopygion* Group.

RELATIONSHIPS OF THE *Hyla pulchella* GROUP

Two derived characters of adult males (**C**, prepollex enlarged with a distal spine projecting medially; **G**, hypertrophied forelimbs) of the *Hyla pulchella* Group are shared with members of the *H. circumdata* Group in southeastern Brazil. This group contains 16 species: *H. alvarengai* Bokermann, 1956; *H. astartea* Bokermann, 1967; *H. biobebe* Bokermann and Sazima, 1973; *H. carvalhoi* Peixoto, 1981; *H. circumdata* Cope, 1867; *H. gouveai* Peixoto and Cruz, 1992; *Hyla hylax* Heyer, 1985; *H. ibitiguara* Cardoso, 1983; *H. ibitipoca* Caramaschi and Feio, 1990; *H. izecksohni* Jim and Caramaschi, 1979; *H. langei* Bokermann, 1966; *H. martinsi* Bokermann, 1964; *H. nanuzae* Bokermann and Sazima, 1973; *H. pseudopseudis* Miranda-Ribeiro, 1937; *H. saxicola* Bokermann, 1964 (considered to be a subspecies of *H. pseudopseudis* by Lutz, 1973, but recognized as a distinct species by Pombal and Caramaschi, 1995); *H. sazimai* Cardoso and Andrade, 1982. These frogs inhabit the interior highlands to elevations in excess of 2000 m in the states of Goiás and Minas Gerais and the coastal ranges from Espírito Santo to Rio Grande do Sul in southeastern Bra-

zil, where they breed in streams (Bokermann, 1964; Bokermann and Sazima, 1973; Cardoso, 1983; Cardoso and Andrade, 1982; Heyer, 1985; Lutz, 1973; Peixoto and Cruz, 1992). Most of the species have allopatric distributions, but three species (*H. astarteae*, *circumdata* and *hylax*) are sympatric at Boracéia at 900 m in the Serra do Mar, São Paulo, Brazil, where a member of the *H. pulchella* group (*H. prasina*) also occurs (Heyer et al., 1990).

Frogs of the *Hyla circumdata* Group are highly variable in size (adult males from 36 mm in *H. ibitipoca* and *H. sazimai* to 76 mm in *H. alvarengai* and *H. biobeba*) and are tan to reddish brown dorsally with darker brown spots or transverse bars on the dorsum; the flanks and hidden surfaces of the thighs are boldly marked with dark spots or vertical bars. (See Heyer et al., 1990, and Lutz, 1973, for color photographs of *H. circumdata*, *hylax*, and *saxicola*). The dentigerous processes of the vomers are relatively small, arched, or oblique between the posterior margins of the choanae. Adult males have distinctly hypertrophied forelimbs and projecting prepollices. In at least some species (e.g., *H. gouveai* and *H. circumdata*) the prepollical spines are simple, curved elements terminating in a sharp point. The prepollex is weakly bifid in *H. biobeba* (Bokermann and Sazima, 1973) and strongly bifid in *H. alvarengai*, *langei*, and *martinsi* (Bokermann, 1956, 1964, 1966). The tadpoles show only slight adaptations to lotic environments. All known tadpoles of the group (*H. biobeba*, *ibitiguara*, *nanuzae*, and *sazimai*) are large (60–66 mm in total length), have only slightly enlarged, anteroventral oral discs, and have moderately long tails and moderately low fins terminating in a point. Marginal papillae are complete across the upper labium in *H. ibitiguara* and *H. nanuzae*, whereas a narrow median gap is present in *H. biobeba* and *H. sazimai*; the LTRF is 2/4 in *H. biobeba* and *H. sazimai*, and 2/5 in *H. ibitiguara* and *H. nanuzae* (Bokermann and Sazima, 1973; Cardoso, 1983; Cardoso and Andrade, 1982).

Although there are many similarities between members of the *H. circumdata* and *H. pulchella* groups in structure, coloration, and larval features, only four of these can be considered synapomorphies; these are the sharp prepollical spines, hypertrophied forelimbs, larvae with moderately long tails with moderately low fins, and increased LTRF in larvae. How meaningful are these characters?

The elongation of the prepollex into a curved spinous structure is unequivocally a derived character state in hyliid frogs. Prepollical spines are present (and nuptial excrescences absent) in five groups of *Hyla* inhabiting the neotropical lowlands—*H. albomarginata* Group (8 species), *H. albopunctata* Group (5 species), *H. boans* Group (8 species), *H. geographica* Group (6 species), *H. granosa* Group (3 species)—and *Plectrohyla* (16 species) in nuclear Central America. Examination of skeletal preparations of representative species in these groups revealed that the prepollical spines vary from shallowly sigmoid to crescent shaped in nearly all species examined; therefore, the spines are like the nonbifid spines in the *H. circumdata* and *H. pulchella* groups. In *H. granosa*, the proximal half of the

prepollex is a quadrangular plate, from the distal edge of which a sharp spine curves medially. The tips of the spines are not sharply pointed in *H. albopunctata*, *calcarata*, and *geographica*. In *Plectrohyla*, there is a transformation series from blunt spines to simple pointed spines to bifid pointed spines (Duellman and Campbell, 1992).

Although none of the species in these five groups of *Hyla* has noticeably enlarged forelimbs, elaborations of the cristae on the humerus were noted in the *Hyla boans* Group. The crista medialis is expanded in *H. boans*, *crepitans*, *faber*, *pardalis*, and barely so in *H. rosenbergi*, whereas the crista ventralis also is expanded in *H. faber*. Male-male combat using prepollical spines has been observed in three of these species—*H. faber* (Lutz, 1960), *H. pardalis* (Lutz, 1973), and *H. rosenbergi* (Kluge, 1981). In most species of *Plectrohyla*, the cristae are expanded; although male-male combat has not been observed in *Plectrohyla*, scars on adult males of *P. hartwegi* and *P. teuchestes* are consistent with wounds caused by prepollical spines (Duellman and Campbell, 1992).

Frogs of the *Hyla albomarginata*, *albopunctata*, *boans*, and *geographica* groups have distinctive dentigerous processes of the vomers. Each process is angulate with a median transverse section continuous with a much longer posterolateral section; the median section generally is between the posterior margins of the choanae, and the posterolateral sections extend to, nearly to, or overlap the neopalatines, which have ventral ridges. Similar dentigerous processes are characteristic of *Osteocephalus*, but the two sections of each process are nearly equal in length, and the posterolateral section is widely separated from the neopalatine (Trueb and Duellman, 1971). The dentigerous processes in species in the *H. granosa* group are relative small, slightly arched structures between the posterior margins of the choanae.

The larvae of these groups are typical pond-type tadpoles with the tail no more than twice the length of the body, relatively high caudal fins terminating in a point, and relatively small oral discs directed anteroventrally with a median gap in the marginal papillae on the upper labium. Most species have a LTRF of 2/3, but *Hyla rufitela* in the *H. albomarginata* Group, and *H. faber*, *pardalis*, and *rosenbergi* in the *H. boans* Group have LTRFs of 2/4 (Bokermann, 1968; Cei, 1980; Duellman, 1970).

The presence of enlarged prepollical spines lacking a quadrangular base is a synapomorphy of the *Hyla albomarginata*, *albopunctata*, *boans*, *circumdata*, *geographica*, and *pulchella* groups. Prepollical spines apparently evolved independently in *Plectrohyla* from an ancestor having a moderately enlarged, blunt spine (represented by the sister group, the *H. bistrincta* Group) (Duellman and Campbell, 1992). The prepollical spine in the *H. granosa* Group, which has distinctly different dentigerous processes of the vomers, is structurally different and apparently represents another independent evolution. The combined *H. circumdata-pulchella* Group is distinguished by a single

synapomorphy, hypertrophied limbs in adult males. We are unaware of any synapomorphies that distinguish the *H. circumdata* Group from the *H. pulchella* Group, so we combine these into a single group, the *H. pulchella* Group. This group is distinguished from the other groups with prepollical spines by having hypertrophied forelimbs in adult males. A single derived character (angulate denticulate processes of the vomers) is a synapomorphy for the

H. albomarginata, *albopunctata*, *boans*, and *geographica* groups. The *H. pulchella* Group is especially diverse with 20 species in streams in mountainous regions in southeastern Brazil, one species (*H. pulchella*) in the lowlands of southeastern Brazil and the Platine Region, one taxon (*H. pulchella cordobae*) in the isolated Cordillera de Córdoba, and eight taxa (the seven species recognized here, plus *H. pulchella riojana*) in the Andes.

DISCUSSION

Our original purpose was to review the systematic status of species of *Hyla* in the Andes of Argentina, Bolivia, and Peru. Our confidence in the taxonomic conclusions is clouded by four factors: (1) the unknown status of *H. pulchella riojana* in the Andes to the south of the known range of *H. andina*, (2) the absence of data on the tadpoles and advertisement calls of some of the species, (3) the existence of another, apparently undescribed, species in the *H. armata* Group now known only from tadpoles, and (4) incomplete knowledge of the skeletal features of many of the species. Nonetheless, we consider our efforts at the alpha taxonomic level to be an important contribution to the taxonomy of Andean *Hyla*.

It is evident from the section on phylogenetic relationships that existing knowledge of South American frogs now placed in the genus *Hyla* is too meager to permit meaningful phylogenetic analyses. Complete data sets—external morphology of adults, osteology, tadpoles, advertisement calls, and karyotypes—exist for probably less than 20% of the species. Although tissues for molecular analyses are being acquired, material is insufficient at this time for meaningful systematic analyses of relationships among

the diverse phenetic groups of *Hyla*. However, on the basis of our incomplete data on morphology, we are reasonably confident that the eight groups of Andean *Hyla* defined herein are natural groups. Obviously, thorough documentation of the extralimital relationships of all of the Andean groups of *Hyla* is not only beyond the scope of this paper but is not feasible at this time. We concur with previous suggestions that the *H. columbiana*, *garagoensis*, and *labialis* groups are most closely related to groups that have a diploid number of 30 chromosomes and that inhabit the tropical lowlands. Also, we have provided evidence that the *H. pulchella* Group is monophyletic and includes species formerly recognized in the *Hyla circumdata* Group in southeastern Brazil. Finally, we have noted that the peculiar mental gland that is a synapomorphy of species in the *H. bogotensis* Group may be shared with *H. granosa* in the cis-Andean lowlands; but it is unknown if the gland in the latter is homologous with that in the *H. bogotensis* group. Hopefully, the suggestions made herein will inspire our colleagues and future workers to investigate these fascinating problems; we wish them well in their endeavors.

LITERATURE CITED

- Andersson, L. G. 1938. Batrachians from Burma collected by Dr. R. Malaise and from Bolivia and Ecuador collected by Dr. C. Hammerlund. *Arkiv för Zoologi* 30A:1–24.
- Altig, R., and G. F. Johnston. 1989. Guilds of anuran larvae: relationships among developmental modes, morphologies, and habitats. *Herpetological Monographs* 3:81–109.
- Ardila-Robayo, M. C., P. M. Ruiz-Carranza, and S. H. Roa-Trujillo. 1993. Una nueva especie de *Hyla* del grupo *larinopygion* (Amphibia: Anura: Hylidae) del sur de la Cordillera Central de Colombia. *Revista de Academia Colombiana de Ciencias* 18:559–565.
- Ayarzagüena, J., and J. C. Señaris. 1993. Dos nuevas especies de *Hyla* (Anura: Hylidae) para las cumbres tepuyanas de Estado Amazonas, Venezuela. *Memorias de la Sociedad de Ciencias Naturales La Salle* 53:127–146.
- Barrio, A. 1965. Las subespecies de *Hyla pulchella* Duméril y Bibron (Anura: Hylidae). *Physis* 25:115–128.
- Berg, C. 1896. Batracios Argentinos. Enumeración sistemática, sinonímica y bibliográfica de los batracios de la República Argentina. *Anales del Museo Nacional de Historia Natural de Buenos Aires* 5:147–226.
- Bogart, J. P. 1973. Evolution of anuran karyotypes. Pp. 337–349 in J. L. Vial (ed.), *Evolutionary Biology of the Anurans*. Columbia: Missouri: Univ. Missouri Press, xii + 470.
- Bokermann, W. C. A. 1956. Sobre uma nova espécie de *Hyla* do Estado de Minas Gerais, Brasil. *Papéis Avulsos do Departamento do Zoologia, Secretaria da Agricultura, São Paulo* 12:357–362.
- Bokermann, W. C. A. 1964. Dos nuevas especies de *Hyla* de Minas Gerais y notas sobre *Hyla alvarengai* Bok. (Amphibia, Salientia, Hylidae). *Neotropica* 10:67–76.
- Bokermann, W. C. A. 1966. "1965." *Hyla langei*, a new frog from Paraná, southern Brasil. *Journal of the Ohio Herpetological Society* 5:49–51.
- Bokermann, W. C. A. 1968. Observações sobre *Hyla pardalis* Spix (Anura: Hylidae). *Revista da Brasileira Biologia* 28:1–5.
- Bokermann, W. C. A. 1972. Notas sobre *Hyla clepsydra* A. Lutz (Anura, Hylidae). *Revista da Brasileira Biologia* 32:291–295.
- Bokermann, W. C. A., and I. SAZIMA. 1973. Anfíbios da Serra do Cipó, Minas Gerais, Brasil. 1—Especies novas de "Hyla" (Anura, Hylidae). *Revista Brasileira de Biologia* 33:329–336.
- Boulenger, G. A. 1882. *Catalogue of the Batrachia Salientia s. Ecaudata in the Collection of the British Museum*. Ed. 2. London: British Museum (Natural History), xvi + 530, pls. 1–30.
- Boulenger, G. A. 1887. Descriptions of new or little-known South American frogs of the genera *Pahudicola* and *Hyla*. *Annals Magazine of Natural History* (5)20:295–300.
- Boulenger, G. A. 1898. A list of the reptiles and batrachians collected by the late Prof. L. Balzan in Bolivia. *Annali del Museo Civico di Storia Naturale Genova* (2)19:128–133.
- Boulenger, G. A. 1902. Descriptions of new batrachians and reptiles from the Andes of Peru and Bolivia. *Annals Magazine of Natural History* (7)10:394–402.
- Boulenger, G. A. 1912. Descriptions of new batrachians from the Andes of South America, preserved in the British Museum. *Annals Magazine of Natural History* (8)10:185–191.
- Cadle, J. E., and R. Altig. 1991. Two lotic tadpoles from the Andes of southern Peru: *Hyla armata* and *Bufo veraguensis*, with notes on the call of *Hyla armata* (Amphibia: Anura: Hylidae and Bufonidae). *Studies on Neotropical Fauna and Environment* 26:45–53.

- Campbell, J. A., and E. N. Smith. 1992. A new frog of the genus *Ptychohyla* (Hylidae) from the Sierra de Santa Cruz, Guatemala, and description of a new genus of Middle American stream-breeding treefrogs. *Herpetologica* 48:153–167.
- Cardoso, A. J. 1983. Descrição e biologia de uma espécie de *Hyla* Laurenti, 1768 (Amphibia, Anura, Hylidae). *Iheringia Zoologia* 62:37–45.
- Cardoso, A. J., and G. V. Andrade. 1982. Nova espécie de *Hyla* do Parque Nacional Serra da Canastra (Anura, Hylidae). *Revista Brasileira de Biologia* 42:589–593.
- Carrizo, G. R. 1992. Cuatro especies nuevas de anuros (Bufonidae: *Bufo* e Hylidae: *Hyla*) del norte de Argentina. *Cuadernos de Herpetologia* 7:14–23.
- Cei, J. M. 1980. Amphibians of Argentina. *Monitore Zoologico Italiano*, (N.S.) Monograph 2:1–609.
- Charis, R. A., S. Mitchell, and C. W. Clark. 1995. *Canary 1.2 User's Manual*. Ithaca, New York: Cornell Laboratory of Ornithology, 229.
- De la Riva, I. 1990. Lista preliminar comentada de los anfibios de Bolivia con datos sobre su distribución. *Bollettino del Museo Regionale di Scienze Naturali Torino* 8:261–319.
- Dingerkus, G., and L. D. Uhler. 1977. Enzyme clearing of alcian blue stained whole small vertebrates for demonstration of cartilage. *Stain Technology* 52:229–232.
- Dixon, W. J. 1981. *BMDP Statistical Software*. Berkeley: University of California Press, 726.
- Duellman, W. E. 1970. The hylid frogs of Middle America. Monograph of the Museum of Natural History, The University of Kansas 1:xi + 753, pls. 1–72.
- Duellman, W. E. 1972. A review of the neotropical frogs of the *Hyla bogotensis* group. *Occasional Papers of the Museum of Natural History, The University of Kansas* 11:1–31.
- Duellman, W. E. 1979. The herpetofauna of the Andes: patterns of distribution, origin, differentiation, and present communities. Pp. 371–459 in W. E. Duellman (ed.), *The South American herpetofauna: its origin, evolution, and dispersal*. Monograph of the Museum of Natural History, The University of Kansas 7:1–485.
- Duellman, W. E. 1989. New species of hylid frogs from the Andes of Columbia and Venezuela. *Occasional Papers of the Museum of Natural History, The University of Kansas* 131:1–12.
- Duellman, W. E. 1993. Amphibians species of the world: additions and corrections. Special Publication Museum of Natural History, The University of Kansas 21:1–372.
- Duellman, W. E., and J. A. Campbell. 1992. Hylid frogs of the genus *Plectrohyla*: systematics and phylogenetic relationships. *Miscellaneous Publication of the Museum of Zoology, The University of Michigan* 181:1–32.
- Duellman, W. E., and L. A. Coloma. 1993. *Hyla staufferorum*, a new species of treefrog in the *Hyla larinopygion* group from the cloud forests of Ecuador. *Occasional Papers of the Museum of Natural History, The University of Kansas* 161:1–11.
- Duellman, W. E., and D. M. Hillis. 1990. Systematics of the frogs of the *Hyla larinopygion* group. *Occasional Papers of the Museum of Natural History, The University of Kansas* 134:1–23.
- Duellman, W. E., and L. Trueb. 1983. Frogs of the *Hyla columbiana* group: taxonomy and phylogenetic relationships. Pp. 33–51 in A. G. J. Rhodin and K. Miyata (eds.), *Advances in Herpetology and Evolutionary Biology*. Cambridge, Mass.: Museum of Comparative Zoology, Harvard University, xix + 725.
- Duellman, W. E., and L. Trueb. 1986. *Biology of Amphibians*. New York: McGraw-Hill Book Co., xvii + 670.
- Duellman, W. E., and J. J. Wiens. 1992. The status of the hylid frog genus *Oloolygon* and the recognition of *Scinax* Wagler, 1830. *Occasional Papers of the Museum of Natural History, The University of Kansas* 151:1–23.
- Duellman, W. E., and E. R. Wild. 1993. Anuran amphibians from the Cordillera de Huancabamba, northern Peru: systematics, ecology, and biogeography. *Occasional Papers of the Museum of Natural History, The University of Kansas* 157:1–53.
- Duméril, A. M., and G. Bibron. 1841. *Erpétologie Générale, ou Histoire Naturelle des Reptiles*. Vol. 8. Paris: Roret, ii + 732.
- Faivovich, J. 1996. La larva de *Hyla semiguttata* A. Lutz, 1925 (Anura, Hylidae). *Cuadernos de Herpetologia* 9:61–67.
- Farris, J. S. 1982. Outgroups and parsimony. *Systematic Zoology* 31:328–334.
- Frost, D. R. 1985. *Amphibian Species of the World. A Taxonomic and Geographic Reference*. Lawrence, Kansas: Allen Press, Inc. and The Association of Systematics Collections. v + 732.
- Gaudin, A. J. 1974. An osteological analysis of holarctic tree frogs, family Hylidae. *Journal of Herpetology* 8:141–152.
- Gosner, K. L. 1960. A simplified table for staging anuran embryos and larvae with notes on identification. *Herpetologica* 16:183–190.
- Heyer, W. R. 1985. New species of frogs from Boracéia, São Paulo, Brazil. *Proceedings of The Biological Society of Washington* 98:657–671.
- Heyer, W. R., A. S. Rand, C. A. G. da Cruz, O. L. Peixoto, and C. E. Nelson. 1990. Frogs of Boracéia. *Arquivos de Zoologica, Museu de Zoologia de Universidade de São Paulo* 31:231–410.
- Hoogmoed, M. S. 1979. Resurrection of *Hyla ornattissima* Noble (Amphibia, Hylidae) and remarks on related species of green tree frogs from the Guiana area. Notes on the herpetofauna of Surinam VI. *Zoologische Verhandelingen, Leiden* 172:1–46.
- Kaplan, M. 1991. A new species of *Hyla* from the eastern slope of the Cordillera Oriental in northern Colombia. *Journal of Herpetology* 25:313–316.
- Kaplan, M. 1994. A new species of frog of the genus *Hyla* from the Cordillera Oriental in northern Colombia, with comments on the taxonomy of *Hyla minuta*. *Journal of Herpetology* 28:79–87.
- Kaplan, M., and P. M. Ruiz. 1997. Two new species of *Hyla* from the Andes of central Colombia and their relationships to other small Andean *Hyla*. *Journal of Herpetology* 31:230–244.
- Klappenbach, M. A., and J. A. Langone. 1992. Lista sistemática y sinonímica de los anfibios del Uruguay. Con comentarios y notas sobre su distribución. *Anales del Museo Nacional de Historia Natural de Montevideo* 8:163–222.
- Kluge, A. G. 1981. The life history, social organization, and parental behavior of *Hyla rosenbergi* Boulenger, a nest-building gladiator frog. *Miscellaneous Publication of the Museum of Zoology, The University of Michigan* 160:1–170.
- Köhler, J., P. L. Ibsch, L. Dirksen, and W. Böhme. 1995. Zur Herpetofauna der semihumiden Samaipata-Region, Bolivien I. *Amphibien. Herpetofauna* 17:13–24.
- Koslowky, J. 1895. Batracios y reptiles de La Rioja y Catamarca, recogidos durante los meses de febrero a mayo de 1895. *Revista del Museo de La Plata* 6:333–344.
- La Marca, E. 1985. Systematics and ecological observations on the neotropical frogs *Hyla jahni* and *Hyla platydictyla*. *Journal of Herpetology* 19:227–237.
- Lavilla, E. O. 1980. "1977." Larvas de *Hyla pulchella andina* (Anura: Hylidae) de la Sierra de Metan (Salta, Argentina): notas preliminares sobre su habitat y comportamiento. I Reunión Iberoamericano de Zoología de Vertebrados (La Rábida, Spain):473–491.
- Lavilla, E. O. 1984. Descripción de larvas de *Hyla pulchella andina* (Anura: Hylidae) con un analisis de la variabilidad interpopulacional. *Neotropica* 30(83):19–30.
- Lavilla, E. O., and M. Fabrezi. 1987. Anatomía de larvas de *Hyla pulchella andina* (Anura: Hylidae). *Physis* 45:77–82.
- Leviton, A. E., R. H. Gibbs, Jr., E. Heal, and C. E. Dawson. 1985. Standards in herpetology and ichthyology: Part I. Standard symbolic codes for institutional resource collections in herpetology and ichthyology. *Copeia* 1985:802–832.
- Lutz, B. 1960. Fighting and incipient notion of territoriality in male tree frogs. *Copeia* 1960:61–63.
- Lutz, B. 1968. New Brazilian forms of *Hyla*. *Pearce-Sellards Series, Texas Memorial Museum* 10:1–19.
- Lutz, B. 1973. *Brazilian Species of Hyla*. Austin: University of Texas Press, xix + 260.
- Lutz, B., and G. L. Orton. 1946. *Hyla claresignata* Lutz & B. Lutz, 1939. Aspects of the life history and description of the rhyacophilus tadpole. (Salientia, Hylidae). *Boletim do Museu Nacional, Rio de Janeiro* 70:1–20.
- Márquez, R., I. De la Riva, and J. Bosch. 1993. Advertisement calls of Bolivian species of *Hyla* (Amphibia, Anura, Hylidae). *Biotropica* 25:426–443.
- Morescalchi, A. 1973. Amphibia. Pp. 233–248 in A. B. Chiarelli and E.

- Capanna eds.), *Cytotaxonomy and Vertebrate Evolution*. New York: Academic Press.
- Müller, L. 1924. "1923." Ueber neue oder seltene Mittel- und südamerikanische Amphibien und Reptilien. Mitteilungen aus dem Zoologischen Museum in Berlin 11:77-93.
- Myers, C. W., and W. E. Duellman. 1982. A new species of *Hyla* from Cerro Santiago, and other tree frog records and geographical notes from western Panama. *American Museum Novitates* 2752:1-32.
- Nieden, F. 1923. Anura I. Subordo Aglossa und Phaneroglossa. Sectio i. Arcifera. *Das Tierreich* 46:xxxii + 548.
- Orbigny, A. d'. 1847. *Voyage a l'Amérique Meridionale*. Vol. 5. Paris: P. Bertrand.
- Orton, G. L. 1953. The systematics of vertebrate larvae. *Systematic Zoology* 2:63-57.
- Peixoto, O. L., and C. A. G. de Cruz. 1992. New species of *Hyla* from the "Serra da Mantiqueira, Itatiaia, Rio de Janeiro" State—(Amphibia, Anura, Hylidae). *Memorias do Instituto Oswaldo Cruz* 87 (Supplement 1):197-200.
- Pombal, J. P., Jr., and U. Caramaschi. 1995. Posição taxonômica de *Hyla pseudopseudis* Miranda-Ribeiro, 1937 e *Hyla saxicola* Bokermann, 1964 (Anura; Hylidae). *Boletim do Museu Nacional, Rio de Janeiro, Zoologia* 363:1-8.
- Reynolds, R. P., and M. S. Foster. 1992. Four new species of frogs and one new species of snake from the Chapare region of Bolivia, with notes on other species. *Herpetological Monographs* 6:83-104.
- Ruiz-Carranza, P. M., and M. C. Ardila-Robayo. 1991. Una nueva especie de *Hyla* del grupo *bogotensis* (Amphibia: Anura: Hylidae) de la Cordillera Oriental de Colombia. *Caldasia* 16:337-342.
- Ruiz-Carranza, P. M., M. C. Ardila-Robayo, and J. D. Lynch. 1996. Lista actualizada de la fauna de Amphibia de Colombia. *Revista de la Academia Colombiana de Ciencias Exactas. Físicas y Naturales* 20:365-415.
- Ruiz-Carranza, P. M., and J. D. Lynch. 1982. Dos nuevas especies de *Hyla* (Amphibia: Anura) de Colombia, con aportes al conocimiento de *Hyla bogotensis*. *Caldasia* 13:647-671.
- Savage, J. M., and W. R. Heyer. 1967. Variation and distribution in the tree-frog genus *Phyllomedusa* in Costa Rica, Central America. *Beiträge zur Neotropischen Fauna* 5:111-131.
- Swofford, D. L. 1991. *PAUP: Phylogenetic Analysis Using Parsimony*. Version 3.0. Champaign, Illinois: Illinois Natural History Survey.
- Trueb, L. 1993. Patterns of cranial diversity among the Lissamphibia. Pp. 255-243 in J. Hanken and B. K. Hall (eds.), *The Skull. Vol. 2. Patterns of Structure and Systematic Diversity*. Chicago: University of Chicago Press, xiii + 566.
- Trueb, L., and W. E. Duellman. 1971. A synopsis of neotropical hylid frogs, genus *Osteocephalus*. *Occasional Papers of the Museum of Natural History, The University of Kansas* 1:1-47.
- Vellard, J. 1970. Contribución al estudio de los batracios andinos. *Revista del Museo Argentino de Ciencias Naturales, Zoología* 10:1-21.
- Watrous, L. E., and Q. D. Wheeler. 1981. The outgroup comparison method of character analysis. *Systematic Zoology* 30:1-11.
- Wiley, E. O. 1981. *Phylogenetics. The Theory and Practice of Phylogenetic Systematics*. New York: John Wiley and Sons, xv + 439.

APPENDIX

SPECIMENS EXAMINED

Localities are given only for those specimens of the *Hyla armata* and *Hyla pulchella* groups from the Andes. Some specimens in the Museo de Historia Natural Noel Kempff Mercado (MNK) have not been catalogued; they are referenced by the field numbers of Michael B. Harvey (MBH) and Eric N. Smith (ENS). Other taxa are listed only by museum codes and numbers; unless specified otherwise, specimens are standard alcoholic preparations; C&S = cleared-and-stained skeletal preparations.

Hyla alborigra

BOLIVIA: *Cochabamba*: Cochabamba, 2600 m, ZSM 18/1949 (8); Incachaca, 2500 m, AMNH 39565-67; Río Julpe, 30 km S Totorá, Prov. Mizque, 2000 m, EBD 28925 (C&S), 28926-28. *Chuquisaca*: Puka Khara, NHRM 1873 (7) (syntypes of *Hyla ocapia*); Río Tomoyapo, 1 km E Iscayachi, 3416 m, MNK 840-46, 851, 858; Tacopaya, MNHN 4817 (2) (syntypes of *Hyla zebra*).

Hyla andina

ARGENTINA: *Catamarca*: Arroyo del Durazno, 19 km N La Merced, 750 m, KU 160410-21, 160408 (tadpoles), 160409 (young); 3.5 km NE La Merced, KU 160370-406, 160407 (tadpoles); Nacimiento, ZSM 18/1922 (3) (syntypes). *Jujuy*: 8.3 km SSW Perico del Carmen, 1230 m, KU 160342-60, 160361-62 (skeletons), 160363 (young), 160364 (tadpoles); Río Grande, 10 km N Tilcara, 2670 m, 160337-41. *Salta*: Finca Jakulika, 560 m, KU 182964-67. *Tucumán*: El Cadillal, 500 m, KU 160368, 160369 (young); Hualinchaí, 8 km W San Pedro de Colalao, KU 128922-26, 128927 (skeleton); Tafecillo, 1275 m, KU 182958-59; 21 km SSE Tafí del Valle, 1600 m, KU 160365, 160366 (tadpoles), 160367; Km 38, Tafí del Valle-Amaicha del Valle road, 1390 m, KU 182960, 182961 (C&S), 182962; Km 44. Tafí del Valle-Amaicha del Valle road, 1640 m, KU 182963.

BOLIVIA: *Cochabamba*: Carahuasi, Prov. Carrasco, UTA 39668-69; Cochabamba, 2600 m, KU 125378, 126083, 154614; 62.7 km E Cochabamba on road to Villa Tunari, USNM 257834; 76.8 km from Cochabamba on road to Villa Tunari, USNM 257835-44; 10 km N Colomi, Prov. Chapare, 3400 m, CET A122-27; 8.6 km N El Empalme, road to Cochabamba, UTA 39670-90; 2.9 km S Epizana, 3070 m, KU 183385-93, 183814 (tadpoles), 183815 (eggs); 3 km S Epizana, 2825 m, KU 160143, 160144 (tadpoles);

34.2 km W Epizana, 3260 m, KU 183394-95; Río Chua Kocha, 9 km N Santa Cruz de la Sierra-Cochabamba road, Prov. Carrasco, 2200 m, CET A144-45; Río Corani, on road to Tablamontes, Prov. Chapare, 2400 m, CET A138-143; Serranía de La Siberia, 45 km from Comarapa on road to Pojo, Prov. Carrasco, 2500 m, CET A133-35; near Tiraque, about 78 km from Cochabamba on road to Santa Cruz de la Sierra, Prov. Arani, 3550 m, CET A136-37; Totorá, USNM 93218. *La Paz*: Cota Cota, Prov. Murillo, USNM 281287, 281289-93, 281295-97, 281383-91, 281473. *Potosí*: 6 km W Betanzos, 3330 m, KU 160195; Río Tupiza, 12.5 km SSE Tupiza, 2920 m, KU 160236-42, 160243 (skeleton). *Santa Cruz*: Comarapa, Prov. Caballero, 1800 m, CET A117-21; Río Comarapa, Prov. Caballero, 1750 m, CET A128-32; 5 km E Samaipata, Prov. Florida, 1650 m, CET A116; Vallegrande, Prov. Vallegrande, 2100 m, CET A146.

Hyla armata

BOLIVIA: *Cochabamba*: Carahuasi, Prov. Carrasco, CET A-484-85 (tadpoles); 0.75 km E Khara Huasi, Prov. Carrasco, UTA 40035; Miguelito, 99 km from Cochabamba on road to Villa Tunari Chapare Prov., 1769 m, USNM 257812-17; Paracti, 83 km from Cochabamba on road to Villa Tunari, Chapare Prov., 2044 m, USNM 257818; Río Chua Kocha, 9 km N Santa Cruz, 2200 m, CET A39-40, MNK 963; 68.8 km SW Villa Tunari, 1860 m, KU 183299-325. *La Paz*: 10 km down from Chuspipata, 2350 m, MNHN B140; La Paz, BMNH 1947.2.13.59-60 (syntypes); Serranía Bellavista, 1450 m, CET A41-42, CET A483 (tadpole). *Santa Cruz*: El Chapé, Prov. Florida, MNK (MBH 1280, 1561, ENS 3590, 3593-94, 3611, 3621), UTA 40032-34, 40036-37; Quebrada Huertillas, Prov. Florida, MNK (ENS 3630), UTA 40038-39.

PERU: *Ayacucho*: Tutumbaro, Río Piene, 1840 m, KU 163345. *Cuzco*: 1 km W Amaybamba, tributary of Río Santa María, FMNH 235542 (tadpoles). Buenos Aires, 2400 m, KU 173219-22; Hacienda Huyro, between Huayopata and Quillabamba, 1720 m, KU 196832, LSU 32061-62; Río Cosñipata, 4 km SW Santa Isabel, 1700 m, KU 163322-33, 163334 (C&S), 163335-44, 164085 (skeleton), 164086-87 (C&S). *Puno*: Río Quiquira, 1 km N Abra Marrancunca, 2000 m, USNM 299310-38; MHNSM 10348, 10350.

Hyla balzani

BOLIVIA: *Cochabamba*: Charuplaya, 1350, BMNH 1947.2.13.64-73 (syntypes of *H. callipleura*), NHMW 6223 (2); Chicotal, Prov. Chapare, KU 148602-03 (skeletons); Miguelito, 99 km from Cochabamba on road

to Villa Tunari, Prov. Chapare, USNM 257819–21; 2.5 km NW of Miguelito, Prov. Chapare, 1769 m, USNM 257822–26; Paracti, 83 km from Cochabamba on road to Villa Tunari, Prov. Chapare, 2044 m, Puente de la Vía, Yungas Valley, BMNH 1940.4.9.99; USNM 257827–33; San Ernesto, 500 m, BMNH 1947.2.13.74 (syntype of *H. callipleura*); Serranía Bellavista, Prov. Noryungas, 1450 m, CET A99–100; Tablasmontes, Prov. Chapare, 2,400 m, CET A93, A96–98, A107, A110–15; 58.1 km W Villa Tunari, 1980 m, KU 183326–29; no specific locality, BMNH 1919.11.12.16, UMMZ 68173 (10), 68174 68175 (21), USNM 93222. *La Paz*: 4.4 km E Chulumani, 1760 m, KU 183330–34, 183425; Coroico, 1750 m, 183337–46, 183320–21 (tadpoles); 33.9 km E Unduavi, 2160 m, KU 183335–36; Yungas, between Coroico and Chulumani, MSNG 28872 (holotype). *Santa Cruz*: 10 km NW Masicuri, CET A1453.

PERU: “Kalinourhin,” NHMW 18448. *Cuzco*: 72 km (by road) N Paucartambo, USNM 298210; 73 km (by road) N Paucartambo, USNM 298211–13; 74 km (by road) N Paucartambo, USNM 298214–18; 75 km (by road) N Paucartambo, USNM 298219–21; 4 km WSW Santa Isabel, KU 139212, 163315–18, 164052–53 (tadpoles), 164054 (young). *Junín*: Chanchamayo, BMNH 1911.12.13.81–82. *Pasco*: Huancabamba, 925 m, BMNH 1911.12.13.63, 1912.11.1.25. *Puno*: Abra Marracuna, 14 km W Yanahuaya, 2210 m, USNM 299399–49; Cerros de Tavará, 900 m, USNM 332412–14; Juliaca, AMNH 6121–28; La Unión, Río Huacamayo, Carabaya, 620 m, BMNH 1907.5.7.33; 11 km (airline) NNE Ollachea, 1880 m, USNM 298953–58; Santo Domingo, Carabaya, 1850 m, BMNH 1902.11.28.17–21, 1903.6.30.16–17, 1907.5.7.34–35.

Hyla marianitae

ARGENTINA: *Salta*: Río Pescado, Serranía de las Pavas, SW part of Parque Nacional Baritú, Depto. Orán, MACN 32330 (holotype).

BOLIVIA: *Cochabamba*: Carahuasi, Serranía de La Siberia, 18 Km N Santa Cruz de la Sierra on road to Cochabamba, 1700 m, CET A85–88, A90, A95, A101–06, A108, A838, MNK (MBH 1559, 1680, ENS 3874), UTA 40027–29; 2 km from Carahuasi on road to Río Grande, Prov. Carrasco, UTA 40026. *Santa Cruz*: El Chapé, Prov. Florida, MNK (MBH 2671–72); Arroyo Las Juntas, 8 km NW Samaipata, Prov. Florida, 1400 m, CET A89; El Chape, Prov. Florida, UTA 40025; Quebrada El Fuerte, 5.1 km E Samaipata, UTA 40030–31; Quebrada Huertillas, Prov. Florida, MNK (ENS 3637), UTA 40024; Río Cheyo, Prov. Ichilo: Parque Nacional Amboró, 700 m, CET A109; stream between La Angostura and Bermejo, Prov. Florida, 800 m, CET A91–92, A94.

Hyla melanopleura

PERU: *Pasco*: Huancabamba, 900 m, BMNH 1947.2.13.45–58 (syntypes).

Hyla palaestes

PERU: *Ayacucho*: San José, Río Santa Rosa, 1005 m, KU 196844–53, LSU 26002–15; Tutumbaro, Río Piene, 1840 m, KU 163305 (holotype), 163306–14, 164051 (tadpoles), 164092 (skeleton).

OTHER MATERIAL EXAMINED

Hyla albomarginata: KU 91925, 91926 (skeleton), 91927, 211294 (larvae); *H. albopunctata*: KU 91931–33, 91936 (skeleton). 146854 (larvae); *H. albosignata*: KU 91937–40, 91942 (skeleton), 211297 (larvae); *H. alytolylax*: KU 117982–84, 111904 (C&S), 120851–60, 166310 (C&S), 180351 (larvae); *H. boans*: KU 104408–09 (skeletons), 109428 (larvae), 150020–24; *H. bogotensis*: KU 169434–60, 170109 (C&S); *H. calcarata*: KU 105396 (skeleton), 112355–56 (larvae), 122658–65; *H. callipeza*: KU 169566–70; *H. carnifex*: KU 98142 (C&S), 111867–68 (C&S), 166311–14 (C&S); 111838–66, 112360 (larvae); *H. caucana*: KU 189598; *H. chlorostea*: USNM 257811 (holotype); *H. circumdata*: KU 71796–97, 91987–89, 152233; *H. columbiana*: KU 139524 (larvae), 148483 (larvae), 169461–98, 170110–12 (C&S); *H. colymba*: KU 31864, 31865 (C&S) 77414, 95979, 116357, 116779–81 (larvae); *H. crepitans*: KU 101550–52, 167663–64 (skeletons), 169499–501; 170204–6 (larvae); *H. denticulenta*: KU 133450–52, 139531 (larvae); *H. faber*: KU 92310 (skeleton), 92311–12; *H. fasciata*: KU 205461–75, 205476 (C&S), 215797–98 (larvae); *H. geographica*: KU 92040 (skeleton), 146789 (larvae), 150229–45; *H. granosa*: KU 109495 (C&S), 122735–38; *H. labialis*: KU 124888 (larvae), 169502–46, 169547 (C&S), 179178 (C&S), 187800 (C&S); *H. lanciformis*: KU 104399–400 (skeletons), 112346–48 (larvae), 122739–60; *H. larinopygion*: KU 144127–28; *H. lascinia*: KU 181079–88, 181145 (larvae); *H. lindae*: KU 155475, 155477 (skeleton), 155523 (larvae), 202728–31, 202966 (larvae); *H. multifasciata*: KU 127811–15, 128478 (skeleton); *H. pacha*: KU 202760–63; *H. palmeri*: KU 148703–04, 169584–85, 170209, 170210 (larvae), 178800; *H. pantosticta*: KU 140385, 190000–01, 202732–33, 202965 (larvae); *H. pardalis*: KU 92109, 92111–12 (skeletons); *H. pelidna*: KU 181108–10; *H. pellucens*: KU 109537–53, 109556 (skeleton); *H. phyllognatha*: KU 143197–205, 146793–94 (larvae), 164334–47, 166315–16 (C&S); *H. platydactyla*: KU 139521–22 (larvae), 166990–97, 180195–97, 167766 (C&S); *H. praestans*: KU 169574–80, 170113 (C&S). *H. psarolaima*: KU 164313–15, 164316 (skeleton), 169582–85, 202727; *H. ptychodactyla*: KU 132553–54 (larvae), 180360 (larvae), 209780–81; *H. pugnax*: KU 101554–55; *H. pulchella*: BMNH 1947.2.23.35–36 (syntypes of *Hyla agrestis*), 1947.2.23.45 (holotype of *Hyla vauterii*), KU 71822–24, 92126–29, 92130–31 (skeletons), 197291–94, MNHN 163, 4836 (syntypes), 176, 751 (syntypes of *Hyla leucomelas*); *H. raniceps*: KU 92143 (skeleton), 130070–72, 130074, 130077–78; *H. rosenbergi*: KU 77291–98, 84990–91 (skeletons), 180356 (larvae); *H. rufitela*: KU 77306–13, 77662 (skeleton), 104300 (larvae); *H. simmonsii*: KU 169554–65; *H. staufferorum*: KU 217694–96, 218315 (larvae); *H. torrenticola*: KU 169571–73, 171187 (larvae); *H. sp.*: KU 181882–83 (larvae). *Plectrohyla avia*: KU 106295 (skeleton); *P. hartwegi*: KU 192443 (skeleton); *P. teuchestes*: KU 59831 (skeleton).

Herrn
 QL668.E24 .D83 1997
 Frogs of the Hyla armata and the Hyla

Harvard MCZ Library BME5842



3 2044 062 463 393

DATE DUE

OCT 22 1998	

DEMCO, INC. 38-2931

PUBLICATIONS OF THE NATURAL HISTORY MUSEUM, THE UNIVERSITY OF KANSAS

The University of Kansas Publications, Museum of Natural History, beginning with Volume 1 in 1946, was discontinued with Volume 20 in 1971. Shorter research papers formerly published in the above series were published as The University of Kansas Natural History Museum Occasional Papers until Number 180 in December 1996. The Miscellaneous Publications of The University of Kansas Natural History Museum began with Number 1 in 1946 and ended with Number 68 in February 1996. Monographs of The University of Kansas Natural History Museum were initiated in 1970 and discontinued with Number 8 in 1992. The University of Kansas Science Bulletin, beginning with Volume 1 in 1902, was discontinued with Volume 55 in 1996. The foregoing publication series are now combined in a new series entitled Scientific Papers, Natural History Museum, The University of Kansas, begun with Number 1 in 1997. Special Publications began in 1976 and continue as an outlet for longer contributions and are available by purchase only. All manuscripts are subject to critical review by intra- and extramural specialists; final acceptance is at the discretion of the editor.

The publication is printed on acid-free paper. Publications are composed using Microsoft Word® and Adobe PageMaker® on a Macintosh computer and are printed by The University of Kansas Printing Services.

Institutional libraries interested in exchanging publications may obtain the Scientific Papers, Natural History Museum, The University of Kansas, by addressing the Exchange Librarian, The University of Kansas Libraries, Lawrence, Kansas 66045-2800, USA. Available back issues of The University of Kansas Science Bulletin may be purchased from the Library Sales Section, Retrieval Services Department, The University of Kansas Libraries, Lawrence, Kansas 66045-2800, USA. Available issues of former publication series, Scientific Papers, and Special Publications of the Natural History Museum can be purchased from the Office of Publications, Natural History Museum, The University of Kansas, Lawrence, Kansas 66045-2454, USA. Purchasing information can be obtained by calling (913) 864-4450, fax (913) 864-5335, or e-mail (kunhm@ukans.edu). VISA and MasterCard accepted; include expiration date.

SERIES EDITOR: William E. Duellman
EDITOR FOR THIS NUMBER: Linda Trueb

MCZ
LIBRARY

SEP 16 1998

HARVARD
UNIVERSITY

PRINTED BY
THE UNIVERSITY OF KANSAS PRINTING SERVICES
LAWRENCE, KANSAS