

THE FRUIT OF THE
FAMILY TREE

— ❖ —
ALBERT EDWARD WIGGAM

The fruit of the family tree /
HQ753 .W55 1924

15865



Wiggam, Albert Edward,
NEW COLLEGE OF CALIFORNIA (SF)

HQ Wiggam, Albert Edward
753 The fruit of the family
W55 tree
1924 #10840

wyg

DATE DUE	BORROWER'S NAME	ROOM NUMBER

HQ
753
W55
1924

#10840

Wiggam, Albert Edward, 1871-
The fruit of the family tree / by
Albert Edward Wiggam. Indianapolis :
Bobbs-Merrill, c1924.
390 p., [5] leaves of plates : ill. ;
23 cm.
Bibliography: p. 371-377.
Includes index.
#10840 Gift:Amsbury \$. .

1. Heredity. 2. Eugenics. 3.
Genetics. I. Title

18 FEB 92

3773948

NEWCxc

26-3387

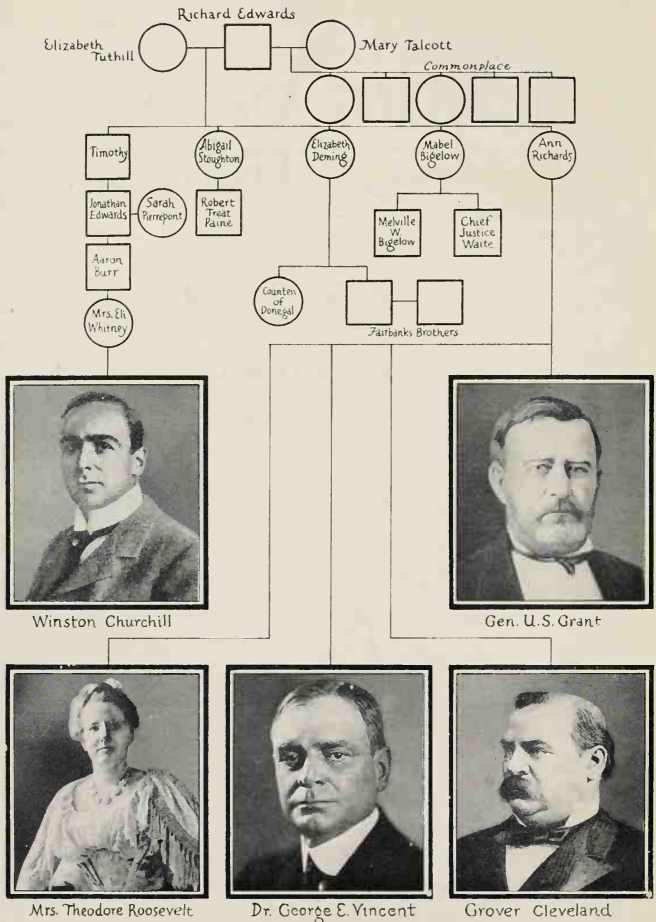

© Underwood & Underwood.

CHART OF THE EDWARDS FAMILY

From Richard Edwards and Elizabeth Tuthill have descended nearly 1400 persons of great social worth. The above pedigree chart shows a few of the best known. The round symbols represent women and the square symbols men.

THE FRUIT OF THE FAMILY TREE

By

ALBERT EDWARD WIGGAM

Author of

THE NEW DECALOGUE OF SCIENCE

Illustrated

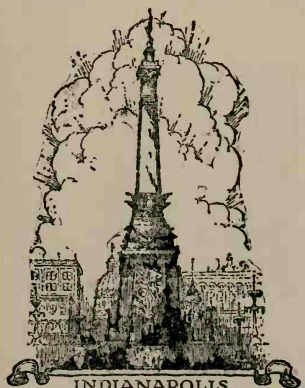

INDIANAPOLIS
THE BOBBS-MERRILL COMPANY
Publishers

0780/#

COPYRIGHT, 1924
BY THE BOBBS-MERRILL COMPANY

Printed in the United States of America

3773948

PRESS OF
BRAUNWORTH & CO
BOOK MANUFACTURERS
BROOKLYN, N. Y.

To

THE HEALTH, INTELLIGENCE AND
BEAUTY OF THE UNBORN

PREFACE

The preface to a book is probably always written last. After completing this incomplete account of the meaning of heredity and of biological forces in human life and society, I can only express the hope that the reader who is not a special student in these matters will learn as much and gain as much pleasure from reading it as I have gained from writing it. If it only stimulates him to reflect upon these problems in a new way, it will have fulfilled its purpose.

The special student will find large omissions in the literature of heredity, genetics and eugenics—especially in the field of biometrics—that might have been brought together and surveyed. But when we sum it all up, there have been very few investigators in these fields who have developed knowledge that seems immediately available for the work of social reconstruction, or which can be just now made interesting to the general reader. I have thought it best to describe more in detail the few investigations which have passed the gauntlet of scientific criticism and have secured an apparently safe place in scientific literature. This does not mean that other studies have not attained that position, but some of them are either incomplete, such as the very important researches now under way by Doctor Raymond Pearl, Professor Karl Pearson, Professor Edward L. Thorndike, and a few others; or else they are somewhat remote from immediate human interest and, therefore, difficult to make dramatic and readable for the general public. My thanks are due to all of these men and to other biolo-

PREFACE

gists and psychologists who have lent me material, called my attention to special researches and also aided me with personal criticism and advice. Needless to say, I am greatly indebted to Doctor Frederick Adams Woods.

Mr. Carl Easton Williams, editor and journalist, first induced me to believe, several years ago, that the general public might be interested in heredity and eugenics; and through his encouragement I wrote a number of magazine articles that seemed to win a generous response. This book is the outcome of that original encouragement—a testimony to the influence of environment. My thanks are also due to Mr. Arthur T. Vance, the far-sighted editor of *The Pictorial Review*, for permission to reprint the main body of several articles which have appeared in that magazine. Throughout every phase of the work, my wife has been my constant and invaluable assistant.

The lay reader must understand *in advance* that this book is not an attempt to cover the problem or problems of eugenics and race improvement in their entirety. That would be impossible. The first criticism of the lay reader is likely to be, "Who is going to do the selecting of parents?" I trust the reader will find from this book, that there is but one answer to that question and that answer is: "Except in rare instances of obvious hereditary defect, *nobody is going to select parents for anybody.*"

The problems of eugenics—there is no one problem—are problems of psychology, of biology, of economics, of political science, of practical politics, of climate, of race, of art, history, education, morals, religion and of all those forces which play ceaselessly, whether he will or no, upon the organic nature and destiny of man. Eugenics is the basis of the new sociology, and sociology is the cap sheaf of all the sciences.

PREFACE

Eugenics is, therefore, the application of human intelligence to human evolution. I trust the following pages will indicate to the reader what some of these problems are and how some of them may be hopefully approached. If they succeed in doing this, they will deserve a small place in what will in time become the largest literature and the most extensive and intensive intellectual and spiritual discipline of mankind—the discipline of race-culture. This is the new humanism which science offers to mankind. It offers, for the first time, the possibility of building a social heredity which will by its own spirit and processes improve human heredity, and this improved human heredity will in its turn improve the social heritage. This is truly a great adventure. But it is the one final adventure of the human intelligence and spirit which, if it succeeds—and it will succeed—will bring the earthly redemption of man and fill the world with inborn intelligence, health and happiness.

A. E. W.

New York City.

CONTENTS

CHAPTER	PAGE
I DOES BLOOD TELL?	1
II WHAT HEREDITY TELLS AND HOW IT TELLS IT	22
III WHAT HEREDITY TELLS AND HOW IT TELLS IT (<i>Continued</i>)	38
IV WHAT EDUCATION TELLS	63
V WHAT PRENATAL INFLUENCE TELLS	85
VI WHAT PRENATAL INFLUENCE TELLS (<i>Continued</i>)	95
VII WHAT TWINS TELL ABOUT HEREDITY	109
VIII WHAT TWINS TELL ABOUT HEREDITY (<i>Continued</i>)	120
IX WHAT COUSIN MARRIAGES TELL ABOUT HEREDITY	133
X IS DISEASE INHERITED?	155
XI IS BRAIN-POWER INHERITED?	173
XII IS BRAIN-POWER INHERITED? (<i>Continued</i>)	190
XIII MEASURING HEREDITY IN ROYALTY	209
XIV MEASURING HEREDITY IN ROYALTY (<i>Continued</i>)	231
XV THE INFLUENCE OF LEADERS UPON NATIONAL LIFE	244
XVI CAN WE MAKE THE HUMAN RACE MORE BEAUTIFUL?	262
XVII WOMAN'S PLACE IN RACE IMPROVEMENT	280
XVIII CAN WE MAKE MOTHERHOOD FASHIONABLE?	304
XIX BIRTH-CONTROL—A TWO-EDGED SWORD	317
XX DOES HEREDITY OR ENVIRONMENT MAKE MEN?	330
XXI WHAT YOU CAN DO TO IMPROVE THE HUMAN RACE	353
APPENDIX	371
INDEX	381

THE FRUIT OF THE FAMILY TREE

THE FRUIT OF THE FAMILY TREE

CHAPTER I

DOES BLOOD TELL?

UNLESS a man understands heredity he can not possibly understand human life. He can not understand one of the largest forces—probably the largest—that has made him the kind of mortal being that he is. And every man would like to know how he came to be what he is, how he came to have his bodily size and appearance, his weaknesses and strength, his likelihood to contract this or that disease, his capacity to do this or that kind of work, his peculiar sort of temper and temperament, and his general mental and physical make-up, tendencies and powers. Unless one understands heredity he can not form any conception as to where his own natural endowments came from, nor what he will transmit to his children. He will not know whether his strength or weakness lies in his hair or in his brains; or whether he got them all by well-understood processes from some of his ancestors, and is likely to hand them on by the same processes to his descendants.

Not only that, he will not know how he ought to act as husband, father or citizen. In the first place, he will know no more than do the beasts of the field whom he ought to marry; second, he will not know what sort of ideas and ideals to teach his children with

THE FRUIT OF THE FAMILY TREE

reference to human nature and character, or with reference to their marriages; and third, he will not be able to vote intelligently upon many public questions, such as taxation, education, the care of the poor, the problems of crime, the promotion of public health, child-labor, minimum wages, the regulation of public morals, the spread of birth-control and a thousand other matters which vitally affect both the present happiness and the future destiny of his fellow-men. He can not approach any of these problems intelligently; indeed, without a knowledge of heredity, there are very few problems of life which he can approach intelligently, because he is in total ignorance of one of the largest forces that enters every moment into human life, human character and social destiny.

It would seem, therefore, to be one of the highest duties of the citizen to learn what scientists have discovered about this thing called heredity—what it is, how it operates, what it does to a man, to his family and to his race and nation. To explain the word heredity is the first object of this book, and the second is to indicate what heredity means to all mankind.

Nearly every one believes in heredity, or to use the popular phrase that "blood will tell" in plants and animals. People do not expect to gather grapes from thorns nor figs from thistles. They do not expect great race horses to be born from draught horses, nor prize cattle from scrubs. And the commendable thing is that they regulate their social, political and economic customs to fit in with and promote these beliefs. But when it comes to the human family many people honestly believe that good children will be born from bad parents quite as often as from good parents; that health will come out of weakness, and that wisdom will be the fruit of the family tree of fools. And they wrongly build their economic, political and social ma-

DOES BLOOD TELL?

chinery and customs, their educational systems, their marriage ideals, their very religions to fit in with these false beliefs.

In addition to this, even when children are born weak, unhealthy, short-lived or foolish, such well-intentioned persons believe that education, moral teaching, medical science and good environment generally, will transform natural weakness into strength, folly into wisdom, and put brains into empty heads. The truly scientific students of both heredity and environment the world over know that these hopes are only to a small degree justified. The surface effects of environment are often so immediate and gratifying that we are misled as to what is really going on underneath. The enthusiast for environment fails to observe that many of his vast efforts to improve human weakness do not have to be undertaken for everybody, but only for certain people. And if he should take the trouble to survey the family history of these people by critical methods he would arrive at the conclusion, amazing to him, that this weakness is related in most cases to similar weaknesses among these people's ancestors. He would learn in a new way that some people are born long and some are born short and that his best service to humanity at large would be to take account of this fact. His own measures would, in the end, be far more effective. And if he went still further and found that even where he does improve the individual by medicine, moral suasion and education, that this improvement is not transmitted to his children—as we shall find proved in a later chapter—he would gain a new conception of what he is doing and seek to adopt methods known to science which would insure just as much success in the end for his own ideals, and that his success would be permanent.

Man gains real happiness only by looking nature,

THE FRUIT OF THE FAMILY TREE

squarely in the face. Good education and good environment should be given to every child that comes into the world. This is the only way to bring to its full expression the child's natural powers. But we must learn that these things will never add anything to the child's natural equipment. The adage that "the world owes every man a living" is in one sense true. If we are to have a decent world to live in for ourselves, we are forced to make it a world where every man has his fullest possible chance. But if we believe along with this that blood does not tell we are likely to build a civilization where the weakling and the dullard are not only given an equal economic, political and social chance, but an *equal biological chance*, that is a chance to propagate their kind equally with the wise, prudent and strong. If we do this, in the end the race will go down. We can not have anything which we can call civilization until the lazy, shiftless and hare-brained get a fair deal, and, if they can not make their own living, are provided for by their abler brethren. We should never forget this. But we can not have a *progressive* civilization—one that can progressively take better care of both its able and unable—until the more richly endowed are given both the opportunity and encouragement to reproduce their kind in greater numbers than those of less natural endowments. If civilization is not conducted upon this plan, the very care and sympathy which the strong give to the weak simply hands on an increasing burden of defectiveness and social wreckage to be carried by the men of to-morrow. And, in the end, our noblest sympathy wrecks the very civilization that it has tried to serve. The honest truth is that without an eugenical policy as wide as society itself, civilization is self-destructive. It sets going forces that often silently and slowly wreck the race that built it. But with a wise eugeni-

DOES BLOOD TELL?

cal policy there is no biological reason, at least, why a civilization might not go on with increasing glory and grandeur for ever.

After a generation of exact experimentation and study by the biologists and psychologists, we can now say that blood, that is heredity, will always tell. As some wit has said, "Sometimes the less it tells the better." But in some families the more it tells the better. I think I can bring this fact home by the following very commonplace example—an example which proves that blood not only tells, but that sometimes it also barks.

A friend of mine, Mr. Clay Smith, of the Smith-Spring-Holmes Orchestral Quintet, known all over America in the chautauquas, believed blood would not tell. Or, rather, he believed it would tell the good and not tell the bad.

Mr. Smith purchased a fine female setter puppy for one hundred fifty dollars. It waxed rapidly in stature and, as the owner supposed, in wisdom. But reckoning on pups is a doubtful business. One day Mr. Smith entered his library where the pup was lying asleep. He scratched a match which happened to go off like a pistol. The dog with a yell made one leap over the library table, smashing a handsome lamp. The next leap she went through the window carrying the sash and shutter into the yard. From there she made a wild dash to the rear of the house and crawled up under the floor as far as her poor frightened body could wriggle. There she stayed for four days and nights without food or water in spite of all coaxings and threats of punishment.

"A gun-shy pup!" said Mr. Smith in disgust. "But I shall get my money back easily enough. No foolish pup can get the better of me." So he mated her with Champion Rodfield, the greatest sire of bird dogs the world up to that time had ever known. Champion

THE FRUIT OF THE FAMILY TREE

sold at one time for fourteen thousand dollars. There had not been a gun-shy dog in Champion's pedigree since some peace-loving Chinaman invented gun-powder.

In due time Mr. Smith's dog presented him with nine little puppies.

They also grew rapidly and soon pointed birds with all of grandfather Rodfield's wisdom and agility. Mr. Smith saw his one hundred fifty dollars coming back with a profiteer's margin. But he reckoned with blood only on one side. He forgot that the mother's blood will tell as much as the father's. He sold the nine little puppies to sportsmen all over the central states at seventy-five dollars each.

A month later the quail and partridge season opened. Within three days Mr. Smith was besieged with angry telegrams from every purchaser of his pups demanding his money back. Every pup was so gun-shy that at the first crack of the gun the owner found himself left alone to contemplate the beauties of nature, while his fine pedigreed setter was shooting for home like a meteor. One man wrote Smith that he tried to shoot his dog, but that it ran so fast that the shot failed to catch him.

Smith is now a wiser and poorer man. So is every man and every nation that reckons spiritual and physical assets without taking account of heredity—the power of blood. No more ruinous belief ever entered the human mind than the belief that blood will not tell. It has cost the lives of families and empires. It has cost America a large share of its labor troubles, its political chaos, many of its frightful riots and bombings—the doings and undings of its undesirable citizens. Investigation proves that an enormous proportion of its undesirable citizens are descended from undesirable blood overseas. America's immigra-

DOES BLOOD TELL?

tion problem is mainly a problem of blood. For over a generation America has been changing her blood. And no nation can change its blood by ever so little but that it will change the very nature and the practical workings of its institutions and ideals. Just so long as the fatuous belief holds sway that American institutions, climate, environment and Uncle Sam's opportunities for getting rich and securing good clothes, will "Americanize" any truly foreign stock with different blood, ideals and history, which are largely the outcome of heredity, and transform it into the grand old native stock that founded this nation, gave it its Constitution and ideals; just so long as this belief prevails "the low foreigner" will constitute our chief national problem. The notion that environment will in reality transform one kind of people into another kind of people is just as fatuous, as a western congressman bluntly put it, as the belief that you "can run a dairy with a herd of mules."

Professor William E. Castle, of Harvard, has proved that blood will tell in the mental qualities of animals. He crossed ordinary wild rats with white "albino" rats. As one scientist said, "The albino rat is about as wild as a bag of meal." They are often given to babies to play with. But the children of this cross were all wild and would literally chew a baby to pieces.

Martin Kallikak was another man who believed that blood would not tell; or, if it did tell, it would not tell on him. Martin's dramatic history, and the history of his germ-cells, his blood, have been related in a little book entitled *The Kallikak Family*, by Doctor Henry H. Goddard, Director of the Juvenile Research Bureau of the State of Ohio, and formerly Superintendent of the famous School for Feeble-Minded at Vineland, New Jersey. He is one of our highest authorities on feeble-mindedness. Blood has been tell-

THE FRUIT OF THE FAMILY TREE

ing its stories of tragedy and splendor ever since Eden; but seldom has it been painted in such clear contrasting colors as upon this little chart of the blood of the Kallikaks. Every parent and every young man and woman, every educator and statesman, should study this simple, but dramatic canvas. The forces that build and destroy empires are here displayed in all their nudity, in all their certainty.

Martin Kallikak was a young soldier of the Revolutionary War. His ancestry was excellent. But one

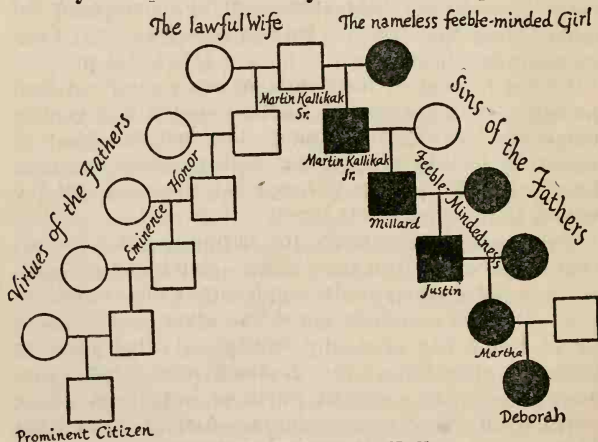

THE KALLIKAK FAMILY

From Goddard's *The Kallikak Family*. Courtesy of the Macmillan Company.

The present writer has added the words, Virtues and Sins of the Fathers, etc. Ancestry of Martin, the central figure, not included, but Martin came from an excellent family. On the left side of the chart, through his lawful wife, Martin Kallikak's 496 descendants, all normal, have included nation builders, governors, signers of the Declaration of Independence, soldiers, university founders, doctors, lawyers, judges, educators. They have all been a credit to their country. Through the other branch of the family, Martin's progeny by the feeble-minded girl, the Kallikaks have given to the country 480 nation-destroying descendants, including 143 feeble-minded persons, 33 immoral, 36 illegitimate, 3 epileptics, 3 criminals, and 8 brothel keepers.

DOES BLOOD TELL?

wild night up the Hudson River Martin forgot his noble blood. In this night of dissipation he met a physically attractive, feeble-minded girl. The result of that meeting was a feeble-minded boy. This boy grew up and married a woman of whose mentality Doctor Goddard could secure no record. But she was evidently of the same ilk. They produced a numerous progeny with a large percentage of feeble-mindedness. These grew up lazy, thriftless, shiftless, trifling, thieving people. Marrying into their own kind, another generation of the same general character came upon the human scene. This has gone on now for six generations.

At the bottom of the chart we see the end of this unhappy road on which Martin started nearly one hundred and fifty years ago. The last character is Deborah Kallikak, a young feeble-minded woman, about twenty-five years old, now being cared for at the school at Vineland, New Jersey. Her mental capacity, which means her capacity for happiness and usefulness, is only that of a little child. Her highest ability to bless the world is to do simple forms of housework.

This line of Martin's blood has never created anything, never produced any substantial wealth, never invented anything, never dreamed any dreams nor added anything to human worth or happiness. This line has given 480 descendants. Among them have been 143 known feeble-minded and many more probably, not known, 36 illegitimates, 33 sexually immoral, 24 confirmed alcoholics, 3 epileptics, 3 criminals, 8 keepers of brothels and 83 children so feeble that they died in infancy.

However, on the other side of the canvas, blood has painted a different and wonderful story. Later in his life Martin married a young Quaker woman of splendid talents and heroic ancestry. It seemed that this

THE FRUIT OF THE FAMILY TREE

line of children simply could not turn out badly in any environment. Indeed, like all blood, good or bad, it made its own environment. This line has given us 496 direct descendants. *All* have been normal people. As Doctor Goddard says, they have given us "Colonial governors, signers of the Declaration of Independence, soldiers, one founder of a great university, doctors, lawyers, judges, educators, landholders, traders and men and women prominent in every phase of social life." The last one on the chart is now a man of wealth and influence.

Nobody ever had to build asylums, penitentiaries, reformatories or special schools for this line of blood. The other line has cost society hundreds of thousands of dollars to restrain their evil tendencies and care for their feeble minds and bodies. One line has torn down, the other has built up; one line has reaped, and the other has scattered; one has contributed nothing but wickedness and woe, while the other has blessed the earth with beauty and achievement.

The reader should perhaps be cautioned that we could not be sure that heredity was the cause of the differences in these two lines of blood, since the factors of heredity and environment are not separated, but we feel sure from certain other more exact studies to be analyzed in detail later that heredity and not environment was the chief cause of the differences between the two streams of descent.

We can not escape the fact that blood for ever tells its story of shame or beauty, whether it flows in plants and animals, or in the veins of beggars, poets and kings.

Two interesting events have recently happened that brought honors to America by virtue of truly royal blood.

In 1920 on the Aqueduct race track near New York

DOES BLOOD TELL?

City the great horse, Man o' War, ran the fastest mile and a quarter ever covered by a horse in human history. He clipped a fifth of a second off the previous world's record. He covered the mile and a quarter in one minute, forty-nine and one-fifth seconds. The record for the same distance had been held by two horses, Barrow and Boots. They each covered the distance in one minute, forty-nine and two-fifths seconds. It would seem that one or both of these horses could have speeded up a bit and clipped off that tiny one-fifth second. But try as they would the trainers could never eliminate that one-fifth second from the record. It could only be done by *faster blood*. And where did Boots, Barrow and Man o' War get their speed? From training? Only partly. They got it chiefly from the blood of Eclipse and Hambletonian 10, two horses of over one hundred years ago. I have seen the pedigrees of hundreds of the world's great race horses. I saw one pedigree that covered three large window blinds written in the finest handwriting. But they practically all go back to Eclipse and Hambletonian 10. These horses "varied" in the direction of speed. And David Starr Jordan assures us that "the blood of Eclipse is to-day flowing in the veins of every great race horse of the world."

The second event of world-wide interest was the preservation by America of the American Yachting Cup through the speed of the yacht *Resolute*. Wonder has often been expressed that this cup has for nearly seventy-five years remained with America despite all of England's efforts to win it. It seems strange, too, since England is much more of a maritime nation than are we Yankees. But, I think, as does Doctor Charles B. Davenport, of the Carnegie Institution, that the explanation is again chiefly the one word "blood." Many of the boats of recent races

THE FRUIT OF THE FAMILY TREE

have been designed by the Herreshoff family. This family has had numerous boat-builders, indeed, has shown a special artistic and mechanical genius for several generations. While Mr. N. G. Herreshoff, the designer of the *Resolute*, the last victorious yacht, personally disclaimed in a letter to me any special gifts from heredity, his opinion is outweighed by an investigation of his ancestry. Nearly all great men believe their success is due to some specious cause. They usually ascribe it to "sheer hard work," "attention to business," or some "inspiration" of their mothers, or some peculiar "education." They do not stop to inquire what gave them great energy to begin with; why they turned their attention to their special profession, or what made their mothers such inspiring women. Nearly all great men of energy and genius have had inspiring mothers from whom they drew their blood. Everywhere, and always, it is blood that tells the tale of national greatness or decay.

It is commonly said that God raises up some great man to lead the people in times of distress and peril. There is no basis in history for this belief. Leaders come not by prayer, sacrifice, hope and desire, but solely by germ-cells. As an instance, Spain has been calling for three hundred years for some great man to restore her former world prestige, but either God has seen fit to chastise her, or else, what seems more probable, the blood that produces great men of a political and military type, at least, has gone. In his research, *The Influence of Monarchs*, which is reviewed fully in a later chapter, Doctor Frederick Adams Woods has shown that the political greatness of Spain lies buried with the blood of her former kings. No doubt in their closing hours Babylon, Crete, Carthage, Greece and Rome cried out to their gods for some heaven-sent leader to save them. But the gods did not because they

DOES BLOOD TELL?

could not respond. Nearly one-half of all the great men of the world have been born from great ancestry or else have left great descendants. That is, they have belonged to great human breeds. And these great families have consisted of scarcely more than four or five individuals out of every thousand persons ever born on earth. Yet their noble heredity, their superior blood, their more richly endowed germ-cells have produced as much genius as has all the balance of the human race.

We often hear it said, and I have often seen it stated by irresponsible journalists, that the House of Lords in England is a proof that blood does not tell, and that their inferiority proves that the aristocratic families from which they spring are in reality very deficient in the qualities of political and social leadership. The fallacy of such reasoning lies in the fact that the House of Lords with its three or four hundred members is pitted against all the balance of the population of England, Scotland, Wales and Ireland. That is, such hasty reasoners are demanding that a few score families shall produce as much genius as springs from thirty-five or forty millions of people, constituting hundreds of thousands of families. This is asking entirely too much of heredity. The simple fact is that there have been many great families among the lords and, true to expectation, these families have produced many times as much genius as the balance of the lords and many, many times as much genius as has been produced from the same number of the common people. Even the man of great mental qualities from commonplace parents is usually found to have received some special talent from ancestors more remote than his parents, that made him notable.

On the western plains of America it is a legend that Indian ponies will not buck if they have yellow ankles

THE FRUIT OF THE FAMILY TREE

and yellow nostrils. It is not the possession of yellow feet and yellow nostrils that makes them gentle. It seems to be because the Arabian horse is the gentlest horse in the world. He is gentle because he has been bred as a household pet for centuries. Petting him and keeping him in the family did not make him gentle. But the wild and vicious colts were sold off or killed, and the gentle ones kept for breeding. As the breeder says, "They were bred for gentleness." And what has this to do with the ponies of the western plains? The story seems substantiated that La Salle and the French missionaries three hundred years ago brought with them some fine Arabian steeds. Some of these horses escaped and bred with the ponies of the plains. And now we see the remnants of noble mental quality in the gentleness of these ponies. And, by mere chance, the factors in the germ-cell that produce gentleness are probably associated with the factors that produce the tawny feet and nostrils. If this particular legend is not true, many experiments that have been performed in the laboratories tell precisely the same story of blood, both in plants and animals. While we commonly use the word "blood," what we mean in reality is the germ-cells, or reproductive cells. It is the germ-cell alone, as we shall see later, which carries all the heredity from one generation to the next.

Everywhere we turn the same great lesson is forced upon us. Nature first produces some "variation"—some new quality that this particular species of plant or animal never had before. If this variation helps the animal or plant in winning food or escaping its enemies, the individual with the new character survives. Its less fortunate fellows fail in the race. Heredity hands on the new character to the survivor's descendants. Thus, when breeders find some new

DOES BLOOD TELL?

variation of speed or beauty they mate it so as to hand it on. In this way special breeds are built up and remain endlessly.

Take the case of the famous Scotch collie, "The Squire of Tyton," the most famous and valuable dog probably that ever lived. The Squire sold at one time for sixty thousand dollars. He "varied" in the direction of intelligence and beauty. A great dog-breeder once said to me, "If you want to get a really great Scotch collie you will have to get one that has in him some of the blood of The Squire of Tyton." His descendants have furnished some of the great prize-winners of our time, and I do not doubt that the owner of The Squire earned more than the sum paid for him by enormous fees for breeding, thus handing down his noble character to bless the future dog world.

Good blood is more precious than rubies. Mr. Frank Fishel, a dog-breeder of Indiana, purchased by chance a pointer pup from a barber for three dollars. Mr. Fishel told me that this dog, "Fishel's Frank," earned him in breeding fees more than forty thousand dollars. His greatest son, "Comanche Frank," is earning even more than his famous father. Recently, I saw female dogs at Mr. Fishel's place at Hope, Indiana, from Sweden, Japan, South America and, indeed, from all over the world. They were sent there to bring back with them some of Comanche's priceless germ-cells—the thing which in popular language is called "blood."

When Luther Burbank came to America it is said he carried with him just one potato. I do not doubt in the same ship were wealthy men carrying millions of dollars. But all their millions were not worth the blood of this one potato. From it he developed the famous Burbank potato which has enriched all the potato fields of the earth.

THE FRUIT OF THE FAMILY TREE

Speaking once on board an Atlantic steamship, the eloquent preacher, Phillips Brooks, illustrated the priceless value of blood. He said, "I hold in my hand two diamonds. Should I drop them overboard the loss would be considerable but easily replaced. But, suppose these two diamonds were the seeds of some valuable plant, the only two left in the world. If I should drop them overboard the loss would be beyond calculation. All the heredity of the ages, all the efforts of God throughout the centuries would be gone for ever." Material wealth can be replaced by man. But God's wealth of heredity stored in the germ-cells, if lost, can never be reproduced. Race-suicide is literally a race casting its germ-cells—its precious jewels of heredity—into oblivion's bottomless sea.

And let us see how this legacy of God's wealth in blood or germ-cells may enrich a nation with infinite usury. Professor A. E. Winship, of Boston, and Doctor Davenport have collected the history of the blood of Elizabeth Tuthill. All over America I have met her descendants. Many of them wear a gold badge known as "The Tuthill Emblem." It is a badge of honor. Everywhere they hold places of distinction. Professor Winship has traced the history of 1,394 of these remarkable persons. "The Blood of Greatness" is the only phrase that would properly describe such a pedigree.

Let the frontispiece chart tell the graphic story, Elizabeth Tuthill was a marvelous girl, nearly three hundred years ago at Hartford, Connecticut. She married Richard Edwards, a great lawyer. They had one son and four daughters. They have all left their mark upon American blood. And when anything marks a nation's blood, it marks for weal or woe its ideals, institutions and history.

Later in life Richard Edwards married Mary Tal-

DOES BLOOD TELL?

cott. She was an ordinary, every-day, commonplace woman. She had ordinary, every-day, commonplace children. The splendid heredity of Richard Edwards was swamped by the mating.

But the union of two streams of great blood of *similar character* begets great blood. The son of the first marriage was Timothy Edwards, one of the founders of Yale University. He was the father of Jonathan Edwards. From Jonathan Edwards, who married also a wonderful woman, Sarah Pierpont, have descended 12 college presidents, 265 college graduates, 65 college professors, 60 physicians, 100 clergymen, 75 army officers, 60 prominent authors, 100 lawyers, 30 judges, 80 public officers—state governors, city mayors and state officials—3 congressmen, 2 United States senators and 1 vice-president of the United States. Compare this with the worthless descendants of Martin Kallikak.

The chart exhibits three of the direct descendants of Jonathan Edwards. In serial order they are Aaron Burr, who was vice-president; Mrs. Eli Whitney, a notable woman, wife of the inventor of the cotton gin; and the novelist, Winston Churchill.

The oldest daughter was Abigail. Perhaps her most notable descendant was Robert Treat Paine, one of the signers of the Declaration of Independence.

From the descendants of the next daughter, Elizabeth, I have chosen the Marchioness of Donegal, a distinguished woman of Ireland; and the Fairbanks brothers, manufacturers of weighing scales used all over the world.

The next daughter, Mabel, gave the world through her blood Melville W. Bigelow, one of the greatest legal writers of our times, and Morrison R. Waite, former Chief Justice of the United States.

The greatest one of the sisters in her descendants

THE FRUIT OF THE FAMILY TREE

was Ann who married a Mr. Richards. From her have descended Bishop Vincent, founder of the Chautauqua movement, and father of George Vincent, head of the Rockefeller foundation, and his brother, a famous attorney; Grover Cleveland, one of America's greatest presidents; Ulysses S. Grant, renowned general and president; and Edith Carow, widow of Theodore Roosevelt and mother of his five sons, one of whom, Quentin, was killed in the air service in France, and the remaining four are starting upon careers of honor and distinction.

The reader must not gather the idea that all of the greatness that has been shown by the Edwards descendants was due to the direct influence of the original heredity of Elizabeth Tuthill or Richard and Jonathan Edwards. The direct influence of any one distinguished ancestor is soon lost, owing to the fact that as the germ-cells divide the great qualities get scattered, and also new marriages bring other factors into the line of descent. Genius of a high order is due to the fortunate concentration in one germ-cell of a large number of the great human qualities. In the division of these cells at the time of ripening, or as the biologist calls it "maturation" of the germ-cells, these great qualities may pass into different cells and lose their high degree of concentration. However, while the gathering together of a large number of good qualities in one cell comes about purely by the laws of chance, yet where there are a great many remarkable qualities in a breed, the probability that any one individual will receive a great many of them is enormously greater than in a poor breed where only a few good qualities exist. As a consequence, while all the children in a good family can not be expected to show all the good qualities or be persons of supreme genius, yet practically all of them are far above the average

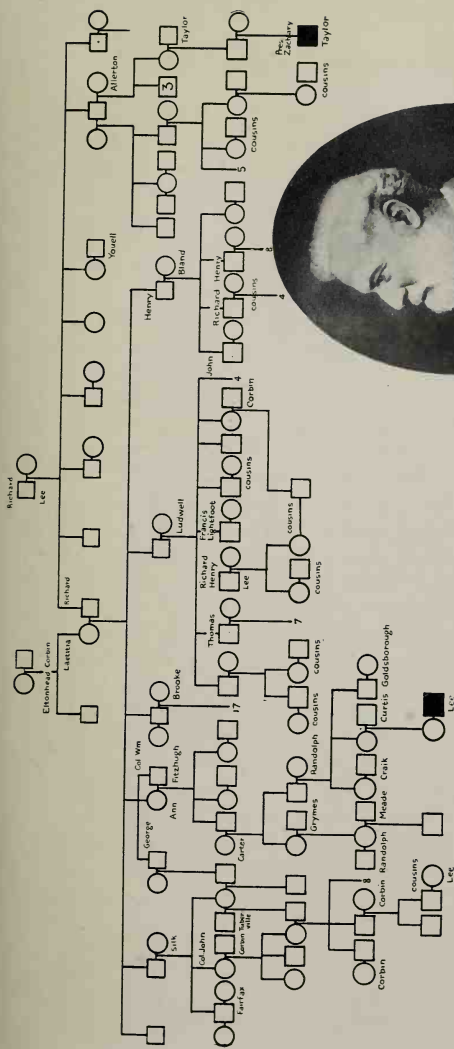

GEN. ROBERT E. LEE.

From Davenport's Heredity in Relation to Eugenics, Henry Holt & Company. 1911.

The First Families of Virginia and the whole South show how blood tells. General Robert E. Lee, possibly America's greatest military genius and the flower of southern chivalry, was the product of old Virginia's best blood. The square black symbol at bottom of chart represents General Lee. The one at the extreme right is President Zachary Taylor.

These old families as one historian states, produced generals by the dozen, congressmen and U. S. Senators of distinction and Virginia was rightly called "The Mother of Presidents." This was due to her rich strains of blood. Abraham Lincoln probably was the product of these great human streams.

DOES BLOOD TELL?

of the human race. And now and then among them it is almost certain that some child will receive so many good qualities that it will rank in adult life among the great persons of human history.

There is another factor, however, which very greatly increases the chances that the high level of the family will be kept up. This factor is known as "assortative mating," that is, the tendency of like to marry like. This is discussed in detail in a later chapter, and has been worked out mathematically by Professor Karl Pearson, the great statistician of England. In the Edwards family, for instance, while the original heredity perhaps long ago disappeared, yet, since the children were of high quality to begin with they have married other persons of high quality, and thus the splendor of the breed has been maintained. This has been true of numerous great families all through history. The Ptolemies of Egypt, some of the royal families of Europe and some of the distinguished families of New England are examples of this tendency to preserve great qualities in a family by the continual mating of like with like. No doubt the Incas of South America, who were conquered by the Spanish conquistadors, maintained, in this way, their splendid breed for a period of four thousand years. In their case (and also in the Ptolemies and other royal families) a great deal of intermarrying continually brought back the *same qualities* into the stock. In this manner the great heredity of the original forebears was preserved, and from this blood of leadership there can be little doubt that the remarkable civilization of the Incas sprang. The same assortative mating, as well as inbreeding, is true of degenerate breeds, such as the Kallikaks, where like marries like and constantly widens the human cess-pool.

It is also true that in Doctor Winship's study of the

THE FRUIT OF THE FAMILY TREE

Edwards family the factor of heredity has not been completely separated from the factor of environment. There can be little doubt that some members of moderate ability attained distinguished positions through family influence. One can readily imagine that the twelve college presidents that have been in the line of descent might not all have been men who were really great educators or executives. Some of them may have attained the official position by the fact that their relatives may have been trustees of the various colleges, and simply voted them into their office. Yet an immense part of the distinction of the Edwards family, beyond question, has been due to their superior natural qualities. We know this partly from the great achievements of many of the members; and also we know from studies of other families, where the factors of heredity and environment have been adequately separated, that heredity has proved to be the largest factor in giving them their position of distinction and power.

Finally, then, we see, actually and literally, that from dogs to kings, from rats to college presidents blood always tells. The one central problem of progress, the endless task of statesmanship and education is, therefore, to bring about those economic conditions those social, political and educational ideals and opportunities which encourage those of good blood to mate with their own kind and produce good families of children, at least more than are produced by stocks of mediocre blood; and to institute stern measures which will insure that those of positively bad blood produce no children at all. Such a race of people can easily run on through all the vicissitudes of time, creating ideals, building institutions of worth and grandeur and developing a culture all of which are simply the outward expressions of the ceaseless energy of nobility.

DOES BLOOD TELL?

blood. Such a people and only such can build great civilizations—civilizations that will continue amid happiness and achievement,

“Until the stars grow old
And the earth grows cold
And the books of the Judgment Day unfold.”

CHAPTER II

WHAT HEREDITY TELLS AND HOW IT TELLS IT

IF YOU cross tall peas with dwarf peas the offspring will be as tall as the tall parents. The dwarfness has completely vanished. Certainly an amazing outcome!

From this point on, however, the events of heredity are even more astonishing. If you cross these tall offspring back with a dwarf, one-half of the offspring of

Mendelism in Peas

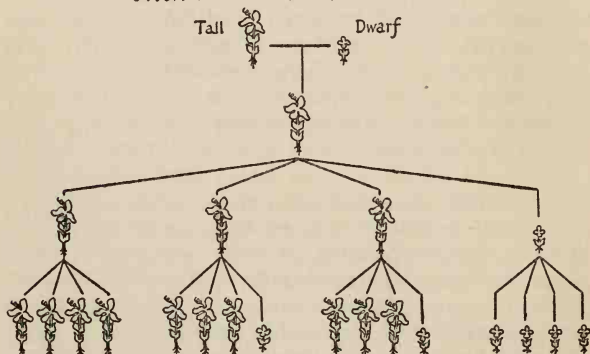

For explanation see text.

this cross will be dwarfs and one-half will be tall. Evidently the dwarf quality has in some mysterious manner been carried through in absolute purity.

However, instead of crossing the tall back with dwarfs, as described in the preceding paragraph, if you place capsules over their blossoms so they will not get crossed with any other plant, and then sow

WHAT HEREDITY TELLS

their seeds, one-fourth—not one-half—of their seeds will come up dwarf and three-fourths will come up tall.

Suppose, for convenience, we now select four of these latter plants at random—that is, the grandchildren of the original pair—taking one short and three tall. We shall then find that the seeds from the dwarf plants will produce nothing but dwarfs. Tallness has been married out of this strain for ever.

Now the three tall which we selected all look precisely alike. But, hidden somewhere within them, beyond the power of the microscope to discover, there is a strange and mysterious difference in their heredity. On the general average one of them will produce nothing but tall offspring. Dwarfness has likewise been married out of this strain, never to return. The two remaining tall, however, evidently still carry dwarfness because their offspring again average one short to three tall.

Again, if you cross peas which have yellow seeds with those having green seeds all the offspring will be yellow. But when you plant these apparently pure yellow seeds, one-fourth of their children produce green seeds and three-fourths, yellow. Nothing is more interesting than to open a pod and see these different colored seeds lying side by side with the same environment, yet with such an enormous difference in their heredity. The same events happen if you cross peas whose seeds have rough, wrinkled coats with those having smooth coats. All the offspring are rough, but these rough carriers produce an average of one-fourth smooth seeds and three-fourths, rough.

It was the fall of an apple that taught Newton the law of gravitation, and it was these simple experiments on garden peas that taught Gregor Mendel, who, like Newton, was one of the few great, original,

THE FRUIT OF THE FAMILY TREE

separate minds of the human race, the laws of heredity. It was on the evening of February 8, 1865, that the great drama of man's discovery of the laws that govern his own heredity began. On that evening this young man, Gregor Mendel, a Catholic monk and a teacher in the little town of Brünn, in old Austria, read a paper before a company of his neighbors which related the foregoing experiments. They probably dozed through most of it, unaware that they were listening to the first announcement of one of the greatest discoveries in the whole history of mankind. What a pity Charles Darwin was not there! Instantly his imperial brain would have grasped the enormous significance of Mendel's discovery!

But Mendel died in 1884, unknown outside his little city. Yet in November, 1922, scientific men gathered from all over the world in the little garden where his peas were grown, in order to dedicate a tablet to his memory. In the long run the world does discover its prophets and saviors, though it often stones and crucifies them while living.

It was not until 1900 that several biologists who were puzzling over the problems of heredity recalled Mendel's little pamphlet and at once recognized that he had indeed given the world the golden key which has at last unlocked the great mystery-house of heredity, that mystery-house of man's own inner being, and how the capacities of his own soul and body were given to him by his ancestors, and how he will transmit them on to his children.

Mendel's little paper has now grown into several thousand volumes and reports of special investigations, and the experiments on heredity in plants and animals have mounted up into the millions, until, in 1916, Professor Thomas Hunt Morgan, the celebrated biologist of Columbia University, who has added more

WHAT HEREDITY TELLS

to our knowledge of the mechanics of heredity than any other man since Mendel, was able to say, "The riddle of heredity has at last been solved." And Professor William Bateson, of England, one of the world's leading students of heredity, was also able recently to say that the knowledge which has grown out of Mendel's experiments will probably have more to do with man's destiny on this earth than any other scientific knowledge which we can now foresee.

The greatness of Gregor Mendel's mind is shown by the fact that he not only observed the remarkable regularity with which the foregoing events occurred in the heredity of his peas, but in that he also offered two clear-cut, simple suggestions, or "laws" of heredity, which underlie and explain them all.

Bringing Mendel's experiments down to date and applying them to animals, when pure-bred black rab-

Mendelism in Rabbits

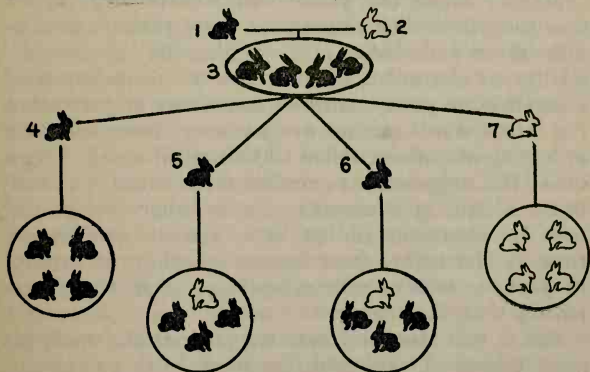

bits or guinea-pigs are crossed with albinos the offspring are all black. If these blacks be crossed back with white, on the average, one-half of the children

THE FRUIT OF THE FAMILY TREE

will be white and the other half black. If mated with each other, however, or with ones having similar parents, the children turn out one white to three blacks. The albinos will breed only albinos. On the other hand, while the three blacks all *look* alike, yet on the average, one will produce only black when mated with black. But the two remaining black-looking animals have a surprisingly different heredity, because if they be mated with each other, or with ones having similar ancestry, the progeny again turns out one white to three blacks.

Since we find that we are studying phenomena of very great human interest and discovering laws of heredity which would apparently be of great economic value if applied to man's plants and animals, and of still greater significance if they could be applied to man himself, let us examine, to some extent at least, the mechanics of the process.

Mendel called the quality—or “character,” as we now term it—which showed the more plainly, such as tallness or yellowness, and the like, the “dominant” quality or character, and the one which disappeared altogether or partly, such as dwarfness or greenness, the “recessive” quality or character, because in the offspring of crosses, called “hybrids” it *receded from view*. His suggestion, somewhat modernized, was that, in the offspring of crosses—that is, where one parent bore one character and the other parent bore its contrasting character—both characters might be present in the body-cells of such offspring, one showing more plainly than the other.

But it was Mendel's next suggestion that made his name immortal. He said that while in these hybrids, that is, the offspring of crosses between two contrasting characters, the body-cells might carry both the dominant character and the recessive character, yet,

WHAT HEREDITY TELLS

that when the plant came to form, or we might say manufacture, its germ-cells, that is its pollen grains, and ovules—in other words its reproductive cells—that the dominant quality, tallness or yellowness, for instance, went into only *one-half of the germ-cells, while the recessive quality went into the other half.*

His conception was that in the body-cells of the offspring of crosses both characters might be present, each represented by what he called a “determiner” but which we now call a “factor” or gene (jean); yet there was a clean-cut separation or “segregation” of the determiners for the dominant and recessive qualities in the germ-cells. He also suggested that in dividing out and each determiner going into a separate germ-cell, these determiners assorted themselves out independently of one another on the laws of chance, just like the shaking of dice or like the mixing of different colored pebbles on the beach. Since the laws of chance average very evenly in the long run, as a consequence of this independent assortment, just about half of the germ-cells would, in the end, get a determiner for the dominant member of any contrasting pair of characters and the remaining half would get a determiner for the recessive character.

It is plain, then, after crossing the tall and dwarf peas, that, while the dominant character, that is, the determiner for tallness, causes the body of the resulting offspring to grow to its full height, yet one half of its pollen grains or ovules—its reproductive cells—would receive a determiner for shortness, and when planted would—if not crossed again—give rise to a “pure” dwarf plant, just as pure as if it had never been crossed with a family of tall. The other half of the reproductive cells would receive a determiner for tallness, and unless crossed again with dwarfs, would give rise to “pure” tall. The independent assort-

THE FRUIT OF THE FAMILY TREE

ment of the genes, or factors, or determiners, would be purely on the laws of average or chance. Yet, the result would be a complete segregation in the reproductive cells of the sheep from the goats, so to speak. And when these reproductive cells were themselves planted, the tall and short, the yellow and green, the smooth and the rough would go merrily on, each breeding true to its own kind, as though nothing had ever happened.

If the reader will think for a moment of the black character of the guinea pigs or rabbits as contrasted with the albino character, the modern conception of Mendelism, is that they follow the same course in their heredity as did the contrasting qualities in the peas. The main difference is that in animals the germ-cells are carried in the inside of the body, where the reproductive cells meet and the young are born. But the same separation of the determiners takes place, half of the germ-cells receiving, as in the case of the guinea pigs, for instance, the dominant quality—in this case, blackness—and half receiving the recessive quality—in this case, albinism.

To make certain that we get the matter clearly in mind let us repeat the three chief things which we have thus far learned about heredity, confirmed, as they have been by millions of experiments on plants and animals during the past twenty-four years, since Mendel's immortal paper was rediscovered.

First, that a great many, and possibly all, characters in plants and animals, such as those we have mentioned, or such as the colors of flowers, or the colors and flavors of fruits, or speed or gentleness or wildness in animals, or straight or curly hair, or insanity or feeble-mindedness or mediocrity or genius or musical or mathematical ability or capacity for self-control—that many, and possibly all, of these

WHAT HEREDITY TELLS

characters are due to genes, or factors or determiners, in the germ-cells from which the plants and animals possessing these qualities are born.

Second, that the determiners for these characters exist throughout the plant and animal world in pairs; tallness, for instance, being paired with dwarfness, straight hair with curly hair, factors that make for normal bodily or mental development being paired with those that have the opposite effect. The further conception is that while, in the offspring of parents who possess the contrasting members of any pair—that is, the offspring of crosses—both characters may have an effect upon the body and its development, that is, be present in all the body-cells, and appear often to blend, yet, in reality, the two qualities—that is, the determiners for them—remain separate. A determiner for each one of every contrasting pair of characters is believed to go into a different germ-cell. The belief is that no two members of any pair of contrasting factors ever go into the same mature germ-cell.

Third, that these determiners assort freely on the laws of chance or average and thus in the long run the result is that half the germ-cells receive the factor for the dominant character, and the remaining half receive the factor for the recessive character.

I think I can do no better than quote what seems to me to be the most admirable account of the whole process yet written in scientific literature when one considers the enormous amount of material that is here sketched in a few lines with the simplicity of true genius. These passages are the opening paragraphs of a little book, entitled *The Mechanism of Mendelian Heredity*, by Thomas Hunt Morgan, of Columbia University, and his pupils and colleagues, Doctors Sturtevant, Muller and Bridges. The chapter is entitled "Mendelian Segregation and the Chromosomes," We

THE FRUIT OF THE FAMILY TREE

shall later learn what the chromosomes are and what part they play in heredity and development.

“Mendel’s law was announced in 1865. Its fundamental principle is very simple. *The units contributed by two parents, separate in the offspring without having had any influence on each other.* For example, in a cross between yellow-seeded and green-seeded peas, one parent contributes to the offspring a unit for yellow and the other parent contributes a unit for green. These units separate in the ripening of the germ-cells of the offspring so that half of the germ-cells are yellow-bearing and half are green-bearing. This separation occurs both in the eggs and in the sperm.

“Mendel did not know of any mechanism by which such a process could take place. In fact in 1865 very little was known about the ripening of the germ-cells. But, in 1900, when Mendel’s long-forgotten discovery was brought to light once more, a mechanism had been discovered that fulfills exactly the Mendelian requirements of pairing and separation.

“The sperm of every species of animal or plant carries a definite number of bodies called chromosomes. The egg carries the same number. Consequently, when the sperm unites with the egg, the fertilized egg will contain the double number of chromosomes. For each chromosome contributed by the sperm there is a corresponding chromosome contributed by the egg, that is, there are two chromosomes of each kind, which together constitute a pair.”

The reader should, if possible, at this point read further in this book, and then read Morgan’s still greater and more recent book entitled *The Physical Basis of Heredity*. Professor Morgan, as I have said, has added more to our knowledge of the mechanics of the germ-cell than any man since Gregor Mendel. His work, together with that of his students, has lifted

WHAT HEREDITY TELLS

American experimental biology to a very high plane in the scientific world.

The reader may wonder what is meant by chromosomes. They are small bodies inside every cell of every living plant, both body-cells and germ cells. At certain stages—that is, when the cell is getting ready to divide and make a new cell—they look somewhat like short strings of beads. They are called chromosomes because they can be stained with a drop of coloring matter like a chromo while the balance of the cell remains clear and colorless. The chromosomes thus stand out so we can see them through the microscope. It was this remarkable property which led to their discovery. Professor Morgan has proved that these tiny chromosomes are as he says “the sole bearers of heredity.”

In the chromosomes are stored the factors or determiners. The chromosomes in the body-cells, which originated of course from the first cell from which the individual was born, determine one's life characteristics, such as height, weight, form, color, nervous organization, temperament, intelligence and the like. The chromosomes in the reproductive cells, such as the eggs of birds or germ-cells of higher animals, carry all these characteristics on in the line of heredity and hand them to the children.

Chromosomes are therefore, as Woods has said, “the most important things for their size in the whole world.” They control the inborn tendencies of the growth and development of the body and brain; while on the other hand, those which are set aside in the germ-cells for reproduction carry the inborn health and weakness, sanity and foolishness of the parents, grandparents and other ancestors down the stream of the generations. Since, as Professor Morgan says, chromosomes are the sole bearers of heredity, it is

THE FRUIT OF THE FAMILY TREE

evident that the qualities, that is, the factors or determiners for these qualities, which are carried in the chromosomes of the two parents and which are united into one cell at the time of sex union, determine all the *natural* characteristics of the children. They determine absolutely whether the children shall be *naturally* long- or short-lived, *naturally* healthy or unhealthy, *naturally* good or bad, wise or foolish. Environment, of course, influences to a considerable extent, the expression of these qualities, that is, which ones shall be fully developed and which ones shall remain dormant or be positively repressed; but a man's natural or inborn abilities, health, temper, temperament and character are determined by the sort of chromosomes from which he was born.

The reader will naturally be interested at this point to discover why, if the characteristics of the peas and guinea pigs are due to these chromosomes in the reproductive cells, it happens that they show up in the particular ratios and proportions which they exhibit in the offspring. This was an utter secret to Mendel; but as Professor Morgan points out in the passage quoted, a mechanism or process has now been discovered which very beautifully accounts for it all.

In the first place every species of plant and animal has a certain definite number of these chromosomes in all its cells, both body-cells and reproductive cells. This number in some species is only two, while some species have as high as two hundred. According to Professor E. B. Wilson, the veteran biologist of Columbia University, in his great work, entitled *The Cell in Inheritance and Development*, the ox, guinea pig and onion each has sixteen chromosomes in each cell; mice, salamanders and trout have twenty-four; monkeys have fifty-four. Since Professor Wilson's book was written it has been discovered that in human

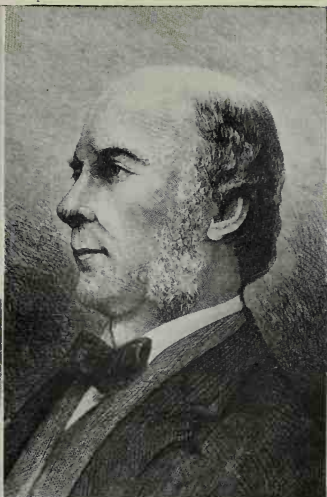

© Underwood & Underwood.

SOME GREAT CONTRIBUTORS TO THE SCIENCE OF RACE-IMPROVEMENT.

Above: Charles Darwin, Francis Galton. Below: Dr. Frederick Adams Woods, Gregor Mendel.

WHAT HEREDITY TELLS

cells there are forty-eight. It is a strange reflection that in every cell of one's body, exactly half of the chromosomes, that is twenty-four, have come from the mother and the remaining twenty-four have come from the father. Very often the characteristics produced by the father's chromosomes, such, for instance, as red hair, brown eyes, facial features or commanding genius, show more plainly, that is, are more dominant, in the children than the characteristics produced by the chromosomes of the mother; and again frequently the reverse is the case. For this reason children often look and act, or as we say—"take after," one parent more than they do the other. But the characteristics of both are carried on down the stream in these living particles and determine the general character of the breed or species that spring from them.

Nothing in all nature is more thrilling than to watch these life processes under the microscope, or to study their outcome in the future offspring. The way these chromosomes behave in the cells, the marvelous and, to us, still mysterious way in which they move with all the mechanical precision of the planets; the way they divide and grow and sort themselves out in Mendelian proportions and thus distribute the various characteristics of the ancestry among the descendants—all carried on as though they were endowed with some inner intelligence or else were under the guidance of some Supreme Will, acting with a vast "purpose" in view—all this to my mind is the most inspiring and exciting series of events which it has ever been the privilege of the human mind to contemplate.

Our poets write of stars, of ocean storms, of waterfalls, sunsets, wars, social inventions and government. But to my mind, vastly more inspiring and wonderful is the mysterious way in which these little particles of living material move their wonders to perform. For

THE FRUIT OF THE FAMILY TREE

behind all wars and governments and civilizations is this living process itself which determines and conditions the whole drama of the life of man.

Each one of these tiny particles bears its own particular and indivisible burden of life as though it had been divinely appointed as the messenger of some Master Builder who had some purpose of His own hidden beyond human ken. Each cell carries its own burden of life from out the eternity of the past, and hands it on to the greater eternity of the future. The chromosomes in this cell carry, it may be, the life of an amœba; the chromosomes in that cell bear within them all the mighty genius of a poet, a philosopher or a king. While they constantly vary and change, from causes and by processes of which we know but little, yet they are the most indestructible form of matter that we know. Professor William Wheeler, of Harvard, has specimens of ants imbedded in amber at least two million years old. They are almost precisely like the ants of to-day. Since they have changed so little in the past two million years, we can imagine that it may have taken two or ten millions of years to evolve them into the form we see them in this amber that has held them such countless centuries. During that time it is probable that diamonds and rubies have been formed and decayed again to dust. But the living ant comes to-day from out these primal chromosomes handed down from century to century, from eon to eon almost without a change.

The philosopher, Kant, said that the two things in the universe which impressed him most were "the starry heavens above and the moral man within." But when we see something of the mechanical, and it may be spiritual, processes by which a moral man capable of contemplating the stars came to be, of how his morality and capacity for measuring his own great-

WHAT HEREDITY TELLS

ness or littleness within against that of the universe without is handed on from generation to generation, we gain a new sense of the majesty and meaning of it all. We gain a new sense of the unity, the safety, the dependability of it all. Whatever God is, or whatever these processes are that lie within and behind it all, we know they can be trusted. Man has at last met the universe face to face and finds that its forces are simply "high-born kinsmen" of his own, and that he need not be afraid.

How these living particles came to be endowed with their burden of life, how they originated, why they move as they do, what it is that motivates them with such unutterable precision, it is not the purpose of this book to discuss. It would take us out into all the great problems of philosophy, of science and religion. Indeed all these great fields of human thought center in and around these problems. Some biologists believe the process is all a purely mechanical one and that life and mind are the outcome of the action and interaction of material forces. Others believe there is in this particular form of matter—the living cell—something different from chemical and physical forces, some inner life or vitalistic force which endows the cell with its apparently self-directing capacities. Some philosophers believe there is a compromise between these two extreme views. The reader and student must settle these problems for himself and gain his own philosophy and views of religion from the great minds which have been engaged with such problems throughout the centuries. The business of the scientist primarily is to discover how the universe works and give us a universe of fact instead of a universe of fancy upon which to build a sound philosophy, a true religion and a constructive ethics. His office is to give us a universe that actually exists instead of one built

THE FRUIT OF THE FAMILY TREE

up out of fear, imagination, superstition or even metaphysical speculation.

But the thing that thrills the man of imagination—and no man can be a scientist who is not a man of imagination—is the beauty and grandeur of these processes of life and these methods by which the life of one generation is handed on,—beating, pulsing with all its primal vigor—to the unborn children of to-morrow. Some great poet will sometime give us the true epic of this mighty process and show the common man, as these prosaic pages can not, the majesty, the nobility, the excitement and adventure of this stream of life, this endless stream of germ-cells that flows down underneath the visible lives of animals and plants and human beings, that flows underneath civilizations and the fleeting works of man and gives character, trend and color to them all.

The reader should understand that this stream of germ-cells is never broken. As I repeat many times in this book, the germ-cells and body-cells are two separate systems of organization. When two cells unite from two parents to form a new being they divide and grow to produce the new living individual. But in the higher plants and animals a few cells are set aside at the beginning of each individual's life. These are the reproductive or sex cells. They remain unchanged, set aside in special organs, until the individual comes to maturity when they begin to multiply and are by sex-union combined with a cell from some other individual and thus a new generation of individuals comes upon the scene. The plant or animal merely carries these germ-cells through life and adds nothing to them in so far as we know—except nourishment—and takes nothing away. It is evident then that heredity, the portion set aside for reproducing the next generations, is one continuous stream. "The body

WHAT HEREDITY TELLS

dies, but the germ-cells are immortal." The eggs or germ-cells which happen to be in any individual's body when it dies, of course die with it and decay; but before it has died, if it has any progeny, it has handed on to its offspring a portion of this hereditary material carried in these chromosomes, which it did not itself produce, but which it received from its parents, who in turn had received it from their parents back to the primal pair of living things. And so, on and on this stream of germ-cells, which is the stream of life itself, flows unbroken throughout the succeeding generations. This stream of germ-cells is never broken unless a whole species is wiped away, and it will continue to flow on until the great drama of living things upon this earth is closed.

Note: The reproductive cells are not endowed with any special quality of immortality different from the body cells. All cells would live for ever if placed under proper conditions, so biologists now believe. Death is not inherently necessary. Doctor Carrel, of the Rockefeller Institute of Medical Research, has a bit of the heart of a chicken which he has now had living and growing in a special fluid for over ten years. The fluid, of course, is frequently changed. Other experimenters have kept one-celled animals living through thousands of their generations—a generation in their case being but a few hours. Biologists know of no reason why, if the waste products could be properly removed, and the conditions of nourishment kept constant, human beings would not live for ever. "In the midst of life we are in death," but purely from mechanical difficulties of nourishment and waste, and not from any inherent quality of life itself. The germ-cells go on living because in each generation they are transferred to a new body and kept under *living conditions*; but if a germ-cell and body cell were isolated and placed side by side in the open one would die as quickly as the other. Under the proper chemical and physical conditions, however, both are potentially immortal and would never die. The spiritual and philosophical problems involved are not here discussed.

The extensive work done in the above fields of research are summed up in a fascinating volume, *The Biology of Death*, by Doctor Raymond Pearl, of The Johns Hopkins University. The special student should also read *Chemical Problems of Growth and Senescence*, by Brailsford Robertson, and *The Behavior of the Lower Organisms*, and other special papers by Professor H. S. Jennings of The Johns Hopkins University.

CHAPTER III

WHAT HEREDITY TELLS AND HOW IT TELLS IT (*Continued*)

THE reader may have grown impatient in the preceding chapter and may feel that we have wandered far afield from the main purpose, which was to tell the story of the mechanical processes of heredity. But at every step each one of these processes and events is so filled with vast human meanings that it is difficult not to lift one's eyes for a moment from the microscope and visualize the immense significance of the drama as a whole. Let us turn back then to the methods by which these wonderful and immortal cells divide and grow into the bodies of living things and how they hand on their qualities to their children.

As I have said, every cell in each species has a definite number of chromosomes. When we look at them in what is called the "resting stage" the material of the chromosomes, called "chromatin," is scattered about in the cell and looks considerably like a tangled skein of yarn. However, when some urge, we know not what, induces the cell to divide and form a new, or as it is called, a daughter-cell, an astonishing series of events takes place. This tangled skein of chromatin which stands out under the microscope, because, as I have noted, it will take a color stain and we can thus see it clearly, gathers up into definite bodies which soon assume the appearance of short rods and in many cases appear like short strings of beads. These are the chromosomes. By and by as we watch them, these strings of beads all move to the middle line or equator of the cell, and there they split from end to end *exactly* in half. The cell membrane then begins to draw in at

WHAT HEREDITY TELLS

the middle between these two sets of half chromosomes. In this way the membrane finally draws entirely together and cuts the half chromosomes into two distinct groups. The two cells, thus formed, then separate and we have two living cells where we had but one before. These half chromosomes now grow to full size and become attenuated into the skein-like chromatin within the cell. Then later, under the same mysterious urge, the chromosomes again gather and divide into two cells, and so on throughout the growth of the individual.

While all these events have been proceeding with the body-cells, also called "soma" cells, from the Greek word meaning body, the germ-cells have remained quiescent. When the individual, however, attains its sexual maturity, they also proceed in the same manner as the body-cells and divide and multiply in the same way. The germ-cell of the female is called an egg or ovum, from which comes the word ovary, the organ whose function is to carry on their reproduction. The germ-cell of the male is called spermatazoon and usually is many times smaller than the egg, which latter, as a rule, carries a quantity of nourishment for the early development of the young.

However, when the egg and sperm are about to unite and give birth to a new individual a most remarkable and entirely new series of events takes place, the drama and beauty of which is not surpassed in all nature's processes. The reader will recall that every cell, both body- and germ-cell, has a certain definite number of chromosomes, which carry the hereditary determiners. It is obvious, then, that if two cells should unite, each with its full quota of chromosomes, there would be twice too many. For instance, there are forty-eight chromosomes in the human cells. If two cells united into one, which they have to do in

THE FRUIT OF THE FAMILY TREE

order to begin a new life, this cell would then contain ninety-six chromosomes. As a result we would no doubt have a monstrosity.

Plainly nature is in a tight place. Something has to be done and, so to speak, done quickly. We need not feel alarm, however, because long ago nature provided for just this contingency. Both the egg and sperm go very rapidly through what is called "reduction divisions," or ripening or "maturation" by which in each one of them one-half of the chromosomes are thrown out. The process is somewhat different in the sperm from that in the egg, but the end result is the same. I advise the reader at this point to consult any high-school text-book on botany or zoology and learn more of the details of this procedure.

Since, however, we are discussing the mechanism by which the characters and features of offspring come out in ratios such as those exhibited in the peas and rabbits, the way the chromosomes behave is of supreme interest. In the reduction divisions, the chromosomes all collect at the equator in the usual manner, but instead of splitting in halves as usual, they separate into two camps, half of them floating to one end of the cell and the remaining half moving to the other end. The cell membrane then contracts between the two camps and, as a result, we have two cells, each containing only half the usual number of chromosomes. These reduced cells are called "gametes" which means "marrying cells," because only after their reduction are they ready to marry each other and give birth to a new plant or animal.

It is just at this point, no doubt, that the segregation of the Mendelian factors takes place so that the characters from them will be distributed properly among the offspring. This is brought about by the fact that when the entire set of chromosomes are collected at

WHAT HEREDITY TELLS

the equator of the cell and begin to migrate some to one end and some to the other end of the cell, it is a mere matter of chance, like the shaking of dice, which end of the cell it shall be toward which any particular chromosomes shall migrate. However, since the factors are believed to exist in pairs, one for the dominant character and one for the recessive character, it is also believed that the two factors of any pair are situated in different chromosomes. Now since half the chromosomes go to one end and half to the other, it is evident that it is a mere matter of chance whether the chromosome which contains the dominant or recessive factor of any pair goes, let us say, to the east or to the west end of the cell. I trust any biologist will indulge my use of such geographical terms, as he has, no doubt, had to resort to every possible illustration to make this matter clear to beginning students.

Since an organism can get along quite well, whether it receives the dominant or the recessive factor of any pair, it is evident that this half set of chromosomes when united with the cell from the opposite sex, also now containing its half set, is quite sufficient for the growth and development of a complete individual. While it is true that in the reduction divisions half the heredity is thrown out, yet a complete set of factors remains—sufficient for perfect development. While the determiners do exist in pairs, yet the dominant factors are not all located in one set of chromosomes and the recessive factors in the other set of chromosomes. In the peas, for instance, the factor for tallness, which is a dominant, may be located in the same chromosome as the factor for green color, which is a recessive. Each chromosome contains a great many both dominant and recessive factors but the members of any particular pair of factors are believed always to be located in different chromosomes. One

THE FRUIT OF THE FAMILY TREE

readily sees that in the chromosomes which are left out in the reduction divisions the result is that many of the hereditary characters of the ancestors are lost, or at least will be absent from the particular individual who is to be born from any particular cell.

Let us suppose that the brown eyes of one's mother was at this point of reduction division represented in one of the chromosomes by a single unit determiner. This is probably not the case, as brown eyes are probably due to more than one determiner. But, if this were true, we can see that if the chromosome containing this factor (or even a group of factors which were linked together) should float, let us say to the east end of the cell, that the west end would be without this factor. Let us suppose that the father was also brown-eyed but had received the factor for blue from one of his parents. Consequently half his germ-cells would carry blue and half carry brown. Suppose then that when a child was to be born, these reduced germ-cells from both parents were brought into contact, it is plain that if a blue-carrying cell should meet a blue-carrying cell, the resulting child would have blue eyes. At least, it would not have brown eyes, since the brown had in both the father and mother migrated to the other set of cells. If a brown should meet a brown, the resulting child would be "pure" brown-eyed. It would receive what Professor Bateson calls a "double-dose" of the brown factors. But suppose there were a great many children born; it is evident that there would be on the average just as many cases where a blue would meet a brown and a brown meet a blue as there would be where a brown met a brown or a blue met a blue. Now since when a blue meets a brown it produces precisely the same result as if a brown had met a blue, there would be twice as many children on the average who would have but one dose

WHAT HEREDITY TELLS

of brown and one dose of blue as there would be children who had a dose of brown from both sides or a dose of blue from both sides. Furthermore, since brown tends to be dominant in the eyes over the blue factor, causing as it does brown pigment cells to appear on the front of the back membrane of the eye, it is plain that the children who were born from the union of a blue and a brown cell or from a brown and a blue, would show brown eyes. They would look brown-eyed, just as the "impure" tall peas resulting from a cross of the tall and short looked tall, or as the black rabbits resulting from the cross of black and white looked black.

We see that if the brown and blue eyes are unit characters, like the tallness and shortness of the peas or blackness and whiteness of the rabbits, a matter which is still in doubt, blue and brown eyes would follow the same course in heredity as did these characters in the animals and plants which we have described. For instance, where a child was born from the union of two cells carrying brown, it would be "pure" brown which means that it would show the brown very strongly in its eyes and also that all its germ-cells would receive a factor for brown. If a child were born from the union of a blue-carrying cell from its mother and the same from its father it would be "pure" blue-eyed. It would show blue eyes, and all its germ-cells would be free from the brown. But if a child were born from the union of a blue cell from one side and a brown cell from the other, it would be "impure" brown. This means it would show brown eyes—probably not so deep a brown as the double-doser,—since the brown-producing factor tends to be dominant over the blue-producing factor. But when such "impure" brown-eyed persons came to maturity and formed their own germ-cells, it is plain that at the

THE FRUIT OF THE FAMILY TREE

reduction divisions when these cells were getting ready to meet a cell from the opposite parent, that the factor for blue would migrate to one end of all such cells, and the brown factor would migrate to the other end. And when these two camps of browns and blues were separated by the cell membrane contracting between them, evidently the individual would be provided at this juncture with a set of reproductive cells half of which carried blue and half carried brown. That is to say, there would be precisely the "free assortment" and the clean-cut separation or "segregation" of the factors into the two sets or camps just as the law of Mendel demands. And, clearly, if the factors do separate in this manner in the germ-cells, and there is every reason to believe they do, the offspring born from these cells would also show the same ratios and proportions in the various characters which these determiners represent.

The reader has no doubt been impressed with the wonderful mechanism of a watch, ticking off the seconds, minutes and hours as it does year after year for perhaps a generation. But here is a mechanism of a hundred times greater precision, a mechanism which has run for millions of years, we might say without winding and certainly without stopping, ticking off the generations, a mechanism which winds itself and which will never run down until life itself shall cease, a thing which many biologists believe will never happen in all the eternities to come. They believe that life is inherent in the very mechanism of the universe. Just before his death, the renowned biologist, Jacques Loeb, advanced the theory that possibly the primal particles of life are so infinitely small that they may travel on waves of light to other planets and stars where the drama of living things will go on and on for ever. It is indisputable, at least, that this mech-

WHAT HEREDITY TELLS

anism of the germ-cell which provides for the transmission of the characters of ancestors to their offspring is unsurpassed in all nature for its perfection, its exactitude and its beauty. And after all it is so simple that, as Professor Morgan says, it leads us to infer that perhaps we shall find in the end that all the mechanism of nature is just as simple. We certainly have no doubt that it is all just as amenable to the reign of order and what we call "natural laws," which are simply the way nature carries on her multitudinous but always orderly processes.

After years of effort to enable the beginner to visualize for himself these apparently complicated, but in reality very simple processes of Mendelian assortment and segregation of the characters of ancestors in their offspring, I have never hit upon a better method than to ask the student to carry out the following easy experiment:

Put two hundred marbles or beans into a bowl, one hundred of which are black and one hundred white, and mix them thoroughly. Place three drinking-glasses by the bowl, and then blindfold yourself and pick the marbles up two at a time, having some friend or member of the family place each pair in the different glasses. Have your assistant place in one glass all the white pairs you hand him while blindfolded, the blacks in a second glass, and the pairs of white and black (or black and white) in the third glass.

When the marbles are exhausted, remove the blindfold and count the marbles in the various glasses. I think you will be somewhat surprised to find that, usually, there are twenty-five pairs of whites, twenty-five pairs of blacks, and fifty pairs of blacks and whites. If not, it will always range very close to these proportions. There will always be precisely the same number in the glass of the pure whites as in the glass

THE FRUIT OF THE FAMILY TREE

of the pure blacks. Most people will not believe this until they try it.

Now, imagine the marbles to be germ-cells, one of each pair coming from each parent and uniting to give

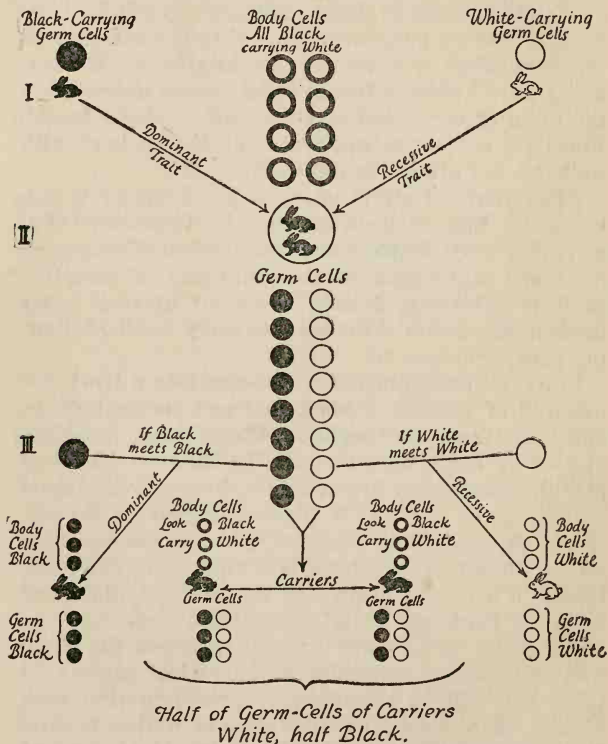

This chart shows roughly the scheme of inheritance of pure unit dominant and recessive traits; why the characters of the two parents "mix" but probably do not often "blend" in the offspring; and why they come out in their original purity in the grandchildren and great-grandchildren.

WHAT HEREDITY TELLS

birth to a new individual. Place the chart of the rabbits before you and you will see that results fall out precisely as the chart predicts. Where a black cell meets a black, the offspring would be pure black—body-cells black and germ-cells black—and, consequently, capable of producing only black offspring. At least one thing is certain, that in this strain there could not possibly be any white. Now, if the white marbles represented the factor or factors for insanity, obviously this black strain of offspring would be free from it. On the other hand, where a white meets a white there would never be any black in this strain. If the black represented the factor or factors for feeble-mindedness, it would be entirely absent from the children.

If, however, a black meets a white or a white meets a black, these children will show the black in their bodies because it is, in this case, the dominant character. But when these children mature and produce their own germ-cells, the black will go into half of the germ-cells, and the white into the other half.

I fear that, after all this brave showing of the Mendelian laws of heredity, the reader is going to experience a positive pang of disappointment when I say that I do not believe that Mendelism applies with sufficient clearness and simplicity to the large and significant traits of human beings to be of very great direct value. I think that the discovery of the Mendelian mechanism has had and will have a great deal of indirect value. I have described it in some detail because I think it aids us very much in ridding the mind of the old notions that mental, moral and physical qualities are handed down by some mystical process, a great deal of which depends on environment or education or on the mental attitudes of the parents. It also rids us of the old bogey that we find pictured in

THE FRUIT OF THE FAMILY TREE

many novels and dramas and even in the older sociology that the ancestors exercise some mysterious "influence" upon the children. We get away from the idea that if a parent thinks evil thoughts, or cultivates his talents, that this sends down some curse or some blessing upon his children.

We see clearly that there is here a perfectly definite piece of machinery, the office of which is to keep the inborn traits of any species of plants or animals intact, a mechanism which insures that they will breed true. Even where individuals with different characters are crossed, we see that, in the long run, what goes into the cross comes out in the offspring.

But when it comes to a direct application of dominance and recessiveness and simple segregation to any very wide range of traits in the higher animals, and especially to the mental traits of the human family, we are met by so many practical difficulties that the case seems to me to be well-nigh hopeless. Even in the physical traits of plants and animals the reader should be assured that the instances I have related are star cases. It is extremely difficult to find characters which are handed down from parents to offspring in such a clean-cut way and as simple single units due to only one pair of determiners as the tallness, dwarfness, blackness and whiteness which we have considered.

Our difficulty is due to at least two major facts: first, that dominance and recessiveness are not often so complete; and, second, that many characters are due not to just one factor and its opposite or possibly its absence in the contrasting chromosome, but are caused by two, three, four and it may be, in some cases, to a still higher number of factors. We also have to deal with the further difficulty that these determiners *influence one another* in the development of the individual.

WHAT HEREDITY TELLS

To emphasize this situation I can do no better than quote one of the most recent statements of the nature of the determiners or genes than that of Professor H. S. Jennings (*The Scientific Monthly*, September, 1924).

“What recent investigation has shown is this: the chemicals that were in the original packages derived from the parents—the genes—interact in complex ways for long periods; and every characteristic is a long-deferred and indirect product of this interaction. Into the production of any characteristic has gone the activity of hundreds of genes, if not all of them; and many intermediate products occur before the final one is reached. In the fruit fly at least fifty genes are known to work together to reproduce so simple a feature as red color of the eye; hundreds are required to produce normal straight wing, and so of all other characteristics. And each of the cooperating packets is necessary; if any one of the fifty is altered, the red color of the eye is not produced.

“For suppose that one parent has all the fifty packets necessary to produce red eye, while the other has but forty-nine of them, the fiftieth containing some substance that will not work in producing red. This parent, then, will not have a red eye but perhaps a white one, although it differs from the other in but a single gene. When these parents produce descendants, the red and white eyes follow in heredity the distribution of that single pair of genes of which one is altered; wherever the altered gene goes appears a white eye; wherever the unaltered one a red eye. So the red and white color inherited according to Mendelian law, were called unit characters; each was supposed to be due to a single gene.

“There is no such thing as ‘unit character’ and it would be a step in advance if that expression should disappear.”

Then, sometimes there are factors present which cause the death either in the germ-cell or in the embryo

THE FRUIT OF THE FAMILY TREE

of a portion of the offspring, and as a consequence when we count the ones that survive some of the expected ones are missing. These, as well as other hardships, confront the student and experimenter who is endeavoring to trace any particular character through the generations. Sometimes also these factors do not, so to speak, stay put, in their own chromosome, but cross over, either singly or in groups, to some other chromosome and the "Mendelian expectation," as it is called, is, to use common parlance, "all shot to pieces."

This does not mean that Mendelism does not apply to the heredity of all or nearly all physical and mental characters in plants, animals and human beings any more than that the laws of chemistry and electro-physics do not apply to complex compounds. Probably all characters are transmitted by the Mendelian mechanism. But these difficulties do mean that nothing but the application of the higher mathematics and the most extensive experimentation—something which we can not carry out with human beings—will enable us to follow the inheritance of the various characters through the generations. This process of following characters in their inheritance from ancestors to descendants is known as "genetic analysis." In plants and animals many of the difficulties I have mentioned can be readily met by the use of refined mathematical methods and extensive and intensive experiments. Consequently, genetic analysis in plants and animals can well be termed a true science, simply because it has developed a body of knowledge by which future events in inheritance can be predicted with more or less certainty. Mendelism has been of great economic value as applied to animals and plants. And while we can apply mathematics to some extent to human traits we can not deal in such large numbers of cases nor place our organisms under varied experimental conditions.

WHAT HEREDITY TELLS

Considerable evidence is developing to indicate that susceptibility to tuberculosis, cancer and some other diseases is due to very few and possibly one unit recessive factor. But we are compelled even here as yet, as the students in these fields themselves urge, to proceed with great caution.

A still further difficulty is met with in the fact that the factors for a few characters are linked with the sex determiner and go with it. This means that the character is transmitted by one sex but shows only in the opposite sex.

It will surprise many people, no doubt, to learn that the cause of sex has long been well known to biologists. At least the factor in the germ-cell which gives the *initial impulse* for the individual to become either male or female can readily be seen through the microscope. The chromosomes, as I have said, are in pairs; but in the cells of many plants and animals can be seen an extra unpaired chromosome. In some species, instead of an extra chromosome, there is a peculiar enlargement or a difference in the shape of one of the chromosomes. *This extra body or peculiarity of size or shape is the sex determiner.*

In most species of plants and animals all the female cells possess this extra body, while only half the male cells possess it. During fertilization, when the male and female cells unite to form a new individual, if the male cell happens to be one with the sex chromosome the fused cell thus is provided with two sex determiners. The plant or animal growing from this union will be a female. If a male cell without a sex determiner enters the union at fertilization, the fused cell is provided with but one sex chromosome. The plant or animal from this union will be a male.

In birds and some other species these facts are reversed. But the above is the usual rule of nature.

THE FRUIT OF THE FAMILY TREE

Since half the male cells have the sex chromosome and half are without it, it is bound to result in the long run that about half the offspring will be males and about half, females.

The reader will, no doubt, at once ask, "Since the cause is known, can sex be controlled?" We can answer in a general way that so far scientists have not succeeded in predetermining sex, except in very special instances. The public should be warned that the frequent claims made by unscientific persons that some mental or physical procedure will predetermine the sex of children according to the desires of the parents, are pure nonsense. *In this sense sex can not be controlled.*

However, by elaborate experimental methods, Doctor Oscar Riddle, of the Carnegie Institute, has been able to produce males and females in pigeons and doves almost at will. He believes there is no absolute dividing line always present, squarely dividing the two sexes, but that the two sexes grade into each other, some individuals—as we observe in human beings—having much stronger masculine or feminine characteristics than others. Doctor Riddle announced recently, at the New York Academy of Science, that sex, in his belief, was probably a matter of chemical energy, those physiological conditions, even after the germ-cell stage, of higher chemical or metabolic energy producing maleness and lower chemical energy resulting in femaleness. The problems involved are highly technical, but evidence is accumulating that in time sex may be a matter of experimental control. If so it would be a matter of great economic value to farmers and practical breeders who wish to produce more of one sex than the other. But it does not seem it could be of much value or interest to the human race since both sexes in about equal ratios are necessary to se-

WHAT HEREDITY TELLS

cial life. The late Doctor Alexander Graham Bell believed that he had probably changed the relative number of males and females in sheep by various types of diet, but the evidence was incomplete at the time of his death.

But the point here is that in studying heredity characters, as I have said, a few characters seem to be linked with these sex chromosomes. The expected simple Mendelian ratios in the offspring are thus disturbed.

It is probable that color-blindness and bald-headedness are what are known as "sex-linked" characters. Probably the reader has never seen or heard of a color-blind woman.* It would involve us in a long mathematical and technical discussion to show the various details of descent and the probable reasons why color-blind women are so rare. The reader is referred to any of the text-books on heredity mentioned at the end of this volume. Bald-headedness probably descends in the same way, being shown almost exclusively by men, but being transmitted by women. It is very probable that a bald-headed man does not inherit his bald-headedness from his father, even if the father had this virtue or affliction, as one may view the matter. What evidence we have indicates that a man gets his bald-headedness through his mother from her bald-headed ancestors. These matters are discussed in the larger technical works on heredity. The point of interest in this chapter is that such factors disrupt the expected Mendelian ratios and have to be taken into account.

Another interesting feature of these hereditary factors or determiners is that some of them act not to produce characters in the plant or animal but to sup-

*If the reader knows of a color-blind woman, it would be of great scientific interest if the name and address of such a person could be forwarded to the American Genetics Association, Washington, D. C. For address see appendix, *Journal of Heredity*.

THE FRUIT OF THE FAMILY TREE

press them. Such factors are called "inhibitors," or "suppressors."

For instance, on some animals, such as Holstein or Hereford cattle and on dogs with white spots, these white patches are not albino white as is the white in the rats and guinea pigs previously described. The entire coat-color of these animals would be colored, but over a portion of the coat the color is suppressed, leaving patches of white hair, large or small, owing to the strength and extent of the inhibitors.

In many cases these inhibitors are dominant factors. This is shown by the fact that when Hereford or Holstein cattle, for instance, are crossed with, say Black Angus, the white patches show, often with very great distinctness, on the offspring.

Professor William Bateson, of Cambridge, England, has even suggested that possibly all evolution may have come about from the elimination of these suppressors. He has suggested that possibly all the characters and features of living things were represented by determiners in the first life cell that ever appeared in the world and that, as these inhibiting factors have dropped out, all the wonders of plant and animal life have leaped forth into full development. Certainly a fascinating speculation!

In evidence of this, Professor Bateson points to the fact that the flavors and colors of our present-day apples are all present in the sourish, bitter, diminutive wild crab and the apples we have now such as the "Delicious," the "Maidenblush," the "Snow" and others, have developed by the dropping out of the factors which inhibited the development of their flavors, colors and great size. This, he thinks, has also been the case with the great size, color and perfume of carnations and chrysanthemums, the beauty and grandeur of which have been released by the elimination of inhi-

WHAT HEREDITY TELLS

bitors which imprisoned them. As one instance, there are two varieties of pure white sweet-peas, each of which breeds true and remains pure white. But when these two varieties are crossed, presto! *seven different varieties*, each with its own distinct color, leap into bloom in the offspring! Had one not kept tab on what seeds he had planted, he might suppose he had sown the seeds from one of those "surprise packages" which floral companies send out to advertise their products.

Then in addition to this, some factors act as "developers" much like the developing chemicals which bring out a photograph on a negative. In some chickens, as an example, there are faint patterns which can barely be traced upon the closest examination. However, when these chickens are crossed with certain other varieties which carry a developing factor in their germ-cells, these faint patterns fill out with distinct and beautiful color. How many similar situations there may be in the deeper anatomy and physiology of plants and animals is entirely unknown.

But all of these facts with reference to inhibitors, developers and the like show us in new ways what a wonderful thing the germ-cell is and what a marvelous piece of machinery nature has provided for preserving the identity and continuity of her species; and it is by the manipulation of this machinery, so to speak, that new species are developed. For the reader should get the idea clearly that evolution probably always takes place first in the germ-cell, indeed, in the chromosomes within the germ-cell. Or, rather, even more fundamental than that, evolution probably all takes place in the determiners—the factors or genes, which later, by the changes which have taken place in them, produce new characters in the body of the animal or plant, or even produce a new species of animal or plant which

THE FRUIT OF THE FAMILY TREE

never before existed in the world. These changes are brought about from causes that we do not clearly know, but these living processes are all full of fascination, of wonder and inexpressible beauty; and the life of an experimental biologist to-day is one that is touched with all the adventure of exploration and the keen excitement of discovery.

But as a last well-nigh insurmountable barrier against easily applying simple Mendelian formulas and ratios to tracing the inheritance of mental traits in human beings, we are, to use common parlance, up against the fact that nobody can say precisely what a mental trait is. That is, we can not see mental traits, we can not weigh them, we have no very accurate method of measuring them, nor have we any undeniable method of very closely estimating them.

Let us ask ourselves, for instance, how we would set about tracing the inheritance of mathematical ability. It is entirely likely that addition, subtraction, multiplication and division require the activity of different brain centers, and we conceive that these brain centers are probably due to different factors in the germ-cell. There may be many other phases of brain activity concerned in mathematical calculation, such as imagination, power of attention and heaven knows what-not. Miss Margaret V. Cobb, of Columbia University, studied a number of families for the inheritance of mathematical ability and her work strongly indicates that the abilities to add, subtract, divide and multiply are different mental qualities, and inherited independently of one another.

For a more extended discussion of the whole matter of the inheritance of intelligence and its various elements, I must here refer the reader to Popenoe and Johnson's *Applied Eugenics*, pages 107 and following, and to a more extended discussion by Professor Sam-

WHAT HEREDITY TELLS

uel J. Holmes, of the University of California, in his fine book, *The Trend of the Race*, especially chapters III, IV and V. Much of the very critical analysis of this whole problem by these authors is also repeated and commented upon with great clearness by Professor Frederick A. Bushee, of the University of Colorado, in his *Principles of Sociology*.

When Mendelism was first rediscovered and its general principles clearly established, it became the fashion for some biologists to seek to apply it without much discrimination and without sound methods of mental measurement and diagnosis, to all sorts of mental characters in man. A number of studies were made of the inheritance of insanity, feeble-mindedness, epilepsy and other mental and physical abnormalities; and some study was also made of the inheritance of various types of ability, such as musical, artistic and literary. The authors found in nearly every case what they were looking for, namely, that these characters were either dominant or recessive, and due to either unit factors or else to so few factors that they could readily be traced through families by Mendelian rules. Since most of these students have somewhat receded from their first extreme position, it is unnecessary to discuss the matter here in detail, except to express my entire agreement with the critical reasoning of Popenoe and Johnson and Professor Holmes. I think we can say with great security that feeble-mindedness is not a unit character nor a clear recessive trait. The same may be said of epilepsy and insanity. If these were unit, recessive traits it would be entirely safe for those afflicted with such defects to marry normal persons as far as the immediate children were concerned. The defects would disappear as completely as the dwarfness did in the cross with tall peas. But there are too many exceptions to this

THE FRUIT OF THE FAMILY TREE

simple rule to make it safe to generalize. We can say with positive assurance that, where feeble-minded persons marry their like, nearly all the children are feeble-minded. "Most of the facts of the inheritance of mental defect," says Professor Holmes, "are conformable to the hypothesis that such defect is dependent upon a number of factors instead of a single one."

All of this does not *necessarily* mean that the mental characters of human beings are not inherited by the Mendelian mechanism, and that they do not segregate in the offspring with a great deal of distinctness. We see clearly that defects, as well as abilities, come out as quite distinct characteristics not only in individuals but in families. The facts of evolution would lead us, I think, to expect that, in a general way, virtues and normal conditions would have a tendency to show more dominance than vices and defects. But this remains to be demonstrated. Professor Holmes believes that he has some evidence that high abilities tend to be dominant over lower abilities and mediocrity.

But while the large traits of the human mind and body do not clearly follow simple Mendelian rules in their inheritance, so that we can predict with certainty the outcome of any particular marriage, yet there is a great deal of evidence that they are transmitted by factors in the germ-cell, and that these factors are subject to the general Mendelian mechanism. These traits are, however, apparently due to so many factors in each case, that tracing them with any clearness is, as I said in the beginning, well-nigh hopeless.

All of this need not, after all, discourage us. The difficulties are rather technical than practical. The work of Woods on the royal families as well as the studies of numerous families by the Eugenics Record Office and by other workers *show clearly and emphat-*

WHAT HEREDITY TELLS

ically that mental and moral tendencies as well as distinct abilities and defects are inherited, and that they are inherited in an alternative manner. That means that they do segregate to a sufficient degree to show much more plainly and powerfully in some individuals and in some families than others. As Popenoe and Johnson put it, "If intelligence is due to the inheritance of a vast number of factors—knowledge of heredity would lead one to expect that some children would receive more of these factors than others. All degrees of intelligence from the idiot to the genius would exist; and yet we can not doubt that a few of these factors are more important than others, and the presence of even one or two may markedly affect the level of intelligence." Professor Holmes sums up his treatment of the whole subject by saying, "Whether the inheritance of mental defects" (and I think we may say the same of mental abilities) "follow simple or complex Mendelian formulas, or whether, indeed, it may not take place according to older conceptions of blended inheritance, makes comparatively little difference in the practical treatment of hereditarily defective persons. The fact that mentality is strongly transmitted is established beyond the possibility of sane objection, and the particularly disastrous results that are pretty sure to follow from the mating of two mental defectives have certainly been made sufficiently impressive by the work of recent investigators."

I think we can see then, after all, that, while we can not directly apply Mendelism to human beings, because of the enormous practical difficulties in the way, yet Mendelism has greatly clarified our conceptions of heredity, and will aid us in developing the science of eugenics. It gives us a clearer conception of what heredity is, how it operates, and of what causes

THE FRUIT OF THE FAMILY TREE

the enormous differences among human beings. We see much more clearly why people vary so much in their defects, virtues and abilities; why, for instance, a great man may have a feeble-minded brother, or even why a genius may have some defect such as epilepsy or insanity. His genius is probably due to factors for high abilities and his defects due to other factors. We see better than ever how it comes about that some men have but one talent, some two and some five. And, for practical race improvement, that is all we really need to know. Intelligent, wholesome, sane, energetic, moral people have more factors in their germ-cells for these virtues than have the unintelligent, the immoral, neurotic and stupid. The high injunction of Mendelism to eugenics is then that these good factors can be concentrated in families, and by wise marriages preserved there and handed down to bless the race. The bad factors have a tendency by assortative mating, the attraction of like for like, to become concentrated also in family lines. Where these become positively anti-social the individuals possessing them can be either confined or sterilized, and their strains of pollution weeded out of the race. This, coupled with a spread of a knowledge of birth-control among those who are merely mediocre, will lessen the ratio of this section of the population to the sections in which are concentrated higher abilities and greater mental and spiritual vigor. If, then, these more able groups of the people will create those economic and social conditions which will cause them to produce somewhat more than their share of children, the race is bound to fare onward and upward. The aim of eugenics will thus be largely attained.

This is a program in which the most ardent believers in heredity and the most ardent believers in environment can unite with the utmost good will. It will

WHAT HEREDITY TELLS

give ample scope to the desires and passions of both. Such a union of both the environmental and hereditary forces all along the line is, indeed, the only hope for race improvement. If the workers for good environment and those who advocate good heredity can thus join their forces, as they are rapidly doing through the new education of the younger generation, it will mean but one thing for the future,—a constantly improving race of people dwelling in a constantly improving world.

NOTE: The reader must understand that what is handed from one generation to the next is merely these little packets or genes in the germ-cell and not the *completed character* such as tallness or black color. Neither the tall character nor black color nor any other feature will develop unless proper environment is supplied, and if there should be a radical change in the environment it might be some other color than black would develop. If either the hereditary material in the germ-cell is changed ever so slightly or the environment changed some other character develops than the one which we commonly speak of as "inherited." The reader must not gain the idea that these determiners will develop into some certain characteristics irrespective of the environment. Professor Herbert S. Jennings, of The Johns Hopkins University, has brilliantly and profoundly argued this whole matter in an article in *The Scientific Monthly* for September, 1924, entitled *Heredity and Environment*. As Professor Jennings puts it: "Clearly it is not necessary to have a characteristic merely because one inherits it. Or more properly, characteristics are not inherited at all; what one inherits is certain material that under certain conditions will produce a particular characteristic; if those conditions are not supplied, some other characteristic is produced."

In this sense a man's knowledge of Latin grammar is just as much an inherited character as is his bald head. Both developed because certain packets of chemicals called factors were in the germ-cell from which he was born, and these factors under the conditions that he met in life developed into these characteristics. Had he met different conditions he would have developed other characteristics in their stead. It is not true that a man is predetermined in or by the germ-cell and that a foreordained man with foreordained characteristics is going to grow up willy-nilly. However, because of merely *practical difficulties* we can not very radically alter men by education and environment, partly because we do not as yet have the proper technical means and partly because the environment is fairly uniform for all human beings during the first nine months of their lives and they come into the world as quite far advanced organisms. But in frogs and fruit flies and other animals where the egg itself and the early embryo can be radically interfered with, changes can easily be produced which make the adult animal strikingly different from what it would have been in the usually expected environ-

THE FRUIT OF THE FAMILY TREE

ment. We predict a certain kind of man by studying his ancestry merely because we *expect* for him a certain type of general environment not profoundly different from that of his ancestors. It is the *expected* environment which leads us to count pretty strongly on heredity and not that the heredity in the germ package predetermines all he shall be. F. A. Woods pointed this out nearly fifteen years ago. Of course there are limits to the alterations possible by environment, but they are far from being reached as yet with human beings. None of this alters the fact that very moderate environmental measures, such as education and moral suasion, expended on rich hereditary material yield far greater results than when expended on poor material. Other measures might produce as marked results with poor material, but in society as a practical matter there is neither the time nor money as yet to try to make imbeciles into geniuses when by proper marriages they can be produced free of charge. The differences among men are, I think, largely due to differences in the original hereditary packets in the germ-cells because so much of the environment of men is common to them all. I can not reproduce all of Professor Jenning's fine presentation and can only urge the thoughtful to study it with care as the most penetrating discussion of the heredity-environment problem that has been made from the standpoint of a biologist.

CHAPTER IV

WHAT EDUCATION TELLS

IF A man educates himself, will his children for that reason be born with any better minds than if he had spent his life digging ditches or in a jungle with savages?

If a man commits a crime, such as forgery, murder, burglary, or arson, will his children for that reason be born with feebler wills, less moral sensitiveness, or in any way more likely to commit crime?

If a blacksmith uses his arms in his work, will that cause his children to be born with any stronger arms or sounder constitutions than if he had all his life carried his arms in a sling?

If a mother cultivates her musical talent by singing, playing the piano, and listening to beautiful music all her life, will her children be born with any greater musical talent than if she had never heard a more musical note than an Indian tom-tom?

If a horse runs round the race-track for many years and his trainer develops him to the highest speed of which he is capable, will that cause his offspring to be any faster than if he had stood hitched all his life to a post?

If a farmer plants his potatoes in rich soil and then does not save the big strong ones for seed, but continues to plant *all* the offspring, will the rich soil improve the stock?

If children are taken from bad homes and filthy immoral surroundings and given good homes, careful training and improved environment, will their children and grandchildren for that reason be born with

THE FRUIT OF THE FAMILY TREE

brighter minds, nobler impulses, warmer sympathies, and better moral instincts than if they had been allowed to grow up in the midst of filth, immorality and ignorance?

After a hundred years of argument and over thirty years of experimentation upon plants, animals and human beings, science can at last answer all these questions with a great deal of assurance in the negative. There is a limited technical sense in which it may be possible that some slight influence which comes from improvement or injury to the parents is in extremely rare instances and under extraordinary conditions transmitted to the children. What this is I shall point out later. But, speaking broadly, we can say with just about as much certainty as we speak of gravitation or relativity that what happens to parents during their lives or what they do, whether they educate themselves or remain in ignorance, cultivate their talents or totally neglect them, develop good or bad habits—that all this has no appreciable influence in causing their children to be born either better or worse, brighter or more stupid, weaker or stronger, wiser or more foolish.

Now, three things always happen when people, either educated or uneducated, first come across these challenging statements. First, they say these statements are not true; that improving the parents *will* improve the children. Second, they say such a doctrine is pessimistic; that if this is really true then all hope of improving humanity is gone. As we shall see, it is quite the contrary, and furnishes us about the only possible hope of improving the human race *so it will remain improved*. And third, they say that if what happens to the parents does not affect the children, then the Biblical statement that the sins of the fathers shall be visited on the children is not true.

WHAT EDUCATION TELLS

This statement, as we shall also see, is perfectly true, but in a wholly different way from that which has always been believed.

Let us take the last statement first. When the Hebrew prophets said that the sins of the fathers shall be visited upon the children to the third and fourth generations, they did not mean that they would be visited by *heredity*, but by *civil and criminal law*. I have consulted the greatest Biblical scholars in the world on this point and they assure me, what any biologist would have supposed in advance, that the Hebrew lawgivers did not refer to heredity because they knew nothing about heredity. They simply meant that if a man had committed a crime, not only should he be punished, but also his children and grandchildren should be made to suffer for his crime. This was a common part of ancient criminal codes and made the whole family responsible for the good conduct of its members—a very salutary process. In some tribes to-day when a man commits a crime they behead the whole family.

If this custom were applied in our time in civilized countries it would probably result in race improvement. However, the new knowledge of heredity, which I hope the reader has gained from the preceding chapters, shows that it would be most unjust because some of the children might inherit the bad tendencies in full force while others would entirely escape. We would thus often be punishing the innocent for the sins of the guilty.

So we get rid of this old bogy at the beginning. It has been used for ages to frighten children. I know when I was a boy that I was kept in mortal terror for fear some sin committed by my great-grandfather, whom I had never seen, might suddenly be visited upon my poor unoffending head. The total misunder-

THE FRUIT OF THE FAMILY TREE

standing of this one sentence in the Bible has, I think, had more to do with making people believe that heredity is some fearful fate, some mysterious "influence" wished on us by our ancestors, than any other one thing. Such a view of heredity is so much gratuitous nonsense.

As I hope I have shown, our ancestors exercise no "influence" over us whatsoever in making us either good or bad except when they decide which shall marry which. This decides the line of germ-cells we shall be born from and consequently which among all the millions of by-gone persons on earth we shall *resemble*.

If we are born from the Smith line we shall be a great deal like the Smiths, and if from the Brown or Jones line we shall resemble either the Browns or Joneses. That is all there is to this bugaboo about heredity being some sinister fate. Everybody who is not feeble-minded or insane has sufficient good natural qualities, that is good heredity, to become a decent, self-controlled citizen.

However, before refuting the two other common beliefs that education and personal improvement or injury are transmitted by the parents to their children, and that not to hold such a belief destroys our hope of race improvement, let us examine the evidence that educating or injuring the parents will not improve or injure the children.

It all rests on the wonderful discovery made about thirty years ago by August Weismann, a great German biologist, that when two reproductive or sex-cells unite—one from the mother plant or animal and one from the father plant or animal—they at first fuse into one single cell. As we learned in a previous chapter, after a short period of quiet known as "the resting stage" this first cell divides into two cells. Next each

WHAT EDUCATION TELLS

of these cells divides, making four, then eight, sixteen, and so on, until the plant or animal becomes full-grown. Gradually these cells become somewhat different in their functions, some going to make nerves and some to make muscles, blood, and the other parts of the body.

However, the surprising thing which Professor Weismann discovered was that during the two-four-eight-sixteen-cell stage, known as "the cleavage stage," before the cells divide to make nerves, muscles, etc., some of them are set aside and take no further part in the life of the individual. *These are the reproductive or sex-cells.* They are set aside in appropriate organs and are carried through life unchanged except that at maturity they increase enormously in numbers. By and by they are handed on and united with the reproductive cells from some other individual, and in this way a new individual again is born. As Professor William E. Castle, of Harvard, says, "The germ-cells are merely guests of the body, but are not members of the household. They feed at the common table, but have no share in the activities of the home. They are themselves unmodified by these activities." Thus the germ-cells are much like coins carried in one's pocket. No amount of education or wishing will change the five-cent piece in one's pocket into a dime. Neither will any amount of education or wishing or "prenatal culture" change the germ-cells which a plant or animal carries into something better or worse. The individual parents go through life, educate themselves or not as they like, behave themselves or not as they choose, but all this does not directly affect the future children. The cells from which they are going to be born, were all set aside in a safe place at the beginning of their parents' lives and will not be affected in any measurable degree.

THE FRUIT OF THE FAMILY TREE

by their desires, education, ambitions, or by their misdemeanors or folly.

We might look at the whole matter as Professor Conklin, of Princeton, has put it. Suppose a man has a wooden leg. His children do not inherit this, because his new member was added to his equipment *after* he was born. It is not very different from the way in which he is given a college diploma. College diplomas and the learning that goes with them are not inherited. And, as Professor Conklin said in a famous witticism, "Wooden legs are not inherited, but wooden heads are." This is because wooden legs are acquired and wooden heads are inborn.

As I have also pointed out in *The New Decalogue of Science*, we might think of it in this way. Suppose a man goes insane from getting hit on the head with a brickbat. This will not affect his children, although they may be born after his accident. The injury affects only his body-cells. It does not affect his germ-cells. Consequently his children do not inherit his cracked brain, although they might inherit his inability to dodge brickbats. But that is all. This is wholly different from true insanity, which is due to determiners in the germ-cell or else a lack of determiners for self-control.

People often say that syphilis is inherited and the sins of the father in this case visited upon the child. This is one instance where the father's sin is visited upon the children, but *not by heredity*. *Syphilis is not inherited*; it is transmitted in an entirely different way from true heredity. The susceptibility to the syphilitic microbe no doubt is inherited.

The microbe, it is believed, is able to travel with the spermatazoa of the father who may be infected and to penetrate the egg of the mother at the time of fertilization. In this way the child develops with the disease from the very beginnings of its life. This is

WHAT EDUCATION TELLS

evidenced by the fact that often a syphilitic child is born from a perfectly innocent and healthy mother. The membranes about the child before its birth prevent the disease with which it is infected from being transmitted to the mother and in this way she escapes, but the child is born foredoomed to a frightful disease and it is often impossible to save the child's life. Sometimes the father imagines that he is not infected, but this can only be determined by the most careful medical examination. The common sense and common humanity of men will surely make it a compulsory procedure for all persons, both men and women, before marriage to undergo the most critical health survey that science can afford, and where the individuals can not pay the expense it should be borne by the state.

But this is not heredity in the true sense of the word. In order to designate syphilis and such things as physical injuries and defects in physiological functions sometimes present in new-born babes, the word "congenital" is now used, which means "born with" as distinguished from true hereditary defects which are due to defects in the germ-cells themselves.

Doctor Paul Kaminer, of Vienna, has been in America, making strong claims that he has produced acquired characters which were inherited, but so far his evidence, while impressive to the public, has failed to convince the American biologists. I believe his evidence is insufficient to support his conclusions.

But when your attention is called to the fact that the germ-cells, which carry the heredity, are entirely separate from the body and merely carried by it as a trustee, you will easily think of a hundred instances which tend to prove that the education of the parent is not inherited by the child. For instance, people have been talking Greek or German or Yiddish for centuries. Yet if the children of these races are reared

THE FRUIT OF THE FAMILY TREE

by English parents it is as hard for them to learn the language of their ancestors when they go to school as if their ancestors had never heard or spoken the native tongue. Some children are naturally better language learners than others, because they belong to naturally bright families. But exercising or neglecting the talent has no influence one way or the other on the future children that scientists have ever been able to detect. People have also been walking on the soles of the feet for centuries, but babies are born now with the skin on the soles of their feet just about as tender and thin as anywhere else on their bodies. We should reflect that if the blacksmith by using his arm caused his children's arms to be larger, by and by the arms would become so big as to be utterly useless.

We see then how fortunate it all is. Children are not affected by the sins of the parents nor by the accidents or injuries that may befall them. Nature has long ago seen to it that the precious germ-cells, the hereditary material from which we are to be born, are placed safely away from all possible injury from such causes. I have said that the Biblical statement was perfectly true that in one sense the sins of the fathers are visited upon the children, and that is when the fathers commit the one unpardonable biological sin of marrying the sinful. Suppose such a man as Theodore Roosevelt had married some feeble-minded woman. Or suppose his great-grandfather, Archibald Bulloch, one time governor of Georgia and one of the ablest men in the South, had married some foolish woman. The grand character of Theodore Roosevelt would never have come into being. Nature visits the sin of unwise and foolish marriages, not only upon the third and fourth but upon the fiftieth and one hundredth generations.

We saw how this happened in the famous case of Martin Kallikak, one of whose matings to a feeble-

WHAT EDUCATION TELLS

minded girl gave rise to 446 worthless and largely criminal descendants; while his second mating to a noble woman, who carried the blood, that is the germ-cells, of a noble ancestry, gave rise to nearly 400 lawyers, doctors, clergymen, merchants, and good citizens generally. We see how optimistic it all is. For if the sins of the fathers are visited by unwise marriages, nature provides also that by wise marriages the virtues of the fathers are also visited with increasing glory and intensified quality to the end of time.

However at this point there comes up a question of supreme importance. If injuring the body or educating it does not affect the germ-cells, what would happen if we could directly improve or injure the germ-cells themselves? Suppose we should give a hen alcohol or some poison, might not the poison directly injure her eggs and cause defective offspring? This brings up a vast set of problems. Indeed it brings up the whole problem of evolution, of how new characters in plants ever got started. Evidently new features have arisen and continue to arise, else we would never have had evolution at all. We are learning a great deal about this problem or set of problems but it is still far, far from solution. It is too highly technical to discuss here with profit as it carries us out into all the great deeps of biology and into many of the vast unsettled problems of philosophy as well.

Suffice it to say that whether we can, either through the body or by direct action on the germ-cell itself, modify it in any way so that the changes we induce are transmitted to the generations to come is a matter that is still in doubt. After thirty years of experiment biologists are not sure whether they have ever been able to poison or improve a germ-cell and thus affect the offspring or not. I am inclined myself to believe that at least one-celled organisms, such as the amoeba,

THE FRUIT OF THE FAMILY TREE

and paramecium, have been changed and the change handed to the children. But one-celled organisms and many-celled plants and animals present somewhat different problems. So we shall leave this matter in doubt, although I think it is slowly approaching a solution. But, however that may be, it is a long way from changing an amoeba or a hen's eggs by chemicals to improving a boy by teaching his parents Latin grammar or the Ten Commandments. The prime thing is to teach these things to the *boy*.*

There are several questions of importance, however, which I hope have occurred to the reader. First he may ask, "If a man is a drunkard, will that not *cause* his son to drink or *cause* him to be born with a taste for alcohol?" We can say with much assurance, "No." In the first place, nobody ever inherited a taste for alcohol. Some people inherit a greater *susceptibility* to its supposed charms than others, or a greater lack of self-control. But if a man has never tasted nor heard of it he has no desire for it. The Indians had no desire for "fire water" until we gave it to them. In the second place, a man drinks to excess from lack of self-control, partly, of course, due to a wrong education or bad companions or wrong environment, but quite largely also from a weak natural make-up. His son is born from the same line of germ-cells and may *resemble* his father in this characteristic. But there is no crucial evidence to indicate that the drinking of the father *caused* the son to drink. The son ought to see from his father's weakness that he should be especially on guard in this direction. We should fortify ourselves against the weaknesses of our ancestors and emulate their virtues. This is genuine character-building.

*The latest and best popular discussion of this whole subject is contained in the *Yale Review*, July, 1924, by Professor Thomas Hunt Morgan.

WHAT EDUCATION TELLS

If for a moment this seems pessimistic let the reader reflect upon the other side of the problem. Suppose that the effects of moral improvement and education were transmitted to the germ-cells and through them to the children, then the *lack of education* would likewise be equally transmitted. Parents who neglected to get an education or to control their appetites, or who, as in pioneer days or during the dark ages, had no chance to get an education, would have nothing but feeble-minded and reckless children. The whole race would soon lose its intelligence and moral control. It is the very *stability* of this line of germ-cells, the fact that they are almost inviolable and unchangeable by any habits or wishes or desires of the parents, that gives us our sole hope of *permanent* race improvement. Suppose the germ-cells were easily affected, that is, easily improved or damaged. Then if we took children from the slums and educated them this improvement would, of course, be handed on to their immediate children. But if war should disrupt the country, if these children should meet with misfortune and the good environment not be continued, all our efforts would soon be destroyed. Bad environment would in time make *everybody* bad. We can enormously improve individuals by education, but fortunately this improvement in no way changes the germ-cells they carry, at least to any extent which science has ever been able to detect or measure.

I say "fortunately" this improvement is not transmitted, because if it were, then wrong education would be transmitted just as readily as right education. Suppose that all the idiotic experiments we have performed upon children in the name of education were transmitted to coming generations! It would wreck the human race and produce a chaotic mental constitution that would shortly turn the world into an insane

THE FRUIT OF THE FAMILY TREE

asylum. Neither God nor nature proposed to trust our poor human ideas of pedagogy. We might educate the race up and we might educate it down. Everybody has a different idea about right and wrong education, especially moral education. No doubt Adam and Eve differed as to the proper education for Cain and Abel. And our professors are quarreling yet over the same problem. If all the wild theories about education and moral training since Adam had been inherited the human race would long ago have gone to pot.

But the glorious thing is—simply because this immortal stream of germ-cells is almost unchanged by anything we can do to it—that if bright people will marry bright people we can absolutely depend upon nature to produce bright children. And if dull people can be persuaded to practise birth-control and the absolutely defective be positively prevented from marrying at all, then the race will automatically improve and *remain improved*.

The work of environment has to be done over and over again for each generation. But the work of heredity done once lasts until the stock commits the unforgivable sin of marrying lower and meaner stock. This will instantly destroy the good effects of a thousand years of either improved environment or improved heredity. But, on the other side, the side of optimism, if misfortunes overtake a family or people, if war wrecks their civilization and education, yet *if the breed be preserved*, all the hardships and vicissitudes of time can not destroy its inner glory. As David Starr Jordan eloquently put it, "You can kill the individual, but you can not tarnish the sacred stream of heredity." Such a virile people will in time rise from their misery and from their very misfortunes build again a civilization of polish and gran-

WHAT EDUCATION TELLS

deur. Their hardships have injured the bodies of each generation, but they have not injured their germ-cells.

The reader may ask, if education is not transmitted and if improving this generation does not improve the next, how are we ever going to improve the human race? I think I can best answer that question by a simple illustration. In China they have been binding up the feet of the women for centuries. But the girl babies are born now with just as big feet as ever. But suppose all the men in China decided that none of them would marry until he could find a woman born with small feet—one which God or nature had made with small feet—that is, had “varied” in the direction of small feet. Then suppose his son and grandson did the same thing. Obviously we should soon have a race of all small-footed women because all the big-footed women would have been left out. And beyond question that is the precise way in which our women to-day got their small feet. Men have always admired small-footed women. And other things being equal—that is, the head being equal to the feet, which is not always the case—they have married such women, and thus this ideal has been bred into the very bone and sinew of the race.

In the same way women have got their beauty. Men have admired beautiful women and tended to prefer them in marriage until to-day the homely women have all disappeared. We have some women whom we still think are homely, but that is because of our advanced ideals. The homeliest are far and away more beautiful than our apelike ancestors.

In this way the ideals of a race become in time stamped upon the very anatomy and physiognomy of the children. This is because men and women tend to marry persons who possess the traits of body and

THE FRUIT OF THE FAMILY TREE

mind which they, themselves, admire. These possessions are thus transmitted to the children. A healthy boy, for instance, admires his mother and tends to select a wife that looks like her and *is* like her. She is his ideal of womanhood. A healthy girl tends to select a husband like her father. In this way family likenesses and traits of character are preserved and handed down. *Like tends strongly to marry like.* This is true all through nature. The popular notion that opposites marry is not true, except in respect of a few particular characteristics, such as high temper, extreme cheerfulness and tendency to mental depression. Like usually marries like, but Doctor Davenport found that exceptionally cheerful persons in a majority of cases marry melancholic persons, probably in order to cheer them up; or else it would seem that the glooms marry the cheerfuls in order to get cheered up. Also he found that high-tempered persons seldom marry each other. This is probably because they never agree well enough to get as far as the marriage altar. The adage that old married couples grow to look alike is true simply because they looked alike when they were married. They grow into similar habits, and we note their likeness more for they live a long time together, but they looked in reality just as much alike the day they were married as they do on the day of their golden wedding.

But just because acquired characters are scarcely if at all transmitted and just because the germ-cells are extremely difficult to change, *whatever the ideals* are that lead young people to select each other these ideals will be handed down in the bodies and minds of their children. Young people may be taught to admire beauty of person or character or athletic prowess or intellectual ability. Or, if wrongly educated, they may come to admire in each other sheer vulgarity or dar-

WHAT EDUCATION TELLS

ing criminal tendencies. But whatever young people admire in the opposite sex soon becomes the actual character and appearance of the race. If a farmer admires fine, healthy, beautiful horses and selects such animals as the parents of each generation, the farmer's ideals soon become the actual physical and mental characters of his animals. We can tell any farmer's ideals in these directions by merely looking at his horses.

As an instance Henry Ward Beecher is said to have told Doctor Newell Dwight Hillis, when the latter was starting out to preach, to study the horses in a community first instead of the people. He said, "If they have fine, spick and span horses, those people have high ideals and you can do them a lot of good. But if they have poor, broken-down, half-starved, low-bred horses, get out of there. You can't save those people's souls because they have no souls to save." And all these selective forces apply to human beings.

While we see, then, that education and environment do not directly modify the body and mind of a parent so that the modifications are in any large representative way transmitted to the children, yet education and environment do influence marriage ideals. And *just because acquired characters are not inherited*, at least visibly and easily, environment is, through this marriage selection, a powerful and wonderful thing because it so largely determines who shall marry whom and thus what characters of body and mind are selected and preserved to furnish the inborn character of the race.

It has always seemed to me that the word "induced" character instead of "acquired" character should be used to designate any new character which has not arisen by the exercise or efforts of the organism itself, although either word presents difficulties. I find

THE FRUIT OF THE FAMILY TREE

from extensive lecturing that the public is very much confused at this point, since highly educated laymen often say to me, "Acquired characters must have been inherited some time or else new plants and animals would never have appeared." This contention is obviously correct. What is meant by the statement that "acquired characters are not inherited" is that no experimenter has ever been able to *induce* or bring about a new character nor have biologists been able to catch nature at the process. Many characters which have been thought to be new have been found to be merely a reshuffling of Mendelian factors already present in the germ plasm.

The logical difficulty, therefore, still remains that unless new characters appeared from some cause we would have no evolution. It can never be solved until some one proves beyond debate that he *has induced a new character* or has discovered how nature does it since, as long ago pointed out, it is impossible to prove a universal negative. Until that time comes the debate between the "vitalists," who believe that characters arise from some inner, vitalistic life force, some inner creative urge, and the "mechanists," who believe that nature is a mere machine, and that characters arise from environmental chemical and physical causes, will go merrily on without the slightest possibility of either side arriving at more than a strong inferential conviction. Few, if any, biologists doubt, I think, that all the visible operative processes of birth, life and death are purely mechanical; but the vitalists believe that "behind and within it all" is a more spiritual element, animated by ideals and purposes, while the mechanists see no need for this assumption.

I often see it asserted in the press that biologists are "opposed to the evidence in favor of the transmission of acquired characters." Biologists are neither in

WHAT EDUCATION TELLS

favor of nor opposed to anything in the matter. Their sole effort is to discover the real evidence and separate it from mystical assumption and careless inference. The natural bias of most biologists would be in favor of the inheritance of acquirements since it would instantly clear up for them so many unsolved problems in evolution. It would also go a long way toward bolstering the mechanistic theory which many, probably most, biologists, espouse.

On the other hand the natural bias of the man in the street, the warm-hearted philanthropist, the reformer, socialist, bolshevist and the extreme environmentalist of every type is toward believing that the effects of education are transmitted, since it is his most ardent hope and deepest life conviction that men can be reformed and made permanently wiser, healthier and better by education or by some radical change in the social machinery. However, if he saw to the bottom of his own problem, he would see that it would be highly to his interest if the germ-cells were extremely stable and very hard to change by education or any other means, since if his new machinery should break down or be upset by outside forces, this change would change men's natures again and then his work would be undone in a day. Three-fourths of all radical programs and reforms, however, continue to proceed upon the assumption that if only this generation can be placed amid happy economic and educational conditions, the next generation will be born wise, just and generous. If these well-intentioned people would think the thing through, they would see that, unless the paradise they propose to set up could be guaranteed to last for ever, that it is little short of a heaven-sent blessing to their own program that the men of the next generation will be, in their natural characteristics, about like we are, unless we can improve them by *selection*. In that case

THE FRUIT OF THE FAMILY TREE

they would be naturally better than we are and their improved natures would be transmitted in this *highly stable germ plasm* and this alone would insure a better social machinery in the ages yet to come.

The confusion of the public, even of otherwise highly educated men, upon this point is little short of pathetic. Not only is it pathetic but the confusion has immense practical social and political consequences, which I think are bound in the end to work great harm to sound methods of social and political improvement. Just this moment I have laid on my table a book, published by one of the leading publishers of science, and written by the medical director of the school of social sciences of one of our leading universities. The author glibly gives us the following, to a biologist, starting information:

“Undoubtedly the most interesting advance in biology in recent years came from Mendel’s discovery of the laws of heredity. What he brought out particularly was that practically every human being has qualities and powers equal to those of every other, only they are inhibited by individual peculiarities. His great work was the biologic demonstration that men are born equal.”

It is difficult to be patient with such solemn and ponderous folly. It is all precisely the opposite of what Mendelism has proved. The thing which Mendelism has proved beyond all sane debate is that men are born irremediably and ineradicably *unequal*, and that by the very mechanism of the germ-cell, no two human beings could possibly be born alike, unless they were born from the same germ-cell or else from a combination of chance circumstances that could not occur more than once in billions. The Mendelian mechanism absolutely guarantees the inequality of men; and the

WHAT EDUCATION TELLS

stability of the Mendelian determiners guarantees that they will always be born unequal. And it is solely the inequalities of men that makes race-progress a possibility. If all men were equal there would be no superiors to encourage to breed the next generation. Moreover, all respect for superiority of character and achievement would disappear from the world. This author does not see his own innocent illogicality in stating that men would be equal if it were not for the fact that the "qualities and powers" which would make them equal "are inhibited by individual peculiarities." As though these "individual peculiarities" might not also be inherited as Mendelian characters!

Another writer, head of the literary department (!) of one of America's leading colleges, writes in what is probably the most influential newspaper in the world, in order to prove that all races are born equal and that the claim of the superiority of the Nordic race is not well-founded, that the prime thing which Mendelism has proved is that the hereditary determiners are extremely unstable, that they are "very fluid," and that races melt into each other with great ease and rapidity; that any superiority that a particular race might possess would not be permanently transmitted because the environment or crossing with some other race would soon destroy it, or fuse it with the common herd of mankind.

I think myself that the claim of Nordic superiority is still unproved; and that the very methods of approach to this important problem of race differences, except in the case of laboratory measurements which have been few and have proved little, have been wholly fallacious. Most of these descriptive methods would never prove anything. Merely collecting instances of the achievements of this race or that proves nothing: these may have been due to a more stimulating climate,

THE FRUIT OF THE FAMILY TREE

or to economic and political accidents and other factors. Since the present writer is descended quite directly from the Nordic Vikings, he could hardly be accused of any special bias. Nothing is proved until it is measured and everything that exists can be measured. Race differences have only to a slight extent been measured and, consequently, we know little about them. But to prove that races are alike and that one *might not be superior to another or to all others* by such utter misstatement of fact belongs in the realm either of fiction and mysticism, or else of plain ignorance. In any case they are pure literary biology.

All this lifts education, sympathy, public health, charity, and all ideals of human improvement, into new importance. The ideals of human excellence, of character, morality, beauty, intelligence, health, sanity and energy which we teach our young men and women, cause them to seek these things in their mates. These ideals are thus, by the marriage of these richly endowed parents, bred into the very blood and bone, into the physical and mental constitution of the race. They become its inner, inborn, indestructible character—its most priceless possession and its most precious legacy to the future. And just because this stream of germ plasm is almost inviolable it comes about that when a race has attained to sound health and character by means of natural selection and other forces of evolution, the very dependability of the germ plasm insures that upon its stream these virtues can be bequeathed until this river of life empties into the great ocean of eternity.

Our environmental friends can thus have full scope for all their efforts and desires. Our hereditarian friends can likewise cooperate in such a great racial program.

In closing this chapter on heredity and national life



FIG. 1

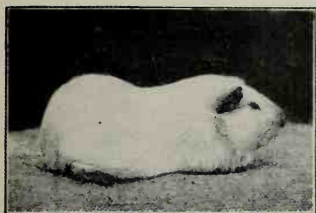

FIG. 2



FIG. 3



FIG. 4

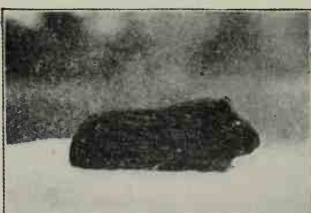

FIG. 5



FIG. 6

From *Genetics and Eugenics* by Prof. Wm. E. Castle. Courtesy, Harvard University Press.

Result of ovarian transplantation in guinea-pigs. Ovaries from a small black guinea-pig (Fig. 1) were transplanted into an albino (Fig. 2) which, mated with another albino (Fig. 3), produced black young (Figs. 4-6).

The albino pair produced two other litters of black offspring not shown here.

WHAT EDUCATION TELLS

I wish to repeat once more that the training of our young men and women to admire and select beauty and excellence in marriage and thus to perpetuate them in the very blood and character of the race through their children, is the richest romance and the loftiest ideal of a truly righteous, full and satisfying life. This education is the most important thing upon the world-stage to-day. This is the point at which all education and efforts to improve environment should converge. When biologists talk of improving the race through eugenics, they do not mean that they propose to produce a race of geniuses. All they desire is a race sound in body and mind and possessed of that inner righteousness, health and energy which alone exalteth a nation. Such a race will teem with genius and leadership and erect a civilization and create a culture worthy of its true inner excellence. No reform equals this in its importance or its majestic objective, for it will lay a new basis for all other reforms and give us the only possible program of both social and racial progress.

The very idea of "civilization" means more sympathy, more warm-heartedness, more tenderness for the weak and unfortunate. It is right that it should be so. But unless a policy of eugenics and race selection is instituted *as wide as civilization itself*, as merciful and as intelligent, then our saving of the weaklings defeats its own end. Instead of decreasing human misery it only increases it. The improved environment is not transmitted, and fortunately so. But improved environment and loftier ideals *which bring about wiser and nobler marriage selections* are transmitted and lift the race constantly to higher levels.

Civilization makes the world safe for weakness and stupidity, and it ought. But it ought also to strengthen and elevate its intelligence by seeing that stupidity

THE FRUIT OF THE FAMILY TREE

and weakness are not perpetuated, while its beauty and capacity are perpetuated in increasing abundance. This is the biologists' way of carrying out the injunction of the Master to give life to the future and give it more abundantly. It is only thus that we can carry out the completed golden rule of science, which is, "Do unto both the born and the unborn as you would have both the born and the unborn do unto you." All the future's unborn children are pleading with us that this shall become the very spirit of our civilization. And only the people that becomes imbued with this new religion, the object of which is to bring into the world better men and women, only such a people will or can take the highest rank in the future annals of mankind.

NOTE: The most crucial work in existence on the acquired character problem is that of Professor Guyer, of the University of Wisconsin, of Doctors Detlefsen and Griffith, of the Wistar Institute of Philadelphia, of Professor Jennings, of The Johns Hopkins University, and especially that of Doctor A. F. Blakeslee, of the Carnegie Experiment Station, Cold Spring Harbor, New York; the first on rabbits, the second on mice, the third on one-celled organisms and the fourth on the common jimson weed. But none of these workers "claims" to have induced an acquired character, notwithstanding the wide claims of the sort made for their experiments by public press and writers who are not even able to read technical and statistical biological literature.

Much newspaper exploitation has been given to the experiments of Pavlov, the Russian investigator, who is said to have taught mice to run for their food through a maze at the sound of a bell; their children and grandchildren are said to thread the maze much more quickly as the result of this transmitted education. This information lacks confirmation. Similar experiments performed with great care in this country have produced no such result. As Professor George H. Shull, biologist of Princeton University and a worker of great importance, writes me, "It seems strange that all the work done in the world for thirty years should be absolutely negative in results, except that of two or three widely advertised workers who get such uniformly successful positive results."

Up to the present writing no incontestable case of an induced or acquired character has ever come forward, at least in the higher plants and animals.

CHAPTER V

WHAT PRENATAL INFLUENCE TELLS

RUMMAGING about, the other day, among some dust-covered volumes in an old store-room of books, I came across half a dozen of what, I am sure, are among the most curious treatises ever written. They are devoted to "prenatal culture," "birthmarks," "the law of prenatal genius," "moral birthmarks," and "mental and spiritual preparation for the birth of children." Of all the absurd conglomerate mixtures of "the true, the false and the unknown," I am sure these books are the prize examples. After browsing for a few hours among them, I confess that I gained a new and immensely widened conception of the capacity of the human mind to contradict itself. Nearly every line contradicts the previous line.

It is the same thing that one finds in reading Chinese philosophy. The Chinaman seems not to have the slightest mental difficulty in believing two things that are diametrically criss-cross. If the first proposition is true, the second can not be true, and if the second is true, the first is bound to be false. Yet, the Chinaman goes about placidly believing both. As I said to a friend, "If what these books say about the universe we live in were true, then I should be afraid to live in it."

Now these books have nothing the matter with them except that they are not true. There is nothing the matter with the numerous inventions for perpetual motion, except that they will not work. And so it is with all this advice about prenatal culture. These

THE FRUIT OF THE FAMILY TREE

authors are perfectly correct in everything except the facts. Prenatal culture has been tried from the time of Adam and Eve, and it has been a failure.

One of their strongest claims is that, unless parents are very much in love with each other and the children very much desired, that the children will be born weak in mind or body and greatly lacking in the finer spiritual qualities. Yet there have been many children whose parents never heard of prenatal culture and who perhaps did not love each other at all, that have turned out to be noble men and women, strong and healthy, and endowed with moral virtue and mental vigor. If the absence of love on the part of the parents, or the lack of a desire for children, had foredoomed these children to weakness and moral degeneracy, the world would have gone to the dogs long ago. There would not be enough people out of the insane asylums and the jails to take care of the rest of us. But the world keeps jogging along, getting a little better all the time, I am sure.

Now, the sad thing about such books is that they are written with the noblest intentions. Their authors are inspired with a positive passion for doing the world good. Every line is touched with nobility of sentiment and a holy zeal to make people's lives happier and healthier, and to aid them in producing beautiful and worthy children. I would not for a moment set out to demolish their inspiring doctrines if I did not have all modern science and all modern philosophy behind me in stating that they are doing an incalculable amount of harm. Nothing but my belief in the motto of Thomas Huxley, that "the deepest sin against the human mind is to believe things without evidence," leads me to say aught against them. But since thousands of copies of these books have been sold all over America, and since they have influenced

WHAT PRENATAL INFLUENCE TELLS

many a husband and wife to the most absurdly mistaken beliefs, it should be made known that these books are unsound from start to finish. They are plainly written in utter ignorance of modern physiology, psychology, biology or any other ology based upon controlled and carefully planned experiments. In short, the vast literature of prenatal culture is simply a case of the blind leading the blind.

Let us examine a few samples from one of these ingenious pieces of "wisdom and learning." Since I have spent a large part of my life trying to discover the true secret of genius, the chapter of this particular volume devoted to the "Law of Genius" instantly engaged my attention. I confess, candidly, that I do not know what the "Law of Genius" is, but I am sure it is not as set forth in this curious but widely read book.

The author starts out by asking, "Why is it that there is so much sin, misery, suffering and premature death, and so very little genuine happiness and success? Why is there so much of the wrong in life, and so little of the right?"

I have long been deeply interested in finding out why, but I have been wholly unable to come to any certain conclusions. But the author explains that "these questions are . . . easy of solution." I envy him the "ease" with which he has solved this riddle of the ages. This is his explanation:

"When it comes to be understood that not more than one child in perhaps ten thousand is brought into the world with the consent and loving desire of the parents, and that the other nine thousand, nine hundred and ninety-nine are endowed with the accumulated sins of the parents, is it any wonder that there is so much sin, sickness, misery, drunkenness, suffering, licentiousness, murder, suicide, and premature

THE FRUIT OF THE FAMILY TREE

death, and so little purity, chastity, success, godliness, happiness and long life in the world? The reformation of the world can never be accomplished, the millennium of purity, chastity and happiness can never reach this earth, except through cheerful obedience to prenatal laws."

Now, I dissent radically from the doctor's statistics. I have taken the trouble to ask several hundred parents about their children, and find that nearly all wanted them very earnestly. The last dozen people I have talked with, all "wanted" all their children. How the doctor arrived at his figure that only one in ten thousand is desired by the parents, he does not inform us. But I have investigated a large enough number of cases to find that the proportion is far and away above fifty per cent., or at least five thousand out of ten thousand children are "wanted." Therefore, our "authority" is at least five or six thousand per cent. wrong in his statistics. Even if the author's statistics were correct, it makes no difference in "being well-born" whether children are wanted or not.

Many of the great minds of the race have pondered over these mysteries, and since the doctor has solved them all, let us hasten on to his conclusions.

He informs us that "All the educational institutions in the world, all the benevolent, industrial and reform societies, all the anti-tobacco advocates, all the temperance societies, and all the divines in the world combined and working harmoniously together, can not do as much in a lifetime of effort in elevating mankind, as can a mother in nine months of prenatal effort."

Such an astounding saving of time, effort and money in making the whole world healthy, wealthy and wise and bringing us into the millennium within a few months instead of several thousand years, which

WHAT PRENATAL INFLUENCE TELLS

is the time most of us had allotted, certainly deserves our undivided attention.

This author divides all mankind into four categories. First are "the thousands of lame, halt, blind, deaf and dumb, deformed, idiotic, weak, diseased, glutinous and debased," who he informs us are all the result of the failure of their parents to follow this "Law of Genius."

Second is "the vast array of the mediocre of mankind." These, we are told, "can be termed harmless." Since most of us belong to this mediocre class, as ample mental tests in the army have shown, it is comforting to learn that we are, at least, a harmless lot and seem, therefore, to constitute no immediate social problem. However, it is evident that our mediocrity or low mental level is due entirely to our not having been brought into the world under the "Law of Genius."

Third, "follows that class of mankind, few in number, who, through accident, were generated under nearly right conditions, and who, therefore, while on earth asserted the strong individuality of their high natures, and who so stamped the original of their souls on the world's highways and byways as to require no granite pile or marble monument to record the fact that they were born, lived and died." The doctor has me confused here. I am not quite certain to whom he refers. I gather, however, that he means those great men and women of the world's history who turned up unexpectedly and surprised even their parents and the neighbors by being geniuses, even though their parents had not thought about it in advance.

Fourth and lastly, "we come to that class, fewest in number, who, desired by both parents [it seems that one parent following the "Law of Genius" alone, can

THE FRUIT OF THE FAMILY TREE

not work this miracle] were generated under right, loving and holy conditions—who, in their prenatal formation, took on the joy, the glory and happiness that appertain to a soul in harmony with God's divine law of love, who, during their life here, maintained their supremacy of character and soul over their unfortunately conceived fellow beings, and who, during the life hereafter, will increase and establish that supremacy."

Of course I do not know with any assurance what is going to happen to anybody in "the life hereafter." That is in the realm of faith and religion and is, at present at least, beyond the pale of science. But since the doctor makes the definite, categorical statement that those persons whose parents "desired" them will "increase and establish their supremacy" and lord it generally over the great hosts of the undesired in the next world, it is up to the doctor to furnish some proof. If he has any statistical knowledge on the subject, he fails to submit it. Consequently, I am forced to conclude that he knows as little about it as I or anybody else, and that is, simply nothing at all.

We do find one little statistic of appalling significance interjected here. The author quotes—apparently with approval—that "some statistician has estimated that every married couple producing children may calculate on over four million descendants in five hundred years." Now if all these four million descendants are going to depend for their health, happiness and success upon the "right thoughts," of one pair of ancestors, five hundred years previously, it places a staggering burden upon them—indeed, too much for human nature to bear. Yet the doctor glibly assures us that such is the case. I frankly doubt this statistician's estimate. There were probably one hundred million pairs of parents in the world five

WHAT PRENATAL INFLUENCE TELLS

hundred years ago. A few millions one way or the other does not matter. But, if there were one hundred millions, and each pair now had on earth four million descendants, there would not be standing room. There would now be on earth something like four hundred thousand billions of inhabitants!

And now comes this "Law of Genius," "The fundamental principles of genius in reproduction are that, through the rightly directed wills of the mother and father preceding and during ante-natal life, the child's form of body, character of mind and purity of soul are formed and established; that, in its plastic state, during ante-natal life, like clay in the hands of the potter, it can be moulded into absolutely any form of body and soul the parents may knowingly desire."

It is a pity that so great and good a woman as Elizabeth Cady Stanton should have said that she "heartily recommended this book to every mother in the land"; or that the *Utica Herald and Gazette* should say, as quoted in the advertisements on the cover, that "it is a medical book," when I am quite sure that ninety-five per cent. of the regular medical profession, at least ninety-five per cent. of all medical men who have conducted original research, would repudiate every line of it. There is not an experimental psychologist of standing in the world who would agree that there was the slightest truth in such unsupported assertions.

But, there are a few more delightful crumbs of wisdom in these books, which we should consider. After giving the most excellent advice that the parents should both lead healthy normal lives and that especially the father, prior to the parental union, should leave off swearing and lying, all of which is decidedly to the good, although if he swore and lied from morning till night, it would not have the slightest influence

THE FRUIT OF THE FAMILY TREE

on the unborn child, this authority informs us that "the period of transmitted influence may be divided into three distinct divisions—the first, the one lunar month before the parental union, which four weeks may be called the *period of introductory preparation.*" As to what the moon has to do with babies, the doctor leaves us in the dark, without even the moon to guide us.

"The next division is the nine months of intra-uterine life, or the period of gestatory influence; and the last division, the twelve months of nursing, the period of nursing influence." During the last two periods, the doctor admits, the influence of the father is only "accessory," that is, "only as he can influence and guide the soul of the mother."

Now this is all purely nebulous nonsense, if the doctor means us to infer that the mental and moral character of a child is going to be influenced in any way by what the mother thinks or does not think during this period.

There is just one more bit of "learning" from this illogical jumble which I wish to quote for the benefit of the reader, and then leave it to him to judge whether it is true or false. He says the great question in every parent's mind about a child is, "Shall we make it a minister or a carpenter, an editor or pedler, a statesman or a farmer?" He points out that the choice is often a misfit, with which I fully agree. But, presto! the doctor has a ready and easy solution for all the vast and perplexing problems of vocational guidance by which no one can possibly go wrong. He says, "Now by observance of the Law of Genius, this doubt of choice can be avoided; for it is required that the choice of trade or profession for the New Life be decided on even before its conception. The mother and father must decide before the commencement of

WHAT PRENATAL INFLUENCE TELLS

the four weeks of preparation, what character and occupation the coming child is to possess and follow, and by and through this decision the future success of the individual is not only settled, but guaranteed!"

Not only must the profession in general be decided upon, we are told, but the particular branch must be picked out, because it takes too long for the child to do this later. Again, we have here a vast economy of both money and time. If we want a child to be an artist, the parents should decide whether they want him to paint in oils or water colors. If he is to be a doctor, they must decide whether he is to specialize on the kidneys or the appendix, or simply be a general practitioner. If the child is to be a farmer, it is essential to his success that he be fitted out by this Law of Genius to raise stock, or fruit, or just plain cabbages. He tells us that farmer parents have a much better chance to put into effect this Law of Genius than town parents. Just why, we are not informed.

Now it would take a volume to answer in detail all this vast body of vacuous assumption. These false and foolish notions which are so wide-spread about prenatal influence come from a wholly mistaken idea of the process of reproduction; how children are born, how the egg cells are formed and what is the real place of parents in the birth of children. It will not, of course, convince the prenatal believer for us merely to assert that the mental life of the parents does not influence the egg or sperm. But when we learn in the next chapter and in the chapter on acquired characters, that nature has not only failed to provide any mechanism by which the mental impressions of the mother are to reach the child, but has actually guarded against such a transfer of influence, I believe all persons of common sense, who will stop to think and use their imaginations a little less, will be convinced.

THE FRUIT OF THE FAMILY TREE

Suffice it to say here, that if the Law of Genius or of alleged prenatal influence be true, if the mother can ingrain her desires into the life and character of the unborn, then obviously all that our colleges and universities are doing to educate the young is wholly wasted. If parents can make genius to order, and manufacture statesmen, artists, inventors and scientists at will, why teach them anything? Why have churches and ministers and teachers at all? These "authorities" assure us that the Law of Genius is stronger than all these influences, since talent of any sort we want can be in advance "settled and guaranteed." Nature never gave into mortal hands such stupendous powers of "creation." It has taken God, or nature, working for untold ages through the laws of evolution, to create one human being and endow him with a small amount of intelligence and a few moral virtues. Now, is He going to turn all that power over to two half-educated, often silly, dreamy young parents in a state of exceptional emotional excitement? The whole thing is irreverent and irreligious. Could even the wisest man or woman who ever lived be entrusted with such divine, godlike powers? But all the wise ones of earth combined are not wise enough to undertake to "create" a child. Fortunately, nature has taken that all out of our hands. Children are born from germ-cells—that is, egg cells and sperm cells. And, as we have already learned, these reproductive cells are separate from the human body. The body supplies them with water, carbon, nitrogen and other elements, but otherwise has nothing to do with them. In the next chapter we shall see again that the parents can not influence the eggs and sperm cells, nor can they even birthmark the growing child before it comes into the world.

CHAPTER VI

WHAT PRENATAL INFLUENCE TELLS (*Continued*)

FOR untold ages people have been taught to believe in birthmarks. The ancients believed in them as a matter of course. We have the famous case of Jacob marking his cattle by placing different colored pieces of wood before their parents. All a scientist can say of this incident is, that it may have happened to Jacob's cattle, but it has never happened since. It has been tried hundreds of times at our agricultural experiment stations and no such effect has ever been produced.

Notwithstanding this, a great many farmers and practical breeders still believe they can color their calves and colts by putting cloth of various colors in constant view of the parents. These are the same breeders, however, who plant potatoes in the dark of the moon, who hang horseshoes over their doors, and carry buckeyes in their pockets to keep off malaria and rheumatism. If they get one colt or calf out of a dozen or two that remotely resembles some piece of cloth or colored object that was in the neighborhood of the parents, they say triumphantly, "That proves the theory!"

In the first place, I often wonder why they do not use *green* cloth. Since green is the prevailing color of nature, it would seem as though we would frequently have green offspring from both wild and domestic animals. It would also seem that animals conceived in the autumn when nature is clothed in all the colors of the rainbow, would be striped and spotted with the

THE FRUIT OF THE FAMILY TREE

colors of the surrounding scenery. Yet we see that every species preserves its own particular set of colors and hands them down with unerring certainty from generation to generation.

In the second place, the experiments should be tried many times with the same parents, and then again with one of the parents changed. Trying it with both parents *different* gives us no evidence. But if it were tried with the same parents, through succeeding years with and without these "prenatal influences," we would have a real experiment.

So it is with this whole matter of prenatal culture and the birthmarking of children. There is nothing that a scientific man would call evidence. The usual method of "proving" birthmarks is that of an old farmer Charles Battell Loomis tells about, who had a most remarkable hen. The farmer was out in the field at work, when the hen came running to him in wild excitement from the railroad track near by. She kept flying up and, as he thought, trying to get on his shoulder. However, he soon noticed that what she wanted was to pull a big red bandanna handkerchief loose from about his neck. Knowing that she was a hen of remarkable brain power, he let her have the handkerchief. Instantly she went sailing away down the track waving the red bandanna in the wind. Just then Number Ten came round the bend, sixty miles an hour. Seeing the danger signal the engineer brought his train to a sudden stop, to discover this brave and thoughtful bird standing on a broken rail, smiling proudly with the farmer's handkerchief still in her teeth. To *prove* this case of unusual animal intelligence, the farmer took his summer boarders out into the back yard and *showed them the hen!*

I have examined many cases of so-called birthmarks, but the only proof I have ever had sub-

WHAT PRENATAL INFLUENCE TELLS

mitted was a display of the birthmark. Of course the parents always relate some remarkable incident which took place before the child was born; but that the one had any connection with the other is a piece of purely childish imagination. I think I can explode this whole theory to better advantage, by quoting from one or two more of the numerous popular books on the subject of prenatal influence.

One book actually reads as if it had been written in the dark ages by some astrologer or alchemist, instead of in an age of science when any schoolboy can secure more enlightenment on the subject of heredity in two hours, than is contained in this entire volume of fairy tales. Yet it is widely sold over the country and no doubt believed to be true.

It is simply impossible to quote all the errors of scientific statement of which this author is guilty, but here is one of them, "The transmission of acquired characters is quite generally accepted." This is absolutely false. I am acquainted with the views on this point of practically every biologist doing independent research work in this field, and have summed up their opinions in the chapter on the inheritance of education. Only four or five believe that anything which the parent *acquires* during his or her lifetime is handed down to the children. Professor Tower, of the University of Chicago, Professor Herbert S. Jennings, of Johns Hopkins University, and Professor M. F. Guyer, of the University of Wisconsin, have probably demonstrated that, under *rare experimental conditions*, an induced character may *possibly* be transmitted. But no scientific man on earth, competent to judge the evidence, believes that the mental states of the parent, their desires, personal wishes and ambitions are transmitted to the children, which is the idea this author tries to convey.

THE FRUIT OF THE FAMILY TREE

He further states, "By awakening a slumbering talent and exercising it with zeal (that is, by the parents doing this in themselves before the child is born), it may be reproduced in an intensified form in the child. By refraining from bad habits . . . the parents may be able to prevent, partly or wholly, their reappearance in the child. This law applies to any case where the tobacco or whisky habit, dishonesty, bad temper, idleness, licentiousness or any other bad trait has existed in the parents or their immediate ancestors." This is all so much gratuitous nonsense. If the parents can cure themselves of bad tendencies, quite likely the children will have the ability to do the same thing. If the parents had uncontrollable, ill-balanced natures, some of the children will likely have these tendencies, purely as a matter of heredity, and not through being birthmarked.

I can not repeat too often that the children are not born from the parents' body-cells, nor from their blood, nor bones, nor tissues, nor nervous systems, nor brains, nor wishes, nor desires, but from the family germ-cells. As I have already pointed out a number of times, these eggs or sperms are carried in the bodies of the parents, but the hereditary characters in them were not put there by these parents. These germ-cells were literally and actually handed to them by the grandparents, who got them from the great-grandparents and so on back to the beginning. As far as science knows to-day, the immediate parents have no influence whatsoever over these cells. They put nothing into them, and they take nothing away from them. This whole problem has been studied and investigated for fifty years all over the world and not a single case of the transmission of an acquired character, in the foregoing sense, has been definitely established. And since thousands of the trained minds have been search-

WHAT PRENATAL INFLUENCE TELLS

ing for one single, clear case for a half-century, and have never found one, it certainly is not a very common occurrence. This author simply perverts all modern research to his own sentimental hypothesis.

All this bears directly on the question of birthmarks and prenatal impressions. If the germ-cells are not manufactured by the body-cells of the parents, but are an entirely separate line of organization, living inside the parents' bodies, it follows that one can not by wish or desire or by any mental or physical effort change their character or the character of the children born from them. If everything that such optimistic and ingenious writers claim is true, and if the parents' desires can influence the egg and sperm cells, "creating" wonderful characters in their children, making them geniuses, artists, musicians, saints, and the like, then indeed, wishes would be horses and beggars would ride.

Professor Carl H. Eigenmann, biologist of Indiana University, used to tell a story to his students which illustrates better than any scientific argument just how much foundation there is to the theory of the transmission of wishes and desires. According to the professor a farmer had a flock of sheep, and one of the mothers fell into a sink-hole and broke her left foreleg. The farmer set it, and, in order to strengthen the member, put a silver band around the fracture. The other mother sheep, and I suppose the father sheep also, constantly saw this piece of jewelry. When their lambs were born, every one of them had a silver bracelet around its left foreleg. But this was not all. Evolution and improvement had set in. The desires and emotions of the mothers had been stamped upon the children. The farmer found engraved on each silver band on the legs of the lambs, the inscription, "Sacred to the Memory of Mother!"

THE FRUIT OF THE FAMILY TREE

I could not prove that this story is not true. But I could prove it is just as nearly true as the stories of birthmarks. Persons who call themselves "authorities" on the subject, can always relate a large number of interesting stories of children receiving birthmarks and prenatal impressions, that have no more sense to them than has this piece of obvious fiction by Professor Eigenmann, which he probably told to keep his college students from going to sleep in their biology classes.

We have been told for ages that Greek mothers created a genius for art in their sons by gazing for hours, before their children were born, at the beautiful statues and pictures in the Grecian temples. I should like to ask, "What did the mothers of the sculptors and artists who made the statues gaze at?" Beyond doubt these talents were inborn characters in the germ-cells of the Greek people.

The author of this curious book makes another statement with which no scientist can agree. He says, "The violation of the laws of sex are the chief causes of human degeneracy." This is not true, because most of human degeneracy is the result of the foolish and ignorant marriage of two stocks which have degeneracy running in their streams of germ-cells.

Let us next take a few "cases" of prenatal influence, as related by these distinguished authors.

In the Town of T——, Kansas, a woman told one of these authors that she was quite nervous and fatigued when she attended the county fair. While there she saw a four-year-old boy wearing the false head of an old man. She was "disgusted" at the sight, but determined that it should not mark the babe she was carrying at the time. However, when the child was born "its head was abnormally large and had the appearance of an old man." In order to enlighten us,

WHAT PRENATAL INFLUENCE TELLS

the author says, "Here was a case due to disgust!" Let me ask the author, if the mother's "will" is powerful enough to produce birthmarks, why can not it also prevent them? She distinctly said that she made determined efforts of will to prevent any mark on her child.

The Reverend T. C——, the author tells us, "had a right thumb that was double to the first joint." The pastor told this writer (again hearsay evidence) that while his mother was washing clothes in a stream, a crawfish grabbed her thumb. He also "studied" another case "almost an exact duplicate of this." "These are examples," he says, "of fright." Nonsense! If all the mothers in history who have been startled by crawfish had given us children with double thumbs, we would see them on the street every day. Double thumbs are sometimes inherited characteristics running in families as simple dominant units for generations.

Mothers have shown me boys with withered or twisted hands or feet. Many of these deformities are due to some pressure, which twists the limb out of its proper shape, and are certainly not to be attributed to the mother's becoming frightened. Absence of hands or feet is usually caused by a fold which prevents the blood from circulating. Such a child never had any hands or feet. A mother told me that the fact of her child's having no hands was due to her seeing a horse have its legs cut off by a train. I asked her when this had occurred. She said about a month before the baby was born. Had she known the simplest facts of physiology—all of which ought to be in every child's school books—she would have known that if the child had ever had hands, they would have been fully developed long before this time.

Another mother showed me a brown stripe running

THE FRUIT OF THE FAMILY TREE

round and round a child's arm from wrist to shoulder. She explained that she had been frightened by a snake, or a rope which she thought was a snake, that had twined itself about her arm. Again I asked when it had occurred. She answered that it had been about two months before the child was born. Now, every physician knows that the stripe was about the child's arm seven or eight months before it was born. It is amazing to consider the jars, shocks, railroad wrecks and auto smash-ups a mother can go through and not injure the baby. The aim of nature is to care for the child, and place it as far as possible from such untoward happenings.

One is moved almost to tears by another sad case which one of these "authorities" on prenatal culture relates. A boy who was helpless and emaciated, and who wheezed when he breathed, was born in this condition, "because" there had been a wheezy "half-grown hog" running about in the yard which had excited the mother's sympathy. If a "half-grown" hog could produce such a result, what a full-grown porker with the heaves would have done is too appalling to think about. "This birthmark," the "professor" who wrote the book informs us, with apostolic finality, "was caused by unusual sympathy."

But the prize example of befuddled thinking in this entire work of art, for it surely must be art, since it most emphatically is not science, is the following soul-racking incident. While lecturing one day the professor noticed a small white-headed boy with a patch of jet black hair on his head. The father told him that he was undecided about which of two things had caused the black patch. It was due either to the mother's having seen a negro stab a man, or to a quarrel she had had with one of the neighbors, during which she pulled the neighbor's hair, which was very

WHAT PRENATAL INFLUENCE TELLS

black. But "our man of science" instantly solved this puzzling riddle. "I know," he said to the father, "with almost absolute certainty that it was the latter incident. . . . Had it been caused by the negro, the patch of black hair would have been kinky!" Is it believable that such things are printed and are circulated through the United States mails, when sane, sound, scientific literature, teaching simple and healthful methods of birth-control, is forbidden the use of the mails on the ground of being indecent?

The last case is almost too sad to relate. An expectant mother, out in the garden, got a twin cucumber caught between her toes. She fully resigned herself to having twins. But all that resulted was a child that had twin toes!

Now, what is the answer to all this nebulous nonsense?

First, that the germ-cells from which children are born are not created by the parents at all. Parents do not "create" their children. God, or nature, does that, by creating the eggs and sperms from which the children are born. Nature creates the hereditary characters that are contained in these germ-cells. She does not leave the great work of infinite creation in the hands of poor, ignorant, weak, short-sighted, foolish human beings. If so, we would make a mess of it in one generation, and wreck the whole course of evolution.

Second, we all know that the only way the mother's mental impressions could travel through her body to that of the babe is *by the pathway of the nerves*. But *no nerves whatsoever run from the mother's body to that of the unborn babe*. There is a small hollow cord—the umbilical cord, which is the sole connection between the mother and child. But this has no more function than a hose-pipe. It is really a part, tem-

THE FRUIT OF THE FAMILY TREE

porarily, of the circulatory system of the child. It does not, so far as modern science knows, convey fright, worry or nervous impressions. And such emotions do not travel in the blood, as far as has ever been ascertained. Obviously, nature has placed the child safely away so nothing of this sort could ever touch it. The whole "purpose" of nature has been to *prevent* the mother's "desires," ambitions, dreams, hopes, disgusts, unusual sympathies for wheezy hogs, or anything else, from ever reaching the unborn.

Of course, it might seem that whatever was in the mother's blood would circulate through the body of the child and injure it. But the mother's blood does not flow through the placenta and into the arteries and veins of the child. The blood circulating in the child's body is *its own blood*, distinct from that of the mother. The placenta, which is the channel through which the unborn child secures nutrition and oxygen and disposes of wastes, is in the nature of a great filter through the membranes of which nutrition and oxygen are passed, but which filters out almost everything that can possibly injure the child.

Even the authors of the books I have quoted would admit, I imagine, that there are no nerves which carry the mother's mental impressions to the child. But I gather that they believe this influence travels after the manner of telepathy. Many people hold this to be the case. The mother reads beautiful books, sings lovely songs, and gazes at wonderful pictures; or perhaps she becomes frightened or angry, and in some mysterious telepathic manner they believe the child receives the impression.

No one knows whether there is such a thing as telepathy. But let us suppose the mother does "telepath" to the child. Very well, then why could not the father do the same thing? Why not the neighbors do

WHAT PRENATAL INFLUENCE TELLS

the same? Why, also, could not the mother telepath to and mark the baby in the incubator? Why need this influence cease at birth? Why should she not go on telepathing after the child is born, and either mark it with deformities or give it good health and genius by wishing hard about such things? This places the babe in a dangerous situation. It is evident that if the good Lord ever permitted the unborn babe to be remotely touched by such contradictory influences, by the time the little fellow got into this world he would be nothing but a grotesque conglomeration of irrelevant absurdities. His own mother would not know him. So I think telepathy can also be ruled out of court. Also, why is it that thousands of mothers suffer fright and then worry for months about marking their babes, with the result that nothing happens to them at all?

I recently went over the report of the French authorities who had charge of the babies of Paris during the most terrible year of the war, 1918. I was in Paris a large part of that time. The mothers lived in hourly dread, in fear, and in anguish—and there was a bombing raid by the Germans nearly every moonlight night. The mothers saw men with the most ghastly wounds. Yet, the report states that the babies born during that period were somewhat larger and fatter and generally more healthy than usual. Why? Because the mothers were put under military direction and properly fed.

I agree with all that these silly books have said about prenatal care, prenatal feeding of the mother, and careful nursing after birth. These things are of surpassing importance. The mother should be calm, free from worry and overwork, and should make these months a period of joy and happiness. All this influences her nutrition, and helps to keep the babe well-

THE FRUIT OF THE FAMILY TREE

nourished. But that is all. It gives the little fellow a proper start, and it is a pity that any babies should ever be born without such a happy prenatal beginning. But this is wholly different from marking it, or implanting in the unborn child extraordinary character, or giving it an artistic talent by playing the piano or looking at pictures.

Of course occasionally babies are born with all sorts of blotches and blemishes on the skin. Sometimes a little hair grows on such a spot, and it might be imagined to look a bit like a rat or mouse at which the mother had been frightened. The true explanation is very simple. Sometimes the color cells in the skin fail to be scattered properly and evenly. This may result from a dozen different causes. The consequence is that they become visible to the eye when they are grouped in one place and then the phenomenon is called by the superstitious, a birthmark. Sometimes red birthmarks are due to the fact that the blood flows between the layers of the skin, and the redness that we see is simply the redness of the blood. But there is nothing remarkable in this, nor anything to cause concern.

It is related that Charles Darwin's father, an eminent physician, asked 11,000 prospective mothers in a maternity hospital to foretell just what marks they thought would appear on their babies. He wrote down all their answers. In scarcely a single case was the mark remotely what the mother predicted or feared. Either the child had no mark at all, or, in a few instances where a mark occurred, it was somewhere else on the body, or did not resemble the animal or object which had frightened the mother.

It is also often alleged that, if the mother craves some particular food or drink and can not secure it, that this will leave a mark—such for instance as a

WHAT PRENATAL INFLUENCE TELLS

strawberry—on the child. In the South a negro mother with a white child often accounts for it on the ground that she craved snow. I think a simpler explanation will occur to almost any one.

We must also remember that, as a rule, a prospective mother has an unusual appetite and "craves" all sorts of things if she is well and free from nausea. This is largely due to what I think is one of the most beautiful things in nature, the process of leucocytosis. It's a long word, but a wonderful process. It means that when the baby begins to grow, the white corpuscles of the mother's blood, the body defenders which attack microbes, begin also to multiply. They increase enormously in number and traverse the whole body like soldiers ready to attack and destroy any invading disease germ. This prepares the mother's body and strengthens it for the great ordeal. It is also nature's method of keeping her free from infectious diseases. Were it not for this beautiful provision of nature, probably fifty per cent. of mothers would die during childbirth. Thus, we find always and everywhere that nature is fighting for the unborn babe, providing barriers against all fortuitous circumstances so it may be brought into this world strong, healthy and endowed with everything that the original little cell from which it grew intended it to have.

There is one more problem on which scientists are now working and on which the last word has not been said, and that is the matter of "hormones." For a few years after these were discovered by Professor Starling, of Cambridge, England, it was thought by some reputable scientists that they might possibly cause birthmarks. They are tiny chemical bodies or chemical messengers that travel about in the blood and lymph and set up nervous reactions at distant points. For instance, when the babe begins to grow, this pro-

THE FRUIT OF THE FAMILY TREE

cess apparently sends up a stream of hormones to the mother's breasts which causes them to prepare food for the coming child. And there are many other hormones in the human body—manufactured by the ductless glands, such as the thyroid and others.

This has given rise to the whole new science of endocrinology, the most important development in recent physiology. But, without going into technical details, it is beyond the power of the imagination to conceive that the mind could *create* a particular sort of hormone, that this would then circulate through the mother's body, through the placenta and umbilical cord, travel to the brain and nerve system of the child and there set up a character or stamp an impulse which would years after manifest itself in the grown child as a genius for music, or science, or art, or statesmanship. This is going to the point of absurdity. And the same is true in regard to the supposition of creating a particular mark as a result of fright, as in the case of the twin toes credited to the experience with the twin cucumbers.

“God takes care of babies and fools.” And I hope those thousands of mothers who are wrecking their nerves in the fear of birthmarks, or breaking their hearts in the thought that they, by some neglect, have caused a child to be born with an imperfect body or mind, will be comforted by knowing the truth on this subject. For the mother had no more to do with it than the man in the moon. She has done her part if she has fed and cared for her body and has been as quiet and happy as possible during those months when the child is in its divine cradle. She should leave the rest to nature and to nature's God.

CHAPTER VII

WHAT TWINS TELL ABOUT HEREDITY

“SHURE and it’s aisy to tell Mike from Dinnis,” said Mrs. Maloney in discoursing proudly to Mrs. Hennessey on her “foine pair of twins.” “I just put me finger into Mike’s mouth,” she explained, “and if he bites I know it’s Dinnis.”

It seems unfortunate that this simple device can not be used to solve all the difficult problems that confront us in the study of twins; but Mrs. Maloney’s methods do not yield satisfactory results when tried in the laboratory. The scientist not only wishes to know Mike from Dennis, but to know why Dennis is so much like Mike and Mike like Dennis. He wishes also to know why Dennis and Mike are sometimes so unlike each other that one would never suspect they had the same father and mother or that both had hailed from Erin’s emerald shores. Another thing that puzzles him is why Dennis is sometimes a boy and Mike a girl or Mike a boy and Dennis a girl. And then there are other things involved in the study of twins, such as the causes of sex, the control of sex, the effects of education and environment in making people different; how far heredity controls character and destiny; and how far this may be changed by the influence of one’s home, country, civilization or religion.

For people seem, at least, to be born different from one another, not only in their physical make-up, but particularly in their mental and moral characteristics. And twins furnish us a chance to measure, in many

THE FRUIT OF THE FAMILY TREE

ways, how great those differences are, and how much environment can change them.

If we could know just how much environment can change the original inheritance with which we come into the world, we should know, for instance, whether a particular race, say, the Japanese, builds a different sort of a civilization from that of the Europeans because the two races have different inborn natures, or because of the climate, or the natural resources, or the teachings of some one or two great saviors and philosophers. We would also be able to predict whether our vast efforts to "Americanize the immigrant" are really going to Americanize him in the sense of making him in the image of the forefathers; or whether they will merely make him a more educated immigrant, able to inject his own inborn character into our national institutions and enable him more readily to transform America into a new Italy or a new Palestine or a new Armenia or a new Germany, resembling the nations and cultures his ancestors built in the country from which he came.

Furthermore, if we could measure the factor of heredity and the factor of environment separately, and determine just how much influence each has, we should know whether our fond belief that we can "mold a child" during "the plastic days of childhood" is a reality or merely a sentimental fiction. Indeed we could find out with much greater certainty whether there really is such a thing as "the plastic days of childhood"—which many modern psychologists very seriously doubt. It seems to me that environment influences me just about as much and just about as little now in my mature years as it did when I was in the supposedly more plastic state of boyhood. But just because it seems that way is not proof that such is the case. Science does not depend on mere seeming but endeavors to weigh and measure.

WHAT TWINS TELL ABOUT HEREDITY

Twins hold, as I have said, many secrets of psychology and the biology of heredity. We have been looking into their faces for ages, trying to decipher these mysteries. Some twins look so nearly alike that their own mothers can not tell them apart. Many of them have become exchanged in childhood, having lost the blue ribbon that distinguished John from Robert and the pink ribbon that distinguished Robert from John, and have gone through their lives not knowing which was which. And what is more, they did not care. It did not make much difference. We can usually and quite readily discern the physical identity of twins. But the interesting point is, that in their mental and moral make-up, and in their emotional reactions under the same circumstances, twins are as similar as they are in physical appearance.

We hear it said that no two people are born exactly alike. This is true although there is one kind of twins which are very nearly alike. They are always of the same sex, being either two brothers or two sisters. Such twins are known as "identical" or "duplicate" twins and are believed to have been born from the same germ-cell.

Many twins of mature years are so nearly alike that, if they changed into each other's skins and personalities, they would scarcely know that anything unusual had happened. They would not behave any more unlike than would two watches—with the same sort of cases and the same kind of works—if you exchanged the works from one case to the other. Indeed, in the example of the watches, you could take the wheel out of one and exchange it for the identical wheel in the other and the watches would go on ticking in just the same harmony. I often think that if we could take an identical portion of the brain out of some of the duplicate twins I have known and could,

THE FRUIT OF THE FAMILY TREE

without injury, exchange the parts and make them function, neither the twins themselves nor any one else would ever be aware of it.

But if we took a part of the brain of any one not an identical twin and exchanged it for the same part of the brain of any one else out of the millions of human beings on earth, the two concerned would cease to be the same sort of persons. Everybody would remark the change, and the two persons themselves would know that they were not the same beings they were before.

Then again there are other twins that seem so dissimilar that no one would suspect they were even brothers or sisters. I have seen some so unlike that they appeared to be of quite different races—and, indeed, I believe they were. One would have a clearly cut Nordic countenance, blond hair and skin and blue eyes, being large, strong and athletic; and the other would, to all appearances, classify as a Mediterranean brunette, with their characteristically smaller bones. It was plain that one had taken his heredity mainly from the brunette parent from Southern Europe and the other mainly from the Norse parent from Northern Europe; and scientists believe that these two races are separated from each other by thousands of years of evolution. No doubt there have been cases of twins, one of which was black and the other white, where the parents were both mulattoes. Such cases are occasionally reported, although I have never seen the phenomenon. Doctor Davenport believes that about one out of sixteen children of mulatto parents has a white skin, and about one out of sixteen an entirely black skin; and there is no reason except the laws of chance why in a case of twins, from such parents, both a black and a white one might not be born at the same time. If any one has ever heard

WHAT TWINS TELL ABOUT HEREDITY

of such a case, it would be of interest to science if it were reported.

Recently I attended what was perhaps one of the most interesting gatherings of human beings ever held in the history of the world. Mr. A. L. Erlanger, the famous theatrical producer of New York City, issued an invitation to all the twins in New York and vicinity to attend what he called a "Twin Matinée" given in honor of the Fairbanks twins, two young ladies who were then the stars in the musical comedy, *Two Little Girls in Blue*.

It was certainly a wonderful gathering and of peculiar interest not only to a scientist but to a public speaker. I have lectured to hundreds of audiences, but I never before saw an audience like this. And I think no other speaker or actor ever before saw one like it. As I fully expected, most of the twins who attended were of the identical type—the kind that look very much alike, since twins who are not alike seldom take great interest in each other. All students of twins have found that it is much easier to find identical twins than opposite twins, not because the former are more numerous but because they are more aware of their similarities. There were over one hundred pairs of twins at this meeting, surely the largest collection of duplicated human beings ever gathered together at one time. And most of the pairs were alike in appearance. As the play proceeded it was easy to see that they also were very much alike in their natures. They laughed at the same things in the same way, and I suppose had there been anything they did not like, they would have turned their noses up at the same time in the same way. Indeed, when the villain came on they did do this, and dozens of pairs of duplicate noses turned up simultaneously, in precisely the same way, and, protruding from the same kind of

THE FRUIT OF THE FAMILY TREE

faces, would seem to have been enough to reform any villain on the spot, if environment had any such revolutionary influence.

As a rule a speaker expects to see only one face of one kind in any given part of his audience. But here he got two of a kind. He got two laughs where ordinarily he expected only one, and the two laughs were nearly always in the same key. And as they laughed, the faces of any particular pair wrinkled and furrowed in almost identical lines. It was certainly an amazing spectacle, and one that ought to inspire any speaker or actor to make the most of such an opportunity to get two laughs with one joke, or double applause for the same sentiment.

The most interesting pair were naturally the twin stars, Madeleine and Marion Fairbanks, who, in the comedy, and I think the same would be true in real life, were able to deceive their lovers completely as to which was which. They were able also to work their passages across the Atlantic Ocean on one ticket, since the captain was wholly unaware of the fact that he had taken on board two passengers of such remarkable similarity. The letters I have received from twins, as well as all the studies on the subject, are filled with just such comic instances of twins deceiving the unsuspecting public with innocent pranks. One mother writes me that she often had to drop her work and go to the school building at the other end of town to help the teacher decide which twin she ought to spank, or which one she had already spanked. I should not be surprised if the wrong twin had some time been hanged, although they are usually so fond of each other that doubtless the real culprit would confess his misdeeds to prevent such a catastrophe.

In the cast with the Fairbanks twins were also Jack A. and Tommy Tomson, young men twins, singers and

WHAT TWINS TELL ABOUT HEREDITY

dancers, who could only be told apart by the fact that one had learned to sing baritone while the other sang their natural tenor. Since these particular pairs of duplicate twins exhibit many of the phenomena of identity, I will describe them at some length.

I held a long interview with the Fairbanks young ladies and their mother, that revealed many interesting facts as to the marvelous likeness which we might call "twinsomeness" bestows upon two human beings. Mrs. Fairbanks said they had always looked and acted like two identical human beings. They not only had similar tastes in foods and dress and in their likes and dislikes for people, but their thoughts seemed at times to be exactly the same even when they were separated from each other.

Mrs. Fairbanks said that often the girls would write letters to their friends which, although written quite independently, would read almost as if they were copies. This, she said, she had tested over and over again, and the letters were so often alike that it was far above what the laws of chance would indicate. She found this extended to their school compositions. Their teachers would frequently accuse them of having copied each other's essays, when as a matter of fact their mother had taken care that they were written when the girls were in separate rooms. On one occasion, they related that the teacher gave them four subjects on which to write compositions, and when these were finished they were each instructed to choose a fifth subject to write about. Each one tried to conceal from the other the subject she had chosen for her fifth essay. Their mother put them in separate rooms and they were themselves considerably surprised when they compared their efforts and found that one had written on the subject, "An April Shower," and the other had written on "A Summer Shower"!

THE FRUIT OF THE FAMILY TREE

This certainly indicates either a remarkable similarity of inborn make-up, or else an almost unbelievable similarity of habits. And since we know of no cases where ordinary brother and sister, or twins who are not of the duplicate sort, display such a degree of similitude in their thoughts, even when living under the same environment, in the same homes, with the same parents, the same teachers and the same set of friends, it would certainly seem to be due to similar brain organizations.

Of course we should cautiously reflect that identical twins are usually together much more and take much more interest in each other than is the case with opposite twins or ordinary brothers and sisters. Yet this is not always the case. Many brothers or sisters who are not twins are almost precise duplicates of each other, looking alike, talking alike and having similar habits. Some criminals can only be told apart by modern anthropometric measurements. Professor Harris Hawthorne Wilder, professor of zoology at Smith College, relates a remarkable case of this sort. He studied a pair of opposite, also called fraternal twins, who were obviously unlike. In the family, however, was a younger sister so similar to one of the twins that this pair of sisters were commonly taken by strangers to be identical twins. As Professor Wilder comments, "Here is a case of three distinct eggs, two born at the same time and one at a subsequent birth, but with a similar composition in the germ plasm of this latter one and in one of the two born simultaneously."

A great many people have taken this similarity of thinking between identical twins when separated, as evidence of mental communication or telepathy. The Tomson twins stated that they were offered ten thousand dollars for their heads, so to speak, by Sir Oliver



Above are the Farmer twins, aged 78, with the Fairbanks twins, two young comedy actresses of New York. Below (left) the Tomson twins and (right) the Demar twins, two stage singers of New York. For descriptions see text.

WHAT TWINS TELL ABOUT HEREDITY

Lodge, the famous exponent of the science of psychics and student of telepathy. They told me they were entertained frequently in his home and were often examined by Sir Oliver and other noted scientists while in separate rooms. At these examinations they were found to be thinking what Sir Oliver, at least, regarded as exactly the same thoughts. They would often ask the same questions and make the same replies to questions when being quizzed by different scientists entirely out of hearing of each other. They said that Sir Oliver wished them to go on the stage with him and assist him before the public in demonstrating that this was a genuine case of mental communication. When sitting at the table and in the midst of conversation with different persons they would often turn simultaneously and say, for instance, "Please pass me the salt," or make some identical remark about the weather, or mention recollection of the same thing at the same time. The Fairbanks twins often say to each other at the same moment when discussing other things, "I want a piece of pumpkin pie," or "I want a dish of ice-cream," or "I wish I had a new pink frock."

It is not my purpose here to write a treatise for or against telepathy or mental communication with persons in this world or the next; for I have found from long experience that if a man believes in telepathy it does not make much difference what you say to him, for he still believes in telepathy. But it would seem to me that the fact of twins thinking similar thoughts at the same time when separated is more easily explained by the fact that they think about the same things when they are together, and this we believe is due to the fact that they have brains and nervous systems that are very much alike throughout. There may be other evidence of a more convincing nature, but I

THE FRUIT OF THE FAMILY TREE

hardly think Sir Oliver can prove his case decisively by twins. People who *are* alike *think* alike. This is shown by the happy way that husbands and wives who are similar in their natures get along together. They think and act alike, I believe, and I think there is much evidence to prove it, because they were born from germ-cells that had in them very similar determiners for mental and physical traits.

However, it is all extremely interesting. Mr. David Belasco, I understand, recently produced a play in New York called *One*, in which the leading lady was Miss Frances Starr. In this play Miss Starr would now and then go to the window and call her twin across the ocean, and seemingly get a great deal of valuable information. I scarcely think any biologist or experimental psychologist would give much for information gained in this way.

As to the causes which lead to twins, making some alike and some unlike, I have not so far broached this phase of the subject because it is rather technical and complicated. Furthermore, I do not think it would add very much to the popular account of the lessons of heredity and environment which twins have to teach us. The histology, embryology, cytology and all the other ologies about twins are illuminatingly described by the highest authority in the world in this field, Professor Horatio Hackett Newman, of the University of Chicago, in a little book entitled *The Biology of Twins*. While it is too scientific a work to enlighten a layman very much, I strongly recommend it to physicians, and urge them to cooperate with Professor Newman and his co-worker, Professor Patterson, of the University of Texas, in furnishing them with evidence as to twins that are born either in the same or in different uterine membranes.

Professor Newman proved with absolute certainty

WHAT TWINS TELL ABOUT HEREDITY

after eight years of labor, that, in a certain species of armadillos which produce quadruplets regularly at one birth, all four of the young come from one egg. This one egg is fertilized with but one male sperm. So all four have a marvelously similar inheritance and remain similar throughout life. Also, the four are always of the same sex. Now we do not absolutely know, but most students believe, that identical human twins are born in the same way. For some reason, at an early stage, we do not know just when, the egg probably divides and two individuals arise from the same germinal substances. Dissimilar or fraternal twins, all evidence indicates, are born when by mere chance two separate eggs are fertilized at the same time by two separate spermatozoa. These twins are no more alike than ordinary brothers and sisters. Sometimes they are both of one sex and sometimes of opposite sexes. But identical twins are always of the same sex. Sex is determined or at least initiated at the time when the two germ-cells of the parents unite. And identical twins having but one sex determiner for both are necessarily never of opposite sexes. Often in the movies and dramas and in novels we see accounts of twins being identical but of different sexes. As Professor Newman says, we can afford to call these "literary twins," for most certainly such identical twins do not occur in nature.

CHAPTER VIII

WHAT TWINS TELL ABOUT HEREDITY (*Continued*)

IN THE previous chapter we brought out many of the interesting known facts about twins; but in this chapter it is our privilege to seek some interpretation of these facts. For it is their significance that counts. What bearing have they upon human life in general, and upon the problems of both social and racial improvement? First, let us ask, do twins "run in families"? In other words, is the tendency to produce twins inherited? The subject is filled with superstitions. I have received several letters asking whether, if a woman who has a twin brother marries, she will not be unable to produce children. The twinning tendency produces no such inherited effect as this. Many students believe that the tendency to produce twins is usually an inherited one, but just precisely how the tendency is transmitted, whether it is a recessive or dominant, or some other type, has not yet been fully worked out; whether it comes through the father, or through the mother, or through both, and just what is inherited that causes eggs sometimes to divide and grow into two human beings, or why two eggs should sometimes be fertilized at one time and thus cause twins to be born, is still far from settled. One woman writes that she had always heard that if she married a man from a set of triplets she would be in no danger of producing triplets, when lo her first "child" was a set of "triplets"! At least this good woman got more than she bargained for.

As to the number of twins that occur, it seems that

WHAT TWINS TELL ABOUT HEREDITY

in the United States about one birth out of ninety results in twins. In about two cases out of five, the twins are of the same sex; but in only about one case in three are they identical. The others are cases of fraternal twins, and sometimes by mere chance happen to be of the same sex. However, about seven cases out of ten, among the twins who have written me and sent their photographs, were obviously of the identical type. This indicates again, as I have previously mentioned and as was proved in a recent collection of six hundred pairs of twins made by the *Journal of Heredity*, of Washington, D. C., that twins that are decidedly unlike do not have as much interest in each other and are not so much aware of being twins as those that are identical. Fraternal twins, although they are more numerous than the identical type, have not been interested enough in the matter to send in their photographs.

But, since only about one birth in ninety results in twins, when we hear in the newspapers of a case of one man who had ten pairs of twins and four single children by one wife, we strongly suspect that this extraordinary number of twins so far above the average number in human births is more than mere chance. And since this man married a second time and had nine more pairs of twins and five single children, it leaves little doubt but that the tendency of the father to produce twins must have been an inborn or hereditary characteristic. And when we learn that this same man married a third woman and had eight more pairs and five single children, making sixty-eight in all, it is plainly to be seen that, if this account be true, and several somewhat similar cases are on record, the father possessed some natural characteristic that was the cause of such a numerous duplicated progeny. There are on record other cases of parents almost

THE FRUIT OF THE FAMILY TREE

equally prolific in the production of twins. It seems certain, therefore, that twinning is often a hereditary characteristic.

There is another extraordinary thing of interest about identical twins, and that is that the right and left sides of their bodies are much more alike than is the case with ordinary persons, or with fraternal twins.

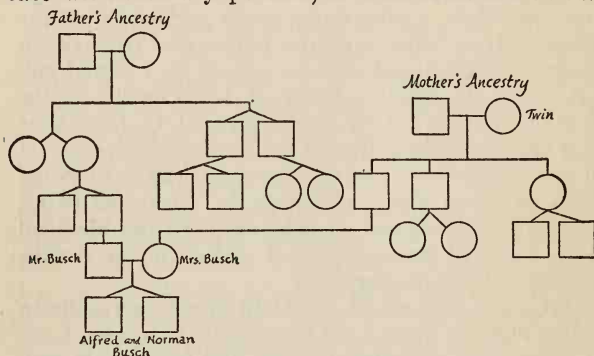

The family pedigree of the Bush twins. The square symbols are males, the round symbols are females, the double symbols are twins. Their grandfather on their father's side was a twin. His father, Mr. Bush's grandfather, was a twin, and his two brothers were twins and each had a pair of twins. On the mother's side her father was not a twin, but had a brother and sister each of whom had twins. Also the great-grandmother of the boys, who started the line on the mother's side, was a twin.

This curious fact has been studied very carefully by Professor Wilder. However, the reason for it has not been ascertained with certainty. Careful observations will reveal to any one that the right and left sides of human beings differ quite markedly. The right side of the face, the right eye, the right eyebrow, or any other feature we study, is often quite different from the same feature on the left side. The hair often grows quite differently on one side of the head from

WHAT TWINS TELL ABOUT HEREDITY

the way it grows on the other. Many persons have been known to have one blue and one brown eye. There is often a marked disparity in general bodily characters.

Professor C. H. Danforth, of the Washington School of Medicine, writing on twins in the *Journal of Heredity*, recalls that a few years ago a great deal

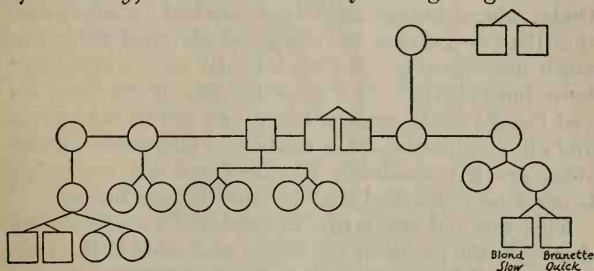

The chart of the W. family. The original ancestor was not a twin, but had a pair of twin brothers. This woman had five single children and one pair of twins, but it will be noticed that most of these single children had twin descendants. By request the name of the family is not given.

This pedigree and the one on page 122 indicate that the tendency to produce twins is inherited in some families. The exact rules of inheritance have not been worked out.

of sport was made in many newspapers, by printing pictures of prominent people, both sides of whose faces were made exactly alike. It was done by cutting away half of the photograph of the face and then having an artist fill in the other side to correspond exactly to the half that was printed. Both eyes, both sides of the nose, mouth and forehead, the eyebrows, ears, and so forth, would then be exact duplicates. Then the full natural face of the individual was reproduced by the side of the half-faked picture. The difference was often so great that the best friends of the originals would not know who they were.

THE FRUIT OF THE FAMILY TREE

Nearly everybody is conscious of the fact that one side of his face is better or worse-looking than the other side. Many women know this so well that they make it a point to keep their "best side" on exhibition as much as possible.

But this is not true of identical twins. One side is as good or as bad as the other. Professor Danforth finds, where brains have been studied in autopsies, that the two sides of the brains of identical twins are much more nearly alike than is the case with singly born individuals. The same is true of the muscles and blood-vessels, and no doubt extends to the nerves and all the minutæ of the anatomy. Of course the two sides are not absolutely identical, but the symmetry is much more marked than in other human beings.

This unusual similarity is exhibited to an extreme degree in the palms of the hands and soles of the feet. It is well-nigh impossible in twins to tell the right and left palm or the soles of the right and left feet apart. If the reader will examine his own hands or feet in these respects, he will notice that they present decided differences. Notice not only the big lines which the palmists study and from which they pretend to predict one's future fortunes, but study rather the pattern of the fine lines, the "finger-print lines," known as the "friction skin configuration," which run all the way down the palm. They can be seen much better with a magnifying-glass. Professor Wilder, of Smith College, and Doctor Arnold Gesell, of Yale, have made extensive and minute studies of the similarities between the friction skin patterns of the right and left hands and feet of twins, and have also studied the similarities in these respects between the twins themselves, and find almost complete identity throughout.

All of this emphasizes the fact that in identical twins we have wonderfully similar human beings, and this is

WHAT TWINS TELL ABOUT HEREDITY

what gives us such excellent material for studying the problem of heredity and environment. Here we have two human beings whose heredity is very nearly identical, and by subjecting them to different environments and influences we can determine to what extent environment may make them unlike. It gives us a chance to measure the environmental influence, separate from that of heredity, to a very high degree.

Sir Francis Galton, the founder of the science of eugenics, was the first man to apply careful methods to the study of twins. He collected the histories of eighty pairs and found some thirty-five about whom he learned numerous details. Though this was over forty years ago, yet the letters he received read like duplicates of the letters I have recently received from twins. While the cases of identical twins all ran about the same, their natures remaining the same under varying circumstances, it is interesting to note a few of the letters written to Galton by the mothers of dissimilar twins and compare them with those given herewith from American mothers in the twentieth century,

One parent wrote Sir Francis, "They have had exactly the same nurture; they are both healthy and strong, yet they are otherwise as dissimilar as two boys could be, physically, mentally and emotionally."

Another one said, "I can answer most decidedly, that the twins have been perfectly dissimilar in character, habits, and likeness from the moment of their birth to the present time, though they were nursed by the same woman, went to school together, and were never separated until the age of thirteen."

Here is another letter: "Very dissimilar in mind and body: one is quiet, retiring, slow but sure, good tempered, but disposed to be sulky when provoked; the other is quick, vivacious, forward, acquiring easily

THE FRUIT OF THE FAMILY TREE

and forgetting soon; quick tempered and choleric, but quickly forgiving and forgetting. They have been educated together and have never been separated."

And another: "They were never alike either in mind or body, and their dissimilarity increases daily. Their external influences have been identical; they have never been separated."

The fifth and last one from which I will quote reads: "The two sisters are very different in ability and disposition. The one is retiring, but firm and determined; she has no taste for music or drawing. The other is of an active, excitable temperament; she displays an unusual talent and is passionately fond of music and drawing. From infancy they have rarely been separated, even at school, and as children visiting their friends, they always went together."

And so on through the entire memoir. Not a single case is found where similarity of environment had any appreciable influence in making two unlike beings more alike, although born at the same time and having no age differences. As Galton sums up his study, "There is no escape from the conclusion that nature prevails enormously over nurture when the differences of nurture do not exceed what is commonly to be found among persons in the same rank in society and in the same country."

As to his identical twins, Sir Francis describes one case which I trust to my memory to relate correctly. One twin was in France and the other in Scotland. Planning not only to surprise their parents but also each other, they each selected a gift to send to their parents for Christmas. What was their own amazement when they found that they had not only selected the same present—a fine set of china—but precisely the same make and pattern with the same decorations! I leave it to Sir Oliver and Sir Arthur Conan Doyle

WHAT TWINS TELL ABOUT HEREDITY

to tell us whether this is telepathy. But, as old man Means used to say in the *Hoosier Schoolmaster*, "It is the quarest thing in natur" how twins do think and act alike when they are born from the same egg, as is probably the case with those that are identical.

But the point which Galton raises is extremely important, indeed crucially important, when he says that the differences of ordinary life seem to make no difference that we can discern. As Frederick Adams Woods has pointed out, the fact that the ordinary vicissitudes of life do not make unlike people more alike, nor "mold" us to this or that pattern, "does not argue that great changes in the environment might not cause a considerable modification in an individual." But the point is that great changes are not usual. A case in point is found in the Tomson twins. They were so nearly alike that an amusing incident occurred when they were both being decorated for bravery by King George V. After the king had decorated the first one, the lad stepped back to his place in the line. Coming to twin number two the king stopped in surprise and said, "Why, sir, I just decorated you a moment ago. I do not want to decorate you twice until you have performed some new deed of bravery." In a moment, however, he discovered his mistake and laughingly decorated the second twin. However, one was badly wounded and the other gassed, and both lay for many months in separate hospitals. They also underwent different trying experiences during the war. It is their belief and also that of their friends, that these extraordinary changes of environment and experience worked a slight change in both their appearance and personality. Galton concluded that some prolonged or severe illness would work a change and increase the differences between the twins which he studied. But this, to my mind, only confirms the view here

THE FRUIT OF THE FAMILY TREE

taken that their likenesses are due to similarity of physical organization. For certainly disease, battle wounds and terrifying experiences do work profound modifications in one's physical make-up, and especially change the general tenor of one's nervous reactions and functions. And when one's bodily organization is changed one's mind and nature are also changed.

It was Professor Edward L. Thorndike, of Columbia University, who, reasoning in this manner some years ago, made a study of the likenesses and differences among twins, and how much environment influenced these differences. This study has become famous all over the world.

There are certain technical objections to the methods Galton used to arrive at his conclusions from his study of twins, but since Professor Thorndike's investigation was carried out with very great refinement of mathematical methods, and since it has received the approval of the most competent investigators, his conclusions published in the *Archives of Psychology* in 1905 can be taken, I think, as well-nigh final. Professor Thorndike secured fifty pairs of twins from the New York City schools and measured their resemblances and differences in six mental traits and eight physical traits. The mental traits were measured by their ability to perform certain tests in arithmetic and other mental exercises.

Using Professor Thorndike's own words; "If now these resemblances are due to the fact that the two members of any twin pair are treated alike at home, have the same parental models, attend the same school and are subject in general to similar environmental conditions, then (1) twins should, up to the age of leaving home, grow more alike, and in our measurements the twins 13 and 14 years old should be much

WHAT TWINS TELL ABOUT HEREDITY

more alike than those 9 and 11 years old. Again, (2) if similarity of training is the cause of the similarity in mental traits, ordinary fraternal pairs not over four or five years apart in age should show a resemblance somewhat nearly as great as twin pairs, for home and school conditions of the former will not be much less similar than those of a pair of the latter. Again, (3) if training is the cause, twins should show greater resemblance in the case of traits much subject to training, such as ability in addition or multiplication, than in traits less subject to training such as quickness in marking off the A's on a sheet of printed capitals, or writing the opposites of words."

Summarizing the results from *Applied Eugenics*, by Popenoe and Johnson, the data showed (1) that twins 12 to 14 years old were no more alike than twins 9 to 11 years old, although they ought to have been if environment has the great power to "mold" the natures of children which has been often ascribed to it. They showed (2) that the resemblance between twins was two or three times as great as between ordinary children of the same age and sex brought up under similar environment. It should also be noted that these fifty pairs were not exclusively what we have called identical twins, but were of all sorts. There seems to be no explanation except heredity why twins should be more alike than ordinary children. The data showed (3) that these twins were no more alike in traits which are ordinarily given very great training such as addition and multiplication, than in traits which are seldom if ever subjected to training at all such as marking A's off of a sheet of printed capitals. "Their achievement in these traits," remarks Popenoe and Johnson, "was determined by their heredity; training did not alter these hereditary potentialities."

Quoting from the 1910 edition of Professor Thorn-

THE FRUIT OF THE FAMILY TREE

dike's *Educational Psychology* (page 91): "The facts then are easily, simply and completely explained by one simple hypothesis: namely, that the natures of the germ-cells—the conditions of conception—cause whatever similarities and differences exist in the original natures of men, that these conditions influence body and mind equally, and that in life the differences in modification of body and mind produced by such differences as obtain in the environments of present-day New York City public school children are slight." If the differences and resemblances of children in New York City are due mainly to heredity it is fair to infer that this is true of mankind in general where the differences in environment are not, as noted by Woods and Galton, extraordinary.

These results should, however, not discourage us about education. For, "We must be careful," continues Professor Thorndike, "not to confuse two totally different things: (1) the power of the environment—for instance, schools, laws, books and social ideals—to produce differences in the relative achievements of men, and (2) the power of environment to produce differences in absolute achievement." These results from twins, he says, "do not in the least deny that better methods of training might improve all their achievements fifty per cent., or that the absence of training, say in spelling and arithmetic, might decrease the corresponding achievements to zero." I have elaborated upon this phase of the problem in the chapter on heredity and environment.

Professor Arnold Gesell, of Yale, has published in the *Scientific Monthly* for April and May, 1922, an account of one pair of little girl twins whom he has been studying closely by elaborate methods for several years. The resemblances of these two remarkable children, who test extraordinarily high for intel-

WHAT TWINS TELL ABOUT HEREDITY

ligence, is almost past belief. It is difficult to believe that any two germ-cells would ever contain such exactly similar hereditary potentialities as to produce these two almost identical human bodies and natures. They strongly impress one with the idea that they were probably born from the two halves of the same reproductive cell.

However, since most twins are reared under the same environment, it is interesting to reproduce here a letter which I have received, with permission to publish, from Mrs. Frank Prenschoff, of Petersburg, Alaska, describing herself and her twin sister from whom she has been separated most of their lives. It seems that they are just as much alike, in a general way at least, as if they had spent their lives together. Mrs. Prenschoff writes:

“We are girl twins, aged twenty-five years, both married. I live in Alaska, while my sister lives in Saskatchewan, Canada. Unlike most twins who are always together, and who dress and talk the same, fate seems to have kept us apart nearly all our lives. We were not reared together and have not seen very much of each other, but for all that we have always been very fond of each other and are as alike as two peas in a pod. We look alike, act alike, talk alike, and talk is the main thing we do when together. We seem to catch each other’s ideas perfectly and often both start to say the same thing at the same time.

“My sister married quite young, several years before I did. We were reared under entirely different environments. Our mother and father separated when we were four years of age, and my sister was reared by a friend of my mother’s people who has no children of her own. Consequently, she was reared as an only child, while I was one of a large family of children, my mother having married again.

THE FRUIT OF THE FAMILY TREE

“We had seen each other only once before my twin sister came to live with us for a year, at the age of fifteen, and we were surprised to see how much alike we were, our tastes being all but the same, in dress and manners, so that even our mother would often mistake us.”

In the *Journal of Heredity* for March, 1922, Mr. Paul Popenoe, formerly editor of this journal, has reported an even more striking case of the slight influence exercised by environment upon twins reared apart. This case is that of twin girls, Jessie and Bess Irwin, born in the Black Hills. One of them, Jessie, has married and is now Mrs. Carl Sanders living in Arizona. These two girls were separated in babyhood by the death of their mother and scarcely saw each other and did not correspond until they were eighteen years old. During their entire lives they were together only two months in 1911, two months in 1913 and six months in 1914.

As outlined by Mrs. Sanders, Bess went to the public schools in Helena, Montana, through the fifth grade and then to business college and at the age of fourteen went into office employment. Since then she has done extension work in Columbia University and has filled very responsible business posts with a large insurance company and with the United States Government, and also did important work with the Red Cross in France. Jessie, on the other hand, went through high school in a rural district, started to train for a nurse, had a physical breakdown, later taught school three years, married in 1915, gave birth to a son, did some open-air work in 1916 and in 1920 began teaching again.

The portraits of these twins published in the *Journal of Heredity* are remarkably alike. According to Mrs. Sanders they are of exactly the same height

WHAT TWINS TELL ABOUT HEREDITY

and nearly always weigh about the same. When together they have worn each other's clothes perfectly, and friends found their voices indistinguishable. Their hair is identical in color and few people can tell them apart. Mrs. Sanders's son has never seen his aunt but can not distinguish her photograph from that of his mother. Both have weak lungs and "have been run down from that cause, and nearly always at the same time." Mrs. Sanders states that several times their letters have crossed telling of similar illnesses at the same time.

As to the mental resemblances they are no less striking. The informant writes:

"It is almost uncanny, the way we are always doing identical things at the same time. The latest instance is having our hair cut without each other's knowledge. This really took courage, because the majority of our friends do not approve.

"We are both high strung and do not seem to conserve our energy as we should, but I have been resting more gracefully this summer than I ever have before, and in her latest letter she expresses the same mood.

"We both favor history and social study 'that functions' and politics. Neither of us cares for mathematics and I would not call either of us a good student. We are too 'smattery,' although we learn rapidly with little effort.

"We both seem to have administrative ability because we invariably hold an office in every organization we affiliate ourselves with. Last year I was treasurer of the state teachers' association and am chairman of two county committees now. The latest letter from Bess advises that she has just been elected president of the women's division of the commercial club.

"We have never had a disagreement between ourselves, and while I am fond of my older sister and two

THE FRUIT OF THE FAMILY TREE

brothers, yet they have never seemed so close to me as Bess."

Mr. Popenoe comments upon the foregoing letter as follows: "It is related of the Siamese twins that if one was touched at night *the other one* would waken and inquire what was wanted. Such mental similarity in two individuals brought up together is striking enough. But when two individuals are separated in infancy, brought up as differently as are the twin sisters described above, and still manifest such mental similarities, it is impossible to resist the conclusion that the psychical make-up of the individual is very largely settled at the time he is born."

Let us contrast these two letters, one from Mrs. Prenschoff and one from Mrs. Sanders, both of which pairs of sisters were born alike and remained alike in spite of all changes of environment, with the following which I received from Mrs. X and her twin, who were born *unlike* and have remained *unlike*, despite all the efforts of similar environment to mold them into a common pattern.

"As for our appearance, as a child I was fat, blonde and healthy. My sister was thin, blonde and much weaker. She is still thin and has to watch her health. Since adolescence, she has become a brunette, with high color when well. She is five feet and one inch in height and weighs about one hundred. I am plump and robust, medium complexion, five feet three inches tall and weigh a hundred and thirty. We both have brown eyes, hers very dark, mine inclined to be hazel. Her hair is massive, heavy and a bit coarse, while mine is shorter, lighter and extremely fine. We both have small hands and feet, mine unusually so, enough to rouse comment wherever I go.

"We have never agreed on any subject, yet never quarreled. We used to use our fists and tear each other's hair when children. We were always inseparable.

WHAT TWINS TELL ABOUT HEREDITY

arable chums until our schooldays were over. She has no aversions that I know of, while I lose all control of myself if a bee buzzes round, due to a fright in childhood, I think. We have always done well in school. I was always the pest and my sister the pet of our classes. She studied hard and I didn't, but all our marks were good and alike except for deportment. My sister's marks were especially fine in history, geography, etc., while I shone in botany, physiology, algebra, music and English. She used to have nightmares over geometry until her doctor had her drop it. Nothing ever worried me.

"We lived together until 1917. We were born in Pasadena in 1894, being now twenty-seven years of age. Our father was a captain in the army. Our mother died when we were four and we were brought up by five great-aunts. At the age of ten we were taken to Massachusetts to be educated, and then came further changes to us both. An aversion was taken to me by our aunts on account of my father, whom I exactly resembled in appearance and disposition. A violent, unreasoning temper was aroused in me by this attitude, and my life while there was a stormy one. I have learned to control my temper since then, I am glad to say. My sister's deportment at home was as excellent as in school, but a tendency to selfishness and obstinancy became manifest.

"After leaving high school on account of my twin's health, it was decided that we go to the Sargent School for Physical Education. It was a wonderful school and we both loved it. Her health became fine and mine remained so. While there, I found that while I had the endurance for long hikes, fencing and rowing, she won out when it came to tennis, swimming, jumping and muscular strength for shot putting and the like. She could go over a wall like lightning, while her plumper twin took minutes.

"We haven't even a family resemblance. My sister resembles my mother's side wholly and I my

THE FRUIT OF THE FAMILY TREE

father's side wholly. No one will believe that we are twins. We grow more unlike as we grow older and marriage will of course bring greater changes."

We see here, in the lives of these six women, as in the cases of all our twins, the wonderful lessons they have to teach us about ourselves and our heredity. In the case of the X sisters, at the beginning of their lives the differences were so small as to be beyond all measurement. They probably weighed about the same at birth and the most delicate balances ever devised could certainly have detected no difference in the weight or size of the egg-cells with which they both began life. But a slight difference in the quality of the particles within those egg-cells, a slight difference in their chemical potency, their arrangement or, it may be, in the relative positions of the determiners in chromosomes of each egg, has worked such enormous differences in their adult natures that they hardly seem to be derived from the same strains of human stock. On the other hand, in the cases of the Prenschoff and Sanders sisters the similarity remained the same despite enormous differences in their mental and physical environment extending over a lifetime.

It seems evident, then, that an extremely slight difference in the make-up of the infinitesimal parental cells from which two individuals are born, may easily make all the difference between an imbecile and a genius. One may build a hovel and the other a palace; one may be a slave while the other is building an empire. Not only the physical, but the mental and temperamental differences between two whole races of people might readily be contained in these infinitesimal parental cells. It is easy to conceive that the race springing from one of these lines of germ plasm might give us the whole galaxy of Grecian genius, might paint pictures, chisel statues, erect immortal

WHAT TWINS TELL ABOUT HEREDITY

works of art, develop philosophies, write deathless literatures and leave a heritage of ideals that would inspire men and civilizations until the books of the Judgment Day unfold; while the other might pass from the stage of history "unknown, unhonored, and unsung."

However it may strike the reader, it seems evident to my mind that, if we are to improve the face of the world, its environment, its civilizations, its intellectual disciplines and cultures, we can do it many times more rapidly and easily by the simple expedient, not of directly improving the environment, which will always be done under any circumstances by good heredity, but by improving the inborn natures of the men and women who are the makers of that environment. Their improved and elevated natures will from their inner necessity, improve the environment and make this world not only a happier and more beautiful place to live in, but fill it with happier, sounder, saner, wiser, nobler human beings to dwell within its social, political and spiritual temples. For it is human capacity, and human capacity only, that is the real wealth of the world; and this is the product not of mere chance environment or the pedagogical inventions of the time, but is resident in that immortal stream of germ plasm from which we are all born and which has been flowing down to our birth from the beginning of the world. To improve it, to clarify it, to enrich it, should be the final *goal* of the world's desire.

NOTE: Since there are still many unsolved problems relative to twins, any one who is a twin or knows of a pair of twins or triplets will confer a genuine service to science and human progress by forwarding the names and addresses of such persons to Mr. David Fairchild, President American Genetic Association, Washington, D. C., an account of which is found in the Appendix. Please accompany the name and address with as many personal details and interesting items of information as possible, and if photographs can be sent it will add greatly to the value of the information. Twins who have been reared apart are of extraordinary importance. All correspondence sent to the Genetic Association is kept in absolute confidence.

CHAPTER IX

WHAT COUSIN MARRIAGES TELL ABOUT HEREDITY

EVERY man carries within himself a host of family skeletons. He is often wholly unaware of them. Yet it may be that he carries the skeleton of some insane grandfather whose very name he does not even know. Two, three, or even ten generations back there may have been some cranky, silly old grandmother, who was a holy terror in her day and time. The skeleton—and more than that—the power to reproduce her nature in his children, may easily still be carried by recessive determiners within his germ-cells. There may have been a high-tempered, ill-natured drunken uncle or a dissolute, epileptic cousin, born a thousand miles away and of whom he has never heard; yet the very seeds of that character may be floating in his blood, or, more accurately, in the germ plasm that he carries, without ever visibly affecting him. By the laws of heredity, all of these things which do not show either in his body or mind may, indeed most certainly will, if he chances to marry a woman who is carrying the *same family skeletons* within her, be transmitted and show once more in full force in his children.

On the other hand, it is a joy to have learned from the new revelations of the laws of heredity, that though a man may be carrying a few of the grinning skeletons of the family, he is always carrying a vast treasury of its virtues. These virtues may also be equally unknown to him and fail to be exhibited in his life or character. He may be a worthless, ne'er-do-well himself, yet he may be carrying the broad human

WHAT COUSIN MARRIAGES TELL

sympathy of some noble ancestor, the courage, grace and charm of some unknown forebear. It is a happy thing to find that while a man may be carrying the vestiges of a few defects, such as insanity, epilepsy, feebleness of mind and will, he may also be carrying a thousand potential glories which are just as likely to crop out in full bloom in the children as have the taints and stains upon the family escutcheon.

It is indeed surprising to discover that all of this helps us in explaining the age old mystery of the numerous defective children that sometimes do follow cousin marriages. In fact, as we shall see, it contains the clear, final and complete explanation of this riddle which has caused so much terror and heartache among the children of men. Not only among human beings, but also among practical breeders of plants and animals, "inbreeding"—the mating of close kin—has always been an unsolvable puzzle. And around anything which men can not understand, there always grows up a vast lore of superstition and exaggerated dread. Here in America, farmers and breeders of poultry, hogs, cattle and other domestic animals are losing thousands, probably millions, of dollars every year because of the vague fears that surround the whole subject of inbreeding and outbreeding.

In the human family, scarcely any subject has been fraught with more terror or has entered more intimately into both church and civil law. Almost the whole of the eighteenth chapter of Leviticus is taken up with the thunderings of divine wrath upon the man "who shall approach unto any that is near of kin to him."

This fear has existed all through the Christian Era, but in some ancient nations it did not exist. Indeed in some countries, what seems horrible to us, brother and sister matings and even matings of father and daugh-

THE FRUIT OF THE FAMILY TREE

ter have been common. This was evidently true in ancient Egypt. Inbreeding of the very closest order does not seem to have injured the wonderful family of the Ptolemies which ruled Egypt and gave it a polished and brilliant civilization for many centuries by the sheer character and intelligence of its members. After centuries of inbreeding we find Cleopatra, who, not-

Family Tree of Cleopatra

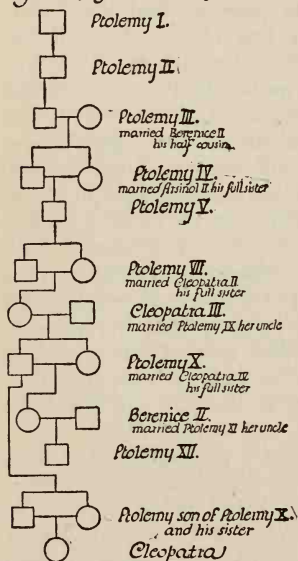

The ancestry of the famous Cleopatra shows the highest inbreeding in recorded history, without ill results. The family furnished illustrious and able rulers for centuries. Many similar brother and sister and uncle and niece marriages took place among the relatives. The family of the present rulers of Siam have intermarried in similar manner for four thousand years except in the past two generations.

Chart condensed by *Journal of Heredity* from Weigall's *Life and Times of Cleopatra*. Doubleday, Page & Company, Publishers.

withstanding her personal vices, was a woman not only of wonderful beauty, but of great intellectual powers.

But among ancient Hebrews and some other nations,

WHAT COUSIN MARRIAGES TELL

as well as among all modern Christian countries, not only have brother and sister matings been looked upon with horror, but cousin marriages have been held under the same fearful taboo. According to Professor Karl Pearson, Plutarch maintains that cousin marriages were forbidden among the early Romans. This prohibition was later removed. However, Theodosius, the Roman Emperor of 379-95 A. D., made a law that no man might marry his cousin under penalty of death by burning, and the confiscation of his property. These laws were changed many times as to the precise degree of cousinship which was permitted to marry. This alone shows the enormous public interest in the subject. Finally, in 1215 the Church issued a decree that only persons related beyond the degree of third cousins might contract marriage. This is essentially the law of the Church to-day in all countries where canon law rules, as in Portugal and Spain. Special dispensations, however, are often obtained from the church, which modifies this prohibition, and permits closer marriages, in certain instances.

In England after many changes by Henry VIII, who was the matrimonial storm center of his day, a civil law in the time of his daughter, Queen Elizabeth, was instituted permitting marriages of first cousins. The church law, however, still forbade closer unions than third cousins. But even in countries where the civil law prevails, cousin marriages have been discouraged by public opinion all through modern history.

To show how extensive this fear is in America to-day, several states forbid first cousins to marry. In Colorado and Kansas cousin marriages are visited with both fine and imprisonment. Customs vary curiously in different countries. In some countries the children of brother and sister can marry while the children of two sisters or two brothers are forbidden marriage.

THE FRUIT OF THE FAMILY TREE

I recite these historical facts in order to show how deeply seated the fear of consanguineous marriages has been in the human race. Nearly any reader will recall instances of heart breaking tragedy where two cousins have fallen in love and have been compelled to separate and marry outside the family just because of this belief that close marriages were either against the laws of God, or else that the cousin marriage in itself created defects in the children.

I recall a young man and woman who were cousins, living near my boyhood home and who had been lovers from their childhood. Two people could hardly have been more divinely intended to marry each other from every standpoint of character, temperament and beautiful interest in each other's lives. Yet the parents and relatives sternly separated them. Each has married an outside person and the lives of both have been filled with heartache and wretchedness. Looking back after science has illuminated the whole subject, and surveying the ancestry of both cousins, I can see what an unnecessary tragedy their lives have been. They should by all means have married, and no doubt would have blessed the world with their own happiness and that of a goodly family of sound healthy children. Yet I know of two other cousins who were married, who were quite sound themselves but who have three defective, feeble children. Reviewing their family histories we now see that all the laws of nature should have forbidden them to marry each other, although it is probable that each might safely have married into a sound outside family.

So we are in the presence of a strange enigma. Cousin marriages do sometimes produce perfectly tragic results, while on the other hand the children are sometimes as good as the parents or even better. In many cases in history the children have proved to be

WHAT COUSIN MARRIAGES TELL

men and women of extraordinary genius. We see this in the chart of the Darwin family, where the marriage of Charles Darwin with his cousin Emma Wedgewood, granddaughter of the founder of the great Wedgewood pottery, has resulted in four sons who have been orna-

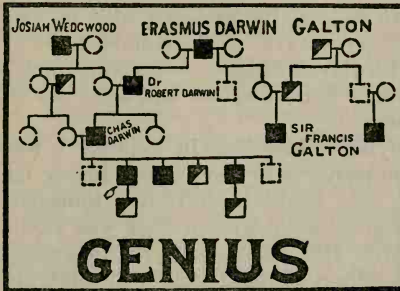

Cousin marriage did not injure the children of Charles Darwin. He married his cousin Emma Wedgewood. Four of his sons rank among the great men of England. The black squares indicate a Fellow of the Royal Society—a high scientific honor. Many of the greatest and healthiest men of genius that ever lived have been the result of a long series of cousin marriages where the stock itself was healthy and strong.

ments to the scientific history of England. At the Eugenics Congress held in September, 1921, in New York City, I talked with Major Leonard Darwin, honorary president of the Congress, one of these famous sons. At the age of seventy-one, he delivered six brilliant addresses within eight days, endured all the hardships of attending a great convention, and at the end was as fresh as many a man of thirty-five. Certainly cousin parents did not injure him.

I have just come from the American Museum of Natural History in New York where I reviewed the pedigrees of the Bach, the Harrison and the Kemble families—the latter being the most famous family of actors and actresses in the world. I found several cousin marriages in each family with no apparent in-

THE FRUIT OF THE FAMILY TREE

jury. President Benjamin Harrison had one parent who was the child of a cousin marriage. In the Bach family I counted within five generations twenty famous musicians and thirteen others of high musical talent. While there were many outmarriages, of course, there were several inmarriages with no bad results. And the same was true of the Kembles, the great family to which Sarah Siddons belonged, which produced nearly twenty famous actors and actresses within five generations.

In studying inbreeding in animals I recently reviewed the pedigree of the famous Jersey bull, Sybils Gamboge, who sold for sixty-five thousand dollars. His great-great-great grandfather was Flying Fox, a famous sire. His great-great-great grandmother was Oxford Lass, a celebrated mother of celebrated calves. Now Sybils Gamboge has descended from these ancestors by half-brother and half-sister matings for four generations. Calculations show that he carries in his blood exactly twenty-five per cent. of the blood, or rather germ plasm, of Flying Fox and thirty-two per cent. of the blood of Oxford Lass. But this mixture of fifty-seven per cent. of the common blood of his ancestors instead of injuring him has made him one of the most famous animals that ever lived. The average human being or animal that is not the result of inbreeding carries but six and one-fourth per cent. of the blood of one of his ancestors four generations in the past.

Certainly this is an extraordinary situation. Cousin matings produce both good and bad results. *Evidently then, there is something besides the mere cousin matings which produces these opposite effects.* Nature does not work first one way and then another. If cousin marriages created defects they would always do it. If they created virtues they would also always cre-

WHAT COUSIN MARRIAGES TELL

ate them. Why, then, does it sometimes fall out one way and sometimes another way? Nature is not a fickle flirt. She can be depended upon to do the same thing always under the same circumstances.

Twenty-five years ago the answer to these questions seemed hopeless. To-day it is a wide open secret. The opening wedge to split the knotty problem was Mendel's discovery, brought to light in 1900, by which the true laws of heredity were at last revealed.

To refresh our memories, let me explain again that some qualities are "dominant" while others are "recessive." You remember black rabbits, crossed with white ones gave only black offspring. But these black children mated together gave some white and some black progeny. Plainly the white had been "carried" by the blacks, because it appeared in full force, pure and clean-cut, among the grandchildren. The black is called "dominant" because it always shows if present at all in either parent. The white is called "recessive" because it recedes from view. By appropriate matings the white could have been "carried" in the blood of the blacks for ten or a hundred generations and then by proper matings been brought to light in all its original purity.

Now note this carefully. *Dominant qualities do not, under typical conditions, ever skip a generation. But recessive qualities may skip one or forty generations.* Note another important point. Dominant qualities will show in the children if only one parent has them. If both parents have them they merely show in greater intensity because the children get a "double dose." But recessive qualities do not typically show unless both parents either show them or else are carrying them. Probably no character is completely dominant or completely recessive. The recessive quality, even when not easily seen, probably always exerts some in-

THE FRUIT OF THE FAMILY TREE

fluence. But often this influence is so slight that we have no way of detecting it.

Let us now make the application of our knowledge to the cousin marriage problem. The most brilliant workers in this field of inbreeding in the world are Doctor Edwin M. East and his assistant, Doctor Donald F. Jones, of Harvard, and Doctor Helen D. King, of the University of Pennsylvania. I strongly urge any practical breeder of plants and animals who understands something of biology to study the little book by Doctors East and Jones called *Inbreeding and Outbreeding*, published by Lippincott.

Doctors East and Jones experimented mainly on corn. Ordinarily corn is cross-fertilized, the pollen grains blowing across the field. But East and Jones fertilized each corn stalk with its own pollen. This is far closer inbreeding than is possible with animals.

The results were amazing. The corn degenerated rapidly. All sorts of blasts, defects and stunted growths appeared. Many of the offspring proved sterile. Many valuable characters were entirely lost. By the fifth or sixth generation any one would have said the corn was worthless. For all practical purposes it was. However, after about the sixth generation no further degeneration of any moment occurred. Like a clock that has been wound up and set going, the degeneration seemed to run down. No new defects appeared after this time.

But this is not the end of the story. The conclusion is dramatic. In the twelfth generation they took these little, worthless-looking "nubbins" from two widely different varieties, and crossed the plants from them. All the old vigor, size and quality of the corn of twelve generations back was instantly regained at one leap. The experiments have not yet gone far enough to say with certainty that this new corn is better than the

WHAT COUSIN MARRIAGES TELL

original, but all evidence points strongly to this conclusion.

Now what is it, really, that has happened? At last the true secret of inbreeding and cross-breeding stands revealed. It is simply this. *Inbreeding has torn the mask from the defects that were already there.* These defects were recessive like the whiteness in the rabbits or the shortness of the peas. They had been concealed all the time by some dominant good quality from the other parent when the corn had been cross-bred. But when self-bred there was nothing to cover up the defect. It stood revealed in its ghastly nakedness.

This goes to the very heart of the cousin marriage problem. As Professor East asks, "Does the inbreeding in itself cause the defects? We can answer emphatically, No. It merely uncovers them."

But the inbreeding purifies the stock. That is, by throwing out the defectives as they are uncovered, a few samples are left which, while they lack in vigor of growth, are free from fatal defects. They are small and runty, but they are pure and free from taints. Now when two such strains which have been *purified by inbreeding, are crossed, a large number of dominant qualities are brought together from both sides entirely freed from recessive defects.* The result is big doses of excellent dominant qualities from both sides. So the stock is better and purer than ever.

Of course, this is an untechnical explanation, but essentially true. Now apply this method to animals. We can not self-fertilize them. We take the next best method, we mate brother and sister or parent and child.

Doctor Helen D. King, of the University of Pennsylvania, has inbred fifty thousand rats by this

THE FRUIT OF THE FAMILY TREE

method. The public has little idea upon what an enormous scale and with what painstaking care these experiments are conducted. The experiment has run for thirty-eight generations. Recently, I had a letter from Doctor King enclosing a picture of one rat of the thirty-fifth generation, No. 3094, which she states is larger and finer than the famous Goliath. Now, Goliath, who was born in the sixth generation, was the largest and finest albino rat ever before recorded in the world. But this latest rat is finer, more perfect and vigorous, and weighs more than his ancestor twenty-nine generations back. And he is the product of brother and sister matings for thirty-five generations. As Doctor King calculates, if these were human generations, it would cover a period of thirteen hundred years, with brother and sister marriages all down the line.

Now what happens in the case of these inbred rats? Almost, but not quite the same as in Doctor East's corn. In self-inbred corn one could be absolutely sure that the inbreeding in and of itself did not produce the injury. In the inbred rats one can be almost as sure. But the sum and substance is that the brother and sister matings soon give a chance for all the recessive defects to come together in the offspring and show themselves. In the experiments, of course, the rats showing these defects were discarded.

By the third or fourth generation it is a practical certainty no more defects are going to show up. But in each litter Doctor King selected the two finest, as parents of the next litter. The inbreeding rapidly purified the stock because the hidden recessive defects soon came to light since the brother and sister mating gave a chance for the recessive determiners from both sides to meet in the united germ-cell. If these rats had been cross-bred as in nature, it would have been

WHAT COUSIN MARRIAGES TELL

only rarely that a recessive defect would have had a chance to meet its like on the opposite side. But the brothers and sisters are carrying very much the same groups of both defects and virtues. That is also true of cousins, only in a slightly lesser degree. The children are much more likely to get double doses of the virtues and also double doses of the defects. But the breeder throws out—as Miss King did—those which *show* the defects, and keeps the ones for parents which show the virtues. Thus the inbreeding has purified the stock because it has reduced it to a set of undefiled dominant qualities.

Now, had Miss King taken the two worst from each litter as she did the two best, and bred two separate lines she would soon have had one line so defective it could not have survived. This proved true in some experiments conducted by Doctor Sewall Wright, Senior Animal Husbandman of the U. S. Department of Agriculture. Some lines were soon established which could not even be kept alive.

Now what is the great lesson these researchers have taught us? Simply this: *that inbreeding, no matter how close or long continued, does not in and of itself create any defects or create any virtues.* It merely gives them a better chance to come together and meet their opposites. It takes off the lid. There is probably a tendency in nature for most defects to be recessive and most virtues, dominant. This is because of the very fact that nature kills off her weaklings as fast as they are manifested and the dominant defects show up early and the individuals possessing them get killed off, while recessive defects may be carried hidden for hundreds of generations.

But by cousin marriages and inbreeding these recessive defects once more get their chance to come from both sides and reveal themselves. It is a pity

THE FRUIT OF THE FAMILY TREE

that the human family does not follow the breeder's practise and throw out all defectives from parenthood, whether cousins or unrelated.

These authorities all conclude, therefore, that the surest way of building up any breed of plants, animals or men, is by inbreeding, coupled with the selection of the best parents, and the elimination of the worst from the line. We can not, of course, do this in the human family, but we can prevent defectives from marrying.

Sometimes great performers, such as prize dogs or show horses, come from crossing two highly inbred and rigidly selected parents from different strains. This brings together a large number of fine dominant characters from both sides, freed from hidden defects. This often results in animals of great size and beauty. Farmers do this continually to produce large hogs or cattle to sell. But while these large fine performers are excellent individuals, they do not make the best sires. To speak loosely, these dominant qualities soon become so scattered out, that the great strength and vigor disappears in the children and grandchildren. The progeny, in short, return to the average. This is what is called "reversion to type" and explains its course. But inbreeding and selection will produce the great sires again.

I think that now the mystery of cousin marriages stands revealed. And like nearly all mysteries the explanation turns out to be very simple. We can see why some cousins ought to marry and some ought not. It depends upon the soundness of the cousins in the first place, and the soundness of the ancestors in the second. Cousins have very much the same set of ancestors. Some of those ancestors might have had defects of a recessive nature. No immediate ancestors may have shown these defects because the opposite

WHAT COUSIN MARRIAGES TELL

side was free from them. Had these defects been dominant characters, the immediate ancestors would have shown them because dominant qualities show if only one parent has them. But in recessive defects both parents must either show them or else carry them.

Now many persons carry these hidden defects of which they themselves are entirely ignorant. They carry them not in their bodies but in a portion of their reproductive cells. Therefore, two cousins would be a little more likely to be carrying the same defect, since they had a common ancestry, even though they themselves were strong and sound.

In that case, a portion—not all the children—would show the defect in full force. Some would be free, and some would still be carriers.

Professor East has calculated that if the same defect has not appeared on both sides within three generations it is as safe for cousins to marry each other as to marry into any outside family. They might even then, in rare cases, produce one defective child out of a dozen or so. But this would be no more likely to happen than if the parents were not related. This comes from the fact that one person out of fourteen, according to East's calculations, is carrying some hidden defect. He admits that these figures are extremely liberal. There are probably, then, no greater dangers for cousins with sound ancestors on both sides for three generations to marry, than for ordinary unrelated people to marry. The chances of a defective child are about equal in either case, and in both cases are fairly remote.

It is plain, therefore, why in some communities where cousin marriages have been frequent we see fine results, while in others the results are disastrous. In the first case the stock was good to begin with. The intermarriages only preserved and built up these good

THE FRUIT OF THE FAMILY TREE

things. In the second case the line began with bad stock and intermarriage handed the bad things along in more frequent and intensified form.

I lectured recently in a town on Long Island. To my surprise everybody seemed to have the same name. Let us call it Brown. The ushers were Browns, the church officers were Browns, the preacher and janitor were both Browns. I asked if there was a reunion of the Brown family or a general convention of all the Browns in the world. They said they were all one family and mostly cousins. They are as fine and sturdy a lot as I have ever seen.

Doctor Charles B. Davenport tells of the inhabitants of Smith's Island off the coast of Maryland where fifty-nine per cent. of the population belong to the Evans, Marsh, Bradshaw and Tyler families. Yet in three years the local physician did not discover a single case of insanity, idiocy, epilepsy or deaf-mutism. Among the first families of Virginia and Kentucky, intermarriage was common and gave the nation governors, generals, senators and national statesmen by the dozen. They were merely good stock to start with.

But where defects are in the stock, cousin marriages are perfectly shocking in their results. Intermarriages wrecked the Royal Houses of Spain and Austria after insanity crept into the blood, probably through the grandmother of Charles the Fifth of Spain. But, among the Royal Houses of England, Denmark, Sweden, Norway and older Germany, intermarriage produced good results.

Among the low families like the Jukes, the Nams, the Hill Folks, the Dacks of Western Pennsylvania, the W— family of Kentucky, studied by Professor Anderson, of Lexington, Kentucky, cousin marriages have led to ghastly results. In one Massachusetts

WHAT COUSIN MARRIAGES TELL

town studied by Mrs. Ruth Moxcey Martin, she reported in a paper read before the Eugenics Congress that the tendency to suicide ran in the leading families. They intermarried and intensified it so much that the town is now known as "Suicide Town." The members live in constant fear of killing themselves.

The sum of the whole matter is, then, that cousin marriages in themselves do not produce or cause anything. They intensify bad things and intensify good things. That is all there is to it. The final teaching is just this. No state should absolutely forbid cousin

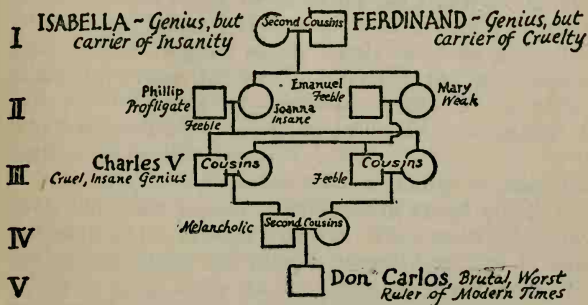

Cousin marriages do not in themselves create or produce defects, but are likely to uncover them if they are in the stock. Cousin marriages are dangerous where there are defects in the common ancestry, as for instance, in this chart of the ancestry of Don Carlos, of Spain. Isabella and Ferdinand, great-great-grandparents of Don Carlos and patrons of Columbus, were second cousins, each sound, but "carrying" the same defects. One daughter, Joanna, insane, married Phillip, and the other daughter, Mary, a mediocre character, married Emanuel. Joanna's son was Charles V, the greatest man of his time, but insane, inheriting both the genius of his grandparents and the insanity of his mother. Charles V married his cousin, his aunt Mary's daughter, and his sister married her cousin, his aunt Mary's son. In the next generation we see the children of these two cousin marriages married to each other. Their son was Don Carlos, said to be "one of the most despicable and unfortunate specimens of humanity in modern history." He had women who jilted him burned alive for amusement. Chart worked out from Dr. F. A. Woods's *Heredity in Royalty*. (Holt and Company.)

THE FRUIT OF THE FAMILY TREE

marriages. Each individual case, like any other marriage, should be judged on its own merits.

For many generations yet, whether cousin marriage or out-marriage, there will be from the noblest parents an occasional defective child. This is because the human race is still carrying the skeletons of the false marriages of our ancestors. But more and more, by using common sense, true religion and the aid of science, these skeletons can be destroyed so they will never again appear, breaking as they do the hearts of loving parents, wrecking the lives of innocent children and cursing our common humanity.

CHAPTER X

IS DISEASE INHERITED?

THE old lady who on her one-hundredth birthday ascribed her long life to "vittles" was probably as nearly right as those who ascribe their length of days to "never drinkin' anything but good whisky," or to drugs, or cold baths, or some special brand of climate.

Professor Karl Pearson said to a hardy guardsman on the English coast, "This must be a healthy place for your bairns." "Well," the guardsman replied, "I says of children, some is un'ealthy wherever you puts 'em, and again others is 'ealthy no matter where they lives."

This story brings to my mind a family of nine children who were reared in defiance of about ninety-five per cent. of the laws of hygiene. They were fine folks, but the children did almost everything that is supposed to cause early death. They went swimming before the ice was out in the spring; they all slept in piles like young pigs; the windows were nailed down in the fall and kept air-tight until warm weather. The father explained to me, apologetically, that one of the boys was so weakly he had to wear underclothes! A friend of mine, driving by the house one day in a buggy, ran over one of the babies asleep in the dust of the road, breathing every sort of microbe known and unknown. They ate three square meals daily and three or four of other shapes, sizes and dimensions in between.

Yet they grew up as fine and sturdy a lot of youngsters as could be found in the county. Most of them

THE FRUIT OF THE FAMILY TREE

went to college. All are still living and filling careers of dignity and credit.

I know another family of ten children who began "doctoring" from the time they were born. They lived out-of-doors and led a beautiful, care-free life. In spite, however, of having the advantages of everything known to science three of them died in early childhood. Four brothers and three sisters went to college. One girl died at seventeen, one at twenty-five and one at thirty-two. Two boys died at twenty-five. One is still living at fifty in sound health and apparently good for twenty-five years more. The oldest brother of the family is, at sixty-two, the soundest man of his age with whom I am acquainted. He hunts big game, runs two or three banks, and said to me recently, "Life is a lot more fun now than it was at eighteen, and I had all there was going then." Without the aid of doctors his life fulfills the definition of health given by F. P. A. that "Health is the thing that makes you feel that now is the best time of the year and that the thing you are doing is the most important thing in the world."

Here, then, we see strange contrasts in health and longevity both between different families, and also within the same family. The second family with all the benefits of science, lost eighty per cent. of the children. The remaining twenty per cent. are sound and strong. But the members of the first family, who never heard of "hygiene" or "health," unless from some patent-medicine vender at the county fair, possesses a physical machinery that takes every hill of life "on high." Mud-guards and wind-shields are superfluous. Chains would be a nuisance to them, as they were born with non-skid health tires.

But let us examine the family tree of the two families. As the Irishman said, "A family tree is a foine

IS DISEASE INHERITED?

thing to have if it isn't too shady." The grandparents in the first family were all four of similar type, built, like the one hoss shay, "to run a hundred years and a day." Some of them pretty nearly came up to the advertisements, and died around ninety. But in the second family, there were great contrasts among the ancestors in health and longevity. The grandparents all lived to be nearly eighty, one to the age of eighty-five. It seems surprising, therefore, that the grandchildren in the second family were not so sound as in the first.

But grandparents are not the only fruit on the family tree. Grandparents have brothers and sisters, and, also, had parents themselves.

The grandparents of the second family had brothers and sisters who died young. The father in the second family had several brothers who died of tuberculosis, and who had children that went the same way. One of these children, that is, a cousin of the children in the second family, was, as a young man, one of the strongest I ever knew. Yet, he contracted "quick consumption" at thirty-five, and died within three months. However, one of the father's brothers, the uncle of the set of children of family number two, married into an extraordinarily sound stock, and had children of two kinds. Some were weakly and died early, but three of them, as was a proverb in the neighborhood, "could whip their weight in wildcats." One of these children had a son who became a well-known prize-fighter.

The mother in family number two died at thirty-seven with pneumonia and had one sister who died young, and a brother who "drank himself to death." The father in this family died with tuberculosis at the age of fifty-seven.

Now, whether we get each one of these children

THE FRUIT OF THE FAMILY TREE

located on the proper branch of the family tree or not, several things stand out clearly. Weakly and short-lived parents, from weakly stock, are likely to beget short-lived children. Feeble parents, from a mixed stock of both strong and weak, beget two sorts of children, some weak and some strong; while strong parents, from strong stock, rarely beget anything but strong healthy children.

Of course, no scientist would be justified in making the foregoing assertions from a study of only two families, but since hundreds of similar families have been studied by exact methods, and since the whole weight of modern investigation in heredity supports these general conclusions, I feel considerable confidence in applying them here as being the general rule of Mother Nature.

It is evident that some strong parents carry the elements of weakness, not only hidden from view, but even hidden from themselves. The elements that cause some types of weakness are probably recessive. And, as we have already learned, the usual rule about recessive characters is that they do not manifest themselves in full force in the children unless they come from both sides of the house—that is, both parents must either have shown them or else have been carrying them unseen in a portion of their germ-cells.

Now, just what it is that a man inherits who contracts tuberculosis, influenza, typhoid or pneumonia more easily than his neighbor or brother and which brings about such a result, we do not know. Very little is known as to what it is in a man's physiological makeup that gives him immunity from or susceptibility to a certain microbe or bacillus. All we can say is that the blood or tissues of some persons furnish a better soil for certain types of micro-organisms than is furnished by the blood or tissues of their fellows. In some cases

IS DISEASE INHERITED?

it seems as though a general constitutional weakness is associated with the susceptibility. But whatever it is, one man will contract an infectious disease, whereas his fellow-man, apparently of equal or even of less general physical vigor, can breathe or swallow the same microbe by the billions without any injury.

In reflecting upon this matter of immunity and susceptibility it has aided my own conception very greatly as to what these phenomena really are, to consider the likes and dislikes of bees and mosquitoes. Honey-bees and "bumble" bees will sting some people without the slightest provocation, while others can use them as playthings. Recently I saw a motion picture which showed a famous bee-keeper picking up his bees and tumbling them about by the handful. The bees seemed to be as happy as petted kittens. Most people would have been stung to death in a short time.

The same liking for or antipathy to different people is also shown by mosquitoes. If the reader will pardon a personal reference I might note that mosquitoes never trouble me at all. However, they make life for my wife utterly miserable. We might say then that some people inherit mosquitoes and some do not. Some persons have something in their blood or bodies that these various insects like, while others have something they do not like. And I conceive it to be very much the same with this thing of natural susceptibility to or immunity from the typhoid or tuberculosis germ or any other species of microbe. Many persons probably inherit something that makes their bodies a more agreeable soil, while others inherit something that either drives them away or else kills them. In one family of my acquaintance there has not been a case of typhoid fever for more than a hundred and fifty years. Yet they have lived in a region where the drinking water has frequently been infected by typhoid-produce-

THE FRUIT OF THE FAMILY TREE

ing organisms which were fatal to their neighbors. Also, in this same family, during that period, there has been but one case of pneumonia, although, no doubt, the members of the family have had as good an opportunity to contract this disease as any of their neighbors, many of whom have died from it. While these homely illustrations are perhaps not strictly scientific, yet I trust they will give us a somewhat clearer idea of what is meant by those rather vague terms, "susceptibility" and "immunity," with reference to that class of diseases which are caused by microbes.

The reader should not gain the idea just because certain diseases, or rather the susceptibility to them are inherited, that this means if he should have inherited the susceptibility, he must of necessity contract the disease and probably die from it. There is, for some reason, in the public mind and also among many of the medical profession, a strange antipathy to the idea that tuberculosis, for instance, is inherited. At a dinner the other evening a woman said to me, "Oh, don't tell me that tuberculosis is inherited. My doctor says it is not and I don't want to believe that it is." This all comes from the idea that a thing which is inherited is likely to be more fatal than a thing which is not. All that the word heredity means, with reference to disease, is that some people contract certain diseases more easily than others and that this susceptibility is related to their ancestry. It does not mean that those who may have a greater susceptibility are foredoomed to an early death. Since we are now discovering the laws which govern the inheritance of susceptibility and immunity, it presents a very happy outlook for the future. It means that, by wise marriages, we can, so to speak, "steer around" these diseases and produce families that are wholly immune from them.

IS DISEASE INHERITED?

But this does not take away the slightest hope from those individuals who have, owing to our previous ignorance of the laws of heredity, inherited a somewhat higher susceptibility than others. To put it plainly, "Skeeterskoot" is very effective in keeping off the mosquitoes. By this very simple device one overcomes the effects of ages of evolution which have made one an easy prey to these pests. Fresh air, good food, hygienic living and the cultivation of a cheerful outlook upon life, above all *absolute rest* for two or three months will often prevent the onset of tuberculosis and also often *completely* cure it in an individual who has inherited a high susceptibility to this bacillus. The medical profession is now practically a unit in declaring that the *slightest exercise when one has tuberculosis is almost certain death while a few months' rest in bed by an open window presents high hopes of complete cure.* Sensible living, together with the aid of modern psychology and neurology, will often prevent insanity in a person who has inherited a very feeble self-control. But the happy thing is that, not only are many people born immune to all of these things, but that by wiser marriage-selection the number of naturally sound, healthy people can be enormously increased and the number of weakly persons, whose lives are mostly spent in fighting their disabilities, can be enormously decreased.

Since the heredity of tuberculosis is a matter, not only of individual but of world-wide concern, I might say that only four or five studies of its inheritance have as yet been made. They have all been made by different methods and upon different material, but the results of all of them have been mutually harmonious and supporting. The net result has been to indicate strongly that the hereditary factor in tuberculosis is very important; and it is not only idle but destructive

THE FRUIT OF THE FAMILY TREE

of all sound measures for the future health of the race for the medical profession longer to claim, as many of their less-informed members do claim, that the hereditary factor counts for little or nothing. It counts for a great deal. Scientists are not yet quite prepared to say how much. Doctor Raymond Pearl, head of the Department of Biometry and Vital Statistics of the Johns Hopkins University at Baltimore, has now under way a great investigation of the whole problem, both as to the method of the heredity of tubercular susceptibility and the relative influence of environmental factors in its onset. Until his investigations, as well as some others now being made, are completed, we are not justified in coming to any conclusions from *a priori* reasoning. It is evident, however, from all investigations to date and from Doctor Pearl's brief published statements, that he is in sympathy with the view that the hereditary factor ranks very high and that the susceptibility to the tubercular bacillus is probably inherited according to Mendelian rules. Professor Karl Pearson, of England, has also made extensive studies of the subject. Doctor Albert Goveartz, of Brussels, Belgium, spent the years 1921 and 1922 at the Eugenics Record Office at Cold Spring Harbor analyzing the extensive data on tuberculosis collected by that institution.

I think we can safely sum up the present status of the matter by saying that the old family doctor of forty years ago, had a sounder view than that which prevails among the majority of the medical profession to-day, when he advised tubercular persons not to take the responsibility of producing children. It is true, as claimed by the United States Government, the Red Cross and other agencies, that the death-rate from tuberculosis is falling. However, we are faced by the disconcerting fact that while the death-rate has been

IS DISEASE INHERITED?

steadily declining since the fresh-air and milk-drinking campaign began back in the 'nineties, yet, as Professor Pearson has shown, it has not been declining in England, at least, as rapidly as it was before that time. Professor Pearson, and I think all biologists, believe this is due to the fact that the hereditary factor has been disregarded and those whom our hygiene and medical science have saved from the disease, have been freely marrying and producing children. Further evidence in this line is furnished by the fact that the young men drafted into our army who came from Colorado, Arizona and California, to which regions tubercular families had been migrating for over a generation, showed the highest tuberculosis rate of any young men in the country. If this goes on and we do not institute an eugenical policy as wide and as thoroughgoing as our hygienic and medical policy, I think no biologist doubts that we are setting the stage for a rapid increase of tuberculosis very soon all over the world. I think this need not occasion undue alarm, although it should occasion a serious change in public thought and the direction of much of our efforts. But because the laws of heredity are so rapidly becoming known, we can, I think, in time swing both public sentiment and medical opinion into line with an eugenical policy which will lead all persons of tubercular stocks to seek the advice of experts when they are confronted by the problem of marriage. Our knowledge up to date seems to indicate not that persons from tubercular families should not marry and produce children, but that persons from such families should *not marry each other*. But upon these points we can not be certain and we must consider that even if the susceptibility to tuberculosis is a constant and simple recessive then where tubercular individuals marry it only hands the susceptibility one step down

THE FRUIT OF THE FAMILY TREE

the line. It does not "stamp out tuberculosis." But the advice of our family doctors forty years ago did produce splendid results, without working undue hardship upon individuals, or running counter to our most humane sentiments.

If such a policy can be resumed once more with the *additional enlightenment* from the field of biology, we can preserve all the benefits of medical science, indulge all our humane impulses, and at the same time build up the stamina of the race instead of tearing it down, as a short-sighted reliance exclusively upon environment is almost certain to do.

The reader, of course, will understand that in this chapter I am merely discussing the types of disease which are due to those infectious micro-organisms known as microbes, bacteria and bacillus; such diseases or defects as insanity, epilepsy and the like are due to structural and functional defects in the organism and belong in a different category. Their inheritance is discussed in other chapters.

As a final consideration, when it comes to the problem of the inheritance of disease, there are two distinct phases to be considered. The first is one's own personal health and happiness, the second is the matter of the happiness and health of the future children.

On the personal side, one should make a survey of his parents, grandparents, uncles, aunts and cousins, and his great-grandparents if any data about them can be found. A man should face candidly his own chances in any game. The weaknesses of our ancestors and relatives should be warning signals to us. But we should also remember that their virtues are flags of truce held out to us by Mother Nature, and are therefore guarantees to us of a safe conduct through life. However, nature is always looking for the weak point in our armor, so it is better to have the weak spots especially guarded.

IS DISEASE INHERITED?

But after one thorough inspection of the strong and the weak points of our ancestors, in so far as we are personally, individually, concerned, we should throw them all overboard bag and baggage. Our soldier boys were not instructed to sit down under a bush in No Man's Land and study their family trees to see if any of their forefathers had been killed in battle. In the fight for our own personal health, happiness and success, all that need to interest us is the here and now. To use common parlance, we are at the bat, and

FOUR GENERATIONS OF INSANITY.

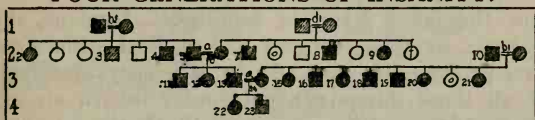

The black symbols represent persons either highly eccentric or positively insane. Double horizontal lines connect husband and wife; single horizontal lines connect brothers and sisters; perpendicular lines connect parents and children. Open symbols normal persons; shaded symbols are believed by the authors to be "carriers," although the evidence and methods are not convincing. Note that the number of abnormal persons seems to increase in the third line, probably due to the mating of the two abnormal persons in the center of the second line.

whether our great-grandfather struck out or made a home run, is of no immediate interest. We can not cure our rheumatism by any amount of detailed information as to our grandfather's gout. If one-half of our ancestors died at forty, it does not mean that we are compelled to do the same thing. The more we worry about this fact, the more likely we are to succumb at even an earlier time of life. Practically every one has a number of ancestors who lived to a good old age. We should keep our minds on them, avoid their vices and emulate their virtues, and it is likely, with modern hygiene and the aid of science, we shall be able to outlive and outdo them all.

THE FRUIT OF THE FAMILY TREE

But when it comes to marriage and children, the question of the inheritance or non-inheritance of disease, or rather the susceptibility to it, is as serious a problem as one ever confronts. Physical and mental soundness, as well as weakness, are inherited; that is, their basis in our physical constitution is transmitted from generation to generation in the germ plasm. Even ten or fifteen years ago this question might have been debated, but it can not be debated now. The evidence is massive and overwhelming. In some cases we know pretty well how a particular disease is handed down. In the case of many other diseases we only know that they "run in families." Hygiene, diet, fresh air, exercise, surgery and medical science may often prolong life and add to efficiency amazingly; but all these things can not confer inborn strength and soundness, either upon an individual or upon his children.

We can not pay too much attention or spend too much money in order to promote public health, and the knowledge as to how to secure individual health and efficiency. In the first place, such measures are eminently useful and successful, and, in the second place, they give us lofty ideals of racial health, beauty and strength. As I have said elsewhere, these very ideals are among our most precious possessions and they are almost wholly new things in the world. But it is wrong to preach that securing health for this generation, by better feeding, pure milk, open windows, better housing, non-spitting regulations, anti-toxins and general sanitation, is *all* that we need. We not only can not stop at this point, but we dare not. I yield to no one in my enthusiasm for all such humanitarian measures. I have spent a great deal of time for many years condemning school boards and factory owners and communities for unsanitary buildings,

IS DISEASE INHERITED?

back-breaking seats in school-houses, and failure to provide adequate dental, medical and hygienic inspection for both workers and children. The stupidity of some communities, factory-owners and parents, as to easily preventable disease and inefficiency, is truly appalling. Diseases to an enormous percentage are in reality not diseases at all, but in the true sense, are crimes—either individual or community crimes. I

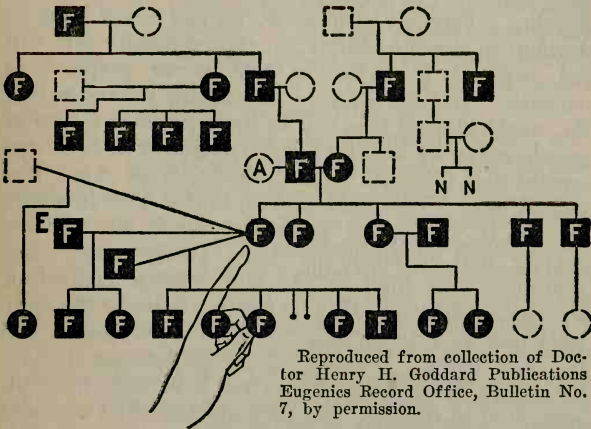

This chart shows the heredity of feeble-mindedness through several generations. The woman indicated by the hand had three mates and produced feeble-minded children by them all. Feeble-mindedness is clearly a heredity character and probably due to several factors; whether it is dominant or recessional is not certain. Square symbols indicate males; round, females; F, feeble-minded; E, epileptic; blank symbols, normal or unknown.

agree heartily with that eminent doctor who said, "When anybody dies of typhoid fever somebody ought to be hung."

But the students of eugenics would carry this doctrine much further—carry it on to a still broader

THE FRUIT OF THE FAMILY TREE

humanitarianism and to a still nobler ideal. For instance, when two people, feeble in either mind or body from constitutional and inborn causes, or when two insane persons marry each other, or when normal persons marry such defectives and beget a brood of socially inadequate children, the eugenicist says that in these cases, also, somebody should be hanged.

The advocate of eugenics believes in saving every baby and every adult that can be saved. If we can not develop a hygienic conscience, we can never hope to develop an eugenic conscience. A community that will not respond to hygienics will never respond to eugenics. But for doctors and health boards to tell the world that all this will in itself produce a race of people *naturally* healthier and stronger in their inborn mental and physical characteristics, is so much biological bosh. The plain fact is, that if that is all we do and if we let the weaklings which our hygiene, charity and philanthropy save, freely marry and reproduce, we shall in the end weaken instead of strengthen the race. By this policy obviously the more weakness we save to maturity the more weakness will be reproduced. Whether these weaknesses are inherited by Mendelian rules or not is of little moment, compared to the fact that they are inherited and that we are thus handing them on to an increasing number of individuals in the future.

It is a bit startling to some people to learn that wherever babies from one to two years of age have been saved by means of pure milk and the like, the death-rate of children from two to ten is, as a direct result, enormously increased. But this is precisely what a biologist would have expected. It shows we have saved a great many babies so inherently weak that they can not live to maturity. But of course we save some who do live to a good old age; so it all pays.

IS DISEASE INHERITED?

But the point is that the principal reason why babies die is that the parents are short-lived. Babies from long-lived ancestry sometimes die, but only *one-fifth* as many as children from short-lived, weakly parents. Professor Karl Pearson has shown that just as the length of life of the parents goes up, the death-rate of the babies goes down.

Not only Professor Pearson and Doctor Pearl's work but other extensive investigations show that it is five to ten times as important to have sound parents before you are born, as to have sound doctors after you are born. Heredity is five to ten times as strong in determining health and longevity as all the environmental measures in the world.

If we had some magic cure for tuberculosis, and I would to heaven we had, and if we cured all the tubercular people on earth and then allowed them freely to marry, we would only scatter the weakness among the people at large. I can not repeat too often that *curing this generation does not make the next generation any stronger*. If we could cure all the psycho-neurotics, the hysterics, neurasthenics, hypochondriacs, epileptics and maniacs—and again I would to heaven we could—and then let them marry freely and reproduce as they *are doing* all the time, we would only spread, as actually we are spreading, these diabolical defects through the blood of the race.

There are some diseases of which we can not say this, not that susceptibility to them is not inherited, but because they do not indicate a general unfitness for parenthood. Susceptibility to typhoid or influenza or diphtheria does not indicate great racial unfitness. Our ancestors, for instance, died from measles like flies. But in time those strains especially susceptible to measles were weeded out. However, we should be foolish to throw away our science and let the race go

THE FRUIT OF THE FAMILY TREE

through this tragic process in order to get stock immune to typhoid and pneumonia and such diseases which seem to attack the just and the unjust, the weak and the strong, about equally. It is true that they will not attack some families, but we can not afford to go through such a tragic evolution to attain a race merely immune against these particular maladies. But with tuberculosis especially, it does seem worth while to prevent such stocks from marrying freely. The same should probably be said of stocks affected with cancer.

When it comes to deaf-mutism, insanity, feeble-mindedness, epilepsy, and those types of feeble self-control which under a very slight environmental stimulus lead to alcoholism and crime, we are in a totally different field. In considering all of those combined causes which lead to early death in families, personal ill-health and general social inadequacy, we should apply science to the problem of marriage.

I have here touched only the borderland of the vast subject of heredity and disease. No one can read hundreds of family pedigrees without being deeply impressed with the fact that, after he has traced the various diseases and virtues of the parents and grandparents, the uncles, aunts, cousins and the like, he can predict with considerable assurance a great many things with reference to the health, stamina and longevity of the children. The outstanding fact is that the sound personal health of the parents, combined with the sound germ plasm which they may be carrying, is from four to five times as important in the future health of the children, as pure milk, good doctors, open air, physical culture and hygiene all put together, notwithstanding the immense importance of all of these fine things.

Consequently health and disease in relation to heredity are immense individual and national

IS DISEASE INHERITED?

problems. Hygiene aims to improve the individual and eugenics to improve the race. The two must go hand in hand. We can not indulge in unlimited hygiene and sanitation and medical measures generally, without at the same time embarking upon an eugenical program just as wide and just as permanent. Our saving of the weaklings is one of the true glories of our civilization; but if we permit those whom we have saved to marry freely, we are extremely likely to make individual improvements not the ally, as it could and should be, but the greatest enemy of race improvement. By applying one-tenth as much science in mating human beings as we do in mating animals, we would probably add more to the health and happiness of our children and grandchildren than can be done by all the medical discoveries of the next hundred years.

“We conquer nature only by obeying her.” And her declaration is that the root of most evil is not love of money but unwise marriage. At least three-fourths of the misery in the world is due to the simple fact that the wrong people got married. Marriage, where children are expected, should be a privilege bestowed by society solely upon the fit. Parentage is not a natural right, and it should be withheld from the unfit.

Disease is inherited. But health is also inherited. There are in the human germ-cells probably a hundred times as many health factors as disease factors. It is not too great a task for human intelligence to eliminate the disease factors and preserve the health factors. We can have a sound, happy, beautiful race if we really want it. The task of eugenics is to teach people to want it, and how to bring it about. And the simplest way is to increase, through better economic conditions and social ideals, the number of children from healthy,

THE FRUIT OF THE FAMILY TREE

long-lived, successful stocks; and through a spread of a knowledge of birth-control and other measures, decrease the number of children from stocks which are less successful in both the physical and intellectual struggles of human life.

CHAPTER XI

IS BRAIN-POWER INHERITED?

WHEN Rip Van Winkle went to sleep the world went right ahead as though nothing had happened. Indeed, nothing of any importance had happened, because Rip had scarcely any brains, and his absence withdrew very little intelligence from the machinery of the world's affairs. There are countless thousands of just such brainless, cheerful loafers as Rip, both on the sidewalk and in limousines, who, should they sleep until kingdom come, would never be missed.

On the other hand, however, there are probably fifty men, possibly a dozen, now living who, should they go to sleep for even a twelvemonth, would wake up to find that the whole world was in disorder. This is solely because civilization is created and held together by a very few men—all of them men of extraordinary brains.

The whole sweep of modern investigation indicates that if five hundred, possibly one hundred, such men could be taken out of human history there would be no great or worthy history; that without the prophets there would have been no Bible; without some unknown genius of the past, no printing; without Phidias and Angelo, no art; without Plato and Kant, no philosophy; without Aristotle and Bacon, no science; without these and a few score of equally precious men, no civilization.

Imagine England, for instance, without Shakespeare, Greece without Pericles, Rome without Cæsar, France without Napoleon, America without Washington and Lincoln!

THE FRUIT OF THE FAMILY TREE

Although the welfare of humanity depends upon the leader, the genius, the man of brains, no one until yesterday ever thought to inquire whence he came, *how he got his brains*, or to follow the star that led to his birthplace. Indeed, it has always been taken for granted that everybody, if not a positive genius, at least had "plenty of brains," and that one man would succeed about as well as another if only he were given an "equal opportunity" or wealth were "equally distributed."

Half the schemes for "regenerating society" rest on the nebulous notion that all that is needed is an equal distribution of "leisure," "economic opportunity," education, and the like, in order to make everybody, even the laziest and most stupid, healthy, wealthy and wise.

I know of no experiment which has so completely riddled this fallacy, and which so powerfully illustrates the astounding differences in original brain-power and the influence of every one's original endowment of brains upon his practical success, as a very simple one devised by Professor Edward L. Thorndike, of Columbia University.

He selected one group of people who could solve a certain number of simple problems in arithmetic in fifteen minutes, and another group who could solve over twice as many of the same problems in the same time. He then gave both groups *an equal amount of practise*. The amazing results are shown in the diagram on the opposite page. Nothing is plainer than that *unto him that hath brains shall be given*.

The slow group advanced a little; the fast group advanced greatly. In the end, *as the direct result of "equal opportunity,"* the fast group was further ahead than ever!

We might as well all candidly admit that the new

IS BRAIN-POWER INHERITED?

psychology, which is founded not upon inward reflection but upon outward experiment, has knocked nearly everything we thought we knew about the human mind into a cocked hat. It has changed nearly all our notions as to how brains operate and where they come from.

(Especially has science found that brains are largely

*Unto every one that
hath shall be given*

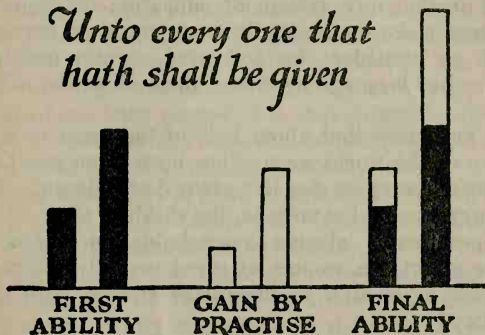

The two columns at the left in this diagram from Professor Thorndike show the relative ability in simple arithmetic of two groups. The two middle columns show the gain each group made with the same amount of practise. The two right-hand columns show their original ability, plus the ability gained by practise. The two groups in the end were farther apart than ever!

a *family* affair; that some families, some strains and breeds furnish numerous children with a high order of brain-power, while other lines of blood would not produce a really intelligent individual in a hundred years.

We often, for instance, see brothers and sisters, some of whom are teeming with brains, energy and decision of character, while the other children will be reckless, intemperate or stupid. We know now that this is due almost entirely to the fact that the ancestry was of *mixed breeds* and some of the children in-

THE FRUIT OF THE FAMILY TREE

herited the high mental tension and will-power of one strain, while their brothers or sisters inherited the weaknesses of the other.

This does not mean that the weakest and laziest will not be enormously improved and energized by education and moral suasion. But it does completely upset our democratic complaisance about men being born equal or that any system of education or economics will ever make them equally wise, moral or energetic.

Let us consider the following simple questions. Science has long ago answered them all in the affirmative.

Do you know that about half of the great men and women of the world were either born from great parents or ancestry or else left great descendants? That, contrary to popular notions, the children of great men are practically always remarkable, *provided* the father married a woman of great mental powers like his own or even a commonplace woman with great ancestry?

Do you know that practically *all* of the remaining half of the great men and women of history have been born from parents and ancestors of sound character and ability? That numerous famous men have had a carpenter or shoemaker or man of similar occupation for a father, but that until recently, in this machine age, such men were usually skilled craftsmen of excellent, often extraordinary, capacity and character?

Do you know that about one per cent. of the world's population has produced one-half of the world's great leaders, while it has taken all the countless millions of people of ordinary blood to produce the other half?

Do you know that the old New England families—the Puritan stocks—owing, no doubt, to the high religious selection of this splendid group of immigrants—have produced two or three times as much brains, two or three times as many national leaders, as

IS BRAIN-POWER INHERITED?

any other section of America of equal population? That their leadership is rapidly declining, owing to the emigration of these stocks to other sections, the reduction in the size of their families, and the replacement of these energetic stocks by duller and lower immigrant breeds?

Do you know that no genius was ever a truly dull boy; that the *really* stupid boy remains a stupid individual throughout life? In short, that dullards are really dull and prodigies really "prod" in later life and are the hope and power of the nation? True, some geniuses have been regarded as dull children, but this was solely because the remarkable methods for measuring brains were but recently invented.

Do you know that it pays both bright and dull children to study? That those who study hard and succeed best in the kindergarten usually succeed best in the grades, those who succeed in the grades succeed in the high school, those who are ahead in the high school are generally still ahead in the university, and those who take honors in the university nearly always take honors in the world?

Do you know that if you have even *one* eminent relative as close as parent, uncle, nephew or grandparent, you have from five hundred to one thousand times as many chances of becoming famous yourself as if you had in your ancestry no remarkable blood?

Do you know that some families—some strains of blood—produce one great person out of every eight, while other strains with apparently the same opportunity produce not one great person out of a million?

Do you know that it is nearly fifty times as advantageous to have a preacher for a father as it is to have an unskilled day-laborer?

All the politics, education, science, morals and religion of the nation should combine to bring about

THE FRUIT OF THE FAMILY TREE

(three great tendencies in our national life: first, to discover, conserve, and make useful every ounce of brains that we have; second, to build up those economic and social conditions, habits and ideals which would *encourage* all people of sound character and abilities to marry and produce at least three to five children, rewarding them for this immense patriotic service with social distinctions, political privileges, and an economic security that would neither pauperize the fit nor encourage the unfit; and third, the stern and absolute prevention of the unfit from reproducing and increasing their kind, by measures that would be both merciful and socially approved.)

A few outstanding investigations will prove, I think, that brains are inherited.

Let us first walk down the corridors of the Hall of Fame on the banks of the Hudson in New York City. Tablets have been erected here to honor America's supreme geniuses. Out of the first fifty-one we find ten of them—one-fifth, practically—were the sons or daughters of preachers. Since there is only about one preacher to every five hundred people and they have an average of about four children each, it follows that the son or daughter of a preacher has from twenty-five to fifty times as many chances of becoming a great leader as the son of a man picked out at random.

Now let us glance at the results of the army mental tests. The men were rated according to their proficiency in these particular tests as follows:

A	Very superior
B	Superior
C plus	High average
C	Average
C minus	Low average
D	Inferior
D minus and E	Very inferior

IS BRAIN-POWER INHERITED?

These tests did not pretend to rate a man's moral character, "will-power," persistence, temperament and the like. For a full discussion as to whether they measured to a fair degree each man's native, inborn intelligence as distinguished from his experience and education, I must refer the reader to the chapter on *Woman's Place in Race Betterment*.

But a point in evidence that they probably did to an encouraging degree measure each man's actual, natural brain-power is the fact that a large majority of the men who rated high in these simple, hastily made tests were later found to be the sons of business men, preachers, teachers, lawyers, accountants, doctors, engineers, expert salesmen, foremen and skilled mechanics, and men generally who had demonstrated their very real brain-power in the vastly harder test of real life.

That is, the A, B and C plus men were in the main the sons of A, B and C plus fathers and mothers. The C minus, D and D minus men, on the other hand, who could make only common soldiers (indeed the D minus men could only make shovelers, truck-loaders and trench-diggers), were mainly the sons of unskilled laborers; that is, C minus, D and D minus fathers and mothers.

Of course there were numerous remarkable exceptions, and on the battle-field one set of men were about as brave as the other. But the leader, the man of brains, upon whom all depends, usually springs from an ancestry whose blood was also teeming with intelligence and energy.

After all, the greatest mental test is the laboratory of human life.

Let me, therefore, set out for our inspection a few exhibits culled at random from this great world laboratory. While the following exhibits of mental

THE FRUIT OF THE FAMILY TREE

tests upon children are much more accurate than were the army tests, yet it may be that some part of the differences among children which they indicate is due to some having had *better nutrition than others, better health, better home surroundings, books, pictures and travel, and above all the example and stimulus of able inspiring parents*. Much of this the tests seek to allow for in advance, and probably do so with encouraging success.

With these considerations in view and admitting that our mental measurements are not perfect, although very helpful, let us consider the facts they seem to reveal.

Exhibit A. In the schools of California Professor Lewis M. Terman, of Leland Stanford, probably our highest authority, found among a large number of children who were picked out at random, forty-one who made high scores in the intelligence tests. All but two of these children had parents or close relatives who had shown superior ability by making important practical achievements in the laboratory of life.

Exhibit B. In the schools of Milan, Italy, the children of the professional and upper middle classes were found by these tests to be decidedly superior in capacity to learn to those of the artizans, servants, unskilled laborers and street venders. Of course a few children of the artizan class proved, as they always do, extraordinarily bright. This shows that we must occasionally have a man of genius with ordinary parents.

Exhibit C. In Brussels, Belgium, the children of the well-to-do were a year and a half ahead of the standard for their age in learning capacity over other children.

Exhibit D. In Columbia, South Carolina, the chil-

IS BRAIN-POWER INHERITED?

dren of the cotton-mills tested distinctly inferior in learning capacity to the children of mill-owners and business men.

Exhibit E. In Cambridge, Massachusetts, the children from "favored homes" did from a quarter to a third better in the mental tests than those from "unfavored homes."

Exhibit F. In Columbus, Ohio, the children of doctors, lawyers, teachers and the other professions were nearly half a year superior in intelligence to the children of traveling salesmen, and the children of traveling salesmen ranked very high; the children of managers were in mental power six months ahead of the children of clerks, and the children of skilled laborers were over half a year superior to the children of the unskilled.

Exhibit G. Mrs. A. H. Arlitt, of Bryn Mawr College, tested 191 American children by these tests and ranged them in four groups according to the occupations of their fathers. As these occupations descended in social and economic worth the mental scores of the children descended, as follows:

Occupation of Father	Children's Rating
1. Professional	125
2. Semiprofessional and higher business.....	118
3. Skilled laborers	107
4. Semiskilled laborers	92

Exhibit H. S. L. Pressey, an American psychologist, used these tests on 548 children. Eighty-five per cent. of the children of the professional group had brains, as measured by these tests at least, above the average; while 68 per cent. of the business group, 41 per cent. of the skilled labor group, and only 39 per cent. of the unskilled labor group were above the average.

THE FRUIT OF THE FAMILY TREE

Exhibit I. In Liverpool, England, Cyril Burt, one of the greatest British psychologists, found that the children of bishops, diplomats and university professors could perform certain mental tests in 74 seconds, the children of small merchants in 91 seconds, while it took children of the poverty-stricken 123 seconds.

Exhibit J. Professor Terman, previously quoted, compiled the results of a large number of mental measurements, and states that superior intelligence, as indicated by these tests, "is five times as common among children of superior social status as among children of inferior social status."*

It must be remembered, of course, that these figures express only *averages*. A group of clerks or salesmen would, for instance, almost certainly *average* lower than a group of managers because the managers have usually climbed up by having more ambition and brains than the *average* clerk or salesman. Beyond question in nearly every establishment there are several office boys who have in them the "makings" of general managers. This is because they are not "average" but superior.

The happy thing about these tests is that they pick them out years earlier than the old hit-and-miss methods and promote them more rapidly. The same is being done right along in our schools and colleges. Nothing is more important to those of us who are slow and dull than to pick out the leader and promote him to his high office as the manager of the rest of us.

The outstanding fact is that a good heredity bestows upon a child a *double advantage*; it first gives the child a rich endowment of health, brains and en-

*For the reports of some of the foregoing mental tests I am indebted to *The Journal of Heredity* and for one or two to Professor William McDougall's *Is America Safe for Democracy?*

IS BRAIN-POWER INHERITED?

ergy to start with; and, second, the parents of such a child are usually able to give it good food, medical attention, moral training, and stimulating friends and teachers, besides their own personal influence and example. Beyond *any question* all of these latter things, which we sum up under the general term "environment," count enormously.)

I am insisting here upon the great importance of heredity, not with a view of belittling the immense influence of environment, but for four very just reasons: (first, because the power and meaning of heredity have been almost wholly neglected in human affairs; second, because the astounding results of good education and good environment have led many to believe that *nothing else mattered*, that we could make a silk purse out of a sow's ear, make a natural-born pauper into a genuine prince of the blood, and put brains into empty heads; third, because all men believed until recently, when science disproved it, that the results of good education were transmitted in the form of improved brain-power and character to the children and that the children therefore would be born better and brighter because the parents educated themselves; and fourth, because heredity—that is, natural-born energy and intelligence or lack of them—is basic and primary to everything else.)

Probably three-fourths of all modern "reforms" are based upon these four fundamental fallacies, all of which science has utterly destroyed, and unless we take account of the newer and *much brighter hopes* that science offers, most of the dreams of the reformer will go to smash. But if he will but listen, in a new humility, to the voice of science, all his dreams and vastly more can and will come true.

But plainly, without the foundation of good horse-sense—that is, good heredity—we can build nothing;

THE FRUIT OF THE FAMILY TREE

first, because there is nothing to build on, and, second, because there is no builder. But upon sound heredity we can build anything within the dreams of men. If we destroy this living foundation of progress, either by race suicide among our abler families or by flooding our nation with low-class immigrants—either immigrants from overseas or “immigrants from heaven”—we shall destroy all possibility of national character and glory.

And in this disaster the man below would lose as much or more than the man above, for he would lose the very leadership, guidance, and example of his abler brother, who is, in fact, his hope and salvation.

On the side of environment I think that psychology and education are to-day on the eve of discoveries and of methods that hold the mind in awe. I think ere long we can likely teach a ten-year-old child twice as much as we can teach him now.

Indeed, nearly every child to-day does gain ten or a hundred times as much real life proficiency, or, as James Harvey Robinson puts it in that wonderful book, *Mind in the Making*, ten times as much “mind,” as was possible in the soul-killing days of Charles Dickens or Queen Elizabeth.

There is, therefore, not the slightest ground for quarrel between those who believe in heredity and those who believe in environment. It is only the fool who does not believe with all his heart in both.

Those who, because environment is so obviously potent, argue against eugenics, that is, improvement in heredity, exhibit not only personal ignorance and bigotry, but show also a pristine innocence of nearly all modern biology, psychology, sociology, and even education itself.

Anybody can easily prove all this in his own home town. Look about you and count noses and you will

IS BRAIN-POWER INHERITED?

find that the leading citizens who have mainly made your town what it is are several hundred times more related to one another than the average individual is related to these civic leaders. Some of your families have not produced a single prominent citizen out of hundreds; some would not produce one out of thousands. Other families amid the same general environment have produced an energetic, stirring, successful, progressive citizen out of every five or ten members. There you have it all in a nutshell.

While eugenics never expects to "breed geniuses to order," nor indulge in any wild schemes, let us imag-

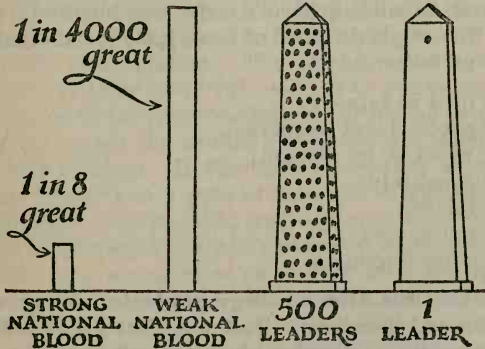

Among ordinary people, on the average, only one out of four thousand becomes eminent. Among famous families, according to Galton, one person out of eight reaches distinction. Imagine two nations in one of which only one citizen in four thousand becomes a leader and in the other one citizen in eight attains leadership.

If each nation hung the portraits of its leaders upon a great monument, speaking comparatively, the first nation would have only the portrait of its solitary, lonely leader, while the other would have its national monument covered with the portraits of its five hundred leaders.

ine two nations, one inhabited by a stock which produces one great person out of every eight citizens and another which produces only one great person in four

THE FRUIT OF THE FAMILY TREE

thousand. By the relative number of portraits of these leaders, hung upon their national monuments, I have shown in the picture of these monuments the amazing result. One nation would have only the lonely portrait of its one leader, whereas the other would have its national monument covered with the portraits of its five hundred leaders! It is high time that America pondered deeply such facts.

Contrast, for instance, the record in brain-power of the Edwards family, given in an earlier chapter, a record of national glory, with another, one of national shame—the melancholy tale of Max Juke, a lazy New England vagabond, born nearly two hundred years ago. The original record of these 1,220 social scourges reads as follows:

- 300 died in infancy
- 310 professional paupers
- 440 wrecked by disease
- 50 prostitutes
- 60 thieves
- 7 murderers
- 53 other criminals

Not one was ever a college graduate. Many were drunken and licentious. Doctor Arthur Estabrook, of the Carnegie Institution, has recently brought the ghastly record down to 1915. Some of them have moved West to new environments, but, as he says, many still exhibit “the same feeble-mindedness, indolence, licentiousness, and dishonesty, despite the fact of their being surrounded by better social conditions.” Doctor Davenport and his pupils have studied similar families, such as the “Nams,” the “Hill Folks,” the “Worthless Dacks,” and the “Rufers,” but they all tell the one unhappy tale—the tale of degenerate blood.

IS BRAIN-POWER INHERITED?

We could go on with the story of other families, such as that of Commodore Perry, which contains *twelve admirals*, including Admiral George Dewey; the Roosevelts with numerous persons of distinction; the Bach family with twenty-eight famous musicians and many other members of high musical talent; the Darwin family with many men of genius among its members and numerous talented women. Many others could be cited, but they only furnish more evidence that the real "honor of the family" is its inherent, in-born qualities and powers.

A volume of reflections could be written upon these new findings of science. The first thing is the lesson they bring to fathers and mothers as to the marriages of their own children. The second, even more important, is their powerful teaching to young men and women as to the immense bearing of a wise or unwise marriage upon the health, happiness and intelligence of their children. In the third place, they should not bring to any one a note of personal discouragement. Some may exclaim, "Oh, well, my ancestors were not great; therefore I can not amount to much!"

This is a wrong view as to just what heredity is. Heredity is not some mysterious "force" or "influence" sent down to you by your ancestors, as it is usually pictured in novels and dramas. The great thing that heredity teaches us is that man *is* "master of his fate and captain of his soul" and that he is *not*, as the extreme environmentalists teach, the helpless victim of environment and the plaything of fate. He would be if environment were the sole or even the larger factor in giving him his inborn energy and ambition. But fortunately it is not.

Every man, unless he be an idiot or insane, has powers *within him* by which he can rise and master well-nigh all handicaps—indeed make them steps on

THE FRUIT OF THE FAMILY TREE

which to climb. Heredity shows us that the kingdom of heaven *is* within and not without in the chance circumstances and surroundings of a man's life.

A man can do almost anything which he *intelligently* thinks he can do even if all his ancestors were molly-coddles and jail-birds. They may have had poor heredity or they may have had poor environment. But if you, yourself, have energy and ambition, for heaven's sake use them to the full. All evidence indicates that they come chiefly by heredity, but so you have them it makes no difference to you where or how you got them. You are at the bat, not your grandfather. Moreover, you had hundreds of grandparents and great-grandparents. Keep your eye fixed on the best and determine to outdo them all.

I know one family in which not a single member in one hundred fifty years has ever saved five hundred dollars *except one*. He is a man of wealth and influence. He has also married into an outside family of good blood, a thing which none of the others did, and he now has three splendid children who by the very laws of heredity bear every promise of careers of dignity and honor.

Finally, heredity and eugenics—which are simply other names for the new biological politics and social sciences—are asking America just two great questions. The first is: Are we replacing the noble strains, the great family lines of our forebears, with weaker, slower and lower streams of immigrant blood? The second is: Are the great native stocks—the living foundations of empire—that created our rich and multitudinous environment and made America the most luxurious abode in the whole earthly life of man—are they reproducing their own kind?

The fate of our civilization, this great dream of human destiny, lies in the answers.

IS BRAIN-POWER INHERITED?

But the hour is not too late for America to give a new and triumphant solution to these questions, which, from the human dawn, have been but the toxins of every nation's doom. There are still sixty million of the old native Americans, and every phase and form of human excellence does exist among the choicer strains of our later immigrations. The hour is, therefore, not too late to carry out the grand purposes of our foundations, to foster *real* superiority and give it the one and only privilege superior blood should have—the privilege to serve; to serve the weaker and the less endowed; to build a true aristo-democracy, a rulership of the wisest and best, the one and only thing which our founders intended us to have; to create those social and political conditions, customs and ideals in which and by which those wisest and best shall naturally and joyously replenish the national soil with the scions of their own truly royal blood; to hold the members of every family who display ability true to these high responsibilities which nature has laid upon them, and make intelligence, coupled with character, the sole right to social rank and political power.

If America does this it will lead the world by the sheer soundness of its character and the power of its ideals. It will do this because it will have made the purification of the blood of the people, the improvement of the clay out of which they are made, the highest aim of its education, the most immediate objective of its religion, and the large final purpose of its national life.

CHAPTER XII

IS BRAIN-POWER INHERITED? (*Continued*)

IF WE should examine the pedigree of the great race horse, Man o' War, and find his ancestors were draft horses or Shetland ponies, our amazement would know no bounds. If we should find Wild Tom, the celebrated Hereford Sire, had brothers and sisters, cousins, uncles, aunts, parents and grandparents that were Holsteins, Jerseys or plain "scrubs" we should be equally astonished. Yet some people seem to believe that this is what they would find if they looked up the pedigree of a human being. When it comes to the human family they expect to find grapes growing on thorns and figs on thistles. They expect righteousness to grow out of iniquity, and genius to be the child of commonplace or foolish parentage. As we have seen, nearly all men of great brain-power have come from great families—great breeds and powerful strains of blood. Nearly all great men have brothers and sisters or ancestors or descendants who are remarkable men and women. All of us can not be great, but most of us are born with a degree of intelligence capable of being highly developed. If a person is well born, with the birthright of health and average intelligence, it is fairly certain that in tracing his ancestry he will find a great deal of excellence all along the line.

We see this if we study the history of great men. It took seven generations of painters to produce Raphael, seven generations of musicians to produce Johann Sebastian Bach, seven generations of preachers and thinkers to produce Ralph Waldo Emerson.

IS BRAIN-POWER INHERITED?

Every one of these ancestors was a sign-post pointing down the stream of human blood toward the great ocean of genius into which the river of their common heredity finally poured.

Of course every one admits the influence of heredity when it comes to bodily structure and features. We would be astounded if children did not frequently look considerably like their parents or other close relatives. May I anticipate by saying that the student of heredity would be equally surprised if all children looked exactly like their relatives? He would be dumfounded and all his theories break down if some of the children did not look *unlike* their parents. Heredity, as we have seen, explains the likenesses among human beings as well as the unlikenesses. No theory of the influence of environment can possibly explain why a great man sometimes rises from the most commonplace parents. But heredity can. Indeed, if a man is like his ancestors it is largely due to heredity; and, paradoxical as it may seem, if he is not like his ancestors it is also largely due to heredity.

Again we find that Frederick Adams Woods has illuminated this problem, perhaps more than any one, as he has so many of the problems of human heredity. Some years ago he made a study of the family histories of the men in whose honor tablets have been placed in the Hall of Fame. Since no one is honored by a place in it who has not been dead at least ten years, and then only by a vote upon his merits made by distinguished scholars and leaders of thought, it seems fair to assume that those chosen constitute our really greatest citizens. They thus offer a splendid opportunity to answer the question whether a great man has more or fewer distinguished relatives than the common run of men. If we find that these persons have a higher percentage of relatives famed for achievement, intel-

THE FRUIT OF THE FAMILY TREE

lectual or moral, we must conclude that the abilities which lead to such achievements are a family inheritance, that is, that they run, as we say, in the blood.

At the time of Woods's study, tablets had been erected to forty-six of our most celebrated citizens. He found precisely what a biologist would have expected, namely, that a large number of these persons were related to others who were also famous; indeed over half of them were related through the male side of their families alone to other distinguished men and women. As a matter of fact, they were found to be from five hundred to one thousand times as much related to persons of distinction as is the case with the ordinary man taken at random. If eminence is due to chance circumstances, if a man rises to fame, not because he has inherited some extraordinary powers of body and mind, but because he happened to be born in favorable circumstances, or got the chance of a good education, then almost any educated man is as likely to land in the Hall of Fame as another.

I often hear people say, "I do not believe in heredity—just look at Abraham Lincoln!" Abraham Lincoln is one of the best examples of the influence of heredity we have. If Lincoln's greatness was due to his early education and surroundings, then we had better tear down our school-houses and set our boys to splitting rails, having made sure in advance that they be born in log cabins. Whatever may have been Lincoln's ancestry, it was the happy combination of the chromosomes from which he was born that made him great. The thing about great blood is that it overcomes all environment and rises to its true level in the national life. This does not mean that training and schooling would not have been a good thing for Lincoln. They are good things for any man. It would have been a great thing had every boy in

IS BRAIN-POWER INHERITED?

England had the wonderful education of Charles Darwin. But had every boy in England a century ago been born with the imperial brain, the tumbling imagination and the mighty capacities of heart and soul of Darwin, the gain to humanity would have been beyond all finite calculation.

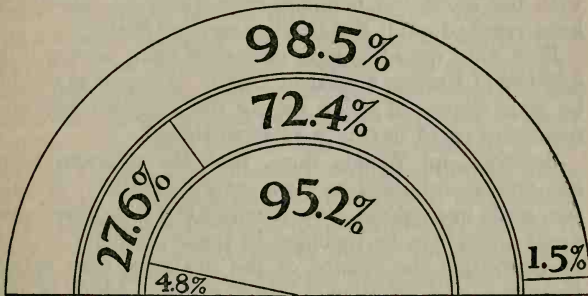

HEREDITY AND SOCIAL FITNESS

The above chart shows the descendants of a German immigrant named, fictitiously, Aaron Rufer, who settled in western Pennsylvania, in the latter part of the eighteenth century. Aaron was ignorant, but energetic and progressive. He married a woman of feeble mind and had seven children of whom five left lines of descendants. The chart shows that of those who remained either on Aaron's four hundred acre farm or in the immediate vicinity 95.2% were defective, socially inadequate and ne'er-do-wells. Of those who had the energy and "get up" to migrate even fifteen miles distance and strike out for themselves only 72.4% were of low quality; while of those who migrated to distant environment, married into sound stocks and built up professions, lines of business and the like only 1.5% were defective. Some of these latter migrated to California, Oregon and Saskatchewan. This study bears profoundly on our immigration problem as it shows the more daring and energetic the pioneers, the higher the motives of migration, the better descendants do these migrants leave.

Chart and study made by Doctor Wilhelmina Key, of the Battle Creek Race Betterment Foundation. Loaned to the author by Doctor Key.

Just so with these men in the Hall of Fame. We find upon study that they belong in the main to great human breeds—to rich strains of blood.

Woods compared the forty-six persons in the

THE FRUIT OF THE FAMILY TREE

Hall of Fame with two other lists containing the biographies of three thousand five hundred of our most distinguished Americans. These lists were made up from Professor Jameson's *Dictionary of United States History* and Lippincott's *Biographical Dictionary of the World*. He also compared these groups with the 35,000,000 common men which he calculates have reached adult life in all American history.

Now what would be your chance of being among this 3,500 or of finding a relative there? Also, what would be your chance of being among the forty-six preeminent ones or of having a relative there?

Suppose, as Woods does, that the average man has twenty relatives as close as grandfather, grandson, uncle or nephew. Now if only 3,500 men have been great enough to be included in these dictionaries out of 35,000,000 the chance of the ordinary man being there is just 3,500 divided into 35,000,000, which is one chance in 10,000. And if he has twenty relatives, that is, twenty people who belong to his line of blood, the chance of one of his twenty relatives being there would plainly be twenty divided into 10,000 which is one chance in 500.

So the average man has just one chance in 10,000 of finding himself famous enough to get his biography written up among the great ones of earth and one chance in 500 of having one of his twenty relatives famous enough to have "his name written there."

Now all this would be true if men became famous by mere chance and one man's chances were as good as another's, regardless of the blood strain. But suppose we found some families, some breeds, some kinds of blood furnished far more than their share of these great people. Any man in his senses would interpret it to mean that some families have better blood, inherit more brains than others.

IS BRAIN-POWER INHERITED?

Woods found this to be the case. He found among the list of 3,500, that one man in every five had an eminent relative in the same list instead of one in 500. If we take the more celebrated individuals, such as the Lees, Adamases or Lowells, one in three has an eminent relative in the 3,500 list. Lastly, if we enter the sacred portals of the Hall of Fame, sacred for its great blood as well as its noble names, we find one in two of this supreme forty-six has a relative in the 3,500 group of other renowned individuals *in the male line alone*, several having two or three of these famous relatives. Indeed, twenty-six men out of the forty-six have distinguished relatives on the male side only. The total number of eminent relatives of these forty-six supreme individuals is fifty-seven. If they were distributed equally among the forty-six it would give them more than one great relative apiece. These great persons, therefore, as a little calculation shows, are almost a thousand times as much related to other eminent men as is the average man picked up at random! Woods's study of the Hall of Fame shows that supposed opportunity here has done nothing to make fame any less a family affair than in Europe.

If we should take a wider and much lower and democratic range of eminence, such as the 24,000 included in *Who's Who in America*, I have no doubt we should find that an immense majority of these men had relatives distinguished enough to be admitted into this group, which represents America's richest strains of blood.

From such a showing I do not see how any one can longer doubt that brain-power is largely a family affair—that is, a matter of heredity running in the family germ plasm. Of course now and then we see a "freak" or "sport" all through nature. We know now that this is nearly always due to a happy chance

THE FRUIT OF THE FAMILY TREE

combination of wonderful elements that were already in the germ-cells, and that only this fortunate mating brought the elements together so that a remarkable individual was born.

A number of other studies have been made of this important subject of the inheritance of intelligence.

286 ENGLISH JUDGES	
$\frac{1}{2}\%$ GR-GR-FATHERS	
$7\frac{1}{2}\%$ GR FATHERS	
26% FATHERS	
109 WITH EMINENT RELATIVES	
36% SONS	
9% GR SONS	
$1\frac{1}{2}\%$ GR-GR-SONS	
177 WITH NO EMINENT RELATIVES	

Sir Francis Galton, the founder of the science of Eugenics, found among 286 English judges, whose lives covered a period of 200 years, that 109 had relatives of distinction, while 177 had no noted relatives. Of the 109 with noted relatives, 26% of their fathers and 36% of their sons reached high places in life. The distinction of the more remote relatives declined, as shown, in proportion to their distance from the central distinguished figure of the family.

Many years ago Sir Francis Galton made a study of the heredity of 286 English judges who had presided over the chief law courts of England during a period of 200 years. Out of the 286 judges, 109 of them had relatives who also rose to distinction. More than one-third of these judges had sons who became eminent; nine per cent. of the grandsons, and one and one-half per cent. of the great-grandsons reached high places in English civilization. Twenty-six per cent. of the fathers of these judges were eminent, seven and one-half per cent. of the grandfathers, and one-half of one per cent. of the great grandfathers.

If, as this seems to prove, heredity and not environment is the main cause of eminent achievement, why

IS BRAIN-POWER INHERITED?

do not all of the sons of eminent fathers attain eminence? They probably would if environment were the cause, for an eminent man gives a peculiarly stimulating atmosphere to his sons. But since the main cause is heredity we do not expect all the sons to attain eminence. Each child is born from a different germ-cell and each of the millions of germ-cells is different from every other germ-cell. We learned in the chapter on Mendelism that the germ-cells get varying proportions of the qualities of the parents. One child might get the father's kindly disposition, but miss his great mathematical ability. Another might get his easily stimulated imagination, but miss the great qualities of sagacity and judgment to back it up. And another might miss so many of the qualities that one would hardly suspect the father and child of kinship. An occasional child might get nearly all the qualities of the father, and with some good qualities from the mother, might even surpass the father.

One thing which many people forget is that the mother's qualities of mind and body play just as large a part in determining whether eminent parents shall have eminent sons as does the father's blood. An impressive study of this was made by Mr. William C. D. Whetham and his wife, two of the most distinguished students of heredity in England.

Mr. and Mrs. Whetham studied three separate groups of men of distinction and their blood relationships. One group of thirty-one names contained many of the great lords, dukes and men from the governing families of English history. The second group of eleven men were those who were themselves just as eminent, but whose families occupied the common walks of life. The third group contained names of fifty-eight who were among the most celebrated in English history, but who did not belong to the titled

THE FRUIT OF THE FAMILY TREE

families, from which have sprung the larger proportion of the governing ability that has spread English laws and ideals around the globe. This group of fifty-eight contained such brilliant names as Walter Scott, Percy Bysshe Shelley, George Stephenson, Rob-

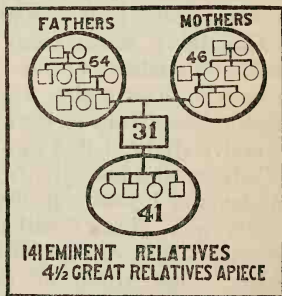
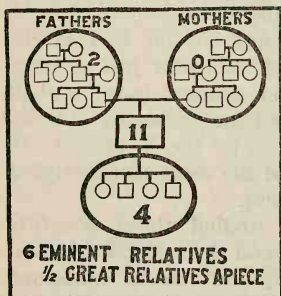
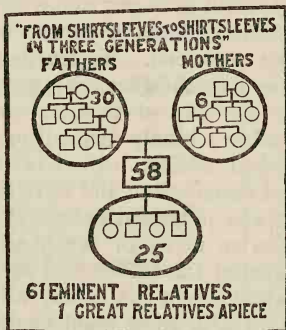

Whether "shirtsleeves return to shirtsleeves in three generations," or not is seen to depend on whether or not the good blood is kept in the family. The upper left-hand circles show the number of distinguished ancestors on the side of the fathers, the upper right-hand circles, the number on the side of the mothers, and the lower circle the number of distinguished descendants left by the distinguished men noted in the central square. It will be seen that the number of distinguished descendants decreases in proportion to the amount of distinction among the ancestors.

IS BRAIN-POWER INHERITED?

ert Southey, Jonathan Swift, William Makepeace Thackeray, John Wesley, William Wordsworth, Sir Joshua Reynolds and names of equal rank in art, science and literature.

Now the interesting thing as shown in the accompanying chart is this: that the men of the first group came from distinguished *families* that had held a powerful place in English life for generations. This group had forty-six celebrated relatives on the side of the mothers, fifty-four on the side of the fathers, and left a total of forty-one descendants who became famous. This made the astounding showing of 140 noble relatives, or four and one-half eminent relatives each!

The second group of eleven had no notable relatives on the side of the mothers, only two on the side of the fathers, and left, all told, only four distinguished descendants. And even of these four, two were from the celebrated Wilberforce blood, and two came through the marriage of one of the men to Laetitia, the daughter of Lucien Bonaparte, the brother of the great Napoleon. Even with the addition of these great strains, the ancestors were so commonplace that each of these eleven men had less than one-half an eminent relative.

The third group tells the same great story. Just in proportion as there were eminent ancestors on both sides did they leave eminent descendants. This group of fifty-eight of England's noblest names had but six eminent relatives on the side of the mothers, but had thirty on the side of the fathers. The whole fifty-eight left but twenty-five eminent descendants, making a total of sixty-one eminent relatives, or barely one each.

We see here in miniature many of the forces that cause the rise and fall of empires. Men of power and command, as in the first group, have risen among

THE FRUIT OF THE FAMILY TREE

their fellows, conquered the neighboring territories, married the leading women of their own empires or those of their fallen foes, and founded great ruling dynasties which have preserved the conquests of their heroic forebears. In the same way high economic ability rises, founds great houses and continues for many generations until either unwise marriages consign their fortunes to the hands of weaklings or fools, or else great national and political crises sweep them into ruin.

That this takes place as an actual phenomenon of social and organic evolution is not merely a theory but has been put to the test of historical investigation by Woods in his development of what he has termed the science of "historiometry," that is, the application of exact mathematical methods to the problem of unraveling the causes that have made history. There can be no doubt that all through history notable families have *pyramided* their blood both by intermarriage and by alliances with other powerful houses, so that a higher and higher proportion of their members are born with great qualities of body and mind; especially have their intermarriages brought the same blood, that is, the same kind of germ-cells, back time and again into the stream, thus enriching it and multiplying its power as it flows on down the generations.

The first actual proof of this theory of the pyramiding of great family strains, Woods presented in his *Influence of Monarchs*, published in 1913. In a notable paper before the Second Eugenics Congress, at New York City, in 1921, he presented further proof of this important biological and social tendency. This was based on extensive studies he had made of the intermarriage of the leading families in Boston and vicinity since early colonial times. He showed that they had progressively increased toward social differentia-

IS BRAIN-POWER INHERITED?

tion. The superior breeds are to-day much more elevated from the masses than in the olden times. To this phenomenon he has given the name, "conification," that is, the building up of a nation into a great social and family cone with leadership at the top, which gives certain families financial, artistic, industrial and political power and fame. It is this phenomenon of "conification" which has, no doubt, been a large element in enabling the old New England families to contribute several times their proportionate share of able men and women as compared with any other region of the United States.

So we have the spectacle of "shirtsleeves to shirtsleeves in three generations," and also the opposite, where by wise marriages, shirtsleeves never return to shirtsleeves until weaker strains of blood enter the great stream of heredity. Shirtsleeves did not return to shirtsleeves in Whetham's first group of families because of this intermarriage among themselves, and also marriage into other strains gifted with political, financial and social ability. But where strong men rise from the ranks, and then marry some weak or commonplace women of their own commonplace stock, their children soon return to the shirtsleeves of the common level. But where fortunate alliances are made with other strong strains of blood, the fortunes of the family are carried on simply because the economic, political or military genius of the family carries them on. Of course various legal enactments often will hand the fortune along to weaklings for one or two generations; but statute laws and constitutions can not permanently dam up the laws of heredity.

But, on the contrary, literary and artistic genius does not often continue long in one family, because those who possess this type of genius have little chance to marry great artistic and literary breeds. Partly for

THE FRUIT OF THE FAMILY TREE

this reason Whetham's third group of great men left few great descendants. The other reason why they left few eminent descendants was that they themselves mostly sprang from rather commonplace ancestry and, therefore, they carried commonplace qualities in a portion of their germ-cells. An immense number of literary, artistic and scientific men are born from very common ranks of life, usually, however, from parents who were scholars, educators or skilled craftsmen. As a rule they marry women of moderate ability; seldom indeed, do they have the good fortune to marry genius like their own, and thus their great talents which have blessed the world are lost for ever in the sluggish stream of blood that flows through the uncounted millions. Again, at some future time, some chance mating brings together two precious germ-cells from which another genius springs.

Another study which indicates that brain-power is inherited was made by Doctor Edgar Schuster, of the Galton Eugenics Laboratory of London. He studied the lives of four thousand graduates of Oxford over a period of approximately one hundred years. The chart tells the story. It means that where the sons took first honors (as shown at the left of the chart) that thirty-six per cent. of such sons—more than one in three—had had fathers who also were graduated with either first- or second-class honors on Commencement Day. Of those young men who took second-class honors, thirty-two per cent. of their fathers had won either first- or second-class honors when they were graduated. Those who ranked at the bottom, in the sixth class, in only one case in eight had had a father who had taken first- or second-class honors at the time of graduation. The stimulus of the father's example may have been a factor in the matter, but, again, other studies where environment and heredity

IS BRAIN-POWER INHERITED?

have been more clearly separated indicate strongly that the chief factor was the superior brain-power of the sons of distinguished fathers.

The latest study of the inheritance of brain-power has been made by Doctor Dean R. Brimhall, Secretary of the Psychological Corporation of New York City—a corporation where every boy and girl who can should have his brain-power tested.

4000 OXFORD GRADUATES	
HONOR SONS	HONOR FATHERS.
1	36%
2	32%
3	29%
4	24%
5	13%
6	12%

100 YEARS OF HEREDITY

Chart made up from Schuster and Elderton's *Inheritance of Ability*, Galton Eugenics Laboratory, London, Memoirs I.

Out of 4,000 graduates of Oxford University, England, whose fathers had competed for honors at the same university, the above diagram shows that of the first-honor men 36% of their fathers had also won either first- or second-class honors. Of the second-honor men 32% of their fathers had won first or second honors; and so on down to those who barely passed in the sixth class, of whose fathers only 12% had been first- or second-honor men.

Doctor Brimhall studied nine hundred fifty-six of America's most distinguished men of science with reference to whether they had brothers who also became distinguished men. The list of scientists had already been collected by Doctor J. McKen Cattell,

THE FRUIT OF THE FAMILY TREE

President of the Psychological Corporation. The entire study, a most interesting one, was published in the *American Naturalist* in the three issues, from November, 1922, to April, 1923.

Summing up Doctor Brimhall's conclusions, he found that if a man, who was a brother of a distinguished man of science, should shake dice with the first man he should meet in the street to see which one of them would become famous, that the brother of the man of science would win seventy-five times to the other man's once. It is evident that nature loads her dice in favor of the man of brains. Put in another way, he found that, if the brother of a man of science had no more chance to become famous than the ordinary man taken at random, the men of science in America would have had to have about eighty brothers apiece to furnish as many brothers who have reached distinction as there have been among the brothers of scientific men! Or, as Brimhall suggests, if we had a town of seven thousand inhabitants, all endowed with as much brain-power as the brothers of men of science seem to have, then this small country town would produce as many distinguished men as the average city of half a million.

We commonly think that the closest possible blood relationship that can exist is between parent and child. But Doctor Brimhall shows by the most technical arguments that brothers are probably more closely related to each other, owing to the mechanics of the germ-cell, than they are related to their parents. The same, of course, would also be true of sisters. This leads one, as a purely side reflection, to wonder if a good deal of the so-called "parental instinct," of which some of the older psychologists made so much, is not due, at least in the case of fathers, largely to social custom, habit, education, association and other factors

IS BRAIN-POWER INHERITED?

of the environment. At any rate, this investigator shows that the brother of a man of science is twice as likely to become distinguished as the father, four times as likely as an uncle, six times as likely as first cousins; and that children of scientific men are three times as likely to reach distinction as are their nieces and nephews. He also shows that the influence of the mother and father is just about equal. If we measure distinction by the mere fact of a man having his biography written up in *Who's Who in America*, then a scientist's brother has about two hundred seventeen times as many chances of this distinction as does the average man at random. It shows that the cash value of a smart father or brother is considerable.

While Doctor Brimhall's aim is to measure the degree to which relatives of scientific men become famous, and the factors of heredity and environment can not in this study be separately measured, yet since they accord so closely with all investigations of both mental and physical characters where the two factors have been separated, we are bound to believe that the chief factor in the case is inherited brain-power. Professor Karl Pearson showed that when environment was separated from heredity, the chief factor in causing children to be near-sighted is heredity and not the way they read nor the sort of light they have nor the time when they are taught to read in childhood. He also showed that the health of babies is closely related to the health of the parents. Doctor Raymond Pearl and Doctor Alexander Graham Bell have shown that the duration of life is also closely related to the duration of the life of one's ancestors. And, since both Pearson and Woods have shown that the inheritance of mentality runs in the same degree, we are forced to the conclusion that intelligence is inherited in the same way and to the same

THE FRUIT OF THE FAMILY TREE

degree as any physical character, such as the coat color of animals, the color of one's eyes or the size of one's nose. This does not mean that environment is of no importance. I have argued that question fully elsewhere. But it does mean that while environment may be of more or less importance in determining the direction in which a man's brain-power may express itself, it is of little importance in determining whether he has any brain-power to start with.

If brains are inherited, as we have seen is the case, so we might say the lack of brains is likewise inherited. Mrs. Anna Finlayson, of the Eugenics Record Office, studied one hundred fifty-three individuals out of more than seven hundred in one family that made up what students call "the hereditary complex." Mrs. Finlayson gives this family the fictitious name of "Dack." Its members are known throughout western Pennsylvania as "the worthless Dacks." Many of them are known affectionately by such pleasing names as "Crazy John," "Old Liz," "Old Sal" and "Rotten Jimmy." This gives a clear idea of their social standing, which after all is usually a pretty fair measure of a man's social worth. Any one who is interested in the inheritance of mental power or who wishes a clear insight into many of our gravest social problems, could not do better than read the detailed history of the members of this junk-pile of social wreckage. It saddens the heart to see so much misery, yet it fills one with enthusiasm for human betterment to discover that it is largely due not to environment but to heredity. We can change heredity, and change it permanently by wiser matings. Or we can entirely eliminate bad strains of heredity. But if environment be the chief cause of misery, we must be downhearted indeed; for the work of environment has to be done over and over again for each generation.

IS BRAIN-POWER INHERITED?

There is nothing more worthy than a just pride of ancestry because it is likely to lead to that true social pride which condemns mating with lesser stock than one's noblest ancestors. This does not need to take the form of social snobbishness, but a true and tolerant pride in one's own inner worth and that of one's family.

For, as I have pointed out, there is one thing we must notice in any family pedigree. It is not the *direct influence* of the original progenitor's blood or germ-cells that causes all the greatness of the descendants. One or two remarkable ancestors soon lose all direct influence. But both intermarriage and associative mating, which I have already described, carry the great qualities from generation to generation. On the average, husband and wife resemble each other as much as uncle and niece or as first cousins. This has been worked out by refined mathematical methods, by Professor Karl Pearson and others. So the great thing a wonderful ancestor does is to leave strong immediate descendants who mate with others of their kind and keep up the breed. When they do this it will keep going to the end of time. When they make bad outmarriages the whole pyramid, even if it has taken a thousand years to build, instantly topples to the ground. Nations have probably perished from just this cause.

But so long as our better families marry into the noble blood of their kind and keep it pure, and raise ample families of children; so long as we have free social customs and institutions that permit, nay encourage any great individual man or woman of humble birth to rise into the upper stocks and marry there and leave the splendid contribution of his blood; so long as, on the contrary side, we drop the worthless scions of upper stocks through the social sieve which is almost as important as raising the lower, then our

THE FRUIT OF THE FAMILY TREE

nation will thrive, our blood will keep at its high level, genius from all classes will rise easily and replenish the older stocks.

No nation is truly free that does not build its institutions on the basis of biology and heredity. An autocracy keeps too much worthless blood in high places. A democracy is likely to carry the doctrine of equality of men too far and not give proper scope and recognition to the abler stocks. An aristo-republicanism such as our fathers intended this country to have; a system that recognizes all elements, that fosters the *differences* among men, their differences of blood and brains; a society that recognizes and rewards social and intellectual worth, will in the long run make the world truly free, progressive, and carry it to higher planes. But a nation that runs counter to the laws of heredity can not endure. There are signs that America is waking up to the situation, beginning to think of the necessity of preserving its best blood and ridding itself of its worst. If it does this, the future is a pathway of progress, strength, genius and national glory. If it fails, then America, as Sir Arthur Balfour said of human history, "will be merely an unimportant episode in the life of an obscure planet." I look, personally, into the future with the utmost optimism, because I believe that the laws of blood, heredity, assortative mating of the good with the good will carry us always toward a great national goal.

CHAPTER XIII

MEASURING HEREDITY IN ROYALTY

HERE in democratic America, we who despise such high-sounding titles as count, duke and king, and are content with such modest designations as "Grand Exalted Ruler," or "Most High and Magnanimous Potentate of the Ancient and Honorable Order of the Sons and Daughters of This, That and the Other," are thoroughly convinced that the royal families of Europe are a low-browed, low-bred, run-out, idiotic lot. Even in the United States Congress we often hear some member proving his "one hundred per cent. Americanism" and the superiority of our institutions by waving the flag and shaking his fists at what he is pleased to call "the degenerate scions of royalty." I recently heard a lecturer deliver an hour's oration which received the enthusiastic approval of his audience, in which he proved to his own satisfaction and that of his hearers that *seventy per cent.* of these royal personages have been imbeciles, insane, or moral degenerates. Naturally it appeals powerfully to the average person to be made to feel that he is superior to men and women, many of whom have made great names for themselves in the world's annals.

Unfortunately, history does not confirm this democratic egotism. When we examine the matter by careful and unbiased scientific methods, we find that these "low degenerates" of the great European family group have produced as many truly great men and women as any other interrelated family of modern times. Indeed, I doubt if in all recorded history

THE FRUIT OF THE FAMILY TREE

there has been any one family which has produced so many persons of high talents and character. A few of them, certainly a much larger number than is found in the average family, will no doubt always remain among the genuinely great of the human race. It is true that just at the moment there seems to be no outstanding genius. This is because nearly all the present members of the royal families have descended from mediocre lines and are, therefore, exactly what we would expect on grounds of heredity, but would not expect on grounds of environment; for they have extraordinary chances to distinguish themselves if they have the ability to do so. We must also remember that we are too close to them in point of time, and that we have no exact method of comparing their real abilities with those of other men in order to enable us to decide with certainty upon their real genius. We have still further fallen upon democratic times when genius for war and government in a prince or king—the two talents in which these persons in past times have excelled—are not the vital interests of nations; and where the very destiny of peoples does not hang solely, as it has in past centuries, upon the military genius and statesmanship of the king.

However, during many years past I have been collecting the pictures of royal personages, as published in the magazines and newspapers. Their portraits do not give a student the impression that they are below the average; and judging from the statements which accompany many of these pictures as to their achievements in science, art, literature and government, they do not impress us as being a family of degenerates. An extraordinary number of them are evidently persons of great personal attractiveness, and even supreme beauty; and there is ample evidence to prove that on the average, beauty is to some extent associat-

MEASURING HEREDITY IN ROYALTY

ed with character and brains. It is true that in some branches of the family, such as those in Spain and Austria, there is more than the average of insanity and feeble-mindedness. This is easily explained on the grounds of heredity, since several generations ago these defects happened to be introduced into these sections of the family by unfortunate marriages. Subsequent intermarriages have simply passed these defects down the line. As we saw in the chapter on cousin marriages, the marriage of cousins does not create either virtue or defect, but merely passes the good or bad along in intensified form.

It is not necessary in order to satisfy the theory that heredity explains the major portion of human character, that every generation should produce geniuses of world renown. These royal persons, however, still constitute a vast family of about two thousand interrelated individuals, of more than the general average of intelligence, personal beauty and character. And, unless they make extremely foolish marriages, it seems quite certain that, as time goes on, other men and women will spring from this royal blood, who under the influence of new times, new ideals and new institutions will in some manner stir and move the world.

Going back, however, beyond the living members of the royal families, an estimate of whose qualities can not be exact, and studying only those of former times, as has been done by Frederick Adams Woods, whose book, *Mental and Moral Heredity in Royalty*, we propose briefly to review in this and the following chapters, we find that the royal families have been of vast service to mankind, and have furnished a high order of character and talent, particularly in the fields of statesmanship and war. It would seem on the face of it that any family that has ruled a continent for a thou-

THE FRUIT OF THE FAMILY TREE

sand years and has been, as we shall see they have been in a later chapter, the great guiding factors in its society, economics and politics, must of necessity have had a great many members endowed by nature with extraordinary intellectual powers. Any family whose members have been able for centuries to maintain their place and power, fighting constantly with one another and with other nations for leadership, and who have been able to inspire either fear or admiration and affection among millions and millions of their fellow-men, could hardly be a family that filled out the picture presented by our perfervid American oratory.

Neither could it be true, as is a common assumption, that wealth, luxury and power have brought about decadence of either ability or character. There is hardly anything more deeply believed by the average person than that wealth is pretty sure to destroy a man's character, and that the sons of rich men are well nigh foredoomed to worthlessness and dissipation. It is true that rich men's sons, even in prohibition times, can purchase champagne and publicity and thus go to the devil much more conspicuously than poor men's sons; but that they do so at any higher rate, in proportion to their numbers, there is not the slightest evidence. On the general average, people with a little money or a great deal of money have more intelligence and character than people who are not able to save their money, create wealth, and utilize its opportunities. If we measured the intelligence of two groups of say one thousand people who were financially successful and one thousand who were not, the former group would no doubt show the higher average of mental ability and moral quality. Mechanics who save their earnings, build their own homes, dress their children well, send them to school and

MEASURING HEREDITY IN ROYALTY

college, fill their houses with good furniture, victrolas, lace curtains and a few books, are beyond question, as every employer knows, superior in both intelligence and morals to the casual, shiftless day laborer, who never has a penny ahead and is always changing his job. These are the very evidences of mental soundness and moral character.*

Furthermore, as we come up in the scale to people with good salaries, professional incomes, and those with capital laid by, we find their sons and daughters at an increasing rate becoming the men and women who bless the nation. Doctor J. McKeen Cattell, the psychologist and philosopher, has shown that all the day laborers of America have never in the past three hundred years produced a single scientific man of first-class importance; whereas parents of the professional class have produced fourteen times as many scientific men among their sons as any other class. Many of these professional men, as is well known, have had a great deal of money. In addition, an enormous percentage of our scientists have been the sons of well-to-do farmers, manufacturers, capitalists, and men of wealth and social position. Wealth and luxury, art and science, fine homes, books and travel will not in and of themselves bring deterioration to any family or nation; but bad marriages into incompetent and neurotic stocks will instantly do so, and science knows of nothing else that will.

The first real study in this field was that made by Sir Francis Galton, published in 1869, in which he endeavored, as I have noted elsewhere, by an examina-

*Since this was written Professor W. V. Bingham, of the Bureau of Personal Research of the Carnegie Institute of Pittsburgh, has published a study of seventy-three highly successful business men in the *Journal of Applied Psychology* which indicates that practically all successful business men are much above the average in intelligence; also far above the average in personal non-intellectual qualities.

THE FRUIT OF THE FAMILY TREE

tion of the lives of the English judges to measure the relative rôle of heredity and environment in the making of men. However, as Galton himself saw, there were certain technical objections that could be urged against his work, the chief being that he was not able to separate with sufficient distinctness the two forces under consideration. He endeavored to meet this difficulty by a comparative study of the adopted sons of the popes of the Catholic church, whose custom it was for a long time to adopt one of their nephews and give him the same rearing and environment that a father gives to a son. Galton showed that, notwithstanding the splendid environment furnished these adopted sons by the popes, they did not rise to eminence as often as did the actual sons of distinguished men. In fact they did distinguish themselves in about the same ratio as did the nephews of men of distinction generally. Since, however, certain objections could be urged even here that the factors of heredity and environment were not accurately enough measured against each other, it is to the credit of Woods that he saw that in the royal families and their intimate records we have a vast mass of material for measuring the relative rôles of heredity and environment in making character and determining achievement upon the large scale of history. Incidentally these records enabled Woods to solve a number of important problems related to the central theme of heredity and environment. Since his study has stood the test of the most searching criticisms from biologists, psychologists and sociologists for nearly two decades and has received from them practically universal assent, it is safe to assume that its place in science and its conclusions are secure. It is for this reason that I examine it here in detail since I believe it to be the most convincing study we have of the problems under discussion.

MEASURING HEREDITY IN ROYALTY

The material of the study is invaluable for five reasons: first, these persons were all interrelated, that is, they belong to the same general breed; second, nearly all of them were rich and all were of high social position; third, while the various members lived in different countries and in different periods of history, that is, under different environments, yet the differences in the environment were very evenly distributed in a purely random way throughout the lives and histories of them all. Nearly all of them had unlimited opportunity to make great practical achievements or show noble moral qualities if they had the natural desire or endowments to do so. But both opportunity and lack of opportunity were fairly evenly scattered over the whole field. Fourth, these royal persons have all lived under the strong light of publicity, their lives being not only the subject of official court historians, who might be subject to bias, but of historians in enemy countries. Also numerous historical scholars of later times and in neutral countries, scholars of undoubted probity and freedom from unusual bias, have made them a subject of study. All of Woods's original data are now open to the inspection of any one who has access to a public library. Fifth, the estimates placed upon each person's character and achievements come from these memoirs and from material written for a different purpose than that which Woods had in view. This would eliminate errors that might arise from the investigator's personal predilections.

The purpose which Woods has in view is not to compare the royal families in ability and morals with mankind in general, but *to compare the members of all these families with one another*. It is a matter of indifference whether they turn out upon inspection to have been seventy per cent. imbeciles or seventy per

THE FRUIT OF THE FAMILY TREE

cent. geniuses. So long as we have ample records of the kind of men and women they actually were we have the material for comparing one with another. We can thus measure their relative differences in hereditary endowment and determine with a high degree of certainty how much of their character and achievements is due to heredity and how much to environment.

The problem of heredity and environment is a problem in the *measure of differences*. All the arguments in the world can never settle the question as to whether it is heredity or environment that makes men what they are. Some more subtle debater might think of some general consideration, not previously advanced, which would upset the most elaborate argument on either side. But when we can separate the two forces and measure one while the other remains unchanged, we have a case which can not be disproved except by proving that the methods of measurement are wrong. If, as Woods suggests, a farmer puts fertilizer on one acre of corn and leaves the acre next to it, of similar soil, without this artificial stimulant, he can measure in actual bushels of yield what has been the effect of this environmental procedure. He has changed the environment on one plot while the heredity of both plots remained the same. Again he may plant one kind of corn on one acre and corn of a different breed on the neighboring plot. In this case he has changed the heredity while the environment remained unchanged. He can thus easily measure, without argument, his problem of heredity and environment. We see this on a small scale in every family of children where the environment is practically the same for all of them, yet they turn out in the most astoundingly different ways. One boy may become a village loafer and his brother a philosopher. It would seem indisputable that the main difference in the two

MEASURING HEREDITY IN ROYALTY

boys was not one of environment but one of heredity. It is this method which Woods has applied with indubitable success to the study of the lives, achievements, the mental and moral character of the royal families of modern Europe.

The method employed by Woods is simplicity itself. "By starting," as he says, "with the present king of England (at that time Edward VII) and including all his ancestors to four generations, and then all the other descendants of these ancestors, all their wives and their ancestors, and stretching out in every direction by this endless-chain method, taking every one about whom enough could be found to be satisfactory, I have at present obtained mental and moral descriptions of over six hundred interrelated individuals, including pretty completely the following countries of Europe: England (House of Hanover), Germany, France, the Netherlands, Spain, Portugal, Austria, Italy, Russia, Denmark and Sweden. The period covered extends in general back to about the sixteenth century, but in the case of Spain and Portugal to the eleventh century." Since about twenty per cent. of the characters had left no records of any moment, all of which quota Woods sets down as "obscure," the total number of individuals comprised in the study is eight hundred and thirty-two.

The author next arranged all these characters in two separate scales, one for morals and one for intellect. As a basis for judging whether an individual was great or commonplace, good or bad, wise or foolish—and there were many of both types—he averaged up all the *adjectives* used by historians in describing their character and achievements. At first thought one might suppose that there would be such a variety of opinions expressed that there would be no way of arriving at an impartial judgment. However, this

THE FRUIT OF THE FAMILY TREE

did not prove to be the case. While historians differed on minor points, there was quite general agreement as to essentials. All historians agree, for instance, that Frederick the Great was a great commander and leader of men. They differ somewhat as to his moral character. The same would be true of Napoleon. But the essential thing in these men is the intellect, and upon this there is general agreement. William of Orange, called the Silent, although he was one of the most eloquent speakers of his time, is agreed by all to have been great both in intellect and moral character. Consequently the error in essentials is slight, and the fact that the grand total of results falls into such complete harmony, gives further evidence that a man who lives under the "fierce light which beats upon a throne" is pretty accurately judged by his fellow-men.

The lowest characters for morals, as judged by this impartial method, were placed in grade (1) in the moral scale, and the dullest and feeblest mentally were placed in grade (1) in the intellectual scale, and so on up to grade (10) in both series of gradings. However, those admitted into grades (9) and (10) for intellect were only those who have been given a place in Lippincott's *Biographical Dictionary of the World* and are there also *eulogized* for their intellect or achievements. Any one will agree that this method was a very fair one, when he learns that very few persons below such great figures among men as William the Silent, Gustavus Adolphus and Peter the Great, and among women very few below Queen Isabella of Castile, Maria Theresa of Austria and the famous Duchess of Longueville came up to this high standard. On the moral scale none was admitted into the two highest grades unless known as altruist, or reformer, or devoted to charity, or the welfare of the country.

MEASURING HEREDITY IN ROYALTY

It is of great interest to see how many of the six hundred and more of these persons for whom Woods obtained full descriptions fell into the various grades for morals and for intellect. These are given in the tables below.

INTELLECT (MEN)

Grades	1	2	3	4	5	6	7	8	9	10	Total
Number individuals	7	21	41	49	71	70	68	43	18	7	395

INTELLECT (WOMEN)

Grades	1	2	3	4	5	6	7	8	9	10	Total
Number individuals	2	5	10	42	87	51	39	21	12	7	276

MORALS (MEN)

Grades	1	2	3	4	5	6	7	8	9	10	Total
Number individuals	9	19	35	51	75	53	52	41	24	12	371

MORALS (WOMEN)

Grades	1	2	3	4	5	6	7	8	9	10	Total
Number individuals	7	8	18	25	59	46	26	24	18	6	237

Now if opportunity were the sole or even chief cause of human success or failure, it is plain that all the persons would be scattered evenly in the above series. If opportunity is the main reason why men succeed or fail, then when we distribute opportunity evenly, as was to a high degree true with these people, they ought to succeed equally well. But plainly they do not. We see only a few at the right end of the scales who succeeded in any notable way or are renowned for their moral character. Also at the left we see the downright stupid and the positively wicked are very few in number, while the great body, just as in human society in general, are in the middle range of mediocrities both for intellect and morals. If success or character were due to random chance, and one man were as likely to succeed as another when given the

THE FRUIT OF THE FAMILY TREE

same opportunity, we might well find sixty or seventy geniuses where we have only seven, and the same would be true of the feeble-minded at the other end of the scale.

Any one giving the matter the slightest thought must see also, when all these six hundred or more persons, the number for whom the author was able to secure descriptions, were thus judged and arranged in grades according to their brain-power and morals, and it turns out that the ones in each grade were quite largely related to each other, that it must be a pretty strong case for heredity being the underlying cause. We found in the two previous chapters that great men as a rule are quite largely related to great men, mediocrities related to mediocrities, and fools related to fools. Of course any great man may have mediocre relatives, but as I have said in a previous chapter, it would be past belief if we found that a great race horse like Man o' War had no relatives or ancestors except draft horses, or "scrubs."

Just so with human beings. If we found in this remarkable series, where we have the complete pedigrees and know the characteristics of all the relatives, that the great ones in grades (9) and (10) were related as closely to those in grades (1), (2) and (3) as to those in grades (6), (7) and (8), we should conclude that their greatness was a mere matter of chance, and that opportunity was the main cause of their noble characters or achievements. But precisely the reverse is the case. *Each grade is related largely to its own grade, or those near it.* The sheep are related to the sheep, and the goats to the goats. There are apparent exceptions, and in nearly every case these exceptions are just what we would expect to find in the laws of heredity, when we know all the ancestry. For instance, if the ancestry of a great man is full of con-

MEASURING HEREDITY IN ROYALTY

trasts, that is, some ancestors being remarkable and others being dull, mediocre or insane, we find the same contrasts running among the children. We sometimes find among royalty, as among other families, that a great man may have an imbecile brother. I personally know one of the most famous men in America, celebrated both for intellect and morals, who has a feeble-minded brother and a sister who is a woman of loose character. But among the ancestry there were the same contrasts. Parents do not transmit themselves to their children but hand on the stream of germ-cells, with all its good and bad, from which they themselves were born.

The outstanding feature of these great families is that we find genius where we expect genius—at least we seldom find it where we do not expect it. Insanity comes out where the laws of heredity would predict it. Feeble-mindedness does not spring out of the blood of nobility, nor is genius bred from the blood of fools.

There has never been such an opportunity to test these principles of heredity upon so large a scale. As Woods suggests, and as I have roughly tried to do in the chart entitled *Mountains and Valleys of Royalty*, on page 224, if you could put all the names in all these pedigrees on a great chart you would find the outstanding characters of any sort largely grouped together, whether their most marked feature was genius, imbecility, insanity, love of arts and literature, or what-not. We do not find the similar characters scattered at random, but largely lying contiguous to one another. We see one group of geniuses about Frederick the Great, another about Isabella of Castile, another in the neighborhood of William the Silent, a fourth about Gustavus Adolphus, and another small group about Henry IV of France. Most of the insanity

THE FRUIT OF THE FAMILY TREE

and imbecility is found grouped in the blood of Spain and Austria. The Saxe-Coburgs, to which the present king of England belongs, have furnished an astounding number of persons of high moral character, coupled with marked literary capacity. This family

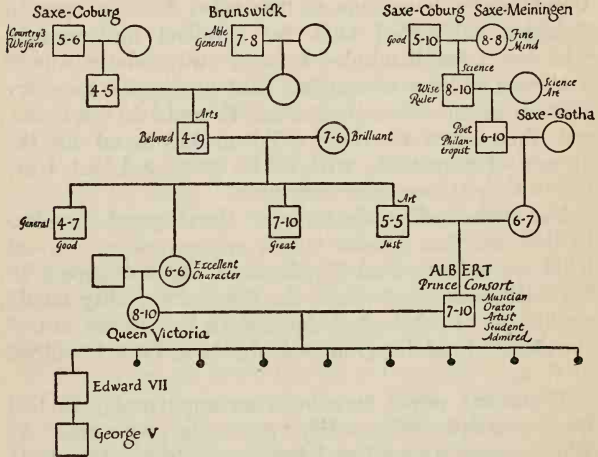

THREE HUNDRED YEARS OF INHERITED VIRTUE

This chart shows a few of the ancestors of King George V, of England, and Queen Victoria. It is above the average in ability, and the best morally in all royalty. Their very moral virtues have frequently placed them on thrones. For nine generations they have been, as Woods says, "of sound judgment, high moral qualities and strong literary tastes." There were eighteen authors or persons with strong bent toward literature in the line. Only one military leader appears, while their neighbors, the Brunswicks and the Orange family, were teeming with military genius. The first number attached to each name indicates the grade for intellect, and the second, for virtue. Note that in this family the virtue has been the outstanding family characteristic. Squares indicate males; circles indicate females. Perpendicular lines connect parents and children.

for three hundred years has been the soundest, morally, in all royalty. But among them there has scarcely been a great military leader. Among

MEASURING HEREDITY IN ROYALTY

their neighboring house, the Brunswicks, during the same period we find *five renowned generals* and no less than *twelve authors* of good rank. One can surely think of no reason except heredity to explain why one family should have a taste and capacity for literature and no military genius to speak of, while the other had literary capacity coupled with military genius of a high order. They all lived amid about the same environment, or at least amid differences in environment which were well distributed at random. They were all rich and of high social position. The times were stirring, and the call for genius in war and government was as great in one family as in the other. Yet the "call" for genius does not produce genius, popular opinion to the contrary. Genius comes solely from "the call of the blood" and not from the fortunes or misfortunes of the individuals or the nations concerned.

Whether royalty compared with commoner be considered superior or not, naturally the largest group on this great chart is found among the mediocrities. As among mankind in general there are only one to three per cent. of feeble-minded and one to three per cent. of persons of marked ability. We find, when these persons are all averaged up, the largest group accords with expectation—it is made up of average individuals. Geniuses are the few who vary upward at one end of the scale, and idiots are the few who vary downward at the other. Even when a genius springs up as a "sport" or "mutation" from commonplace stock, if he marries a genius of like type, he founds a "breed" which, were society so inclined, could be kept going on indefinitely. If once an idiot or genius is produced, and he marries his own kind, a "breed" of idiots or geniuses is produced which will keep on, despite all environmental influences, until marriages

THE FRUIT OF THE FAMILY TREE

into better or worse blood elevate or lower the stock again.

In this manner the mountains and valleys of royalty have been produced, as well as the great level planes of mediocrity. We could see this clearly if we could arrange all these hundreds of individuals in a row, placing the tallest at one end and ranging down to the shortest at the other end. We should most

MOUNTAINS AND VALLEYS IN ROYALTY

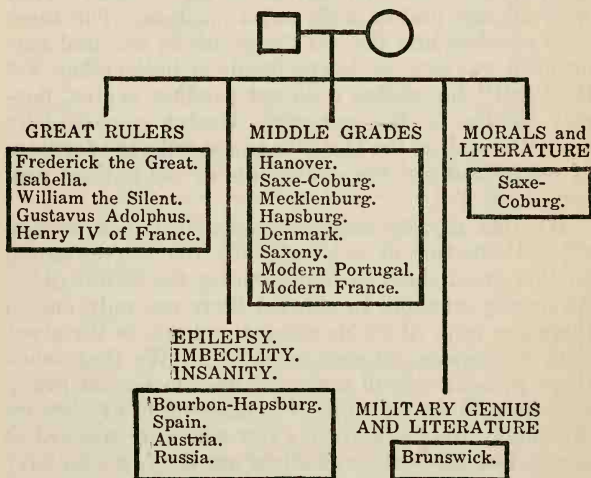

The size of the squares indicates roughly the number of individuals of royalty who have belonged to each group, except the one for middle grades; if space permitted it should be two or three times as large as shown here. Necessarily the largest group is that of the middle grades. The feeble-minded group is about the same size as the group of geniuses. For further details see text. Made up from *Heredity in Royalty*, by F. A. Woods, Henry Holt & Company.

surely find that the tallest were quite largely related to the tallest, and the shortest to the shortest. The persons at both ends would have some relatives in the

MEASURING HEREDITY IN ROYALTY

middle. But imagine that a man's brain-power were in proportion to his physical height. If that were true, which of course it is not, then we would find the tall geniuses largely at one end, and the short mental weaklings at the other. This would not be because they had merely been arranged in this fashion by selection, but because nature had largely related the tall mental giants to each other by blood, and the mental and physical dwarfs by the same invisible bond.

Probably no family pedigree in all human history exhibits so forcibly the startling effect of mating genius with genius, as the pedigree of Frederick the Great. If a boy were ever "born to the purple" it was surely this boy Frederick Hohenzollern. To be a great military commander, autocratic and domineering, was his manifest destiny. The wonderful group of geniuses that preceded and surrounded him has probably never been equaled in modern history. It is difficult to imagine any environment which could have prevented his tremendous powers of mind from coming to the front. It may be objected that his times, his education, his lofty rank and opportunity were all that enabled him to surpass his fellows. But what shall we say of his brother Henry who, while no doubt well educated and of high station, did not inherit the power and opportunity which falls to a king? Henry is ranked by historians as having been as great a man, possibly greater than Frederick, yet it is safe to say a king has a hundred times the opportunity to distinguish himself as his younger brothers and sisters.

One of the notable features of this entire study is the proof which Woods furnishes that all through royalty the brother who inherited the throne did not leave a great name any more often, in proportion to

THE FRUIT OF THE FAMILY TREE

the numbers of such brothers, than the younger brothers who would, it would seem, be peculiarly likely to be overshadowed and outshone by their brother, the king. Also, what shall we say of Frederick's two sisters who were regarded by historians as being almost if not quite the equal of their kingly brother on the throne? It is a plain case of inherited brain-power for them all, if there ever was one.

The pedigree of Frederick the Great also furnishes another case which indicates that throughout the many generations of his noble ancestors, wealth, luxury and power did not lead to mental, moral or physical degeneracy.

Let us for a moment consider in detail this wonderful mountain chain of royal geniuses. It reads like some gigantic drama whose stage is an empire and whose characters are endowed with one great soul. Five generations back was Frederick's ancestor, William the Silent, one of the greatest men in European history. Now biologists would not expect any man's talents or character to be reproduced to any great extent five generations down the line, unless the blood had been brought back into the strain several times during the intervening generations. One great sire alone will not found a breed. His blood must be kept in the stream, or it will soon be dissipated by the rivulets that flow down from the surrounding hills of mediocrity.

This is precisely what did happen to the blood of William the Silent. It would seem as though the family were deliberately breeding for a super-race. William the Silent married four times and had twenty-one grandchildren. Of course some reverted, as we should expect, to the great herd of the mediocre. But many of them intermarried, and their children continued the intermarriages so that the noble blood was kept flowing down the stream.

MEASURING HEREDITY IN ROYALTY.

THE GREAT MOUNTAIN CHAIN OF ROYAL GENUSES

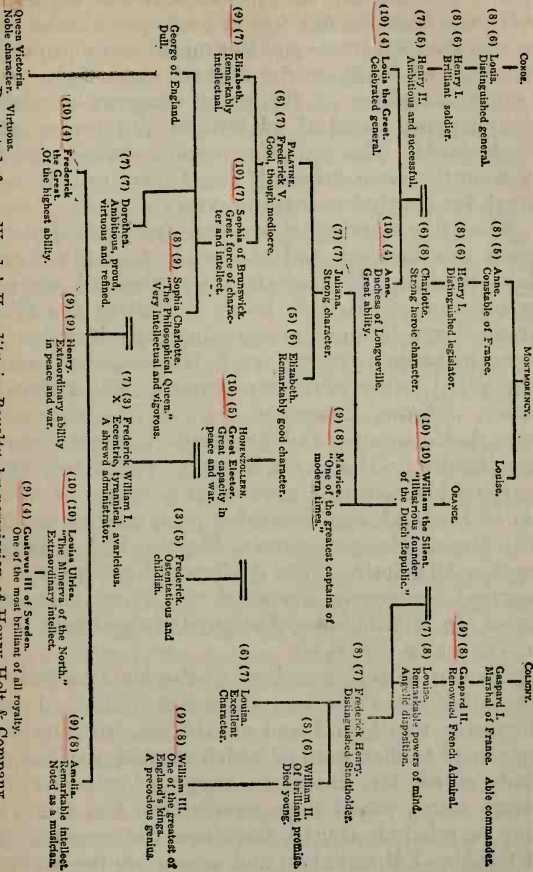

THE FRUIT OF THE FAMILY TREE

By studying this chart, which is not in the least different from the chart of the reader's own ancestors except that different qualities might be found, we find that one of William the Silent's marriages was to Louise, daughter of the great Gaspard of Coligny, the renowned admiral of France and leader of the Protestants. This united two noble strains, and from here on the great drama of royal blood runs without a break for nearly two hundred years.

From this marriage descended Frederick Henry, the great Stadtholder; and at the right of the chart on down the line is William the III of England, one of the greatest of all British kings. William the Silent's greatest son by another marriage was Maurice, who, some historians believe, probably exceeded even his celebrated father in military genius. From Maurice's sister, Juliana, descended Sophia of Brunswick, a remarkable woman, and Frederick William Hohenzollern, known as The Great Elector. This Great Elector married his cousin, Louisa, also a cousin of William III of England, and descended from the Orange blood. The Great Elector's cousin, Sophia, had a daughter Sophia Charlotte, "The Philosophical Queen," who married *her* cousin Frederick the First, bringing in again the Montmorency-Coligny-Orange blood in several doses on this side.

The son of this marriage of Sophia Charlotte and Frederick the First was Frederick William I whose character was brutal and avaricious, but who was a renowned soldier, both of which characteristics a close study of *all* the ancestors, many of whom are not shown here, would have predicted. But again this king married his cousin, Dorothea, the granddaughter of Sophia of Brunswick; and once more the great network of heredity was united, and the blood of these interrelated families lifted again, as a lock lifts the

MEASURING HEREDITY IN ROYALTY

water in a river, to a higher level. Indeed, this is the pinnacle of Hohenzollern-Orange greatness. The four children of this marriage are among the most talented persons in European history. Of course Frederick the Great is the most famous. But, what is not generally known, his brother Henry, as I have pointed out, was probably his equal if not greater in military ability. His sister Louisa Ulrica married Adolphus Frederick, King of Sweden, and her biographer says of her, "she was accustomed to rule the cabinet with absolute authority, a great and inflexible woman of rare endowments." She is justly known in history as "The Minerva of the North." Her son was Gustavus III, one of Sweden's great hero kings. Another sister of Frederick the Great was Amelia, of whom Lippincott's *Biographical Dictionary of the World* states, "her endowments of mind were extraordinary."

It should be noted also in this remarkable pedigree that the Houses of Palatine and Brunswick are also introduced, bringing with them many remarkable qualities. As Woods says, "this wonderful chain of great names is particularly suggestive as to what might be done with the human race were mankind ever so inclined. Starting with Gaspard, Marshal of France, who died in 1522, we can trace genius for leadership of men through no less than ten generations, as far as Gustavus III of Sweden and Charles William Ferdinand, the celebrated commander in the Seven Years' War, who were both nephews of Frederick the Great. These two characters complete the long line of intellectual princes."

It is a sorry comment upon human nature that never, except in the limited families of royalty, and even here very ignorantly and often with foul political purposes, has man ever tried to keep up or raise the level of his blood by wise marriage selection. No real

THE FRUIT OF THE FAMILY TREE

student of eugenics proposes that we set out deliberately to make the whole human family a race of super-men. But that *super-men can be produced among special families and superior breeds*, such a pedigree as this is ample proof. We see mediocrity, brutality and genius all cropping out precisely as we would expect on the basis of heredity, but as we would not expect on the basis of environment. By environment we should expect Frederick the Great to have hated literature as intensely as did his illustrious father with whom he lived. And at first thought, we might have expected Frederick to dislike literature owing to his stern military heredity from his father. But from his mother's side, particularly the Brunswicks, he inherited an admiration for men of letters, as the Brunswicks carried literary talent through their blood for a quarter of a thousand years. Frederick's court was made famous by his intimate friend Voltaire, of whom Victor Hugo says, "there can never be any difference of opinion that he was the greatest wit that ever lived." We should note also that nearly all in this lofty range were persons of rich moral endowments and noble character. The brutal, autocratic characteristics came in chiefly from the Hohenzollern strains.

Frederick the Great had no children and from his time on the marriages did not repeat the great strains of blood. As noted in a former chapter, while the former Kaiser is a Hohenzollern, Woods believes that he is probably the result of new combinations brought about by marriages since the days of the great Frederick; and that whatever talents, good or bad, he and his family may possess, are not really from the source of which they boast, but that the glorious strain of Orange with its galaxy of genius has probably passed away for ever.

CHAPTER XIV

MEASURING HEREDITY IN ROYALTY (*Continued*)

WHILE we have seen in the previous chapter that greatness of soul, nobility of character, commanding talents, and special genius for war and government have been transmitted for ten generations in the Montmorency-Condé-Orange family, interspersed with less noble qualities in almost the exact proportions that the law of heredity would expect, let us now consider this same phenomenon of heredity in the royal houses of Spain. I wish space permitted us also to trace this same drama of blood through Portugal, Sweden, Russia, the Bourbons of France and the Hapsburgs of Austria. But it all tells the same old story, that innate hereditary endowment is the largest single ingredient in human character, and is the master builder of human history.

The drama of Spain is the heredity of her royal family. For twenty-one generations, from Sancho II in the tenth century to Charles V in 1558, Emperor of the Holy Roman Empire, and the most powerful prince of his time, every ruler but five had the virtues that we think of as belonging to the great king. All the great rulers as well as the weak ones are amply accounted for by a simple study of their ancestry. It would be more entertaining to read the story of the noble days of Spain under her long line of wise and virile kings; but it may be more instructive to study the days of her sorrow and loss of world-power, because these coincide with the unwise marriages of her sovereigns. During the period of Spanish greatness

THE FRUIT OF THE FAMILY TREE

there were ninety-seven princes, princesses and kings in the list. Thirty-nine of these had marked ability—more than one in three, rating in grades (7) to (10) for intellect. Among the forty-one actual sovereigns, twenty—almost exactly half—were in the (7) to (10) grades for ability. Spanish greatness culminated with Charles V in 1558. It is difficult to realize that so short a time ago Spain was mistress of the world. But from then on, the blood of the Bourbons, who out of several hundred members have produced scarcely a single great genius, came upon the throne, and soon Spanish glory became only a memory. Spain fell upon evil days, chiefly because of the low blood of her sovereigns; and the low blood was due in every case to low marriages.

It would be extremely illuminating to review every one of these marriages by which the fortunes of Spain, as well as that of her sovereigns, went up and down almost exactly as the tide of her royal blood ebbed and flowed; but I print opposite the names of twelve of the noblest sovereigns which for five centuries kept her upon a high plane of national greatness. Attached to the names are one or two of the many adjectives by which historians have described their characters. Along with this list of great princes I print a second list, the names of the rulers and some of their family which followed the culminating leader, the great emperor, Charles V.

The adjectives in both lists of names by which history describes them, give us almost the whole history of Spain since it is written here clearly in the good and bad blood of her sovereigns.

MEASURING HEREDITY IN ROYALTY

- A LINE OF ROYAL GREATNESS**
- Sancho I. "Pious, prudent, great courage and energy."
- Ferdinand, "The Trembler."
"Trembled in battle, but successful warrior."
- Sancho II, called "The Great."
- Ferdinand I, "The Great."
"Able general, high abilities and virtue."
- Alfonso VI, "The Valiant."
"Great Warrior."
- Alfonso VII. "No common monarch, defeated Moors, enlarged his dominions."
- Ferdinand II. "Very able general, estimable and generous."
- Ferdinand III. "Just, able, pious; valiant soldier; triumphed over Moors."
- Alfonso X, "The Wise."
"Advanced science and learning."
- Alfonso XI, "The Good."
"Great warrior, best king in the world."
- Isabella and Ferdinand.
- "Great rulers, discovered America, noble characters."
- Charles V. "Greatest ruler of his time."
- A LINE OF ROYAL DEGENERACY**
- Louis XV. "Weak, licentious."
- Phillip V. "Weak, indolent, insane."
- Elizabeth. "Bad."
- Charles III. "Good, mediocre, normal."
- Ferdinand VI. "Insane."
- Maria Louisa. "Intriguer, extremely licentious."
- Charles VI. "Weak, indolent, virtuous."
- Phillip. "Imbecile."
- Carlotta. "Violent, ambitious, dissolute."
- Francis I. "Bigoted, cowardly, dissolute."
- Francisca. "Ambitious, haughty, intriguer."
- Ferdinand VII. "Incompetent, dissolute."
- John. "Weak, eccentric."
- Maria Christiana. "Very dissolute."
- Isabella. "Quarrelsome, dissolute."
- Francis d'Assis. "Extremely weak."
- King Alfonso XIII. "Gallant, generous, moderate ability."

THE FRUIT OF THE FAMILY TREE

A volume could be written on these two lists of names. The first list represents actual sovereigns of Spain, who made the great period of Spanish history. The second list consists partly of reigning sovereigns and partly of their brothers and sisters, who came later and guided Spain into ruin, and which I have culled at random to illustrate the blood of the family. But the remarkable thing is to note that the second list belongs mainly to the Bourbon family, which scattered degeneracy all over Southern Europe. In the chapter on "Cousin Marriages" I have shown how insanity entered this branch of royal families. It has been carried on by intermarriages to our own time.

Another remarkable thing is that these Bourbons in Spain, of whom there were several hundred, never produced a single genius; while other families in Prussia, Sweden and Denmark were shining with genius like a galaxy of stars. Only twice did genius ever enter the blood. A breed of feeble characters such as the second series given above, would not be likely to produce a genius in a thousand years. The first of these two outside streams of noble blood was that of Maria Theresa, the famous Austrian Hapsburg queen, who is described as "an able, brave and noble woman." She got her mental superiority from the Brunswick-Palatine families and was the grandmother of Archduke Charles, whose marriage into the Bourbons brought in the second stream to enrich that degenerate line. While Archduke Charles suffered badly from epilepsy—the curse of the Hapsburgs—yet he is described by historians as "one of the greatest princes that ever lived." It is also interesting to note that he was the great-grandfather of King Alfonso, the present Spanish king. King Alfonso seems to repeat some of the gallant qualities of his great-grandfather. He shows the famous Hapsburg lip



Above: Emperor Francis Joseph of Austria as a young man; below (left), Albert, Duke of Teschen and (right) King Alphonso of Spain and a distant kinsman. All show the famous "Hapsburg lip," which Woods has traced as a simple dominant characteristic in the family for eighteen generations—over six hundred years.

MEASURING HEREDITY IN ROYALTY

which Woods has traced through his ancestry for eighteen generations—over six hundred years. Owing to the new knowledge of heredity, my own belief is that these royal families will now marry more wisely and once more build able and powerful houses, which will, under the dominance of new ideals, serve their countries and their times.

Another extremely interesting measure of heredity devised by Doctor Woods, which came as a by-product of this study, is the proof that a child "takes after" its mother's parents with whom it is seldom reared, as much as it does after its father's parents with whom it is usually, as it grows up, much more in contact. For instance, when a royal woman marries, she practically always goes to her husband's country and court to live. Her children as a result are reared with her husband's parents much more than with her own parents. But the interesting thing is that the qualities of the children of such marriages resemble those of the maternal grandparents, whom they have seldom if ever seen, just as much, indeed slightly more in the cases recorded, than they resemble the paternal grandparents under whose influence they have often lived for many years. There seems to be nothing but heredity to explain a phenomenon so contrary to expectation. Woods also showed, as I have already said, that the brothers who did not inherit the throne with all its kingly opportunities distinguished themselves, in proportion to their numbers, just as often as did the king himself. Again environment seems to break down completely as an explanation of these facts of human nature.

It is not contended by Woods that environment and education are of no influence. In other studies he has shown that environment is of measurable importance. It gives a chance for individuals to arrive at certain

THE FRUIT OF THE FAMILY TREE

types of achievement; but that the inborn natures of men constitute the shaping power of history and individual character, and that they are themselves the chief factors in shaping environment and education, I think this research into human nature and conduct has placed beyond debate.*

Instead of this bringing a feeling of gloom, it will always, as I have repeatedly urged, if we only *think our way through the problem*, bring us to a new optimism, based upon the foundations, not of sentiment but of knowledge. The crowning optimism of modern biology comes, I think, from Woods's proof,

*The Behaviorist school of psychologists, under the brilliant leadership of Doctor John Broadus Watson, of The Johns Hopkins University, are developing evidence which they believe proves that nearly all of a man's behavior—the way he reacts to the situations of life—is due to his environment, especially his early experiences and education. The Freudians also make this claim. Beyond question Behaviorism is one of the most, possibly the most, significant and far-reaching development in modern psychology. However, in a number of letters I have received recently from enthusiastic Behaviorists, they seem to agree with the main contention of this book, namely, that the *differences* among men are nearly all due to heredity—differences in inborn constitution: and this, as Thorndike has shown, is the thing of prime importance in society, and education, and in the practical conduct of life. Differences in *relative* character and capacity are the things which give or withhold most of the prizes of life. (See chapter on Heredity and Environment.)

When the Behaviorists claim, however, as some do in writing me, that "ninety per cent. of a man's character (or behavior) is due to environment," it seems mere assertion, simply because there is apparently no way of telling what one hundred per cent. of a man's character would be. They might claim that one hundred per cent. of the reaction he does make to a particular stimulus is due to environment, but again, there seems to be no way of triangulating the problem. But, as Woods has shown (see chapter on Heredity and Leadership), the moment the problem is resolved into a problem of the *relative* differences among men, the situation becomes clarified and we enter a field where measurement—genuine triangulation—is possible. While we probably can not tell what one hundred per cent. of a man's character might be, yet one hundred per cent. of the difference between one man and another is a measureable quantity and for practical purposes of life this largely solves the problems being here discussed; and I gather that the Behaviorists would in the main be in sympathy with this view, since one of their most ardent students writes me that, "ninety per cent. of the differences among men are also due to heredity." I confess myself to be quite enthusiastic over the behavioristic approach to psychology.

MEASURING HEREDITY IN ROYALTY

in 1903, the first ever brought forward upon this important question, that *moral character and intellectual ability tend strongly to go hand in hand*. The common belief is that "the good die young," and that the intellectually able are the morally cunning, the dissipated and wicked. The negative goodness of harmless, ineffective people is one thing; and the positive goodness that organizes charities, develops great political and social philanthropies and devotes itself to public welfare is quite another thing. The former comes from sheer inability to do much harm or much good either one; while the latter springs from a wealth of intellectual powers focused upon large social measures and political aims.

The proof of this furnished by Woods is one of the most brilliant generalizations of modern science. It is illustrated in the two accompanying tables. In the first table in which all the men and women are com-

BOTH SEXES (Averaged).

Grades for virtues.	(1)	(2)	(3)	(4)	(5)	(6)	(7)	(8)	(9)	(10)
Average intellectual grades	3.92	4.34	5.43	5.51	5.29	5.66	5.87	6.37	6.66	7.33

bined into one series and graded for morals from (1) to (10) we find that those, for instance, in grade (1) for morals, grade lowest for intellect, namely 3.92; while those in grades (9) and (10) for morals grade highest in intellect, namely 6.66 and 7.33, respectively. This is one of the happiest things yet discovered about human nature. But we do not see the immense influence this has had and no doubt will continue to have upon the character of men and nations, until we link it with the facts brought out in the next table.

THE FRUIT OF THE FAMILY TREE

BOTH SEXES (Averaged).

Grades for virtues.	(1)	(2)	(3)	(4)	(5)	(6)	(7)	(8)	(9)	(10)
Average No. of adult children	1.66	2.86	2.99	2.41	3.44	3.49	3.05	3.03	3.93	3.80

This table shows that those in grade (1) for morals—who also we must remember grade lowest for intellect—*reared the fewest children to maturity*, namely 1.66; while those in grade (10) for morals, *reared over twice as many children to maturity*, namely 3.80. The remaining grades fall in between in almost absolute sequence.

We have here the strongest possible evidence for believing in the *necessary* mental, moral and physical progress of the human race. Economic conditions, social customs, and national misfortunes may for a time tend to obscure and even counteract the working of this underlying law; but beyond question, the law is there. From the ruins of every nation, the mentally able and the morally good have risen, and within their own class have produced more numerous children than the bad and stupid within the same class, and built new social orders again. There is a tremendous biological meaning in the “first commandment with a promise” that within any social class the children of mental and moral excellence who honor their fathers and mothers shall live long in the land which the Lord God has given unto them. They live longer and rear more children, who inherit their noble qualities of mind, body and soul. We have here the mathematical proof, drawn from hundreds of years of the marriage experiments of actual living human families, that “the way of the transgressor *is* hard,” that “the fool *shall* perish by his own folly,” and that “the wages of sin *is* death.”

This, to my mind, is the cap sheaf of the whole polit-

MEASURING HEREDITY IN ROYALTY

ical economy, political science, and sociology of eugenics and race building. The aim of educators, industrial organizations and statesmen should be to promote the working of this law of nature. They should create living conditions which will give the fullest possible scope to moral excellence, coupled, as we have seen it is, with high mental capacity and tendency to beget healthy children capable of reaching maturity. Morality and its correlative, intelligence, should be paid higher wages and in many ways be given "survival value." To do this is well-nigh the whole of the science of eugenics.

Eugenics is thus seen to be man's highest moral duty; because it will increase, as nothing else can, the inborn goodness of men. It was not until this proof was furnished by Woods, that intellect and character are knit together in the very germ-cells of mankind, that we knew we could accomplish this aim. Men have always supposed that the meek and the lowly possessed nearly all the virtues, and that the strong and able were the cunning and wicked. They have thus built civilizations which chiefly made the world safe for stupidity. And stupidity, on the large general average, as this research proves, is coupled with immorality and crime. But give men natural and open conditions where wholesome family life becomes the national ideal, the objective alike of economics, education and statesmanship, and the superiors in mental, moral and physical endowments will literally outbreed those who are inferior in mentality, morals and physique. Thus, by the very laws of nature "the righteousness that exalteth a nation" shall fill the land because it flows in the very blood of the people themselves.

Among the women included in the group of royal persons, nineteen are ranked by Woods in grades (9)

THE FRUIT OF THE FAMILY TREE

and (10) for intellect. *The majority also ranked high in morals.* Several of them are undoubtedly among the noblest women of history. One can scarcely expect any village of eight hundred citizens to produce this number of remarkable women, even if they should be elevated to high station, wealth and power.

THE GREAT WOMEN OF ROYALTY

1. Maria Theresa. Austria's greatest queen, "able, brave and noble woman."
2. Margaret of Navarre. The gifted grandmother of Henry IV, the most beloved of all French kings.
3. Catherine II of Russia. A remarkable personality. A natural born leader. Dissolute.
4. Anne, Duchess of Montpensier. One of the few great military leaders among women. "Extraordinary woman."
5. Anne, Duchess of Longueville. Dumas' famous heroine, intriguing nature, but of immense political genius. Sister of the Great Condé.
6. Sophia, Duchess of Brunswick. "Ambitious, proud and virtuous," ranks in grade (10) for intellect.
7. Louisa Ulrica, Queen of Sweden. Sister of Frederick the Great, known as "the Minerva of the North," dominated her country.
8. Isabella of Castile. One of the noblest women of history, patroness of Christopher Columbus.
9. Margaret. Daughter of Maximilian I, Emperor of the Holy Roman Empire. Repeated many of the gifts of her illustrious father.
10. Anne Amelia, Duchess of Weimar. Niece of Frederick the Great. Distinguished patroness of Goethe, Herder and Wieland.
11. Amelia, Duchess of Hesse-Cassel. "Extraordi-

MEASURING HEREDITY IN ROYALTY

nary wisdom, virtue and energy." One of the four famous grandchildren of William the Silent.

12. Jeanne D'Albret. The gifted mother of Henry IV, the great French king.
13. Elizabeth, daughter of Frederick V, of Palatine. "Remarkably intellectual, woman of great power."
14. Amelia, sister of Frederick the Great. Almost equal in intellect of her illustrious brother. Had remarkable talent for music.
15. Sophia, half-sister of Peter the Great of Russia. Equal to her famous brother, "extraordinary force of will, high abilities and ambition."
16. Blanche of Castile. One of the heroines of Spanish history.
17. Medina-Sidonia Louisa. Exercised paramount influence in Portugal, elevated the fortunes of her country.
18. Christina, daughter of Gustavus Adolphus. "Astounded her guardians by the vigor of her intellect," promoted learning and literature.
19. Charlotte, Countess Derby. Granddaughter of William the Silent. A skilful commander on the battle-field, many of the qualities of her noble grandfather.

Out of 832 men and women in Woods's Study of Royalty, there have been twenty-five men, whose rank in history is spoken of by historians in the terms placed opposite their names in the accompanying list. All of them are ranked by Woods for intellect in grades (9) and (10) because they are not only placed high by historians but are also eulogized in Lippincott's *Biographical Dictionary of the World*. There are forty-three other men in grade (8) for intellect,

THE FRUIT OF THE FAMILY TREE

many of whom were men of genius, equal in ability no doubt to many of our leading United States senators and many of our presidents, but since they are not eulogized in Lippincott's, they are not admitted by Woods into the two highest grades. This is not done because Lippincott is a high authority. It is merely done to secure a purely impersonal grading.

Following is the list of 25 of the names ranked in grades (9) and (10).

1. Frederick the Great. One of the greatest generals of the world.
2. William the Silent. One of the great firm men of all time. Founder of the Dutch Republic and defender of Protestantism.
3. Gustavus Adolphus. Sweden's great hero king. An original genius in the art of war.
4. Gustavus Vasa. Next to Gustavus Adolphus, Sweden's greatest king, and illustrious soldier.
5. Louis II. "The Great Condé." Celebrated general against "The Great Turenne."
6. The Great Turenne. Said by Napoleon to have been the greatest master of military science in all history.
7. Frederick William. "The Great Elector." Great general and founder of modern Prussia.
8. Archduke Charles. Austria's greatest warrior. Led Southern Europe against Napoleon. He did well considering that his antagonist was Napoleon.
9. Maximilian I. Emperor of Holy Roman Empire, great diplomat and king.
10. Henry IV. Great General, the idol to-day of the French.
11. Gaspard Coligny. One of the great naval commanders of history. Turned back the Turks.

MEASURING HEREDITY IN ROYALTY

12. Alexander Farnese. Duke of Parma. Celebrated general, diplomat and statesman, governor-general of the Netherlands.
13. Maurice of Orange. Son of William the Silent, esteemed by many historians to have been a greater soldier than his father, called "the greatest captain of the age."
14. William III. One of England's greatest kings.
15. Alfonso I. Founder of Portugal, celebrated warrior.
16. Dennis, of Portugal. Called "The Father of His Country," beloved in Portuguese history and considered the founder of Portuguese literature.
17. Henry the Navigator, of Portugal. First great pioneer in promoting maritime discovery.
18. Henry. Brother of Frederick the Great. Great strategist, the equal of Frederick on the battlefield.
19. Peter the Great. Founder of modern Russia. An undoubted genius.
20. Eugene of Savoy. Celebrated commander. Saved Italy from destruction.
21. Maurice. Elector of Saxony. A great hero of the Reformation, called "the savior of German Protestantism."
22. Don John of Austria. Precocious soldier in youth, defeated the Turks and later William the Silent in great battles.
23. Gustavus III. One of Sweden's long line of great kings.
24. Charles XII of Sweden. Extraordinary though unbalanced genius.
25. "John the Great" of Portugal. Celebrated king and diplomat.

CHAPTER XV

THE INFLUENCE OF LEADERS UPON NATIONAL LIFE

NO ACCOUNT of the influence of heredity, either upon the health and happiness of individuals or upon the wealth and destinies of nations, would be complete without reviewing for the reader another research by F. A. Woods, entitled, *The Influence of Monarchs*, published in 1913, the great significance of which to the philosophy of history is just beginning to be appreciated. In his *Mental and Moral Heredity in Royalty*, Woods's aim was to study the relative rôles of heredity and environment in the lives of individuals: in *The Influence of Monarchs*, he applies these same mathematical and objective methods to the still larger problem of the relative rôles of heredity and environment in the lives of nations. His particular problem is the amount of influence exerted by the heredity of the leaders upon the course of national development.

What is it that has made human history? Why have nations, as great and proud as our own, come upon the world stage, played a brief part and then passed away—some of them lost for ever from the memory of man? No one can doubt that in the long roll of the ages many factors have been at work, many forces both within man himself and without, to paint across the firmament of time that marvelous picture of changing human fortunes which the ruins of past civilizations and the records of historians leave upon the mind that contemplates them. Yet, is there not some one color that is stronger, more permanent than any of the others—some color that gives unity and

INFLUENCE ON NATIONAL LIFE

perspective to the entire picture? Is there not some one silver stream that has flowed down to us through all the tangled mountains of the past which has given continuity to human development and which, whenever it has been polluted, has caused the most ambitious social and political efforts of man to come to naught?

That there is such a stream, I think there can no longer be any doubt. Woods has discovered it and traced it through a sufficient period of history so that I think we can feel considerable assurance it has probably run through all history. That stream is the blood of its leaders. Sometimes and in some countries the word king can be replaced with the word premier, regent, judge or statesman. Yet this study makes it seem evident that always and everywhere it is the blood of leadership, the heredity, the inborn quality and character, strength or weakness of the ruler or rulers of every nation that has been the chief factor in making the ever-changing differences in politico-economic history. It is this force of the mind and character of the leaders which has galvanized the people into that mental and physical activity and spirit of adventure which creates art, wealth and culture. When the leader has been weak, it has left the people pulseless and without that unified ambition and national drive which alone enables them to build a rich and stimulating environment.

More than four hundred thousand volumes have been written to record and explain the history of the human family. Practically every theoretical philosopher of history has written his particular book upon some personal assumption as to the "cause" of the events which he set out to record. Among modern examples, Hegel, Bossuet, Rousseau, Schlegel, Comte, Buckle, Froude, Fererro, Thalheimer, Meyers, H. G.

THE FRUIT OF THE FAMILY TREE

Wells and scores of others have assumed that this or that factor was the "cause" of the great movements of history. With these one or two factors in mind some of them have built up great "Philosophies of History." Some have said that nations have risen and fallen because economic conditions changed, trade routes were moved, the church came into power, culture fell into decay and the like. But they have failed to inquire why conditions changed, or to apply any method except that of purely personal judgment to unravel the tangled skein of causation that lay behind the events which they had consciously or unconsciously selected to prove their *a priori* assumptions. In short, historical generalizers universally have found just what they were looking for to explain the cause of the events which they recorded. They have thus failed to lay the foundations upon which any true philosophy of history could possibly be built.

I have little doubt, for instance, that one could start out with the assumption that the weather and not the military genius of the generals had been the chief factor in determining the outcome of the decisive battles of history and find plenty of examples to prove his case. But if one began without *any assumption* as to what caused battles to go first one way and then another and should by some objective method obtain a scale for rating the abilities of all the generals involved, independent of their success in these particular battles, and then should find there was a high association between the results of the battles and the abilities of the commanders, he would be on the road, at least, toward the true explanation. If he found no correlation between the capacity of the commanders and the results of their battles, he must then look to other factors—the weather or the kind of instruments used or the food supply and the like—as the basis of

INFLUENCE ON NATIONAL LIFE

causation. But if he should find any association between the ability of the generals and the results of the battles, and then had some third set of results worked out by laboratory methods which showed that ability and achievement were strongly associated, he would thus have a method of triangulating his results which would introduce a still greater element of certainty that his conclusion was the correct one. As the number of cases increased where the general's genius showed a weight in the same direction as his military success, and as the number of investigations increased in other fields upon other material which showed ability and successful achievement to hang strongly together, the conclusion that military success is due to military genius more than to any other factor would rise in certainty. However, a reasonable number of cases is all that is needed to reach practical certainty where the whole matter can be safely considered closed.

It was these general laboratory methods which Woods applied to the immense problem of historical causation—that is, the methods of the exact sciences, such as chemistry and physics where unbiased experimentation, counting of cases, measurement of factors separately from other factors, and inductive reasoning have brought such satisfying results. It may be objected that we can not experiment with mankind; that we can not set up governments to see how they work, or stage battles for the purpose of measuring the genius of the opposing commanders. No. But as Woods replies to this suggestion, "The experiments *have* been performed. History is their record." For thousands of years man has been experimenting upon himself. The results have been recorded in these four hundred thousand volumes.

It is, therefore, time to examine these results with-

THE FRUIT OF THE FAMILY TREE

out any theory in advance. It may also be objected that "history is a pack of lies agreed upon." Well, if so, the investigation would reveal this because no common factors would anywhere be found. But since certain causative factors run through the whole set of records, it is proof that in the main the facts recorded by historians are true. It may be objected that with the best of intentions, historians have made so many errors that the material is worthless. But if so these errors would be distributed at random among the various historians.

Moreover, by methods too refined to detail here, Woods has shown what can scarcely be appreciated by the reader not familiar to some extent with statistical science, that, as he says, "Any device that can work out a general or continuous principle from the historical elements does so *in spite* of these random errors. This being the case the random errors of history may be ignored (when generalized conclusions are sought) and the results can not be wrong simply because the original material is known or supposed to carry some amount of random error." This leads us to a most paradoxical conclusion. It is one, however, perfectly clear to a statistician. This conclusion, as Woods states, is that "the worse the material the more certain is the generalized conclusion, provided there be no bias in the selection of material toward the conclusion reached." The popular belief is that statistics are devised to prove things and that "you can prove anything by statistics." This is true where statistics are collected to prove some theory formed in advance, but it is not true in the field of statistical *science* where all the investigator wishes to find is *what his statistics do prove* and not whether they substantiate his prearranged fancies.

To this whole method of investigating history and

INFLUENCE ON NATIONAL LIFE

the causes that underlie human events, Woods has given the name "historiometry," meaning the *measurement*, by exact unbiased methods, of the factors which have made the lives of men and nations in the past what they were. I describe it here in some meager detail because I think it offers such an immense field for eugenics. For, if we are able at last to unravel the warp and woof of the web of past events and inspect the separate strands, we can tell of what these strands are made, and how they have all been woven into the great fabric of human history. Once we have these causes clearly in hand and understand something of the operations of the great loom of time, we can weave them into still richer, stronger and more enduring political and social fabrics for the uses of the men of coming ages.

History can be of no use in building a social order where social forces shall minister to race progress, and race improvement in turn minister to social improvement, if we do not know what history means. In reading the dreary debates in Congress or in Parliament one is impressed with the fact that whether the matter under consideration be good roads, foreign policies, taxation, public health, suffrage, prohibition or the ravages of the boll-weevil, there is a monotonous cycle of references by the speakers pro and con to the lives and fortunes of past nations which in their judgment "prove" the proposed legislation to be good or bad. Surely it would be a dull wit that could not find within the range of four hundred thousand volumes, a number of instances that upheld his particular theory of society and politics. By this method you *can* prove anything by statistics, but there is not the slightest certainty that what you "prove" is true. But if one could take any set of phenomena from out the whole series of volumes and *find out what they did*

THE FRUIT OF THE FAMILY TREE

prove, he would then be in a position to aid society with genuine wisdom.

Woods has not taken all the libraries of history nor all of history for his study; but he has taken many hundreds of volumes and a period of from five hundred to eight hundred years of European history with a view to finding some of the common historic elements that emerge from a survey of the whole. It is this which makes his *Influence of Monarchs* a much more original and profound research than his *Mental and Moral Heredity in Royalty*. The reader may remember that in this latter book he had already been able to rate over six hundred of the royal personages of Europe, throughout a period of over four hundred years, in two separate scales ranging from 1 to 10, for their relative standing for both intellectual ability and moral excellence. In *Influence of Monarchs* the aim is to study the conditions of the people as related by historians during the separate reigns of all these monarchs, and then find if the changing conditions of social, economic and political life, in any way were associated with the ability or lack of ability of the sovereigns. In short, the effort is to discover if there is any constant relationship between the conditions of the people, their happiness or misery, their activity or sluggishness, and the heredity of the king.

For this purpose Woods surveyed the history of fourteen countries of modern Europe and the reigns of three hundred fifty-four sovereigns. In some cases the real ruler was a regent, and in the case of England was often a premier instead of the king himself. The fourteen countries studied and compared are: France, Castile, Aragon, Spain, Portugal, Netherlands, Denmark, Sweden, Russia, Prussia, Austria, Turkey, Scotland and England. The period covered extends back

INFLUENCE ON NATIONAL LIFE

in a general way to the fifteenth century, and in the cases of England, France, Spain and Portugal, to the eleventh century.

The astonishing thing is not that there is *some* association between the ability of the ruler and the condition of the people, but that the association should be so uniform and so high. Quoting Woods, "All taken together, the totals show one hundred and five instances of a superior ruler associated with advancing conditions against eleven associated with a decline." The following table shows clearly the grand net result:

TOTAL RESULTS OF THE INFLUENCE OF MONARCHS

RULERS	+	±	—	
+	105	27	11	143
±	26	31	19	76
—	30	18	87	135
Totals	161	76	117	354

Totals

In the above table the plus sign under a ruler means that his ability ranked in the upper grades of the scale, and the minus sign indicates the ruler to be inferior in mental ability. The double plus and minus sign means that the ruler was of indifferent ability. The same signs apply to the conditions of the people, plus meaning they were very prosperous, plus or minus that the conditions were only average, and minus that they were positively bad and declining throughout the reign. As an instance, in the third line, the reader will observe that in thirty cases the ruler was minus and conditions were plus, in eighteen cases where the ruler was minus conditions were indifferent, and, in eighty-seven cases a minus ruler and minus conditions go together.

THE FRUIT OF THE FAMILY TREE

For the reader who has had some drill in statistical methods I might say that Woods found the lowest probable limit of correlation between the ability of the ruler and the conditions of the people to be .60, a very high correlation for biological resemblances. Had the ability of the ruler and social conditions been always identical the resemblance would have been represented by the figure 1.00, which means complete identity. Had there been no relationship between the two factors, such a situation is represented in modern statistical science by 0. The degree of resemblance between two forces or objects is thus easily measured, running all the way from 0, meaning no resemblance to 1.00, meaning complete identity.

However, if we calculate the above forces in ordinary percentages, Woods says: "Out of 354 cases, 41 instances, or less than 12 per cent., show conflict (such as a plus ruler with minus conditions or vice versa): 223, or more than 63 per cent. show identity, and 25 per cent. divide this significance. If the cases with the double sign (\pm or $+$, etc.) are halved and one-half allotted to increasing the percentage of identity, then 70 per cent. of the cases would show identity of signs and less than 10 per cent. would be in conflict, while the remainder would divide their significance.

"A summarized statement of the results," continues Woods, "in terms of percentages, would be: strong, mediocre and weak monarchs are associated with strong, mediocre and weak periods respectively in about 70 per cent. of the cases. Strong monarchs are associated with weak periods and weak monarchs (including non-royal regents) with strong periods in about 10 per cent. of the cases. In about 20 per cent. of the cases mediocre monarchs are associated with strong or with weak periods, or mediocre periods are associated with strong or with weak monarchs."

INFLUENCE ON NATIONAL LIFE

Certainly here is a most remarkable phenomenon, one which has heretofore been almost entirely unsuspected by historians. We see that for a period of from five hundred to nearly one thousand years of European history, in nearly three-fourths of the cases the character and ability of the monarch have been an index of the conditions of his people. There are three possible explanations, according to this author, of so outstanding a fact: first, the conditions may have influenced the ruler—he may have been, as historians and environmentalists are fond of saying, “the product of his times”; second, the ruler may have been the chief cause of the conditions; and, third, both may have been caused by some external agency; or any combination of the three hypotheses is tenable.

I can not reproduce here all the cogent reasoning by which Woods shows, I think beyond cavil, that the second hypothesis is the only tenable one, namely, that the power of the monarch has been the determining influence in making this drama of centuries. I might sum up the arguments by saying that first, many of the changes are so abrupt, the advent of a good king being followed so immediately by prosperity throughout his realm and vice versa that there is no other conceivable cause for the phenomenon except his personal influence; second, where the king has been too young or too feeble to rule, Woods finds good and bad conditions associated with strong and weak regents, in the same degree as with strong and weak kings. The third argument, however, seems to me conclusive that the sovereigns were the chief ingredient in the great social and political changes of modern European history. The reader will remember from the previous chapter that in royalty Woods had already shown that grandchildren resembled their *maternal* grandparents whom they seldom saw as much as their paternal

THE FRUIT OF THE FAMILY TREE

grandparents with whom they were usually brought up. This being true, evidently if circumstances molded the grandparents, since there were different circumstances surrounding the grandchildren, it is inconceivable that the grandchildren could resemble their maternal grandparents from any other cause than that they inherited the inborn qualities of their grandparents. If environment was the cause of the resemblances between grandparents and grandchildren we would have two sets of differing circumstances producing the same result! This is absurd. Presenting Woods's own argument on this point:

“The lines of great kings and princes had correspondingly great pedigrees. The only conclusion is that all the individuals developed as they did by reason of innate differences. The men molded the circumstances and not the reverse. Without such a view we could not explain the pedigrees, for neither the men themselves, nor the events in which they individually lived, could have arranged the marriages of their ancestors of a hundred years previous. In other words, the special conditions in any one country might conceivably have influenced the kings, but these circumstances *could not be retroactive and form pedigrees*. The conditions are correlated with the pedigrees. The conditions could not cause the pedigrees. Therefore, the monarchs are the results of the pedigrees and the conditions the result of the monarchs. By this triangulation of reasoning the question is settled once and for all. No other explanation will suffice. This does not mean that surroundings have not played some share in the whole story; it does mean that such influences have been trivial, illusive and difficult to measure. The question is not, do environmental forces exist, but how great is their importance, and where and when are they to be found.”*

*This argument, which Woods advances with such cogent proof, de-

INFLUENCE ON NATIONAL LIFE

It seems, thus, placed beyond argument that at least in most European countries, the inborn capacities and character of the rulers have been great guiding forces in national life. And one is left with a powerful impression that the character of a nation's leadership has always been the chief factor in deciding its own character and destiny.

Certainly, here is a clear and definite reading from history that should impress its significance upon the minds of every people. It should be put into every child's school book. Every school boy has puzzled over the *causes* of the great events of history. He has wondered, for instance, why Belgium and Denmark are small while France and Germany are big. But here we have simple and complete explanation of it all; the small nations have never for long periods had the chance to come under the genius of great rulers. Nations are like business corporations; they remain small unless they come under the management of big men.

Here is a great lesson for every nation. Races come

 serves more than passing consideration, as it has far-reaching importance, and, I think, has never before been advanced in the discussions of the heredity-environment problem.

If, as is often claimed, "the times make the man," certainly the *present times* did not make a man's ancestors. *Their times* must have made them, also. But, if so, it seems unexplainable that a man's character is more highly correlated with that of his ancestors than with his environment. The character of the ancestors must likewise have been more highly correlated with *their* ancestors than with their environment. The influence of the environment upon the ancestors must, therefore, have been very slight. If the times do make a man, then, whatever likeness there may be between a man and his ancestors must be due to mere chance. But if so, this likeness would not be constant, since we know that the environments are not constant. But the likeness is constant.

It seems passing strange that in an orphan's home, for instance, the environment could be molding one child into a likeness, not to its teachers, but to its parents and grandparents, whom, in many cases it has never seen; while at the same time, the same environment is molding the children about it, not into a likeness of the other children nor that of the teachers, but into likenesses to parents and grandparents whom they, also, have never seen.

THE FRUIT OF THE FAMILY TREE

out of barbarism and erect civilizations; from the very necessity of the case they must place these civilizations in the hands of some sort of rulers. Whether they elect those rulers by popular vote or whether by fighting one another and by natural selection the rulers themselves rise and take command, it is evident that national destiny, education, culture, as well as national permanence, are in their hands. I trust the reader will not gain the absurd notion that I am arguing in favor of monarchical forms of government as being superior to democratic or republican forms. That is not the question I am discussing. The prime lesson is that *whatever form of government we erect*, the way that government will work and the benefits or misery it will bring to the people depend almost entirely upon the character and abilities of the men and women into whose hands it is entrusted for its operation. It carries further the immense lesson that it is the natural inborn qualities of leaders that make them great, and not the circumstances of the time in which they are born. It may be that lesser men are more influenced by their environment than these great commanding spirits who break through all environment and shape fate to their own wills. Indeed, Woods has shown in another research, *Laws of Diminishing Environmental Influence*, that this is the case all through nature. But everywhere and always the great movements of civilizations are determined by leaders, and these leaders are mainly the product not of circumstances, but of great human breeds.

Indeed this latter consideration leads us naturally to inquire if the royal families of Europe really have been a "great human breed," or if they have been the weaklings and feeblings which our democratic enthusiasts, not to mention egotisms, have led most Americans to suppose.

INFLUENCE ON NATIONAL LIFE

Present-day royalty is but very little bred from the strains that once carried the genius. Therefore there is to-day little or no genius among royal families. But going back beyond those now living, every evidence shows that these now despised royal families have probably produced more truly great men and women than any other "family" in the history of the world—certainly more than has been produced by any other family of modern times. In proof of this Woods advances eight very cogent lines of reasoning.

1. Younger sons of kings are not less eminent than heirs to the throne.
2. The precocity of royalty.
3. Royalty's success in government as compared with ministers'.
4. Their success in war as compared with non-royal generals.
5. Their genius or talent in other directions.
6. The proportionate number of recognized geniuses to the total.
7. The slightly excessive amount of insanity.
8. *A priori* consideration: Election of early rulers. Struggles and survival of the fittest.

I have in the previous chapter argued the fact that younger sons reached high grades for intellect just as often as their brothers on the throne, who had presumably the greater opportunities.

The second argument for the actual superiority of royal blood is a powerful one, namely, that a large number of the scions of royal houses have been exceedingly precocious. As Woods says, "Most of the princes who were precocious in youth were great in maturity." We now know from studies on school children and college men that precocity is to be expected in persons of exceptional mentality. "William the Conqueror showed his incisive military genius before

THE FRUIT OF THE FAMILY TREE

he was twenty-one. Henry I, of England, ruled wisely in the Cotentin when only twenty-one years old. Edward I, when only fifteen, became the soul of the reconstructed royalist party, and at twenty-six defeated Simon de Montfort at Evesham and met the demands of a difficult crisis. Edward III took matters into his own hands when eighteen and soon reversed the declining conditions that had marked the reign of Edward II. William III, of England, like Charles XII, of Sweden, was a striking example of premature mental development. William the Silent, received his first military appointment at eighteen, . . . and at twenty-two was preferred to the command . . . over the heads of veteran soldiers much senior to himself. Other great rulers who showed marked precocity were Philip Augustus of France, Louis XI of France, Isabella the Catholic, Margaret of Denmark, Gustavus Vasa, Charles XI, Christina and Gustavus III of Sweden, Ivan the Terrible and Peter the Great of Russia, and the Great Elector of Brandenburg.”

The evidence of the superiority of royalty to either nobles or commoners, gained by comparing them with prime ministers is very strong. Although the royalty was drawn from one family, numbering at most a few thousand, and the statesmen of modern Europe came from millions of people, it at least points to royal superiority when we find that the total number of great statesmen was less than the number of great royalty. Comparing this with the fact that we have everywhere found environment to be of slight influence in producing men of fame, it leads to the conclusion that it is thousands of times more likely than among average people that the breed of kings will produce a statesman. We find the same thing by comparing royal with non-royal generals. It is not true that

INFLUENCE ON NATIONAL LIFE

men of sub-royal birth were not given numerous opportunities to command. But even where they were given opportunity, they fell far below royal generals in the number of their successes. Moreover, many of the improvements in military science were invented by the royal generals.

Finally, the strongest argument comes, as Woods suggests, from the proportionate ratios of men of genius from the royal and non-royal breeds. Woods showed in *Heredity in Royalty* that out of about eight hundred persons there were about twenty men of the intellectual eminence of Frederick the Great, Peter the Great, Gustavus Adolphus, William the Silent and Eugene of Savoy. This makes one in forty, genuine, unquestioned men of genius, men whom all historians agree were truly great. Now in J. McKeen Cattell's list of the one thousand most eminent men of all time (*Popular Science Monthly, February, 1903*) not more than two hundred men of such unquestioned genius appear in any of the nations, England, France, Germany or America during their entire history. Since these countries had millions of inhabitants, it makes the difference in favor of royal inborn genius truly overwhelming. The chances are several hundred thousand times in favor of royalty. And the reader must not forget that we have already eliminated the factor of environment to a very high degree and can be sure we are speaking of true inborn greatness, if fame is any true index of greatness. In other words a royal prince had only a small chance of being a great man, namely one in forty. But the average man has only one chance in thousands or even millions of being equally great, at least as measured by world-wide renown for exceptional or brilliant talents—something we instinctively call "genius."

In addition to the men there have been nineteen

THE FRUIT OF THE FAMILY TREE

women who have ranked high for mental abilities. Three or four of them, such as Isabella, the patroness of Columbus, Maria Theresa of Austria, Catherine II of Russia and Madame de Longueville, would surely rank in intellect among the world's truly great women. Among mediocrities or even among persons of marked ability this proportion is simply incredible.

Let us try to gain a clearer conception of what this means by a few simple comparisons. Imagine some small town of eight hundred citizens producing twenty world geniuses among its men, and five or six women capable of conducting governments and leading armies! Imagine twenty of our presidents or twenty premiers of the British Empire coming from one such town! It staggers the imagination as to the power of heredity in building up great human breeds. Or imagine eight hundred men and women in some street parade and finding among them even five such men as Gustavus Adolphus, Frederick the Great, Henry the Navigator and William the Silent besides two such women as the great Isabella and Maria Theresa. It passes all human belief that environment could produce any such result. William the Silent and Gustavus Adolphus might not rank with Alexander and Napoleon; but certainly a half-dozen of the royal generals would rank with Lee, Grant, Stonewall Jackson, Lords Roberts and Kitchener; and William the Silent would probably rank with General Foch in military genius, and with Washington in character and statesmanship. Napoleon considered the Great Turenne the greatest master of military science in the world's history; and Marshal Foch, who ought to be a judge, says that with all modern inventions "the fundamentals of the science of war are unchanged." At least, then, the great fundamentals of military science, developed so largely by royal generals have not been greatly changed by all modern science.

INFLUENCE ON NATIONAL LIFE

No man of imagination can read this wonderful research without many deep reflections—reflections upon the causes that underlie history, and upon the growth and dissolution of the future societies of men. It shows that in times past great human strains have been built up and have grasped the destiny of the world in their hands. Such breeds will, beyond question, be built again. Indeed, with our new knowledge of heredity, it does not pass belief that the nation which first applies eugenics to founding great families may, by sheer force of the character and intellect of its leadership, rule the world.

Here, indeed, Woods has revealed a gigantic drama played upon a continental stage. The future will be played upon a world stage. Here were between eight and nine hundred persons *related by blood*, the actors in a mighty *Comedie Humaine*, beyond the reach even of Balzac's genius to compass; a drama of blood and germ-cells; a drama stretching over a period of nearly a thousand years, where love tokens were states and principalities and where wedding gifts were empires; a drama where the blood of the children determined the character of great intellectual disciplines, and whole systems of human culture. Democracy will probably wrest the stage management from the control of tyrants and increase the number of actors; yet leadership breeds leadership and leaders control social and national destiny. Thus, the drama will remain the same. Surely this great bas-relief of modern civilization, carved out by Woods in such striking figures, colored as it is with human blood and shaded with the destinies of nations, should become an object lesson for citizens, statesmen and kings alike, and all those who hope intelligently to aid in the guidance of the future affairs of men.

CHAPTER XVI

CAN WE MAKE THE HUMAN RACE MORE BEAUTIFUL?

We can have almost any kind of a race of human beings we want. We can have a race that is beautiful or ugly, wise or foolish, strong or weak, moral or immoral.

This is not a mere fancy. It is as certain as any social fact. The whole question lies in what we can induce people to *want*. Greece wanted beautiful women and got them. Rome did the same thing. The Dark Ages wanted ugly women and got them. Cromwell's Roundheads wanted ugly men and women and got them. The Renaissance wanted beautiful human beings and got them. We want ugly women in America and we are getting them in millions. For nearly a generation until the recent immigration law was enacted, three or four shiploads have been landing at Ellis Island every week. If they are allowed to breed the future "typical American," then the future typical American is going to be as devoid of personal beauty as this vast mass of humanity, the majority of which has never learned to love or understand woman's beauty nor man's nobility of form. And the moment we lose beauty we lose intelligence. Every great period of history bears witness to this obvious fact of human nature. Every high period of intellectual splendor has been characterized by "fair women and brave men." The nobility of any civilization can, to a considerable extent, be measured by the beauty of its women and the physical perfection of its men. In the

THE HUMAN RACE MORE BEAUTIFUL

glory period of Babylon, Persepolis, Crete, Phœnicia, Carthage, Egypt, every evidence of history assures us that the women and men were of a high type of beauty. When Alexandria was mistress of the world's learning, the mecca of scholar and merchant alike, she was likewise the home of art. And the home of art is always the atmosphere which breeds the beauty and charm of woman. The gallery of Grecian greatness is hung thick with the portraits of the noblest type of womanly and manly beauty the world has ever known. In "the most high and palmy state of Rome," Horace and Virgil sang the beauty of Rome's noble women. And poets do not sing of beautiful women if they do not exist to inspire their song.

We could multiply instances. But no man can travel over America extensively and not be impressed with the association between a high type of womanly beauty and a high type of art and culture. The better classes, the higher types of skilled workmen, the intellectual and professional sections of the population, as well as the families of "mere millionaires," simply are more beautiful than the lackadaisical, the thriftless, the day laborer and the ne'er-do-well.

Let us go into some of the backward sections of the United States. I need not name them. But where there is no vision of beauty, the very physical beauty of the people perishes. It is even reflected in the ugliness of their animals.

As I have said, it is all a question of ideals. We can breed the race forward or backward, up or down. We can breed long noses or short noses, straight noses or crooked noses. We can breed people who are lop-eared and lop-sided, mentally and physically. We can breed a race of bald heads, both inside and out.

Nearly all these things have happened to the race in the past. They have usually happened uncon-

THE FRUIT OF THE FAMILY TREE

sciously. But we now have the knowledge to make them happen with beneficence aforethought.

That the race has undergone immense changes due wholly to artificial and natural selection in the past, I think there is not the slightest doubt. Frederick Adams Woods has collected much evidence to indicate that the fundamental types of beauty and personal appearance of the people of the upper classes of Northern Europe and America have undergone great changes within the past few centuries.

I was standing with him one day in the Boston Public Library looking at the Abbey paintings of the knights of the Middle Ages. I said, "They must have been a noble and handsome race of men."

"I doubt it," he replied. "I think quite likely they were extremely ugly, and pretty poor specimens. True, they have been glorified by poets and romancers, but I think the Knights of King Arthur's Round Table would make a poor showing by the side of the Greeks or the finest types of manly beauty we have to-day. And, I imagine the women were as poor specimens as the men. If you will go out to my house and look at my collection of portraits I think you will feel as I do about it."

I went and sat up most of the night with him studying a collection of photographic copies of the portraits of the men and women of Southern Europe during the Renaissance, and compared them with another similar collection of copies of the portraits made by the painters of Northern Europe during the same period. The impression was one of astonishment. The improvement in beauty of the people of Northern Europe during the three hundred years and more following the Renaissance was little short of startling. It was evident that the type of facial beauty had undergone a marked change between the fifteenth and eighteenth

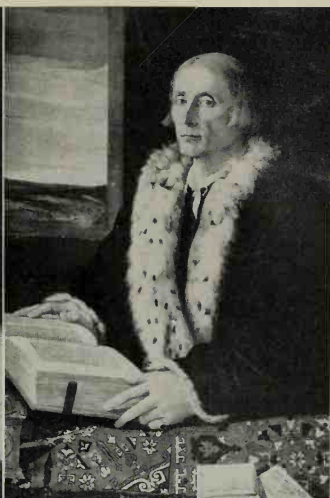

Courtesy of the Metropolitan Museum of Art.

Above: (left) portrait of a woman attributed to Giorgione, showing beautiful modern, that is "classic," features; (right) Portrait of Prothonotary Giuliano, by Lotto, without beauty, but clearly chiseled features of modern type characteristic of upper Italian classes of the Renaissance. Below: (left) portrait of Flemish society belle of 1525 by Hans Memling; (right) Barbara of Brandenburg about 1525, by Mantegna—a case of a northern subject by a southern painter.

Note the high arches, protruding eyes, set widely apart in lower portraits. We would call them rather coarse as compared with the upper portraits.

THE HUMAN RACE MORE BEAUTIFUL

centuries among the upper classes of the northern nations.

The central point of the matter is this. I presented a few paragraphs upon this subject in my *New Decalogue of Science*; but since I have here the opportunity to illustrate these remarkable facial changes with pictures, it seems best to present herewith further data and to amplify the argument. There evidently existed in Spain, Italy and Southern Europe among the upper classes of that period—the only persons of that day who could afford a portrait—a fine type of delicately molded face, with the eyes fairly close together, the nose thin, straight and beautifully chiseled, the eyes deeply set, and the eyebrows and arches above the eyes—the orbital arch—sweeping outward in a gentle delicate curve, and the cheek-bones subdued and flowing down with fine contour toward the mouth and lower part of the face. For want of a more exact word, I shall refer to this type of face as the “Greek” type, although it was probably the result of much selection and a great deal of change that had taken place since the days of classic Greek beauty. However, we do not know but that a great deal of the original Greek ideals of beauty had been handed on down and preserved in the South European population, despite the long period of the Dark Ages which had intervened.

Be that as it may, this fine delicate type of facial beauty did exist, particularly in Italy, during the Renaissance, as is made evident by the paintings of Raphael, Mantagna, Giotto, Angelo and many others, especially from about the year 1500 onward. We see it in some—not all—of their madonnas, and in the groups of women represented in their religious paintings. The same general type is also found among the men. This type must have been very frequent at

THE FRUIT OF THE FAMILY TREE

least among the nobility, as is drawn to represent them in a majority of the paintings.

But if we examine the paintings of this early period, say those of Holbein, Rembrandt, Franz Hals and the old Dutch masters, it is evident that the Flemish, Dutch, English and German nobility, in a majority of cases, possessed faces of a much heavier and more bovine type. Particularly in the region about the eyes and nose, the construction was broader and more massive and the whole architecture heavier both in motif and finish than were the same features in the face of the finer types to the south. The eyes of the northern type are protruding and set widely apart, the bridge of the nose is thick, the cheek-bones are prominent, and the orbital arch is high and almost semi-circular, giving an impression of ugliness that in some cases amounts to positive repulsion. Any one can convince himself of these outstanding facts by comparing a few copies of paintings of this period, made by the northern and southern painters respectively. Indeed, there is in both the Dutch and English paintings of that day a heaviness that is positively bovine, and produces much the same impression one gets from a study of the Mongolian race. The eyebrows are high above the eyes and the orbital arch is high and flaring.

It may be objected that these were not faithful likenesses. That may be true, but it is highly probable that had they been actual photographs they would have been still uglier. Reflect upon the situation back in those times. Only the richest persons of the aristocratic families and the noted beauties could afford a portrait. In addition, as artists were regarded as of the plebeian classes, they were wholly dependent upon their rich patrons. Independence of artistic execution and absolute fidelity to truth would not only have cost

THE HUMAN RACE MORE BEAUTIFUL

them their fees but might have cost them their heads. Consequently it is pretty certain that they made their subjects out as beautiful as they possibly could.

But if these portraits—exaggerated as much as possible toward the beautiful—represent the highest ideals of human beauty the artists possessed, there surely were very few if any types of genuinely noble beauty in the population. It seems a fair inference that they have given us the highest type of manly and womanly beauty that existed in the north countries in that age, which novelists and poets have made us believe was peopled by handsome men and beautiful women. In England, in the time of Henry the Eighth, it is doubtful if the noted beauties were what we would consider beautiful to-day. Henry the Eighth was regarded as one of the handsomest men of his day. He was the matrimonial storm center of his time, and all of his six wives except Anne of Cleves, whom he never saw until her wedding day, must have at least represented his ideals of beauty. Yet among them all there is not one whose portrait presents a type that would to-day rank high in beauty; and judging from the highly flattering portraits of himself—for Henry promptly chopped off anybody's head who did not flatter him—the king himself was about as handsome as a square-head longshoreman who has not shaved for three weeks, dressed up in pink tights, parti-colored, embroidered coat and with a gold crown on his head.

If, however, we trace this phenomenon down to the modern painters such as Reynolds and Gainsborough and count the number of portraits which we are studying of both periods, we can not but be impressed with the fact of the increasing percentage of portraits approaching the Greek type. The change is astounding. The subjects painted have become much more like our

THE FRUIT OF THE FAMILY TREE

own ideals of beauty to-day. We would call many of them beautiful according to our present standards. The old bovine type has largely disappeared. The eyes are set deeper, whereas the eyes of their Nordic ancestors seemed to be set almost on the outside of their heads. The orbital arch is much lower and more delicately molded, which gives a nobler cast to the forehead. Woods does not find much change in the mouth and lower regions of the face, although possibly very delicate measurements might, he thinks, reveal some slight changes here.

Commenting upon this phenomenon before the First Eugenics Congress in London in 1912, Woods said in substance that, while about the year 1500 the heavy bovine type was extremely common, indeed almost universal among the northern painters, even within the next one hundred to two hundred years this type grew less and less frequent. And if we take the work of the northern painters between 1800 and 1900, who furnish us with reliable portraits, and when photography has come to our aid, it is as difficult to find one of the old heavily built faces among them as it is to find one of the Greek or modern type among those back in the fifteenth and sixteenth centuries. The relative proportions of the old and new type of faces have been reversed.

In order to corroborate these findings of Woods, Mrs. Wiggam and I have studied many hundreds of paintings in various galleries in this country, and have gone over thousands of copies in the numerous volumes of paintings in the Metropolitan Art Gallery of New York City. No one can help being convinced that the Nordic peoples in Northern Europe, of the well-to-do and upper economic and political classes, have literally changed their faces, whether they have changed their minds or not, within the past

THE HUMAN RACE MORE BEAUTIFUL

three to four hundred years. As a further evidence that the ancient painters faithfully copied the anatomical features of their subjects, Woods has found a number of painters among the old masters who painted persons both in the north and south of Europe, and when painting in the south their subjects show the Greek or Italian type, and in the north, the Nordic. It is difficult to avoid the conclusion that these painted records are true representations of the people who actually lived in those days of the world.

A friend of mine who is an artist said to me recently, "I think those older painters knew little about art, because it is only when we come down to such artists as Reynolds and Gainsborough that they seem to be painting human beings." Unconsciously this gentleman was giving evidence exactly in point, because the subjects of the older painters of Northern Europe do *not* look like the men and women which we commonly encounter among our American population to-day.

As a further proof that the human face has changed with amazing rapidity in modern times, Woods published in the *Journal of Heredity* of May, 1920, a paper entitled "Portraits of Early Americans." This paper was a study of a collection of portraits published by Mr. Charles K. Bolton, of Boston, a two volume work entitled, *The Founders: Portraits of Persons Born Abroad Who Came to the Colonies in North America before the Year 1701*.

Woods found in this collection of 113 portraits which were sufficiently clear for analysis, 37 which he classed as belonging to the ancient heavy type, 37 doubtful or intermediate, and 39 modern. Comparing this with his records of the ancient North European portraits he found among them fifty per cent. of the distinctly bovine type. But coming on down to our own time, he finds from extensive studies

THE FRUIT OF THE FAMILY TREE

that not more than ten or fifteen per cent. of the portraits of our prominent citizens, men and women, are of this ancient and homely appearance. As the year 1701 is about the middle of the period from 1500 to the present day, over which this record of human faces is available for our observation, the fact that the faces run about thirty-three per cent. ancient type, thirty-three per cent. intermediate, and thirty-three per cent. modern, falls exactly in line with what would be expected in this middle period, provided, as seems evident, a real human evolution is here revealed.

Summing up the entire matter in Woods's own words from the *Journal of Heredity*:

“Portraits are not, like photographs, mechanical records. Consequently the personal equation of the different artists must be taken into consideration. There is for instance the well recognized ‘Sir Peter Lely eye,’ and one is inclined to think that much of this change in eye-form is due to an improvement in the art of painting. But this will not stand the test of comparative analysis. While most of the earliest portraits are crude in their primitiveness (those prior to Holbein, for instance), the portraits by Holbein, himself, who was doubtless an accurate realist, are replete with this early or mongoloid type. Not all of the Holbeins show this characteristic. Some are always in a median or doubtful grade between the early and late types, but the number of distinctly modern ‘eye-nose regions’ is always enumerable, and it is in this increase in proportionate numbers through the centuries without regard to the amount of mastery in the art of portraiture that makes it improbable that the change represents anything less than a real evolution in the bony structure of the face. In other words the archaic type of eye is as common in the finished and accurate work of any given period as it is in the cruder work.

THE HUMAN RACE MORE BEAUTIFUL

“The faces of the upper classes among the Nordic people have approached toward the Mediterranean or even toward the Greek type. Early Greek sculpture shows this mongoloid feature, but it is not at all certain that this was merely because it was primitive art. Primitive Italian art does not show the early type, except nearly always when the Virgin is depicted. She is also represented with very high eyebrows and eyes far apart in most of the later paintings of the sixteenth century. The Mediterranean peoples, including the Italians of the Renaissance, never, except in a small percentage of instances, exhibited the ancient northern type of eye and nose.

“Among modern Nordics the ancient type still persists among perhaps ten or fifteen per cent. of the whole population. . . . The first 337 portraits in Vol. XV of the National Cyclopaedia (published in 1916) show, as regards the height of the eyebrow, 39 of the ancient type, 67 doubtful, and 231 modern.”

It seems to me that in this work of Woods we have here, at last, *caught evolution on the wing*.

Now as to what *caused* this genuine evolution in a whole race of human beings, it is beyond the wit of man at present to say. It may have been due, as Woods has often suggested to the writer, to some necessary correlation between the evolution of intelligence and the evolution of finer and more exquisite physical organization probably under the control of the ductless glands. Our whole knowledge of evolution and its processes would lead us to feel that this would be the most likely explanation. (Beauty and intelligence are probably linked together in the very inner processes of the evolution of organic life. Beauty practically always accompanies economy of structure and movement, indeed is to some extent the expression of this economy.) And all improvement in speed and directness of movement must have been adaptive, that

THE FRUIT OF THE FAMILY TREE

is, must have given the individual an advantage in gaining food, escaping enemies or in some way making its evolutionary position more secure. There can be little doubt, therefore, that beauty and intelligence are the outcome of different phases of the same inner set of forces of organic evolution. What is good we call beautiful.

But, in addition to the above, and entirely in line with it, Woods has made the extremely ingenious suggestion that the immediate cause may have been the spread of the Greek art and its ideals over the Nordic race which followed the Renaissance in Italy. As these ideals flowed northward, carried by scholars, travelers and artists, they did lay a profound hold upon the upper and better educated classes. Woods thinks that perhaps the Greek ideals of physical beauty led the men especially to learn to admire that type of womanhood. The paintings show that a few of that type were to be found among the people. It is quite possible that this led the upper class men to admire and select that type for wives, and thus perpetuate their type of beauty in their sons and daughters. The educated men of the upper classes, at least, were schooled in these ideals of feminine and masculine beauty, and no doubt, as men have always done, married "the women of their dreams." And thus again these old dreams of the human form divine, which made the Greeks a race of men and women so wonderful that, as Shelley says, "the human mind almost refuses to believe that they ever really lived," came back once more into the faces and forms and probably likewise the minds and souls of the race.

All modern biology, indeed, the experience of any farmer in improving the strength and beauty of his animals, would lead us to believe that this is a very reasonable theory as to one of the causes at least of

THE HUMAN RACE MORE BEAUTIFUL

this astonishing and happy change. For there is one field in which dreams do come true. And that is in the field of heredity—the field of mate selection. A race of men who dream of beautiful women and who know them when they see them, who thus select these beautiful and intelligent women in marriage, are going to find these dreams literally come true in the living forms of their children. Heredity does hand down in the living minds and bodies the ideals that animated the marriage selections of past ages. If these ideals of beauty, virtue and intelligence are low, the children will be low and ugly. If their esthetic sense has been cultivated toward right ideals of beauty and character, the children will be the legatees in their souls and bodies of those dreams of human excellence.

If you doubt that the sort of women that men learn to admire and select for wives does have its influence upon the very figure, form and physical appearance, as well as the mentality of the race, examine the farmer women of East Prussia. Hard labor for generations has broken down the delicate, lovely, high-strung, beautiful girls, and either killed them or else destroyed their beauty so early in life that they failed to get husbands. In addition, when men voluntarily put their wives at hard labor, or economic conditions compel them to do so, the men themselves grow to admire only the type of woman that is built like a draft horse.

Examine these women as they are unloaded at Ellis Island. I have studied thousands of them. This fact was first called to my attention by Edward A. Ross in his book, *Changing America*. Scarcely one in hundreds would be called beautiful. They are broad-hipped, short, stout-legged with big feet; broad-backed, flat-chested with necks like a prize fighter and with faces expressionless and devoid of beauty. It is just be-

THE FRUIT OF THE FAMILY TREE

cause these men wanted that kind of women that they got them. If a nation makes its women work like draft horses, it will get women who are built like draft horses, with no more beauty, and scarcely more intelligence.

When we reflect that these women are giving us nearly three babies, where the beautiful women of the old American stocks, the Daughters of the Revolution, are giving us one, it does not take a prophet to predict that the beauty of the American woman will steadily decline. Indeed, it is the belief of Professor Ross that the number of beautiful women, in proportion to the whole population, has notably declined within the past generation. And at this rate, except among the most favored classes, the famous beauties of America will soon be remembered only in their portraits by a race incapable of appreciating or reproducing either their spiritual graces or their physical charms.

As to how ideals of beauty or ugliness, excellence or degradation, may influence a race of people, I do not recall a clearer case than an incident that happened to the writer one day recently in Indianapolis. I was walking along the street and inquired from a passing business man the way to the new public library.

The business man hummed and hawed and finally said, "Humph! Well, now, to tell you the truth I believe they were talking about building a new library, but I guess they never built it. If so I don't know where it is."

Some half a block farther I encountered a newsboy about eleven or twelve years of age. I said, "Sonnie, where is the new public library?" Quick as a flash he said, "Right up the street two blocks and then across the park." As I started on he called out "Say,

THE HUMAN RACE MORE BEAUTIFUL

Mister, you can tell it easy for it's a bully specimen of Greek architecture!"

"Well," I reflected, "if the Indianapolis schools are doing this much to cultivate the esthetic taste of their youngsters, it means that Indianapolis will not only have beautiful buildings as time goes on, but also beautiful people." For if you can educate children to love and understand and admire and above all want beautiful architecture in their buildings you can also educate them to want beautiful architecture in their men and women. And if they want it they will get it.

Yes, we can have any kind of a race we want, provided we will but give our artists and educators a chance to guide our ideals of marriage selection. For like everything else in the human race, it all depends upon who marries whom. Our difficulty has been that we have not educated our young men and women how to pick out good husbands or wives, and do it unconsciously. For picking out a husband or wife must always be largely a purely unconscious process, as unconscious as the coming of love or a May morning. Husbands and wives and likewise their children will be beautiful and intelligent if the ideals of beauty and intelligence are in the minds of our young people beforehand so that they unconsciously reject the ugly and stupid, and find their happiness only in people that are lovely and of good report.

And just as people whose esthetic senses have been trained will unconsciously fill their houses with furnishings that appeal to the finer tastes, and articles of virtue that delight the spirit, just so if their ideals of human beauty are properly trained, will they fill their homes with beautiful wives and handsome husbands and children endowed with both beauty and brains. For we shall never get much beyond Professor William James' definition of an education. He said the

THE FRUIT OF THE FAMILY TREE

final aim of education is to teach us "to know a good man when we see one." This is the real benefit of beauty contests and better-babies shows. They represent a splendid piece of work for national eugenics. It is a step in teaching the youths of America to know a good man or woman when they see one.

Many of the famous beauties who are selected by Florenz Ziegfeld, Jr., for his beauty show in New York, are not regarded as beautiful by their friends and neighbors. Part of this may be because the girls have never been properly costumed. But once their beauty is given a proper setting by Mr. Ziegfeld, the dullest man or woman can see it and wonders why he did not see it before. Beauty is all round us, but we do not see it until the artist who understands points it out. Most people imagine a wet, rainy, soggy day is ugly. I once heard a great artist lecturing to students about a celebrated picture entitled *A Rainy Day in New York*. He said, "Many of you may think this picture ugly. It looks to some of you as nothing but dreariness. But, young ladies and gentlemen, you will never learn the true wonder of art until you learn that all days are beautiful days to the artist." Rain, snow, sleet, hail, thunder and lightning bring out colors, lights and shades that no other days ever show. Henry Ward Beecher said it was John Ruskin who taught him to see the beauty of bad weather. I once traveled for a week or two with a great portrait painter. He was searching for a face to use as a model for a Madonna. The women he selected as being extraordinarily beautiful, did not strike me as being beautiful at all, until he pointed out their exquisite lines or the regularity or even the contrasts in their various features.

I suppose the average person regards Abraham Lincoln as having been very "homely." Indeed, the

THE HUMAN RACE MORE BEAUTIFUL

“homeliness of Lincoln” has become a sort of tradition. But I have heard portrait painters talk with enthusiasm of “the beauty of Lincoln.” Students of art have now come to regard Abraham Lincoln as representing one of the highest types of human beauty. Indeed I have written a little volume on this subject entitled *The Beauty of Lincoln*. Perhaps his lanky, awkward figure would not give him a blue ribbon at a beauty show. Yet a New York physician, Doctor Charles A. Leale, who examined Lincoln’s body from head to foot when he was assassinated, told me that it was the most perfect specimen of anatomical harmony and proportioned development he had ever seen. He said he had searched all over the world for the past fifty years for a physical specimen as perfect and had never found but one, and that one was not a living mortal, but Angelo’s great statue of Moses, which artists have for centuries regarded as one of the noblest of all the conceptions of physical perfection.

We fail to see the beauty of Lincoln probably because we are thinking of Adonis or Apollo as the only type of masculine beauty. But artists have come to the conclusion that, especially in Lincoln’s face, there is a majesty of outline, a dignity and nobility of contour, a sweep and distinction in the lines and a definition of character and of a great soul within, that stamps Lincoln as one of the most beautiful specimens of the human race. Search Lincoln’s face as you will, there is not a commonplace line in it. It is commonplaceness that makes ugliness. It is character that makes beauty. The beauty of Apollo and the Greek heroes is the beauty of spring days, of nature leaping with joy and of running, shouting waters. But the beauty of Lincoln is the beauty of mountain peaks and lonely rugged fastnesses, and in his energy you

THE FRUIT OF THE FAMILY TREE

see the beauty of the ocean storm. And it should be remembered that Edwin Booth, the actor, and brother of the man who murdered Lincoln, always kept a model of one of Lincoln's hands on his table as the most beautiful hand he had ever seen.

Indeed, I have felt if Lincoln should become the type of our national beauty and be handed down by our artists as the "typical American," we would give the future as distinctive a type of human beauty as did the more flowing, rounder and gentler ideals of the Greeks.

It is usually objected that "beauty is only skin deep." This is not true. Beauty is as deep as the human soul, as deep as evolution itself. It is the revelation of character. True, some famous beauties have perhaps not been great women. But nearly every great man or woman has been beautiful. I believe that every woman of character shows beauty somewhere in some of its infinite revelations. Beauty is individual and distinctive. People who are always making you think of somebody else are not beautiful. It is commonplaceness that reminds you of everybody else. And nothing is so ugly as commonplaceness.

We also hear another criticism of beauty that "most beautiful people have no brains," but F. A. Woods and I have proved in a research not yet published that beauty and brains are in quite a high degree associated. While we see some "raving beauties," who, as O. Henry said, "haven't enough sense to drive a nail into a snow bank," yet on the general average the intelligent, active and energetic are more beautiful than the lazy, ignorant and stupid. And since, as we found in the chapter on the royal families, intelligence is quite closely associated with sound moral character—that is, people with brains are usually better morally than people with empty heads—it



Photo, Kadel & Herbert.

CHANGES IN THE HUMAN COUNTENANCE

Above: Stephen Sewall, early Puritan, and John Barrymore, modern actor.
Below: Henry VIII and Mlle. Curie, the beautiful daughter of the discoverer of radium.

Henry VIII was regarded as one of the handsomest men of his time. Compare with Barrymore. Picture of Stephen Sewall taken from "Portraits of the Founders," 2 Vols. by Charles K. Bolton, of the Boston Athenaeum, and reproduced here from Wood's "Portraits of Early Americans," Journal of Heredity, by permission. Modern Americans are distinctly better looking than were the forefathers.

THE HUMAN RACE MORE BEAUTIFUL

follows therefore, that good-looking people are better morally, on the average, than ugly people. No direct study of this has been made but it is a fair inference from all the evidence. Furthermore, people of high ability are also people of abundant energy and vitality. Since, therefore, as Sir Francis Galton said, "energy is the most distinctly inherited character we have," it follows that if men and women should select mates solely for beauty, it would increase all the other good qualities of the race. If we can, by beauty contests, by baby shows, by teaching art in our schools, by teaching children the certainty and beneficence of the laws of heredity; if we can by these means elevate our ideals of human beauty, it follows, as the night the day, that we shall also raise the level of intelligence and human excellence all along the line.

By educating men to appreciate womanly beauty and to select wives that possess it, and by inducing women to look for manly beauty in their husbands, there is not the slightest danger that we will produce a race of lovely but harebrained mollycoddles. On the contrary, every increase of beauty will mean an increase of bodily and mental energy; every increase of physical and mental energy will result in an increase of the spiritual virtues, and an expansion in the whole moral output of the race. And a race that is tumbling with physical and mental vitality will inevitably be a race that is filled with that fundamental "demand for joy," which when we attain political, social and economic freedom is bound to result in a nobler civilization, and make a world that will be a happier place for our children to live in.

CHAPTER XVII

WOMAN'S PLACE IN RACE IMPROVEMENT

WOMAN'S new Promised Land, the objective of her exodus from political bondage, science has at last discovered for her, and, through her, for the race. Its name is Eugenics. It is the land of the well-born. It is for woman to determine whether or not the race shall enter it. Walt Whitman was its poet, the poet of this next great era of the world, when he cried,

Give us great persons, the rest will follow, . . .
Give the world a saner, . . . well-begotten brood.

If America does not produce a great race what else matters? And eugenics means that *the production of a great race* shall become the sum and meaning of all politics, the one living purpose of the state.

It is peculiarly to woman that America looks for the realization of this ideal. She is the natural conservator of the race, the guardian of its blood. Eugenics means the improvement of *life*, and if we can improve *life*, produce better human beings, they will themselves improve everything else. Only a noble race will or can build noble institutions.

And this improvement of life, the perfecting of the babe at her breast, is not only woman's supreme duty, but is her one deathless passion. At last her new freedom has given her the opportunity to make *her natural passion her political platform*.

What, then, is eugenics? What is it all about? What does it propose to do? How does it propose to

WOMAN'S PLACE IN RACE IMPROVEMENT

do it? These questions must be answered and the answers made as dramatic and human as securing clean streets, jailing grafters, or removing garbage. Otherwise eugenics will never get outside of a few dreamers' heads.

Ninety-nine educated persons out of a hundred imagine eugenics has something to do with sex-hygiene, vice campaigns, or personal health certificates before marriage. These are matters of public health and morals and bear only indirectly upon eugenics.

On the other hand the Eighteenth Amendment, if it really prohibits, is the most tremendous "eugenic law" ever passed in the world's history, because it will profoundly influence the health, sanity and stamina of the generations yet unborn.

Some biologists believe it will weaken the race, because they believe alcohol has for ages killed off the weaklings and those lacking self-control; and that if such persons are permitted to live and reproduce and spread their inborn weakness, in time the whole race will become potential drunkards. Other biologists believe that counteracting factors will prevent this disaster. I shall not enter the controversy here. But I cite it as a tremendous eugenical problem, which is also a political problem.

Likewise, the baby-saving campaign, with all its noble impulses, many biologists believe will weaken the race by saving so many weaklings. Indeed nearly everybody, except trained biologists, believes that our fresh air campaigns, universal education, pure food, medical and dental inspection, our hospitals, reformatories and public health measures are already rapidly improving the race. But biology, I think, has proved that *if we stop here and do nothing else* the race will deteriorate rapidly; in fact is probably already deteriorating through the saving of the weak and unfit—

THE FRUIT OF THE FAMILY TREE

not unfit, perhaps, in the sight of Heaven, but unfit for reproduction on earth. Beyond question an "improved environment" will deteriorate a race much more rapidly than a hard environment which weeds out the incompetents, weaklings and fools.

Now, the American woman must become enlightened upon these startling new discoveries. She must take a sound course in biology if she wishes to be the true politician of the new social order. Otherwise she may wreck the very race she is trying to save. She may be throwing a stone to a drowning swimmer instead of a life-preserver.

Eugenics wishes to save all these good things for everybody. It does not believe in letting a single baby die. It desires whole-heartedly to "rescue the perishing, care for the dying," but it also offers a much wider program; it calls for a golden rule which will do unto both the born *and the unborn* as you would have both the born and the unborn do unto you.

The vast educational, social, religious and economic measures necessary to do this constitute the science of eugenics, and lift it into first rank as the last great political program of the human race. Here, indeed, is a program to stir the heart and brain of every woman with a militant and conquering ideal.

I think, therefore, we shall most quickly learn what eugenics is by learning, first, what it is not. Let us throw overboard at once all the junk and nonsense as to what does and what does not improve the race. Eugenics is:

Not sex-hygiene
Not public health
Not prenatal culture
Not free love
Not a vice campaign

WOMAN'S PLACE IN RACE IMPROVEMENT

- Not trial marriage
- Not enforced marriage
- Not physical culture
- Not killing off the weaklings
- Not a plan for producing genius to order
- Not a scheme for breeding supermen
- Not a plan for scientific love-making
- Not a plan for taking the romance out of love
- Not a scheme for "breeding human beings like animals."

Eugenics is none of these things. Some of them are excellent public measures and some, such as physical culture and prenatal culture, may be pleasant personal exercises, but since, contrary to all popular belief, they do not have any influence upon the health, strength or character of the next generation (unless they might slightly influence marriage selection—that is, help to decide who marries whom) they do not come under the head of eugenics.

In the last sentence we have the key to eugenics—*the next generation*. It has to do *only* with those agencies which will improve or impair the *inborn* health and quality of the children yet unborn. Since this takes in almost the whole range of economic, educational, social, political, moral and religious agencies, to explain the science of eugenics in one chapter, or even one volume is a fairly large order. But out of hundreds of eugenical problems which are staring America in the face we might list just a few. Let us see if they are not the prime, basic political problems of the age. As a woman voter, can you answer the following:

Are good people producing more children than bad people?

Have not all civilizations gone to pieces when the

THE FRUIT OF THE FAMILY TREE

bad people produced more children than the good people?

Are there more or fewer good people in the upper social levels than in the lower levels of society?

Is the ratio between the birth-rate and the death-rate increasing or decreasing? Is this ratio rising or falling most among the more or the less successful families?

What is the birth-rate among day laborers, skilled workmen, college graduates, college professors, millionaires, paupers, hoboes, imbeciles, the tubercular, insane and epileptic?

Are wealth and sound social standing any true indication of genuine social worth? Or do the meek, lowly, and unsuccessful possess the best human qualities?

Does education cause early or late marriages, many or few children?

Do educated people have more influence upon national life than the stupid and ignorant?

Do children drop out of school from inborn mental weakness, uninteresting studies, or poor teachers? 2m
+ 1

Does charity really cure or does it increase human misery through keeping alive the unfit and enabling them to reproduce a larger horde of unfit?

Should we discontinue our charity or make it wise and helpful to the race as well as the individual?

Do great men and women have more or fewer great relatives than the average person? In other words, are there not great strains of blood, teeming with talent and genius, as well as poor strains in the nation?

Do you know where the good and bad strains of blood are?

Why do city people produce great men more than twice as fast as country people? Is it because city people have better opportunity or better blood?

WOMAN'S PLACE IN RACE IMPROVEMENT

Do not cities burn up the nation's genius? Do not cities suck up the best boys and girls—the future leaders—from the country and destroy them in the fires of city ambition and race suicide? Is there any way to prevent these disastrous results?

Are great men and women usually born from great or mediocre parents?

Why does child-labor legislation cause children not to be born? Why have large sections of some countries been almost depopulated of laborers by child-labor legislation? Should such legislation be discontinued or improved so as to counteract these damaging racial effects?

Why are more babies born during strikes and hard times than during peace and good times?

Why do more people go insane during peace than during war?

What are the effects of the income tax, factory life, department stores, automobiles, good roads, telephones, railroads, rural free delivery, social, industrial and economic legislation, social, moral and religious customs and ideals upon the health, physique, character and mentality of coming generations?

Can human nature be changed by legislation?

Is crime due to bad heredity or bad social conditions?

Are criminals morally responsible? Should criminals be "punished" or merely separated for life from society, without much reference to the size or character of their crimes, and prevented from reproduction?

Do high wages increase or reduce crime?

Are city slums the product of slum people or are slum people the product of the slums?

What are the effects of race crossings? Do children of race crossings live longer or shorter lives, make better or worse citizens than children of pure races?

THE FRUIT OF THE FAMILY TREE

Does a mixed population with differing racial inheritances, different minds and blood make for the stability or instability of a nation?

Is it better to scour the slums of Europe and the villages of Western Asia to furnish laborers for our factories, mines and forests or to produce those economic and social conditions which will induce our sound, intelligent, high-class native American working men to raise good-sized, pure American families to replenish the national labor market?

Have not the North European peoples and their descendants in America—the blond Nordic race—more will-power, scientific and governing ability, and more self-control in political and social affairs than the South European peoples—the brunette Mediterranean and Slavic races? What influence will their mixture have upon America's future?

Is the blond Nordic race (as a race) more honest, more courageous, more drunken, more adventurous, less artistic, less musical, less sociable, more philosophic, larger, stronger, more dominating and more likely to commit suicide than the brunette races?

Have not all past civilizations gone to pieces when they mixed their breeds?

Are brains and character due to heredity or environment? What are the *relative rôles* played by heredity and environment in producing human character?

Can we legislate intelligently for human beings if we do not know whether a man's misfortunes are due to inborn defects which can not be remedied or to his surroundings and education which can be remedied?

Shall we continue to put all our money on improving environment as we are doing now, or put part of it on improving heredity; that is, the natural inborn qualities of the people?

Can we not so shape our education, political and

WOMAN'S PLACE IN RACE IMPROVEMENT

social legislation and customs that they will improve the people, themselves, instead of merely, as they do now, ameliorate the conditions amid which they live?

Is tuberculosis hereditary; that is, does it "run in families"? Is it decreasing, as some tuberculosis societies and the United States Government claim, or increasing, as some biologists believe?

Do medicine, hygiene and sanitation increase or decrease the inborn stamina of the race? Can we counteract the weakening effects which in some directions these measures probably have?

Do the children of your school know anything about the laws of heredity? Are your citizens and school children being given any sound knowledge on the subject? Is it not as important a branch of knowledge as geography, history or Latin grammar?

Are your school children being taught how to tell a person who would make a good parent from a bad one? Is it more important to learn this or to learn the funeral ceremonies of the ancient Egyptians?

Have you any provisions in your town so that the boys and girls shall make a large number of acquaintances and friends in order that they may have a wide scope for their wholesome, natural instincts to select good wives or husbands?

Have you any laws in your state for finding potential criminals, prostitutes and paupers while they are yet children, which science can now often do, and thus prevent their future ravages upon society as well as their own misery?

The foregoing gives only a hint of the enormous range of questions which eugenics puts squarely to the woman voter. We might add a few somewhat more personal questions which may aid in enlarging our ideas as to the real scope and meaning of eugenics.

THE FRUIT OF THE FAMILY TREE

Before putting these questions, however, some of which are based upon the results of the army mental tests, let me say that the question whether these tests furnish us an accurate measure of the true, inborn intelligence of the American people as a whole is now being warmly debated, both by scientific men and the public press, and I have no wish to enter the controversy here. Indeed such a question can never be settled by debate, but only by an enormous amount of further mental measurements in the laboratories. Most of the popular discussions of the subject are either amateurish or beside the mark. The real questions at issue are too highly technical for anybody except trained students to understand with any completeness.

I am going, therefore, to assume that the army mental tests did not measure, or even attempt to measure the complete intelligence or ability or mental capacity of the soldiers, but that they did probably measure with considerable accuracy their *present* mental proficiency in many directions, and that they did probably select the quick thinkers from the slow thinkers. How much each group might be benefited by education, and whether further education would bring the two groups closer together in proficiency or move them farther apart, I shall assume is not yet fully determined.

Their sole purpose was to make a hasty selection of the quicks from the slows, and there is considerable evidence that they succeeded in selecting *present mental* alertness. Such things, however, as dogged determination, courage, "will-power," willingness to follow a leader and to cooperate with one's fellows and thus make a good citizen, and many other factors of natural make-up, were not accurately measured, or even supposed by the psychologists to be measured,

WOMAN'S PLACE IN RACE IMPROVEMENT

although they were probably considerably indicated. Energy and initiative were probably more clearly indicated by the tests.

These tests occupied only about fifty minutes, often under unfavorable conditions and sometimes with inexpert operators, whereas a careful psychological examination usually occupies from two to three hours under restful, healthful and quiet conditions which will give the individual being tested the best possible chance to do his best.

However, with all these disadvantages, it would not be surprising at all if after future careful individual measurements the general mental averages would remain pretty much the same. True, no method has yet been devised for measuring either the *whole man* or the *whole of intelligence*. Yet, the results are so highly satisfactory that large business houses are using the army tests in selecting employees, and they are being found of great assistance in selecting students from kindergarten to university, for elimination or promotion, or for fitting them into other lines of work. Moreover, they are daily being brought to greater and greater perfection by students all over the world.

As a net result of this wide-spread difference of opinion over the validity of the army tests as measures of the intelligence of the American people the present writer believes there is no greater, more urgent, immediate work that could be undertaken by the American women than the raising of a fund of from \$100,000 to \$250,000 to be placed at once in the hands of our leading psychologists, biologists, anthropologists, sociologists, educators and statisticians to extend this work and determine as nearly as they can to-day determine both the present mental proficiency, the general intelligence and also the probable educability of all sections of the American people.

THE FRUIT OF THE FAMILY TREE

The benefit of such an effort to all social, political and educational reforms would be beyond all calculation. It would, indeed, be the most gigantic attempt in the world's history to apply human intelligence instead of opinion, sentiment, passion and prejudice to government and social problems. If this is not done I predict that a very large part of the enormous values of the army mental tests will be for ever lost. They will remain, instead of a great scientific contribution as they undoubtedly are, a matter of controversy and subjective judgment.

But a supplementary survey of the intelligence, mental capacity, moral reactions, and present proficiency, or whatever we may be pleased to call the spiritual make-up of human beings, would furnish sociologist, educator and statesman with a fairly accurate working chart of the biology, psychology and anthropology of his own people. It would enable them to undertake measures for social, educational, political and even religious progress with many times more intelligence and many times greater certainty of securing beneficial results than has ever before been possible in the history of the world. I feel deeply that this should be the first great signal of the new woman's entry into political life, the first plank in her political platform, and the first great dynamic outlet for her passion for uplifting humanity. Such a measure would easily extend itself by its own momentum to a more complete physical and mental—in other words, eugenical—survey of the whole American people, and the recording of these magnificent results in the archives of the nation as a basis for intelligent democracy for all time to come.

With these provisos, therefore, and assuming for the moment that the army mental tests were fairly representative of the present mental proficiency of

WOMAN'S PLACE IN RACE IMPROVEMENT

the American people, they do raise some portentous questions.

Do you know, for instance, that these tests indicate that there are probably over twenty million people in America who can never learn to read a book of any importance in an understanding way?

That nearly ten million can probably never learn to write an intelligent letter home?

That about forty million can probably never by present educational methods go much beyond the eighth grade of our present school system?

That about fifty or sixty millions can probably never graduate from our present-day college system or ever fully comprehend the principles of free government—at least, aid in their development!

That probably not much over fifteen million of the American people have any real ability to think independently upon social and political problems, and that creative ability and capacity for constructive leadership are possible only to the very few?

Do you know that these tests seem to indicate that about one-fourth of the American people are pretty bright, and about three-fourths are pretty dull; and that the destiny of the nation depends solely upon whether the bright one-fourth or the dull three-fourths produces the larger families of citizens for the future?

Do you know that in many states from one-fourth to one-third of all state tax money goes to support defectives and those who are socially inadequate? That this measures only a small part of their real burden upon society, and that they are mainly the children and grandchildren of the very same defectives, paupers, imbeciles, neurotics, and incompetents whom our grandfathers took care of, only they are growing more numerous while those who care for them are growing relatively less numerous?

THE FRUIT OF THE FAMILY TREE

Do you know that there is no survey of the human stock? That scarcely one person in a hundred knows even the names of his eight great-grandparents, let alone their achievements, character, diseases, defects and virtues—in short, the quality of the blood now coursing in his own veins, which largely makes him what he is, determines mainly his health, character, length of life, and happiness, and will enormously influence the health, character, happiness, and length of life of his future children?

Do you know that children inherit their minds and dispositions in the same way and to the same degree as they inherit their bodies?

Do you know that good and bad housekeeping, good and bad citizenship, bright and dull minds, good and bad health, happiness and unhappiness are largely due to the sort of ancestors a man had, and that such things can be attained to only a limited extent by any economic "system" or scheme of education?

Do you know that education can add nothing to anybody's inborn, natural mental powers; that education can wonderfully train what a man is born with, but can add nothing to natural inborn capacity—mental or physical—which he can transmit to his children?

Do you know that if parents educate themselves it does not cause their children to be born any brighter or more moral; but if bright and good people marry only bright and good people, their children are born with strong tendencies toward goodness, intelligence and virtue; in short, that we can no more hope in humaniculture than in agriculture to gather grapes from thorns nor figs from thistles? Stupidity begets stupidity and intelligence begets brains.

Do you know that two feeble-minded parents have never been known in all history to produce a single normal child?

WOMAN'S PLACE IN RACE IMPROVEMENT

Do you know that crime, pauperism, insanity and human worthlessness are rapidly increasing, while skilled workmen and leaders of all kinds are rapidly decreasing, notwithstanding our desperate efforts to produce them by education?

Do you know that industrial and economic conditions to-day are pushing our best families to the wall, making it a hardship instead of a privilege to raise good sound families; that social ideals and customs are running strongly toward a standard family of but two children among our abler stocks?

Do you know that unless four children are born to every married couple who have any children at all, the race is going backward in actual numbers and probably decreasing in quality? That college graduates, professors, foremen, managers, salesmen, accountants, lawyers, doctors, and teachers have barely two children to the family, while the thoughtless and stupid have from four to six?

Do you know that the United States Government knows exactly how many pedigreed pigs were born in America in the last twelve months, but does not know how many babies were born; that the government knows officially the quality of its best hogs, mules, horses, sheep, cattle and goats, but does not know officially the quality or ancestry of its best or worst human beings?

Do you know that a recent investigation shows that fifty per cent. of our state legislators have never even had a high school education, and only one out of seven has ever been through college; that, with notable and numerous personal exceptions, the chief reason why a man during the past generation in America has not gone through high school or college has been because he did not have enough brains, energy and idealism to do so?

THE FRUIT OF THE FAMILY TREE

Do you know that these men are largely responsible for the laws of your state? Are you women going to let them determine those social, educational, political and economic policies which will largely determine who can and who can not survive and raise children to people this country when you are gone?

Do you know that science has been applied to nearly everything under the sun except human government, and that everything to which science has been applied has progressed, while nothing to which science has not been applied has progressed, and that, therefore, the application of science to government and social organization, to the end of a better, healthier, saner human breed, is the last great task in the mighty processes of human evolution?

These are all burning political questions. Their answer will to an enormous degree determine the very kind of clay out of which America's future citizens will be made, the character of her leadership and the course of her destiny; indeed her very existence is wrapped up in their intelligent answer. I think the most important thing that H. G. Wells said while he was in America was that, "we are in a race between education and catastrophe." There is not a moment to lose. They are running neck and neck, and have already rounded the turn for the home-stretch. The stakes are tremendous. The call to throw all our applause and encouragement to education is here, to-day and now. Every woman's club should therefore at once install a course in eugenics for voters.

And like everything else the task is largely one not of hasty legislation but of slow education. But what sort of education do our young people receive to-day about race problems and about the central drama of human life—marriage? May I turn the reader's attention to a few examples?

WOMAN'S PLACE IN RACE IMPROVEMENT

The other day I talked with a group of college students—the picked youth of the nation. They knew all the records of every baseball- and football-player of prominence in the country. Their knowledge was truly encyclopedic. But when I questioned them about the records and performances of their own ancestors for the past two or three generations, they knew almost nothing. In a school for young women I found the students ranked above the mental requirements for a brigadier in the United States Army. Yet out of a number whom I questioned not one could tell me even the names of her four great-grandmothers. At another college the young men were studying the pedigrees of farm animals. I was particularly attracted by a large chart showing the pedigree of a famous hog named "His Royal Highness." The achievements of His Highness' ancestors in lard, bacon, hardiness, and all that makes a noble porcine breed justified his regal name. Blue ribbons were scattered all over his pedigree.

Yet when I questioned these young men about the blue ribbons in their own pedigrees they were in utter ignorance. Some did know of one or two rather notable ancestors; but a man is the product of *all* his ancestors. At least twenty should be known to every one. Thus none of these students knew anything about his own inner make-up, his heredity, his blood, the things that make a man largely what he is, and also give him all that he will ever transmit to his children.

It will be said: "But there is no use talking to young people in love. They are going to follow good old Mother Nature anyhow and pick their own husbands and wives to suit themselves. They won't pick them out of a pedigree-book."

I hope they will not. No scientist expects people to choose husbands and wives out of pedigree-books. But

THE FRUIT OF THE FAMILY TREE

he does know that sound education about human nature and how it is transmitted with unerring certainty by heredity from parent to child profoundly affects human ideals. Human ideals make human customs; and whether a man be a prince or a pauper, a savage or a philosopher, his notions of human nature, and what will be congenial to live with, immensely sway him in the choice of a wife. The same is true of a woman. Part of this is conscious. But it is, as it should be, chiefly unconscious. Ideals and marriage customs have changed greatly many times in human history. In some tribes a woman is chosen because she is extraordinarily fat, and in others "The Slim Princess" is at a premium. Florenz Ziegfeld, perhaps the ablest judge of feminine beauty in America, states that our ideals of womanly beauty have changed radically within the past twenty years. It is an actual fact that styles in wives and husbands change nearly every generation.

The psychologists have been studying this matter of mate selection. And they find it is not an unfathomable mystery, but as open to study as anything else. Courtship has probably been correctly described as "a man pursuing a woman until she catches him." But what determined one particular man to pursue one particular woman and what led her to decide to catch him is not in the realm of the occult, nor is it a matter of fate, nor is marriage altogether made in heaven. It is a thing which, mostly without our knowing it, has been immensely influenced by our early education.

Instead of this taking the romance out of love, as some have hastily argued, all this new and wonderful knowledge, it seems to me, has added to the great romance of love, marriage and children. Can anything more completely blast the romance of love than defec-

WOMAN'S PLACE IN RACE IMPROVEMENT

tive, neurotic and uncontrollable children? Does anything keep the romance in love more permanently than healthy, happy, well-born children? Moreover, we know from many actual instances that where young men and women have grown up in the light of this new knowledge of heredity and its influence upon themselves and their future children, it has had a profound influence upon their choice of mates.

When young men and women realize that they are the trustees and guardians of this precious heredity, carried in the tiny germ-cells; when they realize that the individual with whose heredity they unite their own means so much to their unborn children; when they see clearly that a marriage into strong, healthy stock means sound, intelligent children, and a marriage into bad stock may mean defective children, it is bound to elevate the dignity, responsibility and beauty of marriage.

The fact that they have learned that mate-selection largely determines the character, happiness and intelligence of their children makes this "sweet fulfilment of the flesh" and sweeter fulfillment of the spirit the greatest and most romantic adventure that the human mind can conceive. Moreover, they see also that through their healthy, well-born children they can control almost the whole future social destiny of man.

Of course many people, including many of our social workers, industrial leaders and politicians, exclaim: "I don't believe in heredity—it is all bosh. There are Mr. and Mrs. Brown, both fine specimens of humanity, and yet their oldest boy drank himself to death and one of their daughters was a wayward, worthless girl. It is the kind of environment, the way you raise them, that counts." The way children are reared does count for a great deal; such uninformed persons fail to note two things that are obvious and

THE FRUIT OF THE FAMILY TREE

one thing not so obvious. First, Mr. and Mrs. Brown did give their children a good environment, as good as that of any children in the neighborhood. Second, this wayward girl had two or three brothers and sisters who, under the very same environment, turned out all right. Third, if they will go back on both sides of the parents' ancestry they will likely find almost exact duplicates of both the wayward and the good children, or else the elements out of which such combination might easily have been made.

Some people have little faith in what can be accomplished by this sort of education. But let us consider the amazing thing that *has* happened from educating people about another great discovery of science, the discovery of microbes. Nobody ever saw a microbe with the naked eye yet their discovery has changed nearly all human life. The education of the people about microbes is one of the most spectacular things in all history. A generation ago microbes were just as mysterious to the public as germ-cells and chromosomes are to-day. Yet every school-child now knows about them. They have changed the architecture of our houses, the kind of clothes we wear, and the sort of food we eat. They have changed our school-books, our morals and habits, even our religion. We see whole nations engaged in "Clean-up Weeks," "Health Campaigns," and "Baby-Saving Weeks," and witness great conventions, international conferences, and long processions of sober citizens carrying banners which proclaim in flaming letters the power and influence of these tiny, unseen creatures called bacteria, bacilli and microbes.

But, notwithstanding all this, indeed, *because of all this*, I predict that within another generation we shall see cities and nations setting aside "Germ-cell Week," "Heredity Week," and "Race-Improvement Week."

WOMAN'S PLACE IN RACE IMPROVEMENT

The State of Kansas has already approached this in its famous "Better Families Contest" at its annual state fair. We shall, I think, ere long, see even longer processions carrying banners with such inscriptions as: "Insanity, Epilepsy, Pauperism, and Feeble-mindedness Are Mainly Caused by Bad Germ-Cells," "Crime Is Largely Due to Bad Germ-Cells," "Tuberculosis Is Chiefly Caused by Unwise Marriages," and "Clean Up Your Family Germ-Cells and Produce a Better Race."

This is no extravagant dream. We have seen the tremendous things people have done already about our invisible *enemies*, the *microbes*. I think they will do ten times more when they learn about our invisible *friends*, the *chromosomes*. Professor Karl Pearson has proved that *heredity* is four or five times as important in causing health and disease as microbes or any environmental factor.

When the average man learns that he is spending an enormous portion of his wages to insure himself and family against disease when a wise marriage would have given him this insurance free of charge, he is bound to be impressed. Heredity is man's best friend. When people learn that at least half their hospitals, asylums, jails, reformatories and bread-lines are due to weak and poor heredity, they are going to wake up to race improvement as a matter of everyday economic and social concern. I am sure we can count on their enthusiastic cooperation once the educators and scientists have impressed this knowledge upon the public.

People already have the right idea about heredity in one direction; that is, in the improvement of their farm plants and animals. The other day a man paid fifty thousand dollars for one strawberry-plant because it had one particle in its germ-cells different

THE FRUIT OF THE FAMILY TREE

from any other strawberry which caused it to bloom and bear throughout the entire summer. All that is needed is to transfer this knowledge and enthusiasm to human beings. I believe with Coburn of Kansas, late Secretary of Agriculture for that State, that "you can't raise high-class hogs from low-class people." Might it not, however, be better to elevate the heredity of the people first, in the belief that high-grade people would naturally produce high-grade hogs. For if we improve the people they will naturally desire to improve the heredity of their hogs. But if we spend all our money on improving the hogs, there is no evidence that better hogs will improve the people.

This new knowledge of heredity, and how it can be used for human benefit, is a tremendous thing—one of the most romantic and dramatic things of human history. It has burst upon the world like a new sun out of heaven. We already see how simple and easy it is to breed defects out of plants and animals and breed virtue and strength into them. We see how inexpensive it all is. Men have done it for ages in a rough haphazard way. But science has at last discovered the actual mechanics of the process, so that it is literally true that biologists are inventing plants and animals that never existed before in the world. They can do it almost as easily as they invent patent door-bells or new carbureters.

It is not the purpose here to outline any complete eugenical program for women voters as to how to put this new knowledge into social and political platforms. The very nature of the vast problems themselves, which eugenics and race building involve, indicate what such a program is bound to be. As one first plank in her program, most assuredly, the woman voter should advocate a survey of the human family and its biological assets—its physical stamina and

WOMAN'S PLACE IN RACE IMPROVEMENT

mental soundness. The pedigree of every family in America should be placed on record. We see of what immense value such pedigrees have been in the study of the royal family—the only family with such a complete record of its history in existence. These family histories would be among the most priceless archives of the nation, for it is upon the biological assets of the nation that all truly statesmanlike legislation must be based.

Another plank in woman's eugenic platform should be the establishment in every state of a State Board of Heredity and Eugenics. This board would work in cooperation with the State University, the Boards of Charities and Correction, the State Prison Board, the Department of Public Health and indeed with every agency of social uplift and advancement. It would have on its staff expert psychologists, biologists and statisticians for the direction of measures of public mental hygiene, the mental survey of schools and the prescription of minimum mental requirements for marriage. It would also study the probable eugenical or dysgenical effect of every proposed piece of legislation. Sometimes, as we saw in the case of child labor legislation of England, the best-intentioned measures have the most far-reaching and unexpected biological effects upon the race.

But the thing of prime importance is that woman is now a free political agent and her natural instincts are those which minister to race conservation and race improvement. In ways that we can not now foresee, as times goes on, these natural passions of woman should be wrought into the political and social fabric of the state. For if women are merely to fight and scramble over the same old political questions which have engaged the attention of men and which they have only partly solved the women will merely in-

THE FRUIT OF THE FAMILY TREE

crease the quantity of politics; they will add nothing to its quality. They know no more about taxation—except as it directly affects woman's interests—than men know and can add nothing to the solution of its intricate problems. The same may be said of the tariff or any other of the familiar problems of political life. If women are merely to discuss such questions and are not to do new things in politics and to politics, they will bring no new wisdom, open no new horizons, stimulate no new social attitudes, inject no new morals, cure no ancient evils.)

(Woman has at this hour of the world a wonderful opportunity. The very problems which I have touched upon—all of them prime political problems, all of them awaiting solution, all of them well-nigh neglected in the political platforms of men—show the directions in which her new ardor and her new freedom could be of untold racial and political benefit.)

With her new power and the new knowledge with which science has equipped her, it is within the grasp of woman to usher in a new era, to bring about what Sir Francis Galton said must come to pass before eugenics could serve the race, and that is to cause eugenics "to sweep the world like a new religion." If it did this, under her influence, it would give us a new view of marriage—marriage based on science and flooded with a new and higher romance, the romance of race-building through happy, well-born children. If, through woman's freedom and power, eugenics should take its place among the great religious movements of mankind, tuberculosis would soon become as rare as a solar eclipse, and feeble-mindedness, insanity and pauperism and the crime that is associated with them could be well-nigh banished from the world. These are not idle dreams, but a clear and definite call to the women of to-day from the unborn life of the

WOMAN'S PLACE IN RACE IMPROVEMENT

future that it may be purified, strengthened and elevated. To aid in this great work is woman's God-given duty and her God-given opportunity. There are signs on every hand that she is beginning to grasp the racial significance of her new position and meet the great call of race improvement.

CHAPTER XVIII

CAN WE MAKE MOTHERHOOD FASHIONABLE?

RECENTLY I lectured in a town of thirty-five hundred people. It is a farming town, a county-seat. The stock is almost entirely native-born "Anglo-Saxon." I was entertained by the editor of the local newspaper, a paper which one New York daily has said "is the best weekly paper in the United States." This would indicate that the editor is a man of high ability, a moral power as a community leader.

He was rearing six children. Marriages may be made in heaven, but children have to be reared on earth. And rearing children on earth requires room and costs money. No country editor was ever rich, yet this one was rearing them and doing it well. This editor's experience indicates that rearing children need not cost nearly as much money as many suppose.

In his office I met his secretary. She was a handsome woman of perhaps thirty. She belonged to one of the leading families. She had declined several offers of marriage, because she wished to be "independent."

At this moment a handsome limousine stopped outside the window. "Oh," she sighed, "I'd give the world for an automobile. I'd marry him, but he can't afford one."

"Well," replied the editor with emphasis, "my wife and I want an automobile as badly as you do. We've wanted one for years for the youngsters. But we talked the matter over and decided we would put the money into another baby. The result is Jane. And

CAN WE MAKE MOTHERHOOD FASHIONABLE

we wouldn't swap Jane for all the automobiles Henry Ford can make in the next hundred years."

I saw Jane. His estimate of her as an asset was the minimum.

I also found that in the neighborhood where this man and his wife lived their example and their high ideals had had a very great influence in making motherhood and babies a genuine fashion. This fine family had set up a sort of unconscious competition among the women. In short it had set a new style in parental ideals.

Now I believe this man is in a stronger financial position than his neighbor without children. If children are of the sort worth rearing they are better than any life insurance policy against the day of rain. This man and woman have blessed their community more than any manufacturer in the state. Such children build factories, colleges, churches, and adorn the times in which they live.

From the Southwest comes another note of hope which I trust will be heard round the world—only by those, however, of the super-common stock.

The despatch, printed in a New York newspaper, reads as follows: "Walter P. Fulkerson, a St. Joseph, Missouri, banker, is building a row of houses for rent only to families which have children and to newly married couples."

As this newspaper comments, "newlyweds, according to Mr. Fulkerson, will be allowed to occupy the houses with the provision that if there are no children within a year the tenants will be asked to vacate. Whenever a child is born, Mr. Fulkerson announces, the rent for one month will be returned."

And then follows perhaps the most important part of the statement, to a biologist: "The houses are in one of the best residential districts." This indicates

THE FRUIT OF THE FAMILY TREE

a better average moral and physical stock than is found in the worst residential sections.

This man is investing his money in perpetuity—the perpetuity of good heredity—the one investment that yields an infinite usury, blessing generation after generation with the endowment of happy, creative, energizing blood.

But Fulkerson has an ally at Marietta, Georgia. Not only has Fulkerson an ally but so have the unborn babies of to-morrow, and so have the mothers who wish for those babies but can not have them because of lack of room.

This man's name is not given, but the despatch from the *Atlanta Constitution* states, "The owner of one of Marietta's leading apartment houses, who lives in the building himself, and has five sturdy youngsters, makes a standing practise of notifying tenants annually that 'if they do not show an increase in their families their rent will be raised.' He furthermore wants the world to know that babies have a preference above dogs."

But the *Constitution* has also discovered another missionary of the new social ethics—the eugenical conscience and patriotism which is merely the conscience of to-day extended into the to-morrow.

"A corporation," says the *Constitution*—even a soulless corporation—"at Augusta, Georgia, has a large apartment house under construction and has notified its rental agents 'to advertise that parents with children will be welcome.'"

The directors make it plain—that "little fairies will be an especial recommendation for those who wish to rent apartments."

Following is the official resolution passed by this board of directors: "To prominently advertise that we desire to present to the first baby born in our

CAN WE MAKE MOTHERHOOD FASHIONABLE

Broadway apartments the finest baby carriage that can be purchased in Augusta. In the event of twins there will be two baby carriages. Tenants without children are hereby notified that while children will not be permitted to annoy or aggravate people who do not like children and can not 'stand children' yet we advise such persons to seek other quarters."

The foregoing statements are taken from an editorial in the *Constitution* quoted by a New York newspaper. The *Constitution* had been commenting upon a "want ad" which had previously appeared in its columns in which a leg-weary house hunter had advertised "two beautiful babies for exchange for one or two poodle dogs" because as the "want ad" stated "his family had to have quarters in which to live and because they had been unable to find desirable apartments in Atlanta where children were welcome, although no objection was offered to dogs."

But from Washington, D. C., comes a positive paean of hope for better babies and more of them of the better stock. By better babies in the eugenical sense is not meant babies who are merely better cared for, better housed or fed, but babies that are better by reason that they are born from more healthy and intelligent parents and thus have a sounder mental and physical heredity. All studies indicate that such babies are on the average also better morally than babies from inferior stocks which have an inferior mental and, therefore, an inferior moral and physical equipment to hand to their children.

The Journal of Heredity, the official organ of the American Genetics (or Heredity) Association of Washington, D. C., investigated forty of the leading apartment houses of that city. It says, "It is gratifying to find that thirty-nine of these do not object to children. Since there are plenty of childless couples

THE FRUIT OF THE FAMILY TREE

in Washington an apartment house owner could easily fill his building with them. Consequently it is evident that it is from no fear of losing money that children are made welcome. While eleven houses refused dogs, only one refused babies."

So at last it seems that the baby is beginning to win in its fight against the poodle.

There is a note of genuine tragedy mingled with hope, however, in the following clipping, reprinted from a despatch in the *New York Times* of April 12th, 1924.

WILL ADMIT CHILDREN IN CHICAGO APARTMENT
ONE BUILDING OFFERS A BONUS FOR BIRTHS THERE—FOL-
LWS SUICIDE OF HOUSE HUNTER

Special to The New York Times

Chicago, April 12.—Several days ago a man who had hunted in vain for a flat where children are admitted turned on the gas and took his 2-year-old boy with him to death.

Had he waited a few days he would have found such a place in Chicago. To-day there was swung out over a forty-two apartment building in Oak Park this sign: "Children welcome; \$25 and a cradle to each baby born in this building."

Prospective families also are informed that the building is equipped with a "kiddies' playground, with complete apparatus," which will keep them off the streets.

In addition to this notice of facilities for children in Oak Park, it would seem from the following quotation from the *Eugenical News* of the Eugenics Research Association, with headquarters at Cold Spring Harbor, New York, that a real movement is on in both Chicago and New York—and probably in other cities—to consider the larger needs of the race in the architecture of our human habitations.

CAN WE MAKE MOTHERHOOD FASHIONABLE

The Child Welfare Directory is quoted by the *Eugenical News* as saying that both cities have architects at work designing apartment houses especially for families with children. "There is no doubt," comments the *Eugenical News*, "that one of the most potent factors for the limitation of motherhood among the well-to-do in cities has been the difficulty of finding space in which to rear children. This is not so much the personal objection of the landlord as the objection to the irrepressible activities of the children as an annoyance to other tenants."

These architects proposed to meet these objections "by providing common play-rooms, gymnasiums, sun parlors, a baby carriage garage, a big back-yard to play in and a *place to make mud pies!*"

No doubt thousands of perfectly good babies have never been born because the parents had no place for them to make mud pies. Possibly the failure to provide a place for making mud pies gives us at last the secret of the downfall of Greece and Rome!

Just one more item from the writer's personal experience.

Recently I was visiting one of New York's most fashionable suburbs when I said to my hostess, "I really wonder if this scare about the nation perishing from a declining birth-rate among its better stocks is as entirely true as alarmists would have us believe. Surely some families in favorable circumstances are having children."

"Well," she replied, pointing to a palace with Italian gardens and a swimming pool in the midst—*not for fishes but for children*—"that family has thirteen! Two of them were killed during the war. The family over there have seven, the next home has six, the one with the big deer park has nine, and so it runs all through this suburb. I have my own little brood of

THE FRUIT OF THE FAMILY TREE

seven, three of them in college, and our Mothers' Club takes in nearly every married woman in the village. A big family is distinctly fashionable."

This "village" has nine thousand persons in it and nearly all are people of wealth.

These are a few of the very encouraging signs in our national life which lead one to infer that motherhood is coming into fashion among the well-to-do. True it is coming more slowly than it should among the women of the more successful strata of the population. And these are the very women upon whose sons and daughters our national future in large measure depends. These women have the leisure to rear children. They have the intelligence and high moral ideals to rear them amid a stimulating environment. And they are also the very women who represent the most abounding and crescent vitality of the national blood. They are the ones who ought most of all to heed this call of the blood which has tingled in every truly womanly woman's veins since the gates of Eden opened upon a world of knowledge, which is always the world of duty,

There is surely, then, some method, some propaganda, some spirit of education that can stimulate these chosen vessels of our national destiny to resume the high office of motherhood. Until recently they could not escape this duty because science had not given us the knowledge of birth-control; and thus made, as it has, among the educated sections who can purchase this knowledge, the bearing of children a purely voluntary matter.

Since this natural function has been brought under personal and scientific control, it then becomes imperative that the young women of the higher social strata, who tend the most to forego this responsibility, should be inspired by a proper education, with a new and deeper patriotism that sees motherhood once more as

CAN WE MAKE MOTHERHOOD FASHIONABLE

woman's noblest duty, her most precious privilege as well as the rôle in life which brings her the richest honors and social esteem.

Another encouraging factor, something unheard of in any previous society, is the institution in our schools and colleges of definite, sane, but rigidly scientific courses of study concerned with all the problems, privileges and duties of motherhood.

At last babies have been put into the curriculum. Doctor Edna Day, before her death some years ago, blazed the way at the University of Missouri for babies to be studied in school the same as cube root or the exact length of the River Nile. She borrowed babies from the good mothers of the neighborhood and demonstrated with living material the problems which many of the young women would some day have to meet.

Another, even more favorable portent for race improvement is that more than one hundred colleges have established courses in heredity and eugenics. I know from talks with thousands of high school and college students that nothing so elevates a man's idea of the sanctity of life and marriage as a study of the facts of heredity, how mental, moral and physical traits arise in families and are transmitted by heredity to the descendants. These courses include actual studies by the students of their own family histories, both the good and the bad traits; and they give a basis of soundness and sanity upon which young men and women can estimate each other for the marriage relation. Eugenics is concerned solely with the application of biological principles to human life and social action. And a study of this science immensely elevates among young men and women their sense of racial duty, the duty first to elevate the race by wiser marriages, and second to preserve it by producing three or four children to the family.

THE FRUIT OF THE FAMILY TREE

Even high schools are beginning to give elementary courses in heredity and eugenics. I have found them all over the country. I lectured in a town of five hundred people on the verge of the desert in western Texas. The audience was mostly made up of cowboys, ranchmen and their children. "Surely," I said to the school superintendent, "you do not want a lecture here on the laws of heredity." He led me into the little school library and showed me a row of six of the latest, most important books on eugenics and heredity. "These," he said, "are required reading among my high school pupils." I have never found a more earnest audience.

These are all simple beginnings, but that a more intelligent view of marriage and parenthood is being roused in America, no student can longer doubt.

It would have been easy, indeed a good deal easier, to fill this chapter with alarming statistics about "race-suicide" and "the declining birth-rate." There are disturbing signs in these directions. The birth-rate even among farm women has declined by half in the last fifty years. This shows that merely room to rear babies is not the only factor in the problem. Babies can not be raised by the acre. But providing better ideals, moral and social view-points along with plenty of room will surely help.

It would have been easy, also, to show that the American college graduates who are usually from our best families are not reproducing themselves. They are giving the world only two children each. When we consider how many die and how many do not marry at all, these do not replace the parents. The American college professor is doing no better for his country. The American men of science, one thousand of them, studied by Doctor McKeen Cattell, seem to have arrived at a standard family of two children each. This

CAN WE MAKE MOTHERHOOD FASHIONABLE

can not go on indefinitely if the nation is to preserve its place of dignity and influence upon the world stage. Many other studies could also be reviewed to prove that our abler national stocks are in danger.

Still, I always like to look for encouraging rather than discouraging signs. Races have probably fallen in the past from a reversed birth-rate, the upper sections dying by race suicide while the lower and more incompetent have been left to occupy the empty shell of the national edifice. But these races knew nothing better to do. In our age the case is different. We know how. We not only have means of diffusing knowledge, but we have a wholly new body of knowledge to diffuse. We have learned more about heredity and the factors of race progress and decay in the past twenty years than in the previous twenty thousand. And I like to believe that humanity is going to be equal to the task of using this new knowledge in the problem of the management of its own evolution.

The moment man organizes his kind into groups to further his happiness and progress, that moment he largely takes his race out of the hands of brute nature and natural selection. He substitutes all sorts of artificial selections. He cares for his weaklings and makes it possible for the fit and the unfit, the just and the unjust, to reproduce alike.

Now, he can not go on for ever with this program. In addition there is the added factor that when he creates luxuries and makes wide avenues for individual social ambitions he lays a trap for ending the reproduction of the very choicest individuals, the individuals that built the society itself. They simply cease having children. And nature is always lying in wait at every corner since she is jealous of this rude interference with her natural selective processes, processes by which she kills off without reprieve the weak, the incompetent and unfit.

THE FRUIT OF THE FAMILY TREE

Consequently once embarked upon the voyage of civilization, man dare not turn back. To use an Irish bull he has before him three alternatives. He can turn about and go back to barbarism, where nature will resume her sway. He can go on and die fighting, sword in hand; the braver elements usually do this while the weak and timid flee, only to resume once more the long and bitter rôle of natural selection until nature forces them again to a more courageous plane. Or, finally he can do what in this age science must do—he can put his wisdom and knowledge of nature into the great task of selecting who shall and who shall not be the bearers of the torch of heredity; he must decide with courage, who shall not only guide, but who shall be borne upon and born in the ship of civilization.

No previous age has had the scientific knowledge to do this. We have. And, if we do not put it to use, if on the one hand medical science and hygiene save the weaklings and send them out to reproduce and enlarge their feeble breeds; and on the other hand if we do not see that parenthood among the abler and more successful members of society is made the thing of highest social honor, the most delightful human duty and the most remunerative reward of life, then the race will periodically fall back into barbarism.

It was Herbert Spencer who some three decades ago pictured a stranger arriving upon earth from another planet and inspecting the text books of our schools.

The visitor found books upon chemistry, mathematics, astronomy, the doings of historic personages, the virtues and misdemeanors of kings, the production of food, art, luxuries and the refinements of life.

“But,” said the starry stranger in astonishment, “where are your books about parenthood? This seems

CAN WE MAKE MOTHERHOOD FASHIONABLE

a noble education for the *mind*, but what about your education for the chief duty of the race? Surely this is an education designed for celibates who will never have such things as children and who need take no thought of the racial to-morrow."

Thirty years ago Herbert Spencer was right, even ten years, yes, even five years ago. But were his imperial mind with us to-day it would discern signs of a change. I have not only examined many text books, but I have had conversations with thousands of the young men and women of our schools and colleges. These experiences convince me that education in this respect is getting better. A new spirit toward the whole set of problems which I have so meagerly presented here, is beginning to manifest itself.

It is still true, of course, that vast numbers of women are deliberately refusing motherhood. But it can be asked, are not those who wilfully forego parenthood perhaps the very ones that might just as well be weeded out by their own selfishness?

I think, myself, that the new education will appeal to the very young men and women *to whom we want to appeal*, the ones richly endowed by nature with the great human emotions, imaginative, idealistic and aspiring. These are the types which best endow a nation with institutions that give it an elevation and a rank of worth in the annals of mankind.

For we must reckon always in forecasting our national future with the *type* that shall be the actual living individuals who dwell in that future. "Our most precious legacy from the past is not its institutions, but its ideals." A race of fools will waste any bequeathment whether it be an ideal or an empire. And to forecast whether our heritage will be dissipated we must reckon with the stern biological warnings of the mathematician. We must accept as a fact, proved by

THE FRUIT OF THE FAMILY TREE

Professor Karl Pearson, that *one-fourth of the married people of each generation produce one-half the next.*

This is one of the great warnings which modern biology has issued to the statesmen.

But, since in our time the lower, more incompetent one-half produce children at a faster rate than the other half, which is socially more adequate, the net result is that the lower one-half is producing about three-fourths of the next generation, while the upper half is producing the remainder. Such a program would wreck the stock of any breeder no matter how much time and money be expended on feeding, housing and sanitation. And in the long run such a program can work nothing but disaster to the human herd.

It is just here that biology warns the statesman, the educator and philanthropist that unlimited charity and hygiene will not stay the hand of nature. Indeed it is true that charity which permits its votaries to reproduce "creates half the misery of the world" and "charity will never relieve one-half the misery which it creates."

But, if motherhood can once more be made a fashion among the better one-half, and sound housing, economic and labor conditions set up so that these stocks can be induced to produce more than their share; if the lower one-half, by the diffusion of birth-control and many other measures which are not repressive nor lacking in true humanitarianism, can be so educated that it will produce less than its share, the central problem of race progress will be solved.

CHAPTER XIX

BIRTH-CONTROL—A TWO-EDGED SWORD

SOME time ago the chief executive of the United States wrote a letter which should have attracted international attention. The letter was addressed to a citizen of the United States, whose name otherwise would never have got before the public, congratulating him on the fact that he had achieved a family of sixteen children. I naturally supposed upon reading the president's laudatory comments that the parents of these children were persons of exceptional distinction in some field of science, commerce, art or public service; and that these fine talents would be inherited by the children to spread throughout the nation. What was my astonishment and disappointment when I learned that this man's services to human society were valued by his fellow-men at twenty dollars a week!

Now some of the greatest men that ever lived had fathers who earned even less than twenty dollars a week. But Sir Francis Galton, Havelock Ellis, Alfred Odin and others, have found that a majority of the great men of the world were born from parents of the abler and more well-to-do classes.

One should remember that a hundred years ago twenty dollars a week was a generous income and could be earned only by men of very excellent ability. But in our time and by our standards it does not usually indicate a very high order of human merit, although without a doubt there are exceptions. During his period in the White House, President Roosevelt

THE FRUIT OF THE FAMILY TREE

wrote a number of similar letters to parents of similar economic status. However, some weeks ago the New York *Evening World* awarded a one-hundred-dollar prize to a family consisting of parents and their twelve children. A study of the picture of this family leads one to believe, from their excellent dress, their obvious physical health, vigor, good looks and keen intelligence, that they are the sort deserving to be congratulated upon their numbers and a family upon whom any biologist would congratulate the whole country.

But whether these particular families produce statesmen and scientists or alcoholics and paupers is not my immediate concern. The whole thing shows that our statesmen in whose hands so much of our destiny rests, and upon whose exact technical knowledge of the factors that make or mar this organic progress of mankind, so much depends, are childishly ignorant—I can use no milder term—of the one central, never-ending, underlying problem of all statesmanship—the problem of *population*. James J. Hill, the railroad builder, used to state grandiloquently that America would ere long have a population of five hundred million people if only we could build railroads to carry their produce to market!

Nearly every school boy has heard of a Reverend J. R. Malthus, an English preacher, who, one hundred years ago, wrote a huge three volume work entitled, *An Essay on Population*. It seems that many of our most eminent statesmen have never read the book, though probably no book in the history of the world, except Darwin's *Origin of Species*, ever created so much controversy.

The principal contention that Malthus set forth was that human beings increase until they reach the limit of their food supply. But the crucial point he made was that since every parent may produce several chil-

BIRTH-CONTROL—A TWO-EDGED SWORD

dren, each of whom is likely to produce several of his own provided he can get enough for them to eat, the number of people increases at a geometrical ratio, that is, on the two-four-eight-sixteen-thirty-two plan; while the food supply increases at an arithmetical ratio, that is on the two-four-six-eight plan. Plainly then, in a little while somebody is going to starve. Either the mothers will be so undernourished they can not nurse their babes, or the old folks will die from starvation, or pestilence due to undernourishment will set in, or else the whole population will go to war and capture the food of some other country and kill off the people of the conquered region. But even then the birth-rate rushes up behind these destroyers and fills in the ranks with more babies to feed until everybody is starving again.

Why so obvious and simple a proposition has failed to impress our modern statesmen with its essential soundness, even though some of its features are mollified by special circumstances, is beyond the wit of the finite mind to discover. It is said that when Charles Darwin read the book, he leaped to his feet and exclaimed, "At last, I have a theory to work by!" For Darwin saw, if Malthus was right, that when the fight was on the strongest would win and get the food as a general thing. Some superiority of strength, speed, color or other factor, would enable one individual or even species to win, while the opponent went down to defeat. As Herbert Spencer put it, there would be a "survival of the fittest."

Now, with many modifications, interrelations and suggestions, this theory that the fight for the full dinner pail has been one of the essential elements in the change of the form and structure of plants and animals, is accepted by practically every educated person in the world. It is known as the "Theory of Organic

THE FRUIT OF THE FAMILY TREE

Evolution," or better still, as the "Theory of Development." Permit me to add that this theory has nothing to do with the so-called evolution of the earth or stars, or the religious views of the evolution of the human spirit to "higher planes," and the like. The majority of competent students, however, believe it does account for the development of the mental faculties in animals and human beings.

The reader who expected from the title of this chapter to find a simple program for bringing in the millennium by urging all women to produce one or two children each, may exclaim in disappointment, "What has all this to do with birth-control? What I want is fewer children and better ones." Well, the biologist is not so sure that in all cases fewer children means better ones, and he is perfectly sure that some classes of the population already have too few children. Thousands of women are shirking their tremendous responsibilities, not because they do not want babies, but because they have allowed themselves to want phonographs, and upholstered furniture, and installment pianos, and "freedom" and travel, more than they want to carry their fair share of the world-old burden of woman. Thousands of women are shouting "birth-control" to-day simply because they do not want to play the game of carrying on this vast scheme of organic evolution toward a happier and better race.

I have outlined the basic facts of population, the food supply and organic evolution, that I might impress upon the young men and women of the nation that they can not lightly throw off these sacred obligations. I want them to see the vastness of the problem. I want them to see that in meddling with birth-control, they are meddling with the biggest instrument for racial salvation or racial decay that nature knows about.

Birth-control, the power to produce or withhold the

BIRTH-CONTROL—A TWO-EDGED SWORD

lives of children at will, is the most dangerous two-edged sword ever placed in the hands of human beings. If it cuts with one edge, it will be an instrument for racial salvation. If it cuts with the other edge it will bring every civilization which tries it to its day of doom. Not only can it be made, if wisely guided, to bring in a better and healthier human race, but it will solve many of our economic and political problems; it will give us all, in the end, still more phonographs and flivvers and "freedom" and art and the good things of life. It is humanity's great hope of ever stopping war, because overpopulation and the resulting struggle for food which is called under various names—"economic imperialism," "lust for conquest," "national expansion," and what-not—is one of the never-ending causes of war.

But let us examine some of the flimsy reasons for which birth-control is sometimes advocated. In a recent issue of *The Birth-Control Review*—a publication which I am usually able to endorse—some "medical student" gives "ten reasons for birth-control."

Among these reasons are, "The fewer children in a family, the better education, the better food they can get." This is only partly true. Among many poor families the children are an asset almost from babyhood, helping the family income, and in the long run giving the parents more to eat, taking care of them in old age, and preventing them from being a charge upon the state. Of course this may be a woefully bad economic arrangement, but birth-control would not necessarily remedy it. It might conceivably make it worse.

Again he says, "The fewer children, the healthier the mother will be." Sometimes this is the case, and sometimes it is not. Many women find that the birth of three or four babies improves the health. A noted

THE FRUIT OF THE FAMILY TREE

beauty surgeon of Paris says: "Babies are the great beauty doctors. With healthy mothers several babies keep the mother young and make her more beautiful. Maternal beauty is the finest beauty woman ever attained." In a town of thirty-five hundred citizens the one woman who is most famous for her youthful appearance, and who is often mistaken for one of her own daughters, is the woman who has the largest family of any among the abler and sounder classes in that town. She has eight big sturdy sons and daughters. Mrs. Lillian Moller Gilbreath, of Montclair, New Jersey, the youthful and beautiful mother of ten children, got her degree as Doctor of Philosophy from Brown University after her fifth baby was born. The women of the well-to-do classes who can afford it should heed such inspiring examples.

The plain fact is, that, if civilization is to continue, the higher classes must have more children. And, since some women of the noblest natures have not the strength to have any children and would endow them with poor bodies if they did; since some women can not healthfully produce more than one or two; since many healthy, able but selfish women will produce none; since many babies are bound with the best of care to die; and since many people do not get married at all, it is a mortal certainty that some women must go on producing four, five, six and even eight or ten children. For numerous statisticians have proved that unless there is an average of about three and three-fourths children born to every couple who have any children at all, the race will gradually die out. No race will ever really do that. No race ever has. Indeed, no race ever can. The late Doctor Alexander Graham Bell showed that race-suicide—the actual disappearance of a race because of the fact that it has no children—is physically impossible. Somebody will always have children.

BIRTH-CONTROL—A TWO-EDGED SWORD

The one central question is, *who is going to have the children*—the wise, provident and strong, or the weak, thoughtless and stupid? There is no such thing as race-suicide. It is always *class-suicide*. And it is always the wrong class. There is immense danger that our birth controllers will influence limitation of families in the one class that ought not to limit its birth-rate to any very great extent. Because the ones who will listen to them are the more intelligent. And when the more intelligent disappear, as *they are disappearing in America*, civilization disappears with them.

There is one tremendous feature of birth-control which I have never heard mentioned at any birth-control meeting nor in any of the literature on the subject. And that is, that when race-suicide—or rather class-suicide—sets in, it leaves just two classes of people who go on producing children. It leaves the shiftless and stupid at the lower end of the scale of social worth, and the unselfish, patriotic, domestic, home-loving, child-loving, motherly and fatherly at the upper end. And since the domestic, home-loving, child-loving instincts are mental and moral qualities, they are inherited by the children of such parents. The result is that voluntary parenthood is going to produce a much more unselfish, more moral, loyal, clean-minded, patriotic class at the upper end of society. This latter fact was first suggested, I think, by Doctor F. A. Woods.

But two dangers lie in birth-control propaganda. First, that the ignorant and empty-headed who need birth-control the most, both for their own happiness and the health and strength of the race, can not be induced to practise it. And second, that such preachments as: "The fewer children women have the healthier they will be," will frighten many of our best and most feminine, baby-loving women and lead them either to have no children, or to stop at one or two.

THE FRUIT OF THE FAMILY TREE

If every little ailment a woman has is going to be ascribed by irresponsible medical students to child-bearing, we shall soon reap the whirlwind from such well-intentioned folly. Our medical student goes on to say "that the fewer children women have the more time they will have to read and study."

Now, I submit to our birth-control friends that it is vastly more important to our national and racial life, as well as to the full personal development and happiness of our best womanhood, that we have a goodly number of children born to our best and healthiest women, than that they should be "free" to have twenty-four hours a day to "read and study." If there is anything this side of Heaven that brings larger returns in culture and bigger expansions of the mind and heart to any man or woman than reading and studying and talking and worrying over the problems and troubles and love affairs of two, three or half a dozen children, I do not know what it is. I have found from long observation that women with several children seem to know life and art and literature and philosophy and science, not only from reading about such things, but from living them with their children, as well or better than women who have devoted their lives to reading and study in books. Women of the right sort—the women whose natures we want transmitted through the blood of the race—find a vaster "freedom," a deeper knowledge of life and its great mysterious beauties in a home filled with children than the gadabout ever finds with all her sophistication and so-called "freedom."

The truth is that birth-control may be the greatest instrument for race progress ever attained by any species. No plant or animal ever possessed such a thing before. It means that the trend of racial evolution is in our hands. Birth-control is the most signifi-

BIRTH-CONTROL—A TWO-EDGED SWORD

cant fact of the modern world. And for this reason it must be guided with all the wisdom and caution we can summon. It is nothing short of the management of organic evolution itself, with all unthinkable consequences. But if such trivial reasons as those advanced above are going to induce our patriotic, devoted women to cease having children, birth-control will wreck the race that practises it.

Voluntary parenthood will make the race more unselfish because it will weed out the selfish and the immoral. It will probably even weed out the wandering, roving, imperious, warlike tendencies. The race will probably become less belligerent, more domestic and home loving through the preservation and reproduction of these types. But it will do this only if our best women can be induced, where their health permits, to see that home building and child-rearing are their greatest service to the nation and their surest source of a happy, personal life. *The Birth-Control Review* has in the main kept these great facts in view; but it should call to its aid, not ignorant students and rampant reformers, but, as it has generally done, it should enlist the services of the ablest statisticians, biologists and philosophers, the largest minded and largest hearted men and women of the world. The Birth-Control Congress, held in November, 1921, in New York, showed great wisdom in doing two things. First, it passed a resolution, offered by one of our leading eugenicists, Professor Roswell H. Johnson, of Pittsburgh, stating that the purpose of the Birth-Control League is to encourage good sound families among our abler and more successful stocks. Had this resolution not been passed every biologist and true eugenicist would have left its ranks. Secondly, it voted down a resolution calling upon the postmaster general to repeal the regulation prohibiting literature

THE FRUIT OF THE FAMILY TREE

dealing directly with methods of birth-control from going through the mails.

In the course of time this regulation may be repealed, with wisdom, but its repeal would be doubtful wisdom now. The provision has probably been a wise one, at least for the present. The great danger is, first of all, that all sorts of death-dealing nostrums would be advertised in this manner. The management of organic evolution should not be placed in the hands of patent medicine venders. And secondly, fathers and mothers have their own individual problems, and these problems can only be handled by careful personal consultations with medical advisers of the highest authority. Birth-control advice by mail would lead thousands of women to diagnose their physical condition themselves, whereas, the wisest physician on earth would not dare to diagnose himself. How much more dangerous, then, for some suffering woman to write out a disjointed, distorted, ignorant account of her physical troubles and ailments and then be trusted, after a guess-work diagnosis, to put even sound advice into practise. Moreover, no reputable physician would ever diagnose and prescribe without seeing his patient. Thus the mercenary and unscrupulous would very largely control the whole racial situation.

The sounder advocates of birth-control have no such purpose in view. They propose to follow the example of Holland, where fifty birth-control clinics have been established over that little country, at which parents may receive individual advice. The system has worked with most admirable results. It is a travesty upon American civilization that such clinics are not now in full operation in every town and hamlet of the nation. This advice should be given at the lowest possible charge, and to the poor who need it the most, it should be given free of charge. It is enormously in the inter-

BIRTH-CONTROL—A TWO-EDGED SWORD

est of the abler classes to pay this expense. For the fewer children among the shiftless and thriftless, the more wealth, food, jobs and opportunities are left for the far-seeing and provident. Indeed, with the very ignorant and improvident, birth-control knowledge should be, with every possible tact, carried into the home by trained nurses who have been properly educated, and who are in cooperation with the health authorities.

It is to the interest of every lover of America, every lover of humanity, to study and understand this problem of birth-control. It is the central, outstanding fact of modern civilization. There is not a particle of doubt that, birth-control or no birth-control, every race is going to expand to the limits of its food supply.

Doctor Raymond Pearl shows by facts and figures which he has developed in his laboratories at the Johns Hopkins University, that the birth-rate is always going to crowd closely upon the supply of food. Doctor Pearl has made discoveries in this field that are entirely new, and of immense importance. He shows that the curve of population follows definite, predictable laws. For instance, in Vienna during the war, there were two hundred and forty deaths for every one hundred births. But the moment you get more food and stop killing off men on the battle-field, the avalanche of babies fills up the gaps. Within twelve months after the Armistice, the birth-death ratio in Vienna had shot up to one hundred and sixty deaths for each one hundred births! The war, he shows, killed 18,000,000, and the influenza 20,000,000. But every nation goes marching gaily on, the moment these earthquakes have passed, creating more mouths to feed. Doctor Pearl, by elaborate mathematical methods, concludes that they will always do this.

Obviously, then, the problem of race improvement,

THE FRUIT OF THE FAMILY TREE

which is the supreme problem of statesmanship, is to devise methods for determining what sort of babies shall be born. Birth-control does furnish us that means. Doctor Pearl proves, I think conclusively, that there will probably never be more than 200,000,000 people in the United States. Within fifteen years, according to Professor E. M. East, of Harvard University, our ablest authority in this field, we shall need every ounce of food our soil can produce to feed our home people. Now whether, when we reach war and famine, we shall be fighting each other for food, or shall be an upstanding breed of free and able people, our upper classes constantly producing a little more and our lower classes a little less than their share of the children and thus slowly marching on toward health, beauty, strength and sanity in the race, is entirely in our own hands.

A nation with a stationary population, constantly improving its stocks, is the only nation that can ever be called truly civilized. To make America such a nation should be the constant aim of all our social, educational, religious, business and political statesmanship. The statesmen who cry for larger families, irrespective of their quality, who talk about a "big nation," "cheap labor," "our unlimited resources," when as a matter of fact our resources are exceedingly limited and already our soil has reached the point of "diminishing returns"; the statesmen, or rather jingoists and junkers, in America, England, Germany and Japan—for we have them in all countries—who talk "expansion," "new lands for our race to breed in," "chosen people," "economic development," and the like, are simply uttering counsels of ultimate despair.

To hope that every nation and race will be content to develop a great society, art, philosophy, science and literature within its own borders may be futile. I do

BIRTH-CONTROL—A TWO-EDGED SWORD

not know. I do know that birth-control with a resulting improvement of the racial stock within each nation is the most efficient instrument of racial salvation within the power of man.

Overcrowding on the one hand, and class suicide of the best stocks on the other, are the chiefest causes of war, pestilence, famine and human misery. Some churches oppose birth-control. Whether they will be converted or their tenets swept away by the onward march of human intelligence, I do not know. But I do know that they are counseling the race to nothing but continued misery. I do know, and every biologist, every statistician, and every student of the things that make races and men, knows that beyond the horizon lie just two things. One is race improvement through rational birth-control—a gradual decrease of the badly born and an increase of the well born—the other is Armageddon.

CHAPTER XX

DOES HEREDITY OR ENVIRONMENT MAKE MEN?

ALL men are born unequal. When the Declaration of Independence made its pronouncement, it was merely to serve notice upon King George that the American colonists were equal in their social, political and human rights to the citizens of England. It was not meant as a scientific formula from some laboratory of psychology which had tested several thousand human beings and found them all exactly equal. In all the common rights of man, the right to life, liberty and the pursuit of happiness, the world now concedes that one man is as good as another.

But, when we study not men's rights, but men's natures and capacities, nothing is more obvious than that all men are unequal; they are born unequal; they will always be unequal; nature intended them to be unequal; and no system of government, social control, or education has yet been devised or ever will be devised, that will make them equal. Indeed, the astonishing and delightful discovery of modern psychology and biology is that the more you educate men the more unequal you make them. The more you equalize opportunity, the more you unequalize men. The more nearly you treat men alike, the more unlike they become. It was Henry van Dyke, I think, who said that there is one thing in which all men are exactly alike, and that is that they are all different. And the more you educate and develop these differences, the more they grow into larger differences.

As a matter of fact, that is what education and good

HEREDITY OR ENVIRONMENT

environment are for, to draw out and develop each man's individual and particular capacities and powers. The old Romans invented the word "education"—*educio*—a leading out of what was in a man, and not a pouring in of some magic fire from Heaven to melt and mold his soul into a likeness to other men. You can teach three boys the same knowledge of history. You can inform them of exactly the same facts of the past. But I do not believe any school-teacher in the world would maintain that he had filled them with the same spirit and view-point. One boy will be inspired by these facts to write historical novels and dramas; another will find them helpful in shaping economic and social legislation; while the third may remain almost wholly unaffected and devote his life to keeping a country grocery or to inventing a new method of making soap. They all had the same facts, the same teacher, the same school-room. But they all reacted differently, each according to his own ability and temperament—that is, his inborn make-up.

So an unalterable fact of human nature is that men are different. The whole question at issue in this world-old heredity-environment debate is, what causes these differences?

All modern biology and psychology support the view that heredity plays a great part, and probably a preponderant part, in shaping a man's actions and reactions, his goings and comings, his health and happiness in this world. We found in the chapters on twins and on the royal families that this is true. But it may be of interest to present here some of the main *arguments* on both sides of this question, with these scientific discoveries as their background.

It is commonly said that it is impossible to separate heredity from environment. This is probably true when we consider merely one individual. I doubt if

THE FRUIT OF THE FAMILY TREE

we shall ever be able to determine whether a particular act by a particular individual, say whether he takes a drink of alcohol on some particular occasion or whether he commits a crime, is due to his heredity or to his environment. The causes are so hopelessly intertwined that no one so far as I am aware has presented the slightest hope of measuring the relative influence of the two forces *within the individual*. As I have already pointed out in a foot-note to a previous chapter, the Behaviorists—a school of psychologists founded by Doctor John B. Watson—assert (at least some of the leading exponents of this school assert) that “ninety per cent. of a man’s behavior is due to his environment.”

This may be entirely true, but so far it seems to me it has not been removed from the realm of assertion into the realm of exact measurement. No one doubts that a man’s early education is of great influence in determining his character and behavior in later life, but exactly *how* great—whether ninety per cent. or twenty per cent.—has not as yet so far as I am aware been measured. And I do not believe we can speak of percentages until we have measurements. Environment *is* important in determining behavior, but *precisely how important* I doubt very much if we have any means at present for determining, when it comes to one individual, whether we consider one particular act or the sum total of his character. Indeed, it seems to me it would be pretty difficult to determine what one hundred per cent. of a man’s character really is, and when we had measured either ten per cent. or ninety per cent. of its total.

I am inclined to believe from what Thorndike and his students, especially Doctor Paul F. Voelker, have proved as to the enormous influence of moral education and as to how much more we can influence the

HEREDITY OR ENVIRONMENT

moral character than we can develop the purely intellectual traits, that by proper education and environment we could prevent nearly all individuals from committing actual crimes. Crime is not itself inherited, because crime is a particular act by a particular individual. And whether he commits that act, no doubt depends very greatly upon previous education, habits, the particular stimulus before him and all the forces of his environment. For all we know a man may commit a particular crime or take a particular drink entirely from environment. And it may be that he can be prevented from these particular acts entirely by environment. We know that moral ideas tend to diffuse themselves very widely over the mental life—or as the psychologists say, there is a very large “transfer of learning” from one set of brain centers to others. No doubt moral ideals set up wider transfers of learning and thus influence larger areas of behavior than the cultivation of particular mental abilities or aptitudes. For this reason teaching a boy trustworthiness, as Voelker has proved, influences his conduct far more widely than teaching him algebra improves his proficiency even in algebra. All of this is granted.

What we know of heredity, therefore, should not in the least discourage us (indeed, when deeply considered it ought to encourage us) from throwing every possible good influence about our youth. The very stability of society depends on our doing this. But when it comes to the question as to *which one of two individuals* is the more likely to commit crime at some time in his life or to take to excessive drink, we are in reality dealing with a different set of scientific problems. And when we come to the question as to *which family* is likely to have more members who, in any one age of the world, will be unable to adjust themselves to sound social behavior or who will easily be filled with

THE FRUIT OF THE FAMILY TREE

aspirations for building a worthy character and maintaining the social and political order, we are in a field where we can measure the factors involved by fairly exact methods, and predict results with considerable confidence.

Doctor Charles F. Goring, of the Galton Eugenics Laboratory of London, has shown in the most exact and elaborate study ever made of the influence of heredity upon the criminal tendencies of men—or what more technically is called the “etiology of crime”—that heredity is by all means the more important factor in the problem. Some families easily react, naturally, to high social ideals, and some lack the foresight and the power to develop that true synthetic wisdom of life which we call in a general way self-control. Education and environment will alter the weight and influence of these factors within each individual, but I am not aware of sufficient evidence to prove that they will much alter the central tendencies either of such individuals or of such families.

Perhaps Woods's illustration will illuminate this problem. As he pointed out in 1912 at the First Eugenics Congress in London (the first time, I think, this distinction had been made), it is only when we come to measure the differences between one or two groups of individuals, that we can really separate heredity from environment. When we consider, as Woods suggests, what causes a white man to be white or a negro to be black, or one person to have brown eyes and one blue, it is evident that these characteristics are the resultant of all the combined forces of heredity and environment. We can not, therefore, by any means now known, separate the two. But that the differences in pigmentation between the white and black races are almost wholly due to the differences in

HEREDITY OR ENVIRONMENT

their germ plasm, no one can very well doubt. True, a tropical sun will develop all the skin pigment a white man has the power to produce, and rearing a negro in a northern climate will reduce his pigmentation; but when placed in the same climate their differences are almost wholly due to heredity.

Therefore we can not consider the heredity-environment problem with much assurance of success, either in method or logic, unless we consider it as the problem of the differences among men. And since, as Thorndike pointed out long ago in his *Educational Psychology*, the prizes of life, whether of health or wealth or social position, are nearly all relative matters, the result is that heredity is the most important factor in determining who shall secure these prizes and who shall not. If the ideal of human health were an individual who could barely hobble about, then to attain this minimum of energy would be our highest ambition. The healthiest man would be one who was utterly helpless. Health would still be, as it is now, a relative matter. Just so wealth and influence are relative matters. Among our ancestors a man with a few shells or arrow heads was rich. The fact, as Thorndike suggests, that Cræsus and Rockefeller were the two richest men in the world is due almost wholly to their superior natural powers over those of other men to acquire wealth. But the fact that Cræsus accumulated only a few thousands, or at most a few millions, while Rockefeller has accumulated perhaps a billion, is almost wholly a matter of the differences in environment between the ancient and modern world.

The differences among men, therefore, as I trust we have shown throughout this book, are almost entirely due to their differences in natural powers and aptitudes. But none of this remotely discourages us

THE FRUIT OF THE FAMILY TREE

from stimulating and educating those powers and aptitudes, nor should it discourage the individual from developing his own inner natural capacities and tendencies to the utmost. To do this is the only way to attain *his* prize in life. And whether he starts with one talent, two, five or a hundred, makes very little real difference. We all regret that we do not have greater natures than we have. I should really like to be such a man in intellect as was Plato or Pericles. I should like especially to have the musical appreciation of Fritz Kreisler and the power to play the piano like Josef Hofmann. But as William James pointed out, we can not be everything. And to want to be everything is as foolish and as much a waste of good energy as it is for a dog to bay at the moon. If we had everything we would probably lose that immense incentive of ambition and rivalry which, just because men are different, probably leads them to make nearly all the practical achievements and moral conquests of life.

In his wonderful little book, *Talks to Teachers and Students*, James relates a story that goes to the heart of the problem. He says that one day he had an old carpenter making some repairs on his house at Cambridge. They were talking about the differences among men—why it is that some men begin at the bottom of the ladder and climb up, while others start at the top and slide down. Incidentally I remember that Josh Billings said, when a man starts down-hill in this world, it seems that all creation is greased for the occasion. However, the old carpenter finally made a remark which James states was one of the most profound observations upon human life he had ever heard or read in all the philosophies of men. "There is very little difference," said the carpenter, "between one man and another; but, what little there is, is very important."

HEREDITY OR ENVIRONMENT

Have we not here the crux of the whole matter? I suppose, if, when a baby, Abraham Lincoln had been placed by the side of all the other babies in the world of that time, the best baby-show judges on earth could have found very little difference between him and the thousands of others. And I am sure that if all the germ-cells from which these babies were born had been weighed and measured and analyzed and peered at through microscopes by all the biologists on earth, they could not have told which one would produce Abraham Lincoln. Yet existing somewhere, somehow, within this tiny microscopic cell, which had been handed down to his parents and which represented his combined ancestry, were mighty and resplendent forces which ordained in advance that the child born from it would be one of the greatest human beings in all the tide of time.

But it will be said that the Civil War "gave Lincoln his opportunity." Certainly it gave him this particular opportunity. No man could ask for a greater chance to serve mankind and enter among the human immortals. But the same opportunity existed for the four or five million other men who were born and grew up about the same time. The Civil War discovered Lincoln, but Lincoln *also discovered the Civil War*. Even the men in his Cabinet who had the stimulus of his overwhelming personality did not become Lincolns. Millions of men since then have taken him as their example and striven to be like him.

Of course we are all better because of the example of Lincoln. That is the value of a rich environment full of high ideals. I am a better man and so are you because this great soul lived and blessed the world. And I do not doubt that Lincoln himself was stimulated by his studies in the firelight of the lives of the men of the great generations gone. I do not doubt he

THE FRUIT OF THE FAMILY TREE

tried to emulate them. Just in proportion to his own greatness does a man try to be like other great men. He does not try to copy them, he tries to expand his own powers in the light of their radiant examples. And I have noticed that the greater men are in real character, the more they have blessed the world with beauty and truth and happiness, men such as Lincoln and Washington, and Foch and William the Silent, and Gustavus Adolphus, and Faraday and Huxley and Darwin and Pasteur and William James, the more nearly do they approach in their lives and personal characters to the Supreme Teacher—that other Carpenter who two thousand years ago also uttered some sayings that have changed the whole course of human history. Huxley, a thoroughgoing atheist in philosophy, was almost fierce in his admiration of the character of Jesus.

As Professor Thorndike has pointed out, when it comes to the absolute achievements of men, the outward performances to which they can attain, environment is well-nigh all powerful. But when it comes to determining which individuals in that civilization will profit the most by it and contribute the most richly to its expansion and continuance, the all-important thing is each individual's heredity. A man gives to his environment and receives from it just in proportion to the richness of his own nature. Was any great environment ever built by a race of fools? No. Was any truly small and mean environment ever built by a race teeming with genius? No. Where there is no vision, no genius, the people perish.

As another example, I walked down the street a while ago upon a pavement which took all the combined physics, chemistry, social, political and economic organization of a great industrial age to construct. I had nothing to do with it. It was a part of my

HEREDITY OR ENVIRONMENT

environment. But I was able to walk faster and reach my journey's end earlier—that is, make a greater absolute achievement—because of it. By my side walked a laboring man with a basket of groceries for his family. Now, it may be that this man has a son in college who will some day write a much better book on heredity and eugenics than this one. But it certainly would surprise me to find that all the students in colleges and all writers of books were laboring men's sons, and all the sons of the abler and more successful classes should to-morrow be handling the picks and shovels of our civilization.

The whole point of this is that the things which men can do depend upon the tools that are at hand in the form of environment, machinery, social organization, ideals and systems of education—in short, what we call the social heritage. But the relative performances of one man as compared with another, that is, what each man does with these tools—this social heritage, depends almost entirely upon his individual, inborn heritage. Consequently, it is the duty of all men to improve the general social heritage because this furnishes multiplied opportunities for each man to develop and express his personal heritage.

Let us see if, in a rough way, we can not measure this. The other day I motored through the western part of the state of New York, where I had learned the lives and histories of the farmers in considerable detail. I was being driven by a man who knew them all intimately. We passed a farm which a few years ago had been one of the model farms of western New York. At the death of the owner, whom we shall call John Crosby, its broad acres were divided into three equal shares for his sons. Within three years the appearance of two of the farms had changed. The fences were run down, the stock was run down, the

THE FRUIT OF THE FAMILY TREE

buildings were run down, while the weeds and underbrush had run up. But on the third farm, which fell to the youngest son, the conditions were better than when the father died. This son, Joseph, was rapidly acquiring the lands of his two brothers, William and Alexander. The parts which he acquired promptly became models of successful tillage. I have no doubt that, as the neighbors prophesied, within a short time William and Alexander will be working as hired laborers for Joseph.

Now here is a clear case where the environment remained unchanged, while the heredity did change and had a chance to reveal its overwhelming power. All the stimulus was there for each one of the sons. But only one reacted to it. Any biologist would say in the light of his own studies, that Joseph was the only son who inherited his father's vigor and decision of character. However they came by it, no one could talk with the three brothers without discerning that they were radically different men.

But let us drive on and see a like phenomenon on another farm. We passed down the road and stopped in front of a large, handsome frame house. Two different men had been on this farm within the last twenty years and "couldn't make it pay." It had grown up in thickets and underbrush, the buildings had become dilapidated, the fruit trees were wind broken and worm eaten, until finally a poor immigrant named Conrad from Switzerland had bought it for a song. Within ten years he had developed it into one of the finest dairy farms in the region. And when I looked at his five-thousand-dollar Holstein bull and his prize cows giving from ten to fifteen thousand pounds of milk a year, I thought on the one hand of what glorious achievements American environment permits men to make, and on the other of what a small

HEREDITY OR ENVIRONMENT

percentage of the millions of job-hunting immigrants America has admitted in the past forty years could do as well as Conrad. Had we had the wit to select and admit only the Conrads and the Joseph Crosbys, what a glorious future for our country! What wonderful cows, what splendid hogs, what brilliant poets, painters, inventors, politicians and statesmen would fill this country for all the generations to come!

It always straightens out this whole tangle of heredity and environment for me to think of two boys I knew in a western state—let us call them George and James. There was no great outward difference in them as boys. Their parents tried their utmost to treat them exactly alike, but the more they treated them alike, the more amazingly unlike they grew. When their mother sent them on an errand James would always loiter and show up an hour late, while George was on time. George was always devising new ways of doing the farm work, while James was content to get by in any old way or not get by at all.

When they went to school the teacher saw no great difference between them, but soon discovered that while James was two years older, still, George could do his class work better and within a year was one grade ahead of his brother. In spite of expending very little effort on George and every possible effort on James, it was impossible to make them progress alike. Of course two or three hundred years ago James, and perhaps George also, might have been mere ignorant louts about the village. Quite possibly both might have been bandits and criminals according to the ideas of crime in that day. But if so, George would have been the leader and James the follower. Consequently the absolute mental and moral achievements of both were enormously increased by the wonderful modern environment. But their achievements and character remained relatively the same,

THE FRUIT OF THE FAMILY TREE

However, the community saw no outstanding differences between these two boys. They were both good, well-behaved lads. But let us look thirty years later. George was in the United States Senate, one of the great orators, one of the great political and economic thinkers of our time, one of the keenest and most graceful writers of the day and, had he not made a political blunder, would probably have been president of the United States; while James was keeping a fourth-class pie counter in western Illinois.

Now this world is made up of Jameses and Georges. And in the careers of these men and these families, the Crosbys, the Conrads, the Jameses and Georges, are exhibited in simple relief the vast forces that make and unmake empires, that create and separate social classes, that evolve great cultures and intellectual disciplines and overthrow them—in short, the forces that make our lives, and make history and civilization what they are. I might add that George married into one of the great families of the world and his two children show promise of helping to glorify the age. James married a woman of his own type and his two children show every promise of continuing in pie-counter channels. Now it is necessary to have pie counters as well as Senates. And I have little doubt that James blames his situation on his environment or upon “bad luck,” or complains that “things went against him.” We all blame our misfortunes upon something or somebody else and lay our successes to ourselves.

The inspiring thing about all this to me is that it gives us such an exalting view of life. It proves, not that we are slaves, but that we are masters of our environment. Look back at your own schoolboy or schoolgirl friends. Have they not all carved out their own fortunes, in the main? Have they not all devel-

HEREDITY OR ENVIRONMENT

oped about as you would expect from your own intimate knowledge of their natures, their heredity? The point is, have they not selected, chosen and built their own environments? There are seeming exceptions; but is not this the general rule? It would fill me with despair if I thought that environment was the main shaping influence of my life. It has some influence on my character, and immense influence on my outward career; but if it had the overwhelming power that many people ascribe to it, the power to change my fundamental *character* then I should not have the slightest idea what sort of man I would be twenty years from now. I have not the slightest fear of the future because I know that my environment, and above all my own inner character are mainly in my own hands. I might be thrown to-morrow among criminals. I have not the slightest doubt that if I were I would begin at once to try to reform them, probably without great results. But if I am the mere victim of my environment, I have precisely the same mathematical chance as any criminal has, of committing murder and being hanged within the year.

Do you suppose that your grandchildren are going to be the victims of their environment as far as their inner characters and mental capacities are concerned? Wars may disrupt the nation. Civilization may go to pieces. But if you marry the right mate and endow your children with your own royal nature and your marked abilities, you may be sure they will rise amid its ashes and build a great and heroic life.

I have no doubt that there were great men among the cave men. But they lived a poor and mean life. In a poor environment men must live a poor life, as we look at it, although men always find excitement, interest and adventure under any set of circumstances. We see that in the case of our Puritan forefathers.

THE FRUIT OF THE FAMILY TREE

Compared to the great buildings, laboratories and libraries of Yale, Harvard or Columbia, their little log academy looks poor indeed. Yet I doubt seriously if the men within this little structure lived a life of less mental excitement or of less true inner glory.

As Karl Pearson has said, "It is man who makes his own environment, and not environment that makes the man." Now while, in the main, this is true, it is not altogether true. The choice of a man's profession is often seemingly a matter of mere accident. I chanced to read a sentence in a book thirty years ago that seems to me was the cause of my devoting my life to the study of heredity. But it was not this sentence nor any sentence that determined whether I should be a success or a failure at the undertaking. Nor was it this sentence nor any sentence that caused me from boyhood to have an overpowering ambition to be a professional scholar of some sort. My parents left me a heredity, an inner urge, to do the best I could in the study of science and in lecturing and writing for my fellow-men. I could not stop this inner urge any more than I could stop Niagara with a pitchfork.

Of course people always say, "But don't you think you can take children from the slums and do wonders for them?" Most assuredly. You can do a great deal for them. But you can, as has been shown by experience, take *the same number of children* from good homes, which have been built by the good heredity of their parents, and do vastly greater wonders for them with the same money, effort and time. Many children from the slums rise by their own heredity and become ornaments to our civilization. This proves that you can put good heredity into bad environment and not wreck the heredity. The trouble is that many people assume that all the children in the slums are bad. You will find many in the slums that are good and many

HEREDITY OR ENVIRONMENT

on the avenue that are bad. But you will find a vastly higher percentage of poorly endowed, mentally, morally and physically—that is to say, of poor heredity—in the slums than on the avenue. Slums are the product of many injustices in our social and industrial organization; but if we have slums, it is those with poor heredity who, in the main, fall into them.

To test this, go if you will, into some small town in a rich farming region. It would surely seem that there opportunity is wide open to all; every tub stands on its own bottom; there is almost no actual want. I was in one town in Iowa where they took up a collection for the poor. But the preacher told me he did not know what to do with the money, as they had no poor. I went into many homes in that town and found some with lace curtains at the front windows and Victrolas in the “settin’-room,” and yet their houses were truly the dirtiest, most ill-smelling places I have ever seen. I have scarcely seen such utter cess-pool dirt in the lowest sections of New York. The “settin’-room” was properly named, for they seemed to do nothing but just “set.”

Now honestly, my uplifting, environmental friend, what *can* you do for such people? They had plenty of money and ample opportunity. They went to picture shows, and their children attended, or rather were forced to attend, school. “The old man” got three to ten dollars a day. The farmers about the town were crying for tenants, and willing, practically, to set a man and his family up in business if they would only properly till the land. But their poverty was pure biological poverty, inborn, ineradicable. Their real poverty was poor heredity. And do you suppose that if those people drifted into the larger cities they would build residences on the avenue, or would they simply fall naturally into the slums? Many a strong

THE FRUIT OF THE FAMILY TREE

man goes into the slums, under the wicked crush of modern industrialism. But such *stock* does not long remain there. Many of the children or the grandchildren fight their way out. The vast slums of the world are in the main inhabited by breeds that have been there for centuries. Sydney, Australia, has the largest slums in the world because Sydney was mainly peopled by criminals and lower stocks deported from England one hundred and fifty years ago.

We have seen then that heredity is the preponderant factor in the relative character of men, and almost the whole factor in mental capacity; and that our success as compared with that of our fellows is largely a matter of our natural endowments. But the real lessons that emerge for us all are, first, that you "can't make a silk purse out of a sow's ear"; and second, that human success and human happiness are largely relative things. "We are not trying to get ahead in this world," as Professor Thorndike says, "but to get ahead of somebody." To be the most beautiful girl in the county is beauty enough. The most beautiful girl in Podunk feels no envy of Agnes Sorel, long the reigning beauty of France. I suppose President Wilson and Theodore Roosevelt were eager to get ahead of each other. But you and I never gave a thought about getting ahead of either one of them. The third conclusion is that environment does not much change the relative situations and achievements and characters of men. But a rich environment gives *all* men the chance for greater achievements and a wider life. If Roosevelt had been born in Africa he would not have been the Roosevelt he was. But even in Africa he would have been the "Buanna Tumbo"—the big hunter as the natives called him, the mighty man with the big stick, with the power to move things and men. And he would have had a "perfectly corking time."

HEREDITY OR ENVIRONMENT

You should remember always that by the hereditarian view you are not mastered by fate, but you are *the masters of fate*. You make your environment to a far greater extent than it makes you. Life is self-expression, self-realization. Every one should study his heredity, and the lives of his immediate ancestors. He should choose his vocation with a view of avoiding their failures and imitating their successes. If they drank to excess, it should be a special warning. If they had particular talents, these should be emulated. You probably have some or all of them. Let your natural, inborn light shine, to be seen of all men. You are always going to live with yourself. Then make yourself a good person to live with. You probably have a great deal of good heredity going to waste. Explore yourself and find out. You can not express somebody else's heredity. You must express your own. For there is no antagonism between heredity and environment. Heredity has furnished you with untold powers and no one ever develops all of them as much as he could and ought. It is your duty to use those powers in building an environment amid which and with which both you and your descendants may make the noblest possible practical achievements.

It seems to me that this view of life, far from being fatalistic, as the extreme environmental view surely is, is filled with the most inspiring optimism. A boy may never hear the chance sermon, or read the inspiring book which our environmental friends often point out as being the "cause" of his fine career in life. If such things are the "causes" of the success or failure of men, then we are mere pawns upon the chess-board of environment, mere marionettes upon the stage whose wires are pulled by this mysterious and awful hand of doom. In a bad environment a boy would be bound to turn out to be bad, and in a good environment

THE FRUIT OF THE FAMILY TREE

he would be bound to turn out to be good. Whatever the optimism or pessimism of such a view may be, we see simply that this is not true. Good boys constantly come up out of bad environment, and boys turn out badly amid the best environment that human wisdom can devise.

But the thing to reflect upon is that every child who is not positively idiotic has within him those glorious powers by which he can seek out the inspiring man who will preach to him the inspiring sermon; he has the power to seek out the good book and read it; he has the power to choose his companions, his teachers, the way he spends his time and money, and in the long run build his own surroundings.

Obviously, however, even here environment plays a very strong hand; for the more choices that are opened before a child, the more it is encouraged to make this choice instead of that, the more surely will it be enabled in the end to form those *right habits of choosing* the good instead of the bad, and also have those right objects and courses before it to choose which lead to self-mastery and success. And self-mastery is merely success in the utilization of one's heredity. For success itself by and by becomes a habit, ingrained in the very motor patterns of the nerve system itself. Every child should be guarded against, and should guard itself against the habit of failure. As James says, you may forget the fine resolution you made and failed to carry out, but the nerve cells do not forget. Down in the very depths of our bodily organization, each tiny nerve cell is registering every act and thought, and laying it up in store for some future occasion, either for or against you. "Make your nervous system," he says, "your ally instead of your enemy." This contains almost the whole basis of moral education. And one should always remember with old Spinoza, the

HEREDITY OR ENVIRONMENT

German philosopher, that "if you can keep from doing a thing because it is bad, you can keep from doing the same thing because something else is good." This is the whole difference between living the positive and the negative life. One can not build a successful and happy life unless he has filled his mind and tuned his nerves to be up and alive with the things he *must* do, instead of always holding them back with the checks, inhibitions and prohibitions of the things he *must not* do. The theological hell which is pictured for lost souls in the future, says James, can be no worse than the hell which many of us build for ourselves in this world by continually fashioning our nervous systems—our wills—in the wrong way. And, granted that there is in us a power of choosing at all, granted that thinking has any purpose in it, then the opportunity to build daily more stately mansions for our souls in this world at least, is every morning opened anew to us all.

Thus, notwithstanding our belief, and I think our demonstration, that a man's inborn nature is the chief cause of his being different from other men, the cause of his making different choices, building a different "personality picture" of himself and his life, from the personality picture of other men, our enthusiasm for environment continues as great as ever. The poorest soil will increase its yield somewhat if fertilized; but the same stimulus given to rich soil will increase its yield manyfold. The one-talent man will improve a great deal by education; but the five-talent man will improve enormously. This should be the chiefest source of comfort to the environmentalist himself—that the better the heredity upon which he expends his efforts the richer will be his rewards. It takes all the skill of teachers trained in the best pedagogy in the world to teach some children to read and write, while other children practically teach them-

THE FRUIT OF THE FAMILY TREE

selves. By doubling our educational efforts we would likely quadruple men's achievements, their generosity, integrity, courage, determination, and thus quadruple what Woodrow Wilson called "the world's fitness for affairs" but if we could double men's hereditary powers, their inborn virtue and excellence, the range and delicacy of their imaginations, the sweetness and charm of their personalities, and the exaltation of their natural desires, the humanism that would result—and what is civilization for except for a larger and finer humanism—would be beyond our power to foresee. And this difference between the two alternatives that are always before mankind—the alternative of building either a better heredity or devoting all their efforts to building a better environment—is not a fanciful difference; for we see always before us that some men have many times—Galton thought thirty times—as great natural endowments as have others. Some men have in some directions a thousand or a million times greater powers than have other men.

The millennium, therefore, will be hastened by better education; but it will be vastly more accelerated by better men. And after all, is not this the final answer to the whole tangle of heredity and environment? Better social machinery will make better men and better men will enormously enhance the efficiency of the social machinery. Our enthusiasm for environment will increase as we see more clearly through the improved education the modern world has given us how a well-born race would use education for still more exalted ends.

Instead, therefore, of being antagonistic, heredity and environment are reciprocal agencies, both placed at last by science within the grasp of man, by which he can lift his species out of the bloody sea of natural selection and fare happily forward to richer and more

HEREDITY OR ENVIRONMENT

fruitful goals. The Garden of Eden is not in the past, it is in the future. And the trees of knowledge grow along the whole highway that leads to it. It is an arduous highway; but its hardships need not be those, as in the past, of the red tooth and claw of nature, but the striving passions of men to realize in richer cultures higher values for which to live.

A rightly directed environment, not by brute death-selection but by the happier method of birth-selection, will improve men's heredity and in turn this better heredity will enrich the social heritage. To instil the "will to believe" in a humanity naturally better than ours is as necessary an aim for education as to instil merely, as education does now, the will to believe in better conditions amid which humanity shall live. Education will be doubly effective when it learns this great lesson.

The ancient Greeks pictured ambition as a beautiful goddess rolling golden apples down the pathway of pursuing youth. Like these fleeting prizes the Eden of eugenics can never be attained. But science and progress has at last stamped the picture of that Eden upon the imagination of mankind: the Eden of a perfect humanity dwelling in an environment of paradise. And, while it is unattainable *it is not a mirage*. It is merely the great dream of human destiny and possibility which men began to dream back in that mysterious time when they started their organic journey from the jungle to their present high estate. Only science and progress have drawn it for us in clearer outlines, drawn it nearer, and made it the conscious goal of the world's desire. And while it can not be attained any more than Heaven can be here on earth attained, yet the passion for it, the going toward it, the belief in it, the training and education of men for it, constitute that "new religion" of a better humanity which Galton

THE FRUIT OF THE FAMILY TREE

said would "sweep the world." The goddess of humanity's ambitions can never be embraced; but as Thackeray said of the woman that a man loves, on that last noble page of *Henry Esmond*, "To think of her is to praise God."

CHAPTER XXI

WHAT YOU CAN DO TO IMPROVE THE HUMAN RACE

IF THE human race is ever improved it is you, my dear reader, who will have to do it. This chapter is written without apology as a direct personal appeal. Improving the human race is *your* task. You can not delegate it to somebody else. It can not be done by some Society for Human Improvement holding monthly meetings and reading esoteric papers to its members. It can not be done by law. You can not legislate a better human race into existence. It can not be done by some wonderful invention. You might invent a better electric light or social system or plan of education. But you can not invent better babies, They simply have to be born.

Each particular baby has to be born from some particular pair of parents; and the sort of parents they are determines the sort of baby that is going to be brought into the world. The kind of human being this particular baby is going to be does not depend upon where he is born but from whom he is born. As old Sir Thomas Browne said, "Give thanks to Heaven, not that thou wert born in Athens, but that thou wert born from noble parents, and that honor, virtue and integrity lay in the same egg and came into the world with thee."

Consequently the whole problem of human improvement centers around the word "*selection.*" Whether the human race is going to go up or down, forward, backward or sidewise, depends upon whom you select as your partner in producing that baby. If your part-

THE FRUIT OF THE FAMILY TREE

ner is better than you are, not only better physically and mentally, but is from better stock, that is, carries better germ-cells than you carry, the race will go up. Most of your babies will be better than you are. If the partner is worse than you are, worse mentally and physically, or even better mentally and physically, yet has sprung from worse stock and consequently carries worse germ-cells than you carry, then the race will go down. Most of your babies will be worse than you are. A few might be as good but the average would be worse. And, even those who are as good as you are would carry the bad germ-cells of the ancestors of the commonplace partner, and the next generation would be lower still.

So, turn and twist, theorize and philosophize as you may, the future of the race is in your hands. You can not pass the task to some one else.

Eugenics, as a whole, should be considered an animating view-point, a dynamic attitude toward human society and social progress, rather than some definite, clearly defined program. Its purposes will be brought about more by changes in our economic structure, our social habits and ideals than it will by any "eugenic planks" in political platforms or any specialized propaganda. Yet, in order to bring about changes in man's social habits, his ethical outlook and his political objectives, it is necessary that each individual shall feel a personal responsibility for changing and broadening his own social attitudes and view-points, in order that he may play his part in bringing into existence a really better world inhabited by a better race of people.

Let us, therefore, consider what, in each profession or situation in life, one may actually do in a definite practical way to aid in "improving the natural, physical and temperamental qualities of the human family," which is the task of eugenics.

TO IMPROVE THE HUMAN RACE

IF YOU ARE A DOCTOR

One naturally thinks of the physician first as the one who comes most directly into contact with life at its beginnings, the one who comes more intimately into the secrets of the human heart than any other person in the community. It is true that he must devote his skill and knowledge first to healing the sick and patching up the sort of people that are already born. But every physician must long for a time when people are born better, stronger, and freer from defect and disease. If we had some magic potion that we could administer to the parents to insure them healthy and intelligent children, children that would never need physicians, there is no doctor worthy the name that would not gladly destroy his own profession in order to attain such a happy consummation. But since no such medical magic is at hand, if you are a physician you can do some very practical things which will in a predictable way project the effect of your advice down the stream of time; advice which, when you are gone, will leave a trail of inborn health and vigor to the children that are still in the womb of the future.

It seems to me, were I a physician, and I know a number of physicians who feel as I do, that, when I came into a community, I should as rapidly as possible learn the histories of families in the neighborhood, especially those of my own patients. I should, in so far as time and money permitted, chart out these family histories for my own reference or that of my colleagues, and carry as many of the marriages and the type of children that had resulted from them as I possibly could in my memory. A physician should be something of a genealogist. I should constantly be observing the mental and physical traits of the people

THE FRUIT OF THE FAMILY TREE

of the neighborhood, and considering whether these traits could be explained by heredity or by environment. One boy takes to drink and low companions while his brother is upright and progressive. It would be of great value if one could find among their parents, grandparents, uncles, aunts or cousins any explanation of these remarkable contrasts. One daughter of a family is constantly in your office for treatment, while her sister is the town's prize winning athlete. We can dismiss it by saying that when one of them was a babe, she had diphtheria which "settled" in various organs. But why did one have severe diphtheria while her sister escaped, or if attacked by the disease it left no bad effects to be carried through life. Two children out of half a dozen die of tuberculosis, while their brothers or sisters, with whom they lived and played and slept all through childhood, have remained immune.

These phenomena strike the student of heredity everywhere. They will strike any one, once his attention has been called to them. In a short time a physician, by observing these things and keeping records of them, will accumulate an enormous store of knowledge of his fellow-men. This knowledge may not aid him greatly in prescribing treatment for any particular case although in some cases it will; but it will give him a fund of information and many practical illustrations of the nature and the power of heredity in creating the basic conditions of health and morals, disease and wickedness. And with this intimate knowledge of family histories he can at times deeply influence the marriage ideals of his patients and the community at large. I have found, for instance, that people are far more deeply impressed by a survey of the heredity of some neighboring family, all charted out so they can see it at one glance, than they are by

TO IMPROVE THE HUMAN RACE

general discourses on genetics, or by a chart of the royal families of Europe or some worthless family in a distant section of the country. Men are not impressed by abstract considerations. They are impressed deeply and their life attitudes affected permanently by the fortunes and misfortunes of their neighbors and friends. We do not lie awake at night over an earthquake in China which has swept away thousands of lives, but a wayward brother or sister, or a child that has died from some disease that might have been prevented by wiser marriages, haunts us for a lifetime.

It is true that many physicians are not equipped with a sufficient knowledge of heredity. Six months of reading for an hour or two a day in the literature of the subject will, to an amazing degree, remedy this deficiency. It will open up the whole science and shed new light upon many medical and social problems. Every physician should keep a supply of family record booklets, which the Life Extension Institute of New York will furnish, both for the use of his patients and for keeping records of his own observations. He is frequently consulted about proposed marriages and also by parents as to the advisability of bringing more children into the world. A knowledge of heredity and a fund of information gained by long intimacy with this particular family and its ancestry will aid both him and his patient at this important juncture. He need not become an expert in genetics and the mathematical analysis of hereditary complexes, but there are some things so obviously due to heredity that he can make his advice sane, cautious and effective.

In addition, physicians are often called upon to speak at community meetings where social problems are up for consideration. At such times, short talks about heredity, marriage selection, the value of inborn

THE FRUIT OF THE FAMILY TREE

mental and physical soundness, with perhaps a chart or two of some family pedigree where the names are not disclosed can be made valuable in bringing the lessons of eugenics home to the every-day man.

IF YOU ARE A CLERGYMAN

I know a splendid young man, a college graduate, whose father is an able but eccentric business man. His mother broke down from nervous prostration, his aunt from epilepsy. He married a lovely woman, also a college graduate, three of whose uncles were alcoholic suicides.

Now, to-day the minister who performs such a marriage has no blame. But to-morrow I think he will be strongly condemned.

I should urge you as a minister to follow much the same course that I have ventured to suggest to the physician. There is little or nothing you can do when people come to the marriage altar. But if you are a real pastor to your flock, gaining their confidences, listening to their heartaches and aspirations, you will have many chances, just as the physician, of putting in a word here, a precept there. You can often talk to young men and women about the great subject of heredity and eugenics. Most of all, you can often preach a sermon along these lines which is wholesome, inspiring, enlightening and thoroughly in the spirit of the Master who came that we might have life and not nervous prostration, health and not disease, good digestions, sound organs, reasonably long life and freedom from hysterics, insanity and wretched hoodoos and hypochondrias.

Moreover, in cooperation with your local physician, you can often induce some lecturer with charts and lantern slides, for a small fee or no fee at all, to come

TO IMPROVE THE HUMAN RACE

from your State Board of Health or from one of your universities and deliver a lecture in your church on eugenics which a mixed audience of men, women and children can hear with interest and delight. There is not the slightest need for discussing heredity and eugenics before audiences "for men only" or "for women only." Eugenics has nothing to do with intimate sex matters nor the "secrets of life." There are no "secrets" about eugenics. I have heard many lectures on eugenics, many of them given to high-school children or to Sunday evening church gatherings, and I have never heard "secrets" or "mysteries of sex" discussed.

IF YOU ARE A LAWYER

You have a wide contact with this greatest of human adventures—marriage. But most of all you can aid in rational eugenic legislation. You may be a member of the state legislature. If so, you can sponsor good or prevent bad legislation bearing upon racial progress. You are always in close touch with state politics and can render great service as a citizen when legislation is pending, by organizing the forces of your community, working with the preachers, doctors, business men and leading women to bring pressure to bear for or against such legislative measures.

IF YOU ARE A TEACHER

In the schools the eugenical opportunity has no limit except that of the wisdom and common sense of the teacher. Every book mentioned at the end of this volume should be put in every high-school and college library in America.

Perhaps best of all you can do what many teachers of biology, psychology and sociology in the great

THE FRUIT OF THE FAMILY TREE

universities of the country are doing. You can secure the necessary blanks from the Life Extension Institute of New York and, as required laboratory work, have your pupils make records of their own families. In addition, they can undertake brief studies in some particular trait, physical or mental, and learn how it has run in the families in the neighborhood. This is being done in a number of schools. The point of this is that it rouses young people as scarcely anything else will, to the actual facts of heredity and its bearing upon their own marriages. It is learning by doing genuine laboratory work in the greatest of all laboratories—human nature. You can also aid in the whole program of modern educational research and in the mental testing and classification of all children, on the basis of their natural qualities. This program aims to discover first, every feeble-minded child and give it proper training. Its second aim is much more important, namely, the discovery and promotion of the bright child who bears promise of high talent or even genius. These two measures constitute probably the most important educational program of our time.

None of these suggestions to ministers, doctors, lawyers and teachers for the practical study of eugenics is in the least fanciful. As an instance, Doctor William A. Goldsmith, teacher in biology in South-eastern College at Winfield, Kansas, has, with the aid of his students, worked up not dozens of family pedigrees but hundreds. They will no doubt soon mount up into the thousands. Doctor Roswell H. Johnson, of the University of Pittsburgh, has also done invaluable work by lecturing and writing widely upon the subject of eugenics. Doctors Goldsmith and Johnson and several other college professors have set an example by this kind of work that should find many followers and imitators all over America.

TO IMPROVE THE HUMAN RACE

IF YOU ARE A BUSINESS MAN

This deserves a whole chapter. When you put your employees under conditions where only the rough and strong can survive, when you put women into steaming, filthy rooms where the high-strung, delicate, refined and beautiful among them are wrecked, when you permit or produce economic conditions which force women to labor on farms or in factories where the toil is too hard for their womanhood to bear, you are wrecking all the hopes for a better humanity. Only the broad-hipped, broad-backed, stout-legged, thick-necked, flat-breasted, big-shouldered ugly women of low mentality and spirit can stand that sort of thing. The lovely and delicate, the beautiful and refined, are killed by such pressure. Not only that, men in time come to admire women who can endure such life and bear them children. The result is the gradual production of an ugly, stupid working people out of whom all life and beauty have been crushed and selected away from the stream of heredity.

Every effort by business men to improve economic conditions has a far-reaching influence upon racial health and stamina. The ambition of business men should be to bring about such economic and social conditions that many, many women could live the protected life of the home and so give their time and high capacities to the central problem of all nations, the proper rearing of children. And, where women are compelled to work, it should be under conditions that will preserve their physical loveliness and mental poise and spirit. Business men should also see to it that their men and women employees have a decent and happy social life which permits wide and wholesome acquaintanceship among them, with a view to having in each individual case numerous marriage choices. Business men can be, indeed always have

THE FRUIT OF THE FAMILY TREE

been, a very large factor in setting up those social and economic conditions which select a race up or down and in this age their opportunities and responsibilities do not end with the cash box, but extend out into all the higher interests of the race.

IF YOU ARE AN EDITOR

If you are an editor you can wield an immense power for race betterment. You can republish stories of fascinating human interest from the *Journal of Heredity* and from the English *Eugenics Review*, or other eugenical studies. (For addresses of these publications see Appendix.) You can have competent biologists and psychologists—you can find them at your own state university—write stories about families they are studying or about the amazing new discoveries in heredity. You can have experts, with little or no charge, write editorials attacking or commending proposed legislation which affects human selection, all the way from building institutions for defectives, putting dullards into special school-rooms, questions as to whether women teachers should marry or what to do with old bachelors, to problems of taxation and unemployment—all of which affect profoundly race culture or deterioration. You can encourage playgrounds, neighborhood associations and proper dancing-rooms where young people can have wide opportunity to meet one another for marriage selection. Indeed, there is no limit except your own spirit and understanding of the subject, to the service you can render in improving the natural qualities of the human race.

IF YOU ARE A LEGISLATOR

Not every legislator can become familiar with the wide range of factors that influence race improvement

TO IMPROVE THE HUMAN RACE

or decay. But at least he can consult experts and vote money for experts to study such questions. Many legislators seem to think that the whole work of eugenics is to pass a bill to sterilize degenerates or to require a health certificate before marriage. This is a most excellent beginning, although such bills should be framed by careful students of the subject. But by far the larger factors of race improvement or decay which flow from legislation utterly escape the general attention. Who would have dreamed, for instance, that forbidding children to labor in the mines of England would have sent the birth-rate in mining sections down with a rush? Professor Karl Pearson has shown that it did. Later a law was passed forbidding children to work in cotton mills in England. Immediately the cotton-mill people lowered their birth-rate. Why? Because they could not afford to have children unless the child at an early age could help support the family, that is, unless the child was an asset instead of a liability. In five minutes' walk from my office in New York City I can show you sections where the old Anglo-Saxon stock quit having children the moment the low-grade immigrant, who, as Professor E. A. Ross says, "is willing to eat macaroni off a board and raise his children in filth," came in and took the jobs. The old native American working man of better instincts refuses to produce children to meet that kind of degrading competition. These are all eugenic, human problems. They are among the large forces that cause a nation to rise or fall; to live in happiness or perish in distress.

IF YOU ARE A YOUNG MAN OR WOMAN

Two great considerations should always be before you in selecting your friends, because some day, in all probability, one of them is going to be the father or

THE FRUIT OF THE FAMILY TREE

mother of your children. You must first think of the individual, whether he is superior to you, for there is no nobler form of education than association with people superior to ourselves. The second question is the ancestry of your friends. It is ancestry which on the large general average plays at least fifty per cent. in the fitness of any one to be an ancestor himself or herself. A consideration of these facts need not take the form of intolerant snobbishness or personal egotism. It is a true and just form of race and family pride. A man's blood and the achievements he makes with his natural equipment are about all he really has to be proud of. Young people must think of any individual from two standpoints or rather as two individuals if there is any prospect of marriage: first, as the outer person whom one sees and whose personality one knows; and, second, as the inner person, the potential person carried in the germ-cells, the person that is to be a combination of the ingredients from the individual's ancestry. To consider this latter problem in its fulness has been the purpose of this book. While our knowledge of the mechanics of the germ-cell is not sufficient to enable us to predict the precise result of any proposed mating, yet we see clearly that all mental and moral traits, as well as physical, are inherited and are segregated with very great distinctness. One must be guided by these considerations in forming the acquaintances and friendships which may result in marriage.

IF YOU ARE A FATHER OR MOTHER

Cultivate in your children a true family pride. Instead of rearing them amid an atmosphere of "don'ts" and repressions—telling them they must not associate with this or that person, must not marry this or that

TO IMPROVE THE HUMAN RACE

individual—talk interestingly about the actual mental, moral and physical characteristics of their friends. Get them interested in how these traits are related to their ancestors; how blood does tell everywhere and always; how long-lived people have very few children who die in babyhood; how intelligent people as a rule are better morally than stupid people; why good people live longer than bad people, as they do on the average; how vice and wickedness weed out families; how the children of the ungodly perish by their own ungodliness; how intelligent people have a larger percentage of bright children than people who are wrecks and failures; and what a blessing and joy bright healthy children really are. You should make them familiar—without lecturing—with the marriages in the neighborhood and the kind and character of the children these marriages have produced. These are all practical experiments in heredity, and I think if you studied your neighboring families carefully you would yourself be surprised at some of the conclusions forced upon you.

FORM A LOCAL EUGENICS SOCIETY

Parents, teachers, doctors, lawyers, business men and women should form in every town in America a local Eugenics Society. This society should meet and study the laws of heredity, the factors of eugenics. The best text-book would be *Applied Eugenics*, by Popenoe and Johnson, supplemented by other books mentioned in the Appendix, and by the monthly *Journal of Heredity*.

The chief difficulty encountered in forming such a society is that most people imagine its sole purpose is to talk about syphilis, prostitution, vice problems, sterilizing degenerates, "secrets of life" and all sorts of sex mysteries. Any good biologist or psychologist

THE FRUIT OF THE FAMILY TREE

from your nearest college will talk to your society on eugenics once a week for two years and never mention such things. He might deliver one lecture on the history of the Pilgrim Fathers, showing how their blood has blessed America and is now dying out; or the problem of feeble-minded children in your grade schools; or on how the new tax law reduces the birth-rate; or on how the supposed "melting pot" does not melt; or whether Americanization as at present pursued really does Americanize; or how heredity has run for centuries in the royal families of Europe; or a hundred and one other vital problems that are demanding intelligent solution.

Finally, while I have said that if the race is to be improved it is a personal task for each individual, I mean this is true only up to the point of those "agencies" which, as Sir Francis Galton expressed it, "are under social"—and he might have added individual—control. For beyond and above all control by the individual or the cooperative will of man, there are forces at work which are making him either a better or else a worse physical, mental and moral being. Beyond question, man is evolving now just as rapidly as ever in his history. Every organ, every muscle, every bone, every gland and tissue, no doubt every cell of his body and brain is undergoing change. Whether these changes are carrying him up or down the scale is at present beyond human knowledge. No doubt civilization sets up some forces that weed out the fit—at least fit from the standpoint of our ideals—and give a chance for the less fit to multiply.

Nevertheless, as Woods points out, while many forces, such as a restricted birth-rate among the more successful stocks, tend downward, yet even here certain correctors enter which, without our knowledge or our ability to control, may be sweeping the median line

TO IMPROVE THE HUMAN RACE

of human strength, beauty and wisdom to higher levels. In the royal families the better ones, morally, were shown to have lived longer than the worse, and to have reared more children to maturity. While it has not been tested, there is no reason to doubt that this runs true through all the human family. If so, this means that the more moral brothers and sisters in any family rear more sons and daughters to adult life who inherit their intelligence and virtue than do their less intelligent and less moral brothers and sisters. This probably also extends to all their relatives. If so, within every family, and doubtless within every social group, there is going on whether man will or no, an increase of moral excellence and intellectual power. When we couple this with the further fact that man has discovered how to control his own birth production, one is bound to believe that strong tendencies are at work leading the unselfish, the prudent, the farsighted, the sound and patriotic—the ones whom we want reproduced in the national blood stream—to persist, despite all economic and social discouragements, in reproducing in their children their own unselfish and lofty natures. Indeed the more severe the social and economic pressure the more effectively would this tendency work.

In addition to this, science and education are setting up on every hand ideals of individual excellence, ideals of health, of athletic prowess, of personal beauty, of intellectual achievement. All of these beyond question are exercising profound influences along the entire line of marriage selection and, therefore, along the entire line of evolution. Professor Karl Pearson has shown also that death itself is not a random archer, but still selects with as unerring aim as ever the weak and the unadapted, and takes his toll of the unfit in preference to the fit. Saving the weaklings

THE FRUIT OF THE FAMILY TREE

by science and charity runs counter to this tendency but can not, in the long run, wholly defeat it. Even where we save one tubercular individual and send him out to marry and reproduce his weakness, yet the elaborate and extensive measures we take in order to teach him the care of his health probably set up higher ideals among his fellows and lead them to seek more substantial mates. The very publicity that is given to-day to weakness, ill health, neuroticism, insanity, epilepsy, tuberculosis, cancer and the like, through our noble and wide-spread efforts to cure the victims of these unhappy maladies is, I can but think, setting up ideals of selection that are leading man, consciously and unconsciously, to evolve his own species to higher goals.

In another direction, our world-wide means of communication, the vast facilities now afforded our youth to make a more comprehensive and, under many educational influences, a wiser mate selection are probably working for and not against racial excellence. Some of these forces are, I think, leading to more and more intensive intermarriage among our more successful social groups, bringing about that "conification"—that pyramiding of man's biological gains—which Woods proved had taken place among our own old New England families. Thus, even with a declining birth-rate, even with a decline in total numbers of the better stocks, the increase in quality and the consequent production of a higher ratio of supreme leaders may more than make up for the loss in other directions. And, as we have abundantly seen, the destiny of man, socially and politically, depends more upon the production of a dozen geniuses than upon the production of thousands or millions of the mediocre and commonplace.

This does not mean that civilization is not a danger-

TO IMPROVE THE HUMAN RACE

ous biological enterprise, that it may not lead to racial deterioration. It is a dangerous enterprise and where it reverses evolution may bring its own end. But after all, it may be, in spite of man's multitudinous folly, that there are forces within him, above him and about him, that are working to make him naturally wise, happy and good. No man can look upon the bones of any prehistoric member of his own species without reflecting that by forces beyond human ken and control he has become a better creature than was this ancestor. And the happy thought that comes from the study of evolution is that these same mighty forces which have been man's friends all along the way are still by his side, lending their cordial ministries in his progress toward excellence and happiness. True, evolution has been a stern task-master. It has been a long and bloody gauntlet that man has run. But out of all its toil and grime and blood there has emerged a creature capable of contemplating the processes of his own evolution, and more than that, capable of cooperating intelligently with the processes that have made him what he is. And to teach man to cooperate intelligently with the forces that have made him what he is and thus make him better, happier and wiser—this is the science of eugenics. What nobler objective can the human mind contemplate? What nobler program can there be for social organization, for education, culture, art, philosophy, economics and politics than that they shall all work together toward the creation of a race of men naturally happy, healthy, just and wise?

We have seen that in some families an extraordinary proportion of their members have, by purely natural processes, been endowed with vastly more genius than the common run of men. Is it an idle dream, now that we know the laws of heredity and of

THE FRUIT OF THE FAMILY TREE

evolution, to believe that the numbers of such individuals and families may be enormously increased? Is it even idle to dream of a whole race of men and women endowed with health, sanity, energy, intelligence and beauty? No, for we have seen that the dreams of human excellence with which we can inspire our children do, through higher mate selection, come true in the very anatomy and structure, the very minds and bodies of their children. As Professor Thorndike has pointed out, such men would invent better medicines, but would need them less; they would devise better education but would have less need for education; they would create finer cultures, but by the inner glory of their spirits they would be richer human beings than could be produced by any culture. It may be, too, as we have seen, that the very forces of nature are working toward such a consummation. Can, then, any higher duty or any loftier adventure touch the mind than to cooperate with those forces? As John Fiske said with matchless eloquence, "The consummate product of a world of evolution is a character which creates happiness, replete within itself with ever fresh possibilities of higher life and richer joy, fulfilling truth and beauty in directions for ever new." To hasten these friendly processes is the task of eugenics; for eugenics is the final great task of politics, of economics, of education, of philanthropy, of science, in short of civilization itself. Environment will then have done its perfect work, for it will have guided this age-old stream of protoplasm—the heredity of organic things—which began with the amœba and which has carried down to us all the forces of life itself, into a race of living creatures which, by its in-born power and excellence, will fill the world with health, wisdom and happiness.

THE END

APPENDIX

THIS book has fulfilled its purpose if it has stimulated the reader to continue his interest in the subject of heredity and its application to individual and national life, which we call eugenics. It would be of no very great service to print here a complete bibliography of the subject. Indeed, that would require a volume larger than this one. The special student who expects to become an expert in the field of eugenics, should purchase a copy of *A Bibliography of Eugenics*, by Doctor Samuel J. Holmes, Professor of Zoology in the University of California, published by the University of California Press, Berkeley, Cal., 514 pp. This work is a necessity to special students.

However, for the general reader who wishes to gain a more thorough knowledge of heredity, the following books are recommended as being the best for the beginner. *They can all be obtained through local bookstores.* Nearly all of them are very simply written and some of them are quite as fascinating as any romance. The reader would perhaps find it profitable to read the first few books in the order named.

1. *Mental and Moral Heredity in Royalty*, by Doctor Frederick Adams Woods. Published by Henry Holt & Co., New York. For the value of this book the reader is referred to the chapters dealing with it.
2. *Applied Eugenics*, by Popenoe & Johnson. Published by Macmillan, New York. This is the best book yet written on the whole field of eugenics. It takes up many social problems from the standpoint of heredity and is essential to every general reader.

THE FRUIT OF THE FAMILY TREE

3. *The Physical Basis of Heredity*, by Professor Thomas Hunt Morgan, of Columbia University. Published by Lippincott, Philadelphia. A bit difficult to read for the beginner, but the greatest book yet published on the mechanism of heredity.
4. *The Influence of Monarchs*, by Doctor Frederick Adams Woods. Published by Macmillan, New York.
5. *Heredity*, by J. Arthur Thompson, author of *The Outline of Science*. While a bit old—published in 1913—this volume probably answers more of the ordinary questions which the average reader would desire to ask about the mechanics of the germ-cell than any other book. Published by G. P. Putnam's Sons, New York. Illustrated.
6. *Heredity and Environment*, by Professor Edwin G. Conklin, of Princeton University. Published by Princeton University Press. This contains the best description of the germ-cell and its mechanism in the English language.
7. *Genetics and Eugenics*, by Professor William E. Castle, of Harvard. Published by Harvard University Press. A very fine book for college students.
8. *Eugenics, Genetics and the Family*, two volumes. Published by William & Wilkins Company, Baltimore, Md. These two volumes contain all the papers and addresses on heredity and eugenics that were made at the Second Eugenics Congress held in New York City in 1921. Many of the chapters are truly dramatic and it is a gold-mine for the student of social problems.

If one has access to a first-class library, the monographs published by Karl Pearson and his colleagues,

APPENDIX

of the Galton Eugenics Laboratory of London, are invaluable.

The following are works of general interest, dealing with human society, human nature and history, social and political problems, from the standpoint of a biologist. Some of them are among the most significant books of the day and, as a whole, they are bound to give the reader a new view of human life and social responsibility.

9. *Mankind at the Crossroads*, by Professor Edward M. East, Harvard University. Published by Scribner's, New York.
10. *Civilization and Climate*, by Ellsworth Huntington. Published by Yale University Press, New Haven, Conn.
11. *Feeble-mindedness, Its Causes and Consequences*, by Henry H. Goddard. Macmillan, New York.
12. *The Biology of Death*, by Raymond Pearl, Johns Hopkins University. Lippincott's.
13. *Educational Psychology*, by Professor Edward L. Thorndike, Columbia University. Columbia University Press.
14. *Crime, Abnormal Minds and the Law*, by Ernest B. Hoag and Edward H. Williams. Published by Bobbs-Merrill, Indianapolis.
15. *The Individual Delinquent*, by William Healy. Published by Little, Brown & Co., Boston.
16. *The Trend of the Race, and Evolution and Eugenics*, by Samuel J. Holmes, University of California Press.
17. *Principles of Sociology*, by Edward A. Ross, University of Wisconsin.
18. *Studies in the Theory of Human Society*, by Professor Franklin H. Giddings.
19. *The New Decalogue of Science*, by Albert Edward Wiggam. Published by The Bobbs-Merrill Company, Indianapolis.

THE FRUIT OF THE FAMILY TREE

20. *A Study of British Genius*, by Havelock Ellis. Published by Hurst & Blackett, London.
21. *Outspoken Essays*, by Dean William R. Inge. Published by Longmans, New York.
22. *The Revolt against Civilization*, by Lothrop Stoddard. Published by Scribner's, New York.
23. *The Passing of the Great Race*, by Madison Grant. Published by Scribner's.
24. *The Psychology of Social Reconstruction*, by Professor G. T. W. Patrick, University of Iowa. Published by Houghton Mifflin, Boston.
25. *The Behavior of Crowds*. Everett Dean Martin. Published by Harper & Brothers, New York.
26. *The Mind in the Making*, by James Harvey Robinson. Published by Harper & Brothers, New York.
27. *The Behavior of the Lower Organisms*, by Professor Herbert S. Jennings, of Johns Hopkins University.
28. *Genetics in Relation to Agriculture*, by Babcock & Clausen. Published by McGraw, Hill, New York.
29. *The Meaning of Evolution*, by Samuel C. Schmucker. Published by Macmillan, New York.
30. *Organic Evolution*, by Maynard M. Metcalf, Oberlin College. Published by Macmillan.
31. *The Men of the Old Stone Age*, by Henry Fairfield Osborn. Published by Scribner's, New York.
32. *Is America Safe for Democracy?* By William MacDougal. Published by Scribner's, New York.
33. *Evolution and Animal Life*, by Jordan and Kellogg. Published by Appleton, New York.
34. *Mind and Heredity*, by Vernon L. Kellogg. Pub-

APPENDIX

lished Princeton University Press, Princeton, New Jersey.

35. *The Science of Life*, by Professor William A. Goldsmith, South Eastern College, Kansas.
36. *The Mechanism and Physiology of Sex Determination*, by Richard Goldschmidt. Published by Doran, New York.
37. *Evolution and Christian Faith*, by Professor H. H. Lane, University of Kansas. Published by Princeton University Press.
38. *Human Nature in Politics*, by Graham Wallis. Published by Constable, London.
39. *The Measurement of Intelligence*, by Lewis M. Terman. Published by Houghton, Mifflin Co., New York.
40. *Evolution*, by Vernon Kellogg. Published by Appleton, New York.
41. *Applied Psychology*, by Hollingsworth and Poffenberger. Published by Appleton, New York.
42. *Vocational Psychology*, by H. L. Hollingsworth. Published by Appleton, New York.
43. *Evolution, Genetics and Eugenics*, by Horatio Hackett Newman. Published by University of Chicago Press.
44. *The Dance of Life*, by Havelock Ellis. Published by Houghton, Mifflin Co., New York.
45. *Studies in Human Biology*, by Doctor Raymond Pearl. Published by Wilkins and Williams, Baltimore—a monumental work.

Every one who is genuinely interested in the subjects of heredity and eugenics should become a member of The American Genetic Association, the headquarters of which are in the Victor Building at Washington, D. C. The Council of the Association is composed of some of the strongest research men in this new science to be found in the world. Upon the Advisory Board are fifty-three of the leading biologists

THE FRUIT OF THE FAMILY TREE

and psychologists and teachers of genetics in America. Membership involves no duties, but entitles each member to receive the monthly publication of the Association, *The Journal of Heredity*, a profusely illustrated journal, full of general human interest, and one which keeps the member informed on the latest discoveries of wide economic and sociological interest in this field, which covers the improvement of domestic animals, cultivated plants and man himself. The reader should also join the Eugenics Research Association, whose address is Cold Springs Harbor, New York. This entitles him to receive monthly the *Eugenical News*. The cost of membership in this Association is two dollars a year.

In order that the reader may gain a clear idea of the objects of the American Genetic Association, a list of articles in the issue for February, 1924, is printed on page 378. It is hoped that many readers of this book will at once become members and thus forward the great work of applying human intelligence to human improvement. It is entirely non-profit making and is supported solely by its members in order to forward race improvement through the spread of knowledge. The following statement has been furnished by the Council of the Association.

THE AMERICAN GENETIC ASSOCIATION

is an incorporated organization devoted to promoting a knowledge of the laws of heredity and their application to the improvement of plants, animals and human racial stocks.

Its membership is composed of men of science, teachers, publicists, physicians, clergymen, parents, students, horticulturists, and breeders of live stock throughout the world.

The Association owns the *Journal of Heredity*,

APPENDIX

which is published monthly and sent to each member without additional cost. Every member is thus a part owner of the *Journal*.

Membership imposes no burdensome obligations. The Association, which is cooperative in nature, welcomes assistance in research, but does not demand it. Members are invited to submit discussions of the results of their research, accompanied by new and unusual photographs. All papers received will be given full consideration by the editorial board.

Manuscripts should be sent to the Editorial Office of the *Journal*, P. O. Box 354, Penna. Ave. Station, Washington, D. C.

Proof: In order to facilitate prompt publication only galley proof will be sent authors.

Reprints: On request the author will receive gratis 100 reprints without covers. Covers and additional copies will be furnished at cost.

REQUIREMENTS FOR MEMBERSHIP

Subject to the approval of the Council, any person interested in the improvement of the human race or the creation of better varieties of plants and animals, is eligible for membership.

The Association welcomes all who are interested in its program, and the Secretary will be glad to answer any inquiries.

Annual dues, giving the right to attend all meetings, and receive the *Journal of Heredity*, are \$3 within the United States and its possessions; \$3.25 in Canada, and \$3.50 in all other foreign countries; life membership, \$50.

If you are not already a member, and want to become one, or if you know of any one who would be interested in membership, write to The American Genetic Association, Washington, D. C.

THE FRUIT OF THE FAMILY TREE

LIST OF ARTICLES IN FEBRUARY, 1924, JOURNAL OF HEREDITY

A DRAGON MILLIPED IN CHINA.....	O. F. COOK
A HANDBOOK FOR GENEALOGISTS (A Review).....	
BOTTLE GRAFTING AGAIN.....	A. F. BLAKESLEE
THE OFFSPRING OF THE MORMON PEOPLE.....	J. E. HICKMAN
EUGENICS IN CONGRESS	
ANOTHER INSTANCE OF DEFECTIVE ENDOSPERM IN MAIZE	R. J. GARBER AND B. L. WADE
MARRY EARLY, WORK HARD, ELIOT URGES.....	
THE PINTO BURRO	T. C. RICHARDSON
NATIVE WHITE POPULATION OUTNUMBERED BY FOREIGN BORN	
GENETICS OF THE MULTI-NIPPLED SHEEP.....	W. E. CASTLE
INSTABILITY IN PEACH VARIETIES.....	GEORGE P. WELDON
THE GENEALOGY OF JOSEPH.....	WILLIAM A. LIPPINCOTT
NON-HEREDITARY LONGEVITY	
THE LINCOLN STOCK	
DOUBLE EARS IN BRAHMA CATTLE	JAY L. LUSH
ANTHROPOLOGY OF GERMANY (A Review)	

The American Genetic Association

President, David Fairchild
Secretary, Sewall Wright

Vice-President, W. E. Castle
Treasurer, Boyd Taylor

EDITORIAL BOARD

C. E. LEIGHTY R. R. GRAVES GEORGE H. SHULL
WILSON POPENOE GEORGE M. DARROW PAUL POPENOE

Members of the Council are ex-officio members of the Editorial Board
Managing Editor: ROBERT C. COOK

COUNCIL

W. E. CASTLE, Professor of Zoology, Harvard University, and Research Associate of the Carnegie Institution of Washington.
LEON J. COLE, Chief, Animal Husbandry Division, U. S. Department of Agriculture.
G. N. COLLINS, Botanist, U. S. Department of Agriculture, Washington, D. C.
O. F. COOK, Bionomist in Charge of Breeding Investigations, U. S. Department of Agriculture.
DAVID FAIRCHILD, Agricultural Explorer in Charge, U. S. Department of Agriculture.

APPENDIX

- GILBERT GROSVENOR, President National Geographic Society, Washington, D. C.
- T. H. KEARNEY, Physiologist in Charge of Drought-Resistant Plant Breeding Investigations, U. S. Department of Agriculture.
- VERNON KELLOGG, Division of Educational Relations, National Research Council, Washington, D. C.
- J. H. KEMPTON, Bureau of Plant Industry, U. S. Department of Agriculture.
- E. W. SHEETS, Acting Chief of Animal Husbandry Division, U. S. Department of Agriculture.
- FREDERICK ADAMS WOODS, Lecturer on Biology, Massachusetts Institute of Technology.
- SEWALL WRIGHT, Senior Husbandman in Animal Genetics, U. S. Department of Agriculture.

ADVISORY COMMITTEE

- W. S. ANDERSON, Genetics Department, University of Kentucky, Lexington, Kentucky.
- E. B. BABCOCK, Genetics Department, University of California, Berkeley, California.
- E. A. BESSEY, Professor of Botany, Michigan Agricultural College, East Lansing, Michigan.
- A. F. BLAKESLEE, Plant Genetist, Carnegie Institution, Cold Spring Harbor, New York.
- J. K. BREITENBECHER, Professor of Zoology, University of Oklahoma, Norman, Oklahoma.
- W. E. BRYAN, Professor of Plant Breeding, University of Arizona, Tucson, Arizona.
- C. B. DAVENPORT, Director, Department of Genetics, Carnegie Institution of Washington, Cold Spring Harbor, L. I., New York.
- J. A. DETLEFSEN, Professor of Genetics, Wistar Institute, Philadelphia, Pennsylvania.
- RUSSELL W. DUCK, Professor of Animal Husbandry, Syracuse University, Syracuse, New York.
- E. M. EAST, Professor of Plant Genetics, Bussey Inst. of Applied Biology, Boston, Massachusetts.
- R. A. EMERSON, Professor of Plant Breeding, Cornell University, Ithaca, New York.
- C. P. GILLETTE, President. The Genetics Foundation, Fort Collins, Colorado.
- FREDERICK O. GROVER, Professor of Botany, Oberlin College, Oberlin, Ohio.
- ROBERT T. HANCE, Professor of Zoology, University of Pennsylvania, Philadelphia, Pa.
- HARRISON R. HUNT, Professor of Biology, Michigan Agricultural College, East Lansing, Mich.
- R. E. HUNT, Professor of Animal Husbandry, Virginia Polytechnic Institute, Blacksburg, Virginia.
- H. S. JENNINGS, Professor of Zoology, Johns Hopkins University, Baltimore, Maryland.
- D. F. JONES, Plant Breeder, Connecticut Agriculture Experiment Station, New Haven, Conn.
- F. B. LINFIELD, Director, Montana Experiment Station, Bozeman, Montana.

THE FRUIT OF THE FAMILY TREE

- WM. A. LIPPINCOTT, Professor of Poultry Husbandry, University of California, Davis, Cal.
- C. C. LITTLE, President, University of Maine, Orono, Maine.
- JAY L. LUSH, Animal Husbandman, Texas Agricultural Experiment Station, College Station, Texas.
- H. H. NEWMAN, Professor of Zoology, University of Chicago, Chicago, Illinois.
- T. S. PALMER, Expert in Game Conservation, U. S. Dept. of Agriculture, Washington, D. C.
- MRS. CHARLES C. RUMSEY, Wheatley Hills, Westbury, Long Island.
- THOMAS W. SALMON, Professor of Psychiatry, Columbia University, New York City.
- JOHN M. SCOTT, Vice-Director, Florida Agriculture Experiment Station, Gainesville, Florida.
- JOHN W. SCOTT, Professor of Zoology, University of Wyoming, Laramie, Wyoming.
- A. D. SHAMEL, Pomologist, U. S. Department of Agriculture, Riverside, California.
- GEORGE H. SHULL, Professor of Biology, Princeton University, Princeton, New Jersey.
- W. W. SMITH, Professor of Animal Husbandry, Purdue University, Lafayette, Indiana.
- CHARLES R. STOCKARD, Professor of Anatomy, Cornell University, New York City.
- A. B. STOUT, New York Botanical Gardens, Bronx, New York City.
- W. T. SWINGLE, Plant Physiologist in Charge of Breeding Investigations, U. S. Department of Agriculture, Washington, D. C.
- E. L. THORNDIKE, Professor of Educational Psychology, Columbia University, New York City.
- L. H. TOMHAVE, Head of Department of Animal Husbandry, Pennsylvania State College, State College, Pennsylvania.
- H. E. WALTER, Associate Professor of Biology, Brown University, Providence, Rhode Island.
- H. J. Webber, Director, Citrus Experiment Station, Riverside, California.
- E. N. WENTWORTH, Armour's Bureau of Agr'l Research and Economics, Chicago, Illinois.
- P. W. WHITING, Child Welfare Research Station, University of Iowa, Iowa City, Iowa.
- JOHN A. WIDTSOE, 47 E. South Temple St., Salt Lake City, Utah.

INDEX

A

- America,
(see also, United States)
class-suicide, 323
future population,
 need of high standards for,
 188-189
immigration,
 effect on types, 262, 274
 result of, 6-7
labor problem, 6
types of facial characteristics,
 269
 changes in, 274
American people,
 intelligence statistics, 291
 mental tests of, 289-290, 300
Americanization,
 environment and heredity,
 relation between, 110
 popular theory of, 7
Anatomy,
 (see, Human anatomy)
Ancestors,
 (see, Genealogy)
 (see, Heredity)
Anderson, Professor, 152
Animals,
 (see also, Dogs)
 (see also, Horses)
ants,
 slight variation in breed, 34
breeding of, 139, 144, 147-150
character inheritance, 45-47
colors,
 factors as suppressors, 54
 genetic analysis, 49-51
 government records kept, 293
 heredity in dogs, 5, 6
 hybrids defined, 26
 mental qualities, 7
prenatal color influence, 95,
 96

Animals—Continued

- rabbits,
 heredity shown in, 25, 26, 46
rats, 7
 inbreeding effects shown, 147-
 149
 reproduction theory, 26-37
 sex determination, 51
Ants,
 slight variation in breed, 34
Apples,
 evolution of, 54
Applied Eugenics,
 Popenoe and Johnson, 56, 129
Arabian horses,
 bred with western ponies, 14
Archives of Psychology,
 Galton, Francis (Sir), 128
Arlitt, A. H. (Mrs.), 181
Army mental tests, 288-291
Art,
 relation to race development,
 263, 275, 279
Assortative mating, 19
Austria,
 intermarriage in royal family, 153
- ### B
- Babies,
 (see, Children)
Bach family, 143, 187
Bach, Johann Sebastian, 190
Bald-headedness, 53
Balfour, Arthur (Sir), 208
"Barrow,"
 famous race horse, 11
Bateson, William (Professor), 54
 student of heredity, 25
Beauty,
 ability to recognize, 276
 defined, 278
 factor in race development, 262-
 279

INDEX

- Beauty of Lincoln*, 277
 Beecher, Henry Ward, 77, 276
 Bees,
 immunity from stings of, 159
 Behaviorists, 236, 332
 Belasco, David, 118
 Bell, Alexander Graham (Doctor),
 53, 205
 on race suicide, 322
 Bigelow, Melville W., 17
 Bingham, W. V. (Professor), 213
 Biology,
 (see also, Animals)
 (see also, Plants)
 woman's knowledge of, 282
Biology of Twins,
 Newman, H. H., 118
 Birth-control, 60, 74
 clinics, 326
 effect on child bearing, 310
 reasons cited, 321
 two classes of parents, 323
 use and abuse, 323-327
 use for race betterment, 329
 Birth-Control League, 325
 Birth-rate,
 among farm women, 312
 among professional people, 312
 maintenance of, 322
 Birthmarks,
 "cases" of, 100-103
 parental influence on, 94, 96,
 99
 Blakeslee, A. F. (Doctor), 84
 "Blood"
 (see, Heredity)
 Body-cells,
 (see also, Cells)
 chromosomes, 30-33
 Bolton, Charles K., 269
 Booth, Edwin, 273
 "Boots,"
 famous race horse, 11
 Brain-power,
 (see, Mentality)
 Breeding, 139-150
 (see also, Inbreeding)
 (see also, Outbreeding)
 (see also, Reproduction)
 Bridges, Doctor, 29
 Brimhall, Dean R. (Doctor), 203
 Brooks, Phillips,
 on heredity, 16
 Browne, Thomas (Sir), 353
 Burbank, Luther,
 potato cultivation, 15
 Burr, Aaron, 17
 Burt, Cyril, 182
 Bush twins, 122
 Bushee, Frederick A. (Professor),
 Principles of Sociology, 57
 Business men,
 influence on economic conditions,
 361-362
- C
- Carow, Edith, 18
 Castle, William E. (Professor), 7
 on germ-cell segregation, 67
 Cattell, J. McKeen (Doctor), 203,
 213, 259, 312
 Cattle,
 "Sybils Gamboge," 144
Cell in Inheritance and Develop-
 ment, 32
 Cells,
 (see also, Body-cells)
 (see also, Germ-cells)
 character assortment, 45-47
 division of, 38, 39
 maturation, 39, 40
 "Champion Rodfield,"
 famous bird dog, 5
 Changing America,
 Ross, Edward A., 273
 Children,
 acquired characters, 77-79, 97
 appreciation of art, 275, 279
 asset to community, 305
 child-labor legislation, 285
 disease,
 relation to heredity, 155-172
 environment,
 influence upon, 344
 heredity,
 influence of, 191
 heredity and environment,
 influence of, 110
 inherited weakness in, 3
 maternal influence, 103-107
 parental environment,
 effect on unborn child, 63, 64,
 70, 72-73
 parental influence, 98
 prenatal influence,
 former theories of, 85-94
 taught to study human life, 360,
 365

INDEX

- Chromatin, 38, 39
 Chromosomes, 30-33
 cell division, 38, 39
 Churchill, Winston, 17
 Civilization,
 (see also, Human life)
 (see also, Mankind)
 (see also, Population)
 (see also, Race)
 beauty,
 influence of, 262-279
 beauty and culture,
 relation between, 263-279
 class-suicide, 323
 destructive forces of, 4
 facial types,
 evolution of, 271
 Renaissance period, 264-269
 great men of history, 173, 190
 leaders' influence, 244-261
 progressive, 4
 regulation of reproduction, 20
 selective mating,
 importance of, 83
 Cleopatra, 140
 family tree of, 140
 Clergyman,
 influence on community, 358-359
 Cleveland, Grover, 18
 Cobb, Margaret V., 56
 Colleges,
 courses in heredity and eugenics,
 311
 Color-blindness, 53
 "Comanche Frank,"
 pointer dog, 15
 "Conification,"
 defined, 201
 Corn,
 inbreeding and outbreeding, 146
 Cows,
 colors,
 factors as suppressors, 54
 Crime,
 control of, 333-334
 Cross-breeding,
 (see, Outbreeding)
- D
- Dacks family, 152, 186, 206
 Danforth, C. H. (Professor), 123,
 124
 Darwin, Charles,
 Origin of Species, 318
- Darwin family, 143, 187, 193
 Davenport, Charles B. (Doctor),
 11, 152
 Tuthill Family history, 16
 Day, Edna (Doctor), 311
 Degeneracy, 100
 transmission of, 9, 10
 Descendants,
 (see, Genealogy)
 (see, Heredity)
 Determiners, 27
 developers, 55
 inhibitors, 53, 54
 Detlefsen Doctor, 84
 Dewey, George (Admiral), 187
 Diphtheria,
 susceptibility to, 169
 Disease,
 heredity,
 relation between, 155-172
 susceptibility to, 158-160, 166
 Doctors,
 (see, Physicians)
 Dogs,
 "Champion Rodfield," 5
 "Comanche Frank," 15
 "Fishel's Frank," 15
 heredity in, 5, 6
 "Squire of Tyton," 15
 Dominant character, 26, 145
- E
- East, Edwin M. (Doctor), 146
 on food supply, 328
 East Prussia,
 women of, 273
 "Eclipse,"
 famous race horse, 11
 Economic conditions,
 effect on race, 361
 Editors,
 scope of community influence, 362
 Education,
 courses in heredity and eugenics,
 311-312
 influence on character, 332
 James' definition, 275-276
 preparation for life, 294, 298
Educational Psychology,
 Thorndike, Edward L. (Profes-
 sor), 129, 130, 335
 Edwards family, 16-17, 186
 Eigenmann, Carl H. (Professor),
 99

INDEX

- Eighteenth Amendment,**
 as eugenic law, 281
Ellis, Havelock, 317
Emerson, Ralph Waldo, 190
Endocrine glands,
 hormones,
 relation between, 108
England,
 cousin marriages in, 141
Environment,
 as factor in race betterment, 7
 children,
 affected by, 3
 forces of human life affected by,
 330-352
 heredity,
 relation between, 61-64, 72, 73,
 79, 80
 improved, 286
 dangers of, 281
Erlanger, A. L., 113
Essay on Population,
 Malthus, J. R. (Reverend), 318
Estabrook, Arthur (Doctor), 186
Eugenics,
 civilization's need of, 4
 college courses in, 311
 community study of, 365
 defined,
 negatively, 282-283
 definition and scope, 280-283
 government recognition, 301
 lectures on, 359
Mendelism,
 aid to study of, 59, 60
 race betterment,
 factor in, 239, 354
 relation to disease control, 167-
 172
 woman's influence, 280-303
European countries,
 leaders studied, 250
European royal families,
 (see, Royal families)
Evolution,
 Bateson theory, 54
 beginning of,
 in determiners, 55
Eyes,
 colors explained, 41-44
- F**
- Factor,**
 (see, Determiner)
- Fairbanks Brothers,** 17
Fairbanks Twins, 113-115
Families,
 (see also, Genealogy)
 in New York suburb, 309
 inheritance of disease in, 155-172
 with children,
 homes for, 305-309
Feeble-mindedness,
 (see, Mental defectives)
Finlayson, Anna (Mrs.), 206
Fishel, Frank, 15
Fiske, John, 370
Food supply,
 effect on population, 318-320,
 327-328
Fulkerson, Walter P., 305
- G**
- Galton, Francis (Sir),** 213, 317,
 366
Archives of Psychology, 128
 eugenics,
 science founded by, 125
 investigation of heredity, 197-
 199
 on energy, 279
 on eugenics, 302
 on twins, 126, 127
Gametes, 40
Gene,
 (see, Determiner)
Genealogy,
 Bigelow, Melville W., 17
 Burr, Aaron, 17
 Carow, Edith, 18
 Churchill, Winston, 17
 Cleopatra, 140
 Cleveland, Grover, 18
 Darwin, Charles, 143
 Edwards,
 Jonathan, 17
 Richard, 16
 Timothy, 17
 Fairbanks Brothers, 17
 Grant, Ulysses S., 18
 Jukes family, 186
 Kallikak family, 7-10, 70, 71
 Marchioness of Donegal, 17
 Paine, Robert Treat, 17
 Pierpont, Sarah, 17
 royal family of Spain, 153
 Rufer, Aaron, 193
 Tuthill Family, 16-18

INDEX

Genealogy—Continued

- Vincent,
 - Bishop, 18
 - George, 18
 - Waite, Morrison R., 17
 - Whitney, Eli (Mrs.), 17
 - Genetic analysis, 49-51
 - Genius, 18
 - Georgia,
 - homes,
 - families with children, 306-307
 - Germ-cells
 - (see also, Cells)
 - characters governed by determiners, 28, 29
 - chromosomes, 30-33
 - determiners,
 - developers, 55
 - inhibitors, 53, 54
 - theory of distribution, 27
 - division at sexual maturity, 39
 - marrying cells, 40
 - possibility of modification, 71, 72
 - qualities transmitted, 18
 - reduction division, 39, 40
 - reproduction theory, 26-37
 - segregation at birth, 36, 66, 67, 93
 - twins, 119, 120
 - Gesell, Arnold (Doctor), 124, 130
 - Gilbreath, Lillian Moller (Mrs.), 322
 - Goddard, Henry H. (Doctor), 167
 - on the Kallikak family, 7
 - Goldsmith, William A. (Doctor), 360
 - Goring, Charles F. (Doctor), 334
 - Goveartz, Albert (Doctor),
 - tuberculosis investigation, 162
 - Government,
 - mental tests, 288-291
 - Grant, Ulysses S., 18
 - Greek type of beauty, 265, 267, 271-272
 - Griffith, Doctor, 84
 - Guyer, M. F. (Professor), 84, 97
- H
- Hall of Fame,
 - members belong to famous families, 192, 193, 194
 - "Hambletonian 10,"
 - famous race horse, 11

- Harrison family, 143
 - Benjamin (President), 144
- Health,
 - and disease,
 - relation to heredity, 155-172
- Hebrew Lawgivers, 64, 65
- Heredity
 - (see also, Germ-cells)
 - brain-power
 - (see, Mentality)
 - character assortment, 45-47
 - characters transmitted,
 - dominant, 26, 145
 - recessive, 26, 145
 - children,
 - influence on, 191
 - chromosomes,
 - factor in, 30-33
 - college courses in, 311
 - disease in relation to, 155-172
 - environment,
 - relation between, 61-64, 72, 73, 79, 80
 - factor in human life, 1, 2
 - first studies of, 24, 80
 - forces of human life,
 - effect on, 330-352
 - general understanding of, 298-300
 - genetic analysis, 49-51
 - germ-cells,
 - possibility of modification, 71, 72
 - government recognition, 301
 - health in relation to, 155-172
 - in royal families, 209-243
 - knowledge of ancestors, 295
 - mechanical processes, 26-37
- Mendelism,
 - aid to study of, 59, 60
 - application to human beings, 58, 59
- nations affected by, 6, 7, 12
- peas,
 - Mendel's discovery, 22-24
- rabbits, 25, 26
- race betterment through, 299
- study of,
 - guide to marriage, 364
- twins
 - (see, Twins)
- types changed by selection, 273
- variation defined, 14

INDEX

Heredity and Environment,
 Jennings, Herbert S. (Professor), 49, 61
 Herreshoff family, 12
 High schools,
 courses in heredity and eugenics, 312
 Hill Folks family, 152, 186
 Hill, James J., 318
 Hillis, Newell Dwight, 77
 Hofmann, Josef, 336
 Holland,
 birth-control clinics, 326
 Holmes, Samuel J. (Professor),
 Trend of the Race, 56, 57
 Homes,
 families with children, 305-309
 Hormones,
 defined, 107
 relation to endocrine glands, 108
 Horses,
 famous race horses, 11, 190
 ponies of the western plains, 14
 Horticulture
 (see, Plants)
 Human anatomy,
 sides of body differ, 122-124
 Human life
 (see also, Life)
 (see also, Mankind)
 (see also, Race)
 germ-cells,
 segregated at birth, 36, 66, 67, 98
 heredity,
 life forces explained by, 1, 2
 mother and child,
 relation between, 103-107
 prenatal influence,
 former theories of, 85-94
 propagation of unfit, 4
 suggestions for betterment of, 353-370
 Human mind
 (see, Mentality)
 Human race
 (see, Civilization)
 (see, Mankind)
 Hybrids,
 defined, 26
 Hygiene, 171

I

Immigration,
 American types changed by, 262, 274
 effect on America, 6, 7
 Inbreeding, 139-154
 defects shown by, 147
Inbreeding and Outbreeding,
 East and Jones, 146
 Incas,
 of South America, 19
Influence of Monarchs,
 Woods, Frederick Adams, 12, 200, 244, 250
 Influenza,
 susceptibility to, 158, 169
 (see, Heredity)
 Insanity
 (see also, Mental defectives)
 four generations of, 165
 Intelligence
 (see also, Mentality)
 mental tests, 289-290, 300
 army, 288-291
 statistics of Americans, 291
 Irwin twins, 132
 Italy,
 Renaissance period,
 types of beauty, 265

J

James, William (Professor), 275
 Talks to Teachers and Students, 336
 Jennings, Herbert S. (Professor), 49, 61, 84, 97
 Johnson, Roswell H. (Professor), 325, 360
 Jones, Donald F. (Doctor), 146
 Jordan, David Starr, 11
 on heredity, 74
 Jukes family, 152, 186

K

Kallikak family, 7-10, 70, 71
 Kameron, Paul (Doctor), 69
 Kemble family, 143
 King, Helen D. (Doctor), 146, 147-148
 Kreisler, Fritz, 336

INDEX

L

- Labor,
 problems,
 heredity as factor, 6
 "Law of Genius," 87
 Lawyers,
 influence on legislation, 359
 Leale, Charles A. (Doctor), 277
 Legislators,
 influence of legislation on race,
 363
 Leviticus,
 quoted, 139
 Life
 (see also, Human Life)
 acquired characters, 77-79
 heredity in relation to, 5
 laws of reproduction, 26-37
 mechanism of, 44, 45
 Life Extension Institute of New
 York, 357, 360
 Lincoln, Abraham, 192, 337
 type of man, 276-278
 Loeb, Jacques, 44
 Lodge, Oliver (Sir), 116, 117

M

- Malthus, J. R. (Reverend),
An Essay on Population, 318
 "Man o' War,"
 famous race horse, 11, 190
 Mankind
 (see also, Civilization)
 (see also, Human life)
 (see also, Mental defectives)
 (see also, Population)
 (see also, Race)
 acquired characters, 77-79, 97
 assortative mating, 19, 74
 benefited by great men, 337-338
 characteristics transmitted, 8
 disease,
 relation to heredity, 155-172
 environment,
 dangers of improving, 281-282
 not transmitted, 63, 64, 70
 great men of history, 173, 190
 heredity,
 importance, 1
 heredity and environment, 330-
 352
 inequality of, 330
 influence of beauty, 262-279
 inheritance of qualities, 47

Mankind—Continued

- intermarriage, 140-144, 147, 150-
 154
 knowledge of ancestors, 295, 298
 leaders' influence, 244-261
 mate-selection,
 importance to race, 364
 Mendelian teachings, 80
 Mendelism,
 application of, 56, 58, 59
 mentality
 (see, Mentality)
 population problem, 318, 327
 qualities transmitted, 18
 race improvement not transmit-
 ted, 3
 regulation of reproduction, 20
 royal families
 (see, Royal families)
 selection,
 means of race betterment, 353
 sex predetermination, 52
 sides of body differ, 122-124
 suggestions for race improve-
 ment, 353-370
 twins
 (see, Twins)
 voluntary parenthood, 325
 Marchioness of Donegal, 17
 Marriage,
 assortative mating, 19, 171
 cousin marriages, 138-154
 disease transmitted by, 162-172
 intermarriage, 140-144, 147, 150-
 154
 selection, 83, 296-297, 353, 364
 types changed by, 273, 275
 similar types attract, 76
 tubercular persons, 163
 Martin, Ruth Moxcey (Mrs.), 153
 Maturation, 18
Mechanism of Mendelian Heredity,
 29
 Mendel, Gregor,
 discoverer of heredity, 23, 80
 Mendel's Law, 30
*Mental and Moral Heredity in
 Royalty*,
 Woods, Frederick Adams, 211,
 244, 250, 259
 Mental defectives
 (see also, Insanity)
 cost to government, 291
 heredity chart, 167

INDEX

- Mental defectives—*Continued*
 increase of, 293
 inherited traits, 57-59
- Mental tests,
 appropriation for, 289
 army, 288-291
 value of, 290, 300
- Mental traits
 (see, Mentality)
- Mentality
 (see also, Intelligence)
 adopted sons of popes, 214
 application of Mendelian formulas, 56
 brain-power in families, 173-208
 relation between, 184-188
 financial status in relation to, 212
 great men of history, 173, 190
 group comparisons, 174, 180-182, 198
 Hall of Fame,
 members of, 192, 193, 194
 heredity in relation to, 183-189, 191-208
 inheritance of, 58, 59
 mental tests,
 in arithmetic, 174, 175
 in army, 178
 in children, 180-182
 percentage of great persons, 176-179, 184-187, 190, 194, 197-199
 professional parentage produces
 higher intelligence, 178-182, 185, 190, 196-197
- Microbes,
 effects of discovery, 298
 immunity from, 158
- Mind in the Making*,
 Robinson, James Harvey, 184
- Ministers
 (see, Clergymen)
- Moses,
 Angelo's statue, 277
- Mosquitoes,
 immunity from bites of, 159
- Morgan, Thomas Hunt (Professor),
Mechanism of Mendelian Heredity, 29
Physical Basis of Heredity, 30
 student of heredity, 24, 25
- Motherhood,
 encouragement of, 310-316
 essential to race, 320
- Muller, Doctor, 29
- N
- Nams family, 152, 186
- Nations,
 conditions in relation to ruler, 251-256
 leaders' influence, 244-261
- New England families,
 mentality in, 176, 200
- Newman, Horatio Hackett (Professor), 118
- Nobility
 (see, Royal families)
- Nordic superiority, 81, 82
- Northern Europe,
 Renaissance period,
 types of beauty, 264-269
- O
- Origin of Species*,
 Darwin, Charles, 318
- Outbreeding, 139, 146-147
- Ovary,
 defined, 39
- P
- Paine, Robert Treat, 17
- Paintings,
 facial types shown by, 264-272
- Parents,
 children,
 shown heredity influence, 364-365
- Patterson, Professor, 118
- Pearl, Raymond (Doctor), 205
 birth-rate statistics, 327
 tuberculosis investigation, 162
- Pearson, Karl (Professor), 155, 205, 207
 on early Roman marriages, 141
 on environment, 344
 on heredity, 19, 299
 on vital statistics, 363, 367
 tuberculosis investigation, 162-163
- Peas,
 heredity shown in, 22, 23
- Perry family, 187
- Physical Basis of Heredity*, 30

INDEX

- Physicians,
 as genealogists, 355
 students of human life, 355-358
- Pierpont, Sarah, 17
- Pigeons,
 sex predetermination, 52
- Plants,
 character assortment, 45-47
 corn,
 inbreeding and outbreeding,
 146
 evolution,
 Bateson theory, 54
 genetic analysis, 49-51
 hybrids defined, 26
 peas,
 heredity shown in, 22, 23
 reproduction theory, 26-37
 sex determination, 51
 strawberry plant,
 variation in, 299-300
- Pneumonia,
 susceptibility to, 158
- Politics,
 woman's place in, 280-303
- Popenoe and Johnson,
Applied Eugenics, 56, 129
- Popenoe, Paul, 132
- Popes,
 adopted sons of, 214
- Population
 (see also, Mankind)
 (see also, Race)
 class-suicide, 323
 food supply,
 relation between, 318-320, 327-
 328
 problem of, 318-320, 327
 vital statistics, 327
- "Portraits of Early Americans,"
 269
- Potatoes,
 Burbank cultivation, 15
- Prenatal influence,
 former theories of, 85-94
 mother and child,
 relation between, 103-107
- Prenschoff, Frank (Mrs.), 131
- Pressey, S. L., 181
- Principles of Sociology*,
 Bushee, Frederick A. (Profes-
 sor), 57
- Ptolemies,
 of Egypt, 19, 140
- Public health promotion, 166
- Puritan Stock,
 mentality in, 176, 200
- Q
- Questions for women voters, 283-
 288, 291-294
- R
- Rabbits,
 heredity shown in, 25, 26
- Race
 (see also, Human life)
 (see also, Mankind)
 (see also, Mental defectives)
 (see also, Population)
 deterioration, 4
 selection as factor in changes,
 264, 273
 variation in types, 75, 76, 80-82
- Race betterment,
 beauty in relation to, 262-279
 eugenics,
 factor in, 239, 280-303, 354
 how to obtain, 353-370
 Mendelism,
 aid to study of, 60, 61
 selective mating, 74, 83
- Race propagation, 314-316
- Race-suicide, 16, 323
- Raphael, 190
- Rats,
 crossing of wild and white, 7
 inbreeding effects shown, 147-
 149
- Recessive character, 26, 145
- Reproduction,
 characters transmitted,
 dominant, 26, 145
 recessive, 26, 145
 germ-cells,
 segregated at birth, 36, 66, 67,
 98
 inbreeding, 139-154
 Mendel's theory, 26
 mother and child,
 relation between, 103-107
 prenatal influence,
 former theories of, 85-94
 "reversion to type," 150
- Reproductive cells
 (see, Germ-cells)
- Resolute*,
 speed yacht, 11

INDEX

- Riddle, Oscar (Doctor), 52
 Robinson, James Harvey,
Mind in the Making, 184
 Romans,
 intermarriage among early, 141
 Roosevelt family, 187
 Roosevelt, Theodore, Sr., 317, 318
 Ross, Edward A., 363
Changing America, 273
 Royal families,
*Chart of Great Mountain Chain
 of Royal Geniuses*, 227
*Chart of Mountains and Valleys
 of Royalty*, 221, 224
 great men, 241-243
 great women, 239-241
 heredity, 209-243, 366-367
 heredity and environment, meas-
 urement of, 214
 mental superiority, 257-260
 Rufers family, 186, 193
- S
- Sanders, Carl (Mrs.), 132-134
 Schuster, Edgar (Doctor), 202
 Sex,
 determination of, 51
 predetermination, 52
 Sex-cells
 (see, Germ-cells)
 Shull, George H. (Professor), 84
 Siamese twins, 134
 Siddons, Sarah, 144
 Smith, Clay, 5
 Soma cells
 (see, Body-cells)
 Southern Europe,
 Renaissance period,
 types of beauty, 264, 265
 Spain
 prestige lost, 12
 royal family, 231-234
 intermarriage, 152, 153
 Spencer, Herbert, 314, 319
 Spermatazoon,
 defined, 39
 "Squire of Tyton,"
 Scotch collie, 15
 Starr, Frances, 118
 Statistics,
 American intelligence, 291
 means of using, 248
 questions for women voters, 283-
 288, 291-294
- Sturtevant, Doctor, 29
 "Sybils Gamboge,"
 famous bull, 144
 Syphilis,
 transmission of, 68, 69
- T
- Talcott, Mary, 16, 17
Talks to Teachers and Students,
 James, William, 336
 Teachers,
 influence on study of human life,
 359-360
 Terman, Lewis M. (Professor),
 180, 182
 "Theory of Organic Evolution,"
 319-320
 Thorndike, Edward L. (Professor),
 128, 130, 338, 346
Educational Psychology, 129,
 130, 335
 mental tests by, 174, 175
 Tomson twins, 114, 116, 127
 Tower, Professor, 97
Trend of the Race,
 Holmes, Samuel J. (Professor),
 56, 57
 Tuberculosis,
 heredity factor in, 160-164
 susceptibility to, 158
 treatment for, 161
 Tuthill family, 16-18
 Twins, 109-137
Biology of Twins, 118
 conception of, 119, 120, 130
 dissimilar, 112, 119, 125, 134-136
 duplicate
 (see, Twins, identical)
 effect of environment, 125, 130
 identical, 111, 116, 117, 121-124,
 126, 129, 130, 132
 effect of illness, 127
 mental traits, 128
 production of, 120-122
 sex of, 119, 121
Two Little Girls in Blue, 113
 Typhoid,
 susceptibility to, 158, 169
- U
- United States
 (see also, America)
 cousin marriage laws, 141

INDEX

University of Missouri,
babies studied, 311

V

Van Dyke, Henry,
on inequality of men, 330

Variation,
defined, 14

Vienna,
vital statistics, 327

Vincent,
Bishop, 18
George, 18

Voelker, Paul F. (Doctor), 332

W

Waite, Morrison R., 17

Watson, John Broadus (Doctor)
236, 332

Wedgewood, Emma,
wife of Charles Darwin, 143

Weismann, August, 66

Wells, H. G., 294

Wheeler, William (Professor), 34

Whetham, C. D. (Mr. and Mrs.),
198

Whitman, Walt, 280

Whitney, Eli (Mrs.), 17

"Wild Tom,"
famous bull, 190

Wilder, Harris Hawthorne (Pro-
fessor), 116, 122, 124

Wilson, E. B. (Professor),
*Cell in Inheritance and Develop-
ment*, 32

Winship, A. E. (Professor), 16

Women,
knowledge of biology, 232
of East Prussia, 273
place in race betterment, 280-
303

voters,
questions for, 283-288, 291-294

Woods, Frederick Adams (Doctor),
127, 334

Influence of Monarchs, 12, 200,
244, 250

*Mental and Moral Heredity in
Royalty*, 211, 244, 250,
259

on changes in types, 264

on intelligence and beauty, 278

on voluntary parenthood, 323

studies of,
heredity in Hall of Fame, 191

Wright, Sewall (Doctor), 149

Y

Yachting,

American supremacy, 11

Yale University,

Timothy Edwards founder, 17

Z

Ziegfeld chorus,

beauty in, 276

Ziegfeld, Florenz, 276

on feminine beauty, 296

Zoology

(see, Animals)

Clifton Linsbury
2216 Ward St.,
Berkeley, Calif.

