

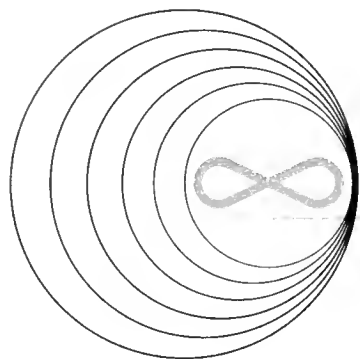

THE FUTURE IS OUR ASSIGNMENT

A Glimpse behind the Scenes at the General Motors Research Laboratories



Some of the General Motors Research Laboratories' Department Heads assemble on the unique spiral stairway in Research Administration Building lobby together with Manager Arthur F. Underwood, Vice-President Lawrence R. Hafstad, and Scientific Director John M. Campbell.

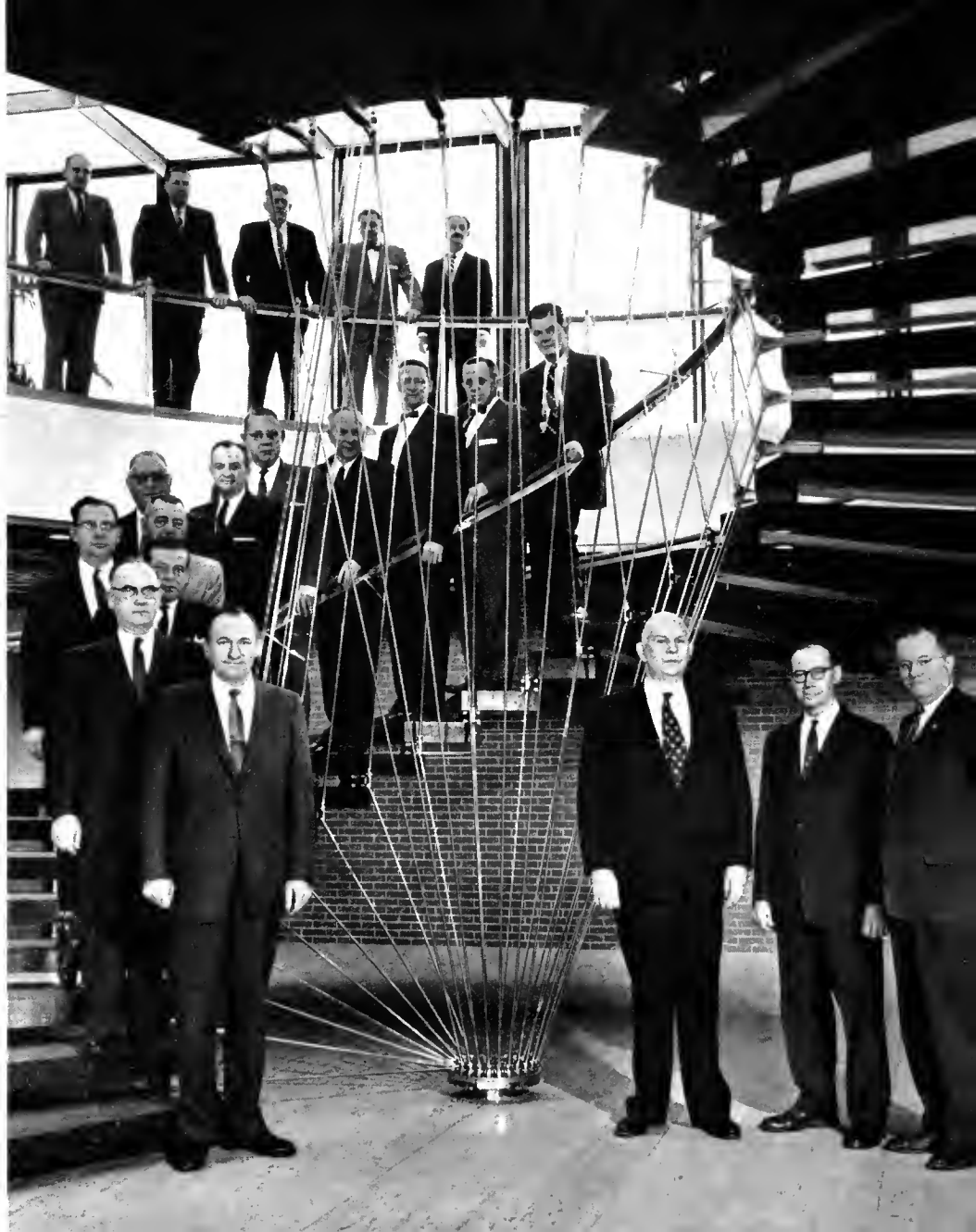

5
6/1/0
8/2

THE FUTURE IS OUR ASSIGNMENT

From the collection of the

o Pre^{z n m}linger^a
v Library
t p

San Francisco, California
2008

Produced with the cooperation
and technical assistance of the

GENERAL MOTORS RESEARCH LABORATORIES

by the

Public Relations Staff

GENERAL MOTORS

Detroit, Michigan

© 1959 GENERAL MOTORS CORPORATION

Contents

page

CHANGE IS A CHALLENGE 4

THE CRYSTAL KEY 8

THE BIG SQUEEZE 13

WINDMILLS AND BOUNCING PISTONS 22

MARVELS IN METALS 27

AN INSIDE STORY OF THE OUTSIDE 32

FLIGHT OF THE FIREBIRDS 39

IMPLEMENTS OF INQUIRY 45

THE OTHER EIGHT HOURS 51

THE FUTURE IS OUR ASSIGNMENT 54

SOME IMPORTANT DEVELOPMENTS . . . *inside back cover*

CHANGE IS A CHALLENGE

In a little over half a century—from 1900 to today—our world has been transformed. Gone is the leisurely world of our parents, or grandparents, as the case may be—the world of the horse, the long workday, the dirt roads, the cavalry and the battleship navy. The geographical frontiers have practically disappeared and isolation is only a word in the dictionary.

At the turn of the century it was difficult to discern this pattern of change. True, there were some tangible evidences: things such as the telephone, the electric light, wireless, and that newcomer on the scene, the horseless carriage. But by and large these had not yet greatly changed the way of living of most Americans.

But, nevertheless, in the minds of certain men in a few isolated laboratories and workshops the future was taking shape. J. J. Thompson had uncovered the electron, Roentgen discovered the X-ray, the Curies

isolated the elements Polonium and Radium, and a German-born physicist, Albert Einstein, while working in the Swiss Patent Office in 1905, formulated one of the most renowned equations of science: $E=mc^2$. In America, Willard Gibbs had already created the science of physical chemistry, the Wright brothers were preparing for Kitty Hawk, Baekeland had started his search for a “synthetic” resin,

De Forest patented the “audion” vacuum tube in 1906, and Ransom Olds, Henry Leland, and Henry Ford were laying the foundations for the American methods of mass production.

Thus, although perhaps only a Jules Verne could visualize it, the stage was being set for our world of today. The interesting thing in this connection was the time lag between the



Dr. LAWRENCE R. HAFSTAD
*Vice President in charge of
Research Laboratories*

initial discovery and when the idea first appeared in a usable or commercial form. The chart below shows that this time interval is becoming shorter and shorter. For instance, though it took thirty-five years to bring radio from an idea to commercial use, it only required five years, fifty years later, to produce a working transistor from a theory.

Today world conditions and demands of people put a premium on time. As science delves deeper into the mysteries of nature, the attendant complications increase. It is obvious that an interstellar spaceship is beyond the capabilities of even two such men as the Wright brothers, and the conception of an atomic-powered airplane in its entirety might well confound the most brilliant mind. We cannot any longer rely entirely on the lone inventor with his comparatively limited means

and facilities. The stakes are too high.

Experiences, such as World War II, have taught us the value of concerted effort—the concentration of teams of scientists, engineers and technicians working with the most modern facilities on the intricate problems that face us today. The larger the problem the more diversified must be the attack and the more versatile must be the task force. Nature is most impartial in her use of the sciences—in the production of a single tree she employs biology, chemistry and physics. And from an engineering viewpoint she uses the materials to the best advantage. To solve her mysteries and advance our frontiers of knowledge we cannot afford to confine ourselves to a narrow front; all resources, both mental and physical, must be brought to bear on the many faceted unknowns.

In recognition of this modern-day challenge General Motors in 1956 dedicated its new Technical Center to the advancement of science and technology. Here four separate Central Office staff activities—Research Laboratories, Central Engineering, Process Development and Styling—employing over five thousand scientists, engineers, designers and technicians, are devoting themselves to the task of uncovering new knowledge and applying it to the production of more and better things for more people.

The Research Laboratories, occupying the largest group of buildings and employing around 1,400 people, are engaged in activities which fall more or less into four categories—basic research, applied research, engineering development and consultation. Because of the very nature of the work it is

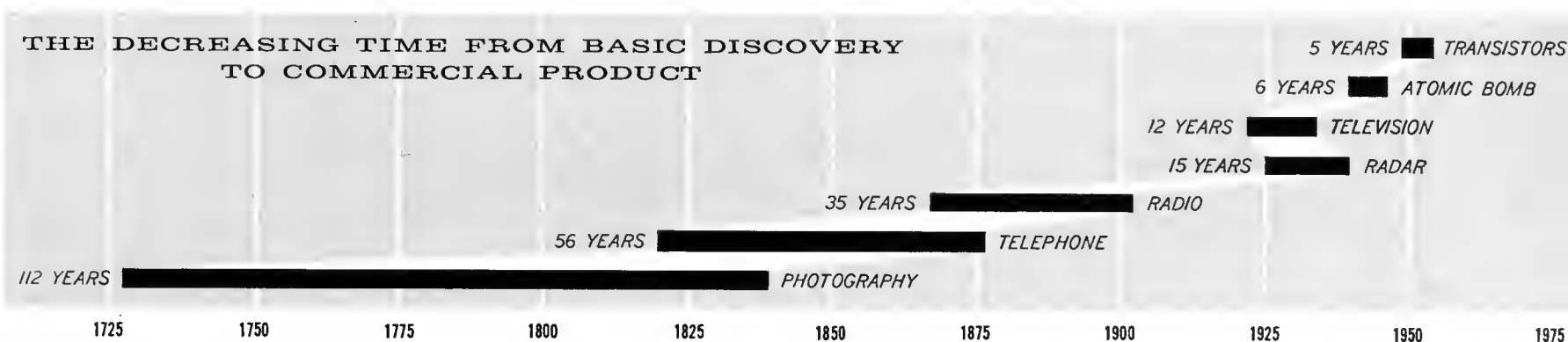

**GENERAL MOTORS
RESEARCH
LABORATORIES
FIELDS OF ACTIVITY**

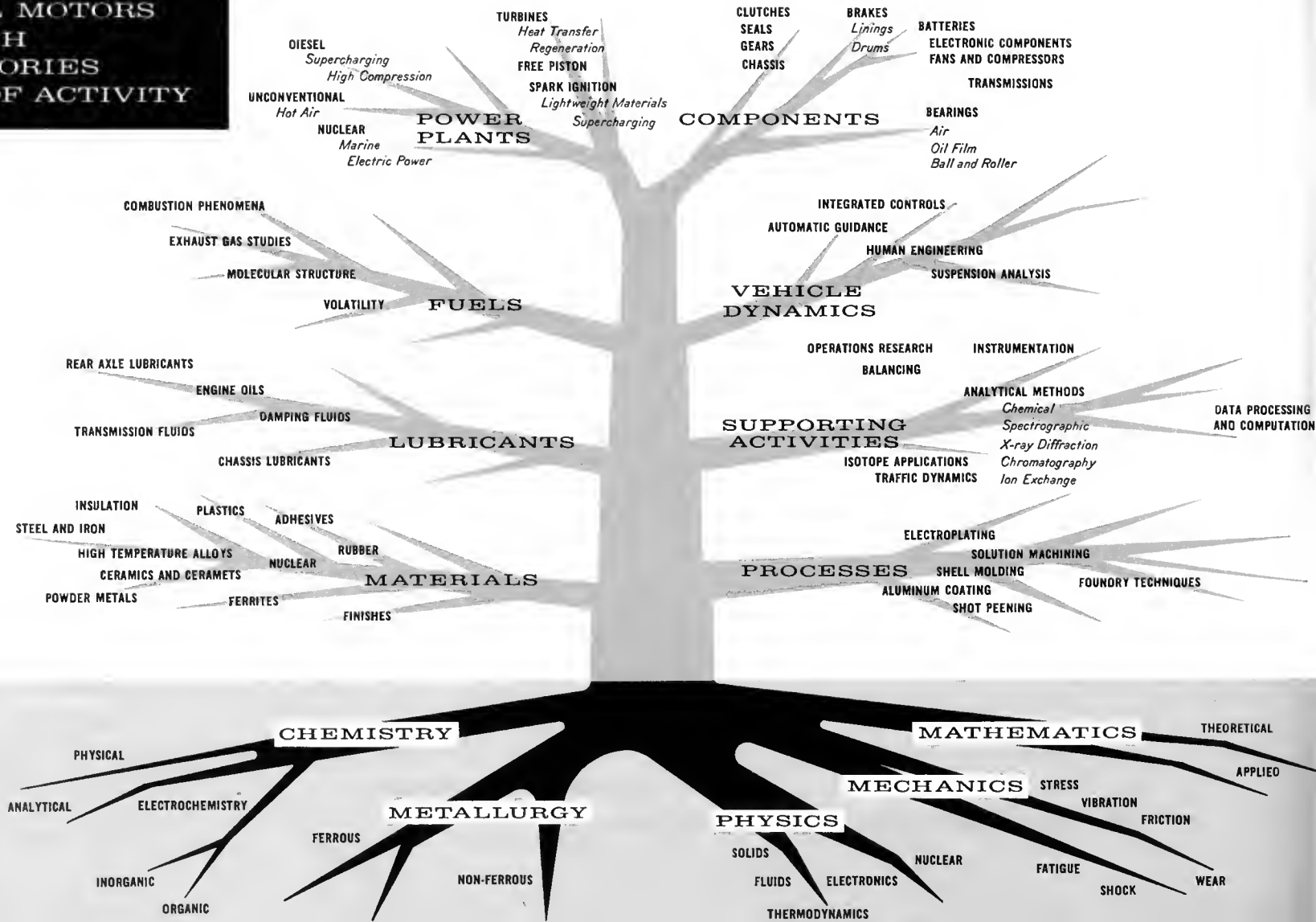

difficult to ascribe definite boundaries to the spheres of operations of these activities inasmuch as they have a tendency to overlap. By the same token the activities of the teams of scientists, engineers and technicians involved cannot be circumscribed. The character of the project itself dictates the selection of people having appropriate training, interests, skills and experience. This means that many branches of science and engineering may be represented on a single project.

The staff of the Research Laboratories is a rich source of experience and skills to call upon for such project assignments. For instance, its 405 professional graduates are presently made up of 50 holding Doctor's degrees, 130 having Master's degrees, and 225 who have received Bachelor's degrees. These cover the sciences: physics, chemistry, and mathematics, as well as the various branches of engineering, such as mechanical, electrical, chemical and metallurgical. In addition to the knowledge and experience of its own personnel, Research maintains a relationship with outstanding authorities of the academic world—in fact, more than fifty representatives of over thirty leading universities and colleges are associated with the

Laboratories' staff in a consulting capacity. This relationship with the colleges is supplemented by a program of research grants and fellowships in selected fields of particular scientific and engineering interest.

To give a reasonably accurate picture of what takes place in a modern industrial research organization such as ours, we are presenting in the pages that follow some case examples of contemporary projects of a research and development nature. We emphasize "contemporary," as of this writing, because constant change is essential to the success of this type of prospecting.

Since its establishment nearly forty years ago under the direction of Charles F. Kettering, the contributions of the General Motors Research Laboratories have significantly changed American transportation both on the road and on the rails. Household refrigeration, medicine and national defense are other fields that have benefited from General Motors Research developments. But this is the past and our major inheritance from that is the intangible thing known as "experience." This, coupled with the highest type of trained personnel and the most up-to-date facilities and instrumentation available, places our

organization in a most advantageous position to explore the future.

What the world of tomorrow holds for us we do not know, but I am inclined to agree with Professor Frederick Soddy(*) when he made this statement earlier in this century:

"We find ourselves, in consequence of the progress of physical science, at the pinnacle of one ascent of civilization, taking the first step upwards out on to the lowest plane of the next. Above us still rises indefinitely the ascent of physical power—far beyond the dreams of mortals in any previous system of philosophy."



*Professor Frederick Soddy—the renowned English chemist who assisted Dr. Rutherford in his radioactivity research, developing the theory of atomic disintegration and investigating the origin and nature of isotopes. He was awarded the 1921 Nobel prize in chemistry.

THE CRYSTAL KEY

Disraeli once said, "Change is inevitable in a progressive country," and in today's world it is generally recognized that basic research is the wellspring of change. This research takes many forms in many fields, but fundamentally the investigations have one thing in common, they usually involve relationships between matter and energy.

In General Motors we are vitally concerned with both of these things—we use tremendous quantities of a great many different materials, and annually produce over half a billion horsepower in the form of internal combustion engines. As a consequence, the acquiring of new fundamental information on the chemistry and physics of matter and energy is of prime importance to our research organization, even though we may not know how such information may be eventually applied. You may recall that Faraday put it this way over a century ago when a lady asked him of what use was his recent electrical discovery. "Madam," he replied, "of what use is a new-born babe?"

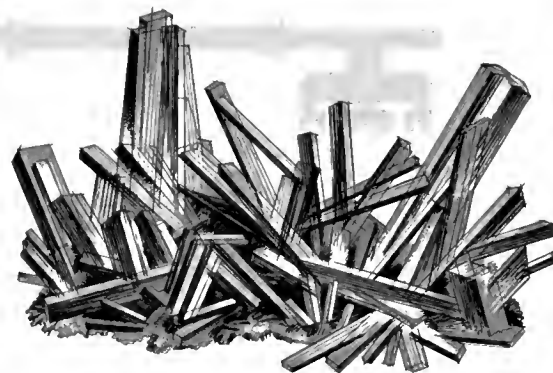

Cd S

Prompted by General Motors' great interest in various materials, the management of General Motors Research Laboratories has assigned a considerable amount of its basic research to that branch of science known as solid state physics—the study of the various properties of solid materials. In recent years knowledge in this field has grown rapidly, and the tangible results of study and experimentation have already yielded results leading to new horizons—a better understanding of electrical phenomena, improved communication, new ways of capturing solar energy, new developments in transforming heat into electrical energy and vice versa, stronger and more durable materials, and a better insight into friction, the enigma of the ages.

At present the focal point of this solid state

research is the crystal. Most solid materials have some degree of crystallinity—even a cotton fiber, a fingernail, or a hair. As world-renowned crystallographer Professor Allan Gwathmey of the University of Virginia has said, "It is difficult to tell which is the most interesting aspect of a crystal—its beauty, such as possessed by the diamond or sapphire; its order; or its strange properties which make it useful, such as the crystals which can talk, hear, remember, amplify, and convert sunlight into electrical energy."

In the 18th Century a biologist, Abbé Hauy, in studying a calcite crystal, came to the conclusion that crystals were made up of atoms arranged in a three-dimensional pattern. In the 19th Century other scientists, after many calculations, concluded there are

an infinite number of crystals depending on whether the atoms are put closer together or farther apart, but the types of patterns, or designs, in which these atoms can be arranged are limited to only 230.

From these studies it is easy to gather that the inner structure of a crystal is a mathematician's paradise. The solid state physicists have their own language involving such terms as "lattices," "dislocations," "magnetic domains," "holes," and "vacancies." In recent years volumes have been written on this subject but rather than attempt to explain the complexities of these studies and their applications, let us pay a brief visit to a few people in the Research Laboratories at the General Motors Technical Center and see first hand some of the things our physicists are exploring in this fruitful field of science.

For instance, let us drop in on Dr. Robert Coleman, an acquaintance of Dr. Gwathmey and graduate of the University of Virginia. Dr. Coleman devotes much of his time to the

Dr. Robert Coleman's research on the magnetic domains in single iron crystals (shown on the right) is a significant contribution to our knowledge of that mysterious force—magnetism.

fascinating art of growing and analyzing single crystals of iron of high purity and perfection—long, thin crystals or "whiskers," as he calls them. He has presented several papers on his work and is becoming an authority on the subject.

"Some years ago," Bob tells us, "a scientist calculated iron made up of pure crystals should be 100 to 1,000 times stronger than the best available commercial iron, or even steel. Experiments with our 'whiskers' indicate this might indeed be so, but we are also

interested just now in studying the magnetic properties of these single crystals or 'whiskers.' A single crystal of high purity offers us opportunities to experiment, study, and mathematically analyze the internal structure and magnetic properties of a single system uncomplicated by impurities or other variables introduced in crystal aggregates."

He might have added that any fundamental knowledge he uncovers—the basic ground rules governing magnetism in single iron crystals—might well be the starting point of



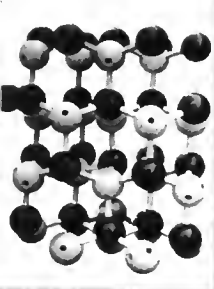

Yro ("Wally") Sihvonen with an atomic model of his cadmium sulfide crystal which is proving its value as a super-sensitive radiation detector.



future startling developments in many electrical devices. By the same token Research studies in the field of crystallography cannot help but cast additional light on such practical problems as the hardening, ductility and

ultimate strength of steels, and also uncover new information on corrosion and internal friction of metals.

While we are on the subject of crystals let us go downstairs and visit some other crystal

growers—Wally Sihvonen and Dave Boyd. Their main interest is bringing into being a crystal that does not exist in nature in a pure and perfect form—a cadmium sulfide crystal as flawless as possible. By artificially altering the crystal structure it can become a tailor-made semi-conductor. Semi-conductors include such things as germanium, the basis of that modern marvel of electronics, the transistor; and silicon, the principal component of the light-sensitive cell which converts sunlight into electricity. In other words, speaking in a very elementary fashion, semi-conductors are substances whose electrical properties are affected by radiation, temperature and electric fields in such a way as to make them very useful as amplifiers, light-sensitive and thermoelectric devices and so on.

The first problem facing Sihvonen and Boyd was to produce as large and as perfect a crystal of cadmium sulfide as possible and then alter, or "dope," its structure to make it useful as a semi-conductor. A book could be written on the intricate techniques developed to produce cadmium sulfide crystals of great purity and precise chemical composition. But the feat has been accomplished and for the first time single crystals weighing over

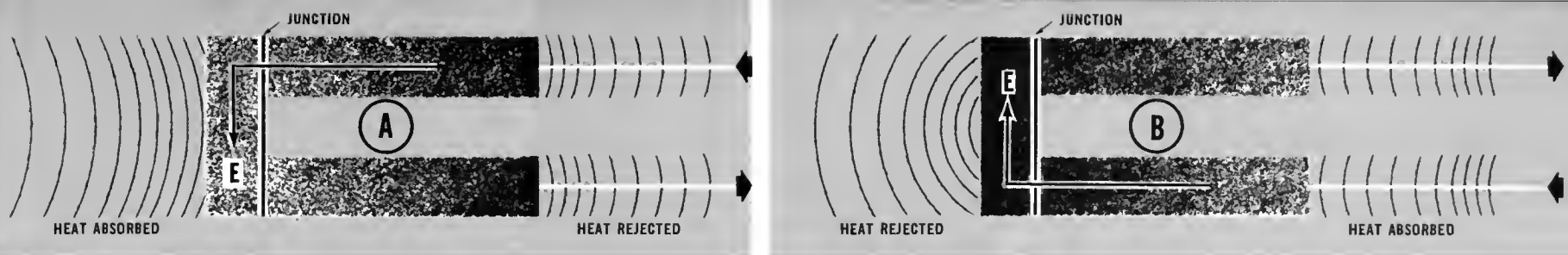

THE PELTIER EFFECT makes thermoelectric cell act as a refrigerating unit or heating unit. Electric input to the cell as shown in A cools the junction, causing it to absorb heat and heats the ends of the semi-conductors at right, causing them to give up heat. By reversing the direction of the current as shown in B the junction can be made to give up heat.

ten grams have been grown—a thing unheard of a few years ago. One consequence of this research has been the development of super-sensitive X-ray and light-sensitive detectors which have the ability to change their resistance *one hundred million times* when irradiated.

“Versatile” is the word for that modern day miracle of science, the semi-conductor. It can change the whisper of an electronic signal into a shout, it can convert the sun’s rays into electrical energy sufficient to power a telephone system, or on the other hand, when electricity is caused to flow through certain semi-conductors, heat can be absorbed or liberated; or vice versa, the application of heat can be made to produce a flow of electricity.

But let’s get the story of this last characteristic from Dr. Thomas Hughel of the Research Metallurgical Department. “One hundred twenty-five years ago,” Dr. Hughel tells us, “Jean Peltier, a French physicist, found that heat is absorbed or liberated at the point

where two dissimilar metals, such as iron and copper, are joined together in a circuit carrying an electric current. This is known as the ‘Peltier effect.’ In the years since, it has been found that this effect could be greatly magnified by the proper choice of metals, such as bismuth and antimony instead of iron and copper. As long ago as 1890 a man by the name of Dewey was assigned a patent on an electrical *refrigerating* system for railway cars using this principle. But as we have since found out, it was not possible to get a sufficient drop in temperature using the metal junctions he recommended. In fact, it looks as though none of the metallic alloys can do such a job.

“However the picture has changed considerably with the advent of the semi-conductors; now it appears some of these may have as much as 100 times the thermoelectric

power of the metallic alloys. In this country and abroad several experimental refrigerators using molecular compounds of bismuth and tellurium or lead have been built. The advantages are obvious—the mechanical middleman, the compressor, between electricity and cold is eliminated. By reversing the ‘Peltier effect’—producing an electrical current by the application of heat—we may be able to use the heat from an atomic pile to produce electricity direct without going through the usual steam boiler, turbine and electric generator. Our new friend, the semi-conductor, seems to have opened another door for us.”

Years ago Charles F. Kettering posed a question which until comparatively recently, after years of basic research, had not been satisfactorily answered—“What is friction?” The Dr. Jekyll-Mr. Hyde qualities of friction

emphasize the importance of obtaining a complete answer because not only is friction a prime robber of efficiency in all moving mechanisms but, vice versa, our land transportation depends upon its action for movement as well as stopping.

Friction occurs when there is resistance to relative motion between two surfaces in contact. Inasmuch as the surface characteristics of most materials depend upon their crystalline structure, GM Researchers in the Mechanical Development Department decided an investigation of the adhesion, or sticking qualities, of two specimens of polycrystalline copper might result in uncovering some fundamental information on friction and wear.

It sounds simple but as investigator Carl Goodzeit knew, the value of the experiment depended not only upon the purity of the specimens but most importantly upon the cleanliness of the contacting surfaces. Even a film of gas *a single molecule thick* on the surfaces could distort the results. So the two specimens would have to be brought together in a vacuum of the highest order obtainable. Months of work went into perfecting an apparatus to create a vacuum so high *that each gas molecule would have to travel an average*



Carl Goodzeit bringing together the two specimens of polycrystalline copper (shown on the left) to determine their adhesion properties.

of over 200 miles before colliding with another molecule!

The result was that when the two copper specimens were just touched together in this vacuum, their surfaces were so clean that adhesion took place on contact and a force of several pounds was required to tear them apart. So another bit of knowledge has been added to the accumulating clues to the friction enigma—why metals adhere.

We have touched upon, in a rather cursory and elementary fashion, the highlights of a few of our Research investigations of a fundamental nature involving that Cinderella of

the Sciences—the study of crystals. Because of the relative infancy of this branch of science it is difficult to predict the myriad implications. From the results of solid state research to date, however, in other laboratories as well as in General Motors Research, we know we are gaining a deeper and deeper insight into the nature of matter that will enable us to predict accurately the behavior of materials. This ever-increasing knowledge of crystals could easily be the key to undreamed of new scientific techniques and tailor-made engineering materials from which we shall form our World of Tomorrow.

THE BIG SQUEEZE

You are rolling smoothly along the Pennsylvania Turnpike at a mile-a-minute speed listening to a newscast and probably giving little thought to the miraculous things taking place up in front of you under the hood of your car. Every minute, and every mile you cover, 10,000 fires are started and burn themselves out in the cylinders of your engine.

Few of us give a second thought to the scores of years of painstaking and time-consuming research that have gone into that marvelous chemical factory under the hood and the developments in fuel chemistry that make its smooth and efficient operation possible. For the inside story let us go behind the scenes at the General Motors Research Laboratories and chat with some of the scientists who have made careers of understanding and perfecting the most widely used source of power in the world today—the internal combustion engine.

AVERAGE
COMPRESSION
RATIO



THIRTY FIVE YEARS

Our first port of call is the office of John Campbell, Scientific Director of the GM Research Laboratories, a veteran of over thirty years in fuel research, and a recipient of the Horning Award, sponsored by the Society of Automotive Engineers, for his contributions to the mutual adaptation of fuels and engines.

“To appreciate where we are today and get a better view of the road ahead,” John Campbell explains, “we should backtrack about forty years when the battle of knock started. Charles F. (‘Boss’) Kettering in a talk before the Society of Automotive Engineers in 1919 pointed out that more efficient automotive engines depended upon higher compression ratios—squeezing the air-fuel mixture in the cylinder more and more before the spark plug fired it. But the thing that limited ‘the big squeeze’ was the resulting fuel knock. He concluded that the molecular structure of the fuels themselves had a great



Over thirty years ago John Campbell began his investigation of the molecular structure of fuels and their knocking characteristics.

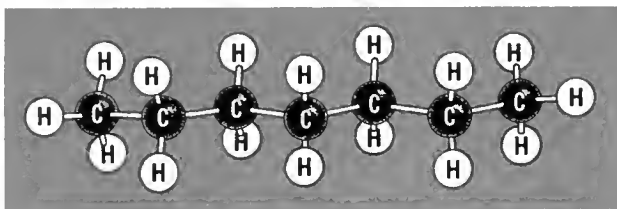

The chain arrangement of the hydrogen and carbon atoms in the normal heptane molecule, shown on the left above, gives a clue to its character as a bad knocker. By contrast the more compact arrangement in iso-octane, in the center above, and triptane, on the right, explains their superior antiknock qualities.

influence on this tendency to knock. It was this thinking that led GM Researchers Thomas Midgley, Jr. and T. A. Boyd to the discovery of the anti-knock properties of tetraethyl lead now almost universally used in gasoline, and charted the course of the petroleum industry in its search for better fuels.

“When I joined the GM Research Laboratories in 1926, the study of molecular structure instituted earlier by Mr. Kettering was just getting started, the intervening years having been devoted very largely to problems associated with the introduction of tetraethyl lead in commercial gasolines. Engine compression ratios were just beginning to increase from a level of around 4 to 1 as a result of the appearance of “Ethyl” gasoline at filling stations. But the fundamental research on combustion was greatly handicapped by the lack of dependable yardsticks

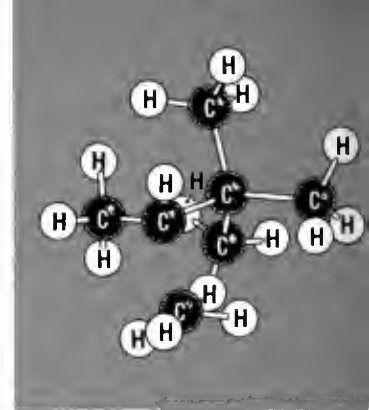
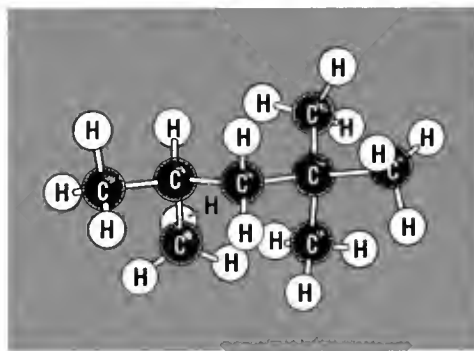

to measure knock. One of our first steps to correct this was to build a single cylinder engine, the compression of which could be varied from a low of 3 to 1 to as high as 15 to 1. Using this engine we found the tendency to knock was also affected by the ratio of air to fuel, the timing of the igniting spark, and water and air temperatures. This information enabled us to set up a standard knock-testing procedure to compare fuels accurately.

“One more thing was missing—a standard fuel to which we could refer our tests. This was supplied by Dr. Graham Edgar in 1927 when he discovered that iso-octane, first synthesized by Russell Marker in the laboratories of the Ethyl Corporation, had excellent anti-knock characteristics. This was taken as 100 on an anti-knock scale. The lower limit, or zero on the scale, was established by normal heptane, a bad knocker. The proportion of

iso-octane to heptane in a mixture of the two that matched any given fuel in knocking tendency was then taken as the measurement of the anti-knocking quality of the fuel in question and was called the *octane number*, a term familiar to nearly all motorists today.

“The yardsticks having been established, the quest for more basic information was accelerated. This search took two paths: one, the determination of the effect of the molecular structure of fuels on their anti-knock quality; and two, the study of the phenomenon of combustion itself within the cylinder. My work took me down the first path, and we measured the knocking characteristics of dozens of pure hydrocarbon fuels on our variable compression engine. Many of these hydrocarbons were synthesized for the first time in our laboratory. The results of these

investigations proved that a hydrocarbon molecule, like normal heptane, which has its hydrogen and carbon atoms arranged in a long straight chain, knocks badly in an engine, as compared to the high anti-knock quality of fuels having more compact molecular structures, such as iso-octane.

“This knowledge of the influence of molecular structure on knocking tendency, coupled with a desire to increase the yield of gasoline from crude petroleum, led the oil industry researchers to investigate new refining processes to get more gasoline of a higher anti-knock quality. While this research on fuels was taking place, other GM Researchers such as Lloyd Withrow and Gerald Rassweiler were going down the other path seeking to unravel the mysteries of combustion inside the engine, but I think you should get that story firsthand from Dr. Withrow himself.”

“As John has intimated,” Dr. Withrow told us, “fuels and combustion are so intimately linked it is difficult to discuss one without mentioning the other, but I’ll try to stick to the actual burning of the air and gasoline in the cylinder. From the beginning, investiga-

tors were greatly handicapped by their ignorance of what was actually taking place in the engine’s stomach. To probe into these mysteries many devices were tried—sampling valves, a quartz peephole, and spectrograph. Later, by using a large quartz window extending across the entire combustion chamber and using high-speed motion picture film, we could photograph the entire burning process from the moment of ignition to its completion.

“This insight into the mysteries of combustion helped clarify the knock problem. The

pictures clearly showed the combustion process—the flame steadily spread from the spark plug across the combustion chamber much as a fire spreads across a field of dry grass on a windy day. At a car speed of 60 miles an hour *this journey across the combustion chamber takes only 1/500 of a second!* When knock occurred the pictures sometimes showed another fire starting spontaneously quite a distance ahead of the oncoming flame front; the heat and pressure built up by the advancing flame apparently caused the unburned

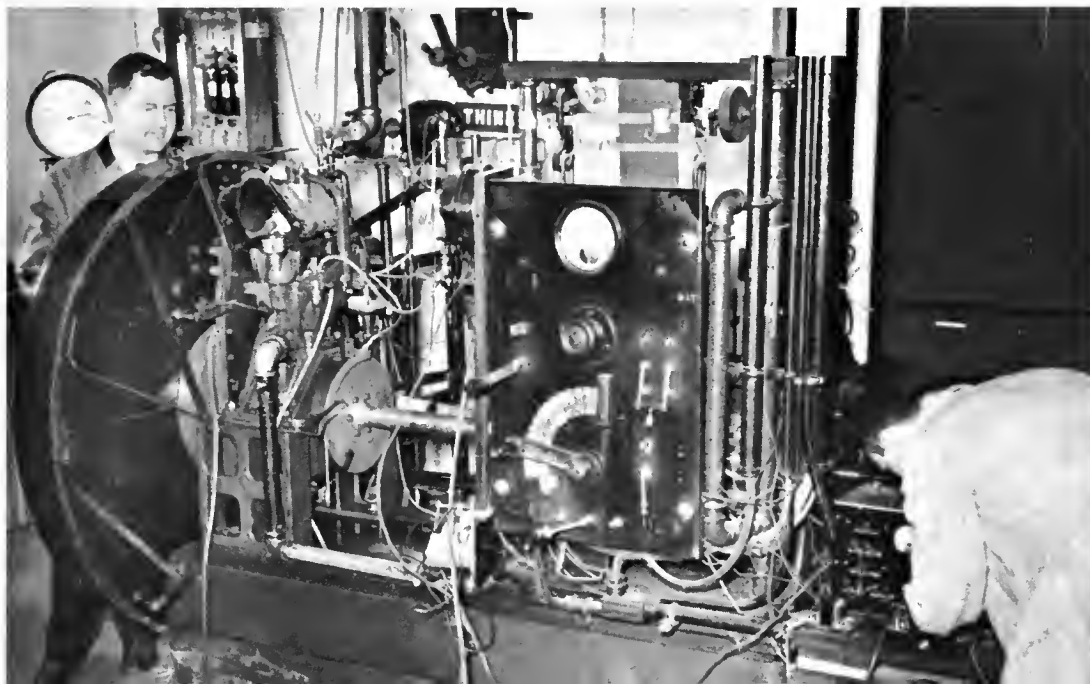

Doctors S. Lloyd Withrow and Gerald Rassweiler at the high-speed camera with which the first flame travel photographs were taken through a quartz window in the head of a test engine.

gas ahead to ignite spontaneously. This resulted in a considerable and sudden rise in pressure which evidenced itself as a detonation, or knock.”

In 1934 the Researchers decided to put to test some of their new knowledge, and built and installed in a car an engine having a compression ratio of 10 to 1, almost double that of the automobile engines then in use. The engine showed some spectacular improvements in performance and economy, but its operation was extremely “rough”—that is to say, the entire engine structure emitted a harsh and objectionable sound. This raised serious doubt among engineers as to the feasibility of using such high compression ratios. However, Researchers Withrow, Stone and Fry investigated mathematically and experimentally the causes of “roughness” and concluded that although it could be controlled to some degree by regulating the combustion, the real culprit was mechanical deflection of the engine structure itself caused by the higher combustion pressures prevailing in the higher compression engines. Hence, they reasoned, if the critical parts of an engine were made rigid enough there would be no incidental “roughness.”

As a result of this study and the subsequent development of a suitable fuel, Triptane, which was synthesized in tank car quantities for the first time during World War II in the Laboratories, the GM Research and Engineering Staffs, working together, produced a new six-cylinder engine having a $12\frac{1}{2}$ to 1 compression ratio, nearly double that of one of the 1946 passenger car engines of comparable horsepower. However, the displacement of the experimental engine was only two-thirds that of the production passenger car engine.

The two engines were installed in identical cars and in June, 1947, Kettering and his associates demonstrated them to members of

the Society of Automotive Engineers at their summer meeting. The results were extremely impressive. It was practically impossible to tell which car was which with respect to smoothness and performance. But at 40 miles per hour the higher compression car gave 8 more miles per gallon than the standard car and at 60 miles per hour the gain was 6 miles per gallon. The average gain in fuel economy in a large number of cross-country trips was about one-third or 33 per cent!

This marked the beginning of the post-war revolution in engine design, the pattern for the industry being set by the introduction of the new overhead-valve, high-compression V-8 engines by Cadillac and Oldsmobile late

“Boss” Kettering examines the revolutionary $12\frac{1}{2}$ to 1 compression ratio engine which he disclosed in a presentation to the Society of Automotive Engineers in June, 1947.





Doctors Bowditch and Withrow study flame photographs for evidence of surface ignition.

in 1948. Once the public had experienced their performance and economy, motoring took on a new dimension.

Today the search for new facts concerning the relationships between fuels and combustion continues on several fronts in the GM Research Laboratories. But let's get the stories first hand from some of our Research scientists and "combustioners."

"The price of progress is trouble," so goes the saying, and as the compression ratios have

climbed, the new, more efficient engines have developed certain characteristics that are occupying the waking hours of many GM Researchers.

As engine compression ratios have increased, and the air-gasoline mixture has been squeezed more and more, a new disturbance has entered the combustion picture—a new noise has been recorded. It has been identified by several different names but most frequently as "rumble" to distinguish it from the

well-known "knock." Rumble is generally encountered when operating at relatively high power or may start at fairly low speeds under heavy load. Old-fashioned knock is a rather high-pitched noise and is recurrent and repeatable; while, on the other hand, rumble is a low-pitched noise and is erratic. And rumble can occur when there is no knock. However, both phenomena are accompanied by high pressure rises in the cylinder. Turning his attention to the problem, Dr. Withrow assisted by Dr. Fred Bowditch, a recent graduate of Purdue at the time, uncovered a clue to this phenomenon for which they too received the Horning Award in 1952. Using a quartz-windowed cylinder head and high-speed photography, they obtained the first pictures of the phenomenon known as surface ignition.

Some years later another General Motors "combustioneer" Warren Wiese in a paper presented to the Society of Automotive Engineers in June, 1958, put it this way, "Knock can be controlled by proper design of the engine to fully utilize the available anti-knock quality of gasoline, but surface ignition (of

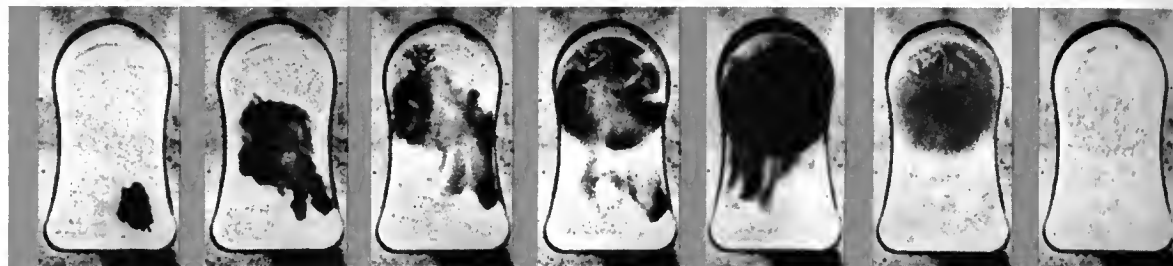
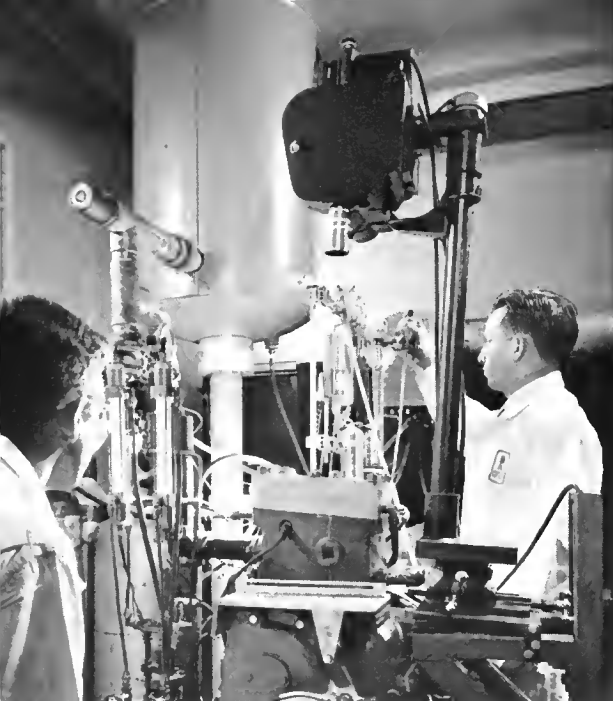

The team of Wentworth and Daniel, using the photographic apparatus on the left, obtained the flame photographs above. The character of the combustion supplies much-needed clues as to source of the unburned hydrocarbons escaping from a car's exhaust.

which rumble may be a symptom) presents a more formidable obstacle because no way is now known to directly control it by engine design. Since surface ignition as well as knock must be controlled to make further gains in engine efficiency, the possibility of reducing surface ignition through changes in gasoline composition is of great interest.”

And so a new phase of the battle against engine noise is taking shape. It has been pretty well established that the villain in the case of rumble is deposits on the combustion chamber

surfaces. These start to glow and ignite the unburned fuel mixture thereby causing a rapid rise in pressure resulting in the erratic, low-pitched, rumbling noise. Obviously then, the solution is to prevent the accumulation of these deposits or control their effect.

It sounds simple, but in just one series of tests reported by Wiese eight cars were driven nearly 300,000 miles to obtain data on the effect on the combustion of the deposits accumulated. These tests pinpointed the fact that the make-up of the gasolines used definitely affected surface ignition and rumble. Also, by using certain phosphorus-type additives in the fuel, ignition could be controlled and there were definite decreases in rumble.

All of which goes to prove that in modern research each forward stride is attained only by extremely painstaking observation and analysis. There is no short cut to new

knowledge.

For example, let's turn our attention to the problem that has been identified with Los Angeles in recent years—smog. Air pollution scientists believe this condition is partly attributable to traces of hydrocarbons found in the exhaust gas of automobiles. For this reason, General Motors and other automobile manufacturers have set up extensive research programs to study this problem. The determination and control of hydrocarbons in automobile exhaust gases have been the object of thousands of hours of research on the part of General Motors scientists, such as Wayne Daniel and Joseph Wentworth of the Fuels and Lubricants Department.

It was known that the highest concentrations of unburned hydrocarbons were found in a car's exhaust gas when the engine was decelerating, or when idling, so the team of

Daniel and Wentworth decided to study a single cylinder engine under these conditions and to observe and to analyze the results. Their engine was fitted with a quartz window extending across the combustion chamber. Using a high-speed motion picture camera capable of taking 800 pictures a second, they were able to follow closely the progress of the combustion flame from start to finish. At the same time, from analysis of the exhaust gas the amounts of unburned hydrocarbons in the exhaust gas could be determined.

For months they tracked down the source of the unburned hydrocarbons flowing out of

the exhaust. They finally reached the conclusion that, when the engine was decelerating, the flame failed to burn completely across the combustion chamber and the unburned mixture escaped out the exhaust system and into the air. The size of this unburned area, and incidentally the quantity of the unburned hydrocarbons emitted from the exhaust, varies as the engine is decelerating, idling or running at full throttle. As a result of this outstanding investigation, the problem of eliminating unburned exhaust gases is one step nearer to solution and these GM Researchers were given the Horning Award in 1955 for their contribution to our knowledge of combustion.

One of the problems that has faced the exhaust gas investigators since the beginning has been the development of a rapid and accurate means of analyzing the exhaust—just what are the hydrocarbons in the exhaust gas, and in what quantities? Here again Wentworth, assisted this time by William Heaton, developed a method that is amazingly accurate and rapid. According to Bill Heaton there was no existing analytical method that

was easy to operate, relatively inexpensive, was extremely sensitive to *all* hydrocarbons and capable of indicating their concentrations.

It was a tall order but after months of experimentation they found the answer in the combination of a gas absorption column coupled with an infrared analyzer. In effect, the gas absorption column separated out the different hydrocarbons and the infrared detector did the measuring job.

The analyzer was extremely rapid, and sensitive and simple to operate. After a series of investigations on engines operating under a variety of conditions it was found that different hydrocarbon fuels did result in exhaust gases of different composition, thus confirming the theory that the type of fuel used in the engine is an important factor governing the composition of the exhaust gas.

In order to determine accurately to what extent the automobile contributes to the smog situation in some cities, no stone is being left unturned. In addition to the exhaust gas possibility, another culprit is suspect—the carburetor.

In order to meter or feed the proper amount of gasoline to the engine under all operating



William Heaton running a sample of exhaust gas through the analyzer he and Joseph Wentworth developed—another step forward in evaluating the gases emitted from a car's exhaust.



Joseph Wentworth measures the gasoline vapor collected in one of his traps.

conditions, it is necessary to provide a small hole, or vent, in the carburetor float bowl. It was known that gasoline fumes escaped to the atmosphere by this route but how large were the quantities, and how could these be reduced? Those were the problems faced again by Researcher Wentworth.

To measure this loss Wentworth had to contrive a trapping system that would collect

and condense the escaping vapors and yet not disturb the functioning of the carburetor. We shall not go into the details of the ingenious system he devised, but only mention in passing that the necessary cold temperature of the traps was maintained at *minus 110° Fahrenheit* by placing them in Dewar flasks containing a mixture of dry ice and trichloroethylene. Two cars in which this apparatus was installed were studied in Detroit and three other cars with similar equipment were studied in desert heat at the General Motors Proving Ground at Phoenix, Arizona.

To make a long story short, two things were found to control gasoline vapor loss—and incidentally affect gasoline economy—the temperature of the carburetor bowl, which acts as a distillation system, and the volatility

of the gasoline. To reduce these losses the automobile fuel system can be completely changed and made more elaborate to eliminate the effects of gasoline vaporizing in the float bowl, or the gasoline refiners can reduce fuel volatility to the point where evaporation losses from present automobile fuel systems are negligible. This, however, would reduce the availability of certain light hydrocarbons for use as motor fuels.

The foregoing are just three of the many fuel and combustion problems that engage the minds and hands of General Motors scientists and engineers. Each advance presents a new set of problems, but we know each forward step also eventually benefits the American motorist.

To set a value on this research in fuels and

Road testing of catalytic converters to reduce undesirable atmospheric contaminants in exhaust gas is an important phase of GM Research Laboratories' investigation of the air pollution problem.

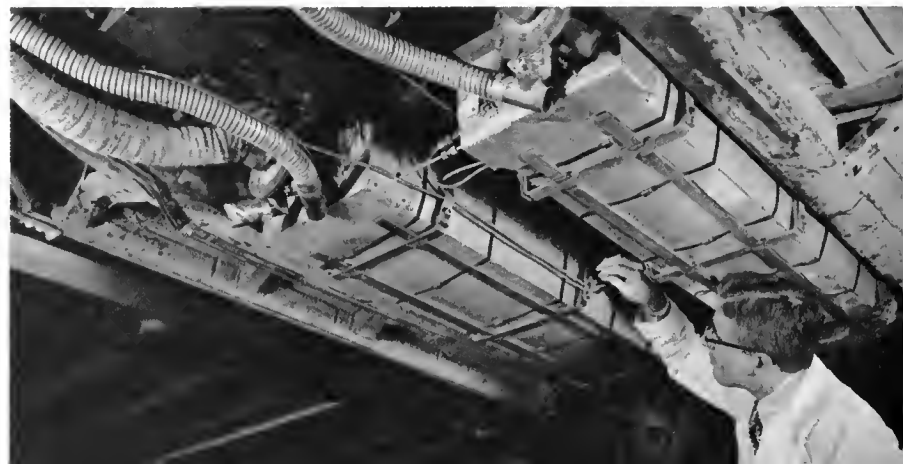

"Boss" Kettering and the GM Research Laboratories winners of the Horning Award,* sponsored by the Society of Automotive Engineers.



combustion—research into the “big squeeze”—we must take into account the fact that through this steady progress in fuels and engines down through the years two gallons of today’s fuel does the same work as three of yesterday’s fuel. We use about 50 billion

gallons of this fuel every year in our automotive vehicles. *But if we used yesterday’s gasoline in yesterday’s engines, we would require 75 billion gallons to do the same job!* Our annual saving—25 billion gallons—is going to stay in the ground in our oil reserves. Or, to put it

another way, if we arbitrarily say gasoline costs about 35 cents a gallon, the annual saving in the American motorists’ gasoline bill is over \$8 billion—a sizable return to the motoring public on the relatively small amount invested in fuel-engine research.

*Standing, left to right—G. M. Rassweiler, L. L. Withrow, F. W. Bowditch, T. A. Boyd, J. M. Campbell, J. T. Wentworth, W. A. Daniel.

Seated—C. F. Kettering

WINDMILLS AND BOUNCING PISTONS

Over 60 years ago when the horseless carriage appeared on the streets in this country and abroad, there was much controversy as to the best means of propelling it. There were three schools of thought as to the best substitute for the horse—those who swore by the internal combustion piston engine, the electric motor and battery proponents, and the steam engine advocates. Over half a century of experience and the production of over 170 million automotive vehicles have clearly demonstrated the superiority of the piston type internal combustion engine. But new knowledge and new materials may some day change this picture just as the advent of the transistor is changing the world of electronics.

What has happened in the skies may foreshadow what may take place on the ground. Air transportation since the Wright brothers also relied on the piston type gasoline engine, that is up to World War II when the jet turbine put in its appearance. Since that time jet propulsion has taken over the combat planes and bombers, and more recently it has been installed in commercial transports.

As a large manufacturer of aviation turbo-jet and turbo-prop engines, General Motors was keenly interested in all applications of this type of power producer. So in 1948 GM Research Director Charles McCuen and his men took a closer look at the gas turbine and asked themselves this question: “What are the chances of pulling this principle down from the sky and putting it to work on the ground turning vehicle wheels?”

The operating principle of the gas turbine is quite simple. Compressed air is fed into a burner or combustion chamber along with a steady flow of fuel. The expansion of the gases resulting from the continuous combustion of this mixture produces a tremendous driving force. Part of the force of these gases is used to operate a sort of windmill or turbine which supplies power to compress the air. The part of the engine consisting of this turbine, compressor, and burner is called the “gasifier.”

The remainder of the gas force can be used in a couple of other ways. It can be exhausted to the air directly through a nozzle, the hot gases under pressure giving a tremendous



William Turunen and the Whirlfire gas turbine installed in Firebird I.

thrust or push, the method usually used on jet-propelled planes. Or the force of these gases can be used to turn another set of windmills or turbine wheels which are geared to a propeller. This turbine-propeller combination is known as a turbo-prop.

William A. Turunen of GM Research was given the job of bringing the “flying blowtorch” down to earth. But instead of utilizing the gas turbine to drive a propeller, his job was to design a new powerplant from scratch and gear it to a set of wheels to run on a road.

As a result of this research and development, the first American gas turbine-equipped car, the unique Firebird I, was tested in 1953. The results revealed the good and bad points of the gas turbine. In its favor were high performance using a lower grade fuel, reliability, low maintenance, simple control and smooth power application. On the other side of the ledger were high fuel consumption, extremely hot exhaust, high noise level and a rather sluggish throttle response when idling.

Some pioneering automotive applications of the gas turbine—the Firebirds I and II, the Turbocruiser coach, and the Turbo-Titan truck.

Months of calculations, designing and re-designing were focused on these shortcomings and in 1955 a new engine for the new Firebird II came into being. The new engine, the GT-304, licked some of the worst problems. For instance, it incorporated a regenerator, a clever rotating drum which picked up a considerable amount of the wasted exhaust heat and delivered it back to the compressed air, thereby increasing efficiency by reducing fuel consumption and simultaneously curing the hot exhaust problem and reducing exhaust noise. The GT-304 was also installed in a heavy duty Chevrolet truck, improving the truck’s acceleration and hill climbing ability while permitting an extra five tons of payload to be carried. At low speeds the piston engine still showed better fuel economy, but at higher speeds the situation was reversed.

But Turunen and his men, like most researchers, are never satisfied. Their latest design, the completely new Whirlfire GT-305,



Bob Carlson recording data in a test of the Whirlfire GT-305 gas turbine.

was installed in the dramatic Firebird III in 1958. It is another step in the direction of smaller size and greater efficiency and is a far cry from the original engine. We asked Turunen if this was it—was this the engine that would in the not too far distant future replace our present piston engines?

“That’s a tough one to answer,” he replied. “There are so many things we must consider. For instance, what do you mean by the ‘not



too far distant future'? We are on the verge of a production job—a powerplant that has some shortcomings but also some definite advantages over the piston engine for certain applications. Running on almost any kind of fuel—gasoline, kerosene, or fuel oil—it smoothly delivers large quantities of power from a relatively small, light package. And every day we are getting nearer to the piston engine in operating economy. But we should remember that over half a century of research and development has been focused on the piston engine, while, on the other hand, the automotive gas turbine has come into being only since World War II. However, today modern research has the know-how, methods and facilities that may close up that gap in a relatively short time. The gas turbine may not be the ultimate powerplant, but we like to consider it a promising candidate as a successor to today's piston engine."

While we are on the subject of possible successors to the piston engine, there is another candidate GM Researchers are investigating—the so-called free-piston powerplant. This is an engine that was born abroad but in recent years has received much attention in this country.

The free-piston engine is unique in that, as its name implies, it has pistons but neither connecting rods nor crankshaft. It is a form of Diesel engine, since the air-fuel mixture is ignited by high compression instead of a spark.

Here is how it works. There is a horizontal cylinder containing two opposed pistons. The inner ends of the pistons and the center section of the cylinder function as a very high compression, two-cycle Diesel engine which can burn a wide variety of fuels. The large outer ends of the pistons compress air in the closed chambers at the ends of the cylinder. This compressed air bounces the pistons back toward the center. The pistons are "free" after a fashion, but they are linked together to keep them in phase.

As the pistons bounce back toward the center of the cylinder, they squeeze the air between their inner ends and consequently heat it to a high temperature. Fuel is injected, as in a Diesel engine, and starts burning immediately, again forcing the pistons apart. One of the pistons as it moves outward uncovers exhaust ports in the cylinder wall, and the exhaust gases under pressure rush out and rotate a turbine wheel at high speed. This is very similar to the action of the gases in the

gas turbine engine we have just discussed. The opposite piston in traveling outward uncovers intake ports and admits fresh air under pressure, forcing out the remaining exhaust gases and filling the combustion space. Both pistons continue to move outward until the air in the end chambers is compressed sufficiently to stop them and bounce them back to start the cycle all over again.

There is one thing we want to remember about the free piston engine—power is not taken directly from it. All it does is supply a flow of gas at a temperature of around 900 degrees Fahrenheit which can be used to drive a turbine. For this reason the engine is called a "free-piston gasifier."

There are certain things about this gasifier that aroused the interest of General Motors Researchers. One thing highly in its favor was its goat-like ability to digest almost any kind of fuel from kerosene to Bunker "C" crude and shale oils. Even whale oil and peanut oil were tried successfully. Also, since it operates as a two-cycle high compression Diesel with a compression ratio exceeding 30 to 1, it is extremely efficient. In fact, when it is hooked up with a turbine in large installations, it has an over-all efficiency of over 36 per cent, which

is about the same as a good Diesel engine.

On the mechanical side it had much to recommend it. For one thing all free-piston engines are inherently balanced, consequently vibrationless. Then there is the flexibility of application. The ability to locate the power turbine remotely from the gasifier, or gasifiers, is a tremendous advantage. The turbine blades in previously mentioned gas turbine installations must necessarily be made of expensive, hard-to-get critical alloys to stand the 1,500 degree temperature. On the other hand, since the temperatures of the gases from the free-piston gasifier approximate only 900 degrees, comparatively cheap, easily available materials can be used in the turbine blades.

“Here is an engine worth looking into,” said the Researchers, and in 1953 General Motors drew up an agreement with S.I.G.M.A., one of the two French concerns licensed to design and build free-piston engines, to permit experimentation with the free-piston idea in the Research Laboratories. They first purchased an air compressor and later one of the large thousand-horsepower French gasifier units to familiarize themselves with free pistons.

After months of studying the operation of the large unit, it was decided to try out the

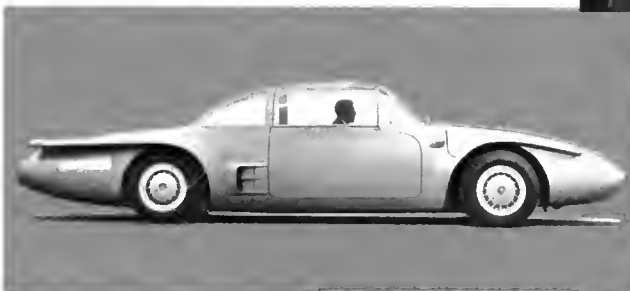

Three Researchers responsible for the XP-500, the first free-piston car—Arthur Underwood, Worth Percival and Gregory Flynn.

idea on a smaller scale, a 250 horsepower free-piston gasifier which could be connected to a turbine to drive a road vehicle. As is the custom today, a research and engineering team was given the job of design, construction and testing. Arthur Underwood headed up the project, assisted by Gregory Flynn, Jr. and Worth Percival, who supervised the construction and testing. In addition, they had invaluable consultation with Robert Huber of the other French concern, S.E.M.E., particularly on the basic engine design.

After months and months of this joint effort the *first* free-piston driven car was born. The



“HYPREX” engine and the streamlined XP-500 car into which it was fitted were unique in many ways. By ingeniously Siamesing two free-piston cylinders the gasifier was made compact enough to fit under the hood of the streamlined vehicle. This also reduced the weight, improved the efficiency and

reduced the noise level.

The installation had other advantages, too. The gasifier could be located under the hood in front and the exhaust gases piped along the side frame to drive the turbine and transmission in the rear. Hence excellent weight distribution was obtained, and there were no humps for the transmission and propeller shaft in the floor to interfere with the passengers' feet.

But General Motors' experimentation with free-piston powerplants is not confined solely to the GM Technical Center in Detroit. In

nearby Cleveland, the GM Cleveland Diesel Engine Division has also come up with a "first."

Working closely with the GM Technical Center team and with S.I.G.M.A. and S.E.M.E. of France, Cleveland Diesel in 1955 began building a free-piston gasifier, model GM-14, designed to deliver over 1,200 gas horsepower. As a builder of large Diesel powerplants Cleveland Diesel was interested in this engine for two reasons—first, the ability of this engine to digest wide ranges of fuel and, second, its flexibility of installation.

The immediate target of this particular bit

of research was the development of a powerplant to furnish 6,000 horsepower to propel the converted Liberty Ship, the William Patterson, as agreed upon in a contract with the U. S. Maritime Administration. Space doesn't permit the recitation of all the problems that arose in Detroit and Cleveland, or how they were solved. Because the approach was new, so were the troubles, and so were the solutions. But in the spring of 1957 the engine was installed in the ship. In September, 1957, the William Patterson passed its official trials and shortly thereafter was placed in trans-Atlantic service.

So the GM inquiring minds have blazed another trail, another power avenue has been opened up. Three power roads are open to the future—the highly developed gasoline and Diesel reciprocating engines, the gas turbine and the free-piston gasifier-turbine. Which road is going to be most popular? Who knows? Perhaps, reading between the lines, we shall see different types of engines used according to the requirements of different types of transportation. The important thing the scientist and the engineer must do is always keep an open mind to all new things. Only in this way can progress be made on all fronts.



Six free-piston gasifiers produce over 6,000 horsepower to propel the William Patterson.

MARVELS IN METALS

If we look back down the long road civilization has traversed, it is interesting to note some of the milestones of our progress. For example, take the discovery and use of metals. Just in this century they have transformed our civilization. Their use has made possible man's flight, bridges and skyscrapers, electric power and communication, not to mention 170 million automotive vehicles.

We have scores of different types of steels—steels for strength, for wear, for heat resistance and anti-corrosion. We have aluminum and magnesium for lightness, and copper and silver for electrical conduction. More recently we have started to use titanium which has the strength of steel, approaches aluminum for lightness, and is also non-corrosive.

You would think we have all the metals we need to do almost any job for the future but in reality the key to many of tomorrow's developments lies in alloys and improved metals unknown to us today. For instance, the use of atomic power is limited by the ability of ordinary metals to withstand radiation damage at high temperatures and resist the effects



of corrosive gases and liquids. Further development of turbo-jet engines and rockets to a large extent hinges on improved metals. And in our automotive world great strides could be made if better metals were available.

This search for new metallic materials is one of the most important undertakings of the GM Research Laboratories and is going ahead in several directions. It runs the gamut of scientific and engineering endeavor from pure research to engineering consultation.

One of the chief problems facing today's metallurgists is the heat barrier. The internal combustion engine, whether it is an automotive type piston engine, a gas turbine or even a rocket, is essentially a heat engine and its efficiency depends upon the effective use of high temperatures. To get an idea of the

magnitudes of some of the temperatures involved, let us take a look at the chart below. In the modern automobile engine the piston heads operate at around 500 degrees Fahrenheit but the rotating blades in a gas turbine must be able to withstand continuously

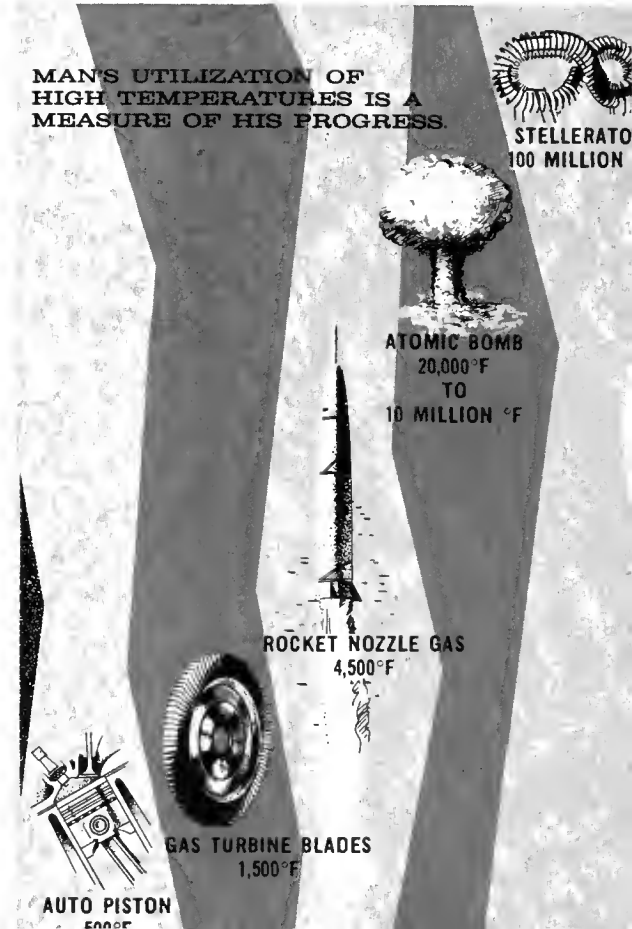

1,500 degrees. Rocket nozzle gas temperatures are higher, 4,500 degrees plus, and atomic bomb temperatures range from 20,000 degrees up to 10 million degrees in the fireball, while at Princeton they hope to attain temperatures exceeding 100 million degrees in the Stellerator!

In the General Motors Research Laboratories this search for high temperature materials is being conducted on several fronts, but let us take a typical example—the development of the alloy GMR-235—and see what it meant to gas turbine progress. For that story let's visit Fred Webbere and Doug McCullough of the Research Metallurgical Department.

“One of the principal problems in getting more power from a gas turbine,” Webbere told us, “is to find turbine blade materials to withstand the continuous flow of increasingly hot gases. To give you some idea of the magnitude of the problem, imagine the type of material necessary to operate continuously at the glowing temperature of 1,500 degrees Fahrenheit, remembering that *each* of these turbine blades, or buckets, transmits power equivalent to that of an automobile engine! In the case of the Allison turbo-prop airplane engine we knew that if we could find a mate-



High temperature alloys are made in the special research furnace shown on the left and are tested in the unique heat and vibration fatigue apparatus on the right.



rial that would not fail when the temperature of the combustion gases was raised 100 degrees we could get a ten per cent increase in the horsepower delivered to the shaft. Sounds simple, doesn't it? Just get the metal to stand another 100 degrees and you increase the output by ten per cent.

“Our development of such an alloy was not the result of mere chance. It involved painstaking analysis of all the possibilities of elements having high temperature properties. Not only must the new alloy have the required strength and ductility at the higher tempera-

ture but it should also contain the minimum amount of strategic alloys. It required months and months of making and testing alloys that looked as though they might do the job. We had to dream up a special vibration fatigue testing device to simulate conditions in a gas turbine. Our experimental alloys were cast into turbine blades which were subjected to air pressure vibration while heated by blow-torches.

“As the result of this arduous process, we came up with an alloy having a nickel base combined with chromium, molybdenum, iron,

aluminum and titanium together with small amounts of carbon, manganese, silicon and boron. The last of these, boron, was present in only a minute amount but was one of the most vital ingredients, having a major influence on the ductility of the alloy. You can easily gather, from the number of elements involved, GMR-235 was no hit-or-miss development but rather a painstakingly worked out scientific achievement."

But, as Douglas McCullough says, "This search for higher temperature materials goes on and on. We knew GMR-235 wasn't the ultimate, and further research more recently led us to an improved alloy which has shown greater strength at higher temperatures. If turbine bucket temperature were the only design consideration, this improvement could mean a power increase of 12.5 per cent for one of the production jet engines. Needless to say, we expect to continue this fruitful search for improved metals and more efficient gas turbines."

As we mentioned earlier, inasmuch as the automobile engine is made up of many metals and their alloys, its future development lies to a large extent in the hands of the metallurgist. He is constantly trying to uncover new metallic

materials that will give greater strength and durability and decrease weight, always keeping in mind the economics of production.

The weight factor is one which the men of Research have been battling for scores of years. One of the answers, of course, is to make wider use of light metals such as aluminum. As an engine block material, for instance, aluminum is not only an important weight saver but tests have shown it provides better cooling and also permits the use of a lower grade fuel than its cast iron counterpart.

But the aluminum available in the past had a serious disadvantage when compared to cast iron as an engine block material. It was a considerably softer metal and did not wear as well as iron when subjected to the friction of the piston rings sliding up and down at high speeds over the cylinder walls.

For years engine designers have tried to solve this wear problem by making the block of aluminum but using cast iron cylinder liners or chrome plating the aluminum cylinder walls. Chrome plating had some undesirable features and the cast iron liners necessitated the use of seals between the liners and the block to confine the cooling water, thereby complicating production and increasing costs.

The obvious answer was to search for a more practical cylinder wall coating than chrome plating or discover a new type of aluminum alloy as a block material that would be hard enough to resist cylinder wall wear without using liners. Don Henry of the GM Research Laboratories Metallurgical Department gave us this account of the progress they have made in this important search.

"As you know," said Don, "the search for a

IMPROVED HEAT RESISTANT TURBINE BLADES SIGNIFICANTLY INCREASE JET ENGINE PERFORMANCE.



GMR-235



GMR-235



Best Previous Alloys

satisfactory aluminum engine goes back quite a way. The main problem, of course, is the wearing of the cylinder walls. First we tried plating the aluminum but this was not the best answer. Then we spray-coated the walls with various wear resistant metals such as molybdenum, but although this provided excellent wear resistance, the cost was prohibitive.

“The ideal solution would be some sort of alloy of aluminum that would wear as well as, or better than, cast iron and could be readily cast and machined. It was generally known that silicon would improve the wear resistance of aluminum but the problems of castability, machinability and brittleness were barriers to the use of aluminum-silicon alloys.

“Our metallurgists concocted hundreds of new aluminum-silicon alloys and tried various heat treatments, made test bars of them and subjected them to wear tests on a special machine. From these they picked the most promising and made them up into cylinder liners to be tested in engines. The process of elimination was continued until the field was narrowed down to only a few alloys. Only then were the complete aluminum alloy cylinder blocks cast and tested. A long process? Certainly, but we feel we have made a

real contribution to the science of metals and are continuing to work on new and improved alloys.”

Don Henry’s point of view is typical of the true researcher who is never satisfied with things as they are—he knows anything and everything can be improved.

However, in the spring of 1958 two General Motors Vice-Presidents, Charles A. Chayne of the GM Engineering Staff and Dr. Hafstad of the GM Research Laboratories, in announcing a series of three experimental aluminum V-8 automotive engines, had this to say about the significance of these Research and Engineering Staff developments. “We consider

these three experimental engines a significant engineering break-through, comparable to the 1947 announcement of GM’s first high compression experimental engine. These engines weigh about 30 per cent less than comparable cast iron engines, which represents about the equivalent weight of one passenger per car and offers interesting possibilities in over-all car weight reduction. It is another look down the road—similar to the Research Laboratories’ experiments with gas

Perfect Balance—Darl Caris of the Central Engineering Staff and Research metallurgist Don Henry compare weights of similar cast iron and aluminum engine blocks. Audrey Zurawski plus the aluminum block on the right just balance the cast iron block on the left.

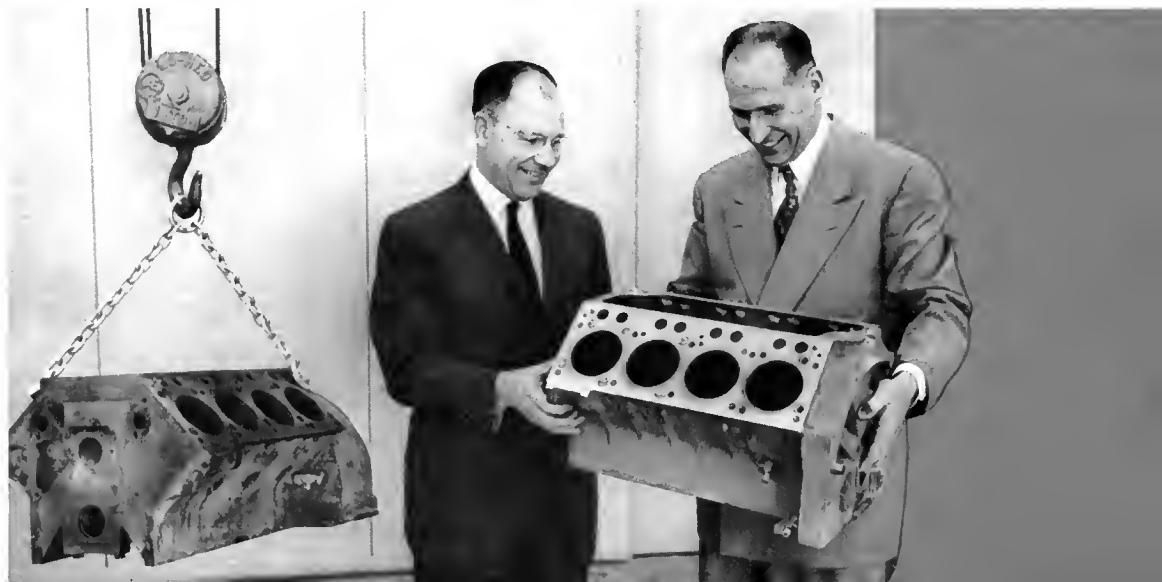

turbines and free-piston engines as possible future 'power packages'."

High temperature alloys and wear resistant aluminum are just two examples of the materials problems that engage the minds and hands of General Motors scientists and engineers. They are constantly probing into the unknown trying to uncover the new materials of which we shall design and construct our world of tomorrow. For instance magnesium, of which we have abundant sources, is

getting greater attention than ever before because of its great lightness. Coating metals gives them new and desirable properties, and metal reinforced ceramics, or cermets, open up new fields of exploration. New facilities, new techniques and above all inquiring minds are the equipment of these 20th Century explorers. The frontiers that stretch before them are limitless.

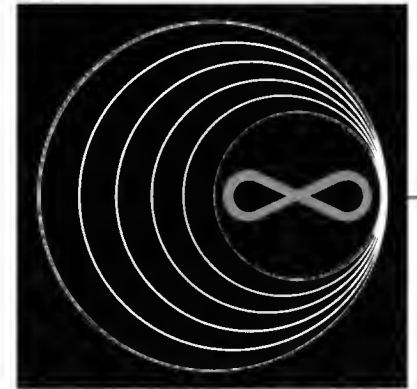

AN INSIDE STORY OF THE OUTSIDE

The automobile is a complex of surfaces. Bearing surfaces rub against each other, tire treads grip the road, passengers slide over seat upholstery, and the exterior surface of the car is subjected to the elements, dirt and salt. But there is one thing all of these surfaces have in common—they must be durable.

For years and years the GM Research Laboratories have been particularly interested in two of these—the exterior of the car and the internal rubbing, or bearing surfaces.

We have come a long way since the hand-brushed varnish finish of forty years ago that took weeks to dry. Du Pont and GM Research chemists solved this problem with quick drying Duco nitrocellulose lacquer, which broke a production bottleneck and gave car owners a more colorful, durable finish. And a little later GM Researchers were responsible for developing the first chrome plating used on automobiles.

But these things happened years ago, so to bring ourselves up to date we called on Ralph Wirshing, a pioneer of forty years' experience in this research on car finishes and head of the



The first spraying of lacquer revolutionized automobile finishing and production.

Chemistry Department of the General Motors Research Laboratories. “We hear a lot these days, Ralph, about wonderful new car finishes—what is the inside story?” we asked.

“First,” he replied, “you have to put yourself in the position of the new car buyer. When he and his wife look at that new car in the showroom, he wants it to have a nice, shiny, pleasing color. A little later, after he has bought it, he may be more interested in how the finish will hold up with a minimum

amount of polishing on his part. To give him these things you might say has been, and is, the object of our research.

“We have three unrelenting enemies to overcome in this battle—loss of luster, chipping and corrosion following chipping or scratching. Loss of luster results from weathering, humidity being an important factor. Chipping can often be attributed to some unusual combination of the undercoat and surface finish. Corrosion also can be reduced by improving the undercoat. These, in general, are the things that occupy our time. But let me tell you a little story that illustrates a seldom-appreciated phase of research.

“About ten years ago we were coming out with gold plated ornamentation on our cars and to protect it we coated it with clear nitrocellulose lacquer. But at our outdoor exposure field in Florida test panels finished this way failed in less than six months. So we asked the chemists of one of our paint suppliers if they had anything else that would do a better job than the nitrocellulose lacquer. So they sent us a thin acrylic lacquer. This acrylic

Ralph Wirshing inspects the original acrylic finished test panel after years of exposure at the GM Research Laboratories Florida Test Field.



liquid might be more familiar to you if we told you it was essentially a solution of Lucite plastic. It was so thin we had to spray ten coats on the gold plated test panel.

“After a year in Florida the test panel was still in good condition so we said to ourselves, ‘If this stands the weather so well, why can’t

we get some that is colored and of a higher viscosity to spray an entire car?’” So to make a long story short, our supplier sent us enough such material to paint five test cars, but the new finish cracked in three to four months’ time. Obviously, the failures were due to the application procedure rather than the mate-

rial itself. The undercoat was suspected to be a likely culprit so we had to evaluate all the undercoats we used in combination with the new acrylic lacquer.

“To do this we had to devise a new method of testing the sample panels, because the acrylic-finished panels passed with flying colors the old test we used with nitrocellulose-lacquered panels. The old test was to repeatedly subject the panels to a 30 degree-below-zero temperature and then hold them under warm water. The new test for acrylic-lacquered panels, however, was very different. We cycled the panels first through a humidity room at 100 degrees, then down to 20 degrees below zero, then back to normal room temperature. A severe test, but one that could more accurately compare the acrylics and the undercoats.

“From these tests we were able to select the most suitable undercoats, but then we ran into the problem of tailoring the new finishing procedures to the processing techniques used in our production plants. These varied widely, which made it necessary that our new finishing process be adaptable to a wide range of conditions, for instance the variations in drying oven temperatures.

“One by one we licked the major problems

and as a result our cars are now coming out with a finish that has practically eliminated polishing and consequently has done away with the rub-through problem. In addition, the new finish is highly resistant to staining by road tar, leaves and so on, not to mention the fact that new, glamorous, highly metallic colors have been made possible by the new acrylics. And just as a matter of interest, did you know that *after seven years' exposure the original acrylic-treated test panel is still in good shape?* In many respects this development is comparable in importance to the original introduction of Duco as a successor to the old hand-applied finishes.”

The part played by Wirshing and his men in making this new finish a production possibility underlines the significance of a type of research effort that is often overlooked by those who are not so close to the practical problems of producing things by the millions. It is one thing to uncover a new idea or originate a new material, but it is equally important, and often as difficult and requires as much research effort, to tailor the laboratory sample to the requirements of mass production and the customers' demands.

The continuing development of a longer

lasting, more colorful finish is undoubtedly a very important Research contribution to the longevity of the automobile's exterior. However, hidden deep inside a car's mechanism are other surfaces that are vital to the day-to-day operation of the vehicle itself. If these sliding, or rolling, surfaces fail, the car itself usually refuses to function.

Let us take, for instance, the connecting rod bearings in an engine—bearings which are subjected to pressure loads exceeding 6,000 pounds per square inch, *over three tons!* The connecting rod bearing encircles the crankpin or journal like a ring on the finger. As we all know, we have to supply a film of oil between the two rotating surfaces to reduce friction and wear. As the speed of rotation increases, the two surfaces are separated by the development of the oil film. This is known as hydrodynamic lubrication.

However when the engine is started, or stopped, or under heavy loading the two surfaces actually come into contact and the surfaces slide against each other with only boundary lubrication. The ability of the bearing material on the connecting rod to resist seizure, or “freezing-up,” is one of the most important properties a bearing should possess. The bearing must also have fatigue strength and the bearing metal should withstand the corrosive effect of certain lubricating oils. Also, inasmuch as it is practically impossible to exclude all dirt from the lubricating oil, the bearing metal should have the ability to tolerate dirt particles; the particles should be easily pushed into the bearing metal out of harm's way thus preventing scoring and wear of the crankpin.

From this very elementary description of the part played by just one type of automo-

HYDRODYNAMIC LUBRICATION

- 1 At the instant of starting the crankpin and connecting rod bearing are in contact.
- 2 As the motion begins the oil film starts to build up separating the bearing from the crankpin.
- 3 As the speed of rotation increases the two surfaces are further separated.

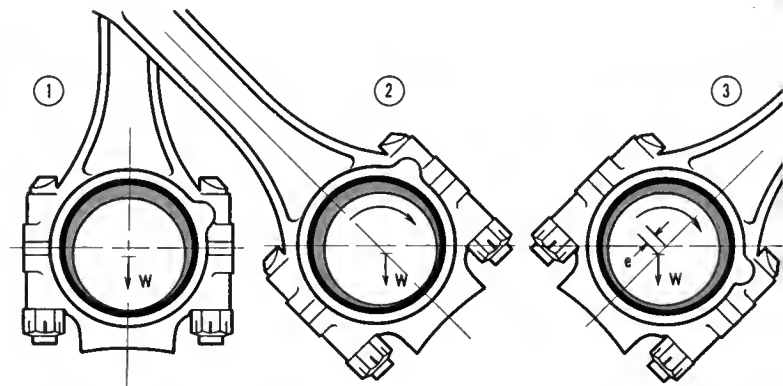

tive bearing, you can readily appreciate the complexities of bearing research involving scores of different types in different applications throughout the car. However, to gain some idea of the progress made, let's go back about 25 years and see the results of some durability tests made on some typical cars of that day at the General Motors Proving Ground.

For instance, there was one series of high-speed durability tests made on fourteen cars. Under the heading "Reason for Ending Test" *eleven out of the fourteen, more than 75 per cent, listed "Bearing Failure"!* None of the cars ran as far as 9,000 miles before failure, and one failed after going less than 200. Today no one thinks it unusual to travel all day over a thruway or turnpike at a constant speed of 65 miles an hour. A fairly common occurrence in the life of a motorist 25 years ago—bearing failure—has become a rarity today.

Some of our older readers will recall that those early connecting rod bearings were made of babbitt, an alloy having a tin or lead base which provided a good bearing surface but lacked the fatigue strength necessary to withstand failure when heavily loaded. In the early Nineteen-Thirties a young engineer, Arthur



Underwood, now Manager of the GM Research Laboratories activities, was given the job of analyzing bearing failures and suggesting improvements. Early in the game, he discovered that testing bearings on production engines was a slow and costly process. And dangerous too, when the heavily loaded engine showered the dynamometer room walls with fragments of broken connecting rods and other miscellaneous pieces of the engine.

Over 25 years ago Arthur Underwood began his bearing research developing special test apparatus to assist in solving the problem of bearing failures.

So Researchers rigged up a bearing fatigue testing machine simulating conditions in the engine. This unique machine accelerated the testing procedure and provided them with some valuable clues to connecting rod bearing failure. For instance they found out that the

failure of existing babbitt bearings to stand up under the severe fatigue tests was mainly attributable to the thickness of the babbitt. A thin layer backed up by steel did a much better job. Later non-corrosive lead embedded in a copper-nickel matrix showed a 50 per cent improvement in strength over babbitt, and today connecting rod bearings of aluminum alloy with steel backs are coming into use. In spite of the fact that the loads on these bearings have been constantly growing as a result of the steady increase in engine compression ratios, the bearing researchers have been able to make this former Achilles' heel of the engine one of its most trouble-free components.

But to maintain and improve this position in the face of the higher and higher output powerplants being developed requires constant research and engineering of the highest order. Take, for instance, the investigation being pursued by Carl Goodzeit. You may recall we mentioned Carl earlier in connection with his experiments with metal surface adhesion in a high vacuum, another phase of this bearing and friction research.

Goodzeit, in 1958, presented a paper before the American Society of Mechanical Engi-

neers titled "Compatibility of Metals in Bearing Contact," which summarized years of research dealing with the ability of various bearing materials to resist seizure when used not only with conventional steel crankshaft journals but with journals of almost any metal. The surface of the ground crankshaft journal when magnified vertically 5,000 times has saw-tooth edges. These sharp edges, known as "asperities," contribute to the metallic friction. When lubrication is at a minimum these asperities have a tendency to become welded to the bearing metal when the sliding surfaces of the two metals come into contact, thus forming a junction.

The photograph shows a special machine developed to test the seizure resistance of various bearing metals. A small sample of the bearing material in question was pressed against a rapidly rotating disk of the same steel as the crankshaft. Carl tested dozens and dozens of different metals against steel as well as other metal disks and reached this conclusion: "Metals that tend to alloy or dissolve into each other form strong welded junctions and therefore make a poor journal and bearing material combination. The metals tend to diffuse into each other and the hardness and



Carl Goodzeit adjusts the latest machine developed to test the seizure resistance of various bearing metals.

strength of the bond increase. So, a bearing metal should be used that does not alloy with the crankshaft journal."

Of course, as we have seen, there are other things to be considered in obtaining a durable bearing—method of fabrication, resistance to corrosion, fatigue and dirt, as well as its suitability for mass production. However, Goodzeit's scientific research on a bearing-metal

theory points the direction towards the choice of materials for new applications and improved performance of existing bearings—it is now possible to “design” bearing alloys rather than rely on the trial and error method.

Before we conclude our little discussion of surfaces and friction there is another well-known anti-friction device we should not overlook—the steel ball. You know the old saying “Nothing rolls like a ball.” That may be so, but even a ball rolling freely on a hard, smooth, level surface eventually stops. “Why?” asked Dick Drutowski of the GM Research Laboratories. Of course, there were theories. One of the most logical attributed this slowing down of the ball to internal friction. This is a little complicated, but putting it in an elementary way, when a ball moves over a plate its slightest advance is an occasion for internal movement of the molecules within the ball and within the plate on which it rolls. This internal movement, or molecular rubbing, dissipates as heat some energy, thereby robbing the ball of its forward motion and eventually stopping it.

This phenomenon of internal friction is not the property only of a rolling ball. For the same reason automobile tires become warm

on long trips, oscillating springs leisurely dampen out, and bouncing balls lose height with each bounce. “So,” reasoned the Researchers, “if we can unravel some of the mysteries surrounding the rolling ball, we shall have the answers to some of these other unaccountable energy losses.” Surprisingly enough, the GM Research Laboratories seems to be almost alone in this country in studying this phenomenon of rolling friction.

Drutowski, who was in charge of this problem, reasoned that to get new facts they would have to take a new approach and develop new

Richard Drutowski's pioneering research into the mysteries of the internal friction of the rolling ball is answering many questions regarding other unaccountable energy losses.



measuring apparatus. Accordingly the Research investigators built the device shown below to measure continuously rolling friction, the only one of its kind in existence. This unique apparatus showed that rolling friction is unaffected by the shape of the impression a ball makes on contact. Whether the ball rolled on a flat plate or in a shallow groove, it met with virtually equal resistance with or without lubricants, thus indicating an absence of sliding friction.

As a result of an analysis of the stress patterns caused by a ball rolling on a flat plate,

This sketch shows how rolling friction is measured. The lower plate floats on a film of high pressure oil making its horizontal movement resistance free. As the plate housing is moved back and forth, rolling friction on the ball displaces the lower plate which, in turn, deflects the thin beams. Strain gages detect this deflection and feed an electrical signal into an instrument which records the rolling friction trace.

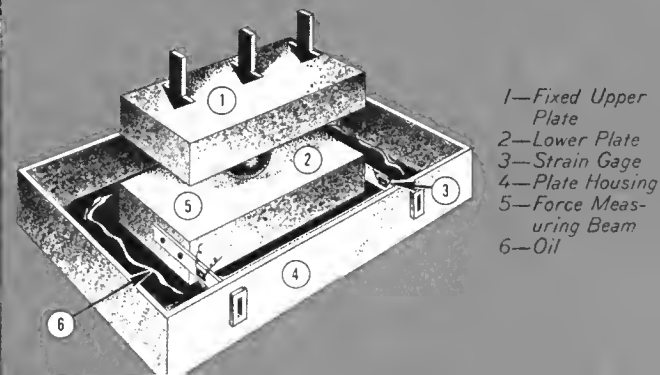

Drutowski developed a mathematical expression to evaluate the specific damping capacity of all materials. Such computations account for all energy losses in rolling balls, and future losses can be predicted. Moreover, this discovery ties in with the theory of internal friction and is a strong argument in support of it.

In the case of a ball then, rolling friction on a flat plate or in shallow grooves boils down to

an understanding of internal friction—the way in which energy is dissipated inside of materials. Out of this fundamental research can come not only improved ball bearings but also a better understanding of a phenomenon that could result in improved springs, reduced vibrations, unerringly accurate instruments, and increased control wherever energy is lost through internal friction.

The average person is usually interested in how a particular mechanism or device serves his or her specific needs, but as we progress our requirements become more sophisticated. It is the job of the Research scientist and engineer not only to extend existing paths of progress but, more important, to delve deep into nature's vast storehouse of the unknown and chart entirely new routes.

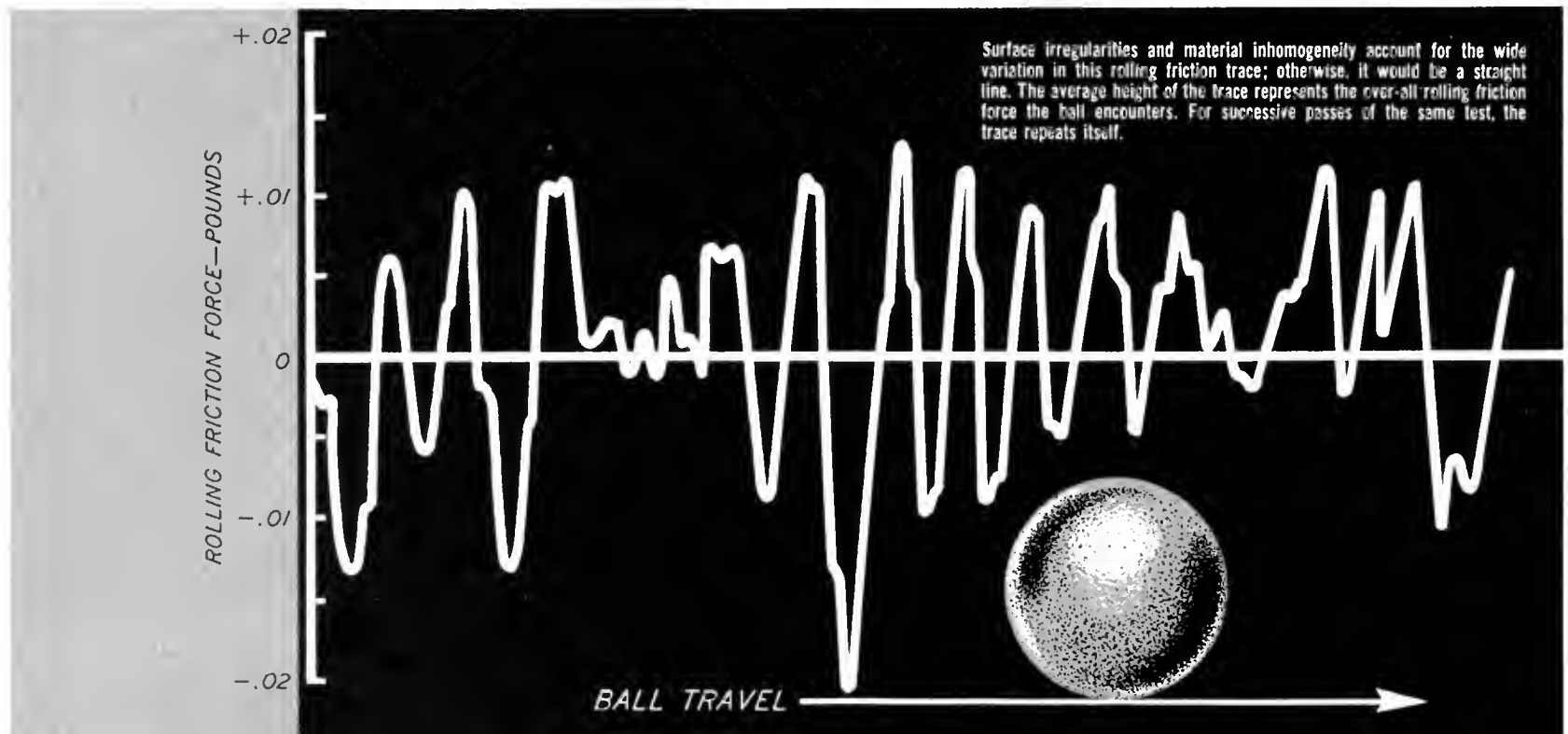

FLIGHT OF THE FIREBIRDS



At the new General Motors Technical Center near Detroit each of the major operations—the Research Laboratories, and the Styling, Process Development and Engineering Staffs—has its own particular sphere of operation. But modern science, engineering, styling and production are so intermingled in developing a new thing, such as an original car, that close proximity and cooperation among all of these General Motors staffs are almost essential.

Here the men and facilities are capable of producing a complete, operating car—from a design on a piece of paper to an automobile you or I can drive. Here dreams of tomorrow materialize and become rolling laboratories in which new ideas run the gantlet of practicality. Let's take a concrete example—the Firebirds, for instance.

The whole thing started as a dream back early in 1953—a dream on the part of Harley Earl, then head of General Motors Styling, who visualized the possibility of capturing the feeling of a Douglas Skyray fighter in a new kind of road vehicle. But this was not to be a

pseudo road vehicle—just a body shell on wheels. It was going to be a complete rolling laboratory—body, engine and chassis, all embodying the most advanced thinking of the Technical Center Staffs. So he and his engineer-designer, Bob McLean, solicited the help of the Research Laboratories and the Engineering Staff.

As we have previously mentioned, Turunen and his men of Research at that time were readying a new gas turbine, the GT-300, for road tests in a coach. So, in keeping with the advanced thinking theme, it was decided to put a slimmed-down version, the GT-302, into the XP-21, as the experimental car was first called. The chassis began to take shape at Research, and the Engineering Staff contributed its ideas on a transmission and brakes. Styling, of course, was fabricating the sleek, streamlined body of fiberglass. At last, in less than a year's time, in the fall of 1953, all the parts came together and the XP-21 was officially christened "Firebird I"—the first American gas turbine car.

Mauri Rose, three-time winner of the

Mauri Rose in Firebird I



Indianapolis “500,” piloted the Firebird on its first “flight” and reported it to be a unique experience—terrific performance, coupled with absolute smoothness and reliability. As we previously reported, it had some drawbacks—an inclination to be noisy, with a hot exhaust and rather poor operating economy. But it seemed decidedly worthwhile to do more experimenting.

In the next two years the GM Technical Center teams designed, built and tested, accepted and rejected, and then started all over again. In 1956 at the General Motors Motorama a new car of the future was presented to the American public—Firebird II.

Out of Styling came an entirely new futuristic body made of the lightweight wonder metal of tremendous strength—titanium. Instead of the Firebird I type of test vehicle—a single-seater design limited to use on the test track—Firebird II was a four-passenger car with a transmission system, suspension, brakes, air conditioning, and overall design capable of making effective, comfortable use of gas tur-

bine power for family transportation. Research installed in it an entirely new gas turbine, the Whirlfire GT-304, incorporating a newly developed regenerator which salvaged 80 per cent of the exhaust heat formerly wasted. This resulted in a fuel economy approaching that of the piston engine and at the same time reduced the objectionable hot exhaust blast by 1,000 degrees. Also a silencer was built into the nose of the engine which reduced the engine noise so successfully that it approached the average automobile engine in quietness.

In addition to providing a highly roadable, gas turbine-powered, family-size car, the designers decided to go a step further and incor-

porate some “imagineering.” Looking down the road they visualized a novel, completely safe, rapid transit highway system which would take advantage of two-way radio communication with TV and “electronic brains.” On the “dream highway”—the “Safety Auto-way of Tomorrow”—the driver of Firebird II could theoretically take his hands from the steering handles and turn over control of the car to an “electronic brain” which received its signals from a metallic conductor buried in the road surface. Although this system was not operative in Firebird II, the driver’s compartment was equipped with the simulated instrumentation. It sounded rather far-fetched at the time, but there were some GM Researchers

A model of the “Dream Highway of Tomorrow”



who felt they could bring such a dream down to earth—at least Joe Bidwell and Roy Cataldo of the Engineering Mechanics Department were willing to try.

This team reasoned that inasmuch as the modern car was already equipped with hydraulically operated brakes and steering that functioned quite efficiently, the thing that was needed was an “electronic brain” that could operate these mechanisms through servo devices. Then, instead of twisting a steering wheel and pushing on an accelerator or brake pedal, all the driver would have to do would be to indicate his intentions to the electronic brain box—something like dialing a telephone. Early in 1957, under the supervision of Bidwell, they started experimenting with, and perfecting, the various elements.

Recalling the imaginary automatic guidance system suggested at the 1956 Motorama, they decided it might be a good idea to try out such a system on a small scale. So, after a year’s experimentation, in January, 1958, they buried a length of cable on the test track at the GM Technical Center. Then Roy rigged up a couple of probes on the bottom of the front bumper of a test car equipped with the automatic steering system. A current of



Testing Firebird II

electricity was sent through the guide cable on the road, the car and the probes straddled it and the experimenting began. Weeks later most of the “bugs” were ironed out, and the press was invited in for a demonstration.

The next day hundreds of American papers carried articles, usually accompanied by a photograph of a girl with both hands off the steering wheel and captioned “Look!—No hands!” The article described the car as automatically following the magnetic path of the cable, the probes “sniffing” the magnetic field around the cable and sending signals back to the electronic analog computer in the car’s glove box. The computer then trans-

lated these signals into “commands” to the modified steering system—all automatic and with no steering effort on the driver’s part.

To Joe Bidwell and Roy Cataldo, though, this proved just one element of their more elaborate scheme. It proved that a combination of electronics and hydraulics could be made to steer a car without benefit of a steering wheel. But could it be combined effectively with the braking and accelerating controls—a thing they had been working on for over a year?

At last they rigged up on a test car a combination of all three and in April, 1958, put it through a series of demonstrations. The test car had *no steering wheel*, but located on a ledge

dividing the front seat was a small knob, resembling a ping-pong ball, on top of a four-inch pencil-like rod. The ball could be moved about two inches in any direction and the results were startling. After starting the engine and putting the car in "Drive," all controlling is done by simply manipulating the ball on the stick. You press it straight forward from the central position and the car accelerates in a straight line. Pull it back and the brakes are automatically applied and the car slows down. Move it to the left and the car turns in that direction, to the right and it goes right. And you still have the "feel" of the steering. Strange as it may seem, it is an easy thing to get accustomed to—the slight finger movement and control seem to be instinctive after a short drive. One simple movement of the fingers takes the place of many manipulations of arms and feet.

What happens when you move the lever is not easy to explain. About the simplest way to describe the operation of the system is to say that wires are the only connection between the control stick and the steering mechanism, throttle and brakes. Sidewise motion of the control stick rotates a potentiometer, a device which varies the voltage going to an electronic

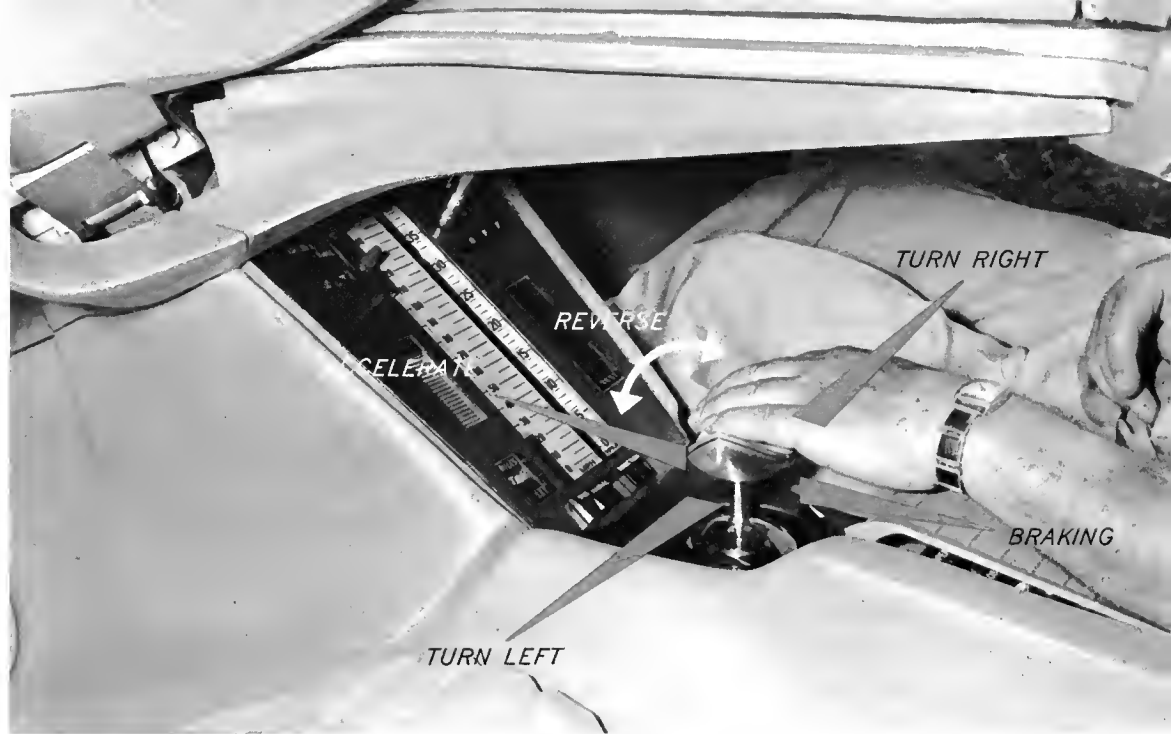

The Firebird III version of Unicontrol provides for acceleration, braking, steering and reversing by the movement of a single control.

computer which in turn sends the appropriate signals to the steering mechanism and turns the wheels right or left. Similarly, a fore and aft motion of the stick operates a second potentiometer which controls the engine, throttle and the brakes. An interesting feature of the steering system is that the ratio varies with car speed. This means that a quick abrupt movement of the control while travel-

ing at high speed will not throw the car into a skid such as might happen if you suddenly twisted the steering wheel of your car under the same conditions. In addition to this built-in safety feature, increased ease of parking or low-speed maneuvers is another advantage.

While Researchers Bidwell and Cataldo were perfecting their "electronic chauffeur,"



Joseph Bidwell and his associates take out the Firebird III chassis for a trial run.

down at the other end of the Technical Center lake Firebird III was taking shape in the minds and on the blackboards of the Stylists. Maintaining a close liaison with the Researchers and the Engineering Staff, Harley Earl's men envisioned an entirely different type of car "which a person may drive to the launching site of a rocket to the moon." Its unique-

ness was to be enhanced by incorporating an improved version of the new Research car control system. Actually it would take the form of three interrelated sub-systems: the Unicontrol system in which steering, accelerating, and braking are performed by means of a single, simplified control stick; an Autoguide system for automatically steering the car down a road equipped with an embedded

electrical cable; and a system, called Cruise-control, for automatically maintaining any preset road speed. Unicontrol and Cruise-control can be used on present-day highways since no signal from the highway is required. Autoguide is designed to operate in accordance with command information from a suitably equipped automatic road system. Supplementing Autoguide with Cruisecontrol gives a combination approaching that required for complete automatic highway control.

The principal operating controls for the Firebird III are all combined in a single four-inch swivel stick topped by a palm-fitting handle weighing about $1\frac{1}{2}$ pounds. The stick is pushed forward to accelerate the car, pulled back to apply the brakes, and moved left or right to turn accordingly. For "Reverse" the handle is rotated 20 degrees to the left or right, and for "Park" it is rotated 80 degrees in either direction. Having complete freedom of motion with a four-inch sweep, the stick can produce any possible combination of driving operations.

The experimental nature of the Firebird III is revealed by some of the car's many unique engineering features. One of these is the dual powerplant system, consisting of the new

Research Whirlfire GT-305 regenerative gas turbine engine and a separate ten-horsepower, accessory drive, aluminum engine designed and built by the Engineering Staff. The small two-cylinder engine is the workhorse of an auxiliary power system which serves all of the car's electrical and hydraulic accessories. With these loads taken care of, all of the available power from the rear-mounted GT-305 engine can be used to propel the vehicle.

The new GT-305 regenerative gas turbine

in Firebird III represents a considerable improvement over the Firebird II GT-304 powerplant. It is 25 per cent lighter, more compact and develops 10 per cent more power, while at the same time the fuel economy has been improved 25 per cent.

The initial flight of Firebird III at the General Motors Desert Proving Ground at Phoenix, Arizona, in August, 1958, was a dramatic demonstration of the integration of form and function in an entirely new transpor-

tation concept. Also, it was a perfect demonstration of the integration of the minds, hands and experiences of hundreds of General Motors scientists, engineers and technicians at the Technical Center. This is true of the building and testing of all the Firebirds. The result is a Twentieth Century saga of research and engineering—a dramatic example of what can be accomplished when many diverse talents working with the most modern facilities are given free rein.



Firebirds I, II and III in flight at the GM Desert Proving Ground in Arizona.

IMPLEMENTS OF INQUIRY

$$1 + \frac{1}{2} [\delta - 3A\lambda] + 3\delta - \left(\frac{9}{2}\right)$$

$$\left(\frac{4}{2}\right) + \frac{1}{2A} [\delta - A\lambda] + \frac{\lambda A}{2(A+1)}$$

Did you ever stop to think that one measurement of man's progress is his ability to extend his faculties? We all know our primeval ancestor was a rather puny individual when compared to some of the other early inhabitants of the earth. But man's ability to think enabled him to harness the muscle power of certain animals and take advantage of some of the natural forces around him.

As a result the horse, steam engine and internal combustion engines have multiplied his muscular efforts thousands of times. The telescope, microscope and television have extended his vision in every direction. The telephone, electronic detection and amplification have increased his ability to hear and transmit sound, and similarly he has devised instrumentation capable of measuring a millionth of an inch instead of the comparatively large fractions used by his ancestors.

But even as recently as World War II he had not found a way to extend greatly his ability to calculate things. Engineering computations were either performed longhand, so to speak, or with the assistance of a slide rule

or desk calculator. Consequently, faced by mountainous piles of calculations, researchers often threw in the sponge and abandoned projects, or, as an alternative, they would take short cuts and base their conclusions on incomplete data and calculations. In other words, scientific inquiry was badly handicapped by the researcher's inability to cope with some of the computing problems that were constantly arising in the course of his investigations.

And then came the computers—the digital and analog computers. The principal difference between the two is that the digital computer calculates by counting and the analog computer operates by measuring. To put

it another way, digital computers operate by performing the arithmetical processes of addition, subtraction, multiplication, and division. On the other hand, an analog computer is a combination of electronic circuits which are organized so they can be wired together easily to *simulate* a physical system. But, to get a better idea of their usefulness, let's see how these new tools of investigation are used by the General Motors Researchers.

For instance, take the problem that faced Paul Vickers and Charles Amann of the GM Research Laboratories Engineering Development Department. When Firebird III was conceived, their department was given the

Paul Vickers and Charles Amann discuss some of the answers supplied by the digital computer.



job of designing and building a new gas turbine for this radical car. It had to be compact enough to fit into the confined space allotted to it, yet produce power comparable to that of a current passenger car engine. In the interests of time and expense they could not afford to build and test several experimental engines so they had to build “paper engines,” i.e., calculate and weigh on paper the advantages and disadvantages of several arrangements.

The new powerplant would consist of a number of components—the compressor, combustion chamber, gasifier turbine, power turbine and heat exchanger—all of which had to be examined for individual operating characteristics which would affect the operating efficiency of the complete engine. The next job was to have engineering specialists write up formulas describing the function of each of the components. After mathematical expressions for the component operations were formulated, the digital computer could solve the problem of determining the performance characteristics of engines using different components. The result was that basic questions in engine design and performance were answered during the computation. *Over 100*

paper engines were “tested” in this manner by the computer without cutting any metal.

The gas turbine engine design analysis is an excellent illustration of the kind of problem for which the digital computer is best suited. It is an example of how a new tool can solve a tedious, time-consuming, computational problem—a problem too large even to consider doing with the desk calculator in the short time allotted. But we should remember that such a machine can basically do only the simple arithmetical problems, and make very simple decisions. As Vickers and Amann put it, “It cannot think; it can-

not create. These things must be done by the researchers. But this modern scientific tool does give the investigators more time for thinking and creating without being handicapped by tedious computing jobs.”

Very briefly this is one way in which a digital computer can assist the engineer. On the other hand, the analog computer contributes in another way. Joseph Bidwell, the Research expert on car control, gave us a good illustration of the part played by this new scientific tool in one of his recent investigations.

“One of the engineer’s problems,” Joe told

The digital computer room is a busy place.



us, "is to obtain information on car operation without going into extended, time-consuming road tests involving elaborate instrumentation and physical changes to complete cars. For instance, we wanted to know how changes in such things as a car's weight distribution, steering gear ratio, tire properties and suspension would affect its stability and control. So we hit upon a technique used by aircraft designers. You know they use a computer-simulator combination which enables them to "fly" synthetic airplanes mathematically. From their computations, aircraft designers can predict how control systems will function before the airplane reaches the blueprint stage. The same general type of information can be computed for an automotive steering and control system before it reaches the early design stage.

"Here is how we used an analog computer to give us the results quickly. You know when you are driving down a highway and twist the steering wheel suddenly in one direction, the car may yaw and roll or sideslip with the amplitude and phase of these variables depending on the steering gear, weight distribution and about twenty other physical properties of the tires or suspension. We have

developed equations which describe mathematically how the car will act when the driver is steering straight ahead, veers to pass a car, rounds a curve, etc.

"Our computer-simulator device consists of an analog computer which continuously solves the equations I have just mentioned for any input to the steering wheel attached to it. Adjustment of controls on the computer permits changes in all of the car and tire characteristics. It can thus represent cars of different wheelbases, different weight distribution and suspension properties.

"The other part of our device is the simu-

lator, which consists of a miniature car controlled by servo mechanisms which receive their signals from the adjacent analog computer. The little car responds to various steering "inputs" at the wheel, just as a full-size vehicle would respond to driver motions at the business end of the steering gear. In other words, our automobile steering computer gives engineers an *immediate visual idea* how a full-size automobile will conduct itself on the

Patricia Jackson under the direction of Robert Kohr puts the miniature car on the right through its paces by means of the analog steering computer.

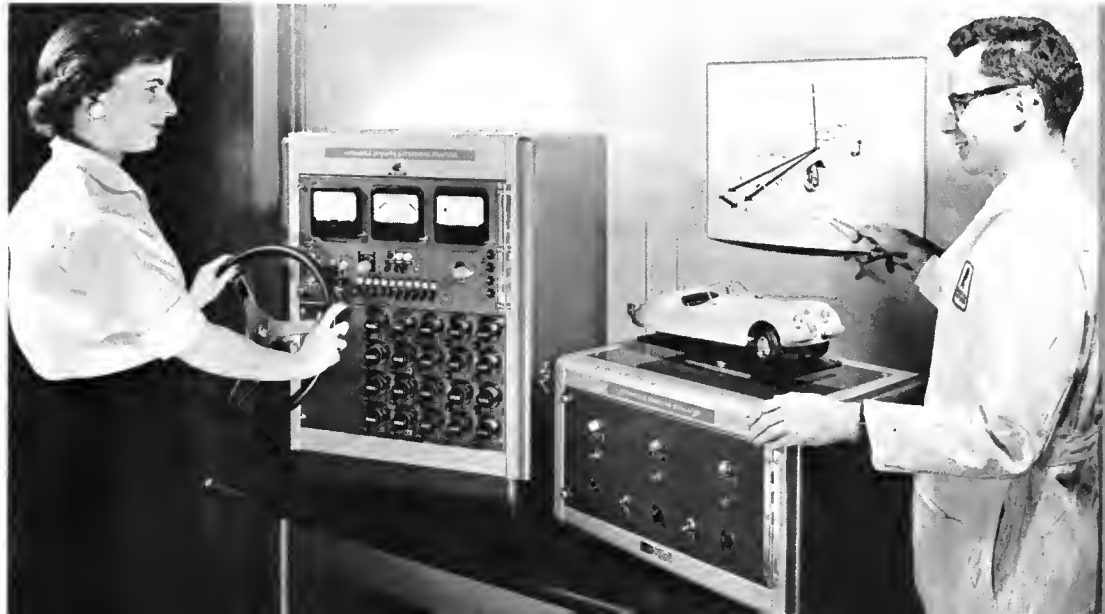

road when the driver twists the wheel. So, you see, we might say we have brought our elaborate test roads and instrumented cars into our little laboratory here.”

As we have seen in a previous chapter, one of the problems that has been with the GM Researchers for over 30 years is that of studying the mechanism of friction and wear and what can be done to minimize these things. Obviously, accurate measurement of wear is the sine qua non of such investigations. But how do you measure wear on a metal part for instance?

First attempts to assess the effect of wear on machine parts necessarily were made with the instruments at hand at the time—micrometers and precision scales. They are still used. In addition the effects of wear can be seen by visual examination using a microscope. But if we are testing a well-designed and built engine, it may have to operate hundreds of hours before sufficient wear occurs to be weighed and measured. Consequently, the big disadvantages of the stop-

and-measure method are that it is slow, the test must be interrupted to gather data, and reassembly of the working parts exactly as they were is difficult, if not impossible.

Another method of measuring wear was developed more recently in connection with a study of the effect of lubricants on the rate of wear. Chemical analysis of the used oil detects the presence of various metals worn from the moving parts of the engine. This eliminates dismantling the engine, and wear figures can be obtained in a fifth the time required by the previous method. However, fifty to one hundred hours of operation are

still required before wear can be measured and you can't pinpoint the wear of a given part. Moreover, there is an unavoidable delay in obtaining the chemical analysis for the various metal wear products in the oil.

Now, a new measuring tool has been placed in the hands of the Researchers. It uses radiation, an offshoot of the atomic age, as a basis for tracing and measuring ultramicroscopic particles. The method is based on the fact that many materials can be irradiated by exposure in atomic piles. This is something like putting a cold bar of iron into a furnace and heating it white hot. When it is removed



Dr. Alex Somerville in a familiar position at a glove box studying some of the properties of a radioisotope.

from the furnace it will itself be a radiator of heat waves. A thermometer, of course, can measure the temperature difference between a cold and hot iron bar. Substances like gold, iron, copper, cobalt, chromium and tin can be made "hot" in an atomic pile. They are then said to be radioactive, or to contain radioisotopes. Although they remain cold to a thermometer, their radiation can be detected by other devices such as the Geiger-Muller counter, or G-M tube. Like the hot bar of iron, these radioactive metals also lose their radioactivity or become "cool" with time. Radioisotopes of different metals lose this radioactivity at different rates. This rate of decay is expressed as the "half life" of an isotope, as, for instance, radioactive iron which loses half its intensity every forty-five days.

Radioactive measurements of wear are hundreds of times more sensitive than any other. Change in wear occurring in a few minutes can often be accurately recorded. *Measurements as minute as a tenth of a millionth of an inch or less can often be detected.* The wear of individual parts can be measured without dismantling the machine, and not only that but the Researcher can tell when and where the greatest amount of wear is taking place.

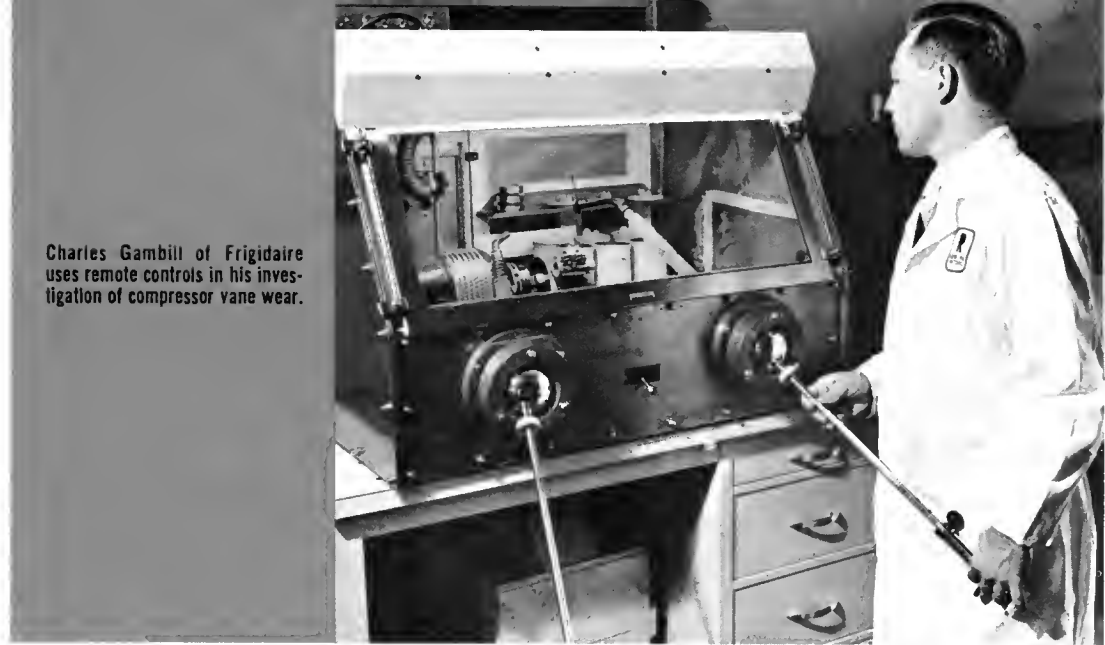

Charles Gambill of Frigidaire uses remote controls in his investigation of compressor vane wear.

But let's take as an illustration an actual test that took place—in this case, a study of the effect of three different oils on the wear of the vanes in a Frigidaire compressor.

Charles Gambill of Frigidaire, with the assistance of Dr. Alex Somerville and his associates of the Isotope Laboratory at the GM Research Laboratories, made a test setup to evaluate the comparative lubricity of three oils in the compressor. Inasmuch as the compressor vanes are about 98 per cent iron, a radioactive iron isotope Fe^{59} having a half life of 45 days was chosen as the wear indicator.

Regular production vanes were then irradiated in a manner so as not to change their physical properties and were installed in the test compressors. Because of the radioactivity, the compressor and refrigeration system were enclosed in a shielded "glove box" as a safety precaution. Small samples of vanes similar to the test parts were also irradiated and later dissolved to prepare standards for determining the total activity per vane—a kind of radiation yardstick. The six compressor units, two for each oil to be tested, were started, and at intervals oil sam-

ples were drawn from each one. The radioactive wear particles in the oil were easily detected and counted by a setup consisting of a scintillation crystal, a photomultiplier tube, amplifiers and a mechanical register. By comparing the count of the wear particles in the oil with the total count registered by the irradiated vane standard, it was a simple matter to compute the weight of the wear particles in the oil. Not only did this technique expedite the testing, but it was also extremely

sensitive and accurate; in fact, it was capable of measuring wear particles weighing as little as *a fraction of a millionth of a gram!*

These tools of Research we have described—the digital computer, the analog computer and the use of radioisotopes as a measuring device—are just three examples of the sophisticated approach modern investigators must take to unravel the complications attendant to modern scientific progress.

In the GM Research Laboratories are

hundreds of unique devices designed to measure the hitherto unmeasurable, to see things formerly invisible, to hear sounds unheard by the ear, and to detect infinitesimal vibrations. As we probe deeper and deeper into Nature's mysteries, we are constantly discovering our old tools and methods to be inadequate, so in a way, our future progress is going to depend to a large extent on our ability to continuously invent new implements of inquiry.

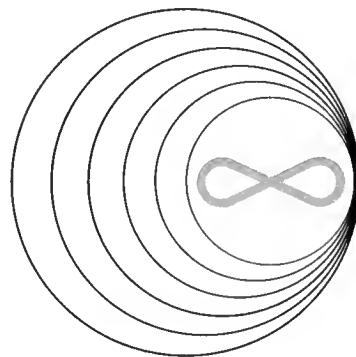

THE OTHER EIGHT HOURS

Up to this point in our story we have spent considerable time discussing projects and some of the scientists and engineers involved—in other words, researchers in action at the General Motors Research Laboratories. But there is another side to this coin. As “Boss” Kettering once put it, “Each of us is allotted twenty-four hours a day, usually divided up into three eight-hour periods—eight hours work, eight hours sleep, and eight hours to do with as we please. It is the use we make of these last eight hours that tells us what sort of people we are.”

Since time immemorial, philosophers, inventors, scientists and engineers have been popularly regarded as a breed apart. Ostensibly this came about as a result of their often fanatical dedication to their work, which left them no time for outside interests. Even to this day the image evoked by this seemingly extreme preoccupation with things scientific persists in the minds of quite a few people. The mere word “scientist” or “engineer” often connotes a rather peculiar individual who burns the midnight oil immersed in

abstruse calculations, mixing odorous chemicals, or peering fixedly through the eyepiece of a microscope. A fairly large segment of the public is apparently under the impression that the scientist is a rather narrow individual oblivious of his surroundings—his family, his community, and the world at large. By the same token, it is assumed that his day is not divided into Kettering’s three eight-hour periods but rather just two—a major work period, and a minor rest period.

But is this negative image a true portrait of the modern researcher? Does it apply to men such as we have mentioned in the preceding pages—the Colemans, the Daniels, the Wentworths, the Cataldos, and all those others at the GM Research Laboratories who are advancing science and technology? What sort of lives do these men lead after they hang up their lab coats at the end of a day, climb into their cars, and head for home? What use do they make of “the other eight hours,” the week ends, and their vacations? Let’s pretend we are private investigators and do a little snooping.



For instance, if we tracked down physicist Dr. Robert Coleman after hours we might come up with a little different picture from that of some of the other Researchers in our book. Dr. Coleman, you see, is a bachelor. But he is interested in house building and such home pursuits as wood working and photography. However, being unmarried, he



"Wally" Sihvonen et al.

is perhaps somewhat freer to engage in a couple of his favorite outdoor sports on his vacations—skiing, and skin diving in the Caribbean. All in all, rather unorthodox pursuits that do not jibe with the popular conception of the interests of a well-known, solid state physicist.

As we implied, most of our Researchers are married and heads of growing families. Such is the case of combustion researcher Wayne

Daniel, who is blessed with a wife, two boys and a newly arrived daughter. Wayne, though, finds time after work to pursue one of his hobbies—amateur astronomy. In fact, any clear night you may find him in the back yard, surrounded by kids, gazing skyward through his homemade six-inch reflecting telescope. Sunday he can probably be found teaching Sunday School.

His fellow Researcher, Joseph Wentworth, another Horning Award winner, found the money he received from the award an excellent means of gratifying one of his hobbies—sailing. In fact it made possible the purchase of a sixteen-foot sloop on which you can find him with his wife and his two youngsters almost any nice week end.

Roy Cataldo, of Unicontrol fame, doubles in brass as a home builder. Faced with a growing family, he and his wife together drew up the plans for a new home—a long, contemporary, ranch-style design. But not satisfied with merely designing, he built the house himself, putting in a mahogany-panelled activities room and many other built-in conveniences. As you can see, there is nothing narrow about Roy's avocations.

But for versatility, past and present, we

believe Charles Amann, who uses the digital computer to design gas turbines, deserves special mention. In his school days Chuck had a dance band, alternating himself at the trumpet and the piano.



Greg Flynn's skill with the épée is nationally known.

Later he was an Elder in his church and after his term of office expired he joined the church choir. He told us his most recent interesting project was a safari he and his wife and two children took to Idaho. Since it was an outdoor camping trip, he devised an upper sleeping deck on his Chevrolet station wagon for the kids.

We could go on and on into the private lives of these scientists and engineers—from the exploits of Gregory Flynn with the foils to Dr. Hafstad's experiences on skis. But by this time we believe we have made our point.

These men may be different in some ways from run-of-the-mine people, but it is principally because their training and intellectual abilities have given them the choice of a wide scope of activities to occupy "the other eight hours." By the same token, they feel a keen sense of civic responsibility; hence their above the average interest in community and national affairs.

We hasten to point out that these things aren't peculiar to General Motors scientists and engineers; a recent painstaking survey in one of our largest chemical industries cor-

roborates our rather sketchy findings. However, we hope our little investigation will help dispel the popular misconception we mentioned earlier. A research career is not an easy one—it requires training, intense application, and sometimes extra long hours. But that is true of any worthwhile career. However, as we have seen, today this seldom results in the narrow, anti-social, fanatically dedicated person often portrayed, but rather in a well-informed, well-rounded member of society upon whom we all depend in a large measure for our future progress.

The Horning Award helped Joe Wentworth realize this dream.



Roy's handiwork supplies the background for the Cataldos.



"Chuck" Amann (at the piano) directed quite a musical aggregation.



THE FUTURE IS OUR ASSIGNMENT

And so we come to the end of our very brief behind-the-scenes visit to the General Motors Research Laboratories at the GM Technical Center. We have met a few of the Researchers and gained an insight into the projects that occupy them at the moment. We want to emphasize “at the moment,” because there is no doubt that by the time this booklet comes off the press many new problems will have arisen to occupy the minds and hands of many of them.

That is the fascinating thing about scientific inquiry and engineering development—there are always new fertile fields for investigation stretching out in every direction. But this is where management comes into the picture, and up to this time we haven’t said too much about the most important role played by those in GM Research who guide the efforts of some 1,400 scientists, engineers and supporting cast. Theirs is a great responsibility, comparable to that of commanding officers mapping a military campaign. What are the objectives? Where will they send their task forces, and what will be the tactical



The atomic-powered U.S.S. Nautilus, the first submarine to make a submerged journey under the polar ice cap.

approach?

Upon the decisions of such men as these in industrial research organizations across the nation hang to a great extent the future of American industry, the pattern of our world of tomorrow and, indeed, the safety of our nation. Surrounded by untapped fields of knowledge, by use of wisdom and foresight they must apply the skills and facilities at their command to those areas which promise the greatest rewards in the form of new knowledge and the undreamed of things that can improve our daily living by making it more convenient, healthier, and more enjoyable.

The preceding chapters have given some clues as to the areas upon which GM Research’s efforts are focused—a better understanding of some of the phenomena of nature, more efficient harnessing of our energy sources, and new and better materials, to mention a few. But ours is only one of thousands of research organizations in this country—a national research and development effort that involves *over three-quarters of a million people* and annually spends *around ten billion dollars!* Only thirty years ago fewer than one hundred thousand researchers were spending less than a quarter of a billion annually.

This increase in itself is symptomatic of a change in national thinking. World-wide events have thrown the spotlight on science and engineering. New words have crept into our vocabulary—words such as “fission” and “fusion,” “radioisotope,” “transistor,” “computer” and “stereophonic” have now become a part of our everyday language.

Earlier we mentioned that the pace of discovery and development is constantly accelerating. It hasn't been many years since Buck Rogers' adventures in space were confined to the comic strips. But today we have man-made satellites orbiting the earth and rocket contact with the moon is only months, instead of decades, distant. We have made a submerged journey under the ice at the North Pole in an atomic-powered submarine and a jet airliner will now take us from New York to Paris in *less than seven hours!*

College Graduates-In-Training discuss their future assignments.

This is a terrific pace to maintain, much less to accelerate. Yet accelerate we must if we are to retain our position of leadership in world progress. We have mentioned on several occasions the effective use made by modern research of “teams” of investigators, or “task forces,” and implied that this technique has been responsible for significant reductions in discovery and development time. Granting this to be true, to do an even more effective job we must constantly improve the quality and quantity of these investigating teams. We must leave no potential scientist undiscovered nor latent engineering talent undeveloped. In

these hands will be placed countless opportunities and rich rewards, not only for themselves, but for our future civilization.

At the General Motors Research Laboratories we have gone to great lengths to provide our scientists and engineers with the world's most up-to-date facilities and equipment. Here in a campus-like atmosphere they may give free rein to their intelligence and skills. Here no limits are placed on imagination or creativity. Our undergraduate summer student and college graduate-in-training programs offer young men unexcelled opportunities to develop creative techniques by work-





ing with experienced scientists and engineers, thus materially broadening their education and experience.

Who knows what adventures lie ahead of these inquiring minds? Yesterday's explorers uncovered some of the secrets of electromotive force, powered flight, and electronic communication. In the preceding pages we have discussed some of the problems that occupy the minds and hands of our researchers today, but let us take a look a little farther down the road. For instance our research in vehicle dynamics and traffic systems analysis could result in entirely new concepts of automotive transportation. Our semi-conductor studies are opening up hitherto unimagined possibilities, as are our experiments with improved methods of directly converting chemical and nuclear energy to electrical and mechanical applications. And we should mention Research explorations into the possible applications of atomic power in spaceships.

So today's researchers are unraveling the atom, probing into the crystal and venturing into space. Tomorrow's adventurers will apply

this accumulated knowledge and uncover more to disclose the answers to some of the age-old questions that have puzzled mankind—What is photosynthesis and how can we use the sun's energy more effectively? What kind of place is the moon, or Mars? How can we utilize the inherent strength of pure metals? Can we cure cancer, the common cold and minimize heart failure? There must be better sources of power than we have today—What are they?

This is research. This is the way we try to find some of the answers to "Why?" and "How?" Nearly forty years ago, we in General Motors embarked in a systematic way on this course by establishing the first research organization in the automotive industry. We have found many answers and the American people have directly benefited therefrom. But that is history and although we are proud of our past contributions we are firmly convinced that our men, our facilities, and our experience will lead us forward to things undreamed of today.

The Future is Our Assignment!

Gifford Scott collecting data in the large Helmholtz coils which cancel out the Earth's magnetic field.

Automotive Engines

Pioneer studies of high compression engines
Fundamental combustion chamber studies
Combustion-detonation phenomena
Crankcase ventilation
Harmonic balancers
Ninety-degree V-8 crankshaft for Cadillac
Resonance-type intake silencers
Resonance-type mufflers
Hydraulic valve lash adjusters
Disc spring clutches
Dynamically balanced engines
Converters for exhaust purification
Chromatographic analysis of exhaust gas

Diesel Engines

Two-cycle, high speed Diesel engines
Unit injector for Diesels
Spiral rotor Roots-type blower

Vehicular Gas Turbines

Automotive application
Military application

Free Piston Machines

Automotive application
Marine application

Bearings

Powdered metal bearings
Copper-nickel matrix corrosion-resistant lead bearings
Waffle-type bearings
Aluminum bearing alloy
Durex porous bronze bearings
Rolling friction phenomena
Bearing metal theory

Fuels

Tetraethyl lead for Ethyl gasoline
Bromine from sea water
High octane fuels
Triptane
Organic phosphorus compounds to prevent surface ignition

Lubrication

Extreme pressure lubricants
Multi-viscosity oils
Hypoid lubricants

Metallurgy

Austenite transformation law
Pearlitic malleable iron
Molybdenum-manganese-silicon steel
Powdered iron process
Tellurium-treated malleable iron
Bismuth-treated malleable iron
Heat resisting valve steel
Steel hardenability test procedures and fixtures
Aluminum dipping process
Prestressing processes
Wear-resistant cast iron
Residual stress-fatigue failure correlation
High temperature alloys
Wear-resistant aluminum
Cast-to-shape tools and dies
Arma-Steel
CentraSteel
GMOODIE

Finishes

Lacquer finishes and their application
Lacquer solvents
Chromium plating
Bright copper plating
Application of acrylic lacquers to automobiles
Testing of automotive finishes

Instrumentation

Dynamic balancing machines
Direct current amplifier
Sonigage ultrasonic flaw detector
Surfagage
Laminagage thickness and crack detector
Automotive research instruments
Combustion pressure indicators
Thermo-electric metal comparator
Infra-red passive bearing finder
Inductor compass

Physics

Quantitative spectrographic analysis
Gyro-magnetic ratio measurements
Compound semi-conductors
Radioisotope applications
X-ray measurements of residual stresses
Physics of phase transformations in metals
Properties of metal single crystal whiskers
Infra-red quantitative analysis of hydrocarbons

Automotive Components and Controls

Four-wheel brake developments
Two-way hydraulic shock absorbers
Fixed focus head lamps
Safety glass
Automatic transmission and control developments
Autoguide and Unicontrol car control systems

Mechanical Refrigeration

Freon refrigerant

Medical

Dodrill-GMR Mechanical Heart
Centri-Filmer Vaccine Purifier
Oxyhemograph
Heart Sound Pick-up

The Cover—Shown on the front and back covers are electron micrographs obtained during corrosion studies using iron single crystal whiskers.

FRONT—*Underlying the title is the terraced structure formed during the hydrogen reduction of oxidation products on iron whiskers.*

Magnification, 30,000 diameters.

BACK TOP—*Oxide nuclei formed in early stage of oxygen attack on a clean surface of an iron single crystal.*

Magnification, 150,000 diameters.

BACK BOTTOM—*Terraced pits and hills suggesting extensive migration of iron atoms accompanying reduction of oxide films.*

Magnification, 35,000 diameters.

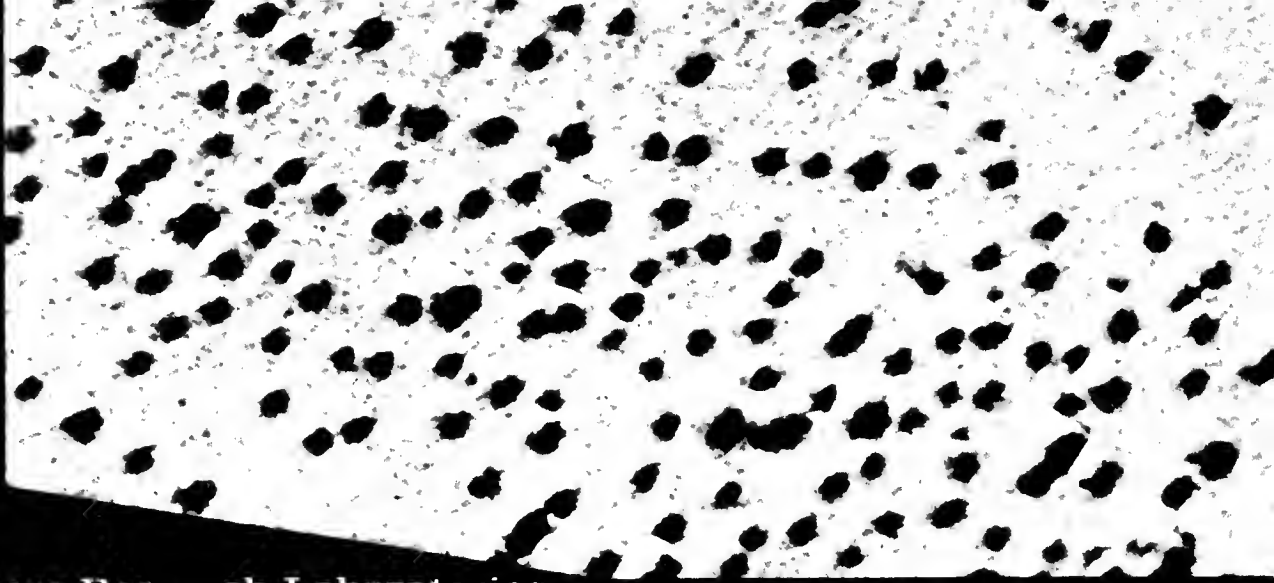

General Motors Research Laboratories

